

BROADVOX-CLEC, LLC
ACCESS SERVICES TARIFF

Regulations and Schedule of Intrastate Access Rates

This tariff includes the rates, charges, terms and conditions of service for the provision of Intrastate access telecommunications services in the State of Kentucky by Broadvox-CLEC, LLC.

Issued: December 17, 2014

Issued by:
Kyle V. Bertrand
Vice President of Regulatory & Network Operations

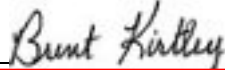
KENTUCKY PUBLIC SERVICE COMMISSION
JEFF R. DEROUEN EXECUTIVE DIRECTOR
TARIFF BRANCH

Effective: 1/1/2015
<small>PURSUANT TO 807 KAR 5:011 SECTION 9 (1)</small>

Effective: **1/1/2015**

1/1/2015
PURSUANT TO 807 KAR 5:011 SECTION 9 (1)

CHECK SHEET

Pages of this tariff, as indicated below, are effective as of the date shown at the bottom of the respective pages. Original and revised pages, as named below, comprise all changes from the original tariff and are currently in effect as of the date on the bottom of this page.

PAGE	REVISION		PAGE	REVISION	PAGE	REVISION
Title	Original		27	Original	54	Original
1	3 rd Revised	*	28	Original	55	Original
2	Original		29	Original	56	Original
3	Original		30	Original	57	Original
4	Original		31	Original	58	Original
5	Original		32	Original	59	Original
6	Original		33	Original	60	1 st Revised
7	Original		34	Original	61	1 st Revised
8	Original		35	Original	62	1 st Revised
9	Original		36	Original	63	1 st Revised
10	Original		37	Original	64	Original
11	Original		38	Original	65	Original
12	Original		39	Original	66	Original
13	Original		40	Original	67	Original
14	Original		41	Original	68	1 st Revised *
15	Original		42	Original	69	2 nd Revised *
16	Original		43	Original	70	1 st Revised *
17	Original		44	Original	71	2 nd Revised *
18	Original		45	Original	72	Original
19	Original		46	Original	73	Original
20	Original		47	Original	74	Original
21	Original		48	Original	75	Original
22	Original		49	Original	76	Original
23	Original		50	Original	77	Original
24	Original		51	Original		
25	Original		52	Original		
26	Original		53	Original		

* - indicates those pages included with this filing

Issued: June 16, 2021

Issued by:
 Richard Monto
 General Counsel

**KENTUCKY
 PUBLIC SERVICE COMMISSION**

Linda C. Bridwell
 Executive Director



EFFECTIVE
7/1/2021
 PURSUANT TO 807 KAR 5:011 SECTION 9 (1)

TABLE OF CONTENTS

Check Sheet	1
Table of Contents	2
Concurring, Connecting and Participating Carriers	3
Explanations of Symbols	4
Section 1 Definitions of Abbreviations	5
Section 2 Rules and Regulations	11
Section 3 Switched Access Service	44
Section 4 Dedicated Access Service	72
Section 5 Miscellaneous Services and Charges	73
Section 6 Special Contracts, Arrangements and Construction	76

Issued: December 17, 2014

Issued by:
Kyle V. Bertrand
Vice President of Regulatory & Network Operations

Effective: ~~January 1, 2015~~

1/1/2015

PURSUANT TO 807 KAR 5:011 SECTION 9 (1)

**KENTUCKY
PUBLIC SERVICE COMMISSION**

**JEFF R. DEROUEN
EXECUTIVE DIRECTOR**

TARIFF BRANCH

Brent Kirtley

Effective: ~~January 1, 2015~~

1/1/2015

PURSUANT TO 807 KAR 5:011 SECTION 9 (1)

ISSUING CARRIERS

Broadvox-CLEC, LLC

CONCURRING CARRIERS

No Concurring Carriers

CONNECTING CARRIERS

No Connecting Carriers

OTHER PARTICIPATING CARRIERS

No Other Participating Carriers

KENTUCKY
PUBLIC SERVICE COMMISSION

JEFF R. DEROUEN
EXECUTIVE DIRECTOR

TARIFF BRANCH

Brent Kirtley

Effective: **EFFECTIVE** January 1, 2015

1/1/2015

PURSUANT TO 807 KAR 5:011 SECTION 9 (1)

Issued: December 17, 2014

Issued by:

Kyle V. Bertrand

Vice President of Regulatory & Network Operations

EXPLANATION OF SYMBOLS

- (C) To signify changed regulation.
- (D) To signify discontinued rate or regulation.
- (I) To signify an increase.
- (M) To signify matter relocated without change.
- (N) To signify new rate or regulation.
- (R) To signify a reduction.
- (T) To signify a change in text, but no change in rate or regulation.
- (S) To signify a reissued matter.
- (Z) To signify a correction.

Issued: December 17, 2014

Issued by:
Kyle V. Bertrand
Vice President of Regulatory & Network Operations

Effective: ~~January 1, 2015~~ **EFFECTIVE**

1/1/2015

PURSUANT TO 807 KAR 5:011 SECTION 9 (1)

**KENTUCKY
PUBLIC SERVICE COMMISSION**

**JEFF R. DEROUEN
EXECUTIVE DIRECTOR**

TARIFF BRANCH

Brent Kirtley

Effective: ~~January 1, 2015~~ **EFFECTIVE**

1/1/2015

PURSUANT TO 807 KAR 5:011 SECTION 9 (1)

SECTION 1 - DEFINITIONS AND ABBREVIATIONS

Access or Access Service - Access or Access Service includes services and facilities provided for the origination or termination of any Intrastate Telecommunication regardless of the technology used in transmission. This includes, but is not limited to, voice and data communications services that may use either TDM or Internet Protocol ("IP") or other technology. Access Service includes the functional equivalent of the incumbent local exchange carrier Intrastate exchange access services typically associated with following rate elements: carrier common line (originating); carrier common line (terminating); local end office switching; common trunk port; common transport multiplexing; interconnection charge; information surcharge; tandem switched transport - termination (fixed); tandem switched transport - facility (per mile); and tandem switching.

Access Code - Denotes a uniform code assigned by the Company to an individual Customer. The code has the form 101XXXX or 950-XXXX.

Access Minutes - The increment for measuring usage of exchange facilities for the purpose of calculating chargeable usage.

Access Service Request (ASR) - The service order form used by access service Customers and the Company to the process of establishing, moving or rearranging access services provided by the Company.

Answer Supervision - The transmission of the switch trunk equipment supervisory signal (off-hook or on-hook) to a carrier's Point of Presence or customer's terminal equipment as an indication that the called party has answered or disconnected.

Automatic Number Identification (ANI) - The automatic transmission of a caller's billing account telephone number to a local exchange company, interexchange carrier or a third party Customer. The primary purpose of ANI is for billing toll calls.

Bit - The smallest unit of information in a binary system of notation.

Bps - Bits per second. The number of bits transmitted in a one second interval.

Call - A Customer or End User attempt for which the complete address code (e.g., 0-, 911, or 10 digits) is provided to the Serving Wire Center, End Office or Access Tandem Switch.

Carrier, Common Carrier, or Telecommunications Carrier - Any individual, partnership, association, joint-stock company, trust, governmental entity or corporation engaged for hire in communication by wire or radio.

Casual Calling - Where access to the Company's network and the subsequent use of service by the Customer is initiated through the dialing of a toll-free number or Access Code. Casual Calling allows non-Presubscribed customers to utilize the services of the Company.

Issued: December 17, 2014

Issued by:
Kyle V. Bertrand
Vice President of Regulatory & Network Operations

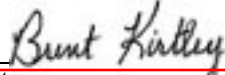
KENTUCKY PUBLIC SERVICE COMMISSION
JEFF R. DEROUEN EXECUTIVE DIRECTOR
TARIFF BRANCH

Effective: EFFECTIVE January 1, 2015 1/1/2015 PURSUANT TO 807 KAR 5:011 SECTION 9 (1)

SECTION 1 - DEFINITIONS AND ABBREVIATIONS, (CONT'D)

Channel - A communications path between two or more points.

CIC - An interexchange carrier identification code.

CMRS or Wireless Provider - Any carrier authorized to operate as a provider of cellular, personal communications, paging or other form of wireless transmission.

Commission - Refers to the Kentucky Public Service Commission, unless otherwise indicated.

Company or Carrier - Used throughout this tariff to indicate Broadvox-CLEC, LLC.

Constructive Order - Delivery of calls to or acceptance of calls from the Customer's End Users over Company-switched local exchange services constitutes a Constructive Order by the Customer to purchase switched access services as described herein. Similarly the selection of the Customer by an End User as the End User's PIC constitutes a Constructive Order for switched access by the Customer.

CPE - Customer Premises Equipment. All Terminal Equipment or other communications equipment and/or systems provided by the Customer for use with the Company's facilities and services.

Customer - Any person, firm, partnership, corporation or other entity which uses service under the terms and conditions of this tariff and is responsible for the payment of charges. Customers typically include interexchange carriers, wireless providers, CLECs, and VoIP providers.

Customer Premises - The premises specified by the Customer for termination of access services. Typically an Interexchange Carrier's Point of Presence.

Dedicated Access - Where originating or terminating access between an end user and an interexchange carrier are provided via dedicated facilities, circuits or channels. A method of reaching the Customer's communication and switching systems whereby the End User is connected directly to the Customer's Point of Presence or designate without utilizing the services of the local switched network.

DS0 - Digital Signal Level 0; a dedicated, full duplex digital channel with line speeds of 2.4, 4.8, 9.6, 19.2, 56 or 64 Kbps.

DS1 - Digital Signal Level 1; a dedicated, high capacity, full duplex channel with a line speed of 1.544 Mbps isochronous serial data having a line signal format of either Alternate Mark Inversion (AMI) or Bipolar with 8 Zero Substitution (B8ZS) and either Superframe (D4) or Extended Superframe (ESF) formats. DS1 Service has the equivalent capacity of 24 Voice Grade or DS0 services.

Issued: December 17, 2014

Issued by:
Kyle V. Bertrand
Vice President of Regulatory & Network Operations

Effective: *January 1, 2015*
EFFECTIVE

1/1/2015
PURSUANT TO 807 KAR 5:011 SECTION 9 (1)

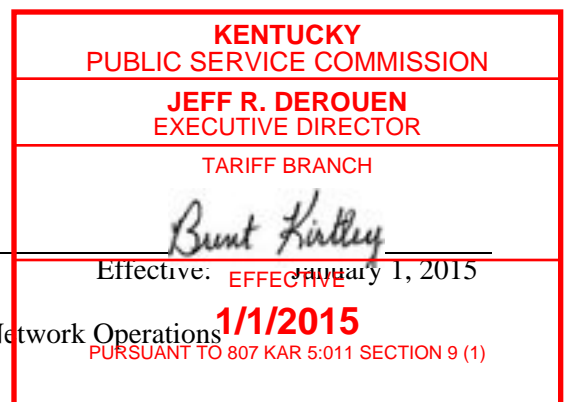

SECTION 1 - DEFINITIONS AND ABBREVIATIONS, (CONT'D)

DS3 -Digital Signal Level 3; a dedicated, high capacity, full duplex channel with a line speed of 44.736 Mbps isochronous serial data having a line code of bipolar with three zero substitution (B3ZS). Equivalent capacity of 28 DS1 Services.

End User - Any individual, association, corporation, governmental agency or any other entity subscribing to intrastate service provided by an Exchange Carrier where such individual association, corporation, governmental agency or other entity is not an Interexchange Carrier, Local Exchange Carrier, CLEC, Wireless Carrier or other entity otherwise utilizing the Company's service to provide a telecommunications service (as defined by applicable law) to its own customers.

End User Premises - The premises specified by the Customer or End User for termination of access services at the End User's physical location.

Exchange - A group of lines in a unit generally smaller than a LATA established by the Company or other local exchange carrier for the administration of communications service in a specified area. An Exchange may consist of one or more central offices together with the associated facilities used in furnishing communications service within that area.

Gbps - Gigabits per second; billions of bits per second.

Individual Case Basis or ICB - A process whereby the terms, conditions, rates and/or charges for a service provided under the general provisions of this tariff are developed or modified based on the unique circumstances in each case.

Issued: December 17, 2014

Issued by:
Kyle V. Bertrand
Vice President of Regulatory & Network Operations

Effective: ~~January 1, 2015~~ **January 1, 2015**

1/1/2015
PURSUANT TO 807 KAR 5:011 SECTION 9 (1)

**KENTUCKY
PUBLIC SERVICE COMMISSION**

**JEFF R. DEROUEN
EXECUTIVE DIRECTOR**

TARIFF BRANCH

Brent Kirtley

SECTION 1 - DEFINITIONS AND ABBREVIATIONS, (CONT'D)

Interstate - For the purpose of this tariff, the term Interstate applies to the regulatory jurisdiction of services used for communications between one or more originating and terminating points located in different states within the United States or between one or more points in the United States and at least one international location.

Intrastate - For the purpose of this tariff, the term Intrastate applies to the regulatory jurisdiction of services used for communications between one or more originating and terminating points, all located within the same state.

InterLATA - For the purpose of this tariff, the term InterLATA applies to the regulatory jurisdiction of services used for communications between one or more originating and terminating points located in different LATAs.

Interexchange Carrier (IXC or IC) - A long distance telecommunications services provider that furnishes services between exchange areas.

Kbps - Kilobits per second; 1000s of bits per second.

LATA - Local Access and Transport Area. A geographic area for the provision and administration of communications services existing on February 8, 1996, as previously established by the U.S. District Court for the District of Columbia in Civil Action No. 82-0192; or established by a Bell operating company after February 8, 1996 and approved by the FCC; or any other geographic area designated as a LATA in the National Exchange Carrier Association (NECA) Tariff F.C.C. No. 4.

LEC - Local Exchange Company.

Mbps - Megabits per second; millions of bits per second.

Message - See Call.

Non-Recurring Charge ("NRC") - The initial charge, usually assessed on a one-time basis, to initiate and establish a service or feature.

NPA - Numbering Plan Area or area code.

OC-12 - A high capacity channel for full duplex, synchronous, optic transmission of digital signals based on the SONET Standard at a rate of 622.08 Mbps.

OC-3 - A high capacity channel for full duplex, synchronous, optic transmission of digital signals based on the SONET Standard at a rate of 155.52 Mbps.

Issued: December 17, 2014

Issued by:
Kyle V. Bertrand

Vice President of Regulatory & Network Operations

**KENTUCKY
PUBLIC SERVICE COMMISSION**

**JEFF R. DEROUEN
EXECUTIVE DIRECTOR**

TARIFF BRANCH

Brent Kirtley

Effective: **EFFECTIVE** January 1, 2015

1/1/2015

PURSUANT TO 807 KAR 5:011 SECTION 9 (1)

SECTION 1 - DEFINITIONS AND ABBREVIATIONS, (CONT'D)

OC-48 - A high capacity channel for full duplex, synchronous, optic transmission of digital signals based on the SONET Standard at a rate of 2.4 Gbps

Off-Hook - The active condition of Switched Access service or a telephone exchange line.

On-Hook - The idle condition of Switched Access service or a telephone exchange line.

Originating Direction - The use of Switched Access Service for the origination of calls from an End User's Premises to a Customer's Point of Presence.

Point of Presence or POP - The physical location associated with an Interexchange Carrier's communication and switching systems.

Point of Termination - The point of demarcation within a Customer or End User Premises at which the Company's responsibility for the provision of access service ends. The point of demarcation is the point of interconnection between Company communications facilities and Customer-provided or End User-provided facilities as defined in Part 68 of the Federal Communications Commission's Rules and Regulations.

Premises - A building, portion of a building in a multi-tenant building, or buildings on continuous property not separated by a highway. May also denote a Customer-owned enclosure or utility vault located above or below ground on private property or on Customer acquired right-of-way.

Query - The inquiry to a Company data base to obtain information, processing instructions or service data.

Recurring Charge - The charges to the Customer for services, facilities or equipment, which continue for the agreed upon duration of the service. Recurring charges do not vary based on Customer usage of the services, facilities or equipment provided.

Remote Switching Modules or Remote Switching Systems (RSM/RSS) - Small remotely controlled electronic End Office Switching equipment which obtains its call processing capability from a Host Office. An RSM/RSS cannot accommodate direct trunks to a Customer.

Service Commencement Date - The first day following the date on which the Company notifies the Customer that the requested service or facility is available for use, unless extended by the Customer's refusal to accept service which does not conform to standards in the service order or this tariff, in which case the service commencement date is the date of the Customer's acceptance. The Company and Customer may mutually agree on a substitute service commencement date.

Service Order - A written request for network services executed by the Customer and the Company. The signing of a Service Order by the Customer and acceptance by the Company begins the respective obligations of the parties in that order services offered under this tariff.

Issued: December 17, 2014

Issued by:
Kyle V. Bertrand
Vice President of Regulatory & Network Operations

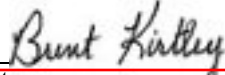
KENTUCKY PUBLIC SERVICE COMMISSION
JEFF R. DEROUEN EXECUTIVE DIRECTOR
TARIFF BRANCH

Effective: January 1, 2015 1/1/2015 PURSUANT TO 807 KAR 5:011 SECTION 9 (1)

SECTION 1 - DEFINITIONS AND ABBREVIATIONS, (CONT'D)

Special Access - See Dedicated Access.

Station - Refers to telephone equipment or an exchange access service from or to which calls are placed.

Switch, Switching, Switched - The term "switching" refers to any technical means by which a communication is directed from an origination point or input source onwards towards a destination or output location. Switching may include (without limitation) either circuit or packet switching, and switching of communications individually (including, if applicable, individual packets) or in groups, depending on the technology deployed. A "switch" is a device, software, or any technical arrangement that performs or accomplishes switching. A communication is "switched" when it passes through a switch.

Terminal Equipment - Telecommunications devices, apparatus and associated wiring on the Customer-designated premises.

TDM – Time Division Multiplexing – a method of transmitting and receiving voice signals over the Public Switched Telephone Network (PSTN).

Terminating Direction - The use of Switched Access Service for the completion of calls from a Customer's Point of Presence to an End User Premises.

Trunk - A communications path connecting two switching systems in a network, used in the establishment of an end-to-end connection.

Trunk Group - A set of trunks which are traffic engineered as a unit for the establishment of connections between switching systems in which all of the communications paths are interchangeable.

V & H Coordinates - Geographic points which define the originating and terminating points of a call in mathematical terms so that the airline mileage of the call may be determined. Call mileage may be used for the purpose of rating calls.

Toll VOIP-PSTN Access Traffic - VoIP-PSTN Access Traffic is the access traffic exchanged between the Company and the Customer in time division multiplexing ("TDM") format that originates and/or terminates in Internet Protocol ("IP") format. Traffic originates and/or terminates in IP format if it originates from and/or terminates to an end user customer of a service that requires Internet protocol compatible customer premises equipment.

VoIP Service – Transmission of communication by aid of wire, cable, radio, or other like connection using Voice Over Internet Protocol that is originated or terminated in Internet Protocol (IP) format. VoIP services are those services that require the use of IP compatible customer premises equipment.

Issued: December 17, 2014

Issued by:

Kyle V. Bertrand

Vice President of Regulatory & Network Operations

**KENTUCKY
PUBLIC SERVICE COMMISSION**

**JEFF R. DEROUEN
EXECUTIVE DIRECTOR**

TARIFF BRANCH

Brent Kirtley

Effective: ~~January 1, 2015~~

1/1/2015

PURSUANT TO 807 KAR 5:011 SECTION 9 (1)

SECTION 2 - RULES AND REGULATIONS

2.1 Undertaking of Broadvox-CLEC, LLC

- 2.1.1** The Company undertakes to furnish switched or dedicated access communications service pursuant to the terms of this tariff.
- 2.1.2** The Company's services and facilities are available twenty-four (24) hours per day, seven (7) days per week.
- 2.1.3** The Company is responsible under this tariff only for the services and facilities provided hereunder, and it assumes no responsibility for any service provided by any other entity that purchases access to the Company network in order to originate or terminate its own services, or to communicate with its own customers.
- 2.1.4** The Company arranges for installation, operation, and maintenance of the communications services provided in this tariff for Customers in accordance with the terms and conditions set forth under this tariff. The Customer shall be responsible for all charges due for such service arrangements.

2.2 Use of the Company's Service

- 2.2.1** Services provided under this tariff may be used by the Customer for any lawful telecommunications purpose for which the service is technically suited.
- 2.2.2** The services the Company offers shall not be used for any unlawful purpose or for any use as to which the Customer has not obtained all required governmental approvals, authorizations, licenses, consents and permits.
- 2.2.3** Recording of telephone conversations of service provided by the Company under this tariff is prohibited except as authorized by applicable federal, state and local laws.
- 2.2.4** Any service provided under this tariff may be resold to or shared (jointly used) with other persons at the Customer's option. The Customer remains solely responsible for all use of service ordered by it or billed to its account(s) pursuant to this tariff, for determining who is authorized to use its service, and for promptly notifying the Company of any unauthorized use. The Customer may advise its customers that a portion of its service is provided by the Company, but the Customer shall not represent that the Company jointly participates with the Customer in the provision of the service. The Company may require applicants for service who intend to use the Company's offerings for resale, shared and/or joint use to file a letter with the Company confirming that their use of the Company's offerings complies with relevant laws and the Commission's regulations, policies, orders, and decisions.

Issued: December 17, 2014

Issued by:
Kyle V. Bertrand
Vice President of Regulatory & Network Operations

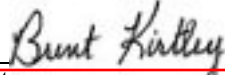
KENTUCKY PUBLIC SERVICE COMMISSION
JEFF R. DEROUEN EXECUTIVE DIRECTOR
TARIFF BRANCH

Effective: EFFECTIVE January 1, 2015 1/1/2015 PURSUANT TO 807 KAR 5:011 SECTION 9 (1)

SECTION 2 - RULES AND REGULATIONS, (CONT'D)

2.3 Limitations

- 2.3.1** The Company does not undertake to transmit messages, but offers the use of its facilities when available, and will not be liable for errors in transmission or for failure to establish connections.
- 2.3.2** The furnishing of service under this tariff is subject to the availability on a continuing basis of all the necessary facilities and equipment and is limited to the capacity of the Company's facilities as well as facilities the Company may obtain from other carriers, from time to time, to furnish service as required at the sole discretion of the Company.
- 2.3.3** The Company reserves the right to limit or to allocate the use of existing facilities, or of additional facilities offered by the Company, when necessary because of lack of facilities, or due to some other cause beyond the Company's control.
- 2.3.4** The Company may block any signals being transmitted over its network by Customers which cause interference to the Company or other users. Customer shall not be relieved of any obligations to make payments for charges relating to any blocked service and shall indemnify the Company for any claim, judgment or liability resulting from such blockage.
- 2.3.5** The Company reserves the right to discontinue service, without liability to Customer, when the Customer is using the service in violation of the provisions of this tariff, or in violation of the law.
- 2.3.6** The Company reserves the right, without liability to Customer, to discontinue service, limit service, or to impose requirements as required to meet changing regulatory or statutory rules and standards, or when such rules and standards have an adverse material affect on the business or economic feasibility of providing service, as determined by the Company in its sole judgment.

Issued: December 17, 2014

Issued by:
Kyle V. Bertrand
Vice President of Regulatory & Network Operations

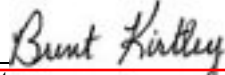
KENTUCKY PUBLIC SERVICE COMMISSION
JEFF R. DEROUEN EXECUTIVE DIRECTOR
TARIFF BRANCH

Effective: January 1, 2015 1/1/2015 PURSUANT TO 807 KAR 5:011 SECTION 9 (1)

SECTION 2 - RULES AND REGULATIONS, (CONT'D)

2.4 Assignment and Transfer

The Company may, without obtaining any further consent from the Customer, assign any rights, privileges or obligations under this tariff. The Customer shall not, without prior written consent of the Company, assign, transfer, or in any other manner dispose of, any of its rights, privileges, or obligations under this tariff, and any attempt to make such an assignment, transfer, disposition without such consent shall be null and void.

2.5 Terms and Conditions

2.5.1 Customers may be required to enter into written or oral service orders which shall contain or reference a specific description of the service ordered, the rates to be charged, the duration of the services, and the terms and conditions in this tariff. Customers will also be required to execute any other documents as may be reasonably requested by the Company.

2.5.2 At the expiration of the initial term specified in each service order, or in any extension thereof, service shall continue on a month-to-month basis at the then current rates unless terminated by either party. Any termination shall not relieve Customer of its obligation to pay any charges incurred under the service order and the tariffs of the Company prior to termination. The rights and obligations which by their nature extend beyond the termination of the term of the service order shall survive such termination.

2.5.3 In the event an action is brought or an attorney is retained by Company to enforce the terms the tariffs of the Company or to collect any moneys due thereunder, Company will be entitled to recover, in addition to any other remedy, reimbursement for reasonable attorneys' fees, court costs, reasonable costs of investigation and other related expenses incurred in connection therewith.

2.5.4 Customer hereby agrees that any and all disputes or actions filed by Customer against Company shall be brought by Customer in its individual capacity, and not as a plaintiff or class member in any purported class or representative proceeding. There shall be no right or authority for any disputes or actions to be filed on a class action basis or in a purported representative capacity on behalf of other parties similarly situated, and Customer hereby expressly, knowingly, irrevocably, voluntarily, unequivocally and intentionally waives any such right to file same.

Issued: December 17, 2014

Issued by:
Kyle V. Bertrand
Vice President of Regulatory & Network Operations

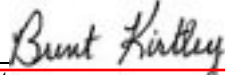
KENTUCKY PUBLIC SERVICE COMMISSION
JEFF R. DEROUEN EXECUTIVE DIRECTOR
TARIFF BRANCH

Effective: January 1, 2015 1/1/2015
PURSUANT TO 807 KAR 5:011 SECTION 9 (1)

SECTION 2 - RULES AND REGULATIONS, (CONT'D)

2.5 Terms and Conditions (Continued)

- 2.5.5** If at any time there is a dispute between the parties regarding this tariff and performance hereunder, the parties agree that they will within ten (10) days following written notice by either party ("Meeting Notice"), engage in face-to-face negotiations in Cleveland, Ohio, or by teleconference, in an attempt to resolve the dispute ("Dispute Meeting"). The parties shall send senior executives with full and complete knowledge and settlement authority ("Settlement Representatives") to the Dispute Meeting. In the event that the Dispute Meeting does not result in a final, binding resolution of the dispute within five (5) days of such Dispute Meeting, the parties may, within five (5) days following notice by either party ("Mediation Notice"), choose a mutually agreeable third party neutral, who shall mediate the dispute between the parties. Mediation shall take place in Cleveland, Ohio within thirty (30) days of the Mediation Notice, shall be non-binding and shall be confidential. The parties shall refrain from court proceedings during the mediation process insofar as they can do so without prejudicing their legal rights. The parties shall send Settlement Representatives to the mediation and shall participate in good faith and in accordance with the recommendations of the mediator, and shall follow the procedures for mediation as suggested by the mediator and agreed upon by the parties. All expenses of mediation except expenses of the individual parties, shall be shared equally by the parties. If the parties are unable to resolve the dispute in good faith by the conclusion of the mediation, which may be extended by agreement of the parties, then the dispute shall be finally determined by a court of law.
- 2.5.6** If any part or provision of this tariff is or becomes illegal, invalid or unenforceable, that part or provision shall be ineffective to the extent of such invalidity or unenforceability only, without in any way affecting the validity or enforceability of the remaining parts of said provision or the remaining provisions of this tariff. No waiver by either party to any provisions of this tariff shall be binding unless made in writing.

Issued: December 17, 2014

Issued by:

Kyle V. Bertrand

Vice President of Regulatory & Network Operations

**KENTUCKY
PUBLIC SERVICE COMMISSION**

**JEFF R. DEROUEN
EXECUTIVE DIRECTOR**

TARIFF BRANCH

Brent Kirtley

Effective: ~~January 1, 2015~~

1/1/2015

PURSUANT TO 807 KAR 5:011 SECTION 9 (1)

SECTION 2 - RULES AND REGULATIONS, (CONT'D)

2.6 Ownership of Facilities

- 2.6.1** The Customer obtains no property right or interest in the use of any specific type of facility, service, equipment, number, process, or code.
- 2.6.2** Title to all facilities utilized by the Company to provide service under the provisions of this tariff shall remain with the Company, its partners, agents, contractors or suppliers. Such facilities shall be returned to the Company, its partners, agents, contractors or suppliers by the Customer, whenever requested, within fourteen (14) days following the request in original condition, reasonable wear and tear expected.

Issued: December 17, 2014

Issued by:
Kyle V. Bertrand
Vice President of Regulatory & Network Operations

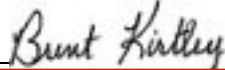
KENTUCKY PUBLIC SERVICE COMMISSION
JEFF R. DEROUEN EXECUTIVE DIRECTOR
TARIFF BRANCH

Effective: January 1, 2015 1/1/2015 PURSUANT TO 807 KAR 5:011 SECTION 9 (1)

SECTION 2 - RULES AND REGULATIONS, (CONT'D)

2.7 Liability of the Company

- 2.7.1** The liability of the Company for damages of any nature arising from errors, mistakes, omissions, interruptions, or delays of the Company, its agents, servants, or employees, in the course of establishing, furnishing, rearranging, moving, terminating, changing or removing the service or facilities or equipment shall not exceed an amount equal to the charges applicable under this tariff (calculated on a proportionate basis where appropriate, at the sole discretion of the Company) to the period during which such error, mistake, omission, interruption or delay occurs.
- 2.7.2** In no event shall the Company be liable for any incidental, indirect, special, reliance or consequential damages (including, without limitation, lost revenue or profits) of any kind whatsoever regardless of the cause or foreseeability thereof, whether in contract, warranty, strict liability, or tort, including without limitation negligence of any kind whether active or passive. Customer hereby releases the Company (and its respective affiliates, directors, employees and agents) from any such claim.
- 2.7.3** When the services or facilities of other common carriers are used separately or in conjunction with the Company's facilities or equipment in establishing connection to points not reached by the Company's facilities or equipment, the Company shall not be liable for any act or omission of such other common carriers or their agents, servants or employees.
- 2.7.4** The Company shall not be liable for any failure of performance hereunder if such failure is due to any cause or causes beyond the reasonable control of the Company. Such causes shall include, without limitation, acts of God, fire, explosion, vandalism, cable cut, storm or other similar occurrence, any law, order, regulation, direction, action or request of the United States government or of any other government or of any civil or military authority, national emergencies, insurrections, riots, wars, strikes, lockouts or work stoppages or other labor difficulties, supplier failures, shortages, breaches or delays, or preemption of existing service to restore service in compliance with FCC, or other relevant Commission, rules and regulations.
- 2.7.5** The Company shall not be liable for interruptions, delays, errors, or defects in transmission, or for any injury whatsoever, caused by the Customer, or the Customer's agents, End Users, or by facilities or equipment provided by the Customer.

Issued: December 17, 2014

Issued by:

Kyle V. Bertrand

Vice President of Regulatory & Network Operations

**KENTUCKY
PUBLIC SERVICE COMMISSION**

**JEFF R. DEROUEN
EXECUTIVE DIRECTOR**

TARIFF BRANCH

Brent Kirtley

Effective: **EFFECTIVE** January 1, 2015

1/1/2015

PURSUANT TO 807 KAR 5:011 SECTION 9 (1)

SECTION 2 - RULES AND REGULATIONS, (CONT'D)

2.7 Liability of the Company (Continued)

- 2.7.6** No liability shall attach to the Company by reason of any defacement or damage to the Customer's premise resulting from the existence of the Company's equipment or facilities on such premise, or by the installation or removal thereof.
- 2.7.7** The Company does not guarantee nor make any warranty with respect to installations provided by it for use in an explosive atmosphere. The Customer shall indemnify and hold the Company harmless from any and all loss, claims, demands, suits, or other action, or any liability whatsoever, including reasonable attorneys' fees (collectively, "Claims"), whether suffered, made, instituted, or asserted by any other party or person(s), and for any loss, damage, or destruction of any property, whether owned by the Customer or others, caused or claimed to have been caused directly or indirectly by the installation, operation, failure to operate, maintenance, removal, presence, condition, location, or use of any installation so provided.
- 2.7.8** The Company reserves the right to require each Customer to sign an agreement acknowledging acceptance of the provisions of this paragraph as a condition precedent to such installations.
- 2.7.9** The service is provided to Customer "as-is". The Company makes no warranties or representations, express or implied, either in fact or by operation of law, statutory or otherwise, including warranties of merchantability or fitness for a particular use, except those expressly set forth herein.
- 2.7.10** Failure by the Company to assert its rights under a provision of this tariff does not preclude the Company from asserting its rights under other provisions.
- 2.7.11** Customer hereby waives any claim that these exclusions and disclaimers deprive it of an adequate remedy or cause this tariff to fail of its essential purpose.

Issued: December 17, 2014

Issued by:
Kyle V. Bertrand
Vice President of Regulatory & Network Operations

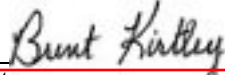
KENTUCKY PUBLIC SERVICE COMMISSION
JEFF R. DEROUEN EXECUTIVE DIRECTOR
TARIFF BRANCH

Effective: January 1, 2015 1/1/2015 PURSUANT TO 807 KAR 5:011 SECTION 9 (1)

SECTION 2 - RULES AND REGULATIONS, (CONT'D)

2.8 Liability of the Customer

- 2.8.1** The Customer will be liable for damages to the facilities of the Company and for all incidental and consequential damages caused by the acts or omissions of the Customer, its officers, employees, agents, invitees, or contractors.
- 2.8.2** To the extent caused by the acts or omissions of the Customer as described in 2.8.1, preceding, the Customer shall indemnify, defend and hold harmless the Company, its parents, subsidiaries, and affiliated individuals and entities (the "Indemnified Parties") from and against all claims, actions, damages, liabilities, costs and expenses, including reasonable attorneys' fees (collectively "Claims"), for (1) any loss, destruction or damage to property of any third party, and (2) any liability incurred by any third party pursuant to this or any other tariff of the Company, or otherwise, for any interruption of, interference to, or other defect in any service provided to such third party.
- 2.8.3** A Customer shall not assert any Claim against any other Customer or user of the Company's services for damages resulting in whole or in part from or arising in connection with the furnishing of service under this tariff including but not limited to mistakes, omissions, interruptions, delays, errors or other defects or misrepresentations, whether or not such other Customer or user contributed in any way to the occurrence of the damages, unless such damages were caused solely by the negligent or intentional act or omission of the other Customer or user and not by any act or omission of the Company. Nothing in this tariff is intended either to limit or to expand Customer's right to assert any Claims against third parties for damages of any nature other than those described in the preceding sentence.
- 2.8.4** The Customer shall be fully liable for any damages, including, without limitation, usage charges, that the Customer may incur as a result of the unauthorized use of services provide to a Customer. Unauthorized use occurs when a person or entity that does not have actual, apparent, or implied authority to use the network, obtains the Company's services provided under this tariff. The unauthorized use of the Company's services includes, but is not limited to, the placement of calls from the Customer's premise, and the placement of calls through equipment controlled and/or provided by the Customer, that are transmitted over the Company's network without the authorization of the Customer. The Customer shall be fully liable for all such usage charges and shall indemnify, defend and hold harmless the Indemnified Parties against all Claims relating to such.

Issued: December 17, 2014

Issued by:

Kyle V. Bertrand

Vice President of Regulatory & Network Operations

**KENTUCKY
PUBLIC SERVICE COMMISSION**

**JEFF R. DEROUEN
EXECUTIVE DIRECTOR**

TARIFF BRANCH

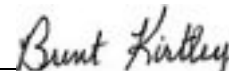

Effective: ~~EFFECTIVE~~ January 1, 2015

1/1/2015

PURSUANT TO 807 KAR 5:011 SECTION 9 (1)

SECTION 2 - RULES AND REGULATIONS, (CONT'D)

2.9 Obligations of the Customer

2.9.1 The Customer is responsible for making proper application for service; placing any necessary orders; for complying with tariff regulations; and payment of charges for services provided. Specific Customer responsibilities include, but are not limited to the following:

- (a) reimbursing the Company for damage to or loss of the Company's facilities or equipment caused by the acts or omissions of the Customer; or the non-compliance by the Customer, with these regulations; or by fire or theft or other casualty on the Customer premise;
- (b) providing at no charge, as specified from time to time by the Company, any needed equipment, secured space, power, supporting structures, and conduit to operate Company facilities and equipment installed on the premise of the Customer, and the level of heating and air conditioning necessary to maintain the proper operating environment on such premise;
- (c) obtaining, maintaining and otherwise having full responsibility for all rights-of-way and conduit necessary for installation of fiber optic cable and associated equipment used to provide communications services to the Customer from the cable building entrance or property line to the location of the equipment space described in Section 2.9.1 (b). Any and all costs associated with the obtaining and maintaining the rights-of-way described herein, including the costs of altering the structure to permit installation of the Company provided facilities, shall be borne entirely by, or may be charged by the Company, to the Customer; the Company may require the Customer to demonstrate its compliance with this section prior to accepting an order for service.
- (d) providing a safe place to work and complying with all laws and regulations regarding the working conditions on the premise at which Company employees and agents shall be installing or maintaining the Company's facilities and equipment; the Customer may be required to install and maintain Company facilities and equipment within a hazardous area if, in the Company's sole opinion, injury or damage to the Company employees or property might result from installation or maintenance by the Company; the Customer shall be responsible for identifying, monitoring, removing and disposing of any hazardous material (e.g., friable asbestos) prior to any construction or installation work and shall indemnify, defend and hold harmless the Indemnified Parties from any Claims relating to Customer's breach of this subsection (d);

Issued: December 17, 2014

Issued by:
Kyle V. Bertrand
Vice President of Regulatory & Network Operations

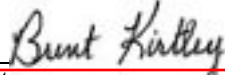
KENTUCKY PUBLIC SERVICE COMMISSION
JEFF R. DEROUEN EXECUTIVE DIRECTOR
TARIFF BRANCH

Effective: EFFECTIVE January 1, 2015 1/1/2015 PURSUANT TO 807 KAR 5:011 SECTION 9 (1)

SECTION 2 - RULES AND REGULATIONS, (CONT'D)

2.9 Obligations of the Customer (Continued)

2.9.1 (continued)

- (e) complying with all laws and regulations applicable to, and obtaining all consents, approvals, licenses and permits as may be required with respect to, the location of Company facilities and equipment in any Customer Premises or the rights-of-way for which Customer is responsible under Section 2.9 1(c); and granting or obtaining permission for Company agents or employees to enter the premise of the Customer at any time for the purpose of installing, inspecting, maintaining, repairing, or upon termination of service as stated herein, removing the facilities or equipment of the Company;
- (f) not creating or allowing to be placed any liens or other encumbrances on the Company's equipment or facilities and shall cause any such liens or encumbrances to be removed, at Customer's expense, within three (3) days of such lien or encumbrances' placement;
- (g) making Company facilities and equipment available periodically for maintenance purposes at a time agreeable to both the Company and the Customer, such agreement not to be unreasonably withheld or denied. No allowance will be made for the period during which service is interrupted for such purposes;
- (h) taking all steps necessary to cancel or otherwise discontinue any service(s) to be replaced by any of the Company's service(s) as described herein; and
- (i) ensuring that any Customer provided equipment and/or systems are properly interfaced with Company facilities or services, that the signals emitted into Company's network are of the proper mode, bandwidth, power, and signal level for the intended use of the Customer and in compliance with the criteria set forth in this tariff, and that the signals do not damage equipment, injure personnel, or degrade service to other Customers.

Issued: December 17, 2014

Issued by:

Kyle V. Bertrand

Vice President of Regulatory & Network Operations

Effective: ~~January 1, 2015~~

1/1/2015

PURSUANT TO 807 KAR 5:011 SECTION 9 (1)

**KENTUCKY
PUBLIC SERVICE COMMISSION**

**JEFF R. DEROUEN
EXECUTIVE DIRECTOR**

TARIFF BRANCH

Brent Kirtley

Effective: ~~January 1, 2015~~

1/1/2015

PURSUANT TO 807 KAR 5:011 SECTION 9 (1)

SECTION 2 - RULES AND REGULATIONS, (CONT'D)

2.9 Obligations of the Customer (Continued)

2.9.2 With regard to access services provided by the Company, specific Customer responsibilities include, but are not limited to the following:

(a) Design of Customer Services

The Customer shall be responsible for its own expense for the overall design of its services and for any redesigning or rearrangements of its services which may be required because of changes in facilities, operations or procedures of the Company, minimum protection criteria, or operating or maintenance characteristics of the facilities.

(b) Network Contingency Coordination

The Customer shall, in cooperation with the Company, coordinate in planning the actions to be taken to maintain maximum network capability following natural or man-made disasters which affect telecommunications service.

(c) Jurisdictional Reports

The jurisdictional reporting requirements will be as specified below. When a Customer orders Access Service, its projected Percent Interstate Usage (PIU) must be provided in whole numbers to the Company. These whole number percentages will be used by the Company to apportion the use and/or charges between interstate and intrastate until a revised report is received as set forth herein. Reported or default PIU factors are used only where the call detail is insufficient to determine the appropriate jurisdiction of the traffic.

- 1) Originating Access: Originating access minutes consist of traffic originating from the Company Switch. The Customer must provide the Company with a projected PIU factor on an annual basis. If no PIU for originating minutes is submitted as specified herein, a default PIU of 50% will be applied by the Company.
- 2) Terminating Access: Terminating access minutes consist of traffic terminating to the Company Switch. The Customer must provide the Company with a projected PIU factor on an annual basis. If no PIU for terminating minutes is submitted as specified herein, a default PIU of 50% will be applied by the Company.

Issued: December 17, 2014

Issued by:
Kyle V. Bertrand
Vice President of Regulatory & Network Operations

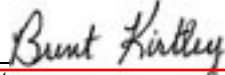
KENTUCKY PUBLIC SERVICE COMMISSION
JEFF R. DEROUEN EXECUTIVE DIRECTOR
TARIFF BRANCH

Effective: 1/1/2015
PURSUANT TO 807 KAR 5:011 SECTION 9 (1)

Effective: January 1, 2015

1/1/2015

PURSUANT TO 807 KAR 5:011 SECTION 9 (1)

SECTION 2 - RULES AND REGULATIONS, (CONT'D)

2.9 Obligations of the Customer (Continued)

2.9.2 (continued)

(c) Jurisdictional Reports (continued)

- 3) Except where the Company measured access minutes are used as set forth above, the Customer reported Projected PIU factor as set forth above will be used until the Customer reports a different projected PIU factor, as set forth below.

(d) Jurisdictional Audits:

- 1) The Customer shall keep sufficient detail from which the percentages of interstate and intrastate use reported to the Company can be verified and upon request of the Company make such records available at Customer's expense, for inspection and audit. The Customer must maintain these records for 24 months from the date the report became effective for billing purposes.
- 2) Initiation of an audit will be at the sole discretion of the Company. The audit shall be performed by an independent party selected by the Company. An audit may be initiated by the Company for a single customer no more than once per year. The customer shall supply the required data within 30 calendar days of the Company request.
- 3) In the event that an audit reveals that any Customer reported PIU was incorrect, the Company shall apply the audit result to all usage affected by the audit. The Customer shall be backbilled or credited, for a period retroactive to the date that the incorrect percentage was reported, but not to exceed 24 months. Backbilled amounts are subject to a late payment penalty and payment shall be made in immediately available funds, within 31 days from receipt of bill or by the following bill date, whichever is a shorter period.

Issued: December 17, 2014

Issued by:
Kyle V. Bertrand
Vice President of Regulatory & Network Operations

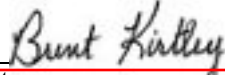
KENTUCKY PUBLIC SERVICE COMMISSION
JEFF R. DEROUEN EXECUTIVE DIRECTOR
TARIFF BRANCH

Effective: 1/1/2015
PURSUANT TO 807 KAR 5:011 SECTION 9 (1)

Effective: **1/1/2015**

1/1/2015

PURSUANT TO 807 KAR 5:011 SECTION 9 (1)

SECTION 2 - RULES AND REGULATIONS, (CONT'D)

2.9 Obligations of the Customer (Continued)

2.9.2 (continued)

(d) Jurisdictional Audits (continued)

- 4) Should an audit reveal that the misreported percentage(s) of use has resulted in an underpayment of access charges to the Company of five percent or more of the total Switched Access Services bill, the Customer shall reimburse the Company for the cost of the audit. Proof of cost shall be the bills, in reasonable detail submitted to the Company by the auditor.
- 5) Within 15 days of completion of the auditor's report, the Company will furnish a copy of the audit results to the person designated by the Customer to receive such results.

2.9.3 Customer shall defend, indemnify and hold harmless the Indemnified Parties for any Claims resulting either directly or indirectly, from Customer's breach of any obligation contained in this Section 2.9.

2.10 Billing and Payment for Service

2.10.1 Responsibility for Charges

The Customer is responsible for payment of all charges for services and equipment furnished to the Customer for transmission of calls via the Company. In particular and without limitation to the foregoing, the Customer is responsible for any and all cost(s) incurred as the result of:

- (a) any delegation of authority resulting in the use of Customer's communications equipment and/or network services which result in the placement of calls via the Company;
- (b) any and all use of the service arrangement provided by the Company, including calls which the Customer did not individually authorize;
- (c) any calls placed by or through the Customer's equipment via any remote access feature(s);

2.10.2 Minimum Period

The minimum period for which services are provided and for which access charges are applicable is one (1) month unless otherwise specified in this tariff or by mutually agreed upon contract. When a service is discontinued prior to the expiration of the minimum period, charges are applicable, whether the service is used or not.

Issued: December 17, 2014

Issued by:
Kyle V. Bertrand
Vice President of Regulatory & Network Operations

Effective: January 1, 2015

TARIFF BRANCH

Brent Kirtley

1/1/2015

PURSUANT TO 807 KAR 5:011 SECTION 9 (1)

SECTION 2 - RULES AND REGULATIONS, (CONT'D)

2.10 Billing and Payment for Service (Continued)

2.10.3 Payment for Service

- A.** Unless otherwise specified herein, bills are due and payable upon receipt.
- B.** The Company shall bill on a current basis all charges incurred by, and credits due to, the Customer under this tariff attributable to services established, provided, or discontinued during the preceding billing period.
- C.** Non-Recurring Charges are due and payable within 20 days after the invoice date.
- D.** The Company shall present invoices for all Charges monthly to the Customer.
- E.** A late payment charge of 1.5% per month, or the highest rate permitted by applicable law, whichever is less, shall be due to the Company for any billed amount for which payment has not been received by the Company within thirty (30) days of the invoice date of the Company's invoice for service, or if any portion of the payment is received by the Company in funds which are not immediately available upon presentment. If the payment due date falls on a Saturday, Sunday, legal holiday or other day when the offices of the Company are closed, the date for acceptance of payments prior to assessment of any late payment fees shall be extended through to the next business day. All undisputed portions of the bill must be paid by the payment due date to avoid assessment of a Late Payment Fee.
- F.** If a service is disconnected by the Company in accordance with this tariff and later restored, restoration of service will be subject to all applicable installation charges.

Issued: December 17, 2014

Issued by:
Kyle V. Bertrand
Vice President of Regulatory & Network Operations

Effective: ~~January 1, 2015~~

1/1/2015

PURSUANT TO 807 KAR 5:011 SECTION 9 (1)

**KENTUCKY
PUBLIC SERVICE COMMISSION**

**JEFF R. DEROUEN
EXECUTIVE DIRECTOR**

TARIFF BRANCH

Brent Kirtley

Effective: ~~January 1, 2015~~

1/1/2015

PURSUANT TO 807 KAR 5:011 SECTION 9 (1)

SECTION 2 - RULES AND REGULATIONS, (CONT'D)

2.10 Billing and Payment for Service (Continued)

2.10.4 Disputed Charges

- A.** In the event that a billing dispute occurs concerning any charges billed to the Customer by the Company, the Customer must submit a documented claim for the disputed amount. The Customer will submit all documentation as may reasonably be required to support the claim, including but not limited to the specific invoices and amounts disputed, and all reasons therefore. All claims must be submitted to the Company within sixty (60) days of the invoice date of the bill for the disputed services. Customer waives the right to dispute any charges not disputed within such sixty (60) day period. The Company shall review Customer disputes in a reasonably timely fashion, and the Company shall resolve each dispute based on the terms of this tariff.
- B.** Customer shall pay any undisputed charges in full by the due date of the disputed invoice(s) and in any event, prior to or at the time of submitting a good faith dispute. Failure to tender payment for undisputed invoices or portions thereof is a sufficient evidence for the Company to deny a dispute due to the Customer's failure to demonstrate that the dispute was made in good faith.
- C.** If the dispute is resolved in favor of the Company and the Customer has withheld the disputed amount, any payments withheld pending resolution of the disputed amount shall be subject to the late payment penalty as set forth herein.
- D.** If the dispute is resolved in favor of the Company and the Customer has paid the disputed amount on or before the payment due date, no interest credit or penalties will apply.
- E.** In the event that the Company pursues a claim in Court or before any regulatory body arising out of a Customer's refusal to make payment pursuant to this tariff, including refusal to pay for services originating from or terminating to any End User, and the Company prevails on all or a substantial part of its claim, Customer shall be liable for the payment of the Company's reasonable attorneys' fees expended in collecting those unpaid amounts.

Issued: December 17, 2014

Issued by:

Kyle V. Bertrand

Vice President of Regulatory & Network Operations

**KENTUCKY
PUBLIC SERVICE COMMISSION**

**JEFF R. DEROUEN
EXECUTIVE DIRECTOR**

TARIFF BRANCH

Brent Kirtley

Effective: ~~January 1, 2015~~

1/1/2015

PURSUANT TO 807 KAR 5:011 SECTION 9 (1)

SECTION 2 - RULES AND REGULATIONS, (CONT'D)

2.10 Billing and Payment for Service (Continued)

2.10.5 Returned Check Charge

A service charge equal to \$50.00 will be assessed for all checks returned by a bank or other financial institution for: insufficient or uncollected funds, closed account, apparent tampering, missing signature or endorsement, or any other insufficiency or discrepancy necessitating return of the instrument at the discretion of the drawee bank or other financial institution.

2.11 Taxes, Surcharges and Fees

2.11.1 All state and local taxes (i.e., gross receipts tax, sales tax, municipal utilities tax) are listed as separate line items on the Customer's bill and are not included in the quoted rates and charges set forth in this tariff. To the extent that a municipality, other political subdivision or local agency of government, or Commission imposes upon and collects from the Company a gross receipts tax, sales tax, occupation tax, license tax, permit fee, rights-of-way fee, franchise fee, or other regulatory fee or tax, such fees and taxes shall, insofar as practicable and allowed by law, be billed pro rata to Customers receiving service from the Company within the territorial limits of such municipality, other political subdivision or local agency of government. It shall be the responsibility of the Customer to pay any such taxes and fees that subsequently become applicable retroactively.

2.11.2 The Company may adjust its rates and charges or impose additional rates and charges on its Customers in order to recover amounts it is required by governmental or quasi-governmental authorities to collect from or pay to others in support of statutory or regulatory programs.

Issued: December 17, 2014

Issued by:
Kyle V. Bertrand
Vice President of Regulatory & Network Operations

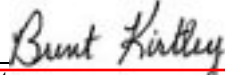
KENTUCKY PUBLIC SERVICE COMMISSION
JEFF R. DEROUEN EXECUTIVE DIRECTOR
TARIFF BRANCH

Effective: January 1, 2015 1/1/2015 PURSUANT TO 807 KAR 5:011 SECTION 9 (1)

SECTION 2 - RULES AND REGULATIONS, (CONT'D)

2.12 Deposits and Advanced Payments

2.12.1 General

The Company reserves the right to validate the creditworthiness of Customers and billed parties through available verification procedures. Where a Customer's creditworthiness is unacceptable to the Company, Company may refuse to provide service, require a deposit or advance payment, or otherwise restrict or interrupt service to a Customer.

2.12.2 Deposits

- A.** To safeguard its interests, the Company may require the Customer to make a deposit to be held as a guarantee for the payment of charges under Commission rules. A deposit may be required if the Customer's financial condition is not acceptable to the Company or is not a matter of general knowledge. A deposit does not relieve the Customer of the responsibility for the prompt payment of bills on presentation. A deposit may be required in addition to an advance payment.
- B.** The maximum amount of any deposit shall not exceed the equivalent of the customers estimated liability for two (2) months service.
- C.** The Company will pay interest on deposits, to accrue from the date the deposit is made until it has been refunded, or until a reasonable effort has been made to effect refund. The Company will pay interest at the rate of 6% per year, simple interest.
- D.** If the amount of a deposit is proven to be less than required to meet the requirements specified above, the Customer shall be required to pay an additional deposit immediately upon request.
- E.** Upon discontinuance of service, the Company shall promptly and automatically refund the Customer's deposit plus accrued interest, or the balance, if any, in excess of the unpaid bills including any penalties assessed for service furnished by the Company.

Issued: December 17, 2014

Issued by:
Kyle V. Bertrand

Vice President of Regulatory & Network Operations

Effective: **January 1, 2015**

1/1/2015

PURSUANT TO 807 KAR 5:011 SECTION 9 (1)

**KENTUCKY
PUBLIC SERVICE COMMISSION**

**JEFF R. DEROUEN
EXECUTIVE DIRECTOR**

TARIFF BRANCH

Brent Kirtley

SECTION 2 - RULES AND REGULATIONS, (CONT'D)

2.12 Deposits and Advanced Payments (Continued)

2.12.3 Advance Payments

To safeguard its interests, the Company may require a Customer to make an advance payment before services and facilities are furnished. The advance payment will not exceed an amount equal to one (1) month's estimated billing. This will be applied against the next month's charges and a new advance payment may be collected for the next month, if necessary. Advance payments do not accrue interest. An advance payment may be required in addition to a deposit.

Issued: December 17, 2014

Issued by:
Kyle V. Bertrand
Vice President of Regulatory & Network Operations

Effective: ~~January 1, 2015~~ **EFFECTIVE**

1/1/2015

PURSUANT TO 807 KAR 5:011 SECTION 9 (1)

**KENTUCKY
PUBLIC SERVICE COMMISSION**

**JEFF R. DEROUEN
EXECUTIVE DIRECTOR**

TARIFF BRANCH

Brent Kirtley

Effective: ~~January 1, 2015~~ **EFFECTIVE**

1/1/2015

PURSUANT TO 807 KAR 5:011 SECTION 9 (1)

SECTION 2 - RULES AND REGULATIONS, (CONT'D)

2.13 Cancellation by Customer

2.13.1 General

- A.** Customers of the Company's service may cancel service by providing the Company with written notification thirty (30) days prior to the requested cancellation date. The Company shall hold the Customer responsible for payment of all bills for service furnished until the cancellation date specified by the Customer or until thirty (30) days after the date that the cancellation notice is received, whichever is later. This subsection A. shall not apply to Customers who have committed to a minimum term greater than thirty (30) days.
- B.** Customers seeking to cancel service have an affirmative obligation to block traffic originating from or terminating to the Company's network. By originating traffic from or terminating traffic to the Company's network, the Customer will have constructively ordered the Company's switched access service.

2.13.2 Cancellation of Contract Services

- A.** If a Customer cancels a service order or terminates services before the completion of an applicable term or where the Customer breaches the terms in the service contract, the Customer may be requested by the Company to pay to Company termination liability charges. These charges shall become due and owing as of the effective date of the cancellation or termination. Unless otherwise specified in this tariff, the termination liability shall be equal to:
 - (a) all unpaid nonrecurring charges reasonably expended by the Company to establish service to Customer, plus;
 - (b) any disconnection, early cancellation or termination charges reasonably incurred and paid to third parties by the Company on behalf of Customer, plus;
 - (c) all recurring charges specified in the applicable service order for the balance of the then current term.
- B.** In the event Customer fails to pay the termination liability charges set forth in subsection A. herein within thirty (30) days of invoice from the Company, said charges shall accrue interest at the rate set forth in Section 2.10.3(E).

Issued: December 17, 2014

Issued by:
Kyle V. Bertrand
Vice President of Regulatory & Network Operations

Effective: ~~January 1, 2015~~

1/1/2015
PURSUANT TO 807 KAR 5:011 SECTION 9 (1)

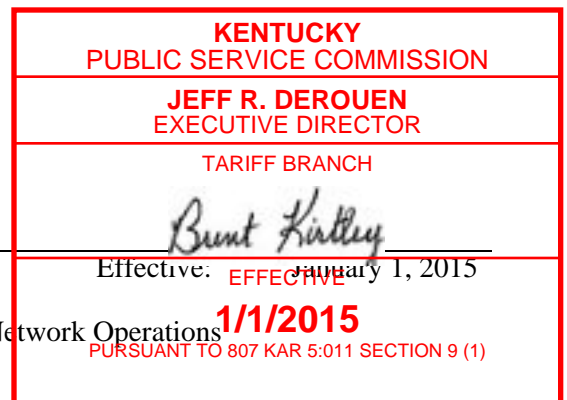

SECTION 2 - RULES AND REGULATIONS, (CONT'D)

2.13 Cancellation by Customer (Continued)

2.13.3 Cancellation of Application for Service

- A.** Where the Company permits the Customer to cancel an application for service prior to the start of service or prior to any special construction, no charges will be imposed except for those specified below.
- B.** Where, prior to cancellation by the Customer, the Company incurs any expenses in installing the service or in preparing to install the service that it otherwise would not have incurred, a charge equal to the costs the Company incurred, less net salvage, shall apply, but in no case shall this charge exceed the sum of the charge for the minimum period of services ordered, including installation charges, and all charges others levy against the Company that would have been chargeable to the Customer had service begun.
- C.** Where the Company incurs any expense in connection with special construction, or where special arrangements of facilities or equipment have begun, before the Company receives a cancellation notice, a charge equal to the costs incurred, less net salvage, may apply. In such cases, the charge will be based on such elements as the cost of the equipment, facilities, and material, the cost of installation, engineering, labor, and supervision, general and administrative expense, other disbursements, depreciation, maintenance, taxes, provision for return on investment, and any other costs associated with the special construction or arrangements.
- D.** The charges described above will be calculated and applied on a case-by-case basis.

Issued: December 17, 2014

Issued by:

Kyle V. Bertrand

Vice President of Regulatory & Network Operations

Effective: ~~January 1, 2015~~

1/1/2015

PURSUANT TO 807 KAR 5:011 SECTION 9 (1)

**KENTUCKY
PUBLIC SERVICE COMMISSION**

**JEFF R. DEROUEN
EXECUTIVE DIRECTOR**

TARIFF BRANCH

Brent Kirtley

SECTION 2 - RULES AND REGULATIONS, (CONT'D)

2.14 Cancellation by Company

2.14.1 Service continues to be provided until canceled by the Customer pursuant to Section 2.13 or until discontinued by the Company. The Company may render bills subsequent to the termination of service for charges incurred before termination. The Customer shall pay such bills in full in accordance with the payment terms of this tariff.

2.14.2 The Company may refuse or discontinue service to a Customer without notice under the following conditions:

- (a) For violation of law or this tariff: Except as provided elsewhere in this tariff, the Company may refuse, suspend or cancel service, without notice, for any violation of terms of this tariff, for any violation of any law, rule, regulation, order, decree or policy of any government authority of competent jurisdiction, or by reason of any order or decision of a court or other government authority having jurisdiction which prohibits the Company from furnishing such service or prohibits Customer from subscribing to, using, or paying for such service.
- (b) For the Company to comply with any order or request of any governmental authority having jurisdiction: The Company may refuse, suspend or cancel service, without notice, in order to permit the Company to comply with any order or request of any governmental authority having jurisdiction.
- (c) In the event of Customer or Authorized User use of equipment in such a manner as to adversely affect the Company's equipment or service to others.
- (d) In the event of tampering with the equipment or services of the Company or its agents.
- (e) In the event of unauthorized or fraudulent use of service. Whenever service is discontinued for fraudulent use of service, the Company may, to the extent that Company opts to restore such service, require the Customer to make, at Customer's own expense, all changes in facilities or equipment necessary to eliminate illegal use and to pay an amount reasonably estimated as the loss in revenues resulting from such fraudulent use.
- (f) If any of the facilities, appliances, or apparatus on Customer's premises are found to be unsafe or causing harm to the Company's facilities, and may refuse to furnish service until the applicant or Customer shall have remedied the condition.

Issued: December 17, 2014

Issued by:
Kyle V. Bertrand
Vice President of Regulatory & Network Operations

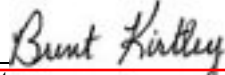
KENTUCKY PUBLIC SERVICE COMMISSION
JEFF R. DEROUEN EXECUTIVE DIRECTOR
TARIFF BRANCH

Effective: EFFECTIVE January 1, 2015 1/1/2015 PURSUANT TO 807 KAR 5:011 SECTION 9 (1)

SECTION 2 - RULES AND REGULATIONS, (CONT'D)

2.14 Cancellation by Company (Continued)

2.14.3 The Company may refuse or discontinue service provided that, unless otherwise stated, the Customer shall be given five (5) days written notice to comply with any rule or remedy any deficiency:

- (a) For nonpayment: The Company, by written notice to the Customer and in accordance with applicable law, may refuse, suspend or cancel service without incurring any liability when there is an unpaid balance for service that is past due.
- (b) For returned checks: The Customer whose check or draft is returned unpaid for any reason, after two attempts at collection, may, at the Company's discretion, be subject to refusal, suspension or cancellation of service in the same manner as provided for nonpayment of overdue charges.
- (c) For neglect or refusal to provide reasonable access to the Company or its agents for the purpose of inspection and maintenance of equipment owned by the Company or its agents.
- (d) For Customer use or Customer's permitting use of obscene, profane or grossly abusive language over the Company's facilities, and who, after five (5) days notice, fails, neglects or refuses to cease and refrain from such practice or to prevent the same, and to remove its property from the premises of such person.
- (e) For use of telephone service for any property or purpose other than that described in the application.
- (f) For Customer's breach of any contract for service between the Company and the Customer.
- (g) For periods of inactivity in excess of sixty (60) days.

Issued: December 17, 2014

Issued by:

Kyle V. Bertrand

Vice President of Regulatory & Network Operations

**KENTUCKY
PUBLIC SERVICE COMMISSION**

**JEFF R. DEROUEN
EXECUTIVE DIRECTOR**

TARIFF BRANCH

Brent Kirtley

Effective: ~~January 1, 2015~~

1/1/2015

PURSUANT TO 807 KAR 5:011 SECTION 9 (1)

SECTION 2 - RULES AND REGULATIONS, (CONT'D)

2.15 Restoration of Service

- 2.15.1** If service has been discontinued for nonpayment or as otherwise provided herein and the Customer wishes service continued, service may be restored at the Company's sole discretion, when all past due amounts are paid or the event giving rise to the discontinuance (if other than nonpayment) is corrected. Customers whose service was disconnected for nonpayment may be required to pay a deposit and/or advance payment prior to service restoration.
- 2.15.2** A restoration fee of \$25.00, or the actual costs incurred by the Company plus an administrative charge, whichever is greater, applies to Customers whose service is restored following disconnection by the Company.
- 2.15.3** Restoration of disrupted services shall be in accordance with applicable Commission and/or Federal Communications Commission Rules and Regulations specified in Part 64, Subpart D, which specify the priority system for such activities.

2.16 Provision of Company Equipment and Facilities

- 2.16.1** The Company shall use reasonable efforts to maintain only the facilities and equipment that it furnishes to the Customer. The Customer may not nor may the Customer permit others to rearrange, disconnect, remove, attempt to repair, or otherwise interfere with any of the facilities or equipment installed by the Company, except upon the written consent of the Company.
- 2.16.2** The Company may substitute, change or rearrange any equipment or facility at any time and from time to time, but shall not thereby alter the technical parameters of the service provided the Customer.
- 2.16.3** Equipment the Company provides or installs at the Customer premises shall not be used for any purpose other than that for which the equipment is provided.
- 2.16.4** The Company shall not be responsible for the installation, operation, or maintenance of any Customer provided communications equipment. Where such equipment is connected to the facilities furnished under this tariff, the responsibility of the Company shall be limited to the furnishing of facilities offered under this tariff and to the maintenance and operation of such facilities. Subject to this responsibility, the Company shall not be responsible for:
- (a) the transmission of signals by Customer-provided equipment or for the quality of, or defects in, such transmission; or
 - (b) the reception of signals by Customer-provided equipment; or
 - (c) network control signaling where such signaling is performed by Customer-provided network control signaling equipment.

Issued: December 17, 2014

Issued by:
Kyle V. Bertrand
Vice President of Regulatory & Network Operations

Effective: January 1, 2015

1/1/2015
PURSUANT TO 807 KAR 5:011 SECTION 9 (1)

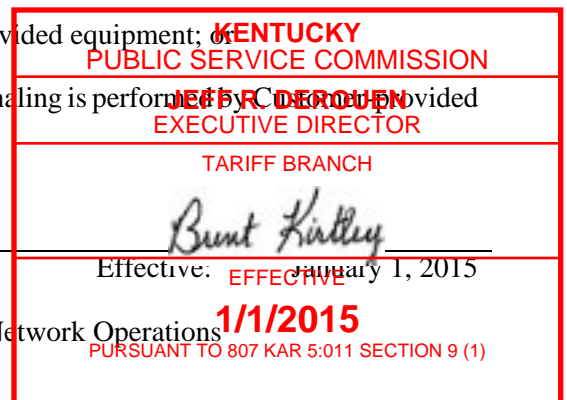

SECTION 2 - RULES AND REGULATIONS, (CONT'D)

2.17 Interconnection

- 2.17.1** Service furnished by the Company may be interconnected with services or facilities of other authorized communications common carriers and with private systems, subject to technical limitations established by the Company. Service furnished by the Company is not part of a joint undertaking with such other common carriers or systems. Any special interface equipment or facilities necessary to achieve compatibility between the facilities of Company and other participating carriers shall be provided at the Customer's expense.
- 2.17.2** Connection with the facilities or services of other carriers shall be under the applicable terms and conditions of the other carriers' tariffs. The Customer is responsible for taking all necessary legal steps for interconnecting Customer-provided terminal equipment or systems with Company's facilities. Customer shall secure all licenses, permits, rights-of-way, and other arrangements necessary for such interconnection.
- 2.17.3** The Customer shall ensure that the facilities or equipment provided by another carrier are properly interconnected with the facilities or equipment of the Company. If the Customer maintains or operates the interconnected facilities or equipment in a manner which results or may result in harm to the Company's facilities, equipment, personnel, or the quality of service, the Company may, upon five (5) days written notice, require the use of protective equipment at the Customer's expense. If this written notice fails to eliminate the actual or potential harm, the Company may, without further notice, terminate the existing service of the Customer.
- 2.17.4** If harm to the Company's network, personnel or services is imminent due to interconnection with another carrier's services, the Company reserves the right to shut down Customer's service immediately, with no prior notice required, and Customer shall be responsible for and indemnify and hold harmless Company from any Claims resulting from such harm.

Issued: December 17, 2014

Issued by:
Kyle V. Bertrand

Vice President of Regulatory & Network Operations

**KENTUCKY
PUBLIC SERVICE COMMISSION**

**JEFF R. DEROUEN
EXECUTIVE DIRECTOR**

TARIFF BRANCH

Brent Kirtley

Effective: ~~January 1, 2015~~

1/1/2015

PURSUANT TO 807 KAR 5:011 SECTION 9 (1)

SECTION 2 - RULES AND REGULATIONS, (CONT'D)

2.18 Customer-Provided Equipment

- 2.18.1** The Company's services are designed primarily for the transmission of voice-grade telephonic signals, except as otherwise stated in this tariff. A user may transmit any form of signal that is compatible with the Company's equipment, but the Company does not represent that its services will be suitable for purposes other than voice-grade telephonic communication except as specifically stated in this tariff.
- 2.18.2** Terminal equipment on the user's premises and the electric power consumed by such equipment shall be provided by and maintained at the expense of the Customer. The Customer is responsible for the provision of wiring or cable to connect its terminal equipment to the Company's network.
- 2.18.3** The Customer is responsible for ensuring that Customer-provided equipment connected to Company equipment and facilities is compatible with such equipment and facilities. The magnitude and character of the voltages and currents impressed on Company-provided equipment and wiring by the connection, operation, or maintenance of such equipment and wiring shall be such as not to cause damage to the Company-provided equipment and wiring or injury to the Company's employees or to other persons. Any additional protective equipment required to prevent such damage or injury shall be provided by the Company at the Customer's expense, subject to prior Customer approval of the equipment expense. Customer agrees to indemnify, defend and hold Company harmless from any and all claims to the extent they arise from Customer's violation of this Section 2.18.3.
- 2.18.4** Upon suitable notification to the Customer, and at a reasonable time, the Company may make such tests and inspections as may be necessary to determine that the Customer is complying with the requirements under this Section 2.18 for the installation, operation, and maintenance of Customer-provided facilities, equipment, and wiring in the connection of Customer-provided facilities and equipment to Company-owned facilities and equipment.
- 2.18.5** If the protective requirements for Customer-provided equipment are not being complied with, the Company may take such action as it deems necessary to protect its facilities, equipment, and personnel. The Company may, upon five (5) days written notice, require the use of additional protective equipment at the Customer's expense. If this written notice fails to remedy any protective deficiencies or potential harm, the Company may, without further notice, terminate the existing service of the Customer.
- 2.18.6** If harm to the Company's network, personnel or services is imminent, the Company reserves the right to shut down Customer's service immediately, with no prior notice required and no liability to Customer.

Issued: December 17, 2014

Issued by:

Kyle V. Bertrand

Vice President of Regulatory & Network Operations

**KENTUCKY
PUBLIC SERVICE COMMISSION**

**JEFF R. DEROUEN
EXECUTIVE DIRECTOR**

TARIFF BRANCH

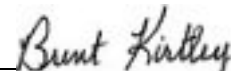

Effective: ~~January 1, 2015~~

1/1/2015

PURSUANT TO 807 KAR 5:011 SECTION 9 (1)

SECTION 2 - RULES AND REGULATIONS, (CONT'D)

2.19 Inspection, Testing and Adjustments

- 2.19.1** The Company may, upon reasonable notice, make such tests and inspections as may be necessary to determine whether the terms and conditions of this tariff are being complied with in the installation, operation or maintenance of the Customer's or the Company's facilities or equipment. The Company may interrupt service at any time, without penalty or liability, due to the departure from or reasonable suspicion of the departure from any of these terms and conditions.
- 2.19.2** Upon reasonable notice, the facilities or equipment provided by the Company shall be made available to the Company for such tests and adjustments as may be necessary for their maintenance in a condition satisfactory to the Company. No interruption allowance shall be granted for the time during which such tests and adjustments are made, unless such interruption exceeds twenty-four hours in length and is requested by the Customer.
- 2.19.3** The Company will provide the Customer reasonable notification of service-affecting activities that may occur in normal operation of its business. Such activities may include, but are not limited to, equipment or facilities additions, removals or rearrangements and routine preventative maintenance. Generally, such activities are not specific to an individual Customer but affect many Customers' services. No specific advance notification period applies to all service activities. The Company will work cooperatively with the Customer to determine the reasonable notification requirements. With some emergency or unplanned service-affecting conditions, such as an outage resulting from cable damage, notification to the Customer may not be possible.

Issued: December 17, 2014

Issued by:
Kyle V. Bertrand

Vice President of Regulatory & Network Operations

**KENTUCKY
PUBLIC SERVICE COMMISSION**

**JEFF R. DEROUEN
EXECUTIVE DIRECTOR**

TARIFF BRANCH

Brent Kirtley

Effective: ~~January 1, 2015~~

1/1/2015

PURSUANT TO 807 KAR 5:011 SECTION 9 (1)

SECTION 2 - RULES AND REGULATIONS, (CONT'D)

2.20 Allowances for Interruptions in Service

2.20.1 General

- A.** Upon the written request of the Customer, delivered to the Company no later than thirty (30) days following the date of service interruption, a credit allowance will be given when service is interrupted, except as specified in Section 2.20.2 below. A service is interrupted when it becomes inoperative to the Customer, e.g., the Customer is unable to transmit or receive, because of a failure of a component furnished by the Company under this tariff.
- B.** An interruption period begins when the Customer reports to the Company a service, facility or circuit is inoperative and, if necessary, releases it for testing and repair by the Company, as determined in its sole and reasonable discretion. An interruption period ends when the service, facility or circuit is operative.
- C.** If the Customer reports a service, facility or circuit to be interrupted but declines to release it for testing and repair, refuses access to its premises for test and repair by the Company, or continues to make voluntary use of the service, the service, facility or circuit is considered to be impaired but not interrupted. No credit allowances will be made for a service, facility or circuit considered by the Company to be impaired.
- D.** The Customer shall be responsible for the payment of service charges for visits by the Company's agents or employees to the premises of the Customer when the service difficulty or trouble report results from the use of equipment or facilities provided by any party other than the Company, including but not limited to the Customer.

Issued: December 17, 2014

Issued by:
Kyle V. Bertrand
Vice President of Regulatory & Network Operations

Effective: ~~January 1, 2015~~

1/1/2015

PURSUANT TO 807 KAR 5:011 SECTION 9 (1)

**KENTUCKY
PUBLIC SERVICE COMMISSION**

**JEFF R. DEROUEN
EXECUTIVE DIRECTOR**

TARIFF BRANCH

Brent Kirtley

Effective: ~~January 1, 2015~~

1/1/2015

PURSUANT TO 807 KAR 5:011 SECTION 9 (1)

SECTION 2 - RULES AND REGULATIONS, (CONT'D)

2.20 Allowances for Interruptions in Service (Continued)

2.20.2 Limitations of Allowances

- A.** No credit allowance will be made for any interruption in service:
- (a) due to the negligence of or noncompliance with the provisions of this tariff by any person or entity other than the Company, including but not limited to the Customer;
 - (b) due to the failure of power, equipment, systems, connections or services not provided by the Company;
 - (c) due to circumstances or causes beyond the reasonable control of the Company;
 - (d) during any period in which the Company is not given full and free access to its facilities and equipment for the purposes of investigating and correcting interruptions;
 - (e) during any period when the Customer has released service to the Company for maintenance purposes or for implementation of a Customer order for a change in service arrangements;
 - (f) that occurs or continues due to the Customer's failure to authorize replacement of any element of special construction; and
 - (g) that was not reported to the Company within 30 days of the date that service was affected.
 - (h) Wireless and VoIP transmission is subject to interruptions including but not limited to, dropped calls, interrupted calls, unintelligible calls, one-way audio and other problems created by factors beyond Company's control. Under no circumstances will Company provide credit or payment of any kind for calls which experience problems related to wireless or VoIP transmissions.

2.20.3 Use of Another Means of Communications

If the Customer elects to use another means of communications during the period of interruption, the Customer must pay the charges for the alternative service used.

Issued: December 17, 2014

Issued by:
Kyle V. Bertrand
Vice President of Regulatory & Network Operations

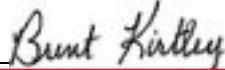
KENTUCKY PUBLIC SERVICE COMMISSION
JEFF R. DEROUEN EXECUTIVE DIRECTOR
TARIFF BRANCH

Effective: 1/1/2015
<small>PURSUANT TO 807 KAR 5:011 SECTION 9 (1)</small>

Effective: January 1, 2015

1/1/2015

PURSUANT TO 807 KAR 5:011 SECTION 9 (1)

SECTION 2 - RULES AND REGULATIONS, (CONT'D)

2.20 Allowances for Interruptions in Service (Continued)

2.20.4 Application of Credits for Interruptions in Service

- A. Except as provided in Section 2.20.2 A., if a Customer's service is interrupted, and it remains interrupted for eight normal working hours or longer after access to the premises is made available and after being reported to be out of order, appropriate adjustments or refunds shall be made to the Customer, when such adjustment exceeds \$1.00.
- B. The amount of adjustment or refund shall be determined on the basis of the known period of interruption, generally beginning from the time the service interruption is first reported. The refund to the Customer shall be a pro rata part of the month's flat rate charges (if any) for the period of days and that portion of the service facilities rendered useless or inoperative. The refund may be accomplished by a credit on a subsequent bill for the service.
- C. For purposes of credit computation every month shall be considered to have seven hundred and twenty (720) hours. For services with a monthly recurring charge, no credit shall be allowed for an interruption of continuous duration of less than eight (8) hours. The Customer shall be credited for an interruption of eight (8) or more hours at the rate of 1/720th of the monthly charge for the services affected for each day that the interruption continues. The formula used for computation of credits is as follows:

$$\text{Credit} = A/720 \times B$$

A = outage time in hours (must be 8 or more)
B = total monthly recurring charge for affected service.
- D. No credits will be provided for usage sensitive services.

Issued: December 17, 2014

Issued by:
Kyle V. Bertrand
Vice President of Regulatory & Network Operations

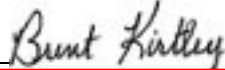
KENTUCKY PUBLIC SERVICE COMMISSION
JEFF R. DEROUEN EXECUTIVE DIRECTOR
TARIFF BRANCH

Effective: January 1, 2015 1/1/2015 PURSUANT TO 807 KAR 5:011 SECTION 9 (1)

SECTION 2 - RULES AND REGULATIONS, (CONT'D)

2.21 Notices and Communications

- 2.21.1** The Customer shall designate on the Service Order, or shall otherwise provide, an address to which the Company shall mail or deliver all notices and other communications, except that Customer may also designate a separate address to which the Company's bills for service shall be mailed.
- 2.21.2** The Company shall designate on the Service Order an address to which the Customer shall mail or deliver all notices and other communications, except that Company may designate a separate address on bills for service to which the Customer shall mail payment on that bill.
- 2.21.3** Notice of a pending disconnection of a Customer's service may contain the reason for the notice, the date of the notice, a description of any remedies the Customer may make, the time allotted for the Customer to make remedies (if any), and a toll free customer service number the Customer may call to obtain additional information.
- 2.21.4** Except as otherwise stated in this tariff, all other notices or communications required to be given under this tariff will be in writing.
- 2.21.5** Notices and other communications of either party, and all bills mailed by the Company, shall be presumed to have been delivered to the other party on the second business day following placement of the notice, communication or bill with the U.S. mail or a private delivery service, prepaid and properly addressed, or when actually received or refused by the addressee, whichever occurs first.
- 2.21.6** The Company or the Customer shall advise the other party of any changes to the addresses designated for notices, other communications or billing, by following the procedures for giving notice set forth herein.

Issued: December 17, 2014

Issued by:
Kyle V. Bertrand
Vice President of Regulatory & Network Operations

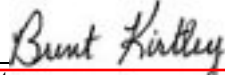
KENTUCKY PUBLIC SERVICE COMMISSION
JEFF R. DEROUEN EXECUTIVE DIRECTOR
TARIFF BRANCH

Effective: 1/1/2015
PURSUANT TO 807 KAR 5:011 SECTION 9 (1)

Effective: **1/1/2015**

1/1/2015
PURSUANT TO 807 KAR 5:011 SECTION 9 (1)

SECTION 2 - RULES AND REGULATIONS, (CONT'D)

2.22 Mixed Interstate and Intrastate Switched Access Services

2.22.1 When mixed interstate and intrastate switched access service is provided, all charges, including Nonrecurring Charges, usage charges, and optional features, will be prorated between interstate and intrastate. The percentage provided in the reports as set forth in 2.9.2 preceding will serve as the basis for prorating the charges. The percentage of an access service to be charged as interstate is applied in the following manner:

- (a) For nonrecurring chargeable rate elements, multiply the PIU times the quantity of chargeable elements times the interstate tariff rate per element.
- (b) For usage sensitive chargeable rate elements, multiply the PIU times actual use (measured or Company assumed average use) times the interstate rate.

2.22.2 A similar calculation is then performed to determine the intrastate portion of the bill.

Issued: December 17, 2014

Issued by:

Kyle V. Bertrand

Vice President of Regulatory & Network Operations

**KENTUCKY
PUBLIC SERVICE COMMISSION**

**JEFF R. DEROUEN
EXECUTIVE DIRECTOR**

TARIFF BRANCH

Brent Kirtley

Effective: ~~January 1, 2015~~

1/1/2015

PURSUANT TO 807 KAR 5:011 SECTION 9 (1)

SECTION 2 - RULES AND REGULATIONS, (CONT'D)

2.23 Determination of Jurisdiction of Mixed Interstate and Intrastate Dedicated Facilities

2.23.1 When mixed interstate and intrastate service is provided over a dedicated facility, the jurisdiction will be determined as follows. For jurisdictional reports required for switched access, see Section 2.9.2.

- (a) If the Customer's estimate of the interstate traffic on the service equals 10% or more of the total traffic on that service, the service will be provided according to the applicable rules and regulations of the appropriate interstate tariff.
- (b) If the Customer's estimate of the interstate traffic on the service is less than 10% of the total traffic on that service, the service will be provided according to the applicable rules and regulations of this tariff.
- (c) If the percentage of interstate traffic on the service changes to the extent that it alters the jurisdiction of the service, the Customer must notify the Company of any required change in status. The affected service will revert to the appropriate jurisdictional tariff within the next full billing cycle. Any applicable termination liability will be transferred with the jurisdictional change of the service.

2.24 Determination of InterMTA and IntraMTA Traffic

CMRS providers will have the responsibility of providing, on a quarterly basis (or as otherwise agreed to by the Company), a report to the Company providing the percentage of the CMRS provider's traffic terminated to the Company that is intraMTA or interMTA. The report will also detail what percentage of the interMTA traffic is intrastate and what percentage is interstate (PIU).

Reports regarding the percentages of intraMTA or interMTA traffic (and the intrastate or interstate jurisdiction of interMTA traffic) shall be based on a reasonable traffic study conducted by the CMRS provider and available to the Company upon request. Upon reasonable written notice, the Company or its authorized representative shall have the right to conduct a review and verification of the CMRS provider's reported percentages. This includes on-site verification reviews at the CMRS provider's or vendor locations. The review may consist of an examination and verification of data involving records, systems, procedures and other information related to the traffic originated by the CMRS provider and terminated to the Company. The customer shall keep records of call detail, including not altering directly or indirectly with a third party call origination or termination data from which the call jurisdiction can be ascertained. The CMRS provider will provide the Company with reasonable access to such information as is necessary to determine amounts payable under this tariff.

If the CMRS provider fails to provide the verifiable reports required under this section, the Company will apply a default percent interMTA of 50% (and a default PIU of 50% on all interMTA traffic) on all traffic originated by the CMRS provider for termination by the Company.

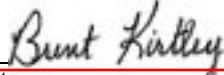
KENTUCKY PUBLIC SERVICE COMMISSION
JEFF R. DEROUEN EXECUTIVE DIRECTOR
TARIFF BRANCH

Effective: EFFECTIVE January 1, 2015 1/1/2015 PURSUANT TO 807 KAR 5:011 SECTION 9 (1)

Issued: December 17, 2014 Issued by:
Kyle V. Bertrand
Vice President of Regulatory & Network Operations

SECTION 2 - RULES AND REGULATIONS, (CONT'D)

2.25 Ordering, Rating and Billing of Access Services Where More Than One Exchange Telephone Company is Involved

When an Access Service is provided to a customer where one portion of the service is provided by one Exchange Telephone Company and the other portion of the service is provided by another Exchange Telephone Company, the Company accepts and adheres to the Ordering and Billing Forum guidelines, Multiple Exchange Carrier Access Billing (MECAB) and Multiple Exchange Carrier Ordering and Design (MECOD).

2.26 Distance-Based Charges

For purposes of determining distance-based charges, mileage will be measured as airline mileage using the V & H coordinates method in accordance with standard industry practices.

Issued: December 17, 2014

Issued by:
Kyle V. Bertrand
Vice President of Regulatory & Network Operations

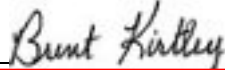
KENTUCKY PUBLIC SERVICE COMMISSION
JEFF R. DEROUEN EXECUTIVE DIRECTOR
TARIFF BRANCH

Effective: EFFECTIVE January 1, 2015 1/1/2015 PURSUANT TO 807 KAR 5:011 SECTION 9 (1)

SECTION 3 - SWITCHED ACCESS SERVICE

3.1 General

- 3.1.1** Switched Access Service, which is available to Customers for their use in furnishing their services to End Users, provides a two-point communications path between a Customer's Premises and an End User's Premises. It provides for the use of common terminating, switching and trunking facilities, and for the use of common subscriber plant of the Company. Switched Access Service provides for the ability to originate calls from an End User's Premises to a Customer's Premises and to terminate calls from a Customer's Premises to an End User's Premises in the LATA where it is provided.
- 3.1.2** When a rate as set forth in this tariff is shown to more than two decimal places, the charges will be determined using the rate shown. The resulting amount will then be rounded to the nearest penny (i.e., rounded to two decimal places).
- 3.1.3** In the absence of an ASR as described in Section 3.4, delivery of calls to, or acceptance of calls from, the Customer's End User location(s) via Company-provided switched access services shall constitute a Constructive Order and an agreement by the Customer to purchase the Company's switched access services as described and priced herein.
- 3.1.4** In those situations where a CMRS provider exchanges interMTA traffic with the Company then the rates, terms and conditions of this tariff will apply.

Issued: December 17, 2014

Issued by:
Kyle V. Bertrand
Vice President of Regulatory & Network Operations

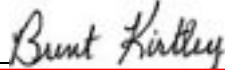
KENTUCKY PUBLIC SERVICE COMMISSION
JEFF R. DEROUEN EXECUTIVE DIRECTOR
TARIFF BRANCH

Effective: January 1, 2015 1/1/2015 PURSUANT TO 807 KAR 5:011 SECTION 9 (1)

SECTION 3 - SWITCHED ACCESS SERVICE, (CONT'D)

3.2 Manner of Provision

- 3.2.1** Switched Access Service is furnished for originating and terminating calls by the Customer to its End User. Switched Access Service is furnished on a per-line or per trunk basis.
- 3.2.2** Originating traffic type represents access capacity within a LATA for carrying traffic from the End User to the Customer; and Terminating traffic type represents access capacity within a LATA for carrying traffic from the Customer to the End User. When ordering capacity for Switched Access Service, the Customer must at a minimum specify such access capacity in terms of originating traffic type and/or terminating traffic type.
- 3.2.3** Switched Access is provisioned, at minimum, at the DS-1 (or equivalent) level and provides trunk-side access to End Office switches, for the Customer's use in originating and terminating communications.
- 3.2.4 Two types of Switched Access are available:**
- 1) Indirect Connection Access: This option applies when the Customer has no direct facilities to the Company Switch. All traffic is routed to and from the Company Switch via a third-party access tandem. Delivery of calls to, or acceptance of calls from, the Company via Tandem Connect Access shall constitute a Constructive Order and an agreement by the Customer to purchase the Company's switched access services as described and priced herein.
 - 2) Direct Connection Access: This option applies when the Customer has direct facilities to the Company Switch. This transmission path is dedicated to the use of a single Customer. The Company may require the Customer to submit an ASR or comparable documentation for Direct Connect Access. Direct Connect Access is provided on an Individual Case Basis as Special Service Arrangements pursuant to Section 6 of this tariff.

Issued: December 17, 2014

Issued by:
Kyle V. Bertrand
Vice President of Regulatory & Network Operations

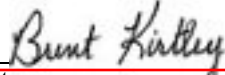
KENTUCKY PUBLIC SERVICE COMMISSION
JEFF R. DEROUEN EXECUTIVE DIRECTOR
TARIFF BRANCH

Effective: January 1, 2015 1/1/2015 PURSUANT TO 807 KAR 5:011 SECTION 9 (1)

SECTION 3 - SWITCHED ACCESS SERVICE, (CONT'D)

3.3 Rate Categories

There are six rate categories which apply to Switched Access Service:

- Common Line
- Switched Transport
- End Office Switching
- Toll-Free 8XX Data Base Access Service
- Toll Free Inter-Exchange Delivery Service
- Signaling System 7 (SS7) Signaling Charges

3.3.1 Common Line

The Common Line component is related to the use of Company-provided or leased end user common lines by customers and end users for Intrastate access.

3.3.2 Switched Transport

The Switched Transport component is related to the transmission and tandem switching facilities between the customer designated premises and the end office switch(es) where the customer's traffic is switched to originate or terminate the customer's communications. The Switched Transport component also includes transport between an end office which serves as host for a remote switching system or module (RSS or RSM) and the RSS or RSM.

3.3.3 End Office Switching

The End Office Switching component is related to the use of end office switching equipment, the terminations in the end office of end user lines, the terminations of calls at Company Intercept Operators or recordings, the Signaling Transfer Point (STP) costs, and the SS7 signaling function between the end office and the STP.

Issued: December 17, 2014

Issued by:
Kyle V. Bertrand
Vice President of Regulatory & Network Operations

Effective: ~~January 1, 2015~~ **1/1/2015**

1/1/2015
PURSUANT TO 807 KAR 5:011 SECTION 9 (1)

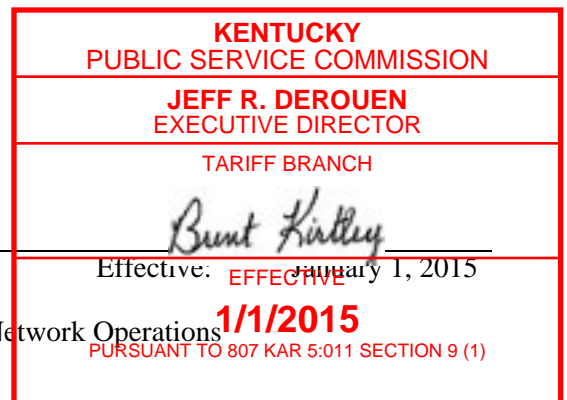

SECTION 3 - SWITCHED ACCESS SERVICE, (CONT'D)

3.3 Rate Categories (Continued)

3.3.4 Toll-Free 8XX Data Base Query

8XX Data Base Query Service is a service offering utilizing originating trunk side Switched Access Service. When an 8XX + NXX + XXXX call is originated by an end user, the Company will perform Customer identification based on screening of the full ten-digits of the 8XX number to determine the Customer location (Carrier identification Code or destination routing number) to which the call is to be routed. This service is billed based on a per query charge.

3.3.5 Toll Free Inter-Exchange Delivery Service

Toll Free Inter-Exchange Delivery Service is an access service in which the Company transports toll free traffic originated by any third party, including CLECs, ILECs, CMRS providers, and VoIP providers.

3.3.6 Signaling System 7 (SS7) Signaling Charges

SS7 Signaling usage charges apply for the SS7 Signaling Option as follows:

(a) Signal Formulation

An Initial Address Message (IAM) Formulation usage charge will be assessed for each IAM message formulated at the Telephone Company End Office for originating switched access traffic and for each IAM message formulated for terminating switched access traffic that is tandem routed. A Transaction Capabilities Application Part (TCAP) Signal Formulation usage charge will be assessed for each TCAP message that is formulated at the Telephone Company end office or tandem switch for the origination of non-call associated signaling messages (excluding LIDB, 800 Access Service and LNP Database Access).

Issued: December 17, 2014

Issued by:
Kyle V. Bertrand
Vice President of Regulatory & Network Operations

Effective: January 1, 2015

1/1/2015
PURSUANT TO 807 KAR 5:011 SECTION 9 (1)

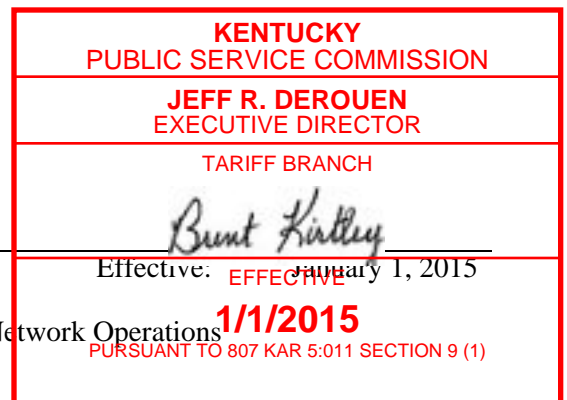

SECTION 3 - SWITCHED ACCESS SERVICE, (CONT'D)

3.3 Rate Categories (Continued)

3.3.6 Signaling System 7 (SS7) Signaling Charges (Continued)

(b) Signal Transport

An IAM Signal Transport usage charge will be assessed for each IAM message associated with direct routed traffic. An IAM Signal Transport usage charge will also be assessed for each IAM message that is transported from the local STP to the end office for terminating switched access traffic that is direct routed to the end office. A TCAP Signal Transport usage charge will be assessed for each TCAP message that is transported to or from the local STP to the designated Service Control Point (SCP) or signaling point.

(c) Signal Switching

An IAM Signal Switching usage charge will be assessed for each IAM message that is switched by the STP for direct routed originating switched access traffic and for each IAM message that is switched for direct routed terminating switched access traffic. A TCAP Signal Switching usage charge will be assessed for each TCAP message that is switched by the STP for the origination or termination of non-call associated signaling messages (excluding LIDB, 800 Access Service and LNP Database Access Query).

(d) Signal Tandem Switching

An IAM Signal Tandem Switching usage charge will be assessed for an IAM message that is transported to and switched by the STP for tandem routed originating switched access traffic and for an IAM message that is switched and transported to an end office for tandem routed terminating switched access traffic.

Issued: December 17, 2014

Issued by:
Kyle V. Bertrand
Vice President of Regulatory & Network Operations

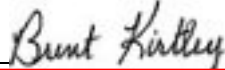
KENTUCKY PUBLIC SERVICE COMMISSION
JEFF R. DEROUEN EXECUTIVE DIRECTOR
TARIFF BRANCH

Effective: 1/1/2015
<small>PURSUANT TO 807 KAR 5:011 SECTION 9 (1)</small>

Effective: January 1, 2015

1/1/2015

PURSUANT TO 807 KAR 5:011 SECTION 9 (1)

SECTION 3 - SWITCHED ACCESS SERVICE, (CONT'D)

3.4 Access Ordering

3.4.1 General

- A. Customers may order Switched Access through a Constructive Order, as defined herein, or through an ASR. The format and terms of the ASR will be as specified in the Industry Access Service Order Guidelines, unless otherwise specified herein.
- B. A Customer may order any number of services of the same type and between the same premises on a single ASR. All details for services for a particular order must be identical.
- C. The Customer shall provide all information necessary for the Company to provide and bill for the requested service. When placing an order for Access Service, the Customer shall provide the following minimum information:
 - (a) Customer name and Premises address(es);
 - (b) Billing name and address (when different from Customer name and address); and
 - (c) Customer contact name(s) and telephone number(s) for the following provisioning activities: order negotiation, order confirmation, interactive design, installation and billing.

3.4.2 Access Service Date Intervals

- A. Access Service is provided with Standard or Negotiated Intervals
- B. The Company will specify a firm order confirmation date and Service Commencement Date contingent on the ASR being complete as received. To the extent the Access Service can be made available with reasonable effort, the Company will provide the Access Service in accordance with the Customer's requested interval, subject to the following conditions:
 - (a) For service provided under a Standard Interval: The Standard Interval for Switched Service will be sixty (60) business days from the Application Date. This interval only applies to standard service offerings where there are pre-existing facilities to the Customer Premises. Access Services provided under the Standard Interval will be installed during Company business hours.

Issued: December 17, 2014

Issued by:
Kyle V. Bertrand
Vice President of Regulatory & Network Operations

Effective: ~~January 1, 2015~~

1/1/2015

PURSUANT TO 807 KAR 5:011 SECTION 9 (1)

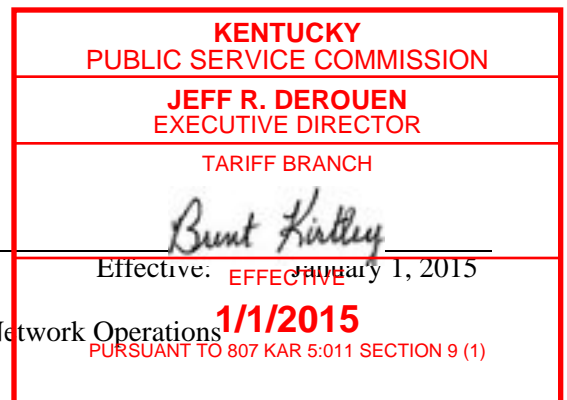

SECTION 3 - SWITCHED ACCESS SERVICE, (CONT'D)

3.4 Access Ordering (Continued)

3.4.2 Access Service Date Intervals (continued)

B. (continued)

(b) For service provided under a Negotiated Interval: The Company will offer a Service Date based on the type and quantity of Access Services the Customer has requested. The Negotiated Interval may not exceed by more than six months the Standard Interval Service Date, or, when there is no Standard Interval, the Company offered Service Date, except as otherwise agreed by the Company in writing. The Company will negotiate a Service Date interval with the Customer when:

- 1) The Customer requests a Service Date before or beyond the applicable Standard Interval Service Date; or
- 2) There is no existing facility connecting the Customer Premises with the Company; or
- 3) The Customer requests a service that is not considered by the Company to be a standard service offering (for example, if additional engineering or special construction is required to complete the order); or
- 4) The Company determines that Access Service cannot be installed within the Standard Interval.

C. All services for which rates are applied on an Individual Case Basis are provided with a Negotiated Interval.

3.4.3 Access Service Request Modifications

The Customer may request a modification of its ASR prior to the Service Commencement Date. All modifications must be in writing using the industry ASR process. The Company will make every effort to accommodate a requested modification when it is able to do so with the normal work force assigned to complete such an order within normal business hours.

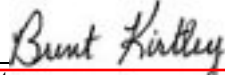
KENTUCKY PUBLIC SERVICE COMMISSION
JEFF R. DEROUEN EXECUTIVE DIRECTOR
TARIFF BRANCH

Effective: January 1, 2015 1/1/2015 PURSUANT TO 807 KAR 5:011 SECTION 9 (1)

Issued: December 17, 2014

Issued by:
Kyle V. Bertrand
Vice President of Regulatory & Network Operations

Effective: ~~January 1, 2015~~

1/1/2015

PURSUANT TO 807 KAR 5:011 SECTION 9 (1)

SECTION 3 - SWITCHED ACCESS SERVICE, (CONT'D)

3.5 Special Construction or Special Service Arrangements

3.5.1 Subject to the agreement of the Company and to all of the regulations contained in this tariff, special construction of Company facilities or development of special service arrangements may be undertaken by the Company on a reasonable-efforts basis at the request of the Customer. Such construction or arrangements will be provided pursuant to regulations contained in Section 6 of this tariff.

3.6 Obligations of the Company

3.6.1 With regard to access services provided by the Company, specific Company responsibilities include:

(a) Network Management

The Company will administer its network to ensure provision of acceptable service levels to all telecommunications users of the Company's network services. Generally, service levels are considered acceptable only when both End Users and Customers are able to establish connections with minimal delay encountered within the Company network. The Company maintains the right to apply protective controls, i.e., those actions, such as call gapping, which selectively cancel the completion of traffic, over any traffic carried over its network, including that associated with a Customer's Switched Access Service. Generally, such protective measures would only be taken as a result of occurrences such as a failure or overload of Company or Customer facilities, natural disasters, mass calling or national security demands.

Issued: December 17, 2014

Issued by:
Kyle V. Bertrand
Vice President of Regulatory & Network Operations

Effective: *January 1, 2015*
EFFECTIVE

1/1/2015
PURSUANT TO 807 KAR 5:011 SECTION 9 (1)

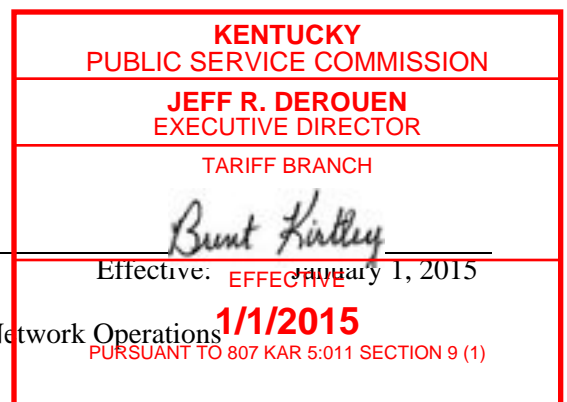

SECTION 3 - SWITCHED ACCESS SERVICE, (CONT'D)

3.6 Obligations of the Company (Continued)

3.6.1 (continued)

(b) Design and Traffic Routing of Switched Access Service

The Company shall design and determine the routing of Switched Access Service, including the selection of the first point of switching and the selection of facilities from the interface to any switching point and to the End Offices. The Company shall also decide if capacity is to be provided by originating only, terminating only, or two-way trunk groups. Finally, the Company will decide whether trunk side access will be provided through the use of two-wire or four-wire trunk terminating equipment.

Selection of facilities and equipment and traffic routing of the service are based on standard engineering methods, available facilities and equipment and the Company's traffic routing plans. If the Customer desires different routing or directionality than that determined by the Company, the Company will work cooperatively with the Customer in determining (1) whether the service is to be routed directly to an end office or through an access tandem switch and (2) the directionality of the service.

Issued: December 17, 2014

Issued by:
Kyle V. Bertrand
Vice President of Regulatory & Network Operations

Effective: ~~January 1, 2015~~

1/1/2015

PURSUANT TO 807 KAR 5:011 SECTION 9 (1)

**KENTUCKY
PUBLIC SERVICE COMMISSION**

**JEFF R. DEROUEN
EXECUTIVE DIRECTOR**

TARIFF BRANCH

Brent Kirtley

Effective: ~~January 1, 2015~~

1/1/2015

PURSUANT TO 807 KAR 5:011 SECTION 9 (1)

SECTION 3 - SWITCHED ACCESS SERVICE, (CONT'D)

3.7 Obligations of the Customer

3.7.1 The Customer has certain specific obligations pertaining to the use of Switched Access Service. These obligations are in addition to obligations specified in Section 2.9 of this tariff and are as follows:

(a) Report Requirements

Customers are responsible for providing the following reports to the Company, when applicable:

1) Jurisdictional Reports

When a Customer orders Switched Access Service for both interstate and intrastate use, the Customer is responsible for providing reports as set forth in Section 2.9.2(c) preceding. Charges will be apportioned in accordance with those reports.

2) Code Screening Reports

When a Customer orders service call routing, trunk access limitation or call gapping arrangements, the customer must report the number of trunks and/or the appropriate codes to be instituted in each end office or access tandem switch, for each of the arrangements ordered.

(b) On and Off-Hook Supervision

The Customer's facilities shall provide the necessary on and off-hook supervision for accurate timing of calls.

Issued: December 17, 2014

Issued by:
Kyle V. Bertrand
Vice President of Regulatory & Network Operations

Effective: ~~January 1, 2015~~

1/1/2015

PURSUANT TO 807 KAR 5:011 SECTION 9 (1)

**KENTUCKY
PUBLIC SERVICE COMMISSION**

**JEFF R. DEROUEN
EXECUTIVE DIRECTOR**

TARIFF BRANCH

Brent Kirtley

Effective: ~~January 1, 2015~~

1/1/2015

PURSUANT TO 807 KAR 5:011 SECTION 9 (1)

SECTION 3 - SWITCHED ACCESS SERVICE, (CONT'D)

3.8 Rate Regulations

3.8.1 General

There are three type of rates and charges that apply to Switched Access Service provided by the Company. These are Monthly Recurring Charges, Usage Charges, and Nonrecurring Charges.

3.8.2 Types of Charges

- A. Nonrecurring charges are one time charges that apply for a specific work activity (e.g., installation or change to an existing service). Non-recurring charges may apply for installation of service, installation of optional features and service rearrangements.
- B. Recurring Charges are flat monthly rates that apply for each month or fraction thereof that a specific rate element is provided. For billing purposes, each month is considered to have 30 days.
- C. Usage Charges are rates that apply only when a specific rate element is used. These are applied on a per-access minute, a per-call or per-query basis. Usage rates are accumulated over a monthly period.

3.8.3 Measurement and Billing of Access Minutes

- A. When recording originating calls over Switched Access Service with multi-frequency address signaling, usage measurement begins when the first wink supervisory signal is forwarded from the Customer's facilities. The measurement of originating call usage over Switched Access Service ends when the originating Switched Access Service entry switch receives disconnect supervision from either the originating End User's End Office (indicating that the originating End User has disconnected), or from the Customer's facilities, whichever is recognized first by the entry switch. For terminating calls over Switched Access Service with multi-frequency address signaling, the measurement of access minutes begins when a seizure signal is received from the Carrier's trunk group at the Point of Presence within the LATA. The measurement of terminating call usage over Switched Access Service ends when a disconnect signal is received, indicating that either the originating or terminating user has disconnected.

Issued: December 17, 2014

Issued by:

Kyle V. Bertrand

Vice President of Regulatory & Network Operations

Effective: **EFFECTIVE** January 1, 2015

1/1/2015

PURSUANT TO 807 KAR 5:011 SECTION 9 (1)

**KENTUCKY
PUBLIC SERVICE COMMISSION**

**JEFF R. DEROUEN
EXECUTIVE DIRECTOR**

TARIFF BRANCH

Brent Kirtley

SECTION 3 - SWITCHED ACCESS SERVICE, (CONT'D)

3.8 Rate Regulations (Continued)

3.8.3 Measurement and Billing of Access Minutes (Continued)

- B.** When recording originating calls over Switched Access Service with SS7 signaling, usage measurement begins with the transmission of the initial address message by the switch for direct trunk groups and with the receipt of an exit message by the switch for tandem trunk groups. The measurement of originating Switched Access Service usage ends when the entry switch receives or sends a release message, whichever occurs first. For terminating calls over Switched Access Service with SS7 signaling, the measurement of access minutes begins when the terminating recording switch receives the initial address message from the terminating End User. On directly routed trunk groups or on tandem routed trunk groups, the Company switch receives the initial address message and sends the indication to the Customer in the form of an answer message. The measurement of terminating Switched Access Service call usage ends when the entry switch receives or sends a release message, whichever occurs first.
- C.** Mileage, where applicable, will be measured in accordance with standard industry practices.
- D.** The Company will use the Small Exchange Carrier Access Billing ("SECAB") guidelines, or the Carrier Access Billing System ("CABS") guidelines, or other system that emulates or otherwise produces a reasonable substitute for the output of SECAB or CABS, for billing all charges under this tariff. The Company will provide billing using an electronic format by way of email or upon request, a mechanized medium (e.g., CD ROM, etc.). Bills will be accurate and contain sufficient supporting details to allow customers to account for the charges and to verify their accuracy in a reasonable and timely fashion. Requests for additional bill detail or formats will be handled and priced on an Individual Case Basis (ICB).
- E.** Access minutes are accumulated during the billing period. Fractional minutes are rounded up to the next whole minute.

Issued: December 17, 2014

Issued by:

Kyle V. Bertrand

Vice President of Regulatory & Network Operations

**KENTUCKY
PUBLIC SERVICE COMMISSION**

**JEFF R. DEROUEN
EXECUTIVE DIRECTOR**

TARIFF BRANCH

Brent Kirtley

Effective: **January 1, 2015**

1/1/2015

PURSUANT TO 807 KAR 5:011 SECTION 9 (1)

SECTION 3 - SWITCHED ACCESS SERVICE, (CONT'D)

3.8 Rate Regulations (Continued)

3.8.4 Application of Access Charges to Toll VoIP-PSTN Access Traffic

- A. All Toll VoIP-PSTN Access traffic will be assessed switched access charges at the rates set forth in this tariff.
- B. The Company shall assess and collect switched access rate elements under this tariff for access services, regardless of whether the Company itself delivers such traffic to the called party's premises or delivers the call to the called party's premises via contractual or other arrangements with an affiliated or unaffiliated provider of VoIP service that does not itself seek to collect switched access charges for the same traffic. The Company will not charge for functions not performed by the Company, its affiliated or unaffiliated provider of VoIP service. For purposes of this provision, functions provided by the Company as part of transmitting telecommunications between designated points using, in whole or in part, technology other than TDM transmission in a manner that is comparable to a service offered by a local exchange carrier constitutes the functional equivalent of carrier access service.

3.8.5 Identification and Rating of Toll VoIP-PSTN Traffic

A. Scope

VoIP-PSTN Traffic is the traffic exchanged in time division multiplexing ("TDM") format that originates and/or terminates in Internet protocol ("IP") format. This section governs the identification of Toll VoIP-PSTN Traffic that is required to be compensated at interstate access rates (unless the parties have agreed otherwise) by the Federal Communications Commission in its Report and Order in WC Docket Nos. 10-90 et. al., FCC No. 11-161 (November 18, 2011) ("FCC Order"). Specifically, this section establishes the method of separating such traffic (referred to in this tariff as "Relevant VoIP-PSTN Traffic") from the Customer's traditional intrastate access traffic, so that such Relevant Toll VoIP-PSTN Traffic can be billed in accordance with the FCC Order.

Issued: December 17, 2014

Issued by:
Kyle V. Bertrand
Vice President of Regulatory & Network Operations

Effective: January 1, 2015

1/1/2015
PURSUANT TO 807 KAR 5:011 SECTION 9 (1)

**KENTUCKY
PUBLIC SERVICE COMMISSION**

**JEFF R. DEROUEN
EXECUTIVE DIRECTOR**

TARIFF BRANCH

Brent Kirtley

SECTION 3 - SWITCHED ACCESS SERVICE, (CONT'D)

3.8 Rate Regulations (Continued)

3.8.5 Identification and Rating of Toll VoIP-PSTN Traffic (Continued)

B. Rating of VoIP-PSTN Traffic

The Relevant VoIP-PSTN Traffic identified in accordance with this tariff section will be billed in accordance with the Company's applicable interstate switched access Tariff FCC No. 1.

C. Calculation and Application of Percent-VoIP-PSTN-Usage Factor

The Company will determine the number of Relevant VoIP-PSTN Traffic minutes of use ("MOU") to which interstate rates will be applied under subsection (B), above, by applying a Percent VoIP Usage ("PVU") factor to the intrastate access MOU (however determined – either based on call detail information or PIU) exchanged between the Company and the Customer. The PVU will be derived and applied as follows:

1. The Customer will calculate and furnish to the Company a factor (the "PVU-A") representing the whole number percentage of the total access MOU that the Customer exchanges with the Company in the State, that (a) is sent to the Company and that originates in IP format; or (b) is received from the Company and terminates in IP format. This PVU-A shall be based on information such as the number of the Customer's retail VoIP subscriptions in the state (e.g., as reported on FCC Form 477), traffic studies, actual call detail, or other relevant and verifiable information.
2. Company will, likewise, calculate a factor (the "PVU-B") representing the percentage of the Company's total access MOU in the State that the Company originates or terminates in IP format. This PVU-B shall be based on information such as the number of the Company's retail VoIP subscriptions in the state (e.g., as reported on FCC Form 477), traffic studies, actual call detail, or other relevant and verifiable information.

Issued: December 17, 2014

Issued by:
Kyle V. Bertrand
Vice President of Regulatory & Network Operations

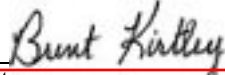
KENTUCKY PUBLIC SERVICE COMMISSION
JEFF R. DEROUEN EXECUTIVE DIRECTOR
TARIFF BRANCH

Effective: January 1, 2015 1/1/2015 PURSUANT TO 807 KAR 5:011 SECTION 9 (1)

SECTION 3 - SWITCHED ACCESS SERVICE, (CONT'D)

3.8 Rate Regulations (Continued)

3.8.5 Identification and Rating of Toll VoIP-PSTN Traffic (Continued)

C. Calculation and Application of Percent-VoIP-PSTN-Usage Factor (Continued)

3. The Company will use the PVU-A and PVU-B factors to calculate an effective PVU factor that represents the percentage of total access MOU exchanged between the Company and the Customer that is originated and/or terminated in IP format, whether at the Company's end, at the Customer's end, or at both ends. The effective PVU factor will be calculated as the sum of: (A) the PVU-A factor and (B) the PVU-B factor times (1.0 minus the PVU-A factor).
4. The Company will apply the effective PVU factor to the total intrastate access MOU exchanged with the Customer to determine the number of Relevant VoIP-PSTN Traffic MOUs.

Example 1: The PVU-B is 10% and the PVU-A is 40%. The effective PVU factor is equal to $40\% + (10\% \times 60\%) = 46\%$. The Company will bill 46% of the Customer's intrastate access MOU in accordance with the Company's applicable interstate switched access tariff.

Example 2: The PVU-B is 10% and the PVU-A is 0%. The effective PVU factor is $0\% + (100\% \times 10\%) = 10\%$. The Company will bill 10% of the Customer's intrastate access MOU in accordance with the Company's applicable interstate switched access tariff.

Example 3: The PVU-A is 100%. No matter what the PVU-B factor is, the effective PVU is 100%. The Company will bill 100% of the Customer's intrastate access MOU in accordance with the Company's applicable interstate switched access tariff.

5. If the Customer does not furnish the Company with a PVU-A pursuant to the preceding paragraph 1, the Company will utilize an effective PVU equal to the PVU-B.
6. The Customer shall not modify their reported PIU factor to account for VoIP-PSTN Traffic.

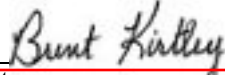
KENTUCKY PUBLIC SERVICE COMMISSION
JEFF R. DEROUEN EXECUTIVE DIRECTOR
TARIFF BRANCH

Effective: EFFECTIVE January 1, 2015 1/1/2015 PURSUANT TO 807 KAR 5:011 SECTION 9 (1)

Issued: December 17, 2014

Issued by:
Kyle V. Bertrand
Vice President of Regulatory & Network Operations

SECTION 3 - SWITCHED ACCESS SERVICE, (CONT'D)

3.8 Rate Regulations (Continued)

3.8.5 Identification and Rating of Toll VoIP-PSTN Traffic (Continued)

D. Initial PVU Factor

If the PVU factor is not available and/or cannot be implemented in the Company's billing systems by December 29, 2011, once the factor is available and can be implemented the Company will adjust the Customer's bills to reflect the PVU retroactively to December 29, 2011. In calculating the initial PVU, the Company will take the Customer-specified PVU-A into account retroactively to December 29, 2011, provided that the Customer provides the factor to the Company no later than April 15, 2012; otherwise, it will set the initial PVU equal to the PVU-B, as specified in subsection (C)(5), above.

E. PVU Factor Updates

The Customer may update the PVU-A factor or the Company may update the PVU-B quarterly using the method set forth in subsection C.1 or C.2, respectively, above. If the Customer chooses to submit such updates, it shall forward to the Company, no later than 15 days after the first day of January, April, July and/or October of each year, a revised PVU-A factor based on data for the prior three months, ending the last day of December, March, June and September, respectively. The Company will use the revised PVU-A to calculate a revised PVU. The revised PVU factor will apply prospectively and serve as the basis for billing until superseded by a new PVU.

F. PVU Factor Verification

Not more than twice in any year, the Company may ask the Customer to verify the PVU-A factor furnished to the Company and Customer may ask the Company to verify the PVU-B factor and the calculation of the PVU factor. The party so requested shall comply, and shall reasonably provide the records and other information used to determine the respective PVU-A and PVU-B factors. The Customer shall retain the call detail, work papers, and/or other information used to develop the PVU factor for a minimum of one year. No prorating or back billing will be done based on updated PVU factors.

Issued: December 17, 2014

Issued by:
Kyle V. Bertrand
Vice President of Regulatory & Network Operations

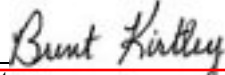
KENTUCKY PUBLIC SERVICE COMMISSION
JEFF R. DEROUEN EXECUTIVE DIRECTOR
TARIFF BRANCH

Effective: EFFECTIVE January 1, 2015 1/1/2015 PURSUANT TO 807 KAR 5:011 SECTION 9 (1)

SECTION 3 - SWITCHED ACCESS SERVICE, (CONT'D)

3.9 Call Flow Diagrams

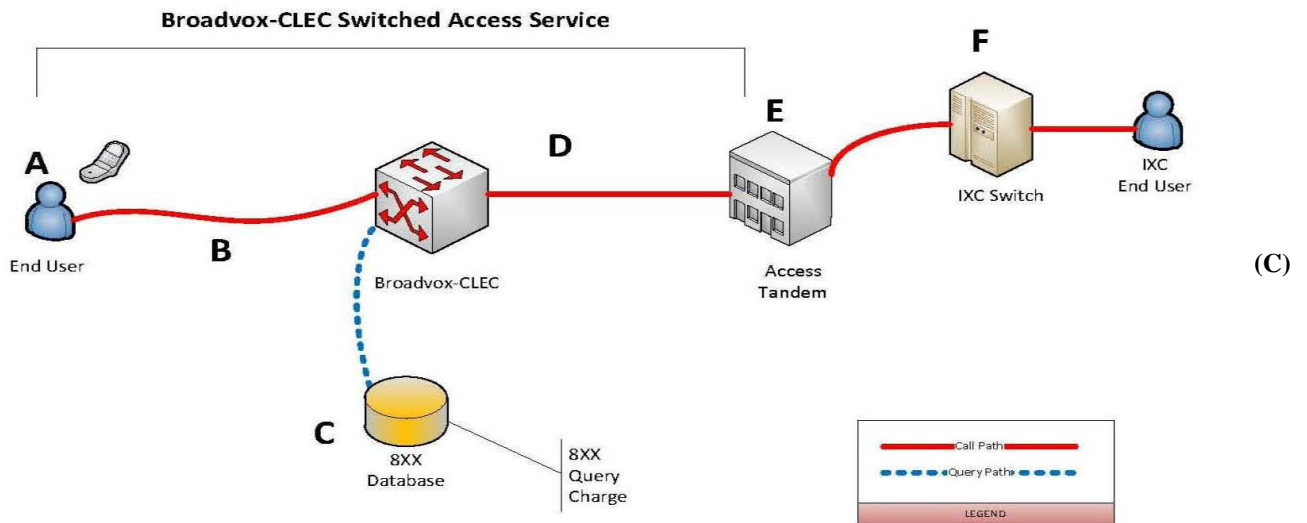
Originating and Terminating Access – Indirect Connection; Broadvox - CLEC End User



Originating Call Flow

- A. Broadvox - CLEC's End User places a long distance call
- B. Call is routed to Broadvox - CLEC switch
- C. If 8XX call, Broadvox - CLEC switch looks up IXC that should receive the call
- D. Call is routed to Access Tandem over shared transport
- E. Tandem Provider routes call to IXC

Originating Charges

- Broadvox-CLEC charges IXC: Switched Access Service – Indirect Connection, which is comprised of Local Switching, Common Trunk Port, Tandem Switched Transport – Termination, Tandem Switched Transport – Facility, and 8XX query charges, as applicable
- Additional charges may apply per Tandem Provider tariff for functions performed by Tandem Provider

Terminating Call Flow

- F. IXC delivers terminating long distance call to Access Tandem for routing to Broadvox - CLEC's End User
- E. Access Tandem routes call over shared transport (D) to Broadvox - CLEC switch
- B. Call is routed to Broadvox - CLEC's End User(A)

Terminating Charges

- Broadvox-CLEC charges IXC: Switched Access Service – Indirect Connection, which is comprised of Local Switching, Common Trunk Port, Tandem Switched Transport – Termination, and Tandem Switched Transport – Facility
- Additional charges may apply per Tandem Provider tariff for functions performed by Tandem Provider

Issued: March 16, 2017

Issued by:
Mary Buley
Senior Regulatory Manager

KENTUCKY PUBLIC SERVICE COMMISSION

Talina R. Mathews
EXECUTIVE DIRECTOR

Talina R. Mathews

EFFECTIVE
Effective: March 31, 2017
3/31/2017
PURSUANT TO 807 KAR 5:011 SECTION 9 (1)

SECTION 3 - SWITCHED ACCESS SERVICE, (CONT'D)

3.9 Call Flow Diagrams (Continued)

Originating and Terminating Access – Indirect Connection; VoIP Carrier End User

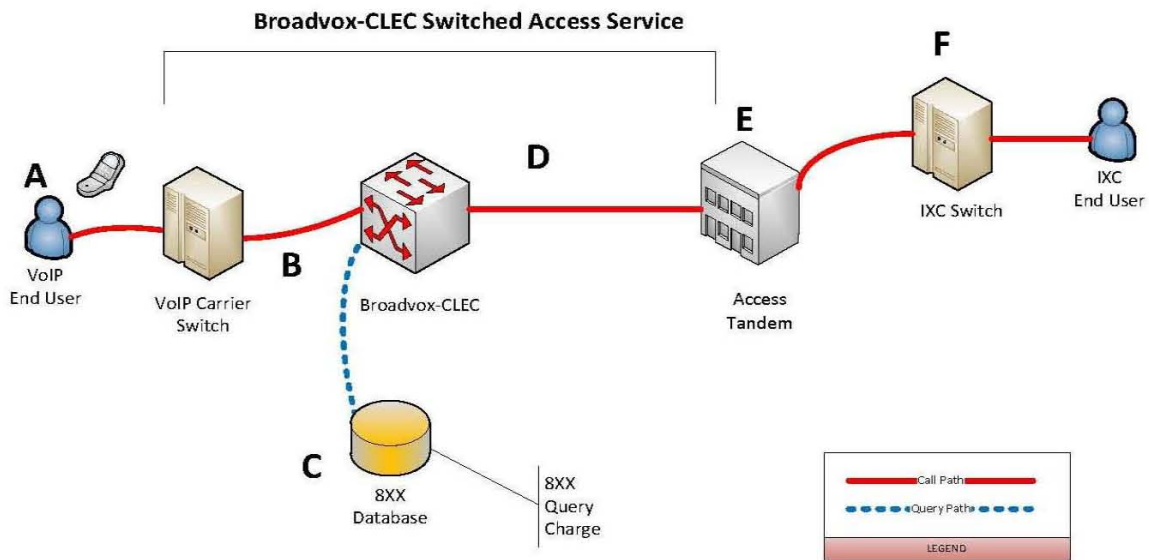

Originating Call Flow

- A. VoIP End User places a long distance call that is routed to VoIP carrier switch
- B. VoIP carrier routes call to Broadvox - CLEC switch.
- C. If 8XX call, Broadvox - CLEC switch looks up IXC that should receive the call
- D. Call is routed to Access Tandem over Shared Transport
- E. Tandem Provider routes call to IXC

Originating Charges

- Broadvox - CLEC charges IXC: Switched Access Service – Indirect Connection, which is comprised of Local Switching, Common Trunk Port, Common Transport Multiplexing, Tandem Switching, Tandem Switched Transport – Termination, Tandem Switched Transport – Facility, and 8XX query charges, as applicable
- Additional charges may apply per Tandem Provider tariff for functions performed by Tandem Provider

Terminating Call Flow

- F. IXC delivers terminating long distance call to Access Tandem for routing to Broadvox - CLEC’s telephone number
- E. Access Tandem routes call over shared transport (D) to Broadvox - CLEC switch
- B. Broadvox – CLEC routes the call to the VoIP carrier

Terminating Charges

- Broadvox - CLEC charges IXC (1) Switched Access Service – Indirect Connection, which is comprised of Local Switching, Common Trunk Port, Common Transport Multiplexing, Tandem Switching, Tandem Switched Transport – Termination, and Tandem Switched Transport – Facility
- Additional charges may apply per Tandem Provider tariff for functions performed by Tandem Provider

Issued: March 16, 2017

Issued by:
Mary Buley
Senior Regulatory Manager

**KENTUCKY
PUBLIC SERVICE COMMISSION**

**Jalina R. Matthews
EXECUTIVE DIRECTOR**

Jalina R. Matthews

EFFECTIVE
Effective: **3/31/2017** March 31, 2017
PURSUANT TO 807 KAR 5:011 SECTION 9 (1)

SECTION 3 - SWITCHED ACCESS SERVICE, (CONT'D)

3.9 Call Flow Diagrams (Continued)

Originating and Terminating Access – Indirect Connection; CLEC/CMRS Carrier End User

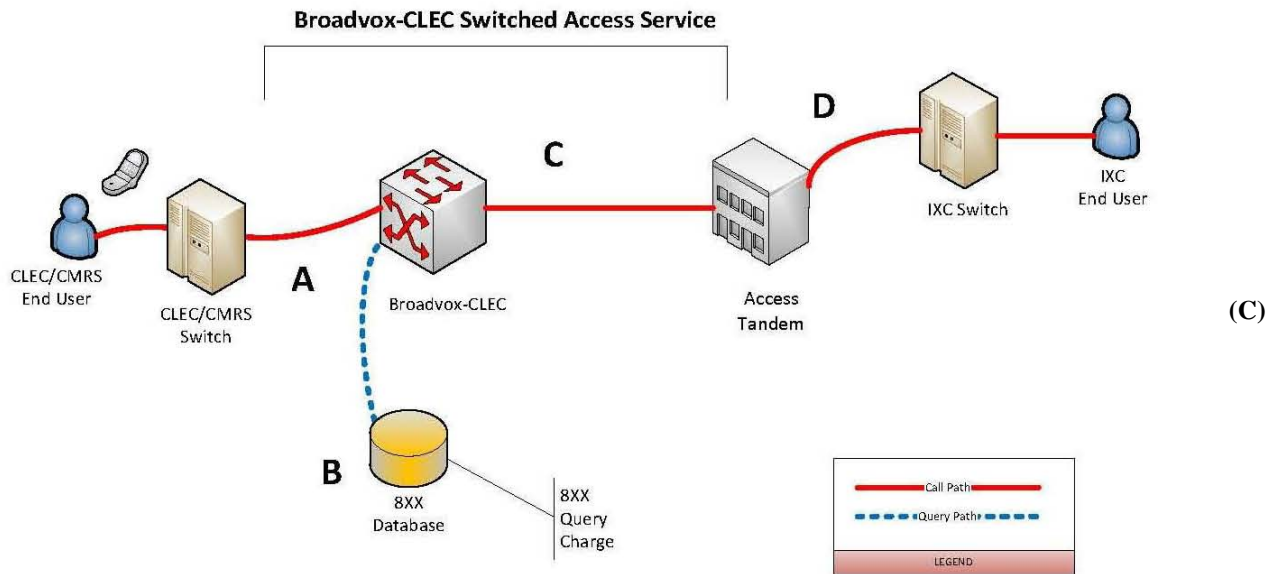

Originating Call Flow

- A. CLEC/CMRS End User places a long distance call that is routed to Broadvox - CLEC switch
- B. If 8XX call, Broadvox - CLEC switch looks up IXC that should receive the call
- C. Call is routed to Access Tandem over shared transport
- D. Tandem Provider routes call to IXC

Originating Charges

- Broadvox - CLEC charges IXC: Switched Access Service – Indirect Connection, which is comprised of: Common Trunk Port, Common Transport Multiplexing, Tandem Switching, Tandem Switched Transport – Termination, Tandem Switched Transport – Facility, and 8XX query charges, as applicable
- Additional charges may apply per Tandem Provider tariff for functions performed by Tandem Provider

Terminating Call Flow

- D. IXC delivers terminating long distance call to Access Tandem for routing to Broadvox - CLEC’s telephone number
- C. Access Tandem routes call over shared transport to Broadvox - CLEC switch
- A. Broadvox - CLEC routes the call to the CLEC/CMRS carrier

Terminating Charges

- Broadvox - CLEC charges IXC: Switched Access Service – Indirect Connection, which is comprised of: Common Trunk Port, Common Transport Multiplexing, Tandem Switching, Tandem Switched Transport – Termination, and Tandem Switched Transport – Facility
- Additional charges may apply per Tandem Provider tariffs for functions performed by Tandem Provider

Issued: March 16, 2017

Issued by:
Mary Buley
Senior Regulatory Manager

**KENTUCKY
PUBLIC SERVICE COMMISSION**

**Talina R. Mathews
EXECUTIVE DIRECTOR**

Talina R. Mathews

EFFECTIVE
Effective: **3/31/2017**
PURSUANT TO 807 KAR 5:011 SECTION 9 (1)

SECTION 3 - SWITCHED ACCESS SERVICE, (CONT'D)

3.9 Call Flow Diagrams (Continued)

**Terminating Access for Non-Local Jurisdiction over Local Tandem – Indirect Connection;
 CLEC/ILEC/CMRS Carrier End User**

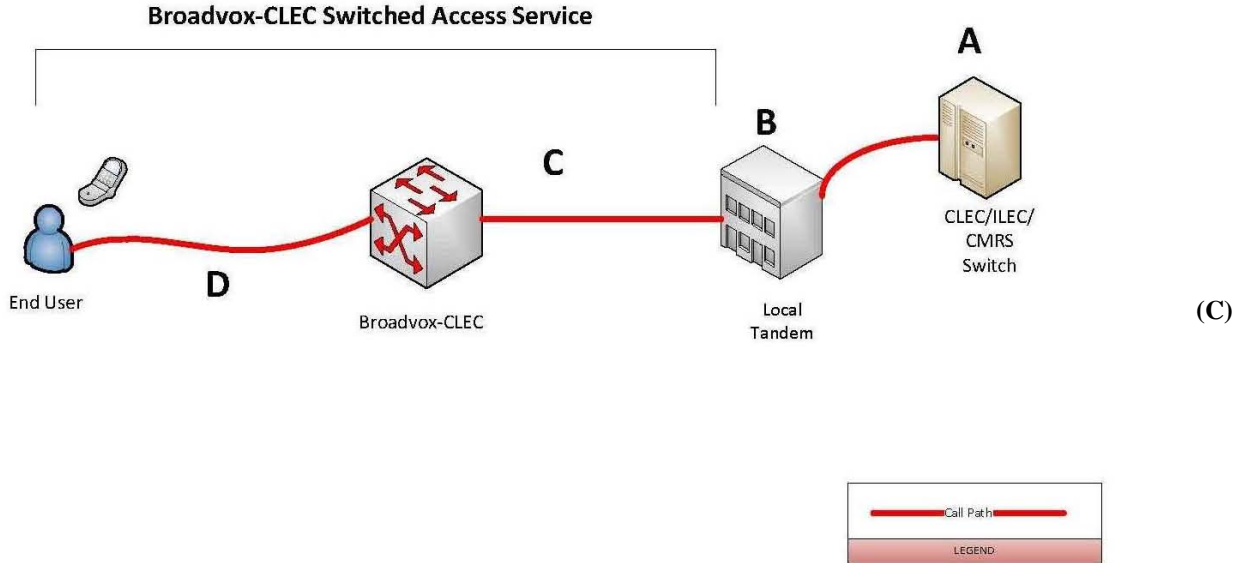

Terminating Call Flow

- A. CLEC/ILEC/CMRS end user dials an Broadvox - CLEC Telephone Number
- B. CLEC/ILEC/CMRS routes the call to the Local Tandem (C)
- C. Local Tandem Provider switches the call to the Broadvox - CLEC's local trunk group (C)
- D. Call is routed across Shared Transport to the Broadvox - CLEC switch
- E. Broadvox - CLEC routes the call to the end user

Terminating Charges

- Broadvox - CLEC charges CLEC/ILEC/CMRS: Local Switching, Common Trunk Port, Common Transport Multiplexing, Tandem Switched Transport – Termination, and Tandem Switched Transport – Facility (C)
- Additional charges may apply per Local Tandem Provider tariff for functions performed by Local Tandem Provider (C)

Issued: March 16, 2017

Issued by:
 Mary Buley
 Senior Regulatory Manager

KENTUCKY
PUBLIC SERVICE COMMISSION

Talina R. Mathews
EXECUTIVE DIRECTOR

Talina R. Mathews

EFFECTIVE
 Effective: **3/31/2017** March 31, 2017
 PURSUANT TO 807 KAR 5:011 SECTION 9 (1)

SECTION 3 - SWITCHED ACCESS SERVICE, (CONT'D)

3.9 Call Flow Diagrams (Continued)

Originating and Terminating Access – Direct Connection; Broadvox - CLEC End User

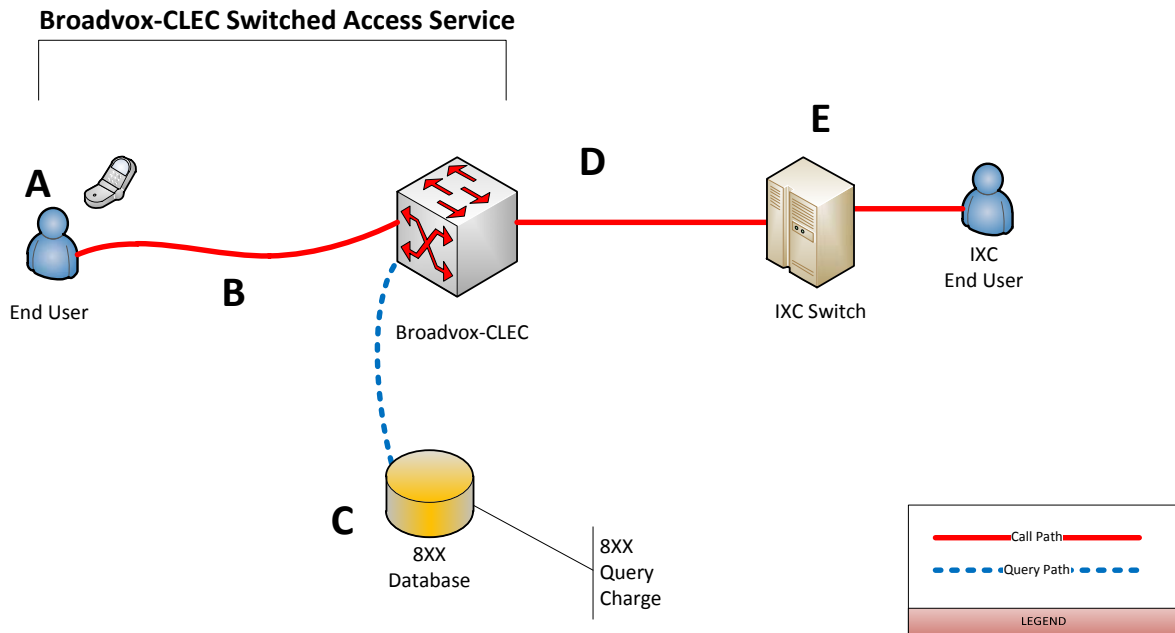

Originating Call Flow

- A. Broadvox - CLEC's End User places a long distance call that is routed to Broadvox - CLEC switch
- C. If 8YY call, Broadvox - CLEC switch looks up IXC that should receive the call
- D. Call is routed to IXC over dedicated transport

Originating Charges

- Broadvox - CLEC charges IXC: Switched Access Service – Direct Connection, which is comprised of Local Switching, Dedicated Trunk Port charge, and 8YY query charges, as applicable
- Customer is responsible for providing or ordering appropriate facility to Broadvox - CLEC's point of presence in the access tandem serving area

Terminating Call Flow

- D. IXC delivers terminating long distance to Broadvox - CLEC switch over dedicated transport
- B. Call is routed to Broadvox - CLEC's End User

Terminating Charges

- Broadvox - CLEC charges IXC: Switched Access Service – Direct Connection, which is comprised of Local Switching, and Dedicated Trunk Port charge
- Customer is responsible for providing or ordering appropriate facility to Broadvox - CLEC's point of presence in the access tandem serving area

Issued: December 17, 2014

Issued by:
 Kyle V. Bertrand
 Vice President of Regulatory & Network Operations

Effective: January 1, 2015

1/1/2015
 PURSUANT TO 807 KAR 5:011 SECTION 9 (1)

**KENTUCKY
 PUBLIC SERVICE COMMISSION**

**JEFF R. DEROWEN
 EXECUTIVE DIRECTOR**

TARIFF BRANCH

Brent Kirtley

Effective: January 1, 2015

1/1/2015
 PURSUANT TO 807 KAR 5:011 SECTION 9 (1)

SECTION 3 - SWITCHED ACCESS SERVICE, (CONT'D)

3.9 Call Flow Diagrams (Continued)

Originating and Terminating Access– Direct Connection; VoIP Carrier End User

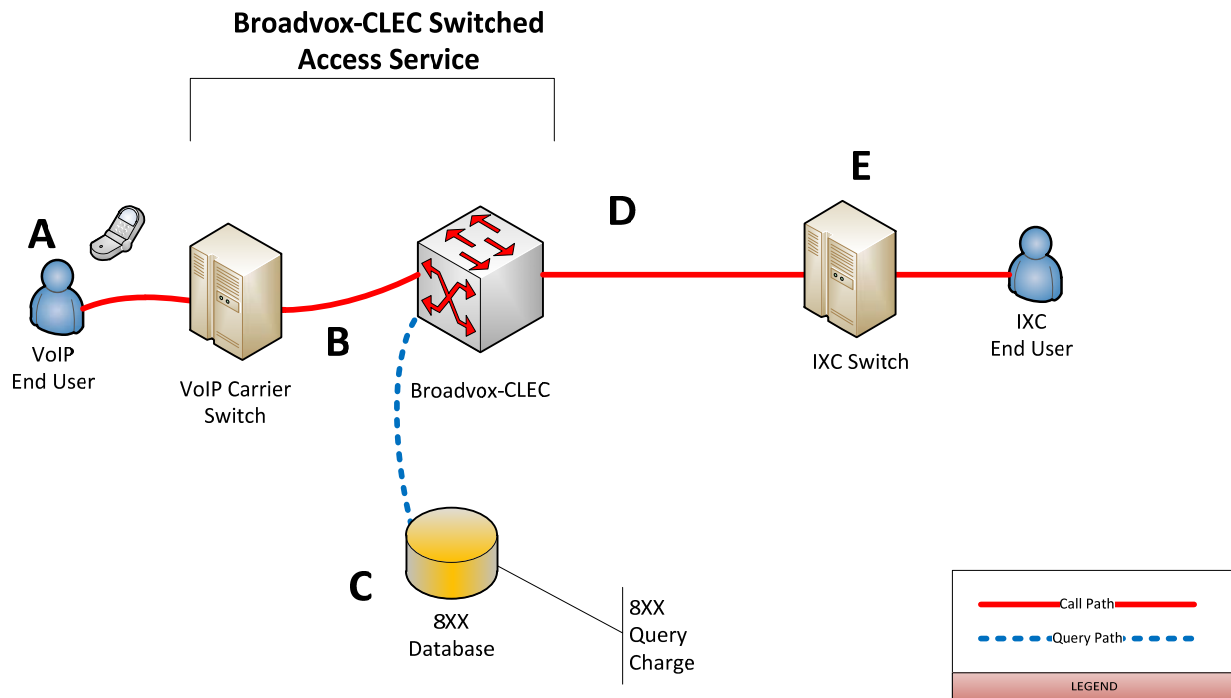

Originating Call Flow

- A. VoIP End User places a long distance call that is routed to VoIP carrier switch
- B. VoIP carrier routes call to Broadvox - CLEC switch.
- C. If 8XX call, Broadvox - CLEC switch looks up IXC that should receive the call
- D. Call is routed to IXC Switch over Dedicated Transport

Originating Charges

- Broadvox - CLEC charges IXC: Switched Access Service – Direct Connection, which is comprised of Local Switching, Common Trunk Port, Common Transport Multiplexing, Dedicated Tandem Trunk Port, Tandem Switching, Tandem Switched Transport – Termination, Tandem Switched Transport – Facility, and 8XX query charges, as applicable
- Additional charges may apply per ILEC tariff for functions performed by ILEC

Terminating Call Flow

- E. IXC End User places a long distance to an Broadvox - CLEC telephone number.
- D. IXC delivers terminating long distance call to Broadvox - CLEC switch over Dedicated Transport
- B. Broadvox - CLEC switches the call to the correct VoIP carrier

Terminating Charges

- Broadvox - CLEC charges IXC: Switched Access Service – Direct Connection, which is comprised of Local Switching, Dedicated Trunk Port, Tandem Switching, Tandem Switched Transport – Termination, and Tandem Switched Transport – Facility. Additional charges may apply per ILEC tariff for function

Issued: December 17, 2014

Issued by:
 Kyle V. Bertrand
 Vice President of Regulatory & Network Operations

Effective: January 1, 2015

1/1/2015

PURSUANT TO 807 KAR 5:011 SECTION 9 (1)

**KENTUCKY
 PUBLIC SERVICE COMMISSION**

**JEFF R. DEROUEN
 EXECUTIVE DIRECTOR**

TARIFF BRANCH

Brent Kirtley

SECTION 3 - SWITCHED ACCESS SERVICE, (CONT'D)

3.9 Call Flow Diagrams (Continued)

Originating and Terminating Access –Direct Connection; CLEC/CMRS Switch

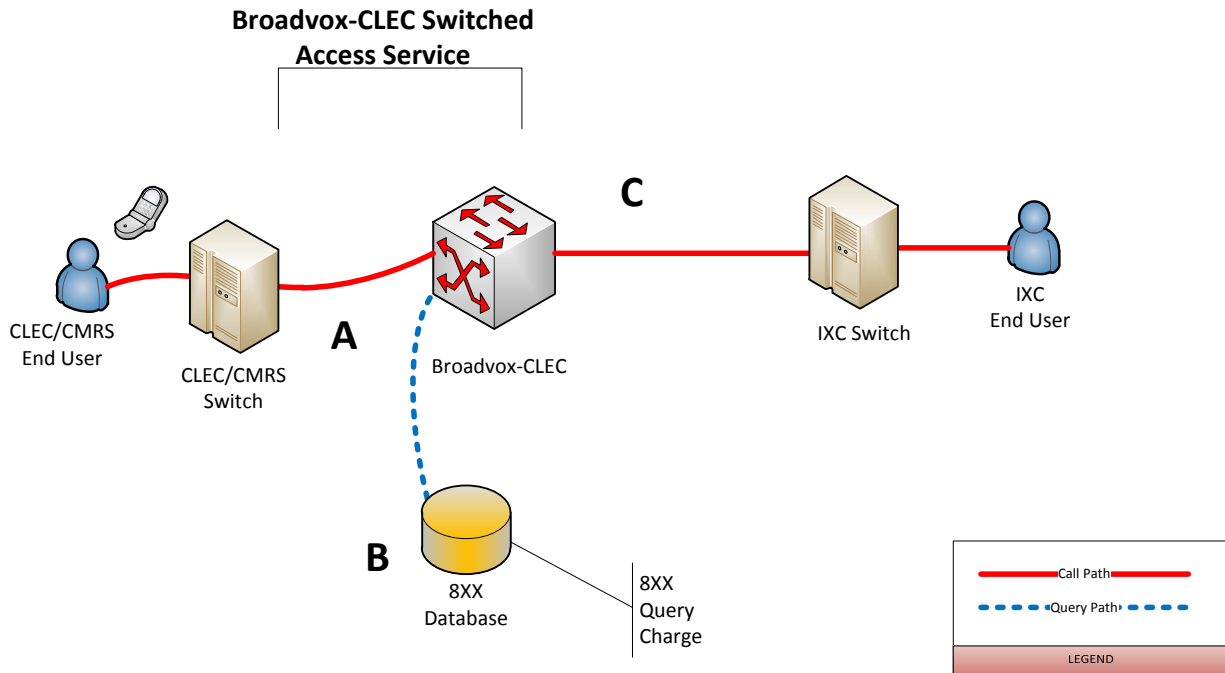

Originating Call Flow

- A. CLEC/CMRS End User places a long distance call that is routed to Broadvox - CLEC switch
- B. If 8XX call, Broadvox - CLEC switch looks up IXC that should receive the call
- C. Call is routed to IXC Switch over Dedicated Transport

Originating Charges

- Broadvox - CLEC charges IXC: Switched Access Service – Direct Connection, which is comprised of Tandem Switching, Dedicated Tandem Trunk Port Charge, Common Transport Multiplexing, Tandem Switched Transport – Termination, Tandem Switched Transport – Facility, and 8XX query charges, as applicable
- Additional charges may apply per CLEC tariff for functions performed by CLEC

Terminating Call Flow

- C. IXC delivers terminating long distance call to Broadvox - CLEC switch over Dedicated Transport, Tandem Switching, Tandem Switched Transport – Termination, and Tandem Switched Transport – Facility
- A. Broadvox - CLEC switches the call to the correct CLEC/CMRS carrier

Terminating Charges

- Broadvox - CLEC charges IXC: Switched Access Service – Direct Connection, which is comprised of Tandem Switching, Dedicated Tandem Trunk Port Charge, Common Transport Multiplexing, Tandem Switched Transport – Termination, Tandem Switched Transport – Facility, and 8XX Query charges as applicable
- Additional charges may apply per ILEC tariff for functions performed by ILEC

**KENTUCKY
PUBLIC SERVICE COMMISSION**

**JEFF S. WIDEN
EXECUTIVE DIRECTOR**

TARIFF BRANCH

Brent Kirtley

Effective: **January 1, 2015**

1/1/2015

PURSUANT TO 807 KAR 5:011 SECTION 9 (1)

Issued: December 17, 2014

Issued by:
 Kyle V. Bertrand
 Vice President of Regulatory & Network Operations

SECTION 3 - SWITCHED ACCESS SERVICE, (CONT'D)

3.10 Entrance Facilities and Direct-Trunked Transport Rates and Charges

Nonrecurring and Monthly Recurring Entrance Facilities and Direct-Trunked Transport charges are priced on an Individual Case Basis (ICB).

Issued: December 17, 2014

Issued by:
Kyle V. Bertrand
Vice President of Regulatory & Network Operations

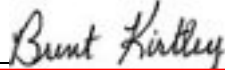
KENTUCKY PUBLIC SERVICE COMMISSION
JEFF R. DEROUEN EXECUTIVE DIRECTOR
TARIFF BRANCH

Effective: 1/1/2015
<small>PURSUANT TO 807 KAR 5:011 SECTION 9 (1)</small>

Effective: **1/1/2015**

1/1/2015
PURSUANT TO 807 KAR 5:011 SECTION 9 (1)

SECTION 3 - SWITCHED ACCESS SERVICE, (CONT'D)

3.11 Other Access Service Rates and Charges

3.11.1 AT&T (former BellSouth) Areas

(A)	Dedicated Trunk Port Per DS1	Originating \$139.98	Terminating Note 1	
(B)	Dedicated Tandem Trunk Port Per DS1	Originating \$139.98	Terminating Note 1	
(C)	Tandem Switching Per minute of use	Originating Note 1	Terminating Note 1	(C)
(D)	Tandem Switched Transport - Termination Per minute of use	Originating Note 1	Terminating Note 1	(C)
(E)	Tandem Switched Transport – Facility Per minute of use per mile	Originating Note 1	Terminating Note 1	(C)
(F)	Common Transport Multiplexing Per minute of use	Originating Note 1	Terminating Note 1	(C)
(G)	Common Trunk Port Per minute of use	Originating Note 1	Terminating Note 1	(C)
(H)	Local Switching Per minute of use	Originating Note 1	Terminating Note 1	(C)
(I)	800 Database Query Per minute of use		Note 1	(C)

Note 1: See the Company's Access Services Tariff FCC No. 1 at the following link <https://apps.fcc.gov/etfs/public/lecTariffs.action?idLec=324>.

**KENTUCKY
PUBLIC SERVICE COMMISSION**

Linda C. Bridwell
Executive Director



**EFFECTIVE
7/1/2021**

PURSUANT TO 807 KAR 5:011 SECTION 9 (1)

Issued: June 16, 2021

Issued by:
 Richard Monto
 General Counsel

SECTION 3 - SWITCHED ACCESS SERVICE, (CONT'D)

3.11 Other Access Service Rates and Charges

3.11.2 Windstream (East/Lexington) Areas

(A)	Dedicated Trunk Port Per DS1			Note 1	
(B)	Dedicated Tandem Trunk Port Per DS1			\$342.96	
(C)	Tandem Switching Per minute of use	Originating Note 1	Terminating Note 1		(C)
(D)	Tandem Switched Transport - Termination Per minute of use	Originating Note 1	Terminating Note 1		(C)
(E)	Tandem Switched Transport – Facility Per minute of use per mile	Originating Note 1	Terminating Note 1		(C)
(F)	Common Transport Multiplexing Per minute of use	Originating Note 1	Terminating Note 1		(C)
(G)	Common Trunk Port Per minute of use	Originating Note 1	Terminating Note 1		(C)
(H)	End Office Switching Local switching, Per minute of use Info Surcharge, Per minute of use	Originating Note 1 Note 1	Terminating Note 1 Note 1		(C) (C)
(I)	800 Database Query Per minute of use			Note 1	(C)

Note 1: See the Company's Access Services Tariff FCC No. 1 at the following link <https://apps.fcc.gov/etfs/public/lecTariffs.action?idLec=324>.

**KENTUCKY
PUBLIC SERVICE COMMISSION**

Linda C. Bridwell
Executive Director



**EFFECTIVE
7/1/2021**

PURSUANT TO 807 KAR 5:011 SECTION 9 (1)

Issued: June 16, 2021 Issued by:
 Richard Monto
 General Counsel

SECTION 3 - SWITCHED ACCESS SERVICE, (CONT'D)

3.11 Other Access Service Rates and Charges

3.11.3 Windstream (West) Areas

(A)	Dedicated Trunk Port Per DS1		\$0.00	
(B)	Dedicated Tandem Trunk Port Per DS1		\$0.00	
(C)	Tandem Switching Per minute of use	Originating Note 1	Terminating Note 1	(C)
(D)	Tandem Switched Transport - Termination Per minute of use	Originating Note 1	Terminating Note 1	(C)
(E)	Tandem Switched Transport – Facility Per minute of use per mile	Originating Note 1	Terminating Note 1	(C)
(F)	Common Transport Multiplexing Per minute of use	Originating Note 1	Terminating Note 1	(C)
(G)	Common Trunk Port Per minute of use	Originating Note 1	Terminating Note 1	(C)
(H)	End Office Switching Local Switching, Per minute of use Interconnection, Per minute of use Info Surcharge, Per minute of use	Originating Note 1 Note 1 Note 1	Terminating Note 1 Note 1 Note 1	(C) (C) (C)
(I)	800 Database Query Per minute of use		Note 1	(C)

Note 1: See the Company's Access Services Tariff FCC No. 1 at the following link <https://apps.fcc.gov/etfs/public/lecTariffs.action?idLec=324>.

KENTUCKY
PUBLIC SERVICE COMMISSION

Linda C. Bridwell
 Executive Director

Linda C. Bridwell
EXECUTIVE DIRECTOR

EFFECTIVE
7/1/2021
 PURSUANT TO 807 KAR 5:011 SECTION 9 (1)

Issued: June 16, 2021 Issued by:
 Richard Monto
 General Counsel

SECTION 3 - SWITCHED ACCESS SERVICE, (CONT'D)

3.11 Other Access Service Rates and Charges

3.11.4 Cincinnati Bell Areas

(A)	Dedicated Trunk Port Per DS1		Note 1	
(B)	Dedicated Tandem Trunk Port Per DS1		Note 1	
(C)	Tandem Switching Per minute of use	Originating Note 1	Terminating Note 1	(C)
(D)	Tandem Switched Transport - Termination Per minute of use	Originating Note 1	Terminating Note 1	(C)
(E)	Tandem Switched Transport – Facility Per minute of use per mile	Originating Note 1	Terminating Note 1	(C)
(F)	Common Transport Multiplexing Per minute of use	Originating Note 1	Terminating Note 1	(C)
(G)	Common Trunk Port Per minute of use	Originating Note 1	Terminating Note 1	(C)
(H)	Local Switching Per minute of use	Originating Note 1	Terminating Note 1	(C)
(I)	800 Database Query Per minute of use		Note 1	(C)

Note 1: See the Company's Access Services Tariff FCC No. 1 at the following link <https://apps.fcc.gov/etfs/public/lecTariffs.action?idLec=324>.

Issued: June 16, 2021

Issued by:
 Richard Monto
 General Counsel

**KENTUCKY
 PUBLIC SERVICE COMMISSION**

Linda C. Bridwell
 Executive Director



**EFFECTIVE
 7/1/2021**

PURSUANT TO 807 KAR 5:011 SECTION 9 (1)

SECTION 4 - DEDICATED ACCESS SERVICE

4.1 General

4.1.1 The Company, at its discretion, may provide Intrastate Dedicated Access Services with transmission speeds ranging from 2.4 Kbps to 2.4 Gbps. Dedicated Access Services are offered on a point-to-point basis only. Each Dedicated Access Service is dedicated to a single Customer and the entire usable bandwidth for each service is available to that Customer for their exclusive use.

4.1.2 All Dedicated Access Services, if offered, will be provided on an Individual Case Basis.

Issued: December 17, 2014

Issued by:
Kyle V. Bertrand
Vice President of Regulatory & Network Operations

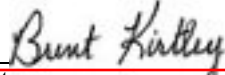
KENTUCKY PUBLIC SERVICE COMMISSION
JEFF R. DEROUEN EXECUTIVE DIRECTOR
TARIFF BRANCH

Effective: January 1, 2015 1/1/2015 PURSUANT TO 807 KAR 5:011 SECTION 9 (1)

SECTION 5 - MISCELLANEOUS SERVICES AND CHARGES

5.1 Billing Name and Address

5.1.1 Service Description

Billing Name and Address (BNA) service provides account detail of the Company's customers to interexchange carriers, operator service providers, enhanced service providers, and any other provider of interstate telecommunications services.

5.1.2 General

- A.** Upon acceptance of an order for BNA service, the Company will furnish account detail for each working number submitted. Account detail consists of current data base information including the end user's billing name and billing address.
- B.** Only current information which resides in the Company's data base will be provided. Customers ordering BNA service must accept BNA account detail on an "as is" basis.
- C.** The Company will specify the location where requests for BNA service are to be received, and the format in which the requests are to be provided.
- D.** The subscribing customer must agree that BNA information will not be resold or otherwise provided to any other person, corporation, partnership or entity, other than Customer's authorized billing agent, and that Billing Name and Address shall be used by Customer or Customer's authorized billing agent solely for:
 - 1. Billing its customers for using Customer's telecommunications services.
 - 2. Any purpose associated with the equal access requirement of United States v. AT&T, 552 F. Supp. 131 (D.D.C. 1982).
 - 3. Verification of service orders of new customers, identification of customers who have moved to a new address, fraud prevention, and similar nonmarketing purposes.

For calling card calls and collect and third party billed calls, Billing Name and Address for ANI service is not available on accounts of nonpublished/unlisted end users who, by request to the Company (which request may be submitted at any time), have specified that such information not be released.

Issued: December 17, 2014

Issued by:
Kyle V. Bertrand
Vice President of Regulatory & Network Operations

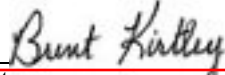
KENTUCKY PUBLIC SERVICE COMMISSION
JEFF R. DEROUEN EXECUTIVE DIRECTOR
TARIFF BRANCH

Effective: January 1, 2015 1/1/2015 PURSUANT TO 807 KAR 5:011 SECTION 9 (1)

SECTION 5 - MISCELLANEOUS SERVICES AND CHARGES, (CONT'D)

5.1 Billing Name and Address (Continued)

5.1.2 (Continued)

E. Manual Request

1. At the Customer's option, the Company will provide BNA via manual request procedures.
2. BNA service information will be provided by the Company in standard paper format via facsimile or first class U.S. mail.
3. Wherever possible, the Company will provide Billing Name and Address for ANI data no later than ten (10) business days from the date of receipt of the Customer's request. Availability of data may be delayed if errors exist in the request received from the customer.
4. In situations where the Customer requests more than forty (40) BNA records on a single order, the Company will provide the requested BNA information in a time frame mutually agreed to by the Customer and the Company.

F. Mechanized Request

1. At the Customer's option, the Company will provide BNA, subject to procedures established for Customer Account Record Exchange (CARE).
2. The Customer will submit its requests through proper CARE procedures, as revised or amended.

Issued: December 17, 2014

Issued by:
Kyle V. Bertrand
Vice President of Regulatory & Network Operations

Effective: *January 1, 2015*

1/1/2015
PURSUANT TO 807 KAR 5:011 SECTION 9 (1)

**KENTUCKY
PUBLIC SERVICE COMMISSION**

**JEFF R. DEROUEN
EXECUTIVE DIRECTOR**

TARIFF BRANCH

Brent Kirtley

Effective: *January 1, 2015*

1/1/2015
PURSUANT TO 807 KAR 5:011 SECTION 9 (1)

SECTION 5 - MISCELLANEOUS SERVICES AND CHARGES, (CONT'D)

5.1 Billing Name and Address (Continued)

5.1.3 Rate Regulations

The number of BNA records for which charges apply will be accumulated by the Company, and billed to the Customer on a monthly basis at the rates set forth in 5.3.4 following.

5.1.4 Rates and Charges

	<u>BNA Request Manual</u>	<u>BNA Request Mechanized</u>
Billing Name and Address for ANI		
- Per Order	\$50.94	ICB
- Per Record	\$ 0.33	ICB

Issued: December 17, 2014

Issued by:
Kyle V. Bertrand
Vice President of Regulatory & Network Operations

Effective: ~~January 1, 2015~~ **1/1/2015**

1/1/2015
PURSUANT TO 807 KAR 5:011 SECTION 9 (1)

**KENTUCKY
PUBLIC SERVICE COMMISSION**

**JEFF R. DEROUEN
EXECUTIVE DIRECTOR**

TARIFF BRANCH

Brent Kirtley

SECTION 6 - SPECIAL CONTRACTS, ARRANGEMENTS, AND CONSTRUCTION

6.1 Special Contract Arrangements

At the option of the Company, services may be offered on a contract basis to meet specialized pricing requirements of the Customer not contemplated by this tariff. The terms of each contract shall be mutually agreed upon between the Customer and Company and may include discounts off of rates contained herein and waiver of recurring, nonrecurring, or usage charges. The terms of the contract may be based partially or completely on the term and volume commitment, type of access arrangement, mixture of services, or other distinguishing features. Service shall be available to all similarly situated Customers for a fixed period of time following the initial offering to the first contract Customer as specified in each individual contract.

6.2 Special Service Arrangements

6.2.1 If a Customer's requirements cannot be met by services included in this tariff, or pricing for a service is shown in this tariff as "ICB", the Company will provide, where practical, special service arrangements at charges to be determined on an Individual Case Basis. These special service arrangements will be provided if the provision of such arrangements is not detrimental to any other services furnished under the Company's tariffs.

6.2.2 Special service arrangement rates are subject to revision depending on changing costs or operating conditions.

6.2.3 If and when a special service arrangement becomes a generically tariffed offering, the tariffed rate or rates will apply from the date of tariff approval.

6.3 Non-Routine Installation Charges

At the Customer's request, installation and/or maintenance may be performed outside the Company's regular business hours or in hazardous locations. In such cases, charges based on cost of the actual labor, material, or other costs incurred by or charged to the Company will apply. If installation is started during regular business hours but, at the Customer's request, extends beyond regular business hours into time periods including, but not limited to, weekends, holidays or night hours, additional charges may apply.

Issued: December 17, 2014

Issued by:
Kyle V. Bertrand
Vice President of Regulatory & Network Operations

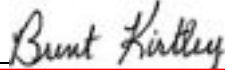
KENTUCKY PUBLIC SERVICE COMMISSION
JEFF R. DEROUEN EXECUTIVE DIRECTOR
TARIFF BRANCH

Effective: 1/1/2015
PURSUANT TO 807 KAR 5:011 SECTION 9 (1)

Effective: January 1, 2015

1/1/2015

PURSUANT TO 807 KAR 5:011 SECTION 9 (1)

SECTION 6 - SPECIAL CONTRACTS, ARRANGEMENTS, AND CONSTRUCTION, (CONT'D)

6.4 Special Construction Charges

6.4.1 General

- A.** Special construction charges may apply for services provided to the Customer by the Company. Special construction includes but is not limited to that construction undertaken:
- (a) where facilities are not presently available, and there is no other requirement for the facilities so constructed;
 - (b) of a type other than that which the Company would normally utilize in the furnishing of its services;
 - (c) over a route other than that which the Company would normally utilize in the furnishing of its services;
 - (d) in a quantity greater than that which the Company would normally construct;
 - (e) on an expedited basis;
 - (f) on a temporary basis until permanent facilities are available;
 - (g) involving abnormal costs;
 - (h) in advance of its normal construction; or
 - (i) when the Company furnishes a facility or service for which a rate or charge is not specified in the Company's tariff.
- B.** Where the Company furnishes a facility or service requiring special construction, charges will be determined by the Company and may include: (1) non-recurring charges; (2) recurring charges; (3) usage charges; (4) termination liabilities; or (5) a combinations thereof.
- C.** Rates and charges for special construction shall be determined and presented to the Customer for its approval prior to the start of construction. No construction will commence until and unless the Customer accepts in writing the rates and charges as presented by the Company.

Issued: December 17, 2014

Issued by:

Kyle V. Bertrand

Vice President of Regulatory & Network Operations

**KENTUCKY
PUBLIC SERVICE COMMISSION**

**JEFF R. DEROUEN
EXECUTIVE DIRECTOR**

TARIFF BRANCH

Brent Kirtley

Effective: ~~January 1, 2015~~

1/1/2015

PURSUANT TO 807 KAR 5:011 SECTION 9 (1)