



BRIAN CUMBO

ATTORNEY AT LAW

86 W. Main St., Suite 100
P.O. Box 1844
Inez, KY 41224
(606) 298-0428
FAX: (606) 298-0316
cumbolaw@cumbolaw.com

ADMITTED IN KY AND WV

RECEIVED

MAY 12 2016

Public Service
Commission

May 10, 2016

Aaron Greenwell, Acting Executive Director
Public Service Commission
P.O. Box 615
Frankfort, KY 40602

RE: Martin County Water District
PSC Case No. 2016-00142

Dear Mr. Greenwell:

Enclosed please find an original and one (1) copy of Motion for Confidentiality and the redacted Martin County Water District's Response to information requested in Appendix H of the Public Service Commission's Order entered April 11, 2016 regarding the above matter.

Thank you for your attention to this matter.

Very truly yours,

BRIAN CUMBO

BC/ld
Enclosure
cc: Martin County Water District

COMMONWEALTH OF KENTUCKY

BEFORE THE PUBLIC SERVICE COMMISSION

In the Matter of:

INVESTIGATION OF THE OPERATING)
CAPACITY OF MARTIN COUNTY WATER) CASE NO. 2016-00142
DISTRICT PURSUANT TO KRS 278.280)

RECEIVED

MAY 12 2016

Public Service
Commission

**MARTIN COUNTY WATER DISTRICT'S RESPONSE TO
INFORMATION REQUESTED IN APPENDIX H OF THE
PUBLIC SERVICE COMMISSIONER'S ORDER
ENTERED APRIL 11, 2016**

CERTIFICATE OF SERVICE

I hereby certify that service was made as required by the April 11, 2016 Order of the Public Service Commission, the original and one true and correct copy of the Martin County Water District's Response to information requested in Appendix H of said Order, to the following on May 5, 2016 via overnight delivery and the redacted Response on May 10, 2016: Aaron D. Greenwell, Acting Executive Director, Public Service Commission, 211 Sower Boulevard, P.O. Box 615, Frankfort, KY 40602



**HON. BRIAN CUMBO
ATTORNEY FOR MARTIN COUNTY
WATER DISTRICT
PO BOX 1844
INEZ, KY 41224
TELEPHONE (606) 298-0428
FACSIMILE (6060) 298-0316
EMAIL: cumbolaw@cumbolaw.com**

TABLE OF CONTENTS

MARTIN COUNTY WATER DISTRICT'S RESPONSE..... 1-8

VERIFICATION OF PREPARER..... 9

EXHIBIT #1 – CURRENT LIST OF WORK ORDERS

EXHIBIT #2 -- NUMBER OF TAPS REQUESTED

EXHIBIT #3 – NUMBER OF TAPS REQUEST PENDING

EXHIBIT #4 – NUMBER OF TURN-OFFS

EXHIBIT #5 – COMPARISON OF ELECTRICITY COST

EXHIBIT #6 – WATER LOSS AND LEAK DETECTION PROGRAM

EXHIBIT #7 – UPDATED CAPITAL IMPROVEMENT PLAN

EXHIBIT #8 – PENDING DISCONNECTS

EXHIBIT #9 – BUSINESS MANAGER'S JOB DUTIES

EXHIBIT #10 – WRITTEN COMPLAINTS

EXHIBIT #11 – TELEMETRY PRESSURE CHARTS

EXHIBIT #12 – PUBLIC NOTIFICATION

EXHIBIT #13 – DIVISION OF WATER



Martin County Water District

Before the Public Service Commission

Martin County Water District ("Martin District"), a water district organized pursuant to KRS Chapter 74, owns and operates facilities that treat and distribute water to approximately 3,533 customers in Martin County, Kentucky.

Joe Hammond
Jhammond58@bellsouth.net

PSC Data Request Response Case No. 2016-00142

Questions 1-17 are related to ongoing Management Audit recommendations steps.

1. Refer to the 2007 Management Audit Action Plan, Recommendation 11-1

Step 3. Provide a current list of work orders for leak repairs, meter sets, meter rereads, meter pulls, low pressure, meter reads (in and out), tap relocates, and similar distribution work, and explain how Martin District addresses these work orders.

- a. Exhibit #1

2. Refer to the 2007 Management Audit Action Plan, Recommendation 11-1

Step 4. Provide the following:

- A. The number of tap requests processed and completed since October 6, 2015 (the date the new NRC tariff was issued).

- a. Exhibit #2
- b. 5 Tap request

- B. The number of tap request pending as of November 13, 2015.

- c. Exhibit #3
- d. No tap request pending

- C. An estimate of when Martin District expects to complete the taps outstanding as of November 13, 2015.

- e. No taps outstanding

3. Refer to the 2007 Management Audit Action Plan, Recommendation 11-1

Step 5. Provide the following:

- A. The number of turn-offs performed since October 6, 2015.

- a. Exhibit #4

- B. The number of outstanding or past-due accounts.

- b. 137 Customers - 30-60-90 days

4. Refer to the 2007 Management Audit Action Plan, Recommendation 11-1

Step 7. Provide the following:

- A. Identify the number and location of additional pumps Martin District plans to install to allow pumping at night. For each, provide an estimate of when Martin District plans to install the pumps.
 - a. None at this time
- B. A comparison of electricity costs for each month for the past two years.
 - b. Electricity comparison for 2014 - 2015
 - c. Exhibit #5

5. Refer to the 2007 Management Audit Action Plan, Recommendation 11-1

Step 9. Provide the following:

- A. Explain whether or not Martin District will reach the goal of five treatment plant operators.
 - a. At present the District has two (2) part-time and two (2) full-time operators.
 - b. The District has one employee full-time training for his class II operator license. He will be testing in July 2016. Hopefully by January 2017, he will be ready for his class III.
 - c. As everyone knows, treatment operators are difficult to find and to hire. In-house training is a must and that is the District's goal.

6. Refer to the 2007 Management Audit Action Plan, Recommendation 11-2

Step 1. Provide the following:

- A. The amount and percentage of line loss on each system (A and B) through December 31, 2015.
 - a. Amount of water loss = 393.097 million gallons
 - b. Percentage = 62%
- B. The amount and percentage of line loss for calendar years 2014, 2013, and 2012.
 - a. Amount of water loss 2012 = 370.087 million gallons
=56% Loss

- b. Amount of water loss 2013 = 399.816 million gallons = 61% Loss
- c. Amount of water loss 2014 = 376.606 million gallons = 52%

7. Refer to the 2007 Management Audit Action Plan, Recommendation 11-1

Step 2 and 3. Provide the following:

- A. Identify known leaks and prioritize the mains and services for replacement or repair based on volumes.
 - a. Pigeon Roost under railroad tracks – casing broke and broke a 4" line. Repaired March 2016. Leak detection assisted by KRWA and District personnel.
 - b. Little Peter Cave, Wolf Creek Area, estimated 2 to 3 million a month. Repaired April 2016. Leak detection assisted by KRWA and District personnel.
 - c. Elk Creek, Beauty KY, estimated 3 to 3.5 million a month. Repaired March 2016. Leak detection assisted by KRWA and District personnel.
- B. An estimate of when replacement or repair will be undertaken.
 - a. This will be an ongoing process until water loss is under control.
 - b. Replacement of old water lines will be determined when funding is in place.
 - c. Repairs to line breaks will be taken care of ASAP.

8. Refer to the 2007 Management Audit Action Plan, Recommendation 11-2

Step 4. Other than identification (of cheater bars) when reading meters, explain how Martin District is addressing this recommendation.

- a. Since August 2015, found 2 cheater bars and turned over to the County Attorney for prosecution.
- b. One customer is now paying his bill due to the County Attorney's action.
- c. No update on the other one.

9. Refer to the 2007 Management Audit Action Plan, Recommendation 11-2

Step 5. Provide an update of Martin District's progress in replacing or repairing all excessively leaking mains and services as outlined in Step 5. Identify any decreases in water loss resulting from it efforts.

- a. Reference Step 2 and 3 above. The leaks mention above have been repaired. Our storage tanks in these areas are maintained at the appropriate levels. Water loss in these areas will be determined at the end of the month.

10. Refer to the 2007 Management Audit Action Plan, Recommendation 11-3

Steps 1-4. Provide Martin District's formal, written preventive maintenance program.

- a. The District has a Water Loss and Leak Detection Program for Preventive Maintenance.
- b. Exhibit #6
- c. The District will begin to prepare a complete Preventive Maintenance Plan for all assets in the District.

11. Refer to the 2007 Management Audit Action Plan, Recommendation 11-5

- a. After consulting with the Health Inspector, concerning the water shed, he is aware of the situation and monitors the area where residents live. No complaints at this time.

12. Refer to the 2007 Management Audit Action Plan, Recommendation 11-6

Steps 1, 2, 3, and 6. Other than working with the electric providers to reduce power outages, explain how Martin District is addressing this recommendation.

- a. The District has purchased a 300kw mobile generator that can run the plant or any other pump station in the system. The District has spent approximately \$23000.00 for the generator. This has and will continue to assist the District in covering our power outages.
- b. Also, the power company has been clearing trees from overhead power lines.

13. Refer to the 2007 Management Audit Action Plan, Recommendation 111-1

Other than working with the Big Sandy ADD, explain what internal or other external steps Martin District is taking to address this recommendation.

- a. Continue to meet with BSADD, KRWA, PSC, and Division of Water planning and prioritizing our system to comply with the rules and regulation set forth for the District.
- b. The District will evaluate the upgrades made to the Capital Improvement Plan of 2003 and improve the Plan to current needs of the system. Plans updated (03/08/2016).
- c. Exhibit #7

14. Refer to the 2007 Management Audit Action Plan, Recommendation 111-2

Steps 1 and 2. Provide the following:

- A. Identify the water loss reduction related construction projects undertaken in the past year and identify those planned for the next six months.
 - a. The District is replacing old service lines and as funding permits, replacing old main lines.
 - b. Training and assistance from KRWA pertaining to the proper technique in locating hard to find leaks and to maintain proper records to ascertain when a leak occurs and repair and track the amount of water loss. This process will continue throughout the daily process of the District.
 - c. Replacing 100 Radio Read meters in the Wolf Creek Area. If funding becomes available, the District plans are to continue replacing all manual read meters. This will help with water loss and theft of services.
 - d. The District believes that each project identified above will contribute to less water loss.

15. Refer to the 2007 Management Audit Action Plan, Recommendation IV-3

Provide a report of pending disconnects for 30-60-90 days, for the most recent date, available at the time of your response.

- a. Exhibit #8

16. Refer to the 2007 Management Audit Action Plan, Recommendation V-4

Steps 1, 2, 3 and 4. Provide the following:

- A. External audit reports for years 2013, 2014, and 2015 when completed.

- a. The audit firm of White and Associates, PSC, Richmond, KY has been engaged to complete audits for the years in question. The projected completion dates are early summer 2016. Copies will be forwarded upon receipt.
 - B. If any of these reports are complete, provide an estimate of when each audit will be completed.
 - b. No audits are complete at this time.
17. Refer to the 2007 Management Audit Action Plan, Recommendation V-5
- Steps 1 and 2: Provide a description of the duties of the Business Manager position.
- a. Exhibit #9
18. Refer to the 2007 Management Audit Action Plan, Recommendation V-5
- A. Provide a copy of each written complaint or electronic mail message containing a complaint concerning water service received by Martin District during the period January 1, 2013 to the present. Include with the response a copy of Martin District's response to the complaint. If Martin District has not retained documentation of the complaints, explain why each document has not been retained.
 - a. 2013 - 2016 Exhibit #10
19. Provide a schedule that contains the date, time, and duration of each event in which Martin District was not in compliance with 807 KAR 5:066, Section 5(1). During the period January 1, 2013, to present.
- a. The District uses our Telemetry system to monitor the pressure (both Suction and Discharge) throughout our system.
 - a. Exhibit #11
 - b. Beginning this month, (April 2016) a pressure recording device will be installed in different areas of the system and charts maintained.
20. Provide a copy of each public notification that Martin District has been required to provide to its customers pursuant to federal or state drinking water regulations during the period January 1, 2013, to present.
- a. Exhibit #12
21. Provide a copy of all communication between Martin District and the Kentucky Division of Water, including its regional offices, during the period January 1, 2013, to present.

- a. Researching files to completely comply with this request.
- b. Exhibit #13

22. Refer to the Public Service Commission's Utility Inspection Report for Martin District dated December 23, 2014. Provide the following:

- A. Explain why Martin District failed to produce pressure surveys that showed a continuous 24-hour pressure recording for a minimum of one week per month as required by 807 KAR 5:066, Section 5(2).
 - a. Ongoing research as to the fail process of the pressure surveys required by 807 KAR 5:066, Section 5(2).
 - b. Policies have been implemented effective April 1, 2016 to be fully compliant.
- B. Explain Martin District's procedure for monitoring and documenting withdrawals from Martin District by fire departments.
 - c. Reports have been presented to the Fire Departments to complete the withdrawals from the Martin District's system, however, no cooperation.
- C. For each fire department that made a withdrawal from the Martin District system for the purpose of extinguishing fires or training purposes during the period January 1, 2013, to present, provide a copy of the fire department's estimate of the withdrawal.
 - d. Estimates were made by the District's Office since no reports were present for withdrawals and placed on the water loss report as estimates.
- D. For any instance in which a fire department failed to provide an estimate of a withdrawal during the period January 1, 2013, to present, state the actions that Martin District took concerning the failure.
 - e. A meeting was held with the County Judge Executive the Chairman of the Board and Business Manager, concerning the lack of water withdrawal reports from the Fire Departments and was informed that the Judge Executive would withhold funds from the Fire Departments.
- E. Provide a copy of each record kept by Martin District pursuant to 807 KAR 5:006, Section 26(3), for the period January 1, 2015, to date.
 - f. The District will be presented with a Utility Inspection Checklist for approval at the next meeting on May 24, 2016. The Inspection Checklist will then be sent to the Commission for review.

23. Identify each contract that Martin District has with another water system for the purchase or sale of water. For each contract, state the date the contract was filed with the Commission.
- a. Mountain Water District (04/16/1992)
 - b. Paintsville Utilities (05/01/2013)
 - c. Prestonsburg Utilities (Agreement (01/15/1998))
24. Confirm whether Martin District is currently providing water service to the United States Penitentiary, Big Sandy, and if not, explain why Martin District is unable to provide water service to the federal prison.
- a. The District supplies water to the Honey Branch Tank and that water pumped is metered at the pump station, located at the entrance to the Honey Branch Industrial Park. Martin County customers or businesses located on the Industrial Site and on New Route 3, Davella Road, Brookview Apartments, and Holding Hills Trailer Park are supplied by the Honey Branch Tank. The water supplied to District's customers is metered by the outgoing meter at the pump station. The difference in water going to the Honey Branch Tank and water supplied to the Martin County customers is purchased by Prestonsburg Utilities at \$3.05 per thousand. If we do not pump sufficient amount of water to supply our businesses and customers mention, we must pay Prestonsburg Utilities \$3.05 per thousand. Prestonsburg Utilities has the Contract with the United States Prison

VERIFICATION

I, Joe Hammond, of the Martin County Water District, hereby verify that the responses and exhibits attached hereto are true and correct to the best of my knowledge.



JOE HAMMOND

STATE OF KENTUCKY)

COUNTY OF MARTIN)

SUBSCRIBED, SWORN and ACKNOWLEDGED before me by Joe Hammond
this 9th day of May, 2016.

My Commission Expires: 9-18-18.



NOTARY PUBLIC, STATE AT LARGE

Exhibit #1
Current List of Work Orders

Martin County Water District

387 East Main St., Suite 140
Inez, KY 41224
(606) 298-3885

Service Orders Dated Between 4/1/2016 And 4/29/2016

Type of Work	Service Order Count	Closed Order Count	Open Order Count
Change Out	28	14	14
Cheater Bar Investigation	2	1	1
Complaints	6	3	3
Leak	28	20	8
Line Locate	2	1	1
Meter Pull Non-Pay	16	10	6
Meter Set	32	31	1
MISC.	32	20	12
Pull - Customer Request	21	16	5
Pull - MCWD Request	2	2	0
Read IN	13	11	2
Read Out	13	11	2
Replace shut off	4	2	2
Re-Read	1	1	0
Tap	5	1	4
Verify Meter Number And Re	16	15	1
Totals:	221	159	62

Exhibit #2
Number of Taps Requested

Martin County Water District

387 East Main St., Suite 140

Inez, KY 41224

(606) 298-3885

Service Orders Dated Between 10/6/2015 And 4/29/2016

Type of Work	Service Order Count	Closed Order Count	Open Order Count
Tap	14	10	4
Totals:	14	10	4

Exhibit #3

Number of Taps Request Pending

Martin County Water District

387 East Main St., Suite 140
Inez, KY 41224
(606) 298-3885

Service Orders Dated Between 10/6/2015 And 11/13/2015

Type of Work	Service Order Count	Closed Order Count	Open Order Count
Tap	5	5	0
Totals:	5	5	0

Exhibit #4
Number of Turn-offs

Martin County Water District

387 East Main St., Suite 140

Inez, KY 41224

(606) 298-3885

Service Orders Dated Between 10/6/2016 And 4/29/2016

Type of Work	Service Order Count	Closed Order Count	Open Order Count
Meter Pull Non-Pay	143	137	6
Pull - Customer Request	117	111	6
Pull - MCWD Request	3	3	0
Totals:	263	251	12

Exhibit #5
Comparison of Electricity Cost

MARTIN COUNTY WATER DISTRICT

Purchased Power: 2015		Purchased Power: 2014	
Jan 2015	25,804.90	Jan 2014	30,264.06
Feb 2015	24,920.52	Feb 2014	21,212.23
March 2015	33,022.57	March 2014	20,753.67
April 2015	18,694.78	April 2014	13,010.71
May 2015	16,534.37	May 2014	22,947.20
June 2015	21,505.77	June 2014	22,637.44
July 2015	25,425.76	July 2014	27,219.42
Aug 2015	23,221.15	Aug 2014	33,597.27
Sept 2015	25,847.90	Sept 2014	32,347.95
Oct 2015	35,897.10	Oct 2014	29,940.51
Nov 2015	31,206.11	Nov 2014	29,764.02
Dec 2015	32,613.03	Dec 2014	24,272.98
	<u>314,693.96</u>		<u>307,967.46</u>

Exhibit #6
Water Loss and Leak Detection Program

**Martin County Water District
Water Loss Plan
February 2016**

Steps to follow:

- Read the master meters daily and at the same time each day. At a minimum, they should be read Monday through Friday. This will minimize water loss due to a large leak that can go undetected for a week or month.
- Divide the distribution system into zones or subsections where possible and calculate water loss for each zone. This will allow for the prioritizing of work based upon the severity of the problem in a particular zone.
- Utilize computer billing software to generate water loss reports for sections or zones as well as to generate an overall water loss report.
- Install bypass monitor meters as needed to isolate lines with potential leaks. A 5/8- x 3/4- inch meter will suffice for each 100 customer section of line.
- Install a 2 – inch bypass monitor meter at water storage tanks to isolate sections of the line with potential leaks during the night (1:00 a.m. to 4:00 a.m.)
- Utilize pressure recordings to detect fluctuating pressures and abnormally low or high pressures in distribution systems lines.
- Test and change-out all meters according to Kentucky Public Service Commission (PSC) regulations. PSC regulations require residential meters to be tested and changed-out in 10-year intervals. Four-inch and larger meters are to be tested annually.

- It may be feasible to hire a part-time operator to utilize leak detection equipment to search for leaks. A portion of the distribution system could be covered each month.
- Identify sections of pipe in the distribution system with the most frequent line breaks. Budgeting for infrastructure replacement is imperative in any water utility.
- Having a main transmission line from the master meter to a water storage tank will reduce pressure fluctuations in the distribution system and result in fewer line breaks.
- Provide the necessary resources for manpower and equipment to properly maintain the distribution system appurtenances such as gate valves, pressure reducing valves, and hydrants.

COMPONENTS OF A WATER LOSS PREVENTION PLAN

How do the terms "water loss" and "weight gain" relate? Can it be that apathy, procrastination, or plain idleness might apply to both situations? Definitely, good intentions abound with either problem. No one wants to be overweight, just as no one who is responsible for the management and operation of a water utility wants to have excessive water loss. How do we attack these problems? In either case, we must identify the root of the problem, focus on a solution and stick with it! How many times have we heard the phrase, "If you fail to plan, you plan to fail." A good plan is the key to any long-term solution.

A person's physical and psychological make-up has a huge impact when attempting to solve the weight problem. Heredity affects us in many ways, but especially in regards to our ability to lose weight. What about the person who accepted the position of manager and soon learned that they had inherited an inadequately operated water system?

Age is another common factor in both problems. A water distribution system that was installed in the WPA days of the 1930's will most likely experience problems that newly installed water lines will not possess. The older that I get, the harder it is to keep the weight off! We can list other analogies such as our body shapes and sizes compared to the geographical terrain of our utilities and our distribution system sizes. However, let's get going with a proactive approach to the problem of water loss.

Accurate records are vital to any water loss prevention plan. How do we know the status of our water loss if we do not keep records? There is a water loss template that is available for download from the Kentucky Rural Water Association website (www.krwa.org). This Excel spreadsheet, or a similar record keeping system, can be utilized in a preliminary water audit. The initial step in water loss prevention is the water loss calculation. Secondly we must locate and eliminate all water leaks. Sounds easy, doesn't it?

The following steps can be utilized to prevent or reduce water loss and should be incorporated into a water loss prevention plan:

1. Read the master meters daily and at the same time each day. At a minimum, they should be read Monday through Friday. This will minimize water loss due to a large leak that can go undetected for a week or month.
2. Read all meters in the distribution system within a 3- to 5-day window. When the meters are read over a

2-week period, this will cause fluctuations of monthly water loss numbers. However, these numbers will average out over a year's period of time.

3. Divide the distribution system into zones or subsections where possible and calculate water loss for each zone. This will allow for the prioritizing of work based upon the severity of the problem in a particular zone.
4. Utilize computer billing software to generate water loss reports for sections or zones as well as to generate an overall water loss report.
5. Install bypass monitor meters as needed to isolate lines with potential leaks. A 5/8- x 3/4-inch meter will suffice for each 100-customer section of line.
6. Install a 2-inch bypass monitor meter at water storage tanks to isolate sections of the line with potential leaks during the night (1:00 a.m. to 4:00 a.m.)
7. Utilize pressure recordings to detect fluctuating pressures and abnormally low or high pressures in distribution system lines.
8. Test and change-out all meters according to Kentucky Public Service Commission (PSC) regulations. PSC regulations require residential meters to be tested and changed-out in 10-year intervals. Four-inch and larger meters are to be tested annually.
9. It may be feasible to hire a part-time operator to utilize leak detection equipment to search for leaks. A portion of the distribution system could be covered each month.
10. Identify sections of pipe in the distribution system with the most frequent line breaks. Budgeting for infrastructure replacement is imperative in any water utility.
11. Having a main transmission line from the master meter to a water storage tank will reduce pressure fluctuations in the distribution system and result in fewer line breaks.
12. Provide the necessary resources for manpower and equipment to properly maintain the distribution system appurtenances such as gate valves, pressure reducing valves, and hydrants.

Today's advanced technology can certainly enhance our water loss prevention plan. Computers not only utilize software for spreadsheets to calculate water loss expediently, but can be used in a variety of ways to identify areas of the distribution system with potential leaks. Both master meters and customer meters can be read by satellites or other automated meter reading mechanisms.

Telemetry/SCADA systems operated with computers can produce trend charts for water flows, water pressures, and water levels in storage tanks. This kind of data is valuable in determining where leaks are or are not prevalent. Computers analyze hydraulic data to determine if theoretical and actual water flows and water pressures in the distribution system match. Computerized maps with GPS and GIS data are beneficial when used properly. A water utility's budget is the major limiting factor as to why technology is not used more frequently.

By industry standards, more than 15 percent water loss in a rural system is unacceptable. Probably, no one realizes this more than the managers of water districts, water associations, and investor-owned utilities under the jurisdiction of the Kentucky Public Service Commission. Just as we should be concerned with our health due to being overweight, the PSC is concerned with the financial health and well-being of water utilities under their jurisdiction in Kentucky. PSC inspectors routinely discuss water loss during their inspections. When a water system exceeds 15 percent water loss on their annual report to the PSC, a deficiency is issued.

Numerous water systems' response to the PSC's Deficiency Tracking Reports (DTR) has been deemed unacceptable by PSC. A common request from PSC to the water system with a deficiency due to water loss is for a water loss control plan. A good water loss control plan should include the above-mentioned components with a time frame to implement the improvements and follow-up evaluations to measure the success of the plan.

Whether we are weighing in or wading in, we should always do so with a goal in mind. We cannot continue to ignore our problem and hope it resolves itself. Just as there are various diets to control an individual's weight, there are various methods for controlling water loss.

Let's start implementing all of our good intentions!

Exhibit #7
Updated Capital Improvement Plan

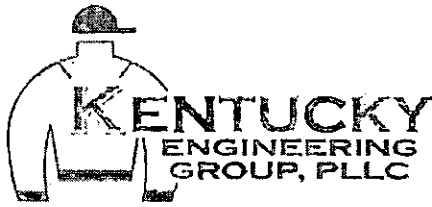

Preliminary Project Cost Estimate

Project : Water Treatment Plant Improvements

Date :

Job No. :

Revised : 03/08/16

Est. By: BKL

ITEM NO.	SUMMARY OF:	QUANTITY		COST PER UNIT	TOTAL COST
		NO. OF UNITS	UNIT MEAS.		
1	Electrical System Improvements	1	LS	\$ 280,000.00	\$ 280,000.00
2	Mechanical Renovations (Operations Building)	1	LS	\$ 196,000.00	\$ 196,000.00
3	Structural Renovations (Operations Building)	1	LS	\$ 216,000.00	\$ 216,000.00
4	Architectural Renovations (Operations Building)	1	LS	\$ 425,000.00	\$ 425,000.00
5	Process Improvements and Expansion	1	LS	\$ 3,430,000.00	\$ 3,430,000.00
	Subtotal				\$ 4,547,000.00
	Contractors OH&P (10%)				\$ 454,700.00
	Subtotal				\$ 5,001,700.00
	Mobilization, Bonds, and General Conditions (10%)				\$ 500,170.00
	Subtotal				\$ 5,501,870.00
	Contingency @ 10%				\$ 550,187.00
	Total				\$ 6,052,057.00
	TOTAL AMOUNT - CONSTRUCTION COST				\$ 6,052,057.00
	ENGINEERING DESIGN		6.64%		\$ 402,150.00
	RESIDENT INSPECTION		3.31%		\$ 200,600.00
	LEGAL AND ADMINISTRATION				
	TOTAL ESTIMATED PROJECT COST				\$ 6,654,807.00

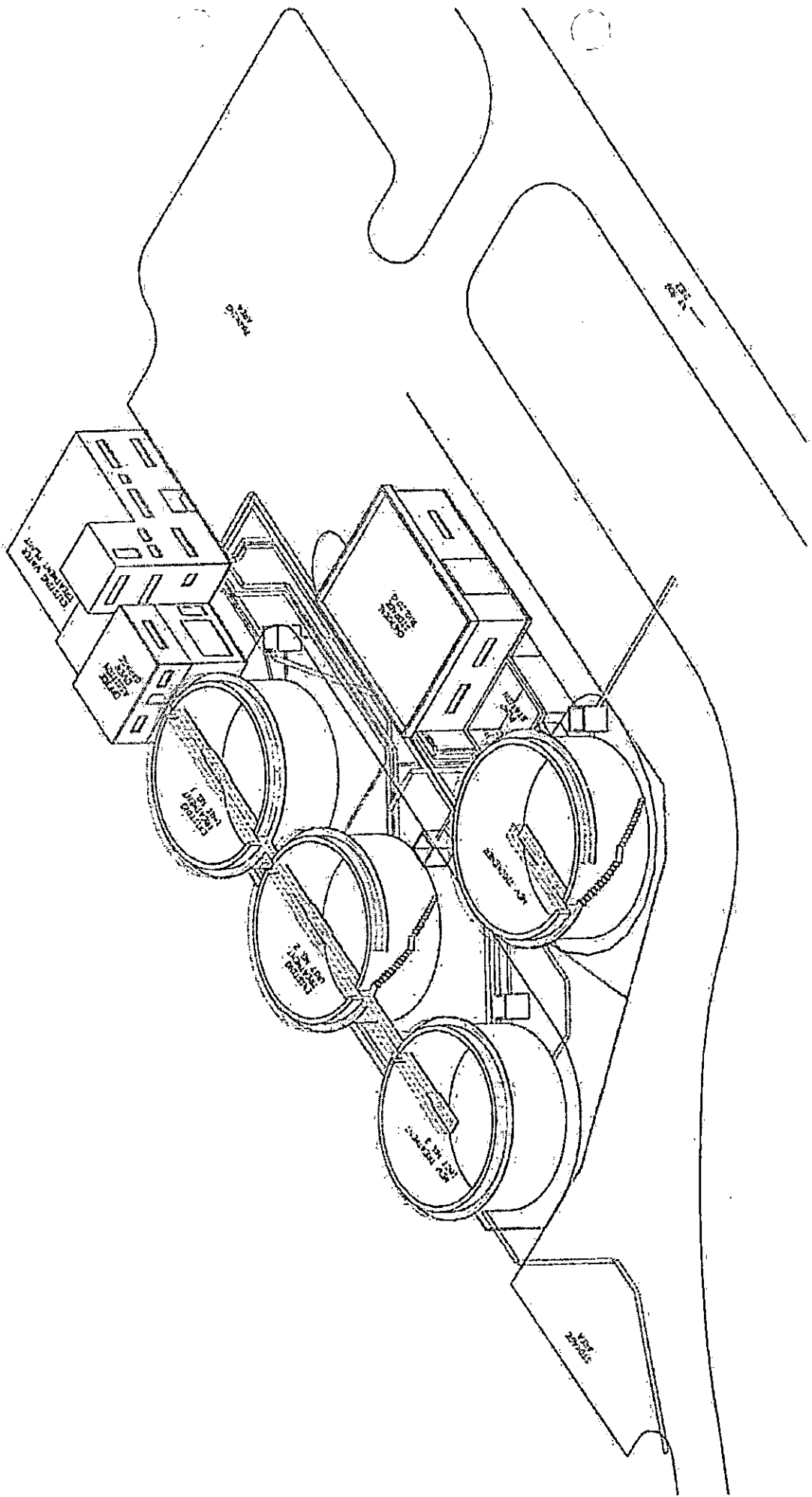

Exhibit #8
Pending Disconnects

Martin County Water

Past Due

04 29 2016

Text44	Text46	Current	30 Days	60 Days	90 Days	Total Due
KY	41224	\$57.33	\$98.68	\$75.91	\$0.00	\$231.92
KY	41224	\$57.33	\$37.62	\$37.62	\$115.86	\$248.43
KY	41267	\$86.31	\$45.21	\$9.63	\$0.00	\$141.15
KY	41267	\$57.33	\$30.03	\$96.80	\$0.00	\$184.16
KY	-41231	\$34.20	\$0.00	\$0.00	\$325.40	\$359.60
KY	-41267	\$102.87	\$105.94	\$30.03	\$120.12	\$358.96
KY	-41224	\$318.17	\$166.66	\$166.66	\$834.34	\$1,485.83
KY	-41267	\$157.38	\$105.94	\$23.76	\$0.00	\$287.08
KY	41267	\$57.33	\$37.62	\$0.54	\$0.00	\$95.49
KY	41224	\$64.23	\$45.21	\$104.92	\$0.00	\$214.36
KY	-41224	\$85.62	\$57.97	\$37.62	\$27.70	\$208.91
KY	41231	\$61.80	\$0.00	\$0.00	\$206.73	\$268.53
KY	-41231	\$57.33	\$30.03	\$4.60	\$0.00	\$91.96
KY	41231	\$52.61	\$0.00	\$0.00	\$171.04	\$223.65
KY	41231	\$71.82	\$37.62	\$3.78	\$0.00	\$113.22
KY	41231	\$57.33	\$45.21	\$5.93	\$0.00	\$109.47
KY	41231	\$57.33	\$30.03	\$2.06	\$0.00	\$89.42
KY	41231	\$100.11	\$67.98	\$0.31	\$0.00	\$168.40
KY	41224	\$79.41	\$75.57	\$37.62	\$0.00	\$192.60
KY	-41250	\$30.03	\$30.03	\$45.21	\$231.66	\$336.93
KY	-41250	\$30.03	\$30.03	\$10.15	\$0.00	\$70.21
KY	-41250	\$37.62	\$37.62	\$5.49	\$0.00	\$80.73
KY	-41250	\$67.98	\$189.44	\$30.03	\$302.74	\$590.19
Ky	-41250	\$0.00	\$0.00	\$0.00	\$229.46	\$229.46
KY	-41250	\$0.00	\$0.00	\$0.00	\$241.55	\$241.55
KY	-41250	\$0.00	\$0.00	\$0.00	\$67.95	\$67.95
KY	-41250	\$0.00	\$0.00	\$59.61	\$109.31	\$168.92
KY	-41224	\$0.00	\$0.00	\$74.03	\$0.00	\$74.03
KY	41224	\$30.03	\$30.03	\$30.03	\$0.00	\$90.09
KY	-41250	\$57.33	\$30.03	\$37.62	\$39.29	\$164.27
KY	-41267	\$262.97	\$86.30	\$0.00	\$163.66	\$512.93
KY	-41267	\$93.21	\$52.80	\$37.62	\$8.15	\$191.78
KY	41231	\$64.23	\$30.03	\$5.42	\$0.00	\$99.68
KY	-41231	\$100.11	\$0.00	\$0.00	\$190.38	\$290.49
KY	41231	\$71.13	\$52.80	\$23.66	\$134.86	\$282.45
KY	-41231	\$149.79	\$90.75	\$50.97	\$0.00	\$291.51
Ky	-41231	\$57.33	\$30.03	\$20.06	\$0.00	\$107.42
Ky	41514	\$89.03	\$37.62	\$30.03	\$3.46	\$160.14
KY	-41514	\$64.23	\$30.03	\$30.03	\$4.06	\$128.35
KY	41203	\$115.29	\$83.16	\$9.78	\$0.00	\$208.23
KY	41203	\$61.80	\$0.00	\$0.00	\$157.14	\$218.94
KY	41203	\$57.33	\$30.03	\$8.06	\$39.96	\$135.38
KY	-41203	\$64.23	\$52.80	\$13.86	\$0.00	\$130.89
KY	41231	\$57.33	\$30.03	\$30.03	\$0.00	\$117.39
KY	41203	\$57.33	\$37.62	\$23.16	\$0.00	\$118.11

Martin County Water

Past Due

04 29 2016

KY	41203	\$130.47	\$83.16	\$67.98	\$173.86	\$455.47
KY	41203	\$93.90	\$52.80	\$27.18	\$29.65	\$203.53
KY	-41203	\$57.33	\$45.21	\$7.59	\$0.00	\$110.13
KY	41567	\$57.33	\$37.62	\$10.60	\$0.00	\$105.55
Ky	-41224	\$129.09	\$45.21	\$67.98	\$153.23	\$395.51
KY	-41224	\$78.72	\$30.03	\$19.29	\$0.00	\$128.04
KY	-41224	\$64.92	\$30.03	\$46.60	\$126.18	\$267.73
KY	41224	\$71.82	\$37.62	\$12.01	\$0.00	\$121.45
KY	-41224	\$57.33	\$0.00	\$0.00	\$62.98	\$120.31
Ky	-41224	\$78.72	\$37.62	\$45.21	\$6.70	\$168.25
KY	41224	\$41.10	\$0.00	\$2.13	\$224.58	\$267.81
KY	41224	\$57.33	\$30.03	\$3.42	\$0.00	\$90.78
KY	41224	\$115.29	\$52.80	\$39.12	\$0.00	\$207.21
KY	41224	\$100.11	\$30.03	\$11.27	\$0.00	\$141.41
KY	-41224	\$131.85	\$143.89	\$8.36	\$0.00	\$284.10
KY	41224	\$107.62	\$0.00	\$0.70	\$0.00	\$108.32
KY	41224	\$406.10	\$401.30	\$6.89	\$0.00	\$814.29
KY	-41224	\$79.41	\$37.62	\$40.63	\$0.00	\$157.66
KY	-41224	\$108.39	\$83.16	\$68.42	\$0.00	\$259.97
Ky	-41230	\$64.23	\$52.80	\$30.03	\$115.32	\$262.38
KY	41224	\$57.33	\$30.03	\$2.73	\$0.00	\$90.09
KY	41224]	\$41.10	\$0.00	\$0.00	\$132.87	\$173.97
KY	41224]	\$57.33	\$48.62	\$30.03	\$0.00	\$135.98
KY	-41224	\$172.52	\$52.80	\$30.03	\$239.38	\$494.73
KY	-41224	\$115.98	\$52.80	\$12.82	\$0.00	\$181.60
KY	-41224	\$93.21	\$52.80	\$37.62	\$21.54	\$205.17
KY	-41224	\$57.33	\$190.63	\$9.33	\$0.00	\$257.29
KY	-41224	\$78.72	\$52.80	\$4.11	\$0.00	\$135.63
Ky	-41224	\$86.31	\$30.03	\$83.16	\$0.00	\$199.50
KY	-41224	\$54.90	\$0.00	\$0.00	\$96.31	\$151.21
KY	-41224	\$64.92	\$30.03	\$32.28	\$0.49	\$127.72
KY	-41230	\$71.82	\$0.00	\$44.41	\$87.04	\$203.27
KY	41224-09	\$100.80	\$52.80	\$14.29	\$0.00	\$167.89
KY	41224	\$93.90	\$67.98	\$30.03	\$285.51	\$477.42
KY	41224	\$130.47	\$75.57	\$52.80	\$264.83	\$523.67
KY	41224	\$79.41	\$37.62	\$45.21	\$91.28	\$253.52
KY	-41224	\$71.82	\$30.03	\$45.21	\$193.18	\$340.24
Ky	-41224	\$100.11	\$37.62	\$52.80	\$455.23	\$645.76
KY	41224	\$172.56	\$83.16	\$8.94	\$0.00	\$264.66
KY	-41224	\$107.70	\$75.57	\$10.39	\$0.00	\$193.65
KY	-41224	\$78.72	\$30.03	\$10.36	\$0.00	\$119.11
KY	-41224	\$79.41	\$37.62	\$5.21	\$0.00	\$122.24
KY	-41214	\$86.31	\$60.39	\$15.99	\$0.00	\$162.69
KY	41224	\$95.28	\$0.00	\$0.00	\$172.47	\$267.75
KY	-41214	\$79.41	\$60.39	\$60.21	\$62.25	\$262.26
KY	-41214	\$163.91	\$0.00	\$0.00	\$200.00	\$363.91

Martin County Water

Past Due

04 29 2016

KY	41214	\$71.82	\$30.03	\$15.42	\$0.00	\$117.27
KY	-41214	\$34.20	\$0.00	\$0.00	\$1.00	\$35.20
KY	-41224	\$41.10	\$0.00	\$0.00	\$68.67	\$109.77
KY	41214	\$78.03	\$30.03	\$0.06	\$0.00	\$108.12
Ky	-41214	\$57.33	\$37.62	\$2.73	\$0.00	\$97.68
KY	-41224	\$71.82	\$52.80	\$11.14	\$0.00	\$135.76
KY	41224	\$57.33	\$30.03	\$37.62	\$25.30	\$150.28
KY	41224]	\$64.23	\$15.97	\$0.00	\$16.20	\$96.40
KY	-41224	\$57.33	\$30.03	\$0.03	\$0.00	\$87.39
KY	41224	\$27.30	\$0.00	\$0.00	\$57.31	\$84.61
KY	-41230	\$57.33	\$0.00	\$0.00	\$895.27	\$952.60
Ky	-41224	\$34.20	\$7.33	\$37.62	\$74.60	\$153.75
Ky	-41230	\$108.39	\$60.39	\$4.80	\$0.00	\$173.58
KY	41230	\$100.80	\$45.21	\$52.80	\$303.05	\$501.86
KY	-41230	\$122.88	\$30.03	\$90.75	\$137.92	\$381.58
KY	-41230	\$114.60	\$52.80	\$83.16	\$54.87	\$305.43
KY	-41230	\$86.31	\$37.62	\$47.25	\$0.00	\$171.18
KY	41224	\$57.33	\$30.03	\$2.73	\$0.00	\$90.09
KY	41224]	\$100.80	\$52.80	\$2.29	\$0.00	\$155.89
KY	-41224	\$174.64	\$107.30	\$53.30	\$0.00	\$335.24
KY	-41224	\$64.92	\$30.03	\$3.03	\$0.00	\$97.98
Ky	41224	\$61.80	\$97.11	\$124.80	\$0.00	\$283.71
KY	41224	\$57.33	\$30.03	\$0.27	\$0.00	\$87.63
KY	41224	\$100.80	\$60.39	\$25.57	\$0.00	\$186.76
KY	41224	\$27.30	\$0.00	\$0.00	\$129.63	\$156.93
KY	41224	\$497.60	\$166.66	\$227.39	\$2,191.41	\$3,083.06
KY	41224	\$57.33	\$30.03	\$30.03	\$30.03	\$147.42
Ky	-41262	\$78.72	\$37.62	\$2.11	\$0.00	\$118.45
KY	41262	\$57.33	\$30.03	\$5.63	\$0.00	\$92.99
KY	41262	\$64.23	\$45.21	\$23.22	\$0.00	\$132.66
KY	-41262	\$54.90	\$0.00	\$0.00	\$146.69	\$201.59
KY	-41262	\$64.92	\$30.03	\$3.42	\$0.00	\$98.37
KY	41224	\$54.90	\$0.00	\$0.00	\$215.66	\$270.56
KY	41224	\$64.23	\$37.62	\$37.62	\$199.73	\$339.20
KY	41224	\$209.15	\$121.12	\$16.49	\$0.00	\$346.76
KY	-41224	\$71.82	\$45.21	\$3.08	\$0.00	\$120.11
KY	41262	\$64.23	\$30.03	\$30.03	\$38.06	\$162.35
KY	41262	\$64.23	\$30.03	\$29.61	\$0.00	\$123.87
Ky	-41262	\$100.80	\$45.21	\$0.21	\$0.00	\$146.22
KY	-41262	\$57.33	\$30.03	\$0.03	\$0.00	\$87.39
KY	-41262	\$71.82	\$37.62	\$2.89	\$0.00	\$112.33
KY	-41262	\$71.82	\$30.03	\$31.98	\$0.00	\$133.83
KY	41262	\$100.11	\$52.80	\$2.80	\$0.00	\$155.71
KY	41224	\$78.72	\$121.12	\$75.57	\$76.88	\$352.29
Ky	41262	\$57.33	\$30.03	\$5.67	\$0.00	\$93.03
KY	41267	\$60.67	\$31.78	\$31.78	\$8,414.59	\$8,538.82

Martin County Water

Past Due

04 29 2016

137	CUSTOMER	\$11,488.65	\$6,278.54	\$3,521.94	\$19,996.57	\$41,285.70
-----	----------	-------------	------------	------------	-------------	-------------

Exhibit #9
Business Manager's Job Duties

Position Responsibilities

Business Mgr.

- Responsible for Financial and legal issues
- Policy enforcement
- Safety Training and reviews
- Handle PSC issues (forms, regulations, etc.)
- Control legal documents and correspondence
- Maintain personnel records
- Develop Inventory controls
- Develop purchase order protocol and controls
- Solid waste (garbage) accounts?
- Budget controls
- Quotes and bids as requested by Operations Mgr.
- Develop training programs
- Maintain office systems (hardware and software)
- Continuous system upgrades and improvements
- Equipment maintenance (office related equipment, etc.)
- Provide a safe and clean working environment
- Interface with contractors
- Report to Board

Exhibit #10
Written Complaints

Martin County Water District

387 East Main St., Suite 140
Inez, KY 41224

WORK ORDER

COMPLETED

WO # 130100208

Time Started _____

Work Complete _____

Loc # _____

Master Meter # _____

Dat 1/29/2013

Account # _____

SEQ # 479

Name: Kelly Maynard

Phone # _____

Address: _____

Employee Josh Williams

Inez, KY 41224

Location: 2032 app. 3rd trailer, white/brown

THICKETY FORK

Type of Work: Complaints

Material Used: _____

Customer Line Inspection _____

Comments: no water for three days

Current System Information:

New Information:

Meter # 1: 29934541

Meter # 1: _____

Meter # 2: Radio _____

Meter # 2: Radio _____

MXU #: _____

MXU #: _____

Current Reading 12/20/2012 362

Current Reading 0

Type of Meter: Badger

Type of Meter: _____

Year MFG: 2004

Year MFG: _____

GPS - Longitude _____

GPS - Latitude _____

Employee Signature(s): JW

Date Completed 1-29-13

Martin County Water District

387 East Main St., Suite 140
Inez, KY 41224



WORK ORDER

COMPLETED

WO # 130100197

Time Started _____

Work Complete _____

Loc # _____

Master Meter # _____

Date 1/28/2013

Account # _____

SEQ # 123

Name: Mark & Donna Howard

Phone # _____

Address: _____

Louisa, Ky 41230

Location: _____

Blankenship Hlw Rd

Type of Work: Complaints

Material Used: _____

Customer Line Inspection Blowed off

Done

Comments: Air in lines; says everyone up hollow has a lot of air in lines too

Current System Information:

Meter # 1: 29935136

Meter # 2: Radio 29935136

MXU #: _____

Current Reading 12/20/2012 112

Type of Meter: Badger

Year MFG: 2004

GPS - Longitude _____

New Information:

Meter # 1: _____

Meter # 2: Radio _____

MXU #: _____

Current Reading 0

Type of Meter: _____

Year MFG: _____

GPS - Latitude _____

Employee Signature(s): JW

Date Completed 1-29-13

Martin County Water District

387 East Main St., Suite 140
Inez, KY 41224



WORK ORDER

COMPLETED

WO # 130100132

Time Started _____

Work Complete _____

Loc # _____

Master Meter # _____

Date 1/18/2013

Account # _____

SEQ # _____

Name: Floretta Coleman

Phone # _____

Address: _____

Location: Newberry Ln

Type of Work: Complaints

Material Used: _____

Customer Line Inspection _____

Comments: pot holes from previous work done by MCWD

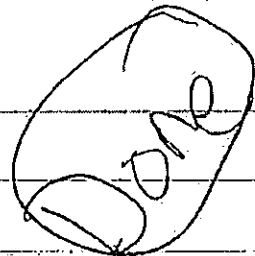

Current System Information:

New Information:

Meter # 1: _____

Meter # 1: _____

Meter # 2: Radio _____

Meter # 2: Radio _____

MXU #: _____

MXU #: _____

Current Reading 0

Current Reading 0

Type of Meter: _____

Type of Meter: _____

Year MFG: _____

Year MFG: _____

GPS - Longitude _____

GPS - Latitude _____

Employee Signature(s): JCS

Date Completed 1-22-13

Martin County Water District

387 East Main St., Suite 140
Inez, KY 41224

✓

WORK ORDER

COMPLETED

WO # 121200166

Time Started _____

Work Complete _____

Loc # _____

Master Meter # _____

Dat 12/28/2012

Account # _____

SEQ # 42

Name: Landon Jude

Phone # _____

Address: P.O. Box

Employee Kyle Sammons

Lovely, KY 41231

Location E Main St, Inez, last house past pawn shop, white w/green shutters, next to empty lot

: Main St

Type of Work: Complaints

Material Used: _____

Customer Line Inspection _____

Comments extremely low water pressure

Checked

High pressure at Box but really low flow

Current System Information:

New Information:

Meter # 1: 70616368

Meter # 1: _____

Meter # 2: Radio 70616368

Meter # 2: Radio _____

MXU #: 14440339

MXU #: _____

Current Reading 12/20/2012 3

Current Reading 0

Type of Meter: _____

Type of Meter: _____

Year MFG: _____

Year MFG: _____

GPS - Longitude _____

GPS - Latitude _____

Employee Signature(s): JW

Date Completed 1-17-13

Martin County Water District

387 East Main St., Suite 140
Inez, KY 41224

WORK ORDER

COMPLETED

WO # 121200072

Time Started _____

Work Complete Yes _____

Loc # _____

Master Meter # _____

Dat 12/18/2012

Account # _____

SEQ # 256

Name: William Maynard

Phone # _____

Address: _____

Employee Josh Williams

Lovely, KY 41231

Location 2nd driveway before Big Branch, Maynard Flat, white trailer w/black shutters

Type of Work: Complaints

Material Used: Looked good

Customer Line Inspection _____

Comments needs more gravel where contractors put in line around driveway

Told County

3021 need gravel

Joe Fed Maynard

Current System Information:

New Information:

Meter # 1: _____

Meter # 1: _____

Meter # 2: Radio _____

Meter # 2: Radio _____

MXU #: _____

MXU #: _____

Current Reading 0

Current Reading 0

Type of Meter: _____

Type of Meter: _____

Year MFG: _____

Year MFG: _____

GPS - Longitude _____

GPS - Latitude _____

Employee Signature(s): _____

Date Completed _____

~~29934504~~
~~343~~
0 done with Blacklag

~~70750162~~
~~130~~

Martin County Water District

387 East Main St., Suite 140
Inez, KY 41224

WORK ORDER

COMPLETED

WO # 130100111

Time Started _____

Work Complete _____

Loc # _____

Master Meter # _____

Date 1/10/2013

Account # _____

SEQ # 175

Name: BARBARA MARCUM

Phone # (_____) _____

Address: PO BOX

BEAUTY, KY 41203

Location: Big Elk Crk up Big Elk Creek road (from rt 40) before Gospel Light, red brick house on left across from big black barn.

Type of Work: Complaints

Material Used: _____

Customer Line Inspection 85-Pounds AT The Pump Station

Comments: complaints of too much pressure

Current System Information:

Meter # 1: 29541976
Meter # 2: Radio _____
MXU #: _____
Current Reading 12/20/2012 503
Type of Meter: Badger
Year MFG: 2004
GPS - Longitude 0

New Information:

Meter # 1: _____
Meter # 2: Radio _____
MXU #: _____
Current Reading 0
Type of Meter: _____
Year MFG: _____
GPS - Latitude 0

Employee Signature(s) JS-TB-GS-RV

Date Completed 1-11-13

Martin County Water District

387 East Main St., Suite 140
Inez, KY 41224

APR 11 2013



WORK ORDER

WO # 130200100

Time Started _____ Work Complete _____

Loc # _____ Master Meter # _____

Date 2/6/2013 Account # _____ SEQ # 437

Name: MELVIN HOWARD Phone # _____

Address: P.O. BOX
INEZ, KY 41224

Location: Eden Ln, ON RIGHT ACROSS FROM PUMP STATION, grey/white single-white

645-SAW MILL RD

Type of Work: Complaints

Material Used: _____

Customer Line Inspection _____

Comments: box is too deep in the box to reach, customer would like it fixed / put a 6" riser

Done

Current System Information:

Meter # 1: 98343293

Meter # 2: Radio _____

MXU #: _____

Current Reading 1/20/2013 708

Type of Meter: Badger

Year MFG: 1998

GPS - Longitude 0

New Information:

Meter # 1: _____

Meter # 2: Radio _____

MXU #: _____

Current Reading 0

Type of Meter: _____

Year MFG: _____

GPS - Latitude 0

Employee Signature(s): JS

Date Completed 2-11-13

Martin County Water District

387 East Main St., Suite 140
Inez, KY 41224

WORK ORDER

COMPLETED

WO # 130200095

Time Started _____

Work Complete _____

Loc # _____

Master Meter # _____

Date 2/6/2013

Account # _____

SEQ # 199

Name: ROBERT & KIMBERLY SMITH

Phone # _____

Address: P.O. BOX

INEZ, KY 41224

Location: _____

COLDWATER RD.

Type of Work: Complaints

Material Used: _____

Customer Line Inspection _____

Comments: extremely low pressure / has about 44 pounds of pressure at box

Done

Current System Information:

Meter # 1: 19447503
Meter # 2: Radio _____
MXU #: _____
Current Reading 1/20/2013 852
Type of Meter: Badger
Year MFG: 2003
GPS - Longitude 0

New Information:

Meter # 1: _____
Meter # 2: Radio _____
MXU #: _____
Current Reading 0
Type of Meter: _____
Year MFG: _____
GPS - Latitude 0

Employee Signature(s): JS

Date Completed 2-7-13

Martin County Water District

387 East Main St., Suite 140
Inez, KY 41224

WORK ORDER

WO # 130100235

Time Started _____ Work Complete _____

Loc # _____ Master Meter # _____

Dat 1/31/2013 Account # _____ SEQ # 461

Name: Sue Dutton Phone # _____

Address: Tomahawk Rd. Employee Josh Williams
TOMAHAWK, KY 41262

Location: Tomahawk Rd, end of line on Rt 40, single-wide on right

ROUTE 40 WEST

Type of Work: Complaints

Material Used: _____

Customer Line Inspection 30 lbs / regulator pit showed 75 lbs

Comments: complaints of extremely low pressure

Done

Current System Information:		New Information:	
Meter # 1:	<u>97094028</u>	Meter # 1:	_____
Meter # 2: Radio	_____	Meter # 2: Radio	_____
MXU #:	_____	MXU #:	_____
Current Reading	<u>1/20/2013 444</u>	Current Reading	<u>0</u>
Type of Meter:	<u>Badger</u>	Type of Meter:	_____
Year MFG:	<u>1997</u>	Year MFG:	_____
GPS - Longitude	<u>0</u>	GPS - Latitude	<u>0</u>

Employee Signature(s): Josh Williams

Date Completed 2-1-13

Martin County Water District

387 East Main St., Suite 140
Inez, KY 41224

WORK ORDER

COMPLETED

WO # 130300126

Time Started _____

Work Complete _____

Loc # _____

Master Meter # _____

Dat 3/19/2013

Account # _____

SEQ # 16

Name: DARRELL HARMON

Phone # () _____

Address: Big Branch

Employee Josh Williams

LOVELY, KY 41231

Location 3lg Br, 1/2 mile up Big Br, 3rd bridge on right, white house w green shutters.

BIG BRANCH

Done

Type of Work: Complaints

Material Used: _____

Customer Line Inspection _____

Comments has had no water since Friday.

Current System Information:

New Information:

Meter # 1: 74846443

Meter # 1: _____

Meter # 2: Radio 74846443

Meter # 2: Radio _____

MXU #: 14992020

MXU #: _____

Current Reading 3/15/2013 0

Current Reading 0

Type of Meter: _____

Type of Meter: _____

Year MFG: _____

Year MFG: _____

GPS - Longitude _____

GPS - Latitude _____

Employee Signature(s): KS

Date Completed 3-19-13

Martin County Water District

387 East Main St., Suite 140
Inez, KY 41224

WORK ORDER

WO # 130300210

COMPLETED

Time Started _____

Work Complete _____

Loc # _____

Master Meter # _____

Date 3/27/2013

Account # _____

SEQ # 369

Name: Darlene Crum

Phone # _____

Address: _____

Inez, Ky 41224

Location: Johnson Btm. Old Rt 3. Johnson Btm. After crossing bridge, go right. Greyish trailer next to old store.

Johnson Btm

Type of Work: Complaints

Material Used: _____

Customer Line Inspection _____

Comments: Redo Tap

Current System Information:

New Information:

Meter # 1: _____

Meter # 1: _____

Meter # 2: Radio

Meter # 2: Radio

MXU #: _____

MXU #: _____

Current Reading: 0

Current Reading: 0

Type of Meter: _____

Type of Meter: _____

Year MFG: _____

Year MFG: _____

GPS - Longitude _____

GPS - Latitude _____

Employee Signature(s): JM

Date Completed 3/27/13

Martin County Water District

387 East Main St., Suite 140
Inez, KY 41224



WORK ORDER

WO # 140500167

Time Started _____

Work Complete _____

Loc # _____

Master Meter # _____

Date 5/22/2014

Account # _____

SEQ # 227

Name: Loretta Moore

Phone # _____

Address: Pigeon Roost Rd
Pilgrim, Ky 41250

Location: Pigeon Roost Rd. 2nd house on hill. Brick house behind Max Hale.

Pigeon Roost Rd

Type of Work: Complaints

Done

Material Used: _____

Customer Line Inspection _____

Comments: complaining that driveway is too rough after repairs were made / put gravel in hole

Current System Information:		New Information:	
Meter # 1:	<u>97176588</u>	Meter # 1:	_____
Meter # 2: Radio	<u>97176588</u>	Meter # 2: Radio	_____
MXU #:	_____	MXU #:	_____
Current Reading	<u>4/20/2014 311</u>	Current Reading	<u>0</u>
Type of Meter:	<u>Badger</u>	Type of Meter:	_____
Year MFG:	<u>1997</u>	Year MFG:	_____
GPS - Longitude	_____	GPS - Latitude	_____

Employee Signature(s): TH, GS, JS

Date Completed 5-23-14

Martin County Water District

387 East Main St., Suite 140
Inez, KY 41224

WORK ORDER

WO # 140500166

Time Started _____

Work Complete _____

Loc # _____

Master Meter # _____

Date 5/22/2014

Account # _____

SEQ # 310

Name: ROBERT FRALEY

Phone # _____

Address: Halls Br

TOMAHAWK, KY 41262

Location: Halls Br

HALL BRANCH ROAD

Type of Work: Complaints

Material Used: _____

Customer Line Inspection _____

Comments: very low water pressure

leak on M.C.W.D. side of box

Done

Current System Information:		New Information:	
Meter # 1:	<u>96130886</u>	Meter # 1:	_____
Meter # 2: Radio	_____	Meter # 2: Radio	_____
MXU #:	_____	MXU #:	_____
Current Reading	<u>4/20/2014 1219</u>	Current Reading	<u>0</u>
Type of Meter:	<u>Badger</u>	Type of Meter:	_____
Year MFG:	<u>1996</u>	Year MFG:	_____
GPS - Longitude	<u>0</u>	GPS - Latitude	<u>0</u>

Employee Signature(s): [Signature]

Date Completed 5-22-14

Martin County Water District

387 East Main St., Suite 140
Inez, KY 41224



WORK ORDER

WO # 140500161

Time Started _____ Work Complete _____

Loc # _____ Master Meter # _____

Date 5/22/2014 Account # _____ SEQ # 442

Name: Recycling Solutions Tech. Phone # _____

Address: PO Box
Allen, KY 41601

Location: Right side, go thru gate, meter sets to the left of garage doors, in front of boiler

Martin County Coal Hill

Type of Work: Complaints

Material Used: _____

Customer Line Inspection _____

Comments: extremely low pressure, Paul Aiken 298-0065 / 226-5554 / Fixed valve was closed

Current System Information:		New Information:	
Meter # 1:	<u>70025360</u>	Meter # 1:	_____
Meter # 2: Radio	<u>70025360</u>	Meter # 2: Radio	_____
MXU #:	<u>14640449</u>	MXU #:	_____
Current Reading	<u>4/20/2014 1293</u>	Current Reading	<u>0</u>
Type of Meter:	_____	Type of Meter:	_____
Year MFG:	_____	Year MFG:	_____
GPS - Longitude	_____	GPS - Latitude	_____

Employee Signature(s): AW Date Completed 5-22-14

Martin County Water District

387 East Main St., Suite 140
Inez, KY 41224



WORK ORDER

WO # 140500154

Time Started _____

Work Complete _____

Loc # _____

Master Meter # _____

Date 5/21/2014

Account # _____

SEQ # 381

Name: James McGinnis

Phone # _____

Address: McGinnis Br
Debord, Ky 41214

Location: Grey doublewide before Walker Preece, McGinnis Br

Middlefork

Type of Work: Complaints

Material Used: _____

Customer Line Inspection _____

Comments: low pressure / 100 PSI @ box

Current System Information:		New Information:	
Meter # 1:	<u>29541627</u>	Meter # 1:	_____
Meter # 2: Radio	_____	Meter # 2: Radio	_____
MXU #:	_____	MXU #:	_____
Current Reading	<u>4/20/2014 221</u>	Current Reading	<u>0</u>
Type of Meter:	<u>Badger</u>	Type of Meter:	_____
Year MFG:	<u>2004</u>	Year MFG:	_____
GPS - Longitude	<u>0</u>	GPS - Latitude	<u>0</u>

Employee Signature(s): TH / LS / GS

Date Completed 5-21-14

Martin County Water District ✓

387 East Main St., Suite 140
Inez, KY 41224

WORK ORDER

WO # 140500099

Time Started _____ Work Complete _____

Loc # _____ Master Meter # _____

Dat 5/14/2014 Account # _____ SEQ # 372

Name: Carey Dindal Phone # (_____)

Address: Davella Rd Employee Jason W.
Debord, Ky 41214

Location Blue house on left, Davella Rd

Davella Rd

Type of Work: Complaints

Material Used _____

Customer Line Inspection _____

Comments low pressure since last night

Current System Information:		New Information:	
Meter # 1:	<u>19408276</u>	Meter # 1:	_____
Meter # 2: Radi	_____	Meter # 2: Radi	_____
MXU #:	_____	MXU #:	_____
Current Reading	<u>4/20/2014 1234</u>	Current Reading	<u>0</u>
Type of Meter:	<u>Badger</u>	Type of Meter:	_____
Year MFG:	<u>2003</u>	Year MFG:	_____
GPS - Longitude	<u>0</u>	GPS - Latitude	<u>0</u>

Employee Signature(s): _____

Date Completed 5-15-14

Martin County Water District

387 East Main St., Suite 140
Inez, KY 41224

WORK ORDER

WO # 140500105

Time Started _____

Work Complete _____

Loc # _____

Master Meter # _____

Dat 5/14/2014

Account # _____

SEQ # 442

Name: Recycling Solutions Tech.

Phone # _____

Address: PO Box

Employee Jason W.

Allen, KY 41601

Location Right side, go thru gate, meter sets to the left of garage doors, in front of boiler

Martin County Coal Hill

Type of Work: Complaints

Material Used _____

Customer Line Inspection _____

Comments NO WATER FOR DAYS

Current System Information:

New Information:

Meter # 1: 70025360

Meter # 1: _____

Meter # 2: Radi 70025360

Meter # 2: Radi _____

MXU #: 14640449

MXU #: _____

Current Reading 4/20/2014 1293

Current Reading _____ 0

Type of Meter: _____

Type of Meter: _____

Year MFG: _____

Year MFG: _____

GPS - Longitude _____

GPS - Latitude _____

Employee Signature(s): _____

Date Completed 5-15-14

Martin County Water District

387 East Main St., Suite 140
Inez, KY 41224

WORK ORDER

WO # 140500076

Time Started _____

Work Complete _____

Loc # _____

Master Meter # _____

Date 5/7/2014

Account # _____

SEQ # 270

Name: Wanda Jude

Phone # _____

Address: Pigeon Roost Rd

Pilgrim, Ky 41250

Location: Pigeon Roost Rd. 1 mile up Pigeon Roost on right. Tan/brown double-wide.

Pigeon Roost Rd

Type of Work: Complaints

Material Used: _____

Customer Line Inspection _____

Comments: milky water, lines need flushed

Flushed

Current System Information:

Meter # 1: 67012626
Meter # 2: Radio 67012626
MXU #: _____
Current Reading 4/20/2014 362
Type of Meter: Sensus
Year MFG: 2006
GPS - Longitude _____

New Information:

Meter # 1: _____
Meter # 2: Radio _____
MXU #: _____
Current Reading 0
Type of Meter: _____
Year MFG: _____
GPS - Latitude _____

Employee Signature(s): JS, RS

Date Completed 5-8-14

Martin County Water District

387 East Main St., Suite 140
Inez, KY 41224

WORK ORDER

WO # 140500098

Time Started _____

Work Complete _____

Loc # _____

Master Meter # _____

Dat 5/14/2014

Account # _____

SEQ # 382

Name: JAY ROWE

Phone # () _____

Address: Hillcrest Dr

Employee Jason W.

DEBORD, , KY 41214

Location Hillcrest Dr left fork last house up hill brown.

MCGINNIS BRANCH

Type of Work: Complaints

Checked and has 120 lbs

Material Used At box.

Customer Line Inspection _____

Comments check pressure, complaints of low pressure, said they read 10 lbs at box

Current System Information:		New Information:	
Meter # 1:	<u>93749223</u>	Meter # 1:	_____
Meter # 2: Radi	_____	Meter # 2: Radi	_____
MXU #:	_____	MXU #:	_____
Current Reading	<u>4/20/2014 1182</u>	Current Reading	<u>0</u>
Type of Meter:	<u>Badger</u>	Type of Meter:	_____
Year MFG:	<u>1993</u>	Year MFG:	_____
GPS - Longitude	<u>0</u>	GPS - Latitude	<u>0</u>

Employee Signature(s): CH SM

Date Completed 5-19-14

Martin County Water District

387 East Main St., Suite 140
Inez, KY 41224

WORK ORDER

COMPLETED

WO # 130600159

Time Started _____

Work Complete _____

Loc # _____

Master Meter # _____

Date 6/20/2013

Account # _____

SEQ # 140

Name: Johnny Marcum

Phone # _____

Address: Poplar Frk

Beauty, Ky 41203

Location: Poplar Fork. On right before Jake's Place.

Poplar Fork

Type of Work: Complaints

Fixed

Material Used: _____

Customer Line Inspection ~~_____~~

Comments: customer tried to turn on water, nothing is coming thru meter

Current System Information:

Meter # 1: 12760362

Meter # 2: Radio 12760362

MXU #: _____

Current Reading 5/30/2013 19

Type of Meter: Hersey

Year MFG: 2012

GPS - Longitude _____

New Information:

Meter # 1: _____

Meter # 2: Radio _____

MXU #: _____

Current Reading 0

Type of Meter: _____

Year MFG: _____

GPS - Latitude _____

Employee Signature(s): JS, SK

Date Completed 6-20-13

Martin County Water District

387 East Main St., Suite 140
Inez, KY 41224

WORK ORDER

COMPLETED

WO # 130600179

Time Started _____ Work Complete _____

Loc # _____ Master Meter # _____

Date 6/24/2013 Account # _____ SEQ # 227

Name: Russel Maynard Phone # _____

Address: P.O. Box
Inez, KY 41224

Location: Peter Cave Br. On left down over hill almost to the end before you get to Lum Porters. Cream
double-wide.

Old Rt 3

Type of Work: Complaints

Material Used: _____

Customer Line Inspection _____

Comments: customer has had little water pressure after meter was reinstalled, now they have no water

Done

Current System Information:	New Information:
Meter # 1: _____	Meter # 1: _____
Meter # 2: Radio _____	Meter # 2: Radio _____
MXU #: _____	MXU #: _____
Current Reading <u>0</u>	Current Reading <u>0</u>
Type of Meter: _____	Type of Meter: _____
Year MFG: _____	Year MFG: _____
GPS - Longitude _____	GPS - Latitude _____

Employee Signature(s): JW

Date Completed 6-25-13

Martin County Water District

387 East Main St., Suite 140
Inez, KY 41224



WORK ORDER

COMPLETED

WO # 130600128

Time Started _____ Work Complete _____

Loc # _____ Master Meter # _____

Date 6/17/2013 Account # _____ SEQ # 89

Name: Jack Small Phone # () _____

Address: 1 Buck Branch
Lovely, KY 41231

Location: _____

Buck Cranch - House

Type of Work: Complaints

Material Used: _____

Customer Line Inspection Flushed Line Done

Comments: customer is complaining of muddy water

Current System Information:		New Information:	
Meter # 1:	<u>74604131</u>	Meter # 1:	_____
Meter # 2: Radio	<u>74604131</u>	Meter # 2: Radio	_____
MXU #:	<u>14992781</u>	MXU #:	_____
Current Reading	<u>5/20/2013 12</u>	Current Reading	<u>0</u>
Type of Meter:	_____	Type of Meter:	_____
Year MFG:	_____	Year MFG:	_____
GPS - Longitude	_____	GPS - Latitude	_____

Employee Signature(s): SW

Date Completed 6-18-13

Martin County Water District

387 East Main St., Suite 140
Inez, KY 41224

WORK ORDER

WO # 130500005

COMPLETED

RE COPY

Time Started _____

Work Complete _____

Loc # _____

Master Meter # _____

Dat 5/1/2013

Account # _____

SEQ # 543

Name: Chester Johnson Jr.

Phone # _____

Address: Boyd Ward Rd
Tomahawk, KY 41262

Employee ~~Josh Williams~~

Tony

Location Boyd Ward Rd, Rockhouse 3 miles, 3rd house past Davis Port Church, cedar house, across crk

Boyd Ward Rd

Type of Work: Complaints

Material Used: _____

Customer Line Inspection _____

Comments customer is complaining of extremely low water pressure

Current System Information:

New Information:

Meter # 1: 19713241

Meter # 1: _____

Meter # 2: Radio 19713241

Meter # 2: Radio _____

MXU #: _____

MXU #: _____

Current Reading 4/20/2013 1177

Current Reading 0

Type of Meter: Badger

Type of Meter: _____

Year MFG: 2003

Year MFG: _____

GPS - Longitude _____

GPS - Latitude _____

Employee Signature(s): _____

Date Completed _____

Martin County Water District

387 East Main St., Suite 140
Inez, KY 41224

WORK ORDER

WO # 130700002

COMPLETED

Time Started _____

Work Complete _____

Loc # _____

Master Meter # _____

Date 7/1/2013

Account # _____

SEQ # 178

Name: JEFF HINKLE

Phone # _____

Address: P.O. BOX

INEZ, KY 41224

Location: Union Rd

TURKEY ROAD

Type of Work: Complaints

Material Used: fixed check valve

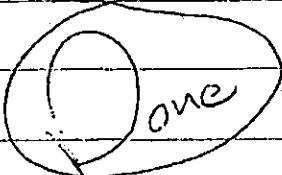

Customer Line Inspection _____

Comments: no water

Current System Information:		New Information:	
Meter # 1:	<u>70616457</u>	Meter # 1:	_____
Meter # 2: Radio	<u>70616457</u>	Meter # 2: Radio	_____
MXU #:	<u>13152697</u>	MXU #:	_____
Current Reading	<u>6/20/2013 158</u>	Current Reading	<u>0</u>
Type of Meter:	_____	Type of Meter:	_____
Year MFG:	_____	Year MFG:	_____
GPS - Longitude	_____	GPS - Latitude	_____

Employee Signature(s): JW

Date Completed 7-1-13

Martin County Water District

387 East Main St., Suite 140
Inez, KY 41224

WORK ORDER

WO # 130700168

Time Started _____ Work Complete _____

Loc # _____ Master Meter # _____

Date 7/18/2013 Account # _____ SEQ # 21

Name: People's Market Phone # () _____

Address: P.O. BOX
INEZ, KY 41224

Location: Old Middlefork. Behind court house.

MIDDLEFORK RD.

Type of Work: Complaints

Material Used: Fixed

Customer Line Inspection _____

Comments: ditch line on left just before Eclipse driveway needs dug deeper, runs across the road to this customer's

Current System Information:		New Information:	
Meter # 1:	<u>70840736</u>	Meter # 1:	_____
Meter # 2: Radio	_____	Meter # 2: Radio	_____
MXU #:	_____	MXU #:	_____
Current Reading	<u>6/20/2013 152</u>	Current Reading	<u>0</u>
Type of Meter:	<u>Sensus</u>	Type of Meter:	_____
Year MFG:	<u>2009</u>	Year MFG:	_____
GPS - Longitude	<u>0</u>	GPS - Latitude	<u>0</u>

Employee Signature(s): TBTS-GS-RV

Date Completed 8-30-13

Martin County Water District

387 East Main St., Suite 140
Inez, KY 41224

WORK ORDER

WO # 130900145

Time Started _____ Work Complete _____

Loc # _____ Master Meter # _____

Date 9/18/2013 Account # _____ SEQ # 175

Name: ROGER CASTLE Phone # _____

Address: Dean Castle Br.
INEZ, KY 41224

Location: _____

CASTLE BRANCH RD

Type of Work: Complaints

Material Used: 3/4" WRAP

Customer Line Inspection _____

Comments: customer had no water Last night and this morning

Current System Information:		New Information:	
Meter # 1:	<u>99691594</u>	Meter # 1:	_____
Meter # 2: Radio	_____	Meter # 2: Radio	_____
MXU #:	_____	MXU #:	_____
Current Reading	<u>8/20/2013 776</u>	Current Reading	<u>0</u>
Type of Meter:	<u>Badger</u>	Type of Meter:	_____
Year MFG:	<u>1999</u>	Year MFG:	_____
GPS - Longitude	<u>0</u>	GPS - Latitude	<u>0</u>

Employee Signature(s): J.S. - TB - G.S. - RT

Date Completed 9-19-13

Martin County Water District

387 East Main St., Suite 140
Inez, KY 41224

WORK ORDER

WO # 130800101

Time Started

Work Complete

Loc #

Master Meter #

Dat 8/6/2013

Account #

SEQ # 158

Name: HORN'S BP

Phone #

Address: P.O. BOX

Employee Clyde Stanley

INEZ, KY 41224

Location:

ROUTE 1884/645 BY PASS

Type of Work: Complaints

Material Used: *rePLASTEd Line*

Customer Line Inspection

Comments: box is showing 80 lbs of pressure but flow dies down

Current System Information:

Meter # 1: 29934478

Meter # 2: Radio 29934478

MXU #:

Current Reading 7/20/2013 200

Type of Meter: Badger

Year MFG: 2004

GPS - Longitude 0

New Information:

Meter # 1:

Meter # 2: Radio

MXU #:

Current Reading 0

Type of Meter:

Year MFG:

GPS - Latitude 0

Employee Signature(s): *TB-JS-GS-N*

Date Completed *9-5-13*

Martin County Water District

387 East Main St., Suite 140
Inez, KY 41224

WORK ORDER

COMPLETED

WO # 131000178

Time Started _____

Work Complete _____

Loc # _____

Master Meter # _____

Date 10/18/2013

Account # _____

SEQ # 36

Name: Clifford Endicott

Phone # _____

Address: PO Box

Lovely, KY 41231

Location: Last house on left - gray

Chapman Bottom

Type of Work: Complaints

Material Used: _____

Customer Line Inspection _____

Comments: has extremely low pressure

Done

Current System Information:		New Information:	
Meter # 1:	<u>74846474</u>	Meter # 1:	_____
Meter # 2: Radio	<u>74846474</u>	Meter # 2: Radio	_____
MXU #:	<u>14993070</u>	MXU #:	_____
Current Reading	<u>9/20/2013 15</u>	Current Reading	<u>0</u>
Type of Meter:	_____	Type of Meter:	_____
Year MFG:	_____	Year MFG:	_____
GPS - Longitude	_____	GPS - Latitude	_____

Employee Signature(s): JS

Date Completed 10-21-13

Martin County Water District

387 East Main St., Suite 140
Inez, KY 41224

WORK ORDER

COMPLETED

WO # 131000147

Time Started _____ Work Complete _____

Loc # _____ Master Meter # _____

Date 10/14/2013 Account # _____ SEQ # 152

Name: Kirk Memorial Church Phone # _____

Address: PO Box
Inez, KY 41224

Location: Big Lick, Sansom Drive, 1st drive on the right, meter on right across from gravel drive that turns left

RT 3

Type of Work: Complaints

Material Used: _____

Customer Line Inspection _____

Comments: customer is complaining of extremely low pressure / 100 lbs

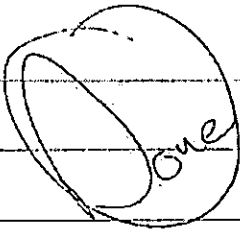

Current System Information:		New Information:	
Meter # 1:	<u>99691417</u>	Meter # 1:	_____
Meter # 2: Radio	_____	Meter # 2: Radio	_____
MXU #:	_____	MXU #:	_____
Current Reading	<u>9/20/2013 37</u>	Current Reading	<u>0</u>
Type of Meter:	<u>Badger</u>	Type of Meter:	_____
Year MFG:	<u>1999</u>	Year MFG:	_____
GPS - Longitude	_____	GPS - Latitude	_____

Employee Signature(s): JW & RJ

Date Completed 10-15-13

Martin County Water District

387 East Main St., Suite 140
Inez, KY 41224

WORK ORDER

WO # 130900207

Time Started _____

Work Complete _____

Loc # _____

Master Meter # _____

Date 9/27/2013

Account # _____

SEQ # 291

Name: Wilma Ball

Phone # _____

0

Address: } Riverfront Rd

Belfry, KY 41514

Location: } Riverfront Rd Next to the church, doublewide trailer

HUNTLYVILLE

Type of Work: Complaints

Material Used: _____

Customer Line Inspection Replaced gravel & raked area

Comments: customer said yard and gravel was a mess

Current System Information:		New Information:	
Meter # 1:	<u>29934881</u>	Meter # 1:	_____
Meter # 2: Radio	<u>29934881</u>	Meter # 2: Radio	_____
MXU #:	_____	MXU #:	_____
Current Reading	<u>9/20/2013 355</u>	Current Reading	<u>0</u>
Type of Meter:	<u>Badger</u>	Type of Meter:	_____
Year MFG:	<u>2004</u>	Year MFG:	_____
GPS - Longitude	<u>0</u>	GPS - Latitude	<u>0</u>

Employee Signature(s): T.B.

Date Completed 11/27/13

Martin County Water District

387 East Main St., Suite 140
Inez, KY 41224

WORK ORDER

WO # 131100017

Time Started _____ Work Complete _____

Loc # _____ Master Meter # _____

Date 11/4/2013 Account # _____ SEQ # 470

Name: Christopher Chapman Phone # _____

Address: PO Box
Inez, KY 41224

Location: Madison Sarah Ln., Across from Eden Elementary, beige/stone siding w/stone garage

Madison Sarah Ln.

Type of Work: Complaints

Material Used: 1x 3/4" SHARKBITE

Customer Line Inspection _____

Comments: extremely low pressure since last week, customer has 12 lbs at box

Current System Information:		New Information:	
Meter # 1:	<u>29935332</u>	Meter # 1:	_____
Meter # 2: Radio	<u>29935332</u>	Meter # 2: Radio	_____
MXU #:	_____	MXU #:	_____
Current Reading	<u>10/20/2013 389</u>	Current Reading	<u>0</u>
Type of Meter:	<u>Badger</u>	Type of Meter:	_____
Year MFG:	<u>2004</u>	Year MFG:	_____
GPS - Longitude	_____	GPS - Latitude	_____

Employee Signature(s): JR-JS-TR-rj

Date Completed 11-6-13

Martin County Water District

387 East Main St., Suite 140
Inez, KY 41224

WORK ORDER

WO # 131100083

Time Started _____ Work Complete _____

Loc # _____ Master Meter # _____

Date 11/7/2013 Account # _____ SEQ # 186

Name: CLAUDE MILLS Phone # _____

Address: P.O. BOX
BEAUTY, KY 41203

Location: 7193 Beauty Rd brown trailer on the left past Tommy's Auto Sales

Type of Work: Complaints

Material Used: _____

Customer Line Inspection _____

Comments: extremely low water pressure since leak was fixed 80 PSI At box

DO NOT

Current System Information:	New Information:
Meter # 1: <u>29934843</u>	Meter # 1: _____
Meter # 2: Radio _____	Meter # 2: Radio _____
MXU #: _____	MXU #: _____
Current Reading <u>10/20/2013 121</u>	Current Reading <u>0</u>
Type of Meter: <u>Badger</u>	Type of Meter: _____
Year MFG: _____	Year MFG: _____
GPS - Longitude <u>0</u>	GPS - Latitude <u>0</u>

Employee Signature(s): [Signature]

Date Completed 11-12-13

Martin County Water District

387 East Main St., Suite 140
Inez, KY 41224

WORK ORDER

COMPLETED

WO # 130500216

Time Started _____

Work Complete _____

Loc # _____

Master Meter # _____

Date 5/30/2013

Account # _____

SEQ # 164

Name: JOYCE DIALS

Phone # _____

Address: PO BOX

LOVELY, KY 41231

Location: 3835 N Wolf Crk Rd 1714 Papaws Driveway, 2 miles past Lovely Post Office on left raised house white /black block

Type of Work: Complaints

Material Used: Fixed

Customer Line Inspection _____

Comments: wants mess in yard from contractors cleaned up and grass seed spread

Current System Information:		New Information:	
Meter # 1:	<u>74846427</u>	Meter # 1:	_____
Meter # 2: Radio	<u>74846427</u>	Meter # 2: Radio	_____
MXU #:	<u>14991359</u>	MXU #:	_____
Current Reading	<u>5/20/2013 9</u>	Current Reading	<u>0</u>
Type of Meter:	_____	Type of Meter:	_____
Year MFG:	_____	Year MFG:	_____
GPS - Longitude	_____	GPS - Latitude	_____

Employee Signature(s): J.P. GOSWAMI

Date Completed 5-31-13

Martin County Water District

387 East Main St., Suite 140
Inez, KY 41224

WORK ORDER

WO # 130400187

COMPLETED

Time Started _____

Work Complete _____

Loc # _____

Master Meter # _____

Date 4/18/2013

Account # _____

SEQ # 71

Name: PILGRIM POST OFFICE

Phone # _____

Address: PO BOX

PILGRIM, KY 41250

Location: _____

Type of Work: Complaints

Material Used: Fixed

Customer Line Inspection _____

Comments: contractors left rock & unlevel ground around tap box, cannot mow around.

Current System Information:		New Information:	
Meter # 1:	<u>23864805</u>	Meter # 1:	_____
Meter # 2: Radio	_____	Meter # 2: Radio	_____
MXU #:	_____	MXU #:	_____
Current Reading	<u>3/20/2013 107</u>	Current Reading	<u>0</u>
Type of Meter:	<u>Sensus</u>	Type of Meter:	_____
Year MFG:	<u>1974</u>	Year MFG:	_____
GPS - Longitude	<u>0</u>	GPS - Latitude	<u>0</u>

Employee Signature(s) [Signature]

Date Completed 5-31-13

48604646

416

badger

Martin County Water District

387 East Main St., Suite 140
Inez, KY 41224

WORK ORDER

COMPLETED

WO # 130500005

Time Started _____

Work Complete _____

Loc # _____

Master Meter # _____

Date 5/1/2013

Account # _____

SEQ # 539

Name: Chester Johnson Jr.

Phone # _____

Address: Boyd Ward Rd

Tomahawk, KY 41262

Location: Boyd Ward Rd, Rockhouse 3 miles, 3rd house past Davis Port Church, cedar house, across crk

Boyd Ward Rd

Type of Work: Complaints

Material Used: 150 - Cooltop $\frac{3}{4}$ 1 - $\frac{1}{4}$ TEE

Customer Line Inspection _____

Comments: customer is complaining of extremely low water pressure

Current System Information:		New Information:	
Meter # 1:	<u>19713241</u>	Meter # 1:	_____
Meter # 2: Radio	<u>19713241</u>	Meter # 2: Radio	_____
MXU #:	_____	MXU #:	_____
Current Reading	<u>4/20/2013 1177</u>	Current Reading	<u>0</u>
Type of Meter:	<u>Badger</u>	Type of Meter:	_____
Year MFG:	<u>2003</u>	Year MFG:	_____
GPS - Longitude	_____	GPS - Latitude	_____

Employee Signature(s): 18-GS-JS-N-JG

Date Completed 5-30-13

~~37-885984W~~
~~002-49641W~~

~~74846483~~
~~14996895~~

[Signature]

Martin County Water District

387 East Main St., Suite 140
Inez, KY 41224

WORK ORDER

COMPLETED

WO # 130500106

Time Started _____

Work Complete _____

Loc # _____

Master Meter # _____

Date 5/9/2013

Account # _____

SEQ # 452

Name: Junior Hunt

Phone # _____

Address: Little Rockcastle Rd

Inez, KY 41224

Location: Little Rockcastle Rd, about 3m, up 2032, across mountain, grey double wide w/black shutters on the right over the bank

Little Rockcastle Rd

Type of Work: Complaints

Material Used: _____

Customer Line Inspection _____

Comments: need gravel in driveway. There are sink holes left after leak was fixed.

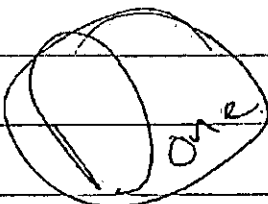

Current System Information:	New Information:
Meter # 1: _____	Meter # 1: _____
Meter # 2: Radio _____	Meter # 2: Radio _____
MXU #: _____	MXU #: _____
Current Reading <u>0</u>	Current Reading <u>0</u>
Type of Meter: _____	Type of Meter: _____
Year MFG: _____	Year MFG: _____
GPS - Longitude _____	GPS - Latitude _____

Employee Signature(s): JH

Date Completed 5-20-13

Martin County Water District

387 East Main St., Suite 140
Inez, KY 41224

WORK ORDER

COMPLETED

WO # 130500132

Time Started _____

Work Complete _____

Loc # _____

Master Meter # _____

Date 5/15/2013

Account # _____

SEQ # 352

Name: ELMER DIALS

Phone # () _____

Address: Blackburn & Dials Rd

TOMAHAWK, KY 41262

Location: Blackburn & Dials Rd REPAIR YARD. Damage was done last year when water line was replaced.

ROUTE 40 WEST

Type of Work: Complaints

Material Used: Fixed

Customer Line Inspection _____

Comments: _____

Current System Information:	New Information:
Meter # 1: _____	Meter # 1: _____
Meter # 2: Radio _____	Meter # 2: Radio _____
MXU #: _____	MXU #: _____
Current Reading <u>0</u>	Current Reading <u>0</u>
Type of Meter: _____	Type of Meter: _____
Year MFG: _____	Year MFG: _____
GPS - Longitude _____	GPS - Latitude _____

Employee Signature(s): TJ-S-JS-GS-JG-N

Date Completed 5-22-13

Martin County Water District

387 East Main St., Suite 140
Inez, KY 41224

WORK ORDER

COMPLETED

WO # 130300215

Time Started _____

Work Complete _____

Loc # _____

Master Meter # _____

Date 3/28/2013

Account # _____

SEQ # 22

Name: RUSSELL STEPP

Phone # _____

Address: PO BOX

LOVELY, KY 41231

Location: Bruce St Lovely, 292 & 1714 Intersection, right on 1714, 1st brick house on the left

Done

Type of Work: Complaints

Material Used: 1- 6" Meter Box Riser + 1- 3" Meter Box Riser

Customer Line Inspection _____

Comments: needs boxes raised/ he has two boxes/

Current System Information:

New Information:

Meter # 1: 72918851

Meter # 1: _____

Meter # 2: Radio 72918851

Meter # 2: Radio _____

MXU #: 14755871

MXU #: _____

Current Reading 3/20/2013 4

Current Reading _____ 0

Type of Meter: _____

Type of Meter: _____

Year MFG: _____

Year MFG: _____

GPS - Longitude _____

GPS - Latitude _____

Employee Signature(s): KS

Date Completed 5-8-13

Martin County Water District

387 East Main St., Suite 140
Inez, KY 41224



WORK ORDER

COMPLETED

WO # 130500009

Time Started _____ Work Complete _____

Loc # _____ Master Meter # _____

Date 5/2/2013 Account # _____ SEQ # _____

Name: Kenneth Berry Phone # _____

Address: P.O. Box
Lovely, KY 41231

Location: Dogwood DR, 2nd trailer on right

Type of Work: Complaints

Material Used: _____

Customer Line Inspection _____

Comments: customer has no pressure since the set, box is filling up w/water / CO problem

Done

Current System Information:	New Information:
Meter # 1: _____	Meter # 1: _____
Meter # 2: Radio _____	Meter # 2: Radio _____
MXU #: _____	MXU #: _____
Current Reading <u>0</u>	Current Reading <u>0</u>
Type of Meter: _____	Type of Meter: _____
Year MFG: _____	Year MFG: _____
GPS - Longitude _____	GPS - Latitude _____

Employee Signature(s): JW

Date Completed 5-3-13

Martin County Water District

387 East Main St., Suite 140
Inez, KY 41224

WORK ORDER

WO # 140600171

Time Started _____ Work Complete _____

Loc # _____ Master Meter # _____

Date 6/23/2014 Account # _____ SEQ # 224

Name: Norma McCoy Phone # _____

Address: Meathouse Rd
Pilgrim, KY 41250

Location: Meathouse Rd, turn right @ 1439 4 or 5 miles on right grey trailer on hill

MEATHOUSE

Type of Work: Complaints

Material Used: _____

Customer Line Inspection: _____

Comments: went from low pressure to no water / got water

Current System Information:		New Information:	
Meter # 1:	<u>29934888</u>	Meter # 1:	_____
Meter # 2: Radio	<u>29934888</u>	Meter # 2: Radio	_____
MXU #:	_____	MXU #:	_____
Current Reading	<u>5/20/2014 529</u>	Current Reading	<u>0</u>
Type of Meter:	<u>Badger</u>	Type of Meter:	_____
Year MFG:	<u>2004</u>	Year MFG:	_____
GPS - Longitude	_____	GPS - Latitude	_____

Employee Signature(s): TH, CS

Date Completed 6-23-14

Martin County Water District

387 East Main St., Suite 140
Inez, KY 41224



WORK ORDER

WO # 131000143

Time Started _____ Work Complete _____

Loc # _____ Master Meter # _____

Date 10/11/2013 Account # _____ SEQ # 101

Name: MARY STANLEY Phone # () _____

Address: PO Box
WARFIELD, KY 41267

Location: 84 Stanley Dr

COLLINS CREEK

Type of Work: Complaints

Material Used: Check and had 28 # Pressure

Customer Line Inspection _____

Comments: extremely low pressure

Current System Information:		New Information:	
Meter # 1:	<u>70616608</u>	Meter # 1:	_____
Meter # 2: Radio	_____	Meter # 2: Radio	_____
MXU #:	<u>13154928</u>	MXU #:	_____
Current Reading	<u>9/20/2013 273</u>	Current Reading	<u>0</u>
Type of Meter:	_____	Type of Meter:	_____
Year MFG:	_____	Year MFG:	_____
GPS - Longitude	_____	GPS - Latitude	_____

Employee Signature(s): CS, DS, BJ

Date Completed 10-28-13

Martin County Water District

387 East Main St., Suite 140
Inez, KY 41224

WORK ORDER

WO # 140600182

Time Started _____ Work Complete _____

Loc # _____ Master Meter # _____

Date 6/25/2014 Account # _____ SEQ # 297

Name: SAMUEL JUDE Phone # _____

Address: Pigeon Roost Rd Employee Jason W.

PILGRIM, KY 41250

Location: Pigeon Roost Rd, 1 3/4 miles up at the mouth of Hale Br in a brown brick house

Type of Work: Complaints

Material Used: _____

Customer Line Inspection _____

Comments: too much air in lines, needs flushed

Flushed

Current System Information:		New Information:	
Meter # 1:	<u>97728674</u>	Meter # 1:	_____
Meter # 2: Radio	_____	Meter # 2: Radio	_____
MXU #:	_____	MXU #:	_____
Current Reading	<u>5/20/2014 850</u>	Current Reading	<u>0</u>
Type of Meter:	<u>Badger</u>	Type of Meter:	_____
Year MFG:	<u>1997</u>	Year MFG:	_____
GPS - Longitude	<u>0</u>	GPS - Latitude	<u>0</u>

Employee Signature(s): JW

Date Completed 6-26-14

Martin County Water District

387 East Main St., Suite 140
Inez, KY 41224

WORK ORDER

WO # 140600211

Time Started _____

Work Complete _____

Loc # _____

Master Meter # _____

Date 6/27/2014

Account # _____

SEQ # 224

Name: Norma McCoy

Phone # (_____) _____

Address: Weathouse Rd
Pilgrim, KY 41250

Employee Justin Scott

Location: Weathouse Rd, turn right @ 1439 4 or 5 miles on right grey trailer on hill

MEATHOUSE

Type of Work: Complaints

Material Used: _____

Customer Line Inspection _____

Comments: nothing but air in lines

Current System Information:	New Information:
Meter # 1: _____	Meter # 1: _____
Meter # 2: Radio _____	Meter # 2: Radio _____
MXU #: _____	MXU #: _____
Current Reading <u>0</u>	Current Reading <u>0</u>
Type of Meter: _____	Type of Meter: _____
Year MFG: _____	Year MFG: _____
GPS - Longitude _____	GPS - Latitude _____

Employee Signature(s): _____

Date Completed 6-27-14

Martin County Water District

387 East Main St., Suite 140
Inez, KY 41224

WORK ORDER

WO # 140600150

Time Started _____ Work Complete _____

Loc # _____ Master Meter # _____

Date 8/17/2014 Account # _____ SEQ # 184

Name: Jason Robinson Phone # _____

Address: Meathouse Rd
PILGRIM, KY 41250

Location: Meathouse Rd, beside LeAnna Church, brick house

Meathouse Rd

Type of Work: Complaints

Material Used: _____

Customer Line Inspection: _____

Comments: no water / ~~no~~ got water

Done

Current System Information:		New Information:	
Meter # 1:	<u>47824008</u>	Meter # 1:	_____
Meter # 2: Radio	<u>47824008</u>	Meter # 2: Radio	_____
MXU #:	_____	MXU #:	_____
Current Reading	<u>5/20/2014 853</u>	Current Reading	<u>0</u>
Type of Meter:	<u>Sensus</u>	Type of Meter:	_____
Year MFG:	<u>1993</u>	Year MFG:	_____
GPS - Longitude	<u>0</u>	GPS - Latitude	<u>0</u>

Employee Signature(s): TH, CS

Date Completed 8-19-14

Martin County Water District

387 East Main St., Suite 140
Inez, KY 41224

WORK ORDER

WO # 140600040

Time Started _____ Work Complete _____

Loc # _____ Master Meter # _____

Date 6/4/2014 Account # _____ SEQ # 357

Name: Betty Lopez Phone # _____

Address: P.O. Box
Inez, Ky 41224

Location: Fields Traile Ct. Tomahawk: 2nd trailer (white camper) on right.

Fields Trailer Ct

Type of Work: Complaints

Material Used: _____

Customer Line Inspection _____

Comments: no water / Checked pressure box had 80psi

Done

Current System Information:		New Information:	
Meter # 1:	<u>16721822</u>	Meter # 1:	_____
Meter # 2: Radio	<u>16721822</u>	Meter # 2: Radio	_____
MXU #:	_____	MXU #:	_____
Current Reading	<u>5/20/2014 343</u>	Current Reading	<u>0</u>
Type of Meter:	<u>Badger</u>	Type of Meter:	_____
Year MFG:	<u>2000</u>	Year MFG:	_____
GPS - Longitude	_____	GPS - Latitude	_____

Employee Signature(s): TH, GS, CS

Date Completed 6-5-14

Martin County Water District

387 East Main St., Suite 140
Inez, KY 41224

WORK ORDER

WO # 140700258

Time Started _____ Work Complete _____

Loc # _____ Master Meter # _____

Date 7/29/2014 Account # _____ SEQ # 492

Name: ROGER SPENCE Phone # _____

Address: P.O. Box Employee Rainbo
TOMAHAWK, KY 41262

Location: Orville Rd 3rd house on left white 1 story

ORVILLE ROAD

Type of Work: Complaints

Material Used: _____

Customer Line Inspection: _____

Comments: extremely low pressure / PRV pit is being ~~reset~~ Adjusted

DONE

Current System Information:		New Information:	
Meter # 1:	<u>19408808</u>	Meter # 1:	_____
Meter # 2: Radio	<u>19408808</u>	Meter # 2: Radio	_____
MXU #:	_____	MXU #:	_____
Current Reading	<u>7/20/2014 246</u>	Current Reading	<u>0</u>
Type of Meter:	<u>Badger</u>	Type of Meter:	_____
Year MFG:	<u>2003</u>	Year MFG:	_____
GPS - Longitude	<u>0</u>	GPS - Latitude	<u>0</u>

Employee Signature(s): JS

Date Completed Revised 7-31-14

Martin County Water District

387 East Main St., Suite 140
Inez, KY 41224

WORK ORDER

WO # 140700199

Time Started _____

Work Complete _____

Loc # _____

Master Meter # _____

Date 7/23/2014

Account # _____

SEQ # 221

Name: Tina Ward

Phone # _____

Address: PO Box
Inez, KY 41224

Employee Justin Scott

Location: Spence Branch, 19 Tina Ln, app 1/2 mile on right in beige trailer

MILO

Type of Work: Complaints

Material Used: _____

Customer Line Inspection: _____

Comments: water has a stale odor, has been like this for a few days. So does father next door.

Flushed

Current System Information:		New Information:	
Meter # 1:	<u>29935324</u>	Meter # 1:	_____
Meter # 2: Radio	_____	Meter # 2: Radio	_____
MXU #:	_____	MXU #:	_____
Current Reading	<u>6/20/2014 398</u>	Current Reading	<u>0</u>
Type of Meter:	<u>Badger</u>	Type of Meter:	_____
Year MFG:	<u>2004</u>	Year MFG:	_____
GPS - Longitude	_____	GPS - Latitude	_____

Employee Signature(s): Justin Scott

Date Completed 7-24-14

Martin County Water District ✓

387 East Main St., Suite 140
Inez, KY 41224

WORK ORDER

WO # 140700175

Time Started _____ Work Complete _____

Loc # _____ Master Meter # _____

Date 7/21/2014 Account # _____ SEQ # 165

Name: Will & Shana Newsome Phone # _____

Address: PO Box Employee Justin Scott

WARFIELD, KY 41267

Location: 77 Hode Rd, on the right side of T&D hardware nursery lot, grey raised house

HODE

Type of Work: Complaints

Material Used: _____

Customer Line Inspection _____

Comments: very low water pressue 100 to 125 PSI

Done

Current System Information:		New Information:	
Meter # 1:	<u>70616551</u>	Meter # 1:	_____
Meter # 2: Radio	<u>70616551</u>	Meter # 2: Radio	_____
MXU #:	<u>13136511</u>	MXU #:	_____
Current Reading	<u>6/20/2014 205</u>	Current Reading	<u>0</u>
Type of Meter:	_____	Type of Meter:	_____
Year MFG:	_____	Year MFG:	_____
GPS - Longitude	_____	GPS - Latitude	_____

Employee Signature(s): JS

Date Completed 7-24-14

Martin County Water District

387 East Main St., Suite 140
Inez, KY 41224



WORK ORDER

WO # 140700087

Time Started _____

Work Complete _____

Loc # _____

Master Meter # _____

Date 7/8/2014

Account # _____

SEQ # 818

Name: CHESTER GARTIN JR

Phone # () _____

Address: Hode Rd.
WARFIELD, KY 41267

Employee Rainbo

Location: Hode Rd, 6 miles from T&D Hardware on Warfield side, across from Alonzo Alley, grey double wide w/gazebo & chain link fence.

Type of Work: Complaints

Material Used: showed 100 psi at box

Customer Line Inspection: _____

Comments: low pressure for a week; call before going, has 6 dogs

Current System Information:		New Information:	
Meter # 1:	<u>47823903</u>	Meter # 1:	_____
Meter # 2: Radio	_____	Meter # 2: Radio	_____
MXU #:	_____	MXU #:	_____
Current Reading	<u>6/20/2014 811</u>	Current Reading	<u>0</u>
Type of Meter:	<u>Sensus</u>	Type of Meter:	_____
Year MFG:	<u>1993</u>	Year MFG:	_____
GPS - Longitude	<u>0</u>	GPS - Latitude	<u>0</u>

Employee Signature(s): L.H. Sm

Date Completed 7/14/14

Martin County Water District

387 East Main St., Suite 140
Inez, KY 41224

WORK ORDER

WO # 140700170

Time Started _____ Work Complete _____

Loc # _____ Master Meter # _____

Date 7/18/2014 Account # _____ SEQ # 33

Name: James R. Shepherd Phone # _____

Address: P.O.BOX Employee Rainbo
INEZ, KY 41224

Location: 88 Nichols Street. Last house on right. Across from Henry Ward.

NICHOLS STREET

Type of Work: Complaints

Material Used: all ash screen is spot up

Customer Line Inspection water is flowing through a water

Comments: no water hose,

Current System Information:		New Information:	
Meter # 1:	<u>70840668</u>	Meter # 1:	_____
Meter # 2: Radio	<u>70840668</u>	Meter # 2: Radio	_____
MXU #:	_____	MXU #:	_____
Current Reading	<u>6/20/2014 159</u>	Current Reading	<u>0</u>
Type of Meter:	<u>Sensus</u>	Type of Meter:	_____
Year MFG:	<u>2012</u>	Year MFG:	_____
GPS - Longitude	<u>0</u>	GPS - Latitude	<u>0</u>

Employee Signature(s): BJ Date Completed 7-18-14

Martin County Water District ✓

387 East Main St., Suite 140
Inez, KY 41224

WORK ORDER

WO # 140700026

Time Started _____ Work Complete _____

Loc # _____ Master Meter # _____

Date 7/7/2014 Account # _____ SEQ # 224

Name: Norma McCoy Phone # (_____) _____

Address: Meathouse Rd Employee Rainbo
Pilgrim, KY 41250

Location: 3 Meathouse Rd, turn right @ 1439 4 or 5 miles on right grey trailer on hill

MEATHOUSE

Type of Work: Complaints

Material Used: Water meter loss

Customer Line Inspection: _____

Comments: no water

Current System Information:	New Information:
Meter # 1: <u>29934888</u>	Meter # 1: _____
Meter # 2: Radio <u>29934888</u>	Meter # 2: Radio _____
MXU #: _____	MXU #: _____
Current Reading <u>6/20/2014 532</u>	Current Reading <u>0</u>
Type of Meter: <u>Badger</u>	Type of Meter: _____
Year MFG: <u>2004</u>	Year MFG: _____
GPS - Longitude _____	GPS - Latitude _____

Employee Signature(s): B.J.

Date Completed 7-7-14

Martin County Water District ✓

387 East Main St, Suite 140
Inez, KY 41224

WORK ORDER

WO # 140700018

Time Started _____

Work Complete _____

Loc # _____

Master Meter # _____

Date 7/3/2014

Account # _____

SEQ # 172

Name: John Moore

Phone # _____

Address: leathouse Rd

Employee Rainbo

Pilgrim, KY 41250

Location: , Meathouse Rd Below Leanna Church, 1st Drive, Grey Trallor

Wolf Creek

Type of Work: Complaints

Material Used: _____

Customer Line Inspection: all water was off ✓

Comments: extremely low water pressure

Current System Information:	New Information:
Meter # 1: <u>47823969</u>	Meter # 1: _____
Meter # 2: Radio _____	Meter # 2: Radio _____
MXU #: _____	MXU #: _____
Current Reading <u>6/20/2014 581</u>	Current Reading <u>0</u>
Type of Meter: <u>Sensus</u>	Type of Meter: _____
Year MFG: <u>1993</u>	Year MFG: _____
GPS - Longitude <u>0</u>	GPS - Latitude <u>0</u>

Employee Signature(s): B.J.

Date Completed 7-11-14

Martin County Water District

387 East Main St., Suite 140
Inez, KY 41224

WORK ORDER

WO # 140700031

Time Started _____ Work Complete _____

Loc # _____ Master Meter # _____

Date 7/7/2014 Account # _____ SEQ # 123

Name: George Spence Phone # ()

Address: P.O. Box Employee Clyde Stanley
Inez, KY 41224

Location: 148 Mckinney Rd. Mudfork Rd., across from Milo Bridge, 1/2 mile up Mudfork stay left, blacktop hill 2nd drive on left, meter is @ bottom of hill

148 Mckinney Dr

Type of Work: Complaints

Done

Material Used: _____

Customer Line Inspection _____

Comments: no water / got water

Current System Information:		New Information:	
Meter # 1:	<u>12760367</u>	Meter # 1:	_____
Meter # 2: Radio	<u>12760367</u>	Meter # 2: Radio	_____
MXU #:	_____	MXU #:	_____
Current Reading	<u>6/20/2014 49</u>	Current Reading	<u>0</u>
Type of Meter:	<u>Hersey</u>	Type of Meter:	_____
Year MFG:	<u>2012</u>	Year MFG:	_____
GPS - Longitude	_____	GPS - Latitude	_____

Employee Signature(s): TH, CS

Date Completed 7-8-14

Martin County Water District

387 East Main St., Suite 140
Inez, KY 41224

WORK ORDER

WO # 140700113

Time Started _____ Work Complete _____

Loc # _____ Master Meter # _____

Date 7/11/2014 Account # _____ SEQ # 106

Name: MARY STANLEY Phone # (_____)

Address: PO Box : _____ Employee Kyle Sammons
WARFIELD , KY 41267

Location: 84 Stanley Dr

COLLINS CREEK

Type of Work: Complaints

Material Used: _____

Customer Line Inspection _____

Comments: no water / Contractors forgot to turn valve back on

Current System Information:		New Information:	
Meter # 1:	<u>70816608</u>	Meter # 1:	_____
Meter # 2: Radio	_____	Meter # 2: Radio	_____
MXU #:	<u>13154928</u>	MXU #:	_____
Current Reading	<u>6/20/2014 283</u>	Current Reading	<u>0</u>
Type of Meter:	_____	Type of Meter:	_____
Year MFG:	_____	Year MFG:	_____
GPS - Longitude	_____	GPS - Latitude	_____

Employee Signature(s): KS, SF Date Completed 7/11/14

Martin County Water District

387 East Main St., Suite 140
Inez, KY 41224

WORK ORDER

WO # 140700106

Time Started _____ Work Complete _____

Loc # _____ Master Meter # _____

Date 7/10/2014 Account # _____ SEQ # 184

Name: Jason Robinson Phone # _____

Address: Meathouse Rd Employee Rainbo
PILGRIM, KY 41250

Location: Meathouse Rd, beside LeAnna Church, brick house

9006 Meathouse Rd

Type of Work: Complaints

Material Used: they know the reason got a bad P.R.S

Customer Line Inspection: _____

Comments: low pressure

Current System Information:		New Information:	
Meter # 1:	<u>47824008</u>	Meter # 1:	_____
Meter # 2: Radio	<u>47824008</u>	Meter # 2: Radio	_____
MXU #:	_____	MXU #:	_____
Current Reading	<u>6/20/2014 857</u>	Current Reading	<u>0</u>
Type of Meter:	<u>Sensus</u>	Type of Meter:	_____
Year MFG:	<u>1993</u>	Year MFG:	_____
GPS - Longitude	<u>0</u>	GPS - Latitude	<u>0</u>

Employee Signature(s): BJ,

Date Completed 7-10-14

Martin County Water District

387 East Main St., Suite 140
Inez, KY 41224

WORK ORDER

WO # 140700108

Time Started _____ Work Complete _____

Loc # _____ Master Meter # _____

Date 7/10/2014 Account # _____ SEQ # 142

Name: HENRY JUDE Phone # _____

Address: North Wolf Creek Employee Rainbo
LOVELY, KY 41231

Location: N Wolf Crk, white house w/ green trim on hill; Ralf Maynard is nearest neighbor

Type of Work: Complaints

Material Used: Line broke in Warfield

Customer Line Inspection: _____

Comments: no water

Current System Information:		New Information:	
Meter # 1:	<u>74846459</u>	Meter # 1:	_____
Meter # 2: Radio	<u>74846459</u>	Meter # 2: Radio	_____
MXU #:	<u>14991931</u>	MXU #:	_____
Current Reading	<u>6/20/2014 42</u>	Current Reading	<u>0</u>
Type of Meter:	_____	Type of Meter:	_____
Year MFG:	_____	Year MFG:	_____
GPS - Longitude	_____	GPS - Latitude	_____

Employee Signature(s): BJ Date Completed 7-10-14

Martin County Water District

387 East Main St., Suite 140
Inez, KY 41224

WORK ORDER

WO # 140700011

Time Started _____ Work Complete _____

Loc # _____ Master Meter # _____

Date 7/1/2014 Account # _____ SEQ # 163

Name: Forest Fitch Phone # (_____

Address: P.O. Box Employee John Mills
Inez, KY 41224

Location: luckleberry Ridge.. Brown brick house on left.

luckleberry Ridge

Type of Work: Complaints

Material Used: _____

Customer Line Inspection _____

Comments: no water, check Otto Brown pump station / Done, electrical issues

Current System Information:		New Information:	
Meter # 1:	<u>63860615</u>	Meter # 1:	_____
Meter # 2: Radio	<u>63860615</u>	Meter # 2: Radio	_____
MXU #:	<u>13155594</u>	MXU #:	_____
Current Reading	<u>6/20/2014 463</u>	Current Reading	<u>0</u>
Type of Meter:	_____	Type of Meter:	_____
Year MFG:	_____	Year MFG:	_____
GPS - Longitude	_____	GPS - Latitude	_____

Employee Signature(s): JM

Date Completed: 7/1/14

Martin County Water District

387 East Main St., Suite 140
Inez, KY 41224

WORK ORDER

COMPLETED

WO # 130800177

Time Started _____

Work Complete _____

Loc # _____

Master Meter # _____

Date 8/20/2013

Account # _____

SEQ # 260

Name: STERLING MARCUM

Phone # _____

Address: _____

LOUISA, KY 41230

Location: Rockcastle Rd, 1st white house on the right past Friendship Church

Meter box is up in the yard next to the house if you drive up the drive way it will be right in front of the truck ROUTE 3 NORTH side walk is to the left side of box

Type of Work: Complaints

Material Used: _____

Customer Line Inspection _____

Comments: says water is foamy and has dirt in it

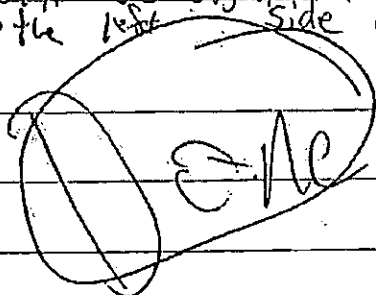

Current System Information:		New Information:	
Meter # 1:	<u>47823998</u>	Meter # 1:	_____
Meter # 2: Radio	<u>47823998</u>	Meter # 2: Radio	_____
MXU #:	_____	MXU #:	_____
Current Reading	<u>7/20/2013 456</u>	Current Reading	<u>0</u>
Type of Meter:	<u>Sensus</u>	Type of Meter:	_____
Year MFG:	<u>1993</u>	Year MFG:	_____
GPS - Longitude	<u>0</u>	GPS - Latitude	<u>0</u>

Employee Signature(s): JAS

Date Completed 8-21-13

Martin County Water District

387 East Main St., Suite 140
Inez, KY 41224

WORK ORDER

COMPLETED

WO # 130800168

Time Started _____ Work Complete _____

Loc # _____ Master Meter # _____

Date 8/16/2013 Account # _____ SEQ # 834

Name: Thomas & Diana Thompson Phone # _____

Address: Thompson Lane
Inez, ky 41224

Location: .. Thompson Ln Turkey, past fire dept., 2nd house past new Nazarene Church, tan w/green roof

292

Type of Work: Complaints

Material Used: _____

Customer Line Inspection told customer to check regulator

Comments: customer has had low water pressure for at least 2 months. over 100lbs of psi

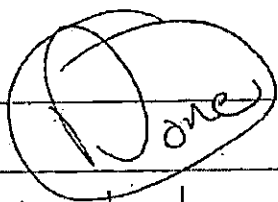

Current System Information:	New Information:
Meter # 1: _____	Meter # 1: _____
Meter # 2: Radio _____	Meter # 2: Radio _____
MXU #: _____	MXU #: _____
Current Reading <u>0</u>	Current Reading <u>0</u>
Type of Meter: _____	Type of Meter: _____
Year MFG: _____	Year MFG: _____
GPS - Longitude _____	GPS - Latitude _____

Employee Signature(s): JW Date Completed 8-26-13

Martin County Water District

387 East Main St., Suite 140
Inez, KY 41224

WORK ORDER

COMPLETE

WO # 130600152

Time Started _____ Work Complete _____

Loc # _____ Master Meter # _____

Date 6/19/2013 Account # _____ SEQ # 393

Name: DONALD HINKLE Phone # _____

Address: P.O. BOX
INEZ, KY 41224

Location: Reservoir Rd. 2nd driveway.

LICKBRANCH RD.

Type of Work: Complaints

Material Used: 3/4 WRAP

Customer Line Inspection _____

Comments: leak across the road from his house.

Current System Information:		New Information:	
Meter # 1:	<u>70616419</u>	Meter # 1:	_____
Meter # 2: Radio	_____	Meter # 2: Radio	_____
MXU #:	<u>13150995</u>	MXU #:	_____
Current Reading	<u>5/20/2013 183</u>	Current Reading	<u>0</u>
Type of Meter:	_____	Type of Meter:	_____
Year MFG:	_____	Year MFG:	_____
GPS - Longitude	_____	GPS - Latitude	_____

Employee Signature(s): JB-JS-GS-JG-N

Date Completed 8-1-13

Martin County Water District

387 East Main St., Suite 140
Inez, KY 41224

WORK ORDER

COMPLETED

WO # 130800013

Time Started _____ Work Complete _____

Loc # _____ Master Meter # _____

Date 8/2/2013 Account # _____ SEQ # 179

Name: JEFF HINKLE Phone # (_____)

Address: P.O. BOX
INEZ, KY 41224

Location: 109 Union Rd

TURKEY ROAD

Type of Work: Complaints

Material Used: _____

Customer Line Inspection No leak found

Comments: high bill

Done

Current System Information:		New Information:	
Meter # 1:	<u>70616457</u>	Meter # 1:	_____
Meter # 2: Radio	<u>70616457</u>	Meter # 2: Radio	_____
MXU #:	<u>13152697</u>	MXU #:	_____
Current Reading	<u>7/20/2013 169 / 170</u>	Current Reading	<u>0</u>
Type of Meter:	_____	Type of Meter:	_____
Year MFG:	_____	Year MFG:	_____
GPS - Longitude	_____	GPS - Latitude	_____

Employee Signature(s): JW

Date Completed 8-5-13

Martin County Water District ✓

387 East Main St., Suite 140
Inez, KY 41224

COMPLETED

WORK ORDER

WO # 130800110

Time Started _____

Work Complete _____

Loc # _____

Master Meter # _____

Dat 8/8/2013

Account # _____

SEQ # 178

Name: KAREN MARCUM

Phone # _____

Address: PO BOX

Employee Kyle Sammons

BEAUTY, KY 41203

Location Big Elk Rd. 1 mile up Big Elk Rd on right, beside Black barn w/sign that says "Buck Creek Scooter"

Type of Work: Complaints

Material Used: _____

Customer Line Inspection _____

Comments no water is coming from meter, please stop by Karen's house (white w/black fence)

Done

Current System Information:

Meter # 1: 29934697

Meter # 2: Radio 29934697

MXU #: _____

Current Reading 7/20/2013 876

Type of Meter: Badger

Year MFG: 2004

GPS - Longitude 0

New Information:

Meter # 1: _____

Meter # 2: Radio _____

MXU #: _____

Current Reading 0

Type of Meter: _____

Year MFG: _____

GPS - Latitude 0

Employee Signature(s): JV

Date Completed 8-8-13

Martin County Water District

387 East Main St., Suite 140
Inez, KY 41224

WORK ORDER

WO # 140800265

Time Started _____ Work Complete _____

Loc # _____ Master Meter # _____

Date 8/25/2014 Account # _____ SEQ # 101

Name: LEE SUMPTER Phone # _____

Address: P.O. BOX Employee Clyde Stanley
INEZ, KY 41224

Location: Blackburn Ln on Blacklog; trailer on right

ROUTE 40 EAST

Type of Work: Complaints

Material Used: 30lb of grass seed, ~~and~~ 4 bails of straw

Customer Line Inspection: _____

Comments: property behind Johnny Stacy's need repaired

Current System Information:		New Information:	
Meter # 1:	<u>29935408</u>	Meter # 1:	_____
Meter # 2: Radio	_____	Meter # 2: Radio	_____
MXU #:	_____	MXU #:	_____
Current Reading	<u>7/20/2014 301</u>	Current Reading	<u>0</u>
Type of Meter:	<u>Badger</u>	Type of Meter:	_____
Year MFG:	<u>2004</u>	Year MFG:	_____
GPS - Longitude	<u>0</u>	GPS - Latitude	<u>0</u>

Employee Signature(s): T.H. CS

Date Completed 8-25-14

Martin County Water District ✓

387 East Main St., Suite 140
Inez, KY 41224

WORK ORDER

WO # 140800268

Time Started _____ Work Complete _____

Loc # _____ Master Meter # _____

Date 8/25/2014 Account # _____ SEQ # 126

Name: George Spence Phone # _____

Address: P.O. Box Employee Rainbo
Inez, KY 41224

Location: McKinney Rd. Mudfork Rd., across from Milo Bridge, 1/2 mile up Mudfork stay left, blacktop hill 2nd drive on left, meter is @ bottom of hill

McKinney Dr

Type of Work: Complaints

Material Used: _____

Customer Line Inspection: 3/4" WLD AT Spring BR

Comments: low pressure all day, neighbors are having same issue

Current System Information:	New Information:
Meter # 1: _____	Meter # 1: _____
Meter # 2: Radio _____	Meter # 2: Radio _____
MXU #: _____	MXU #: _____
Current Reading <u>0</u>	Current Reading <u>0</u>
Type of Meter: _____	Type of Meter: _____
Year MFG: _____	Year MFG: _____
GPS - Longitude _____	GPS - Latitude _____

Employee Signature(s): [Signature] Date Completed: 8-25-14

Martin County Water District ✓

387 East Main St., Suite 140
Inez, KY 41224

WORK ORDER

WO # 140800250

Time Started _____ Work Complete _____

Loc # _____ Master Meter # _____

Date 8/20/2014 Account # _____ SEQ # 400

Name: Helen MILLS Phone # _____

Address: P.O. BOX Employee Troy Horn
INEZ, KY 41224

Location: 71 Helen Mills Rd, white house

TURKEY ROAD

Type of Work: Complaints

Material Used: _____

Customer Line Inspection: _____

Comments: customer has had low pressure since leak was worked on / got ~~low~~ pressure

Done

Current System Information:	New Information:
Meter # 1: <u>70616398</u>	Meter # 1: _____
Meter # 2: Radio _____	Meter # 2: Radio _____
MXU #: <u>13152700</u>	MXU #: _____
Current Reading <u>7/20/2014 222</u>	Current Reading <u>0</u>
Type of Meter: _____	Type of Meter: _____
Year MFG: _____	Year MFG: _____
GPS - Longitude _____	GPS - Latitude _____

Employee Signature(s): TH, CS

Date Completed 8-25-14

Martin County Water District

387 East Main St., Suite 140
Inez, KY 41224

WORK ORDER

WO # 140800016

Time Started _____

Work Complete _____

Loc # _____

Master Meter # _____

Date 8/4/2014

Account # _____

SEQ # 268

Name: LILLIAN STACY

Phone # _____

Address: PO BOX :

Employee Justin Scott

LOVELY , KY 41231

Location: Himmlerville Rd, on left, Yellow house w/brown trim

Type of Work: Complaints

Material Used: _____

Customer Line Inspection: _____

Comments: complaints of water smelling bad

Flushed

Current System Information:		New Information:	
Meter # 1:	<u>29934938</u>	Meter # 1:	_____
Meter # 2: Radio	_____	Meter # 2: Radio	_____
MXU #:	_____	MXU #:	_____
Current Reading	<u>7/20/2014 245</u>	Current Reading	<u>0</u>
Type of Meter:	<u>Badger</u>	Type of Meter:	_____
Year MFG:	_____	Year MFG:	_____
GPS - Longitude	<u>0</u>	GPS - Latitude	<u>0</u>

Employee Signature(s): Justin Scott

Date Completed 8-4-14

249
Martin County Water District ✓

387 East Main St., Suite 140
Inez, KY 41224

WORK ORDER

WO # 140800017

Time Started _____ Work Complete _____

Loc # _____ Master Meter # _____

Date 8/4/2014 Account # _____ SEQ # 462

Name: Penny Todd Phone # _____

Address: PO Box Employee Justin Scott
Inez, KY 41224

Location: Davis Cemetery Rd 1st house on right past Ooten, Grey in color, Church of Christ in front of house

STAFFORD

Type of Work: Complaints

Material Used: _____

Customer Line Inspection _____

Comments: foul odor since low water pressure last week, lines may need flushed

Flushed

Current System Information:		New Information:	
Meter # 1:	<u>67012673</u>	Meter # 1:	_____
Meter # 2: Radio	_____	Meter # 2: Radio	_____
MXU #:	_____	MXU #:	_____
Current Reading	<u>7/20/2014 137</u>	Current Reading	<u>0</u>
Type of Meter:	<u>Sensus</u>	Type of Meter:	_____
Year MFG:	<u>2006</u>	Year MFG:	_____
GPS - Longitude	<u>0</u>	GPS - Latitude	<u>0</u>

Employee Signature(s): *Justin Scott*

Date Completed 8-4-14

Martin County Water District

387 East Main St., Suite 140
Inez, KY 41224

WORK ORDER

WO # 140800123

Time Started _____ Work Complete _____

Loc # _____ Master Meter # _____

Date 8/11/2014 Account # _____ SEQ # 24

Name: ARNOLD MURPHY Phone # _____

Address: Hewitt Ave Employee Justin Scott
LOVELY, KY 41231

Location: Hewitt Ave, 1st house on left, beige 2-story house

Type of Work: Complaints *90 PSI at box*

Material Used: _____

Customer Line Inspection: _____

Comments: low pressure

Current System Information:		New Information:	
Meter # 1:	<u>99459379</u>	Meter # 1:	_____
Meter # 2: Radio	<u>99459379</u>	Meter # 2: Radio	_____
MXU #:	_____	MXU #:	_____
Current Reading	<u>7/20/2014 678</u>	Current Reading	<u>0</u>
Type of Meter:	<u>Badger</u>	Type of Meter:	_____
Year MFG:	<u>1999</u>	Year MFG:	_____
GPS - Longitude	<u>0</u>	GPS - Latitude	<u>0</u>

Employee Signature(s): CH-JM

Date Completed 8-12-14

Martin County Water Dist ✓
387 East Main St., Suite 140
Inez, KY 41224

WORK ORDER

WO # 140800145

Time Started _____ Work Complete _____

Loc # _____ Master Meter # _____

Date 8/13/2014 Account # _____ SEQ # 82

Name: EDDIE HINKLE Phone # () _____
Address: P.O.BOX Employee Rainbo
BEAUTY, KY 41203

Location: Bone Holw 2031.Lower Poplar.Bone Hollow.1st trailer on right at top of hill.Grey & white.

Type of Work: Flush Line *Done*

Material Used: Flush line 8-13-14

Customer Line Inspection _____

Comments: water still has odor and low pressure

Current System Information:		New Information:	
Meter # 1:	<u>97728662</u>	Meter # 1:	_____
Meter # 2: Radio	_____	Meter # 2: Radio	_____
MXU #:	_____	MXU #:	_____
Current Reading	<u>7/20/2014 794</u>	Current Reading	<u>0</u>
Type of Meter:	<u>Badger</u>	Type of Meter:	_____
Year MFG:	<u>1997</u>	Year MFG:	_____
GPS - Longitude	<u>0</u>	GPS - Latitude	<u>0</u>

Employee Signature(s): RJ Date Completed 8-13-14

Martin County Water District ✓

387 East Main St., Suite 140
Inez, KY 41224

WORK ORDER

WO # 140800092

Time Started _____

Work Complete _____

Loc # _____

Master Meter # _____

Date 8/6/2014

Account # _____

SEQ # 224

Name: Norma McCoy

Phone # _____

Address: Meathouse Rd
Pilgrim, KY 41250

Employee Rainbo

Location: : 1 Meathouse Rd, turn right @ 1439 4 or 5 miles on right grey trailer on hill

MEATHOUSE

Type of Work: Complaints

Material Used: _____

Customer Line Inspection: _____

Comments: no water / repaired break

Current System Information:		New Information:	
Meter # 1:	<u>29934888</u>	Meter # 1:	_____
Meter # 2: Radio	<u>29934888</u>	Meter # 2: Radio	_____
MXU #:	_____	MXU #:	_____
Current Reading	<u>7/20/2014 536</u>	Current Reading	<u>0</u>
Type of Meter:	<u>Badger</u>	Type of Meter:	_____
Year MFG:	<u>2004</u>	Year MFG:	_____
GPS - Longitude	_____	GPS - Latitude	_____

Employee Signature(s): RS

Date Completed 8/10/14

Martin County Water District

387 East Main St., Suite 140
Inez, KY 41224

WORK ORDER

WO # 140500138

Time Started _____

Work Complete _____

Loc # _____

Master Meter # _____

Date 5/19/2014

Account # _____

SEQ # 63

Name: FRANK BALDRIDGE

Phone # () _____

Address: P.O. BOX

INEZ , KY 41224]

Location: RIGHT SIDE 133 Haney Pl

HANEY PLACE

Type of Work: Complaints

Material Used: _____

Customer Line Inspection _____

Comments: driveway has been destroyed since line was repaced last year.

Current System Information:		New Information:	
Meter # 1:	<u>98003195</u>	Meter # 1:	_____
Meter # 2: Radio	_____	Meter # 2: Radio	_____
MXU #:	_____	MXU #:	_____
Current Reading	<u>4/20/2014 774</u>	Current Reading	<u>0</u>
Type of Meter:	<u>Badger</u>	Type of Meter:	_____
Year MFG:	<u>1998</u>	Year MFG:	_____
GPS - Longitude	<u>0</u>	GPS - Latitude	<u>0</u>

Employee Signature(s): JM

Date Completed 8/20/14

Martin County Water District ✓

387 East Main St., Suite 140
Inez, KY 41224

WORK ORDER

WO # 140800076

Time Started _____

Work Complete _____

Loc # _____

Master Meter # _____

Date 8/5/2014

Account # _____

SEQ # 35

Name: GLEN BLEVINS

Phone # (_____) _____

Address: PO Box

Employee Justin Scott

INEZ , KY 41224

Location: 131 Blevins Ln

MIDDLEFORK RD.

Type of Work: Complaints

Material Used: _____

Customer Line Inspection: _____

Comments: musty smell with greasy texture / Tam is trying to fix it

(Handwritten signature: Tam)

Current System Information:		New Information:	
Meter # 1:	<u>29213201</u>	Meter # 1:	_____
Meter # 2: Radio	_____	Meter # 2: Radio	_____
MXU #:	_____	MXU #:	_____
Current Reading	<u>7/20/2014 757</u>	Current Reading	<u>0</u>
Type of Meter:	<u>Badger</u>	Type of Meter:	_____
Year MFG:	<u>2004</u>	Year MFG:	_____
GPS - Longitude	<u>0</u>	GPS - Latitude	<u>0</u>

Employee Signature(s): *(Handwritten signature)*

Date Completed 8-6-14

Martin County Water District

387 East Main St., Suite 140
Inez, KY 41224

WORK ORDER

WO # 140900215

Time Started _____ Work Complete _____

Loc # _____ Master Meter # _____

Date 9/26/2014 Account # _____ SEQ # 221

Name: LON CRUM Phone # () _____

Address: P.O. Box Employee Troy Horn
Inez, KY 41224

Location: 81 Guyton Rd, Little Lick Br, top of hill last house @ top of hill, red

GUYTON RD

Type of Work: Complaints

Material Used: _____

Customer Line Inspection _____

Comments: very low water pressure / said it came back up

Current System Information:		New Information:	
Meter # 1:	_____	Meter # 1:	_____
Meter # 2: Radio	_____	Meter # 2: Radio	_____
MXU #:	_____	MXU #:	_____
Current Reading	<u>0</u>	Current Reading	<u>0</u>
Type of Meter:	_____	Type of Meter:	_____
Year MFG:	_____	Year MFG:	_____
GPS - Longitude	_____	GPS - Latitude	_____

Employee Signature(s): CS, JS, TH Date Completed 9-26-14

Martin County Water District

387 East Main St., Suite 140
Inez, KY 41224

WORK ORDER

WO # 140900003

Time Started _____

Work Complete _____

Loc # _____

Master Meter # _____

Date 9/2/2014

Account # _____

SEQ # 218

Name: JAMES HOWELL

Phone # _____

Address: P.O. BOX 1
INEZ, KY 41224

Employee Troy Horn

Location: 37 James Howell Dr Left Fork

LITTLE LICK BRANCH

Type of Work: Complaints

Done

Material Used: _____

Customer Line Inspection _____

Comments: low water pressure all weekend / had 30 psi at box

Current System Information:	New Information:
Meter # 1: <u>94261366</u>	Meter # 1: _____
Meter # 2: Radio _____	Meter # 2: Radio _____
MXU #: _____	MXU #: _____
Current Reading <u>8/20/2014 1326</u>	Current Reading <u>0</u>
Type of Meter: <u>Badger</u>	Type of Meter: _____
Year MFG: <u>1994</u>	Year MFG: _____
GPS - Longitude <u>0</u>	GPS - Latitude <u>0</u>

Employee Signature(s): T.H., CS

Date Completed 9-12-14

Martin County Water District

387 East Main St., Suite 140
Inez, KY 41224

WORK ORDER

WO # 140900090

Time Started _____ Work Complete _____

Loc # _____ Master Meter # _____

Date 9/4/2014 Account # _____ SEQ # _____

Name: Ashley Tiller Phone # _____

Address: _____ Employee Rainbo

Location: mouth of Setser Br, Debord. Wants locking lid for pit.

Type of Work: Complaints

Material Used: _____

Customer Line Inspection _____

Comments: put lid and flagged it off

Done

Current System Information:

Meter # 1: _____

Meter # 2: Radio _____

MXU #: _____

Current Reading 0

Type of Meter: _____

Year MFG: _____

GPS - Longitude _____

New Information:

Meter # 1: _____

Meter # 2: Radio _____

MXU #: _____

Current Reading 0

Type of Meter: _____

Year MFG: _____

GPS - Latitude _____

Employee Signature(s): THCS

Date Completed 9-11-14

Martin County Water District ✓

387 East Main St., Suite 140
Inez, KY 41224

WORK ORDER

WO # 140900086

Time Started _____ Work Complete _____

Loc # _____ Master Meter # _____

Date 9/5/2014 Account # _____ SEQ # 270

Name: Edna Daniel Phone # _____

Address: PO Box Employee Justin Scott
Inez, KY 41224

Location: Rocky Top, Past Ratliff Town, road turns right between two brick houses, go up the hill, 1st place on the left.

Old Rt. 3

Type of Work: Complaints

Material Used: _____

Customer Line Inspection: Had 30 PSI Af box

Comments: this customer and her neighbor are experiencing no/low water for a week

Current System Information:	New Information:
Meter # 1: <u>29935126</u>	Meter # 1: _____
Meter # 2: Radio _____	Meter # 2: Radio _____
MXU #: _____	MXU #: _____
Current Reading <u>8/20/2014 421</u>	Current Reading <u>0</u>
Type of Meter: <u>Badger</u>	Type of Meter: _____
Year MFG: <u>2004</u>	Year MFG: _____
GPS - Longitude <u>0</u>	GPS - Latitude <u>0</u>

Employee Signature(s): [Signature] Date Completed 9-5-14

Martin County Water District ✓

387 East Main St., Suite 140
Inez, KY 41224

WORK ORDER

WO # 140800118

Time Started _____

Work Complete _____

Loc # _____

Master Meter # _____

Date 8/8/2014

Account # _____

SEQ # 137

Name: MARK HOWARD

Phone # _____

Address: P.O. BOX
Inez, KY 41224

Employee Clyde Stanley

Location: Hinkle Valley, turn left after crossing bridge, white doublewide

ROUTE 1884 MILO

Type of Work: Complaints

Material Used: Pest or better, ~~water~~, 6' line

Customer Line Inspection: Line never stop upon our side.

Comments: extremely low pressure since leak was worked on.

Current System Information:		New Information:	
Meter # 1:	<u>19667271</u>	Meter # 1:	<u>29934572</u>
Meter # 2: Radio	_____	Meter # 2: Radio	_____
MXU #:	_____	MXU #:	_____
Current Reading	<u>7/20/2014 809</u>	Current Reading	<u>8960</u>
Type of Meter:	<u>Badger</u>	Type of Meter:	<u>Badger</u>
Year MFG:	<u>2003</u>	Year MFG:	_____
GPS - Longitude	<u>0</u>	GPS - Latitude	<u>0</u>

Employee Signature(s): TR, JR, RJ

Date Completed 9-8-14

Martin County Water District ✓

387 East Main St., Suite 140
Inez, KY 41224

WORK ORDER

WO # 141000201

Time Started _____ Work Complete _____

Loc # _____ Master Meter # _____

Date 10/23/2014 Account # _____ SEQ # 158

Name: RICKY HORN Phone # _____

Address: Mountain View Employee Clyde Stanley

INEZ, KY 41224

Location: Mountain View

CALF CREEK

Type of Work: Complaints

Material Used: _____

Customer Line Inspection: Water came back on

Comments: complaints of no water

Current System Information:		New Information:	
Meter # 1:	<u>99691124</u>	Meter # 1:	_____
Meter # 2: Radio	_____	Meter # 2: Radio	_____
MXU #:	_____	MXU #:	_____
Current Reading	<u>9/20/2014 645</u>	Current Reading	<u>0</u>
Type of Meter:	<u>Badger</u>	Type of Meter:	_____
Year MFG:	<u>1999</u>	Year MFG:	_____
GPS - Longitude	<u>0</u>	GPS - Latitude	<u>0</u>

Employee Signature(s): CH, JM

Date Completed 10-23-14

Martin County Water District ✓

387 East Main St., Suite 140
Inez, KY 41224

WORK ORDER

WO # 141000231

Time Started _____ Work Complete _____

Loc # _____ Master Meter # _____

Date 10/27/2014 Account # _____ SEQ # 107

Name: ERVIN STEPP Phone # _____

Address: Collins Crk Employee Rainbo
WARFIELD, KY 41267

Location: Collins Crk Main end of Collins Creek. Meter box on right

Type of Work: Complaints

Material Used: _____

Customer Line Inspection: blow air of line deemed to working

Comments: low water pressure for new.

Current System Information:		New Information:	
Meter # 1:	<u>16151170</u>	Meter # 1:	_____
Meter # 2: Radio	<u>16151170</u>	Meter # 2: Radio	_____
MXU #:	_____	MXU #:	_____
Current Reading	<u>10/20/2014 1041</u>	Current Reading	<u>0</u>
Type of Meter:	<u>Badger</u>	Type of Meter:	_____
Year MFG:	<u>2000</u>	Year MFG:	_____
GPS - Longitude	<u>-82.42864</u>	GPS - Latitude	<u>37.83200</u>

Employee Signature(s): RJ.

Date Completed 10-26-14

Martin County Water District

387 East Main St., Suite 140
Inez, KY 41224



WORK ORDER

WO # 141000142

Time Started _____ Work Complete _____

Loc # _____ Master Meter # _____

Date 10/15/2014 Account # _____ SEQ # 9

Name: DOROTHY FARRA Phone # _____

Address: P.O.BOX Employee Corey Hill
WARFIELD, KY 41267

Location: Riverfront Rd

LOVELY

Type of Work: Complaints Done

Material Used: _____

Customer Line Inspection: _____

Comments: check water meter to see if it is busted / ground water in box; stop leak on customer's side

Current System Information:		New Information:	
Meter # 1:	<u>97728665</u>	Meter # 1:	_____
Meter # 2: Radio	_____	Meter # 2: Radio	_____
MXU #:	_____	MXU #:	_____
Current Reading	<u>9/20/2014 495</u>	Current Reading	<u>0</u>
Type of Meter:	<u>Badger</u>	Type of Meter:	_____
Year MFG:	<u>1997</u>	Year MFG:	_____
GPS - Longitude	<u>0</u>	GPS - Latitude	<u>0</u>

Employee Signature(s) CH, JM

Date Completed 10/15/14

Martin County Water District

387 East Main St., Suite 140
Inez, KY 41224

WORK ORDER

WO # 141100140

Time Started _____ Work Complete _____

Loc # _____ Master Meter # _____

Date 11/24/2014 Account # _____ SEQ # 223

Name: TIM MCCOY #2 Phone # _____

Address: Beauty Rd Employee Troy Horn

BEAUTY, KY 41203

Location: Beauty Rd

Type of Work: Complaints

Material Used: _____

Customer Line Inspection: Flushed line Done

Comments: air in lines; blowing his service lines apart

Current System Information:		New Information:	
Meter # 1:	<u>16368696</u>	Meter # 1:	_____
Meter # 2: Radio	<u>16368696</u>	Meter # 2: Radio	_____
MXU #:	_____	MXU #:	_____
Current Reading	<u>11/20/2014 429</u>	Current Reading	<u>0</u>
Type of Meter:	<u>Badger</u>	Type of Meter:	_____
Year MFG:	<u>2000</u>	Year MFG:	_____
GPS - Longitude	<u>0</u>	GPS - Latitude	<u>0</u>

Employee Signature(s): RJ, JS

Date Completed 11-24-14

Martin County Water District ✓

387 East Main St., Suite 140
Inez, KY 41224

WORK ORDER

WO # 141100088

Time Started _____

Work Complete _____

Loc # _____

Master Meter # _____

Date 11/13/2014

Account # _____

SEQ # 226

Name: LON CRUM

Phone # () _____

Address: P.O. Box

Employee Justin Scott

Inez, KY 41224

Location: Guyton Rd, Little Lick Br, top of hill last house @ top of hill, red

GUYTON RD

Type of Work: Complaints

Material Used: fixed 2 ~~leaks~~ leaks Has inside meter

Customer Line Inspection: _____

Comments: customer has no water

Done

Current System Information:

Meter # 1: 29935077
Meter # 2: Radio 29935077
MXU #: _____
Current Reading 10/20/2014 610
Type of Meter: Badger
Year MFG: 2004
GPS - Longitude 0

New Information:

Meter # 1: _____
Meter # 2: Radio _____
MXU #: _____
Current Reading 0
Type of Meter: _____
Year MFG: _____
GPS - Latitude 0

Employee Signature(s): CS, JS, TH

Date Completed 11-25-14

Martin County Water District

387 East Main St., Suite 140
Inez, KY 41224

WORK ORDER

WO # 141100110

Time Started _____ Work Complete _____

Loc # _____ Master Meter # _____

Date 11/18/2014 Account # _____ SEQ # 27

Name: Carol Stevens Phone # _____

Address: Long Br. Employee Rainbo
Lovely, Ky 41230

Location: Long Br, new white home on the right, less than 1/2 mile to next rd

292

Type of Work: Complaints

Material Used: it was air in line when we was

Customer Line Inspection: shutting it off on em.

Comments: water is milky white since last night, check for problems

Current System Information:		New Information:	
Meter # 1:	<u>29934536</u>	Meter # 1:	_____
Meter # 2: Radio	_____	Meter # 2: Radio	_____
MXU #:	_____	MXU #:	_____
Current Reading	<u>10/20/2014 534</u>	Current Reading	<u>0</u>
Type of Meter:	<u>Badger</u>	Type of Meter:	_____
Year MFG:	<u>2004</u>	Year MFG:	_____
GPS - Longitude	_____	GPS - Latitude	_____

Employee Signature(s): RJ

Date Completed 11-20-14

Martin County Water District

387 East Main St., Suite 140
Inez, KY 41224

WORK ORDER

WO # 140900237

Time Started _____ Work Complete _____

Loc # _____ Master Meter # _____

Date 9/29/2014 Account # _____ SEQ # 66

Name: FRANK BALDRIDGE Phone # (_____) _____

Address: P.O. BOX
INEZ, KY 41224 Employee John Mills

Location: Haney Pl, last house, green house;

HANEY PLACE

Type of Work: Complaints

Material Used: _____

Customer Line Inspection: _____

Comments: driveway has been destroyed since line was repaced last year, needs blacktop

Current System Information:		New Information:	
Meter # 1:	<u>98003195</u>	Meter # 1:	_____
Meter # 2: Radio	_____	Meter # 2: Radio	_____
MXU #:	_____	MXU #:	_____
Current Reading	<u>9/20/2014 792</u>	Current Reading	<u>0</u>
Type of Meter:	<u>Badger</u>	Type of Meter:	_____
Year MFG:	<u>1998</u>	Year MFG:	_____
GPS - Longitude	<u>0</u>	GPS - Latitude	<u>0</u>

Employee Signature(s): Hinkles Blacktopping Date Completed 11-24-14

Martin County Water District



387 East Main St., Suite 140
Inez, KY 41224

WORK ORDER

WO # 141000176

Time Started _____ Work Complete _____

Loc # _____ Master Meter # _____

Date 10/21/2014 Account # _____ SEQ # _____

Name: Maggie Collins Phone # _____

Address: _____ Employee Clyde Stanley
Inez, KY 41224

Location: 2 driveways past Frog Pond; Maggie Collins; driveway up hill, recent work by MCWD has left her driveway rough, needs repaired.

Type of Work: Complaints *Fix*

Material Used: Level out the rough spot

Customer Line Inspection: _____

Comments: Still need a drain pipe

Current System Information:	New Information:
Meter # 1: _____	Meter # 1: _____
Meter # 2: Radio _____	Meter # 2: Radio _____
MXU #: _____	MXU #: _____
Current Reading <u>0</u>	Current Reading <u>0</u>
Type of Meter: _____	Type of Meter: _____
Year MFG: _____	Year MFG: _____
GPS - Longitude _____	GPS - Latitude _____

Employee Signature(s): JS, RJ, TR

Date Completed 10-30-14

Health Dept.

Martin County Water District

387 East Main St., Suite 140
Inez, KY 41224

WORK ORDER

WO # 140100432

Time Started _____ Work Complete _____

Loc # _____ Master Meter # _____

Dat 1/31/2014 Account # _____ SEQ # 14

Name: MARIE LOWE Phone # _____

Address: S. Wolf Creek Rd. Employee Rainbo
PILGRIM, KY 41250

Location: Wolf creek past miners in between garbage dump and martin co freewill baptist

Type of Work: Complaints

Done

Material Used: _____

Customer Line Inspection _____

Comments: no water *to ad meter loose on water was going through meter but froze on their side*

Current System Information:		New Information:	
Meter # 1:	<u>96130852</u>	Meter # 1:	_____
Meter # 2: Radio	_____	Meter # 2: Radio	_____
MXU #:	_____	MXU #:	_____
Current Reading	<u>1/20/2014 718</u>	Current Reading	<u>0</u>
Type of Meter:	<u>Badger</u>	Type of Meter:	_____
Year MFG:	<u>1996</u>	Year MFG:	_____
GPS - Longitude	<u>0</u>	GPS - Latitude	<u>0</u>

Employee Signature(s): B.J.

Date Completed 1-30-14

Martin County Water District

387 East Main St., Suite 140
Inez, KY 41224

WORK ORDER

WO # 140100058

Time Started _____

Work Complete _____

Loc # _____

Master Meter # _____

Date 1/7/2014

Account # _____

SEQ # 212

Name: LON CRUM

Phone # () _____

Address: P.O. Box

Inez, KY 41224

Location: Guyton Rd, Little Lick Br, top of hill last house @ top of hill, red

GUYTON RD

Type of Work: Complaints

Material Used: Water Pressure is good

Customer Line Inspection _____

Comments: low water pressure

Current System Information:		New Information:	
Meter # 1:	<u>29935077</u>	Meter # 1:	_____
Meter # 2: Radio	<u>29935077</u>	Meter # 2: Radio	_____
MXU #:	_____	MXU #:	_____
Current Reading	<u>12/20/2013 575</u>	Current Reading	<u>0</u>
Type of Meter:	<u>Badger</u>	Type of Meter:	_____
Year MFG:	<u>2004</u>	Year MFG:	_____
GPS - Longitude	<u>0</u>	GPS - Latitude	<u>0</u>

Employee Signature(s): TR-SS-JS-JP

Date Completed 1-15-14

Martin County Water District

387 East Main St., Suite 140
Inez, KY 41224

WORK ORDER

WO # 140100222

Time Started _____

Work Complete _____

Loc # _____

Master Meter # _____

Dat 1/10/2014

Account # _____

SEQ # 144

Name: Kathy Jude

Phone # _____

Address: Calf Crk Rd
Inez, Ky 41224

Employee Tony Blevins

Location: Calf Crk Rd. Brick house at the forks of the road, meter is by the wellhouse, nearest neighbor is Dennis Hinkle.

24 Calf Crk Rd

Type of Work: Complaints

Material Used: _____

Customer Line Inspection _____

Comments: water pressure comes and goes after they changed meter out. Stated - At 100 PSI

Done

Current System Information:		New Information:	
Meter # 1:	<u>29802064</u>	Meter # 1:	_____
Meter # 2: Radio	<u>29802064</u>	Meter # 2: Radio	_____
MXU #:	_____	MXU #:	_____
Current Reading	<u>12/20/2013 828</u>	Current Reading	<u>0</u>
Type of Meter:	<u>Badger</u>	Type of Meter:	_____
Year MFG:	<u>2004</u>	Year MFG:	_____
GPS - Longitude	_____	GPS - Latitude	_____

Employee Signature(s): JB, CC

Date Completed 1-16-14

Martin County Water District

387 East Main St., Suite 140
Inez, KY 41224

WORK ORDER

WO # 140100234

Time Started _____

Work Complete _____

Loc # _____

Master Meter # _____

Dat 1/13/2014

Account # _____

SEQ # 104

Name: NORMA SLONE

Phone # _____

Address: P.O. BOX 1
INEZ, KY 41224

Employee Jason W.

Location 19 Hill Vw on Camp Br, 1/3 of a mile on left, white house w/screened in front porch and green roof.

CAMP BRANCH

Type of Work: Complaints

Material Used: _____

DONE

Customer Line Inspection _____

Comments low pressure / 6.5 PSI A box

Current System Information:		New Information:	
Meter # 1:	<u>99085893</u>	Meter # 1:	_____
Meter # 2: Radio	_____	Meter # 2: Radio	_____
MXU #:	_____	MXU #:	_____
Current Reading	<u>12/20/2013 443</u>	Current Reading	<u>0</u>
Type of Meter:	<u>Badger</u>	Type of Meter:	_____
Year MFG:	<u>1999</u>	Year MFG:	_____
GPS - Longitude	<u>0</u>	GPS - Latitude	<u>0</u>

Employee Signature(s): JS/CC

Date Completed 1-15-14

Martin County Water District

387 East Main St., Suite 140
Inez, KY 41224

WORK ORDER

WO # 140100202

Time Started _____ Work Complete _____

Loc # _____ Master Meter # _____

Date 1/10/2014 Account # _____ SEQ # 271

Name: ALBERT SMITH Phone # _____

Address: P.O. BOX
INEZ, KY 41224

Location: _____

J CASSADY BR.

Type of Work: Complaints

Material Used: _____

Customer Line Inspection _____

Comments: low water pressure for 2 days

Current System Information:		New Information:	
Meter # 1:	<u>97354363</u>	Meter # 1:	_____
Meter # 2: Radio	_____	Meter # 2: Radio	_____
MXU #:	_____	MXU #:	_____
Current Reading	<u>12/20/2013 836</u>	Current Reading	<u>0</u>
Type of Meter:	<u>Badger</u>	Type of Meter:	_____
Year MFG:	<u>1997</u>	Year MFG:	_____
GPS - Longitude	<u>0</u>	GPS - Latitude	<u>0</u>

Employee Signature(s): John Mills

Date Completed 1/13/14

Martin County Water District

387 East Main St., Suite 140
Inez, KY 41224

WORK ORDER

WO # 140100220

Time Started _____ Work Complete _____

Loc # _____ Master Meter # _____

Dat 1/10/2014 Account # _____ SEQ # 102

Name: MARY STANLEY Phone # () _____

Address: PO Box 1 Employee Jason W.
WARFIELD, KY 41267

Location: 84 Stanley Dr

COLLINS CREEK

Type of Work: Complaints

Material Used: _____

Customer Line Inspection _____

Comments: has had low water pressure for days so has neighbors at bottom of hill 35 PSI AT 60

Current System Information:		New Information:	
Meter # 1:	<u>70616608</u>	Meter # 1:	_____
Meter # 2: Radio	_____	Meter # 2: Radio	_____
MXU #:	<u>13154928</u>	MXU #:	_____
Current Reading	<u>12/20/2013 273</u>	Current Reading	<u>0</u>
Type of Meter:	_____	Type of Meter:	_____
Year MFG:	_____	Year MFG:	_____
GPS - Longitude	_____	GPS - Latitude	_____

Employee Signature(s): SS/CC

Date Completed 1-13-14

Martin County Water District

387 East Main St., Suite 140
Inez, KY 41224

WORK ORDER

WO # 140100209

Time Started _____

Work Complete _____

Loc # _____

Master Meter # _____

Date 1/10/2014

Account # _____

SEQ # 452

Name: Robert Nichols #3

Phone # _____

Address: PO Box

Inez, KY 41224

Location: Middle Fork, last railer on right, greyish tan in color 308 Holden Hills

308 Holden Hills

Type of Work: Complaints

Material Used: _____

Customer Line Inspection _____

Comments: no water

Has water now

Current System Information:		New Information:	
Meter # 1:	<u>70616589</u>	Meter # 1:	_____
Meter # 2: Radio	<u>70616589</u>	Meter # 2: Radio	_____
MXU #:	<u>13154916</u>	MXU #:	_____
Current Reading	<u>12/20/2013 183</u>	Current Reading	<u>0</u>
Type of Meter:	_____	Type of Meter:	_____
Year MFG:	_____	Year MFG:	_____
GPS - Longitude	_____	GPS - Latitude	_____

Employee Signature(s): Sy/GG

Date Completed 1-14-14

Martin County Water District

387 East Main St., Suite 140
Inez, KY 41224

WORK ORDER

WO # 140200265

Time Started _____ Work Complete _____

Loc # _____ Master Meter # _____

Date 2/11/2014 Account # _____ SEQ # 103

Name: MARY STANLEY Phone # () _____

Address: PO Box
WARFIELD, KY 41267

Location: 84 Stanley Dr

COLLINS CREEK

Type of Work: Complaints

Material Used: She HAS WATER

Customer Line Inspection _____

Comments: customer has no water

Current System Information:		New Information:	
Meter # 1:	<u>70616608</u>	Meter # 1:	_____
Meter # 2: Radio	_____	Meter # 2: Radio	_____
MXU #:	<u>13154928</u>	MXU #:	_____
Current Reading	<u>1/20/2014 273</u>	Current Reading	<u>0</u>
Type of Meter:	_____	Type of Meter:	_____
Year MFG:	_____	Year MFG:	_____
GPS - Longitude	_____	GPS - Latitude	_____

Employee Signature(s): TB-GS-TH Date Completed 2-12-14

Martin County Water District

387 East Main St., Suite 140
Inez, KY 41224

WORK ORDER

WO # 140200249

Time Started _____ Work Complete _____

Loc # _____ Master Meter # _____

Dat 2/11/2014 Account # _____ SEQ # 234

Name: JEAN COPELAND Phone # _____

Address: Jean Copeland Ln Employee Justin Scott
TOMAHAWK, KY 41262

Location Jean Copeland Ln on Milo, grey house by road

ROUTE 1884 MILO

Type of Work: Complaints

Material Used: _____

Customer Line Inspection _____

Comments low water pressure / 80 PSI At box

Current System Information:		New Information:	
Meter # 1:	_____	Meter # 1:	_____
Meter # 2: Radio	_____	Meter # 2: Radio	_____
MXU #:	_____	MXU #:	_____
Current Reading	<u>0</u>	Current Reading	<u>0</u>
Type of Meter:	_____	Type of Meter:	_____
Year MFG:	_____	Year MFG:	_____
GPS - Longitude	_____	GPS - Latitude	_____

Employee Signature(s): JS

Date Completed 2-12-14

Martin County Water District

387 East Main St., Suite 140
Inez, KY 41224

WORK ORDER

WO # 140200172

Time Started _____

Work Complete _____

Loc # _____

Master Meter # _____

Dat 2/4/2014

Account # _____

SEQ # 109

Name: Matthew Preece

Phone # _____

Address: P.O. Box

Employee Justin Scott

Inez, KY 41224

Location Smith Rd. Between Kenny McCoy and Tommy Maynard's. Smith Rd. Last trailer. Meter is at bottom of the hill.

Smith Rd

Type of Work: Complaints

Material Used: Tha Wed

Customer Line Inspection _____

Comments customer has not had water in over a week, check for problems

Current System Information:

New Information:

Meter # 1: 29934714

Meter # 1: _____

Meter # 2: Radio 29934714

Meter # 2: Radio _____

MXU #: _____

MXU #: _____

Current Reading 1/20/2014 502

Current Reading 0

Type of Meter: Badger

Type of Meter: _____

Year MFG: 2004

Year MFG: _____

GPS - Longitude 0

GPS - Latitude 0

Employee Signature(s): B-G-JH-JS

Date Completed 2-7-14

Martin County Water District

387 East Main St., Suite 140
Inez, KY 41224

WORK ORDER

WO # 140200198

Time Started _____

Work Complete _____

Loc # _____

Master Meter # _____

Date 2/6/2014

Account # _____

SEQ # 58

Name: Mel Markin

Phone # (606)

Address: Russell Workman Rd

Lovely, KY 41231

Location: Lovely, Long BR, 2 m, on right yellow house

1 Russell Workman Rd

Type of Work: Complaints

Material Used: _____

Customer Line Inspection _____

Comments: water is going on and off

Water is Good. I worked on Regulator

Current System Information:

New Information:

Meter # 1: 94788708

Meter # 1: _____

Meter # 2: Radio 94788708

Meter # 2: Radio _____

MXU #: _____

MXU #: _____

Current Reading 1/20/2014 180

Current Reading 0

Type of Meter: Badger

Type of Meter: _____

Year MFG: 1994

Year MFG: _____

GPS - Longitude _____

GPS - Latitude _____

Employee Signature(s): JW, RJ

Date Completed 2/10/14

Martin County Water District

387 East Main St., Suite 140
Inez, KY 41224

WORK ORDER

WO # 140200185

Time Started _____

Work Complete _____

Loc # _____

Master Meter # _____

Dat 2/5/2014

Account # _____

SEQ # 62

Name: RUSSELL WORKMAN

Phone # (_____)

Address: Russell Workman Rd (Long Branch)
LOVELY, KY 41231

Employee Jason W.

Location: _____

Type of Work: Complaints

Material Used: _____

Customer Line Inspection _____

Comments: no water water is good / worked on Regulator

Current System Information:		New Information:	
Meter # 1:	<u>47823828</u>	Meter # 1:	_____
Meter # 2: Radio	_____	Meter # 2: Radio	_____
MXU #:	_____	MXU #:	_____
Current Reading	<u>1/20/2014 727</u>	Current Reading	<u>0</u>
Type of Meter:	<u>Sensus</u>	Type of Meter:	_____
Year MFG:	<u>1993</u>	Year MFG:	_____
GPS - Longitude	<u>0</u>	GPS - Latitude	<u>0</u>

Employee Signature(s): JW, RJ

Date Completed 2/10/14

Martin County Water District ✓

387 East Main St., Suite 140
Inez, KY 41224

WORK ORDER

WO # 140200194

Time Started _____ Work Complete _____

Loc # _____ Master Meter # _____

Dat 2/5/2014 Account # _____ SEQ # 321

Name: Heather Harrison Phone # _____

Address: 1 Mullett Br Employee Tony Blevins

INEZ, KY 41224

Location: Mullett Br. Coldwater. Last house on the right, white house on hill, stone bottom

Mullett Br

Type of Work: Complaints

Material Used: _____

Customer Line Inspection _____

Comments: extremely low water pressure / 20 PSI At box

Done

Current System Information:		New Information:	
Meter # 1:	<u>92701651</u>	Meter # 1:	_____
Meter # 2: Radio	<u>92701651</u>	Meter # 2: Radio	_____
MXU #:	_____	MXU #:	_____
Current Reading	<u>1/20/2014 959</u>	Current Reading	<u>0</u>
Type of Meter:	<u>Badger</u>	Type of Meter:	_____
Year MFG:	<u>1992</u>	Year MFG:	_____
GPS - Longitude	<u>0</u>	GPS - Latitude	<u>0</u>

Employee Signature(s): JS, CH

Date Completed 2-6-14

Martin County Water District ✓

387 East Main St., Suite 140
Inez, KY 41224

WORK ORDER

WO # 140200202

Time Started _____ Work Complete _____

Loc # _____ Master Meter # _____

Date 2/6/2014 Account # _____ SEQ # 59

Name: DAVID MILLS Phone # _____

Address: P.O. BOX
INEZ, KY 41224

Location: Turkey Rd. 1st driveway on left past Reservoir Rd.

TURKEY ROAD

Type of Work: Complaints

Done

Material Used: _____

Customer Line Inspection took meter out on check water was going through meter

Comments: hasn't had water in 2 weeks

Current System Information:		New Information:	
Meter # 1:	<u>70616474</u>	Meter # 1:	_____
Meter # 2: Radio	<u>70616474</u>	Meter # 2: Radio	_____
MXU #:	<u>14440372</u>	MXU #:	_____
Current Reading	<u>1/20/2014 35</u>	Current Reading	<u>0</u>
Type of Meter:	_____	Type of Meter:	_____
Year MFG:	_____	Year MFG:	_____
GPS - Longitude	_____	GPS - Latitude	_____

Employee Signature(s): JW, RJ.

Date Completed 2-6-14

Martin County Water District ✓

387 East Main St., Suite 140
Inez, KY 41224

WORK ORDER

WO # 140200204

Time Started _____ Work Complete _____

Loc # _____ Master Meter # _____

Date 2/6/2014 Account # _____ SEQ # 214

Name: Dahryl Keller Phone # _____

Address: Setser Br
Inez, Ky 41224

Location: Setser Br. Wood sided house @ end of road

Setser Br

Type of Work: Complaints

Material Used: _____

Customer Line Inspection _____

Comments: extremely low pressure 2 weeks Problem Fixed! worked on Cold Water master met

Current System Information:	New Information:
Meter # 1: <u>33076067</u>	Meter # 1: _____
Meter # 2: Radio <u>33076067</u>	Meter # 2: Radio _____
MXU #: _____	MXU #: _____
Current Reading <u>1/20/2014 249</u>	Current Reading <u>0</u>
Type of Meter: <u>Badger</u>	Type of Meter: _____
Year MFG: <u>2006</u>	Year MFG: _____
GPS - Longitude _____	GPS - Latitude _____

Employee Signature(s): TR, TH, GS, CS

Date Completed 2/6/14

Martin County Water District ✓

387 East Main St., Suite 140
Inez, KY 41224

WORK ORDER

WO # 140200164

Time Started _____ Work Complete _____

Loc # _____ Master Meter # _____

Dat 2/4/2014 Account # _____ SEQ # 248

Name: Ronald D. & Evelyn Preece Phone # _____

Address: P.O. Box Employee Clyde Stanley
INEZ, KY 41224

Location Muddy Br. Coldwater. Last cream double-wide on left.

Muddy Br

Type of Work: Complaints

Material Used: _____

Customer Line Inspection Problem Fixed ! worked on cold water master meter

Comments extremely low water pressure, cannot even flush toilet

Current System Information:		New Information:	
Meter # 1:	<u>97176433</u>	Meter # 1:	_____
Meter # 2: Radio	<u>97176433</u>	Meter # 2: Radio	_____
MXU #:	_____	MXU #:	_____
Current Reading	<u>12/20/2013 923</u>	Current Reading	<u>0</u>
Type of Meter:	<u>Badger</u>	Type of Meter:	_____
Year MFG:	<u>1997</u>	Year MFG:	_____
GPS - Longitude	<u>0</u>	GPS - Latitude	<u>0</u>

Employee Signature(s): TB, TH, GS, CS

Date Completed 2/6/14

Martin County Water District ✓

387 East Main St., Suite 140
Inez, KY 41224

WORK ORDER

WO # 140200163

Time Started _____

Work Complete _____

Loc # _____

Master Meter # _____

Dat 2/4/2014

Account # 2

SEQ # 114

Name: ROGER SMITH

Phone # _____

Address: PO BOX

Employee Tony Blevins

INEZ, KY 41224

Location Camp Br Rd

CAMP BRANCH

Type of Work: Complaints

Material Used: _____

Customer Line Inspection worked on coldwater master meter

Comments extremely low pressure problem fixed! so psi at box

Current System Information:		New Information:	
Meter # 1:	<u>19629183</u>	Meter # 1:	_____
Meter # 2: Radio	_____	Meter # 2: Radio	_____
MXU #:	_____	MXU #:	_____
Current Reading	<u>12/20/2013 782</u>	Current Reading	<u>0</u>
Type of Meter:	<u>Badger</u>	Type of Meter:	_____
Year MFG:	<u>2003</u>	Year MFG:	_____
GPS - Longitude	<u>0</u>	GPS - Latitude	<u>0</u>

Employee Signature(s): T.B., G.S., T.H., C.S.

Date Completed 2/6/14

Wartin County Water District

367 East Main St., Suite 140
Inez, KY 41224

WORK ORDER

WO # 140100407

Time Started _____ Work Complete _____

Loc # _____ Master Meter # _____

Dat 1/30/2014 Account # _____ SEQ # 321

Name: Heather Harrison Phone # _____

Address: Mullett Br Employee Clyde Stanley

INEZ, KY 41224

Location: Mullett Br. Coldwater. Last house on the right, white house on hill, stone bottom

2 Mullett Br

Type of Work: Complaints

Material Used: _____

Customer Line Inspection _____

Comments: extremely low pressure

Done

Current System Information:		New Information:	
Meter # 1:	<u>92701651</u>	Meter # 1:	_____
Meter # 2: Radio	<u>92701651</u>	Meter # 2: Radio	_____
MXU #:	_____	MXU #:	_____
Current Reading	<u>12/20/2013 951</u>	Current Reading	<u>0</u>
Type of Meter:	<u>Badger</u>	Type of Meter:	_____
Year MFG:	<u>1992</u>	Year MFG:	_____
GPS - Longitude	<u>0</u>	GPS - Latitude	<u>0</u>

Employee Signature(s): *AW*

Date Completed 2.6.14

Martin County Water District

387 East Main St., Suite 140
Inez, KY 41224

WORK ORDER

WO # 140100404

Time Started _____ Work Complete _____

Loc # _____ Master Meter # _____

Dat 1/30/2014 Account # _____ SEQ # 109

Name: Allen Bowen Phone # _____

Address: P.O. BOX Employee Justin Scott
Inez, Ky 41224

Location Camp Br, White Doublewide behind cemetery

Camp Branch

Type of Work: Complaints

Material Used: _____

Customer Line Inspection _____

Comments customer has extremely low pressure

Done

Current System Information:		New Information:	
Meter # 1:	<u>96646016</u>	Meter # 1:	_____
Meter # 2: Radio	_____	Meter # 2: Radio	_____
MXU #:	_____	MXU #:	_____
Current Reading	<u>12/20/2013 1542</u>	Current Reading	<u>0</u>
Type of Meter:	<u>Badger</u>	Type of Meter:	_____
Year MFG:	<u>1996</u>	Year MFG:	_____
GPS - Longitude	<u>0</u>	GPS - Latitude	<u>0</u>

Employee Signature(s): [Signature]

Date Completed 2.6.14

Martin County Water District

387 East Main St., Suite 140
Inez, KY 41224

WORK ORDER

WO # 140200008

Time Started _____ Work Complete _____

Loc # _____ Master Meter # _____

Dat 2/3/2014 Account # _____ SEQ # 260

Name: LORRAINE JUDE Phone # _____

Address: 1 Dunceast Rd Employee Justin Scott
Lake Worth, FI 33467

Location: Dans Br

DAVIS BRANCH

Type of Work: Complaints

Material Used: THAWED

Customer Line Inspection _____

Comments: Gary Jude-former owner of property

Current System Information:		New Information:	
Meter # 1:	<u>46220019</u>	Meter # 1:	_____
Meter # 2: Radio	_____	Meter # 2: Radio	_____
MXU #:	_____	MXU #:	_____
Current Reading	<u>1/20/2014 1034</u>	Current Reading	<u>0</u>
Type of Meter:	<u>Sensus</u>	Type of Meter:	_____
Year MFG:	<u>1992</u>	Year MFG:	_____
GPS - Longitude	<u>0</u>	GPS - Latitude	<u>0</u>

Employee Signature(s): JR-GS-JS-JH

Date Completed 2-04-14

Martin County Water District

387 East Main St., Suite 140
Inez, KY 41224



WORK ORDER

WO # 140200006

COMPLETED

Time Started _____

Work Complete _____

Loc # _____

Master Meter # _____

Dat 2/3/2014

Account # _____

SEQ # 204

Name: EXCEL MINING CO., LLC

Phone # _____

Address: St Hwy 194 West
Pikeville, KY 41501

Employee Justin Scott

Location: Meathouse Rd, meter is beside main road by guard shack

Type of Work: Complaints

Material Used: changed meter

Customer Line Inspection _____

Comments: has no water at box,

Current System Information:		New Information:	
Meter # 1:	_____	Meter # 1:	<u>10788513</u>
Meter # 2: Radio	_____	Meter # 2: Radio	_____
MXU #:	_____	MXU #:	_____
Current Reading	<u>0</u>	Current Reading	<u>0 000</u>
Type of Meter:	_____	Type of Meter:	<u>ABB (2 In)</u>
Year MFG:	_____	Year MFG:	_____
GPS - Longitude	_____	GPS - Latitude	_____

Employee Signature(s): TB-JS-COS-TA

Date Completed 2-5-14

Martin County Water District

387 East Main St., Suite 140
Inez, KY 41224

WORK ORDER

WO # 140200181

Time Started _____

Work Complete _____

Loc # _____

Master Meter # _____

Dat 2/5/2014

Account # _____

SEQ # 83

Name: ARLEN COOK

Phone # (_____) _____

Address: PO BOX

Employee Jason W.

BEAUTY, KY 41203

Location: Bone Hollow Rd

Type of Work: Complaints

Material Used: got WATER

Customer Line Inspection _____

Comments: water went off around 10 pm last night

Reset Pump since unit 2

Current System Information:		New Information:	
Meter # 1:	<u>19713222</u>	Meter # 1:	_____
Meter # 2: Radio	_____	Meter # 2: Radio	_____
MXU #:	_____	MXU #:	_____
Current Reading	<u>1/20/2014 732</u>	Current Reading	<u>0</u>
Type of Meter:	<u>Badger</u>	Type of Meter:	_____
Year MFG:	<u>2003</u>	Year MFG:	_____
GPS - Longitude	<u>0</u>	GPS - Latitude	<u>0</u>

Employee Signature(s): JOB AT JB-JS-GS-1A

Date Completed 2-5-14

Martin County Water District

387 East Main St., Suite 140
Inez, KY 41224

WORK ORDER

WO # 140200184

Time Started _____ Work Complete _____

Loc # _____ Master Meter # _____

Dat 2/5/2014 Account # _____ SEQ # 84

Name: FREDDIE & CAROL CHAFFINS Phone # 1

Address: PO BOX Employee Jason W.
BEAUTY, KY 41203

Location: Bone Hollow

Type of Work: Complaints

Material Used: got water

Customer Line Inspection _____

Comments: no water since last night Reets Pump sand unit 2

Current System Information:		New Information:	
Meter # 1:	<u>72305550</u>	Meter # 1:	_____
Meter # 2: Radio	<u>72305550</u>	Meter # 2: Radio	_____
MXU #:	_____	MXU #:	_____
Current Reading	<u>1/20/2014 83</u>	Current Reading	<u>0</u>
Type of Meter:	<u>Sensus</u>	Type of Meter:	_____
Year MFG:	<u>2010</u>	Year MFG:	_____
GPS - Longitude	<u>0</u>	GPS - Latitude	<u>0</u>

Employee Signature(s): JW, BT, TG, JS, TA Date Completed 2-5-14

Martin County Water District

387 East Main St., Suite 140
Inez, KY 41224

WORK ORDER

WO # 140200182

Time Started _____ Work Complete _____

Loc # _____ Master Meter # _____

Dat 2/5/2014 Account # _____ SEQ # 82

Name: MAGGIA HINKLE Phone # (_____) _____

Address: PO BOX Employee Jason W.

BEAUTY, KY 41203

Location: Bone Hollow on 2031, 1/4 of a mile on Poplar Fork on left, 2nd single wide on left

Type of Work: Complaints

Material Used: ~~_____~~ got water

Customer Line Inspection _____

Comments: no water since about 10:30 last night Reset Pump and unit 2

Current System Information:		New Information:	
Meter # 1:	<u>99085837</u>	Meter # 1:	_____
Meter # 2: Radio	<u>99085837</u>	Meter # 2: Radio	_____
MXU #:	_____	MXU #:	_____
Current Reading	<u>1/20/2014 584</u>	Current Reading	<u>0</u>
Type of Meter:	<u>Badger</u>	Type of Meter:	_____
Year MFG:	<u>1999</u>	Year MFG:	_____
GPS - Longitude	<u>0</u>	GPS - Latitude	<u>0</u>

Employee Signature(s): [Signature] Date Completed 2-5-14

Martin County Water District ✓

387 East Main St., Suite 140
Inez, KY 41224

WORK ORDER

WO # 140100438

Time Started _____ Work Complete _____

Loc # _____ Master Meter # _____

Dat 1/31/2014 Account # _____ SEQ # 244

Name: GARY CHAPMAN Phone # (_____) _____

Address: P.O.BOX Employee Rainbo
INEZ, KY 41224

Location: Coldwater Rd

COLDWATER RD.

Type of Work: Complaints

Material Used: _____

Customer Line Inspection _____

Comments: no water / Has water today

Done

Current System Information:		New Information:	
Meter # 1:	<u>93144891</u>	Meter # 1:	_____
Meter # 2: Radio	_____	Meter # 2: Radio	_____
MXU #:	_____	MXU #:	_____
Current Reading	<u>12/20/2013 837</u>	Current Reading	<u>0</u>
Type of Meter:	<u>Badger</u>	Type of Meter:	_____
Year MFG:	<u>1993</u>	Year MFG:	_____
GPS - Longitude	<u>0</u>	GPS - Latitude	<u>0</u>

Employee Signature(s): JS

Date Completed 2-3-14

Martin County Water District

387 East Main St., Suite 140
Inez, KY 41224

WORK ORDER

WO # 140100465

Time Started _____

Work Complete _____

Loc # _____

Master Meter # _____

Dat 1/31/2014

Account # _____

SEQ # 117

Name: Janice Blackburn

Phone # _____

Address: Camp Branch

Employee Justin Scott

Inez, KY 41224

Location: 1 Camp Br, last house in hollow, green double wide

Coldwater

Type of Work: Complaints

Material Used: _____

Customer Line Inspection _____

Comments: Extremely low pressure

had about 52 PSI At box

Done

Current System Information:

Meter # 1: 29935159
Meter # 2: Radio 29935159
MXU #: _____
Current Reading 12/20/2013 309
Type of Meter: Badger
Year MFG: 2004
GPS - Longitude _____

New Information:

Meter # 1: _____
Meter # 2: Radio _____
MXU #: _____
Current Reading 0
Type of Meter: _____
Year MFG: _____
GPS - Latitude _____

Employee Signature(s): JS

Date Completed 2-2-14

Martin County Water District

387 East Main St., Suite 140
Inez, KY 41224

WORK ORDER

WO # 140100450

Time Started _____ Work Complete _____

Loc # _____ Master Meter # _____

Dat 1/31/2014 Account # _____ SEQ # 298

Name: TRACY BUTCHER Phone # _____

Address: Coldwater Rd Employee Tony Blevins
INEZ, KY 41224

Location: around Pleasant Valley

COLDWATER RD.

Type of Work: Complaints

Material Used: _____

Customer Line Inspection _____

Comments: Pressure Bottle

Current System Information:		New Information:	
Meter # 1:	<u>99691581</u>	Meter # 1:	_____
Meter # 2: Radio	_____	Meter # 2: Radio	_____
MXU #:	_____	MXU #:	_____
Current Reading	<u>12/20/2013 646</u>	Current Reading	<u>0</u>
Type of Meter:	<u>Badger</u>	Type of Meter:	_____
Year MFG:	<u>1999</u>	Year MFG:	_____
GPS - Longitude	<u>0</u>	GPS - Latitude	<u>0</u>

Employee Signature(s): [Signature]

Date Completed 2-3-14

Martin County Water District ✓

387 East Main St., Suite 140
Inez, KY 41224

WORK ORDER

WO # 140100447

Time Started _____ Work Complete _____

Loc # _____ Master Meter # _____

Dat 1/31/2014 Account # _____ SEQ # 222

Name: Tommy Allen Phone # _____

Address: Creekwood Estates Employee Tony Blevins
Inez, KY 41224

Location: Creekwood Estates, 1st house on right, new construction

Coldwater

Type of Work: Complaints

Material Used: _____

Done

Customer Line Inspection _____

Comments: Extremely low pressure *PRESSURE IS FINE*

Current System Information:		New Information:	
Meter # 1:	<u>29934735</u>	Meter # 1:	_____
Meter # 2: Radio	_____	Meter # 2: Radio	_____
MXU #:	_____	MXU #:	_____
Current Reading	<u>12/20/2013 1127</u>	Current Reading	<u>0</u>
Type of Meter:	<u>Badger</u>	Type of Meter:	_____
Year MFG:	<u>2004</u>	Year MFG:	_____
GPS - Longitude	_____	GPS - Latitude	_____

Employee Signature(s): *[Signature]*

Date Completed 2.3.14

Martin County Water District

387 East Main St., Suite 140
Inez, KY 41224

WORK ORDER

WO # 140100457

Time Started _____

Work Complete _____

Loc # _____

Master Meter # _____

Dat 1/31/2014

Account # _____

SEQ # 52

Name: Laraya Fields

Phone # (_____)

Address: P.O. BOX

Employee Tony Blevins

INEZ, KY 41224

Location 1/4 mile on left. 1st white double-wide on left.

COLDWATER RD.

Type of Work: Complaints

Material Used: _____

Customer Line Inspection _____

Comments extremely low pressure

Pressure Better

Current System Information:		New Information:	
Meter # 1:	<u>93749257</u>	Meter # 1:	_____
Meter # 2: Radio	_____	Meter # 2: Radio	_____
MXU #:	_____	MXU #:	_____
Current Reading	<u>12/20/2013 1153</u>	Current Reading	<u>0</u>
Type of Meter:	<u>Badger</u>	Type of Meter:	_____
Year MFG:	<u>1993</u>	Year MFG:	_____
GPS - Longitude	<u>0</u>	GPS - Latitude	<u>0</u>

Employee Signature(s): [Signature]

Date Completed 2.3.14

Martin County Water District

387 East Main St., Suite 140
Inez, KY 41224

WORK ORDER

WO # 140100468

Time Started _____

Work Complete _____

Loc # _____

Master Meter # _____

Dat 1/31/2014

Account # _____

SEQ # 198

Name: Arlena Evans

Phone # _____

Address: P.O. Box

Employee Tony Blevins

INEZ, KY 41224

Location: Coldwater Rd. 3.2 miles on left. Pine tree lined driveway. Brown house w/brown tin roof.

Coldwater Rd

Type of Work: Complaints

Material Used: _____

Customer Line Inspection _____

Comments: low water pressure,

Done

Current System Information:

Meter # 1: 33076070
Meter # 2: Radio 33076070
MXU #: _____
Current Reading 12/20/2013 853
Type of Meter: Badger
Year MFG: 2006
GPS - Longitude 0

New Information:

Meter # 1: _____
Meter # 2: Radio _____
MXU #: _____
Current Reading 0
Type of Meter: _____
Year MFG: _____
GPS - Latitude 0

Employee Signature(s): BJ

Date Completed 2-3-14

Martin County Water District ✓

387 East Main St., Suite 140
Inez, KY 41224

WORK ORDER

WO # 140100452

Time Started _____ Work Complete _____

Loc # _____ Master Meter # _____

Dat 1/31/2014 Account # _____ SEQ # 271

Name: ALBERT SMITH Phone # _____

Address: P.O. BOX Employee Tony Blevins
INEZ, KY 41224

Location: Jack Cassady Br

J CASSADY BR.

Type of Work: Complaints *Done*

Material Used: _____

Customer Line Inspection _____

Comments: no water pressure but better now

Current System Information:		New Information:	
Meter # 1:	<u>97354363</u>	Meter # 1:	_____
Meter # 2: Radio	_____	Meter # 2: Radio	_____
MXU #:	_____	MXU #:	_____
Current Reading	<u>12/20/2013 836</u>	Current Reading	<u>0</u>
Type of Meter:	<u>Badger</u>	Type of Meter:	_____
Year MFG:	<u>1997</u>	Year MFG:	_____
GPS - Longitude	<u>0</u>	GPS - Latitude	<u>0</u>

Employee Signature(s): BJ

Date Completed 2-3-14

Martin County Water District

387 East Main St., Suite 140
Inez, KY 41224

WORK ORDER

WO # 140100443

Time Started _____ Work Complete _____

Loc # _____ Master Meter # _____

Dat 1/31/2014 Account # _____ SEQ # 110

Name: Jimmy Hensley Phone # _____

Address: Camp Br Employee Tony Blevins
INEZ, KY 41224

Location: Camp Br. Tan two tone trailer on the right.

Camp Br

Type of Work: Complaints *Done*

Material Used: _____

Customer Line Inspection _____

Comments: extremely low pressure *a little better now*

Current System Information:		New Information:	
Meter # 1:	<u>47823736</u>	Meter # 1:	_____
Meter # 2: Radio	<u>47823736</u>	Meter # 2: Radio	_____
MXU #:	_____	MXU #:	_____
Current Reading	<u>12/20/2013 405</u>	Current Reading	<u>0</u>
Type of Meter:	<u>Sensus</u>	Type of Meter:	_____
Year MFG:	<u>1993</u>	Year MFG:	_____
GPS - Longitude	<u>0</u>	GPS - Latitude	<u>0</u>

Employee Signature(s): RJ

Date Completed 2-3-14

Martin County Water District

387 East Main St., Suite 140
Inez, KY 41224

WORK ORDER

WO # 140100444

Time Started _____ Work Complete _____

Loc # _____ Master Meter # _____

Dat 1/31/2014 Account # _____ SEQ # 115

Name: Paul Hensley Phone # _____

Address: Camp Branch Employee Tony Blevins
Inez, KY 41224

Location: Coldwater, Camp Branch, about 1 on left, 2 tone brown house

Coldwater

Type of Work: Complaints

Done

Material Used: _____

Customer Line Inspection _____

Comments: extremely low pressure *better than it was*

Current System Information:		New Information:	
Meter # 1:	<u>67012625</u>	Meter # 1:	_____
Meter # 2: Radio	_____	Meter # 2: Radio	_____
MXU #:	_____	MXU #:	_____
Current Reading	<u>12/20/2013 186</u>	Current Reading	<u>0</u>
Type of Meter:	<u>Sensus</u>	Type of Meter:	_____
Year MFG:	<u>2006</u>	Year MFG:	_____
GPS - Longitude	_____	GPS - Latitude	_____

Employee Signature(s): RJ

Date Completed 2-3-14

Martin County Water District ✓

387 East Main St., Suite 140
Inez, KY 41224

WORK ORDER

WO # 140100471

Time Started _____ Work Complete _____

Loc # _____ Master Meter # _____

Dat 1/31/2014 Account # _____ SEQ # 307

Name: Aaron & Jackie Gauze Phone # _____

Address: P.O. Box Employee Clyde Stanley
INEZ, KY 41224

Location: Coldwater Rd

Coldwater Rd

Type of Work: Complaints

Material Used: _____

Customer Line Inspection _____

Comments: very low water pressure / Has good pressure now

Done

Current System Information:		New Information:	
Meter # 1:	<u>98604665</u>	Meter # 1:	_____
Meter # 2: Radio	<u>98604665</u>	Meter # 2: Radio	_____
MXU #:	_____	MXU #:	_____
Current Reading	<u>12/20/2013 662</u>	Current Reading	<u>0</u>
Type of Meter:	<u>Badger</u>	Type of Meter:	_____
Year MFG:	<u>1998</u>	Year MFG:	_____
GPS - Longitude	<u>0</u>	GPS - Latitude	<u>0</u>

Employee Signature(s): JS

Date Completed 2-3-14

Martin County Water District

387 East Main St., Suite 140
Inez, KY 41224

WORK ORDER

WO # 140100451

Time Started _____ Work Complete _____

Loc # _____ Master Meter # _____

Dat 1/31/2014 Account # _____ SEQ # 285

Name: ALBERT SMITH Jr. Phone # _____

Address: COLDWATER RD Employee Tony Blevins
INEZ, KY 41224

Location: Coldwater Rd

COLDWATER RD.

Type of Work: Complaints

Material Used: _____

Customer Line Inspection Done

Comments: no water Customer has water to lawn but not to house

Current System Information:		New Information:	
Meter # 1:	<u>98985892</u>	Meter # 1:	_____
Meter # 2: Radio	_____	Meter # 2: Radio	_____
MXU #:	_____	MXU #:	_____
Current Reading	<u>12/20/2013 199</u>	Current Reading	<u>0</u>
Type of Meter:	<u>Badger</u>	Type of Meter:	_____
Year MFG:	<u>1998</u>	Year MFG:	_____
GPS - Longitude	<u>0</u>	GPS - Latitude	<u>0</u>

Employee Signature(s): 1-31-14 J.S.
JW, RJ

Date Completed 2-3-14

Martin County Water District ✓

387 East Main St., Suite 140
Inez, KY 41224

WORK ORDER

WO # 140200101

Time Started _____ Work Complete _____

Loc # _____ Master Meter # _____

Dat 2/4/2014 Account # _____ SEQ # 469

Name: TIM SIZEMORE Phone # _____

Address: Tomahawk Rd. Employee Justin Scott

TOMAHAWK, KY 41262

Location _____

ROUTE 40 WEST

Type of Work: Complaints

Material Used: _____

Customer Line Inspection _____

Comments no water / Completed - leak on main caused pressure to drop

Current System Information:		New Information:	
Meter # 1:	<u>98607414</u>	Meter # 1:	_____
Meter # 2: Radio	_____	Meter # 2: Radio	_____
MXU #:	_____	MXU #:	_____
Current Reading	<u>12/20/2013 600</u>	Current Reading	<u>0</u>
Type of Meter:	<u>Badger</u>	Type of Meter:	_____
Year MFG:	<u>1998</u>	Year MFG:	_____
GPS - Longitude	<u>0</u>	GPS - Latitude	<u>0</u>

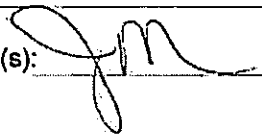
Employee Signature(s): 

Date Completed 2/4/14

Martin County Water District ✓

387 East Main St., Suite 140
Inez, KY 41224

WORK ORDER

WO # 140100488

Time Started _____ Work Complete _____

Loc # _____ Master Meter # _____

Dat 1/31/2014 Account # _____ SEQ # 319

Name: JOE STATON Phone # _____

Address: Mullett Br Employee Tony Blevins

INEZ, KY 41224

Location: Mullett Br

MOLLETT BRANCH

Type of Work: Complaints

Material Used: _____

Customer Line Inspection _____

Comments: extremely low pressure / Has 40 PSI At box

Done

✓

Current System Information:		New Information:	
Meter # 1:	<u>97354329</u>	Meter # 1:	_____
Meter # 2: Radio	_____	Meter # 2: Radio	_____
MXU #:	_____	MXU #:	_____
Current Reading	<u>12/20/2013 1058</u>	Current Reading	<u>0</u>
Type of Meter:	<u>Badger</u>	Type of Meter:	_____
Year MFG:	<u>1997</u>	Year MFG:	_____
GPS - Longitude	<u>0</u>	GPS - Latitude	<u>0</u>

Employee Signature(s): JS, CH

Date Completed 2-4-14

Martin County Water Dist. Inc

387 East Main St., Suite 140
Inez, KY 41224



WORK ORDER

WO # 140200271

Time Started _____ Work Complete _____

Loc # _____ Master Meter # _____

Date 2/12/2014 Account # _____ SEQ # 474

Name: John Curtis Kirk Phone # _____

Address: P.O. Box
Inez, Ky 41224

Location: : Eden West. Last residence on hill.

: Eden West

Type of Work: Complaints

Done

Material Used: ~~Put down gravel~~

Customer Line Inspection already had gravel put down

Comments: customer needs gravel put down, they were removed when tap was put in

Current System Information:		New Information:	
Meter # 1:	<u>98003080</u>	Meter # 1:	_____
Meter # 2: Radio	<u>98003080</u>	Meter # 2: Radio	_____
MXU #:	_____	MXU #:	_____
Current Reading	<u>1/20/2014 334</u>	Current Reading	<u>0</u>
Type of Meter:	<u>Badger</u>	Type of Meter:	_____
Year MFG:	<u>1998</u>	Year MFG:	_____
GPS - Longitude	_____	GPS - Latitude	_____

Employee Signature(s): JS, RJ

Date Completed 3-24-14

Martin County Water District

387 East Main St., Suite 140
Louisa, KY 41224

WORK ORDER

WO # 140300177

Time Started _____ Work Complete _____

Loc # _____ Master Meter # _____

Date 3/24/2014 Account # _____ SEQ # 288

Name: Niki J. Boyes Phone # _____

Address: Buffalo Horn
Louisa, Ky 41230

Location: Buffalo Horn Rd. About 1 mile on left. White trailer down over hill after you pass small graveyard.

Buffalo Horn Rd

Type of Work: Complaints

Material Used: _____

Customer Line Inspection _____

Comments: NO WATER / came back on about an hour after he calls

Current System Information:		New Information:	
Meter # 1:	<u>70840680</u>	Meter # 1:	_____
Meter # 2: Radio	<u>70840680</u>	Meter # 2: Radio	_____
MXU #:	_____	MXU #:	_____
Current Reading	<u>2/20/2014 153</u>	Current Reading	<u>0</u>
Type of Meter:	<u>Sensus</u>	Type of Meter:	_____
Year MFG:	<u>2012</u>	Year MFG:	_____
GPS - Longitude	_____	GPS - Latitude	_____

Employee Signature(s): JAW, JS

Date Completed 3-26-14

Martin County Water District

387 East Main St., Suite 140
Inez, KY 41224

WORK ORDER

WO # 140300138

Time Started _____

Work Complete _____

Loc # _____

Master Meter # _____

Dat 3/14/2014

Account # _____

SEQ # 158

Name: NOAH WEBB

Phone # (_____)

Address: PO BOX

Employee Jason W.

LOVELY, KY 41231

Location N Wolf Crk Lovely. 1714. First house on left on Webbville. White 2-story. N. Wolf Creek.

Type of Work: Complaints

Material Used: _____

Customer Line Inspection _____

Comments complaints of air in line, needs flushed

Flushed

Current System Information:		New Information:	
Meter # 1:	<u>74604138</u>	Meter # 1:	_____
Meter # 2: Radio	<u>74604138</u>	Meter # 2: Radio	_____
MXU #:	<u>14992318</u>	MXU #:	_____
Current Reading	<u>2/20/2014 38</u>	Current Reading	<u>0</u>
Type of Meter:	_____	Type of Meter:	_____
Year MFG:	_____	Year MFG:	_____
GPS - Longitude	_____	GPS - Latitude	_____

Employee Signature(s): RJ,

Date Completed 3-14-14

Martin County Water District ✓

387 East Main St., Suite 140
Inez, KY 41224

WORK ORDER

WO # 140300138

COPY

Time Started _____ Work Complete _____

Loc # _____ Master Meter # _____

Dat 3/14/2014 Account # _____ SEQ # 158

Name: NOAH WEBB Phone # () _____

Address: PO BOX Employee Jason W.

LOVELY, KY 41231

Location: 1 N Wolf Crk Lovely, First house on left on Webbville, White 2-story, N. Wolf Creek.

Type of Work: Complaints

Material Used: _____

Customer Line Inspection _____

Comments: complaints of air in line, needs flushed

Current System Information:		New Information:	
Meter # 1:	<u>74604138</u>	Meter # 1:	_____
Meter # 2: Radio	<u>74604138</u>	Meter # 2: Radio	_____
MXU #:	<u>14992318</u>	MXU #:	_____
Current Reading	<u>2/20/2014 38</u>	Current Reading	<u>0</u>
Type of Meter:	_____	Type of Meter:	_____
Year MFG:	_____	Year MFG:	_____
GPS - Longitude	_____	GPS - Latitude	_____

Employee Signature(s): _____

Date Completed 3-19-14

Martin County Water District

387 East Main St., Suite 140
Inez, KY 41224

WORK ORDER

WO # 140300113

Time Started _____ Work Complete _____

Loc # _____ Master Meter # _____

Date 3/10/2014 Account # _____ SEQ # 48

Name: Landon Jude Phone # _____

Address: P.O. Box
Inez, KY 41224

Location: E Main St, Inez, last house past pawn shop, white w/green shutters, next to empty lot

E Main St

Type of Work: Complaints

Material Used: _____

Customer Line Inspection INSPECTED FOR SEWER BOY

Comments: complaints of extremely low water pressure, going to burn up his wash machine, has reported several ti

Current System Information:		New Information:	
Meter # 1:	<u>70616368</u>	Meter # 1:	_____
Meter # 2: Radio	<u>70616368</u>	Meter # 2: Radio	_____
MXU #:	<u>14440339</u>	MXU #:	_____
Current Reading	<u>2/20/2014 23</u>	Current Reading	<u>0</u>
Type of Meter:	_____	Type of Meter:	_____
Year MFG:	_____	Year MFG:	_____
GPS - Longitude	_____	GPS - Latitude	_____

Employee Signature(s): [Signature]

Date Completed 3/10/14

Martin County Water District

387 East Main St., Suite 140
Inez, KY 41224

WORK ORDER

WO # 150700198

Time Started

Work Complete

Loc #

Master Meter #

Date 7/28/2015

Account #

SEQ # 202

Name: Stephanie Tackett

Phone #

Address: N Wolf Crk Rd
Pilgrim, Ky 41250

Employee Justin Scott

Location: N Wolf Crk Rd. 1/4 mile from Pigeon Roost community center. White house on the left with green roof & shutters

N Wolf Creek RD

Type of Work: Complaints

Material Used:

Customer Line Inspection

Comments: no water

Stopped up on customer's side

Current System Information:

New Information:

Meter # 1: 96982418

Meter # 1:

Meter # 2: Radio 96982418

Meter # 2: Radio

MXU #:

MXU #:

Current Reading 6/20/2015 1168

Current Reading 0

Type of Meter: Badger

Type of Meter:

Year MFG: 1996

Year MFG:

GPS - Longitude

GPS - Latitude

Employee Signature(s): *RJ*

Date Completed

7-29-15

Martin County Water District

387 East Main St., Suite 140
Inez, KY 41224



WORK ORDER

WO # 150700191

Time Started

Work Complete

Loc #

Master Meter #

Date 7/28/2015

Account #

SEQ # 397

Name: PAUL MORRISON

Phone # ()

Address: PO BOX

Employee Troy Horn

INEZ, KY 41224

Location: Across from Venters Branch. Little grey house on left. 3428 New Rt 3

NEW RT 3

Type of Work: Complaints

Material Used:

Customer Line Inspection

Comments: air in the lines

Blew off line

Current System Information:

New Information:

Meter # 1: 29934564

Meter # 1:

Meter # 2: Radio

Meter # 2: Radio

MXU #:

MXU #:

Current Reading 6/20/2015 495

Current Reading 0

Type of Meter: Badger

Type of Meter:

Year MFG: 2004

Year MFG:

GPS - Longitude 0

GPS - Latitude 0

Employee Signature(s):

TH

Date Completed

7-28-15

Martin County Water District

387 East Main St., Suite 140
Inez, KY 41224

WORK ORDER

WO # 150700144

Time Started

Work Complete

Loc #

Master Meter #

Date 7/20/2015

Account #

SEQ # 237

Name: Dahryl Keller

Phone #

Address: Setser Br
Inez, Ky 41224

Employee Troy Horn

Location: Setser Br. Wood sided house @ end of road

Setser Br

Type of Work: Complaints

Material Used:

Customer Line Inspection

Comments: as extremely low water pressure

Done

= 28 PSI. A box

Current System Information:

New Information:

Meter # 1: 33076067

Meter # 1:

Meter # 2: Radio 33076067

Meter # 2: Radio

MXU #:

MXU #:

Current Reading 6/20/2015 311

Current Reading 0

Type of Meter: Badger

Type of Meter:

Year MFG: 2006

Year MFG:

GPS - Longitude

GPS - Latitude

Employee Signature(s): *JS*

Date Completed

7-27-15

Martin County Water District

387 East Main St., Suite 140
Inez, KY 41224

WORK ORDER

WO # 150700018

Time Started

Work Complete

Loc #

Master Meter #

Date 7/1/2015

Account #

SEQ # 121

Name: Charles Tipton

Phone # (

Address: P.O. Box

Employee Rainbo

INEZ KY 41224

Location: Boone Br of Eli Rd; last house in hollow; box is on BANK IN FRONT

BOONE BR.

Type of Work: Complaints

Material Used:

Customer Line Inspection:

Comments: had extremely low pressure for a week

Done
-40 PSI At box

Current System Information:

New Information:

Meter # 1: 99691122

Meter # 1:

Meter # 2: Radio

Meter # 2: Radio

MXU #:

MXU #:

Current Reading 6/20/2015 520

Current Reading 0

Type of Meter: Badger

Type of Meter:

Year MFG: 1999

Year MFG:

GPS - Longitude 0

GPS - Latitude 0

Employee Signature(s): *JS*

Date Completed 7-23-15

Martin County Water District ✓

387 East Main St., Suite 140
Inez, KY 41224

WORK ORDER

WO # 150700037

Time Started _____ Work Complete _____

Loc # _____ Master Meter # _____

Date 7/6/2015 Account # _____ SEQ # 117

Name: James Williamson Phone # _____

Address: Poplar Frk Rd Employee Rainbo
BEAUTY KY 41203

Location: Lower Poplar Frk, top of hill, 2nd drive on right, green double wide

ELK CREEK

Type of Work: Complaints *Done*

Material Used: Had a line into on the tank went empty.

Customer Line Inspection but he got water now we fix the

Comments: no water line on Sunday

Current System Information:

New Information:

Meter # 1: 47823585

Meter # 1: _____

Meter # 2: Radio

Meter # 2: Radio

MXU #: _____

MXU #: _____

Current Reading 6/20/2015 719

Current Reading 0

Type of Meter: Sensus

Type of Meter: _____

Year MFG: 1993

Year MFG: _____

GPS - Longitude 0

GPS - Latitude 0

Employee Signature(s): JS, CS, RJ.

Date Completed 7-6-15

Martin County Water District ✓

387 East Main St., Suite 140
Inez, KY 41224

WORK ORDER

WO # 150700101

Time Started

Work Complete

Loc #

Master Meter #

Date 7/9/2015

Account #

SEQ # 107

Name: Kirby PREECE

Phone #

Address: PO BOX

Employee Rainbo

INEZ, KY 41224

Location: Howard Spence Rd, After crossing Inez hill, 1st drive on left up on hill, Tan trailer

ROUTE 40 WEST

Type of Work: Complaints

Material Used:

Customer Line Inspection:

has water now

Comments: customer has no water

Current System Information:

New Information:

Meter # 1: 90819244

Meter # 1:

Meter # 2: Radio

Meter # 2: Radio

MXU #:

MXU #:

Current Reading 6/20/2015 1536

Current Reading 0

Type of Meter: Badger

Type of Meter:

Year MFG: 1990

Year MFG:

GPS - Longitude 0

GPS - Latitude 0

Employee Signature(s):

Date Completed

Martin County Water District

387 East Main St., Suite 140
Inez, KY 41224

WORK ORDER

WO # 150700111

Time Started

Work Complete

Loc #

Master Meter #

Date 7/13/2015

Account #

SEQ # 108

Name: MARY STANLEY

Phone # (

Address: PO Box

Employee Troy Horn

WARFIELD, KY 41267

Location: Stanley Dr

COLLINS CREEK

Type of Work: Complaints

Material Used:

Customer Line Inspection: was pumping into Elk Creek & it took their pressure down

Comments: no water

Current System Information:

New Information:

Meter # 1: 70616608

Meter # 1:

Meter # 2: Radio

Meter # 2: Radio

MXU #: 13154928

MXU #:

Current Reading 6/20/2015 353

Current Reading 0

Type of Meter:

Type of Meter:

Year MFG:

Year MFG:

GPS - Longitude

GPS - Latitude

Employee Signature(s): TH

Date Completed 7-13-15

Martin County Water District ✓

387 East Main St., Suite 140
Inez, KY 41224

WORK ORDER

WO # 150700030

Time Started

Work Complete

Loc #

Master Meter #

Date 7/2/2015

Account #

SEQ # 96

Name: JASON MAYNARD

Phone #

Address: Cassell Br

Employee Rainbo

INEZ, KY 41224

Location: Cassell Br

CASSELL BRANCH

Type of Work: Complaints

Done

Material Used:

Customer Line Inspection:

Comments: no water

Pressure was at #153

Current System Information:

Meter # 1: 29541979

Meter # 2: Radio 29541979

MXU #:

Current Reading 6/20/2015 457

Type of Meter: Badger

Year MFG: 2004

GPS - Longitude 0

New Information:

Meter # 1:

Meter # 2: Radio

MXU #:

Current Reading 0

Type of Meter:

Year MFG:

GPS - Latitude 0

Employee Signature(s): *RJ.*

Date Completed

7-2-15

Martin County Water District ✓

387 East Main St., Suite 140
Inez, KY 41224

WORK ORDER

WO # 150800183

Time Started

Work Complete

Loc #

Master Meter #

Date 8/19/2015

Account #

SEQ # 7

Name: William Scott

Phone #

Address: P.O. Box

Employee Justin Scott

Inez, KY 41224

Location: Newberry Ln. Inez. Slate colored house on the left.

Newberry Ln

Type of Work: Complaints

Material Used:

Customer Line Inspection

Comments: customer said water stank

Flushed

Current System Information:

New Information:

Meter # 1:

Meter # 1:

Meter # 2: Radio

Meter # 2: Radio

MXU #:

MXU #:

Current Reading 0

Current Reading 0

Type of Meter:

Type of Meter:

Year MFG:

Year MFG:

GPS - Longitude

GPS - Latitude

Employee Signature(s): JS

Date Completed 8-25-15

Martin County Water District

387 East Main St., Suite 140
Inez, KY 41224

WORK ORDER

WO # 150800117

Time Started

Work Complete

Loc #

Master Meter #

Date 8/11/2015

Account #

SEQ # 82

Name: John Glass

Phone #

Address: P.O. Box

Employee Justin Scott

Nagatuck, WV 25685

Location: Maple Dr. 1st house on left. Brown double-wide w/chain link fence.

Maple Dr

Type of Work: Complaints

Material Used:

Customer Line Inspection

Comments: water is milky white

Flushed

Current System Information:

Meter # 1: 94261289

Meter # 2: Radio 94261289

MXU #:

Current Reading 7/20/2015 2260

Type of Meter: Badger

Year MFG: 1994

GPS - Longitude

New Information:

Meter # 1:

Meter # 2: Radio

MXU #:

Current Reading 0

Type of Meter:

Year MFG:

GPS - Latitude

Employee Signature(s): *JS*

Date Completed *8-20-15*

Martin County Water District

387 East Main St., Suite 140
Inez, KY 41224

WORK ORDER

WO # 150800188

Time Started

Work Complete

Loc #

Master Meter #

Date 8/19/2015

Account #

SEQ # 242

Name: Billy Hammond

Phone #

Address: PO Box

Employee Justin Scott

Warfield, KY 41267

Location: App. 1 mile, blue house on hill,

Sheppard Ln

SPENCE BR

Type of Work: Complaints

Material Used:

2 3" slip, 5 ft of 3" Line

Customer Line Inspection:

Comments: customer reported Sheppard Lane is without water

State broke main while cleaning ditch lines

Current System Information:

New Information:

Meter # 1: 29934524

Meter # 1:

Meter # 2: Radio

Meter # 2: Radio

MXU #:

MXU #:

Current Reading 7/20/2015 884

Current Reading 0

Type of Meter: Badger

Type of Meter:

Year MFG: 2004

Year MFG:

GPS - Longitude 0

GPS - Latitude 0

Employee Signature(s): T.H.CS, J.M.

Date Completed: 8-20-15

Martin County Water District

387 East Main St., Suite 140
Inez, KY 41224

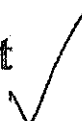

WORK ORDER

WO # 150800120

Time Started

Work Complete

Loc #

Master Meter #

Date 8/11/2015

Account #

SEQ # 234

Name: Billy Greer

Phone #

Address: P.O. Box
Lovely, KY 41231

Employee Troy Horn

Location: Riverfront Rd. Past Jackie & Alice Scott.

Riverfront Rd

Type of Work: Complaints

Material Used:

Customer Line Inspection:

Comments: low pressure for over a week

Due to PSI at low

Current System Information:

New Information:

Meter # 1: 33001041

Meter # 1:

Meter # 2: Radio 33001041

Meter # 2: Radio

MXU #:

MXU #:

Current Reading 7/20/2015 183

Current Reading 0

Type of Meter: Badger

Type of Meter:

Year MFG: 2006

Year MFG:

GPS - Longitude

GPS - Latitude

Employee Signature(s): *JG*

Date Completed 8-12-15

Martin County Water District

387 East Main St., Suite 140
Inez, KY 41224

WORK ORDER

WO # 150800085

Time Started

Work Complete

Loc #

Master Meter #

Date 8/6/2015

Account #

SEQ # 595

Name: Maurice & Rita Mills

Phone #

Address: 3 Rockhouse Road

Employee Justin Scott

Tomahawk, Ky 41262

Location: Mills Lane, 1st house, meter on right of driveway, beside fence 3 Rockhouse Road

Rockhouse

Type of Work: Complaints

Material Used:

Customer Line Inspection:

Comments: requested a flush, water stinks

Done

Flushed line

Current System Information:

New Information:

Meter # 1: 96725763

Meter # 1:

Meter # 2: Radio

Meter # 2: Radio

MXU #:

MXU #:

Current Reading 7/20/2015 1550

Current Reading 0

Type of Meter: Badger

Type of Meter:

Year MFG: 1996

Year MFG:

GPS - Longitude 0

GPS - Latitude 0

Employee Signature(s): *Justin Scott*

Date Completed

8-11-15

Martin County Water District

387 East Main St., Suite 140
Inez, KY 41224

WORK ORDER

WO # 150700200

Time Started

Work Complete ✓

Loc #

Master Meter #

Date 7/28/2015

Account #

SEQ # 158

Name: DAVID MARCUM

Phone # 1

Address: Calf Crk

Employee Justin Scott

Inez, Ky 41224

Location: Calf Crk, 1st house on left, white w/black shutters used to be there now going to be putting a doublewide in

CALF CRREK

Type of Work: Complaints

Material Used:

Customer Line Inspection

Comments: pressure is low and very milky

*Checked Pressure, Read over 100ps;
Checked for Milky water, none visible at meter*

Current System Information:

New Information:

Meter # 1:

Meter # 1:

Meter # 2: Radio

Meter # 2: Radio

MXU #:

MXU #:

Current Reading 0

Current Reading 0

Type of Meter:

Type of Meter:

Year MFG:

Year MFG:

GPS - Longitude

GPS - Latitude

Employee Signature(s):

JS JS

Date Completed

8/3/15

Martin County Water District

387 East Main St., Suite 140
Inez, KY 41224

WORK ORDER

WO # 150700185

Time Started

Work Complete ✓

Loc #

Master Meter #

Date 7/27/2015

Account #

SEQ # 98

Name: HAROLD GOBLE

Phone #

Address: P.O.BOX

Employee Justin Scott

INEZ, KY 41224

Location: Eli Rd

MIDDLEFORK RD.

Type of Work: Complaints

Material Used:

Customer Line Inspection

74 PSI Af box

Comments: very low water pressure

Current System Information:

Meter # 1: 92701640

Meter # 2: Radio

MXU #:

Current Reading 6/20/2015 1420

Type of Meter: Badger

Year MFG: 1992

GPS - Longitude 0

New Information:

Meter # 1:

Meter # 2: Radio

MXU #:

Current Reading 0

Type of Meter:

Year MFG:

GPS - Latitude 0

Employee Signature(s): JS 

Date Completed 8-3-15

Martin County Water District

387 East Main St., Suite 140
Inez, KY 41224



WORK ORDER

WO # 150700188

Time Started

Work Complete

Loc #

Master Meter #

Date 7/27/2015

Account #

SEQ # 20

Name: Sherry Moore

Phone #

Address: P.O. Box
Lovely, KY 41231

Employee Justin Scott

Location: Locust Crt. 1st house on the right.

Locust Crt

Type of Work: Complaints

Material Used:

Customer Line Inspection

Comments: has bad odor to water

Re doing all the line on locust CRT

Current System Information:

New Information:

Meter # 1:

Meter # 1:

Meter # 2: Radio

Meter # 2: Radio

MXU #:

MXU #:

Current Reading 0

Current Reading 0

Type of Meter:

Type of Meter:

Year MFG:

Year MFG:

GPS - Longitude

GPS - Latitude

Employee Signature(s):

JS, TH, CS, RS, JS

Date Completed

8-3-15

Martin County Water District

387 East Main St., Suite 140
Inez, KY 41224



WORK ORDER

WO # 150800080

Time Started

Work Complete

Loc #

Master Meter #

Date 8/5/2015

Account #

SEQ # 473

Name: Mary M FITCH

Phone # (

Address: bb's Lane

Employee Justin Scott

INEZ, KY 41224

Location: Abbs Ln LEFT FORK. 4th house. White w/blue shutters.

ABBS LANE

Type of Work: Complaints

Material Used:

Done

Customer Line Inspection:

Comments: extremely low pressure

73 + 78 PSI At box

Current System Information:

New Information:

Meter # 1: 94056605

Meter # 1:

Meter # 2: Radio

Meter # 2: Radio

MXU #:

MXU #:

Current Reading 7/20/2015 849

Current Reading 0

Type of Meter: Badger

Type of Meter:

Year MFG: 1994

Year MFG:

GPS - Longitude 0

GPS - Latitude 0

Employee Signature(s)

OS, SS

Date Completed

8-5-15

Martin County Water District

387 East Main St., Suite 140
Inez, KY 41224

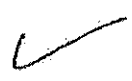

WORK ORDER

WO # 150800088

Time Started

Work Complete

Loc #

Master Meter #

Date 8/6/2015

Account #

SEQ # 218

Name: Miranda McCoy

Phone # (

Address: P.O. Box
Beauty, KY 41203

Employee Rainbo

Location: Big Elk Rd. Across from Water Tower, grey trailer

Done

Big Elk Rd

Type of Work: Complaints

took 2 case of gal. = 8 gall

Material Used:

Customer Line Inspection:

Comments: customer has no water

/needs water

Current System Information:

New Information:

Meter # 1: 29935189

Meter # 1:

Meter # 2: Radio 29935189

Meter # 2: Radio

MXU #:

MXU #:

Current Reading 7/20/2015 397

Current Reading 0

Type of Meter: Badger

Type of Meter:

Year MFG: 2004

Year MFG:

GPS - Longitude

GPS - Latitude

Employee Signature(s): *RJ*

Date Completed *8-6-15*

Martin County Water District

387 East Main St., Suite 140
Inez, KY 41224

WORK ORDER

WO # 150800093

Time Started

Work Complete

Loc #

Master Meter #

Date 8/7/2015

Account #

SEQ # 99

Name: Ronnie Mills

Phone #

Address: PO Box

Employee Rainbo

Inez, KY 41224

Location: 5.8 miles up Turkey, turn left at Fire Dept, appr. 1 mile on right, 2nd house on Meadow Lark Lane, tan house

TURKEY

Type of Work: Complaints

Material Used:

Customer Line Inspection 100 psi @ box; issue on customer's side

Comments: no water

Current System Information:

New Information:

Meter # 1: 99691595

Meter # 1:

Meter # 2: Radio

Meter # 2: Radio

MXU #:

MXU #:

Current Reading 7/20/2015 401

Current Reading 0

Type of Meter: Badger

Type of Meter:

Year MFG: 1999

Year MFG:

GPS - Longitude

GPS - Latitude

Employee Signature(s): JS, JS

Date Completed 8/7/15

Martin County Water District

387 East Main St., Suite 140
Inez, KY 41224

WORK ORDER

COMPLETED

WO # 150200011

Time Started _____

Work Complete _____

Loc # _____

Master Meter # _____

Date 2/3/2015

Account # _____

SEQ # 400

Name: JIM WHITT

Phone # _____

Address: P.O. BOX

Employee Clyde Stanley

TOMAHAWK, KY 41262

Location: Shirley Moore Ln

ROUTE 40 WEST

Type of Work: Complaints

Material Used: _____

Customer Line Inspection: _____

Comments: customer needs drain line repaired that we messed up while installing a line / Drain Looked

Fine

Current System Information:		New Information:	
Meter # 1:	<u>29935046</u>	Meter # 1:	_____
Meter # 2: Radio	_____	Meter # 2: Radio	_____
MXU #:	_____	MXU #:	_____
Current Reading	<u>1/20/2015 291</u>	Current Reading	<u>0</u>
Type of Meter:	<u>Badger</u>	Type of Meter:	_____
Year MFG:	<u>2004</u>	Year MFG:	_____
GPS - Longitude	<u>0</u>	GPS - Latitude	<u>0</u>

Employee Signature(s): JS, TH, [Signature]

Date Completed 9-28-15

Martin County Water District

387 East Main St., Suite 140
Inez, KY 41224



WORK ORDER

COMPLETED

WO # 150900198

Time Started

Work Complete

Loc #

Master Meter #

Date 9/18/2015

Account #

SEQ # 69

Name: DEBBIE DIALS

Phone # (

Address: Russell Workman Rd

Employee Rainbo

LOVELY, KY 41231

Location. Russell Workman Rd of 292.Long Branch.Russell Workman Rd.Go right up on hill.Last house.

Type of Work: Complaints

Material Used:

Done
rod air in line blow it off

Customer Line Inspection:

Comments: no water

Current System Information:

New Information:

Meter # 1: 19667238

Meter # 1:

Meter # 2: Radio

Meter # 2: Radio

MXU #:

MXU #:

Current Reading 8/20/2015 611

Current Reading 0

Type of Meter: Sensus

Type of Meter:

Year MFG: 1966

Year MFG:

GPS - Longitude 0

GPS - Latitude 0

Employee Signature(s): R.J.

Date Completed 9-18-15

Martin County Water District

387 East Main St., Suite 140
Inez, KY 41224

WORK ORDER

WO # 150900182

COMPLETED

Time Started _____

Work Complete _____

Loc # _____

Master Meter # _____

Date 9/15/2015

Account # _____

SEQ # 220

Name: Miranda McCoy

Phone # _____

Address: P.O. Box

Employee Justin Scott

Beauty, KY 41203

Location: 1 Big Elk Rd. Across from Water Tower, grey trailer

Big Elk Rd

Type of Work: Complaints

Material Used: _____

Customer Line Inspection _____

Comments: no water

Rain has is coming AC if has water now

Current System Information:

New Information:

Meter # 1: _____

Meter # 1: _____

Meter # 2: Radio

Meter # 2: Radio

MXU #: _____

MXU #: _____

Current Reading 0

Current Reading 0

Type of Meter: _____

Type of Meter: _____

Year MFG: _____

Year MFG: _____

GPS - Longitude _____

GPS - Latitude _____

Employee Signature(s): _____

Date Completed 9-15-15

Martin County Water District

387 East Main St., Suite 140
Inez, KY 41224

WORK ORDER

WO # 150900003

COMPLETED

Time Started

Work Complete

Loc #

Master Meter #

Date 9/1/2015

Account #

SEQ # 30

Name: WENDELL STEPP

Phone # ()

Address: P.O. Box

Employee Justin Scott

INEZ, KY 41224

Location: Twin Oak Dr., red brick home

CASSADY AVE.

Type of Work: Complaints

Material Used:

Customer Line Inspection:

Comments: low pressure ^{100'} Possible leak on service line
Edge of Black Top at Bottom of drive

Current System Information:

New Information:

Meter # 1: 70616430

Meter # 1:

Meter # 2: Radio 70616430

Meter # 2: Radio

MXU #: 13155681

MXU #:

Current Reading 8/20/2015 191 / 192

Current Reading 0

Type of Meter:

Type of Meter:

Year MFG:

Year MFG:

GPS - Longitude

GPS - Latitude

Employee Signature(s): JS / 

Date Completed 9/2/15

Martin County Water District

387 East Main St., Suite 140
Inez, KY 41224

WORK ORDER

COMPLETED

WO # 150900042

Time Started _____

Work Complete _____

Loc # _____

Master Meter # _____

Date 9/4/2015

Account # _____

SEQ # 69

Name: DEBBIE DIALS

Phone # (_____) _____

Address: Russell Workman Rd

Employee Rainbo

LOVELY, KY 41231

Location: Russell Workman Rd of 292. Long Branch. Russell Workman Rd. Go right up on hill. Last house.

Type of Work: Complaints

Material Used: _____

Customer Line Inspection

turned pressure back up

Comments: no water

Current System Information:

New Information:

Meter # 1: 19667238

Meter # 1: _____

Meter # 2: Radio

Meter # 2: Radio

MXU #: _____

MXU #: _____

Current Reading 8/20/2015 611

Current Reading 0

Type of Meter: Sensus

Type of Meter: _____

Year MFG: 1966

Year MFG: _____

GPS - Longitude 0

GPS - Latitude 0

Employee Signature(s): RS

Date Completed 9/4/15

Martin County Water District

387 East Main St., Suite 140
Inez, KY 41224

WORK ORDER

WO # 150800266

COMPLETED

Time Started

Work Complete

Loc #

Master Meter #

Date 8/28/2015

Account #

SEQ # 125

Name: Charles Tipton

Phone # (

Address: P.O. Box

Employee Justin Scott

INEZ, KY 41224]

Location: Boone Br of Eli Rd; last house in hollow; box is on BANK IN FRONT

BOONE BR.

Type of Work: Complaints

Material Used:

(Done)

Customer Line Inspection:

Comments: VERY LOW WATER PRESSURE

? Needs Hooked up to main

Current System Information:

New Information:

Meter # 1: 99691122

Meter # 1:

Meter # 2: Radio

Meter # 2: Radio

MXU #:

MXU #:

Current Reading 7/20/2015 524

Current Reading 0

Type of Meter: Badger

Type of Meter:

Year MFG: 1999

Year MFG:

GPS - Longitude 0

GPS - Latitude 0

Employee Signature(s): JS

Date Completed 9/9/15

Martin County Water District

387 East Main St., Suite 140
Inez, KY 41224

WORK ORDER

WO # 151000218

Time Started _____

Work Complete _____

Loc # _____

Master Meter # _____

Date 10/23/2015

Account # _____

SEQ # 177

Name: Jimmie Stone

Phone # _____

Address: P.O. Box

Employee Justin Scott

Inez, KY 41224

Location: Split Rock Hollow. Coldwater. Off Moore Branch. Blue-grey house on hill.

Split Rock Hlw

Type of Work: Complaints

Material Used: _____

Customer Line Inspection: _____

Comments: water has been off since MCWD checked his meter yesterday

Current System Information:

New Information:

Meter # 1: 94788708

Meter # 1: _____

Meter # 2: Radio 94788708

Meter # 2: Radio _____

MXU #: _____

MXU #: _____

Current Reading 9/11/2015 254

Current Reading 0

Type of Meter: Badger

Type of Meter: _____

Year MFG: 1994

Year MFG: _____

GPS - Longitude _____

GPS - Latitude _____

Employee Signature(s): 

Date Completed 10/23/15

Martin County Water District

387 East Main St., Suite 140
Inez, KY 41224



WORK ORDER

WO # 151000190

Time Started _____

Work Complete _____

Loc # _____

Master Meter # _____

Date 10/21/2015

Account # _____

SEQ # 821

Name: Pauline Hayes

Phone # _____

Address: Wendy St

Employee Justin Scott

Warfield, KY 41267

Location: Wendy St 5 mi from Warfield, on right, Wendy St, 2nd trailer on right, white & brown

Wendy St

Type of Work: Complaints

Material Used: _____

Customer Line Inspection _____

Comments: cloudy water

FuShed

Current System Information:

New Information:

Meter # 1: 29935240

Meter # 1: _____

Meter # 2: Radio 29935240

Meter # 2: Radio _____

MXU #: _____

MXU #: _____

Current Reading 9/20/2015 247

Current Reading 0

Type of Meter: Badger

Type of Meter: _____

Year MFG: 2004

Year MFG: _____

GPS - Longitude _____

GPS - Latitude _____

Employee Signature(s): *SS*

Date Completed 10-21-15

Martin County Water District ✓

387 East Main St., Suite 140
Inez, KY 41224

WORK ORDER

WO # 151000199

Time Started _____ Work Complete _____

Loc # _____ Master Meter # _____

Date 10/21/2015 Account # _____ SEQ # 178

Name: EDGAR SLONE Phone # (61) _____

Address: PO BOX Employee Justin Scott
INEZ, KY 41224

Location: Split Rock Holw

MOORE BRANCH

Type of Work: Complaints

Material Used: _____

Customer Line Inspection _____

Comments: has low water pressure 24 PSI At box

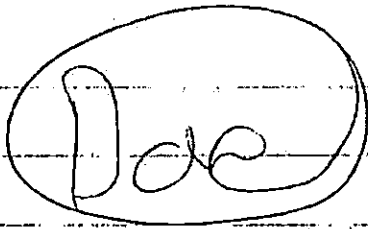

Current System Information:

New Information:

Meter # 1: 89107955

Meter # 1: _____

Meter # 2: Radio

Meter # 2: Radio

MXU #: _____

MXU #: _____

Current Reading 9/20/2015 1699

Current Reading 0

Type of Meter: Badger

Type of Meter: _____

Year MFG: 1989

Year MFG: _____

GPS - Longitude 0

GPS - Latitude 0

Employee Signature(s): JS

Date Completed 10-22-15

Martin County Water District

387 East Main St., Suite 140
Inez, KY 41224

WORK ORDER

WO # 150900253

Time Started

Work Complete

Loc #

Master Meter #

Date 9/29/2015

Account #

SEQ #

Name: Thomas Delong reported

Phone #

Address:

Employee Clyde Stanley

Location: at the mouth of Big Branch; Water Dept cut across road a few years ago to extend water line, it is now rough and washed out and needs repaired

Type of Work: Complaints

Material Used:

Customer Line Inspection:

Comments: needs blacktoped

Current System Information:

New Information:

Meter # 1:

Meter # 1:

Meter # 2: Radio

Meter # 2: Radio

MXU #:

MXU #:

Current Reading 0

Current Reading 0

Type of Meter:

Type of Meter:

Year MFG:

Year MFG:

GPS - Longitude

GPS - Latitude

Employee Signature(s): JS

Date Completed 10-22-15

Martin County Water District ✓

387 East Main St., Suite 140
Inez, KY 41224

WORK ORDER

WO # 151000136

Time Started _____

Work Complete _____

Loc # _____

Master Meter # _____

Date 10/9/2015

Account # _____

SEQ # 377

Name: JERRY MAYNARD

Phone # (_____)

Address: Montgomery Lane
Belfry, KY 41514

Employee Rainbo

Location: Montgomery Lane, Two story house beside park, towards Pike Co line

Type of Work: Complaints

*Put a Gauge on it on it show it 100 Psi.
at the Box.*

Material Used: _____

Customer Line Inspection: _____

Done

Comments: low pressure

Current System Information:

New Information:

Meter # 1: 47823709

Meter # 1: _____

Meter # 2: Radio

Meter # 2: Radio

MXU #: _____

MXU #: _____

Current Reading 9/20/2015 1631

Current Reading 0

Type of Meter: Sensus

Type of Meter: _____

Year MFG: 1993

Year MFG: _____

GPS - Longitude 0

GPS - Latitude 0

Employee Signature(s): *BJ*

Date Completed

10-12-15

Martin County Water District

387 East Main St., Suite 140
Inez, KY 41224

WORK ORDER

WO # 151000149

Time Started

Work Complete

Loc #

Master Meter #

Date 10/12/2015

Account #

SEQ # 118

Name: James Williamson

Phone #

Address: Poplar Frk Rd

Employee Rainbo

BEAUTY, KY 41203

Location: Lower Poplar Frk, top of hill, 2nd drive on right, green double wide

ELK CREEK

Type of Work: Complaints

no water

Material Used:

Customer Line Inspection:

Comments: no water

Current System Information:

Meter # 1: 47823585

Meter # 2: Radio

MXU #:

Current Reading 9/20/2015 732

Type of Meter: Sensus

Year MFG: 1993

GPS - Longitude 0

New Information:

Meter # 1:

Meter # 2: Radio

MXU #:

Current Reading 0

Type of Meter:

Year MFG:

GPS - Latitude 0

Employee Signature(s): RJ

Date Completed 10-12-15

Martin County Water District

387 East Main St., Suite 140
Inez, KY 41224

WORK ORDER

WO # 151000030

Time Started _____

Work Complete _____

Loc # _____

Master Meter # _____

Date 10/5/2015

Account # _____

SEQ # _____

Name: Ed Pack

Phone # (____) _____

Address: Tomahawk Rd

Employee Troy Horn

Tomahawk, Ky 41262

Location: Tomahawk Rd,

Type of Work: Complaints

Material Used: _____

Customer Line Inspection _____

Comments: need to repair driveway damaged when fixing leak

Current System Information:

New Information:

Meter # 1: _____

Meter # 1: _____

Meter # 2: Radio _____

Meter # 2: Radio _____

MXU #: _____

MXU #: _____

Current Reading 0

Current Reading 0

Type of Meter: _____

Type of Meter: _____

Year MFG: _____

Year MFG: _____

GPS - Longitude _____

GPS - Latitude _____

Employee Signature(s): Unit 2

Date Completed 10/12/15

Martin County Water District

387 East Main St., Suite 140
Inez, KY 41224



WORK ORDER

WO # 150800215

Time Started

Work Complete

Loc #

Master Meter #

Date 8/25/2015

Account #

SEQ # 96

Name: LLOYD HEDGES

Phone #

Address: PO BOX

Employee Troy Horn

LOVELY, KY 41231

Location: Riverfront Rd of Lovely; 3rd driveway on right past Railroad Bridge, white house w/red shutters and A shaped garage

DONE

Type of Work: Complaints

Material Used: 30 ft of 4" sewer pipe, 2 4" couplers,

Customer Line Inspection:

Comments: covered customer's drain while fixing leak

Current System Information:

New Information:

Meter # 1: 95748911

Meter # 1:

Meter # 2: Radio

Meter # 2: Radio

MXU #:

MXU #:

Current Reading 7/20/2015 711

Current Reading 0

Type of Meter: Badger

Type of Meter:

Year MFG: 1995

Year MFG:

GPS - Longitude 0

GPS - Latitude 0

Employee Signature(s): *TH, CS, RJ, JS, JLS*

Date Completed 10-1-15

Martin County Water District ✓

387 East Main St., Suite 140
Inez, KY 41224

WORK ORDER

WO # 151000036

Time Started _____ Work Complete _____

Loc # _____ Master Meter # _____

Date 10/5/2015 Account # _____ SEQ # 146

Name: GARY HUNT Phone # (_____

Address: Hunt Place Employee Rainbo
INEZ, KY 41224

Location: Hunt Pl
ROUTE 2032

Type of Work: Complaints

Material Used: _____

Customer Line Inspection _____

Comments: no water Power issue

Current System Information:

Meter # 1: 29935364

Meter # 2: Radio

MXU #: _____

Current Reading 9/20/2015 473

Type of Meter: Badger

Year MFG: 2004

GPS - Longitude 0

New Information:

Meter # 1: _____

Meter # 2: Radio

MXU #: _____

Current Reading 0

Type of Meter: _____

Year MFG: _____

GPS - Latitude 0

Employee Signature(s): RS

Date Completed 10-5-15

Martin County Water District ✓

387 East Main St., Suite 140
Inez, KY 41224

WORK ORDER

WO # 151000122

Time Started

Work Complete

Loc #

Master Meter #

Date 10/8/2015

Account #

SEQ # 679

Name: Phyllis Lowe

Phone #

Address: P.O. Box

Employee Justin Scott

Tomahawk, Ky 41262

Location: Rockhouse Rd. Tomahawk. 5 4/10 mile from bridge. Grey & white trailer on the right on a bank.
Has blacktop driveway.

Rockhouse Rd

Type of Work: Complaints

Material Used:

Customer Line Inspection

Customer side

Comments: no water

Current System Information:

Meter # 1: 29934859

Meter # 2: Radio 29934859

MXU #:

Current Reading 9/20/2015 626

Type of Meter: Badger

Year MFG: 2004

GPS - Longitude

New Information:

Meter # 1:

Meter # 2: Radio

MXU #:

Current Reading 0

Type of Meter:

Year MFG:

GPS - Latitude

Employee Signature(s): RS

Date Completed 10-8-15

Martin County Water District

387 East Main St., Suite 140
Inez, KY 41224



WORK ORDER

WO # 151100181

Time Started _____

Work Complete ✓

Loc # _____

Master Meter # _____

Date 11/25/2015

Account # _____

SEQ # 110

Name: MARY STANLEY

Phone # _____

Address: PO Box

Employee Justin Scott

WARFIELD, KY 41267

Location: Stanley Dr

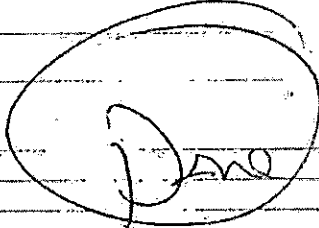

COLLINS CREEK

Type of Work: Complaints

Material Used: Water pressure was low due to pump being

Customer Line Inspection ran @ Elk Creek

Comments: no water

Current System Information:		New Information:	
Meter # 1:	<u>70616608</u>	Meter # 1:	_____
Meter # 2: Radio	_____	Meter # 2: Radio	_____
MXU #:	<u>13154928</u>	MXU #:	_____
Current Reading	<u>11/20/2015 371</u>	Current Reading	<u>0</u>
Type of Meter:	_____	Type of Meter:	_____
Year MFG:	_____	Year MFG:	_____
GPS - Longitude	_____	GPS - Latitude	_____

Employee Signature(s): [Signature] / TC / JS

Date Completed 11/25/15

Martin County Water District

387 East Main St., Suite 140
Inez, KY 41224

WORK ORDER

WO # 151100168

Time Started _____ Work Complete _____

Loc # _____ Master Meter # _____

Date 11/24/2015 Account # _____ SEQ # 295

Name: Ronnie & Marcella Cook Phone # (_____) _____

Address: Crum Br Employee Rainbo
Debord, Ky 41214

Location: Crum Br.

Crum Br

Type of Work: Complaints

Material Used: _____

Customer Line Inspection _____

Comments: could not find leak had SOPSI at box

Done

Current System Information:		New Information:	
Meter # 1:	<u>47823639</u>	Meter # 1:	_____
Meter # 2: Radio	<u>47823639</u>	Meter # 2: Radio	_____
MXU #:	_____	MXU #:	_____
Current Reading	<u>10/20/2015 1135</u>	Current Reading	<u>0</u>
Type of Meter:	<u>Sensus</u>	Type of Meter:	_____
Year MFG:	<u>1993</u>	Year MFG:	_____
GPS - Longitude	_____	GPS - Latitude	_____

Employee Signature(s): [Signature] Date Completed 11-24-15

Martin County Water District

387 East Main St., Suite 140
Inez, KY 41224

WORK ORDER

WO # 151100136

Time Started _____

Work Complete _____

Loc # _____

Master Meter # _____

Date 11/13/2015

Account # _____

SEQ # 40

Name: Connie Mills

Phone # _____

Address: P.O. Box 4

Employee Troy Horn

Warfield, Ky 41267

Location: Lower Carter Br.

Lower Carter Br

Type of Work: Complaints

Material Used: 2 ea - 1" Couplers, 2 ft - 1" Line

Customer Line Inspection _____

Comments: Low water pressue. Said there is a leak at Lower Carter Br in the blacktop.

Current System Information:		New Information:	
Meter # 1:	<u>33001035</u>	Meter # 1:	_____
Meter # 2: Radio	<u>33001035</u>	Meter # 2: Radio	_____
MXU #:	_____	MXU #:	_____
Current Reading	<u>10/20/2015 483</u>	Current Reading	<u>0</u>
Type of Meter:	<u>Badger</u>	Type of Meter:	_____
Year MFG:	<u>2006</u>	Year MFG:	_____
GPS - Longitude	_____	GPS - Latitude	_____

Employee Signature(s):  / JR / TD

Date Completed 11/13/15

Martin County Water District

387 East Main St., Suite 140
Inez, KY 41224

WORK ORDER

WO # 151100151

Time Started _____ Work Complete _____

Loc # _____ Master Meter # _____

Date 11/18/2015 Account # _____ SEQ # 161

Name: RICKY HORN Phone # _____

Address: Mountain View Employee Troy Horn
INEZ, KY 41224

Location: Mountain View

CALF CREEK

Type of Work: Complaints

Material Used: _____

Customer Line Inspection: _____

Comments: customer has no water

flooding lines

Current System Information:

Meter # 1: 99691124
Meter # 2: Radio _____
MXU #: _____
Current Reading 10/20/2015 691
Type of Meter: Badger
Year MFG: 1999
GPS - Longitude 0

New Information:

Meter # 1: _____
Meter # 2: Radio _____
MXU #: _____
Current Reading 0
Type of Meter: _____
Year MFG: _____
GPS - Latitude 0

Employee Signature(s): RS

Date Completed 11/18/15

Martin County Water District

387 East Main St., Suite 140
Inez, KY 41224



WORK ORDER

WO # 151100147

Time Started _____ Work Complete _____

Loc # _____ Master Meter # _____

Date 11/16/2015 Account # _____ SEQ # 427

Name: TRUMAN HORN Phone # () _____

Address: P.O. BOX Employee Clyde Stanley
INEZ, KY 41224

Location: Horn Br
LICKBRANCH RD.

Type of Work: Complaints *None*

Material Used: *Put some gravel in driveway*

Customer Line Inspection: _____

Comments: MCWD left a mess at the end of her driveway on RT 908

Current System Information:	New Information:
Meter # 1: _____	Meter # 1: _____
Meter # 2: Radio _____	Meter # 2: Radio _____
MXU #: _____	MXU #: _____
Current Reading <u>0</u>	Current Reading <u>0</u>
Type of Meter: _____	Type of Meter: _____
Year MFG: _____	Year MFG: _____
GPS - Longitude _____	GPS - Latitude _____

Employee Signature(s): *R.J.*

Date Completed *11-18-15*

Martin County Water District

367 East Main St., Suite 140
Inez, KY 41224

WORK ORDER

WO # 151100134

Time Started _____

Work Complete _____

Loc # _____

Master Meter # _____

Date 11/13/2015

Account # _____

SEQ # _____

Name: Charlie Mills

Phone # _____

Address: _____

Employee Rainbo

Location: Riverfront Rd, new meter set

Type of Work: Complaints

Material Used: _____

Customer Line Inspection customer has leak

Comments: no water

Current System Information:	New Information:
Meter # 1: _____	Meter # 1: _____
Meter # 2: Radio _____	Meter # 2: Radio _____
MXU #: _____	MXU #: _____
Current Reading <u>0</u>	Current Reading <u>0</u>
Type of Meter: _____	Type of Meter: _____
Year MFG: _____	Year MFG: _____
GPS - Longitude _____	GPS - Latitude _____

Employee Signature(s): RS

Date Completed 11-13-15

Martin County Water District ✓

387 East Main St., Suite 140
Inez, KY 41224

WORK ORDER

WO # 151100123

Time Started _____ Work Complete Yes _____

Loc # _____ Master Meter # _____

Date 11/11/2015 Account # _____ SEQ # 20

Name: Sherry Moore Phone # _____

Address: P.O. Box Employee Rainbo
Lovely, KY 41231

Location: Locust Crt. 1st house on the right.

Locust Crt

Type of Work: Complaints

Material Used: _____

Customer Line Inspection problem on customer side

Comments: low pressure

Current System Information:		New Information:	
Meter # 1:	<u>70840490</u>	Meter # 1:	_____
Meter # 2: Radio	<u>70840490</u>	Meter # 2: Radio	_____
MXU #:	_____	MXU #:	_____
Current Reading	<u>10/20/2015 630</u>	Current Reading	<u>0</u>
Type of Meter:	<u>Sensus</u>	Type of Meter:	_____
Year MFG:	<u>2012</u>	Year MFG:	_____
GPS - Longitude	_____	GPS - Latitude	_____

Employee Signature(s): RS

Date Completed 11-11-15

Martin County Water District

387 East Main St., Suite 140
Inez, KY 41224

WORK ORDER

WO # 151100015

Time Started _____ Work Complete _____

Loc # _____ Master Meter # _____

Date 11/2/2015 Account # _____ SEQ # 449

Name: James McGinnis Phone # _____

Address: McGinnis Br Employee Justin Scott
Debord, Ky 41214

Location: HillCrest Dr; across the bridge by Bud's Bike Shop; turn left and it is the 1st white single-wide on hill

Middlefork

Type of Work: Complaints

Material Used: Flushed

Customer Line Inspection _____

Comments: milky water

Current System Information:

Meter # 1: 29541627
Meter # 2: Radio _____
MXU #: _____
Current Reading 10/20/2015 255
Type of Meter: Badger
Year MFG: 2004
GPS - Longitude 0

New Information:

Meter # 1: _____
Meter # 2: Radio _____
MXU #: _____
Current Reading 0
Type of Meter: _____
Year MFG: _____
GPS - Latitude 0

Employee Signature(s): JS

Date Completed 11-5-15

Martin County Water District ✓

387 East Main St., Suite 140
Inez, KY 41224

WORK ORDER

WO # 151200064

Time Started _____

Work Complete _____

Loc # _____

Master Meter # _____

Date 12/14/2015

Account # _____

SEQ # 417

Name: ELMER DIALS

Phone # () _____

Address: Blackburn & Dials Rd

Employee Troy Horn

TOMAHAWK, KY 41262

Location: Blackburn & Dials Rd on Tomhawk just past Tomahawk Freewill Baptist wooden bridge on left,
driveway on right fork

ROUTE 40 WEST

Done

Type of Work: Complaints

Material Used: *1 3/4 coupler, 1 1" to 3/4 coupler, 3 3/4 inserts, 1 1" insert, 3/4 wrap*

Customer Line Inspection: _____

Comments: extremely low pressure; possibly creek crossing

Current System Information:

New Information:

Meter # 1: 93534937

Meter # 1: _____

Meter # 2: Radio _____

Meter # 2: Radio _____

MXU #: _____

MXU #: _____

Current Reading 11/20/2015 1093

Current Reading 0

Type of Meter: Badger

Type of Meter: _____

Year MFG: 1993

Year MFG: _____

GPS - Longitude 0

GPS - Latitude 0

Employee Signature(s): *THCS, JLS, JS*

Date Completed *12-23-15*

Martin County Water District ✓

387 East Main St., Suite 140
Inez, KY 41224

WORK ORDER

WO # 151200088

Time Started _____ Work Complete _____

Loc # _____ Master Meter # _____

Date 12/21/2015 Account # _____ SEQ # 244

Name: LON CRUM Phone # (_____) _____

Address: P.O. Box _____ Employee Troy Horn

Inez, KY 41224

Location: Guyton Rd, Little Lick Br, top of hill last house @ top of hill, red

GUYTON RD

Type of Work: Complaints

Material Used: _____

Customer Line Inspection _____

Comments: low water pressure / got water now

Current System Information:		New Information:	
Meter # 1:	<u>29935077</u>	Meter # 1:	_____
Meter # 2: Radio	<u>29935077</u>	Meter # 2: Radio	_____
MXU #:	_____	MXU #:	_____
Current Reading	<u>11/20/2015 650</u>	Current Reading	<u>0</u>
Type of Meter:	<u>Badger</u>	Type of Meter:	_____
Year MFG:	<u>2004</u>	Year MFG:	_____
GPS - Longitude	<u>0</u>	GPS - Latitude	<u>0</u>

Employee Signature(s): TH, CS,

Date Completed 12-23-15

Martin County Water District

387 East Main St., Suite 140
Inez, KY 41224

WORK ORDER

WO # 150800121

Time Started _____

Work Complete _____

Loc # _____

Master Meter # _____

Date 8/11/2015

Account # _____

SEQ # 49

Name: Always Perfect Floral

Phone # _____

Address: Fluty Lick Rd

Employee Troy Horn

Louisa, KY 41230

Location: Beauty Rd. Building beside Shop Rite. Across road from Rite Aid.

Beauty Rd

Type of Work: Complaints

Patched the bad spot in parking lot

Material Used: _____

Customer Line Inspection: _____

Comments: has mess in parking lot that MCWD made; wants it cleaned up

Current System Information:

New Information:

Meter # 1: 29934563

Meter # 1: _____

Meter # 2: Radio 29934563

Meter # 2: Radio _____

MXU #: _____

MXU #: _____

Current Reading 7/20/2015 651

Current Reading 0

Type of Meter: Badger

Type of Meter: _____

Year MFG: 2004

Year MFG: _____

GPS - Longitude -82.25144

GPS - Latitude 37.50562

Employee Signature(s): JS, JS, RJ, CS, TH

Date Completed 12/12/15

Martin County Water District

387 East Main St., Suite 140
Inez, KY 41224

WORK ORDER

WO # 150900002

Time Started

Work Complete

Loc #

Master Meter #

Date 9/1/2015

Account #

SEQ # 54

Name: WARFIELD SHOPRITE

Phone #

Address: PO BOX

Employee Troy Horn

INEZ KY 41224

Location: Beauty Rd

Type of Work: Complaints

Patched the bad spot in parking lot

Material Used:

Customer Line Inspection:

Comments: parking lot needs repaired

Current System Information:

New Information:

Meter # 1: 37229319

Meter # 1:

Meter # 2: Radio

Meter # 2: Radio

MXU #:

MXU #:

Current Reading 8/20/2015 8029

Current Reading 0

Type of Meter: Sensus

Type of Meter:

Year MFG: 1986

Year MFG:

GPS - Longitude 0

GPS - Latitude 0

Employee Signature(s): JS, JS, RJ, CS, TH

Date Completed 12/16/15

Martin County Water District

387 East Main St., Suite 140
Inez, KY 41224

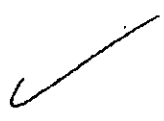

WORK ORDER

WO # 150900059

Time Started _____

Work Complete _____

Loc # _____

Master Meter # _____

Date 9/8/2015

Account # _____

SEQ # 39

Name: DARRELL CLARK

Phone # _____

Address: Collins Crk

Employee Rainbo

Warfield, KY 41267

Location: Collins Creek. 1/2 miles up. Brown brick house on left.

Type of Work: Complaints

Material Used: _____

Customer Line Inspection: _____

Comments: repair blacktop

Current System Information:

New Information:

Meter # 1: 70616376

Meter # 1: _____

Meter # 2: Radio

Meter # 2: Radio

MXU #: 13151496

MXU #: _____

Current Reading 8/20/2015 215

Current Reading 0

Type of Meter: _____

Type of Meter: _____

Year MFG: _____

Year MFG: _____

GPS - Longitude _____

GPS - Latitude _____

Employee Signature(s): JS, JS, TH, CS

Date Completed 12/11/15

Martin County Water District

387 East Main St., Suite 140
Inez, KY 41224

WORK ORDER

WO # 151200045

Time Started _____ Work Complete _____

Loc # _____ Master Meter # _____

Date 12/10/2015 Account # _____ SEQ # 30

Name: WENDELL STEPP Phone # _____

Address: P.O. Box
INEZ, KY 41224 Employee Justin Scott

Location: ? Twin Oak Dr., red brick home

CASSADY AVE.

Type of Work: Complaints

Material Used: _____

Customer Line Inspection _____

Comments: ~~leak~~ ~~leak~~ 2 3/4" couplings about 4' of 3/4" line
and 4 3/4" inserts

Done

Current System Information:		New Information:	
Meter # 1:	<u>70616430</u>	Meter # 1:	_____
Meter # 2: Radio	<u>70616430</u>	Meter # 2: Radio	_____
MXU #:	<u>13155681</u>	MXU #:	_____
Current Reading	<u>11/20/2015 197</u>	Current Reading	<u>0</u>
Type of Meter:	_____	Type of Meter:	_____
Year MFG:	_____	Year MFG:	_____
GPS - Longitude	_____	GPS - Latitude	_____

Employee Signature(s): JS, JS, TH, LS Date Completed 12-10-15

Martin County Water District

387 East Main St., Suite 140
Inez, KY 41224

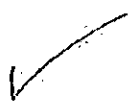

WORK ORDER

WO # 151100195

Time Started _____

Work Complete _____

Loc # _____

Master Meter # _____

Date 11/30/2015

Account # _____

SEQ # 328

Name: Earyetta GILLMAN

Phone # _____

Address: Riverfront Rd
Belfry, KY 41514

Employee Rainbo

Location: Riverfront Rd. 2nd driveway past Gospel Revelation. Black & white double-wide on hill.

Type of Work: Complaints

Down

Material Used: Dug the meter on ch. Pressure gauge had 90# at Box

Customer Line Inspection: told her to get someone to check on her side for another

Comments: extremely low pressure please let customer know if issue is on her side

Current System Information:

New Information:

Meter # 1: 29935301

Meter # 1: _____

Meter # 2: Radio

Meter # 2: Radio

MXU #: _____

MXU #: _____

Current Reading 11/20/2015 301

Current Reading 0

Type of Meter: Sensus

Type of Meter: _____

Year MFG: 1980

Year MFG: _____

GPS - Longitude 0

GPS - Latitude 0

Employee Signature(s): ABERT

Date Completed 12-4-15

Martin County Water District

387 East Main St., Suite 140
Inez, KY 41224

WORK ORDER

WO # 151200018

Time Started _____

Work Complete _____

Loc # _____

Master Meter # _____

Date 12/4/2015

Account # _____

SEQ # 135

Name: GARLAND SPENCE

Phone # (_____)

Address: Garland Spence Dr

Employee Justin Scott

INEZ, KY 41224

Location: Garland Spence Dr on Mudfork, right fork, rd will fork again go left white house on hill w/railing on porch

MUDFORK ROAD

Type of Work: Complaints

DONE

Material Used: 2 3/4 Couplers, 4 3/4 inserts, 10 ft of 3/4 Line, 3/4 wrap

Customer Line Inspection _____

Comments: _____

Current System Information:		New Information:	
Meter # 1:	<u>98604648</u>	Meter # 1:	_____
Meter # 2: Radio	_____	Meter # 2: Radio	_____
MXU #:	_____	MXU #:	_____
Current Reading	<u>11/20/2015 1687</u>	Current Reading	<u>0</u>
Type of Meter:	<u>Badger</u>	Type of Meter:	_____
Year MFG:	<u>1998</u>	Year MFG:	_____
GPS - Longitude	<u>0</u>	GPS - Latitude	<u>0</u>

Employee Signature(s): TH, CS

Date Completed 12-04-15

Martin County Water District

387 East Main St., Suite 140
Inez, KY 41224

WORK ORDER

WO # 141200092

Time Started _____ Work Complete _____

Loc # _____ Master Meter # _____

Date 12/12/2014 Account # _____ SEQ # 226

Name: ELMER FITCH Phone # (_____)

Address: P.O.BOX Employee Troy Horn
Inez, KY 41224

Location: Guyton Rd, 2nd driveway on left up Little Lick; 2nd driveway, white double-wide

GUYTON RD

Type of Work: Complaints

Material Used: _____

Customer Line Inspection: _____

Comments: got water

Current System Information:		New Information:	
Meter # 1:	<u>29934978</u>	Meter # 1:	_____
Meter # 2: Radio	_____	Meter # 2: Radio	_____
MXU #:	_____	MXU #:	_____
Current Reading	<u>11/20/2014 389</u>	Current Reading	<u>0</u>
Type of Meter:	<u>Badger</u>	Type of Meter:	_____
Year MFG:	<u>2004</u>	Year MFG:	_____
GPS - Longitude	<u>0</u>	GPS - Latitude	<u>0</u>

Employee Signature(s): JH, CS

Date Completed 1-5-15

Martin County Water District

387 East Main St., Suite 140
Inez, KY 41224

WORK ORDER

WO # 150200238

COMPLETED

Time Started _____ Work Complete _____

Loc # _____ Master Meter # _____

Date 2/24/2015 Account # _____ SEQ # 220

Name: Eric Copeland Phone # _____

Address: PO Box Employee Rainbo
Lovely, KY 41231

Location: 3 Riverfront Rd

292

Type of Work: Complaints *Done*

Material Used: _____

Customer Line Inspection *he took the meter out & check it seem to be good*

Comments: *turn the water on had good pressure*
no one will home. I left it on
Beck & found it
no water coming thru meter

Current System Information:		New Information:	
Meter # 1:	<u>98655397</u>	Meter # 1:	_____
Meter # 2: Radio	_____	Meter # 2: Radio	_____
MXU #:	_____	MXU #:	_____
Current Reading	<u>1/20/2015 997</u>	Current Reading	<u>0</u>
Type of Meter:	<u>Badger</u>	Type of Meter:	_____
Year MFG:	<u>1998</u>	Year MFG:	_____
GPS - Longitude	<u>0</u>	GPS - Latitude	<u>0</u>

Employee Signature(s): RJ.

Date Completed 2-26-15

Martin County Water District

387 East Main St., Suite 140
Inez, KY 41224

WORK ORDER

WO # 150200236

Time Started _____

Work Complete _____

Loc # _____

Master Meter # _____

Date 2/24/2015

Account # _____

SEQ # 484

Name: Recycling Solutions Tech.

Phone # _____

Address: PO Box
Allen, KY 41601

Employee Troy Horn

Location: Right side, go thru gate, meter sets to the left of garage doors, in front of boiler

Martin County Coal Hill

Type of Work: Complaints

Material Used: _____

Customer Line Inspection Had a valve off

Comments: no water, checked fire hydrant and there is no water coming to it either.

Current System Information:		New Information:	
Meter # 1:	<u>70025360</u>	Meter # 1:	_____
Meter # 2: Radio	<u>70025360</u>	Meter # 2: Radio	_____
MXU #:	<u>14640449</u>	MXU #:	_____
Current Reading	<u>1/20/2015 1981</u>	Current Reading	<u>0</u>
Type of Meter:	_____	Type of Meter:	_____
Year MFG:	_____	Year MFG:	_____
GPS - Longitude	_____	GPS - Latitude	_____

Employee Signature(s): CS, JS, TH

Date Completed 2-28-15

Martin County Water District

387 East Main St., Suite 140
Inez, KY 41224

WORK ORDER

WO # 150200227

Time Started _____ Work Complete _____

Loc # _____ Master Meter # _____

Date 2/24/2015 Account # _____ SEQ # 183

Name: PATRICIA MAYNARD Phone # _____

Address: Everett Rd Employee Justin Scott

BEAUTY, KY 41203

Location: Everette Rd, 2nd house on left, white single-wide

EVERETT LANE

Type of Work: Complaints

Material Used: _____

Customer Line Inspection: _____

Comments: no water / flow on their side

Current System Information:		New Information:	
Meter # 1:	<u>29934968</u>	Meter # 1:	_____
Meter # 2: Radio	_____	Meter # 2: Radio	_____
MXU #:	_____	MXU #:	_____
Current Reading	<u>1/20/2015 756</u>	Current Reading	<u>0</u>
Type of Meter:	<u>Badger</u>	Type of Meter:	_____
Year MFG:	_____	Year MFG:	_____
GPS - Longitude	<u>0</u>	GPS - Latitude	<u>0</u>

Employee Signature(s): TS

Date Completed 2-24-15

Martin County Water District

387 East Main St., Suite 140
Inez, KY 41224

WORK ORDER

WO # 150200225

Time Started _____

Work Complete _____

Loc # _____

Master Meter # _____

Date 2/24/2015

Account # _____

SEQ # 384

Name: WANDA Maynard

Phone # ():

Address: Honeysuckle Ln
Debord, KY 41214

Employee Justin Scott

Location: Honeysuckle Ln, 90 Babe Delong Rd

BABE DELONG RD

Type of Work: Complaints

Done
Frozen on our side

Material Used: 4 1/2" cupplers, 8 1/2" inserts, 100ft of 1/2" inline,
1/2" wrap

Customer Line Inspection: _____

Comments: NO WATER

Current System Information:		New Information:	
Meter # 1:	<u>29935196</u>	Meter # 1:	_____
Meter # 2: Radio	_____	Meter # 2: Radio	_____
MXU #:	_____	MXU #:	_____
Current Reading	<u>1/20/2015 594</u>	Current Reading	<u>0</u>
Type of Meter:	<u>Badger</u>	Type of Meter:	_____
Year MFG:	<u>2004</u>	Year MFG:	_____
GPS - Longitude	<u>0</u>	GPS - Latitude	<u>0</u>

Employee Signature(s): JH, SS, CH

Date Completed: 2-24-15

Martin County Water District

387 East Main St., Suite 140
Inez, KY 41224

WORK ORDER

WO # 150200218

Time Started _____

Work Complete _____

Loc # _____

Master Meter # _____

Date 2/23/2015

Account # _____

SEQ # 525

Name: Jonathan Johnson

Phone # _____

Address: Blackberry Rd
Debord, KY 41214

Employee Clyde Stanley

Location: Blackberry Rd. New Rt 3. Turn left by Fast Lane. Grey double-wide on left.

Blackberry Rd

Type of Work: Complaints

Material Used: _____

Customer Line Inspection: on their side

Comments: customer has not had water since it was changed out; meter is on, nothing is turning

Current System Information:

Meter # 1: 94261254

Meter # 2: Radio 94261254

MXU #: _____

Current Reading 1/20/2015 513

Type of Meter: Badger

Year MFG: 1994

GPS - Longitude _____

New Information:

Meter # 1: _____

Meter # 2: Radio _____

MXU #: _____

Current Reading 0

Type of Meter: _____

Year MFG: _____

GPS - Latitude _____

Employee Signature(s): *CHJ*

Date Completed 2-24-15

Martin County Water District

387 East Main St., Suite 140
Inez, KY 41224

WORK ORDER

WO # 150200202

Time Started _____

Work Complete _____

Loc # _____

Master Meter # _____

Date 2/23/2015

Account # _____

SEQ # 525

Name: Jonathan Johnson

Phone # _____

Address: Blackberry Rd
Debord, KY 41214

Employee Justin Scott

Location: Blackberry Rd. New Rt 3. Turn left by Fast Lane. Grey double-wide on left.

Blackberry Rd

Type of Work: Complaints

Material Used: _____

Customer Line Inspection _____

Comments: no water on their side

Current System Information:		New Information:	
Meter # 1:	<u>18963034</u>	Meter # 1:	_____
Meter # 2: Radio	_____	Meter # 2: Radio	_____
MXU #:	_____	MXU #:	_____
Current Reading	<u>0.321</u>	Current Reading	<u>0</u>
Type of Meter:	<u>Badger</u>	Type of Meter:	_____
Year MFG:	_____	Year MFG:	_____
GPS - Longitude	_____	GPS - Latitude	_____

Employee Signature(s): JS/CH

Date Completed 2-24-15

Martin County Water District

387 East Main St., Suite 140
Inez, KY 41224

WORK ORDER

WO # 150200175

Time Started _____

Work Complete _____

Loc # _____

Master Meter # _____

Date 2/18/2015

Account # _____

SEQ # 214

Name: Miranda McCoy

Phone # _____

Address: P.O. Box
Beauty, KY 41203

Employee Justin Scott

Location: Big Elk Rd. Across from Water Tower, grey trailer

Big Elk Rd

Type of Work: Complaints

Done

Material Used: _____

Customer Line Inspection: _____

Comments: possibly frozen at meter / had water going through the meter

Current System Information:		New Information:	
Meter # 1:	<u>29935189</u>	Meter # 1:	_____
Meter # 2: Radio	<u>29935189</u>	Meter # 2: Radio	_____
MXU #:	_____	MXU #:	_____
Current Reading	<u>1/20/2015 374</u>	Current Reading	<u>0</u>
Type of Meter:	<u>Badger</u>	Type of Meter:	_____
Year MFG:	<u>2004</u>	Year MFG:	_____
GPS - Longitude	_____	GPS - Latitude	_____

Employee Signature(s): TH, RJ

Date Completed 2-19-15

Martin County Water District

387 East Main St., Suite 140
Inez, KY 41224

WORK ORDER

WO # 150200169

Time Started _____ Work Complete _____

Loc # _____ Master Meter # _____

Date 2/18/2015 Account # _____ SEQ # 142

Name: EARL ALLEY Phone # _____

Address: Poplar Fork Employee Troy Horn
BEAUTY, KY 41203

Location: Poplar Fork

Type of Work: Complaints

Material Used: _____

Customer Line Inspection: Water pressure good at meter

Comments: complaints of air in line

Current System Information:		New Information:	
Meter # 1:	<u>98607413</u>	Meter # 1:	_____
Meter # 2: Radio	_____	Meter # 2: Radio	_____
MXU #:	_____	MXU #:	_____
Current Reading	<u>1/20/2015 734</u>	Current Reading	<u>0</u>
Type of Meter:	<u>Badger</u>	Type of Meter:	_____
Year MFG:	<u>1998</u>	Year MFG:	_____
GPS - Longitude	<u>0</u>	GPS - Latitude	<u>0</u>

Employee Signature(s): RS

Date Completed 2/18/15

Martin County Water District

387 East Main St., Suite 140
Inez, KY 41224

WORK ORDER

WO # 150200171

Time Started _____ Work Complete _____

Loc # _____ Master Meter # _____

Date 2/18/2015 Account # _____ SEQ # 380

Name: B. ARANAS Phone # () _____

Address: P.O. BOX
BEAUTY, KY 41203 Employee Troy Horn

Location: beauty, Beside Nazarene church. Pink house right side

BEAUTY

Type of Work: Complaints

Material Used: _____

Customer Line Inspection: Water is flowing at meter; problem is on customer's side

Comments: customer thinks meter is frozen

Current System Information:		New Information:	
Meter # 1:	<u>96130786</u>	Meter # 1:	_____
Meter # 2: Radio	_____	Meter # 2: Radio	_____
MXU #:	_____	MXU #:	_____
Current Reading	<u>1/20/2015 1343</u>	Current Reading	<u>0</u>
Type of Meter:	<u>Badger</u>	Type of Meter:	_____
Year MFG:	<u>1996</u>	Year MFG:	_____
GPS - Longitude	<u>0</u>	GPS - Latitude	<u>0</u>

Employee Signature(s): RJ, TH

Date Completed 2/18/15

Martin County Water District

387 East Main St., Suite 140
Inez, KY 41224

WORK ORDER

WO # 150200168

Time Started _____ Work Complete _____

Loc # _____ Master Meter # _____

Date 2/18/2015 Account # _____ SEQ # 538

Name: Ivlean Hager Phone # _____

Address: PO Box Employee Rainbo
Inez, Ky 41224-0295

Location:) Hager Hill Dr, single wide at bottom

Skyview Drive

Type of Work: Complaints

Material Used: _____

Customer Line Inspection: Customer had water at lock

Comments: no water

Current System Information:	New Information:
Meter # 1: <u>95748781</u>	Meter # 1: _____
Meter # 2: Radio _____	Meter # 2: Radio _____
MXU #: _____	MXU #: _____
Current Reading <u>1/20/2015 1773</u>	Current Reading <u>0</u>
Type of Meter: <u>Badger</u>	Type of Meter: _____
Year MFG: <u>1995</u>	Year MFG: _____
GPS - Longitude <u>0</u>	GPS - Latitude <u>0</u>

Employee Signature(s): RS

Date Completed 2/17/15

Martin County Water District

387 East Main St., Suite 140
Inez, KY 41224

WORK ORDER

WO # 150300205

Time Started _____

Work Complete _____

Loc # _____

Master Meter # _____

Date 3/25/2015

Account # _____

SEQ # 98

Name: GARY & Trish HUNT

Phone # (_____)

Address: PO BOX

Employee Justin Scott

INEZ, KY 41224

Location: Cassell Br. Brown 16X80 trailer at head of hollow

CASELL BRANCH

Type of Work: Complaints

Material Used: _____

Customer Line Inspection: _____

Comments: no water pump was down

Current System Information:

Meter # 1: 29935252

Meter # 2: Radio _____

MXU #: _____

Current Reading 3/20/2015 961

Type of Meter: Badger

Year MFG: 2004

New Information:

Meter # 1: _____

Meter # 2: Radio _____

MXU #: _____

Current Reading 0

Type of Meter: _____

Year MFG: _____

GPS - Elevation 0

GPS - Elevation 0

Employee Signature(s): JS

Date Completed 3-25-15

Martin County Water District

367 East Main St., Suite 140
Inez, KY 41224

WORK ORDER

WO # 150300144

Time Started _____

Work Complete _____

Loc # _____

Master Meter # _____

Date 3/18/2015

Account # _____

SEQ # 174

Name: Judy Harmon

Phone # _____

Address: PO BOX

Employee Justin Scott

LOVELY, KY 41231

Location: N Wolf Creek

Type of Work: Complaints

Material Used: _____

Customer Line Inspection: _____

Comments: complains of white, murky water; please flush lines / cont flush lines Have to save
Water

Current System Information:		New Information:	
Meter # 1:	<u>74604140</u>	Meter # 1:	_____
Meter # 2: Radio	<u>74604140</u>	Meter # 2: Radio	_____
MXU #:	<u>14992935</u>	MXU #:	_____
Current Reading	<u>2/20/2015 13</u>	Current Reading	<u>0</u>
Type of Meter:	_____	Type of Meter:	_____
Year MFG:	_____	Year MFG:	_____
GPS - Longitude	_____	GPS - Latitude	_____

Employee Signature(s): JS

Date Completed 3-19-15

Martin County Water District

387 East Main St., Suite 140
Inez, KY 41224

WORK ORDER

WO # 150300112

Time Started _____ Work Complete _____

Loc # _____ Master Meter # _____

Date 3/12/2015 Account # _____ SEQ # 121

Name: Mary V Moore Phone # (_____)

Address: Yellow Crk Rd Employee Justin Scott

LOUISA, KY 41230

Location:) Yellow Crk, 4th house on right, white

LOWER FLUTY LICK

Type of Work: Complaints

Material Used: _____

Customer Line Inspection: _____

Comments: low pressure 60 PSI At box.

Current System Information:	New Information:
Meter # 1: <u>330010033</u>	Meter # 1: _____
Meter # 2: Radio <u>330010033</u>	Meter # 2: Radio _____
MXU #: _____	MXU #: _____
Current Reading <u>2/20/2015 293</u>	Current Reading <u>0</u>
Type of Meter: <u>Badger</u>	Type of Meter: _____
Year MFG: _____	Year MFG: _____
GPS - Longitude: <u>0</u>	GPS - Latitude: <u>0</u>

Employee Signature(s):  Date Completed 3-12-15

Martin County Water District ✓

387 East Main St., Suite 140
Inez, KY 41224

WORK ORDER

WO # 150300117

Time Started _____ Work Complete _____

Loc # _____ Master Meter # _____

Date 3/13/2015 Account # _____ SEQ # 295

Name: Justin Pinson Phone # (_____) _____

Address: Music Ln Employee Rainbo
Inez, Ky 41224

Location: Music Ln. 1st driveay across bridge, brown house. 1st bridge on the right after Ok Corral.

Music Ln

Type of Work: Complaints

Material Used: _____

Customer Line Inspection _____

Comments: very low water pressure for days / 100 psi At box TR. Sold

Current System Information:		New Information:	
Meter # 1:	<u>70472562</u>	Meter # 1:	_____
Meter # 2: Radio	<u>70472562</u>	Meter # 2: Radio	_____
MXU #:	_____	MXU #:	_____
Current Reading	<u>2/20/2015 194</u>	Current Reading	<u>0</u>
Type of Meter:	<u>Sensus</u>	Type of Meter:	_____
Year MFG:	<u>2010</u>	Year MFG:	_____
GPS - Longitude	_____	GPS - Latitude	_____

Employee Signature(s): TH, CS

Date Completed 3-16-15

Martin County Water District ✓

387 East Main St., Suite 140
Inez, KY 41224

WORK ORDER

WO # 150300098

Time Started _____ Work Complete _____

Loc # _____ Master Meter # _____

Date 3/10/2015 Account # _____ SEQ # 524

Name: Kayla Hall Phone # _____

Address: Tomahawk Rd Employee Rainbo
Tomahawk, Ky 41262

Location: 3 Tomahawk Rd. Tan house beside Phillip Cove Church

Tomahawk Rd

Type of Work: Complaints

Material Used: _____

Customer Line Inspection Done

Comments: milky water Blowed hydrant at Spicy Mountain.

Current System Information:		New Information:	
Meter # 1:	<u>47823902</u>	Meter # 1:	_____
Meter # 2: Radio	<u>47823902</u>	Meter # 2: Radio	_____
MXU #:	_____	MXU #:	_____
Current Reading	<u>2/20/2015 418</u>	Current Reading	<u>0</u>
Type of Meter:	<u>Sensus</u>	Type of Meter:	_____
Year MFG:	<u>1993</u>	Year MFG:	_____
GPS - Longitude	_____	GPS - Latitude	_____

Employee Signature(s): SE, CH, KS

Date Completed 3-11-15

Martin County Water District

387 East Main St., Suite 140
Inez, KY 41224

WORK ORDER

WO # 150300115

Time Started _____ Work Complete _____

Loc # _____ Master Meter # _____

Date 3/13/2015 Account # _____ SEQ # 118

Name: RONDA CRUM Phone # _____

Address: 1 Blacklog Rd Employee Clyde Stanley
Inez, KY 41224

Location: 2 Blacklog Rd Blacklog, 1st house on the right past Preece Hollow

BLACKLOG

Type of Work: Complaints leak on customers side

Material Used: _____

Customer Line Inspection: _____

Comments: check meter to see if it busted or a leak on customer's side

Current System Information:		New Information:	
Meter # 1:	<u>90770481</u>	Meter # 1:	_____
Meter # 2: Radio	_____	Meter # 2: Radio	_____
MXU #:	_____	MXU #:	_____
Current Reading	<u>2/20/2015 1487</u>	Current Reading	<u>0</u>
Type of Meter:	<u>Badger</u>	Type of Meter:	_____
Year MFG:	_____	Year MFG:	_____
GPS - Longitude	<u>0</u>	GPS - Latitude	<u>0</u>

Employee Signature(s): JS

Date Completed 3/13

Martin County Water District

387 East Main St., Suite 140
Inez, KY 41224

WORK ORDER

WO # 150300114

Time Started _____ Work Complete _____

Loc # _____ Master Meter # _____

Date 3/13/2015 Account # _____ SEQ # 162

Name: Dinah Ratliff Phone # (_____)

Address: Oakie Drive Employee Clyde Stanley
Inez, KY 41224

Location: Calf Creek, . Oakie Dr, stay straight, last house, beige 2story

Type of Work: Complaints

Material Used: _____

Customer Line Inspection: _____

Comments: problem is on customer's side

Current System Information:		New Information:	
Meter # 1:	<u>99459123</u>	Meter # 1:	_____
Meter # 2: Radio	<u>99459123</u>	Meter # 2: Radio	_____
MXU #:	_____	MXU #:	_____
Current Reading	<u>2/20/2015 1247</u>	Current Reading	<u>0</u>
Type of Meter:	<u>Badger</u>	Type of Meter:	_____
Year MFG:	<u>1999</u>	Year MFG:	_____
GPS - Longitude	_____	GPS - Latitude	_____

Employee Signature(s): JS

Date Completed 3/13/15

Martin County Water District

387 East Main St., Suite 140
Inez, KY 41224



WORK ORDER

WO # 150300100

Time Started _____ Work Complete _____

Loc # _____ Master Meter # _____

Date 3/11/2015 Account # _____ SEQ # 229

Name: Norma McCoy Phone # (_____) _____

Address: 5 Meathouse Rd Employee Rainbo
Pilgrim, KY 41250

Location: 3 Meathouse Rd, turn right @ 1439 4 or 5 miles on right grey trailer on hill

MEATHOUSE

Type of Work: Complaints

Material Used: _____

Customer Line Inspection _____

Comments: no water pump was off

Current System Information:		New Information:	
Meter # 1:	<u>71799523</u>	Meter # 1:	_____
Meter # 2: Radio	<u>71799523</u>	Meter # 2: Radio	_____
MXU #:	_____	MXU #:	_____
Current Reading	<u>2/20/2015 140</u>	Current Reading	<u>0</u>
Type of Meter:	<u>Sensus</u>	Type of Meter:	_____
Year MFG:	<u>2012</u>	Year MFG:	_____
GPS - Longitude	_____	GPS - Latitude	_____

Employee Signature(s): JS/RT

Date Completed 3-11-15

Martin County Water District

387 East Main St., Suite 140
Inez, KY 41224



WORK ORDER

WO # 150300039

Time Started _____ Work Complete _____

Loc # _____ Master Meter # _____

Date 3/6/2015 Account # 1 SEQ # 177

Name: John Moore Phone # _____

Address: Meathouse Rd Employee Rainbo
Pilgrim, KY 41250

Location: Meathouse Rd Below Leanna Church, 1st Drive, Grey Traylor

Wolf Creek

Type of Work: Complaints

Material Used: _____

Customer Line Inspection _____

Comments: low pressure / had water

Done

Current System Information:		New Information:	
Meter # 1:	<u>47823969</u>	Meter # 1:	_____
Meter # 2: Radio	_____	Meter # 2: Radio	_____
MXU #:	_____	MXU #:	_____
Current Reading	<u>2/20/2015 582</u>	Current Reading	<u>0</u>
Type of Meter:	<u>Sensus</u>	Type of Meter:	_____
Year MFG:	<u>1993</u>	Year MFG:	_____
GPS - Longitude	<u>0</u>	GPS - Latitude	<u>0</u>

Employee Signature(s): TH, CS

Date Completed 3-10-15

Martin County Water District

367 East Main St., Suite 140
Inez, KY 41224

WORK ORDER

WO # 150300052

Time Started _____ Work Complete _____

Loc # _____ Master Meter # _____

Date 3/9/2015 Account # _____ SEQ # 224

Name: JAMES MOLLETT Phone # _____

Address: 4 Big Elk Road Employee Rainbo
INEZ, KY 41224

Location: Big Elk Rd

Type of Work: Complaints

Material Used: _____

Customer Line Inspection: _____

Comments: no water / had water

Done

Current System Information:		New Information:	
Meter # 1:	<u>98985758</u>	Meter # 1:	_____
Meter # 2: Radio	_____	Meter # 2: Radio	_____
MXU #:	_____	MXU #:	_____
Current Reading	<u>2/20/2015 700</u>	Current Reading	<u>0</u>
Type of Meter:	<u>Badger</u>	Type of Meter:	_____
Year MFG:	<u>1998</u>	Year MFG:	_____
GPS - Longitude	<u>0</u>	GPS - Latitude	<u>0</u>

Employee Signature(s): TH, CS

Date Completed 3-10-15

Martin County Water District

387 East Main St., Suite 140
Inez, KY 41224

WORK ORDER

WO # 150300036

Time Started _____ Work Complete Yes

Loc # _____ Master Meter # _____

Date 3/6/2015 Account # _____ SEQ # 262

Name: EUGENE MAYNARD Phone # _____

Address: Debord Rd Employee Rainbo

DEBORD , KY 41214

Location: Debord Rd. On the hill on the left past post office. 2nd driveway

DEBOARD RD

Type of Work: Complaints

Material Used: _____

Customer Line Inspection: _____

Comments: water is milky / Flashed line

Current System Information:		New Information:	
Meter # 1:	<u>92701760</u>	Meter # 1:	_____
Meter # 2: Radio	<u>92701760</u>	Meter # 2: Radio	_____
MXU #:	_____	MXU #:	_____
Current Reading	<u>2/20/2015 1507</u>	Current Reading	<u>0</u>
Type of Meter:	<u>Badger</u>	Type of Meter:	_____
Year MFG:	<u>1992</u>	Year MFG:	_____
GPS - Longitude	<u>0</u>	GPS - Latitude	<u>0</u>

Employee Signature(s): [Signature]

Date Completed 3-26-15

Martin County Water District

387 East Main St., Suite 140
Inez, KY 41224

WORK ORDER

WO # 150300065

Time Started _____ Work Complete _____

Loc # _____ Master Meter # _____

Date 3/10/2015 Account # _____ SEQ # 154

Name: JOE HACKNEY Phone # _____

Address: PO BOX 1 Employee Justin Scott
LOVELY, KY 41231

Location: Stepp Br

STEPP BRANCH

Type of Work: Complaints *Kyle took him water ✓*

Material Used: _____

Customer Line Inspection _____

Comments: no water for days

Current System Information:		New Information:	
Meter # 1:	<u>19906223</u>	Meter # 1:	_____
Meter # 2: Radio	<u>19906223</u>	Meter # 2: Radio	_____
MXU #:	_____	MXU #:	_____
Current Reading	<u>2/20/2015 380</u>	Current Reading	<u>0</u>
Type of Meter:	<u>Sensus</u>	Type of Meter:	_____
Year MFG:	<u>1967</u>	Year MFG:	_____
GPS - Longitude	<u>0</u>	GPS - Latitude	<u>0</u>

Employee Signature(s): _____

Date Completed 3-10-15

Martin County Water District

387 East Main St., Suite 140
Inez, KY 41224

WORK ORDER

WO # 150300049

Time Started _____ Work Complete _____

Loc # _____ Master Meter # _____

Date 3/9/2015 Account # _____ SEQ # 331

Name: William Chapman Phone # _____

Address: Nolan St Employee Rainbo
Williamson, WV 25661

Location: Chapman Farm Rd of Riverfront, 1 mile from county line, Spring Br, right side of rd, beige double wide,

RIVERFRONT

Type of Work: Complaints *took water to customer*

Material Used: _____

Customer Line Inspection: _____

Comments: havent had water since Tuesday, neighbors are having no pressure /

Current System Information:		New Information:	
Meter # 1:	<u>29934670</u>	Meter # 1:	_____
Meter # 2: Radio	_____	Meter # 2: Radio	_____
MXU #:	_____	MXU #:	_____
Current Reading	<u>2/20/2015 334</u>	Current Reading	<u>0</u>
Type of Meter:	<u>Badger</u>	Type of Meter:	_____
Year MFG:	<u>2004</u>	Year MFG:	_____
GPS - Longitude	_____	GPS - Latitude	_____

Employee Signature(s): _____ Date Completed 3-9-15

Martin County Water District

387 East Main St., Suite 140
Inez, KY 41224

WORK ORDER

WO # 150300040

Time Started _____ Work Complete _____

Loc # _____ Master Meter # _____

Date 3/6/2015 Account # _____ SEQ # 203

Name: CLIFFORD KEENER Phone # (_____)

Address: . Riverfront Rd Employee Rainbo
LOVELY, KY 41231

Location: Riverfront Rd.

Type of Work: Complaints *Value shut off / tank low*

Material Used: _____

Customer Line Inspection: _____

Comments: water had low pressure, now has none

Current System Information:		New Information:	
Meter # 1:	<u>25088029</u>	Meter # 1:	_____
Meter # 2: Radio	_____	Meter # 2: Radio	_____
MXU #:	_____	MXU #:	_____
Current Reading	<u>2/20/2015 710</u>	Current Reading	<u>0</u>
Type of Meter:	<u>Sensus</u>	Type of Meter:	_____
Year MFG:	<u>1976</u>	Year MFG:	_____
GPS - Longitude	<u>0</u>	GPS - Latitude	<u>0</u>

Employee Signature(s): _____

Date Completed 3-6-15

Martin County Water District

387 East Main St., Suite 140
Inez, KY 41224

WORK ORDER

WO # 150400180

Time Started

Work Complete

Loc #

Master Meter #

Date 4/23/2015

Account #

SEQ # 382

Name: SD & MARY MOORE

Phone # (

Address: P.O.BOX

Employee Troy Horn

INEZ , KY 41224]

Location: 1 Rockcastle Crk

ROUTE 3 NORTH

Type of Work: Complaints

Material Used:

Customer Line Inspection:

Comments: fence was tore down Friday by MCWD

Fixed put fence back up

Current System Information:

New Information:

Meter # 1: 15094918

Meter # 1:

Meter # 2: Radio

Meter # 2: Radio

MXU #:

MXU #:

Current Reading 3/20/2015 1464

Current Reading 0

Type of Meter: Badger

Type of Meter:

Year MFG: 1982

Year MFG:

GPS - Longitude 0

GPS - Latitude 0

Employee Signature(s): *TR, CS*

Date Completed *4-27-15*

Martin County Water District ✓

387 East Main St., Suite 140
Inez, KY 41224

WORK ORDER

WO # 150400202

Time Started

Work Complete

Loc #

Master Meter #

Date 4/24/2015

Account #

SEQ # 282

Name: Eva Spence

Phone # (E)

Address: PO Box

Employee Troy Horn

Inez, KY 41224

Location: 3 Rockcastle Rd Old Rt 3, Past Ratliff town on hill on the right, brick house, beside Rocky Top Hill.

Old Rt 3

Type of Work: Complaints

Material Used:

fixed

Customer Line Inspection:

Comments: customer wants dirt filled and grass sown on bank where water dept had worked

put dirt back

grass seed

Current System Information:

New Information:

Meter # 1: 29934897

Meter # 1:

Meter # 2: Radio 29934897

Meter # 2: Radio

MXU #:

MXU #:

Current Reading 4/20/2015 394

Current Reading 0

Type of Meter: Badger

Type of Meter:

Year MFG: 2004

Year MFG:

GPS - Longitude

GPS - Latitude

Employee Signature(s): *TH, CS*

Date Completed *4-27-15*

Martin County Water District

387 East Main St., Suite 140
Inez, KY 41224

WORK ORDER

WO # 150500078

Time Started

Work Complete

Loc #

Master Meter #

Date 5/7/2015

Account #

SEQ # 303

Name: PAUL ENDICOTT

Phone #

Address: 2 Buffalo Horn Rd.

Employee Justin Scott

LOUISA, KY 41230

Location: 2 Buffalo Horn Rd 1st white house on the left past Burkes Body Shop. Wood fence around yard.

BUFFALO HORN

Type of Work: Complaints

Material Used:

Customer Line Inspection:

Comments: extremely low pressure / had good pressure

Done

Current System Information:

New Information:

Meter # 1: 92917046

Meter # 1:

Meter # 2: Radio

Meter # 2: Radio

MXU #:

MXU #:

Current Reading 4/20/2015 920

Current Reading 0

Type of Meter: Badger

Type of Meter:

Year MFG: 1992

Year MFG:

GPS - Longitude 0

GPS - Latitude 0

Employee Signature(s): YH, CS

Date Completed 5-8-15

Martin County Water District

387 East Main St., Suite 140
Inez, KY 41224



WORK ORDER

WO # 150500096

Time Started

Work Complete

Loc #

Master Meter #

Date 5/11/2015

Account #

SEQ # 117

Name: Linda Smith

Phone # (6

Address: Camp Branch
Inez, KY 41224

Employee Justin Scott

Location: Camp Br, 1/2 m on left, brick split level

Coldwater

Type of Work: Complaints

Material Used:

Done

Customer Line Inspection:

Comments: very low pressure; water is cloudy

- 70 ~~psi~~ PSI At box

Current System Information:

New Information:

Meter # 1: 70840768

Meter # 1:

Meter # 2: Radio

Meter # 2: Radio

MXU #:

MXU #:

Current Reading 4/20/2015 190

Current Reading 0

Type of Meter: Sensus

Type of Meter:

Year MFG: 2009

Year MFG:

GPS - Longitude

GPS - Latitude

Employee Signature(s):

JS

Date Completed

5-12-15

Martin County Water District ✓

387 East Main St., Suite 140
Inez, KY 41224

WORK ORDER

WO # 150500101

Time Started Work Complete

Loc # Master Meter #

Date 5/11/2015 Account # SEQ # 293

Name: STERLING MARCUM Phone # (

Address: RT 5 BOX Employee Justin Scott

LOUISA , KY 41230]

Location: Rockcastle Rd, 1st white house on the right past Friendship Church

ROUTE 3 NORTH

Type of Work: Complaints

Material Used:

Customer Line Inspection:

Comments: extremely low pressure

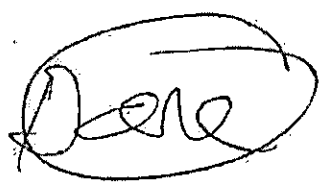

80 PSI Ax FOX

Current System Information:

New Information:

Meter # 1: 47823998
Meter # 2: Radio 47823998
MXU #:
Current Reading 4/20/2015 530
Type of Meter: Sensus
Year MFG: 1993
GPS - Longitude 0

Meter # 1:
Meter # 2: Radio
MXU #:
Current Reading 0
Type of Meter:
Year MFG:
GPS - Latitude 0

Employee Signature(s): JS

Date Completed 5-16-15

24934790
428
bada ✓

Martin County Water District

387 East Main St., Suite 140
Inez, KY 41224

WORK ORDER

WO # 150500087

Time Started Work Complete

Loc # Master Meter #

Date 5/8/2015 Account # SEQ # 352

Name: Heather Harrison Phone # ()

Address: Mullett Br Employee Justin Scott
INEZ , KY 41224

Location: Mullett Br. Coldwater. Last house on the right, white house on hill, stone bottom

Mullett Br

Type of Work: Complaints

Material Used:

Customer Line Inspection:

Comments: low pressuree - 40 ~~PSI~~ At box

Current System Information:

New Information:

Meter # 1: 29934533
Meter # 2: Radio 29934533
MXU #:
Current Reading 4/20/2015 447
Type of Meter: Badger
Year MFG: 2004
GPS - Longitude 0

Meter # 1:
Meter # 2: Radio
MXU #:
Current Reading 0
Type of Meter:
Year MFG:
GPS - Latitude 0

Employee Signature(s): JS

Date Completed 5-11-15

Martin County Water District ✓

387 East Main St., Suite 140
Inez, KY 41224

WORK ORDER

WO # 150400151

Time Started

Work Complete

Loc #

Master Meter #

Date 4/16/2015

Account #

SEQ # 352

Name: Heather Harrison

Phone # (

Address: Mullett Br

Employee Troy Horn

INEZ, KY 41224

Location: Mullett Br. Coldwater. Last house on the right, white house on hill, stone bottom

- Mullett Br

Type of Work: Complaints

Material Used:

Customer Line Inspection:

40 PSI At box

Comments: extremely low pressure

Current System Information:

Meter # 1: 29934533

Meter # 2: Radio 29934533

MXU #:

Current Reading 3/20/2015 443

Type of Meter: Badger

Year MFG: 2004

GPS - Longitude 0

New Information:

Meter # 1:

Meter # 2: Radio

MXU #:

Current Reading 0

Type of Meter:

Year MFG:

GPS - Latitude 0

Employee Signature(s): *JS*

Date Completed *5-4-15*

Martin County Water District ✓

387 East Main St., Suite 140
Inez, KY 41224

WORK ORDER

WO # 150500071

Time Started

Work Complete

Loc #

Master Meter #

Date 5/7/2015

Account #

SEQ # 85

Name: DICIE CHARLES

Phone #

Address: PO BOX

Employee Rainbo

LOVELY, KY 41231

Location: 1 Maple St 3rd house down, red & white.

MAPLE STREET

Done

Type of Work: Complaints

Pull meter on it seem to be ok

Material Used:

I think she has a bad Regulator on she

Customer Line Inspection

said ok

Comments: very low water pressure

Current System Information:

New Information:

Meter # 1: 47823885

Meter # 1:

Meter # 2: Radio

Meter # 2: Radio

MXU #:

MXU #:

Current Reading 4/20/2015 366

Current Reading 0

Type of Meter: Sensus

Type of Meter:

Year MFG: 1993

Year MFG:

GPS - Longitude 0

GPS - Latitude 0

Employee Signature(s):

B.J

Date Completed

5-7-15

Martin County Water District

387 East Main St., Suite 140
Inez, KY 41224

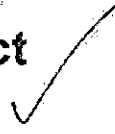

WORK ORDER

WO # 150600053

Time Started

Work Complete

Loc #

Master Meter #

Date 6/8/2015

Account #

SEQ # 105

Name: HERMAN ENDICOTT

Phone # ()

Address: Tug River Rd.

Employee Troy Horn

INEZ , KY 41224]

Location: Tug River Rd, 1 mile up Tug River, green roof w. grey siding

TURKEY ROAD

Type of Work: Complaints

Material Used:



Customer Line Inspection:

Comments: customer thinks driveway is damaged due to water meter busting - Did not see any thing wrong

Current System Information:

New Information:

Meter # 1: 96646084

Meter # 1:

Meter # 2: Radio 96646084

Meter # 2: Radio

MXU #:

MXU #:

Current Reading 5/20/2015 1050

Current Reading 0

Type of Meter: Badger

Type of Meter:

Year MFG: 1996

Year MFG:

GPS - Longitude 0

GPS - Latitude 0

Employee Signature(s): JS

Date Completed 6-8-15

Martin County Water District

387 East Main St., Suite 140
Inez, KY 41224

WORK ORDER

WO # 150600124

Time Started

Work Complete

Loc #

Master Meter #

Date 6/16/2015

Account #

SEQ # 95

Name: FRANK STACY

Phone #

Address: PO BOX

Employee Rainbo

INEZ, KY 41224

Location: Frank Stacy Ln blacktop hill goes right-handed white house all the way to end of road.

CASSELL BRANCH

Type of Work: Complaints

Material Used:

Customer Line Inspection

Comments: no water / got water now

Done

Current System Information:

Meter # 1: 33001067

Meter # 2: Radio

MXU #:

Current Reading 5/20/2015 642

Type of Meter: Badger

Year MFG: 2006

GPS - Longitude 0

New Information:

Meter # 1:

Meter # 2: Radio

MXU #:

Current Reading 0

Type of Meter:

Year MFG:

GPS - Latitude 0

Employee Signature(s): TH, CS

Date Completed 6-17-15

Martin County Water District

387 East Main St., Suite 140
Inez, KY 41224

WORK ORDER

WO # 150600101

Time Started

Work Complete

Loc #

Master Meter #

Date 6/11/2015

Account #

SEQ # 120

Name: R&J Development

Phone #

Address: P.O. Box

Employee Justin Scott

Warfield, Ky 41267

Location: W Main St Suite 110. Beside Melissa's House of Style

W Main St Suite 110

Type of Work: Complaints

Material Used:

Customer Line Inspection:

Comments: customer stated water had odor / flushed line

Current System Information:

Meter # 1: 72136096

Meter # 2: Radio 72136096

MXU #: 14639897

Current Reading 5/20/2015 43

Type of Meter:

Year MFG:

GPS - Longitude

New Information:

Meter # 1:

Meter # 2: Radio

MXU #:

Current Reading 0

Type of Meter:

Year MFG:

GPS - Latitude

Employee Signature(s): JS

Date Completed 6-15-15

Martin County Water District

387 East Main St., Suite 140
Inez, KY 41224

WORK ORDER

WO # 150600218

Time Started

Work Complete

Loc #

Master Meter #

Date 6/29/2015

Account #

SEQ # 231

Name: LON CRUM

Phone # ()

Address: P.O. Box

Employee Justin Scott

Inez, KY 41224

Location: Guyton Rd, Little Lick Br, top of hill last house @ top of hill, red

GUYTON RD

Type of Work: Complaints

Material Used:

Customer Line Inspection:

Comments: low pressure / *look for a leak*

Current System Information:

New Information:

Meter # 1: 29935077

Meter # 1:

Meter # 2: Radio 29935077

Meter # 2: Radio

MXU #:

MXU #:

Current Reading 5/20/2015 632

Current Reading 0

Type of Meter: Badger

Type of Meter:

Year MFG: 2004

Year MFG:

GPS - Longitude 0

GPS - Latitude 0

Employee Signature(s): *RS + JS*

Date Completed *6/29*

Martin County Water District

387 East Main St., Suite 140
Inez, KY 41224



WORK ORDER

WO # 160100234

Time Started _____ Work Complete _____

Loc # _____ Master Meter # _____

Date 1/26/2016 Account # _____ SEQ # 408

Name: Haskel Mills Phone # (6

Address: PO Box Employee Rainbo

Inez, KY 41224

Location: 4 Union Rd, clay house on hill with green roof

Union Rd

Type of Work: Complaints

Material Used: _____

Customer Line Inspection: _____

Comments: extremely thick mud has a leak with can not find

Current System Information:		New Information:	
Meter # 1:	<u>70616597</u>	Meter # 1:	_____
Meter # 2: Radio	<u>70616597</u>	Meter # 2: Radio	_____
MXU #:	<u>13155911</u>	MXU #:	_____
Current Reading	<u>12/20/2015 285</u>	Current Reading	<u>0</u>
Type of Meter:	_____	Type of Meter:	_____
Year MFG:	_____	Year MFG:	_____
GPS - Longitude	_____	GPS - Latitude	_____

Employee Signature(s): JS

Date Completed 1-28/16

Martin County Water District ✓

387 East Main St., Suite 140
Inez, KY 41224

WORK ORDER

WO # 160100234

Time Started _____

Work Complete _____

Loc # _____

Master Meter # _____

Date 1/26/2016

Account # _____

SEQ # 408

Name: Haskel Mills

Phone # _____

Address: PO Box

Employee Rainbo

Inez, KY 41224

Location: 4 Union Rd, clay house on hill with green roof

Union Rd

Type of Work: Complaints

We had a lead on COPY

Material Used: _____

We fix it so they should

Customer Line Inspection: _____

have water now.

Comments: extremely

Current System Information:		New Information:	
Meter # 1:	<u>70616597</u>	Meter # 1:	_____
Meter # 2: Radio	<u>70616597</u>	Meter # 2: Radio	_____
MXU #:	<u>13155911</u>	MXU #:	_____
Current Reading	<u>12/20/2015 285</u>	Current Reading	<u>0</u>
Type of Meter:	_____	Type of Meter:	_____
Year MFG:	_____	Year MFG:	_____
GPS - Longitude	_____	GPS - Latitude	_____

Employee Signature(s): B. J.

Date Completed 1-28-16

Martin County Water District

387 East Main St., Suite 140
Inez, KY 41224

WORK ORDER

WO # 160100215

Time Started _____

Work Complete _____

Loc # _____

Master Meter # _____

Date 1/20/2016

Account # _____

SEQ # 245

Name: LON CRUM

Phone # (_____) _____

Address: P.O. Box

Employee Troy Horn

Inez, KY 41224

Location: Guyton Rd, Little Lick Br, top of hill last house @ top of hill, red

GUYTON RD

Type of Work: Complaints

Material Used: _____

Customer Line Inspection _____

Comments: no water / Has water but low pressure think it is case every one
is running water from driveway

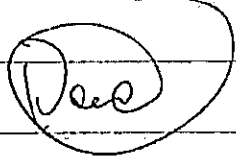

Current System Information:		New Information:	
Meter # 1:	<u>29935077</u>	Meter # 1:	_____
Meter # 2: Radio	<u>29935077</u>	Meter # 2: Radio	_____
MXU #:	_____	MXU #:	_____
Current Reading	<u>12/20/2015 653</u>	Current Reading	<u>0</u>
Type of Meter:	<u>Badger</u>	Type of Meter:	_____
Year MFG:	<u>2004</u>	Year MFG:	_____
GPS - Longitude	<u>0</u>	GPS - Latitude	<u>0</u>

Employee Signature(s): JCS, JS

Date Completed 1-20-16

Martin County Water District

387 East Main St., Suite 140
Inez, KY 41224

WORK ORDER

WO # 160100071

Time Started _____ Work Complete _____

Loc # _____ Master Meter # _____

Date 1/6/2016 Account # _____ SEQ # 219

Name: Charlie Jude Phone # (____) _____

Address: 3 Coldwater Rd
Inez, Ky 41224 Employee Justin Scott

Location: 1 Spence Br. Milo. 1/4 mile on left. 3rd driveway up. Double-wide.

1 Spence Br

Type of Work: Complaints

Material Used: 2 3/4" caps & a set 30' of 3/4" line 2 joints of

Customer Line Inspection: Red oak creek crossing 1" conduct

Comments: creek crossing is uncovered; possibly froze off creek crossing needs to be Red oak
and new meters

Current System Information:		New Information:	
Meter # 1:	<u>47823965</u>	Meter # 1:	_____
Meter # 2: Radio	<u>47823965</u>	Meter # 2: Radio	_____
MXU #:	_____	MXU #:	_____
Current Reading	<u>12/20/2015 1113</u>	Current Reading	<u>0</u>
Type of Meter:	<u>Sensus</u>	Type of Meter:	_____
Year MFG:	<u>1993</u>	Year MFG:	_____
GPS - Longitude	_____	GPS - Latitude	_____

Employee Signature(s): JS, CS, TH

Date Completed 1-19-16

Martin County Water District

387 East Main St., Suite 140
Inez, KY 41224

WORK ORDER

WO # 160100206

Time Started _____ Work Complete _____

Loc # _____ Master Meter # _____

Date 1/20/2016 Account # _____ SEQ # 143

Name: WILBERT WEBB Phone # _____

Address: PO BOX :
LOVELY , KY 41231 Employee Rainbo

Location: Riverfront Rd 1/2 mile up riverfront; wood siding house

Type of Work: Complaints

Material Used: _____

Customer Line Inspection: _____

Comments: all immediate neighbors are out of water / rain bow fixed ok

Current System Information:	New Information:
Meter # 1: <u>99085874</u>	Meter # 1: _____
Meter # 2: <u>Radio</u>	Meter # 2: <u>Radio</u>
MXU #: _____	MXU #: _____
Current Reading <u>12/20/2015 1169</u>	Current Reading <u>0</u>
Type of Meter: <u>Badger</u>	Type of Meter: _____
Year MFG: <u>1999</u>	Year MFG: _____
GPS - Longitude <u>0</u>	GPS - Latitude <u>0</u>

Employee Signature(s):  _____

Date Completed 1-20-16

Martin County Water District

387 East Main St., Suite 140
Inez, KY 41224

WORK ORDER

WO # 160100203

Time Started _____ Work Complete _____

Loc # _____ Master Meter # _____

Date 1/16/2016 Account # _____ SEQ # 106

Name: GARY & Trish HUNT Phone # (_____)

Address: PO BOX Employee Justin Scott
INEZ, KY 41224

Location: Cassell Br. Brown 16X80 trailer at head of hollow

CASELL BRANCH

Type of Work: Complaints

Material Used: _____

Customer Line Inspection: turned pump station back on

Comments: no water

Current System Information:		New Information:	
Meter # 1:	<u>29935252</u>	Meter # 1:	_____
Meter # 2: Radio	_____	Meter # 2: Radio	_____
MXU #:	_____	MXU #:	_____
Current Reading	<u>12/20/2015 1087</u>	Current Reading	<u>0</u>
Type of Meter:	<u>Badger</u>	Type of Meter:	_____
Year MFG:	<u>2004</u>	Year MFG:	_____
GPS - Longitude	<u>0</u>	GPS - Latitude	<u>0</u>

Employee Signature(s): JS

Date Completed 1/16/16

Martin County Water District

387 East Main St., Suite 140
Inez, KY 41224

WORK ORDER

WO # 160100190

Time Started _____

Work Complete _____

Loc # _____

Master Meter # _____

Date 1/19/2016

Account # _____

SEQ # 44

Name: GLADYS STACY

Phone # _____

Address: P.O. BOX

Employee Justin Scott

INEZ, KY 41224]

Location: Aaron St

ROUTE 40 EAST

Type of Work: Complaints

Material Used: _____

Customer Line Inspection _____

Comments: low water pressue

Had 75 PSI At box

Doen

Current System Information:

New Information:

Meter # 1: 29934551

Meter # 1: _____

Meter # 2: Radio

Meter # 2: Radio

MXU #: _____

MXU #: _____

Current Reading 12/20/2015 609

Current Reading 0

Type of Meter: Badger

Type of Meter: _____

Year MFG: 2004

Year MFG: _____

GPS - Longitude 0

GPS - Latitude 0

Employee Signature(s): *CS*

Date Completed 1-19-16

Martin County Water District ✓

387 East Main St., Suite 140
Inez, KY 41224

WORK ORDER

WO # 160100171

Time Started _____ Work Complete _____

Loc # _____ Master Meter # _____

Date 1/15/2016 Account # _____ SEQ # 47

Name: William Davis Phone # _____

Address: Po Box Employee Justin Scott
Inez, Ky 41224

Location: Behind Farm Bureau

Blacklog

Type of Work: Complaints

Material Used: _____

Customer Line Inspection froze on customer side

Comments: no water

Current System Information:		New Information:	
Meter # 1:	<u>18576453</u>	Meter # 1:	_____
Meter # 2: Radio	_____	Meter # 2: Radio	_____
MXU #:	_____	MXU #:	_____
Current Reading	<u>12/20/2015 257</u>	Current Reading	<u>0</u>
Type of Meter:	<u>Badger</u>	Type of Meter:	_____
Year MFG:	<u>2002</u>	Year MFG:	_____
GPS - Longitude	<u>0</u>	GPS - Latitude	<u>0</u>

Employee Signature(s): JS

Date Completed 1-15-16

Martin County Water District

387 East Main St., Suite 140
Inez, KY 41224

WORK ORDER

WO # 151200130

Time Started _____

Work Complete _____

Loc # _____

Master Meter # _____

Date 12/30/2015

Account # _____

SEQ # 170

Name: Elsie Jarvis

Phone # €

Address: PO Box

Employee Justin Scott

Inez, KY 41224

Location: Happy Hollow

Happy Hollow

Type of Work: Complaints

Material Used: _____

Customer Line Inspection _____

Comments: very low water pressure

/ kainta found it up on 16 4th

Current System Information:	New Information:
Meter # 1: _____	Meter # 1: _____
Meter # 2: Radio _____	Meter # 2: Radio _____
MXU #: _____	MXU #: _____
Current Reading <u>0</u>	Current Reading <u>0</u>
Type of Meter: _____	Type of Meter: _____
Year MFG: _____	Year MFG: _____
GPS - Longitude _____	GPS - Latitude _____

Employee Signature(s): RS

Date Completed 1-4-15

Martin County Water District

387 East Main St., Suite 140
Inez, KY 41224



WORK ORDER

WO # 151100139

Time Started

Work Complete Yes

Loc #

Master Meter #

Date 11/13/2015

Account #

SEQ # 31

Name: WENDELL STEPP

Phone #

Address: P.O. Box 1

Employee John Stafford

INEZ, KY 41224

Location: Twin Oak Dr., red brick home

CASSADY AVE.

Type of Work: Complaints

Material Used:

Customer Line Inspection: fixed leak

Comments: extremely low pressure

Current System Information:

New Information:

Meter # 1: 70616430

Meter # 1:

Meter # 2: Radio 70616430

Meter # 2: Radio

MXU #: 13155681

MXU #:

Current Reading 10/20/2015 195

Current Reading 0

Type of Meter:

Type of Meter:

Year MFG:

Year MFG:

GPS - Longitude

GPS - Latitude

Employee Signature(s): TR; JS, JS

Date Completed 2/16/16

Martin County Water District

387 East Main St., Suite 140
Inez, KY 41224



WORK ORDER

WO # 160200213

Time Started _____

Work Complete

Loc # _____

Master Meter # _____

Date 2/22/2016

Account # _____

SEQ # 163

Name: MIKE HORN

Phone # (_____) _____

Address: Dakie Drive

Employee: Troy Horn

INEZ, KY 41224

Location: Dakie Dr of Calf Creek, 5th driveway on right. white double-wide

CALF CREEK

Dr

Type of Work: Complaints

Material Used: 50 Ft - 1" Line, 2 ea - 1" Coupling, 4 ea - 1" Inserts

Customer Line Inspection: _____

Comments: no water

Current System Information:		New Information:	
Meter # 1:	<u>29935042</u>	Meter # 1:	_____
Meter # 2: Radio	<u>29935042</u>	Meter # 2: Radio	_____
MXU #:	_____	MXU #:	_____
Current Reading	<u>1/20/2016 200</u>	Current Reading	<u>0</u>
Type of Meter:	<u>Badger</u>	Type of Meter:	_____
Year MFG:	<u>2004</u>	Year MFG:	_____
GPS - Longitude	<u>0</u>	GPS - Latitude	<u>0</u>

Employee Signature(s): *JS / JS*

Date Completed 2/23/16

Martin County Water District

387 East Main St., Suite 140
Inez, KY 41224

WORK ORDER

WO # 160200193

Time Started _____

Work Complete _____

Loc # _____

Master Meter # _____

Date 2/18/2016

Account # 1

SEQ # 802

Name: CLYDE WALLER

Phone # _____

Address: Hode Rd

Employee Rainbo

WARFIELD, KY 41267

Location: Hode Rd

Type of Work: Complaints

Material Used: _____

Customer Line Inspection

Problem on customer's side

Comments: no water

Current System Information:		New Information:	
Meter # 1:	<u>29935145</u>	Meter # 1:	_____
Meter # 2: Radio	_____	Meter # 2: Radio	_____
MXU #:	_____	MXU #:	_____
Current Reading	<u>1/20/2016 445</u>	Current Reading	<u>0</u>
Type of Meter:	<u>Badger</u>	Type of Meter:	_____
Year MFG:	<u>2004</u>	Year MFG:	_____
GPS - Longitude	<u>0</u>	GPS - Latitude	<u>0</u>

Employee Signature(s):

RT

Date Completed

2-18-16

Martin County Water District ✓

387 East Main St., Suite 140
Inez, KY 41224

WORK ORDER

WO # 160200184

Time Started _____ Work Complete _____

Loc # _____ Master Meter # _____

Date 2/16/2016 Account # _____ SEQ # 494

Name: MARK FITCH Phone # (_____

Address: Weeping Cherry Ln Employee Troy Horn
INEZ, KY 41224

Location: Weeping Cherry Ln

ABBS LANE

Type of Work: Complaints

Material Used: 3/4" coupler, 200 ft of 3/4" line, 3/4 to 1" shadblates

Customer Line Inspection: ran temp 1" to 3/4" in line across bridge

Comments: no water

Current System Information:		New Information:	
Meter # 1:	<u>29934818</u>	Meter # 1:	_____
Meter # 2: Radio	_____	Meter # 2: Radio	_____
MXU #:	_____	MXU #:	_____
Current Reading	<u>1/20/2016 1072</u>	Current Reading	<u>0</u>
Type of Meter:	<u>Badger</u>	Type of Meter:	_____
Year MFG:	<u>2004</u>	Year MFG:	_____
GPS - Longitude	<u>0</u>	GPS - Latitude	<u>0</u>

Employee Signature(s): JS, CS, TH

Date Completed 2/17/16

Martin County Water District

387 East Main St., Suite 140
Inez, KY 41224

WORK ORDER

WO # 160200190

Time Started _____

Work Complete _____

Loc # _____

Master Meter # _____

Date 2/17/2016

Account # _____

SEQ # 82

Name: DIANA SLONE

Phone # _____

Address: Phoebe Trace Rd.

Employee Rainbo

BEAUTY, KY 41203

Location: Phoebe Trce

PHOEBE TRACE

Type of Work: Complaints

Material Used: _____

Customer Line Inspection: Customer has water @ box

Comments: customer and neighbors have nothing but air in lines

Current System Information:

Meter # 1: 29934831

Meter # 2: Radio _____

MXU #: _____

Current Reading 1/20/2016 280

Type of Meter: Badger

Year MFG: _____

GPS - Longitude 0

New Information:

Meter # 1: _____

Meter # 2: Radio _____

MXU #: _____

Current Reading _____

0

Type of Meter: _____

Year MFG: _____

GPS - Latitude 0

Employee Signature(s): RS

Date Completed 2/17/16

Martin County Water District

387 East Main St., Suite 140
Inez, KY 41224

WORK ORDER

WO # 160200025

Time Started

Work Complete

Loc #

Master Meter #

Date 2/3/2016

Account #

SEQ # 316

Name: HELEN MCGINNIS

Phone # (

Address: Tomahawk Road

Employee Justin Scott

TOMAHAWK, KY 41262

Location: Tomahawk Rd; Donna Jude

ROUTE 40 WEST

Type of Work: Complaints

Material Used: *Changed out on 5 bar setting and Reluctor*

Customer Line Inspection *She said that it is a lot better pressure now*

Comments: low pressure; check for problems *Go PSI at box now*

Current System Information:

New Information:

Meter # 1: 94261251

Meter # 1:

Meter # 2: Radio

Meter # 2: Radio

MXU #:

MXU #:

Current Reading 1/20/2016 615

Current Reading 0

Type of Meter: Badger

Type of Meter:

Year MFG: 1994

Year MFG:

GPS - Longitude 0

GPS - Latitude 0

Employee Signature(s): *JS*

Date Completed *2-9-16*

Martin County Water District ✓

387 East Main St., Suite 140
Inez, KY 41224

WORK ORDER

WO # 160300204

Time Started _____ Work Complete _____

Loc # _____ Master Meter # _____

Date 3/23/2016 Account # _____ SEQ # 276

Name: ILENE HARDIN Phone # (_____

Address: North Milo Rd. Employee Troy Horn
TOMAHAWK, KY 41262

Location: North Milo Rd. On the right after Pack Bottom church. Grey house w/red roof and shutters.

ROUTE 1884 MILO

Type of Work: Complaints

Material Used: _____

Customer Line Inspection _____

Comments: low water pressure since last night *Done?* about 60 PSI at box

Current System Information:		New Information:	
Meter # 1:	<u>70472580</u>	Meter # 1:	_____
Meter # 2:	<u>Radio</u>	Meter # 2:	<u>Radio</u>
MXU #:	_____	MXU #:	_____
Current Reading	<u>2/20/2016 309</u>	Current Reading	<u>0</u>
Type of Meter:	<u>Sensus</u>	Type of Meter:	_____
Year MFG:	<u>2009</u>	Year MFG:	_____
GPS - Longitude	<u>0</u>	GPS - Latitude	<u>0</u>

Employee Signature(s): JS

Date Completed 3-23-16

Martin County Water District ✓

387 East Main St., Suite 140
Inez, KY 41224

WORK ORDER

WO # 160300161

Time Started

Work Complete ✓

Loc #

Master Meter #

Date 3/16/2016

Account #

SEQ # 154

Name: Willie Mollette Jr.

Phone #

Address: Emily Crk
Pilgrim, KY 41250

Employee Troy Horn

Location: 4 Emily Crk, White house with green roof above Terry Harmon on right

Emily

Type of Work: Complaints

Material Used: Spoke with Customer Has water. Good pressure in
Canned + Bath tubs just low pressure in Kitchen sink.
Customer Line Inspection: Problem with Customer.

Comments: meter was relocated; now customer has no water

Current System Information:

Meter # 1: 70840680

Meter # 2: Radio 70840680

MXU #:

Current Reading 2/20/2016 235

Type of Meter: Sensus

Year MFG:

GPS - Longitude 0

New Information:

Meter # 1:

Meter # 2: Radio

MXU #:

Current Reading 0

Type of Meter:

Year MFG:

GPS - Latitude 0

Employee Signature(s):

Date Completed

3/22/16

Martin County Water District ✓

387 East Main St., Suite 140
Inez, KY 41224

WORK ORDER

WO # 160300208

Time Started

Work Complete

Loc #

Master Meter #

Date 3/24/2016

Account #

SEQ # 185

Name: Gracie Reed

Phone #

Address: PO Box

Employee Rainbo

Beauty, KY 41203

Location: Cliffside Dr, Moore's Trailer Prk, Last trailer on the right on the bank, brown

Cliffside Dr

Type of Work: Complaints

Material Used:

Customer Line Inspection

Comments: 626-6846 no water pressure

Pumps on

Current System Information:

New Information:

Meter # 1: 16721209

Meter # 1:

Meter # 2: Radio 16721209

Meter # 2: Radio

MXU #:

MXU #:

Current Reading 2/20/2016 761

Current Reading 0

Type of Meter: Badger

Type of Meter:

Year MFG: 2000

Year MFG:

GPS - Longitude 0

GPS - Latitude 0

Employee Signature(s):

RS

Date Completed

3-24-16

Martin County Water District

387 East Main St., Suite 140
Inez, KY 41224



WORK ORDER

WO # 160200212

Time Started _____

Work Complete _____

Loc # _____

Master Meter # _____

Date 2/19/2016

Account # 1

SEQ # 84

Name: EDDIE HINKLE

Phone # () _____

Address: P.O. BOX 1

Employee Rainbo

BEAUTY, KY 41203

Location: Bone Holw 2031.Lower Poplar.Bone Hollow.1st trailer on right at top of hill.Grey & white.

Type of Work: Complaints

Material Used: _____

Customer Line Inspection _____

Comments: wants to know why the water is so nasty.

/installed new pump

Current System Information:		New Information:	
Meter # 1:	<u>97728662</u>	Meter # 1:	_____
Meter # 2: Radio	_____	Meter # 2: Radio	_____
MXU #:	_____	MXU #:	_____
Current Reading	<u>1/20/2016 853</u>	Current Reading	<u>0</u>
Type of Meter:	<u>Badger</u>	Type of Meter:	_____
Year MFG:	<u>1997</u>	Year MFG:	_____
GPS - Longitude	<u>0</u>	GPS - Latitude	<u>0</u>

Employee Signature(s): RT

Date Completed 3/19/16

Martin County Water District

387 East Main St., Suite 140
Inez, KY 41224

WORK ORDER

WO # 160200221

Time Started _____

Work Complete _____

Loc # _____

Master Meter # _____

Date 2/22/2016

Account # 1

SEQ # 85

Name: MAGGIA HINKLE

Phone # (_____)

Address: PO BOX

Employee Rainbo

BEAUTY, KY 41203

Location: ., Bone Hollow on 2031, 1/4 of a mile on Poplar Fork on left, 1st single wide on left

Type of Work: Complaints

Material Used: _____

Customer Line Inspection: _____

Comments: low pressure

installed new pump

58 psi @ box

Current System Information:		New Information:	
Meter # 1:	<u>99085837</u>	Meter # 1:	_____
Meter # 2: Radio	<u>99085837</u>	Meter # 2: Radio	_____
MXU #:	_____	MXU #:	_____
Current Reading	<u>1/20/2016 623</u>	Current Reading	<u>0</u>
Type of Meter:	<u>Badger</u>	Type of Meter:	_____
Year MFG:	<u>1999</u>	Year MFG:	_____
GPS - Longitude	<u>0</u>	GPS - Latitude	<u>0</u>

Employee Signature(s): RS

Date Completed 2/22/16

Martin County Water District

387 East Main St., Suite 140
Inez, KY 41224



WORK ORDER

WO # 160300142

Time Started

Work Complete

Loc #

Master Meter #

Date 3/14/2016

Account #

SEQ # 56

Name: Dick Young

Phone # (

Address: Flat Hollow
Inez, KY 41224

Employee Rainbo

Location: Flat Hollow, Last house

Flat Hollow

Type of Work: Complaints

Material Used:

Customer Line Inspection

Comments: no water

tightened fittings

Current System Information:

New Information:

Meter # 1: 95748912

Meter # 1:

Meter # 2: Radio 95748912

Meter # 2: Radio

MXU #:

MXU #:

Current Reading 2/20/2016 952

Current Reading 0

Type of Meter: Badger

Type of Meter:

Year MFG: 1995

Year MFG:

GPS - Longitude

GPS - Latitude

Employee Signature(s):

RS

Date Completed

3/14/16

Martin County Water District

387 East Main St., Suite 140
Inez, KY 41224



WORK ORDER

WO # 160200226

Time Started _____

Work Complete

Loc # _____

Master Meter # _____

Date 2/23/2016

Account # _____

SEQ # 347

Name: Marcia Mills

Phone # (6

Address: PO Box 7

Employee Troy Horn

Inez, KY 41224

Location: Tug River Rd, Traylor past Holbert Mills house on left

Done

Type of Work: Complaints

Material Used: _____

Customer Line Inspection: Checked Drain not crushed, Cleared up ditch

Comments: MCWD unloaded equipment and crushed drain pipe; needs repaired and gravel needs put down
Rainbow called to get gravel delivered for him.

Current System Information:		New Information:	
Meter # 1:	<u>70616407</u>	Meter # 1:	_____
Meter # 2: Radio	<u>70616407</u>	Meter # 2: Radio	_____
MXU #:	<u>13153136</u>	MXU #:	_____
Current Reading	<u>1/20/2016 262</u>	Current Reading	<u>0</u>
Type of Meter:	_____	Type of Meter:	_____
Year MFG:	_____	Year MFG:	_____
GPS - Longitude	_____	GPS - Latitude	_____

Employee Signature(s): JB / JR

Date Completed 3/11/16

Martin County Water District

387 East Main St., Suite 140
Inez, KY 41224

WORK ORDER

WO # 160300156

Time Started

Work Complete

Loc #

Master Meter #

Date 3/16/2016

Account #

SEQ # 130

Name: Kenneth Aldrich

Phone #

Address: Collins Crk
Warfield, KY 41267

Employee Justin Scott

Location: Yellow Crk Rd. White trailer on the left.

Yellow Crk Rd

Type of Work: Complaints

Material Used:

Customer Line Inspection

Comments: water stinks

Flushed lines all the way up Blankenship Rd

Current System Information:

New Information:

Meter # 1: 47823868

Meter # 1:

Meter # 2: Radio 47823868

Meter # 2: Radio

MXU #:

MXU #:

Current Reading 2/20/2016 486

Current Reading 0

Type of Meter: Sensus

Type of Meter:

Year MFG: 1993

Year MFG:

GPS - Longitude 0

GPS - Latitude 0

Employee Signature(s): *JSC*

Date Completed *3-17-16*

Martin County Water District

387 East Main St., Suite 140
Inez, KY 41224



WORK ORDER

WO # 160200254

Time Started _____

Work Complete _____

Loc # _____

Master Meter # _____

Date 2/24/2016

Account # _____

SEQ # 510

Name: SHONNIE PAULEY

Phone # _____

Address: P.O.BOX

Employee Rainbo

Pilgrim, KY 41250

Location: Little Rockcastle Rd just as you start up 2032 hill, turn right at Jude's feed store, house up on the hill

Type of Work: Complaints

Material Used: _____

Customer Line Inspection: _____

Comments: Low Pressure

Current System Information:		New Information:	
Meter # 1:	<u>29934956</u>	Meter # 1:	_____
Meter # 2:	<u>Radio</u>	Meter # 2:	<u>Radio</u>
MXU #:	_____	MXU #:	_____
Current Reading	<u>1/20/2016 404</u>	Current Reading	<u>0</u>
Type of Meter:	<u>Badger</u>	Type of Meter:	_____
Year MFG:	<u>2004</u>	Year MFG:	_____
GPS - Longitude	<u>0</u>	GPS - Latitude	<u>0</u>

Employee Signature(s): _____

Date Completed _____

Martin County Water District

387 East Main St., Suite 140
Inez, KY 41224

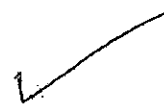

WORK ORDER

WO # 160200217

Time Started _____

Work Complete _____

Loc # _____

Master Meter # _____

Date 2/22/2016

Account # _____

SEQ # 4

Name: BECKY GRIFFITH

Phone # (60)

Address: PO BOX

Employee Justin Scott

INEZ, KY 41224

Location: E Main St, across from Pizza Stop

Type of Work: Complaints

Material Used: _____

Customer Line Inspection: _____

(DAM)
about 80 PSI at box

Comments: low pressure; check pressure at the box

Current System Information:		New Information:	
Meter # 1:	<u>19667728</u>	Meter # 1:	_____
Meter # 2: Radio	_____	Meter # 2: Radio	_____
MXU #:	_____	MXU #:	_____
Current Reading	<u>1/20/2016 434</u>	Current Reading	<u>0</u>
Type of Meter:	<u>Badger</u>	Type of Meter:	_____
Year MFG:	<u>2003</u>	Year MFG:	_____
GPS - Longitude	<u>0</u>	GPS - Latitude	<u>0</u>

Employee Signature(s): JJ

Date Completed 3-7-16

Martin County Water District

387 East Main St., Suite 140
Inez, KY 41224

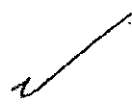

WORK ORDER

WO # 160300030

Time Started _____

Work Complete ✓

Loc # _____

Master Meter # _____

Date 3/3/2016

Account # _____

SEQ # 128

Name: Vina Sue PREECE

Phone # _____

Address: Blacklog Rd
INEZ, KY 41224

Employee Rainbo

Location: Preece Hill on Blacklog; Tri-level house.3rd driveway.

ROUTE 40 EAST

Done

Type of Work: Complaints

Material Used: 1ea - 3/4 Coupler, 3ea - 3/4 insert, 8ft - 3/4 Line

Customer Line Inspection: _____

Comments: now water

Current System Information:		New Information:	
Meter # 1:	<u>29935412</u>	Meter # 1:	_____
Meter # 2: Radio	_____	Meter # 2: Radio	_____
MXU #:	_____	MXU #:	_____
Current Reading	<u>2/20/2016 450</u>	Current Reading	<u>0</u>
Type of Meter:	<u>Badger</u>	Type of Meter:	_____
Year MFG:	<u>2004</u>	Year MFG:	_____
GPS - Longitude	<u>0</u>	GPS - Latitude	<u>0</u>

Employee Signature(s): *AS / JS*

Date Completed 3/7/16

Martin County Water District

387 East Main St., Suite 140
Inez, KY 41224



WORK ORDER

WO # 160200266

Time Started

Work Complete

Loc #

Master Meter #

Date 2/26/2016

Account #

SEQ # 11

Name: Denzil Marcum

Phone #

Address: PO Box
Lovely, KY 41231

Employee Rainbo

Location: Virginia St, 2nd on right, beige house w/maroon shutters

GASOLINE ALLEY

Type of Work: Complaints

Done

Material Used:

Customer Line Inspection

Comments: has low pressure

*talked to customer and had good pressure
just want to see if he had a leak*

Current System Information:

New Information:

Meter # 1: 98604661

Meter # 1:

Meter # 2: Radio

Meter # 2: Radio

MXU #:

MXU #:

Current Reading 2/20/2016 486

Current Reading 0

Type of Meter: Badger

Type of Meter:

Year MFG: 1998

Year MFG:

GPS - Longitude 0

GPS - Latitude 0

Employee Signature(s): *RS*

Date Completed

3-8-16

Martin County Water District

367 East Main St., Suite 140
Inez, KY 41224

WORK ORDER

WO # 160400211

Time Started

Work Complete

Loc #

Master Meter #

Date 4/22/2016

Account #

SEQ # 223

Name: Miranda McCoy

Phone # (

Address: P.O. Box

Employee Rainbo

Beauty, KY 41203

Location: Big Elk Rd. Across from Water Tower, grey trailer

Big Elk Rd

Type of Work: Complaints

Material Used:

Customer Line Inspection

65 lbs PSI @ box

Comments: no water

Current System Information:

Meter # 1: 29935189

Meter # 2: Radio 29935189

MXU #:

Current Reading 4/20/2016 426

Type of Meter: Badger

Year MFG: 2004

GPS - Longitude

New Information:

Meter # 1:

Meter # 2: Radio

MXU #:

Current Reading 0

Type of Meter:

Year MFG:

GPS - Latitude

Employee Signature(s): RS

Date Completed 4/22/16

Martin County Water District

387 East Main St., Suite 140
Inez, KY 41224



WORK ORDER

WO # 160400195

Time Started

Work Complete

Loc #

Master Meter #

Date 4/20/2016

Account #

SEQ # 496

Name: Charlene Daniels

Phone # ()

Address: Wooten Rd

Employee Justin Scott

Tomahawk, KY 41262

Location: Wooten, 7th double wide on left, grey w/blue shutters. Wooten Rd

Tomahawk

Type of Work: Complaints

Had 90# at box I told her

Material Used:

it probably was the P.R.V stop up.

Customer Line Inspection:

Comments: LOW WATER PRESSURE

Done

Current System Information:

New Information:

Meter # 1: 17762829

Meter # 1:

Meter # 2: Radio

Meter # 2: Radio

MXU #:

MXU #:

Current Reading 3/20/2016 442

Current Reading 0

Type of Meter: Badger

Type of Meter:

Year MFG: 2002

Year MFG:

GPS - Longitude

GPS - Latitude

Employee Signature(s): *RJ*

Date Completed *4-21-16*

Martin County Water District

387 East Main St., Suite 140
Inez, KY 41224

WORK ORDER

WO # 160400121

Time Started

Work Complete

Loc #

Master Meter #

Date 4/11/2016

Account #

SEQ # 253

Name: Rowdy Kinser

Phone #

Address: PO Box
Lovely, KY 41231

Employee John Mills

Location: 2, Riverfront Rd, 3rd blacktop drive on right past Riverfront Store

RIVERFRONT

Type of Work: Complaints

Done 1 1/2" shut off 1-3/4" tee 3-3/4" nipple

Material Used:

Put in a Pressure Chart

1-3/4" union on

Customer Line Inspection:

*Install a Chart for 7 days
to check water pressure & flow
of water*

Comments: low pressure

Showing 100 PSI

Current System Information:

New Information:

Meter # 1: 70750157

Meter # 1:

Meter # 2: Radio

Meter # 2: Radio

MXU #:

MXU #:

Current Reading 3/20/2016 242

Current Reading 0

Type of Meter: Sensus

Type of Meter:

Year MFG: 2009

Year MFG:

GPS - Longitude

GPS - Latitude

Employee Signature(s): *J.S., T.R., C.S., R.J.*

Date Completed *4-11-16*

Martin County Water District

387 East Main St., Suite 140
Inez, KY 41224

WORK ORDER

WO # 160300242

Time Started

Work Complete

Loc #

Master Meter #

Date 3/28/2016

Account #

SEQ # 233

Name: Lydia Perry

Phone # (603) 233-2333

Address: PO Box 1

Employee Justin Scott

INEZ, KY 41224

Location: Little Lick. Right fork of Little Lick Rd. Last house on hill. Brown.

Little Lick

Type of Work: Complaints

Material Used:

Customer Line Inspection: Shut off needs to be closed

Comments: hissing noise and water is coming from box even though meter has been pulled; land owner reported

Current System Information:

New Information:

Meter # 1:

Meter # 1:

Meter # 2: Radio

Meter # 2: Radio

MXU #:

MXU #:

Current Reading 0

Current Reading 0

Type of Meter:

Type of Meter:

Year MFG:

Year MFG:

GPS - Longitude

GPS - Latitude

Employee Signature(s): JS

Date Completed 4-1-16

Martin County Water District

387 East Main St., Suite 140
Inez, KY 41224

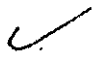

WORK ORDER

WO # 160300208

Time Started

Work Complete Yes

Loc #

Master Meter #

Date 3/24/2016

Account #

SEQ # 185

Name: Gracie Reed

Phone #

Address: PO Box
Beauty, KY 41203

Employee Rainbo

Location: Cliffside Dr, Moore's Trailer Prk, Last trailer on the right on the bank, brown

3 Cliffside Dr

Type of Work: Complaints

Material Used:

Customer Line Inspection: pump is on

Comments: 626-6846 no water pressure

*Pump was running
Still has same issue*
COPY

Current System Information:

New Information:

Meter # 1: 16721209

Meter # 1:

Meter # 2: Radio 16721209

Meter # 2: Radio

MXU #:

MXU #:

Current Reading 2/20/2016 761

Current Reading 0

Type of Meter: Badger

Type of Meter:

Year MFG: 2000

Year MFG:

GPS - Longitude 0

GPS - Latitude 0

Employee Signature(s):

Date Completed

Martin County Water District

387 East Main St., Suite 140
Inez, KY 41224

WORK ORDER

WO # 160300208

COPY

Time Started

Work Complete Yes

Loc #

Master Meter #

Date 3/24/2016

Account #

SEQ # 186

Name: Gracie Reed

Phone #

Address: PO Box
Beauty, KY 41203

Employee Rainbo

Location: Cliffside Dr, Moore's Trailer Prk, Last trailer on the right on the bank, brown

Cliffside Dr

Type of Work: Complaints

Done

Material Used: *Put gauge on it on it show a 100 ps'*

Customer Line Inspection: *pump is on that was on use not Hermit*

Comments: 626-6846 no water pressure *the pump was not running*

Current System Information:

New Information:

Meter # 1: 16721209

Meter # 1:

Meter # 2: Radio 16721209

Meter # 2: Radio

MXU #:

MXU #:

Current Reading 2/20/2016 761

Current Reading 0

Type of Meter: Badger

Type of Meter:

Year MFG: 2000

Year MFG:

GPS - Longitude 0

GPS - Latitude 0

Employee Signature(s): *RJ*

Date Completed *4/12*

Exhibit #11
Telemetry Pressure Charts

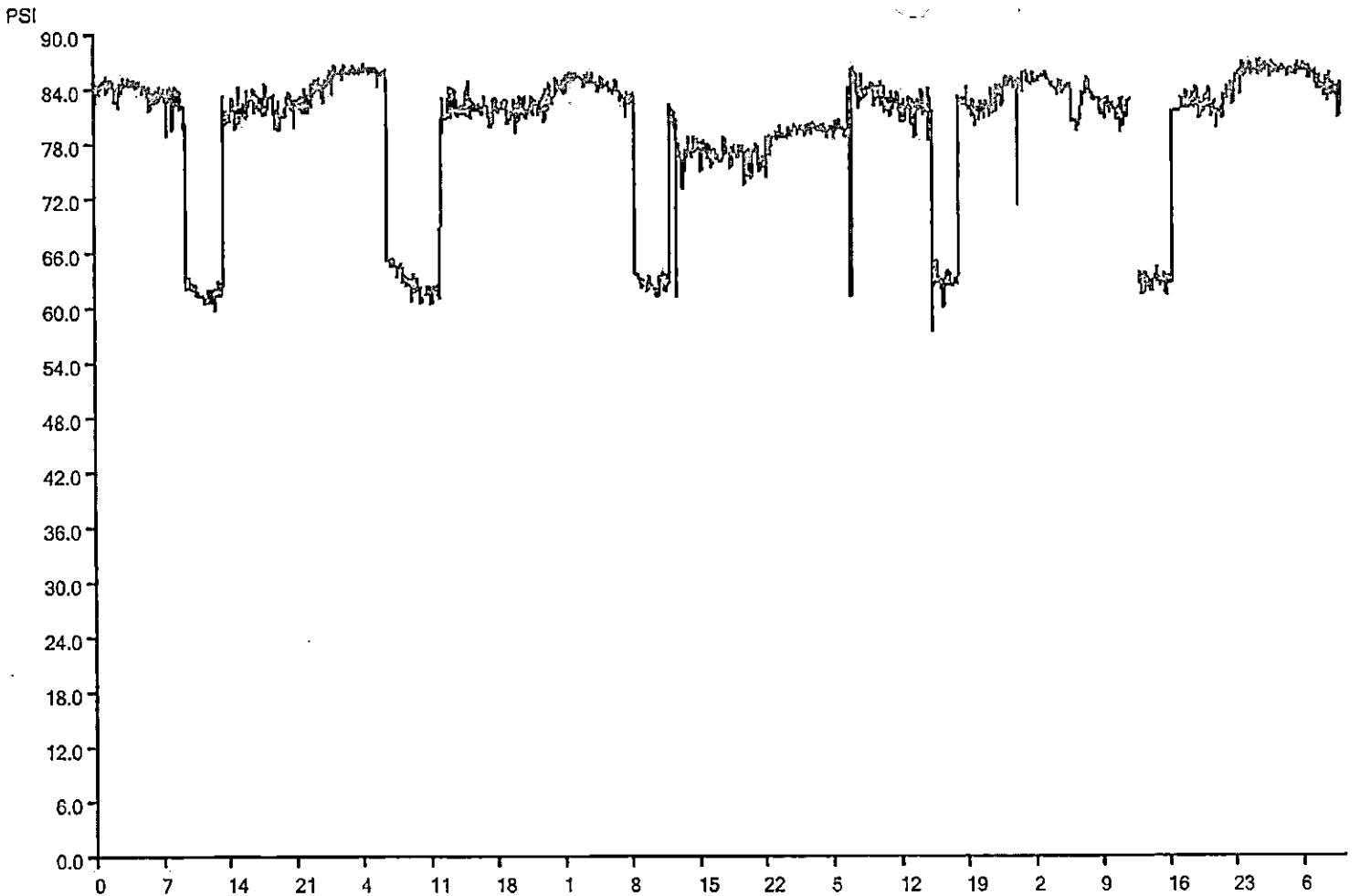

Month: July | Day: 18 | Year: 2015 | Type: 7 Day

Item	Value	Unit	Item	Value	Unit	Item	Value	Unit
<input checked="" type="checkbox"/>	PZA-Big Elk	Suction Pressure	<input checked="" type="checkbox"/>			<input checked="" type="checkbox"/>		
<input checked="" type="checkbox"/>			<input checked="" type="checkbox"/>			<input checked="" type="checkbox"/>		
<input checked="" type="checkbox"/>			<input checked="" type="checkbox"/>			<input checked="" type="checkbox"/>		
<input type="checkbox"/>			<input type="checkbox"/>			<input type="checkbox"/>		

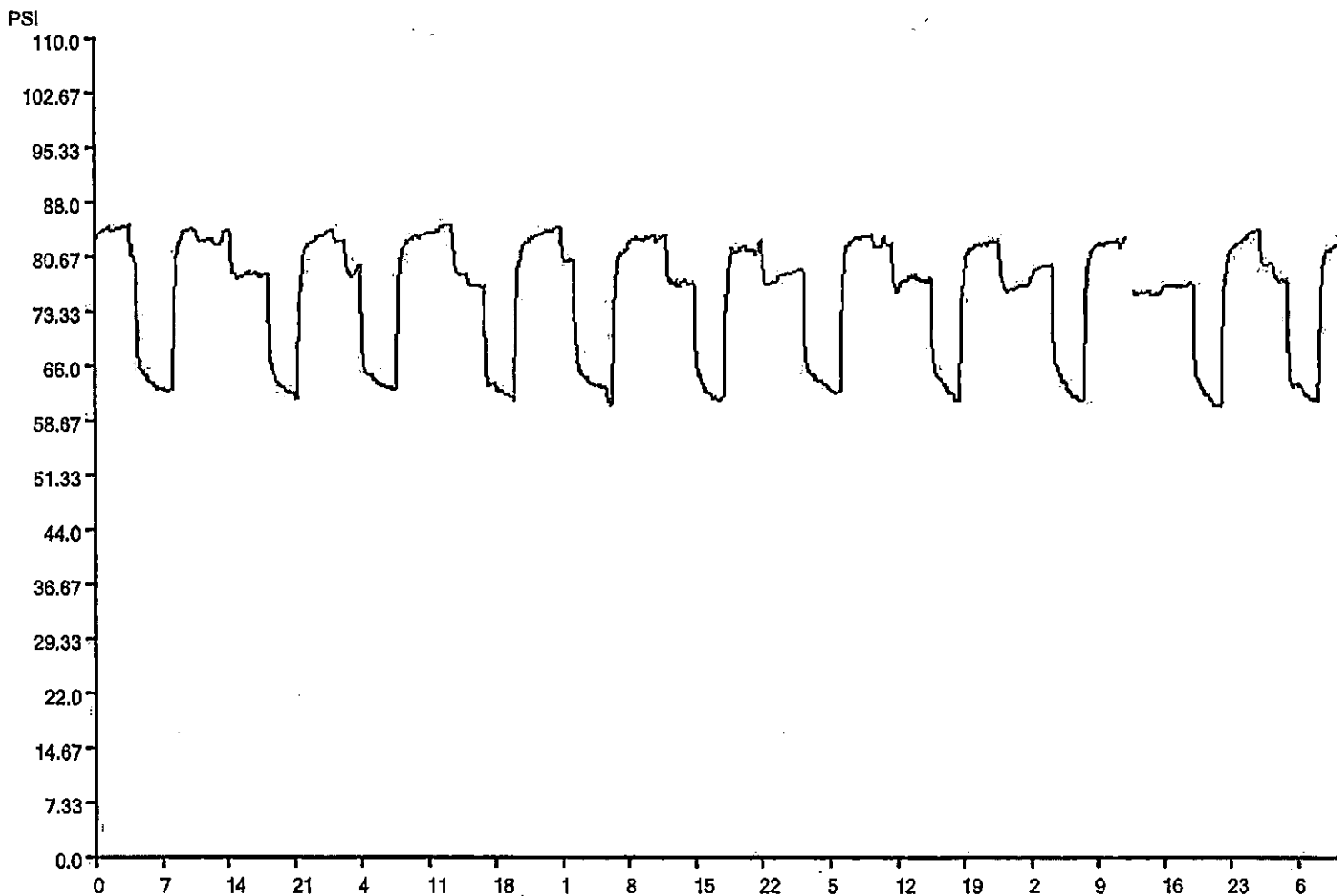

Month	Day	Year	Type
July	18	2015	7 Day
BBB-0107-Staw	Suction Pressure		

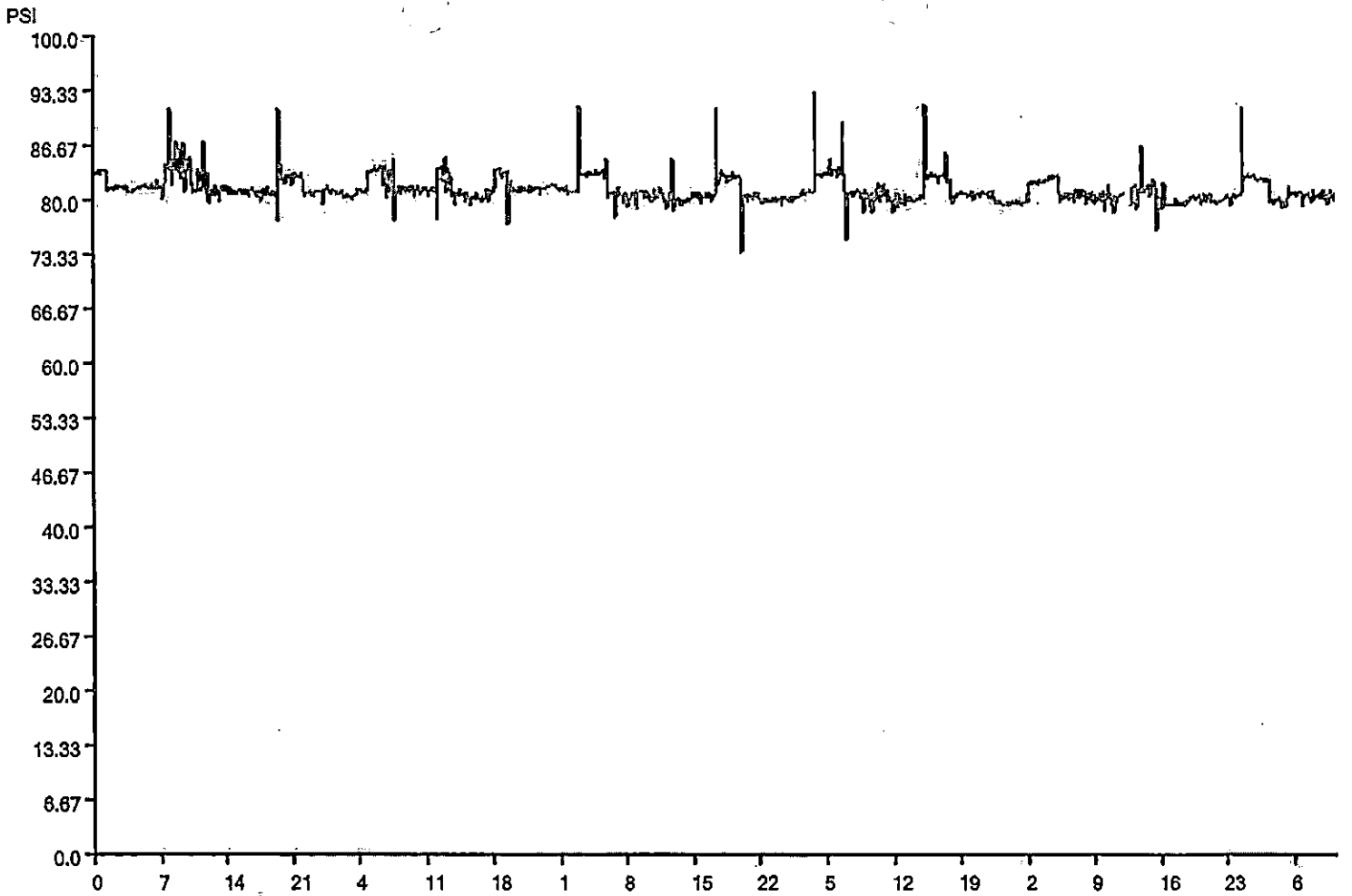

Month: Day: Year: Type:

<input checked="" type="checkbox"/>	<input type="text" value="REAR AIRFLOW PSI"/>	<input type="text" value="Suction Pressure"/>	<input checked="" type="checkbox"/>	<input type="text" value=""/>	<input type="text" value=""/>	<input checked="" type="checkbox"/>	<input type="text" value=""/>	<input type="text" value=""/>
<input checked="" type="checkbox"/>	<input type="text" value=""/>	<input type="text" value=""/>	<input checked="" type="checkbox"/>	<input type="text" value=""/>	<input type="text" value=""/>	<input checked="" type="checkbox"/>	<input type="text" value=""/>	<input type="text" value=""/>
<input checked="" type="checkbox"/>	<input type="text" value=""/>	<input type="text" value=""/>	<input checked="" type="checkbox"/>	<input type="text" value=""/>	<input type="text" value=""/>	<input checked="" type="checkbox"/>	<input type="text" value=""/>	<input type="text" value=""/>
<input checked="" type="checkbox"/>	<input type="text" value=""/>	<input type="text" value=""/>	<input checked="" type="checkbox"/>	<input type="text" value=""/>	<input type="text" value=""/>	<input checked="" type="checkbox"/>	<input type="text" value=""/>	<input type="text" value=""/>

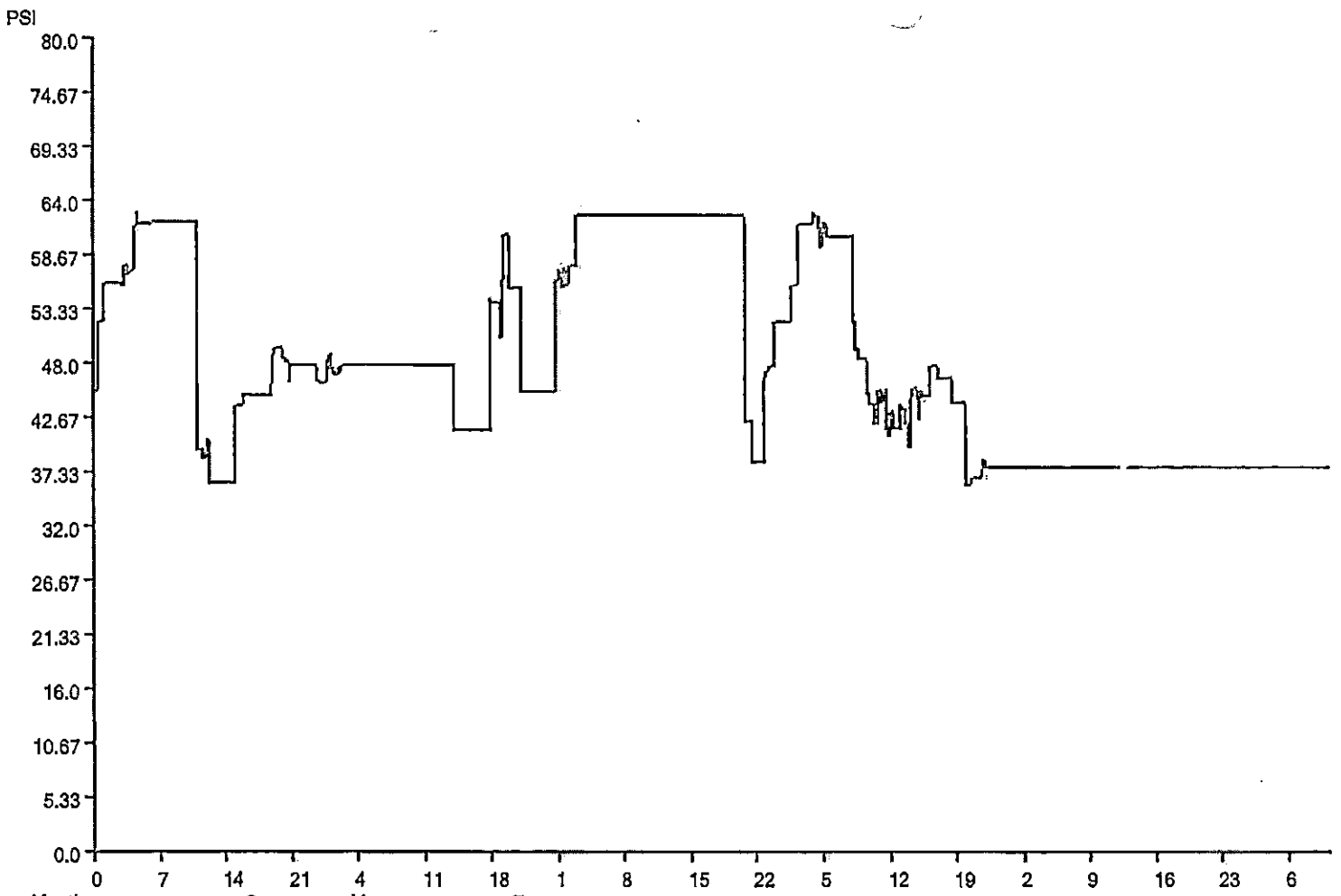

Month: July | Day: 18 | Year: 2015 | Type: 7 Day

<input checked="" type="checkbox"/>	PRIME MOTOR	Suction Pressure	<input checked="" type="checkbox"/>		<input checked="" type="checkbox"/>	
<input checked="" type="checkbox"/>			<input checked="" type="checkbox"/>		<input checked="" type="checkbox"/>	
<input checked="" type="checkbox"/>			<input checked="" type="checkbox"/>		<input checked="" type="checkbox"/>	
<input checked="" type="checkbox"/>			<input checked="" type="checkbox"/>		<input checked="" type="checkbox"/>	

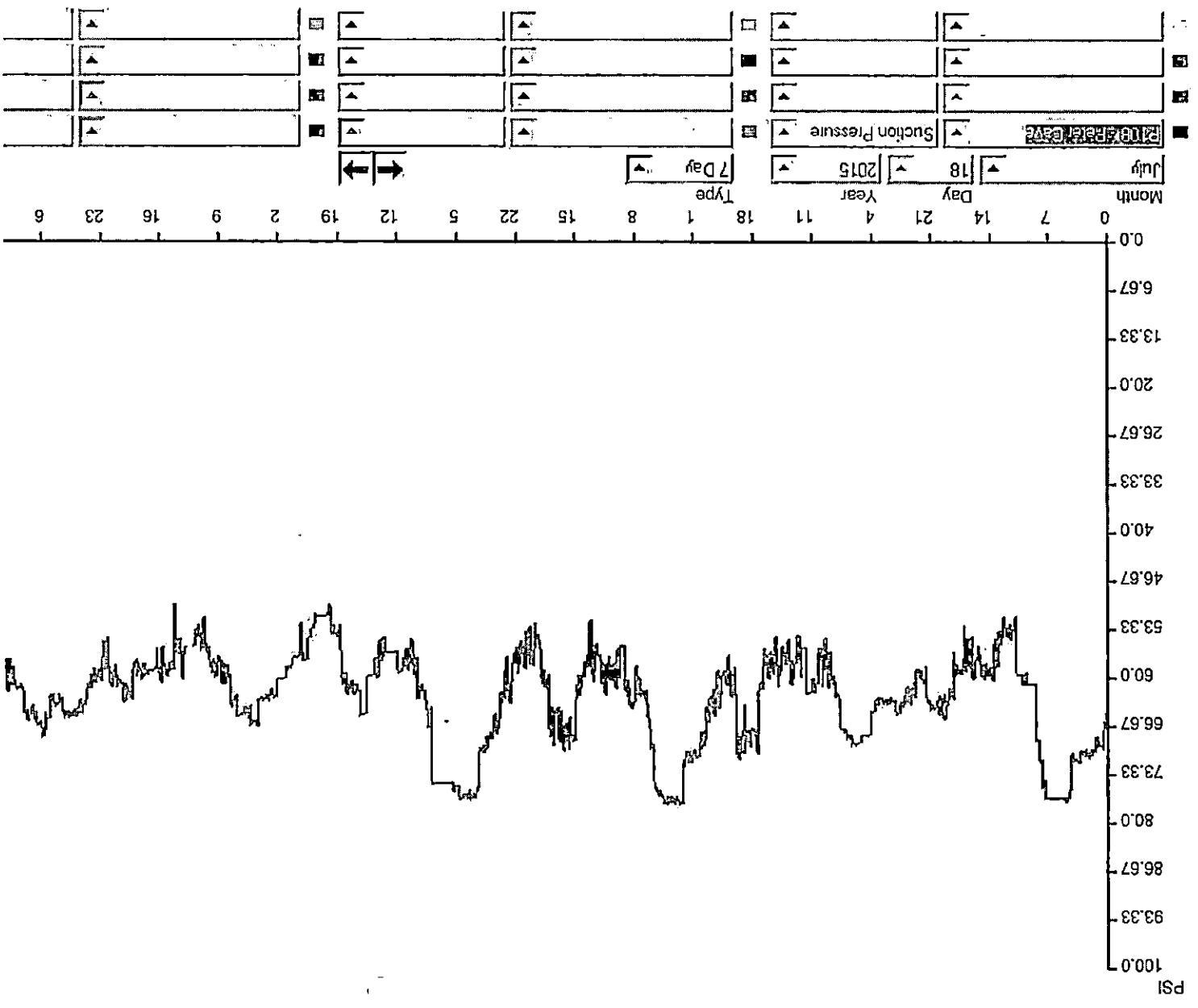

Exhibit #12
Public Notification

Notice by Martin County Water District - System ID#: KY0800273
Your water system recently violated a drinking water standard. Although this incident was not an emergency, as our customers, you have a right to know what happened and what we did (are doing) to correct this situation.

We routinely monitor for the presence of drinking water contaminants. Testing results from 1/1/2013 through 3/31/2013 show that our system exceeds the standard, or maximum contaminant level (MCL), for trihalomethanes (THM) and haloacetic acids (HAA). The standard for THM is 0.080 mg/L and the standard for HAA is 0.060 mg/L. These are determined by averaging all samples collected by our system for the last 12 months. The level of THM averaged our system for 1/1/2013 to 3/31/2013 was 0.083 mg/L and HAA was 0.088 mg/L.

- There is nothing you need to do. You do not need to boil your water or take other corrective actions. If a situation arises where the water is no longer safe to drink, you will be notified within 24 hours.
- If you have a severely compromised immune system, have an infant, are pregnant, or are elderly, you may be at increased risk and should seek advice from your health care providers about drinking this water.

Some people who drink water containing trihalomethanes in excess of the MCL over many years may experience problems with their liver, kidneys, or central nervous system, and may have an increased risk of getting cancer. Some people who drink water containing haloacetic acids in excess of the MCL over many years may have an increased risk of getting cancer.

This is not an emergency. If it had been an emergency, you would have been notified within 24 hours.

We are working to minimize the formation of trihalomethanes and haloacetic acids while ensuring we maintain an adequate level of disinfectant. We have taken additional steps to change disinfectant types/levels, remove natural organic matter, and increased flushing of water lines to determine if our efforts have been effective. We are also monitoring water storage tank levels and water flow patterns within the distribution system. We anticipate resolving the problem within the next quarter.

For more information, please contact John Mills at (606) 298-3885 or 397 E Main St. Suite 140, Inez, KY 41224

Please share this information with all the other people who drink this water, especially those who may not have received this notice directly (for example, people in apartments, nursing homes, schools, and businesses). You can do this by posting this notice in a public place or distributing copies by hand or mail.

In 2012, Martin County Water District detected 13 contaminants in the drinking water and none of them were above the EPA accepted level for drinking water. Please go to www.krwa.org/2012ccr/martincounty.pdf to view your 2012 annual water quality report and learn more about your drinking water. This report contains important information about the source and quality of your drinking water. To speak with someone about the report, please call (606) 298-3885. If you would like a paper copy of the 2012 Annual Water Quality Report mailed to your home please check the paper copy box and mail back with your payment or call (606) 298-3885, Mail a copy

Notice by Martin County Water District - System ID#: KY0800273

Your water system recently violated a drinking water standard. Although this incident was not an emergency, as our customers, you have a right to know what happened and what we did (are doing) to correct this situation.

We routinely monitor for the presence of drinking water contaminants. Testing results from 1/1/2013 through 3/31/2013 show that our system exceeds the standard, or maximum contaminant level (MCL), for trihalomethanes (THM) and haloacetic acids (HAA). The standard for THM is 0.080 mg/L and the standard for HAA is 0.060 mg/L. These are determined by averaging all samples collected by our system for the last 12 months. The level of THM averaged our system for 1/1/2013 to 3/31/2013 was 0.083 mg/L and HAA was 0.088 mg/L.

- There is nothing you need to do. You do not need to boil your water or take other corrective actions. If a situation arises where the water is no longer safe to drink, you will be notified within 24 hours.
- If you have a severely compromised immune system, have an infant, are pregnant, or are elderly, you may be at increased risk and should seek advice from your health care providers about drinking this water.

Some people who drink water containing trihalomethanes in excess of the MCL over many years may experience problems with their liver, kidneys, or central nervous system, and may have an increased risk of getting cancer. Some people who drink water containing haloacetic acids in excess of the MCL over many years may have an increased risk of getting cancer.

This is not an emergency. If it had been an emergency, you would have been notified within 24 hours.

We are working to minimize the formation of trihalomethanes and haloacetic acids while ensuring we maintain an adequate level of disinfectant. We have taken additional steps to change disinfectant types/levels, remove natural organic matter, and increased flushing of water lines to determine if our efforts have been effective. We are also monitoring water storage tank levels and water flow patterns within the distribution system. We anticipate resolving the problem within the next quarter.

For more information, please contact John Mills at (606) 298-3885 or 397 E Main St. Suite 140, Inez, KY 41224

Please share this information with all the other people who drink this water, especially those who may not have received this notice directly (for example, people in apartments, nursing homes, schools, and businesses). You can do this by posting this notice in a public place or distributing copies by hand or mail.

In 2012, Martin County Water District detected 13 contaminants in the drinking water and none of them were above the EPA accepted level for drinking water. Please go to www.krwa.org/2012ccr/martincounty.pdf to view your 2012 annual water quality report and learn more about your drinking water. This report contains important information about the source and quality of your drinking water. To speak with someone about the report, please call (606) 298-3885. If you would like a paper copy of the 2012 Annual Water Quality Report mailed to your home please check the paper copy box and mail back with your payment or call (606) 298-7439, Mail a copy

THM & HAA Stage 1
DBPR Template 2-18

Insert water system name and ID# in header. Insert compliance period begin date, end date, and average level. Remove brackets.

Do not modify mandatory language!

Replace explanation language with your own to explain what happened, what is being done and date that compliance is anticipated

Insert contact information.

No text below this point.

Copy and paste notice. Prior to paste make sure that the cursor is at the highest point in the text box.

No text below this point.

Notice by Martin County Water District – System ID#: KY0800273

Our water system recently violated a drinking water standard. Although this incident was not an emergency, as our customers, you have a right to know what happened and what we did (are doing) to correct this situation.

We are required to monitor your drinking water for specific contaminants on a regular basis. Results of regular monitoring are an indicator of whether or not our drinking water meets health standards. During 2/1/2013 – 2/28/2013, we did not complete all monitoring or testing for chlorine and turbidity, and therefore cannot be sure of the quality of your drinking water during that time.

There is nothing you need to do at this time. You may continue to drink the water. If a situation arises where the water is no longer safe to drink, you will be notified within 24 hours.

By the 10th of each month we must submit a Monthly Operation Report (MOR) to the Division of Water. The MOR for February 2013 did not arrive by the required deadline and this caused three violations. One violation for not submitting the MOR by the required deadline, another for not submitting daily chlorine results, and another for failing to submit the daily turbidity readings. (The chlorine results and turbidity readings are contained within the MOR.) We have modified our procedures to assure that the MOR arrives by the required deadline.

For more information, please contact John Mills at (606) 298-3885 or 387 E Main St. Suite 140, Inez, KY 41224

Please share this information with all the other people who drink this water, especially those who may not have received this notice directly (for example, people in apartments, nursing homes, schools, and businesses). You can do this by posting this notice in a public place or distributing copies by hand or mail.

Notice by Martin County District – System ID#: KY0800273

Our water system recently violated a drinking water standard. Although this incident was not an emergency, as our customers, you have a right to know what happened and what we did (are doing) to correct this situation.

Template 3-2 Monitoring

We are required to monitor your drinking water for specific contaminants on a regular basis. Results of regular monitoring are an indicator of whether or not our drinking water meets health standards. During 2/1/2013 – 2/28/2013, we did not complete all monitoring or testing for chlorine and turbidity, and therefore cannot be sure of the quality of your drinking water during that time.

There is nothing you need to do at this time. You may continue to drink the water. If a situation arises where the water is no longer safe to drink, you will be notified within 24 hours.

Do not modify mandatory language!

By the 10th of each month we must submit a Monthly Operation Report (MOR) to the Division of Water. The MOR for February 2013 did not arrive by the required deadline and this caused three violations. One violation for not submitting the MOR by the required deadline, another for not submitting daily chlorine results, and another for failing to submit the daily turbidity readings. (The chlorine results and turbidity readings are contained within the MOR.) We have modified our procedures to assure that the MOR arrives by the required deadline.

For more information, please contact John Mills at (606) 298-3885 or 387 E Main St. Suite 140, Inez, KY 41224

Please share this information with all the other people who drink this water, especially those who may not have received this notice directly (for example, people in apartments, nursing homes, schools, and businesses). You can do this by posting this notice in a public place or distributing copies by hand or mail.

No text below this point.

Notice by Martin County Water District – System ID#: KY0800273

Our water system recently violated a drinking water standard. Although this incident was not an emergency, as our customers, you have a right to know what happened and what we did (are doing) to correct this situation.

Copy and paste notice. Prior to paste make sure that the cursor is at the highest point in the text box.

We are required to monitor your drinking water for specific contaminants on a regular basis. Results of regular monitoring are an indicator of whether or not our drinking water meets health standards. During 2/1/2013 – 2/28/2013, we did not complete all monitoring or testing for chlorine and turbidity, and therefore cannot be sure of the quality of your drinking water during that time.

There is nothing you need to do at this time. You may continue to drink the water. If a situation arises where the water is no longer safe to drink, you will be notified within 24 hours.

By the 10th of each month we must submit a Monthly Operation Report (MOR) to the Division of Water. The MOR for February 2013 did not arrive by the required deadline and this caused three violations. One violation for not submitting the MOR by the required deadline, another for not submitting daily chlorine results, and another for failing to submit the daily turbidity readings. (The chlorine results and turbidity readings are contained within the MOR.) We have modified our procedures to assure that the MOR arrives by the required deadline.

For more information, please contact John Mills at (606) 298-3885 or 387 E Main St. Suite 140, Inez, KY 41224

Please share this information with all the other people who drink this water, especially those who may not have received this notice directly (for example, people in apartments, nursing homes, schools, and businesses). You can do this by posting this notice in a public place or distributing copies by hand or mail.

No text below this point.

Notice by Martin County Water District – System ID#: KY0800273

Template 2-6 Turbidity

Our water system recently violated a drinking water requirement. Although this was not an emergency, as our customers, you have a right to know what happened, what you should do, and what we did (are doing) to correct this situation. We routinely monitor your water for turbidity (cloudiness). This tells us whether we are effectively filtering the water supply. Water samples for January 2014 showed that 5.4 percent of turbidity measurements were over 0.3 turbidity units – the standard is that no more than 5 percent of samples may exceed 0.3 turbidity units per month. The turbidity levels are relatively low. However, their persistence is a concern. Normal turbidity levels at our plant are 0.1 units. This is not an emergency. If it had been, you would have been notified within 24 hours.

- There is nothing you need to do. You do not need to boil your water or take other actions. We do not know of any contamination, and none of our testing has shown disease-causing organisms in the drinking water.
- If you have a severely compromised immune system, have an infant, are pregnant, or are elderly, you may be at increased risk and should seek advice from your health care providers about drinking this water. General guidelines on ways to lessen the risk of infection by microbes are available from EPA's Safe Drinking Water Hotline at 1-800-426-4791.

Turbidity has no health effects. However, turbidity can interfere with disinfection and provide a medium for microbial growth. Turbidity may indicate the presence of disease causing organisms. These organisms include bacteria, viruses, and parasites which can cause symptoms such as nausea, cramps, diarrhea, and associated headaches. These symptoms are not caused only by organisms in drinking water. If you experience any of these symptoms and they persist, you may want to seek medical advice.

We made repairs to our equipment. We inspected and cleaned the filters. The problem is resolved. For more information, please contact John Mills at (606) 298-3885 or 387 E Main St. Suite 140, Inez, KY 41224.

Please share this information with all the other people who drink this water, especially those who may not have received this notice directly (for example, people in apartments, nursing homes, schools, and businesses). You can do this by posting this notice in a public place or distributing copies by hand or mail.

Do not modify mandatory language!

No text below this point.

Notice by Martin County Water District – System ID#: KY0800273

Our water system recently violated a drinking water requirement. Although this was not an emergency, as our customers, you have a right to know what happened, what you should do, and what we did (are doing) to correct this situation. We routinely monitor your water for turbidity (cloudiness). This tells us whether we are effectively filtering the water supply. Water samples for January 2014 showed that 5.4 percent of turbidity measurements were over 0.3 turbidity units – the standard is that no more than 5 percent of samples may exceed 0.3 turbidity units per month. The turbidity levels are relatively low. However, their persistence is a concern. Normal turbidity levels at our plant are 0.1 units. This is not an emergency. If it had been, you would have been notified within 24 hours.

- There is nothing you need to do. You do not need to boil your water or take other actions. We do not know of any contamination, and none of our testing has shown disease-causing organisms in the drinking water.
- If you have a severely compromised immune system, have an infant, are pregnant, or are elderly, you may be at increased risk and should seek advice from your health care providers about drinking this water. General guidelines on ways to lessen the risk of infection by microbes are available from EPA's Safe Drinking Water Hotline at 1-800-426-4791.

Turbidity has no health effects. However, turbidity can interfere with disinfection and provide a medium for microbial growth. Turbidity may indicate the presence of disease causing organisms. These organisms include bacteria, viruses, and parasites which can cause symptoms such as nausea, cramps, diarrhea, and associated headaches. These symptoms are not caused only by organisms in drinking water. If you experience any of these symptoms and they persist, you may want to seek medical advice.

We made repairs to our equipment. We inspected and cleaned the filters. The problem is resolved. For more information, please contact John Mills at (606) 298-3885 or 387 E Main St. Suite 140, Inez, KY 41224.

Please share this information with all the other people who drink this water, especially those who may not have received this notice directly (for example, people in apartments, nursing homes, schools, and businesses). You can do this by posting this notice in a public place or distributing copies by hand or mail.

Copy and paste notice. Prior to paste make sure that the cursor is at the highest point in the text box.

No text below this point.

Notice by Martin County Water District – System ID#: KY0800273

Our water system recently violated a drinking water standard. Although this incident was not an emergency, as our customers, you have a right to know what happened and what we did (are doing) to correct this situation.

We routinely monitor for the presence of drinking water contaminants. Testing results from 7/1/2014 through 9/30/2014 show that our system exceeds the standard, or maximum contaminant level (MCL), for trihalomethanes (THM) and haloacetic acids (HAA). The standard for THM is 0.080 mg/L and the standard for HAA is 0.060 mg/L. These are determined by averaging all samples collected at each sampling location for the last 12 months. The level of THM averaged at one of our system's locations for 7/1/2014 to 9/30/2014 was 0.101 mg/L and HAA was 0.081 mg/L.

- There is nothing you need to do. You do not need to boil your water or take other corrective actions. If a situation arises where the water is no longer safe to drink, you will be notified within 24 hours.
- If you have a severely compromised immune system, have an infant, are pregnant, or are elderly, you may be at increased risk and should seek advice from your health care providers about drinking this water.

Some people who drink water containing trihalomethanes in excess of the MCL over many years may experience problems with their liver, kidneys, or central nervous system, and may have an increased risk of getting cancer. Some people who drink water containing haloacetic acids in excess of the MCL over many years may have an increased risk of getting cancer.

This is not an emergency. If it had been an emergency, you would have been notified within 24 hours.

We are working to minimize the formation of trihalomethanes and haloacetic acids while ensuring we maintain an adequate level of disinfectant. We have taken additional steps to change disinfectant levels, remove natural organic matter, and increased flushing of water lines to determine if our efforts have been effective. We are also monitoring water storage tank levels and water flow patterns within the distribution system. We anticipate resolving the problem within the next quarter but the compliance calculation is based upon annual averages and it may be several quarters before compliance is achieved.

For more information, please contact John Mills at 606-298-3885 or 387 E Main St. Suite 140, Inez, KY 41224.

Please share this information with all the other people who drink this water, especially those who may not have received this notice directly (for example, people in apartments, nursing homes, schools, and businesses). You can do this by posting this notice in a public place or distributing copies by hand or mail.

Notice by Martin County Water District - System ID#: KY0800273
Your water system recently violated a drinking water standard. Although this incident was not an emergency, as our customers, you have a right to know what happened and what we did (are doing) to correct this situation.

We routinely monitor for the presence of drinking water contaminants. Testing results from 7/1/2014 through 9/30/2014 show that our system exceeds the standard, or maximum contaminant level (MCL), for trihalomethanes (THM) and haloacetic acids (HAA). The standard for THM is 0.080 mg/L and the standard for HAA is 0.060 mg/L. These are determined by averaging all samples collected at each sampling location for the last 12 months. The level of THM averaged at one of our system's locations for 7/1/2014 to 9/30/2014 was 0.101 mg/L and HAA was 0.081 mg/L.

- There is nothing you need to do. You do not need to boil your water or take other corrective actions. If a situation arises where the water is no longer safe to drink, you will be notified within 24 hours.
- If you have a severely compromised immune system, have an infant, are pregnant, or are elderly, you may be at increased risk and should seek advice from your health care providers about drinking this water.

Some people who drink water containing trihalomethanes in excess of the MCL over many years may experience problems with their liver, kidneys, or central nervous system, and may have an increased risk of getting cancer. Some people who drink water containing haloacetic acids in excess of the MCL over any years may have an increased risk of getting cancer.

This is not an emergency. If it had been an emergency, you would have been notified within 24 hours.

We are working to minimize the formation of trihalomethanes and haloacetic acids while ensuring we maintain an adequate level of disinfectant. We have taken additional steps to change disinfectant levels, remove natural organic matter, and increased flushing of water lines to determine if our efforts have been effective. We are also monitoring water storage tank levels and water flow patterns within the distribution system. We anticipate resolving the problem within the next quarter but the compliance calculation is based upon annual averages and it may be several quarters before compliance is achieved.

For more information, please contact John Mills at 606-298-3885 or 387 E Main St. Suite 140, Inez, KY 41224.

Please share this information with all the other people who drink this water, especially those who may not have received this notice directly (for example, people in apartments, nursing homes, schools, and businesses). You can do this by posting this notice in a public place or distributing copies by hand or mail.

THM & HAA Stage 2
DBPR Template 2-19

Insert water system name and ID# in header. Insert compliance period begin date, end date, and average level. Remove brackets. Do not modify mandatory language!

Printing Instructions

This template is designed to print the notice on the back of the water bill sheets prior to printing the water bills using procedures the same as printing a letter.

After the notice has been printed to all sheets place the stack of sheets upside down on a flat surface and place a weight on the stack to remove the curl.

When the stack of sheets have cooled and straightened print the water bills as usual.

No text below this point.

Notice by Martin County Water District - System ID#: KY0800273
Your water system recently violated a drinking water standard. Although this incident was not an emergency, as our customers, you have a right to know what happened and what we did (are doing) to correct this situation.

We routinely monitor for the presence of drinking water contaminants. Testing results from 7/1/2014 through 9/30/2014 show that our system exceeds the standard, or maximum contaminant level (MCL), for trihalomethanes (THM) and haloacetic acids (HAA). The standard for THM is 0.080 mg/L and the standard for HAA is 0.060 mg/L. These are determined by averaging all samples collected at each sampling location for the last 12 months. The level of THM averaged at one of our system's locations for 7/1/2014 to 9/30/2014 was 0.101 mg/L and HAA was 0.081 mg/L.

- There is nothing you need to do. You do not need to boil your water or take other corrective actions. If a situation arises where the water is no longer safe to drink, you will be notified within 24 hours.
- If you have a severely compromised immune system, have an infant, are pregnant, or are elderly, you may be at increased risk and should seek advice from your health care providers about drinking this water.

Some people who drink water containing trihalomethanes in excess of the MCL over many years may experience problems with their liver, kidneys, or central nervous system, and may have an increased risk of getting cancer. Some people who drink water containing haloacetic acids in excess of the MCL over any years may have an increased risk of getting cancer.

This is not an emergency. If it had been an emergency, you would have been notified within 24 hours.

We are working to minimize the formation of trihalomethanes and haloacetic acids while ensuring we maintain an adequate level of disinfectant. We have taken additional steps to change disinfectant levels, remove natural organic matter, and increased flushing of water lines to determine if our efforts have been effective. We are also monitoring water storage tank levels and water flow patterns within the distribution system. We anticipate resolving the problem within the next quarter but the compliance calculation is based upon annual averages and it may be several quarters before compliance is achieved.

For more information, please contact John Mills at 606-298-3885 or 387 E Main St. Suite 140, Inez, KY 41224.

Please share this information with all the other people who drink this water, especially those who may not have received this notice directly (for example, people in apartments, nursing homes, schools, and businesses). You can do this by posting this notice in a public place or distributing copies by hand or mail.

Copy and paste notice. Prior to paste make sure that the cursor is at the highest point in the text box.

No text below this point.

Notice by Martin County Water District – System ID#: KY0800273

Our water system recently violated a drinking water standard. Although this incident was not an emergency, as our customers, you have a right to know what happened and what we did (are doing) to correct this situation.

We routinely monitor for the presence of drinking water contaminants. Testing results from 10/1/2014 through 12/31/2014 show that our system exceeds the standard, or maximum contaminant level (MCL), for trihalomethanes (THM) and haloacetic acids (HAA). The standard for THM is 0.080 mg/L and the standard for HAA is 0.060 mg/L. These are determined by averaging all samples collected at each sampling location for the last 12 months. The level of THM averaged at one of our system's locations for 10/1/2014 to 12/31/2014 was 0.096 mg/L and HAA was 0.105 mg/L.

- There is nothing you need to do. You do not need to boil your water or take other corrective actions. If a situation arises where the water is no longer safe to drink, you will be notified within 24 hours.
- If you have a severely compromised immune system, have an infant, are pregnant, or are elderly, you may be at increased risk and should seek advice from your health care providers about drinking this water.

Some people who drink water containing trihalomethanes in excess of the MCL over many years may experience problems with their liver, kidneys, or central nervous system, and may have an increased risk of getting cancer. Some people who drink water containing haloacetic acids in excess of the MCL over many years may have an increased risk of getting cancer.

This is not an emergency. If it had been an emergency, you would have been notified within 24 hours.

We are working to minimize the formation of trihalomethanes and haloacetic acids while ensuring we maintain an adequate level of disinfectant. We have taken additional steps to change disinfectant levels, remove natural organic matter, and increased flushing of water lines to determine if our efforts have been effective. We are also monitoring water storage tank levels and water flow patterns within the distribution system. We anticipate resolving the problem within the next quarter but the compliance calculation is based upon annual averages and it may be several quarters before compliance is achieved.

For more information, please contact John Mills at 606-298-3885 or 387 E Main St. Suite 140, Inez, KY 41224.

Please share this information with all the other people who drink this water, especially those who may not have received this notice directly (for example, people in apartments, nursing homes, schools, and businesses). You can do this by posting this notice in a public place or distributing copies by hand or mail.

Notice by Martin County Water District - System ID# KY0800273
Your water system recently violated a drinking water standard. Although this incident was not an emergency, as our customers, you have a right to know what happened and what we did (are doing) to correct this situation.

We routinely monitor for the presence of drinking water contaminants. Testing results from 10/1/2014 through 12/31/2014 show that our system exceeds the standard, or maximum contaminant level (MCL), for trihalomethanes (THM) and haloacetic acids (HAA). The standard for THM is 0.080 mg/L and the standard for HAA is 0.060 mg/L. These are determined by averaging all samples collected at each sampling location for the last 12 months. The level of THM averaged at one of our system's locations for 10/1/2014 to 12/31/2014 was 0.096 mg/L and HAA was 0.105 mg/L.

- There is nothing you need to do. You do not need to boil your water or take other corrective actions. If a situation arises where the water is no longer safe to drink, you will be notified within 24 hours.
- If you have a severely compromised immune system, have an infant, are pregnant, or are elderly, you may be at increased risk and should seek advice from your health care providers about drinking this water.

Some people who drink water containing trihalomethanes in excess of the MCL over many years may experience problems with their liver, kidneys, or central nervous system, and may have an increased risk of getting cancer. Some people who drink water containing haloacetic acids in excess of the MCL over many years may have an increased risk of getting cancer.

This is not an emergency. If it had been an emergency, you would have been notified within 24 hours. We are working to minimize the formation of trihalomethanes and haloacetic acids while ensuring we maintain an adequate level of disinfectant. We have taken additional steps to change disinfectant levels, remove natural organic matter, and increased flushing of water lines to determine if our efforts have been effective. We are also monitoring water storage tank levels and water flow patterns within the distribution system. We anticipate resolving the problem within the next quarter but the compliance calculation is based upon annual averages and it may be several quarters before compliance is achieved.

For more information, please contact John Mills at 606-298-3885 or 387 E Main St, Suite 140, Inez, KY 41224.

Please share this information with all the other people who drink this water, especially those who may not have received this notice directly (for example, people in apartments, nursing homes, schools, and businesses). You can do this by posting this notice in a public place or distributing copies by hand or mail.

THM & HAA Stage 2
DBPR Template 2-19

Insert water system name and ID# in header. Insert compliance period begin date, end date, and average level. Remove brackets. Do not modify mandatory language!

Printing Instructions

This template is designed to print the notice on the back of the water bill sheets prior to printing the water bills using procedures the same as printing a letter.

After the notice has been printed to all sheets place the stack of sheets upside down on a flat surface and place a weight on the stack to remove the curl.

When the stack of sheets have cooled and straightened print the water bills as usual.

No text below this point.

Notice by Martin County Water District - System ID# KY0800273
Your water system recently violated a drinking water standard. Although this incident was not an emergency, as our customers, you have a right to know what happened and what we did (are doing) to correct this situation.

We routinely monitor for the presence of drinking water contaminants. Testing results from 10/1/2014 through 12/31/2014 show that our system exceeds the standard, or maximum contaminant level (MCL), for trihalomethanes (THM) and haloacetic acids (HAA). The standard for THM is 0.080 mg/L and the standard for HAA is 0.060 mg/L. These are determined by averaging all samples collected at each sampling location for the last 12 months. The level of THM averaged at one of our system's locations for 10/1/2014 to 12/31/2014 was 0.096 mg/L and HAA was 0.105 mg/L.

- There is nothing you need to do. You do not need to boil your water or take other corrective actions. If a situation arises where the water is no longer safe to drink, you will be notified within 24 hours.
- If you have a severely compromised immune system, have an infant, are pregnant, or are elderly, you may be at increased risk and should seek advice from your health care providers about drinking this water.

Some people who drink water containing trihalomethanes in excess of the MCL over many years may experience problems with their liver, kidneys, or central nervous system, and may have an increased risk of getting cancer. Some people who drink water containing haloacetic acids in excess of the MCL over many years may have an increased risk of getting cancer.

This is not an emergency. If it had been an emergency, you would have been notified within 24 hours. We are working to minimize the formation of trihalomethanes and haloacetic acids while ensuring we maintain an adequate level of disinfectant. We have taken additional steps to change disinfectant levels, remove natural organic matter, and increased flushing of water lines to determine if our efforts have been effective. We are also monitoring water storage tank levels and water flow patterns within the distribution system. We anticipate resolving the problem within the next quarter but the compliance calculation is based upon annual averages and it may be several quarters before compliance is achieved.

For more information, please contact John Mills at 606-298-3885 or 387 E Main St, Suite 140, Inez, KY 41224.

Please share this information with all the other people who drink this water, especially those who may not have received this notice directly (for example, people in apartments, nursing homes, schools, and businesses). You can do this by posting this notice in a public place or distributing copies by hand or mail.

Copy and paste notice. Prior to paste make sure that the cursor is at the highest point in the text box.

No text below this point.

Notice by Martin County Water District – System ID#: KY0800273

Our water system recently violated a drinking water requirement. Although this was not an emergency you have a right to know what happened.

We routinely monitor your water for turbidity (cloudiness). This tells us whether we are effectively filtering the water supply. On 2/23/2015 we had a turbidity result of 1.195 NTU. This was above the standard of 1.0 NTU. Water samples for February 2015 showed that 6.58 percent of turbidity measurements were over 0.3 turbidity units – the standard is that no more than 5 percent of samples may exceed 0.3 turbidity units per month. The turbidity levels are relatively low. However, their persistence is a concern. Normal turbidity levels at our plant are 0.12 units. This is not an emergency. If it had been, you would have been notified within 24 hours.

- There is nothing you need to do. You do not need to boil your water or take other actions. We do not know of any contamination, and none of our testing has shown disease-causing organisms in the drinking water.
- If you have a severely compromised immune system, have an infant, are pregnant, or are elderly, you may be at increased risk and should seek advice from your health care providers about drinking this water. General guidelines on ways to lessen the risk of infection by microbes are available from EPA's Safe Drinking Water Hotline at 1-800-426-4791.

Turbidity has no health effects. However, turbidity can interfere with disinfection and provide a medium for microbial growth. Turbidity may indicate the presence of disease causing organisms. These organisms include bacteria, viruses, and parasites which can cause symptoms such as nausea, cramps, diarrhea, and associated headaches. These symptoms are not caused only by organisms in drinking water. If you experience any of these symptoms and they persist, you may want to seek medical advice.

High turbidity on top of the filters occurred when a rake motor failed and due to high demand we had to continue operations. The problem was resolved within three days. For more information, please contact John Mills at (606) 298-3885 or 387 E Main St. Suite 140, Inez, KY 41224.

Please share this information with all the other people who drink this water, especially those who may not have received this notice directly (for example, people in apartments, nursing homes, schools, and businesses). You can do this by posting this notice in a public place or distributing copies by hand or mail.

Notice by Martin County Water District – System ID#: KY0800273

Our water system recently violated a drinking water requirement. Although this was not an emergency you have a right to know what happened. We routinely monitor your water for turbidity (cloudiness). This tells us whether we are effectively filtering the water supply. On 2/23/2015 we had a turbidity result of 1.195 NTU. This was above the standard of 1.0 NTU. Water samples for February 2015 showed that 6.58 percent of turbidity measurements were over 0.3 turbidity units – the standard is that no more than 5 percent of samples may exceed 0.3 turbidity units per month. The turbidity levels are relatively low. However, their persistence is a concern. Normal turbidity levels at our plant are 0.12 units. This is not an emergency. If it had been, you would have been notified within 24 hours.

- There is nothing you need to do. You do not need to boil your water or take other actions. We do not know of any contamination, and none of our testing has shown disease-causing organisms in the drinking water.
- If you have a severely compromised immune system, have an infant, are pregnant, or are elderly, you may be at increased risk and should seek advice from your health care providers about drinking this water. General guidelines on ways to lessen the risk of infection by microbes are available from EPA's Safe Drinking Water Hotline at 1-800-426-4791.

*Turbidity has no health effects. However, turbidity can interfere with disinfection and provide a medium for microbial growth. Turbidity may indicate the presence of disease causing organisms. These organisms include bacteria, viruses, and parasites which can cause symptoms such as nausea, cramps, diarrhea, and associated headaches.** These symptoms are not caused only by organisms in drinking water. If you experience any of these symptoms and they persist, you may want to seek medical advice.

High turbidity on top of the filters occurred when a rake motor failed and due to high demand we had to continue operations. The problem was resolved within three days. For more information, please contact John Mills at (606) 298-3885 or 387 E Main St. Suite 140, Inez, KY 41224.

*Please share this information with all the other people who drink this water, especially those who may not have received this notice directly (for example, people in apartments, nursing homes, schools, and businesses). You can do this by posting this notice in a public place or distributing copies by hand or mail.**

2014 Martin County Water District annual water quality report is available. This report contains important information about your drinking water. Please go to <http://www.krwa.org/2014ccr/martincounty.pdf> to view your 2014 annual water quality report or to request a paper copy call (606) 298-3885.

← No text below this point

Notice by Martin County Water District – System ID#: KY0800273

Our water system recently violated a drinking water requirement. Although this was not an emergency you have a right to know what happened. We routinely monitor your water for turbidity (cloudiness). This tells us whether we are effectively filtering the water supply. On 2/23/2015 we had a turbidity result of 1.195 NTU. This was above the standard of 1.0 NTU. Water samples for February 2015 showed that 6.58 percent of turbidity measurements were over 0.3 turbidity units – the standard is that no more than 5 percent of samples may exceed 0.3 turbidity units per month. The turbidity levels are relatively low. However, their persistence is a concern. Normal turbidity levels at our plant are 0.12 units. This is not an emergency. If it had been, you would have been notified within 24 hours.

- There is nothing you need to do. You do not need to boil your water or take other actions. We do not know of any contamination, and none of our testing has shown disease-causing organisms in the drinking water.
- If you have a severely compromised immune system, have an infant, are pregnant, or are elderly, you may be at increased risk and should seek advice from your health care providers about drinking this water. General guidelines on ways to lessen the risk of infection by microbes are available from EPA's Safe Drinking Water Hotline at 1-800-426-4791.

*Turbidity has no health effects. However, turbidity can interfere with disinfection and provide a medium for microbial growth. Turbidity may indicate the presence of disease causing organisms. These organisms include bacteria, viruses, and parasites which can cause symptoms such as nausea, cramps, diarrhea, and associated headaches.** These symptoms are not caused only by organisms in drinking water. If you experience any of these symptoms and they persist, you may want to seek medical advice.

High turbidity on top of the filters occurred when a rake motor failed and due to high demand we had to continue operations. The problem was resolved within three days. For more information, please contact John Mills at (606) 298-3885 or 387 E Main St. Suite 140, Inez, KY 41224.

*Please share this information with all the other people who drink this water, especially those who may not have received this notice directly (for example, people in apartments, nursing homes, schools, and businesses). You can do this by posting this notice in a public place or distributing copies by hand or mail.**

2014 Martin County Water District annual water quality report is available. This report contains important information about your drinking water. Please go to <http://www.krwa.org/2014ccr/martincounty.pdf> to view your 2014 annual water quality report or to request a paper copy call (606) 298-3885.

← No text below this point

Notice by Martin County Water District – System ID#: KY0800273

Our water system recently violated a drinking water standard. Although this incident was not an emergency, as our customers, you have a right to know what happened and what we did (are doing) to correct this situation.

We routinely monitor for the presence of drinking water contaminants. Testing results from 4/1/2015 through 6/30/2015 show that our system exceeds the standard, or maximum contaminant level (MCL), for trihalomethanes (THM) and haloacetic acids (HAA). The standard for THM is 0.080 mg/L and the standard for HAA is 0.060 mg/L. These are determined by averaging all samples collected at each sampling location for the last 12 months. The level of THM averaged at one of our system's locations for 4/1/2015 to 6/30/2015 was 0.088 mg/L and HAA was 0.077 mg/L.

- There is nothing you need to do. You do not need to boil your water or take other corrective actions. If a situation arises where the water is no longer safe to drink, you will be notified within 24 hours.
- If you have a severely compromised immune system, have an infant, are pregnant, or are elderly, you may be at increased risk and should seek advice from your health care providers about drinking this water.

Some people who drink water containing trihalomethanes in excess of the MCL over many years may experience problems with their liver, kidneys, or central nervous system, and may have an increased risk of getting cancer. Some people who drink water containing haloacetic acids in excess of the MCL over many years may have an increased risk of getting cancer.

This is not an emergency. If it had been an emergency, you would have been notified within 24 hours.

We are working to minimize the formation of trihalomethanes and haloacetic acids while ensuring we maintain an adequate level of disinfectant. We have taken additional steps to change disinfectant levels, remove natural organic matter, and increased flushing of water lines to determine if our efforts have been effective. We are also monitoring water storage tank levels and water flow patterns within the distribution system. We anticipate resolving the problem within the next quarter but the compliance calculation is based upon annual averages and it may be several quarters before compliance is achieved.

For more information, please contact John Mills at 606-298-3885 or 387 E Main St. Suite 140, Inez, KY 41224.

Please share this information with all the other people who drink this water, especially those who may not have received this notice directly (for example, people in apartments, nursing homes, schools, and businesses). You can do this by posting this notice in a public place or distributing copies by hand or mail.

Notice by Martin County Water District - System ID#: KY0800273
Our water system recently violated a drinking water standard. Although this incident was not an emergency, as our customers, you have a right to know what happened and what we did (are doing) to correct this situation.

We routinely monitor for the presence of drinking water contaminants. Testing results from 4/1/2015 through 6/30/2015 show that our system exceeds the standard, or maximum contaminant level (MCL), for trihalomethanes (THM) and haloacetic acids (HAA). The standard for THM is 0.080 mg/L and the standard for HAA is 0.060 mg/L. These are determined by averaging all samples collected at each sampling location for the last 12 months. The level of THM averaged at one of our system's locations for 4/1/2015 to 6/30/2015 was 0.088 mg/L and HAA was 0.077 mg/L.

- There is nothing you need to do. You do not need to boil your water or take other corrective actions. If a situation arises where the water is no longer safe to drink, you will be notified within 24 hours.
- If you have a severely compromised immune system, have an infant, are pregnant, or are elderly, you may be at increased risk and should seek advice from your health care providers about drinking this water.

Some people who drink water containing trihalomethanes in excess of the MCL over many years may experience problems with their liver, kidneys, or central nervous system, and may have an increased risk of getting cancer. Some people who drink water containing haloacetic acids in excess of the MCL over any years may have an increased risk of getting cancer.

This is not an emergency. If it had been an emergency, you would have been notified within 24 hours. We are working to minimize the formation of trihalomethanes and haloacetic acids while ensuring we maintain an adequate level of disinfectant. We have taken additional steps to change disinfectant levels, remove natural organic matter, and increased flushing of water lines to determine if our efforts have been effective. We are also monitoring water storage tank levels and water flow patterns within the distribution system. We anticipate resolving the problem within the next quarter but the compliance calculation is based upon annual averages and it may be several quarters before compliance is achieved.

For more information, please contact John Mills at 606-298-3885 or 387 E Main St. Suite 140, Inez, KY 41224.

Please share this information with all the other people who drink this water, especially those who may not have received this notice directly (for example, people in apartments, nursing homes, schools, and businesses). You can do this by posting this notice in a public place or distributing copies by hand or mail.

THM & HAA Stage 2
DBPR Template 2-19

Insert water system name and ID# in header. Insert compliance period begin date, end date, and average level. Remove brackets. Do not modify mandatory language!

Printing Instructions

This template is designed to print the notice on the back of the water bill sheets prior to printing the water bills using procedures the same as printing a letter.

After the notice has been printed to all sheets place the stack of sheets upside down on a flat surface and place a weight on the stack to remove the curl.

When the stack of sheets have cooled and straightened print the water bills as usual.

No text below this point.

Notice by Martin County Water District - System ID#: KY0800273
Our water system recently violated a drinking water standard. Although this incident was not an emergency, as our customers, you have a right to know what happened and what we did (are doing) to correct this situation.

We routinely monitor for the presence of drinking water contaminants. Testing results from 4/1/2015 through 6/30/2015 show that our system exceeds the standard, or maximum contaminant level (MCL), for trihalomethanes (THM) and haloacetic acids (HAA). The standard for THM is 0.080 mg/L and the standard for HAA is 0.060 mg/L. These are determined by averaging all samples collected at each sampling location for the last 12 months. The level of THM averaged at one of our system's locations for 4/1/2015 to 6/30/2015 was 0.088 mg/L and HAA was 0.077 mg/L.

- There is nothing you need to do. You do not need to boil your water or take other corrective actions. If a situation arises where the water is no longer safe to drink, you will be notified within 24 hours.
- If you have a severely compromised immune system, have an infant, are pregnant, or are elderly, you may be at increased risk and should seek advice from your health care providers about drinking this water.

Some people who drink water containing trihalomethanes in excess of the MCL over many years may experience problems with their liver, kidneys, or central nervous system, and may have an increased risk of getting cancer. Some people who drink water containing haloacetic acids in excess of the MCL over any years may have an increased risk of getting cancer.

This is not an emergency. If it had been an emergency, you would have been notified within 24 hours. We are working to minimize the formation of trihalomethanes and haloacetic acids while ensuring we maintain an adequate level of disinfectant. We have taken additional steps to change disinfectant levels, remove natural organic matter, and increased flushing of water lines to determine if our efforts have been effective. We are also monitoring water storage tank levels and water flow patterns within the distribution system. We anticipate resolving the problem within the next quarter but the compliance calculation is based upon annual averages and it may be several quarters before compliance is achieved.

For more information, please contact John Mills at 606-298-3885 or 387 E Main St. Suite 140, Inez, KY 41224.

Please share this information with all the other people who drink this water, especially those who may not have received this notice directly (for example, people in apartments, nursing homes, schools, and businesses). You can do this by posting this notice in a public place or distributing copies by hand or mail.

Copy and paste notice. Prior to paste make sure that the cursor is at the highest point in the text box.

No text below this point.

Notice by Martin County Water District – System ID#: KY0800273

Our water system recently violated a drinking water standard. Although this incident was not an emergency, as our customers, you have a right to know what happened and what we did (are doing) to correct this situation.

We routinely monitor for the presence of drinking water contaminants. Testing results from 7/1/2015 through 9/30/2015 and 10/1/2015 through 12/31/2015 show that our system exceeds the standard, or maximum contaminant level (MCL), for trihalomethanes (THM) and haloacetic acids (HAA). The standard for THM is 0.080 mg/L and the standard for HAA is 0.060 mg/L. These are determined by averaging all samples collected at each sampling location for the last 12 months. The level of THM averaged at one of our system's locations for 7/1/2015 to 9/30/2015 was 0.081 mg/L and HAA was 0.070 mg/L. The level of THM for 10/1/2015 to 12/31/2015 was 0.100 mg/L.

- There is nothing you need to do. You do not need to boil your water or take other corrective actions. If a situation arises where the water is no longer safe to drink, you will be notified within 24 hours.
- If you have a severely compromised immune system, have an infant, are pregnant, or are elderly, you may be at increased risk and should seek advice from your health care providers about drinking this water.

Some people who drink water containing trihalomethanes in excess of the MCL over many years may experience problems with their liver, kidneys, or central nervous system, and may have an increased risk of getting cancer. Some people who drink water containing haloacetic acids in excess of the MCL over many years may have an increased risk of getting cancer.

This is not an emergency. If it had been an emergency, you would have been notified within 24 hours.

We are working to minimize the formation of disinfection by-products while ensuring we maintain an adequate level of disinfectant. We have taken steps to change disinfectant levels, remove natural organic matter, and increased flushing of water lines. We anticipate resolving the problem within the next six months.

For more information, please contact John Mills at 606-298-3885 or 387 E Main St. Suite 140, Inez, KY 41224.

Please share this information with all the other people who drink this water, especially those who may not have received this notice directly (for example, people in apartments, nursing homes, schools, and businesses). You can do this by posting this notice in a public place or distributing copies by hand or mail.

Notice by Martin County Water District - System ID# KY080273
Your water system recently violated a drinking water standard. Although this incident was not an emergency, as our customers, you have a right to know what happened and what we did (are doing) to correct this situation.

We routinely monitor for the presence of drinking water contaminants. Testing results from 7/1/2015 through 9/30/2015 and 10/1/2015 through 12/31/2015 show that our system exceeds the standard, or maximum contaminant level (MCL), for trihalomethanes (THM) and haloacetic acids (HAA). The standard for THM is 0.080 mg/L and the standard for HAA is 0.060 mg/L. These are determined by averaging all samples collected at each sampling location for the last 3 months. The level of THM averaged at one of our system's locations for 7/1/2015 to 9/30/2015 was 0.081 mg/L and HAA was 0.070 mg/L. The level of THM for 10/1/2015 to 12/31/2015 was 0.100 mg/L.

- There is nothing you need to do. You do not need to boil your water or take other corrective actions. If a situation arises where the water is no longer safe to drink, you will be notified within 24 hours.
- If you have a severely compromised immune system, have an infant, are pregnant, or are elderly, you may be at increased risk and should seek advice from your health care providers about drinking this water.

Some people who drink water containing trihalomethanes in excess of the MCL over many years may experience problems with their liver, kidneys, or central nervous system, and may have an increased risk of getting cancer. Some people who drink water containing haloacetic acids in excess of the MCL over many years may have an increased risk of getting cancer.

This is not an emergency. If it had been an emergency, you would have been notified within 24 hours.

We are working to minimize the formation of disinfection by-products while ensuring we maintain an adequate level of disinfectant. We have taken steps to range disinfectant levels, remove natural organic matter, and increased flushing of water lines. We anticipate resolving the problem within the next six months.

For more information, please contact John Mills at 606-298-3885 or 387 E Main St, Suite 140, Inez, KY 41224.

Please share this information with all the other people who drink this water, especially those who may not have received this notice directly (for example, people in apartments, nursing homes, schools, and businesses). You can do this by posting this notice in a public place or distributing copies by hand or mail.

THM & HAA Stage 2
DBPR Template 2-19

Insert water system name and ID# in header. Insert compliance period begin date, end date, and average level. Remove brackets. Do not modify mandatory language!

Printing Instructions

This template is designed to print the notice on the back of the water bill sheets prior to printing the water bills using procedures the same as printing a letter.

After the notice has been printed to all sheets place the stack of sheets upside down on a flat surface and place a weight on the stack to remove the curl.

When the stack of sheets have cooled and straightened print the water bills as usual.

No text below this point.

Notice by Martin County Water District - System ID#; KY080273

Your water system recently violated a drinking water standard. Although this incident was not an emergency, as our customers, you have a right to know what happened and what we did (are doing) to correct this situation.

We routinely monitor for the presence of drinking water contaminants. Testing results from 7/1/2015 through 9/30/2015 and 10/1/2015 through 12/31/2015 show that our system exceeds the standard, or maximum contaminant level (MCL), for trihalomethanes (THM) and haloacetic acids (HAA). The standard for THM is 0.080 mg/L and the standard for HAA is 0.060 mg/L. These are determined by averaging all samples collected at each sampling location for the last 3 months. The level of THM averaged at one of our system's locations for 7/1/2015 to 9/30/2015 was 0.081 mg/L and HAA was 0.070 mg/L. The level of THM for 10/1/2015 to 12/31/2015 was 0.100 mg/L.

- There is nothing you need to do. You do not need to boil your water or take other corrective actions. If a situation arises where the water is no longer safe to drink, you will be notified within 24 hours.
- If you have a severely compromised immune system, have an infant, are pregnant, or are elderly, you may be at increased risk and should seek advice from your health care providers about drinking this water.

Some people who drink water containing trihalomethanes in excess of the MCL over many years may experience problems with their liver, kidneys, or central nervous system, and may have an increased risk of getting cancer. Some people who drink water containing haloacetic acids in excess of the MCL over many years may have an increased risk of getting cancer.

This is not an emergency. If it had been an emergency, you would have been notified within 24 hours.

We are working to minimize the formation of disinfection by-products while ensuring we maintain an adequate level of disinfectant. We have taken steps to range disinfectant levels, remove natural organic matter, and increased flushing of water lines. We anticipate resolving the problem within the next six months.

For more information, please contact John Mills at 606-298-3885 or 387 E Main St, Suite 140, Inez, KY 41224.

Please share this information with all the other people who drink this water, especially those who may not have received this notice directly (for example, people in apartments, nursing homes, schools, and businesses). You can do this by posting this notice in a public place or distributing copies by hand or mail.

Copy and paste notice
Prior to paste make sure that the cursor is at the highest point in the text box.

No text below this point.

Exhibit #13
Division of Water



MATTHEW G. BEVIN
GOVERNOR

CHARLES G. SNAVELY
SECRETARY

ENERGY AND ENVIRONMENT CABINET
DEPARTMENT FOR ENVIRONMENTAL PROTECTION

Division of Water
233 Birch St
Hazard, KY 417012115
www.kentucky.gov

March 14, 2016

Martin Co Water District
14 Flat Hollow
Inez, Kentucky 41224

RE: Martin Co Water District -- 2987
Permit No.: KY0800273
Martin County, Kentucky
Activity ID: CIN20160002

Dear Martin Co Water Dist:

Attached for your information and records is a copy of the DW Comp-Surface performed at Martin Co Water District on February 22, 2016.

The system should continue efforts to leak detect the distribution system and repair any issues as they are found. Measure should be taken to perform a full system flush twice per year while flushing dead ends as often as needed.

If you have any questions or comments concerning this inspection, please contact the Hazard Regional Office at: (606) 435-6022.

Sincerely,

Robert Back
Environmental Inspector
Hazard Regional Office
Division of Water

RB
Enclosure:

ENERGY AND ENVIRONMENT CABINET
 KENTUCKY DEPARTMENT FOR ENVIRONMENTAL PROTECTION
 DIVISION OF WATER
Routine Surface Inspection

Site/Permit ID: 0800273	Division: Water	Regional Office: Hazard
Site Name: MARTIN CO. WATER DISTRICT.	Program: Drinking Water	
Site Address: HC69 Box 875		
City: INEZ	State: KY	Zip: 41224
County: Martin		
Inspection Type: Routine Surface	Purpose: Comprehensive	AI #: 2987
Inspection Date: 2/22/16	Time: Start 9.55 AM End 1.10 PM	
Latitude: 37 52 20.3	Longitude: 82 31 09.8	
Coordinate Collection Method: G40-Handheld receiver		Revision Code: 112108

Drinking Water Data

Plant Name: MARTIN CO. WATER DISTRICT	Contact Name: Tom Alley	
Phone No.: 606-298-3885	Fax No:	Email Address:

I. Administrative Requirements

Comments:

I. Compliance Status - Not Evaluated

II. Operator Certification/Accreditation Requirements

Operator in Charge or on duty.

Operator Name	Plant Certification #	Distribution Certification #
Tom Alley	17562	
Mike Sartin	21944	
Tim Reed/ Elbert Osborne	24590	27800

Comments:

II. Compliance Status - Not Evaluated

III. Record Keeping Requirements

Comments:

III. Compliance Status - No violations observed

Comments: Wolf creek, Coldwater, Inez 1&2 tanks are not in service. The system does not use these tanks at this time. The System has switched from gas chlorine to liquid bleach disinfectant. The system is using a Thornsorb activated carbon system. The water treatment plant has a 100,000 gallon clearwell at the plant and two 500,000 gallon clearwell tanks on the hill above the plant.

The system needs to perform a complete system flush however approximately 50% water loss and low storage due to distribution leaks in the Warfield area make it difficult. Failure to properly flush the system will make meeting future DBP limits a difficult task.

V. **Compliance Status** - No violations obs-but impending viol trends obs

VI. Discharge/Emission Compliance

Comments:

VI. **Compliance Status** - No violations observed

VII. Monitoring/Analyses Evaluation

Comments: The system has multiple violations for disinfection by-products from the 2015 year. The Division of Enforcement is addressing these violations.

VII. **Compliance Status** - Out of Compliance- No action taken

VIII. Environmental/Health Impact

Work Site Hazard Assessment : ATTACHED REVIEWED

Comments:

VIII. **Compliance Status** – No violations observed

IX. Documentation

- Samples taken by DEP
- Samples taken by outside source
- Instrument readings taken by DEP regional office
- Photographs obtained by DEP
- Copies of records obtained by DEP
- Other documentation

Inspector: Robert D. Back	Title: Environmental Inspector III	Date: 2/22/16
----------------------------------	---	----------------------



ENERGY AND ENVIRONMENT CABINET

Matthew G Bevin
Governor

Department for Environmental Protection
Division of Water
200 Fair Oaks Lane
4 Floor
Frankfort, Kentucky 40601
Phone: (502) 564-3410
Fax: (502) 564-2741
www.water.ky.gov

Charles G
Snively
Secretary

R. Bruce Scott
Commissioner

March 9, 2016

CERTIFIED MAIL: 70 15 3430 0000 4915 0321
RETURN RECEIPT REQUESTED

JOHN MILLS
MARTIN CO WATER DISTRICT #1
287 E MAIN ST SUITE 140
INEZ, KY 41224

Re: NOTICE OF VIOLATION
AI ID: 2987
PWSID: KY0800273
PWS NAME: MARTIN CO WATER DISTRICT #1
COUNTY: MARTIN

Dear Mr. Mills:

The Kentucky Department for Environmental Protection (DEP) has issued the enclosed Notice of Violation for violations discovered at your facility. Please review this Notice of Violation carefully to ensure that all remedial measures are completed by the specified deadlines.

Failure to comply with all remedial measures could result in enforcement action and the assessment of penalties. Your cooperation and attention to this matter is appreciated. If you have any questions, please contact Kellee Husband at (502)564-3410 ext. 4986 or email at kelteem.husband@ky.gov.

Sincerely,
Brian M. Chitti

Brian Chitti
Drinking Water CTAB Supervisor
Compliance & Technical Assistance Branch
Division of Water

C: Drinking Water Program files
Enclosure

COMMONWEALTH OF KENTUCKY

ENERGY & ENVIRONMENT CABINET
DEPARTMENT FOR ENVIRONMENTAL PROTECTION
Division of Water

NOTICE OF VIOLATION

MARTIN CO WATER DISTRICT #1
287 E MAIN ST SUITE 140
INEZ, KY 41224

PWSID: KY0800273
PWS Name: MARTIN CO WATER DISTRICT AI ID: 2987
County: MARTIN
Violation Number: 2016 - 9951 175
Determination Date: 02/10/2016
Compliance Period: 10/01/2015 - 12/31/2015
Violation Type: 02 MCL, LRAA Tier Level: 2
PWS Facility: IDSE9999 IDSE - MARTN CO WATER DIST Contaminant:
2950 TTHM

Public Water Systems are subject to the requirements of 401 KAR Chapter 8. [401 KAR 8:020 Section 1]
This is to advise that you are in violation of the provision(s) cited below:

Description of Non Compliance:

401 KAR 8:510 mHM The public water system exceeded the MCL for locational running annual average (LRAA) of samples for the specific contaminant in compliance period 10/01/2015 - 12/31/2015. The reported result of .123 mg/l exceeded the MCL of 0.080 mg/l,

The remedial measure(s) and date(s) to be completed by are as follows: Begin or continue quarterly monitoring for TTHM

Perform public notification for the above-mentioned violation in accordance with 401 KAR 8:070. The public notification must not contain language that contradicts or detracts from the standard mandatory language or the purpose of the notice. Submit proof of public notification and its certification within ten (10) days of executing public notification. [401 KAR 8:070] The specific public notification activities to be performed are listed below.

PWS must give notice to consumers, including other water systems you may provide water to, about a violation by mail delivery or hand delivery. The notice must be executed within thirty (30) days following receipt by the PWS of this Notice of Violation.

If not all consumers can be notified by mail or hand delivery then the PWS must give notice to consumers about a violation by 1) publication in a newspaper of general circulation in the area served by the PWS or 2) by continuous posting in conspicuous places within the area served by the PWS. The notice must be executed within thirty (30) days following receipt by the PWS of this Notice of Violation.

Submit proof of public notification and its certification within ten (10) days of executing public notification.

Violations of the above cited statutes and/or regulations are subject to a civil penalty. Violations carry civil penalties of up to \$25,000 per day per violation depending on the statutes/regulations violated. In addition, violations may be concurrently enjoined. Compliance with remedial measures and their deadlines does not provide exemption from liability for violations during the period of remediation, nor prevent additional remedial measures from being required.

Detailed information about your water system's violations & monitoring requirements can be easily accessed on Kentucky Drinking Water Watch at <http://dep.gateway.ky.gov/DWW/>

If you have questions or need further information, write or call Kellee Husband at (502)564-3410 ext 4986 or email at kelleem.husbandt@ky.gov.

ALL DOCUMENTATION MUST BE SUBMITTED TO:

Drinking Water Compliance & Technical Assistance
Division of Water, Department for Environmental Protection
200 Fair Oaks Lane, 4th Floor Frankfort,
KY 40601

Brian M. Chitti

Issued By:

Brian Chitti
Drinking Water CTAB Supervisor
Compliance & Technical Assistance Branch
Division of Water

Date: March 9, 2016

How Delivered: Certified/Registered #7015 3430 0000 4915 0.321

Notice by Martin County Water District - System ID#: KY060273
Our water system recently violated a drinking water standard. Although this incident was not an emergency, as our customers, you have a right to know what happened and what we did (are doing) to correct this situation.

We routinely monitor for the presence of drinking water contaminants. Testing results from 7/1/2015 through 9/30/2015 and 10/1/2015 through 12/31/2015 show that our system exceeds the standard, or maximum contaminant level (MCL), for trihalomethanes (THM) and haloacetic acids (HAA). The standard for THM is 0.080 mg/L and the standard for HAA is 0.060 mg/L. These are determined by averaging all samples collected at each sampling location for the last 12 months. The level of THM averaged at one of our system's locations for 7/1/2015 to 9/30/2015 was 0.081 mg/L and HAA was 0.070 mg/L. The level of THM for 10/1/2015 to 12/31/2015 was 0.100 mg/L.

- There is nothing you need to do. You do not need to boil your water or take other corrective actions. If a situation arises where the water is no longer safe to drink, you will be notified within 24 hours.
- If you have a severely compromised immune system, have an infant, are pregnant, or are elderly, you may be at increased risk and should seek advice from your health care providers about drinking this water.

Some people who drink water containing trihalomethanes in excess of the MCL over many years may experience problems with their liver, kidneys, or central nervous system, and may have an increased risk of getting cancer. Some people who drink water containing haloacetic acids in excess of the MCL over many years may have an increased risk of getting cancer.

This is not an emergency. If it had been an emergency, you would have been notified within 24 hours.

We are working to minimize the formation of disinfection by-products while ensuring we maintain an adequate level of disinfectant. We have taken steps to change disinfectant levels, remove natural organic matter, and increased flushing of water lines. We anticipate resolving the problem within the next six months.

For more information, please contact John Mills at 606-298-3885 or 387 E Main St, Suite 140, Inez, KY 41224.

Please share this information with all the other people who drink this water, especially those who may not have received this notice directly (for example, people in apartments, nursing homes, schools, and businesses). You can do this by posting this notice in a public place or distributing copies by hand or mail.

THM & HAA Stage 2
DBPR Template 2-19

Insert water system name and ID# in header. Insert compliance period, begin date, end date, and average level. Remove brackets. Do not modify mandatory language!

Printing Instructions

This template is designed to print the notice on the back of the water bill sheets prior to printing the water bills using procedures the same as printing a letter.

After the notice has been printed to all sheets place the stack of sheets upside down on a flat surface and place a weight on the stack to remove the curl.

When the stack of sheets have cooled and straightened print the water bills as usual.

No text below this point

Notice by Martin County Water District - System ID#: KY060273

Our water system recently violated a drinking water standard. Although this incident was not an emergency, as our customers, you have a right to know what happened and what we did (are doing) to correct this situation.

We routinely monitor for the presence of drinking water contaminants. Testing results from 7/1/2015 through 9/30/2015 and 10/1/2015 through 12/31/2015 show that our system exceeds the standard, or maximum contaminant level (MCL), for trihalomethanes (THM) and haloacetic acids (HAA). The standard for THM is 0.080 mg/L and the standard for HAA is 0.060 mg/L. These are determined by averaging all samples collected at each sampling location for the last 12 months. The level of THM averaged at one of our system's locations for 7/1/2015 to 9/30/2015 was 0.081 mg/L and HAA was 0.070 mg/L. The level of THM for 10/1/2015 to 12/31/2015 was 0.100 mg/L.

- There is nothing you need to do. You do not need to boil your water or take other corrective actions. If a situation arises where the water is no longer safe to drink, you will be notified within 24 hours.
- If you have a severely compromised immune system, have an infant, are pregnant, or are elderly, you may be at increased risk and should seek advice from your health care providers about drinking this water.

Some people who drink water containing trihalomethanes in excess of the MCL over many years may experience problems with their liver, kidneys, or central nervous system, and may have an increased risk of getting cancer. Some people who drink water containing haloacetic acids in excess of the MCL over many years may have an increased risk of getting cancer.

This is not an emergency. If it had been an emergency, you would have been notified within 24 hours.

We are working to minimize the formation of disinfection by-products while ensuring we maintain an adequate level of disinfectant. We have taken steps to change disinfectant levels, remove natural organic matter, and increased flushing of water lines. We anticipate resolving the problem within the next six months.

For more information, please contact John Mills at 606-298-3885 or 387 E Main St, Suite 140, Inez, KY 41224.

Please share this information with all the other people who drink this water, especially those who may not have received this notice directly (for example, people in apartments, nursing homes, schools, and businesses). You can do this by posting this notice in a public place or distributing copies by hand or mail.

Copy and paste notice. Prior to paste make sure that the cursor is at the highest point in the text box.

No text below this point.



ENERGY AND ENVIRONMENT CABINET

Matthew G Bevin
Governor

Department for Environmental Protection
Division of Water
200 Fair Oaks Lane, 4th Floor
Frankfort, Kentucky 40601
Phone: (502) 564-3410
Fax: (502) 564-2741
water.ky.gov

Charles G. Snaveley
Secretary

R. Bruce Scott
Commissioner

December 22, 2015

Earl Alley
Martin County Water District #1
387 East Main St Suite 140
Inez, KY 41224

Re: Repeat Public Notice Extension
AI ID: 2987
PWSID: KY0800273
PWS NAME: Martin County Water District #1
COUNTY: Greenup

Dear Mr. Alley,

The Division of Water has considered your request and will grant an extension to the required repeat public notice for the ongoing disinfection byproduct MCL exceedance *or* a reduction in frequency of the repeat public notice. This will depend on the Locational Running Annual Average that is calculated for the 4th quarter of 2015.

If the water system continues to exceed the MCL for disinfection byproducts for the 4th quarter, the water system will use the 4th quarter results in the repeat public notice. If the water system comes back into compliance in the 4th quarter, the water system will be required to perform a public notice using the 3rd quarter results.

The public notice shall be performed no later than **February 10th, 2016**.

It is not required for the water system to receive a 4th quarter Notice of Violation before issuing the public notice. The water system may issue the notice as soon as they receive 4th quarter TTHM analysis results and can make a determination whether or not they are in compliance for the 4th quarter.

Please note all violations shall be listed in the 2015 Consumer Confidence Report.

If you have any questions or concerns, please contact Brook Overbay at (502) 564-3410, extension 4958.
Or ashlee.overbay@ky.gov

Sincerely,

Brook Overbay
Compliance Section
Division of Water

C: Drinking Water Files

KentuckyUnbridledSpirit.com



An Equal Opportunity Employer M/F/D



PAID
DEC 28 2015

MARTIN CO. WATER

Matthew G. Bevin
Governor

ENERGY AND ENVIRONMENT CABINET

Department for Environmental Protection
Division of Water
200 Fair Oaks Lane, 4th Floor
Frankfort, Kentucky 40601
Phone: (502) 564-3410
Fax: (502) 564-2741
www.water.ky.gov

Charles G. Snively
Secretary

R. Bruce Scott
Commissioner

December 14, 2015

To Whom It May Concern:

The Kentucky Department for Environmental Protection (DEP) has enclosed multiple notices for violations discovered at your facility. Please review each notice of violation carefully to ensure that all remedial measures are completed by the specified deadlines.

If you have questions regarding any of the violations, please call or write the contact identified on each of the violations.

Sincerely,

Brian M. Chitti

Brian Chitti
Drinking Water CTAB Supervisor
Compliance & Technical Assistance Branch
Division of Water

Enclosures



ENERGY AND ENVIRONMENT CABINET

Matthew G. Bevin
Governor

Department for Environmental Protection
Division of Water
200 Fair Oaks Lane
4th Floor
Frankfort, Kentucky 40601
Phone: (502) 564-3410
Fax: (502) 564-2741
www.water.ky.gov

Charles G. Snively
Secretary

R. Bruce Scott
Commissioner

December 11, 2015

CERTIFIED MAIL: 7015 0640 0005 6317 6221
RETURN RECEIPT REQUESTED

JOHN MILLS
MARTIN CO WATER DISTRICT #1
287 E MAIN ST SUITE 140
INEZ, KY 41224

Re: **NOTICE OF VIOLATION**
AI ID: 2987
PWSID: KY0800273
PWS NAME: MARTIN CO WATER DISTRICT #1
COUNTY: MARTIN

Dear Mr. Mills:

The Kentucky Department for Environmental Protection (DEP) has issued the enclosed Notice of Violation for violations discovered at your facility. Please review this Notice of Violation carefully to ensure that all remedial measures are completed by the specified deadlines.

Failure to comply with all remedial measures could result in enforcement action and the assessment of penalties. Your cooperation and attention to this matter is appreciated. If you have any questions, please contact Kellee Husband at (502)564-3410 ext. 4986 or email at kelleem.husband@ky.gov.

Sincerely,

Brian Chitti
Drinking Water CTAB Supervisor
Compliance & Technical Assistance Branch
Division of Water

C: Drinking Water Program files
Enclosure

**COMMONWEALTH OF KENTUCKY
ENERGY & ENVIRONMENT CABINET
DEPARTMENT FOR ENVIRONMENTAL PROTECTION
Division of Water**

NOTICE OF VIOLATION

To:
MARTIN CO WATER DISTRICT #1
287 E MAIN ST SUITE 140
INEZ, KY 41224

PWSID: KY0800273
PWS Name: MARTIN CO WATER DISTRICT #1 **AI ID:** 2987
County: MARTIN
Violation Number: 2016 - 9951173
Determination Date: 11/09/2015
Compliance Period: 07/01/2015 - 09/30/2015
Violation Type: 02 MCL, LRAA **Tier Level:** 2
PWS Facility: IDSE9999 IDSE - MARTN CO WATER DIST
Contaminant: 2456 TOTAL HALOACETIC ACIDS (HAA5)

Public Water Systems are subject to the requirements of 401 KAR Chapter 8. [401 KAR 8:020 Section 1]
This is to advise that you are in violation of the provision(s) cited below:

Description of Non Compliance:

401 KAR 8:510 TOTAL HALOACETIC ACIDS (HAA5) The public water system exceeded the MCL for locational running annual average (LRAA) of samples for the specific contaminant in compliance period 07/01/2015 - 09/30/2015. The reported result of .07 mg/l exceeded the MCL of 0.060 mg/l.

The remedial measure(s) and date(s) to be completed by are as follows:

Begin or continue quarterly monitoring for TOTAL HALOACETIC ACIDS (HAA5)

Perform public notification for the above-mentioned violation in accordance with 401 KAR 8:070. The public notification must not contain language that contradicts or detracts from the standard mandatory language or the purpose of the notice. Submit proof of public notification and its certification within ten (10) days of executing public notification. [401 KAR 8:070] The specific public notification activities to be performed are listed below.

PWS must give notice to consumers, including other water systems you may provide water to, about a violation by mail delivery or hand delivery. The notice must be executed within thirty (30) days following receipt by the PWS of this Notice of Violation.

If not all consumers can be notified by mail or hand delivery then the PWS must give notice to consumers about a violation by 1) publication in a newspaper of general circulation in the area served by the PWS or 2) by continuous posting in conspicuous places within the area served by the PWS. The notice must be executed within thirty (30) days following receipt by the PWS of this Notice of Violation.

Submit proof of public notification and its certification within ten (10) days of executing public notification.

Violations of the above cited statutes and/or regulations are subject to a civil penalty. Violations carry civil penalties of up to \$25,000 per day per violation depending on the statutes/regulations violated. In addition, violations may be concurrently enjoined. Compliance with remedial measures and their deadlines does not provide exemption from liability for violations during the period of remediation, nor prevent additional remedial measures from being required.

Detailed information about your water system's violations & monitoring requirements can be easily accessed on Kentucky Drinking Water Watch at <http://dep.gateway.ky.gov/DWW/>

If you have questions or need further information, write or call Kellee Husband at (502)564-3410 ext 4986 or email at kelleem.husband@ky.gov.

ALL DOCUMENTATION MUST BE SUBMITTED TO:

Drinking Water Compliance & Technical Assistance
Division of Water, Department for Environmental Protection
200 Fair Oaks Lane, 4th Floor
Frankfort, KY 40601

Issued By: *Brian M. Chitti*
Brian Chitti
Drinking Water CTAB Supervisor
Compliance & Technical Assistance Branch
Division of Water

Date: December 11, 2015

How Delivered: Certified/Registered #7015 0640 0005 6317 6221



ENERGY AND ENVIRONMENT CABINET

Matthew G. Bevin
Governor

Department for Environmental Protection
Division of Water
200 Fair Oaks Lane
4th Floor
Frankfort, Kentucky 40601
Phone: (502) 564-3410
Fax: (502) 564-2741
www.water.ky.gov

Charles G. Snively
Secretary

R. Bruce Scott
Commissioner

December 11, 2015

CERTIFIED MAIL: 7015 0640 0005 6317 6221
RETURN RECEIPT REQUESTED

JOHN MILLS
MARTIN CO WATER DISTRICT #1
287 E MAIN ST SUITE 140
INEZ, KY 41224

Re: **NOTICE OF VIOLATION**
AI ID: 2987
PWSID: KY0800273
PWS NAME: MARTIN CO WATER DISTRICT #1
COUNTY: MARTIN

Dear Mr. Mills:

The Kentucky Department for Environmental Protection (DEP) has issued the enclosed Notice of Violation for violations discovered at your facility. Please review this Notice of Violation carefully to ensure that all remedial measures are completed by the specified deadlines.

Failure to comply with all remedial measures could result in enforcement action and the assessment of penalties. Your cooperation and attention to this matter is appreciated. If you have any questions, please contact Kellee Husband at (502)564-3410 ext. 4986 or email at kelleem.husband@ky.gov.

Sincerely,

Brian M. Chitti

Brian Chitti
Drinking Water CTAB Supervisor
Compliance & Technical Assistance Branch
Division of Water

C: Drinking Water Program files
Enclosure

**COMMONWEALTH OF KENTUCKY
ENERGY & ENVIRONMENT CABINET
DEPARTMENT FOR ENVIRONMENTAL PROTECTION
Division of Water**

NOTICE OF VIOLATION

To:
MARTIN CO WATER DISTRICT #1
287 E MAIN ST SUITE 140
INEZ, KY 41224

PWSID: KY0800273
PWS Name: MARTIN CO WATER DISTRICT #1 **AI ID:** 2987
County: MARTIN
Violation Number: 2016 - 9951174
Determination Date: 11/09/2015
Compliance Period: 07/01/2015 - 09/30/2015
Violation Type: 02 MCL LRAA **Tier Level:** 2
PWS Facility: IDSE9999 IDSE - MARTN CO WATER DIST
Contaminant: 2950 TTHM

Public Water Systems are subject to the requirements of 401 KAR Chapter 8. [401 KAR 8:020 Section 1]
This is to advise that you are in violation of the provision(s) cited below:

Description of Non Compliance:

401 KAR 8:510 TTHM The public water system exceeded the MCL for locational running annual average (LRAA) of samples for the specific contaminant in compliance period 07/01/2015 - 09/30/2015. The reported result of .081 mg/l exceeded the MCL of 0.080 mg/l.

The remedial measure(s) and date(s) to be completed by are as follows:

Begin or continue quarterly monitoring for TTHM

Perform public notification for the above-mentioned violation in accordance with 401 KAR 8:070. The public notification must not contain language that contradicts or detracts from the standard mandatory language or the purpose of the notice. Submit proof of public notification and its certification within ten (10) days of executing public notification. [401 KAR 8:070] The specific public notification activities to be performed are listed below.

PWS must give notice to consumers, including other water systems you may provide water to, about a violation by mail delivery or hand delivery. The notice must be executed within thirty (30) days following receipt by the PWS of this Notice of Violation.

If not all consumers can be notified by mail or hand delivery then the PWS must give notice to consumers about a violation by 1) publication in a newspaper of general circulation in the area served by the PWS or 2) by continuous posting in conspicuous places within the area served by the PWS. The notice must be executed within thirty (30) days following receipt by the PWS of this Notice of Violation.

Submit proof of public notification and its certification within ten (10) days of executing public notification.

Violations of the above cited statutes and/or regulations are subject to a civil penalty. Violations carry civil penalties of up to \$25,000 per day per violation depending on the statutes/regulations violated. In addition, violations may be concurrently enjoined. Compliance with remedial measures and their deadlines does not provide exemption from liability for violations during the period of remediation, nor prevent additional remedial measures from being required.

Detailed information about your water system's violations & monitoring requirements can be easily accessed on Kentucky Drinking Water Watch at <http://dep.gateway.ky.gov/DWW/>

If you have questions or need further information, write or call Kellee Husband at (502)564-3410 ext 4986 or email at kelleehusband@ky.gov.

ALL DOCUMENTATION MUST BE SUBMITTED TO:

Drinking Water Compliance & Technical Assistance
Division of Water, Department for Environmental Protection
200 Fair Oaks Lane, 4th Floor
Frankfort, KY 40601

Issued By: *Brian M. Chitti*
Brian Chitti
Drinking Water CTAB Supervisor
Compliance & Technical Assistance Branch
Division of Water

Date: December 11, 2015

How Delivered: Certified/Registered #7015 0640 0005 6317 6221