

SPECIFICATION

Residential Electromagnetic Meter 5/8" through 1"

Type

Meter shall be solid state, battery operated electromagnetic flow measurement system with a hermetically sealed, glass covered, electronic register with a programmable 9-digit display.

Conformance to Standards

The Meter must conform to American Water Works Standard C-700 and C-710 as most recently revised with respect to accuracy and pressure loss requirements. Meter shall be compliant with ANSI/NSF Standard 61 Annex G & F

Register

The register must be an electronic device encapsulated in glass with 9 programmable digits utilizing a liquid crystal display (LCD). It will have indicators for flow direction, empty pipe, battery life and unit of measurement. The register must be hermetically sealed with a heat tempered glass cover and be tamper resistant. The register shall not be removable from the measuring sensor. The register shall utilize a magnetic coupling technology to connect to a touch read, radio read or fixed base meter reading system in either an inside or pit set installation. The electronic register shall have internal data logging capability and alarm status messaging to include reverse flow, tamper detection, empty pipe, leak detections, and battery status.

Measuring Element

The measuring element shall be made of a noncorrosive, lead-free glass fiber reinforced, PPS (polyphenylene sulfide) based resin. A battery powered magnetic flow sensor utilizing silver/silver chloride electrodes will be utilized to measure the velocity of the water which is linearly proportional to the volume. The measuring element will have no moving parts and will be specific for each size. The meter operating range shall be 0.03 gpm (0.007 m³/hr) @ 95% minimum to 55 gpm (12.5 m³/hr) @ 100% ± 1.5% registration of actual throughput.

External Housing

The register and measuring element will be an integrated unit housed within a thermal plastic external casing. This integrated unit will not be removable from the external housing. The systems shall have the size and direction of water flow through the system imprinted on the external housing.

Accuracy and Headloss Tests

Systems shall conform to current AWWA C-700 and C-710, current revision, or other appropriate American Water Works Standard, test flows, headloss and accuracy standards. The meter shall not exceed the below listed headloss

5/8" (DN 15mm) size: 4 psi at 15 gpm (0.3 bar at 3.4 m³/h)

3/4" (DN 20mm) size: 2 psi at 15 gpm (0.1 bar at 3.4 m³/h)

1" (DN 25mm) size: 2 psi at 25 gpm (0.1 bar at 5.7 m³/h)

Pressure Capability

System shall operate up to a working pressure of 200 pounds per square inch (psi), without leakage or damage to any parts. The accuracy shall not be affected by variation of pressure up to 200 psi.

Performance Warranties

In evaluating bid submittals, warranty coverage will be considered. All bidders are required to submit their most current nationally published warranty statements for water meter maincases, registers and measuring chambers. The meter shall have new meter accuracy warranty for 20 years as stated in published documentation.

Manufacturer

Residential water meters shall be of the electromagnetic technology with no moving parts and shall be manufactured by Sensus Metering Technologies or written approved equal.

iPERL™ Water Management System

Electromagnetic Flow Measurement System

5/8" (DN 15mm), 3/4" (DN 20mm) and 1" (DN 25mm) Sizes

DESCRIPTION

MODEL: With no moving parts, the Sensus iPERL water management system is based on innovative electromagnetic flow measurement technology. The iPERL system family has an operating range of 0.03 gpm (0.007 m³/hr) @ 95% minimum to 55 gpm (12.5 m³/hr) @ 100% ± 1.5% registration of actual throughput.

CONFORMANCE TO STANDARDS: The iPERL system far exceeds the most recent revision of ANSI/AWWA Standard C-700 and C-710 for accuracy and pressure loss requirements. All iPERL systems are NSF Standard 61 Annex G compliant and tested to AWWA standards.

PERFORMANCE: The patented measurement technology of the iPERL system allows enhanced accuracy ranges at both low and high flows and perpetual accuracy over the life of the product as well as the full measurement range.

CONSTRUCTION: The iPERL system is an integrated unit that incorporates an electronic register and measuring device encased in an external housing. The measuring device is comprised of a polyphenylene sulfide alloy flowtube with externally-threaded spud ends. Embedded in the flowtube are magnetic flow sensors and a replaceable strainer screen. The all electronic programmable register is hermetically sealed with a tempered glass cover. The iPERL system has a 20 year life cycle, along with a 20 year battery life guarantee. At the end of this life cycle, you do not have to be concerned about repairing the iPERL system since the design is not meant to be repaired but is easily replaceable.

ELECTRONIC REGISTER: The high resolution 9-digit hermetically sealed electronic register with LCD display was designed to eliminate dirt, lens fogging issues and moisture contamination in pit settings with built in tamper protection. The tempered glass register cover displays readings with the AMR digits highlighted. Direction of flow and units of measure are also easily readable on the register display. The register is programmable using the UniPro programming package to display in either gallon, cubic feet or cubic meter totalization. The large, easy to read display also includes battery life and empty pipe indicators.

TAMPERPROOF FEATURES: The ingenious integrated construction of an iPERL system prevents removal of the register to obtain free water. The magnetic tamper and low field alarms will both indicate any attempt to tamper with the magnetic field of the iPERL system.

AMR/AMI SYSTEMS: iPERL systems are compatible with current Sensus AMR/AMI systems.

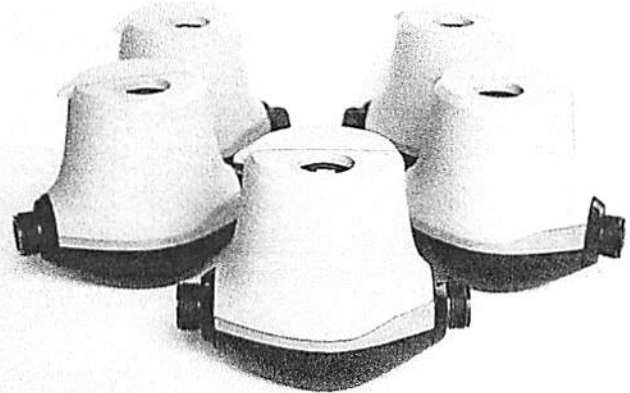

Electronic Register LCD Display

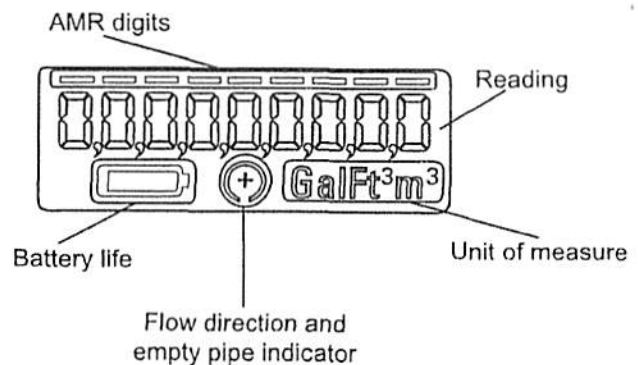

Copyright © 2010 Sensus.
iPERL is a trademark of Sensus USA Inc.

Technology for the iPERL system is licensed from Sentec Limited.

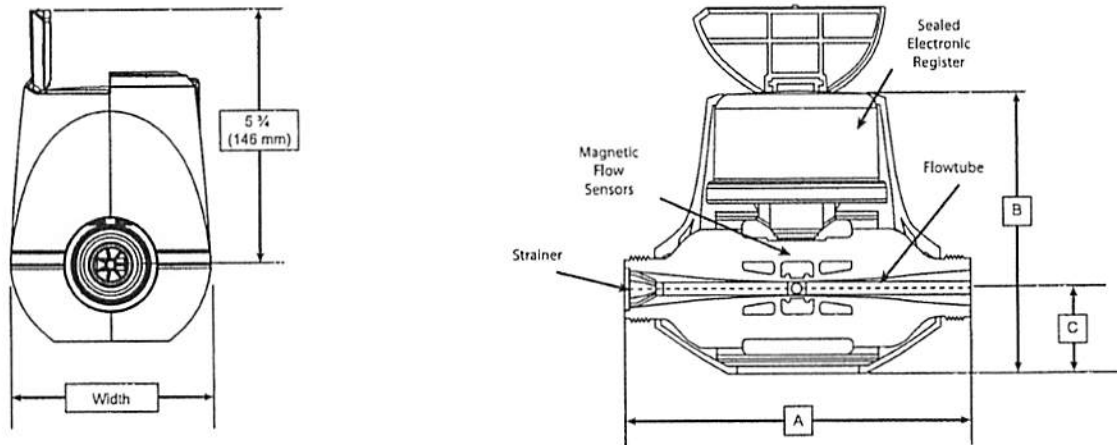

DIMENSIONS AND NET WEIGHTS

Size	A (lay length)	B	C	Spud Ends	NPSM Thread Size	Width	Net Weight
5/8" (DN 15 mm)	7-1/2" (190 mm)	6-1/10" (155 mm)	1-3/4" (44 mm)	5/8" (15 mm)	3/4" (19 mm)	4-1/2" (114 mm)	3.1 lb. (1.4 kg)
3/4" S (5/8" x 3/4") (DN 20 mm)	7-1/2" (190 mm)	6-1/10" (155 mm)	1-3/4" (44 mm)	3/4" (20 mm)	1" (25 mm)	4-1/2" (114 mm)	3.1 lb. (1.4 kg)
3/4" (DN 20 mm)	9" (229 mm)	6-1/10" (155 mm)	1-3/4" (44 mm)	3/4" (20 mm)	1" (25 mm)	4-1/2" (114 mm)	3.2 lb. (1.5 kg)
1" (DN 25 mm)	10-3/4" (273 mm)	6-1/10" (155 mm)	1-3/4" (44 mm)	1" (25 mm)	1-1/4" (32 mm)	4-1/2" (114 mm)	3.3 lb. (1.6 kg)

SPECIFICATIONS

SERVICE	Measurement of cold water with flow in one direction only.
NORMAL OPERATING FLOW RANGE (100%±1.5% of actual throughput)	5/8" (DN 15mm) size: 0.11 to 25 gpm (0.02 m ³ /h to 5.7 m ³ /h) 3/4" (DN 20mm) size: 0.11 to 35 gpm (0.02 m ³ /h to 8.0 m ³ /h) 1" (DN 25mm) size: 0.4 to 55 gpm (0.09 m ³ /h to 12.5 m ³ /h)
LOW FLOW REGISTRATION (95%-101.5%)	5/8" (DN 15mm) size: 0.03 gpm (0.007 m ³ /h) 3/4" (DN 20mm) size: 0.03 gpm (0.007 m ³ /h) 1" (DN 25mm) size: 0.11 gpm (0.025 m ³ /h)
MAXIMUM PRESSURE LOSS	5/8" (DN 15mm) size: 4 psi at 15 gpm (0.3 bar at 3.4 m ³ /h) 3/4" (DN 20mm) size: 2 psi at 15 gpm (0.1 bar at 3.4 m ³ /h) 1" (DN 25mm) size: 2 psi at 25 gpm (0.1 bar at 5.7 m ³ /h)
MAXIMUM OPERATING PRESSURE	200 psi (13.8 bar)
MEASUREMENT TECHNOLOGY	Solid state electromagnetic flow

REGISTER	Hermetically sealed, tempered glass covered 9-digit programmable electronic register AMR/AMI compatible iPERL system register programmable using the UniPro programming package iPERL systems are shipped in active mode
MATERIALS	External housing – Thermal plastic Flowtube – Polyphenylene sulfide alloy Electrode – Silver/silver chloride Strainer – Synthetic polymer Register cover – Tempered soda lime glass
ALARM DEFAULTS	Alarm Duration – 90 days Leak Duration – 24 hours Datalog Interval – 1 hour Alarm Mask – All alarms reported History Mask – All event types reported

HEADLOSS CURVES

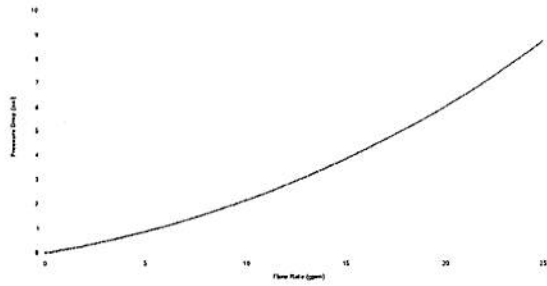

5/8" Headloss Curve

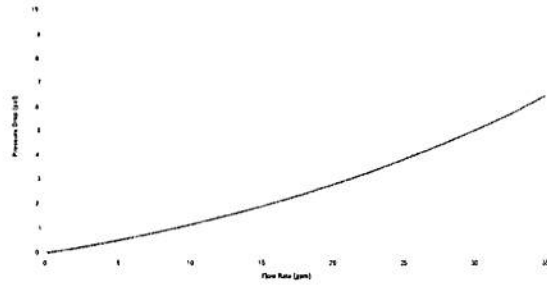

3/4" Short Headloss Curve

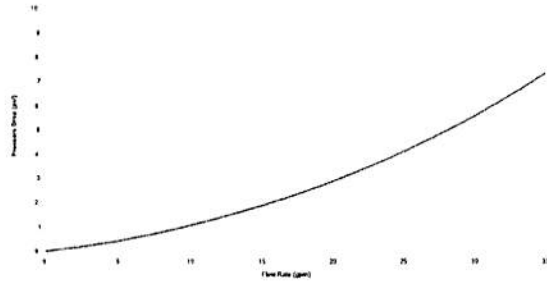

3/4" Headloss Curve

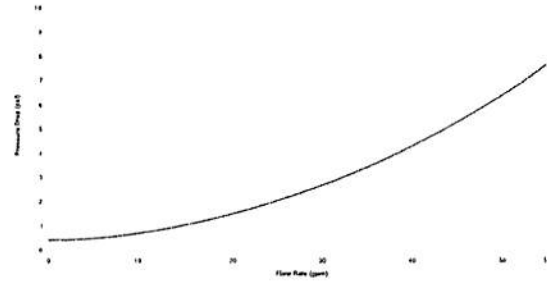

1" Headloss Curve