

EQO O QPY GCNVJ 'QHMGPVWEMJ "

DGHQTG'VJ G'MGPPVWEMJ 'UVCVG'DQCTF'QP'GNGEVTKE'I GP'GTCVKQP "
CPF'VTCPUO KUKQP'UKVPI "

"

KP'VJ G'O CVVGT'QH'

"

VJ G'GNGEVTQPKE'CRRNKE CVKQP'QH	+'	
Y GK'U'ETGGMUQNCT.'NNE'HQT'C"	+'	
EGTVHKE CVG'VQ'EQPUVTWEV'CP "	+'	
CRRTQZKO CVGN['372'O GI CY CVV	+'	
O GTEJ CP V'UQNCT'GNGEVTKE	+'	ECUG'PQ0'
I GP'GTCVKPI 'HCEKNK['R'Y GDUVGT	+'"	4246/222;;
EQWPV[CPF'J QRMPUEQWPV[.''''''''''	+'	
MGPVWEMJ 'RWTUWCP V'VQ'MTU'49: 022	+'	
GVUGS 0CPF'!: 29'MCT'7-332 ""	+'	

aa

Y GK'U'ETGGMUQNCT.'NNE'UTGURQPUGU'VQ'UKVPI 'DQCTF'UVCHHU'HKTUV"
TGS WGV'HQT'KPHQTO CVKQP ""

aa

" Ego gu'pqy "Y gktu'EtggniUqrcr.'NNE"*öY gktu'Etggmö"qt"öy g'Cr r rkecpö+."d{ "eqwpugn"cpf "
f qgu"j gtgd{ "vgpf gt"ku""T gur qpugu"vq"UkVpi "Dqctf "Uchhu" Hktuv" T gs wguv'ht "Kphqto cvkqp" gpvgtgf "
Lypg"44."42460""

"
"
"
"
"
"
"
"
"
"
"

Hkpf <"Cwi wuv'7."4246"" "

COMMONWEALTH OF KENTUCKY
BEFORE THE KENTUCKY STATE BOARD ON
ELECTRIC GENERATION AND TRANSMISSION SITING

IN THE MATTER OF:

THE ELECTRONIC APPLICATION OF)
WEIRS CREEK SOLAR, LLC FOR A)
CERTIFICATE TO CONSTRUCT AN)
APPROXIMATELY 150 MEGAWATT)
MERCHANT SOLAR ELECTRIC)
GENERATING FACILITY AND RELATED)
NONREGULATED TRANSMISSION LINE)
IN WEBSTER COUNTY AND HOPKINS)
COUNTY, KENTUCKY PURSUANT)
TO KRS 278.700 ET SEQ. AND 807 KAR 5:110)

CASE NO. 2024-00099

VERIFICATION OF ELIZABETH WILBURN

STATE OF KENTUCKY)

COUNTY OF FAYETTE)

Co Comes now Elizabeth Wilburn of ECT, Consultant for Weirs Creek, LLC, being first duly sworn, and states that she has supervised the preparation of certain responses of Weirs Creek Solar, LLC to the Siting Board Staff's First Request for Information in the above-referenced case, and that the matters and things set forth therein are true and accurate to the best of her knowledge, information and belief, formed after reasonable inquiry.

Elizabeth Wilburn

Elizabeth Wilburn

Subscribed and sworn to before me on this

1st

day of August 2024

L. Alyson Houth

Notary ID: *KYNP76727*

Expires: *8/2/27*

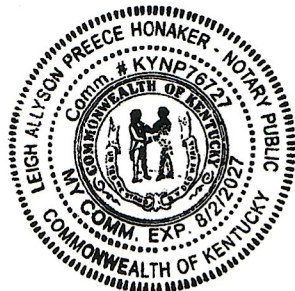

COMMONWEALTH OF KENTUCKY

BEFORE THE KENTUCKY STATE BOARD ON
ELECTRIC GENERATION AND TRANSMISSION SITING

IN THE MATTER OF:

THE ELECTRONIC APPLICATION OF)
WEIRS CREEK SOLAR, LLC FOR A)
CERTIFICATE TO CONSTRUCT AN)
APPROXIMATELY 150 MEGAWATT)
MERCHANT SOLAR ELECTRIC)
GENERATING FACILITY AND RELATED)
NONREGULATED TRANSMISSION LINE)
IN WEBSTER COUNTY AND HOPKINS)
COUNTY, KENTUCKY PURSUANT)
TO KRS 278.700 ET SEQ. AND 807 KAR 5:110)

CASE NO. 2024-00099

VERIFICATION OF LESTER MORALES

STATE OF KENTUCKY)

COUNTY OF FAYETTE)

Comes now Lester Morales, Lead Project Manager of NextEra Energy Resources, Inc., being first duly sworn, and states that he has supervised the preparation of certain responses of Weirs Creek Solar, LLC to the Siting Board Staff's First Request for Information in the above-referenced case, and that the matters and things set forth therein are true and accurate to the best of his knowledge, information and belief, formed after reasonable inquiry.

Lester Morales

Subscribed and sworn to before me on this 15th day of August 2024.

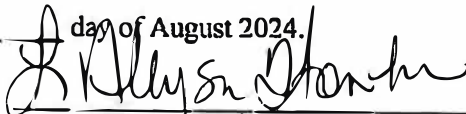
Notary ID: JK4N P76727
Expires: 8/2/27

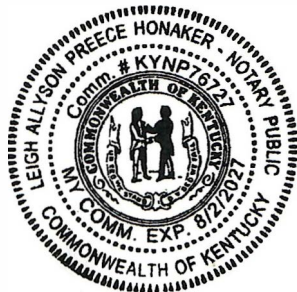

COMMONWEALTH OF KENTUCKY

BEFORE THE KENTUCKY STATE BOARD ON
ELECTRIC GENERATION AND TRANSMISSION SITING

IN THE MATTER OF:

THE ELECTRONIC APPLICATION OF)
 WEIRS CREEK SOLAR, LLC FOR A)
 CERTIFICATE TO CONSTRUCT AN)
 APPROXIMATELY 150 MEGAWATT)
 MERCHANT SOLAR ELECTRIC) CASE NO. 2024-00099
 GENERATING FACILITY AND RELATED)
 NONREGULATED TRANSMISSION LINE)
 IN WEBSTER COUNTY AND HOPKINS)
 COUNTY, KENTUCKY PURSUANT)
 TO KRS 278.700 ET SEQ. AND 807 KAR 5:110)

VERIFICATION OF ESTHER ATKINSON

STATE OF FLORIDA)

COUNTY OF PALM BEACH)

Comes now Esther Atkinson, Engineering and Construction Project Manager of NextEra Energy Resources, Inc., being first duly sworn, and states that he has supervised the preparation of certain responses of Weirs Creek Solar, LLC to the Siting Board Staff's Second Request for Information in the above-referenced case, and that the matters and things set forth therein are true and accurate to the best of his knowledge, information and belief, formed after reasonable inquiry.

Esther Atkinson
Esther Atkinson

Subscribed and sworn to before me on this 2nd day of August 2024.

Jennifer Reynoso
Notary ID: HH091424
Expires: 2-21-25

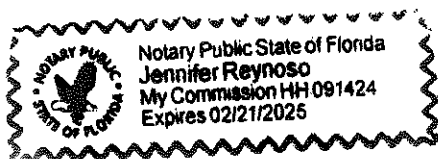

COMMONWEALTH OF KENTUCKY

BEFORE THE KENTUCKY STATE BOARD ON
ELECTRIC GENERATION AND TRANSMISSION SITING

IN THE MATTER OF:

THE ELECTRONIC APPLICATION OF)	
WEIRS CREEK SOLAR, LLC FOR A)	
CERTIFICATE TO CONSTRUCT AN)	
APPROXIMATELY 150 MEGAWATT)	
MERCHANT SOLAR ELECTRIC)	CASE NO. 2024-00099
GENERATING FACILITY AND RELATED)	
NONREGULATED TRANSMISSION LINE)	
IN WEBSTER COUNTY AND HOPKINS)	
COUNTY, KENTUCKY PURSUANT)	
TO KRS 278.700 ET SEQ. AND 807 KAR 5:110)	

VERIFICATION OF BRIAN BARTELS

STATE OF FLORIDA)

COUNTY OF PALM BEACH)

Comes now Brian Bartels, Senior Environmental Specialist of NextEra Energy Resources, Inc., being first duly sworn, and states that he has supervised the preparation of certain responses of Weirs Creek Solar, LLC to the Siting Board Staff's First Request for Information in the above-referenced case, and that the matters and things set forth therein are true and accurate to the best of his knowledge, information and belief, formed after reasonable inquiry.

Brian Bartels
Brian Bartels

Subscribed and sworn to before me on this 29th day of July 2024.

Jennifer Reynolds
Notary ID: 6H091424
Expires: 2-21-25

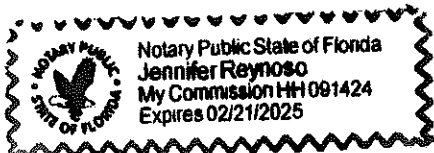

Tgur qpug'3"

Rci g'3qh'3"

Y kpguu<"Ngungt'O qtcngu"

"" "" "" "" ""

Y gk u'Et ggmUqret.'NNE'''

Ecug'P q04246/222; ;'''

Uslpi 'Dqctf 'Uclhu'Hkt u' Tgs wguv'ht 'kphqto cvkqp'''

"

Tgs wguv'3<"F gvckl'cp { "eqo o wplecvkqp'y kj 'o go dgtu'qh'yj g'r wdrk. 'kpenwf kpi 'pgki j dqt kpi "

mpf qy pgtu. 'tgi ctf kpi "eqputwevkap'pqkug0"

Tgur qpug'3<'

Vj gtg'j cu'dggp'pq'ur gekhe"eqo o wplecvkqp'y kj 'o go dgtu'qh'yj g'r wdrk. 'tgi ctf kpi "eqputwevkap"

pqkug'qyj gt 'yj cp'kphqto cnf kuewuukqp'kp'r wdrk 'o ggkpi u0"Ugg'yj g'Tgur qpug'vq'Kgo '85'ht'yj g"

rmpu'vq'kphqto 'yj g'eqo o wpkv { "cdqw'eqputwevkap'pqkug0"

"

"

Tgur qpug"4"
Rci g"3qh"4"
Y kpguu<"Dtkcp"DctvgnlDgy "Y krdwtp"

Y gkt u'Et ggmUqret.'NNE''
Ecug'P q04246/222; ; ''

Uslpi 'Dqctf 'Uclhau'Hkt u'Tgs wguv'ht 'kphqto cvkqp''

Tgs wguv'4<"Rtqxf g'c'rkuv'qh'r gto ku'vj cv'y kn'dg'tgs wktgf 'htqo 'cp{ 'qy gt'hqecn'ucvq."qt'hgf gtcn'
ci gpekgu'ht'vj g'r tqlgev'0kpenmf g'lp'vj g'tgur qpug'vj g'ucwau'qh'vj qugr' gto ku0'

Tgur qpug'4<'

Vj g'rkuv'r tqxf gf "dgmjy "ku"e"eqo r t g j gpukxg'rkuv'qh'vj g'r qvgp'kcn'r gto ku'vj cv'eqwrf "dg"tki i gtgf "
d{ 'vj g'Rtqlgev="j qy gxgt."pqv'cm'qh'vj gug'r gto ku'ctg'rkngn' "i qkpi "vq"dg"cr r rkecdrg"vq"vj g'Rtqlgev'
Vj g'pggf 'hqt'gcej 'r gto kv'y kn'dg'tgxky gf "qpeg"c'hpcn'ukg'r rcp'ku'f gxgnr gf 0'

Gpxlt qpo gpvcn'

- Hgf gtcn'
 - WUCEG"626"P cvkqpy kf g"Rgto kv"PY R+/"vj ku'r tqlgev'y kn'rkngn' "ugrh/egt vkh{ "
wpf gt"c"PY R'36"o"pqv'uactvgf "vq"fcvg0'
- Ucvq"
 - Kpf kxkf wcn'623"Y cvgt'S wcnkv' "Egt vhlcvkqp"*Y SE+/"vj ku'r tqlgev'y kn'rkngn' "pqv"
tki i gt"vj g'pggf 'hqt"vj ku'r gto kv'o"pqv'uactvgf "vq"fcvg0'
 - Hqqf r rckp"o"vj ku'r tqlgev'y kn'rkngn' "pqv"tki i gt"vj g'pggf "hqt"vj ku'r gto kv'o"pqv"
uactvgf "vq"fcvg0'
- Eqwv{ "
 - Hqqf r rckp"o"vj ku'r tqlgev'y kn'rkngn' "pqv"tki i gt"vj g'pggf "hqt"vj ku'r gto kv'o"pqv"
uactvgf "vq"fcvg0' ki'cr r rkecdrg."vj g"Cr r rkecpv'y kn'tgxky "vj g'pggf "vq"qdvkqp"
eqpewttgpeg'htqo "dqy 'J qr nkpucpf "Y gduvgt"eqwvku0'

Pqp/Gpxlt qpo gpvcn

- Ucvq"

- I tqwpf y cvgt 'Rtqvgevkqp'Rncp'ó'pqv'uuctvgf 'vq'f cvg'ó'GRE'y kni'eqo r rvg'r tkqt 'vq' eqputwevkqp0'
- Y cvgt 'Y kj f tcy cn'Rgto k'ó'pqv'uuctvgf 'vq'f cvg'ó'GRE'y kni'eqo r rvg'r tkqt 'vq' eqputwevkqp0'
- Mgpwem{ " Rqmwcqv' F kiej cti g" Giko kpcvkqp" U{uygo " *MRF GU+" Eqputwevkqp" Uqto y cvgt " Rgto k' ó" pqv' uuctvgf " vq" f cvg" ó" GRE " y kni' eqo r rvg" r tkqt " vq" eqputwevkqp0'
- Mgpwem{ "Vtcur qt vvkqp'Ecdkpgv'MVE+'qxgty gli j vlxgt/f ko gpukqpcnr gto ku" cpf "gpetqcej o gpvr gto ku'ó'pqv'uuctvgf 'vq'f cvg'ó'GRE'y kni'gxcnvcg'vj g'pggf 'hqt" vj gug'r gto ku'r tkqt 'vq'eqputwevkqp0'
- Eqwpv{ "
 - Dwkf lpi "cpf 'GgextlecnRgto k'ó'pqv'uuctvgf 'vq'f cvg'ó'GRE'y kni'gxcnvcg'vj g'pggf " hqt'vj gug'r gto ku'r tkqt 'vq'eqputwevkqp0'

"

"

"

Tgur qpug'5"
Rci g'3qh'3"
Y kpguu<Dtkp"DctvgnlDgyj "Y krdwtp"

"
Y gkt u'Et ggmUqret.'NNE'''
Ecug'P q04246/222; ;'''
Uslpi 'Dqctf 'Uclhau'Hkt u'Tgs wguv'ht 'kphqto cvkqp'''

"
Tgs wguv'5<"Rtqxf g'c'f gckrgf "cdrg'hkupi "cm'tgukf gp'kcn'lutwewtgu'hqecvqf 'y kj lp'4.222'hggv'qh'

vj g'r tqlgev'dqwpf ct { 'hpg0Hqt "gcej 'utwewtg. 'r tqxf g-<"

c0 Vj g'f kucpeg'vq'vj g'dqwpf ct { 'hpg0'

d0 Vj g'f kucpeg'vq'vj g'emuguv'uqret 'r cpgr0'

"
e0 Vj g'f kucpeg'vq'vj g'pgctgukpxgtvt0'

"
f0 Vj g'f kucpeg'vq'vj g'uwducvqp0'

"
Tgur qpug'5<"

Vj g"Uqwpf "Cuuguuo gpv'kpenmf gf "cu"Gzj kdk'6"vq"vj g"Ukg"Cuuguuo gpv'Tgr qt v"*UCT+"kpenmf gu'cm'
qeewr kgf "utwewtgu"*kpenmf kpi "uej qqnu."ej wtej gu."tgukf gpegu."gve0"y kj lp'3/o kg"qh'vj g'r tqlgev"
dqwpf ct { 'hpg'y kj 'vj g'f kucpeg'vq'vj g'emuguv'uqret 'r cpgn'kpxgtvt."cpf "uwducvqp0"Ugg'vj g'Gzegri'
hkg'r tqxf gf "ugr ctcvgnl "hqt "c"eqo dkgf "cdrg'uj qy kpi "cm'qeewr kgf "utwewtgu'y kj lp'4.222'hggv'qh"
vj g'r tqlgev0'

**ATTACHMENT
IS AN EXCEL
SPREADSHEET
AND UPLOADED
SEPARATELY**

Tgur qpug'6"
Rci g'3qh'3"
Y kpguu<Dtkp"Dct vgnlDgy "Y krdwtp"

"

Y gkt u'Et ggmUqret.'NNE'''

Ecug'P q04246/222; ;'''

Uslpi 'Dqct f 'Uc htu' Hkt u' Tgs wguv' hqt 'kphqt o cvkqp'''

"

Tgs wguv'6<"Rtqxkf g'c'f gvckrgf "cdrg'hkxkpi 'cm'lpqp/tgukf gp'vkn'utwewt gu'iqecvqf 'y kj kp'4.222"

hggv'qh'vj g'r tqlgv'dqwpf ct { 'hpg0Hqt "gcej "utwewt.g.'t qxkf g<"

c0 Vj g'f kxcpeg'vq'vj g'dqwpf ct { 'hpg0'

d0 Vj g'f kxcpeg'vq'vj g'emquguv'uqret 'r cpgr0'

"

e0 Vj g'f kxcpeg'vq'vj g'pgctguv'kpxgtvgt0'

"

f0 Vj g'f kxcpeg'vq'vj g'uwduxv'kqp0'

"

"

Tgur qpug'6<'

Rrgcug'ugg'vj g'Tgur qpug'vq'Kgo '5"cpf 'vj g'Gzegni'krg'r tqxkf gf 'ugr ctcvgn(0'''

"

Tgur qpug'7"
Rci g'3qh'3"
Y kpguu<"Ngugt 'O qtcrgu"

"

Y ght u'Et ggnlUqnt.'NNE'''
Ecug'P q04246/222; ;'''
Uslpi 'Dqctf 'Uc hzu' Hlt ur' Tgs wguv' hqt 'Kphqto cvkqp'''

"

Tgs wguv'7<"Gzr mlp'y j gj gt"eqpwt wekqp"cevxkkgu'y kn'qeew"ugs wgpvkcml "qt"eqpewttgpvnl "

cetquu'vj g'r tqlgev'ukg0'

Tgur qpug'7<'

Vj g"eqpwt wekqp"cevxkkgu'y kn'qeew"ugs wgpvkcml "cetquu'vj g'r tqlgev'ukg0"

"

"

"

Tgur qpug'8"
Rci g"3qh'3"
Y kpguu<Ngungt'O qtcngu'"

"

Y gkt u'Et ggmUqret.'NNE'''

Ecug'P q04246/222; ;'''

Uslpi 'Dqctf 'Uclhu'Hkt u'Tgs wguv'ht 'kphqto cvkqp'''

"

Tgs wguv'8<"Enctkh{ 'y j gj gt'cp{ 'gzkukpi 'utwewtgu'qp'vj g'r tqlgev'ukg'y kmldg'f go qrkuj gf "qt"

tgo qxgf 'kp'qtf gt'v'cee qo o qf cvg'vj g'r tqlgev0

Tgur qpug'8<'

P q'gzkukpi 'utwewtgu'ctg'r rppgf 'v'dg'tgo qxgf "qt" f go qrkuj gf "cv'vj ku'vko g0

"

"

Tgur qpug'9"
Rci g'3qh'3"
Y kpguu<Dtkcp"DctvgnlDgy "Y krdwtp"

"

Y gkt u'Et ggmUqret.'NNE'''

Ecug'P q04246/222; ;'''

Uslpi 'Dqctf 'Uclhu'Hkt u'Tgs wguv'ht 'kphqto cvkqp'''

"

Tgs wguv'9<"Rtqxf g"cpcttcvkg"fguetkr vkp"qh'cp{ "xgi gcvkg"engctkpi "vj cv'y kn'qeew"cetquu'vj g"
rtqlge\0kpenf g"cpvlek cvgf "cetgci g"cpf "cp{ 'r gto ku'vj cv'y kn'dg'tgs wktgf 0'

'Tgur qpug'9<

Cr r tqzko cvgn("320 "cetgu"qh'v'gguy kn'dg"engctgf "kp"vj g"Rtqlgev' Ctgco'Vj ku"v'gg"engctkpi "ku"
rtlo ctkf "cuuqekcvf "y kj "uo cm'y qqf m'u'cpf "j gf i gtqy u'vj cv'y kn'pggf "vq'dg"engctgf "hqt'hpepf "
cttc{ 'ctgcu'cpf 'ceegu'tqcf "etquukpi u0P q'r gto ku'ctg'gzr gev'vq'dg'tgs wktgf "cv'vj ku'vko g0'

"

"

Tgur qpug": "
Rci g"3qh"3"
Y kpguu<Dtkcp"DctvgnlDgy "Y krdwtp"

"

Y gkt u'Et ggmUqret.'NNE''

Ecug'P q04246/222; ; ''

Uslpi 'Dqctf 'Uclhu'Hkt u'Tgs wguv'ht 'kphqto cvkqp''

"

Tgs wguv'<"Eqphkto 'y j gyj gt'xgi gcvkxg'engctkpi 'y km'dg'tgs wktgf "vq"ceeqo o qf cvg'yj g'r tqr qugf "

35: "mX."2Q /o kg/nqpi "vcpuo kukqp"rpg0'k" { gu."r tqxkf g"y g"cpvlekr cvgf 'betgei g"qh"xgi gcvkxg"

engctkpi "cpf "cp{ 'r gto ku'y cv'y km'dg'tgs wktgf 0'

Tgur qpug'<

P q'tgg'engctkpi 'ku'cpvlekr cvgf 'kp'y g'vcpuo kukqp"rpg'eqttkf qt0'

"

"

"

"

"

Tgur qpug"; "
Rci g"3qh"3"
Y kpguu<Dtkcp"DctvgnlDgy "Y krdwtp"

"

Y gkt u'Et ggmlUqret.'NNE'''

Ecug'P q04246/222; ;'''

Uslpi 'Dqctf 'Uclhau'Hkt ur'Tgs wguv'ht 'kphqto cvkqp'''

"

Tgs wguv'<"Eqphkto 'y j gvj gt'vj g'ukg'y kn'dg'ktti cvg'vq'r tqo qvg'xgi gvcvkqp0k'pqv."gZR mlp'y j {"
pqv0'

Tgur qpug'<'

Vj gtg"ctg"o cp{"hcevqtu"vq"eqpukf gt"y j gp"f kuewuukpi "vj g'pggf "vq"ktti cvg'xgi gvcvkqp."kpenw lpi "
vj lpi u'uwej "cu"v{r gu"cpf "ur geku"qh'r rcpwu"dgkpi "wugf ". "ko g"qh'r rcpvkpi ."cpf "y gvj gt"eqpf kkpqu"
*f tqwi j wu."gve00'C"ukg/ur gekkle"xgi gvcvkqp"o cpci go gpv'r rcp"y kn'dg"r tgr ctgf "d{ "vj g"ugrgevfg "
xgi gvcvkxg" uggf lpi " cpf " o cpci go gpv' eqpvtcevqt" r tkqt" vq" eqpvtwevkqp" vj cv' y kn' veng" kvq"
eqpukf gtevkqp"vj g'pggf "vq"ktti cvg'vq'r tqo qvg'cpf "o clpvclp"vj g'iqpi gxkv{ "qh'vj g'xgi gvcvkqp"qpukg0'

Tgur qpug'32"
Rci g'3qh'3"
Y kpguu<"Nguvt'O qtcngu"

"

Y gkt u'Et ggmUqret.'NNE'''
Ecug'P q04246/222; ;'''

Uslpi 'Dqctf 'Uclhau'Hkt u' Tgs wguv'ht 'kphqto cvkqp'''

"

Tgs wguv'32<"Ceeqtf kpi 'q'vj g'Cr r rlecvkqp.'vj g'qvcn'cetgci g'qh'vj g'r ctegnukpenwf gf 'kp'vj g'r tqlgev'
dqwpf ct { 'ku'cr r tqzko cvgn' "4.482"cetgu0Y kj kp'vj ku'Rtqlgev'ctgc.'vj g'hqqr tkp'qh'vj g'r tqlgev'y km'
qpn' "dg'cr r tqzko cvgn' ": 32"cetgu0Gzr rkp'y j { "4.482"cetgu'y gtg'rcugf 'hqt'vj ku'r tqlgev'y j gp'qpn' "
: 32'y km'dg'wugf 'hqt'grgevtle'i gpgtcvkqp'r wtr qugu0'

Tgur qpug'32<'''

I gpgtcm' ".y j gp'f gxgnr kpi "wkrkv' "uecng"uqret'r tqlgevu."c'r tqlgev'rcugu"ci tgcvtg'r tqlgev'ctgc"vq"
cmqy "hqt'dgvtg'uklpi "qr r qtwpklgu"cpf "qr vkpu"cu'vj g'r tqlgev'o cwtgu'kpq"cf guki p'r j cug0'Vj g"
cxckrdng"cetgci g'wpf gt "rcug"gpdcngu"vj g'r tqlgev'vq"cxqkf "ugpukkg"ctgcu."ceeqpvp'hqt"tgs wktgf "
ugdcemu."vgttclp"*qr qi tcr j { +."gpi kpggtkpi "cpf "f guki p"eqpukf gtcvkqpu."gpvktqpo gpvcn'tguqwtegu."
cpf "gzenvukqp"ctgcu0"

Vj wu."y j kng"4.482"cetgu'y cu'rcugf "hqt"vj g'r tqlgev."k'ku"guvko cvgf "vj cv'cr r tqzko cvgn' ": 32"cetgu"
y km'dg'wugf "hqt'grgevtle'i gpgtcvkqp0'Wr qp"vj g'hkpcn'f guki p."cp { "cetgci g'vj cv'ku'pqv'wkrk' gf "hqt"
grgevtle'i gpgtcvkqp'r wtr qugu."cpf "qwuikf g'qh'vj g'hpeg'hkpg'ecp'dg'tgwtpgf 'q'ci tlewnwtcn'qr gtcvkqpu"
cv'vj g'kpf kxf wcn'rcpf qy pgt'au'f kuetgkqp0'''

"

"

Tgur qpug'33"
Rci g'3qh'3"
Y kpguu<"Nguyt'O qtcngu"

"

**Y gkt u'Et ggmlUqret.'NNE'''
Ecug'P q04246/222; ;'''**

Uslpi 'Dqctf 'Uclhu'Hkt u'Tgs wguv'ht 'kphqto cvkqp'''

"

Tgs wguv'33< " Rtqxf g" cp{" eqo o wplecvkqpu" y kj " yj g" Y gduvgt" cpf " J qr nkpu" Eqwpv{ " Tqcf "
F gr ctvo gpv'tgi ctf kpi "r gto ku'qt"ci tgggo gpv'pgeguuct { "hqt"yj g'r tqlgeu'0ki'pq"eqo o wplecvkqp"j cu"
dggp'kpkkcvf . "gzi rkp"y j gp"yj cv'eqpcev'y kni'qewt'0

"

Tgur qpug'33<

C"dtlgh'kpvtf wvkap"cpf "kpkkn'f kuewuukqp"y kj "yj g"Y gduvgt"Eqwpv{ "Tqcf u"F gr ctvo gpv'qewt'gf "
qp'kcpwct { "5."42460"Vj g'eqo o wplecvkqp"egpvt'gf "qp"yj g'tgs wkt go gpv'ht"Y gkt u'Et ggml'v"guvdrkuj "
c"tqcf "Wug"ci tgggo gpv'y kj "Y gduvgt"Eqwpv{ . "uko krt"v"qy gt"wkiv{ "uecrg"uqrcr"r tqlgeu"m'ecvfg "
k"Y gduvgt"Eqwpv{ ."Ml 0'Vj gt g"j cu"pqv'dggp"cp{ "ur gekhe"eqo o wplecvkqp"tgi ctf kpi "r gto ku'qt"
ci tgggo gpv'y kj "yj g"J qr nkpu"Eqwpv{ 'Rwdne"Y qtmu"tqcf 'F gr ctvo gpv'0Eqo o wplecvkqp"cpf 'hqmly "
qp'f kuewuukqpu'ct g'r tqlgevfg "v"q'qewt'k"yj g'6'j 'S wctvgt'qh'42460Y gkt u'Et ggml'v'gpv' u'v"q'qdvkcp"cp{ "
tgs wkt'gf "r gto ku'qt"ci tgggo gpv'ht'qo "dqy "Y gduvgt"cpf "J qr nkpu"Eqwpv{ 0"

Tgur qpug'34"
Rci g'3qh'3"
Y kpguu<"Nguvt'O qtcngu"

"

Y gktu'Etggm'Uqret.'NNE''

Ecug'P q04246/222; ; ''

Uslpi 'Dqctf 'Uc'hu'Hktu'Tgs wguv'ht 'kphqto cvkqp''

"

Tgs wguv'34<"Rtqxf g'cp{ "eqo o wplecvkqp"y kj "yj g'Mgpwem{ "Vtcur qtvcvqp"Ecdkpgv'tgi ctf lpi "

r gto ku'qt"ci tgggo gpw'pgeguuct{ "hqt"yj g'r tqlge'0k'pq"eqo o wplecvkqp"j cu'dggp'kpkcvgf ."gzn rkp"

y j gp'yj cv'eqpcev'y kniqeewt0'

Tgur qpug'34<'

"

P q"eqo o wplecvkqp"tgi ctf lpi "r gto ku'qt"ci tgggo gpw'y kj "yj g'M VE"j cu'qeewt'gf "vq"fcvg'0kpkcn'

eqpcev'ku'cpvkr cvgf "vq"qeewt'kp"yj g'Hqwt'y "S wctvgt"qh"42460Y gktu'Etggm'Uqret'y kn'qdvkqp"cp{ "

r gto ku'qt"ci tgggo gpw"MV"tgs wktgu0'

"

"

T gur qpug'35"
Rci g'3qh'4"
Y kpguu'Nguvt'O qtcngu'"

**Y gkt u'Et ggmUqret.'NNE''''
Ecug'P q04246/222; ; ''**

Uslpi 'Dqctf 'Uc hhu' Hkt u' Tgs wgu' hqt 'kphqt o cvkqp''''

Tgs wgu'35<"Rtqxf g'c"qpg/r ci g'f k gcvkpcnib cr "uj qy kpi 'j ki j rki j vgf "cpvkek cvgf 'f grkxgt { 'tqwgu"
hqt "y g'r tqlgev'0'kpenmf g'y g'hqmny kpi "qp"y g'o cr <"ceeguu'tqcf u."ceeguu'r qkpu."gzkukpi "tqcf u."
dtkf i gu."grgevtle'i gpgtcvkkp"eqo r qpgpvu."cpf "cm'utwewtgu'y kj kp'y q'o krgu'qh'y g'r tqlgev'

Tgur qpug'35<

Vj g'Vtchle'Uwf { 'kpenmf gf "cu'Gzj kdk'8'lp'y g'UCT'kpenmf gu'c'o cr "qh'y g'Rtqlgev'y kj "y g'ceeguu"
r qkpu"*rdgrgf "cu'ukvg"gpvtcpegu+"cpf 'r tqr qugf "kpvtkqt "ceeguu'tqcf u'vq'y g'hgpegf "cttc { "ctgcu0"

J cwitqwgu'hqt "y g'Rtqlgev'j cxg'pqv'dggp'f gvgto kpgf "v'f cvg0Vj g'Gpi kpggtkpi 'Rtqewtgo gpv'
Eqputwvkkp "GRE+"eqpvcevt."qpeg" qpdqctf gf . "y km'ckf "kp" f gvgto kpkpi "y g'j cwi' tqwgu" cpf "
kf gpvkh { "cp { "gzkukpi "dtkf i gu"qt"qy gt"tqcf "hgcwtgu"y cv'eqwf "dg'r qvqpvkcm { "chgevgf "f wtkpi "
eqputwvkkp "v'y g'ukg0Vj g'Cr r rkecpv'r tqxf gf "c'Rtqlgev'Nqecvkkp'O cr "y kj "y g'cr r rkecvkkp"y cv'
uj qy u"cm'tgukf gpegu'y kj kp'y q"*4+"o krgu'qh'Rtqlgev'dqwpf ct { 0'Vj g'Rtqlgev'Nqecvkkp'O cr "cnuq"
kpenmf gu'qeer kcf "utwewtgu'wej "cu'uej qqn'cpf "ej wtej gu0'

Vj g'GRE "y km'y qtm'y kj "y g'Cr r rkecpv'vq"lphqto "cpf "qdvkpv'r gto ku'htqo "Ucvg"cpf "rqecn"
tqcf "cwj qtkkku"cu'pggf gf "hqt"Emuu'43"xgj keng"vcpur qt'vq"y g'ukgu0Tqcf "qhkekcu"y km'j gr "
kf gpvkh { "cp { "ur gekn'vcpur qt'vkkp"tgs wktgo gpvu'hqt"j gcx { "vtwemu" f wtkpi "eqputwvkkp"*gd 0"y g'
pggf "v'cxqkf "gzkukpi "dtkf i gu."y g'pggf "v'tgkphqteg"qt'tco r "qxgt"gzkukpi "dtkf i gu'hqt'y j kej "y gtg"
ku'pq" f gqwt."f gqwtu'qh'j ki j y c { "vchle."qt"vgo r qtct { "emuwgu'0'Vj g'GRE"cpf "y g'Cr r rkecpv'y km'
eqo r n { "y kj "cm'r gto k'tgs wktgo gpvu"cpf "y km'eqqtf kpcvg"y kj "r tqr gt"tqcf "qhkekcu"cu'pggf gf "

*Mgpwem{ " Ucvg" J ki j y c{ " F gr ctwo gpv" Gpetqcej o gpv" Rgto kv" Qxgty gli j vQxgt/fko gpukqpcn'

r gto ku.'Eqwpv{ "cpf "Ucvg'F tkxgy c{ 'r gto ku."gve0f0'

"

"

"

"

Tgur qpug'36"
Rci g'3qh'3"
Y kpguu<Guj gt'Cvirkpuqp"

"

**Y gkt u'Et ggmUqret.'NNE'''
Ecug'P q04246/222; ;'''**

Uslpi 'Dqctf 'Uclhu'Hkt u' Tgs wguv'ht 'kphqto cvkqp'''

"

Tgs wguv'36<"Rtqxf g'y g'hqmy kpi 'kphqto cvkqp'eqpegtkpi "xgj keng'tchke<"

"

c0 Rtqxf g'y g'y gki j v'iko ku'qh'gcej "hqcni'tqcf y c{ 'v' dg'wugf 'hqt'eqputwekqp'tchke0'

d0 Rtqxf g'y g'pwo dgt'qh'y qtmgt'xgj kengu'tcxgrkpi "v'y g'ukg'gcej 'f c{ 'f wtkpi 'eqputwekqp0'

e0 Rtqxf g'y g'pwo dgt'cpf "cr r tqzko cvg'y gki j v'encuugu'qh'y g'j gcx{ "cpf "rki j v'f w{ "t wenu"
cpvlekr cvgf "qp'ukg'r gt'f c{ 'f wtkpi 'y g'eqputwekqp'r j cug0'

f0 Rtqxf g'y g'guko cvgf 'y gki j v'qh'y g'r tqlgewu'tgs wktgf 'uwdxv'kqp'tcpuhqto gt'cpf 'y g'twenu'
encuu'pgeguuct { 'hqt'ku'f grkxgt { 0'

"

Tgur qpug'36<'

Ugg'y g'Tgur qpug'v'Kgo '350J cwn'tqwwu'ht'y g'Rtqlgev'j cxg'pqv'dggp'f gvgto kpgf "v'f cvg0'Qpeg"
y g"GRE" f gvgto kpgu'y g'j cwn'tqwwu'v' dg'wugf 'f wtkpi 'eqputwekqp. "y g'kphqto cvkqp"tgs wguv'f "
cdqyg'ecp'dg'r tqxf gf "cu'pgeguuct { 0'

"

"

"

"

Tgur qpug'37"
Rci g'3qh'3"
Y kpguu<"Nguvt'O qtcngu"

"

Y gkt u'Et ggmUqret.'NNE'''

Ecug'P q04246/222; ;'''

Uslpi 'Dqctf 'Uclhu'Hkt u'Tgs wguv'ht 'kphqto cvkqp'''

"

Tgs wguv'37<"Tghgt"vq"Ukg'Cuuguuo gpv'Tgr qtv*UCT+.'r ci g'33.'O kki cvkqp'O gcwtg'33<'Nku'vj g"

r gto ku'vj cv'y km'dg'qdvckpgf "r tkqt"vq"dtkpi kpi "kp"j gcx{ 'hqcf u0'

Tgur qpug'37<'

Ugg'vj g'Tgur qpug"vq"Kgo '350Vj g'Cr r rkecpv'cpvlekr cvgu'vj g'pggf "vq'tgxkgy "vj g'cr r rkecdkkr{ "qh'vj g"

ucvq"cpf "eqwpv{ "gpetqcej o gpv'r gto ku."qxgty gli j vlqxt/f ko gpukqpcn'r gto ku."cpf "f tkxgy c{ "

r gto ku"cpf "y km'qdvckp"cu"pgeguuct { 0'Eqqtf kpcvkap"y kj "vj g"eqwpv{ "gpi kpggtu"ku"cpvlekr cvgf "vq"

f kuewu'j cwitqwguc'cu'pgeguuct { 0'

"

"

Tgur qpug'38"
Rci g'3qh'3"
Y kpguu<Guyj gt'Cvirkpuqp"

"

Y gkt u'Et ggmUqret.'NNE''
Ecug'P q04246/222; ; ''

Uslpi 'Dqctf 'Uchlhu'Hkt u'Tgs wguv'ht 'kphqt o cvkqp''

"

Tgs wguv'38<"Tghgt'v'Cr r nekcvkqp'6'Gzj kdk'34.'Cwcej o gpvC.'Gzj kdk'8.'Vtchhe"cpf 'F wuv'Uwf {."

40450Rtqxkf g"vj g"gzr gevfg "pwo dgt"qh'eqputwekqp"xgj kergu"gpvgtkpi "cpf "gzkkpi "Gpvtcpeg"hqwt"

*6+"gcej 'fc{0'

Tgur qpug'38<'

Y gkt u'Et ggmUqret"cpvlekr cvgu'32/42"eqputwekqp"xgj kergu"gpvgtkpi "cpf "gzkkpi "ukg"gpvtcpeg"hqwt"

*6+"*cu'uj qy p"kp"Gzj kdk'34."Cwcej o gpvC."Gzj kdk'8."Vtchhe"cpf "F wuv'Uwf {."4045-0'P qvg"vj cv"

eqputwekqp"vtchhe"cv'vj ku"gpvtcpeg"ku"pqv'cpvlekr cvgf "vq"qeew"fvtkpi "vj g"gpvktgv{"qh'Rtqlgev"

eqputwekqp"cu'vj g"eqputwekqp"qh'vj g"cttc{u'y km'qeew"ugs wgpvkm{0'

Tgur qpug'39"
Rci g'3qh'3"
Y kpguu<"Guyj gt'Cvukpuqp"

"

Y gkt u'Et ggmUqret.'NNE''
Ecug'P q04246/222; ; ''

Uslpi 'Dqctf 'Uc htu' Hkt u' Tgs wgu' hqt 'Iphqt o cvkqp''

"

Tgs wgu'39<"K gpvh{ "cm'dtkf i gu'cmipi "cm'tqcf u'r tqr qugf "vq"dg"wgf "f wtkpi "vj g'f grkxgt { "cpf " eqputwekqp'r j cug'qh'vj g'r tqlgex0K gpvh{ 'vj g'y kf vj "cpf "y gki j v'ecr cekv{ "qh'gcej "dtkf i g'cpf "cp{ " wri tcf gu'qt'tgr cku'vj cvy kmpggf "vq"dg"o cf g'r tkqt "vq"vj g'eqo o gpego gpv'qh'eqputwekqp0'

Tgur qpug'39<'

Ugg'vj g'Tgur qpug'vq"Kgo "350J cwitqwggu'hqt'vj g'Rtqlgev'j cxg'pqv'dggp'f gygto kpgf "vq"fcvg0'Qpeg" vj g'GRE'f gygto kpgu'vj g'j cwitqwggu.'gzkukpi "dtkf i gu'qt'qyj gt'tqcf 'hgcwtgu'vj cv'eqwrf "dg'r qv'pvcn{ " chgevgf "f wtkpi "eqputwekqp"vq"vj g'ukg'y knidg'gxcnvcvgf "hqt'vj g'r qv'pvcn'p'ggf "vq"wr i tcf g'qt'tgr ckt" r tkqt "vq"vj g'eqo o gpego gpv'qh'eqputwekqp0'

"

"

Tgur qpug'3: "
Rci g'3qh'3"
Y kpguu<"Nguvt'O qtcngu"

"

**Y gktu'Etggm'Uqret.'NNE''
Ecug'P q04246/222; ; ''**

Uslpi 'Dqctf 'Uclhu'Hktu'Tgs wguv'ht 'kphqto cvkqp''

"

Tgs wguv'3: < " Rtqxf g" cp{ "eqo o wplecvkqp" y kj "mecn' go gti gpe{ "ugtxlegu" qp" ugewtkv{ "cpf " go gti gpe{ "rtqvceqn'f wtkpi "eqputwekqp"cpf "qr gtcvqpu'0'ki'eqpcev'j cu'pqv'dggp'o cf g."gzn rkp" y j gp'yj cv'eqpcev'y kn'qeewt"cpf 'y kj 'y j lej 'f gr ctwo gpw0'

Tgur qpug'3: <'

Vj gtg'j cu'pqv'dggp'cp{ "eqo o wplecvkqp" y kj "mecn' go gti gpe{ "ugtxlegu"qp"ugewtkv{ "cpf "go gti gpe{ "rtqvceqn'f wtkpi "eqputwekqp"cpf "qr gtcvqpu'0'Y gktu'Etggm' Uqret'au'k'v'ku"vq"eqpf wev'kpkkn' eqo o wplecvkqp" y kj "mecn' go gti gpe{ "ugtxlegu"kp"y g"Hqwtj "S wctvt"qh'4246"cpf "dgi kp"kpkn' eqqtf kpcvqkp"cpf "eqo o wplecvkqp" y kj "y g'Hktg'F gr ctwo gpv."Eqwv{ 'Go gti gpe{ 'O gf kcn'Ugtxlegu" *GO U+'cpf "cp{ "qvj gt"cuuqekcvgf "go gti gpe{ "tgur qpug'r gtuqppgr0"Cff kkpccm{ ."Y gktu'Etggm'Uqret" y kn'kvtqf weg."tgxky ."cpf "eqpuwv"y kj "mecn' go gti gpe{ "ugtxlegu"qp" c"Go gti gpe{ "Cevkqp"Rr'p" yj cv'y kn'ugtxg"cu" c"Ucpcf ctf "Qr gtcvqpi "Rtqegf wtg"*UQR+'hqt"cevqpu."tgur qpugu."cpf "eqpcev' kphqto cvkqp'ht'cm'go gti gpeku'tgrv'gf "v'j g'r tqlgex0"

"

"

Tgur qpug'3; "
Rci g'3qh'3"
Y kpguu<Dtkcp"DctvgnlDgy "Y krdwtp"

"

Y gkt u'Et ggmUqret.'NNE'''

Ecug'P q04246/222; ;'''

Uslpi 'Dqctf 'Uclhu'Hkt u'Tgs wguv'ht 'kphqto cvkqp'''

"

Tgs wguv'3;<"Eqphkto .d{ "pco g'cpf "cftftguu."cmlej wtej gu'qt"qyj gt"tgnki kquw'hceknkku'y kj kp"c"

wy q/o kg'tcf kwu'qh'y g'r tqlge0'

Tgur qpug'3;<"

Eqtkpyj "Ej wtej "ku"cf lcegpv"vq"yj g'pqtjy "qh'yj g"Rtqlgev"Ctgc"qp"yj g"uqwj "ukf g"qh"Ml /3420'Vj g"

cftftguu'ht'jy g'ej wtej "ku'4328'Ml /342."Rtqxf gpeg."Ml "646720"

"

Uct'J qr g'Ej wtej "ku'crr tqzko cvgn{ "30'o kgu'vq'jy g'pqtjy /pqtjy gcuv'qh'yj g'Rtqlgev'c'6; 77'Ml /342."

Fkzqp."Ml "6462; 0'

Tgur qpug'42"
Rci g'3qh'3"
Y kpguu'Ngunvt'O qtcngu'"

"

Y gktu'Etggm'Uqirt.'NNE''

Ecug'P q04246/222; ; ''

Uslpi 'Dqctf 'Uclhu'Hktu'Tgs wguv'ht 'kphqto cvkqp''

"

Tgs wguv'42<"Rtqxf g'cp{ 'eqo o wplecvkqp'y kj "cp{ 'ej wtej gu'qt "qy gt'tgrki kquw'hekkkku'tgi ctf lpi " yj g'r tqlgev'0Rtqxf g'f qewo gpvcvkqp"qh'cp{ 'eqpegtpu'y cv'y gtg'tckugf 0k'pq'f qewo gpvcvkqp"gzkuu." r tqxf g'c'wwo o ct{ 'qh'y g'eqo o gpw0'

Tgur qpug'42<"

Y gktu'Etggm'Uqirt"j cu"o cf g"eqo o wplecvkqp"y kj "yj g"Eqtlpy "Ej wtej 0""Y gktu'Etggm'Uqirt"o gv" y kj "c'tgrtgugpvcxg"qh'y g"ej wtej "cr r tqzko cvgn{ 'yj tgg"wo gu0"Qpg"o ggkpi "y cu'lp"r gtuqp."cpf " yj g"qy gt'y q'xlc'r j qpg0"P q"eqpegtpu"qp"yj g'r tqlgev'y gtg'tckugf "f wtkpi "yj g"eqo o wplecvkqp0"

"

"

Tgur qpug'43
Rci g'3qh'3"
Y kpguu<Dtkcp"DctvgnlDgy "Y krdwtp"

"
Y gkt u'Et ggmUqret.'NNE'''
Ecug'P q04246/222; ;'''
Uslpi 'Dqctf 'Uc htu'Hkt uv'Tgs wguv'ht 'kphqto cvkqp'''

"
Tgs wguv'43<"K gpvkh{ "cpf "f gvckn'vj g'vy q'ewmwtenlukgu'uj qy p"qp"vj g'ukg'r rcp0"

"
Tgur qpug'43<'

Gpxktqpo gpvcrn'Eqpuwmlpi "("Vgej pqmi { ."kpe0"*GEV+."qp"dgi crh'qh"vj g"Cr r rkecpv."eqpf wevgf "c"
Rj cug'Kctej cgqmi kecnluwxg{ 'ht'vj g'Rtqlgevlp'O ctej '4246'cpf 'eqo r rvgf "c"eqttgur qpf kpi 'tgr qtv"
lp'O c{ '4246.'f wtkpi 'y j lej 'GEV'qdvckpgf 'ukg'pwo dgtu'ht'vj g'vy q'ewmwtenlukgu'htqo 'vj g'Mgpwem{ "
Qhleg'qh'Ucvg'Ctej cgqmi { 0C'322/hqqv'ugvdenly cu'cr r rkgf "q'dqv 'ewmwtenlukgu'vq'cxqkf 'ko r ceu"
htqo 'Rtqlgevlphtcutwewtg0'

Vj g'htuv'ewmwtenlukg."Ukg'37J M626.'ku'lp"vj g'gcvgt p'r qt vqp"qh'vj g'Rtqlgevlp'htqo."qp"vj g"
pqtv 'ukf g'qh'cp"wpcco gf "tkdwct{ "qh'Y gktu'Et ggm0Ukg'37J M626'ku'qp"vj g'r tgrko kpc{ "ukg'r rcpu"
*Gzj kdk'5'lp"vj g'UCT+"qp"vj g'qxgtxky 'r ci gu.'E303"cpf 'E304."cpf 'vj g'f gvckngf 'r ci g'E4070GEV"
tgeqo o gpf gf 'vj ku'ukg'cu'pqv'gri kdr'ht'htkpi 'lp"vj g'P cvkpcn'Tgi kvgt'qh'J kvqtk'Rrcegu'cpf 'pq"
cf f kkpccn'y qtnly cu'tgeqo o gpf gf 0"

Vj g'ugeqpf 'ewmwtenlukg."Ukg'37J M627.'ku'lp"vj g'uqwj /egpvcnr qt vqp"qh'vj g'Rtqlgevlp'htqo."
y j gtg'pq'lphtcutwewtg'ku'dgkpi 'ukgf 037J M627'ku'uj qy p"qp"vj g'qxgtxky 'r ci gu.'E303"cpf 'E304"
cpf 'ku'pqv'uj qy p"qp"c'f gvckngf 'r ci g'ukpeg'kzu'pqv'pgct'cp{ 'lphtcutwewtg0'

"
"

Tgur qpug'44"
Rci g'3qh'3"
Y kpguu<Dtkp"Dct vgnlDgy "Y krdwtp"

"
Y gkt u'Et ggmUqret.'NNE''
Ecug'P q04246/222; ; ''
Uslpi 'Dqctf 'Uclhu'Hkt u'Tgs wguv'ht 'kphqto cvkqp''

"
Tgs wguv'44<"Gzr rkp'kp'f gvckn'kpenwf kpi 'nqecvqp"cpf "uk' g."cm'ego gvg { 'hcekkkku'v'j cv'o c { "dg"
chgevgf "d { 'v' g'r tqlgev0

Tgur qpug'44<

Eqo r vqp"Ego gvg { "ku'lp"v'j g"egpvcn'r qt vqp"qh'v'j g"Rtqlgev"Ctgc"qp"v'j g"uqwj "uk' g"qh'F qpcrf uqp"
Tqcf 0'Vj g"eqqtf kpcvgu'ht"v'j ku'ego gvg { .r tqxkf gf "lp'f geko cnf gi tgg. "ku'rc'kwf g"59062: 237"cpf "
npi kwf g'6: 908923340'Vj ku'ego gvg { "ku'cr r tqzko cvgn { "204"cetgu0C"322/hqqv'ugvdcen'y cu'cr r rkgf "
v'j g"dqwpf ct { "qh'v'j g"ego gvg { 0'Vj g"enquguv'kphcutwewt g"ku'c"hgpegf "cttc { "v'j cv'ku'o cr r gf "
cr r tqzko cvgn { "462'hggv'v'j g'y guv'cetquu'c'cti g'y qqf nqv0

Eqtkpvj 'Ego gvg { .y j lej 'ku'cuuqekcvf "y kj 'Eqtkpvj 'Ej wtej . 'ku'cf lcegpv'v'j g'pqt v'j "qh'v'j g"
RtqlgevCtgc"qp"v'j g"uqwj "uk' g'qh'M [/3420'Vj g'cf f tgu'ht"v'j g'ej wtej 'ku'4328'M [/342.'Rtqxf gpeg."
M [" 646720' C" 322/hqqv' ugvdce n' y cu' cr r rkgf " v'j g" dqwpf ct { " qh" v'j g" ego gvg { 0' Vj g" enquguv"
kphcutwewt g"ku'c"hgpegf "cttc { "ctgc."o cr r gf "cr r tqzko cvgn { ": 52'hggv'v'j g' uqwj gcu0

"
"

Tgur qpug'45"
Rci g'3qh'3"
Y kpguu'Nguvt'O qtcngu'"

"

Y gkt u'Et ggmlUqrct.'NNE'''

Ecug'P q04246/222; ;'''

Uslpi 'Dqctf 'Uclhu'Hkt u'Tgs wguv'ht 'kphqto cvkqp'''

"

Tgs wguv'45<"Rtqxkf g'c'pcttcvkg'f guetkr vkqp"qh'y j gtg'vj g'uqrct'o gvgqtqmqi kecn'ucvklqpu'y km'dg"

mecvgf 0'

Tgur qpug'45<'

Vj g'uqrct'o gvgqtqmqi kecn'ucvklqpu'mecvklqpu'j cxg'pqv'dggp'f gvgto kpgf 0Qpeg'vj g'GRE'j cu'dggp"

qpdqctf gf.'vj g'r tqlgcvgf "mecvklqpu'y km'dg"f gvgto kpgf 'f wtkpi 'vj g'f gvckrgf 'f guki p'r tqeguu0'"

Tgur qpug'46"
Rci g'3qh'3"
Y kpguu<"Guj gt'Cvnpuqp"

"

Y gkt u'Et ggmUqret.'NNE'''

Ecug'P q04246/222; ;'''

Uslpi 'Dqctf 'Uclhu'Hkt u'Tgs wguv'ht 'kphqto cvkqp'''

"

Tgs wguv'46<"Rtqxkf g'c'pcttcvkg'f guetkr vkqp"qh'y j gtg'vj g'eqpvtqnj qwug'y kn'dg'qecvfg 0'

"

Tgur qpug'46<'

"

Vj g'eqpvtqnj qwug'y kn'dg'qecvfg 'y ky "vj g'r tqlgev'uwducvqp0"

"

Tgur qpug'47"
Rci g'3qh'3"
Y kpguu<"Guyj gt'Cvirkpuqp"

"

Y gkt u'Et ggmUqret.'NNE'''

Ecug'P q04246/222; ;'''

Uslpi 'Dqctf 'Uchhu'Hkt uv'Tgs wguv'ht 'kphqto cvkqp'''

"

Tgs wguv'47<"Gzr rclp'y j gjj gt 'y g'wduvcvqp'y knj cxg'ku'qy p'ugr ctcvg'hgpekp'i . 'cpf 'khuq.'y j gjj gt"

k'y kn'eqo r n' 'y kj 'P cvkqpcn'Grgextkcn'Uchgv' 'Eqf g"ucpf ctf u0'

"

Tgur qpug'47<'

"

Vj g'wduvcvqp'y knj cxg'ku'qy p'ugr ctcvg'hgpekp'i "cpf 'k'y kn'eqo r n' 'y kj 'P cvkqpcn'Grgextkcn'

Uchgv' 'Eqf g"ucpf ctf u0"

"

Tgur qpug'48"
Rci g'3qh'3"
Y kpguu<Guj gt'Cvnpuqp'"

"

Y gkt u'Et ggmUqret.'NNE'"

Ecug'P q04246/222; ; '"

Uslpi 'Dqct f 'Uc htu' Hkt u' Tgs wguv' hqt 'kphqt o cvkqp'"

"

Tgs wguv'48<"T ght "vq"UCT.'r ci g'33.'O kki cvkqp"O gcuwtg"320Gzr rckp"y j q"y kn'eqpvtqr'ceegu"vq"

vj g"ukg'f wtkpi "eqpvtwvckqp"cpf "qr gtcvckpu0'

Tgur qpug'48: Vj g'GRE "*Eqpvtcevqt+'lp"eqplwpevckqp"y kj Weirs Creek Solar, LLC *Qy pgt+'y kn' eqpvtqr'ukg"ceegu0'

"

Tgur qpug'49"
Rci g'3qh'3"
Y kpguu<Dtkcp"DctvgnlDgy "Y krdwtp"
"

Y gkt u'Et ggmUqret.'NNE''
Ecug'P q04246/222; ; ''
Uslpi 'Dqctf 'Uc htu'Hkt u'Tgs wguv'ht 'kphqto cvkqp''

"

Tgs wguv'49<''Tghgt"vq"UCT."r ci g"33."O kki cvkqp"O gcuwtg"; f 0'Rtqxkf g"f qewo gpcvkqp"qh'v'j g"
eqo o wplecvkqp"v'j cv'j cu'qeewtg"y kj "v'j g'cr r rkecdng"ucv'g"cpf "hgf gtcn'ci gpeku0'

'Tgur qpug'49<'

Vj g"Cr r rkecpv"eqo r ngvf "v'j g" hqmqy kpi "eqo o wplecvkqp" tgi ctf kpi "r qv'gpv'kcn'v'j tgcvgpgf" cpf "
gpf cpi gtgf "ur gelgu"*VGU+hqt"v'j g'Rtqlgev'Ctgc"cpf "3/o kg'dwhgt<''

- WU0Hkuj "cpf "Y kfr rnhg"Ugtxleg"*WUHY U+"kphqto cvkqp"ht"Rrcppkpi "cpf "Eqpuwncvkqp"
*RcE+"vqnl'kp"Lxpg'4246''
- Cp'go ckn'v'j g'WUHY U'Mgpwem' Hgrf "Qhleg"*MHQ+tgs wguv'kpi 'cxckrdng'kphqto cvkqp"
qp'npqy p"qeewtgpeg"qh'ugpukxg'ur gelgu'y kj kp"v'j g'Rtqlgev'Ctgc'kp'O c { '42460'
- C"ngwt"v'j g'Mgpwem' "Qhleg"qh'P cwtg'Rt gugt xgu'tgs wguv'kpi 'kphqto cvkqp"qp'npqy p"
qeewtgpeg"qh'ugpukxg'ur gelgu'y kj kp"v'j g'Rtqlgev'Ctgc'kp'O ctej '42430'
- C"ngwt"v'j g'Mgpwem' "F gr ctvo gpv'qh"Hkuj "cpf "Y kfr rnhg"Tuquwtegu"*M' "FHY T+"
tgs wguv'kpi "cxckrdng" kphqto cvkqp"qp'npqy p"qeewtgpeg"tgeqtf u"qh' Ucv'g"tctg" cpf "
gpf cpi gtgf "r rcpw"cpf "cpko cn'ur gelgu'kp"v'j g'Rtqlgev'Ctgc'kp'O ctej '42430'

Vj g"Cr r rkecpv'cnuq"eqpf wevgf "c" f gumqr "uwf { "v'j k'f gpv'kh { "cp { "r qv'gpv'kcn'dcv"j cdkcv'kp"v'j g'Rtqlgev'
Ctgc"cpf "gxcn'cv'g"v'j gug'ctgcu'f wtkpi "v'j g'hgrf y qtm'eqpf wevgf "kp"Cr tki'4245"cpf "Hgdwtct { "42460'
Vtgg"ergetkpi "y qwf "dg'nko kgf "v'j g'WUHY U"tgg"ergetkpi "y kpf qy "htqo "P qxgo dgt"37"v'j tqwi j "
O ctej '530'

"

Tgur qpug'4: "
Rci g'3qh'3"
Y kpguu'Ngugt'O qtcngu"

"

Y gkt u'EtggmUqret.'NNE'''
Ecug'P q04246/222; ; '''
Uslpi 'Dqctf 'Uchhu'Hkt u' Tgs wguv'ht 'Iphqt o cvkqp'''

"

Tgs wguv'4: <"Rtqxf g'cp{ 'eqo o wplecvkqp'y kj "y g'Rtqxf gpeg/Y gduvgt'Eqwv{ 'Ckr qtvtgi ctf lpi "
y g'r tqlge0'

Tgur qpug'4: <'

"

Y gktu"Etggm'j cu"pqv'f ktgev{ "eqpvcvfg "y g"Rtqxf gpeg/Y gduvgt"Eqwv{ "ckr qtvtgi ctf lpi "y g"
r tqlge0'Y gktu"Etggm'ku"y qtnlpi "f ktgev{ "y kj "c"y kt f/r ctv{ "eqpuwncpv."tgi ctf lpi "y g"cr r tqr tkvg"
HCC'hkpi 'tgs wktgo gpv0'''

"

"

"

"

"

"

"

"

"

"

"

"

"

"

"

"

"

"

"

"

"

Tgur qpug'4; "
Rci g'3qh'3"
Y kpguu'Nguyt'O qtcngu"

"

Y gktu'Etggm'Uqnt.'NNE''

Ecug'P q04246/222; ; ''

Uslpi 'Dqctf 'Uc'hu'Hktu'Tgs wguv'ht 'kphqto cvkap''

"

Tgs wguv'4; <"Rtqxkf g'cp{ 'eqo o wplecvkap'y kj 'yj g'Hgf gtcn'Cxkcvkap'Cf o kpkwcvkap'HCC+'qt'yj g"

Mgpwemf 'Cktr qtv\ qplpi 'Eqo o kuukap'tgi ctf lpi 'yj g'tqlgev0'

"

Tgur qpug'4; <'

"

Y gktu'Etggm'Uqnt''j cu'pqv'j cf "cp{ 'fktgeveqo o wplecvkap'y kj 'yj g'HCC"qt'yj g'Mgpwemf 'Cktr qtv"

\ qplpi "Eqo o kuukap0"Y gktu'Etggm'Uqnt''ku'wkt lpi "c's wkt hgf "yj ktf "r ctv'eqpuwncpv"v"eqpuwv."

r tgr ctg"cpf "uwo kv'yj g'pgeguuct{ "tgs wkt go gpv"v"hg'y kj "dqj "yj g'HCC"cpf "Mgpwemf 'Cktr qtv"

\ qplpi "Eqo o kuukap0'Cu'tgs wkt gf."Y gktu'Etggm'Uqnt''y kn'o cng"eqpcev"y kj "dqj "ci gpekgu"v"

gpwv'g'cm'tgs wkt go gpv'ctg'eqo r rnygf 0''

"

Tgur qpug'52"
Rci g'3qh'Z"
Y kpguu<"Ngungt'O qtcngu"

"

Y gktu'EtggmUqret.'NNE''''
Ecug'P q04246/222; ; ''
Uslpi 'Dqctf 'Uclhu'Hktu'Tgs wguv'ht 'kphqto cvkqp''''

"

Tgs wguv'52<"Rtqxf g'eqr lgu'qh'cp{ 'tgr qtwa'eqpf wevgf "d{ 'yj g'HCC'tgi ctf lpi 'yj g'r tqlgex0'

"

Tgur qpug'52<"

P q'tgr qtwa'j cxg'dggp'eqo r nvgf "d{ 'yj g'HCC'cv'j ku'ko g0'Y gktu'EtggmUqret'cpvklr cvgu'c'342/vq/
3: 2/fc{ 'tgxky 'r gtlqf 'htqo 'yj g'HCC'dghqtg'tgegkxpi 'c'f gygto kpcvqp'tgur qpug0'HCC'tgr qtv'o wuv'
dg'eqo r nvg'd{ 'yj g'wctv'qh'eqputwevqp. 'kicr r necdng0'Y gktu'EtggmUqret'r rpu'vq'lwdo kv'c'tgs wguv'
vq' 'yj g'HCC" d{ "pq" nvg" 'yj cp" Qevdgt" 4246" cpf "tgegkxg" c" F gygto kpcvqp" d{ "O ctej " 42470"
F gygto kpcvqpu'ctg'xcikf 'ht"3: 'o qpj u0'

"

"

"

"

"

"

"

"

"

"

"

"

"

"

"

"

"

"

"

"

"

"

Tgur qpug'53"
Rci g'3qh'3"
Y kpguu<"Ngungt'O qtcngu"

"

Y gkt u'Et ggmUqret.'NNE'''

Ecug'P q04246/222; ;'''

Uslpi 'Dqctf 'Uclhu'Hkt u' Tgs wguv'ht 'kphqto cvkqp'''

"

Tgs wguv'53<"Rtqxf g'c'I nctg'Cpcn{ uki'Uwf { 'ht'j'g'r tqlge0'

"

Tgur qpug'53<'

"

Vj g'I nkv'cpf 'I nctg'Cpcn{ uki'uwf { 'ku'ewttgpw{ 'kp'r tqi tguu'cpf 'ecp'dg'r tqxf gf 'wr qp'eqo r ngkqp0'

"

"

Tgur qpug'54"
Rci g'3qh'3"
Y kpguu<"Guyj gt'Cvnpuqp"

"

Y gkt u'Et ggmUqret.'NNE''

Ecug'P q04246/222; ;''

Uslpi 'Dqctf 'Uc htu'Hkt u'Tgs wguv'ht 'kphqto cvkqp''

"

Tgs wguv'54<"Rtqxkf g'cp{ 'I gqvej pkecn'tgr qtu'ht'y g'r tqige0'

"

Tgur qpug'54<'

"

Please see the'I gqvej pkecn'tgr qtv filed separately0"

"

CVVCEJ O GP V'FILED SEPARATELY"

Tgur qpug'55"
Rci g'3qh'3"
Y kpguu<Dtkcp"DctvgnlDgy "Y krdwtp"

"
Y gkt u'Et ggmUqret.'NNE'''
Ecug'P q04246/222; ;'''
Uslpi 'Dqctf 'Uclhau'Hkt u'Tgs wguv'ht 'kphqto cvkqp'''

"
Tgs wguv'55<"T ght 'v'j g'Mgpwem{ 'I gqmi kecn'Uwtxg{ 'Qkicpf 'I cu'Y gmi'Ugctej '*Ml 'I gqf g<
Ml U'Qkicpf 'I cu'Y gmi'Ugctej '*m{ Qf w+0'

- c0 Hkg'c'b cr 'y kj 'cm'cevxg'cpf 'kpevxg'qkrlt 'i cu'y gmi'qp'vj g'r tqr qugf 'ukg0kpenmf g'cp{ 'i cu/
i cvj gtkpi 'r kr gkpgu'cuuqekcvf 'y kj 'y g'y gmi0'
- d0 Fvgto kpg'cpf 'eqphkto 'y j gvj gt'cp{ 'qh'vj gug'y gmi'ctg'ewtgpw{ 'r gto kwgf 'cpf 'cevxg0'
- e0 Eqphkto 'y j gvj gt'vj g'gzkvgpeg'qh'qkicpf 'i cu'y gmi'cpf 'r kr gkpguy knitgs wktg'cf lwuo gpw"
v'j g'r tqr qugf 'mcevkqp'qh'uqmt'r cpgn0'

"
Tgur qpug'55<

Ugg'cwcej gf 'O cr 'qh'Qkicpf 'I cu'kphcutwewtg0"Dcugf "qp'vj g'qkicpf "i cu'f cv'f qy pmcf gf "htqo "
vj g'Mgpwem{ 'I gqmi kecn'Uwtxg{ '*Ml U+ 'y gtg'ctg'hqwt'y gmi'o cr r gf 'kpkf g'vj g'Rtqlgev'Ctgc0C"
52/hqv'ugvdcenly cu'cr r rkgf 'v'j gug'y gmi'v'cxqkf 'ko r ceu'htqo 'kphcutwewtg0Vj tgg'qh'vj g'y gmi"
ctg'b cr r gf 'qwu'kf g'vj g'hpepf 'cttc{ 'ctgcu'y kj 'pq'kphcutwewtg'ko r ceu'cpf 'ceeqtflpi 'v'j g'Ml U"
cwtkdwgu'j cxg'cm'dggp'r nmi i gf 0Vj g'hqwt'vj 'y gmi'ku'o cr r gf 'kpkf g'vj g'ctgc'f guki pcvgf 'hqt'vj g'r qkpv"
qh'kpvgteqppgev"*RQK'cpf "ceeqtflpi "v'j g'Ml U'cwtkdwgu'y cu'r nmi i gf "kp'Hgdtwct{ "3; 860'Vj g"
Cr r ncepv'y kn'xgth{ 'y g'mcevkqp'qh'vj ku'y gmi'r tkqt'v'eqpuwewkqp'cpf 'y g'RQKf guki p'y kn'cxqkf "
ko r cevkpi 'y ku'y gmi'cpf "cmqy "ceegu'v'j g'y gmi'cu'pggf gf 0'

CVVCEJ O GP V'RESPONSE 33''

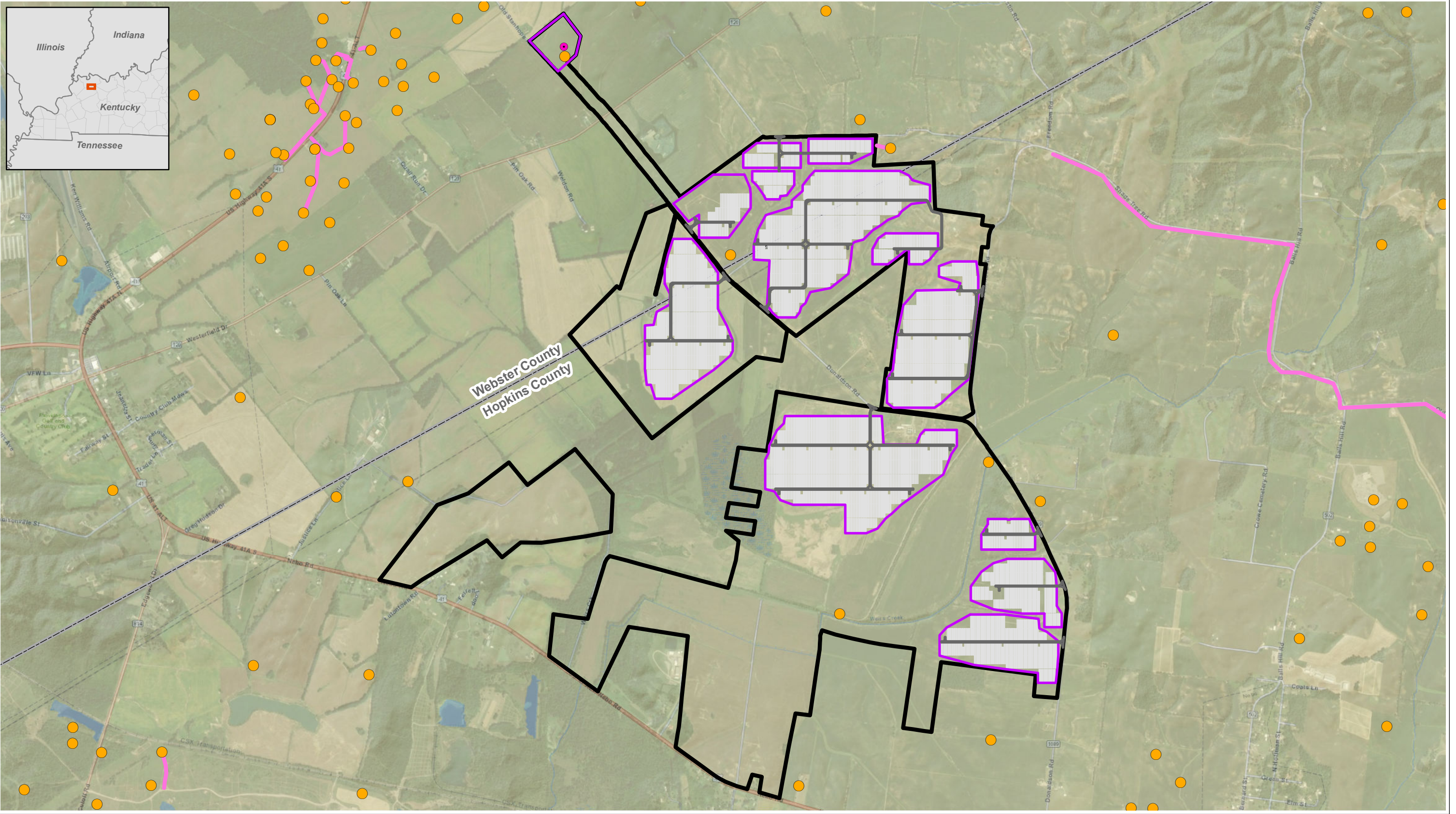

Data Response #33 - Oil and Gas Infrastructure
 Weirs Creek Solar Project
 Hopkins and Webster Counties, KY
 Date: 7/29/2024
 Sources: ESRI World Imagery 9/2023; Weirs Creek Solar, LLC, 2024; ECT 2024.

- Legend**
- Point of Interconnect (POI)
 - Oil and Gas Well (KGS)
 - Oil and Gas Gathering Line (KGS)
 - Access Road
 - Fenced Array Area
 - PV Panel
 - Project Boundary
 - County Boundary

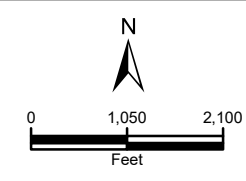

Tgur qpug'56"
Rci g'3qh'5"
Y kpguu<Dtkcp"DctvgnlDgy "Y krdwtp"

"
Y gktu'EtggmUqret.'NNE''
Ecug'P q04246/222; ;''
Uslpi 'Dqctf 'Uclhau'Hktu'Tgs wguv'hqt 'kphqto cvkqp''
"

Tgs wguv'56<"Tghgt"v"vj g"Rj cug"KGpxktqpo gpvcn'Ukg"Cuuguo gpv'Gzr rckp"j qy "Y gktu'Etggm'
Uqret'y kn'o kki cvg"gej "qh'vj g'vj tgg"Teqi pk gf "Gpxktqpo gpv"Eqpf kkpqu"*TGE+"kf gpvklgf "kp"
vj g'cuuguo gpv'

Tgur qpug'56<

TGE"%tghgtgpegu'vj g"qkncpf"i cu'y gmu'o cr r gf "qpukg'dcugf "qp"vj g'MI U'f cvc'Cu'f kuewuugf "kp"
Tgur qpug'55.'vj g'Rtqlgev'kphctcutwewtg'cu'uj qy p'kp"vj g'r tgrko kpcct { "ukg'r rcp'ku'cxqkf kpi "cm'qkncpf "
i cu'kphctcutwewtg.'vj gthgtg.'o kki cvkqp'ku'pqv'cpvlekr cvgf "vq'dg'pggf gf 0"

TGE"%tghgtgpegu'o wnr ng'rti g'hcto "f wo r u'cv'c'hcto uvgcf "kp"vj g'Rtqlgev'ctgc"rtecvgf "
qp'F qpcrf uqp"Tqcf 0C"f gxgr o gpv'gzenukqp"ctgc"y cu'r rnegf "qp"vj ku'r tqr gtv { "cpf "vj g'Rtqlgev"
kphctcutwewtg'cu'uj qy p'kp"vj g'r tgrko kpcct { "ukg'r rcp'ku'cxqkf kpi "vj g'hcto "f wo r u'cv'c'uwttqwpf kpi "
ctgcu.'vj gthgtg.'o kki cvkqp'ku'pqv'cpvlekr cvgf "vq'dg'pggf gf 0"

TGE"%tghgtgpegu'vj g'wvf gti tqwpf "cpf "uwthceg"eqcn'o kpkpi 'r gto ku'kf gpvklgf 'hqt'vj g'ukg."
ucv'kpi "occeqtf kpi "vq"vj g'Mgpwemf "Gpgti { "cpf "Gpxktqpo gpv'Ecdkpgv"*Ml "GGE+"F kxkqp"qh"
O kpkpi "Rgto kxu" *F O R+" qprkg" Ml "Uwthceg" O kpkpi "Xky gt." kpcv'xg"o kpgf "qww" ctgcu" cpf "
r gto kwgf "o kpg'dqwpf ctkgu'hqt'dqj 'uwthceg'cpf 'wvf gti tqwpf "o kpgu'y gtg'kf gpvklgf "qp"vj g'bo clqtkv { "
qh'vj g'Uwdlgev'Rtqr gtv { "cpf "vj g'uwttqwpf kpi "ctgc'0Ceeqtf kpi "vq"vj g'F O R."r gto k'pwo dgtu"; 39/
7235."; 39/7237."cpf "; 39/7245"ctg"cm'wvf gti tqwpf "o kpgu'cuuqekcvgf "y kj "vj g'F qv'nk'O kpg"cpf "
j cxg"pqv'dggp"tgemko gf 0'Vj g"vy q'cev'xg"o kpgu."; 39/7238"cpf ": 76/7254."ctg"uwthceg"o kpgu"
ceeqtf kpi "vq"vj g'F O R O I kxgp'vj cv'wvf gti tqwpf "o kpgu'gzv'gpf "dgpgej "cpf "vj tqwi j qw'vj g'Uwdlgev"

Rtqr gtv{ . "vj gtg'ku'c"eqpegt p"ht "uwdulf gpeg"uj qwf "cp"wpf gti tqwpf "eqmcr ug"qeew0'k'cf f kkkp"vq"
uwdulf gpeg"eqpegt pu."r qvpp'kcn'kuu wgu"y kj "o kpkpi "kpenmf g"vj g"wg"qh'hkm'o cvgtkcn'qh'wmpqy p"
qt ki kp. "vj g'wg"qh'j gcx{ "gs wkr o gpv'y kj "r quukdng'ur kmu'qh'qku"cpf lqt 'i wkf u'qxgt "ko g."cdcpf qpgf "
o kpg'f tckpci g."cpf "o gj cp g"i cu'dwkrf wr "kp"wpf gti tqwpf "o kpgu'Ukpeg't genco cvkqp"j cu'pqv'dggp"
cej kxgf "ht"vj tgg"o kpg'r gto ku'r t gupv'qp"vj g"Uwdlgev'Rtqr gtv{ "cpf "y q"o kpg'r gto ku'ctg"ukm"
cevxg."pgeguuct { 'tgi wrcvt { 'ucpf ctf u'j cxg'pqv'dggp'tgcej gf 0"

Vq'o kki cvg'eqpegt pu'tgi ctf kpi "vj g'wpf gti tqwpf "o kpgu'cpf "uwdulf gpeg."vj g'Cr r rkecp'y kmi"
eqpf wev'i gqvej plecn'uxt xg{ u'kp"vj g'Rtqlgev'ctgc"*ugg"t gur qpug"54+"r tkqt "vq"eqput wekqp0'Vj g"
t guwmu"qh"vj g"i gqvej plecn'uxt xg{ "y km' dg" vngp" kvq" eqpukf gtcvqp" y j gp" ukkpi "vj g" Rtqlgev"
kphcuv wewt g"ht"vj g'hpcn'ukg'r rcpu0" k'cf f kkkp."GEV"qdvkpgf "I gmqi le"Etquu"Ugevkpu"ht"
Rgto k"; 39/7237."y j lej 'kpf lecvgu'vj cv'vj g'wpf gti tqwpf "o kpkpi "dpggcj "vj g'Rtqlgev'ctgc"qeewu'cv"
c'f gr y "qh'cr r tqzko cvgn{ "522"vq"622"hgvdgpgcj "vj g'uwthceg0"P qv"vj cv'cnj qwi j "Rgto k0"; 39/
7237"ku'pq"npi gt "cp"cevxg'r gto k"vj g'etquu"ugevkpu" f gr kev f "ht"vj ku'r gto k'ew"vj tqwi j "vj g"
Rtqlgev'ctgc"cpf "vj gtghqtg"ctg"cp"ceewcvg"tgr t gupv'cvqp"qh"vj g'f gr y "qh'wpf gti tqwpf "o kpgu"
dpggcj "vj g"Rtqlgev'ctgc0'O qt gqxt."eqput wekqp"cevxkkgu"vj cv'y qwf "ko r cev"uwduwthceg"ctg"
i gpgtcm{ 'hko kfg "vq'r krg'f tkkpi "ht"vj g'r cpgr'kpuv'cvqp."y j lej 'ku'v' r kcm{ "eqo r rvgf "cv'c'f gr y "
qh': "vq"32"hgvdgmy "i tqwpf "uwthceg0"Dcugf "qp"vj g'f gr y "qh'vj g'wpf gti tqwpf "o kpgu"dpggcj "vj g"
Rtqlgev'ctgc"cpf "vj g'cpvkr cvgf "uwduwthceg"eqput wekqp"ko r cev"htqo "r cpgr' r krg'f tkkpi ."GEV"
f qgu'pqv'eqpukf gt"o gj cp g"i cu'dwkrf wr "cu'c"eqpegt p'f wtkpi "f gxgr o gpv'qh'vj g'Rtqlgev0"

GEV'tgxky gf "vj g'y q'cevxg"o kpg'r gto k'pwo dgtu"; 39/7238"cpf ". 76/7254+'vj tqwi j "vj g"
Uwthceg'O kpkpi "kphqto cvkqp"U{ ugo . "o ckpvkpgf "d{ "vj g'O kpkpi "F kkkkqp"qh'vj g'M{ "GGE."qp'Lw{ "
47."4246."cpf "k'cr r gctu"vj cv'vj gug'y q"o kpgu'qr gtcvgf "d{ "Y cttkt "Eqcn"NNE"cpf "Y gduvt "Eqcn"
Eqo r cp{ . "NNE"ctg'wpf gti tqwpf "o kpgu."pqv'uwthceg"o kpgu0'F wg'vq"vj g'rcen'qh'r t guppeg'qh'uwthceg"

o kpgu'lp'yj g'Rtqlgev'Ctgc."yj g'eqpegtpu'tgi ctf lpi 'r qvgrvkn'kuuwgu'y kj 'yj g'wug'qh'hkn'o cvgtkn'qh'
wmpqy p"qtki lp"cpf "yj g"cdcpf qpgf "o kpg"f tckpci g"ku"pq"mipi gt"eqpukf gtgf "c"eqpegtp"f wtkpi "
f gxgnqr o gpv'qh'yj g'Rtqlgev0"

P q"gxkf gpeg"qh"t'gngcug"qt"uclp'lp'i "y cu"qdugt'xgf "f wtkpi "yj g'Rj cug"KGUC"ukg"xkuk'cu"c"
tguwn'qh'wug'qh'j gcx{"gs wkr o gpv'Vj g'GRE'y knko r ngo gpv'dgu'bo cpci go gpv'r tce'legu"*DO Ru+'hqt"
yj g'bo clpv'gpcpeg"cpf "wug'qh'j gcx{"gs wkr o gpv'qpukg"f wtkpi "eqputwe'kqp"ce'v'x'k'ku0"

kp'uwo o ct{.TGE"%3"cpf "TGE"%4"j cxg'dggp"o kki cvgf "yj tqwi j 'Rtqlgev'f guki p'ej ql'egu"cpf "
cxqkf gf "d{"Rtqlgev'lpht'cutwe'wtg0Rtgrko kpct{"i gq'vej plecn'uwt'xg{u"j cxg'dggp"eqo r ngvf "hqt"yj g"
Rtqlgev'cpf "cf f k'k'qpcn'i gq'vej plecn'y qtn'y kn'dg"eqo r ngvf "cu"p'geguuct{"cu"yj g'Rtqlgev'f guki p"
gxq'ngu0P q"cf f k'k'qpcn'lp'x'gu'ki cv'k'p"ku"cp'v'ekr cvgf "dg'kpi "pggf gf "hqt"yj g'Rtqlgev'vq"o kki cvg"yj g"
r qvgrvkn'tkumi'cuuqek'cvgf "y kj 'TGE"%5"cu"q'w'k'p'gf "kp"f gv'kn'cd'q'xg0

Tgur qpug'57"
Rci g'3qh'3"
Y kpguu'<Dtkcp'DctvgnlDgy "Y krdwtp"

"
Y gkt u'Et ggmUqret.'NNE''
Ecug'P q04246/222; ; ''

Uklpi 'Dqctf 'Uclhau'Hkt u' Tgs wguv'ht 'kphqto cvkqp''

"
Tgs wguv'57<"Tghgt'vq'Cr r nckvqp.'UCT.'Gzj kdk'9.'Rctv'3.'r ci g'39.'80'Uwdlgev'Rtqr gtv' 'Nkukpi u0'
Vj g'Uwdlgev'Rtqr gtv' "Uwo o ct { "Vcdrg'kpf kcvgu'vj cv'vj g'uwdlgev'r tqr gtv' "y cu'kuvgf "qp'r tqr gtv' "
qy pgf "d{ "Y gduvgt "Eqwv' "Eqcn"NNE0'Eqphkto "y j gj gt "vj g'r tqr qugf "ukv"y cu"gxgt "wugf "hqt"
o klpki "qr gtcvkqpu0'

Tgur qpug'57<

[gu."cu'f kuewugf "k'f gvckl'k"vj g'Tgur qpug"vq"Kgo "56."vj gtg"ctg"o wnk r g"eqo r cpkgu"y j q"j cxg"
r gto ku'hqt"wpf gti tqwpf "o kpgu'vj cv'etquu'vj g'Rtqlgev'Ctgc0'Rgto ku'cuuqekcvf "y kj "vj g"Y gduvgt"
Eqwv' "Eqcn"NNE"eqo r cp{ "f cvg'dceni'vq"vj g'3; 82u'cpf "r gto ku'cuuqekcvf "y kj "vj g"Y cttkqt'Eqcn"
NNE"eqo r cp{ "f cvg'dceni'vq"vj g'3; ; 2u0'Dcugf "qp"tgxkgy "qh'cxckrdrg"o cr u'cuuqekcvf "y kj "vj g"
Y gduvgt "Eqwv' "Eqcn"NNE"eqo r cp{ "r gto ku."k' cr r gctu" vj cv'wpf gti tqwpf "o klpki "j cu"dgpp"
eqpf wevf "dpggcj "vj g'Rtqlgev'Ctgc'ukpeg'cv'ngcu'vj g'3; ; 2u0'Vj g'gzkukpi "r gto ku'cuuqekcvf "y kj "
vj g'wpf gti tqwpf "o kpgu'dpggcj "vj g'Rtqlgev'Ctgc"gzr ktg'dgy ggp"4242"cpf "42480

""Tgur qpug'58"

""Rci g'3qh'4"

""Y kpguu<Dtkp"DctvgnlDgy "Y krdvtp"

"

Y gktu'EtggmUqirt.'NNE''

Ecu'P q04246/222; ; ''

Uklpi 'Dqctf 'Uclhu'Hktu'Tgs wguv'ht 'kphqto cvkqp''

"

Tgs wguv'58<""Tghgt"v"j g"Rj cug"KGpxkqpo gpvcl'Ukg"Cuuguo gpv."r ci g"40'Vj g"tgr qt'v'ucvgu."

õUkpeg'tgemco cvkqp"j cu'pqv'dggp"cej kxgf "hqt"vj tgg'o kpg'r gto ku'r tgu'p'v'q"vj g"Uwdlgev'Rtqr gtv" "

cpf "vy q"o kpg'r gto ku'ctg'ukm'cev'xg."pgeguact { 'tgi wrcvt { 'ucpf ctf u'j cxg"pqv'dggp'tgcej gf 06"

c0 Gzr nkp'y j gj gt"Y gktu'EtggmUqirt'y kn'p'ggf "v"qd'v'k'p"cp { 'r gto ku'tgi ctf kpi 'vj ku'o cvgt0'

d0 Gzr nkp"j qy "vj g"eqpen'ukqp"tgi ctf kpi "tgi wrcvt { 'ucpf ctf u'y kn'ch'gev"vj g"Y gktu'Etggm' Uqirt'r tqlgev0'

e0 Gzr nkp'y j gj gt"Y gktu'EtggmUqirt"j cu'j cf "cp { 'eqo o wplecvk'p'y kj "vj g"ucv'g'tgi ctf kpi " vj g" cev'xg" w'p'f'gti tqw'p'f " cpf " u'w'h'ceg" eqcn' o kpgu" qp" vj g" Uwdlgev' Rtqr gtv" " cpf " vj g" u'w't'q'w'p'f kpi 'ctgc0'

f0 Rtq'x'k'f'g"cp { 'u'w'f'k'g'u'v'j cv'j cxg"dggp'r gthqto gf "qp"vj g'o kpgu't'g'rc'v'g'f "v"vj g'f'g'x'g'm'r o gpv'qh" vj g'r tqlgev0'

"

Tgur qpug'58<

Vj g"Cr r n'ec'p'v'f'q'g'u'p'q'v'c'p'v'k'r cv'g"vj g"p'ggf "v"qd'v'k'p"cp { 'r gto ku'eq'p'eg't'p'k'pi "o k'p'k'pi "w'p'f'g't'p'g'cv'j "

vj g"Rt'q'l'g'ev' Ctgc0'Ugg"vj g" Tgur qpugu"ht" Kgo "56"cpf "Kgo "57"ht"o qtg"f'g'v'c'k'u"tgi ctf kpi "vj g"

ucv'go gpv'q'p'tgi wrcvt { 'ucpf ctf u'0'k'p"uwo o ct { ."vj gtg'ctg'cev'xg'w'p'f'gti tqw'p'f "o k'p'k'pi "r gto ku'j grf "

d { "dqj "Y gdu'gt "Eqw'p'v { "Eqcn"NNE"cpf "Y ctt'k'qt "Eqcn"NNE"vj cv'q'x'g't'r "vj g"Rt'q'l'g'ev' Ctgc0'Vj gug"

eqcn'eqo r c'p'k'g'u"j cxg"pqv'er'q'ug'f "q'w'v'j gkt"r gto ku'v'f'cv'g."cpf "vj g't'g'h'q't'g."t'gemco cvkqp"j cu'pqv'dggp"

cej kxgf "cpf "vj g" w'p'f'gti tqw'p'f "o kpgu"ctg'ukm'cx'k'rc'd'ng"v" w'ug" w'p'v'k'i'v'j g'r gto ku'gzr k'g"dgvy ggp"

4242"cpf "42480Vj cv'ku'yj g'ftkxkpi "hcevt"v"vj g"ucvgo gpv'yj cv"õpgeguuct {"tgi wrcvt {"ucpf ctf u"
j cxg"pqv'dggp'tgcej gf õo"

Qprkpg"o kpg'r gto ku'y gtg'kf gpv'kkgf "y kj k'p"vj g"Uwdlgev"Rtqr gtv{"cpf "uwtqwpf kpi "ctgcu"
f wtkpi "vj g'Rj cug"KGUC"tgugetej 0Vj g'O cf kuqpxkmg"Dtcpej "qh'vj g'F kxkukq"qh'O kpg"tgenco cvkqp"
cpf "Gphqtego gpv'y cu'eqpcevfg "v'eqphko "vj g'ucwuu'qh'gcej "o kpg'r gto k'kf gpv'kkgf 0Vj g'hqmjy kpi "
kphqto cvkqp"y cu'r tqxkf gf "k'p"vj g'Rj cug"KGUC"tgr qtv"õVj g'o kpg'r gto ku'kf gpv'kkgf "qp"vj g"Uwdlgev"
Rtqr gtv{"y gtg'ugctej gf "qp"vj g"Uwtceg"O k'kpi "kphqto cvkqp"U{ ugo "UO KU"y gdukg0Vj g'k'pcevkg"
o kpg'r gto k'pwo dgt": 76/7249."y cu'ht"cp'wvf gti tqwpf "o kpg'cpf "y cu'tgrgcugf "k'p'4222."k'p'kcvkpi "
vj ku'o kpg'j cu'dggp'tgenko gf 0Rgto k'pwo dgtu"; 39/7237"cpf "; 39/7245"ctg"cevkg"y kj "c"ucwuu'qh"
tgenco cvkqp"qpn{ "cu'qh'4222"cpf "4232."tgr gevkgnt{."k'p'kcvkpi "vj g{"ctg"k'p"vj g'r tqegu"qh'dgkpi "
tgenko gf 0Dqj "r gto k'pwo dgtu"ctg"cuuqekcvf "y kj "vj g'F qvknk'O kpg."cp"gzvpukg"wpf gti tqwpf "
eqcn'o kpg'0Rgto k'pwo dgt"; 39/7238"cpf "; 39/7235"ctg"cuuqekcvf "y kj "vj g'F qvknk'O kpg"y kj "
cevkg"ucwugu"qh"cevkgnt{ "r tqf wvki "cpf "cevkg"vgo r qtct {"eguucvqp"cu"qh'4222."tgr gevkgnt{ 0
Cevkg"vgo r qtct {"eguucvqp"ucwuu'o gcpu"vj g'o kpg'ku'pqv'cevkgnt{ "r tqf wvki "cpf "kphcutwewt"j cu"
dggp"fkcuugo drgf="j qy gxgt."tgenco cvkqp"j cu'pqv'dggp"cej kxgf 0Rgto k'pwo dgt": 76/7254"ku"
cuuqekcvf "y kj "vj g"Y cttkqt"Eqcn/Ectf kpcn'o kpg."cp"wpf gti tqwpf "eqcn'o kpg'0Vj g'ucwuu'qh"vj ku"
r gto k'ku'cevkg"qr gtcvqpu"cu'qh'4223o"

Rtgrko k'pct {"i gqvej p'kcn' uwtxg{ u"j cxg" dggp" eqo r ngvf "ht" vj g" Rtqlgev" cpf " cf f k'kqpcn"
i gqvej p'kcn'y qtn'y kn'dg"eqo r ngvf "cu'pgeguuct {"cu"vj g" Rtqlgev" f guki p" gxqrgu'0P q" cf f k'kqpcn"
k'pxguki cvkqp"ku'cpv'kcvf "dgkpi "pggf gf "ht" vj g" Rtqlgev"v"o k'k' cvg"vj g'r qv'p'kcn'tkumi"cuuqekcvf "
y kj "TGE"%5"cu'qwnkpgf "k'p"vj g" Tgur qpug"v"Kgo "560"

T gur qpug'59"
Rci g'3qh'3"
Y kpguu<Dtkcp"DctvgnlDgyj "Y krdwtp"

"
Y gkt u'Et ggmUqret.'NNE'''
Ecug'P q04246/222; ;'''
Uslpi 'Dqctf 'Uclhau'Hkt uv'Tgs wguv'ht 'kphqto cvkqp'''

"
Tgs wguv'59< " Tghgt" vq" vj g" Rj cug" K Gpxktqpo gpvni' Cuuguuo gpv." rci g" 6." 3045." Cff kkpncn'
kpxgunki cvkqp0"

c0 Eqphto 'vj g'c'f f kkpncn'kpxgunki cvkqp"qh'vj g'r tqlgev'dg"eqpf wevgf 'd{ 'vj g'Gpxktqpo gpvni'
Rtqhgukqpcn'0' Ki" pqv." r tqxkf g" vj g" pco g" cpf " s wckh'ecv'kpu" qh" vj g" gpvni' " f qlpi " vj g"
kpxgunki cvkqp0'

d0 Uj qwf "vj g'r tgugpeg"qh'j c| ctf qwu'uwducpegu"qt'r gvtqrgwo "r tqf wevu'dg"f gvgevgf "chgt"
c'f f kkpncn'kpxgunki cvkqp. "g'zr n'k'p"y j cv'o kki cvkqp"qt"eqwvgt"o gcuw'gu"Y gktu"Et ggm'
Uqret'y kniko r ngo gpv0'

"
Tgur qpug'59<'

Rgt"CUVO "G4469/38"tgs wktgo gpw."c"ucvgo gpv'qh'y j gj gt"cf f kkpncn'kpxgunki cvkqp"hqmqy kpi "c"
Rj cug"KGUC"ku'y ctcpvgf 'y cu'kpenwf gf 'kp"vj g'tgr qtv'j qy gxgt."cp"cf f kkpncn'kpxgunki cvkqp"j cu'pqv"
dggp"eqpf wevgf 'cv'vj g'UwdlgevRtqr gtv'0K'ku'vj g'qr kpkqp"qh'vj g'Gpxktqpo gpvni'Rtqhgukqpcn'vj cv'cp"
c'f f kkpncn'kpxgunki cvkqp"o c{ 'pqv'dg'tgs wktgf "vq"cxqkf "qt"o kki cvg'vj g'TGEu'kf gpv'k'gf 'kp"vj g'Rj cug"
KGUC"cu'f k'ewuugf 'kp'f gvckn'kp"vj g'Tgur qpug'vq"Kgo "560""

"
DO Ru'y knidg'hqmqy gf 'f wtkpi 'i gqvg'ej plecn'y qtnikh'gxkf gpeg'qh'j c| ctf qwu'uwducpegu"qt'r gvtqrgwo "
r tqf wevu'ku'f gvgevgf 0"

Tgur qpug'5: "
Rci g'3qh'3"
Y kpguu<"Nguvt'O qtcngu"

"

Y gkt u'Et ggmlUqret.'NNE'''

Ecug'P q04246/222; ;'''

Uslpi 'Dqctf 'Uclhu'Hkt u'Tgs wguv'ht 'kphqto cvkqp'''

"

Tgs wguv'5: <""Uwdo k'c"eqr { "qh'yj g"ngcug"qt"r wtej cug"ci tgggo gpwu."kpenwf kpi "qr vkqpu."ugr ctcvg"

ci tgggo gpwu."qt"f ggf u."yj cv"Y gkt u'Et ggmlUqret"j cu"gpvgtgf "kpvq"kp"eqppgewkqp"y kj "yj g'r tqr qugf "

uqret'hcekkv{."kpenwf kpi "yj g'ci tgggo gpwu'ht"gcej "qh'yj g'r ctegni"qh'yj g'r tqlge0'

Tgur qpug'5: <'

"

Rngcug'ugg'Ngcug'Ci tgggo gpwu'hkrgf "ugr ctcvgn{0"

"

ATTACHMENT FILED SEPARATELY

Tgur qpug'5; "
Rci g'3qh'3"
Y kpguu<"Nguvt'O qtcngu"

"

Y gktu'EtggmUqret.'NNE'''

Ecug'P q04246/222; ;'''

Uslpi 'Dqctf 'Uclhu'Hktu'Tgs wguv'ht 'Kphqto cvkap'''

"

Tgs wguv'5; <"Rtqxf g'c'f gckngf "ceeqwpv'qh'cp{"eqptcew'd{"y j lej "Y gktu'EtggmUqret'j cu'r ckf ."qt"

pgi qv'cvgf "v'rc{.cp{"eqo r gpucvkap"v'pqp/r ctv'ekr cvkpi "rcpf qy pgtu."y j gj gt'ecuj "qt"qyj gty kug."

pgct"yj g'r tqlge'0'Kpenxf g'yj g'v'gto u'qh'yj g'ci tggo g'pw'cpf "y j lej "r tqr gt'v'gu'ctg'kpxqrxgf "k'v'gto u"

qh'f kvcpeg'v'yj g'r tqlge'vdqwpf ct'lg'u'0'

Tgur qpug'5; <'

Y gktu'Etggm'j cu'p'qv'r ckf ."pgi qv'cvgf "v'rc{.cp{"eqo r gpucvkap"v'pqp/r ctv'ekr cvkpi "rcpf qy pgtu."

y j gj gt'ecuj "qt"qyj gty kug'pgct"yj g'r tqlge'0'"

"

Tgur qpug'62"
Rci g'3qh'3"
Y kpguu<Dtkp"DctvgnlDgy "Y krdwtp"

"

Y gkt u'Et ggmUqret.'NNE'''

Ecug'P q04246/222; ;'''

Uslpi 'Dqctf 'Uchlhu'Hkt u'Tgs wguv'ht 'kphqto cvkqp'''

"

Tgs wguv'62<'''Rtqxkf g"c"qpg/r ci g"ukg"o cr "vj cv'eqpvkpu"mqcvkpu"qh'y cvgt "hgcwt gu."kpenwf kpi "

tkxgtu.'utgco u.'rcngu.'cpf 'r qpf u0Cnuq'kpenwf g'cp { 'hpqy p"qt'lwur gevfg 'nctuv'hgcwt gu0'

Tgur qpug'62<'''

Ugg'cwcej gf "o cr 'qhF grikpgcvfg 'Cs wvkeTguqwtegu0'Dcugf 'qp'tgxkgy 'qh'y g'Ml UMctuv'Qeewttgpeg"

kp'Mgpwenf "o cr "cpf "y g'Ml U'ukpnj qrg'f cw.'y gtg'ctg'pq'nctuv'hgcwt gu'kp"y g'Rtqlgev'xkelpk\0'

CVVCEJ O GP V'RESPONSE 40''

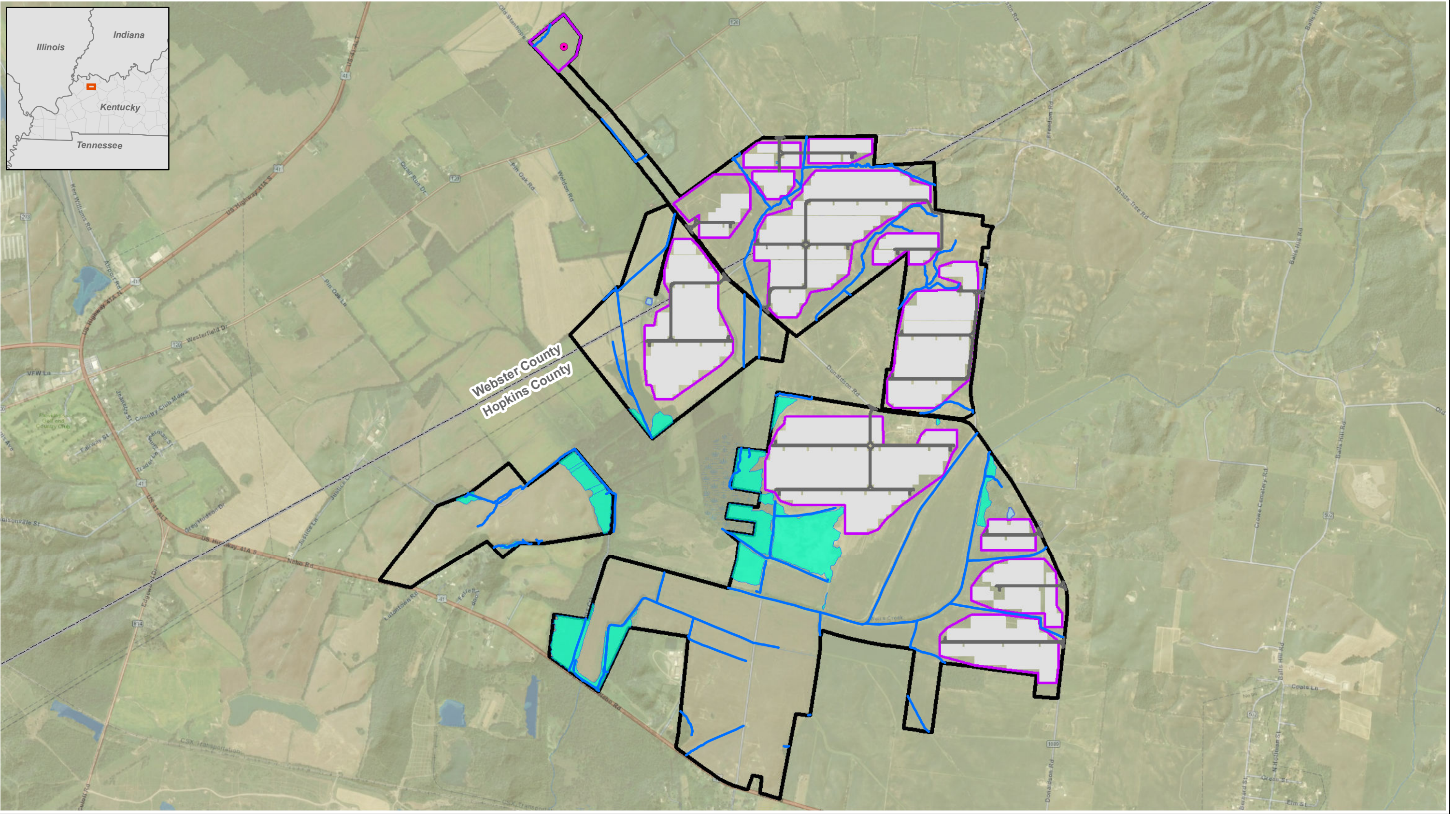

Data Response #40 - Delineated Aquatic Resources
 Weirs Creek Solar Project
 Hopkins and Webster Counties, KY
 Date: 7/24/2024
 Sources: ESRI World Imagery 9/2023; Weirs Creek Solar, LLC, 2024; ECT 2024.

- Legend**
- Delineated Stream
 - Delineated Wetland
 - Delineated Waterbody
 - Access Road
 - Fenced Array Area
 - PV Panel
 - Project Boundary
 - County Boundary

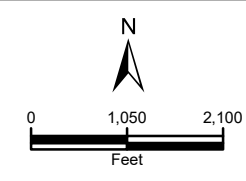

T gur qpug'63"
Rci g'3qh'3"
Y kpguu<"Guy gt Atkinson"

"

**Y gkt u'Et ggmUqret.'NNE''
Ecug'P q04246/222; ; ''**

Uslpi 'Dqctf 'Uc hhu' Hkt u' Tgs wguv' hqt 'kphqt o cvkqp''

"

Tgs wguv'63<"Rtqxkf g'c'pcttcvkg'f guetk vqp'qh'y g'hqecvqp'qh'gcej 'qh'y g'hqmy kpi 'ukg'hgcwt gu<"

c0 Gcej "eqputwekqp"gpvtcepg0'

"

d0 Gcej "gpvtcepg'vq'dg'wugf 'kp'qr gtcvqpu0'

"

e0 Qr gtcvqpu'(' O ckpgpcpeg'*Q(O +'ctgc0'

"

f0 Gcej 'rc{f qy p'ctgc0'

"

Tgur qpug'63<'

Vj g" r tgrko kpcct { " ukvg" r rcpu" *Gzj kdk' 5" kp" vj g" UCT+" uj qy " vj g" r tqr qugf " ceeguu" tqcf u" y kj " eqttgur qpf kpi "eqputwekqp"gpvtcegu"cpf "vj g'cpvkek cvgf "vgo r qtct { 'rc{f qy p'ctgc'hqt'vj g'Rtqlgev0' Vj g"Vtchle"Uwf { "lpenwfg"cu"Gzj kdk'8"kp"vj g"UCT"cuq"lpenwfgu"o cr "qh'vj g'Rtqlgev'y kj "vj g" ceeguu'r qkpw"*rcdgrgf "cu"ukvg"gpvtcegu+"cpf "r tqr qugf "kpvgtkqt"ceeguu"tqcf u"vq"vj g'hgpegf "cttc{ " ctgcu0'Vj g'Q(O 'tckngt leqpvkpgt'ku'r tqlgvvgf "vq'dg'eq/mqecvgf "y kj kp"vj g'r tqlgv'uwduv'vqp'ctgc0' Cu'r tgrkqwu { "f kuewugf "kp"vj g" Tgur qpug"vq"Kgo "35."j cwi'tqwgu'hqt"vj g'Rtqlgev'j cxg"pqv'dggp" f gvgto kpgf "vq'f cvg0'Vj g'GRE"eqvtcevt."qpeg"qpdqctf gf ."y kn'ckf "kp'f gvgto kpkpi "vj g'j cwi'tqwgu" cpf "vj g'eqttgur qpf kpi "gpvtcegu'vq'vj g'Rtqlgev'vq'dg'wugf "f wtkpi "eqputwekqp0'

"

"

"

"

Tgur qpug'64"
Rci g'3qh'3"
Y kpguu<"Guy gt'Cvnpuqp"

"

Y gkt u'Et ggmUqret.'NNE'''

Ecug'P q04246/222; ;'''

Uslpi 'Dqctf 'Uclhu'Hkt u'Tgs wguv'ht 'kphqto cvkqp'''

"

Tgs wguv'64<"Gzr rkp"y j gj gt"vj g"eqputwekqp"cpf "qr gtcvkapcn'gpvcpegu'y kn'dg'hqengf "qwukf g"

qh'pqto cn'y qtnkpi 'j qwtu0'

Tgur qpug'64<"

"

Vj g"eqputwekqp"cpf "qr gtcvkapcn'gpvcpegu'y kn'dg'hqengf "qwukf g"qh'y qtnkpi 'j qwtu0'''

"

"

Tgur qpug'65"
Rci g'3qh'3"
Y kpguu<"Guy gt'Cvnpuqp"

"

Y gkt u'Et ggmUqret.'NNE'''

Ecug'P q04246/222; ;'''

Uslpi 'Dqctf 'Uclhu'Hkt u'Tgs wguv'ht 'kphqto cvkqp'''

"

Tgs wguv'65<"Rtqxkf g'vj g'ugewtkv{ "o gcuwtgu'ht "yj g'Q(O "ctgc"cpf "lwducvkap0"

"

Tgur qpug'65<'

C'r gto cpgpv'r gtko gvt'ugewtkv{ "hpep'uj cm'kpenw'g'c'o kpk wo "qh'qpg'f qwdng'y kf g'o cpwcnf cvg"

c'vj g'RX'Rqy gt'Rcpv'cpf "Uwducvkap"gpvcpegu0"

"

"

"

Tgur qpug'66"
Rci g'3qh'3"
Y kpguu<"Nguvt'O qtcngu"

"

Y gktu'EtggmUqret.'NNE''

Ecug'P q04246/222; ; ''

Uslpi 'Dqctf 'Uclhu'Hktu'Tgs wguv'ht 'kphqto cvkqp''

"

Tgs wguv'66<"Gzr mlp'j qy "Y gktu'EtggmUqret'y km'eqqtf kpcvg'y kj "mecniry "gphqtego gpv'cpf 'hktg"
ugtxlegu'tgi ctf kpi 'ugewkv{ 'cpf "go gti gpe{ 'r tqveqni'f wtkpi "eqputwekqp"cpf "qr gtcvkqpu0'

'''

Tgur qpug'66<'

Y gktu'EtggmUqret'y km'eqqtf kpcvg'y kj "mecniry "gphqtego gpv'cpf 'hktg'ugtxlegu'r tkqt 'v'j g'uctv"
qh'eqputwekqp'v'tgxky . 'f kiewuu. 'cpf "eqpuwn'qp'cml'tgeqo o gpf gf "go gti gpe{ 'r tqveqni'f wtkpi "
eqputwekqp"cpf "qr gtcvkqpu0"Y gktu'EtggmUqret'y km'wkkk g'j g'r tqlgewu'Go gti gpe{ 'Cevkqp'Rncp"
cu'j g'Ucpcf ctf 'Qr gtcvkpi 'Rtqegf wtg'*UQR+'f qewo gpv'cu'j g'r tko ct{ 't'gur qpug'eqqtf kpcvkqp'vqqr0"

Tgur qpug'67"
Rci g'3qh'3"
Y kpguu<"Guyj gt'Cvukpuqp"

"

Y gkt u'Et ggmUqret.'NNE''

Ecug'P q04246/222; ; ''

Uslpi 'Dqctf 'Uc htu'Hkt ur'Tgs wguv'ht 'kphqt o cvkqp''

"

Tgs wguv'67<"F guetldg"cp{ "wkrkku'vj cv'y km'dg'tgs wkt gf "f wtkpi "eqputwekqp"qt"qr gtcvkapu"cpf "

y j cv'wkrkv{ 'y km'r tqxkf g"vj g'ugtxleg0'

"

Tgur qpug'67<'

Vj g"lphcuv wewtg"eqpukuu"qh"c"322C"342X"r qy gt"uqwtg"cpf "c"ukpi ng"o qf g"hdgt0"Vj g"342X"

r qy gt"uqwtg"uj cm'dg'htqo "vj g'uco g'f kntkdwkqp"uqwtg'r tqxkf kpi "r qy gt"vq"gkj gt"vj g'eqputwekqp"

hcekrkku"qt"uwducvkqp"eqpvtqnj' qwug"cpf "vj g'hdgt"uj cm'dg'tqwgf "vj tqwi j "c"eqpf wkv'gzvpgf kpi "vgp"

hggv'qwukf g'qh'vj g'uwducvkqp'hgpeg0'

"

"

"

"

Tgur qpug'68"
Rci g'3qh'3"
Y kpguu<'"

"

Y gk u'Et ggmUqret.'NNE''

Ecug'P q04246/222; ;''

Uskpi 'Dqctf 'Uc htu'Hkt u' Tgs wguv' hqt 'Kphqto cvkqp''

"

Tgs wguv'68<"Eqphkto 'y j gj gt"cp"gppti { 'uqtci g'u{ ugo 'y km'dg'wugf "cu'r ctv'qh'y ku'r tqlgev0

"

Tgur qpug'68<'

"

Cp"gppti { 'uqtci g'u{ ugo 'y km'dg'eqpukf gtgf "r ctv'qh'y ku'uqret' hcekry{ 0"

"

"

"

"

"

"

"

"

"

"

"

"

"

"

"

"

"

"

"

"

"

"

"

"

"

"

"

"

"

"

"

"

"

Tgur qpug'69"

Rci g'3qh'3"

Y kpguu<"Ngugt'O qtcngu"

"

Y gkt u'Et ggmUqret.'NNE'"

Ecug'P q04246/222; ; '"

Uslpi 'Dqctf 'UcHtu'Hkt u'Tgs wguv'ht 'kphqto cvkqp'"

"

Tgs wguv'69<"Rtqxkf g"r tqlgev'eqputwekqp"uej gf wrg"qwrkpi "vj g"f gvcnu"qh"gej "r j sug."vq"

kpenf g"f wcvkqp"qh'gej 'r j sug0'

"

Tgur qpug'69<'

"

"

O kguvpg'"	Gzr gevfg 'Eqo r ngvqp" F cvg"	<u>Rj sug'F gvcnu"</u>
Eqputwekqp'Egt vklecvg" "	F gego dgt "4246"	Rtqlgev'tgegkxgf 'M' "Ucvg'Uslpi 'Dqctf " Eqputwekqp'Egt vklecvg"
Cm'r gto ku'kp'J cpf "o" Uqret'Cttc{ " "	Rt gupv' C wi wuv'44.'4247"	Rtqlgev'j cu'cm'tgs wkt gf 'r gto ku'cr r tqxgf "
Ukg'O qdkk cvkqp"	C wi wuv'o'Ugr vgo dgt "4247"	Wpt gultevgf 'Eqputwekqp'Ceegu.'GRE'ku" o qdkk gf 'qp'ukg'cpf 'r tgr ctgf "v" dgi kp" eqputwekqp"
Ekxki'Y qtm'Eqo r ngv'"	Ugr vgo dgt "o'Qevdgt "4247"	Cp{ 'tgs wkt gf 'i tcf kpi .'ceegu'tqcf u.'f tkxgy c{ u." cpf 'rc{ f qy p" { ctf u'gucdnkj gf 'qp'r tqlgev'
O gej cplecn'Y qtm' Eqo r ngv'"	Qevdgt/"Ugr vgo dgt "4248"	GRE"eqpf wevtcentpi "cpf 'r cpnlpucm'vqp"qh'RX" cttc{ "v" kpenf g'O X'eqmgevqp"npgu="Uy kej { ctf " eqputwekqp"eqo r ngv"
Eqo o kuqkpi "Eqo r ngv'"	Qevdgt/P qxgo dgt "4248"	Hlpcn'Vgukpi .'kpur gevqp."cpf 'Eqo o kuqkpi " Eqo r ngv"
Eqo o gtekn'Qr gtcvqp" F cvg"	F gego dgt "53.'4248"	Rtqlgev'ku'qr gtcvqpcn'

" " "

Tgur qpug'6: "
Rci g'3qh'3"
Y kpguu<"Nguvt'O qtcngu"

"

Y gkt u'Et ggmUqret.'NNE''

Ecug'P q04246/222; ; ''

Uslpi 'Dqctf 'Uclhu'Hkt u'Tgs wguv'ht 'kphqto cvkqp''

"

Tgs wguv'6: <"Eqphkto 'y j cv'ko g'eqputwekqp."qr gtcvqp."cpf "o clpvgpcpeg"qr gtcvqpu'y km'dgi kp"

cpf "gpf "gcej "fc{0'

'Tgur qpug'6: <"

Vj g'eqputwekqp'r j cug'qh'y g'r tqlgv'y qwf 'pqto cm{ "qr gtcvg'dgy ggp'9-22" c0 0cpf '8-22'r 0 0"

O qpf c{ 'y tqwi j 'Hkf c{. "wprguu'cp"gzr gf kvgf "eqputwekqp'uej gf wr'ku"gpcevfg. 'kp'y j kej 'y g"

j qwtu'hkvgf 'j qwtu'y qwf "qeewt'O qpf c{ 'y tqwi j "Uwpc{0''''

F wtkpi 'y g'qr gtcvqp"cpf "o clpvgpcpeg'r j cug.'y g'pqto cndwukpguu'j qwtu'y qwf "dg'cr r tqzko cvgn{ "

9-22" c0 0vq '8-22'r 0 0"

"

"

"

"

"
Tgur qpug'72"
Rci g'3qh'3"
Y kpguu<"Guj gt'Cvikuqp"

"
Y gktu'EtggniUqirt.'NNE'"
Ecug'Pq04246/222; ; '"
Uskpi 'Dqctf 'UcHtu'Hktuv'Tgs wguv'ht 'kphqto cvkqp'"

"
Tgs wguv'72<"Rtqxkf g'kphqto cvkqp"qp'uqirt'r cpgnu'vq'dg'wugf . 'v'kpenwf g<"

"
c0 Fcvc'uj ggu0'

d0 Eqwpt{ 'qh'o cpwxcwgt0'

"
Tgur qpug'72<"

"
Y gktu'EtggniUqirt'f qgu'pqv'j cxg'v'j g'kphqto cvkqp"qp'v'j g'uqirt'r cpgnu.'cu'v'j g'ur gekhe"cmqecvqrp"

j cu'pqv'dggp'f gvgto kpgf 0'"

" " "

Tgur qpug'73"
Rci g'3qh'3"
Y kpguu<"Guy gt'Cvirkpuqp"

"

Y gktu'EtggmUqret.'NNE'''

Ecug'P q04246/222; ;'''

Uslpi 'Dqctf 'Uc htu' Hktu' Tgs wguv' hqt 'kphqto cvkqp'''

"

Tgs wguv'73<"Rtqxkf g'kphqto cvkqp"qp'kpxgtvgtu'vq'dg'wugf . "v'kpenwf g<"

"

c0 Fcvc'uj ggvu0'

d0 Eqwpt{ 'qh'o cpwrcwgtg0'

Tgur qpug'73<'

Y gktu'EtggmUqret'f qgu'pqvj cxg'vj g'kphqto cvkqp"qp'vj g'kpxgtvgtu."cu'vj g'ur gekke"cmqecv'kqp'j cu"

ppv'dggp"fgvgtu kpgf 0'''

"

"

Tgur qpug'74"
Rci g'3qh'3"
Y kpguu<"Guyj gt'Cvirkpuqp"

"

Y gktu'EtggmUqrct.'NNE'''

Ecug'Pq04246/222; ;'''

Uslpi 'Dqctf 'Uc htu' Hktu' Tgs wguv' hqt 'Iphqto cvkqp'''

"

Tgs wguv'74<"Rtqxkf g'kphqto cvkqp"qp'tgeqo dkgptu'vq'dg'wugf.'vq'kpenwf g<"

c0 Fcvc'Uj ggw0"

d0 Eqwpt{ 'qh'o cpwkcwgtg0"

"

Tgur qpug'74<'

Y gktu'EtggmUqrct'f qgu'pqvj cxg'vj g'kphqto cvkqp"qp'vj g'tgeqo dkgptu.'cu'vj g'ur gekhe'cmqecvqkp"

j cu'pqv'dggp'f gvgto kpgf 0'''

"

"

T gur qpug'75"
Rci g'3qh'4"
Y kpguu<"Nguvt'O qtcngu"

**Y gkt u'Et ggm'Uqret.'NNE''''
Ecug'P q04246/222; ;''''**

Uklpi 'Dqctf 'Uc hhu' Hkt u' Tgs wguv' hqt 'Iphqt o cvkqp''''

Tgs wguv'75<"Rtqxkf g"cp"gzr rncpvkqp"htq"y j { "c"o qvkvq"htq" f gxkcvkqp"ku'pqv'pgegf gf "vq"o qf kh{ "vj" g"
ugvdcem' tgs wkt go gpv'qh'3.222' hggv'htqo "vj" g'r tqr gtv{ "dqwpf ct { "qh'cp { 'cf lqkpkpi "r tqr gtv{ "qy pgt" r' gt"
MTU'49: 026*4-0'

T gur qpug'75<'

MTU'49: 026*4+'ucvqu.'''

í pq" eqpuxwvkvq" egt v' h'ecv" uj cm' dg" kuwgf " vq" eqpuxwv' c" o gtej cpv' grgevtke"
i gpgtcvki "hcekkv{ "vprguu"vj" g"gzj cwuv'ucem'qh'vj" g'r tqr qugf "hcekkv{ "cpf "cp { "y kpf "
wtdkpg"ku'cv'ngcu"qpg"vj" qwucpf ""*3.222+'hggv'htqo "vj" g'r tqr gtv{ "dqwpf ct { "qh"cp { "
cf lqkpkpi " r tqr gtv{ " qy pgt" cpf " cm' r tqr qugf " utwewtgu" qt " hcekkvku" wugf " hqt "
i gpgtcvkvq" qh' grgevtke{ "ctg"vy q"vj" qwucpf ""*4.222+'hggv'htqo 0" Hqt "r vtr qugu"qh"
cr r r' h'ecvkvpu"htq" ukv"eqo r cvdkkv{ "egt v' h'ecvqu"r wtuwcpv"vq" MTU'49: 0438. "qpn{ "vj" g"
gzj cwuv'ucem'qh'vj" g'r tqr qugf "hcekkv{ "vq" dg" cewcm{ "wugf "hqt" eqcn'qt"i cu/hk'gf "
i gpgtcvkvq"qt. "dgi kppkpi "y kj "cr r r' h'ecvkvpu"htq" ukv"eqo r cvdkkv{ "egt v' h'ecvqu" h'k'gf "
qp"qt "ch'gt' Lcpwct { "3.4237. "vj" g'r tqr qugf "utwewt g'qt" h'cekkv{ "vq" dg" cewcm{ "wugf "hqt"
uqret"qt"y kpf "i gpgtcvkvq"uj cm'dg'tgs wkt gf "vq" dg"cv'ngcu"qpg"vj" qwucpf ""*3.222+'hggv'
htqo "vj" g'r tqr gtv{ "dqwpf ct { "qh"cp { "cf lqkpkpi "r tqr gtv{ "qy pgt" cpf "vy q"vj" qwucpf "
*4.222+'hggv'htqo "cp { "t'gukf gpv'cn'p'gki j dqtj qqf . "uej qqn"j qur kcn"qt" pwtukpi "j qo g"
hcekkv{ 0'
"

Y gktu'Et ggm'uqret "ku'pqv'r tqr qukpi "vq" dwkf "c" hcekkv{ "y kj "c"y kpf "wtdkpg"qt"gzj cwuv'ucem"uq" c"
tgs wguv'htq" c" f gxkcvkqp"htqo "vj" g'3.222' hggv'ku'pqv'pgeguuct { 0" Cf f k'k'qpcm{ . "Y gktu'Et ggm'Uqret"j cu"
tgxkgy gf "cm'r tkqt"Uklpi "Dqctf "f gekukpu. "kpenmf kpi "vj" g"o quv'tgegpv'f gekukqp. "cpf "ecp" h'k'pf "pq"
kpuwpeg"qh'vj" g'Uklpi 'Dqctf 'tgs wkt kpi "cp"cr r r' h'ecpv'vq'tgs wguv'c' f gxkcvkqp'htq"vj" g'3.222/hqqv'ugvdcem'
dgecvug"vj" g'r tqlgew'f q'pqv'r tqr qug"vq" kpenmf g" c"y kpf "wtdkpg"qt"gzj cwuv'ucem"0" Vj" g'qpn{ "vko" g"vj" g"
MTU'49: 026*4+'tgs wkt gu'vj" g'3.222/hqqv'ugvdcem'htq"uqret"i gpgtcvkvq"ku'y j gp" c" ukv"eqo r cvdkkv{ "
egt v' h'ecv"ku'tgs wguv'gf 0"Ukpeg"Y gktu'Et ggm'Uqret"ku'c"o gtej cpv'grgevtke"i gpgtcvki "hcekkv{ "cpf "pqv"

c'wkrkv{ 'tgi wrcvgf 'd{ 'yj g'Rwdrke "Ugtxleg'Ego o kukqp. "Y gktu'Etggm'Uqirt'ku'pqv'tgs wktgf "vq'qdvckp"
c'ukvg'eqo r cvdkkv{ 'egt vkkcvg"cpf 'yj gtghqtg'yj g"3.222'hqqv'ugvdcenif qgu'pqv'cr r n{ 0""

Cf fkkqpcm{. "Y gktu'Etggm'Uqirt'ku'pqv'r tqr qukpi "vq'dwkrf "cp{ "r tqlgcv'eqo r qpgrw'y kj kp"
4.222" hggv'qh"cp{ "tgukf gpvkn'pgki j dqtj qqf. "uej qqn"j qur kcn"qt" pwtukpi "j qo g" hcekkv{ "uq"pq"
f gxcvkqp'ku'tgs wktgf 0'Rrgcug'ugg'yj g'cwcej gf "Tgukf gpvkn'P gki j dqtj qqf "O cr 0'Rrgcug'pqvg. "Y gktu"
Etggm'Uqirt'j cu'rcpf 'hgcugf 'yj cvku'y kj kp"4.222'hggv'qh'c'pgki j dqtj qqf. "dw'cu'kpf kcvgf 'kp'yj g'o cr "
d{ 'yj g'tgf "kpgu. "pq'kphcutwewtg"*kpenw'kpi 'hpegu+'ku'y kj kp"4.222'hggv'qh'c'pgki j dqtj qqf 0""

"
"
"
"

"

CVVCEJ O GP V'RESPONSE 53''

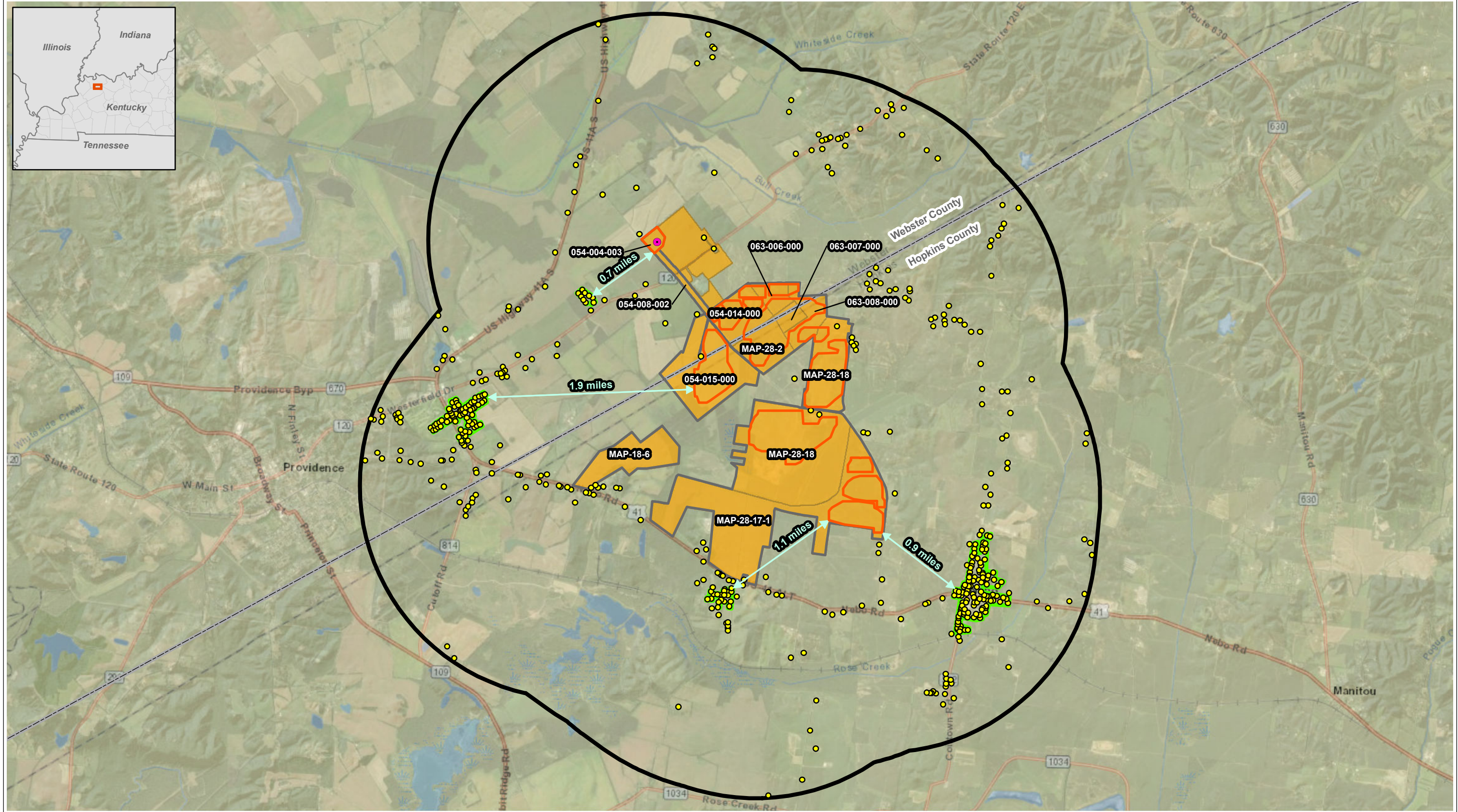

Project Location Map
 Weirs Creek Solar Project
 Hopkins and Webster Counties, KY
 Date: 5/17/2024

Sources: ESRI World Imagery 9/2023; Weirs Creek Solar, LLC, 2024; ECT 2024.

Legend

- Residential Structure
- Point of Interconnect (POI)
- Project Fence
- Distance (Miles) from Residential Neighborhood to Closest Project Facility
- Residential Neighborhood per KRS 278.700
- Project Parcel
- Project Boundary
- 2-Mile Project Boundary Buffer

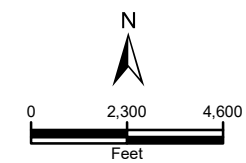

Tgur qpug'76"
Rci g'3qh'3"
Y kpguu<"Guyj gt'Cvnpuqp"

"

Y gkt u'Et ggmUqret.'NNE'''

Ecug'P q04246/222; ;'''

Uslpi 'Dqctf 'Uclhu'Hkt u'Tgs wguv'ht 'kphqto cvkqp'''

"

Tgs wguv'76<"Rtqxkf g'kphqto cvkqp"qp"y j gyj gt'vj g'r rpppgf "eqo o wplecvkqp"pgvy qtmly knidg"cdqyg"

qt"dgrqy 'i tqwvf 0'

Tgur qpug'76<'

Vj g'r rpppgf "eqo o wplecvkqp"pgvy qtmly"hdgt "eqpf wks#y knidg"wpf gti tqwvf 0'

"

Tgur qpug'77"
Rci g'3qh'3"
Y kpguu<"Nguvt'O qtcngu"

"

Y gkt u'Et ggmUqret.'NNE'''

Ecug'P q04246/222; ;'''

Uslpi 'Dqctf 'Uclhu'Hkt u'Tgs wguv'ht 'kphqto cvkqp'''

"

Tgs wguv'77<"Rtqxkf g'c"qpg'kpg'ht"vj g'r tqlgev0'

"

Tgur qpug'77<'

"

Rrgcug'ugg'Qpg'Nkpg'cwcej o gp0'

"

CVVCEJ O GP V'RESPONSE 55''

Exhibit A1. Interconnection Customer One-Line and Site Map
A1-1: Interconnection Customer One-Line Diagram

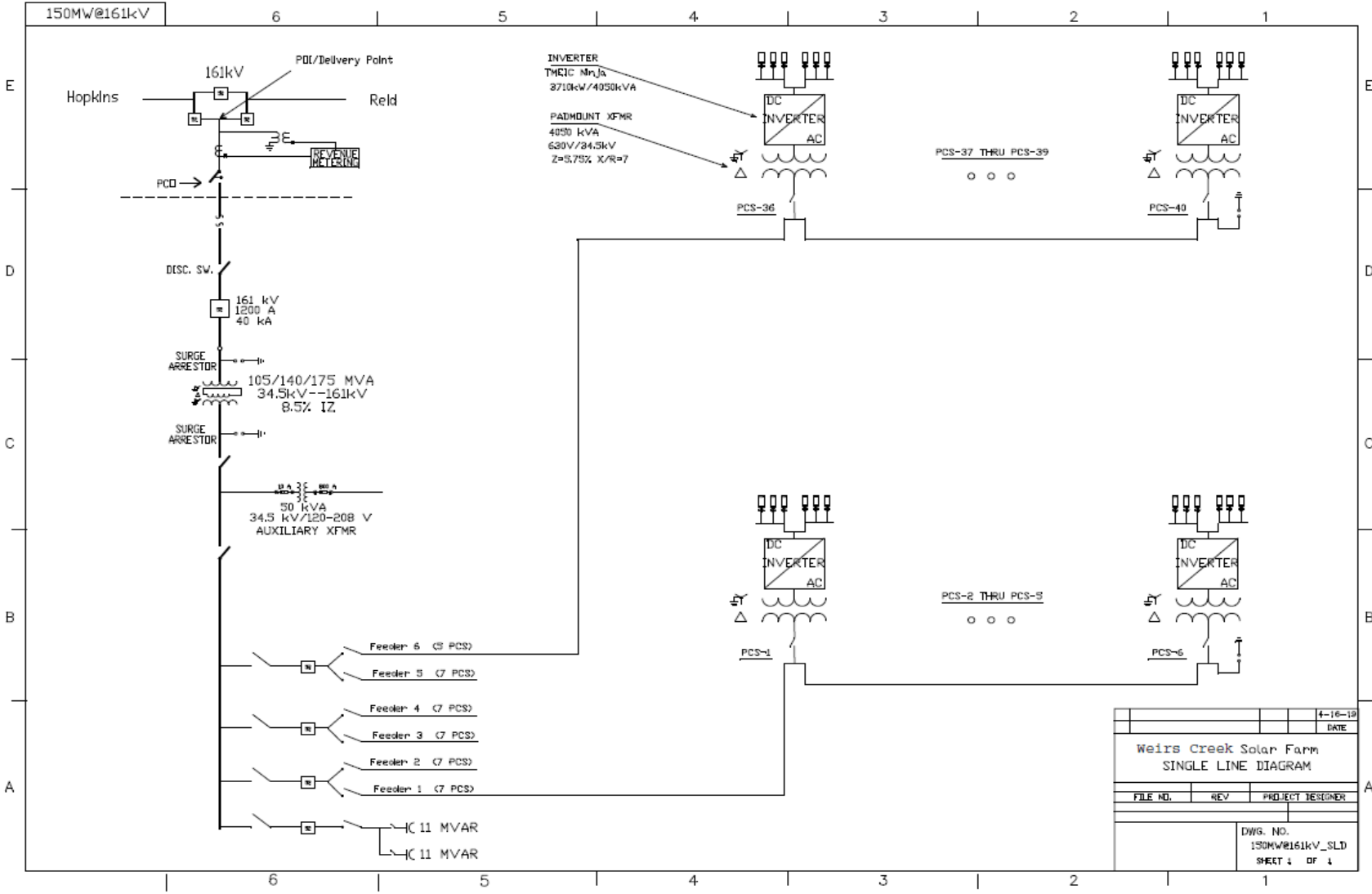

**Exhibit A2. Transmission Owner One-Line (CEII)
A2-1: Interconnection Substation One-Line**

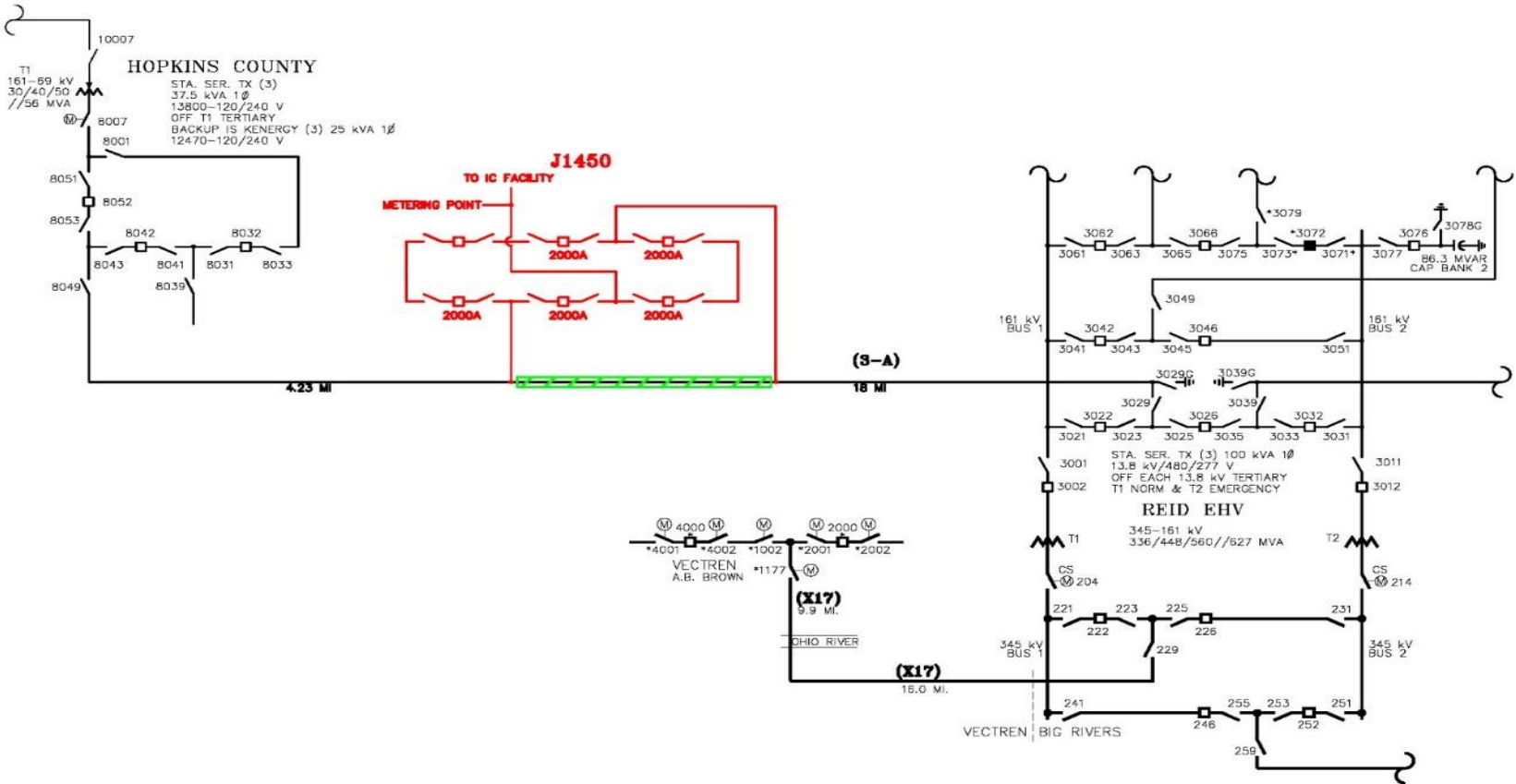

Tgur qpug'78"
Rci g'3qh'3"
Y kpguu<Dtkcp"DctvgnlDgy "Y krdwtp"

"

Y gkt u'Et ggmUqret.'NNE'''
Ecug'P q04246/222; ;'''

Uslpi 'Dqctf 'Uchlhu'Hkt u' Tgs wguv'ht 'kphqto cvkqp'''

"

Tgs wguv'78<"Rtqxf g'kphqto cvkqp"qp'y j gvj gt'y gwrpf "f grkpgcvkqpu'j cxg"dggp'eqo r rvgf "hqt'yj g"
rtqlgev0'

Tgur qpug'78<'

GEV"eqpf wevgf "hgrf "kpxguki cvkqpu"kp"Cr tkr'4245"cpf "Hgdwtct{ "4246"vq"kf gpwh{ ."f grkpgcvg."cpf "
ej ctcevgtk g"cs wcvk"tguqwtegu0' Cp"qxgtxlgy "o cr "qh'yj gug"hgcvwtgu"ku"r tqxf gf "cu"r ctv'qh'yj g"
Tgur qpug'vq'kgo "620"

"

Tgur qpug'79"

Rci g'3qh'3"

Y kpguu<Dtkp"DctvgnlDgy "Y kdwtp"

"

Y ght u'Et ggmUqret.'NNE'''

Ecug'Pq04246/222; ;'''

Uslpi 'Dqctf 'UcHtu'Hlt u'Tgs wguv'ht 'Kphqto cvkqp'''

"

Tgs wguv'79<"Gzr mlp'y j cv'ghgevy'j g'r tqlgevy knlj cxg"qp"lwt kuf kevqpcny gvrpf u0'

'''

Tgur qpug'79<'

Dcugf "qp'vj g'r tgrko kpc{ 'ukg'r rcp"*Gzj kdk/5'kp"vj g'UCT+."cmkphcwt wewtg'j cu'dggp'ukgf "vq"cxqkf "

cp{ 'f grkpgcvgf "y gvrpf 'hgcwtg0C"47/hqqv'ugvdcemly cu'cr r kfg "vq"cmqh'vj g'cs wvke'tguqwtegu'kp'vj g"

eqputckpw'o cr r kpi 0'

Tgur qpug'7: "
Rci g'3qh'3"
Y kpguu<Dtkcp"DctvgnlDgy "Y krdwtp"

"
Y gkt u'Et ggmUqret.'NNE''
Ecug'P q04246/222; ;''
Uslpi 'Dqctf 'Uc hhu'Hkt ur'Tgs wguv'ht 'kphqto cvkqp''
"

Tgs wguv'7: < "Rtqxf g" kphqto cvkqp" qp" y j gyj gt" cp { "gpf cpi gtgf" ur gekgu" uco r rki . "kpenwf kpi "
gpf cpi gtgf "dcu. j cu'dggp"eqo r rgyf "hqt"vj g't qlgv0

Tgur qpug'7: <'

Cu"pqvgf "kp" Tgur qpug'9. "vj g" Cr r rkecpv'eqpf wevgf "c" f gumqr "uww { "v" kf gpvkh { "cp { "r qvprken'dcv"
j cdkcv'kp"vj g'Rtqlgev'Ctgc"cpf "gxcnvcvgf"vj gug'ctgcu'f wtkpi "vj g'hgrf y qtm'eqpf wevgf 'kp'Cr tki'4245"
cpf "Hgdwtct { "42460P q"ur gekgu/ur gekhe'lwtxg { u*o kv'pgwki "qt'ceqwvke+ j cxg'dggp"eqo r rgyf "v"
fcv"ht"vj g'Rtqlgev'Vtgg"ergctki "y qwf "dg"nko kcf "v"vj g"UHY U"vgg"ergctki "y kpf qy "htqo "
Pqxgo dgt'37"vj tqwi j 'O ctej "530'

Vj g'Cr r rkecpv'eqo r rgyf "vj g'hqmy kpi "eqo o wplecvkpu'tgi ctf kpi "r qvprken'vj tgcvgpgf "cpf "
gpf cpi gtgf "ur gekgu"*VGU+hqt"vj g'Rtqlgev'Ctgc"cpf "3/o kg'dwhgt<"

- WUOHkuj "cpf "Y kf rkhg"Ugtxleg"*UHY U+"kphqto cvkqp"ht'Rrcppkpi "cpf "
Eqpuwncvqp"*RCE+"vqqr'kp"Lwp'g'42460'

- Cp"go cki'v"vj g"UHY U'Mgpwem { "Hgrf "Qhleg"*MHQ+"tgs wguv'kpi "cxckrdng" kphqto cvkqp"
qp"mpqy p"qeewtgpeg"qh'ugpukxg"ur gekgu'y kj kp"vj g'Rtqlgev'Ctgc"kp'O c { "42460"
- C"rgwt"v"vj g" Mgpwem { "Qhleg"qh"P cwtg"Rtgugtxgu"tgs wguv'kpi "kphqto cvkqp"qp"mpqy p"
qeewtgpeg"qh'ugpukxg"ur gekgu'y kj kp"vj g'Rtqlgev'Ctgc"kp'O ctej "42430'
- C"rgwt"v"vj g" Mgpwem { "F gr ctvo gpv"qh"Hkuj "cpf "Y kf rkhg" Tguqwtegu" *M { "F HY T+"
tgs wguv'kpi " cxckrdng" kphqto cvkqp" qp" mpqy p" qeewtgpeg" tgeqtfu" qh' Ucvg" tctg" cpf "
gpf cpi gtgf "r rcpw"cpf "cpko cn'ur gekgu'kp"vj g'Rtqlgev'Ctgc"kp'O ctej "42430'

Tgur qpug'7;
Rci g'3qh'3"
Y kpguu<Dtkcp"DctvgnlDgy "Y krdwtp"

"

Y gkt u'Et ggmUqret.'NNE'''

Ecug'P q04246/222; ; '''

Uslpi 'Dqctf 'Uc hku'Hkt u' Tgs wguv' hqt 'Iphqto cvkqp'''

"

Tgs wguv'7; <"Rtqxkf g'kphqto cvkqp"qp'y j gyj gt'vj gtg'ku'cp"gpfcpi gtgf "dcv'o kki cvkqp' rcp0"

"

Tgur qpug'7; <"

Ugg'vj g'Tgur qpug'vq"Kgo '9'hqt"o qtg'f gvcku0Vj g'Cr r nkecpv'j cu'pqv'f gxgnr gf "cp"gpfcpi gtgf "dcv"
o kki cvkqp'r rcp'hqt"vj g'Rtqlgev0Vj g'Rtqlgev'lphctwewtg"j cu'dggp"ukgf "vq"o kpk0 k g'ko r cew'vq"
r qvppkcn'dcv'j edkcv'y kj "cp"gvko cvgf "320 "cetgu'vq"dg'engctgf "dcugf "qp"vj g'r tgn0 kpcct { "ukg'r rcpu0"
Vtgg"engctkpi "y qwf "dg'iko kgf "vq"vj g"WUHY U"vagg'engctkpi "y kpf qy "htqo "P qxgo dgt"37"vj tqwi j "
O ctej "53"vq"o kpk0 k g'ko r cew'vq"vj tgcvgpgf "cpf "gpfcpi gtgf "dcv'ur geku0"

"

"

T gur qpug'82"
Rci g'3qh'3"
Y kpguu<Dtkcp"Dct vgnlDgyj "Y krdwtp"

"

Y gkt u'Et ggmUqret.'NNE''
Ecug'P q04246/222; ; ''

Uslpi 'Dqctf 'Uclhau'Hkt ur'Tgs wguv'ht 'kphqto cvkqp''

"

Tgs wguv'82<"Rtqxkf g'kphqto cvkqp'qp'y j gyj gt 'y g'WUOCto { 'Eqtr u'qhGpi kpggtu*WUCEG'j cu'dggp"
qt'y kn'dg'eqpuwngf 'tgi ctf kpi 'y g'w'p'f 'f g'kpgcvkqpu'cpf 'y tgcvgpgf "qt"gp'f cpi gt'gf 'ur geku0

T gur qpug'82<'

Dcugf "qp'y g'r tgrko kpc{ 'ukg'r rcp"Gzj kdk'5'kp'y g'UCT+.'y g'Rtqlgev'kphcwtwewt'g'ku'cxqkf kpi 'cm'
f g'kpgcvgf 'y g'w'p'f 'hgcw'gu0Vj gt'g'ku'qpg'wt'gco 'etqukpi 'y kj 'cp'ceegu'tqcf 'y cv'ku'pqv'cp'v'ekr cvgf "
vq"gzeggf "y g'y tguj qf u'y cv'y qwf "t'ki i gt"r tg'eqputwv'kqp"pq'k'k'v'kqp"*REP +'y tqwi j "y g'
WUCEG'*522"n'p'gct "hggv'ht"dqy 'tgi kqpcn'cpf "623"Y S E"eqpf k'k'qpu+0Vj ku'etqukpi "cniq'f qgu'pqv"
tgs w'g'cp { 't'gg'engctkpi 0'K'ku'cp'v'ekr cvgf "y cv'y g'Rtqlgev'y kn'l'ugr/egt'v'h { 'w'p'f gt"p Y R'36"dcugf "
qp'y g'r tgrko kpc{ 'ukg'r { qw0Vj g'Cr r n'ecpv'ku'pqv'cp'v'ekr cvkpi 'y g'p'ggf "v'q'wdo k'c'lwt'kuf k'v'kqpcn'
f g'v'gto k'p'cv'kqp"v'q'y g'WUCEG'f w'g'v'q'y g'h'cev'y cv'y g'r tgrko kpc{ 'ukg'r rcp'ku'cxqkf kpi 'cm'dw'qpg"
qh'y g'f g'kpgcvgf "cs w'v'k'et'gu'w'egu'lp'y g'Rtqlgev'c'tgc0"Cu'r tgx'k'q'wun { 'f k'uew'ugf "lp'y g'T gur qpug"
vq"Kgo '9.'y g'Cr r n'ecpv'j cu'eqqtf k'p'cv'gf 'y kj 'y g'WUHY U'cpf "cr r n'ecdn'g'w'v'g'ci g'p'ekgu'tgi ctf kpi "
VGU0"

Tgur qpug'83"
Rci g'3qh'3"
Y kpguu<Dtkcp"Dct vgnlDgyj "Y krdwtp"

"

Y gkt u'Et ggmUqret.'NNE'''

Ecug'P q04246/222; ;'''

Uslpi 'Dqctf 'Uclhu'Hkt ur'Tgs wguv'ht 'kphqto cvkqp'''

"

Tgs wguv'83<"Rtqxkf g'kphqto cvkqp"qp"y j gyj gt "yj g"WUOHkj "cpf "Y kf rktg'Ugt xleg"j cu'dggp"qt "y km'

dg"eqpuwngf "tgi ctf lpi "y gvcpf "f grkpgcvkqpu"cpf "yj tgcvgpgf "qt "gpf cpi gt gf "ur gekgu0'

Tgur qpug'83<'

Ugg"yj g'Tgur qpug"v"Kgo '820'

Tgur qpug'84"
Rci g'3qh'3"
Y kpguu<Dtkcp"Dct vgnlDgy "Y krdwtp"

"

Y gkt u'Et ggmUqret.'NNE'''

Ecug'P q04246/222; ;'''

Uslpi 'Dqctf 'Uclhu'Hkt u'Tgs wguv'ht 'kphqto cvkqp'''

"

Tgs wguv'84<" Gzr rckp" y j gyj gt" vj g"ukg"rc {qw"r rcp"y km'dg"o qf kkgf"dcugf"qp"vj g"y gvcpf"

f gkpgcvkqpu'vj cvj cxg'dggp'eqo r ngvf 0'

Tgur qpug'84<'

P q.'vj g'r tgrko kpct { "ukg"r rcp" Gzj kdk'5'kp'vj g'UCT +j cu'cxqkf gf "cmf' gkpgcvgf "y gvcpf u0'

Tgur qpug'85"
Rci g'3qh'4"
Y kpguu<Dtkcp"DctvgnlDgy "Y krdwtp"

"
Y gkt u'Et ggmUqret.'NNE'''
Ecug'P q04246/222; ;'''
Uslpi 'Dqctf 'Uclhau'Hkt u'Tgs wguv'ht 'kphqto cvkqp'''

"
Tgs wguv'85<"Tghgt "v'j g'UCT."Gzj kdk'6."P qlug"K r cevCuuguo gpv0'

c0 Gzr nkp"y j g"pqkug"ko r cev'qh'r krf tkxkpi "cpf "y j gj gt "k'y km'j cxg"c"uki pkhecpv'ko r cev"qp"
cf lcegpv'hepf qy pgtu0'

d0 Eqphko "y j gj gt"pgctd{ "rpf qy pgtu'y km'dg"eqpwevgf "r tkqt "v'cp{ "j k j /pqkug"eqputwekqp"
qt"cevxkv{ 0'

e0 Gzr nkp"kp"f gvcklj qy "uqwpf"ko r cev'f wtkpi "eqputwekqp"cpf "qr gtcvqp"y km'dg'o kki cvgf 0'

f0 Gzr nkp"y j gj gt"rpf qy pgtu"y km'dg"eqpuwngf "y tqwi j qw"y j g"eqputwekqp"r tqegu"v"
gpwtg"pqkug"o kki cvkqp"o gcwtgu'ctg'y qtnkpi 0'

"
Tgur qpug'85<

Cu"f kuewugf "kp"y j g"P qlug"K r cevCuuguo gpv'qp"r ci g"8."y j g"nqwf guv'eqputwekqp"uqwpf "rgxgr'
ecrewevgf "cv'c'r ctvlekr cvkpi "tgegr vqt'ht"y j g'r krf tkxkpi "r j cug'ku": 8'f DC"cpf "; 5'f D'cv'tgegr vqt'98"
nqecvgf "355'hw'htqo "y j g'pgctguv"RX"r cpgr0Vj g'nqwf guv'eqputwekqp"uqwpf "rgxgr'ecrewevgf "cv'c"pqp/
r ctvlekr cvkpi "tgegr vqt'ht"y j g'r krf tkxkpi "r j cug'ku"98'f DC"cpf ": 8'f D'cv'tgegr vqt"; ; "nqecvgf "4; 9'hw'
htqo "y j g"pgctguv"RX"r cpgr0K'ku"ko r qtwpv"v"pqv"y j cv'y ku"cpn{ uku"cuuwo gu"y j g"eqputwekqp"
gs wkr o gpv'cuuqekvgf "y kj "y j g'r tqgevk'qr gtcvki "uko wncpgqwn{ 0Vj ku'cuuwo r vqp'ku'eqputxcvkg"
cu'y j g"gs wkr o gpv'y km'rkngn{ "dg"o qtg'ur tgecf "qw'ctqwpf "y j g'ukg"cpf "pqv'rkngn{ "v"dg"qr gtcvki "cv"
y j g"uco g"vko g0'Qy j gt"pqkug"cwgpwekqp"ghgeu"uwej "cu"cw qur j gtle"cdutr vqp."i tqwpf "ghgev."
tghgevkqp"cpf "uj krf kpi "d{ "vr qi tcr j kcn'hcwgtgu'qt"qdlgew"y gtg"pqv'eqpukf gtgf "kp"y j g"cpn{ uku0'

O gcuwtgf "uqwpf 'r tguwtg'ngxgnu'f wtkpi "eqputwekqp"cevxkkgu'ctg'yj gthgtg'gZR gevgf "vq'dg'my gt " vj cp'uj qy p'kp'Cr r gpf kz "D0'

V{r kecn'hcto kpi "gs wkr o gpv'uwej "cu"c"tcevt"ecp"go k'uqwpf "ngxgnu"cv'cr r tqzko cvgn{ ": 2" f DC"cv72'h'cu'uj qy p'kp'Vcdng"4/30Vj g'ecrewevgf "eqputwekqp"uqwpf 'r tguwtg'ngxgnu'ctg'gZR gevgf " vq"dg"uko kctt"qt"my gt"vj cp"v{r kecn'hcto kpi "gs wkr o gpv'cv'o quv'tgegr vqtu0'Uqwpf "go kwgf "htqo " eqputwekqp"gs wkr o gpv'ku"gZR gevgf "vq"dg"eqo r ctdng"kp'ej ctcevt"vq"kpvtpcn'eqo dwukqp"gpi kpg" uqwpf "cuuqekvgf "y kj "hcto kpi "gs wkr o gpv'Eqpukf gtkpi "hcto kpi "cevxkkgf {"qeewu"fwtkpi "vj g"fc{" y j gp"eqputwekqp"ku'uej gf wrgf ."uqwpf "go kwgf "d{"eqputwekqp"gs wkr o gpv'uj qwf "dg"uko kctt"vq" y j cv' vj g" eqo o wpkv{ "ewtgpv{ "gZR gtlgpegu" kp" vj g"gzlkupi "uqwpf "gpXktqpo gpv'F wg" vq" vj g" eqpugtxcvkg"pcwtg"qh"vj g"cuuguu gpv."k'ku"gZR gevgf "vj cv'uqwpf "ngxgnu"o c{"dg"nguu"vj cp"vj g" tghgtgpegf "tcevt"uqwpf "ngxgnu"cv72'h'hqt"o quv'qh'vj g"fc{"fwtkpi "c'i kxgp"fc{"qh'eqputwekqp0"

I kxgp"vj g'tguwu"qh'vj g'P qkug"K r cev'Cuuguu gpv."vj g'pqkug"htqo "vj g'r krg'f tkkpi "fwtkpi " eqputwekqp"qh'vj g'Rtqlgev'ku'pqv'cpvkr cvgf "vq"j cxg"c"uki pkkcepv'ko r cev'qp"cf lcegpv'rcpf qy pgtu0' Vj g"Cr r ncepv'y km'pqvkh{ "tgukf gpw"cpf "dwukguugu"o cr r gf "y kj kp"4.622"hggn"qh'vj g"Rtqlgev" dqwpf ct {"cdqw'vj g'eqputwekqp"r rcp."vj g'pqkug"r qvgrvkn"cpf "o kki cvkqp"r rcpu'qpg"o qp vj "r tkqt"vq" vj g'uvctv'qh'eqputwekqp0"Vj g"Cr r ncepv'y km'f kuewu'pqkug"o kki cvkqp"qr vkpu'y kj "vj g"GRE."qpeg" qpdqctf gf ."r tkqt"vq"eqputwekqp"cpf "eqpf wev'c"vj qtqwi j "'eqpuwncvqp"vq"fgvto kpg"cp {"DO Rcu"vq" o kki cvg" pqkug" fwtkpi "eqputwekqp0" " Vj g" Cr r ncepv' y km' kpkvcg" cpf " o clpvkcp" c" Eqo r nkp v" Tguqnwkp'Rtqi tco 'r tqxkf gf "vq"vj g'Ukupi 'Dqctf 'kp'vj g'ecug'tgeqtf "vq"cf f tguu'cp {"eqo r nkp w'htqo " eqo o wpkv{ "o go dgtu'tgi ctf kpi "pqkug"ngxgnu0'Vj g"Cr r ncepv'uj cm'cnuq"uwdo k'cppwcm {"c"ucwu" tgr qtv'cuuqekvgf "y kj "ku"Eqo r nkp v" Tguqnwkp" Rtqi tco ."r tqxkf kpi ."co qpi "qvj gt"vj kpi u."vj g" kpf kxkf wcn'eqo r nkp w."j qy "vj g"Cr r ncepv'cf f tguugf "vj qug'eqo r nkp w."cpf "vj g'wnko cvg'tguqnwkp" qh'vj qug'eqo r nkp w'kf gpvkh{ kpi "y j gvj gt"vj g'tguqnwkp"y cu"vq"vj g'eqo r nkp cpv'u'ucvukcevkqp0

T gur qpug'86"
Rci g'3qh'3"
Y kpguu<Dtkcp"DctvgnlDgy "Y krdwtp"
"

Y gkt u'Et ggmUqret.'NNE'''
Ecug'P q04246/222; ;'''
Uslpi 'Dqctf 'Uclhau'Hkt u'Tgs wguv'ht 'kphqto cvkqp'''

"

Tgs wguv'86<"Rtqxkf g'kphqto cvkqp"qp"cp{"r tqvgevkqp"r rpu'ht"mecn'ego gvtkgu"cpf "qj gt"j kuvtke"
tguqwtegu'kp"vj g'r tqlgev'ctgc0'

T gur qpug'86<

Cu'f kuewuugf "kp"vj g" T gur qpug"vq"Kgo "44."y q"ego gvtkgu"ctg"o cr r gf "kp"vj g"Rtqlgev'xlekpky(0'
Eqo r vqp"Ego gvt {"ku"o cr r gf "kp"vj g"egpvtcn'r qtvkqp"qh"vj g"Rtqlgev'ctgc"qp"vj g"uqwj "ukf g"qh"
F qpcrf uqp"Tqcf 0'C"322/hqqv'ugvdcen'y cu'cr r rkgf "vq"vj g"dqwpf ct {"qh"vj g"ego gvt {0'Vj g'emuguv'
kphcutwewt g'ku"o"hgpegf "cttc {"vj cv'ku"o cr r gf "cr r tqzko cvgn {"462"hggn'vq"vj g'y guv'cetquu"o"mcti g"
y qqf m0'

Eqtkpvj "Ego gvt {.ku"cuuqekcvgf "y kj "vj g'Eqtkpvj "Ej wtej .ku"o cr r gf "cf lcegpv'vq"vj g'pqtvj "
qh"vj g"Rtqlgev'ctgc"qp"vj g'uqwj "ukf g"qh"m /3420C"322/hqqv'ugvdcen'y cu'cr r rkgf "vq"vj g"dqwpf ct {"
qh"vj g"ego gvt {0'Vj g'emuguv'kphcutwewt g'ku"o"hgpegf "cttc {"ctgc."o cr r gf "cr r tqzko cvgn {"52"hggn'
vq"vj g'uqwj gcu0'Vj g'Cr r rkecpvf qgu'pqv'cpvlekr cvg'vj g'pggf "hqt"o"r tqvgevkqp"r rpu'ht"vj g'ego gvtkgu"
cu"vj gug'hgcwtgu"j cxg"dggp"kf gpv'kfg "cpf "cf f gf "vq"vj g'r tgrko kpc {"ukg"r rpu'y kj "cp"cxqkf cpeg"
ugvdcen0'

Cu'f kuewuugf "kp"vj g" T gur qpug"vq"Kgo '8; .GEV'j cu'eqpf wewf "dqj 'f gumqr "cpf hgrf 'ewnwten'
uwf lgu'cpf "vj g'eqttgur qpf kpi 'ewnwtenhgcwtgu"j cxg"dggp'kpenw gf "kp"vj g'eqputckpw'o cr r kpi "y kj "
c"322/hqqv'ugvdcen0'

Weirs Creek Solar, LLC
Case No. 2024-00099
Siting Board Staff's First Request for Information

Request 66: Explain whether Weirs Creek Solar intends to hire as many local workers for the construction and operations phases of the project as possible, all other qualifications for the positions being equal. If confirmed, explain how Weirs Creek Solar will ensure this occurs.

Response 66:
Weirs Creek's desire would be to hire as many local workers as possible for the construction and operations phases for the project, however the Weirs Creek does not directly control the hiring process and can only recommend to the hiring authority the multiple advantages of hiring locally.

Weirs Creek Solar, LLC
Case No. 2024-00099
Siting Board Staff's First Request for Information

Request 67: Explain whether Weirs Creek Solar has developed a plan to protect endangered bats in the project area during tree clearing.

Response 67:

See the Response to Item 7 and the Response to Item 59.

Weirs Creek Solar, LLC
Case No. 2024-00099
Siting Board Staff's First Request for Information

Request 68: Explain what impact farm dumps will have on the project.

Response 68:

See the Response to Item 34.

Weirs Creek Solar, LLC
Case No. 2024-00099
Siting Board Staff's First Request for Information

Request 69: Provide any information concerning historical or archaeological research done for the project. If none have been done, explain why.

Response 69:

ECT obtained the desktop cultural files (IE. archaeological sites, cemeteries, Kentucky Heritage Council Historic Coded Resources, etc.) for the Project Area and 2-kilometer buffer in June 2023 and completed a desktop report. ECT, on behalf of the Applicant, conducted a Phase I archaeological survey for the Project in March 2024 and completed a corresponding report in May 2024. The desktop and field-identified cultural sites were included in the constraints mapping for the Project with a 100-foot setback to avoid impacts.