

COMMONWEALTH OF KENTUCKY
BEFORE THE PUBLIC SERVICE COMMISSION

In the Matter of:

ELECTRONIC APPLICATION OF NORTHERN KENTUCKY)
WATER DISTRICT FOR A CERTIFICATE OF PUBLIC) **CASE NO. 2024-00025**
CONVENIENCE AND NECESSITY TO CONSTRUCT A 0.50 MG)
WATER STORAGE TANK)

RESPONSE TO FEBRUARY 26, 2024 NOTICE OF FILING DEFICIENCY

Northern Kentucky Water District (“NKWD”), by and through counsel, submits its response to Commission Staff’s February 26, 2024 Letter providing notice of a filing deficiency:

1. **KRS 322.340: Engineering plans, specifications, drawings, plats and reports for the proposed construction or extension prepared by a registered engineer, must be signed, sealed, and dated by an engineer registered in Kentucky; Attachment A-4, Preliminary Engineering Report was not signed, sealed, and dated by an engineer certified in Kentucky.**

RESPONSE: NKWD submits the attached updated Exhibit A-4, Preliminary Engineering Report.

NKWD believes that the information provided contains all requirements of the regulations. To the extent that the information provided does not adequately address some portion of the regulations cited, NKWD requests a deviation.

RESPECTFULLY SUBMITTED:



Tom Edge, Esq. (KBA #95534)
General Counsel
Cassandra Zoda, Esq. (KBA #96871)
Contracts, Claims and Procurement Coordinator
Northern Kentucky Water District
2835 Crescent Springs Rd.
Erlanger, KY 41018
Phone - 859-578-5457
Fax - 859-426-2770
Email: tedge@nkywater.org
czoda@nkywater.org
Counsel for Northern Kentucky Water District

CERTIFICATE OF SERVICE

In accordance with 807 KAR 5:001, Section 8, I certify that this document was submitted electronically to the Public Service Commission on February 26, 2024 and that there are currently no parties that the Public Service Commission has excused from participation by electronic means in this proceeding.

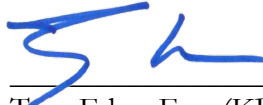

Tom Edge, Esq. (KBA #95534)



PRELIMINARY ENGINEERING REPORT

Taylor Mill Tank

Northern Kentucky
Water District

November 2022



GRW Project No. 5059



engineering | architecture | geospatial

**NORTHERN KENTUCKY WATER DISTRICT
TAYLOR MILL TANK**

PRELIMINARY ENGINEERING REPORT

Draft - September 2022

Final - November 2022

TABLE OF CONTENTS

1.0	BACKGROUND	1
2.0	DESIGN CONSIDERATIONS	1
	A. Tank Site and Tank Location	1
	B. Tank Style	2
	C. Paint System and Containment	4
	D. Valve Vault and Valve Assembly	7
	E. Tank Site Work	8
	F. Cellular Equipment	9
	G. Active Mixing System	9
	H. SCADA Controlled Valve	10
	I. Electrical and Instrumentation - Tank Site	11
	J. Electrical and Instrumentation - SCADA Valve Site	14
3.0	PERMITS.....	15
4.0	SCHEDULE.....	16
5.0	OPINIONS OF PROBABLE COST.....	16

LIST OF TABLES

Table 1 – Preliminary Tank Budget Pricing

Table 2 – Interior Wet Coatings – Option 1

Table 3 – Interior Wet Coatings – Option 2

Table 4 – Exterior Coatings – Option 1

Table 5 – Exterior Coatings – Option 2

Table 6 – Construction Cost Summary

Table 7 – 60-Year Coating Cost Summary

LIST OF FIGURES

Figure A - Tank Site Plan

Figure B - SCADA Valve Site Plan

Figure C - Multi-Column Tank Elevation

Figure D - Pedesphere Tank Elevation

Figure E - Composite Tank Elevation

Figure F – Tank Site Valve Vault

Figure G - Pedesphere Tank Valve Assembly

Figure H - Composite Tank Valve Assembly

APPENDICES

Appendix A - GridBee Submersible Mixer Budget Pricing and Brochure

Appendix B - Pulsed Hydraulics, Inc. Bubble Mixing Budget Pricing and Brochure

Appendix C - Cla-Val Model 58-01 Valve and Model X105L Limit Switch Data Sheets

NORTHERN KENTUCKY WATER DISTRICT TAYLOR MILL TANK

PRELIMINARY ENGINEERING REPORT

Draft - September 2022

Final - November 2022

1.0 BACKGROUND

The Northern Kentucky Water District (NKWD) has identified a need to construct a new 500,000 gallon water storage tank located just east of KY 16 in Taylor Mill, Kentucky. NKWD has indicated for the new tank to have an overflow elevation of 1,040 ft to be consistent with the hydraulic zone in the area. The District procured a 0.9 acre site off of KY 16 for the new tank. The following report summarizes preliminary design considerations, options and decisions for various aspects of the new tank design such as style, coatings, mixing, instrumentation, etc. The information in this report will be used as a basis for preparation of the final design drawings and specifications for bidding of the project.

2.0 DESIGN CONSIDERATIONS

The following items were examined by GRW during the preliminary engineering phase of this project and will be further considered and developed by NKWD and GRW during final design for the new Taylor Mill Tank.

A. Tank Site and Tank Location

The NKWD has acquired a 0.9-acre property directly across KY 16 from 5402 Pride Parkway in Taylor Mill for construction of the new Taylor Mill Tank. The site is bordered by a school bus/truck turnaround to the south, a large KYTC drainage basin to the north and KY 16 to the west. Entry to the tank site is planned to be from the south off the existing school bus/truck turnaround. The tank site is currently approximately half wooded and the topography slopes from the west to the east.

1. Existing Utilities

Based on recent survey information, there are no existing utilities within the NKWD property. There is an existing gas line along the east KY 16 right-of-way, an existing NKWD 16" waterline along the west KY 16 right-of-way and an existing storm pipe south of the property that crosses the existing bus/truck turnaround. There is also an emergency alert system in the east KY 16 right-of-way. GRW does not anticipate issues or conflicts with existing utilities for construction of the new tank.

2. Zoning Requirements

The tank site is located in a Residential Conventional Subdivision (R-CVS) zone. The City of Taylor Mill Zoning Ordinance Article IX, Section 9.5 Utilities Locations

indicates that utility uses such as electrical transformer stations, sewage and water treatment plants, standpipes for public water supply, etc. may be located in any zone subject to the approval of the board of adjustment. This section of the zoning ordinance includes the following requirements for such utility facilities:

- a. A building or structure, except an enclosing fence, shall be set back at least fifty (50) feet from any property line.
- b. Facilities shall be enclosed by a protective fence as regulated in Article XIII.
- c. Open spaces shall be landscaped and maintained and a screening area according to Section 9.17 may be required in and along any yard.

The above mentioned 50-foot property line setback requirement limits the location for the new tank on the tank property. The enclosed Figure A “Tank Site Plan” shows a preliminary site plan for the tank site with the property lines and 50-foot setback lines shown. Also shown is a preliminary proposed location for the new tank outside the setback lines. Once geotechnical borings are performed on the site during final design and the subgrade geotechnical information is known, it can be determined whether the tank can be located in this preliminary location, or if it needs to be moved inside the setback. If the tank needs to be located inside the setback, a site setback variance will need to be requested from the City of Taylor Mill.

B. Tank Style

Elevated water storage tanks can be constructed in various tank styles and geometries. The Multi-Column, Composite and Pedosphere style tanks would all be possible styles for the new Taylor Mill Tank based on site constraints and the project budget. Most tank erectors offer multiple bowl configurations as well. In general, the higher head range offerings are generally more cost effective because of lower quantities of plate steel. Further, the Multi-Column tank has two leg configurations: plumb legs and battered legs. The volume of the tank also has a definite impact on tank geometry and economy. In addition, each of these different tank styles/configurations has differing foundation implications.

Following is a brief description of each of the three tank styles being considered for the new Taylor Mill Tank, including some advantages and disadvantages of each style per information provided by Caldwell Tanks.

1. Multi-Column
 - a. An elevated welded carbon-steel water storage tank, supported by a series of carbon-steel supporting columns and cross braces.
 - b. Advantages
 - 1) Most economical style in terms of initial capital cost in small and medium capacities (less than 1,000,000 gallons).
 - 2) Traditional elevated water storage tank design.
 - 3) Balcony and handrail around the tank with access ladders on the tower column and tank which provide useful exterior access.

- c. Disadvantages
 - 1) More expensive to repaint due to greater steel surface area than a composite style tank of the same capacity.
2. Pedesphere
- a. An elevated, welded, carbon-steel, spherical water storage tank; supported by a single cylindrical carbon-steel support pedestal with a flared conical base.
 - b. Advantages
 - 1) Interior ladders and piping protected from weather and vandalism in the support pedestal.
 - 2) Aesthetically pleasing tank style due to simple, contoured shape, small "sky print" and small ground silhouette.
 - 3) Sleek design reduces steel surface area and future maintenance costs.
 - 4) Beneficial in specific types of soil and seismic conditions.
 - c. Disadvantages
 - 1) Typically higher capital cost than Multi-Column style tank of the same capacity.
3. Composite
- a. An elevated welded carbon-steel water storage tank, supported by a steel-reinforced concrete support pedestal (extending vertically from the steel-reinforced foundation as a circular concrete support structure). The reinforced concrete pedestal features architectural, horizontal, and vertical rustication patterns formed into the exterior of the pedestal.
 - b. Advantages
 - 1) Minimizes steel surface area for repainting operations.
 - 2) Low maintenance.
 - 3) Most modern style / attractive.
 - 4) Utilized in areas where future repainting is either limited or more frequent (such as tight sites or aggressive environments)
 - 5) Most common and typically most economical style in capacities greater than 1,000,000 gallons.
 - 6) No coating system required for the concrete pedestal which means less long-term maintenance and reduced surface area for repainting.
 - 7) Interior ladders and piping protected from weather and vandalism in the concrete pedestal.
 - c. Disadvantages
 - 1) Typically higher capital cost than Multi-Column style in small and medium capacities (less than 1,000,000 gallons).

Below in Table 1 is a summary of preliminary budget pricing GRW received from two tank manufacturers for the Multi-Column, Pedesphere and Composite style tanks. Landmark Structures does not offer Multi-Column tanks, so they could not provide a price for that tank

style. In general, the below prices include tank fabrication and erection, as well as shallow foundations, standard tank accessories (hatches, handrail, ladders, etc.), interior and exterior coatings (shop primed and field painted), combined inlet/outlet piping and overflow piping.

**Table 1
Preliminary Tank Budget Pricing**

Tank Manufacturer	500,000 Gallon Multi-Column Tank	500,000 Gallon Pedosphere Tank	500,000 Gallon Composite Tank
Caldwell Tanks	\$2,300,000	\$2,800,000	\$2,900,000
Landmark Structures	---	\$2,500,000	\$2,550,000

See enclosed Figure C “Multi-Column Tank Elev.,” Figure D “Pedosphere Tank Elev.” and Figure E “Composite Tank Elev.” for preliminary depictions of the proposed elevated tank styles and accessories, with elevations labeled. Note the tank accessories such as openings, piping, valves, ladders, handrail, etc. shown in these Figures are only preliminary at this time. Detailed design of these items (location, size, etc.) will be developed during final design.

Following review of the Draft PER, NKWD elected to include design documents for two tank styles – the Multi-Column and Pedosphere – in the project contract documents. This will allow the District to receive bid pricing for both tank styles to aid in their final decision on the style of tank to construct. GRW will prepare design drawings and specifications for construction of the Multi-Column and Pedosphere style tanks to be included in the contract documents for the project.

C. Paint System and Containment

NKWD initially indicated a preference of Tnemec products for the interior and exterior coatings on their water storage tanks as they have used Tnemec products on other tanks in the past with positive results. NKWD has, however, recently experienced some Tnemec coating product shortages and delay issues, so have also used Induron coatings on recent projects. NKWD and GRW discussed to include comparable Tnemec and Induron interior and exterior coating products in the final project specifications.

GRW contacted the local Tnemec representative, Nexgen Coating Resources, Inc., to discuss coating system options and obtain updated coating system specifications. Two coating system options for interior wet surfaces and two coating system options for exterior surfaces were discussed and provided to GRW. Below in Tables 2, 3, 4 and 5 are summaries of these options.

GRW will also contact Induron during final design to obtain their comparable products to the selected interior and exterior Tnemec coating systems shown below.

1. Interior Wet Coatings:

Table 2
Interior Wet Coatings - Option 1
High Solids Epoxy System with Zinc Rich Primer
AWWA D102 ICS No. 3

Coat	Tnemec Product	Dry Mils
Primer	Aromatic Urethane, Zinc-Rich, Hydro-Zinc Series 94 H2O	2.5 - 3.5
"Stripe Coat"	Polyamidoamine Epoxy, Pota-Pox Plus Series N140 or N140F	---
Finish	Modified Polyamine Epoxy, Epoxoline Series 22	20.0 to 30.0
Total Minimum Dry Film Thickness	---	22.5 mils

Table 3
Interior Wet Coatings - Option 2
Solventated Epoxy with Zinc Rich Primer
AWWA D102 ICS No. 6

Coat	Tnemec Product	Dry Mils
Primer	Aromatic Urethane, Zinc-Rich, Hydro-Zinc Series 94 H2O	2.5 - 3.5
"Stripe Coat"	Polyamidoamine Epoxy, Pota-Pox Plus Series N140 or N140F	---
Finish	Phenalkamine Epoxy, Epoxoline Series 21	10.0 to 14.0
Total Minimum Dry Film Thickness	---	12.5 mils

The only difference in the above two interior coating systems are the Finish coat products. Both interior systems include a zinc rich primer which will greatly extend the service life of the coating system. Option 1 is similar to the coating system used on the Aqua Drive Tank overcoat and Option 2 is similar to the coating system used on the new Lumley Tank. The Series 22 product in Option 1 is a 100% solids epoxy that provides greater barrier protection due to the higher application thickness but can

be marginally more expensive than the Series 21 product in Option 2. The Tnemec representative did not have a recommendation of one Finish coat over the other.

2. Exterior Coatings:

Table 4
Exterior Coatings - Option 1
Fluoropolymer with Zinc Rich Primer
AWWA D102 OCS No. 4

Coat	Tnemec Product	Dry Mils
Primer	Aromatic Urethane, Zinc-Rich, Hydro-Zinc Series 94 H2O	2.5 - 3.5
Intermediate	Aliphatic Acrylic Polyurethane, Endura Shield Series 1095	2.0 - 3.0
Finish	Fluoropolymer, HydroFlon Series 700	2.0 - 3.0
Lettering and Logo	Fluoropolymer, HydroFlon Series 700	2.0 - 3.0
Total Minimum Dry Film Thickness	---	6.5 mils

Table 5
Exterior Coatings - Option 2
Polyurethane with Zinc Rich Primer
AWWA D102 OCS No. 6

Coat	Tnemec Product	Dry Mils
Primer	Aromatic Urethane, Zinc-Rich, Hydro-Zinc Series 94 H2O	2.5 - 3.5
Intermediate	Polyamidoamine Epoxy Hi-Build Epoxoline Series N69	3.0 - 5.0
Finish	Aliphatic Acrylic Polyurethane, Endura Shield Series 1094-Color	2.0 - 4.0
Lettering and Logo	Fluoropolymer, HydroFlon Series 700	2.0 - 3.0
Total Minimum Dry Film Thickness	---	7.5 mils

The Tnemec representative recommended the Option 1 fluoropolymer exterior coating system as the Series 700 Hydroflon Finish coat product has extended color and gloss retention when compared to the Option 2 acrylic polyurethane Finish coat product. They indicated that the fluoropolymer system provides the lowest life cycle cost over time, as it is a 20 - 30 year system compared to a 15 -20 year system for the polyurethane system. Also, the rep indicated that there currently is a polyurethane global shortage, so the fluoropolymer product is a more sustainable solution.

The Option 1 fluoropolymer exterior coating system is more expensive initially than the Option 2 polyurethane system. Caldwell Tanks indicated that the fluoropolymer system on the exterior of a 500,000 gallon tank would be an upcharge of \$30,000 to \$50,000. This cost is not reflected in the budget pricing above provided by Caldwell and Landmark but has been included in the total opinions of probable costs provided below in Section 5. At a minimum, a fluoropolymer product is recommended to be specified for use on the NKWD logos to be painted on the new tank.

Following review of the Draft PER, NKWD indicated to specify the fluoropolymer exterior coating system due to supply issues with polyurethane and long-term benefits of the fluoropolymer products.

3. Containment:

After the Draft PER was submitted, GRW spoke with Caldwell Tanks about containment recommendations for coating operations of the new tank. Since the tank site is not immediately surrounded by homes and businesses, Caldwell indicated that full containment of the entire work area may not be necessary, so they recommended not requiring it to save on project costs. Instead, because there are still some homes and a school near the tank site, Caldwell recommended including language in the contract documents requiring the Contractor to be responsible for protecting all property from fugitive blast media and paint particles. This will require the Contractor to determine the means and methods used to contain the coating debris.

D. Valve Vault and Valve Assembly

As discussed in more detail below in Section H, the filling and tank levels for the new Taylor Mill Tank will initially be controlled by a new SCADA controlled valve at a remote site. Therefore, an Altitude valve at the tank site is not needed initially. However, there may be a need to add an Altitude valve in the future, so the tank site will include a valve vault that will be sized and piped to accommodate a bypass pipe for an Altitude valve on the tank inlet piping and a check valve on the tank outlet piping.

The vault will be a below grade, precast concrete vault that will initially house one inlet and one outlet pipe, straight pipe through the vault (no check valve or Altitude valve), isolation valves, and dismantling joints. There will also be a standard hose bib in the vault on the active water line for connection to a garden hose for site maintenance/washdown. Additionally, corporation stops will be installed on the piping for a sample line for the chlorine, pH and turbidity analyzers and for the pressure transducer discussed below in

Section I. See Figure F - "Tank Site Valve Vault" for a preliminary plan view of this valve vault.

If the new tank is either the Pedosphere or Composite style, the future check valve and Altitude valve and associated pipe assemblies could be located indoors in the base of the tank support pedestals. Figure G - "Pedosphere Tank Valve Assembly" and Figure H "Composite Tank Valve Assembly" show section views of preliminary possible valve and piping layouts in the tank pedestals. Detailed design of these valves and piping for the Pedosphere style will be developed during final design.

E. Tank Site Work

As design progresses on the project, improvements to the tank site will be developed. Following are anticipated Site Work items that will be included in the final design documents.

1. Site Piping
 - a. A 16" water line extension will be designed from the existing 16" water line on the west side of KY 16 to the tank site to facilitate filling and draining the new tank.
 - b. The water line extension will be encased in steel pipe that is bored and jacked beneath KY 16 and potentially open cut under the bus/truck turnaround. GRW will determine the best location for the KY 16 crossing during final design to minimize disturbance to neighboring properties and minimize the length of new water line needed.
 - c. Water line to be ductile iron with single polywrap.
 - d. A fire hydrant assembly will be installed on the new 16" DI site piping between the valve vault and tank that can be used to drain the tank. Drain water will be routed to flow to the existing KYTC drainage basin to the north of the tank site with the overflow pipe discussed below.
 - e. The tank overflow pipe will be routed to drain to the existing KYTC drainage basin to the north of the tank site via a rip rap lined drainage channel.
2. Entrance Drive and Parking
 - a. An entrance drive from the existing bus/truck turnaround to the base of the tank and instruments building will be designed.
 - b. KYTC requires the new entrance drive to be 100 feet from the KY 16 curb at the bus/truck turnaround, measured along the north side of the entrance drive.
 - c. At this time, entrance drive and any parking area are planned to be concrete.
3. Construction Areas
 - a. Locations for material and equipment staging areas and access to the site during construction will be determined.

4. Fencing
 - a. Initial direction was for the site fence to be chain link fence with barbed wire at the top. GRW will confirm fencing requirements with the City of Taylor Mill Zoning Ordinance.
 - b. Site fence to include a single "man" gate and vehicular slide gate. These gates will be equipped with security features and controlled as discussed in Paragraph I Electrical and Instrumentation – Tank Site below.
5. Landscaping
 - a. Landscaping and/or screening design will be performed in accordance with the City of Taylor Mill Zoning Ordinance.

F. Cellular Equipment

During design of the new Taylor Mill Tank, consideration will be given to the accommodation of cellular and radio equipment such as cables and antennas. Design documents for the new tank will include mounting appurtenances dedicated for the cellular providers and NKWD and consideration of the ability to add more cellular and radio equipment to the new tank. The design and location of these features will take into account safe access to the tank, potential damage to the tank and future maintenance of the tank.

G. Active Mixing System

Through discussions with NKWD, it was decided to include an active mixing system in the interior of the new tank to improve water quality. GRW contacted two mixer equipment representatives/vendors and obtained the following information on two mixing options. Brochures and budget pricing for both options are provided in the Appendices of this report. Following are summaries of the system components and operation, budget pricing and energy usage.

1. GridBee Electric Submersible Mixer
 - a. 24" long, 10" diameter submersible mixer with motor and impeller that either hangs from the top of the tank or sits on the tank bowl floor.
 - b. Water enters one end of the mixer, passes over the motor to the impeller, is released through slits on the end of the mixer, then water sheets get pushed to the top of the tank to induce mixing.
 - c. 24-hour active mixing
 - d. 0.5 hp motor
 - e. Control Box with SCADA monitoring at base of tank
 - f. Budget price \$11,380
 - g. Estimated energy cost of \$1 to \$1.5 per day

2. Pulsed Hydraulics Inc. Large Bubble Mixing
 - a. System consists of two 8" diameter bubble forming plates in the tank bowl, 1" diameter air piping from base of tank to bowl, and air compressor and mixing valve control enclosure at base of tank.
 - b. Air is delivered from the electro-pneumatic valve at the base of the tank through the air piping where it is squished between the two forming plates to create a 36" diameter bubble that rises to the top of the tank to induce mixing.
 - c. Mixing cycle once per day
 - d. Each bubble requires $\frac{3}{4}$ hp
 - e. Control enclosure includes an Allen Bradley CompactLogix PLC to integrate with SCADA system
 - f. Budget price \$57,653
 - g. Estimated energy cost of \$1 to \$2 per day

Both of these appear to be good options to provide active mixing. They both provide mixing at low energy costs and have minimal equipment requiring maintenance. If NKWD would like to talk to the manufacturers/representatives and/or Owners that have these products in service, GRW can request additional information and facilitate those discussions during final design.

The Pulsed Hydraulics Inc. (PHI) system is clearly more expensive than the GridBee system. Much of the cost for the PHI system is due to the Allen Bradley CompactLogix PLC. PHI can provide the bubbler equipment (forming plates, air compressor, piping and mixing valve) without the Allen Bradley PLC, for a lower cost. This option has limited functionality for communicating externally, however. If NKWD is interested in this system, during final design, GRW can review if there are any options for communicating the mixer with the SCADA system that may be cheaper than an Allen Bradley PLC being provided with the mixer.

Following review of the above two mixing system options in the Draft PER, NKWD indicated a preference to install a drop-in type submersible mixer, such as the GridBee mixer, since they have similar mixers installed in other tanks in the their system and there did not appear to be any cost savings/incentive to use the PHI bubble mixing system.

H. SCADA Controlled Valve

The new Taylor Mill Tank will initially be supplied by an existing pump station within NKWD's water system that also supplies two existing water tanks. To control the filling and water level of the new tank, a new control valve will be included in the project to be located at a remote site from the new tank. The valve operations will be controlled via SCADA based on the tank water elevations. Through correspondence and recommendations from Cla-Val, NKWD indicated for this valve to be a Model 58-01 Combination Back Pressure and Solenoid Shut-Off Valve with check feature by Cla-Val.

Following is a summary of preliminary operation and control discussions between NKWD and Cla-Val for this valve. As design progresses for the project, these items will be finalized and specified in the contract documents. Data sheets for the Cla-Val Model 58-01 valve and

optional Model X105L Limit Switch discussed below are included in the Appendices of this report.

1. Valve will include a solenoid that will be energized and de-energized by the SCADA system remotely to open and close the valve. It will be configured to be normally open and energized to close so that in a power failure, the valve will remain open. The valve will also be equipped with a battery backup to power the valve to close, if needed, during a grid power failure to the valve.
2. A manual operator can be supplied with the control valve to open the valve in an emergency when power is not available at the valve.
3. The valve check feature will prevent reverse flow from the new Taylor Mill Tank back towards the pump station and other tanks.
4. The backpressure pilot control system on the control valve can be set somewhere between the pressure at the valve when the supply pumps are running and the static pressure at the valve when the level in the other tanks is close to their low level to allow the Taylor Mill tank to fill when the supply pumps are off but not fill when the other tanks in the system are low.
5. A single limit switch can be supplied with the control valve that can be connected to the SCADA system to provide a contact closure for feedback on valve open/close status.

This valve will be located in a new precast concrete vault adjacent to NKWD's existing 16" water line near Eaton Drive in Fort Wright, Kentucky on a new 12" DI bypass line. The vault will include 12" isolation gates valves on either side of the new 12" control valve. The vault will be sized to allow at least four feet of straight pipe downstream of the control valve to allow NKWD to install a clamp-on flow meter on the pipe. Required straight runs of upstream and downstream pipe for the meter will also be taken into account when determining vault size and valves and piping layout. Site modifications will include new electrical and instrumentation items discussed below in Paragraph J Electrical and Instrumentation – SCADA Valve Site. Additionally, an isolation gate valve and box will be installed on the existing 16" water line. This valve will remain closed during normal conditions.

See enclosed Figure B "SCADA Valve Site Plan" for a preliminary Site Plan of this valve site. This Site Plan shows a preliminary location for the new valve vault adjacent to the existing water line.

Also shown in Figure B is the location of an existing water main easement. This easement has been drawn/placed by GRW Surveyors based on information in Exhibit A, Part B of the existing easement agreement provided to GRW by NKWD. The agreement is recorded in Deed Book 15, Page 176. According to the existing easement documents, a temporary construction easement was also provided with the water main easement as well as a right-of-way. The agreement grants a right-of-way and easement to construct, operate, maintain, repair, replace and remove a water main, service lines, meter boxes and other appurtenant improvements and equipment on and under the real estate. At the proposed location of the new vault, the existing easement is 10 feet wide. At this time of this PER, GRW anticipates that the new vault can be installed within the existing easement but will confirm during final design.

I. Electrical and Instrumentation - Tank Site

As the electrical design for the new Taylor Mill Tank progresses, the below electrical and instrumentation items will be included in the contract documents at the water tank site based on discussions and decisions by NKWD.

1. An existing three-phase, overhead distribution line is located across the street (KY 16) from the proposed tank site. A new overhead electrical service drop will be required to cross KY 16 and terminate at new utility-owned transformer pole. A new underground 100-ampere service (engineer to coordinate with equipment to be proposed - likely a 120/240-volt, single-phase, 100-ampere electrical service) will be installed from the utility-owned transformer pole to the new tank electrical service equipment (located within new prefabricated instrument building).
2. A new grounding system will be provided in accordance with the NEC for the new electrical service.
3. A new surge protection device (Type 2) will be provided at the service entrance equipment for surge and over-voltage protection of downstream equipment.
4. A new RTU (SCADA) telemetry panel w/PLC (NEMA 12 enclosed) shall be located within the new prefabricated instrument building. The RTU PLC shall monitor the following equipment:
 - a. Intrusion Alarm - Tank Access Ladder
 - b. Intrusion Alarm - Water Tank Access Hatch
 - c. Intrusion Alarm - Tank Overflow on Flap Valve
 - d. Intrusion Alarm - Valve Vault Access Hatch
 - e. Intrusion Alarm - Man-Door at Instrument Building
 - f. Flood Alarm - Valve Vault Sump/Floor
 - g. Entry Gate Position - Gate Open Status
 - h. Water Tank Continuous Level (via pressure transducer) - Primary Level
 - i. Water Tank Continuous Level (via radar) - Backup Level
 - j. Hach TU5 Turbidimeter
 - k. Hach CL17sc
 - l. Hach pH analyzer
 - m. Tank Mixer
5. The new RTU PLC and radio equipment will be coordinated with equipment provided as part of the SCADA Phase 2 project. GRW will coordinate requirements with Mr. Nathan Hodges.
6. SCADA Programming:
 - a. NKWD indicated initial direction for the SCADA programming to be provided by the Contractor, not NKWD. GRW will coordinate

required SCADA programming with NKWD as the design progresses.

7. FAA obstruction lighting complying with FAA's document Obstruction Marking and Lighting will be installed on top of the new Taylor Mill Tank (if required).
8. A chlorine analyzer (Hach CL17sc), turbidimeter (Hach TU5 Series) and pH analyzer (Hach) will be provided with the new tank. The continuous analytical signals will be connected to the SCADA PLC panel as noted above.
9. Both a pressure transducer and a radar depth indicator will be installed on the new tank for measuring tank levels. Both continuous signals will be connected to the SCADA PLC panel.
10. It is recommended that the radar transmitter, located at the top of the water tank, be provided with an EDCO SS64, or equal, signal suppressor, for over-voltage transient protection.
11. For the Multi-Column style tank, a prefabricated instruments building will be located adjacent to the valve vault. This building will be a temperature-controlled space and will house the following equipment:
 - a. RTU PLC/SCADA
 - b. Chlorine Analyzer
 - c. Turbidimeter
 - d. pH Analyzer
 - e. Electrical Panel w/surge protection device
 - f. Tank Mixer Motor Controller (and other mixer appurtenances such as air compressor)
 - g. Verkada Access Control System
 - h. FAA obstruction light control panel
 - i. LED lighting - interior and exterior
 - j. General purpose receptacles
12. For the Pedosphere and Composite style tanks, the equipment noted above can be located within the base of the support pedestals.
13. As previously discussed, isolation valves will be provided on the tank inlet and outlet piping in a precast concrete vault. A new sump level monitor, Magnetrol T20, or equal, shall be provided just above the bottom of the vault floor, for detection of flooding events. The sump level monitor will be located 4" above the floor slab and shall provide a digital output to the RTU PLC to transmit a flooded condition when actuated.
14. Site Security
 - a. Verkada cameras will be located at the site in the following locations:
 - 1) One camera to monitor the bottom of the tank ladder hatch

- 2) One camera to monitor the vehicle/man gate
 - 3) One camera to monitor the prefabricated instrument building (wall mounted adjacent to man-door.
 - 4) Cameras will be interfaced to the new ethernet switch provided as part of the RTU PLC cabinet.
 - b. Two pole-mounted (20' aluminum pole) with LED luminaires shall be provided for general site security, each controlled via photocell.
 - c. A vehicular slide gate shall be provided for site access. The gate shall be accessed via local keypad and system shall be incorporated into the Verkada Access Control System. In addition, a digital output shall be provided from the gate controller to the RTU PLC for monitoring of gate position (open or closed).
 - d. GRW will coordinate the requirements of the Verkada System with NKWD. It is assumed a Verkada AC41 - 4-Door Controller (Cloud-managed controller) will be provided at the site for access control. This system will be coordinated for the man-door located at the instrument building, as well as the main gate.
15. A new grounding counterpoise, encircling the water tank support legs, shall be installed. Each water tank leg shall be bonded to grounding counterpoise via exothermic welds.

J. Electrical and Instrumentation – SCADA Valve Site

As the electrical design for the new Taylor Mill Tank progresses, the below electrical and instrumentation items will be included in the contract documents at the SCADA valve vault site based on discussions and decisions by NKWD.

1. There is an existing three-phase, overhead distribution line located approximately 250' from the proposed altitude valve vault site. A new overhead electrical service will be extended from the existing overhead distribution line to the site - GRW to coordinate requirements with Duke Energy. A new underground 60-ampere service (engineer to coordinate with equipment to be proposed - likely a 120/240-volt, single-phase, 60-ampere electrical service) will be installed from the utility-owned transformer pole to the new tank electrical service equipment (rack-mounted adjacent to the altitude valve vault).
2. A new grounding system will be provided in accordance with the NEC for the new electrical service.
3. A new surge protection device (Type 2) will be provided at the service entrance equipment for surge and over-voltage protection of downstream equipment.
4. A new RTU (SCADA) telemetry panel w/PLC (NEMA 4X enclosed) shall be located at the common electrical equipment rack, adjacent to the service entrance equipment. The RTU PLC shall monitor the following equipment:

- a. Intrusion Alarm - Valve Vault Access Hatch
 - b. Intrusion Alarm - RTU PLC Control Panel
 - c. Flood Alarm - Valve Vault Sump/Floor
 - d. Altitude Valve Position
5. The new RTU PLC and radio equipment will be coordinated with equipment provided as part of the SCADA Phase 2 project. GRW will coordinate requirements with Mr. Nathan Hodges.
 6. SCADA Programming:
 - a. The control valve will be controlled via the SCADA System (RTU PLC) - GRW will coordinate the desired operation with NKWD as the design progresses.
 - b. NKWD indicated initial direction for the SCADA programming to be provided by the Contractor, not NKWD. GRW will coordinate required SCADA programming with NKWD as the design progresses.
 7. Site Security
 - a. Currently, there are no plans for cameras at this site.
 - b. A single pole-mounted (20' aluminum pole) with LED luminaire shall be provided for general site security, controlled via photocell.
 8. A new sump level monitor, Magnetrol T20, or equal, shall be provided just above the bottom of the valve vault floor, for detection of flooding events. The sump level monitor will be located 4" above the floor slab and shall provide a digital output to the RTU PLC to transmit a flooded condition when actuated.

3.0 PERMITS

Based on the scope of work, the following permits are anticipated to be required during the design phase:

- A. Kentucky Division of Water "Construction Application for Drinking Water Distribution" Form DW-1.
- B. Kentucky Transportation Cabinet "Application for Encroachment Permit" Form TC99-1A.
- C. Kentucky Department of Housing, Building and Construction "Plan Application Form", if required.
- D. Sanitation District No. 1 Clearing Permit, Grading Permit or Land Disturbance Permit, if required.
- E. Federal Aviation Administration (FAA) permit.

- F. Local permits or inspections, if any, will be the responsibility of the contractor.

4.0 SCHEDULE

Below is the preliminary design and construction schedule for the new Taylor Mill Tank.

- A. Final design / prepare bidding documents – September through January 2022
- B. Perform geotechnical borings –October 2022
- C. Permitting – December 2022 through February 2023
- D. Bidding – March and April 2023
- E. Bid Opening and Bid Approval – April 2023
- F. Construction – July 2023 through October 2024
 - a. Sitework and Foundation – July through September 2023
 - b. Tank Construction – October through June 2024
 - c. Painting – June through August 2024
 - d. Fencing, Paving, Final Sitework – September through October 2024
- G. Substantial Completion – November 1, 2024
- H. Final Completion – December 15, 2024

5.0 OPINIONS OF PROBABLE COST

See following four pages and below summary in Table 6 for total Opinions of Probable Cost for the 500,000 gallon Multi-Column tank style, Pedosphere tank style and Composite tank style. These total cost estimates include the tank costs as well as site work, valves, piping, electrical and professional services costs. The largest portion of the total project costs are for construction of the tank itself, which are shown in the cost estimates as the preliminary budget pricing provided by Caldwell Tanks for the three tank styles discussed above. Note these total project costs include budget pricing for fluoropolymer exterior coating system. Also shown in Table 6 are typical construction durations from Caldwell Tanks for each tank style.

**Table 6
Construction Cost Summary**

Tank Style	Total Estimated Construction Cost	Construction Length
Multi-Column	\$4,667,000	12 months
Pedesphere	\$5,177,000	14 months
Composite	\$5,279,000	15 months

Additionally, estimated 60-year life cycle coating costs for each tank style from Caldwell Tanks and Landmark Structures are shown below in Table 7. These costs are estimated in Net Present Value (NPV) for consideration of the estimated costs in today’s prices. These life cycle coating costs are based on the square feet of coating surface area for each tank style, assumed touch-up and overcoat coatings costs per square foot of surface area, and assumed full removal and replacement coating costs per square foot of surface area. The below costs assume recoating the interior and exterior surfaces every 20 years (3 recoating cycles over 60 years) which include touching-up and overcoating the exterior coatings twice, full removal and replacement of the exterior coatings once, full removal and replacement of the interior wet coatings three times and one touch-up and overcoat and one full removal and replacement of the interior dry coatings over a 60-year time period.

Through discussions with Caldwell and Landmark, there are many variables that affect the life cycle coating costs such as paint systems used each cycle, life expectancy of each coating, type of coating – overcoat or full removal, etc. Therefore, the below costs are only estimates based on the above and each tank manufacturer’s assumptions.

**Table 7
60-Year Coating Cost Summary**

	500,000 Gallon Multi-Column Tank	500,000 Gallon Pedesphere Tank	500,000 Gallon Composite Tank
Caldwell Tanks	\$988,787	\$718,342	\$579,338
Landmark Structures	\$1,713,000	\$1,436,000	\$990,000
Average	\$1,351,000	\$1,078,000	\$785,000
Total Construction Cost Plus 60 Year Coatings Cost	\$6,018,000	\$6,255,000	\$6,064,000

The bottom of Table 7 above shows the total estimated construction and coating cost for each tank style based on the construction costs from Table 6 above and the average of the 60-year coating costs from Caldwell and Landmark in Table 7. As you can see, based on these figures, the total cost after 60 years is competitive between the Multi-Column and the Composite tank styles. Although the Multi-Column tank has a higher capital cost than the Composite tank, the cost to recoat a Multi-Column tank is more expensive due to its larger steel surface area that requires coatings. For a 500,000 gallon tank of this height, a Multi-

Column tank will have approximately 35,000 square feet of steel surfaces vs. approximately 20,000 square feet for a Composite tank.

* * * * *

 GRW Engineers, Inc.	Project: Taylor Mill Tank			
	Owner: Northern Kentucky Water District			
	Project No.: 5059			
Opinion of Probable Cost	Date:	11/02/22	Dwg. No.:	N/A
	Estimator:	ADH	Type:	PER
Item Description	No. of Units	Units of Measure	Unit Cost	Total Cost
Site Work, Valves, Piping and Electrical:				
16" DI Site Piping (Tank Site)	220	LF	\$ 225.00	\$ 49,500.00
16" DI Pipe Bored and Jacked in 24" Steel Casing Pipe under KY 16	120	LF	\$ 1,000.00	\$ 120,000.00
16" DI Pipe Open Cut in 24" Steel Casing Pipe under Bus/Truck Turnaround	60	LF	\$ 500.00	\$ 30,000.00
Wet Tap with 16"x16" Tapping Sleeve and Valve (Tank Site)	1	EA	\$ 25,000.00	\$ 25,000.00
12" DI Site Piping (SCADA Valve Site)	40	LF	\$ 200.00	\$ 8,000.00
Wet Tap with 16"x12" Tapping Sleeve and Valve (Valve Site)	2	EA	\$ 20,000.00	\$ 40,000.00
Precast Concrete Valve Vault at Tank Site	1	EA	\$ 60,000.00	\$ 60,000.00
Precast Concrete Valve Vault at SCADA Valve site	1	EA	\$ 36,000.00	\$ 36,000.00
Painting Pipe inside Valve Vaults	1	LSUM	\$ 8,000.00	\$ 8,000.00
Double Leaf Aluminum Access Hatches (Valve Vaults)	2	EA	\$ 8,000.00	\$ 16,000.00
Excavation for Valve Vaults	300	CY	\$ 50.00	\$ 15,000.00
Backfill around Valve Vaults	100	CY	\$ 15.00	\$ 1,500.00
Sidewalk Repair/Replacement	1	LSUM	\$ 5,000.00	\$ 5,000.00
Site Restoration and Grading	1	LSUM	\$ 10,000.00	\$ 10,000.00
Tree Clearing	1	LSUM	\$ 6,000.00	\$ 6,000.00
Overflow Pipe Rip Rap Drainage Channel	200	LF	\$ 40.00	\$ 8,000.00
Valve Vault 4" PVC Drain Lines	200	LF	\$ 30.00	\$ 6,000.00
Concrete Drive and Parking Area	400	SY	\$ 135.00	\$ 54,000.00
Landscaping	1	LSUM	\$ 20,000.00	\$ 20,000.00
Chain Link Fence and Gate	400	LF	\$ 120.00	\$ 48,000.00
12" SCADA Controlled Valve (Cla-Val Model 58-01)	1	EA	\$ 24,000.00	\$ 24,000.00
Valves for Valve Vault Assemblies	1	LSUM	\$ 141,000.00	\$ 141,000.00
16" MJ Gate Valve and Box (SCADA Valve Site)	1	EA	\$ 21,000.00	\$ 21,000.00
Fire Hydrant Assembly (Tank Site)	1	EA	\$ 6,000.00	\$ 6,000.00
DI Flanged Piping and Fittings for Valve Vaults	1	LSUM	\$ 25,000.00	\$ 25,000.00
DI Fittings	3	TON	\$ 8,000.00	\$ 24,000.00
Submersible Mixer	1	LSUM	\$ 15,000.00	\$ 15,000.00
Cellular Equipment Attachments	1	LSUM	\$ 65,000.00	\$ 65,000.00
Prefabricated Instruments Building	1	LSUM	\$ 50,000.00	\$ 50,000.00
Final Restoration	1	LSUM	\$ 15,000.00	\$ 15,000.00
Sediment and Erosion Control	1	LSUM	\$ 5,000.00	\$ 5,000.00
Electrical and Instrumentation (see attached breakdown)				\$ 396,000.00
			Sub-Total	\$ 1,353,000.00
Contingency (30%)				\$ 405,900.00
			Sub-Total	\$ 1,758,900.00
Contractor Overhead & Profit (Prime 15%, Sub 5%)				\$ 163,350.00
Sub-Total for Site Work, Valves, Piping and Electrical (Rounded)				\$ 1,923,000.00

 GRW Engineers, Inc.	Project: Taylor Mill Tank			
	Owner: Northern Kentucky Water District			
	Project No.: 5059			
Opinion of Probable Cost	Date: 11/02/22	Dwg. No.: N/A		
	Estimator: ADH	Type: PER		
Item Description	No. of Units	Units of Measure	Unit Cost	Total Cost

500,000 Gallon Multi-Column Elevated Water Storage Tank				
New Elevated Tank:				
500,000 Multi-Column Elevated Tank*	1	LSUM	\$ 2,300,000.00	\$ 2,300,000.00
Included: Inlet/outlet and overflow piping, painting, shallow foundation system, standard accessories				
Upcharge for Fluoropolymer Exterior Coating System	1	LSUM	\$ 50,000.00	\$ 50,000.00
Tank Logo	1	LSUM	\$ 20,000.00	\$ 20,000.00
Sub-Total				\$ 2,370,000.00
Contingency (10%)				\$ 237,000.00
Sub-Total				\$ 2,607,000.00
Sub-Total for New Tank, Site Work, Piping, Valves and Electrical (Rounded)				\$ 4,530,000.00
Mobilization/Demobilization (1%)				\$ 46,000.00
Bonding & Insurance (2%)				\$ 91,000.00
Sub-Total for Construction Costs				\$ 4,667,000.00
Professional Services**				\$ 250,722.00
TOTAL ESTIMATED COSTS FOR 500,000 GALLON MULTI-COLUMN TANK				\$ 4,918,000.00

* Preliminary budget pricing provided by Caldwell Tanks

** Based on 16 months for construction services

500,000 Gallon Pedesphere Elevated Water Storage Tank				
New Elevated Tank:				
500,000 Pedesphere Elevated Tank*	1	LSUM	\$ 2,800,000.00	\$ 2,800,000.00
Included: Inlet/outlet and overflow piping, painting, shallow foundation system, standard accessories				
Upcharge for Fluoropolymer Exterior Coating System	1	LSUM	\$ 50,000.00	\$ 50,000.00
Tank Logo	1	LSUM	\$ 20,000.00	\$ 20,000.00
Deduct for Instruments Building	1	LSUM	\$ (50,000.00)	\$ (50,000.00)
Sub-Total				\$ 2,820,000.00
Contingency (10%)				\$ 282,000.00
Sub-Total				\$ 3,102,000.00
Sub-Total for New Tank, Site Work, Piping, Valves and Electrical (Rounded)				\$ 5,025,000.00
Mobilization/Demobilization (1%)				\$ 51,000.00
Bonding & Insurance (2%)				\$ 101,000.00
Sub-Total for Construction Costs				\$ 5,177,000.00
Professional Services**				\$ 250,722.00
TOTAL ESTIMATED COSTS FOR 500,000 GALLON PEDESHERE TANK				\$ 5,428,000.00

* Preliminary budget pricing provided by Caldwell Tanks

** Based on 16 months for construction services

 GRW Engineers, Inc.	Project: Taylor Mill Tank			
	Owner: Northern Kentucky Water District			
	Project No.: 5059			
Opinion of Probable Cost	Date: 11/02/22	Dwg. No.: N/A		
	Estimator: ADH	Type: PER		
Item Description	No. of Units	Units of Measure	Unit Cost	Total Cost

500,000 Gallon Composite Elevated Water Storage Tank				
New Elevated Tank:				
500,000 Composite Elevated Tank*	1	LSUM	\$ 2,900,000.00	\$ 2,900,000.00
Included: Inlet/outlet and overflow piping, painting, shallow foundation system, standard accessories				
Upcharge for Fluoropolymer Exterior Coating System	1	LSUM	\$ 40,000.00	\$ 40,000.00
Tank Logo	1	LSUM	\$ 20,000.00	\$ 20,000.00
Deduct for Instruments Building	1	LSUM	\$ (50,000.00)	\$ (50,000.00)
			Sub-Total	\$ 2,910,000.00
Contingency (10%)				\$ 291,000.00
			Sub-Total	\$ 3,201,000.00
			Sub-Total for New Tank, Site Work, Piping, Valves and Electrical (Rounded)	\$ 5,124,000.00
Mobilization/Demobilization (1%)				\$ 52,000.00
Bonding & Insurance (2%)				\$ 103,000.00
			Sub-Total for Construction Costs	\$ 5,279,000.00
			Professional Services**	\$ 250,722.00
			TOTAL ESTIMATED COSTS FOR 500,000 GALLON COMPOSITE TANK	\$ 5,530,000.00

* Preliminary budget pricing provided by Caldwell Tanks

** Based on 16 months for construction services

 GRW Engineers, Inc.	Project: Taylor Mill Tank			
	Owner: Northern Kentucky Water District			
	Project No.: 5059			
Opinion of Project Cost Electrical and Instrumentation	Date: 11/02/22		Dwg. No.: N/A	
	Estimator: WER		Type: PER	
Item Description	No. of Units	Units of Measure	Unit Cost	Total Cost
Instrumentation and Electrical - Water Tank Site:				
Grounding:				
Ground Rod	3	EACH	\$250	\$ 750.00
#2 AWG Bare	50	LF	\$2	\$ 100.00
Exothermic Weld	3	EACH	\$300	\$ 900.00
Ground Meter Base/CT Cabinet	1	EACH	\$300	\$ 300.00
Ground Test/Report	1	LSUM	\$750	\$ 750.00
Grounding @ Tank:				
Ground Rod	6	EACH	\$250	\$ 1,500.00
#2 AWG Bare	225	LF	\$2	\$ 450.00
Exothermic Weld	12	EACH	\$300	\$ 3,600.00
Service Entrance:				
2" Conduit (Schedule 40 PVC)	75	LF	\$14	\$ 1,068.75
2" Conduit (Aluminum)	25	LF	\$24	\$ 600.00
Long Sweep 90 Elbow	2	EACH	\$150	\$ 300.00
#2 AWG	400	LF	\$3	\$ 1,100.00
Terminations	8	EACH	\$34	\$ 268.00
Trenching/Backfill	75	LF	\$16	\$ 1,200.00
NEMA 1, 100A, 120/240V, 1-Phase, 3-Wire Panelboard	1	EACH	\$3,000	\$ 3,000.00
Surge Protection Device	1	EACH	\$750	\$ 750.00
Meter Base	1	EACH	\$250	\$ 250.00
RTU Cabinet w/PLC, Ethernet Switch, Cellular Modem	1	LSUM	\$25,000	\$ 25,000.00
Pressure Transmitter	1	EACH	\$2,500	\$ 2,500.00
Radar Transmitter w/signal suppressor	1	EACH	\$2,750	\$ 2,750.00
1"C (Aluminum) - 4-20mAdc - Radar to PLC	185	LF	\$16	\$ 3,006.25
1"C (Schedule 40 PVC) - 4-20mAdc - Radar to PLC	50	LF	\$10	\$ 475.00
#16 STP (4-20mAdc Signal)	235	LF	\$2	\$ 411.25
Interference Lighting System - Panel, Luminaires, Wiring	1	LSUM	\$13,000	\$ 13,000.00
LED Obstruction Light	1	LSUM	\$7,000	\$ 7,000.00
Hach CL17sc	1	LSUM	\$6,000	\$ 6,000.00
Hach TU5 Turbidimeter	1	LSUM	\$7,500	\$ 7,500.00
Hach pH Analyzer/Controller	1	LSUM	\$2,000	\$ 2,000.00
Verkada Cameras w/Cloud License	3	EACH	\$2,250	\$ 6,750.00
Camera Pole	2	EACH	\$750	\$ 1,500.00
Verkada Access Controller (AC41)	1	LSUM	\$5,000	\$ 5,000.00
3/4"C (Aluminum) - Door Contact - Hatch @ Top of Tank	185	LF	\$13	\$ 2,451.25
3/4"C (Schedule 40 PVC) - Door Contact - Hatch	50	LF	\$8	\$ 387.50
2#12 AWG + 1#12 GND	705	LF	\$1	\$ 705.00
3/4"C (Aluminum) - Door Contact - Tank Access Ladder	20	LF	\$13	\$ 265.00
3/4"C (Schedule 40 PVC) - Door Contact - Tank Ladder	50	LF	\$8	\$ 387.50
2#12 AWG + 1#12 GND	210	LF	\$1	\$ 210.00
3/4"C (Aluminum) - Door Contact - Overflow	20	LF	\$13	\$ 265.00

 GRW Engineers, Inc.	Project: Taylor Mill Tank			
	Owner: Northern Kentucky Water District			
	Project No.: 5059			
Opinion of Project Cost Electrical and Instrumentation	Date: 11/02/22		Dwg. No.: N/A	
	Estimator: WER		Type: PER	
Item Description	No. of Units	Units of Measure	Unit Cost	Total Cost
3/4"C (Schedule 40 PVC) - Door Contact - Overflow	50	LF	\$8	\$ 387.50
2#12 AWG + 1#12 GND	210	LF	\$1	\$ 210.00
Sump Level Switch	1	EACH	\$800	\$ 800.00
Misc. Wiring/Conduit to/from Valve Vault	1	LSUM	\$750	\$ 750.00
Pole-Mounted LED/Pole Base/Wiring	2	EACH	\$2,500	\$ 5,000.00
3/4"C (Aluminum) - Mixer	185	LF	\$13	\$ 2,451.25
3/4"C (Schedule 40 PVC) - Mixer	50	LF	\$8	\$ 387.50
2#12 AWG + 1#12 GND	705	LF	\$1	\$ 705.00
3/4"C (Aluminum) - Gate Controller Power	5	LF	\$13	\$ 66.25
3/4"C (Schedule 40 PVC) - Gate Controller Power	75	LF	\$8	\$ 581.25
2#12 AWG + 1#12 GND	240	LF	\$1	\$ 240.00
3/4"C (Aluminum) - Gate Controller Keypad	5	LF	\$13	\$ 66.25
3/4"C (Schedule 40 PVC) - Gate Controller Keypad	75	LF	\$8	\$ 581.25
CAT6	80	LF	\$2	\$ 140.00
1"C (Aluminum) - Camera	20	LF	\$16	\$ 325.00
1"C (Schedule 40 PVC) - Camera	100	LF	\$10	\$ 950.00
CAT6	120	LF	\$2	\$ 210.00
Camera Mount/Pole	2	EACH	\$750	\$ 1,500.00
Miscellaneous Small Power/Wiring within Building	1	LSUM	\$2,000	\$ 2,000.00
Temporary Power	1	LSUM	\$1,200	\$ 1,200.00
Inspection	1	LSUM	\$2,000	\$ 2,000.00
Duke Energy Fees (Estimated)	1	LSUM	\$5,000	\$ 5,000.00
Instrumentation and Electrical - SCADA Valve Site:				
Grounding:				
Ground Rod	3	EACH	\$250	\$ 750.00
#2 AWG Bare	50	LF	\$2	\$ 100.00
Exothermic Weld	3	EACH	\$300	\$ 900.00
Ground Meter Base/CT Cabinet	1	EACH	\$300	\$ 300.00
Ground Test/Report	1	LSUM	\$750	\$ 750.00
Service Entrance:				
2" Conduit (Schedule 40 PVC)	75	LF	\$14	\$ 1,068.75
2" Conduit (Aluminum)	25	LF	\$24	\$ 600.00
Long Sweep 90 Elbow	2	EACH	\$150	\$ 300.00
#6 AWG	400	LF	\$2	\$ 800.00
Terminations	8	EACH	\$34	\$ 268.00
Trenching/Backfill	75	LF	\$16	\$ 1,200.00
NEMA 1, 60A, 120/240V, 1-Phase, 3-Wire Panelboard	1	EACH	\$2,750	\$ 2,750.00
Surge Protection Device	1	EACH	\$750	\$ 750.00
Meter Base	1	EACH	\$250	\$ 250.00
RTU Cabinet w/PLC, Ethernet Switch, Cellular Modem	1	LSUM	\$25,000	\$ 25,000.00
3/4"C (Aluminum) - Door Contact - Hatch @ Vault	10	LF	\$13	\$ 132.50
3/4"C (Schedule 40 PVC) - Door Contact - Hatch @ Vault	30	LF	\$8	\$ 232.50
2#12 AWG + 1#12 GND	120	LF	\$1	\$ 120.00
Sump Level Switch	1	EACH	\$800	\$ 800.00
Misc. Wiring/Conduit to/from Valve Vault	1	LSUM	\$750	\$ 750.00

 GRW Engineers, Inc.	Project: Taylor Mill Tank			
	Owner: Northern Kentucky Water District			
	Project No.: 5059			
Opinion of Project Cost Electrical and Instrumentation	Date: 11/02/22		Dwg. No.: N/A	
	Estimator: WER		Type: PER	
Item Description	No. of Units	Units of Measure	Unit Cost	Total Cost
Pole-Mounted LED/Pole Base/Wiring	1	EACH	\$2,500	\$ 2,500.00
Temporary Power	1	LSUM	\$1,200	\$ 1,200.00
Inspection	1	LSUM	\$2,000	\$ 2,000.00
Duke Energy Fees (Estimated)	1	LSUM	\$5,000	\$ 5,000.00
SCADA Programming	1	LSUM	\$75,000	\$ 75,000.00
Sub-Total				\$ 253,530.00
Contingency (20%)				\$ 50,710.00
Sub-Total				\$ 304,240.00
Subcontractor Overhead & Profit (30%)				\$ 91,280.00
TOTAL ESTIMATED ELECTRICAL AND INSTRUMENTATION				\$ 396,000.00

FIGURES

FILE NAME: C:\5059-NKWD TaylorMill\Working Drawings\AutoCAD\5059-Fig B.dwg
 PRINTED: 11/2/2022 @ 11:43AM
 PLOTTED BY: skratz

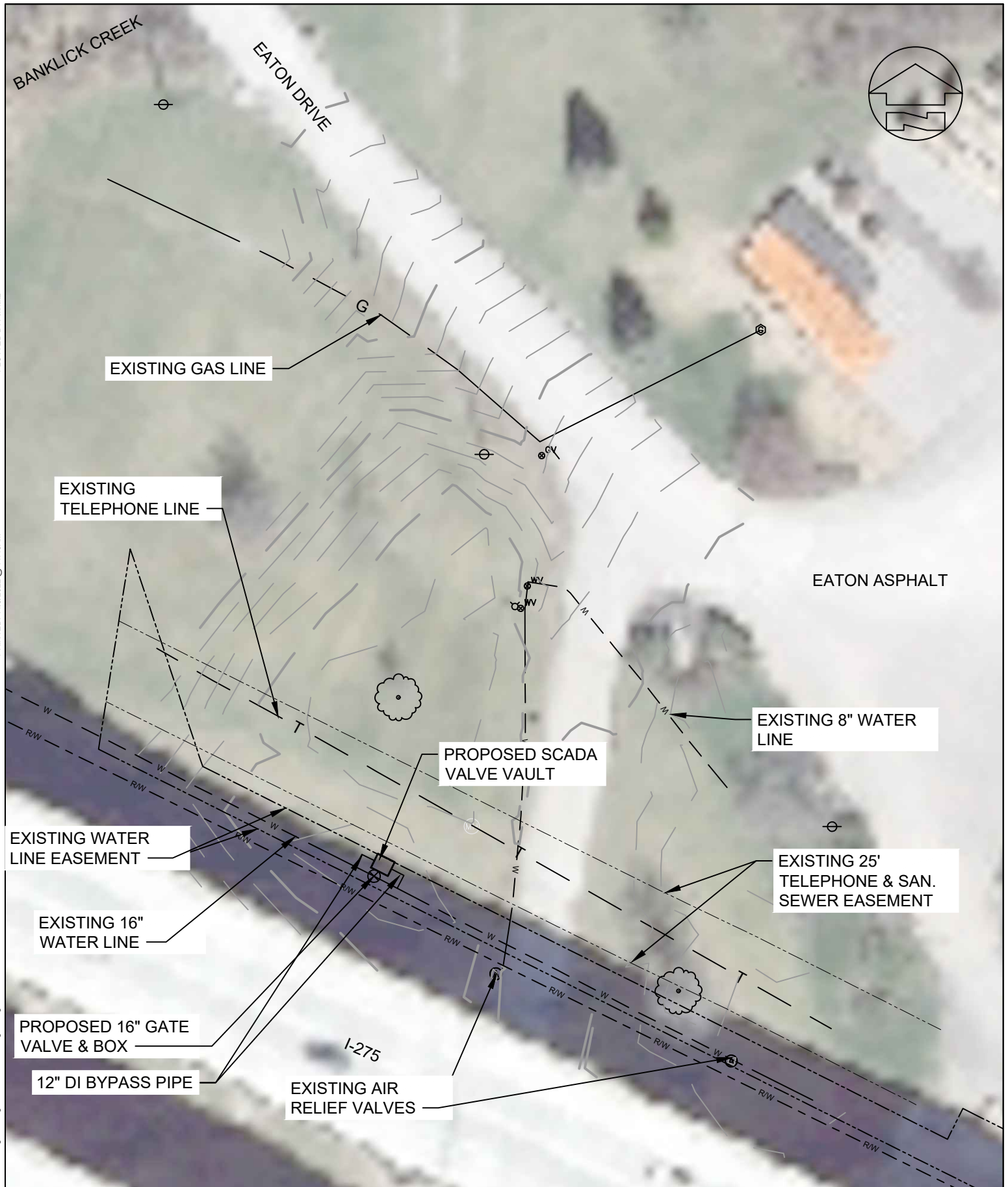

GRW PROJECT NO. 5059		CLIENT PROJECT NO. XXXX		DESIGNED: ADH
REVISIONS				DRAWN: CEK
NO.	DESCRIPTION	DATE	BY	REVIEWED: ADH
				APPROVED: ADH
SCALE CHECK				
THIS MARK SHOULD MEASURE EXACTLY 1/2" WHEN PLOTTED				

**SCADA VALVE
SITE PLAN**
TAYLOR MILL TANK
N.K.W.D.

GRW
engineering | architecture | geospatial
www.grwinc.com

ALL RIGHTS RESERVED. THIS DOCUMENT IS THE PROPERTY OF GRW ENGINEERS, INC. AND SHALL NOT BE REPRODUCED IN WHOLE OR IN PART OR USED FOR CONSTRUCTION OF OTHER THAN THIS SPECIFIC PROJECT WITHOUT WRITTEN PERMISSION

DATE:
SEPTEMBER, 2022

SCALE:
1" = 40'

SHEET NO.
B

PLOTTED BY: ckhatz

PRINTED: 11/3/2022 @ 11:31AM

FILE NAME: G:\5059-NKWD TaylorMill\Working Drawings\AutoCAD\5059-Fig C.dwg

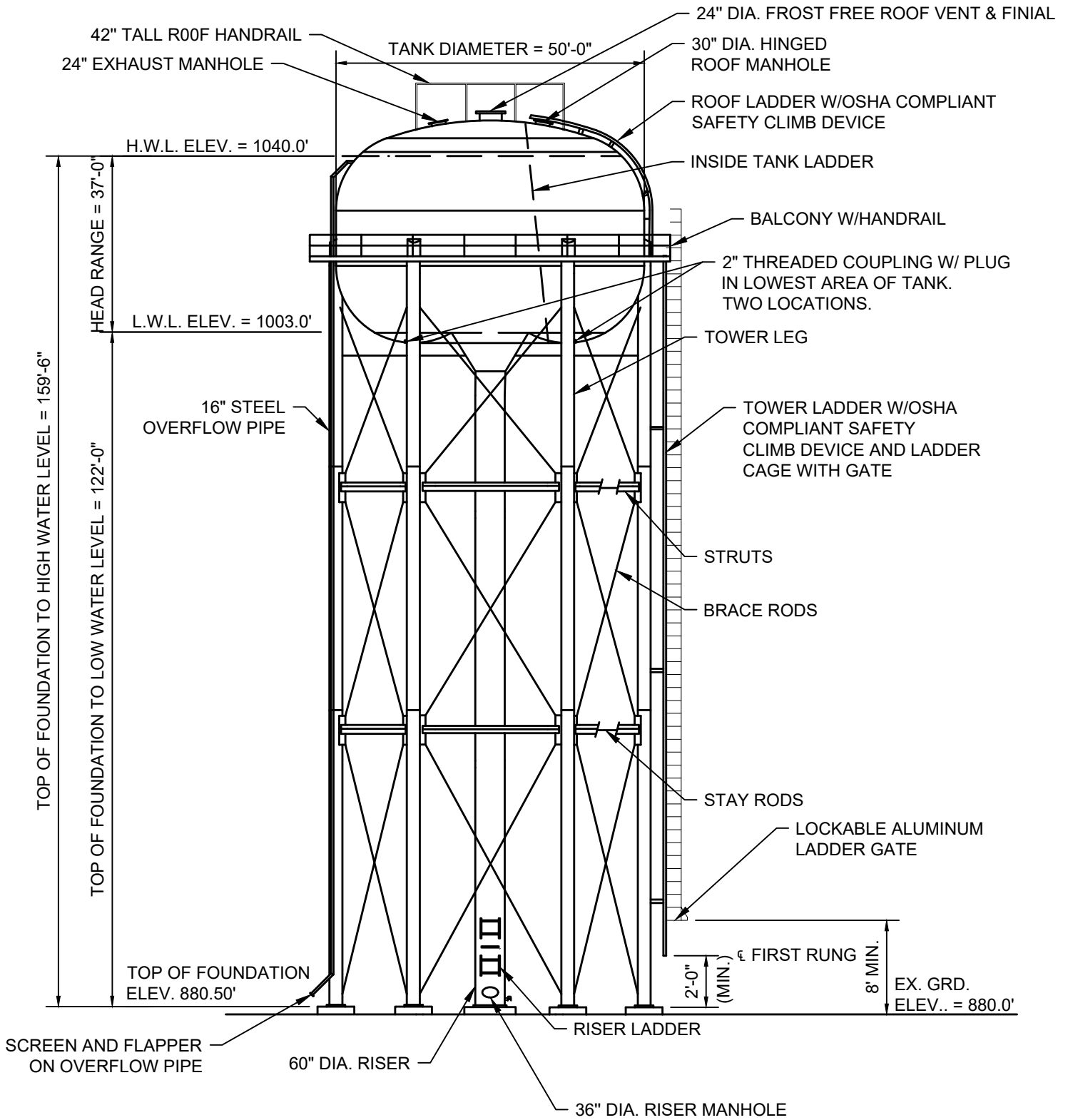

GRW PROJECT NO. 5059		CLIENT PROJECT NO. XXXX		DESIGNED: ADH
REVISIONS				DRAWN: CEK
NO.	DESCRIPTION	DATE	BY	REVIEWED: ADH
				APPROVED: ADH
SCALE CHECK: THIS MARK SHOULD MEASURE EXACTLY 1/2" WHEN PLOTTED				

MULTI-COLUMN TANK ELEV.
 TAYLOR MILL TANK
 N.K.W.D.



engineering | architecture | geospatial
 www.grwinc.com

ALL RIGHTS RESERVED.
 THIS DOCUMENT IS THE PROPERTY OF GRW ENGINEERS, INC. AND SHALL NOT BE REPRODUCED IN WHOLE OR IN PART OR USED FOR CONSTRUCTION OF OTHER THAN THIS SPECIFIC PROJECT WITHOUT WRITTEN PERMISSION

DATE: SEPTEMBER, 2022
SCALE: N.T.S.
SHEET NO. C

PLOTTED BY: skratz

PRINTED: 11/23/2022 @ 11:22AM

FILE NAME: C:\5059-NKWD-TaylorMill\Working Drawings\AutoCAD\5059-Fig D.dwg

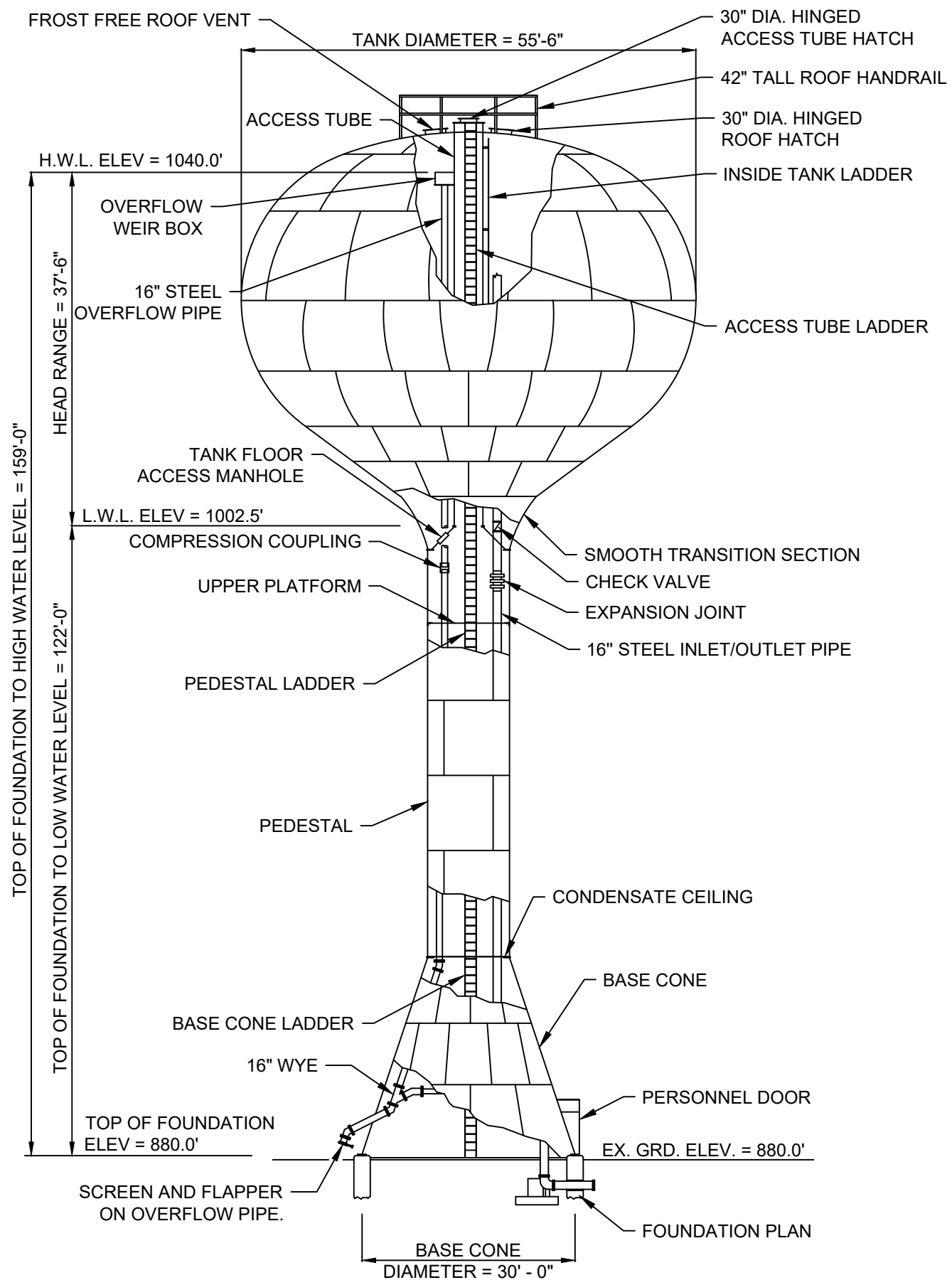

GRW PROJECT NO. 5059		CLIENT PROJECT NO. XXXX		DESIGNED: ADH
REVISIONS				DRAWN: CEK
NO.	DESCRIPTION	DATE	BY	REVIEWED: ADH
				APPROVED: ADH
SCALE CHECK				THIS MARK SHOULD MEASURE EXACTLY 1/2" WHEN PLOTTED

PEDESPHERE TANK ELEV.
TAYLOR MILL TANK
N.K.W.D.



engineering | architecture | geospatial
www.grwinc.com

ALL RIGHTS RESERVED. THIS DOCUMENT IS THE PROPERTY OF GRW ENGINEERS, INC. AND SHALL NOT BE REPRODUCED IN WHOLE OR IN PART OR USED FOR CONSTRUCTION OF OTHER THAN THIS SPECIFIC PROJECT WITHOUT WRITTEN PERMISSION

DATE: SEPTEMBER, 2022
SCALE: N.T.S.
SHEET NO. D

PLOTTED BY: skratz

PRINTED: 11/23/2022 @ 11:28AM

FILE NAME: G:\5059-NKWD-TaylorMill\Working Drawings\AutoCAD\5059-Fig. E.dwg

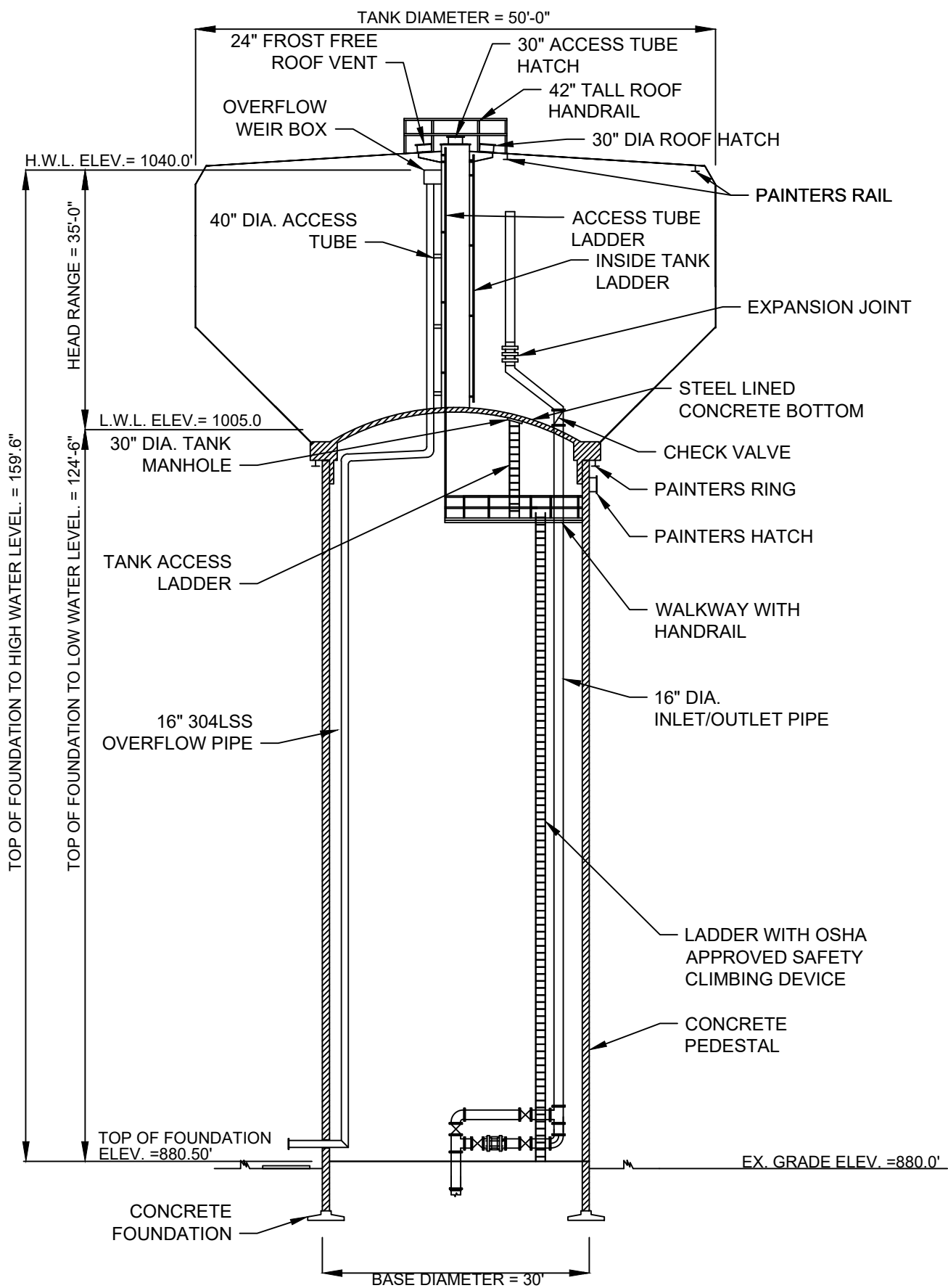

GRW PROJECT NO. 5059		CLIENT PROJECT NO. XXXX		DESIGNED: ADH
REVISIONS				DRAWN: CEK
NO.	DESCRIPTION	DATE	BY	REVIEWED: ADH
				APPROVED: ADH
SCALE CHECK				THIS MARK SHOULD MEASURE EXACTLY 1/2" WHEN PLOTTED

COMPOSITE TANK ELEV.
TAYLOR MILL TANK
N.K.W.D.



engineering | architecture | geospatial
www.grwinc.com

ALL RIGHTS RESERVED. THIS DOCUMENT IS THE PROPERTY OF GRW ENGINEERS, INC. AND SHALL NOT BE REPRODUCED IN WHOLE OR IN PART OR USED FOR CONSTRUCTION OF OTHER THAN THIS SPECIFIC PROJECT WITHOUT WRITTEN PERMISSION

DATE: SEPTEMBER, 2022
SCALE: N.T.S.
SHEET NO. E

PLOTTED BY: skratz

PRINTED: 11/2/2022 @ 11:41 AM

FILE NAME: C:\5059-NKWD-TaylorMill\Working Drawings\AutoCAD\5059-Fig F.dwg

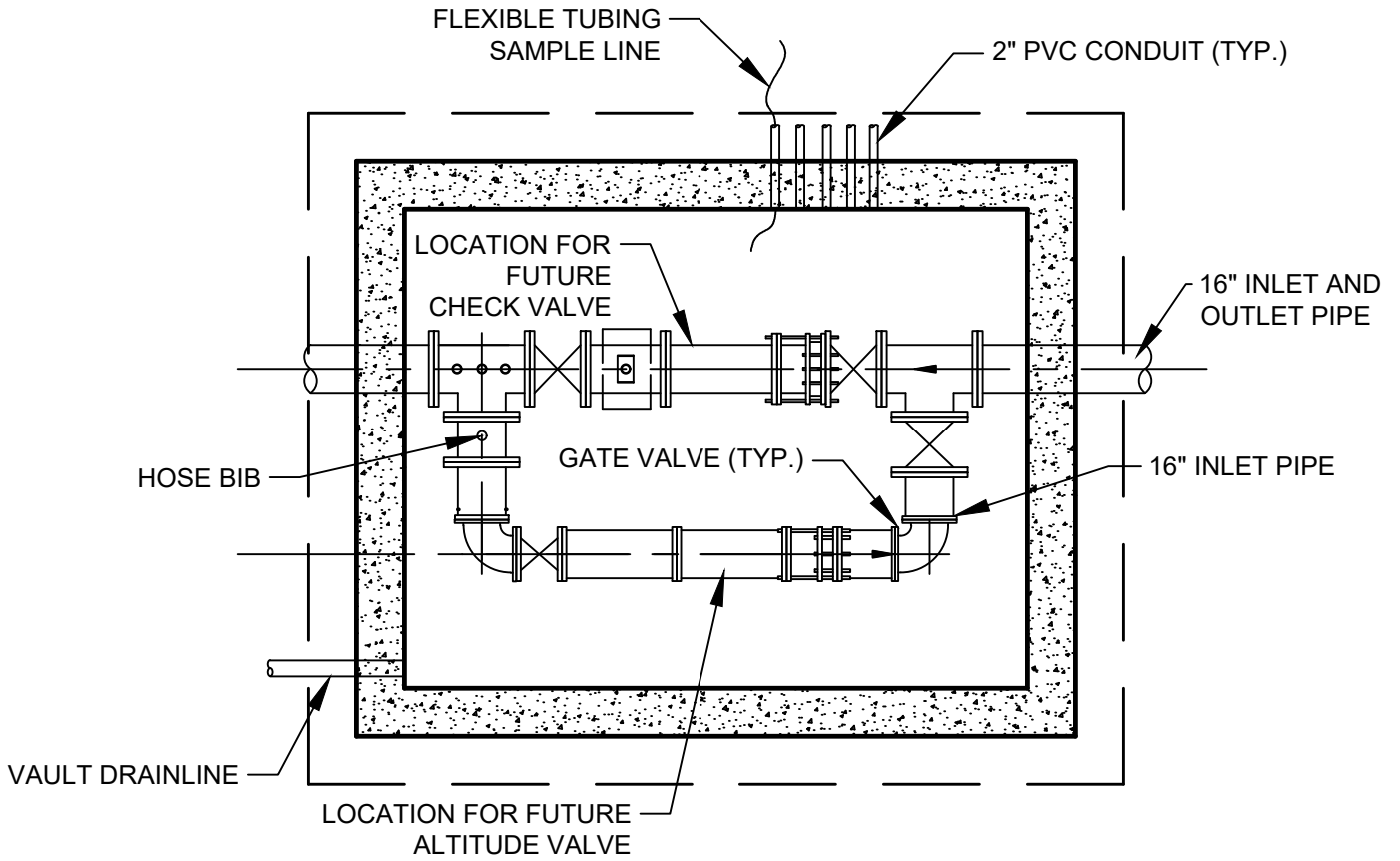

VALVE VAULT

NOT TO SCALE

GRW PROJECT NO. 5059		CLIENT PROJECT NO. XXXX		DESIGNED: ADH
REVISIONS				DRAWN: CEK
NO.	DESCRIPTION	DATE	BY	REVIEWED: ADH
				APPROVED: ADH
SCALE CHECK				THIS MARK SHOULD MEASURE EXACTLY 1/2" WHEN PLOTTED

TANK SITE
VALVE VAULT
 TAYLOR MILL TANK
 N.K.W.D.



engineering | architecture | geospatial
www.grwinc.com

ALL RIGHTS RESERVED. THIS DOCUMENT IS THE PROPERTY OF GRW ENGINEERS, INC. AND SHALL NOT BE REPRODUCED IN WHOLE OR IN PART OR USED FOR CONSTRUCTION OF OTHER THAN THIS SPECIFIC PROJECT WITHOUT WRITTEN PERMISSION

DATE: SEPTEMBER, 2022
SCALE: 1/4"=1'-0"
SHEET NO. F

PLOTTED BY: skratz

PRINTED: 11/2/2022 @ 11:15 AM

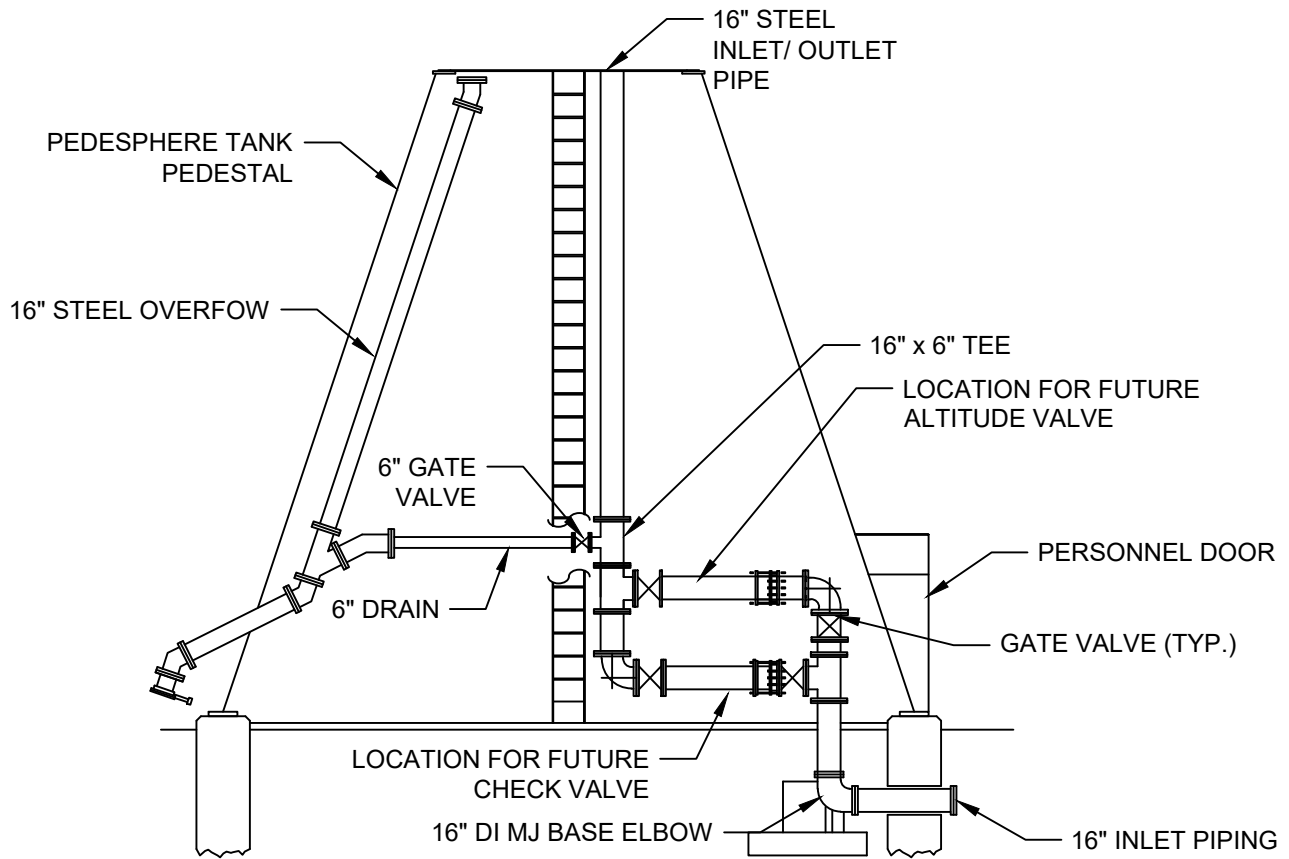

PEDESHERE TANK VALVE ASSEMBLY

NOT TO SCALE

FILE NAME: G:\5059-NKWD-TaylorMill\Working Drawings\AutoCAD\5059-Fig. G.dwg

GRW PROJECT NO. 5059		CLIENT PROJECT NO. XXXX		DESIGNED: ADH
REVISIONS				DRAWN: CEK
NO.	DESCRIPTION	DATE	BY	REVIEWED: ADH
				APPROVED: ADH
SCALE CHECK				THIS MARK SHOULD MEASURE EXACTLY 1/2" WHEN PLOTTED

PEDESHERE TANK VALVE ASSEMBLY
TAYLOR MILL TANK
N.K.W.D.



engineering | architecture | geospatial
www.grwinc.com

ALL RIGHTS RESERVED. THIS DOCUMENT IS THE PROPERTY OF GRW ENGINEERS, INC. AND SHALL NOT BE REPRODUCED IN WHOLE OR IN PART OR USED FOR CONSTRUCTION OF OTHER THAN THIS SPECIFIC PROJECT WITHOUT WRITTEN PERMISSION

DATE: SEPTEMBER, 2022
SCALE: 1/4"=1'-0"
SHEET NO. G

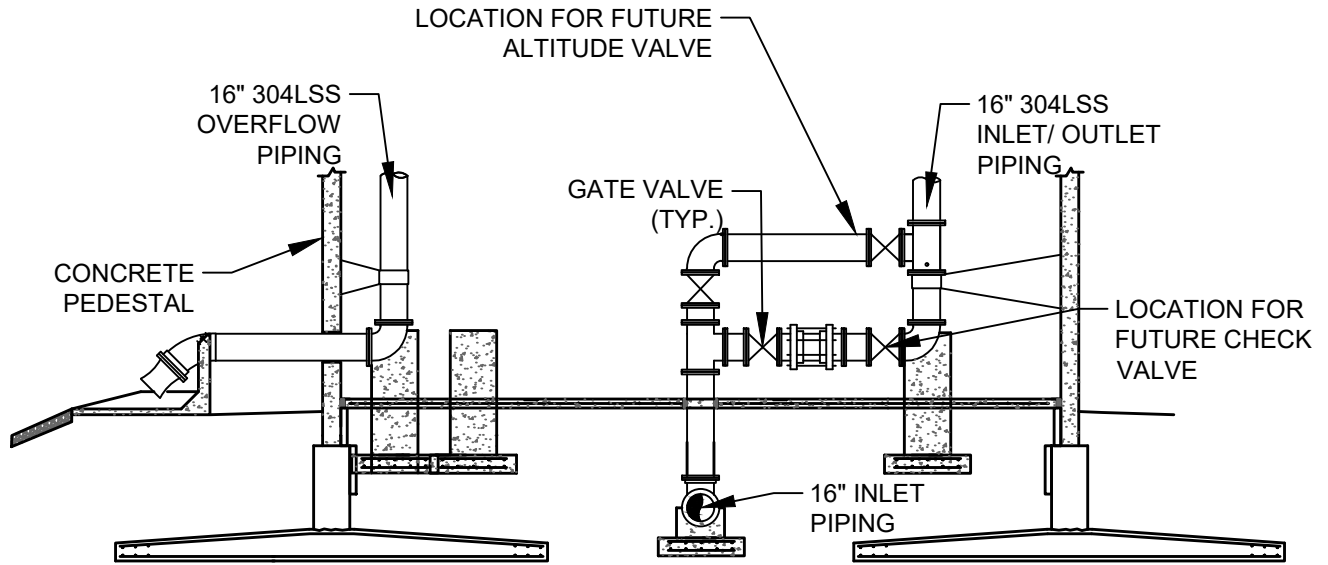

COMPOSITE BASE VALVE ASSEMBLY

NOT TO SCALE

PLOTTED BY: skratz

PRINTED: 11/2/2022 @ 11:25AM

FILE NAME: C:\5059-NKWD-TaylorMill\Working Drawings\AutoCAD\5059-Fig H.dwg

GRW PROJECT NO. 5059		CLIENT PROJECT NO. XXXX		DESIGNED: ADH
REVISIONS				DRAWN: CEK
				REVIEWED: ADH
NO.	DESCRIPTION	DATE	BY	APPROVED: ADH
SCALE CHECK				THIS MARK SHOULD MEASURE EXACTLY 1/2" WHEN PLOTTED

COMPOSITE TANK VALVE ASSEMBLY
TAYLOR MILL TANK
N.K.W.D.



engineering | architecture | geospatial
www.grwinc.com

ALL RIGHTS RESERVED. THIS DOCUMENT IS THE PROPERTY OF GRW ENGINEERS, INC. AND SHALL NOT BE REPRODUCED IN WHOLE OR IN PART OR USED FOR CONSTRUCTION OF OTHER THAN THIS SPECIFIC PROJECT WITHOUT WRITTEN PERMISSION

DATE: SEPTEMBER, 2022
SCALE: 3/32"=1'-0"
SHEET NO. H

APPENDICES

APPENDIX A

GridBee Submersible Mixer Budget Pricing and Brochure



IXOM Watercare Inc.
 3225 Hwy 22, Dickinson ND 58601
 866-437-8076 • watercare@ixom.com



Budget Estimate - (Bid Specs Vary, Do Not Use for Bid Pricing)

GS-12 / GS-9 Electric Potable Water Tank Mixers

Last Updated: June 8, 2022 - Note: International Pricing Will Vary

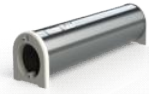

Performance guaranteed or your money back! GS Mixers are the most effective and competitively priced mixers on the market with the lowest life cycle cost and the best warranty. Specifications can be found at www.ixomwatercare.com/equipment/gs-series-submersible-mixers
 Installing a GS mixer is well within the capabilities of most cities and contractors. GS mixers are usually installed directly under the hatch with no need to center it in tank. A GS Series Electric Mixer Training Video is available at: www.ixomwatercare.com/video/1802/gs-11-minute-installation-training

Description	GS-12	GS-9
GS Submersible Electric Mixer: with 75 ft of in-tank submersible electrical cable	\$12,595	\$9,075
GS Submersible Electric Mixer: with 150 ft of in-tank submersible electrical cable	\$12,950	\$9,515
Freight cost for each basic system:	\$150	\$130
Horsepower, Voltage, Phase: GS Mixers are available on request at the same price: 240vAC 1PH and 460vAC 3PH	0.50 hp, 120vAC, 1PH Other voltage / ph available	
Mixer length x diameter, inches: 12" or larger hatch size required, no need to enter or drain the tank	36" x 10"	24" x 10"
Weight: submersible mixer only	75 lbs	65 lbs
Maximum recommended tank volumes for moderate conditions: * The GS-12 is recommended for higher turnover rate, or ice issues, or areas with high heat.	8 MG (million gallons)	3 MG (million gallons)
Options		
100217 Chemical injection interior hose: per 100 ft:	\$285	
100321 Chemical injection hose penetration thru fitting: for steel tanks:	\$506	
Chemical injection exterior hose kit: includes 50 ft SS braided hose & valve termination:	\$798	
Additional - Chemical injection exterior hose: price per ft:	\$8.00 per ft	
102423 Control Box (120v): UL listed, NEMA 4, 120vAC/1ph, with SCADA monitoring, HOA switch, indicator light, locking latch	\$1,695	Shipped with mixer for electrical contractor installation
102424 Control Box (240v): UL listed, NEMA 4, 240vAC/1ph, with SCADA monitoring, HOA switch, indicator light, locking latch	\$1,735	Shipped with mixer for electrical contractor installation
100264 Control Box (120v): UL listed, NEMA 4X, 120vAC/1ph, with timer but No SCADA, on/off switch, indicator light, locking latch	\$908	Shipped with mixer for electrical contractor installation
Factory Delivery & Placement: Installing the above mixer is within the scope of work that most cities/contractors can perform	\$16,000	Varies with tank height and tank construction
DBS - Portable Disinfectant Boost System: An electric or engine-driven air compressor (4 cfm @ 60 psi) is required to operate the air-powered diaphragm pump; air compressor is <u>not</u> included	\$9,977 + \$600 Freight	

$$\boxed{\$9,515 + \$130 + \$1,735 = \$11,340}$$

GridBee® GS Series Submersible Mixers

Effective. Efficient. Affordable.

Reliable 24-hour active mixing with the lowest life-cycle cost. The benefits are immediate!

Benefits

- Prevents stagnation, thermal stratification & short-circuiting.
- Provides uniform water age & equal distribution of disinfectant.
- Minimize chemical disinfectant usage & disinfection by-products.
- Increases contact time (baffle factor) in clearwells.
- Reduces nitrification in chloraminated systems.
- Eliminate energy intensive & costly deep-cycling and/or flushing of tanks.
- Reduces ice buildup & tank damage in cold climates.

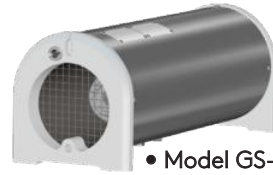

• Model GS-9

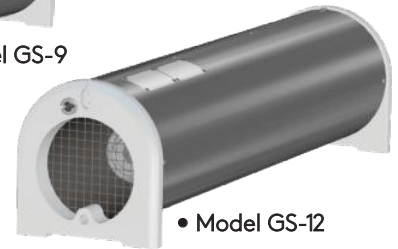

• Model GS-12

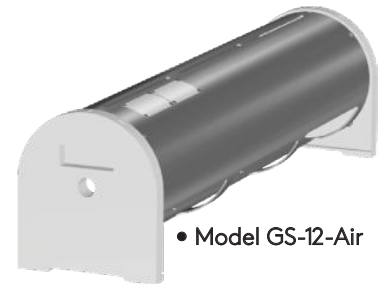

• Model GS-12-Air

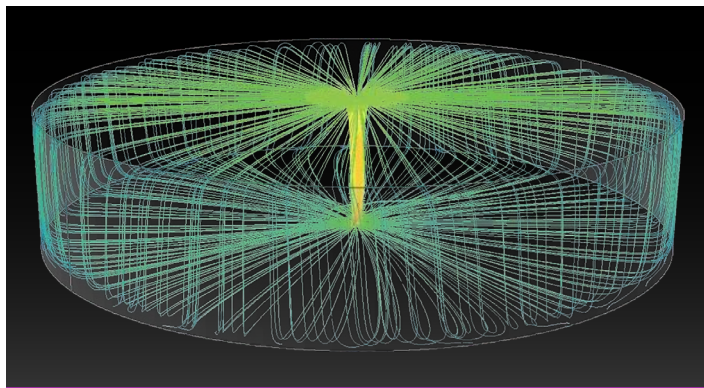

CFD of a GS-12 in an 8 million gallon reservoir.

Performance Guaranteed.

Features

- Engineered for easy deployment.
- No tank entry required.
- Utilizes efficient sheet mixing technology.
- 316SS Construction.
- Certified to NSF/ANSI 61 and NSF/ANSI 372.
- 120VAC 1Ph Standard.
- 240VAC 1PH or 460vAC 3PH available.
(for GS-9 and GS-12 models only)
- 5-Year Warranty.
- Liquid disinfectant boosting port.

Effective mixing for any tank size, any tank build.



NSF / ANSI Standard 61 Certified By

	NSF	UL	CSA
GS Mixer	X		
GS Motor		X	X

NSF / ANSI Standard 372 Certified By

	NSF	UL	CSA
GS Mixer	X		
GS Motor		X	X

GridBee® GS Series Submersible Mixers

GridBee® GS Series Submersible Tank Mixers are easily deployed through a hatch, vent, or other tank opening twelve (12) inches or larger in diameter. The “GS” thoroughly mixes the entire tank volume from tank floor to water surface resulting in consistent disinfectant residuals, even temperature profiles and uniform water age.

Assembled Machine Dimensions

	Length	Diameter	Weight
GS-9	24 in. (61 cm)	10 in. (25 cm)	65 lbs. (29 kg)
GS-12	36 in. (91 cm)	10 in. (25 cm)	75 lbs. (34 kg)
GS-12-Air	36 in. (91 cm)	10 in. (25 cm)	50 lbs. (23 kg)

Everything you need for a fast & efficient deployment is included!

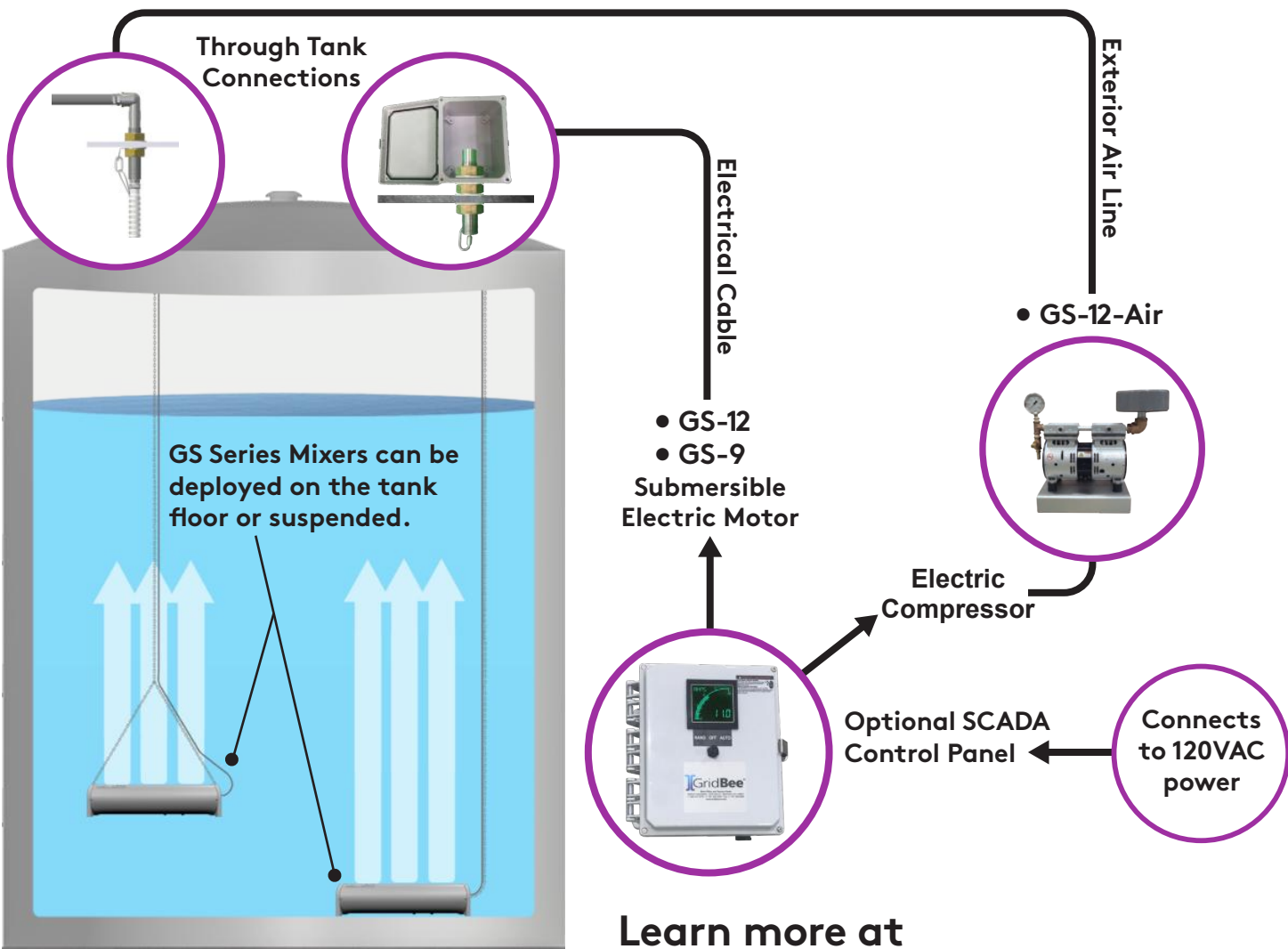

Learn more at www.ixomwatercare.com

APPENDIX B

**Pulsed Hydraulics, Inc. Bubble Mixer Budget
Pricing and Brochure**

VERSION: 03.30.21

**PHI 360 STANDARD
PRICE WORKSHEET**

**ENTER INFORMATION IN
YELLOW BOXES ONLY**



DATE: 07/15/22

Job Name: Northern KY Water District
Water Storage Mixing System

PHI Job #:

REP COMPANY NAME: ICS, Inc.
Purchase order #:
Purchase order date:

REP NAME: L Bell

SELECT SYSTEM FEATURE No Heater E

**MIXING VALVE ENCLOSURE (MVE)
BASIC ENCLOSURE**

36" x 36" x 8" SST Enclosure, one (1) to eight (8) Valves, Allen Bradley CompactLogic 1769-L16LER PLC, PanelView "7" touchscreen, 50 watt heater, pressure regulator, filter, surge protector, lightning arrestor, 120vac

TOTAL NUMBER OF VALVES (Enter 1, 2, 3, 4, 5, 6, 7, 8) 1 38,000

PHI 360 MIXING VALVE ENCLOSURE PART NUMBER: PHI 360 - 1

NUMBER OF ENCLOSURES ORDERED 1 38,000

BUBBLE FORMING PLATE(S) Stainless steel

Enter total number of plates for project in box at right. 1 500

Bubble Forming Plate Material: Enter SS= Stainless Steel
P=PVC

SPARE PARTS: See spare parts tab below 337

PHI EQUIPMENT SUB-TOTAL 38,837

PRICING ADJUSTMENT

PHI EQUIPMENT TOTAL 38,837

OTHER ITEMS:

Engineering submittals: Required? Enter Y=Yes or N=No in box at right. Y 3,000

Start-up services: Enter amount in box at right. 1,000

Training services: Enter amount in box at right. 500

Compressor: See Compressor tab below 13,816

Special items: See Special Items tab below 500

PROJECT TOTAL 57,653

SHIPPING INSTRUCTIONS:

SHIP TO:
Name
Address
Contact name and phone
Special Instructions:



PHi-350 WATER STORAGE MIXER



Description: The PHI 350 mixer is unique in that it utilizes large air bubbles which are sequentially injected into a liquid to create powerful mixing currents. The system is contained in an NEMA-4X enclosure.

PROVEN TO

- Eliminate thermoclines and stratification of the water in storage tanks
- Prevent nitrification of drinking water
- Keep purification chemicals in solution
- Reduce chlorine use



Bubble Forming Plate: The only equipment installed in the vessel is the NSF-61 approved bubble forming plate and piping. The bubble forming plate is an 8-inch disk consisting of two 3/16" SS plates which are separated by 3/16" and connected to a 1-inch NPT pipe. Piping is run from the enclosure and connected to the bubble forming plate. The electro-pneumatic valve delivers the compressed air through the piping to the forming plates where it is squished between the two plates thus creating a large, relatively flat bubble. The mixing is created by the bubble rapidly rising to the top the vessel, forcing the water to the sides of the tank, down the walls and back to the bubble forming plate.

Applications: The PHi-350 is used to mix potable water tanks of any size or shape. The sequenced bubbles quickly mix water tanks to prevent stratification and maintain chlorine residuals equally throughout. Since stratification and residual loss does not typically reoccur within 24 hours, mixing once per day for 60 minutes will keep the potable water within required chlorine specifications without hot spots or bio-film formation.

Energy Savings: Substantial energy is saved as the system typically needs to operate once per day for 60 minutes.

FOR INFORMATION: Visit our website at www.phiwater.com, email info@phiwater.com, call us at (800) 641-1726, or write us at 15 Oro Beach Dr., Oroville, WA 98844



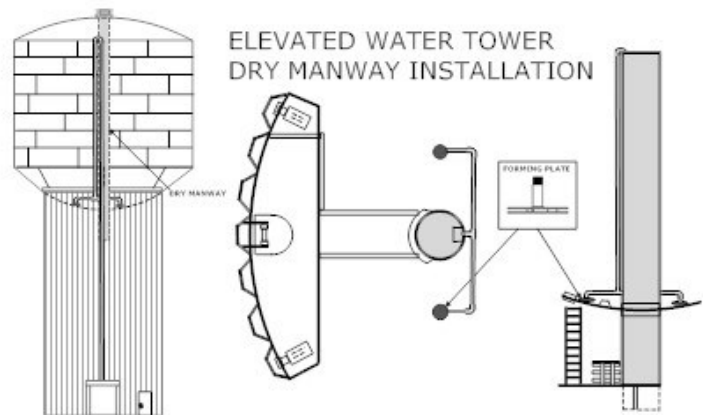
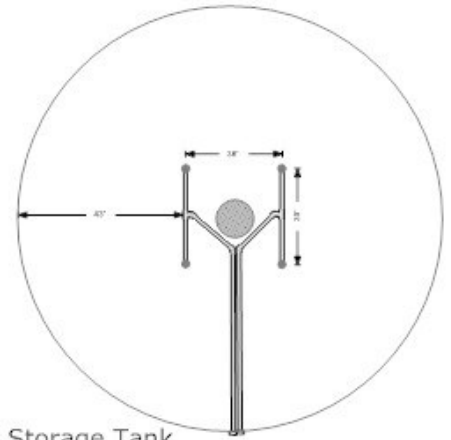
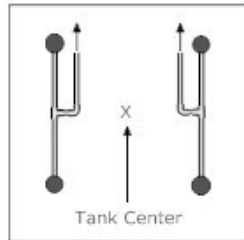
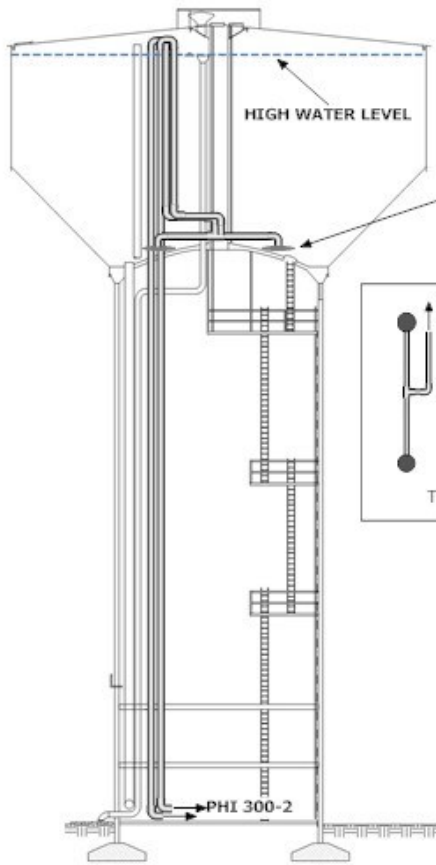

A Pennsylvania water utility compared the chlorine reading of their PHi mixed water tank to their two other non-mixed tanks. They discovered that the mixed tank had a free chlorine reading of .3 ppm in and .2 ppm out. The non-mixed tanks had a free CL reading of .8 ppm in and .03 ppm out and 1.1 ppm in and .15 out, respectively.

FOR INFORMATION: Visit our website at www.phewater.com, email info@phewater.com, call us at (800) 641-1726, or write us at 15 Oro Beach Dr., Oroville, WA 98844



APPENDIX C

**Cla-Val Model 58-01 Valve and Model X105L
Limit Switch Data Sheets**



— MODEL — 58-01

Combination Back Pressure & Solenoid Shut-Off Valve



- Accurate Pressure Control
- Wide Adjustment Ranges
- Optional Check Feature Available
- Quick Acting Solenoid Shut-Off
- Easy Installation and Maintenance

The Cla-Val Model 58-01 valve performs two separate functions. It maintains a constant back pressure by discharging excess pressure downstream and when the solenoid is activated the valve closes drip-tight.

In operation, the valve is actuated by hydraulic line pressure through the pilot control system. When inlet pressure is greater than the control setting, the valve opens. When inlet pressure is equal to the control setting, the pilot modulates the valve, maintaining the preselected back pressure. When inlet pressure is less than the control setting, the pilot system closes the valve drip tight. Changing the pressure setting simply involves turning an adjusting screw on the pilot control.

The solenoid control is available in energize to open or de-energize to open models.

Schematic Diagram

Item	Description
1	100-01 Hytrol Main Valve
2	X42N-3 Strainer & Needle Valve
3	CRL-60 Pressure Relief Control
4	CS3 Solenoid Control
5	100-01 Hytrol (Reverse Flow)

Optional Features

Item	Description
B	Shutoff Isolation Valve
D	Check Valves with Isolation Valve
F	Remote Pilot Sensing
H	Drain to Atmosphere
P	X141 Pressure Gauge
S	CV Speed Control (Opening)
V	X101 Valve Position Indicator

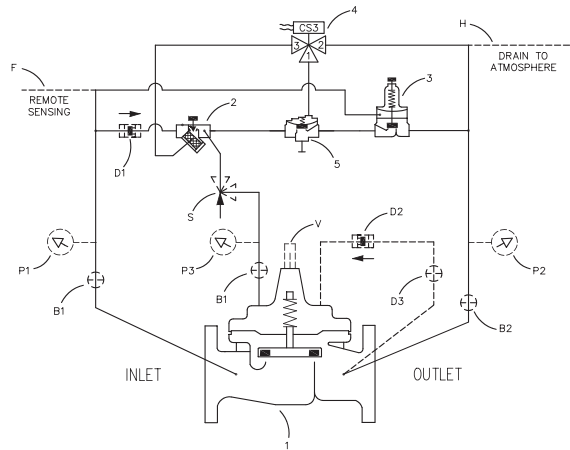

The "D" feature on a vertically installed 6" and larger valve must be horizontally oriented.

Typical Applications

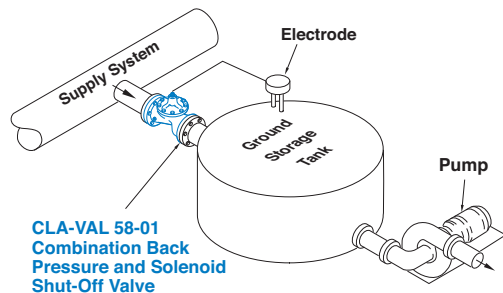

Back Pressure Maintenance Service

A frequent application of this valve is to maintain minimum back pressure in the system while supplying water to a reservoir. The electrode in the storage tank activates the solenoid shutoff feature when the tank reaches a preset level.

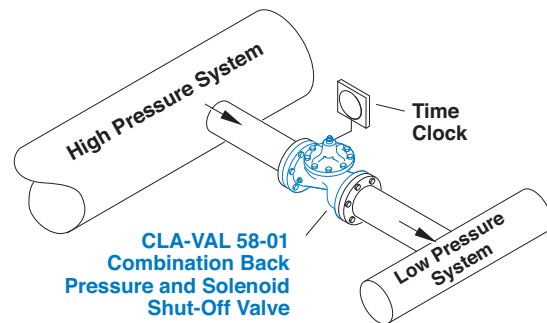

Electronic Control Service

Using a timer connected to the solenoid control of the valve, flow from the high pressure system to the low pressure system can be controlled at certain times during the day.

Model 58-01 (Uses 100-01 Hytrol Main Valve)

Pressure Ratings (Recommended Maximum Pressure - psi)

Valve Body & Cover		Pressure Class				
		Flanged			Grooved	Threaded
Grade	Material	ANSI Standards*	150 Class	300 Class	300 Class	End‡ Details
ASTM A536	Ductile Iron	B16.42	250	400	400	400
ASTM A216-WCB	Cast Steel	B16.5	285	400	400	400
UNS 87850	Bronze	B16.24	225	400	400	400

Note: * ANSI standards are for flange dimensions only.
 Flanged valves are available faced but not drilled.
 ‡ End Details machined to ANSI B2.1 specifications.
Valves for higher pressure are available; consult factory for details

Materials

Component	Standard Material Combinations		
Body & Cover	Ductile Iron	Cast Steel	Bronze
Available Sizes	1" - 36" 25 - 900mm	1" - 16" 25 - 400mm	1" - 16" 25 - 400mm
Disc Retainer & Diaphragm Washer	Cast Iron	Cast Steel	Bronze
Trim: Disc Guide, Seat & Cover Bearing	Bronze is Standard Stainless Steel is Optional		
Disc	Buna-N® Rubber		
Diaphragm	Nylon Reinforced Buna-N® Rubber		
Stem, Nut & Spring	Stainless Steel		
For material options not listed, consult factory. Cla-Val manufactures valves in more than 50 different alloys.			

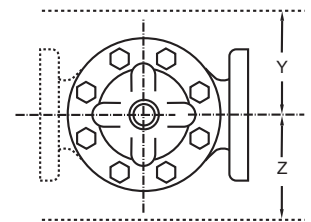
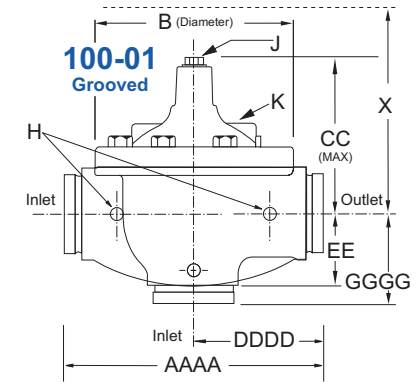
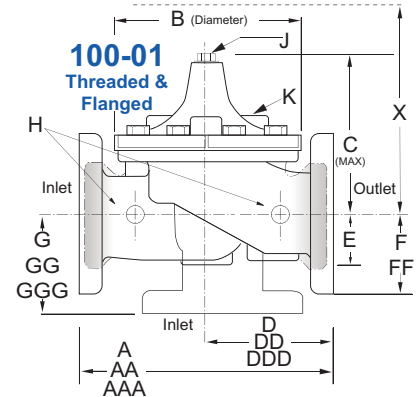

For sizes 18 - 36-inches, use 50-66 E-Sheet

Model 58-01 Dimensions (in inches)

Valve Size (Inches)	1	1 1/4	1 1/2	2	2 1/2	3	4	6	8	10	12	14	16	18	20	24	30	36
A Threaded	7.25	7.25	7.25	9.38	11.00	12.50	—	—	—	—	—	—	—	—	—	—	—	—
AA 150 ANSI	—	—	8.50	9.38	11.00	12.00	15.00	20.00	25.38	29.75	34.00	39.00	41.38	46.00	52.00	61.50	63.00	72.75
AAA 300 ANSI	—	—	9.00	10.00	11.62	13.25	15.62	21.00	26.38	31.12	35.50	40.50	43.50	47.64	53.62	63.24	64.50	74.75
AAAA Grooved End	—	—	8.50	9.00	11.00	12.50	15.00	20.00	25.38	—	—	—	—	—	—	—	—	—
B Diameter	5.62	5.62	5.62	6.62	8.00	9.12	11.50	15.75	20.00	23.62	28.00	32.75	35.50	41.50	45.00	53.16	56.00	66.00
C Maximum	5.50	5.50	5.50	6.50	7.56	8.19	10.62	13.38	16.00	17.12	20.88	24.19	25.00	39.06	41.90	43.93	54.60	59.00
CC Maximum Grooved End	—	—	4.75	5.75	6.88	7.25	9.31	12.12	14.62	—	—	—	—	—	—	—	—	—
D Threaded	3.25	3.25	3.25	4.75	5.50	6.25	—	—	—	—	—	—	—	—	—	—	—	—
DD 150 ANSI	—	—	4.00	4.75	5.50	6.00	7.50	10.00	12.69	14.88	17.00	19.50	20.81	—	—	30.75	—	—
DDD 300 ANSI	—	—	4.25	5.00	5.88	6.38	7.88	10.50	13.25	15.56	17.75	20.25	21.62	—	—	31.62	—	—
DDDD Grooved End	—	—	—	4.75	—	6.00	7.50	—	—	—	—	—	—	—	—	—	—	—
E	1.12	1.12	1.12	1.50	1.69	2.06	3.19	4.31	5.31	9.25	10.75	12.62	15.50	12.95	15.00	17.75	21.31	24.56
EE Grooved End	—	—	2.00	2.50	2.88	3.12	4.25	6.00	7.56	—	—	—	—	—	—	—	—	—
F 150 ANSI	—	—	2.50	3.00	3.50	3.75	4.50	5.50	6.75	8.00	9.50	10.50	11.75	15.00	16.50	19.25	22.50	28.50
FF 300 ANSI	—	—	3.06	3.25	3.75	4.13	5.00	6.25	7.50	8.75	10.25	11.50	12.75	15.00	16.50	19.25	24.00	30.00
G Threaded	1.88	1.88	1.88	3.25	4.00	4.50	—	—	—	—	—	—	—	—	—	—	—	—
GG 150 ANSI	—	—	4.00	3.25	4.00	4.00	5.00	6.00	8.00	8.62	13.75	14.88	15.69	—	—	22.06	—	—
GGG 300 ANSI	—	—	4.25	3.50	4.31	4.38	5.31	6.50	8.50	9.31	14.50	15.62	16.50	—	—	22.90	—	—
GGGG Grooved End	—	—	—	3.25	—	4.25	5.00	—	—	—	—	—	—	—	—	—	—	—
H NPT Body Tapping	0.375	0.375	0.375	0.375	0.50	0.50	0.75	0.75	1.00	1.00	1.00	1.00	1.00	1.00	1.00	1.00	2.00	2.00
J NPT Cover Center Plug	0.25	0.25	0.25	0.50	0.50	0.50	0.75	0.75	1.00	1.00	1.25	1.50	2.00	1.00	1.00	1.00	2.00	2.00
K NPT Cover Tapping	0.375	0.375	0.375	0.375	0.50	0.50	0.75	0.75	1.00	1.00	1.00	1.00	1.00	1.00	1.00	1.00	2.00	2.00
Stem Travel	0.40	0.40	0.40	0.60	0.70	0.80	1.10	1.70	2.30	2.80	3.40	4.00	4.50	5.10	5.63	6.75	7.50	8.50
Approx. Ship Weight (lbs)	15	15	15	35	50	70	140	285	500	780	1165	1600	2265	2982	3900	6200	7703	11720
Approx. X Pilot System	11	11	11	13	14	15	17	29	31	33	36	40	40	43	47	68	79	85
Approx. Y Pilot System	9	9	9	9	10	11	12	20	22	24	26	29	30	32	34	39	40	45
Approx. Z Pilot System	9	9	9	9	10	11	12	20	22	24	26	29	30	32	34	39	42	47

Model 58-01 Metric Dimensions (Uses 100-01 Hytrol Main Valve)

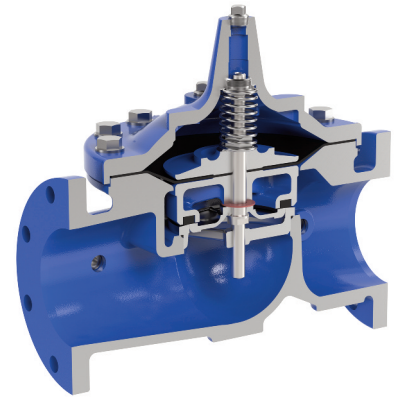
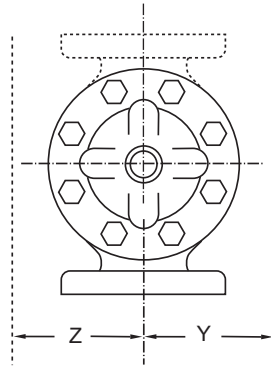
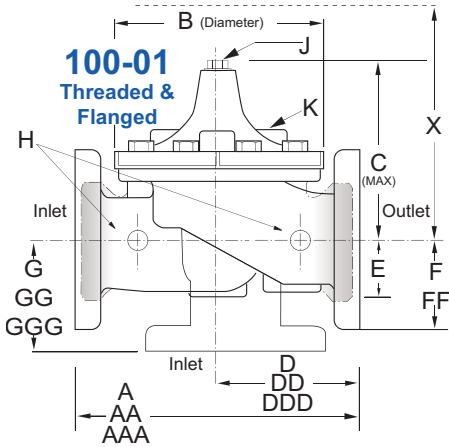

Model 100-01 Full Port Hytrol Main Valve

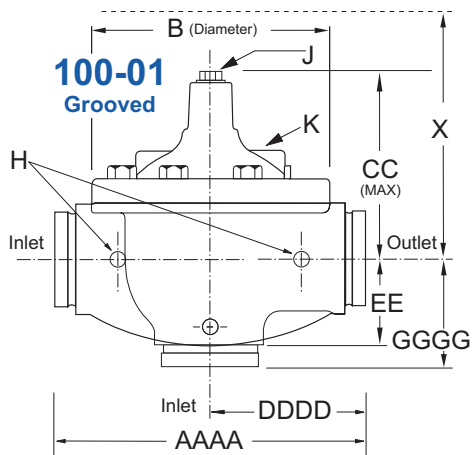

Model 58-01 Dimensions (in mm)

Valve Size (mm)	25	32	40	50	65	80	100	150	200	250	300	350	400	450	500	600	750	900
A Threaded	184	184	184	238	279	318	—	—	—	—	—	—	—	—	—	—	—	—
AA 150 ANSI	—	—	216	238	279	305	381	508	645	756	864	991	1051	1168	1321	1562	1600	1848
AAA 300 ANSI	—	—	229	254	295	337	397	533	670	790	902	1029	1105	1210	1326	1606	1638	1899
AAAA Grooved End	—	—	216	228	279	318	381	508	645	—	—	—	—	—	—	—	—	—
B Diameter	143	143	143	168	203	232	292	400	508	600	711	832	902	1054	1143	1350	1422	1676
C Maximum	140	140	140	165	192	208	270	340	406	435	530	614	635	992	1064	1116	1387	1499
CC Maximum Grooved End	—	—	120	146	175	184	236	308	371	—	—	—	—	—	—	—	—	—
D Threaded	83	83	83	121	140	159	—	—	—	—	—	—	—	—	—	—	—	—
DD 150 ANSI	—	—	102	121	140	152	191	254	322	378	432	495	528	—	—	781	—	—
DDD 300 ANSI	—	—	108	127	149	162	200	267	337	395	451	514	549	—	—	803	—	—
DDDD Grooved End	—	—	—	121	—	152	191	—	—	—	—	—	—	—	—	—	—	—
E	29	29	29	38	43	52	81	110	135	235	273	321	394	329	381	451	541	624
EE Grooved End	—	—	52	64	73	79	108	152	192	—	—	—	—	—	—	—	—	—
F 150 ANSI	—	—	64	76	89	95	114	140	171	203	241	267	298	381	419	489	572	724
FF 300 ANSI	—	—	78	83	95	105	127	159	191	222	260	292	324	381	419	489	610	762
G Threaded	48	48	48	83	102	114	—	—	—	—	—	—	—	—	—	—	—	—
GG 150 ANSI	—	—	102	83	102	102	127	152	203	219	349	378	399	—	—	560	—	—
GGG 300 ANSI	—	—	102	89	110	111	135	165	216	236	368	397	419	—	—	582	—	—
GGGG Grooved End	—	—	—	83	—	108	127	—	—	—	—	—	—	—	—	—	—	—
H NPT Body Tapping	0.375	0.375	0.375	0.375	0.50	0.50	0.75	0.75	1.00	1.00	1.00	1.00	1.00	1.00	1.00	1.00	2.00	2.00
J NPT Cover Center Plug	0.25	0.25	0.25	0.50	0.50	0.50	0.75	0.75	1.00	1.00	1.25	1.50	2.00	1.00	1.00	1.00	2.00	2.00
K NPT Cover Tapping	0.375	0.375	0.375	0.375	0.50	0.50	0.75	0.75	1.00	1.00	1.00	1.00	1.00	1.00	1.00	1.00	2.00	2.00
Stem Travel	10	10	10	15	18	20	28	43	58	71	86	102	114	130	143	171	190	216
Approx. Ship Weight (kgs)	7	7	7	16	23	32	64	129	227	354	528	726	1027	1353	1769	2812	3494	5316
Approx. X Pilot System	280	280	280	331	356	381	432	737	788	839	915	1016	1016	1093	1194	1728	2007	2159
Approx. Y Pilot System	229	229	229	229	254	280	305	508	559	610	661	737	762	813	864	991	1016	1143
Approx. Z Pilot System	229	229	229	229	254	280	305	508	559	610	661	737	762	813	864	991	1067	1194

58-01 Valve Selection	100-01 Pattern: Globe (G), Angle (A), End Connections: Threaded (T), Grooved (GR), Flanged (F) Indicate Available Sizes																			
	Inches	1	1¼	1½	2	2½	3	4	6	8	10	12	14	16	18	20	24	30	36	
	mm	25	32	40	50	65	80	100	150	200	250	300	350	400	450	500	600	750	900	
Main Valve 100-01	Pattern	G, A	G, A	G, A	G, A	G, A	G, A	G, A	G, A	G, A	G, A	G, A	G, A	G, A	G	G	G, A	G	G	
	End Detail	T	T	T, F, Gr*	T, F, Gr	T, F, Gr*	T, F, Gr	F, Gr	F, Gr*	F, Gr*	F	F	F	F	F	F	F	F	F	F
Suggested Flow (gpm)	Maximum	55	93	125	210	300	460	800	1800	3100	4900	7000	8400	11000	14000	17000	25000	42000	50000	
	Maximum Surge	120	210	280	470	670	1000	1800	4000	7000	11000	16000	19000	25000	31000	39000	56500	63000	85000	
Suggested Flow (Liters/Sec)	Maximum	3.5	6	8	13	19	29	50	113	195	309	442	530	694	883	1073	1577	2650	3150	
	Maximum Surge	7.6	13	18	30	42	63	113	252	441	693	1008	1197	1577	1956	2461	3560	3975	5360	

100-01 Series is the full internal port Hytrol.

*Globe Grooved Only

Notes:

- For sizes 18 through 36-inches / 450mm through 900 mm, use 50-66 E-Sheet
- Many factors should be considered in sizing pressure reducing valves including inlet pressure, outlet pressure and flow rates.
- For sizing questions or cavitation analysis, consult Cla-Val with system details.

Pilot System Specifications



CRL-60 Pilot Control

Adjustment Ranges

- 0 to 75 psi Max.
- 20 to 105 psi
- 20 to 200 psi *
- 100 to 300 psi

*Supplied unless otherwise specified. Other ranges are available, please consult factory.

Temperature Range

Water: to 180°F (82°C)

Materials

Standard Pilot System Materials

Pilot Control: Low Lead Bronze

Trim: Stainless Steel Type 303

Rubber: Buna-N® Synthetic Rubber

Tubing & Fittings: Copper and Bronze

Optional Pilot System Materials

Pilot Systems are available with optional Aluminum, Stainless Steel or Monel materials.

Electrical Ratings:

- Voltage:
- 24, 48, 120, 240, 480 – 60 Hz. VAC
- 6, 12, 24, 120, 240 VDC



CS3 Solenoid Control

When Ordering, Specify:

1. Catalog No. 58-01
2. Valve Size
3. Pattern - Globe or Angle
4. Pressure Class
5. Threaded or Flanged
6. Trim Material
7. Energized or De-energized to Open Main Valve
8. Adjustment Range
9. Desired Options
10. Electrical Selection
11. When Vertically Installed

Main Valve Options

EPDM Rubber Parts

Optional diaphragm, disc and o-ring fabricated with EPDM synthetic rubber

Viton® Rubber Parts - suffix KB

Optional diaphragm, disc and o-ring fabricated with Viton® synthetic rubber

Epoxy Coating - suffix KC

NSF/ANSI 61 Fusion Bonded Epoxy

Dura-Kleen® Stem - suffix KD

Fluted design prevents dissolved minerals build-up on the stem

LFS Trim

Designed to regulate precisely and smoothly at typical flow rates as well as lower than the industry standard of 1 fps, without decreasing the valve's capacity



CLA-VAL

1701 Placentia Avenue • Costa Mesa, CA 92627

800-942-6326 • Fax: 949-548-5441 • Web Site: cla-val.com • E-mail: info@cla-val.com

CLA-VAL CANADA

4687 Christie Drive
Beamsville, Ontario
Canada L0R 1B4
Phone: 905-563-4963
E-mail sales@cla-val.ca

CLA-VAL EUROPE

Chemin des Mésanges 1
CH-1032 Romanel/
Lausanne, Switzerland
Phone: 41-21-643-15-55
E-mail: cla-val@cla-val.ch

CLA-VAL UK

Dainton House, Goods Station Road
Tunbridge Wells
Kent TN1 2 DH England
Phone: 44-1892-514-400
E-mail: info@cla-val.co.uk

CLA-VAL FRANCE

Porte du Grand Lyon 1
ZAC du Champ du Périer
France - 01700 Neyron
Phone: 33-4-72-25-92-93
E-mail: cla-val@cla-val.fr

CLA-VAL PACIFIC

45 Kennaway Road
Woolston, Christchurch, 8023
New Zealand
Phone: 64-39644860
www.cla-valpacific.com
E-mail: info@cla-valpacific.com



Model X105L

LIMIT SWITCH ASSEMBLY

PRODUCT FEATURES

Cla-Val Model X105L Limit Switch Assembly is a rugged, dependable and positive acting switch assembly actuated by the opening or closing of a Cla-Val control valve on which it is mounted. The single pole, double throw micro switch can be connected either to open or to close an electrical circuit when actuated. By loosening the allen screw on the actuating collar and raising or lowering the collar on the stem, the X105L is easily adjusted to signal that the valve has fully reached the desired position (open or closed).

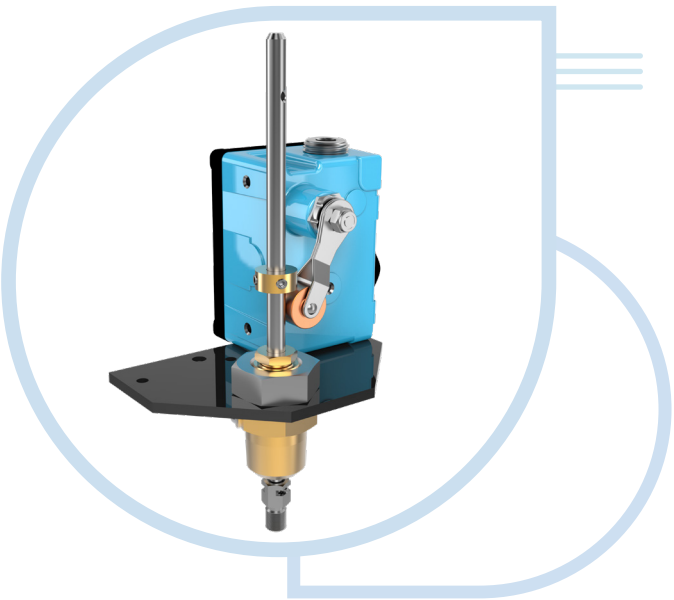

INSTALLATION

Single Pole Double Throw Switch

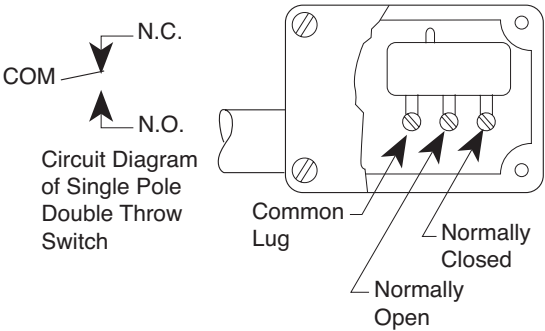

Double Pole Double Throw Switch

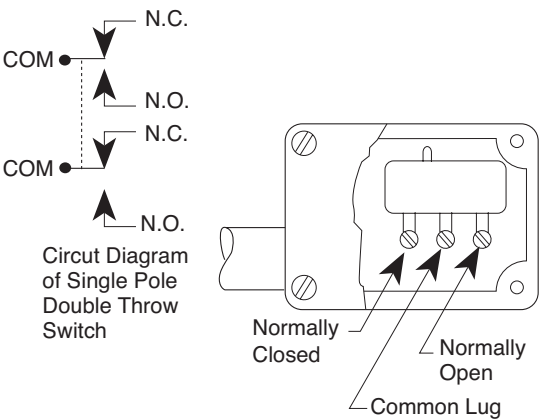

Switches shown in unactivated position.

SPECIFICATIONS

- Standard Materials*:** Aluminum switch housing
Steel bracket and brass adapter
Stainless steel stem
- Electrical:** 1/2" Conduit connection
- Switch Type:** SPDT UL, File No. E12252,
CSA Certified, File No. LR57325
Weather proof
NEMA 1,3,4, and 13
- Switch Rating:** UL/CSA rating: L96
15 amp. 125, 250, or 480 volts AC
1/2 amp. 125 volts DC
1/4 amp. 250 volts DC
- Switch Options:** DPDT switches available on request
UL/CSA Rating: L59, 10 amps

Explosion proof micro switches are NEMA 1,7, and 9
UL Listed, File No. E14274 and CSA Certified, File No. LR57324: Class I, Group C and D and Class II, Group E, F and G.

*Optional Materials Available

CLA-VAL Company
www.cla-val.com
info@cla-val.com
S-X105L (R-01/2021)



Model X105L

LIMIT SWITCH ASSEMBLY

DIMENSIONS

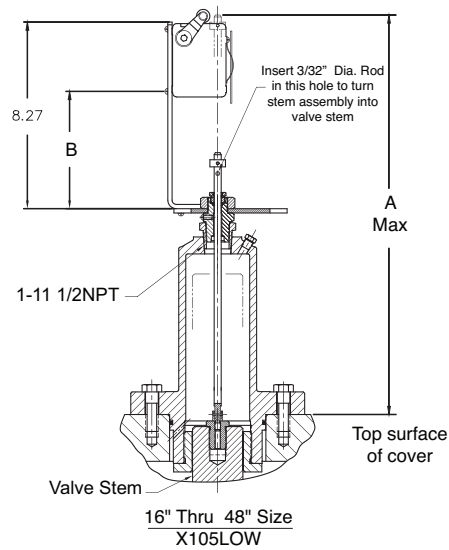
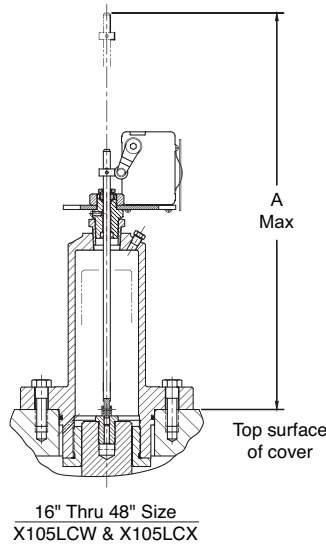
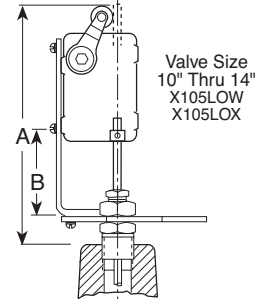
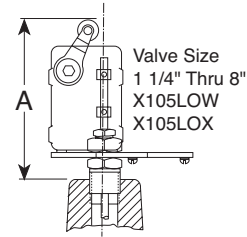
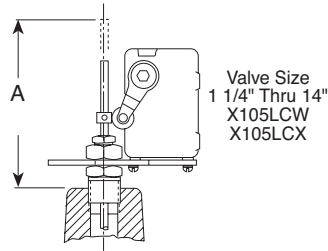
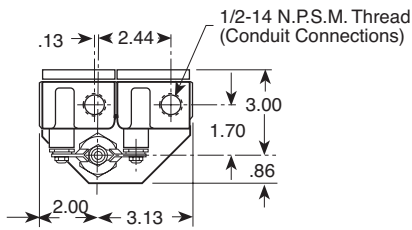

Basic Valve 100-01	1 1/4	1 1/2	2	2 1/2	3	4	6	8	10	12	14	16	18	20	24	30	36	42	48
Dimension "A"	10.19	10.19	7.16	7.16	7.43	7.00	6.69	6.91	9.88	9.59	9.16	10.78	10.78	18.23	19.10	35.07	36.07	36.07	36.07
Dimension "B"							1.69	1.69	2.44	2.94	2.94	2.94	2.94	4.32	5.19	8.40	8.40	8.40	8.40
Basic Valve 100-20					3	4	6	8	10	12	14	16	18	20	24	30	36	42	48
Dimension "A"					7.16	7.34	7.00	6.69	6.91	9.88	9.59	9.59	10.78	10.78	10.78	11.30	35.07	36.07	36.07
Dimension "B"								1.69	1.69	2.44	2.94	2.94	2.94	2.94	2.94	5.19	8.40	8.40	8.40

CATALOG NO.	ACTUATION POSITION	SWITCH ENCLOSURE
X105LCW	Valve Closed	Weather Proof
X105LCX	Valve Closed	Explosion Proof
X105LOW	Valve Open	Weather Proof
X105LOX	Valve Open	Explosion Proof

CLA-VAL Company

www.cla-val.com

info@cla-val.com

S-X105L (R-01/2021)

