

**KENTUCKY-AMERICAN WATER COMPANY
CASE NO. 2023-00191
LEXINGTON-FAYETTE URBAN COUNTY GOVERNMENT'S
FIRST REQUEST FOR INFORMATION**

Witness: Dave Hill

75. Provide all reports, studies, or analysis performed by American Water regarding AMI equipment.

Response:

This question is overly broad with undefined terms and time periods. Having said that, in an effort to be as responsive as reasonably possible, the Company has made a reasonable interpretation and has conducted due diligence to find reports, studies or analysis on AMI equipment from the last five years. Please see the following attachment:

KAW_R_LFUCGDR1_NUM075_081823 – Attachment 1: This document reviews AMI equipment strategies, including guidance for many best practices that KAWC is proposing, including the use of cellular rather than fixed network technology, the pairing of same-vendor meters and endpoints, brand specific recommendations on cellular products and the installation of composite lids.

Please also see responses to other discovery that have a relationship to AMI equipment analysis:

- Please see PSC 2-12, Attachment 2 – Propagation Study which shows estimated quantities of fixed network equipment required depending on coverage and location of collectors.
- Please see PSC 2-12, Attachment 3- Ops Matrix for some contrasting analysis of equipment options
- Please see PSC 2-11, Attachments 1 through 4: These documents are from the RFP process to select metering equipment.

Meter Operations AMI Strategy

AMI is not a single technology, but an integration of many technologies that provides an intelligent connection between customers and the water utility.

Continuing to provide safe, clean and reliable water to our customers We will make smart, data-driven decisions and leverage technology to provide solutions that improve the quality and the reliability of water service to our customers.

WE KEEP LIFE FLOWING™



Objectives/Agenda

1

Current State

2

AMI Overview / Education

3

AMI Stratgey / Recommendations

4

Supporting AMI & Next Steps

Current Challenges

1

Do not have full visibility of AMI data for our current AMI meters. No Visibility of interval reads to our customers. Alert and Alarm data not utilized properly.

2

Rely heavily on Fathom to get billable AMI reads for customer billing.

3

Every state manages their own AMI data. They do manual processing for reports and alarms. This requires a lot of manual steps, data extraction from different systems and is not a very efficient process..

4

Rolling trucks for move-in/move-outs, account changes, meter changes, etc..

AMI vs AMR

American Water – Current State

AMR Meters = 2,790,473

AMI Meters = 427,440

What is the difference?

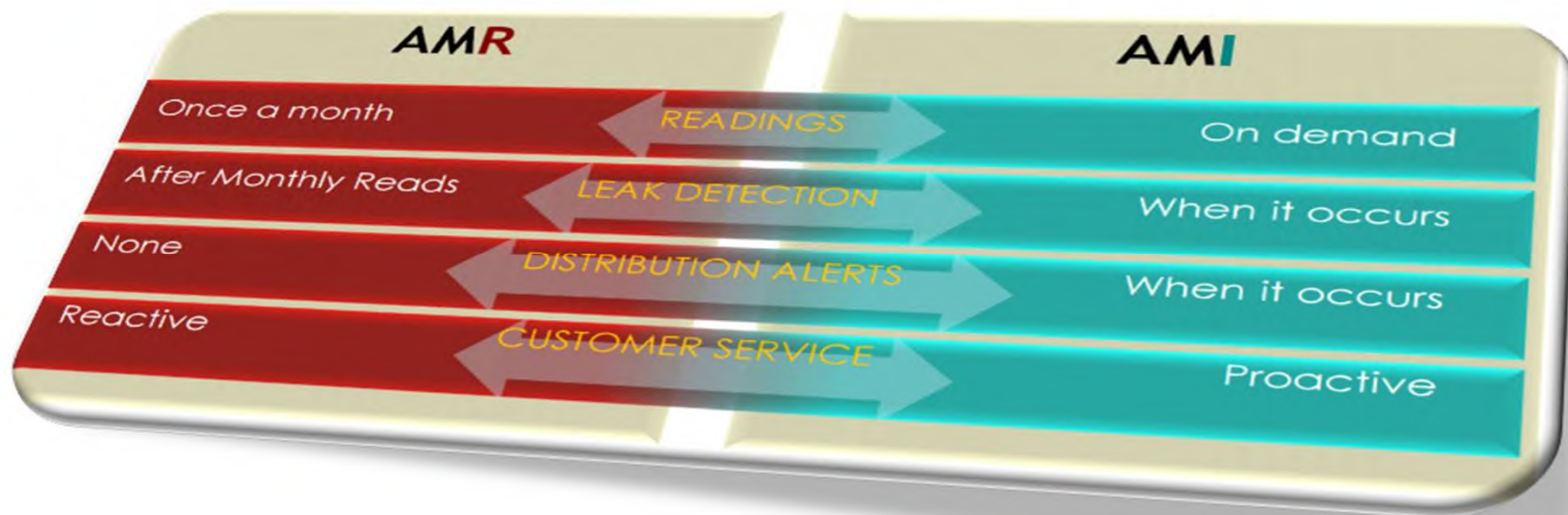

AMI Current State Survey Results

What AMI solution(s) is implemented in your state? (Click all that apply)

[More Details](#)

- Aclara 3
- Badger 4
- Itron 2
- Master Meter 0
- Metron Farnier 0
- Mueller 2
- Neptune 5
- Sensus 1
- Zenner 1
- No AMI 1

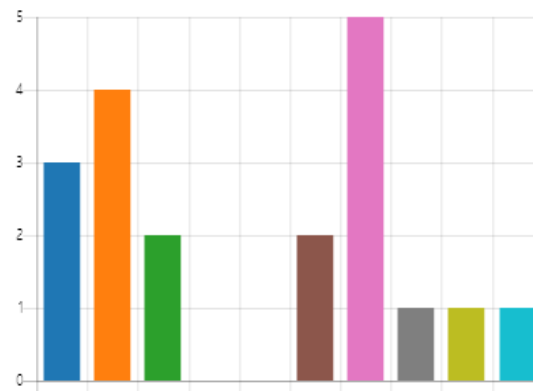

Are you planning any AMI implementations?

[More Details](#)

- Yes 10
- No 2

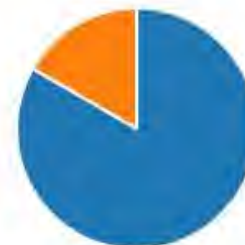

Does your state require regulatory approval to implement AMI?

[More Details](#)

- Yes 5
- No 6
- Not Sure 1

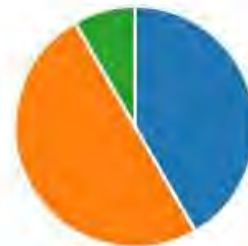

Have you created a business case for your project?

[More Details](#)

- Yes 2
- No 4
- In-Progress 6
- Need to start one 0
- Don't need one 0



Do you have money budgeted for AMI in 2020?

[More Details](#)

- Yes 5
- No 7

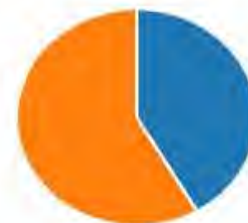

AMI – Advanced Metering Infrastructure

The Power of Interval Data



Register – read showing total consumption over time

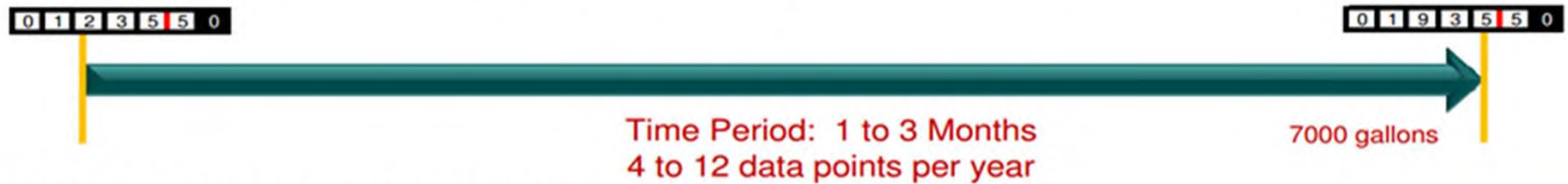

Interval – read showing usage at specific time



Key Points

1

AMI may not be for everyone. Key considerations to be evaluated at the district level include topography, customer density, NRW opportunity, meter reading costs and Meter/MIU strategy.

2

AMI offers significant benefits for both the utility and their customers. The key to unlocking these benefits lies in the data AMI delivers. Thus, the ability to analyze and identify patterns in the data is a critical piece of the overall investment.

3

Cost drivers are shifting as meter manufacturers now offer a dual purpose, “migratable” radio that can be read by either AMR or AMI. This has the potential to significantly reduce the cost of AMI deployment and consequently make the business case more attractive to a much broader segment of AW districts.

4

Several districts have already initiated or are planning AMI deployments. Corporate technology, integration, and funding decisions are critical to enabling and realizing the long term benefits.

There are two types of AMI systems:

- **Fixed-Network Systems** – With AMI fixed-network systems, meter reading is accomplished by meter transmission units (MTUs) installed on each meter. The MTUs collect real-time water use readings from the meter and transmit them via radio signals to data collection units (DCUs) that are owned by the utility.
- **Cellular-Network Systems** – AMI cellular-network systems utilize cellular endpoints installed on each meter to transmit the meter data via an existing cellular infrastructure to a central database system (hosted or on-premise) for analysis and reporting.

Components of an AMI System:

There are four components to an AMI system:

- 1) A Smart Meter
- 2) Communications Module
- 3) Collectors and Head End Systems
- 4) Meter Data Management System





ADVANCED METERING INFRASTRUCTURE



AMERICAN WATER

THE BENEFITS OF AMI

- Leak Notifications
- Informed Decisions on Water Usage
- Water Conservation
- Improved Billing Accuracy
- Increased Safety for Employees

SMART WATER METERS

A smart water meter combined with a communications module can transmit water usage in real time — a typical AMI system tracks water usage every hour. Smart meters can also detect continuous usage or expected leaks, and detect attempts to tamper with the meter.

DATA IS SENT TO THE CLOUD

The data is sent to a Head End System via a cellular signal. The Head End System directly interfaces with our Meter Data Management (MDM) and billing system providing highly accurate bills.

LEAK DETECTION ALERTS

Because they are transmitting data on a regular basis, smart meters are able to send alerts when a leak is suspected. This data is received by our MDM and can be sent to customers via text automatically before the problem becomes too serious.

FIELD SERVICE REPRESENTATIVES (FSR) RETRIEVE DATA ON DEMAND

Our FSRs are able to view real-time data on their tablets and better assist customers using the most current information.

AMI Value Proposition



Operational Benefits

- Reduction in Non Revenue Water
- Meter Reading Automation
- Operational Efficiencies in Field & Meter Services
- Operational Efficiencies in Billing & Customer Management
- Improvement in Capital Spend Efficiency



Customer Benefits

- Enhanced Customer Service & Convenience
- Billing Accuracy Improvement
- High Use & Continuous Flow Notifications
- Informed Decisions on Water Usage
- Near Real Time Access to Account Information
- Comparative Analysis, Conservation and Bill-Reducing Tips



Additional Benefits

- Increased Safety for Meter Readers & Field Services Personnel
- Environmental Benefits
- Water Conservation
- Backflow Prevention
- AMI presents an opportunity to have employees who are dedicated to meter readings or are focused on customer service tasks that will be reduced, refocus their efforts on tasks that improve our responsiveness to and the overall experience of our customers.

Improved Water Resource Management

What is Meter Data Management System

- ✓ A system that imports data to

- Validate
- Estimate
- Edit (cleanse)

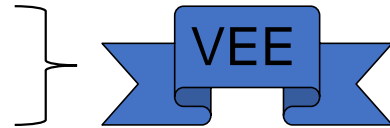

- ✓ Then process to make it available for

- Billing
- Other analysis

- ✓ MDMS objectives

- VEE
- Normalization of Actionable Data
- Push high priority alerts to data warehouse – increased awareness, notifications
- Phased approach – AMI first, AMR next, all remaining meter systems
- Retire Fathom (current system)

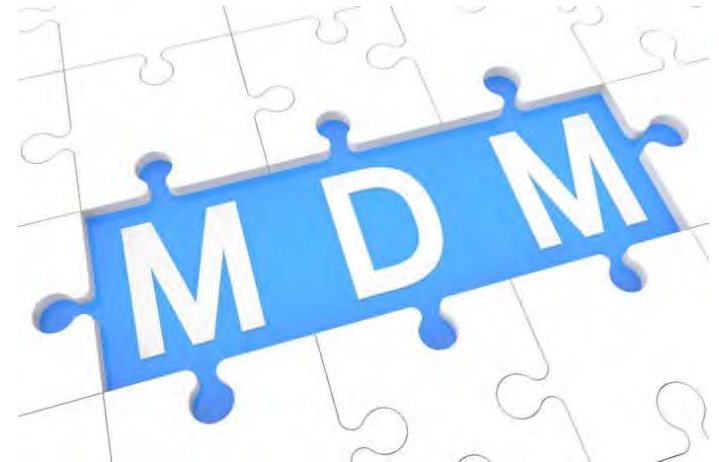

AW MDMS Core Release 1.0:

- Data Sync between SAP, MDMS and HES systems for technical master data.
 - HES Integration with Aclara and Mueller for AMI.
 - Raw and processed interval meter reads for all meter types(compound meters etc.)
 - Satisfy MRO order generated by SAP.
 - Avoid truck rolls by utilizing MDMS data for Move-in/Move-out, Off-cycle reads, account changes, etc.
 - Basic VEE Rules(Estimation of hourly reads to fill time gaps.)
 - Storage of Exceptions, Alarms data provided from HES in a standardized way.(System generated exceptions to be handled later)
 - Dashboards for viewing data and analytics.
 - Sending Alerts data to MeterOps for manual actions and trend analysis.
- 

AW MDMS Timeline:

MDMS 1.0 Product Timeline

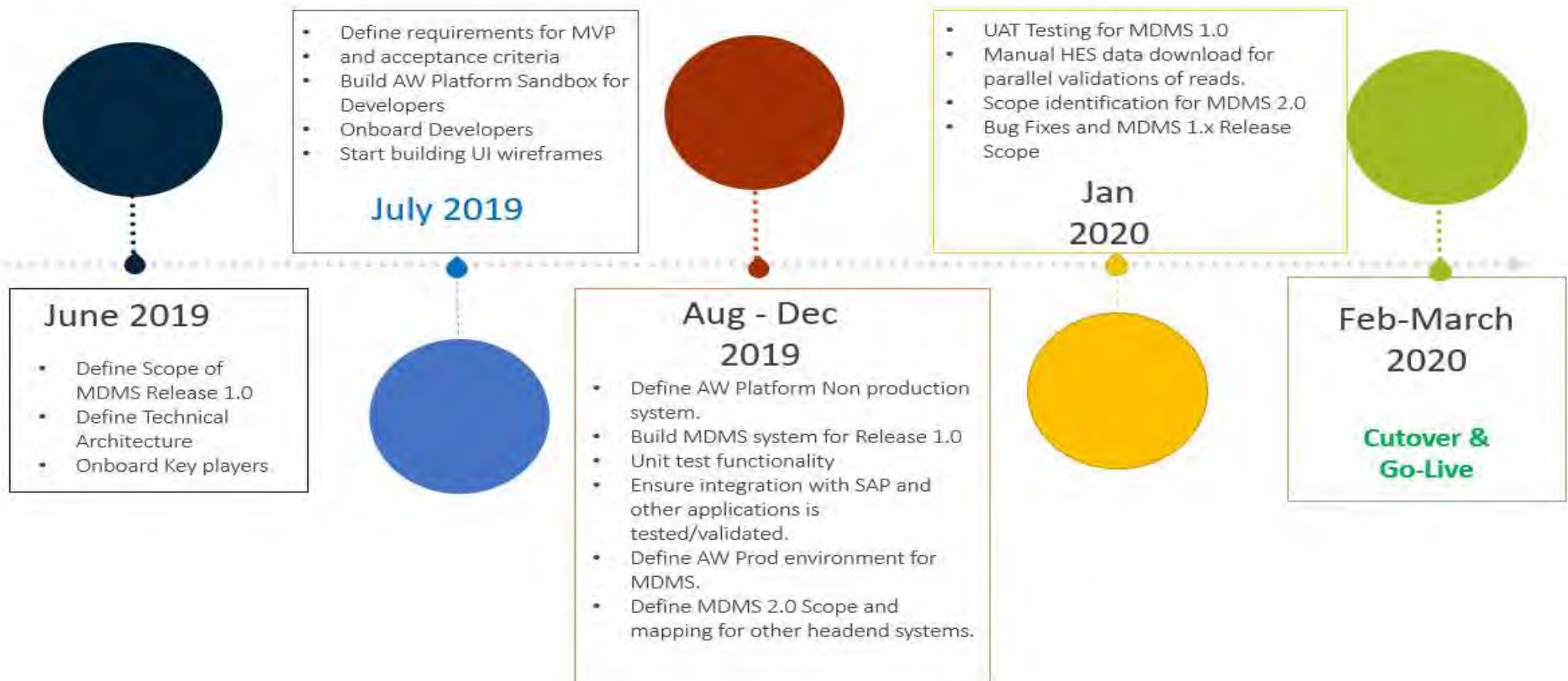

AMI Strategy Recommendations

WE KEEP LIFE FLOWING™



AMERICAN WATER

Forward Looking AMI Strategy:







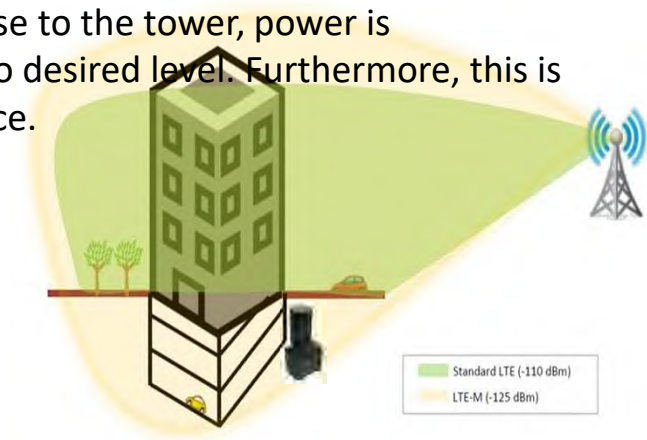











- **No building out of infrastructure for AMI. We understand the many complexities and you may need to put up infrastructure to leverage your current investment, so you may have a Hybrid AMI solution. As you work to define your states AMI strategy, we are asking that you try to move to a cellular LTE-M AMI solution when and wherever possible, that requires no infrastructure to install or maintain.**
 - **LTE-M was selected as the communication solution for AMI.**
 - **2 - Cellular Meter Vendors selected, Badger & Neptune with long term agreements,10,15 & 20 years.**
 - **Meter and Endpoint (MIU) selection must be certified for full extended alert/alarm functionality.**
 - **Purchase meter and connectivity as a package (complete AMI solution). No need to build out a communications network.**
 - **Timing of migrating should be based on your LOS and regulatory requirements.**
 - **Meters can be purchased with 5,10,15 and 20 years of connectivity.**
- 

Why Cellular LTE-M: (Benefits)

- LTE-M endpoint has an extended coverage that is optimized for basements and pit set applications.
- Lower power draw.
- Stronger signal power.
- Guaranteed operations for 20 years.
- Security and resiliency built in and maintained by vendor.
- Cellular networks are constantly updated to keep up with the latest technologies and provide greater coverage, reliability and security.
- The LTE-M endpoint works like a cell phone in that, the endpoint will vary its power output depending on how much power is needed to reach a cell tower. For example, if the endpoint is close to the tower, power is decreased. If the endpoint is farther away from cell tower, power is increased to desired level. Furthermore, this is all done automatically by the endpoint and does not require any human interface.
- Signal penetration comparison LTE-M endpoint versus LTE 4/5G version;



Note: Model based on dBm estimates

Cellular LTE-M vs Fixed Network (Licensed/Unlicensed MHz Spectrum)	Cellular	Fixed
No build-out infrastructure and network requirements. Utility does not need to purchase, build and maintain an infrastructure of collectors, repeaters and structures.		
Ability to leverage robust security programs and ongoing security assessments.		
Access to the same disaster recovery systems used by emergency services for faster up time during a disasters.		
Protected from any liabilities related to the physical structure caused by storms, security patches, equipment failures, etc.		
Limited ongoing maintenance related to security reviews, hardware refreshes and changes in technology.		
Lower initial capital outlay, as well as lower annual operational expenses. Allows for rapid deployment and decreases ongoing maintenance.		
Ability to leverage an existing communications network that constantly evolves its technology without increased capital costs.		
No intervention required by FSR, endpoint automatically registers when its turned on.		
Was designed for sensors, requiring less power and longer battery life. Built for supporting IoT (Internet of Things)		

Current AMI Recommendations:

- Best Practice is to pair the same vendor meter to the same vendor endpoint. This will ensure you get all the extended protocols from the meter.
- Best Practice, MIU endpoints should be installed outside the premise, if not must be installed as high in the rafters or near a window to ensure adequate connectivity.
- Best Practice, Composite lids should be used for pit installations, if not it's recommended to run endpoint into a composite housing next to pit.
- If you already have an AMI fixed network, you may want to leverage your existing investment or move to cellular depending on your regulatory/rate and commission approvals. Do not increase your Fixed Network footprint or life cycle replacement of equipment if all possible.
- Existing fixed networks must be maintained for security updates.
- Look over your LOS life cycle in your system to determine when is the right time to move to a cellular AMI solution. Timing of migrating should be based on your LOS and regulatory requirements
- Always first check if you need to seek and gain regulatory and commission AMI technology approval from your state.
- Remember to engage your Corporate Meter Operations Team to discuss moving to and selecting the right AMI technology.
- AMI helpful information can be found on the Meter Operations Portal, example; AMI Readiness & Pilot Checklist:
<https://amwater.sharepoint.com/sites/meterops/Shared%20Documents/Forms/AllItems.aspx?id=%2Fsites%2Fmeterops%2FShared%20Documents%2FAMI%2FAMI%20Readiness%20Check%20List%202019%5FV4%2Epdf&parent=%2Fsites%2Fmeterops%2FShared%20Documents%2FAMI>
- <https://amwater.sharepoint.com/sites/meterops/Shared%20Documents/Forms/AllItems.aspx?id=%2Fsites%2Fmeterops%2FShared%20Documents%2FMetering%20Pilots%2FMetering%20Pilot%20Check%20List%202019%5FV3%2Epdf&parent=%2Fsites%2Fmeterops%2FShared%20Documents%2FMetering%20Pilots>
- SharePoint Portal; <https://amwater.sharepoint.com/sites/meterops>
- METEROPS App; <https://meterops.amwater.com/#/>

Supporting AMI Next Steps

WE KEEP LIFE FLOWING™



AMI Support: Program Management

Develop a comprehensive framework of methods, processes, tools, and responsibilities to establish and deploy an effective Advanced Metering Infrastructure (AMI) PMO function supporting the state AMI projects.

- Establish guidelines, roles and responsibilities, and governance.
 - Define and manage processes, standards, and tools to manage scope, schedule, costs, issues and risks including change control and release management.
 - Coordinate communications, activities and dependencies across program internal and external stakeholders.
 - Support in managing overall business case and benefits realization as appropriate.
 - Manage quality assurance and adherence to standards.
 - Vendor Management and Sourcing.
- 

AMI Support: Business Integration

Develop and update the future-state AMI business processes and requirements which define the interactions between the enterprise solutions and the AMI solution.

- Prepare workshop schedule including the identification of Subject Matter Advisor (SMA) participation for each workshop.
 - Prepare workshop materials that illustrate standard AMI business process practices to be customized.
 - Conduct small group working sessions (e.g. SMA interviews) to prepare business process drafts for design workshops.
 - Develop level 2 and level 3 business processes through design workshops with (business and technical stakeholders & SMAs) and AMI vendor.
 - Develop business, functional, and technical requirements for future state processes that will capture dependencies on/for other areas of AMI functionality and support the business processes (to be stored in Requirements Traceability Matrix).
 - Document assumptions, risks, issues, and decisions.
- 

AMI Support: Change Management

Identify stakeholders and determine how they are impacted by AMI.

- Identify key internal and external stakeholders.
 - Capture how identified changes will impact the organization (people, process, and technology) and tie to key stakeholder groups.
 - Identify change management needed for aforementioned stakeholders.
 - Determine communication needs by stakeholder group including key points, timing, reviewers/approvers, and delivery method.
 - Build a high-level plan that details the specific activities and events for engaging stakeholders and preparing them for change.
 - Develop training plans outlining training needs by stakeholder.
 - Develop training curriculum and training material for the global design.
- 

Questions – Are You Ready For AMI?



Appendix



Work Breakdown Structure, AMR vs AMI

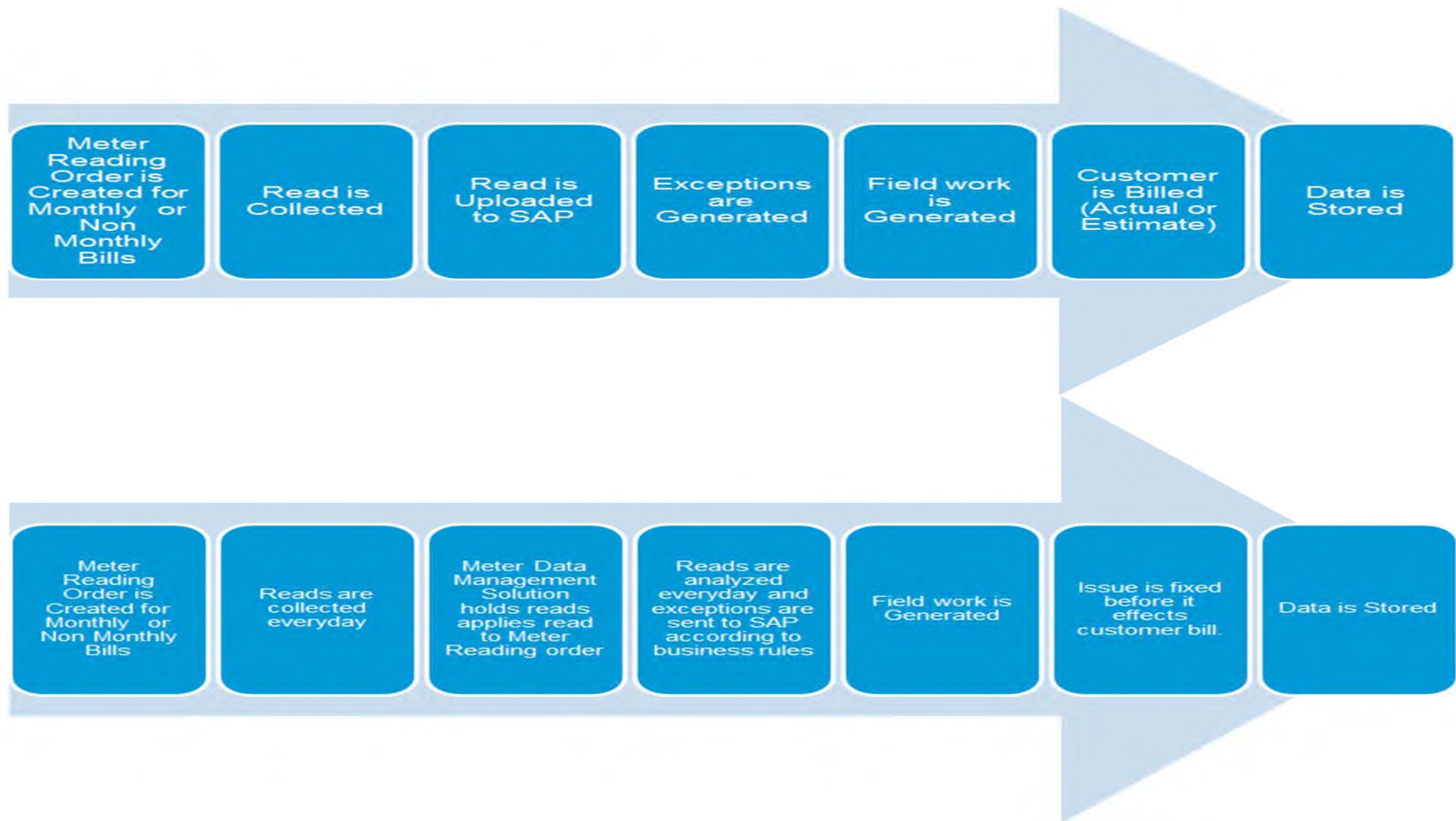

Badger LTE-M Endpoint Features

- Activates on consumption
- Reads meter every 15 minutes
- 96 reads / day
- Transmits 4 times/day
- D-cell lithium ion battery



- **How does the Endpoint get Activated?**
 - Self activation with consumer water use
 - Run 1 to 10 gallons thru the meter. (dependent on meter size)
 - Force start using the Trimble (Orion Endpoint Utility)
 - Force start using the LTE Activation Tool
 - Force start using Orion Endpoint Utility
- **When will the Meter readings start to display in Beacon?**
 - "Rule of thumb" is 72 hours Once Activated

Metal Lids

- Signal Reflection/Reduction
- Significant amount of radiated power is reflected back into the pit
- For network applications, endpoints need to be mounted through / under non-metal lids for optimal performance
- Even “through the lid” in Metal lid installations have significant interaction of the metal lid and the antenna, reducing radiated power
- Signal Reduction Metal Lid (Cone Affect)

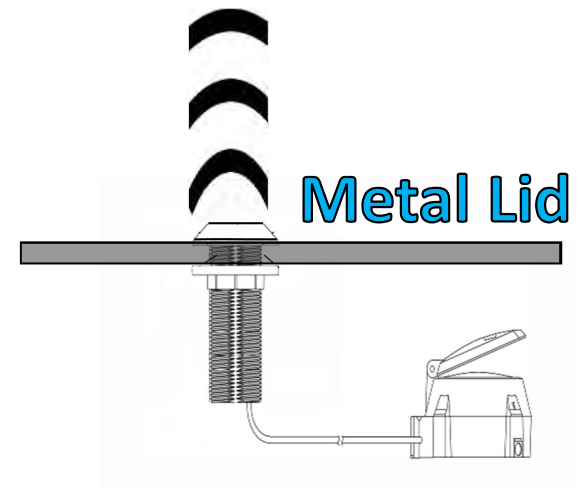
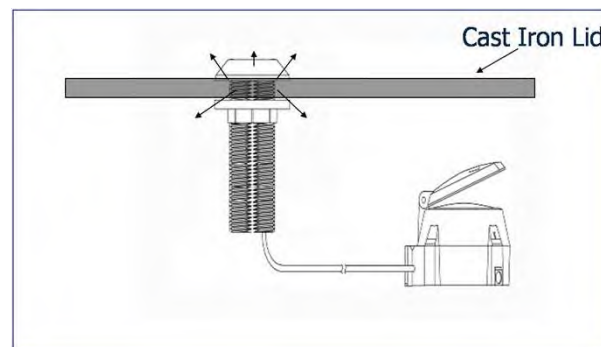
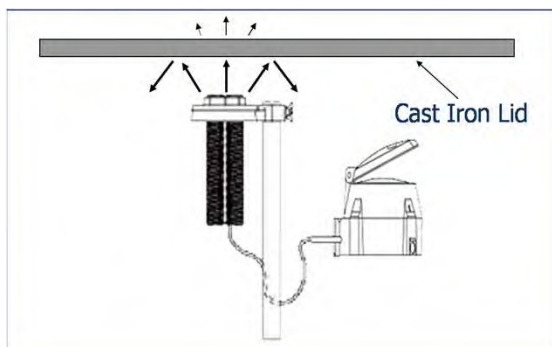

Composite Lids

- No signal Reflection/Reduction
- Through the lid / Insert in lid in Composite Lid installations have minimal effect on radiated power
- Signal Coverage is good with Composite Lids

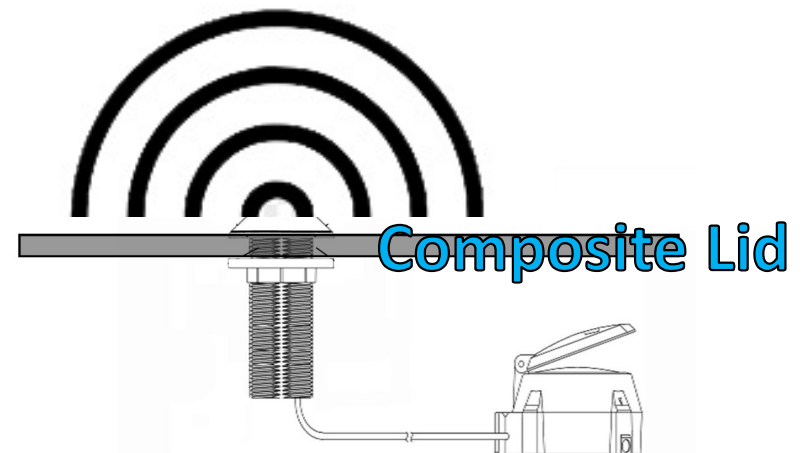
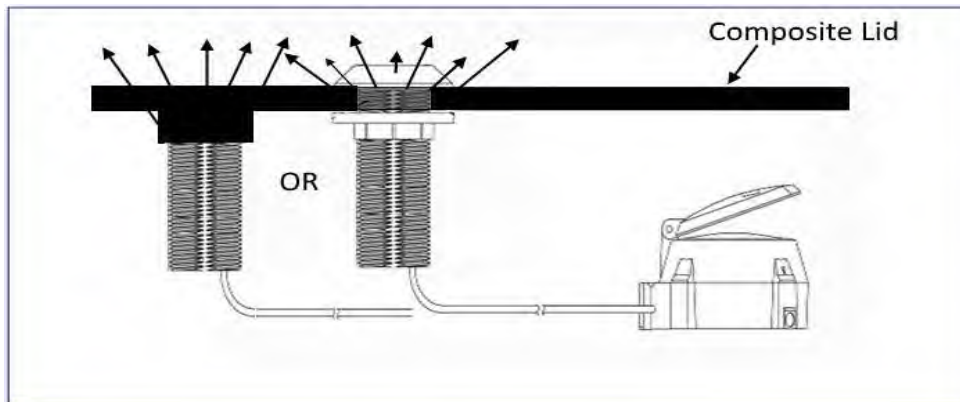

Proper Cellular Installation Methods

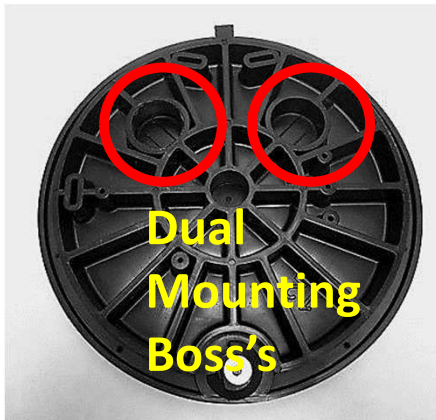

Ensure that the Pit Rings are securely fastened

Please ensure tie wraps have been removed or lengthened from the transmitter wiring.

What's Wrong Here.....

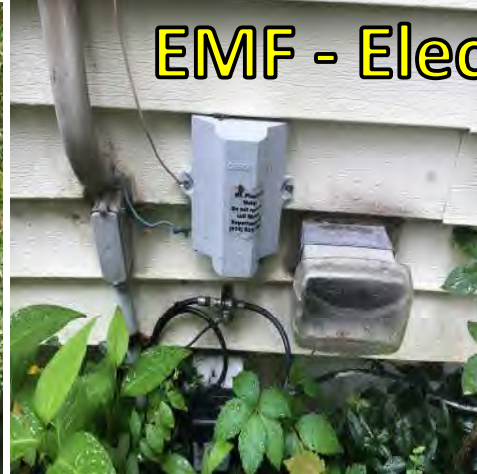

Vault Installation Methods



Installation Instructions AMR ANTENNA COVER ASSEMBLY Model: AC-01 **OPARK**

Component list:

- 2x Screws M6 30mm
- 2x Screws M4 15mm
- 1x Universal Bracket
- 1x AMR Antenna Cover
- 1x Gasket

Installation

Step 1. Fit the gasket into the grooves to ensure the gasket is properly seated on the gasket on the ANTENNA COVER assembly. The gasket should be seated in the grooves.

Step 2. Carefully place the UNIVERSAL BRACKET over the ANTENNA COVER. The UNIVERSAL BRACKET should be seated on the ANTENNA COVER. The UNIVERSAL BRACKET should be seated on the ANTENNA COVER. The UNIVERSAL BRACKET should be seated on the ANTENNA COVER.

Step 3. Carefully secure the UNIVERSAL BRACKET to the ANTENNA COVER using the provided Screws. The UNIVERSAL BRACKET should be seated on the ANTENNA COVER. The UNIVERSAL BRACKET should be seated on the ANTENNA COVER. The UNIVERSAL BRACKET should be seated on the ANTENNA COVER.

Park AC-01 Composite Vault Insert

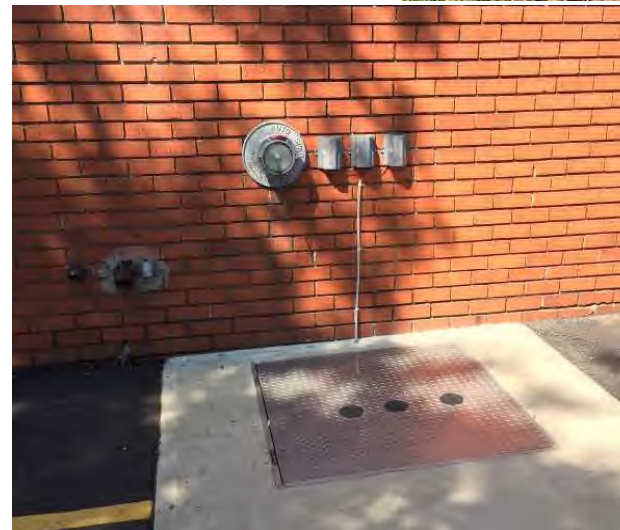

Attachment of Transmitter to Encoder/Register

- Nicor Connector
 - Ensure that alignment arrows are pointing at each other.
 - If they are not lined up properly the transmitter will not be able to communicate with the encoder/register
 - Potential damage to the connector pins of the meter and/or endpoint will occur rendering the meter/endpoint inoperable.
- Twist Tight Connector
 - Simply twist the connectors together until they stop and you can no longer see the pink Oring



Nicor caps removed, ends connected

Figure 8: Nicor in-line connector



Twist Tight, caps removed, ends connected

Figure 4: Twist Tight in-line connector

Installation Review

- Typical Drive By only required the endpoint to communicate up to 75 yards
- Cellular requires the endpoint to transmit up to 5 miles
- Cellular CDMA / LTE: Less forgiving when it comes to installation



Metal Lids

- Verify Pit Rings are tight
- Remove or lengthen tie wraps from cables to prevent snags
- Nicor Connectors? Verify Arrows are aligned BEFORE pushing together.
- Twist Tight Connectors? Tighten completely.
- Activating the Endpoint?

Run 5 gallons of water thru the meter

OR

Use a Trimble, LTE Activation Tool or Orion Endpoint Utility