

# **OFFICIAL CONTRACT DOCUMENTS**

**CONTRACT DOCUMENTS and SPECIFICATIONS**

**EAST-WEST INTERCONNECT PROJECT – PHASE 2**

**Contract No. 6**

## **WATER DISTRIBUTION SYSTEM IMPROVEMENTS PROJECT GRAYSON COUNTY WATER DISTRICT**

**Leitchfield, Grayson County, Kentucky**

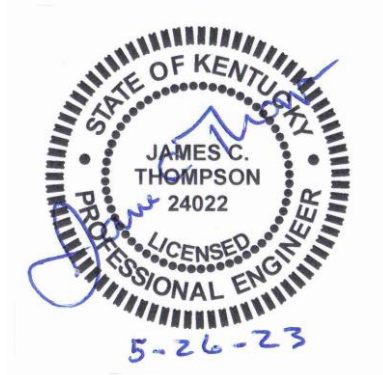

**Kentucky Engineering Group, PLLC**

**P.O. Box 1034**

**Versailles, Kentucky 40383**

**December, 2022**

**KEG Project No. 20016**

**TABLE OF CONTENTS**  
**CONTRACT No. 6 – WATER DISTRIBUTION SYSTEM IMPROVEMENTS PROJECT**  
**Grayson County Water District**

TOC-1

---

**ADVERTISEMENT FOR BIDS**

SECTION 00010 – ADVERTISEMENT FOR BIDS..... 1-2  
SECTION 00100 – INSTRUCTIONS TO BIDDERS ..... 1-11

**BID FORMS**

SECTION 00410 – BID FORM ..... 1-7  
SECTION 00420 – QUALIFICATIONS STATEMENT ..... 1-12  
SECTION 00430 – BID BOND ..... 1-2  
SECTION 00440 – RD COMPLIANCE STATEMENT ..... 1-2  
SECTION 00450 – RD CERTIFICATION FOR CONTRACTS, GRANTS AND LOANS..... 1  
SECTION 00460 – RD CERTIFICATION REGARDING DEBARMENT ..... 1-2

**AGREEMENT FORMS**

SECTION 00510 – NOTICE OF AWARD ..... 1  
SECTION 00521 – AGREEMENT FORMS..... 1-6  
SECTION 00550 – NOTICE TO PROCEED ..... 1

**BONDS & CERTIFICATIONS**

SECTION 00600 – INSURANCE CERTIFICATES..... 1  
SECTION 00610 – PERFORMANCE BOND..... 1-3  
SECTION 00615 – PAYMENT BOND ..... 1-3  
SECTION 00620 – PARTIAL PAY ESTIMATE..... 1  
SECTION 00625 – CHANGE ORDER ..... 1  
SECTION 00635 – CERTIFICATE OF SUBSTANTIAL COMPLETION ..... 1  
SECTION 00640 – CERTIFICATE OF OWNER’S ATTORNEY & AGENCY CONCURRENCE..... 1  
SECTION 00645 – KENTUCKY BULLETIN 1780-2 AIS REQUIREMENTS ..... 1-31

**GENERAL AND SUPPLEMENTAL CONDITIONS**

SECTION 00710 – RD GENERAL CONDITIONS ..... 1-73  
SECTION 00810 – RD SUPPLEMENTAL GENERAL CONDITIONS..... 1-8  
SECTION 00811 – SRF SUPPLEMENTAL GENERAL CONDITIONS..... 1-8

**DIVISION 1 - GENERAL REQUIREMENTS**

SECTION 01010 - SUMMARY ..... 1-2  
SECTION 01015 - WORK SEQUENCE ..... 1  
SECTION 01016 - OCCUPANCY ..... 1  
SECTION 01025 - MEASUREMENT AND PAYMENT ..... 1-6  
SECTION 01030 – LABOR PROVISIONS ..... 1  
SECTION 01040 - COORDINATION ..... 1  
SECTION 01200 - SUBSTITUTIONS..... 1-5  
SECTION 01210 - ALLOWANCES ..... 1-14  
SECTION 01300 - SUBMITTALS..... 1-3  
SECTION 01380 – CONSTRUCTION PHOTOGRAPHY..... 1  
SECTION 01450 – QUALITY CONTROL..... 1  
SECTION 01500 - TEMPORARY FACILITIES AND CONTROLS..... 1-3  
SECTION 01550 - ACCESS ROADS AND PARKING AREAS ..... 1  
SECTION 01570 - TRAFFIC REGULATION ..... 1-2  
SECTION 01580 - PROJECT IDENTIFICATION AND SIGNS..... 1-3  
SECTION 01600 – MATERIALS AND EQUIPMENT ..... 1-2

**TABLE OF CONTENTS**  
**CONTRACT No. 6 – WATER DISTRIBUTION SYSTEM IMPROVEMENTS PROJECT**  
**Grayson County Water District**

	TOC-2
SECTION 01610 - TRANSPORTATION AND HANDLING.....	1
SECTION 01700 - PROJECT CLOSEOUT.....	1-3
SECTION 01710 - CLEANING .....	1-3
SECTION 01720 - PROJECT RECORD DOCUMENTS.....	1-2
SECTION 01730 - OPERATING AND MAINTENANCE DATA.....	1-3
SECTION 01740 - WARRANTIES AND BONDS .....	1-2
 <b>DIVISION 2 - SITE WORK</b>	
SECTION 02110 – SITE CLEARING.....	1-2
SECTION 02200 - EARTHWORK.....	1-13
SECTION 02211 – ROUGH GRADING.....	1-2
SECTION 02222 - EXCAVATION .....	1-2
SECTION 02226 – TRENCHING, BACKFILLING AND COMPACTING .....	1-3
SECTION 02228 – ROCK REMOVAL .....	1-3
SECTION 02255 – CRUSHED STONE AND DENSE GRADE AGGREGATE.....	1
SECTION 02270 – SLOPE PROTECTION AND EROSION CONTROL.....	1-2
(KPDES) Notice of Intent Form.....	1-2
(KPDES) Notice of Termination Form.....	1-2
SECTION 02302 – RAILROAD OR HIGHWAY CROSSING.....	1-4
SECTION 02500 – BITUMINOUS PAVEMENT.....	1-3
SECTION 02600 – PIPE, FITTINGS AND INSTALLATION .....	1-16
SECTION 02626 – CUSTOMER METER AND SERVICE TUBING.....	1-5
SECTION 02630 – TAPPED CONNECTIONS.....	1-3
SECTION 02640 – VALVES .....	1-6
SECTION 02645 – HYDRANT ASSEMBLY .....	1-2
SECTION 02700 - SITE RESTORATION .....	1
SECTION 02720 – VAULTS AND INLETS .....	1-3
SECTION 02900 – SEEDING AND SODDING.....	1-7
 <b>DIVISION 4 - MASONRY</b>	
SECTION 04200 – CONCRETE UNIT MASONRY .....	1-4
 <b>DIVISION 6 – WOODS AND PLASTICS</b>	
SECTION 06100 – ROUGH CARPENTRY.....	1-5
 <b>DIVISION 11 – EQUIPMENT</b>	
11917-HACH CL17 FREE/TOTAL CHLORINE ANALYZER.....	1-4
 <b>DIVISION 15 - MECHANICAL</b>	
SECTION 15243 – ABOVE GROUND MASTER METER STATION .....	1-7
 <b>DIVISION 16 - ELECTRICAL</b>	
SECTION 16925 – ELECTRICAL.....	1-11

# ADVERTISEMENT FOR BIDS



# INFORMATION FOR BIDDERS



# BID FORMS



## **SUPPLEMENTS TO BID FORMS**



# AGREEMENT FORMS





## **BONDS & CERTIFICATIONS**



**GENERAL CONDITIONS**



## SUPPLEMENTAL CONDITIONS



**DIVISION 1**

**GENERAL REQUIREMENTS**



**DIVISION 2**  
**SITE WORK**



**DIVISION 4**

**MASONRY**



**DIVISION 6**  
**WOODS AND PLASTICS**



**DIVISION 16**

**ELECTRICAL**





**SECTION 00100  
ADVERTISEMENT FOR BIDS**

**Grayson County Water District  
21 Shull White Road  
Leitchfield, Kentucky 42754**

Separate sealed Bids for the construction of the **East - West Interconnect Project - Phase 2 - Contract No. 6 - Water Distribution System Improvements Project** including approximately 480 LF of 18", 23,200 LF of 16", 260 LF of 14", 26,020 LF of 12", 320 LF of 10" and 6,155 LF of 8" water main, one new master meter and all related appurtenances as shown on the DRAWINGS and described in the SPECIFICATIONS will be received by Grayson County Water District at the office of Grayson County Water District at 21 Shull White Road, Leitchfield, Kentucky 42754 until **11:00 a.m., (Local Time) Thursday, January 19, 2023**, and then at said office publicly opened and read aloud.

Bids will be received for a single prime Contract. Bids shall be on a unit price basis as indicated in the Bid Form.

The Contract Documents may be examined at the following locations:

**KENTUCKY ENGINEERING GROUP, PLLC.**, 101 High Street, Versailles, Kentucky 40383  
Phone: 859.251.4127

**GRAYSON COUNTY WATER DISTRICT**, 21 Shull White Road, Leitchfield, Kentucky 42754  
Phone: 270.259.2917

Issuing office for the Bidding Documents is: LYNN IMAGING -328 Old Vine Street, Lexington, KY 40507, Phone: 859-255-1021, Website: [www.lynnimaging.com](http://www.lynnimaging.com). Printed copies of the Contract Documents may be obtained upon receipt of a non-refundable amount of \$850.00 for each complete set of documents. Included with the printed copy contract documents is an electronic download (as portable document format PDF).

All bids must be made on required Bid Form and must be fully completed and executed with original signatures and corporate seals. All bidders must be listed as plan holder by the plan distributor.

The Contract Time allotted for the substantial completion of this Contract is (425) consecutive calendar days with final completion within (455) consecutive calendar days.

The contract is being funded by a Kentucky Infrastructure Authority, SRF loan and USDA Rural Development.

Bidders must comply with President's Executive Orders No. 11246 and No. 11375 and any amendments or supplements to those Executive Orders. Attention of bidders is particularly called to the requirements as to conditions of employment to be observed under the contract, Section 3, Segregated Facility, Section 109 and E.O. 11246.

Bidders must certify they do not and will not maintain or provide for their employees any facilities that are segregated or based on race, color, creed or national origin. Bidders must comply with 41 CFR 60-4 in regard to affirmative action and to insure equal opportunity to females and minorities,

and all that are applicable. Minorities and small businesses are encouraged to submit bids on this project.

Bidders must comply with Title VI of the Civil Rights Act of 1964 Anti-Kickback Act, and the Contract Work Hours Standard Act and with OSHA (P.L. 91-596) and the Contract Work Hours and Safety Standards Act (P.L. 91-54).

The procurement and performance of this contract are subject to the requirements of the DOW Procurement Guidance including the Davis-Bacon Act.

Successful Bidder shall make positive efforts to use small, minority, women owned and disadvantaged businesses.

The award of the contract will be made to the lowest, responsive and responsible bidder.

Section 746 of Title VII of the Consolidated Appropriations Act of 2017 (Division A-Agriculture, Rural Development, Food and Drug Administration, and Related Agencies, Appropriations Act, 2017) and subsequent statutes mandating domestic preference applies to American Iron and Steel requirement to this project. All listed iron and steel products used in this project must be produced in the United States. The term "iron and steel products" means the following products made primarily of iron and steel: lines or unlined pipes and fittings, manhole covers and other municipal castings, hydrants, tanks, flanges, pipe clamps and restraints, valves, structural steel, reinforced precast concrete, and construction materials. The de minimis and minor components waiver {all project specific waivers as applicable} apply to this contract.

The Grayson County Water District, reserves the right to waive any bidding informalities and to reject any or all bids, for any reason. The right is reserved by the Owner, in the exercise of its sole judgment to reject any or all Bids, and to re-advertise and award the Contract in the regular manner or to waive any informalities, irregularities, mistakes, errors, or omissions in any Bid received and to accept any Bid deemed to be responsive to this invitation and favorable to interests of the Owner.

The sealed bid for this project shall be clearly marked on the outside of the envelope: "**Sealed Bid for East - West Interconnect Project - Phase 2 - Contract No. 6 - Water Distribution System Improvements Project**" for the Grayson County Water District, Kentucky. The bid may be mailed to: Grayson County Water District, 21 Shull White Road, Leitchfield, Kentucky 42754. A certified check or Bid Bond payable to the Grayson County Water District in the amount of five (5) percent of the Bid shall accompany the Bid.

Nancy Cain, Chairperson

Date:

Grayson County Water District

## INSTRUCTIONS TO BIDDERS

### TABLE OF CONTENTS

	<b>Page</b>
ARTICLE 1 – Defined Terms.....	2
ARTICLE 2 – Copies of Bidding Documents.....	2
ARTICLE 3 – Qualifications of Bidders.....	2
ARTICLE 4 – Site and Other Areas; Existing Site Conditions; Examination of Site; Owner’s Safety Program; Other Work at the Site.....	2
ARTICLE 5 – Bidder’s Representations .....	4
ARTICLE 6 – Pre-Bid Conference .....	5
ARTICLE 7 – Interpretations and Addenda .....	5
ARTICLE 8 – Bid Security .....	5
ARTICLE 9 – Contract Times.....	6
ARTICLE 10 – Liquidated Damages .....	6
ARTICLE 11 – Substitute and “Or-Equal” Items.....	6
ARTICLE 12 – Subcontractors, Suppliers, and Others.....	7
ARTICLE 13 – Preparation of Bid.....	7
ARTICLE 14 – Basis of Bid.....	8
ARTICLE 15 – Submittal of Bid .....	9
ARTICLE 16 – Modification and Withdrawal of Bid.....	9
ARTICLE 17 – Opening of Bids.....	9
ARTICLE 18 – Bids to Remain Subject to Acceptance .....	9
ARTICLE 19 – Evaluation of Bids and Award of Contract.....	10
ARTICLE 20 – Bonds and Insurance .....	10
ARTICLE 21 – Signing of Agreement .....	10
ARTICLE 22 – NOT USED.....	11
ARTICLE 23 – NOT USED.....	11
ARTICLE 24 – Power Of Attorney .....	11
ARTICLE 25 – Laws And Regulations.....	11
ARTICLE 26 – Safety Standards And Accident Prevention.....	11
ARTICLE 27 – Wage Rate Requirments.....	11

**ARTICLE 1 – DEFINED TERMS**

- 1.01 Terms used in these Instructions to Bidders have the meanings indicated in the General Conditions and Supplementary Conditions. The term "Bidder" means one who submits a Bid directly to Owner, as distinct from a subbidder, who submits a bid to a Bidder. The term "Successful Bidder" means the lowest, qualified, responsible, and responsive Bidder to whom Owner (on the basis of Owner's evaluation as hereinafter provided) makes an award. The term "Bidding Documents" includes the Advertisement or Invitation to Bid, Instructions to Bidders, the Bid Form, and the proposed Contract Documents (including all Addenda issued prior to receipt of Bids).

**ARTICLE 2 – COPIES OF BIDDING DOCUMENTS**

- 2.01 Complete sets of the Bidding Documents must be obtained from the Issuing Office in the number and format stated in the advertisement or invitation to bid. Bids from anyone not on the Engineer's Plan Holders List will not be opened.
- 2.02 Complete sets of Bidding Documents shall be used in preparing Bids; neither Owner nor Engineer assumes any responsibility for errors or misinterpretations resulting from the use of incomplete sets of Bidding Documents.
- 2.03 Owner and Engineer, in making copies of Bidding Documents available on the above terms, do so only for the purpose of obtaining Bids for the Work and do not authorize or confer a license for any other use.

**ARTICLE 3 – QUALIFICATIONS OF BIDDERS**

- 3.01 To demonstrate Bidder's qualifications to perform the Work, Bidder shall submit with its Bid written evidence establishing its qualifications such as financial data, previous experience, and present commitments, and the additional information listed in the Bid Form.
- 3.02 A Bidder's failure to submit required qualification information within the times indicated may disqualify Bidder from receiving an award of the Contract.
- 3.03 No requirement in this Article 3 to submit information will prejudice the right of Owner to seek additional pertinent information regarding Bidder's qualifications.
- 3.04 Bidder is advised to carefully review those portions of the Bid Form requiring Bidder's representations and certifications.

**ARTICLE 4 – SITE AND OTHER AREAS; EXISTING SITE CONDITIONS; EXAMINATION OF SITE; OWNER'S SAFETY PROGRAM; OTHER WORK AT THE SITE**

- 4.01 *Site and Other Areas*
- A. The Site is identified in the Bidding Documents. By definition, the Site includes rights-of-way, easements, and other lands furnished by Owner for the use of the Contractor. Any additional lands required for temporary construction facilities, construction equipment, or storage of materials and equipment, and any access needed for such additional lands, are to be obtained and paid for by Contractor.

#### 4.02 *Existing Site Conditions*

##### A. Subsurface and Physical Conditions; Hazardous Environmental Conditions

1. If there are reports and/or additional information concerning site conditions available, they will be included as Appendices to the Bidding Documents.
2. Geotechnical Report: If a Geotechnical Report is available, it will be included as an appendix to the Bidding Documents. The Geotechnical Report describes certain select subsurface conditions that are anticipated to be encountered by Contractor during construction in specified locations.

The Conditions in the Geotechnical Report are intended to reduce uncertainty and the degree of contingency in submitted Bids. However, Bidders cannot rely solely on the said Conditions. Bids should be based on a comprehensive approach that includes an independent review and analysis of the Report, all other Contract Documents, Technical Data, other available information, and observable surface conditions. Not all potential subsurface conditions are reported.

Nothing in the report is intended to relieve Bidders of the responsibility to make their own determinations regarding construction costs, bidding strategies, and Bid prices, nor of the responsibility to select and be responsible for the means, methods, techniques, sequences, and procedures of construction, and for safety precautions and programs incident thereto.

- B. Underground Facilities: Information and data shown or indicated in the Bidding Documents with respect to existing Underground Facilities at or contiguous to the Site are set forth in the Contract Documents and are based upon information and data furnished to Owner and Engineer by owners of such Underground Facilities, including Owner, or others.
- C. Adequacy of Data: Provisions concerning responsibilities for the adequacy of data furnished to prospective Bidders with respect to subsurface conditions, other physical conditions, and Underground Facilities, and possible changes in the Bidding Documents due to differing or unanticipated subsurface or physical conditions appear in Paragraphs 5.03, 5.04, and 5.05 of the General Conditions. Provisions concerning responsibilities for the adequacy of data furnished to prospective Bidders with respect to a Hazardous Environmental Condition at the Site, if any, and possible changes in the Contract Documents due to any Hazardous Environmental Condition uncovered or revealed at the Site which was not shown or indicated in the Drawings or Specifications or identified in the Contract Documents to be within the scope of the Work, appear in Paragraph 5.06 of the General Conditions.

#### 4.03 *Site Visit and Testing by Bidders*

- A. Bidder shall conduct the required Site visit during normal working hours, and shall not disturb any ongoing operations at the Site.
- B. Bidder is not required to conduct any subsurface testing, or exhaustive investigations of Site conditions.
- C. On request, and to the extent Owner has control over the Site, and schedule permitting, the Owner will provide Bidder access to the Site to conduct such additional examinations, investigations, explorations, tests, and studies as Bidder deems necessary for preparing and submitting a successful Bid. Owner will not have any obligation to grant such access if doing

so is not practical because of existing operations, security or safety concerns, or restraints on Owner's authority regarding the Site.

- D. Bidder shall comply with all applicable Laws and Regulations regarding excavation and location of utilities, obtain all permits, and comply with all terms and conditions established by Owner or by property owners or other entities controlling the Site with respect to schedule, access, existing operations, security, liability insurance, and applicable safety programs.
- E. Bidder shall fill all holes and clean up and restore the Site to its former condition upon completion of such explorations, investigations, tests, and studies.

#### 4.04 *Owner's Safety Program*

- A. Site visits and work at the Site may be governed by an Owner safety program. As the General Conditions indicate, if an Owner safety program exists, it will be noted in the Supplementary Conditions.

#### 4.05 *Other Work at the Site*

- A. Reference is made to Article 8 of the Supplementary Conditions for the identification of the general nature of other work of which Owner is aware (if any) that is to be performed at the Site by Owner or others (such as utilities and other prime contractors) and relates to the Work contemplated by these Bidding Documents. If Owner is party to a written contract for such other work, then on request, Owner will provide to each Bidder access to examine such contracts (other than portions thereof related to price and other confidential matters), if any.

### **ARTICLE 5 – BIDDER'S REPRESENTATIONS**

5.01 It is the responsibility of each Bidder before submitting a Bid to:

- A. examine and carefully study the Bidding Documents, and any data and reference items identified in the Bidding Documents;
- B. visit the Site, conduct a thorough, alert visual examination of the Site and adjacent areas, and become familiar with and satisfy itself as to the general, local, and Site conditions that may affect cost, progress, and performance of the Work;
- C. become familiar with and satisfy itself as to all Laws and Regulations that may affect cost, progress, and performance of the Work;
- D. carefully study all: (1) reports of explorations and tests of subsurface conditions at or adjacent to the Site and all drawings of physical conditions relating to existing surface or subsurface structures at the Site that have been identified in the Bidding Documents, especially with respect to Technical Data in such reports and drawings, and (2) reports and drawings relating to Hazardous Environmental Conditions, if any, at or adjacent to the Site that have been identified in the Bidding Documents, especially with respect to Technical Data in such reports and drawings;
- E. consider the information known to Bidder itself; information commonly known to contractors doing business in the locality of the Site; information and observations obtained from visits to the Site; the Bidding Documents; and the Site-related reports and drawings identified in the Bidding Documents, with respect to the effect of such

information, observations, and documents on (1) the cost, progress, and performance of the Work; (2) the means, methods, techniques, sequences, and procedures of construction to be employed by Bidder; and (3) Bidder's safety precautions and programs;

- F. agree, based on the information and observations referred to in the preceding paragraph, that at the time of submitting its Bid no further examinations, investigations, explorations, tests, studies, or data are necessary for the determination of its Bid for performance of the Work at the price bid and within the times required, and in accordance with the other terms and conditions of the Bidding Documents;
- G. become aware of the general nature of the work to be performed by Owner and others at the Site that relates to the Work as indicated in the Bidding Documents;
- H. promptly give Engineer written notice of all conflicts, errors, ambiguities, or discrepancies that Bidder discovers in the Bidding Documents and confirm that the written resolution thereof by Engineer is acceptable to Bidder;
- I. determine that the Bidding Documents are generally sufficient to indicate and convey understanding of all terms and conditions for the performance and furnishing of the Work; and
- J. agree that the submission of a Bid will constitute an incontrovertible representation by Bidder that Bidder has complied with every requirement of this Article, that without exception the Bid and all prices in the Bid are premised upon performing and furnishing the Work required by the Bidding Documents.

#### **ARTICLE 6 – PRE-BID CONFERENCE**

6.01 No pre-bid conference is scheduled for this project.

#### **ARTICLE 7 – INTERPRETATIONS AND ADDENDA**

7.01 All questions about the meaning or intent of the Bidding Documents are to be submitted to Engineer in writing via email to [rtaylor@kyengr.com](mailto:rtaylor@kyengr.com). Interpretations or clarifications considered necessary by Engineer in response to such questions will be issued by Addenda delivered to all parties recorded as having received the Bidding Documents. Questions received less than seven days prior to the date for opening of Bids may not be answered. Only questions answered by Addenda will be binding. Oral and other interpretations or clarifications will be without legal effect.

7.02 Addenda may be issued to clarify, correct, supplement, or change the Bidding Documents.

#### **ARTICLE 8 – BID SECURITY**

8.01 A Bid must be accompanied by Bid security made payable to Owner in an amount of five (5) percent of Bidder's maximum Bid price (determined by adding the base bid and all alternates) and in the form of a certified check, bank money order, or a Bid bond (on the form included in the Bidding Documents) issued by a surety meeting the requirements of Paragraphs 6.01 and 6.02 of the General Conditions.

8.02 The Bid security of the apparent Successful Bidder will be retained until Owner awards the contract to such Bidder, and such Bidder has executed the Contract Documents, furnished the

required contract security, and met the other conditions of the Notice of Award, whereupon the Bid security will be released. If the Successful Bidder fails to execute and deliver the Contract Documents and furnish the required contract security within 15 days after the Notice of Award, Owner may consider Bidder to be in default, annul the Notice of Award, and the Bid security of that Bidder will be forfeited. Such forfeiture shall be Owner's exclusive remedy if Bidder defaults.

- 8.03 The Bid security of other Bidders that Owner believes to have a reasonable chance of receiving the award may be retained by Owner until the earlier of seven days after the Effective Date of the Contract or 91 days after the Bid opening, whereupon Bid security furnished by such Bidders will be released.
- 8.04 Bid security of other Bidders that Owner believes do not have a reasonable chance of receiving the award will be released within seven days after the Bid opening.

#### **ARTICLE 9 – CONTRACT TIMES**

- 9.01 The number of days within which, or the dates by which, the Work is to be substantially completed and ready for final payment are set forth in the Agreement.

#### **ARTICLE 10 – LIQUIDATED DAMAGES**

- 10.01 Provisions for liquidated damages, if any, for failure to timely attain Substantial Completion, or completion of the Work in readiness for final payment, are set forth in the Supplemental General Conditions and referred to in the Agreement.

#### **ARTICLE 11 – SUBSTITUTE AND “OR-EQUAL” ITEMS**

- 11.01 The Contract for the Work, if awarded, will be on the basis of materials and equipment specified or described in the Bidding Documents, and those “or-equal” or substitute or materials and equipment subsequently approved by Engineer prior to the submittal of Bids and identified by Addendum. No item of material or equipment will be considered by Engineer as an “or-equal” or substitute unless written request for approval has been submitted by Bidder and has been received by Engineer at least 15 days prior to the date for receipt of Bids in the case of a proposed substitute and 5 days prior in the case of a proposed “or-equal”. Each such request shall comply with the requirements of Paragraphs 7.04 and 7.05 of the General Conditions. The burden of proof of the merit of the proposed item is upon Bidder. Engineer's decision of approval or disapproval of a proposed item will be final. If Engineer approves any such proposed item, such approval will be set forth in an Addendum issued to all prospective Bidders. Bidders shall not rely upon approvals made in any other manner. Substitutes and “or-equal” materials and equipment may be proposed by Contractor in accordance with Paragraphs 7.04 and 7.05 of the General conditions after the Effective Date of the contract.
- 11.02 All prices that Bidder sets forth in its Bid shall be based on the presumption that the Contractor will furnish the materials and equipment specified or described in the Bidding Documents, as supplemented by Addenda. Any assumptions regarding the possibility of post-Bid approvals of “or-equal” or substitution requests are made at Bidder's sole risk.
- 11.03 If an award is made, Contractor shall be allowed to submit proposed substitutes and “or-equals” in accordance with the General Conditions.



## ARTICLE 12 – SUBCONTRACTORS, SUPPLIERS, AND OTHERS

- 12.01 If required by the bid documents, the Bidder shall submit to Owner a list of the Subcontractors or Suppliers proposed for the major portions of the Work. If requested by Owner, such list shall be accompanied by an experience statement with pertinent information regarding similar projects and other evidence of qualification for each such Subcontractor, Supplier, or other individual or entity. If Owner or Engineer, after due investigation, has reasonable objection to any proposed Subcontractor, Supplier, individual, or entity, Owner may, before the Notice of Award is given, request apparent Successful Bidder to submit an acceptable substitute.
- 12.02 If apparent Successful Bidder declines to make any such substitution, Owner may award the Contract to the next lowest Bidder that proposes to use acceptable Subcontractors, Suppliers, or other individuals or entities. Declining to make requested substitutions will constitute grounds for forfeiture of the Bid security of any Bidder. Any Subcontractor, Supplier, individual, or entity so listed and against which Owner or Engineer makes no written objection prior to the giving of the Notice of Award will be deemed acceptable to Owner and Engineer subject to subsequent revocation of such acceptance as provided in Paragraph 7.06 of the General Conditions.
- 12.03 Subsequent to the submittal of the Bid, Owner may not require the Successful Bidder or Contractor to retain any Subcontractor, Supplier, or other individual or entity against which Contractor has reasonable objection.
- 12.04 The Contractor shall not award work to Subcontractor(s) in excess of the limits stated in SGC 7.06.

## ARTICLE 13 – PREPARATION OF BID

- 13.01 The Bid Form is included with the Bidding Documents.
- A. All blanks on the Bid Form shall be completed in ink and the Bid Form signed in ink. Erasures or alterations shall be initialed in ink by the person signing the Bid Form. A Bid price shall be indicated for each section, Bid item, alternate, adjustment unit price item, and unit price item listed therein.
- B. If the Bid Form expressly indicates that submitting pricing on a specific alternate item is optional, and Bidder elects to not furnish pricing for such optional alternate item, then Bidder may enter the words “No Bid” or “Not Applicable.”
- 13.02 A Bid by a corporation shall be executed in the corporate name by a corporate officer (whose title must appear under the signature), accompanied by evidence of authority to sign. The corporate address and state of incorporation shall be shown.
- 13.03 A Bid by a limited liability company shall be executed in the name of the firm by a member or other authorized person and accompanied by evidence of authority to sign. The state of formation of the firm and the official address of the firm shall be shown.
- 13.04 A Bid by an individual shall show the Bidder’s name and official address.

- 13.05 A Bid by a joint venture shall be executed by an authorized representative of each joint venturer in the manner indicated on the Bid Form. The official address of the joint venture shall be shown.
- 13.06 All names shall be printed in ink below the signatures.
- 13.07 The Bid shall contain an acknowledgment of receipt of all Addenda, the numbers of which shall be filled in on the Bid Form.
- 13.08 Postal and e-mail addresses and telephone number for communications regarding the Bid shall be shown.
- 13.09 The Bid shall contain evidence of Bidder's authority and qualification to do business in the state where the Project is located, or Bidder shall covenant in writing to obtain such authority and qualification prior to award of the Contract and attach such covenant to the Bid. Bidder's state contractor license number, if any, shall also be shown on the Bid Form. 11.8. The Bid price shall include such amounts as the Bidder deems proper for overhead and profit on account of any cash allowances named in the Contract Documents as provided in Paragraph 11.02 of the General Conditions.
- The Bid price shall include such amounts as the Bidder deems proper for overhead and profit on account of any cash allowances named in the Contract Documents as provided in Paragraph 11.02 of the General Conditions.
- 13.10 Each Bid must be submitted on the prescribed form and accompanied by the submittals listed in the Bid Form.

#### **ARTICLE 14 – BASIS OF BID**

- 14.01 Unit Price
- A. Bidders shall submit a bid on a unit price basis for each item of work listed in the bid schedule.
  - B. The total of all estimated prices will be the sum of the products of the estimated quantity of each item and the corresponding unit price. The final quantities and contract price will be determined in accordance with paragraph 11.03 of the general conditions.
  - C. Discrepancies between the multiplication of units of work and unit prices will be resolved in favor of the unit prices. Discrepancies between the indicated sum of any column of figures and the correct sum thereof will be resolved in favor of the correct sum. Discrepancies between words and figures will be resolved in favor of the words.
- 14.02 The bid price shall include such amounts as the bidder deems proper for overhead and profit on account of cash allowances, if any, named in the contract documents as provided in paragraph 11.02 of the general conditions.
- 14.03 Bid prices will be compared after resolution of discrepancies, if any, as described above.

**ARTICLE 15 – SUBMITTAL OF BID**

- 15.01 With each copy of the Bidding Documents, a Bidder is furnished one separate unbound copy of the Bid Form, and, if required, the Bid Bond Form. The unbound copy of the Bid Form is to be completed and submitted with the Bid security and the other documents required to be submitted under the terms of Article 7 of the Bid Form.
- 15.02 A Bid shall be received no later than the date and time prescribed and at the place indicated in the advertisement or invitation to bid and shall be enclosed in a plainly marked package with the Project title (and, if applicable, the designated portion of the Project for which the Bid is submitted), the name and address of Bidder, and shall be accompanied by the Bid security and other required documents. If a Bid is sent by mail or other delivery system, the sealed envelope containing the Bid shall be enclosed in a separate package plainly marked on the outside with the notation "BID ENCLOSED."
- 15.03 Bids received after the date and time prescribed for the opening of bids, or not submitted at the correct location or in the designated manner, will not be accepted and will be returned to the Bidder unopened.

**ARTICLE 16 – MODIFICATION AND WITHDRAWAL OF BID**

- 16.01 A Bid may be withdrawn by an appropriate document duly executed in the same manner that a Bid must be executed and delivered to the place where Bids are to be submitted prior to the date and time for the opening of Bids. Upon receipt of such notice, the unopened Bid will be returned to the Bidder.
- 16.02 If a Bidder wishes to modify its Bid prior to Bid opening, Bidder must withdraw its initial Bid in the manner specified in Paragraph 16.01 and submit a new Bid prior to the date and time for the opening of Bids.
- 16.03 If within 24 hours after Bids are opened any Bidder files a duly signed written notice with Owner and promptly thereafter demonstrates to the reasonable satisfaction of Owner that there was a material and substantial mistake in the preparation of its Bid, that Bidder may withdraw its Bid, and the Bid security will be returned. Thereafter, if the Work is rebid, that Bidder will be disqualified from further bidding on the Work.

**ARTICLE 17 – OPENING OF BIDS**

- 17.01 Bids will be opened at the time and place indicated in the advertisement or invitation to bid and, unless obviously non-responsive, read aloud publicly. An abstract of the amounts of the base Bids and major alternates, if any, will be made available to Bidders after the opening of Bids.

**ARTICLE 18 – BIDS TO REMAIN SUBJECT TO ACCEPTANCE**

- 18.01 All Bids will remain subject to acceptance for the period of time stated in the Bid Form, but Owner may, in its sole discretion, release any Bid and return the Bid security prior to the end of this period.

**ARTICLE 19 – EVALUATION OF BIDS AND AWARD OF CONTRACT**

- 19.01 Owner reserves the right to reject any or all Bids, including without limitation, nonconforming, nonresponsive, unbalanced, or conditional Bids. Owner will reject the Bid of any Bidder that Owner finds, after reasonable inquiry and evaluation, to not be responsible. If Bidder purports to add terms or conditions to its Bid, takes exception to any provision of the Bidding Documents, or attempts to alter the contents of the Contract Documents for purposes of the Bid, then the Owner will reject the Bid as nonresponsive; provided that Owner also reserves the right to waive all minor informalities not involving price, time, or changes in the Work.
- 19.02 If Owner awards the contract for the Work, such award shall be to the responsible Bidder submitting the lowest responsive Bid.
- 19.03 In evaluating Bids, Owner will consider whether or not the Bids comply with the prescribed requirements, and such alternates, unit prices, and other data, as may be requested in the Bid Form or prior to the Notice of Award.
- 19.04 In evaluating whether a Bidder is responsible, Owner will consider the qualifications of the Bidder and may consider the qualifications and experience of Subcontractors and Suppliers proposed for those portions of the Work for which the identity of Subcontractors and Suppliers must be submitted as provided in the Bidding Documents.
- 19.05 Owner may conduct such investigations as Owner deems necessary to establish the responsibility, qualifications, and financial ability of Bidders and any proposed Subcontractors or Suppliers.

**ARTICLE 20 – BONDS AND INSURANCE**

- 20.01 Article 6 of the General Conditions, as may be modified by the Supplementary Conditions, sets forth Owner's requirements as to performance and payment bonds and insurance. When the Successful Bidder delivers the Agreement (executed by Successful Bidder) to Owner, it shall be accompanied by required bonds and insurance documentation.

**ARTICLE 21 – SIGNING OF AGREEMENT**

- 21.01 When Owner issues a Notice of Award to the Successful Bidder, it shall be accompanied by the unexecuted counterparts of the Agreement along with the other Contract Documents as identified in the Agreement. Within 15 days thereafter, Successful Bidder shall execute and deliver the required number of counterparts of the Agreement (and any bonds and insurance documentation required to be delivered by the Contract Documents) to Owner. Within ten days thereafter, Owner shall deliver one fully executed counterpart of the Agreement to Successful Bidder, together with printed and electronic copies of the Contract Documents as stated in Paragraph 2.02 of the General Conditions.

**ARTICLE 22 – NOT USED****ARTICLE 23 – NOT USED****ARTICLE 24 – POWER OF ATTORNEY**

24.01 Attorneys-in-fact who sign Bid Bonds or Contract Bonds must file with each bond a certified and effective dated copy of their power of attorney.

**ARTICLE 25 – LAWS AND REGULATIONS**

25.01 The Bidder's attention is directed to the fact that all applicable State Laws, municipal ordinance, and the rules and regulations of all authorities having jurisdiction over construction of the Project shall apply to the Contract throughout, and they will be deemed to be included in the Contract the same as though herein written out in full.

**ARTICLE 26 – SAFETY STANDARDS AND ACCIDENT PREVENTION**

26.01 With respect to all Work performed under this contract, the Contractor shall:

- A. Comply with the safety standards provisions of applicable laws, building and construction codes and the "Manual of Accident Prevention in Construction" published by the Associated General Contractors of America, the requirements of the Occupational Safety and Health Act of 1970 (Public Law 91-596), and the requirements of Title 29 of the Code of Federal Regulations, Section 1518 as published in the "Federal Register", Volume 36, No. 75, Saturday, April 17, 1971.
- B. Exercise every precaution at all times for the prevention of accidents and the protection of persons (including employees) and property.
- C. Maintain at his/her office or other well-known place at the job site, all articles necessary for giving first aid to the injured, and shall make standing arrangements for the immediate removal to a hospital or doctor's care of persons (including employees), who may be injured on the job site before the employer has made a standing arrangement for removal of injured persons to a hospital or a doctor's care.

**ARTICLE 27 – WAGE RATE REQUIREMENTS**

27.01 If the contract price is in excess of \$100,000, provisions of the Contract Work Hours and Safety Standards Act at 29 CFD 5.5(b) apply.

# BID FORM

## East-West Interconnect Project – Phase 2 CONTRACT NO. 6 – WATER DISTRIBUTION SYSTEM IMPROVEMENTS PROJECT Grayson County Water District

### ARTICLE 1 – BID RECIPIENT

This Bid is submitted to:

**GRAYSON COUNTY WATER DISTRICT**

**21 Shull White Road**

**Leitchfield, Kentucky 42754**

- 1.01 The undersigned Bidder proposes and agrees, if this Bid is accepted, to enter into an Agreement with Owner in the form included in the Bidding Documents to perform all Work as specified or indicated in the Bidding Documents for the prices and within the times indicated in this Bid and in accordance with the other terms and conditions of the Bidding Documents.

### ARTICLE 2 – BIDDER’S ACKNOWLEDGEMENTS

- 2.01 Bidder accepts all of the terms and conditions of the Instructions to Bidders, including without limitation those dealing with the disposition of Bid security. This Bid will remain subject to acceptance for 90 days after the Bid opening, or for such longer period of time that Bidder may agree to in writing upon request of Owner.

### ARTICLE 3 – BIDDER’S REPRESENTATIONS

3.01 In submitting this Bid, Bidder represents that:

- A. Bidder has examined and carefully studied the Bidding Documents, and any data and reference items identified in the Bidding Documents, and hereby acknowledges receipt of the following Addenda:

**Addendum No.**

**Addendum, Date**

_____	_____
_____	_____
_____	_____
_____	_____

- B. Bidder has visited the Site, conducted a thorough, alert visual examination of the Site and adjacent areas, and become familiar with and satisfied itself as to the general, local, and Site conditions that may affect cost, progress, and performance of the Work.
- C. Bidder is familiar with and has satisfied itself as to all Laws and Regulations that may affect cost, progress, and performance of the work and including all AIS requirements.
- D. Bidder has carefully studied all: (1) reports of explorations and tests of subsurface conditions at or adjacent to the Site and all drawings of physical conditions relating to

---

EJCDC® C-410, Bid Form for Construction Contracts.

Copyright © 2013 National Society of Professional Engineers, American Council of Engineering Companies,  
and American Society of Civil Engineers. All rights reserved.

existing surface or subsurface structures at the Site that have been identified in the Supplementary Conditions, especially with respect to Technical Data in such reports and drawings, and (2) reports and drawings relating to Hazardous Environmental Conditions, if any, at or adjacent to the Site that have been identified in the Supplementary Conditions, especially with respect to Technical Data in such reports and drawings.

- E. Bidder has considered the information known to Bidder itself; information commonly known to contractors doing business in the locality of the Site; information and observations obtained from visits to the Site; the Bidding Documents; and any Site-related reports and drawings identified in the Bidding Documents, with respect to the effect of such information, observations, and documents on (1) the cost, progress, and performance of the Work; (2) the means, methods, techniques, sequences, and procedures of construction to be employed by Bidder; and (3) Bidder's safety precautions and programs.
- F. Bidder agrees, based on the information and observations referred to in the preceding paragraph, that no further examinations, investigations, explorations, tests, studies, or data are necessary for the determination of this Bid for performance of the Work at the price bid and within the times required, and in accordance with the other terms and conditions of the Bidding Documents.
- G. Bidder is aware of the general nature of work to be performed by Owner and others at the Site that relates to the Work as indicated in the Bidding Documents.
- H. Bidder has given Engineer written notice of all conflicts, errors, ambiguities, or discrepancies that Bidder has discovered in the Bidding Documents, and confirms that the written resolution thereof by Engineer is acceptable to Bidder.
- I. The Bidding Documents are generally sufficient to indicate and convey understanding of all terms and conditions for the performance and furnishing of the Work.
- J. The submission of this Bid constitutes an incontrovertible representation by Bidder that Bidder has complied with every requirement of this Article, and that without exception the Bid and all prices in the Bid are premised upon performing and furnishing the Work required by the Bidding Documents.

#### **ARTICLE 4 – BIDDER'S CERTIFICATION**

4.01 Bidder certifies that:

- A. This Bid is genuine and not made in the interest of or on behalf of any undisclosed individual or entity and is not submitted in conformity with any collusive agreement or rules of any group, association, organization, or corporation;
- B. Bidder has not directly or indirectly induced or solicited any other Bidder to submit a false or sham Bid;
- C. Bidder has not solicited or induced any individual or entity to refrain from bidding; and
- D. Bidder has not engaged in corrupt, fraudulent, collusive, or coercive practices in competing for the Contract. For the purposes of this Paragraph 4.01.D:
  - 1. "corrupt practice" means the offering, giving, receiving, or soliciting of any thing of value likely to influence the action of a public official in the bidding process;
  - 2. "fraudulent practice" means an intentional misrepresentation of facts made (a) to influence the bidding process to the detriment of Owner, (b) to establish bid prices at

artificial non-competitive levels, or (c) to deprive Owner of the benefits of free and open competition;

3. "collusive practice" means a scheme or arrangement between two or more Bidders, with or without the knowledge of Owner, a purpose of which is to establish bid prices at artificial, non-competitive levels; and
4. "coercive practice" means harming or threatening to harm, directly or indirectly, persons or their property to influence their participation in the bidding process or affect the execution of the Contract.

**ARTICLE 5 – BASIS OF BID**

5.01 Bidder will complete the Work in accordance with the Contract Documents for the following unit price(s):

**BID SCHEDULE**

<b>Item No.</b>	<b>Description</b>	<b>Unit</b>	<b>Estimated Quantity</b>	<b>Bid Unit Price</b>	<b>Bid Price</b>
1	<b>16-inch Water Main</b> , PVC Pipe, Class 250, SDR 17 with all appurtenances and fittings. Complete in Place.	LF	23,200		
2	<b>12-inch Water Main</b> , PVC Pipe, Class 250, SDR 17 with all appurtenances and fittings. Complete in Place.	LF	26,020		
3	<b>8-inch Water Main</b> , PVC Pipe, Class 250, SDR 17 with all appurtenances and fittings.	LF	6,155		
4	<b>Directional Boring with 18" HDPE Pipe DR 11</b> for Water Main. Complete in Place.	LF	480		
5	<b>Directional Boring with 14" HDPE Pipe DR 9</b> for Water Main. Complete in Place.	LF	260		
6	<b>Directional Boring with 10" HDPE Pipe DR 9</b> for Water Main. Complete in Place.	LF	320		
7	<b>Directional Boring with 8" HDPE Pipe DR 9</b> for Water Main. Complete in Place.	LF	100		
8	<b>Highway Bore with 24" Steel Casing Pipe</b> Complete in Place.	LF	250		
9	<b>Highway Bore with 20" Steel Casing Pipe</b> Complete in Place.	LF	330		
10	<b>12-inch Gate Valve and Box</b> . Complete in Place.	EA	8		



11	<b>8-inch Gate Valve and Box.</b> Complete in Place.	EA	4		
12	<b>16-inch Gate Valve and Box w/Bypass Meter.</b> Complete in Place.	EA	3		
13	<b>12-inch Gate Valve and Box w/Bypass Meter.</b> Complete in Place.	EA	2		
14	<b>8-inch Gate Valve and Box w/Bypass Meter.</b> Complete in Place.	EA	2		
15	<b>Wet Tap Connection</b> to Existing Water Main, Including Tapping Sleeve and Valve, Complete in Place.	EA	4		
16	<b>Connection to Existing Water Main</b> Complete in Place.	EA	3		
17	<b>Flushing Hydrant Assembly</b> including gate valve. Complete in Place	EA	9		
18	<b>KY 259 North Master Meter/Control Valve Building.</b> Complete in Place.	LS	1		
19	<b>Cash Allowance – SCADA System Improvements.</b> Complete in Place.	LS	1	\$00,000.00	\$00,000.00

**AWARD OF CONTRACT will be based on the lowest responsible, responsive Bidder on the total of the BASE BID.**

**TOTAL AMOUNT BID:** \_\_\_\_\_ **Dollars and** \_\_\_\_\_ **(Cents)**

(\$ \_\_\_\_\_ )

Bidder acknowledges that (1) each Bid Unit Price includes an amount considered by Bidder to be adequate to cover Contractor’s overhead and profit for each separately identified item, and (2) estimated quantities are not guaranteed, and are solely for the purpose of comparison of Bids, and final payment for all unit price Bid items will be based on actual quantities, determined as provided in the Contract Documents.

**ARTICLE 6 – TIME OF COMPLETION**

6.01 Bidder agrees that the Work will be substantially complete within 425 calendar days after the date when the Contract Times commence to run as provided in Paragraph 4.01 of the General Conditions, and will be completed and ready for payment in accordance with Paragraph 15.06 of the General Conditions within 455 calendar days after the date when the Contract Times commence to run.

6.02 Bidder accepts the provisions of the Agreement as to liquidated damages. Contractor and Owner recognize that time is of the essence of this Agreement and that Owner will suffer financial loss if the Work is not completed within the times specified in Paragraph 6.01 above, plus any extensions thereof allowed in accordance with Article 15 of the General Conditions. The parties also recognize the delays, expense, and difficulties involved in proving in a legal or arbitration proceeding the actual loss suffered by Owner if the Work is not completed on time. Accordingly, instead of requiring any such proof, Owner and Contractor agree that as liquidated damages for delay (but not as a penalty), Contractor shall pay Owner \$500 for each day that expires after the time specified in Paragraph 6.01 for Substantial Completion until the Work is substantially complete. After Substantial Completion, if Contractor shall neglect, refuse, or fail to complete the remaining Work within the Contract Time or any proper extension thereof granted by Owner, Contractor shall pay Owner \$500 for each day that expires after the time specified in Paragraph 6.01 for completion and readiness for final payment until the Work is completed and ready for final payment.

#### **ARTICLE 7 – ATTACHMENTS TO THIS BID**

- 7.01 The following documents are submitted with and made a condition of this Bid:
- A. Required Bid security SECTION 00430 EJCDC C-430;
  - B. List of Proposed Subcontractors;
  - C. List of Proposed Suppliers;
  - D. List of Project References;
  - E. Evidence of authority to do business in the state of the Project; or a written covenant to obtain such license within the time for acceptance of Bids;
  - F. Contractor's License No.: [REDACTED] [or] Evidence of Bidder's ability to obtain a State Contractor's License and a covenant by Bidder to obtain said license within the time for acceptance of Bids;
  - G. Required Bidder Qualification Statement with supporting data.
  - H. If Bid amount exceeds \$10,000, signed Compliance Statement (RD 400-6). Refer to specific equal opportunity requirements set forth in paragraph 18.10 of the General Conditions;
  - I. If Bid amount exceeds \$25,000, signed Certification Regarding Debarment, Suspension, Ineligibility and Voluntary Exclusion - Lower Tier Covered Transactions (AD-1048);
  - J. If Bid amount exceeds \$100,000, signed RD Instruction 1940-Q, Exhibit A-1, Certification for Contracts, Grants, and Loans. Refer to paragraph 18.11 of the General Conditions;
  - K. Manufacturer's Certification Letter (Exhibit D) on any approved "or equal" or substitute request to ensure compliance with AIS requirements and any subsequent statutes mandating domestic preference

#### **ARTICLE 8 – DEFINED TERMS**

8.01 The terms used in this Bid with initial capital letters have the meanings stated in the Instructions to Bidders, the General Conditions, and the Supplementary Conditions.



**ARTICLE 9 – BID SUBMITTAL**

BIDDER: *[Indicate correct name of bidding entity]*

By:

*[Signature]* \_\_\_\_\_

*[Printed name]* \_\_\_\_\_

*(If Bidder is a corporation, a limited liability company, a partnership, or a joint venture, attach evidence of authority to sign.)*

Attest:

*[Signature]* \_\_\_\_\_

*[Printed name]* \_\_\_\_\_

Title: \_\_\_\_\_

Submittal Date: \_\_\_\_\_

Address for giving notices:

\_\_\_\_\_  
\_\_\_\_\_  
\_\_\_\_\_

Telephone Number: \_\_\_\_\_

Fax Number: \_\_\_\_\_

Contact Name and e-mail address: \_\_\_\_\_  
\_\_\_\_\_

Bidder's License No.: \_\_\_\_\_

*(where applicable)*

*NOTE TO USER: Use in those states or other jurisdictions where applicable or required.*

# BID FORM

## East-West Interconnect Project – Phase 2 CONTRACT NO. 6 – WATER DISTRIBUTION SYSTEM IMPROVEMENTS PROJECT Grayson County Water District

### ARTICLE 1 – BID RECIPIENT

This Bid is submitted to:

**GRAYSON COUNTY WATER DISTRICT**

**21 Shull White Road**

**Leitchfield, Kentucky 42754**

- 1.01 The undersigned Bidder proposes and agrees, if this Bid is accepted, to enter into an Agreement with Owner in the form included in the Bidding Documents to perform all Work as specified or indicated in the Bidding Documents for the prices and within the times indicated in this Bid and in accordance with the other terms and conditions of the Bidding Documents.

### ARTICLE 2 – BIDDER’S ACKNOWLEDGEMENTS

- 2.01 Bidder accepts all of the terms and conditions of the Instructions to Bidders, including without limitation those dealing with the disposition of Bid security. This Bid will remain subject to acceptance for 90 days after the Bid opening, or for such longer period of time that Bidder may agree to in writing upon request of Owner.

### ARTICLE 3 – BIDDER’S REPRESENTATIONS

3.01 In submitting this Bid, Bidder represents that:

- A. Bidder has examined and carefully studied the Bidding Documents, and any data and reference items identified in the Bidding Documents, and hereby acknowledges receipt of the following Addenda:

<u>Addendum No.</u>	<u>Addendum, Date</u>
_____	_____
_____	_____
_____	_____
_____	_____

- B. Bidder has visited the Site, conducted a thorough, alert visual examination of the Site and adjacent areas, and become familiar with and satisfied itself as to the general, local, and Site conditions that may affect cost, progress, and performance of the Work.
- C. Bidder is familiar with and has satisfied itself as to all Laws and Regulations that may affect cost, progress, and performance of the work and including all AIS requirements.
- D. Bidder has carefully studied all: (1) reports of explorations and tests of subsurface conditions at or adjacent to the Site and all drawings of physical conditions relating to

---

EJCDC® C-410, Bid Form for Construction Contracts.

Copyright © 2013 National Society of Professional Engineers, American Council of Engineering Companies,  
and American Society of Civil Engineers. All rights reserved.

existing surface or subsurface structures at the Site that have been identified in the Supplementary Conditions, especially with respect to Technical Data in such reports and drawings, and (2) reports and drawings relating to Hazardous Environmental Conditions, if any, at or adjacent to the Site that have been identified in the Supplementary Conditions, especially with respect to Technical Data in such reports and drawings.

- E. Bidder has considered the information known to Bidder itself; information commonly known to contractors doing business in the locality of the Site; information and observations obtained from visits to the Site; the Bidding Documents; and any Site-related reports and drawings identified in the Bidding Documents, with respect to the effect of such information, observations, and documents on (1) the cost, progress, and performance of the Work; (2) the means, methods, techniques, sequences, and procedures of construction to be employed by Bidder; and (3) Bidder's safety precautions and programs.
- F. Bidder agrees, based on the information and observations referred to in the preceding paragraph, that no further examinations, investigations, explorations, tests, studies, or data are necessary for the determination of this Bid for performance of the Work at the price bid and within the times required, and in accordance with the other terms and conditions of the Bidding Documents.
- G. Bidder is aware of the general nature of work to be performed by Owner and others at the Site that relates to the Work as indicated in the Bidding Documents.
- H. Bidder has given Engineer written notice of all conflicts, errors, ambiguities, or discrepancies that Bidder has discovered in the Bidding Documents, and confirms that the written resolution thereof by Engineer is acceptable to Bidder.
- I. The Bidding Documents are generally sufficient to indicate and convey understanding of all terms and conditions for the performance and furnishing of the Work.
- J. The submission of this Bid constitutes an incontrovertible representation by Bidder that Bidder has complied with every requirement of this Article, and that without exception the Bid and all prices in the Bid are premised upon performing and furnishing the Work required by the Bidding Documents.

#### **ARTICLE 4 – BIDDER'S CERTIFICATION**

4.01 Bidder certifies that:

- A. This Bid is genuine and not made in the interest of or on behalf of any undisclosed individual or entity and is not submitted in conformity with any collusive agreement or rules of any group, association, organization, or corporation;
- B. Bidder has not directly or indirectly induced or solicited any other Bidder to submit a false or sham Bid;
- C. Bidder has not solicited or induced any individual or entity to refrain from bidding; and
- D. Bidder has not engaged in corrupt, fraudulent, collusive, or coercive practices in competing for the Contract. For the purposes of this Paragraph 4.01.D:
  - 1. "corrupt practice" means the offering, giving, receiving, or soliciting of any thing of value likely to influence the action of a public official in the bidding process;
  - 2. "fraudulent practice" means an intentional misrepresentation of facts made (a) to influence the bidding process to the detriment of Owner, (b) to establish bid prices at

artificial non-competitive levels, or (c) to deprive Owner of the benefits of free and open competition;

3. "collusive practice" means a scheme or arrangement between two or more Bidders, with or without the knowledge of Owner, a purpose of which is to establish bid prices at artificial, non-competitive levels; and
4. "coercive practice" means harming or threatening to harm, directly or indirectly, persons or their property to influence their participation in the bidding process or affect the execution of the Contract.

#### ARTICLE 5 – BASIS OF BID

5.01 Bidder will complete the Work in accordance with the Contract Documents for the following unit price(s):

#### BID SCHEDULE

Item No.	Description	Unit	Estimated Quantity	Bid Unit Price	Bid Price
1	<b>16-inch Water Main</b> , PVC Pipe, C900 DR 18 with all appurtenances and fittings. Complete in Place.	LF	23,200		
2	<b>12-inch Water Main</b> , PVC Pipe, C900 DR 18 with all appurtenances and fittings. Complete in Place.	LF	26,020		
3	<b>8-inch Water Main</b> , PVC Pipe, C900 DR 18 with all appurtenances and fittings.	LF	6,155		
4	<b>Directional Boring with 18" HDPE Pipe DR 11</b> for Water Main. Complete in Place.	LF	480		
5	<b>Directional Boring with 14" HDPE Pipe DR 9</b> for Water Main. Complete in Place.	LF	260		
6	<b>Directional Boring with 10" HDPE Pipe DR 9</b> for Water Main. Complete in Place.	LF	320		
7	<b>Directional Boring with 8" HDPE Pipe DR 9</b> for Water Main. Complete in Place.	LF	100		
8	<b>Railroad Bore with 8" HDPE Pipe DR 9 for Water Main with 16" Steel Casing Pipe</b> Complete in Place.	LF	100		
9	<b>Highway Bore with 24" Steel Casing Pipe</b> Complete in Place.	LF	250		
10	<b>Highway Bore with 20" Steel Casing Pipe</b> Complete in Place.	LF	330		

11	<b>12-inch Gate Valve and Box.</b> Complete in Place.	EA	8		
12	<b>8-inch Gate Valve and Box.</b> Complete in Place.	EA	4		
13	<b>16-inch Gate Valve and Box w/Bypass Meter.</b> Complete in Place.	EA	3		
14	<b>12-inch Gate Valve and Box w/Bypass Meter.</b> Complete in Place.	EA	2		
15	<b>8-inch Gate Valve and Box w/Bypass Meter.</b> Complete in Place.	EA	2		
16	<b>Wet Tap Connection</b> to Existing Water Main, Including Tapping Sleeve and Valve, Complete in Place.	EA	4		
17	<b>Connection to Existing Water Main</b> Complete in Place.	EA	3		
18	<b>Flushing Hydrant Assembly</b> including gate valve. Complete in Place	EA	9		
19	<b>KY 259 North Master Meter/Control Valve Building.</b> Complete in Place.	LS	1		
20	<b>Cash Allowance – SCADA System Improvements.</b> Complete in Place.	LS	1	\$20,843.00	\$20,843.00

**AWARD OF CONTRACT will be based on the lowest responsible, responsive Bidder on the total of the BASE BID.**

**TOTAL AMOUNT BID:** \_\_\_\_\_ **Dollars and** \_\_\_\_\_ **(Cents)**

**(\$ \_\_\_\_\_ )**

Bidder acknowledges that (1) each Bid Unit Price includes an amount considered by Bidder to be adequate to cover Contractor’s overhead and profit for each separately identified item, and (2) estimated quantities are not guaranteed, and are solely for the purpose of comparison of Bids, and final payment for all unit price Bid items will be based on actual quantities, determined as provided in the Contract Documents.

**ARTICLE 6 – TIME OF COMPLETION**

6.01 Bidder agrees that the Work will be substantially complete within 425 calendar days after the date when the Contract Times commence to run as provided in Paragraph 4.01 of the General Conditions, and will be completed and ready for final payment in accordance with Paragraph 15.06 of the General Conditions within 455 calendar days after the date when the Contract Times commence to run.



6.02 Bidder accepts the provisions of the Agreement as to liquidated damages. Contractor and Owner recognize that time is of the essence of this Agreement and that Owner will suffer financial loss if the Work is not completed within the times specified in Paragraph 6.01 above, plus any extensions thereof allowed in accordance with Article 15 of the General Conditions. The parties also recognize the delays, expense, and difficulties involved in proving in a legal or arbitration proceeding the actual loss suffered by Owner if the Work is not completed on time. Accordingly, instead of requiring any such proof, Owner and Contractor agree that as liquidated damages for delay (but not as a penalty), Contractor shall pay Owner \$500 for each day that expires after the time specified in Paragraph 6.01 for Substantial Completion until the Work is substantially complete. After Substantial Completion, if Contractor shall neglect, refuse, or fail to complete the remaining Work within the Contract Time or any proper extension thereof granted by Owner, Contractor shall pay Owner \$500 for each day that expires after the time specified in Paragraph 6.01 for completion and readiness for final payment until the Work is completed and ready for final payment.

#### **ARTICLE 7 – ATTACHMENTS TO THIS BID**

- 7.01 The following documents are submitted with and made a condition of this Bid:
- A. Required Bid security SECTION 00430 EJCDC C-430;
  - B. List of Proposed Subcontractors;
  - C. List of Proposed Suppliers;
  - D. List of Project References;
  - E. Evidence of authority to do business in the state of the Project; or a written covenant to obtain such license within the time for acceptance of Bids;
  - F. Contractor's License No.: [REDACTED] [or] Evidence of Bidder's ability to obtain a State Contractor's License and a covenant by Bidder to obtain said license within the time for acceptance of Bids;
  - G. Required Bidder Qualification Statement with supporting data.
  - H. If Bid amount exceeds \$10,000, signed Compliance Statement (RD 400-6). Refer to specific equal opportunity requirements set forth in paragraph 18.10 of the General Conditions;
  - I. If Bid amount exceeds \$25,000, signed Certification Regarding Debarment, Suspension, Ineligibility and Voluntary Exclusion - Lower Tier Covered Transactions (AD-1048);
  - J. If Bid amount exceeds \$100,000, signed RD Instruction 1940-Q, Exhibit A-1, Certification for Contracts, Grants, and Loans. Refer to paragraph 18.11 of the General Conditions;
  - K. Manufacturer's Certification Letter (Exhibit D) on any approved "or equal" or substitute request to ensure compliance with AIS requirements and any subsequent statutes mandating domestic preference

#### **ARTICLE 8 – DEFINED TERMS**

8.01 The terms used in this Bid with initial capital letters have the meanings stated in the Instructions to Bidders, the General Conditions, and the Supplementary Conditions.

**ARTICLE 9 – BID SUBMITTAL**

BIDDER: *[Indicate correct name of bidding entity]*

\_\_\_\_\_  
By:  
*[Signature]* \_\_\_\_\_

*[Printed name]* \_\_\_\_\_  
*(If Bidder is a corporation, a limited liability company, a partnership, or a joint venture, attach evidence of authority to sign.)*

Attest:  
*[Signature]* \_\_\_\_\_

*[Printed name]* \_\_\_\_\_

Title: \_\_\_\_\_

Submittal Date: \_\_\_\_\_

Address for giving notices:  
\_\_\_\_\_  
\_\_\_\_\_  
\_\_\_\_\_

Telephone Number: \_\_\_\_\_

Fax Number: \_\_\_\_\_

Contact Name and e-mail address: \_\_\_\_\_  
\_\_\_\_\_

Bidder's License No.: \_\_\_\_\_  
*(where applicable)*

*NOTE TO USER: Use in those states or other jurisdictions where applicable or required.*

# BID FORM

## East-West Interconnect Project – Phase 2 CONTRACT NO. 6 – WATER DISTRIBUTION SYSTEM IMPROVEMENTS PROJECT Grayson County Water District

### ARTICLE 1 – BID RECIPIENT

This Bid is submitted to:

**GRAYSON COUNTY WATER DISTRICT**

**21 Shull White Road**

**Leitchfield, Kentucky 42754**

- 1.01 The undersigned Bidder proposes and agrees, if this Bid is accepted, to enter into an Agreement with Owner in the form included in the Bidding Documents to perform all Work as specified or indicated in the Bidding Documents for the prices and within the times indicated in this Bid and in accordance with the other terms and conditions of the Bidding Documents.

### ARTICLE 2 – BIDDER’S ACKNOWLEDGEMENTS

- 2.01 Bidder accepts all of the terms and conditions of the Instructions to Bidders, including without limitation those dealing with the disposition of Bid security. This Bid will remain subject to acceptance for 90 days after the Bid opening, or for such longer period of time that Bidder may agree to in writing upon request of Owner.

### ARTICLE 3 – BIDDER’S REPRESENTATIONS

3.01 In submitting this Bid, Bidder represents that:

- A. Bidder has examined and carefully studied the Bidding Documents, and any data and reference items identified in the Bidding Documents, and hereby acknowledges receipt of the following Addenda:

**Addendum No.**

**Addendum, Date**

_____	_____
_____	_____
_____	_____
_____	_____

- B. Bidder has visited the Site, conducted a thorough, alert visual examination of the Site and adjacent areas, and become familiar with and satisfied itself as to the general, local, and Site conditions that may affect cost, progress, and performance of the Work.
- C. Bidder is familiar with and has satisfied itself as to all Laws and Regulations that may affect cost, progress, and performance of the work and including all AIS requirements.
- D. Bidder has carefully studied all: (1) reports of explorations and tests of subsurface conditions at or adjacent to the Site and all drawings of physical conditions relating to

---

EJCDC® C-410, Bid Form for Construction Contracts.

Copyright © 2013 National Society of Professional Engineers, American Council of Engineering Companies,  
and American Society of Civil Engineers. All rights reserved.

existing surface or subsurface structures at the Site that have been identified in the Supplementary Conditions, especially with respect to Technical Data in such reports and drawings, and (2) reports and drawings relating to Hazardous Environmental Conditions, if any, at or adjacent to the Site that have been identified in the Supplementary Conditions, especially with respect to Technical Data in such reports and drawings.

- E. Bidder has considered the information known to Bidder itself; information commonly known to contractors doing business in the locality of the Site; information and observations obtained from visits to the Site; the Bidding Documents; and any Site-related reports and drawings identified in the Bidding Documents, with respect to the effect of such information, observations, and documents on (1) the cost, progress, and performance of the Work; (2) the means, methods, techniques, sequences, and procedures of construction to be employed by Bidder; and (3) Bidder's safety precautions and programs.
- F. Bidder agrees, based on the information and observations referred to in the preceding paragraph, that no further examinations, investigations, explorations, tests, studies, or data are necessary for the determination of this Bid for performance of the Work at the price bid and within the times required, and in accordance with the other terms and conditions of the Bidding Documents.
- G. Bidder is aware of the general nature of work to be performed by Owner and others at the Site that relates to the Work as indicated in the Bidding Documents.
- H. Bidder has given Engineer written notice of all conflicts, errors, ambiguities, or discrepancies that Bidder has discovered in the Bidding Documents, and confirms that the written resolution thereof by Engineer is acceptable to Bidder.
- I. The Bidding Documents are generally sufficient to indicate and convey understanding of all terms and conditions for the performance and furnishing of the Work.
- J. The submission of this Bid constitutes an incontrovertible representation by Bidder that Bidder has complied with every requirement of this Article, and that without exception the Bid and all prices in the Bid are premised upon performing and furnishing the Work required by the Bidding Documents.

#### **ARTICLE 4 – BIDDER'S CERTIFICATION**

4.01 Bidder certifies that:

- A. This Bid is genuine and not made in the interest of or on behalf of any undisclosed individual or entity and is not submitted in conformity with any collusive agreement or rules of any group, association, organization, or corporation;
- B. Bidder has not directly or indirectly induced or solicited any other Bidder to submit a false or sham Bid;
- C. Bidder has not solicited or induced any individual or entity to refrain from bidding; and
- D. Bidder has not engaged in corrupt, fraudulent, collusive, or coercive practices in competing for the Contract. For the purposes of this Paragraph 4.01.D:
  - 1. "corrupt practice" means the offering, giving, receiving, or soliciting of any thing of value likely to influence the action of a public official in the bidding process;
  - 2. "fraudulent practice" means an intentional misrepresentation of facts made (a) to influence the bidding process to the detriment of Owner, (b) to establish bid prices at

artificial non-competitive levels, or (c) to deprive Owner of the benefits of free and open competition;

3. “collusive practice” means a scheme or arrangement between two or more Bidders, with or without the knowledge of Owner, a purpose of which is to establish bid prices at artificial, non-competitive levels; and
4. “coercive practice” means harming or threatening to harm, directly or indirectly, persons or their property to influence their participation in the bidding process or affect the execution of the Contract.

**ARTICLE 5 – BASIS OF BID**

5.01 Bidder will complete the Work in accordance with the Contract Documents for the following unit price(s):

**BID SCHEDULE**

<b>Item No.</b>	<b>Description</b>	<b>Unit</b>	<b>Estimated Quantity</b>	<b>Bid Unit Price</b>	<b>Bid Price</b>
1	<b>16-inch Water Main</b> , PVC Pipe, Class 250, SDR 17 with all appurtenances and fittings. Complete in Place.	LF	23,200		
2	<b>12-inch Water Main</b> , PVC Pipe, Class 250, SDR 17 with all appurtenances and fittings. Complete in Place.	LF	26,020		
3	<b>8-inch Water Main</b> , PVC Pipe, Class 250, SDR 17 with all appurtenances and fittings.	LF	6,155		
4	<b>Directional Boring with 18” HDPE Pipe DR 11</b> for Water Main. Complete in Place.	LF	480		
5	<b>Directional Boring with 14” HDPE Pipe DR 9</b> for Water Main. Complete in Place.	LF	260		
6	<b>Directional Boring with 10” HDPE Pipe DR 9</b> for Water Main. Complete in Place.	LF	320		
7	<b>Directional Boring with 8” HDPE Pipe DR 9</b> for Water Main. Complete in Place.	LF	100		
8	<b>Railroad Bore with 8” HDPE Pipe DR 9 for Water Main with 16” Steel Casing Pipe</b> Complete in Place.	LF	100		
9	<b>Highway Bore with 24” Steel Casing Pipe</b> Complete in Place.	LF	250		
10	<b>Highway Bore with 20” Steel Casing Pipe</b> Complete in Place.	LF	330		

11	<b>12-inch Gate Valve and Box.</b> Complete in Place.	EA	8		
12	<b>8-inch Gate Valve and Box.</b> Complete in Place.	EA	4		
13	<b>16-inch Gate Valve and Box w/Bypass Meter.</b> Complete in Place.	EA	3		
14	<b>12-inch Gate Valve and Box w/Bypass Meter.</b> Complete in Place.	EA	2		
15	<b>8-inch Gate Valve and Box w/Bypass Meter.</b> Complete in Place.	EA	2		
16	<b>Wet Tap Connection</b> to Existing Water Main, Including Tapping Sleeve and Valve, Complete in Place.	EA	4		
17	<b>Connection to Existing Water Main</b> Complete in Place.	EA	3		
18	<b>Flushing Hydrant Assembly</b> including gate valve. Complete in Place	EA	9		
19	<b>KY 259 North Master Meter/Control Valve Building.</b> Complete in Place.	LS	1		
20	<b>Cash Allowance – SCADA System Improvements.</b> Complete in Place.	LS	1	\$20,843.00	\$20,843.00

**AWARD OF CONTRACT will be based on the lowest responsible, responsive Bidder on the total of the BASE BID.**

**TOTAL AMOUNT BID:** \_\_\_\_\_ **Dollars and** \_\_\_\_\_ **(Cents)**

**(\$ \_\_\_\_\_ )**

Bidder acknowledges that (1) each Bid Unit Price includes an amount considered by Bidder to be adequate to cover Contractor’s overhead and profit for each separately identified item, and (2) estimated quantities are not guaranteed, and are solely for the purpose of comparison of Bids, and final payment for all unit price Bid items will be based on actual quantities, determined as provided in the Contract Documents.

**ARTICLE 6 – TIME OF COMPLETION**

6.01 Bidder agrees that the Work will be substantially complete within 425 calendar days after the date when the Contract Times commence to run as provided in Paragraph 4.01 of the General Conditions, and will be completed and ready for final payment in accordance with Paragraph 15.06 of the General Conditions within 455 calendar days after the date when the Contract Times commence to run.

6.02 Bidder accepts the provisions of the Agreement as to liquidated damages. Contractor and Owner recognize that time is of the essence of this Agreement and that Owner will suffer financial loss if the Work is not completed within the times specified in Paragraph 6.01 above, plus any extensions thereof allowed in accordance with Article 15 of the General Conditions. The parties also recognize the delays, expense, and difficulties involved in proving in a legal or arbitration proceeding the actual loss suffered by Owner if the Work is not completed on time. Accordingly, instead of requiring any such proof, Owner and Contractor agree that as liquidated damages for delay (but not as a penalty), Contractor shall pay Owner \$500 for each day that expires after the time specified in Paragraph 6.01 for Substantial Completion until the Work is substantially complete. After Substantial Completion, if Contractor shall neglect, refuse, or fail to complete the remaining Work within the Contract Time or any proper extension thereof granted by Owner, Contractor shall pay Owner \$500 for each day that expires after the time specified in Paragraph 6.01 for completion and readiness for final payment until the Work is completed and ready for final payment.

#### **ARTICLE 7 – ATTACHMENTS TO THIS BID**

- 7.01 The following documents are submitted with and made a condition of this Bid:
- A. Required Bid security SECTION 00430 EJCDC C-430;
  - B. List of Proposed Subcontractors;
  - C. List of Proposed Suppliers;
  - D. List of Project References;
  - E. Evidence of authority to do business in the state of the Project; or a written covenant to obtain such license within the time for acceptance of Bids;
  - F. Contractor's License No.: [REDACTED] [or] Evidence of Bidder's ability to obtain a State Contractor's License and a covenant by Bidder to obtain said license within the time for acceptance of Bids;
  - G. Required Bidder Qualification Statement with supporting data.
  - H. If Bid amount exceeds \$10,000, signed Compliance Statement (RD 400-6). Refer to specific equal opportunity requirements set forth in paragraph 18.10 of the General Conditions;
  - I. If Bid amount exceeds \$25,000, signed Certification Regarding Debarment, Suspension, Ineligibility and Voluntary Exclusion - Lower Tier Covered Transactions (AD-1048);
  - J. If Bid amount exceeds \$100,000, signed RD Instruction 1940-Q, Exhibit A-1, Certification for Contracts, Grants, and Loans. Refer to paragraph 18.11 of the General Conditions;
  - K. Manufacturer's Certification Letter (Exhibit D) on any approved "or equal" or substitute request to ensure compliance with AIS requirements and any subsequent statutes mandating domestic preference

#### **ARTICLE 8 – DEFINED TERMS**

8.01 The terms used in this Bid with initial capital letters have the meanings stated in the Instructions to Bidders, the General Conditions, and the Supplementary Conditions.

**ARTICLE 9 – BID SUBMITTAL**

BIDDER: *[Indicate correct name of bidding entity]*

\_\_\_\_\_  
By:  
*[Signature]* \_\_\_\_\_

*[Printed name]* \_\_\_\_\_  
*(If Bidder is a corporation, a limited liability company, a partnership, or a joint venture, attach evidence of authority to sign.)*

Attest:  
*[Signature]* \_\_\_\_\_

*[Printed name]* \_\_\_\_\_

Title: \_\_\_\_\_

Submittal Date: \_\_\_\_\_

Address for giving notices:  
\_\_\_\_\_  
\_\_\_\_\_  
\_\_\_\_\_

Telephone Number: \_\_\_\_\_

Fax Number: \_\_\_\_\_

Contact Name and e-mail address: \_\_\_\_\_  
\_\_\_\_\_

Bidder's License No.: \_\_\_\_\_  
*(where applicable)*

*NOTE TO USER: Use in those states or other jurisdictions where applicable or required.*



# QUALIFICATIONS STATEMENT

Prepared by



Issued and Published Jointly by



Endorsed by



---

EJCDC® C-451, Qualifications Statement.  
Copyright © 2013 National Society of Professional Engineers, American Council of Engineering Companies,  
and American Society of Civil Engineers. All rights reserved.

Copyright © 2013:

National Society of Professional Engineers  
1420 King Street, Alexandria, VA 22314-2794  
(703) 684-2882  
[www.nspe.org](http://www.nspe.org)

American Council of Engineering Companies  
1015 15th Street N.W., Washington, DC 20005  
(202) 347-7474  
[www.acec.org](http://www.acec.org)

American Society of Civil Engineers  
1801 Alexander Bell Drive, Reston, VA 20191-4400  
(800) 548-2723  
[www.asce.org](http://www.asce.org)

The copyright for this EJCDC document is owned jointly by the three sponsoring organizations listed above. The National Society of Professional Engineers is the Copyright Administrator for the EJCDC documents; please direct all inquiries regarding EJCDC copyrights to NSPE.

NOTE: EJCDC publications may be purchased at [www.ejcdc.org](http://www.ejcdc.org), or from any of the sponsoring organizations above.

### QUALIFICATIONS STATEMENT

**THE INFORMATION SUPPLIED IN THIS DOCUMENT IS CONFIDENTIAL TO THE EXTENT PERMITTED BY LAWS AND REGULATIONS**

**1. SUBMITTED BY:**

Official Name of Firm: \_\_\_\_\_

Address: \_\_\_\_\_

\_\_\_\_\_

\_\_\_\_\_

**2. SUBMITTED TO:**

\_\_\_\_\_

**3. SUBMITTED FOR:**

\_\_\_\_\_

Owner: Grayson County Water District

Project Name: East - West Interconnect Project - Phase 2

Contract No. 6 - Water Distribution System Improvements Project

\_\_\_\_\_

\_\_\_\_\_

**TYPE OF WORK:** Contract No. 6 – including approximately 480 LF of 18”, 23,200 LF of 16”, 260 LF of 14”, 26,020 LF of 12”, 320 LF of 10” and 6,155 LF of 8” water main, one new master meter and all related appurtenances as shown on the DRAWINGS and described in the SPECIFICATIONS

**CONTRACTOR'S CONTACT INFORMATION**

Contact Person: \_\_\_\_\_

Title: \_\_\_\_\_

Phone: \_\_\_\_\_

Email: \_\_\_\_\_

**4. AFFILIATED COMPANIES:**

Name: \_\_\_\_\_

Address: \_\_\_\_\_

\_\_\_\_\_

\_\_\_\_\_

**5. TYPE OF ORGANIZATION:**

SOLE PROPRIETORSHIP

Name of Owner: \_\_\_\_\_

Doing Business As: \_\_\_\_\_

Date of Organization: \_\_\_\_\_

PARTNERSHIP

Date of Organization: \_\_\_\_\_

Type of Partnership: \_\_\_\_\_

Name of General Partner(s): \_\_\_\_\_

\_\_\_\_\_

\_\_\_\_\_

CORPORATION

State of Organization: \_\_\_\_\_

Date of Organization: \_\_\_\_\_

Executive Officers:

- President: \_\_\_\_\_

- Vice President(s): \_\_\_\_\_

\_\_\_\_\_

\_\_\_\_\_

- Treasurer: \_\_\_\_\_

- Secretary:

\_\_\_\_\_

LIMITED LIABILITY COMPANY

State of Organization:

\_\_\_\_\_

Date of Organization:

\_\_\_\_\_

Members:

\_\_\_\_\_

\_\_\_\_\_

\_\_\_\_\_

\_\_\_\_\_

JOINT VENTURE

Sate of Organization:

\_\_\_\_\_

Date of Organization:

\_\_\_\_\_

Form of Organization:

\_\_\_\_\_

Joint Venture Managing Partner

- Name:

\_\_\_\_\_

- Address:

\_\_\_\_\_

\_\_\_\_\_

\_\_\_\_\_

Joint Venture Managing Partner

- Name:

\_\_\_\_\_

- Address:

\_\_\_\_\_

\_\_\_\_\_

Joint Venture Managing Partner

- Name:

\_\_\_\_\_

- Address:

\_\_\_\_\_

**6. LICENSING**

Jurisdiction: \_\_\_\_\_

Type of License: \_\_\_\_\_

License Number: \_\_\_\_\_

Jurisdiction: \_\_\_\_\_

Type of License: \_\_\_\_\_

License Number: \_\_\_\_\_

**7. CERTIFICATIONS**

**CERTIFIED BY:**

Disadvantage Business Enterprise: \_\_\_\_\_

Minority Business Enterprise: \_\_\_\_\_

Woman Owned Enterprise: \_\_\_\_\_

Small Business Enterprise: \_\_\_\_\_

Other ( \_\_\_\_\_ ): \_\_\_\_\_

**8. BONDING INFORMATION**

Bonding Company: \_\_\_\_\_

Address: \_\_\_\_\_

Bonding Agent: \_\_\_\_\_

Address: \_\_\_\_\_

Contact Name: \_\_\_\_\_

Phone: \_\_\_\_\_

Aggregate Bonding Capacity: \_\_\_\_\_

Available Bonding Capacity as of date of this submittal: \_\_\_\_\_

**9. FINANCIAL INFORMATION**

Financial Institution: \_\_\_\_\_

Address: \_\_\_\_\_

\_\_\_\_\_

Account Manager: \_\_\_\_\_

Phone: \_\_\_\_\_

INCLUDE AS AN ATTACHMENT AN AUDITED BALANCE SHEET FOR EACH OF THE LAST 3 YEARS

**10. CONSTRUCTION EXPERIENCE:**

Current Experience:

List on **Schedule A** all uncompleted projects currently under contract (If Joint Venture list each participant's projects separately).

Previous Experience:

List on **Schedule B** all projects completed within the last 5 Years (If Joint Venture list each participant's projects separately).

Has firm listed in Section 1 ever failed to complete a construction contract awarded to it?

YES  NO

If YES, attach as an Attachment details including Project Owner's contact information.

Has any Corporate Officer, Partner, Joint Venture participant or Proprietor ever failed to complete a construction contract awarded to them in their name or when acting as a principal of another entity?

YES  NO

If YES, attach as an Attachment details including Project Owner's contact information.

Are there any judgments, claims, disputes or litigation pending or outstanding involving the firm listed in Section 1 or any of its officers (or any of its partners if a partnership or any of the individual entities if a joint venture)?

YES  NO

If YES, attach as an Attachment details including Project Owner's contact information.

**11. SAFETY PROGRAM:**

Name of Contractor's Safety Officer: \_\_\_\_\_

Include the following as attachments:

Provide as an Attachment Contractor's (and Contractor's proposed Subcontractors and Suppliers furnishing or performing Work having a value in excess of 10 percent of the total amount of the Bid) OSHA No. 500- Log & Summary of Occupational Injuries & Illnesses for the past 5 years.

Provide as an Attachment Contractor's (and Contractor's proposed Subcontractors and Suppliers furnishing or performing Work having a value in excess of 10 percent of the total amount of the Bid) list of all OSHA Citations & Notifications of Penalty (monetary or other) received within the last 5 years (indicate disposition as applicable) - IF NONE SO STATE.

Provide as an Attachment Contractor's (and Contractor's proposed Subcontractors and Suppliers furnishing or performing Work having a value in excess of 10 percent of the total amount of the Bid) list of all safety citations or violations under any state all received within the last 5 years (indicate disposition as applicable) - IF NONE SO STATE.

Provide the following for the firm listed in Section V (and for each proposed Subcontractor furnishing or performing Work having a value in excess of 10 percent of the total amount of the Bid) the following (attach additional sheets as necessary):

Workers' compensation Experience Modification Rate (EMR) for the last 5 years:

YEAR	_____	EMR	_____
YEAR	_____	EMR	_____
YEAR	_____	EMR	_____
YEAR	_____	EMR	_____
YEAR	_____	EMR	_____

Total Recordable Frequency Rate (TRFR) for the last 5 years:

YEAR	_____	TRFR	_____
YEAR	_____	TRFR	_____
YEAR	_____	TRFR	_____
YEAR	_____	TRFR	_____
YEAR	_____	TRFR	_____



Total number of man-hours worked for the last 5 Years:

YEAR	_____	TOTAL NUMBER OF MAN-HOURS	_____
YEAR	_____	TOTAL NUMBER OF MAN-HOURS	_____
YEAR	_____	TOTAL NUMBER OF MAN-HOURS	_____
YEAR	_____	TOTAL NUMBER OF MAN-HOURS	_____
YEAR	_____	TOTAL NUMBER OF MAN-HOURS	_____

Provide Contractor's (and Contractor's proposed Subcontractors and Suppliers furnishing or performing Work having a value in excess of 10 percent of the total amount of the Bid) Days Away From Work, Days of Restricted Work Activity or Job Transfer (DART) incidence rate for the particular industry or type of Work to be performed by Contractor and each of Contractor's proposed Subcontractors and Suppliers) for the last 5 years:

YEAR	_____	DART	_____
YEAR	_____	DART	_____
YEAR	_____	DART	_____
YEAR	_____	DART	_____
YEAR	_____	DART	_____

**12. EQUIPMENT:**

MAJOR EQUIPMENT:

List on **Schedule C** all pieces of major equipment available for use on Owner's Project.

I HEREBY CERTIFY THAT THE INFORMATION SUBMITTED HEREWITH, INCLUDING ANY ATTACHMENTS, IS TRUE TO THE BEST OF MY KNOWLEDGE AND BELIEF.

NAME OF ORGANIZATION: \_\_\_\_\_

BY: \_\_\_\_\_

TITLE: \_\_\_\_\_

DATED: \_\_\_\_\_

NOTARY ATTEST:

SUBSCRIBED AND SWORN TO BEFORE ME

THIS \_\_\_\_\_ DAY OF \_\_\_\_\_, 20\_\_

NOTARY PUBLIC - STATE OF \_\_\_\_\_

MY COMMISSION EXPIRES: \_\_\_\_\_

REQUIRED ATTACHMENTS

1. Schedule A (Current Experience).
2. Schedule B (Previous Experience).
3. Schedule C (Major Equipment).
4. Audited balance sheet for each of the last 3 years for firm named in Section 1.
5. Evidence of authority for individuals listed in Section 7 to bind organization to an agreement.
6. Resumes of officers and key individuals (including Safety Officer) of firm named in Section 1.
7. Required safety program submittals listed in Section 13.
8. Additional items as pertinent.

## SCHEDULE A

### CURRENT EXPERIENCE

Project Name	Owner's Contact Person	Design Engineer	Contract Date	Type of Work	Status	Cost of Work
	Name: Address: Telephone:	Name: Company: Telephone:				
	Name: Address: Telephone:	Name: Company: Telephone:				
	Name: Address: Telephone:	Name: Company: Telephone:				
	Name: Address: Telephone:	Name: Company: Telephone:				
	Name: Address: Telephone:	Name: Company: Telephone:				
	Name: Address: Telephone:	Name: Company: Telephone:				
	Name: Address: Telephone:	Name: Company: Telephone:				
	Name: Address: Telephone:	Name: Company: Telephone:				

## SCHEDULE B

PREVIOUS EXPERIENCE (Include ALL Projects Completed within last 5 years)

Project Name	Owner's Contact Person	Design Engineer	Contract Date	Type of Work	Status	Cost of Work
	Name: Address: Telephone:	Name: Company: Telephone:				
	Name: Address: Telephone:	Name: Company: Telephone:				
	Name: Address: Telephone:	Name: Company: Telephone:				
	Name: Address: Telephone:	Name: Company: Telephone:				
	Name: Address: Telephone:	Name: Company: Telephone:				
	Name: Address: Telephone:	Name: Company: Telephone:				
	Name: Address: Telephone:	Name: Company: Telephone:				
	Name: Address: Telephone:	Name: Company: Telephone:				

## SCHEDULE B

PREVIOUS EXPERIENCE (Include ALL Projects Completed within last 5 years)

Project Name	Owner's Contact Person	Design Engineer	Contract Date	Type of Work	Status	Cost of Work
	Name: Address: Telephone:	Name: Company: Telephone:				
	Name: Address: Telephone:	Name: Company: Telephone:				
	Name: Address: Telephone:	Name: Company: Telephone:				
	Name: Address: Telephone:	Name: Company: Telephone:				
	Name: Address: Telephone:	Name: Company: Telephone:				
	Name: Address: Telephone:	Name: Company: Telephone:				
	Name: Address: Telephone:	Name: Company: Telephone:				
	Name: Address: Telephone:	Name: Company: Telephone:				

SCHEDULE C - LIST OF MAJOR EQUIPMENT AVAILABLE

ITEM	PURCHASE DATE	CONDITION	ACQUIRED VALUE

## BID BOND

Any singular reference to Bidder, Surety, Owner or other party shall be considered plural where applicable.

---

BIDDER (*Name and Address*):

SURETY (*Name, and Address of Principal Place of Business*):

OWNER (*Name and Address*): Grayson County Water District  
21 Shull White Road  
Leitchfield, Kentucky 42754

BID

Bid Due Date:

Description: East – West Interconnect Project – Phase 2

Contract No. 6 – Water Distribution System Improvements Project

BOND

Bond Number:

Date:

Penal sum \_\_\_\_\_ \$ \_\_\_\_\_

(Words)

(Figures)

Surety and Bidder, intending to be legally bound hereby, subject to the terms set forth below, do each cause this Bid Bond to be duly executed by an authorized officer, agent, or representative.

**BIDDER**

**SURETY**

\_\_\_\_\_  
(Seal)

\_\_\_\_\_  
(Seal)

Bidder's Name and Corporate Seal

Surety's Name and Corporate Seal

By:

\_\_\_\_\_  
Signature

By:

\_\_\_\_\_  
Signature (Attach Power of Attorney)

\_\_\_\_\_  
Print Name

\_\_\_\_\_  
Print Name

\_\_\_\_\_  
Title

\_\_\_\_\_  
Title

Attest:

\_\_\_\_\_  
Signature

Attest:

\_\_\_\_\_  
Signature

\_\_\_\_\_  
Title

\_\_\_\_\_  
Title

*Note: Addresses are to be used for giving any required notice.*

*Provide execution by any additional parties, such as joint venturers, if necessary.*

1. Bidder and Surety, jointly and severally, bind themselves, their heirs, executors, administrators, successors, and

assigns to pay to Owner upon default of Bidder the penal sum set forth on the face of this Bond. Payment of the penal sum is the extent of Bidder's and Surety's liability. Recovery of such penal sum under the terms of this Bond shall be Owner's sole and exclusive remedy upon default of Bidder.

2. Default of Bidder shall occur upon the failure of Bidder to deliver within the time required by the Bidding Documents (or any extension thereof agreed to in writing by Owner) the executed Agreement required by the Bidding Documents and any performance and payment bonds required by the Bidding Documents.

3. This obligation shall be null and void if:

3.1 Owner accepts Bidder's Bid and Bidder delivers within the time required by the Bidding Documents (or any extension thereof agreed to in writing by Owner) the executed Agreement required by the Bidding Documents and any performance and payment bonds required by the Bidding Documents, or

3.2 All Bids are rejected by Owner, or

3.3 Owner fails to issue a Notice of Award to Bidder within the time specified in the Bidding Documents (or any extension thereof agreed to in writing by Bidder and, if applicable, consented to by Surety when required by Paragraph 5 hereof).

4. Payment under this Bond will be due and payable upon default of Bidder and within 30 calendar days after receipt by Bidder and Surety of written notice of default from Owner, which notice will be given with reasonable promptness, identifying this Bond and the Project and including a statement of the amount due.

5. Surety waives notice of any and all defenses based on or arising out of any time extension to issue Notice of Award agreed to in writing by Owner and Bidder, provided that the total time for issuing Notice of Award including extensions shall not in the aggregate exceed 120 days from the Bid due date without Surety's written consent.

6. No suit or action shall be commenced under this Bond prior to 30 calendar days after the notice of default required in Paragraph 4 above is received by Bidder and Surety and in no case later than one year after the Bid due date.

7. Any suit or action under this Bond shall be commenced only in a court of competent jurisdiction located in the state in which the Project is located.

8. Notices required hereunder shall be in writing and sent to Bidder and Surety at their respective addresses shown on the face of this Bond. Such notices may be sent by personal delivery, commercial courier, or by United States Registered or Certified Mail, return receipt requested, postage pre-paid, and shall be deemed to be effective upon receipt by the party concerned.

9. Surety shall cause to be attached to this Bond a current and effective Power of Attorney evidencing the authority of the officer, agent, or representative who executed this Bond on behalf of Surety to execute, seal, and deliver such Bond and bind the Surety thereby.

10. This Bond is intended to conform to all applicable statutory requirements. Any applicable requirement of any applicable statute that has been omitted from this Bond shall be deemed to be included herein as if set forth at length. If any provision of this Bond conflicts with any applicable statute, then the provision of said statute shall govern and the remainder of this Bond that is not in conflict therewith shall continue in full force and effect.

11. The term "Bid" as used herein includes a Bid, offer, or proposal as applicable.



**COMPLIANCE STATEMENT**

This statement relates to a proposed contract with \_\_\_\_\_

\_\_\_\_\_  
*(Name of borrower or grantee)*

who expects to finance the contract with assistance from either the Rural Housing Service (RHS), Rural Business-Cooperative Service (RBS), or the Rural Utilities Service (RUS) or their successor agencies, United States Department of Agriculture (whether by a loan, grant, loan insurance, guarantee, or other form of financial assistance). I am the undersigned bidder or prospective contractor, I represent that:

1.  I have,  have not, participated in a previous contract or subcontract subject to Executive Order 11246 (regarding equal employment opportunity) or a preceding similar Executive Order.
2. If I have participated in such a contract or subcontract,  I have,  have not, filed all compliance reports that have been required to file in connection with the contract or subcontract.

If the proposed contract is for \$50,000 or more and I have 50 or more employees, I also represent that:

3.  I have,  have not previously had contracts subject to the written affirmative action programs requirements of the Secretary of Labor.
4. If I have participated in such a contract or subcontract,  I have,  have not developed and placed on file at each establishment affirmative action programs as required by the rules and regulations of the Secretary of Labor.

I understand that if I have failed to file any compliance reports that have been required of me, I am not eligible and will not be eligible to have my bid considered or to enter into the proposed contract unless and until I make an arrangement regarding such reports that is satisfactory to either the RHS, RBS or RUS, or to the office where the reports are required to be filed.

I also certify that I do not maintain or provide for my employees any segregated facilities at any of my establishments, and that I do not permit my employees to perform their services at any location, under my control, where segregated facilities are maintained. I certify further that I will not maintain or provide for my employees any segregated facilities at any of my establishments, and that I will not permit my employees to perform their services at any location, under my control, where segregated facilities are maintained. I agree that a breach of this certification is a violation of the Equal Opportunity clause in my contract. As used in this certification, the term "segregated facilities" means any waiting rooms, work areas, restrooms and wash rooms, restaurants and other eating areas time clocks, locker rooms and other storage or dressing areas, parking lots, drinking fountains, recreation or entertainment areas, transportation, and housing facilities provided for employees which are segregated by explicit directive or are in fact segregated on the basis of race, creed, color, or national origin, because of habit, local custom, or otherwise. I further agree that (except where I have obtained identical certifications for proposed subcontractors for specific time periods) I will obtain identical certifications from proposed subcontractors prior to the award of subcontracts exceeding \$10,000 which are not exempt from the provisions of the Equal Opportunity clause; that I will retain such certifications in my files; and that I will forward the following notice to such proposed subcontractors (except where the proposed subcontractors have submitted identical certifications for specific time periods): (See Reverse).

---

*According to the Paperwork Reduction Act of 1995, an agency may not conduct or sponsor, and a person is not required to respond to a collection of information unless it displays the valid OMB control number. The valid OMB control number for this information collection is 0575-0018. The time required to complete this information collection is estimated to average 10 minutes per response, including the time for reviewing instructions, searching existing data sources, gathering and maintaining the data needed, and completing and reviewing the collection of information.*

---

**NOTICE TO PROSPECTIVE SUBCONTRACTORS OF REQUIREMENTS FOR  
CERTIFICATIONS OF NON-SEGREGATED FACILITIES**

A certification of Nonsegregated Facilities, as required by the May 9, 1967, order (32F.R. 7439, may 19, 1967) on Elimination of Segregated Facilities, by the Secretary of Labor, must be submitted prior to the award of a subcontract exceeding \$ 10,000 which is not exempt from the provisions of the Equal Opportunity clause. The certification may be submitted either for each subcontract or for all subcontracts during a period (i.e., quarterly, semiannually, or annually).

NOTE: The penalty for making false statements in offers is prescribed in 18 U.S.C. 1001.

Date \_\_\_\_\_

\_\_\_\_\_  
*(Signature of Bidder or Prospective Contractor)*

\_\_\_\_\_  
*Address (including Zip Code)*

CERTIFICATION FOR CONTRACTS, GRANTS AND LOANS

The undersigned certifies, to the best of his or her knowledge and belief, that:

1. No Federal appropriated funds have been paid or will be paid, by or on behalf of the undersigned, to any person for influencing or attempting to influence an officer or employee of any agency, a Member of Congress, an officer or employee of Congress, or an employee of a Member of Congress in connection with the awarding of any Federal contract, the making of any Federal grant or Federal loan, and the extension, continuation, renewal, amendment, or modification of any Federal contract, grant or loan.

2. If any funds other than Federal appropriated funds have been paid or will be paid to any person for influencing or attempting to influence an officer or employee of any agency, a Member of Congress, an officer or employee of Congress, or an employee of a Member of Congress in connection with this Federal contract, grant or loan, the undersigned shall complete and submit Standard Form - LLL, "Disclosure of Lobbying Activities," in accordance with its instructions.

3. The undersigned shall require that the language of this certification be included in the award documents for all subawards at all tiers (including contracts, subcontracts, and subgrants under grants and loans) and that all subrecipients shall certify and disclose accordingly.

This certification is a material representation of fact upon which reliance was placed when this transaction was made or entered into. Submission of this certification is a prerequisite for making or entering into this transaction imposed by section 1352, title 31, U.S. Code. Any person who fails to file the required certification shall be subject to a civil penalty of not less than \$10,000 and not more than \$100,000 for each such failure.

\_\_\_\_\_  
(name)

\_\_\_\_\_  
(date)

\_\_\_\_\_  
(title)

oOo

**U.S. DEPARTMENT OF AGRICULTURE**

---

**Certification Regarding Debarment, Suspension, Ineligibility  
and Voluntary Exclusion - Lower Tier Covered Transactions**

---

This certification is required by the regulations implementing Executive Order 12549, Debarment and Suspension, 7 CFR part 3017, Section 3017.510, Participants' responsibilities. The regulations were published as Part IV of the January 30, 1989, Federal Register (pages 4722-4733). Copies of the regulations may be obtained by contacting the Department of Agriculture agency with which this transaction originated.

**(BEFORE COMPLETING CERTIFICATION, READ INSTRUCTIONS ON REVERSE)**

- (1) The prospective lower tier participant certifies, by submission of this proposal, that neither it nor its principals is presently debarred, suspended, proposed for debarment, declared ineligible, or voluntarily excluded from participation in this transaction by any Federal department or agency.
- (2) Where the prospective lower tier participant is unable to certify to any of the statements in this certification, such prospective participant shall attach an explanation to this proposal.

---

Organization Name

PR/Award Number or Project Name

---

Name(s) and Title(s) of Authorized Representative(s)

---

Signature(s)

Date

**Instructions for Certification**

1. By signing and submitting this form, the prospective lower tier participant is providing the certification set out on the reverse side in accordance with these instructions.
2. The certification in this clause is a material representation of fact upon which reliance was placed when this transaction was entered into. If it is later determined that the prospective lower tier participant knowingly rendered an erroneous certification, in addition to other remedies available to the Federal Government, the department or agency with which this transaction originated may pursue available remedies, including suspension and/or debarment.
3. The prospective lower tier participant shall provide immediate written notice to the person to which this proposal is submitted if at any time the prospective lower tier participant learns that its certification was erroneous when submitted or has become erroneous by reason of changed circumstances.
4. The terms "covered transaction," "debarred," "suspended," "ineligible," "lower tier covered transaction," "participant," "person," "primary covered transaction," "principal," "proposal," and "voluntarily excluded," as used in this clause, have the meanings set out in the Definitions and Coverage sections of rules implementing Executive Order 12549. You may contact the person to which this proposal is submitted for assistance in obtaining a copy of those regulations.
5. The prospective lower tier participant agrees by submitting this form that, should the proposed covered transaction be entered into, it shall not knowingly enter into any lower tier covered transaction with a person who is debarred, suspended, declared ineligible, or voluntarily excluded from participation in this covered transaction, unless authorized by the department or agency with which this transaction originated.
6. The prospective lower tier participant further agrees by submitting this form that it will include this clause titled "Certification Regarding Debarment, Suspension, Ineligibility and Voluntary Exclusion - Lower Tier Covered Transaction," without modification, in all lower tier covered transaction and in all solicitations for lower tier covered transactions.
7. A participant in a covered transaction may rely upon a certification of a prospective participant in a lower tier covered transaction that is not debarred, suspended, ineligible, or voluntarily excluded from the covered transaction, unless it knows that the certification is erroneous. A participant may decide the method and frequency by which it determines the eligibility of its principals. Each participant may, but is not required to, check the Nonprocurement List.
8. Nothing contained in the foregoing shall be construed to require establishment of a system of records in order to render in good faith the certification required by this clause. The knowledge and information of a participant is not required to exceed that which is normally possessed by a prudent person in the ordinary course of business dealings.
9. Except for transactions authorized under paragraph 5 of these instructions, if a participant in a covered transaction knowingly enters into a lower tier covered transaction with a person who is suspended, debarred, ineligible, or voluntarily excluded from participation in this transaction, in addition to other remedies available to the Federal Government, the department or agency with which this transaction originated may pursue available remedies, including suspension and/or debarment.

**NOTICE OF AWARD**

---

Date of Issuance:

Owner: Grayson County Water District      Owner's Contract No.: Contract No. 6  
Engineer: Kentucky Engineering Group, PLLC      Engineer's Project No.: 20016  
Project: Water Distribution System      Contract Name: Water Distribution System  
Improvements Project      Improvements Project

Bidder:

Bidder's Address:

**TO BIDDER:**

You are notified that Owner has accepted your Bid dated \_\_\_\_\_ for the above Contract, and that you are the Successful Bidder and are awarded a Contract for:

Contract No. 6 – Water Distribution System Improvements Project \_\_\_\_\_ .

The Contract Price of the awarded Contract is: \$ \_\_\_\_\_

[ 0 ] unexecuted counterparts of the Agreement accompany this Notice of Award, and one copy of the Contract Documents accompanies this Notice of Award, or has been transmitted or made available to Bidder electronically. *[revise if multiple copies accompany the Notice of Award]*

a set of the Drawings will be delivered separately from the other Contract Documents.

You must comply with the following conditions precedent within 15 days of the date of this Notice of Award:

1. Deliver to Owner [ 6 ] counterparts of the Agreement, fully executed by Bidder.
2. Deliver with the executed Agreement(s) the Contract security *[e.g., performance and payment bonds]* and insurance documentation as specified in the Instructions to Bidders and General Conditions, Articles 2 and 6.
3. Other conditions precedent (if any):

Failure to comply with these conditions within the time specified will entitle Owner to consider you in default, annul this Notice of Award, and declare your Bid security forfeited.

Within ten days after you comply with the above conditions, Owner will return to you one fully executed counterpart of the Agreement, together with any additional copies of the Contract Documents as indicated in Paragraph 2.02 of the General Conditions.

---

Owner: Grayson County Water District

Authorized Signature

By:

Title: Chairman

Copy: Engineer

This document has important legal consequences; consultation with an attorney is encouraged with respect to its use or modification. This document should be adapted to the particular circumstances of the contemplated Project and the controlling Laws and Regulations.

**AGREEMENT  
BETWEEN OWNER AND CONTRACTOR FOR  
CONSTRUCTION CONTRACT (STIPULATED PRICE)**

Prepared by



Issued and Published Jointly by



Endorsed by



Copyright © 2013:

National Society of Professional Engineers  
1420 King Street, Alexandria, VA 22314-2794  
(703) 684-2882  
[www.nspe.org](http://www.nspe.org)

American Council of Engineering Companies  
1015 15th Street N.W., Washington, DC 20005  
(202) 347-7474  
[www.acec.org](http://www.acec.org)

American Society of Civil Engineers  
1801 Alexander Bell Drive, Reston, VA 20191-4400  
(800) 548-2723  
[www.asce.org](http://www.asce.org)

The copyright for this EJCDC document is owned jointly by the three sponsoring organizations listed above. The National Society of Professional Engineers is the Copyright Administrator for the EJCDC documents; please direct all inquiries regarding EJCDC copyrights to NSPE.

NOTE: EJCDC publications may be purchased at [www.ejcdc.org](http://www.ejcdc.org), or from any of the sponsoring organizations above.



## INTRODUCTION

This Agreement between Owner and Contractor for Construction Contract (Stipulated Price) ("Agreement") has been prepared for use with the Suggested Instructions to Bidders for Construction Contracts ("Instructions to Bidders") (EJCDC® C-200, 2013 Edition); the Suggested Bid Form for Construction Contracts ("Bid Form") (EJCDC® C 410, 2013 Edition); and the Standard General Conditions of the Construction Contract ("General Conditions") (EJCDC® C-700, 2013 Edition). Their provisions are interrelated, and a change in one may necessitate a change in the others. See also the Guide to the Preparation of Supplementary Conditions (EJCDC® C-800, 2013 Edition), and the Commentary on the 2013 EJCDC Construction Documents (EJCDC® C-001, 2013 Edition).

In construction contracting, as a general matter the "agreement" is the legal instrument executed (signed) by the project owner and the construction contractor, binding the parties to the terms of the contract. See CSI Project Delivery Practice Guide (2011), Section 11.1.2, p. 210, and CSI Construction Specification Practice Guide (2011), Section 5.1, p. 75. This EJCDC Agreement form serves that basic function, by identifying the parties and Contract Documents, and establishing the Contract Price and Contract Times. This Agreement form is specifically intended for stipulated price (fixed price) contracts—that is, contracts in which Owner and Contractor identify specific lump sums and unit prices as Contractor's compensation for performing the Work. For construction contracts in which the Contract Price is primarily based on costs incurred during construction, users should select EJCDC® C-525, Agreement between Owner and Contractor for Construction Contract (Cost-Plus).

This Agreement form is drafted to be flexible enough to be used on projects that are competitively bid, and for public and private contracts that are negotiated or awarded through a proposal process or otherwise. On competitively bid projects, the following documentary information would typically be made available to bidders:

- Bidding Requirements, which include the Advertisement or invitation to bid, the Instructions to Bidders, and the Bid Form that is suggested or prescribed, all of which provide information and guidance for all Bidders, and Bid Form supplements (if any) such as Bid Bond and Qualifications Statement.
- Contract Documents, which include the Agreement, performance and payment bonds, the General Conditions, the Supplementary Conditions, the Drawings, and the Specifications.
- Documents referred to in the Supplementary Conditions or elsewhere as being of interest to bidders for reference purposes, but which are not Contract Documents.

Together, the Bidding Requirements and the Contract Documents are referred to as the Bidding Documents. (The terms "Bidding Documents," "Bidding Requirements," and "Contract Documents" are defined in Article 1 of the General Conditions.) The Bidding Requirements are not Contract Documents because much of their substance pertains to the relationships prior to the award of the Contract and has little effect or impact thereafter. Many contracts are awarded without even going through a bidding process, and thus have no Bidding Requirements, illustrating that the bidding items are typically superfluous to the formation of a binding and comprehensive construction contract. In some cases, however, a bid or proposal will contain numerous line items and their prices; in such case the actual bid or proposal document may be attached as an exhibit to the Agreement to avoid extensive rekeying.

Suggested provisions are accompanied by “Notes to User” and bracketed notes and prompts to assist in preparing the Agreement. The provisions have been coordinated with the other forms produced by EJCDC. Much of the language should be usable on most projects, but modifications and additional provisions will often be necessary. When modifying the suggested language or writing additional provisions, the user must check the other documents thoroughly for conflicts and coordination of terms, and make appropriate revisions in all affected documents.

All parties involved in construction projects benefit significantly from a standardized approach in the location of subject matter throughout the documents. Experience confirms the danger of addressing the same subject matter in more than one location; doing so frequently leads to confusion and unanticipated legal consequences. When preparing documents for a construction project, careful attention should be given to the guidance provided in EJCDC® N-122/AIA® A521, Uniform Location of Subject Matter (2012 Edition), available at no charge from the EJCDC website, [www.ejcdc.org](http://www.ejcdc.org), and from the websites of EJCDC’s sponsoring organizations.

CSI MasterFormat™ (50-Division format) designates Document “00 52 XX” for various forms of the owner-contractor agreement. If this format is used, the first page of the Agreement would be numbered 00 52 13-1 (or other appropriate third pair of numbers, in accordance with MasterFormat™).

Instructions and restrictions regarding the use of this document are set out in the License Agreement that accompanied the document at the time of purchase. To prepare the Agreement for inclusion in a Project Manual or for use in a specific contractual engagement, (1) remove the cover pages and this Introduction, (2) fill in Project-specific information and make revisions to the Agreement, following the guidance in the Notes to Users and bracketed notes and prompts, and the advice of legal counsel, and (3) delete the Notes to Users and bracketed notes and prompts.

**AGREEMENT  
BETWEEN OWNER AND CONTRACTOR  
FOR CONSTRUCTION CONTRACT (STIPULATED PRICE)**

THIS AGREEMENT is by and between Grayson County Water District (“Owner”) and  
\_\_\_\_\_ (“Contractor”).

Owner and Contractor hereby agree as follows:

**ARTICLE 1 – WORK**

1.01 Contractor shall complete all Work as specified or indicated in the Contract Documents. The Work is generally described as follows:

**ARTICLE 2 – THE PROJECT**

2.01 The Project, of which the Work under the Contract Documents is a part, is generally described as follows: Contract No. 6 – Water Distribution System Improvements including approximately 480 LF of 18”, 23,200 LF of 16”, 260 LF of 14”, 26,020 LF of 12”, 320 LF of 10” and 6,155 LF of 8” water main, one new master meter and all related appurtenances as shown on the DRAWINGS and described in the SPECIFICATIONS.

**ARTICLE 3 – ENGINEER THE PART OF THE PROJECT THAT PERTAINS TO THE WORK HAS BEEN DESIGNED BY KENTUCKY ENGINEERING GROUP, PLLC.**

3.01 The Owner has retained Kentucky Engineering Group, PLLC (“Engineer”) to act as Owner’s representative, assume all duties and responsibilities, and have the rights and authority assigned to Engineer in the Contract Documents in connection with the completion of the Work in accordance with the Contract Documents.

**ARTICLE 4 – CONTRACT TIMES**

4.01 *Time of the Essence*

A. All time limits for Milestones, if any, Substantial Completion, and completion and readiness for final payment as stated in the Contract Documents are of the essence of the Contract.

4.02 *Contract Times: Days*

A. The Work will be substantially completed within 425 days after the date when the Contract Times commence to run as provided in Paragraph 4.01 of the General Conditions, and completed and ready for final payment in accordance with Paragraph 15.06 of the General Conditions within 455 days after the date when the Contract Times commence to run.

4.03 *Liquidated Damages*

A. Contractor and Owner recognize that time is of the essence as stated in Paragraph 4.01 above and that Owner will suffer financial and other losses if the Work is not completed and Milestones not achieved within the times specified in Paragraph 4.02 above, plus any extensions thereof allowed in accordance with the Contract. The parties also recognize the delays, expense, and difficulties involved in proving in a legal or arbitration proceeding the

actual loss suffered by Owner if the Work is not completed on time. Accordingly, instead of requiring any such proof, Owner and Contractor agree that as liquidated damages for delay (but not as a penalty):

1. Substantial Completion: Contractor shall pay Owner \$ 500 for each day that expires after the time (as duly adjusted pursuant to the Contract) specified in Paragraph 4.02.A above for Substantial Completion until the Work is substantially completed.

## ARTICLE 5 – CONTRACT PRICE

5.01 Owner shall pay Contractor for completion of the Work in accordance with the Contract Documents the amounts that follow, subject to adjustment under the Contract:

- A. For all Work, at the prices stated in Contractor’s Bid, attached hereto as an exhibit.

## ARTICLE 6 – PAYMENT PROCEDURES

6.01 *Submittal and Processing of Payments*

- A. Contractor shall submit Applications for Payment in accordance with Article 15 of the General Conditions. Applications for Payment will be processed by Engineer as provided in the General Conditions.

6.02 *Progress Payments; Retainage*

- A. Owner shall make progress payments on account of the Contract Price on the basis of Contractor’s Applications for Payment on or about the TBD day of each month during performance of the Work as provided in Paragraph 6.02.A.1 below, provided that such Applications for Payment have been submitted in a timely manner and otherwise meet the requirements of the Contract. All such payments will be measured by the Schedule of Values established as provided in the General Conditions (and in the case of Unit Price Work based on the number of units completed) or, in the event there is no Schedule of Values, as provided elsewhere in the Contract.

1. Prior to Substantial Completion, progress payments will be made in an amount equal to the percentage indicated below but, in each case, less the aggregate of payments previously made and less such amounts as Owner may withhold, including but not limited to liquidated damages, in accordance with the Contract

- a. 95 percent of Work completed (with the balance being retainage). If the Work has been 50 percent completed as determined by Engineer, and if the character and progress of the Work have been satisfactory to Owner and Engineer, then as long as the character and progress of the Work remain satisfactory to Owner and Engineer, there will be no additional retainage; and
- b. 100 percent of cost of materials and equipment not incorporated in the Work (with the balance being retainage).

- B. Upon Substantial Completion, Owner shall pay an amount sufficient to increase total payments to Contractor to 95 percent of the Work completed, less such amounts set off by Owner pursuant to Paragraph 15.01.E of the General Conditions, and less 5 percent of Engineer’s estimate of the value of Work to be completed or corrected as shown on the punch list of items to be completed or corrected prior to final payment.

### 6.03 *Final Payment*

- A. Upon final completion and acceptance of the Work in accordance with Paragraph 15.06 of the General Conditions, Owner shall pay the remainder of the Contract Price as recommended by Engineer as provided in said Paragraph 15.06.

### ARTICLE 7 – INTEREST

- 7.01 All amounts not paid when due shall bear interest at the rate of 3.5 percent per annum.

### ARTICLE 8 – CONTRACTOR’S REPRESENTATIONS

- 8.01 In order to induce Owner to enter into this Contract, Contractor makes the following representations:
- A. Contractor has examined and carefully studied the Contract Documents, and any data and reference items identified in the Contract Documents.
  - B. Contractor has visited the Site, conducted a thorough, alert visual examination of the Site and adjacent areas, and become familiar with and is satisfied as to the general, local, and Site conditions that may affect cost, progress, and performance of the Work.
  - C. Contractor is familiar with and is satisfied as to all Laws and Regulations that may affect cost, progress, and performance of the Work.
  - D. Contractor has considered the information known to Contractor itself; information commonly known to contractors doing business in the locality of the Site; information and observations obtained from visits to the Site; the Contract Documents; and the Site-related reports and drawings identified in the Contract Documents, with respect to the effect of such information, observations, and documents on (1) the cost, progress, and performance of the Work; (2) the means, methods, techniques, sequences, and procedures of construction to be employed by Contractor; and (3) Contractor’s safety precautions and programs.
  - E. Based on the information and observations referred to in the preceding paragraph, Contractor agrees that no further examinations, investigations, explorations, tests, studies, or data are necessary for the performance of the Work at the Contract Price, within the Contract Times, and in accordance with the other terms and conditions of the Contract.
  - F. Contractor is aware of the general nature of work to be performed by Owner and others at the Site that relates to the Work as indicated in the Contract Documents.
  - G. Contractor has given Engineer written notice of all conflicts, errors, ambiguities, or discrepancies that Contractor has discovered in the Contract Documents, and the written resolution thereof by Engineer is acceptable to Contractor.
  - H. The Contract Documents are generally sufficient to indicate and convey understanding of all terms and conditions for performance and furnishing of the Work.
  - I. Contractor’s entry into this Contract constitutes an incontrovertible representation by Contractor that without exception all prices in the Agreement are premised upon performing and furnishing the Work required by the Contract Documents.

## ARTICLE 9 – CONTRACT DOCUMENTS

### 9.01 Contents

A. The Contract Documents consist of the following:

1. This Agreement (pages 1 to 6, inclusive).
2. Performance bond (pages 1 to 3, inclusive).
3. Payment bond (pages 1 to 3, inclusive).
4. Other bonds.
  - a. [ ] (pages [ ] to [ ], inclusive).

*NOTE(S) TO USER:*

*Such other bonds might include maintenance or warranty bonds intended to manage risk after completion of the Work.*

5. General Conditions (pages 1 to 73, inclusive).
  6. Supplementary Conditions (pages 1 to 8, inclusive).
  7. Specifications as listed in the table of contents of the Project Manual.
  8. Drawings (not attached but incorporated by reference) consisting of \_\_ sheets with each sheet bearing the following general title: Contract No. 6 – Water Distribution System Improvements Project [or] the Drawings listed on the attached sheet index.
  9. Addenda (numbers 1 to 1, inclusive).
  10. Exhibits to this Agreement (enumerated as follows):
    - a. Contractor’s Bid (pages [ ] to [ ], inclusive).
  11. The following which may be delivered or issued on or after the Effective Date of the Contract and are not attached hereto:
    - a. Change Orders
- B. The documents listed in Paragraph 9.01.A are attached to this Agreement (except as expressly noted otherwise above).
- C. There are no Contract Documents other than those listed above in this Article 9.
- D. The Contract Documents may only be amended, modified, or supplemented as provided in the General Conditions.

## ARTICLE 10 – MISCELLANEOUS

### 10.01 Terms

A. Terms used in this Agreement will have the meanings stated in the General Conditions and the Supplementary Conditions.

### 10.02 Assignment of Contract

A. Unless expressly agreed to elsewhere in the Contract, no assignment by a party hereto of any rights under or interests in the Contract will be binding on another party hereto without the written consent of the party sought to be bound; and, specifically but without

limitation, money that may become due and money that is due may not be assigned without such consent (except to the extent that the effect of this restriction may be limited by law), and unless specifically stated to the contrary in any written consent to an assignment, no assignment will release or discharge the assignor from any duty or responsibility under the Contract Documents.

#### 10.03 *Successors and Assigns*

- A. Owner and Contractor each binds itself, its successors, assigns, and legal representatives to the other party hereto, its successors, assigns, and legal representatives in respect to all covenants, agreements, and obligations contained in the Contract Documents.

#### 10.04 *Severability*

- A. Any provision or part of the Contract Documents held to be void or unenforceable under any Law or Regulation shall be deemed stricken, and all remaining provisions shall continue to be valid and binding upon Owner and Contractor, who agree that the Contract Documents shall be reformed to replace such stricken provision or part thereof with a valid and enforceable provision that comes as close as possible to expressing the intention of the stricken provision.

#### 10.05 *Contractor's Certifications*

- A. Contractor certifies that it has not engaged in corrupt, fraudulent, collusive, or coercive practices in competing for or in executing the Contract. For the purposes of this Paragraph 10.05:
1. "corrupt practice" means the offering, giving, receiving, or soliciting of any thing of value likely to influence the action of a public official in the bidding process or in the Contract execution;
  2. "fraudulent practice" means an intentional misrepresentation of facts made (a) to influence the bidding process or the execution of the Contract to the detriment of Owner, (b) to establish Bid or Contract prices at artificial non-competitive levels, or (c) to deprive Owner of the benefits of free and open competition;
  3. "collusive practice" means a scheme or arrangement between two or more Bidders, with or without the knowledge of Owner, a purpose of which is to establish Bid prices at artificial, non-competitive levels; and
  4. "coercive practice" means harming or threatening to harm, directly or indirectly, persons or their property to influence their participation in the bidding process or affect the execution of the Contract.

#### 10.06 *Other Provisions*

- A. Owner stipulates that if the General Conditions that are made a part of this Contract are based on EJCDC® C-700, Standard General Conditions for the Construction Contract, published by the Engineers Joint Contract Documents Committee®, and if Owner is the party that has furnished said General Conditions, then Owner has plainly shown all modifications to the standard wording of such published document to the Contractor, through a process such as highlighting or "track changes" (redline/strikeout), or in the Supplementary Conditions.

IN WITNESS WHEREOF, Owner and Contractor have signed this Agreement.

This Agreement will be effective on June 29, 2020 (which is the Effective Date of the Contract).

OWNER:

CONTRACTOR:

Grayson County Water District

\_\_\_\_\_

By: \_\_\_\_\_

By: \_\_\_\_\_

Title: Chairman

Title: \_\_\_\_\_

*(If Contractor is a corporation, a partnership, or a joint venture, attach evidence of authority to sign.)*

Attest: \_\_\_\_\_

Attest: \_\_\_\_\_

Title: \_\_\_\_\_

Title: \_\_\_\_\_

Address for giving notices:

Address for giving notices:

21 Shull White Road

\_\_\_\_\_

Leitchfield, KY 42754

\_\_\_\_\_

\_\_\_\_\_

\_\_\_\_\_

License No.: \_\_\_\_\_

*(where applicable)*

*(If Owner is a corporation, attach evidence of authority to sign. If Owner is a public body, attach evidence of authority to sign and resolution or other documents authorizing execution of this Agreement.)*

*NOTE TO USER: Use in those states or other jurisdictions where applicable or required.*



**NOTICE TO PROCEED**

---

Owner:	Grayson County Water District	Owner's Contract No.:	Contract No. 6
Contractor:		Contractor's Project No.:	
Engineer:	Kentucky Engineering Group, PLLC	Engineer's Project No.:	20016
Project:	Contract No. 6 Water Distribution System Improvements Project	Contract Name:	Water Distribution System Improvements Project
		Effective Date of Contract:	

---

**TO CONTRACTOR:**

Owner hereby notifies Contractor that the Contract Times under the above Contract will commence to run on \_\_\_\_\_ . *[see Paragraph 4.01 of the General Conditions]*

On that date, Contractor shall start performing its obligations under the Contract Documents. No Work shall be done at the Site prior to such date. In accordance with the Agreement, the date of Substantial Completion is \_\_\_\_\_, and the date of readiness for final payment is \_\_\_\_\_ **or** the number of days to achieve Substantial Completion is **425**, and the number of days to achieve readiness for final payment is **455**.

Before starting any Work at the Site, Contractor must comply with the following:  
*[Note any access limitations, security procedures, or other restrictions]*

---

Owner:	Grayson County Water District
By:	Authorized Signature
Title:	Chairman
Date Issued:	

Copy: Engineer

## SECTION 00600

### INSURANCE CERTIFICATE

Certificate of Insurance shall be provided in accordance with:

#### **OWNER'S MINIMUM INSURANCE REQUIREMENTS**

The Contractor at its expense shall procure and shall maintain the insurance required in this Contract and to be provided by the Contractor. The Contractor shall require each subcontractor to procure and maintain the insurance required by this Contract and to be provided by subcontractors. At a minimum, the following insurance

Limits shall be procured:

General Liability – Commercial General Liability

Limits of Insurance - \$2,000,000 general aggregate  
 \$2,000,000 products & completed operations aggregate  
 \$1,000,000 personal & advertising  
 \$1,000,000 each occurrence

Automobile Liability – All Owned, Non-owned & Hired vehicles

Limits of Liability - \$1,000,000 per accident

Excess or Umbrella Liability

Limits of Liability - \$2,000,000

Workmen's Compensation – Statutory Coverage in each state of operations or “all states” coverage

Limits of Liability - \$100,000 each accident bodily injury  
 \$500,000 policy limit bodily injury by disease  
 \$100,000 each employee bodily injury by disease

Description of Operations

Garrard County Water Association, Kentucky and Kentucky Engineering Groups, PLLC must be added to the Commercial General Liability policy as an additional insured by Standard Endorsements CG 2010(11-85) and CG 2037 or their equivalents.

All policies, except workers compensation, shall include a waiver of subrogation.

Certificate Holder

Must list: Grayson County Water District  
 21 Shull White Road  
 Leitchfield, Kentucky 42754

Cancellation

Thirty (30) days prior written notice is required.

Builders Risk/Installation Floater

May be required in an amount equal to the contract. If above ground structures are involved in the Contract, this is required.

END OF SECTION



### PERFORMANCE BOND

CONTRACTOR *(name and address):*

SURETY *(name and address of principal place of business):*

OWNER *(name and address):*

Grayson County Water District  
21 Shull White Road  
Leitchfield, Kentucky 42754

#### CONSTRUCTION CONTRACT

Effective Date of the Agreement:

Amount:

Description *(name and location):*

#### BOND

Bond Number:

Date *(not earlier than the Effective Date of the Agreement of the Construction Contract):*

Amount:

Modifications to this Bond Form:  None  See Paragraph 16

Surety and Contractor, intending to be legally bound hereby, subject to the terms set forth below, do each cause this Performance Bond to be duly executed by an authorized officer, agent, or representative.

#### CONTRACTOR AS PRINCIPAL

#### SURETY

\_\_\_\_\_  
*(seal)*  
Contractor's Name and Corporate Seal

\_\_\_\_\_  
*(seal)*  
Surety's Name and Corporate Seal

By: \_\_\_\_\_  
Signature

By: \_\_\_\_\_  
Signature *(attach power of attorney)*

\_\_\_\_\_  
Print Name

\_\_\_\_\_  
Print Name

\_\_\_\_\_  
Title

\_\_\_\_\_  
Title

Attest: \_\_\_\_\_  
Signature

Attest: \_\_\_\_\_  
Signature

\_\_\_\_\_  
Title

\_\_\_\_\_  
Title

**Notes: (1) Provide supplemental execution by any additional parties, such as joint venturers. (2) Any singular reference to Contractor, Surety, Owner, or other party shall be considered plural where applicable.**

1. The Contractor and Surety, jointly and severally, bind themselves, their heirs, executors, administrators, successors, and assigns to the Owner for the performance of the Construction Contract, which is incorporated herein by reference.

2. If the Contractor performs the Construction Contract, the Surety and the Contractor shall have no obligation under this Bond, except when applicable to participate in a conference as provided in Paragraph 3.

3. If there is no Owner Default under the Construction Contract, the Surety's obligation under this Bond shall arise after:

3.1 The Owner first provides notice to the Contractor and the Surety that the Owner is considering declaring a Contractor Default. Such notice shall indicate whether the Owner is requesting a conference among the Owner, Contractor, and Surety to discuss the Contractor's performance. If the Owner does not request a conference, the Surety may, within five (5) business days after receipt of the Owner's notice, request such a conference. If the Surety timely requests a conference, the Owner shall attend. Unless the Owner agrees otherwise, any conference requested under this Paragraph 3.1 shall be held within ten (10) business days of the Surety's receipt of the Owner's notice. If the Owner, the Contractor, and the Surety agree, the Contractor shall be allowed a reasonable time to perform the Construction Contract, but such an agreement shall not waive the Owner's right, if any, subsequently to declare a Contractor Default;

3.2 The Owner declares a Contractor Default, terminates the Construction Contract and notifies the Surety; and

3.3 The Owner has agreed to pay the Balance of the Contract Price in accordance with the terms of the Construction Contract to the Surety or to a contractor selected to perform the Construction Contract.

4. Failure on the part of the Owner to comply with the notice requirement in Paragraph 3.1 shall not constitute a failure to comply with a condition precedent to the Surety's obligations, or release the Surety from its obligations, except to the extent the Surety demonstrates actual prejudice.

5. When the Owner has satisfied the conditions of Paragraph 3, the Surety shall promptly and at the Surety's expense take one of the following actions:

5.1 Arrange for the Contractor, with the consent of the Owner, to perform and complete the Construction Contract;

5.2 Undertake to perform and complete the Construction Contract itself, through its agents or independent contractors;

5.3 Obtain bids or negotiated proposals from qualified contractors acceptable to the Owner for a contract for performance and completion of the Construction Contract, arrange for a contract to be prepared for execution by the

Owner and a contractor selected with the Owners concurrence, to be secured with performance and payment bonds executed by a qualified surety equivalent to the bonds issued on the Construction Contract, and pay to the Owner the amount of damages as described in Paragraph 7 in excess of the Balance of the Contract Price incurred by the Owner as a result of the Contractor Default; or

5.4 Waive its right to perform and complete, arrange for completion, or obtain a new contractor, and with reasonable promptness under the circumstances:

5.4.1 After investigation, determine the amount for which it may be liable to the Owner and, as soon as practicable after the amount is determined, make payment to the Owner; or

5.4.2 Deny liability in whole or in part and notify the Owner, citing the reasons for denial.

6. If the Surety does not proceed as provided in Paragraph 5 with reasonable promptness, the Surety shall be deemed to be in default on this Bond seven days after receipt of an additional written notice from the Owner to the Surety demanding that the Surety perform its obligations under this Bond, and the Owner shall be entitled to enforce any remedy available to the Owner. If the Surety proceeds as provided in Paragraph 5.4, and the Owner refuses the payment or the Surety has denied liability, in whole or in part, without further notice the Owner shall be entitled to enforce any remedy available to the Owner.

7. If the Surety elects to act under Paragraph 5.1, 5.2, or 5.3, then the responsibilities of the Surety to the Owner shall not be greater than those of the Contractor under the Construction Contract, and the responsibilities of the Owner to the Surety shall not be greater than those of the Owner under the Construction Contract. Subject to the commitment by the Owner to pay the Balance of the Contract Price, the Surety is obligated, without duplication for:

7.1 the responsibilities of the Contractor for correction of defective work and completion of the Construction Contract;

7.2 additional legal, design professional, and delay costs resulting from the Contractor's Default, and resulting from the actions or failure to act of the Surety under Paragraph 5; and

7.3 liquidated damages, or if no liquidated damages are specified in the Construction Contract, actual damages caused by delayed performance or non-performance of the Contractor.

8. If the Surety elects to act under Paragraph 5.1, 5.3, or 5.4, the Surety's liability is limited to the amount of this Bond.

9. The Surety shall not be liable to the Owner or others for obligations of the Contractor that are unrelated to the Construction Contract, and the Balance of the Contract Price shall not be reduced or set off on account of any such unrelated

obligations. No right of action shall accrue on this Bond to any person or entity other than the Owner or its heirs, executors, administrators, successors, and assigns.

10. The Surety hereby waives notice of any change, including changes of time, to the Construction Contract or to related subcontracts, purchase orders, and other obligations.

11. Any proceeding, legal or equitable, under this Bond may be instituted in any court of competent jurisdiction in the location in which the work or part of the work is located and shall be instituted within two years after a declaration of Contractor Default or within two years after the Contractor ceased working or within two years after the Surety refuses or fails to perform its obligations under this Bond, whichever occurs first. If the provisions of this paragraph are void or prohibited by law, the minimum periods of limitations available to sureties as a defense in the jurisdiction of the suit shall be applicable.

12. Notice to the Surety, the Owner, or the Contractor shall be mailed or delivered to the address shown on the page on which their signature appears.

13. When this Bond has been furnished to comply with a statutory or other legal requirement in the location where the construction was to be performed, any provision in this Bond conflicting with said statutory or legal requirement shall be deemed deleted herefrom and provisions conforming to such statutory or other legal requirement shall be deemed incorporated herein. When so furnished, the intent is that this Bond shall be construed as a statutory bond and not as a common law bond.

#### 14. Definitions

14.1 Balance of the Contract Price: The total amount payable by the Owner to the Contractor under the Construction Contract after all proper adjustments have been

made including allowance for the Contractor for any amounts received or to be received by the Owner in settlement of insurance or other claims for damages to which the Contractor is entitled, reduced by all valid and proper payments made to or on behalf of the Contractor under the Construction Contract.

14.2 Construction Contract: The agreement between the Owner and Contractor identified on the cover page, including all Contract Documents and changes made to the agreement and the Contract Documents.

14.3 Contractor Default: Failure of the Contractor, which has not been remedied or waived, to perform or otherwise to comply with a material term of the Construction Contract.

14.4 Owner Default: Failure of the Owner, which has not been remedied or waived, to pay the Contractor as required under the Construction Contract or to perform and complete or comply with the other material terms of the Construction Contract.

14.5 Contract Documents: All the documents that comprise the agreement between the Owner and Contractor.

15. If this Bond is issued for an agreement between a contractor and subcontractor, the term Contractor in this Bond shall be deemed to be Subcontractor and the term Owner shall be deemed to be Contractor.

16. Modifications to this Bond are as follows:

## PAYMENT BOND

CONTRACTOR *(name and address)*:

SURETY *(name and address of principal place of business)*:

OWNER *(name and address)*

Grayson County Water District  
21 Shull White Road  
Leitchfield, Kentucky 42754

### CONSTRUCTION CONTRACT

Effective Date of the Agreement:

Amount:

Description *(name and location)*:

### BOND

Bond Number:

Date *(not earlier than the Effective Date of the Agreement of the Construction Contract)*:

Amount:

Modifications to this Bond Form:  None  See Paragraph 18

Surety and Contractor, intending to be legally bound hereby, subject to the terms set forth below, do each cause this Payment Bond to be duly executed by an authorized officer, agent, or representative.

### CONTRACTOR AS PRINCIPAL

### SURETY

\_\_\_\_\_ *(seal)*

Contractor's Name and Corporate Seal

\_\_\_\_\_ *(seal)*

Surety's Name and Corporate Seal

By: \_\_\_\_\_

Signature

By: \_\_\_\_\_

Signature *(attach power of attorney)*

\_\_\_\_\_  
Print Name

\_\_\_\_\_  
Print Name

\_\_\_\_\_  
Title

\_\_\_\_\_  
Title

Attest: \_\_\_\_\_

Signature

Attest: \_\_\_\_\_

Signature

\_\_\_\_\_  
Title

\_\_\_\_\_  
Title

**Notes: (1) Provide supplemental execution by any additional parties, such as joint venturers. (2) Any singular reference to Contractor, Surety, Owner, or other party shall be considered plural where applicable.**

1. The Contractor and Surety, jointly and severally, bind themselves, their heirs, executors, administrators, successors, and assigns to the Owner to pay for labor, materials, and equipment furnished for use in the performance of the Construction Contract, which is incorporated herein by reference, subject to the following terms.
2. If the Contractor promptly makes payment of all sums due to Claimants, and defends, indemnifies, and holds harmless the Owner from claims, demands, liens, or suits by any person or entity seeking payment for labor, materials, or equipment furnished for use in the performance of the Construction Contract, then the Surety and the Contractor shall have no obligation under this Bond.
3. If there is no Owner Default under the Construction Contract, the Surety's obligation to the Owner under this Bond shall arise after the Owner has promptly notified the Contractor and the Surety (at the address described in Paragraph 13) of claims, demands, liens, or suits against the Owner or the Owner's property by any person or entity seeking payment for labor, materials, or equipment furnished for use in the performance of the Construction Contract, and tendered defense of such claims, demands, liens, or suits to the Contractor and the Surety.
4. When the Owner has satisfied the conditions in Paragraph 3, the Surety shall promptly and at the Surety's expense defend, indemnify, and hold harmless the Owner against a duly tendered claim, demand, lien, or suit.
5. The Surety's obligations to a Claimant under this Bond shall arise after the following:
  - 5.1 Claimants who do not have a direct contract with the Contractor,
    - 5.1.1 have furnished a written notice of non-payment to the Contractor, stating with substantial accuracy the amount claimed and the name of the party to whom the materials were, or equipment was, furnished or supplied or for whom the labor was done or performed, within ninety (90) days after having last performed labor or last furnished materials or equipment included in the Claim; and
    - 5.1.2 have sent a Claim to the Surety (at the address described in Paragraph 13).
  - 5.2 Claimants who are employed by or have a direct contract with the Contractor have sent a Claim to the Surety (at the address described in Paragraph 13).
6. If a notice of non-payment required by Paragraph 5.1.1 is given by the Owner to the Contractor, that is sufficient to satisfy a Claimant's obligation to furnish a written notice of non-payment under Paragraph 5.1.1.
7. When a Claimant has satisfied the conditions of Paragraph 5.1 or 5.2, whichever is applicable, the Surety shall promptly and at the Surety's expense take the following actions:
  - 7.1 Send an answer to the Claimant, with a copy to the Owner, within sixty (60) days after receipt of the Claim, stating the amounts that are undisputed and the basis for challenging any amounts that are disputed; and
  - 7.2 Pay or arrange for payment of any undisputed amounts.
  - 7.3 The Surety's failure to discharge its obligations under Paragraph 7.1 or 7.2 shall not be deemed to constitute a waiver of defenses the Surety or Contractor may have or acquire as to a Claim, except as to undisputed amounts for which the Surety and Claimant have reached agreement. If, however, the Surety fails to discharge its obligations under Paragraph 7.1 or 7.2, the Surety shall indemnify the Claimant for the reasonable attorney's fees the Claimant incurs thereafter to recover any sums found to be due and owing to the Claimant.
8. The Surety's total obligation shall not exceed the amount of this Bond, plus the amount of reasonable attorney's fees provided under Paragraph 7.3, and the amount of this Bond shall be credited for any payments made in good faith by the Surety.
9. Amounts owed by the Owner to the Contractor under the Construction Contract shall be used for the performance of the Construction Contract and to satisfy claims, if any, under any construction performance bond. By the Contractor furnishing and the Owner accepting this Bond, they agree that all funds earned by the Contractor in the performance of the Construction Contract are dedicated to satisfy obligations of the Contractor and Surety under this Bond, subject to the Owner's priority to use the funds for the completion of the work.
10. The Surety shall not be liable to the Owner, Claimants, or others for obligations of the Contractor that are unrelated to the Construction Contract. The Owner shall not be liable for the payment of any costs or expenses of any Claimant under this Bond, and shall have under this Bond no obligation to make payments to or give notice on behalf of Claimants, or otherwise have any obligations to Claimants under this Bond.
11. The Surety hereby waives notice of any change, including changes of time, to the Construction Contract or to related subcontracts, purchase orders, and other obligations.

12. No suit or action shall be commenced by a Claimant under this Bond other than in a court of competent jurisdiction in the state in which the project that is the subject of the Construction Contract is located or after the expiration of one year from the date (1) on which the Claimant sent a Claim to the Surety pursuant to Paragraph 5.1.2 or 5.2, or (2) on which the last labor or service was performed by anyone or the last materials or equipment were furnished by anyone under the Construction Contract, whichever of (1) or (2) first occurs. If the provisions of this paragraph are void or prohibited by law, the minimum period of limitation available to sureties as a defense in the jurisdiction of the suit shall be applicable.
13. Notice and Claims to the Surety, the Owner, or the Contractor shall be mailed or delivered to the address shown on the page on which their signature appears. Actual receipt of notice or Claims, however accomplished, shall be sufficient compliance as of the date received.
14. When this Bond has been furnished to comply with a statutory or other legal requirement in the location where the construction was to be performed, any provision in this Bond conflicting with said statutory or legal requirement shall be deemed deleted herefrom and provisions conforming to such statutory or other legal requirement shall be deemed incorporated herein. When so furnished, the intent is that this Bond shall be construed as a statutory bond and not as a common law bond.
15. Upon requests by any person or entity appearing to be a potential beneficiary of this Bond, the Contractor and Owner shall promptly furnish a copy of this Bond or shall permit a copy to be made.
16. **Definitions**
- 16.1 **Claim:** A written statement by the Claimant including at a minimum:
1. The name of the Claimant;
  2. The name of the person for whom the labor was done, or materials or equipment furnished;
  3. A copy of the agreement or purchase order pursuant to which labor, materials, or equipment was furnished for use in the performance of the Construction Contract;
  4. A brief description of the labor, materials, or equipment furnished;
  5. The date on which the Claimant last performed labor or last furnished materials or equipment for use in the performance of the Construction Contract;
  6. The total amount earned by the Claimant for labor, materials, or equipment furnished as of the date of the Claim;
  7. The total amount of previous payments received by the Claimant; and
8. The total amount due and unpaid to the Claimant for labor, materials, or equipment furnished as of the date of the Claim.
- 16.2 **Claimant:** An individual or entity having a direct contract with the Contractor or with a subcontractor of the Contractor to furnish labor, materials, or equipment for use in the performance of the Construction Contract. The term Claimant also includes any individual or entity that has rightfully asserted a claim under an applicable mechanic's lien or similar statute against the real property upon which the Project is located. The intent of this Bond shall be to include without limitation in the terms of "labor, materials, or equipment" that part of the water, gas, power, light, heat, oil, gasoline, telephone service, or rental equipment used in the Construction Contract, architectural and engineering services required for performance of the work of the Contractor and the Contractor's subcontractors, and all other items for which a mechanic's lien may be asserted in the jurisdiction where the labor, materials, or equipment were furnished.
- 16.3 **Construction Contract:** The agreement between the Owner and Contractor identified on the cover page, including all Contract Documents and all changes made to the agreement and the Contract Documents.
- 16.4 **Owner Default:** Failure of the Owner, which has not been remedied or waived, to pay the Contractor as required under the Construction Contract or to perform and complete or comply with the other material terms of the Construction Contract.
- 16.5 **Contract Documents:** All the documents that comprise the agreement between the Owner and Contractor.
17. If this Bond is issued for an agreement between a contractor and subcontractor, the term Contractor in this Bond shall be deemed to be Subcontractor and the term Owner shall be deemed to be Contractor.
18. Modifications to this Bond are as follows:





## Contractor's Application for Payment No.

	Application Period:	Application Date:
To (Owner): Grayson County Water District	From (Contractor):	Via (Engineer): Kentucky Engineering Group, PLLC
Project: Water Distribution Ssystem Improvements Project	Contract: Contract No. 6	
Owner's Contract No.: 1	Contractor's Project No.:	Engineer's Project No.: 20016

### Application For Payment Change Order Summary

Approved Change Orders	Number	Additions	Deductions		
				1. ORIGINAL CONTRACT PRICE.....	\$ _____
				2. Net change by Change Orders.....	\$ _____
				3. Current Contract Price (Line 1 ± 2).....	\$ _____
				4. TOTAL COMPLETED AND STORED TO DATE (Column F total on Progress Estimates).....	\$ _____
				5. RETAINAGE:	
				a.     X                   Work Completed.....	\$ _____
				b.     X                   Stored Material.....	\$ _____
				c. Total Retainage (Line 5.a + Line 5.b).....	\$ _____
				6. AMOUNT ELIGIBLE TO DATE (Line 4 - Line 5.c).....	\$ _____
				7. LESS PREVIOUS PAYMENTS (Line 6 from prior Application).....	\$ _____
				8. AMOUNT DUE THIS APPLICATION.....	\$ _____
				9. BALANCE TO FINISH, PLUS RETAINAGE (Column G total on Progress Estimates + Line 5.c above).....	\$ _____
TOTALS					
NET CHANGE BY CHANGE ORDERS					

<p><b>Contractor's Certification</b></p> <p>The undersigned Contractor certifies, to the best of its knowledge, the following:</p> <p>(1) All previous progress payments received from Owner on account of Work done under the Contract have been applied on account to discharge Contractor's legitimate obligations incurred in connection with the Work covered by prior Applications for Payment;</p> <p>(2) Title to all Work, materials and equipment incorporated in said Work, or otherwise listed in or covered by this Application for Payment, will pass to Owner at time of payment free and clear of all Liens, security interests, and encumbrances (except such as are covered by a bond acceptable to Owner indemnifying Owner against any such Liens, security interest, or encumbrances); and</p> <p>(3) All the Work covered by this Application for Payment is in accordance with the Contract Documents and is not defective.</p>	
<p><b>Contractor Signature</b></p> <p>By: _____</p>	<p>Date: _____</p>

Payment of:	\$ _____	(Line 8 or other - attach explanation of the other amount)
is recommended by:	_____	(Date)
	Kentucky Engineering Group, PLLC	
Payment of:	\$ _____	(Line 8 or other - attach explanation of the other amount)
is approved by:	_____	(Date)
	Grayson County Water District	
Approved by:	_____	(Date)
	Rural Development	

**Change Order No.** \_\_\_\_\_

Date of Issuance:	Effective Date:
Owner: Grayson County Water District	Owner's Contract No.:
Contractor:	Contractor's Project No.:
Engineer: Kentucky Engineering Group, PLLC	Engineer's Project No.: 20016
Project: Water Distribution System Improvements Project	Contract Name: Contract 6

The Contract is modified as follows upon execution of this Change Order:

Description:

Attachments: *[List documents supporting change]*

CHANGE IN CONTRACT PRICE	CHANGE IN CONTRACT TIMES <i>[note changes in Milestones if applicable]</i>
Original Contract Price: \$ _____	Original Contract Times: Substantial Completion: _____ Ready for Final Payment: _____ days or dates
[Increase] [Decrease] from previously approved Change Orders No. ___ to No. ___: \$ _____	[Increase] [Decrease] from previously approved Change Orders No. ___ to No. ___: Substantial Completion: _____ Ready for Final Payment: _____ days
Contract Price prior to this Change Order: \$ _____	Contract Times prior to this Change Order: Substantial Completion: _____ Ready for Final Payment: _____ days or dates
[Increase] [Decrease] of this Change Order: \$ _____	[Increase] [Decrease] of this Change Order: Substantial Completion: _____ Ready for Final Payment: _____ days or dates
Contract Price incorporating this Change Order: \$ _____	Contract Times with all approved Change Orders: Substantial Completion: _____ Ready for Final Payment: _____ days or dates

<b>RECOMMENDED:</b>	<b>ACCEPTED:</b>	<b>ACCEPTED:</b>
By: _____ Engineer (if required)	By: _____ Owner (Authorized Signature)	By: _____ Contractor (Authorized Signature)
Title: _____	Title: _____	Title: _____
Date: _____	Date: _____	Date: _____

Approved by Funding Agency (if applicable)

By: \_\_\_\_\_ Date: \_\_\_\_\_  
Title: \_\_\_\_\_

**CERTIFICATE OF SUBSTANTIAL COMPLETION**

Owner: Grayson County Water District	Owner's Contract No.:
Contractor:	Contractor's Project No.:
Engineer: Kentucky Engineering Group, PLLC	Engineer's Project No.: 20016
Project: Water Distribution System Improvements Project	Contract Name: Contract No. 6

**This [preliminary] [final] Certificate of Substantial Completion applies to:**

All Work  The following specified portions of the Work:

**Date of Substantial Completion**

The Work to which this Certificate applies has been inspected by authorized representatives of Owner, Contractor, and Engineer, and found to be substantially complete. The Date of Substantial Completion of the Work or portion thereof designated above is hereby established, subject to the provisions of the Contract pertaining to Substantial Completion. The date of Substantial Completion in the final Certificate of Substantial Completion marks the commencement of the contractual correction period and applicable warranties required by the Contract.

A punch list of items to be completed or corrected is attached to this Certificate. This list may not be all-inclusive, and the failure to include any items on such list does not alter the responsibility of the Contractor to complete all Work in accordance with the Contract.

The responsibilities between Owner and Contractor for security, operation, safety, maintenance, heat, utilities, insurance, and warranties upon Owner's use or occupancy of the Work shall be as provided in the Contract, except as amended as follows: *[Note: Amendments of contractual responsibilities recorded in this Certificate should be the product of mutual agreement of Owner and Contractor; see Paragraph 15.03.D of the General Conditions.]*

Amendments to Owner's responsibilities:  None  
 As follows

Amendments to Contractor's responsibilities:  None  
 As follows:

The following documents are attached to and made a part of this Certificate: *[punch list; others]*

This Certificate does not constitute an acceptance of Work not in accordance with the Contract Documents, nor is it a release of Contractor's obligation to complete the Work in accordance with the Contract.

EXECUTED BY ENGINEER:	RECEIVED:	RECEIVED:
By: _____ (Authorized signature)	By: _____ Owner (Authorized Signature)	By: _____ Contractor (Authorized Signature)
Title: _____	Title: _____	Title: _____
Date: _____	Date: _____	Date: _____

**CERTIFICATE OF OWNER'S ATTORNEY AND AGENCY CONCURRENCE**

CERTIFICATE OF OWNER'S ATTORNEY

**PROJECT NAME: Contract No. 6 - Water Distribution System Improvements Project**

---

**CONTRACTOR NAME: Cleary Construction, Inc.**

---

I, the undersigned, **Thomas H. Goff**, the duly authorized and acting legal representative of **Grayson County Water District**, do hereby certify as follows: I have examined the attached Contract(s) and performance and payment bond(s) and the manner of execution thereof, and I am of the opinion that each of the aforesaid agreements is adequate and has been duly executed by the proper parties thereto acting through their duly authorized representatives; that said representatives have full power and authority to execute said agreements on behalf of the respective parties named thereon; and that the foregoing agreements constitute valid and legally binding obligations upon the parties executing the same in accordance with the terms, conditions, and provisions thereof.

---

Thomas H. Goff

Date

**AGENCY CONCURRENCE**

As lender or insurer of funds to defray the costs of this Contract, and without liability for any payments thereunder, the Agency hereby concurs in the form, content, and execution of this Agreement.

---

Agency Representative

Date

---

Name

UNITED STATES DEPARTMENT OF AGRICULTURE  
Rural Utilities Service  
**KENTUCKY BULLETIN 1780-2**

**SUBJECT:** Guidance for Implementation of American Iron and Steel (AIS).

**TO:** Applicants, Consulting Engineers, Contractors, and Manufacturers

**EFFECTIVE DATE:** Date of approval.

**INSTRUCTIONS:** This is a new Bulletin and does not replace any existing Kentucky Bulletin.

**AVAILABILITY:** This Bulletin, as well as any RD or RUS instructions, regulations, or forms referenced in this Bulletin are available at any RD State Office or Area Office. The State Office staff is familiar with the use of the documents and can answer specific questions or RD requirements.

The basic concept of this new requirement is that all iron and steel products used in projects funded by RUS WEP must be produced in the United States. Iron and steel products are defined on page 14 of this Bulletin.

**PURPOSE:** This Bulletin provides information and guidance to effected parties regarding the AIS Requirements mandated by Section 746 of Title VII Consolidated Appropriations Act of 2017 (Division A-Agriculture, Rural Development, Food and Drug Administration, and Related Agencies Appropriations Act, 2017) and subsequent statues mandating domestic preference.

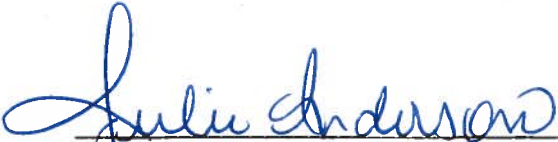
  
\_\_\_\_\_  
Julie Anderson  
State Engineer  
Water and Environmental Programs

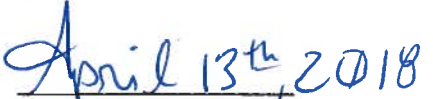
  
\_\_\_\_\_  
Date

**TABLE OF CONTENTS**

1. BACKGROUND.....3

2. APPLICABILITY.....3

3. IMPLEMENTATION.....4

4. OWNER RESPONSIBILITIES.....5

5. ENGINEER RESPONSIBILITIES.....5

6. CONTRACTOR RESPONSIBILITIES.....6

7. MANUFACTURER, SUPPLIER, DISTRIBUTOR RESPONSIBILITIES.....7

8. RESPONSIBILITIES UNDER THE GUARANTEED LOAN PROGRAM.....8

9. ECWAG.....8

10. AGREEMENT BETWEEN OWNER & ENGINEER (E-500).....8

11. BIDDING AND CONSTRUCTION CONTRACT DOCUMENTS (EJCDC C-SERIES, 2013).....10

12. PURCHASE OF EQUIPMENT AND MATERIALS.....17

13. WAIVER PROCESS.....17

14. MONITORING.....19

15. NON-COMPLIANCE.....19

16. INTERNATIONAL AGREEMENTS.....20

17. USE OF EXHIBITS.....20

1. BACKGROUND

- A. Section 746 of Title VII Consolidated Appropriations Act of 2017 (Division A- Agriculture, Rural Development, Food and Drug Administration, and Related Agencies Appropriations Act, 2017) and subsequent statues mandating domestic preference. It applies a new American Iron and Steel (AIS) requirement on the Rural Development (RD) WEP program.
- B. Statutory Language: SEC 746 Division A Title VII the Consolidated Appropriations Act of 2017.
  - (1) No Federal funds made available for this fiscal year for the rural water, waste water, waste disposal, and solid waste management programs authorized by sections 306, 306A, 306C, 306D, and 310B of the Consolidated Farm and Rural Development Act (7 USC 1926 et seq.) shall be used for a project for the construction, alteration, maintenance, or repair of a public water or wastewater system unless all of the iron and steel products used in the project are produced in the United States.
  - (2) In this section, the term "iron and steel products" means the following products made primarily of iron or steel: lined or unlined pipe flanges, manhole covers, and other municipal castings, hydrants, tanks, flanges, pipe clamps and restraints, valves, structural steel, reinforced precast concrete, and construction materials.

2. APPLICABILITY

- A. The requirements of AIS apply only to projects that construct, alter, enlarge, extend, maintain, repair or otherwise improve rural water, sanitary sewage, solid waste disposal, and storm wastewater disposal facilities.
- B. The requirements apply to projects using funds from RD WEP. Any amount of funding from this program requires compliance with the AIS requirements. Use of funds from this program is not allowed unless the requirements for AIS are met for the entire project. Projects that leverage funds from other funding sources are also subject to the requirements.
- C. The requirements apply in the United States as defined in Section 746 (g) of the statute and therefore do not apply to projects located in Puerto Rico, the Virgin Islands, or Western Pacific Territories.
- D. The requirements apply to any used iron and steel products to be constructed in the project.
- E. The requirements do not apply to projects for which any funds were obligated on or before May 5, 2017. The requirements therefore do not apply to subsequent obligation of funds for projects which had an initial obligation of funds on or before May 5, 2017.
- F. The requirements do not apply to contracts which were executed prior to or on May 5, 2017, regardless of date of obligation.

- G. The requirements do not apply to projects for which contracts were executed and/or construction is already underway and/or completed prior to applying to USDA for funding.
  - H. The requirements do not apply to products primarily composed of iron and/or steel (composed of more than 50%) if they are not listed in the statute.
  - I. The requirements do not apply to raw materials used in the production of iron or steel such as iron ore, limestone, scrap iron and scrap steel.
  - J. The requirements do not apply to any items that are at the construction site temporarily, such as scaffolding, trench boxes, and equipment temporarily used or stored on site.
  - K. The requirements do not apply when the sole purpose of the loan and/or grant is to fund non-construction activities such as capacity/connection fees or the acquisition of a system.
  - L. The requirements supersede any regulation on full and open competition stated in 7 CFR 1780.70 (b) and 2 CFR Part 200.319. For example, if an iron and steel product that is compliant with AIS is made by only one manufacturer, provided documentation is submitted and verified, sole source procurement of said product may be used.
  - M. The requirements only apply to the final product as delivered to the work site and incorporated into the project. The need for compliance of an item with AIS depends on whether or not the final assembled product is listed. Components of a final product, even if they are listed, do not need to comply with the AIS requirements. In the case of an assembled product where the primary component is not listed in the 2017 Consolidated Appropriations Act and includes components/appurtenances that are specifically listed, said assembled product is not subject to AIS (e.g. pump assembly).
3. IMPLEMENTATION (Agency, Owner, Engineer, Contractor, manufacturer's et al)
- A. There are several parties involved in compliance with the AIS requirement and some requirements are specific to a party.
  - B. The parties that have one or more responsibilities under AIS include: the Agency funding recipients under the Water and Waste Disposal Loan and Grant program and Guaranteed Loan Program, consulting engineers, construction contractors, suppliers, distributors, manufacturers; lenders under the Guaranteed Loan Program; and grantees under 306C and ECWAG programs.



4. OWNER RESPONSIBILITIES:

- A. Sign loan resolutions, grant agreements and letters of intent to meet conditions which include AIS language, accepting AIS requirements in those documents and in the letter of conditions.
- B. Sign Agreement for Engineering Services, executed construction contracts and all other appropriate and necessary documents which include AIS language.
- C. Acknowledge responsibility for compliance with AIS requirements by signing change orders (i.e. C-941 of EJCDC or RD Form 1924-7) and partial payment estimates (i.e. C-602 of EJCDC or RD Form 1924-18).
- D. Obtain the certification letters from the Engineer once substantial completion has been achieved and maintain this documentation for the life of the loan.
- E. In special cases where the Owner provides its' own engineering and/or construction services, provide copies of Engineer's Certification Letter (Exhibit B) and Contractor's Certification Letter (Exhibit C) to the Agency. Manufacturer's Certification Letter (Exhibit D) must be obtained by the Owner for each AIS qualifying product. All certification letters must be kept in the Engineer's project file and on site during construction. For Owner Construction (Force Account), all AIS clauses from Section 11 must be included in the Agreement for Engineering Services.

5. ENGINEER RESPONSIBILITIES

- A. Costs of compliance with AIS should be included in the engineering fees (if appropriate) and in Engineer's opinions of probable project costs.
- B. Develop the initial AIS Materials List (Exhibit J) for each contract using project specifications and include the initial qualifying list with the bid documents. An excel version that will compute all totals can be obtained from the RD State Office that can be used as a working copy.
- C. Include AIS language (Section 11) in the Agreement for Engineering Services.
- D. Plans, specifications, bidding documents and bid addenda must include required AIS language (Section 12). For any AIS products specified by brand names, obtain a Manufacturer's Certification Letter (Exhibit D) from the manufacturer to verify the products comply with AIS.
- E. Certify that plans, specifications, and bidding documents comply with AIS and commit that bid addenda, executed contracts and change orders will comply with AIS and submit Engineer's Certification Letter (Exhibit B) to the Agency prior to authorization to advertise for bids.

- F. Provide a copy of the Manufacturer's Certification Letter (Exhibit D) on any specified brand name AIS products in the plans, specifications and bidding documents including any bid addenda to the Contractor.
  - G. Coordinate with the Contractor(s) to compile a complete AIS Materials List (Exhibit J) for each contract, sign and date, and provide a copy to the Agency in the construction contract(s).
  - H. Review shop drawings and change orders to ensure compliance with AIS. For shop drawings under consideration for any brand name, equal and/or substitute, any iron and steel products subject to AIS, obtain the Manufacturer's Certification Letter (Exhibit D) from the Contractor to verify the products comply with AIS.
  - I. Keep all certification letters (including those from the Engineer, Contractor, and any manufacturer providing AIS products) in the Engineer's project file.
  - J. Review AIS Materials List (Exhibit J) submitted with each invoice to verify accuracy and sign and date.
  - K. For any change order under consideration for any AIS products, obtain a Manufacturer's Certification Letter (Exhibit D) from party submitting the change proposal to ensure compliance with AIS.
  - L. Acknowledge responsibility for compliance with AIS requirements by signing change orders (i.e. C-941 of EJCDC or RD Form 1927-7) and partial pay estimates (i.e. C-620 of EJCDC or RD Form 1924-18).
  - M. Upon substantial completion of project, obtain the Contractor's Certification Letter (Exhibit C) and a complete and final AIS Materials List (Exhibit J) to submit to the RD State Engineer. Obtain copies of any/all manufacturers' certification letters for all AIS products used in the project to be kept in the Owner's project file.
  - N. Resident project representative (RPR) reports must include verification, either by picture or written statement, that an item subject to AIS was installed and was in compliance with requirements.
6. CONTRACTOR RESPONSIBILITIES
- A. Review the Engineer's AIS Materials List (Exhibit J) prior to bid preparation.
  - B. Bid submittal with a request for consideration from a proposed equal or substitute should also include a Manufacturer's Certification Letter (see Exhibit D) to verify the products comply with AIS.
  - C. Upon award of the contract, obtain copies of any and all manufacturers' certification letters from the Engineer for brand name products specified by the Engineer.

- D. Work with the Engineer to compile a complete AIS Materials List (Exhibit J) for each contract as bid.
- E. Shop drawing submittals for proposed equals, substitutes, and any iron and steel product subject to AIS, provide a Manufacturer's Certification Letter (Exhibit D) to verify the product complies with AIS.
- F. Prior to construction, ensure that copies of any and all manufacturers' certification letters, including those from others (e.g. Engineer, Owner, etc.), for any AIS products to be used in the project are in the project file on site prior to installation.
- G. Pay request must have an updated AIS Materials List (Exhibit J) submitted with each pay request. All columns must be filled out completely as applicable. Do not complete columns under "De Minimis Materials Only" for qualifying materials. Sign and date. An excel version that will compute all totals can be obtained from the RD State Office that can be used as a working copy.
- H. Change orders for any AIS products must include a Manufacturer's Certification Letter (Exhibit D) to the Engineer to verify the products comply with AIS.
- I. Acknowledge responsibility for compliance with AIS requirement by signing change orders (i.e. C-941 of EJCDC or RD Form 1924-7) and partial pay estimates (C-620 of EJCDC or RD Form 1924-18).
- J. Keep all manufacturer certification letters (including those from the Engineer, Contractor and any manufacturer providing AIS products) on site during construction in the construction project file.
- K. Upon substantial completion of the project, provide Contractor's Certification Letter (Exhibit C) to the Engineer that all iron and steel products installed comply with AIS

7. MANUFACTURER, SUPPLIER, DISTRIBUTOR RESPONSIBILITIES

- A. If iron and steel products are produced in the United States as defined in this Bulletin, prepare (applicable to manufacturers and fabricators) or obtain (applicable to suppliers, distributors, vendors, etc.) Manufacturer's Certification Letters (Exhibit D) and make available upon request to Engineer, Contractor, etc.

8. RESPONSIBILITIES UNDER THE GUARANTEED LOAN PROGRAM

AIS applies to projects funded by Section 306A- Guaranteed Loan Program

- A. Lenders are responsible to ensure that loan recipients comply with AIS requirements.
- B. Loan recipients are ultimately responsible for compliance with AIS requirements.

9. ECWAG

- A. If construction contracts were awarded and/or executed or construction began prior to application, these projects are not subject to AIS (Section 2).
- B. If construction contracts were awarded and/or executed or construction began during the application process, these projects are subject to AIS.

10. AGREEMENT BETWEEN OWNER AND ENGINEER (EJCDC E-500) PROVISIONS

- A. Article 5.01.A: Add the following "Opinions of probable cost and any revisions thereof should reflect compliance with American Iron and Steel (AIS) requirements mandated in the Consolidated Appropriations Act of 2017 and any subsequent mandating domestic preferences."
- B. Add paragraph 5.03.B: "Opinions of total project cost and any revisions thereof should reflect compliance with AIS and any subsequent statutes mandating domestic preference."
- C. Add paragraph A.1.03.A.13: "Services required to determine and certify that to the best of the Engineer's knowledge and belief that all iron and steel products referenced in engineering analysis, the plans, specifications, bidding documents, and associated bid addenda requiring design revisions are either produced in the US or are subject to approved waiver. Services required to determine to the best of the Engineer's knowledge and belief that approved substitutes, equals, and all iron and steel products proposed in the shop drawings, change orders and partial payment estimates are either produced in the US, or are subject of an approved waiver. The de minimis and minor components waiver {add project specific waivers if applicable} apply to this contract."
- D. Add paragraph A.1.04.A.10: "Provide copies of all manufacturers' certification letters to the Bidders on brand name iron and steel products along with plans, specifications and bidding documents. Manufacturers' certification letters are to be included in the bidding documents and must be kept in the Engineer's project file and in site during construction."
- E. Add paragraph A.1.04.11: "Provide copies of all manufacturers' certification letters to the Contractor on any brand name iron and steel products along with the plans, specifications, bidding documents. Including any bid addenda and change orders. Manufacturers' certification letters must be kept in the Engineer's project file for the duration of construction."
- F. Add paragraph A.1.04.12: "Develop AIS Materials list (Exhibit J) for bidding purposes and finalize with the Contractor for tracking. Review updated AIS Materials list for accuracy each month and include in each pay request. An excel version that will compute all totals can be obtained from the RD State Office that can be used as a working copy."

- G. Modify A.1.05.A.17: Add the following prior to the first sentence "Review and approve, or take other appropriate action, with respect to shop drawings, samples, and other required Contractor submittals to ensure compliance with AIS requirements and any subsequent statutes mandating domestic preference. Any iron and steel products included in any submittal by the Contractor, must include the Manufacturer's Certification Letter (Exhibit D) to verify the products were produced in the U.S. Copies of these letters must be kept in the Engineer's project file and on site during construction."
- H. Article A.1.05.A.18: Add the following at the end of the paragraph as amended by Kentucky Bulletin 1780-1 "Prior to approval of any substitute "or equal" obtain the Manufacturer's Certification Letter (Exhibit D) to verify the products were produced in the U.S. Manufacturers' certification letters must be kept in Engineer's project file and on site during construction to ensure compliance with AIS requirements and any subsequent statutes mandating domestic preference, if applicable."
- I. Add subparagraph A.1.05.A.19.d: "Receive and review all manufacturers' certification letters for materials required to comply with AIS and any subsequent statutes mandating domestic preference to verify the products were procured in the U.S. Manufacturers' certification letters must be kept in the Engineer's project file on site during construction."
- J. Add subparagraph (c) to the end of A.1.05.A.20: (c) Review change proposals to ensure compliance with AIS requirements and any subsequent statutes mandating domestic preference."
- K. Add item "a" as a deliverable under paragraph A.1.05.A.25: (s) Obtain the Contractor's Certification Letter (Exhibit C) and copies of manufacturers' certification letters for all AIS used in the project. Upon substantial completion, provide copies of Engineer's, Contractor's, and all manufacturers' certification letters to the Owner. Attach Contractor's Certification Letter (Exhibit C) and a final AIS Materials List (Exhibit J) with letter of substantial completion and submit it to the Agency."
- L. Add the following language to B.2.02: "Owners are ultimately responsible for compliance with AIS and any subsequent statutes mandating domestic preference and will be responsible for the following:
  - 1. Signing loan resolutions, grant agreements and letter of intent to meet conditions which include AIS language, accepting AIS requirements in those documents and in the letter of conditions.
  - 2. Signing change orders (i.e. C-941 of EJCDC or RD Form 1924-7) and partial pay estimates (C-620 of EJCDC or RD Form 1924-18) and thereby acknowledging responsibility for compliance with AIS requirements.
  - 3. Obtaining all certification letters from the Engineer upon substantial completion of the project and maintaining this documentation for the life of the loan.

4. Where the Owner provides their own engineering and/or construction services, provide copies of Engineer's, and Contractor's certification letters to the Agency, and obtain all manufacturers' certification letters as required. All certification letters must be kept in the Engineer's project file and on site during construction. For Owner Construction (Force Account), all clauses from Section 11 must be included in the Agreement or Engineering Services.
5. Where the Owner directly procures AIS products, including AIS clauses in the procurement contracts and obtaining manufacturers' certification letters and providing copies to consulting engineers and contractors.

M. Add subparagraph D.1.01.C.11.g: "(g) Maintain all manufacturers' certification letters in the project file and on site during construction to ensure compliance with AIS requirements and any subsequent statutes mandating domestic preference, as applicable."

N. Add the following at the end of D.1.01.c.11b: Daily reports should document installation of an AIS material and verify by picture or statement on the report that the manufacturer was the same as that listed on the AIS materials list and complied with AIS requirements.

11. BIDDING AND CONSTRUCTION CONTRACT DOCUMENTS (EJCDC C-SERIES, 2013)

A. Advertisement for Bids (C-111)

Add at the end of C-111 prior to the Owner's name: "Section 746 of Title VII of the Consolidated Appropriations Act of 2017 (Division A- Agriculture, Rural Development, Food and Drug Administration, and Related Agencies, Appropriations Act, 2017) and subsequent statutes mandating domestic preference applies to American Iron and Steel requirement to this project. All listed iron and steel products used in this project must be produced in the United States. The term "iron and steel products" means the following products made primarily of iron and steel: lines or unlined pipes and fittings, manhole covers and other municipal castings, hydrants, tanks, flanges, pipe clamps and restraints, valves, structural steel, reinforced precast concrete, and construction materials. The de minimis and minor components waiver {all project specific waivers as applicable} apply to this contract."

B. Instruction to Bidders (C-200)

1. Article 5.01.C: Delete the semicolon at the end of the article and insert the following "included but not limited to the AIS requirements as mandated and any subsequent statutes mandating domestic preference which apply to the following products made primarily of iron or steel: lined or unlined pipes and fittings, manhole covers and other municipal castings, hydrants, tanks, flanges, pipe clamps and restraints, valves, structural steel, reinforced precast concrete, and construction materials.
2. Article 11.01: Modify article as previously amended by Kentucky Bulletin 1780-1 by inserting the following sentence after "Each such request shall comply with the requirements of Paragraphs 7.04 and 7.05 of the General Conditions. Each such request shall include the Manufacturer's Certification Letter (Exhibit D) for compliance with AIS requirements and any subsequent statutes mandating domestic preference, if applicable.

3. Article 24.02: Add paragraph 24.02:Section 746 of Title VII Consolidated Appropriations Act of 2017 (Division A- Agriculture, Rural Development, Food and Drug Administration, and Related Agencies Appropriations Act, 2017) and any subsequent statues mandating domestic preference applies an American Iron and Steel requirement to this project. All iron and steel products used in this project must be procured in the United States. "Iron and Steel Products" is defined in Section 1.b.2. The de minimis and minor components waivers {add project specific waivers as applicable} apply to this contract."
- C. Bid Form (C-410)
1. Article 3.01.C: Add language at the end of the sentence "...and including all AIS requirements.
  2. Article 7.01: Add 7.01.K "Manufacturer's Certification Letter (Exhibit D) on any approved "or equal" or substitute request to ensure compliance with AIS requirements and any subsequent statutes mandating domestic preference.
- D. Supplementary General Conditions (C-800)
1. SC 1.01.A.51: "Manufacture's Certification Letter (Exhibit D) is documentation provided by the manufacturer, supplier, distributor, vendor, fabricator, etc. to various entities stating that the AIS products to be used in the project are produced in the U.S. in accordance with the AIS requirements.
  2. SC 1.01.A.52: "AIS refers to requirements mandated by Section 746 Title VII of the Consolidated Appropriation s Act of 2017 and any subsequent statutes mandating domestic preference. "Iron and Steel Products" is defined in Section 1.b.2.
  3. SC 7.03: Add sentence "all iron and steel must meet AIS requirements.
  4. SC 7.04.B.1: "Contractor shall include the Manufacturer's Certification Letter (Exhibit D) for compliance with AIS requirements to support data, if applicable. In addition, Contractor shall maintain an updated AIS Materials List (Exhibit J), to ensure that for de minimis waiver, cost is less than 5% of total materials cost for project and for minor components waiver, the cost of the non-domestically produced component is less than 5% of the total materials cost of the product." An excel version that will compute all totals can be obtained from the RD State Office that can be used as a working copy.
  5. SC 7.05.A.3.a4: "4) comply with AIS by providing the Manufacturer's Certification Letter (Exhibit D), if applicable.
  6. SC 7.11.A: Modify by inserting the following after "written interpretations and clarifications,"; "Manufacturer's Certification Letter (Exhibit D) is documentation provided by the manufacturer, supplier, distributor, vendor, fabricator, etc. to various entities stating that the iron and steel products to be used in the project are produced in the U.S. in accordance with AIS requirements.
  7. SC 7.16.A.1.e: "e. obtain the Manufacturer's Certification Letter (Exhibit D) for any item in the submittal subject to AIS requirements and include the certificate in the submittal.
  8. SC 7.16.D.9: "Engineer's review and approval of shop drawings or sample shall include review of compliance with AIS requirements, as applicable."

9. SC 7.17.E: "Contractor shall certify upon substantial completion that all work and materials has complied with AIS requirements as mandated and any subsequent statutes mandating domestic preference. Contractor shall provide Contractor's Certification Letter (Exhibit C) to Owner.
10. SC 10.10.A: "A: Services required to determine and certify that, to the best of the Engineer's knowledge and belief, all iron and steel products referenced in the engineering analysis, the plans, specifications, bidding documents, and associated bid addenda requiring design revisions are either produced in the U.S. or are the subject of an approved waiver. Services required to determine, to the best of the Engineer's knowledge and belief, that approved substitutes, equals, and all iron and steel products proposed in the shop drawings, change orders, and partial pay estimates are either produced in the U.S. or are the subject of an approved waiver under the Consolidate Appropriations Act of 2017.
11. SC 11.06.A.1: Modify by inserting the following sentence after "within 15 days after the submittal of the change proposal..." "Include supporting data (project name, name of manufacturer, city and state where the product was manufactured, description of product, signature of authorized manufacturer's representative) in the Manufacturer's Certification Letter (Exhibit D), as applicable."
12. SC 14.03G: Installation of materials that are non-compliant with AIS requirements shall be considered defective work.
13. SC 15.01.B.4: "4. By submitting materials for payment, Contractor is certifying that the submitted materials are compliant with AIS requirements. Manufacturers' Certification letter for Materials satisfy this certification. Refer to Manufacturer's Certification Letter provided in these Contract Documents.
14. SC 15.01.D.2: An updated AIS Materials List (See Exhibit J) included in these contract documents must be dated and signed and submitted with each pay request prior to payment being authorized. An excel version that will compute all totals can be obtained from the RD State Office that can be used as a working copy.
15. SC 15.01.C.2d: "d. The materials presented for payment comply with AIS requirements.
16. SC 15.03.A: Modify by adding the following "Services required to determine and certify that, to the best of the Contractor's knowledge and belief, all substitutes, equals, and iron and steel products proposed in the shop drawings, change orders, and partial payment estimates are produced in the U.S. or are the subject of an approved waiver. Services required to certify that, to the best of the Contractor's knowledge, all those products installed for the project are either produced in the U.S. or are the subject of an approved waiver.
17. SC19.14: Section 746 of Title VII of the Consolidated Appropriations Act of 2017 (Division A- Agriculture, Rural Development, Food and Drug Administration, and Related Agencies Appropriations Act, 2017) and any subsequent statutes mandating domestic preference applies in AIS requirement to this project. All iron and steel products used in this project must be produced in the U.S. The term "iron and steel products" is defined in Section 1.b.2. The de minimis and minor components waivers {add project specific waivers as applicable} apply to this contract."



18. SC 19.15: add Definitions:

"Assistance recipient" is the entity that received funding assistance from programs required to comply with AIS requirements in the Consolidated Appropriations Act of 2017 and any subsequent statutes mandating domestic preference. This term includes owner and/or applicant.

"Certifications" means the following:

- *Manufacturers'* certification is the documentation provided by the manufacturer or fabricator to various entities stating that the iron and steel products to be used in the project are produced in the U.S. in accordance with AIS requirements. If items are purchased via a supplier, distributor, vendor, etc. vs. direct from the manufacturer or fabricator directly, then the supplier, distributor, vendor, etc. will be responsible for obtaining and providing these certification letters to the parties purchasing the product.
- *Engineer's* certification is documentation that plans, specifications, and bidding documents comply with AIS.
- *Contractors'* certification is documentation submitted upon substantial completion of the project that all iron and steel products installed were produced in the U.S.

"Coating" means a covering that is applied to the surface of an object. If a coating is applied to the external surface of a domestic iron or steel component, and the application takes place outside of the U.S., said product will be considered a compliant product under the AIS requirements. Any coating processes that are applied to the external surface of iron and steel components that would otherwise be AIS compliant would not disqualify the product from meeting the AIS requirements regardless of where the coating processes occur, provided that final assembly of the product occurs in the U.S. This exemption only applies to coatings on the *external surface* of iron and steel products, such as the lining of lined pipes. All manufacturing processes for lined pipes, including the application of pipe lining, must occur in U.S. for the product to be compliant with AIS requirements.

"Contractor" is the individual or entity with which the applicant has contracted (or is expected to) to perform construction services (or for water and waste projects funded by the programs which are subject to AIS requirements). This includes bidders and/or contractors that have received an award from the applicant and any party having a direct contractual relationship with the owner/applicant. A general contractor is often referred to as the prime contractor.

"Construction materials" are those articles, materials, or supplies made primarily of iron and steel, that are permanently incorporated into the project, not included mechanical and/or electrical components, equipment and systems. Some of these products may overlap with what is also considered "structural steel".

*Note:* Mechanical and electrical components, equipment, and systems are not considered construction materials. See definition of mechanical and electrical equipment.

"De minimis incidental components" are various miscellaneous low-cost components that are essential for, but incidental to, the construction and are incorporated into the physical structure of the project. Examples of incidental components could include small washers, screws, fasteners (such as "off the shelf" nuts and bolts, miscellaneous wire, corner bead, ancillary tube, signage, trash bins, door hardware etc. Costs for de minimis incidental components cumulatively may comprise no more than a total of five percent of the total cost of the materials used in and incorporated into a project. The cost of an individual item may not exceed one percent of the total cost of the materials used in and incorporated into a project.

"Engineer" is an individual or entity with which the owner has contracted to perform engineering/architectural services for water and waste projects funded by the programs subject to AIS requirements.

"Iron and Steel Products" are defined as the following products made primarily of iron and steel: lined or unlined pipes and fittings, manhole covers and other municipal castings, hydrants, tanks, flanges, pipe clamps and restraints, valves, structural steel, reinforced precast concrete, and construction materials. Only items on the above list made of primarily iron or steel, permanently incorporated into the project must be produced in the U.S. For example; trench boxes, scaffolding or equipment, which are removed from the project site upon completion of the project, are not required to be made of U.S. Iron or Steel.

"Manufacturers" meaning supplier, fabricator, distributor, materialman, or vendor is an entity with which the applicant, general contractor or with any subcontractor has contracted to furnish materials or equipment to be incorporated in the project by the applicant, contractor or subcontractor.

"Manufacturing processes" are processes such as melting, refining, forming, rolling, drawing, finishing, and fabricating. Further, if a domestic iron and steel product is taken out of the U.S. for any part of the manufacturing process, it becomes foreign source material. However, raw materials such as iron ore, limestone, and iron and steel scrap are not covered by the AIS requirements, and the material(s), if any, being applied as coating are similarly not covered. Non-iron or steel components of an iron and steel product may come from non-U.S. sources. For example, for products such as valves and hydrants, the individual non-iron and steel components do not have to be of domestic origin. Raw materials, such as iron ore, limestone, scrap iron, and scrap steel, can come from non-U.S. sources.

"Mechanical equipment" is typically that which has motorized parts and/or is powered by a motor. "Electrical equipment" is typically any machine powered by electricity and included components that are part of the electrical distribution system. AIS does not apply to mechanical equipment.

"Minor components" are components within an iron or steel product otherwise compliant with the AIS requirements. This is different from the de minimis definition where de minimis pertains to the entire project and the minor component definition pertains to a single product. This waiver would allow non-domestically produced miscellaneous minor components comprising up to five percent of the total material cost of an otherwise domestically produced iron and steel product to be used. However, unless a separate waiver for a product has been approved, all other iron and steel components in said product must still meet the AIS requirements. This waiver does not exempt the whole product from the AIS requirements. Only minor components within said product and the iron or steel components of the product must be produced domestically. Valves and hydrants are also subject to the cost ceiling requirements described here. Examples of minor components could include items such as pins and springs in valves/hydrants, bands/straps in couplings, and other low cost items such as small fasteners etc.

"Municipal castings" are cast iron and steel infrastructure products that are melted and cast. They typically provide access, protection, or housing for components incorporated into utility owned drinking water, storm water, wastewater, and solid waste infrastructure.

"National Office" refers to the office responsible for the oversight and administration of the program nationally. The National Office sets policy, develops program regulations, and provides training and technical assistance to help the state offices administer the program. The National Office is located in Washington, D.C.

"Owner" is the individual or entity with which the general contractor has contracted regarding the work, and which has agreed to pay the general contractor for the performance of the work pursuant to the terms of the contract for water and waste projects funded by the programs subject to AIS requirement. For the purpose of this Bulletin, the term is synonymous with the term "applicant" as defined in 7 CFR 1780.7 (a) (1), (2), and (3), and is an entity receiving financial assistance from the programs subject to AIS requirements.

"Primarily iron or steel" is defined as a product made of greater than 50 percent iron or steel, measured by cost. The cost should be based on the material costs. An exception to this definition is reinforced precast concrete (see Definition). All technical specifications and applicable industry standards (e.g. NIST, NSF, AWWA) must be met. If a product is determined to be less than 50 percent iron and steel, the AIS requirements do not apply.

For example, the cost of a fire hydrant includes:

1. The cost of materials used for the iron portion of the fire hydrant (e.g. bonnet, body, and shoe); and
2. The cost to pour and cast and create those components (e.g. labor and energy).

Not included in the cost are:

1. The additional material costs for the non-iron and steel internal working of the hydrant (e.g. stem, coupling, valve, seals, etc.); and
2. The cost to assemble the internal workings into the hydrant body.

"Produced in the United States" means that the production in the United States of the iron or steel products used in the project requires that all manufacturing processes must take place in the United States, with the exception of metallurgical processes involving refinement of steel additives.

"Project" is the total undertaking to be accomplished for the applicant by consulting engineers, general contractors, and others, including the planning, study, design, construction, testing, commissioning, and start-up of which the work to be performed under the contract is a part. A project includes all activity that an applicant is undertaking to be financed in whole or part by programs subject to AIS requirements. The intentional splitting of projects to separate into smaller contracts or obligations to avoid AIS requirements is prohibited.

"Reinforced Precast Concrete" may not consist of at least 50 percent iron or steel, but the reinforcing bar and wire must be produced in the United States and meet the same standards for any other iron or steel product. Additionally, the casting of the concrete product must take place in the United States. The cement and other raw materials used in concrete production are not required to be of domestic origin. If the reinforced concrete is cast at the construction site, the reinforcing bar and wire are considered to be a construction material and must be produced in the United States.

"Steel" means an alloy that includes at least 50 percent iron between 0.02 and 2 percent carbon, and may include other elements. Metallic elements such as chromium, nickel, molybdenum, manganese, and silicon may be added during the melting of steel for the purpose of enhancing properties such as corrosion resistance, hardness, or strength. The definition of steel covers carbon steel, alloy steel, stainless steel, tool steel, and other specialty steels.

"Structural steel" is rolled flanged shapes, having at least one dimension of their cross-section three inches or greater, which are used in the construction of bridges, buildings, ships, railroad rolling stock, and for numerous other constructional purposes. Such shapes are designated as wide-flange shapes, standard I beams, channels, angles, tees, and zees. Other shapes include but are not limited to, H-piles, sheet piling, tie plates, cross ties, and those for other special purposes.

"United States" means each of the several states, the District of Columbia, and each Federally Recognized Indian Tribe.

## 12. PURCHASE OF EQUIPMENT AND MATERIALS

Irrespective of who purchases AIS products, owner, contractor or other parties must ensure that the products were produced in the United States as defined in this Bulletin. It is the manufacturers' responsibility to provide manufacturers' certification letters to ensure compliance with AIS requirements. The AIS requirements supersede any regulation on full and open free competition stated in 7 CFR 1780.70(b) and (d) and 2 CFR Part 200.319. For example, if an iron and steel product that is compliant with AIS is made by only one manufacturer, sole source procurement of said product may be used.

## 13. WAIVER PROCESS

### A. General

Each entity that receives financial assistance for the construction, alteration, maintenance, or repair of water and waste infrastructure from programs mandated to comply with the statute, must use iron and steel products produced in the United States. A waiver is a legal document granting a project an exception to AIS requirements, to use iron and steel products of non-domestic origin specified in the waiver(s). More than one waiver could be applied to a project.

Any funding recipient subject to AIS requirements are eligible to apply for waivers as outlined in the statute which states:

"A waiver may be granted by the Secretary of Agriculture or designee, if one or more of the following conditions are met:

1. Applying the American Iron and Steel requirements of the Act would be inconsistent with the public interest;
2. Iron and Steel products are not produced in the United States in sufficient and reasonably available quantities or of satisfactory quality; or
3. Inclusion of iron and steel products produced in the United States will increase the overall cost of the project by more than 25 percent."

Until a waiver is granted by USDA, the AIS requirement stands except with respect to municipalities covered by international agreements (see Section 17).

One public interest waiver has been granted by the Secretary of Agriculture or designee that addresses: (1) de minimis items and (2) minor components. This waiver is national in scope and applies to all projects. The term de minimis applies to products when they occur as a de minimis incidental components as intended for assistance recipients to use for their projects. The term minor components applies to minor components within an iron and/or steel product and is intended for manufacturers to certify that their products comply with AIS requirements. For definitions of de minimis and minor components see Definitions.

B. Application

To request a project specific waiver, proper and sufficient documentation must be provided by the assistance recipient (see Exhibit H).

To apply for a waiver under condition one (public interest), applicants and their consulting engineers must demonstrate definitive impacts on the community if a specified product is not utilized. Information must be submitted to the National Office (via [EESEngineering@wdc.usda.gov](mailto:EESEngineering@wdc.usda.gov)), copy to the RD State Engineer and approved by the Administrator of RUS. Public interest waivers national in scope will be identified and approved by the Administrator of RUS.

To apply for a waiver under special condition two (quality or quantity), applicants and their consulting engineers must submit information outlined in Exhibit I and J to the National Office (via [EESEngineering@wdc.usda.gov](mailto:EESEngineering@wdc.usda.gov)).

All waiver applications must be submitted to National Office. If RD State Office receives any waiver requests, the request must be submitted to National Office for approval.

C. Timing

Waivers should be submitted prior to and no later than the submission of final plans, specifications, and bidding documents for any iron and steel products of known foreign origin. All waiver requests must be approved by the Agency prior to authorization to advertise for bids. In the event that a waiver is requested during construction such as via change order, it must be approved by the Agency prior to installation.

#### D. Evaluation by USDA

After receiving an application for a waiver of the AIS requirements, USDA National Office will publish the request on its website for 15 days and receive informal comment. National Office will evaluate whether the application adequately documents the statutory basis cited for the waiver. The Secretary or designee will determine whether or not to grant the waiver.

Approved and disapproved waivers will be posted on the USDA AIS website.

For project specific waivers where EPA and USDA are co-funding and the applicant has already submitted a request to and received an approval waiver from EPA, USDA will review said waiver for the co-funded project. Applicants/owners or their representatives are required to submit approved waiver to ESEngineerig@wdc.usda.gov for USDA RD review and concurrence.

All approved waivers must be included in the bidding documents, any bid addenda, change orders, and partial estimates. All information presented in waiver requests are subject to verification. Waiver requests deliberately containing false information will be rejected.

#### 14. MONITORING

In order to comply with the Executive Order 13788 "Buy American, Hire American", dated April 18, 2017, and AIS requirements, monitoring activities will be completed by the State Office and/or National Office.

#### 15. NON-COMPLIANCE

No Federal funds made available for the rural water, waste water, waste disposal, and solid waste management programs authorized by sections 306, 306A, 306C, 306D, 306E, and 310B of the Consolidated Farm and Rural Development Act (7 U.S.C. 1926 et seq.) shall be used for a project for the construction, alteration, maintenance, or repair of a public utility system unless all of the iron and steel products used in the project are produced in the United States.

Noncompliance occurs when funds are used from these programs for construction, alteration, maintenance, or repair using non-domestic iron or steel products and the product is not covered by either a project-specific or a national waiver. Loan and grant recipients should avoid non-compliance at all times as it is a violation of a Federal statute.

##### Process for Noncompliance

- (1) Identify the noncompliant product.
- (2) The loan or grant recipient notifies appropriate USDA RD State or National Office contact.
- (3) If USDA RD State Office is notified, the Program Director will notify the National Office, Director of EES.
- (4) USDA will apply remedies for noncompliance as per 2 CFR 200 338-342.

16. INTERNATIONAL AGREEMENTS

The AIS requirements apply in a manner consistent with United States obligations under international agreements. In a few cases where such an agreement exists between a loan and/or grant recipient and an international entity, the recipient is under the obligation to determine the applicability of the AIS requirements and document the actions taken to comply with these requirements.

17. USE OF EXHIBITS

The following explains the purpose of each Exhibit to this Bulletin:

- A. AMERICAN IRON AND STEEL: Exhibit A is to be read by the RD Specialist at the pre-construction and signed by all parties subject to the AIS requirements on the project. Signature of this form will serve as certification of advisement and acknowledgement of the AIS requirements.
- B. ENGINEER'S CERTIFICATION OF COMPLIANCE: Exhibit B consists of a letter to be completed and signed by the consulting engineer certifying that he/she will ensure that plans, specifications, bidding documents, and associated bid addenda, executed contracts and change orders for this project will comply with the AIS requirements. This certification letter is to be submitted to the Agency for approval prior to the Advertisement for Bids and must be kept in the engineer's project file and on-site during construction.
- C. GENERAL (PRIME) CONTRACTOR'S CERTIFICATION OF COMPLIANCE  
Exhibit C consists of a letter to be completed and signed by the general contractor certifying that he/she will ensure that all iron and steel products installed for this project, comply with the AIS requirements. This includes not only installation and/or construction by their own company, but any and all subcontractors and manufacturers their company has contracted with on this project. This certification letter is to be submitted upon substantial completion of the project to the project engineer.
- D. EXAMPLE OF A MANUFACTURER'S CERTIFICATION LETTER OF COMPLIANCE: Exhibit D is an example of a letter to be completed and signed by the manufacturer certifying that he/she will ensure that all iron and steel products and/or materials shipped or provided for the subject project are in full compliance with the AIS requirements. This includes listing each individual item/product/material provided to the project and providing the location of this/these item(s) being manufactured, including assembly. All manufacturers' certification letters must be kept in the engineer's project file and on site during construction.
- E. EXAMPLES OF MUNICIPAL CASTINGS: Exhibit E provides a sample list of iron and steel products that are subject to the AIS requirements. This list is not exhaustive and is meant only to provide examples. A unique list should be completed for each specific project/contract.



- F. **EXAMPLES OF CONSTRUCTION MATERIALS:** Exhibit F provides a sample list of construction materials that are subject to the AIS requirements. This list is not exhaustive and is meant only to provide examples.
- G. **EXAMPLES OF NON-CONSTRUCTION MATERIALS:** Exhibit G provides a sample list of items that are not subject to AIS requirements. This list is not exhaustive and is meant only to provide examples.
- H. **INFORMATIONAL CHECKLIST FOR PROJECT SPECIFIC WAIVER REQUEST:** Exhibit I is a checklist that is to be completed by the applicant and/or consulting engineer to help ensure that all appropriate and necessary information is submitted with the request to USDA. This checklist should not be used for public interest waiver. It is for informational purposes only and does not need to be included as part of the waiver application. Project specific waivers may be requested if one or more of the following conditions applies: (1) The iron and/or steel products are not produced in the United States in sufficient and reasonably available quantities and of satisfactory quality; (2) The inclusion of iron and/or steel products produced in the United States will increase the overall cost of the project by more than 25 percent. All approved waivers must be included in the bidding documents, any bid addenda, change orders, and partial estimates. All information presented in waiver requests are subject to evaluation. Waiver requests deliberately containing false information will be rejected.
- I. **EXAMPLE COST TABLE FOR A PROJECT COST WAIVER:** Exhibit I is an example of a table that must be included with any cost based project waiver request. Information included in the table; product reference in the specification, brief description of the product, quantity, unit, unit price and two costs of the item: (1) cost of an AIS compliant product and (2) cost of a non-domestic product. The total cost for all items will be part of the evaluation. Waiver requests deliberately containing false information in order to receive a project cost waiver will be rejected.
- J. **AIS MATERIALS TRACKING:** Exhibit J is a spreadsheet to track all AIS products, de minimis components, and minor components. An updated list must be signed and dated and submitted to the Engineer by the Contractor with each pay request. Once reviewed for accuracy, the signed and updated list must be submitted to the Agency with each pay request. If an AIS qualifying or de minimis material is delivered more than once, a new line will be required for each delivery of that material. An excel version that will compute all totals can be obtained from the RD State Office that can be used as a working copy.

**AMERICAN IRON AND STEEL COMPLIANCE STATEMENT**

"Section 746 of Title VII of the Consolidated Appropriations Act of 2017 (Division A- Agriculture, Rural Development, Food and Drug Administration, and Related Agencies Appropriations Act, 2017) and subsequent statues mandating domestic preference applies an American Iron and Steel requirement to this project.

All parties are required to comply with these requirements and to ensure that all iron and steel products used on this project are produced in the United States. The term "iron and steel products" means the following products made of primarily iron or steel: lined or unlined pipes and fittings, manhole covers and other municipal castings, hydrants, tanks, flanges, pipe clamps and restraints, valves, structural steel, reinforced precast concrete, and construction materials."

\_\_\_\_\_  
**RD Specialist Signature**

\_\_\_\_\_  
Date

\_\_\_\_\_  
Printed Name

\_\_\_\_\_  
**Borrower Signature or Approved Representative**

\_\_\_\_\_  
Date

\_\_\_\_\_  
Printed Name

\_\_\_\_\_  
**Engineer's Signature**

\_\_\_\_\_  
Date

\_\_\_\_\_  
Printed Name

\_\_\_\_\_  
**Contractor's Signature**

\_\_\_\_\_  
Date

\_\_\_\_\_  
Printed Name

**ENGINEER'S CERTIFICATION LETTER**

DATE:

RE: APPLICANT  
PROJECT NAME  
CONTRACT NUMBER

I hereby certify that to the best of my knowledge and belief, iron and steel products referenced in the Plans, Specifications, and Bidding Documents for this project comply with Section 746 of Title VII of the Consolidated Appropriations Act of 2017 and any subsequent statutes mandating domestic preference or are the subject of a waiver approved by the Secretary of Agriculture or designee. This certification is not intended to be a warranty in any way, but rather the designer's professional opinion that to the best of their knowledge, the products comply.

I hereby commit that to the best of my ability, all iron and steel products that will be referenced in the Bid Addenda, Executed contracts, and Change Orders will comply with Section 746 of the Title VII of the Consolidated Appropriations Act, 2017 and any subsequent statutes mandating domestic preference or are/will be the subject of a waiver approved by the Secretary of Agriculture or designee.

\_\_\_\_\_  
Name of Engineering Firm (Print)

\_\_\_\_\_  
By Authorized Representative (Signature)

\_\_\_\_\_  
Title

This document is to be submitted prior to Agency authorization for Advertisement for Bids.

**CONTRACTOR'S CERTIFICATION LETTER**

DATE:

**RE: APPLICANT  
PROJECT NAME  
CONTRACT NUMBER**

I hereby certify that, to the best of my knowledge and belief, all iron and steel products installed for this project by my company and by any and all subcontractors and manufacturers my company has contracted with for this project, comply with Section 746 of Title VII of the Consolidated Appropriations Act of 2017 and any subsequent statutes mandating domestic preference or are the subject of a waiver approved by the Secretary of Agriculture or designee.

\_\_\_\_\_  
Name of Construction Company (Print)

\_\_\_\_\_  
By Authorized Representative (Signature)

\_\_\_\_\_  
Title

This certification is to be submitted upon completion of the project to the project engineer.

**MANUFACTURER'S CERTIFICATION LETTER**

Date:

Company Name:

Company Address:

Subject: AIS Step Certification for Project (X), Owner's Name, and Contract Number

I, (company representative), certify that the (melting, bending, galvanizing, cutting, etc.) processes for (manufacturing or fabricating) the following products and/or material shipped or provided for the subject project is in full compliance with the mandated AIS requirements.

Item, Products and/or Materials, and location of delivery (City, State)

- 1.
- 2.
- 3.

Such process for AIS took place in the following location:

---

City, State

This certification is to be submitted upon request to interested parties (e.g. municipalities, consulting engineers, general contractors, etc.)

If any of the above compliance statements change while providing materials to this project, please immediately notify the person(s) who is requesting to use your product(s).

---

Authorized Company Representative

*(Note: Authorized signature shall be manufacturer's representative and not the materials distributor or supplier)*

**EXAMPLES OF MUNICIPAL CASTINGS** *(includes but not limited to):*

Access Hatches  
Ballast Screen  
Benches (Iron or Steel)  
Bollards  
Cast Bases  
Cast Iron Hinged Hatches, Square and Rectangular  
Cast Iron Riser Rings  
Catch Basin Inlet  
Cleanout/Monument Boxes  
Construction Covers and Frames  
Curb Corner Guards  
Curb Openings  
Detectable Warning Plates  
Downspout Shoes (Boot, Inlet)  
Drainage Grates, Frames and Curb Inlets  
Inlets  
Junction Boxes  
Lampposts  
Manhole Covers, Rings and Frames, Risers  
Meter Boxes  
Service Boxes  
Steel Hinged Hatches, Square and Rectangular  
Steel Riser Rings  
Trash Receptacles  
Tree Grates  
Tree Guards  
Trench Grates  
Valve Boxes, Covers and Risers

**EXAMPLES OF CONSTRUCTION MATERIALS (included but not limited to)**

Wire rod, bar, angles  
Concrete reinforcing bar, wire, wire cloth  
Wire rope and cables  
Tubing  
Framing  
Joists  
Trusses  
Fasteners (i.e., nuts and bolts)  
Welding rods  
Decking  
Grating  
Railings  
Stairs  
Access ramps  
Fire escapes  
Ladders  
Wall panels  
Dome structures  
Roofing  
Ductwork  
Surface drains  
Cable hanging systems  
Manhole steps  
Fencing and fence tubing  
Guardrails  
Doors  
Stationary screens

**EXAMPLES OF NON-CONSTRUCTION MATERIALS-** (includes but not limited to):

(Note: includes appurtenances necessary for their intended use and operation and are not subject to AIS requirements)

Pumps  
Motors  
Gear Reducers  
Drives (including variable frequency drives (VFD's))  
Electric/pneumatic/manual accessories used to operate valves (such as electric valve actuators).  
Mixers  
Gates (e.g. sluice and slide gates)  
Motorized screens (such as traveling screens)  
Blowers/aeration equipment  
Compressors  
Meters (flow and water meters)  
Sensors  
Controls and switches  
Supervisory control data acquisition (SCADA)  
Membrane filtration systems (includes RO package plants)  
Filters  
Clarifier arms and clarifier mechanisms  
Rakes  
Grinders  
Disinfection systems  
Presses (including belt presses)  
Conveyors  
Cranes  
HVAC (excluding network)  
Water heaters  
Heat exchangers  
Generators  
Cabinetry and housing (such as electrical boxes/enclosures)  
Lighting fixtures  
Electrical conduit  
Emergency life systems  
Metal office furniture  
Shelving  
Laboratory equipment  
Analytical instrumentation  
Dewatering equipment



**INFORMATIONAL CHECKLIST FOR PROJECT SPECIFIC WAIVER REQUEST**

Please reference the specifications of the product.

<b>Information</b>	<input type="checkbox"/>	<b>Note</b>
<p><b>General</b></p> <ul style="list-style-type: none"> <li>• Waiver request includes the following information:                             <ul style="list-style-type: none"> <li>— Description of the foreign and domestic construction materials</li> <li>— Unit of measure</li> <li>— Quantity</li> <li>— Price</li> <li>— Date that product is needed (e.g. time of delivery or availability)</li> <li>— Location of the construction project</li> <li>— Name and address of the proposed supplier</li> <li>— A detailed justification for the use of foreign construction materials</li> </ul> </li> <li>• Waiver request was submitted according to the instructions in the memorandum</li> <li>• Assistance recipient made a good faith effort to solicit bids for domestic iron and steel products, as demonstrated by language in requests for proposals, contracts, and communications with the prime</li> </ul>		
<p><b>Cost Waiver Requests</b></p> <ul style="list-style-type: none"> <li>• Waiver request includes the following information:                             <ul style="list-style-type: none"> <li>— Comparison of overall cost of project with domestic iron and steel products to overall cost of project with foreign iron and steel products (Exhibit J)</li> <li>— Relevant excerpts from the bid documents used by the contractors to complete the comparison</li> <li>— Supporting documentation indicating that the contractor made a reasonable survey of the market, such as a description of the process for identifying suppliers and a list of contacted suppliers</li> </ul> </li> </ul>		
<p><b>Availability Waiver Requests</b></p> <ul style="list-style-type: none"> <li>• Waiver request includes the following supporting documentation necessary to demonstrate the availability, quantity, and/or quality of the materials for which the waiver is requested:                             <ul style="list-style-type: none"> <li>— Supplier information or pricing information from a reasonable number of domestic suppliers indicating availability/delivery date for construction materials</li> <li>— Documentation of the assistance recipient's efforts to find available domestic sources, such as a description of the process for identifying suppliers and a list of contacted suppliers.</li> <li>— Date that product is needed (e.g. time of delivery or availability) to provide justification</li> <li>— Relevant excerpts from project plans, specifications, and permits indicating the required quantity and quality of construction materials</li> </ul> </li> <li>• Waiver request includes a statement from the prime contractor and/or supplier confirming the non-availability of the domestic construction materials for which the waiver is sought</li> <li>• Has the State received other waiver requests for the materials described in this waiver request, for comparable projects?</li> </ul>		

EXAMPLE COST TABLE FOR A PROJECT COST WAIVER

AIS/Non-AIS Cost Comparison Table								
Specification	Item or Description	Quantity	Unit	Unit Price	Cost if applying AIS	Cost if a waiver to AIS is applied		
					\$ -	\$ -		
					\$ -	\$ -		
					\$ -	\$ -		
					\$ -	\$ -		
					\$ -	\$ -		
					\$ -	\$ -		
					\$ -	\$ -		
					\$ -	\$ -		
					\$ -	\$ -		
					\$ -	\$ -		
					\$ -	\$ -		
					\$ -	\$ -		
					\$ -	\$ -		
					\$ -	\$ -		
					\$ -	\$ -		
					\$ -	\$ -		
					\$ -	\$ -		
					\$ -	\$ -		
					\$ -	\$ -		
					\$ -	\$ -		
					\$ -	\$ -		

TOTAL COST:

\$0.00

\$0.00



This document has important legal consequences; consultation with an attorney is encouraged with respect to its use or modification. This document should be adapted to the particular circumstances of the contemplated Project and the controlling Laws and Regulations.

## STANDARD GENERAL CONDITIONS OF THE CONSTRUCTION CONTRACT

Prepared by



Issued and Published Jointly by



Endorsed by



These General Conditions have been prepared for use with the Agreement Between Owner and Contractor for Construction Contract (EJCDC® C-520, Stipulated Sum, or C-525, Cost-Plus, 2013 Editions). Their provisions are interrelated and a change in one may necessitate a change in the other.

To prepare supplementary conditions that are coordinated with the General Conditions, use EJCDC's Guide to the Preparation of Supplementary Conditions (EJCDC® C-800, 2013 Edition). The full EJCDC Construction series of documents is discussed in the Commentary on the 2013 EJCDC Construction Documents (EJCDC® C-001, 2013 Edition).

Copyright © 2013:

National Society of Professional Engineers  
1420 King Street, Alexandria, VA 22314-2794  
(703) 684-2882  
[www.nspe.org](http://www.nspe.org)

American Council of Engineering Companies  
1015 15th Street N.W., Washington, DC 20005  
(202) 347-7474  
[www.acec.org](http://www.acec.org)

American Society of Civil Engineers  
1801 Alexander Bell Drive, Reston, VA 20191-4400  
(800) 548-2723  
[www.asce.org](http://www.asce.org)

The copyright for this document is owned jointly by the three sponsoring organizations listed above. The National Society of Professional Engineers is the Copyright Administrator for the EJCDC documents; please direct all inquiries regarding EJCDC copyrights to NSPE.

NOTE: EJCDC publications may be purchased at [www.ejcdc.org](http://www.ejcdc.org), or from any of the sponsoring organizations above.

# STANDARD GENERAL CONDITIONS OF THE CONSTRUCTION CONTRACT

## TABLE OF CONTENTS

	<b>Page</b>
Article 1 – Definitions and Terminology .....	8
1.01 Defined Terms .....	8
1.02 Terminology .....	12
Article 2 – Preliminary Matters .....	13
2.01 Delivery of Bonds and Evidence of Insurance .....	13
2.02 Copies of Documents .....	13
2.03 Before Starting Construction .....	13
2.04 Preconstruction Conference; Designation of Authorized Representatives .....	14
2.05 Initial Acceptance of Schedules .....	14
2.06 Electronic Transmittals .....	14
Article 3 – Documents: Intent, Requirements, Reuse .....	15
3.01 Intent .....	15
3.02 Reference Standards .....	15
3.03 Reporting and Resolving Discrepancies .....	16
3.04 Requirements of the Contract Documents .....	16
3.05 Reuse of Documents .....	17
Article 4 – Commencement and Progress of the Work .....	17
4.01 Commencement of Contract Times; Notice to Proceed .....	17
4.02 Starting the Work .....	17
4.03 Reference Points .....	17
4.04 Progress Schedule .....	18
4.05 Delays in Contractor’s Progress .....	18
Article 5 – Availability of Lands; Subsurface and Physical Conditions; Hazardous Environmental Conditions .....	19
5.01 Availability of Lands .....	19
5.02 Use of Site and Other Areas .....	19
5.03 Subsurface and Physical Conditions .....	20
5.04 Differing Subsurface or Physical Conditions .....	21
5.05 Underground Facilities .....	22

5.06	Hazardous Environmental Conditions at Site .....	24
Article 6 – Bonds and Insurance .....		26
6.01	Performance, Payment, and Other Bonds .....	26
6.02	Insurance—General Provisions .....	26
6.03	Contractor’s Insurance .....	28
6.04	Owner’s Liability Insurance .....	30
6.05	Property Insurance .....	30
6.06	Waiver of Rights .....	32
6.07	Receipt and Application of Property Insurance Proceeds .....	33
Article 7 – Contractor’s Responsibilities .....		33
7.01	Supervision and Superintendence .....	33
7.02	Labor; Working Hours .....	33
7.03	Services, Materials, and Equipment.....	34
7.04	“Or Equals” .....	34
7.05	Substitutes .....	35
7.06	Concerning Subcontractors, Suppliers, and Others .....	37
7.07	Patent Fees and Royalties .....	38
7.08	Permits .....	39
7.09	Taxes .....	39
7.10	Laws and Regulations.....	39
7.11	Record Documents.....	40
7.12	Safety and Protection.....	40
7.13	Safety Representative .....	41
7.14	Hazard Communication Programs .....	41
7.15	Emergencies .....	41
7.16	Shop Drawings, Samples, and Other Submittals.....	41
7.17	Contractor’s General Warranty and Guarantee.....	43
7.18	Indemnification .....	44
7.19	Delegation of Professional Design Services .....	45
Article 8 – Other Work at the Site .....		45
8.01	Other Work .....	45
8.02	Coordination .....	46
8.03	Legal Relationships.....	46

Article 9 – Owner’s Responsibilities.....	47
9.01 Communications to Contractor.....	47
9.02 Replacement of Engineer .....	48
9.03 Furnish Data .....	48
9.04 Pay When Due.....	48
9.05 Lands and Easements; Reports, Tests, and Drawings .....	48
9.06 Insurance .....	48
9.07 Change Orders.....	48
9.08 Inspections, Tests, and Approvals.....	48
9.09 Limitations on Owner’s Responsibilities .....	48
9.10 Undisclosed Hazardous Environmental Condition.....	48
9.11 Evidence of Financial Arrangements.....	48
9.12 Safety Programs .....	49
Article 10 – Engineer’s Status During Construction.....	49
10.01 Owner’s Representative.....	49
10.02 Visits to Site.....	49
10.03 Project Representative.....	49
10.04 Rejecting Defective Work.....	49
10.05 Shop Drawings, Change Orders and Payments.....	50
10.06 Determinations for Unit Price Work .....	50
10.07 Decisions on Requirements of Contract Documents and Acceptability of Work .....	50
10.08 Limitations on Engineer’s Authority and Responsibilities.....	50
10.09 Compliance with Safety Program.....	51
Article 11 – Amending the Contract Documents; Changes in the Work .....	51
11.01 Amending and Supplementing Contract Documents .....	51
11.02 Owner-Authorized Changes in the Work .....	51
11.03 Unauthorized Changes in the Work .....	52
11.04 Change of Contract Price .....	52
11.05 Change of Contract Times .....	53
11.06 Change Proposals.....	53
11.07 Execution of Change Orders.....	54
11.08 Notification to Surety.....	54
Article 12 – Claims.....	55



12.01	Claims .....	55
Article 13 – Cost of the Work; Allowances; Unit Price Work.....		56
13.01	Cost of the Work .....	56
13.02	Allowances .....	58
13.03	Unit Price Work .....	59
Article 14 – Tests and Inspections; Correction, Removal or Acceptance of Defective Work.....		59
14.01	Access to Work.....	59
14.02	Tests, Inspections, and Approvals.....	60
14.03	Defective Work.....	60
14.04	Acceptance of Defective Work.....	61
14.05	Uncovering Work .....	61
14.06	Owner May Stop the Work .....	62
14.07	Owner May Correct Defective Work.....	62
Article 15 – Payments to Contractor; Set-Offs; Completion; Correction Period .....		63
15.01	Progress Payments.....	63
15.02	Contractor’s Warranty of Title .....	66
15.03	Substantial Completion.....	66
15.04	Partial Use or Occupancy .....	67
15.05	Final Inspection .....	67
15.06	Final Payment.....	67
15.07	Waiver of Claims .....	69
15.08	Correction Period .....	69
Article 16 – Suspension of Work and Termination .....		70
16.01	Owner May Suspend Work .....	70
16.02	Owner May Terminate for Cause .....	70
16.03	Owner May Terminate For Convenience .....	71
16.04	Contractor May Stop Work or Terminate .....	71
Article 17 – Final Resolution of Disputes .....		72
17.01	Methods and Procedures.....	72
Article 18 – Miscellaneous .....		72
18.01	Giving Notice .....	72
18.02	Computation of Times.....	72
18.03	Cumulative Remedies .....	72

18.04 Limitation of Damages ..... 73  
18.05 No Waiver ..... 73  
18.06 Survival of Obligations ..... 73  
18.07 Controlling Law ..... 73  
18.08 Headings..... 73

## ARTICLE 1 – DEFINITIONS AND TERMINOLOGY

### 1.01 *Defined Terms*

- A. Wherever used in the Bidding Requirements or Contract Documents, a term printed with initial capital letters, including the term's singular and plural forms, will have the meaning indicated in the definitions below. In addition to terms specifically defined, terms with initial capital letters in the Contract Documents include references to identified articles and paragraphs, and the titles of other documents or forms.
1. *Addenda*—Written or graphic instruments issued prior to the opening of Bids which clarify, correct, or change the Bidding Requirements or the proposed Contract Documents.
  2. *Agreement*—The written instrument, executed by Owner and Contractor, that sets forth the Contract Price and Contract Times, identifies the parties and the Engineer, and designates the specific items that are Contract Documents.
  3. *Application for Payment*—The form acceptable to Engineer which is to be used by Contractor during the course of the Work in requesting progress or final payments and which is to be accompanied by such supporting documentation as is required by the Contract Documents.
  4. *Bid*—The offer of a Bidder submitted on the prescribed form setting forth the prices for the Work to be performed.
  5. *Bidder*—An individual or entity that submits a Bid to Owner.
  6. *Bidding Documents*—The Bidding Requirements, the proposed Contract Documents, and all Addenda.
  7. *Bidding Requirements*—The advertisement or invitation to bid, Instructions to Bidders, Bid Bond or other Bid security, if any, the Bid Form, and the Bid with any attachments.
  8. *Change Order*—A document which is signed by Contractor and Owner and authorizes an addition, deletion, or revision in the Work or an adjustment in the Contract Price or the Contract Times, or other revision to the Contract, issued on or after the Effective Date of the Contract.
  9. *Change Proposal*—A written request by Contractor, duly submitted in compliance with the procedural requirements set forth herein, seeking an adjustment in Contract Price or Contract Times, or both; contesting an initial decision by Engineer concerning the requirements of the Contract Documents or the acceptability of Work under the Contract Documents; challenging a set-off against payments due; or seeking other relief with respect to the terms of the Contract.
  10. *Claim*—(a) A demand or assertion by Owner directly to Contractor, duly submitted in compliance with the procedural requirements set forth herein: seeking an adjustment of Contract Price or Contract Times, or both; contesting an initial decision by Engineer concerning the requirements of the Contract Documents or the acceptability of Work under the Contract Documents; contesting Engineer's decision regarding a Change Proposal; seeking resolution of a contractual issue that Engineer has declined to address; or seeking other relief with respect to the terms of the Contract; or (b) a demand or assertion by Contractor directly to Owner, duly submitted in compliance with the procedural requirements set forth herein, contesting Engineer's decision

regarding a Change Proposal; or seeking resolution of a contractual issue that Engineer has declined to address. A demand for money or services by a third party is not a Claim.

11. *Constituent of Concern*—Asbestos, petroleum, radioactive materials, polychlorinated biphenyls (PCBs), hazardous waste, and any substance, product, waste, or other material of any nature whatsoever that is or becomes listed, regulated, or addressed pursuant to (a) the Comprehensive Environmental Response, Compensation and Liability Act, 42 U.S.C. §§9601 et seq. (“CERCLA”); (b) the Hazardous Materials Transportation Act, 49 U.S.C. §§5101 et seq.; (c) the Resource Conservation and Recovery Act, 42 U.S.C. §§6901 et seq. (“RCRA”); (d) the Toxic Substances Control Act, 15 U.S.C. §§2601 et seq.; (e) the Clean Water Act, 33 U.S.C. §§1251 et seq.; (f) the Clean Air Act, 42 U.S.C. §§7401 et seq.; or (g) any other federal, state, or local statute, law, rule, regulation, ordinance, resolution, code, order, or decree regulating, relating to, or imposing liability or standards of conduct concerning, any hazardous, toxic, or dangerous waste, substance, or material.
12. *Contract*—The entire and integrated written contract between the Owner and Contractor concerning the Work.
13. *Contract Documents*—Those items so designated in the Agreement, and which together comprise the Contract.
14. *Contract Price*—The money that Owner has agreed to pay Contractor for completion of the Work in accordance with the Contract Documents. .
15. *Contract Times*—The number of days or the dates by which Contractor shall: (a) achieve Milestones, if any; (b) achieve Substantial Completion; and (c) complete the Work.
16. *Contractor*—The individual or entity with which Owner has contracted for performance of the Work.
17. *Cost of the Work*—See Paragraph 13.01 for definition.
18. *Drawings*—The part of the Contract that graphically shows the scope, extent, and character of the Work to be performed by Contractor.
19. *Effective Date of the Contract*—The date, indicated in the Agreement, on which the Contract becomes effective.
20. *Engineer*—The individual or entity named as such in the Agreement.
21. *Field Order*—A written order issued by Engineer which requires minor changes in the Work but does not change the Contract Price or the Contract Times.
22. *Hazardous Environmental Condition*—The presence at the Site of Constituents of Concern in such quantities or circumstances that may present a danger to persons or property exposed thereto. The presence at the Site of materials that are necessary for the execution of the Work, or that are to be incorporated in the Work, and that are controlled and contained pursuant to industry practices, Laws and Regulations, and the requirements of the Contract, does not establish a Hazardous Environmental Condition.

23. *Laws and Regulations; Laws or Regulations*—Any and all applicable laws, statutes, rules, regulations, ordinances, codes, and orders of any and all governmental bodies, agencies, authorities, and courts having jurisdiction.
24. *Liens*—Charges, security interests, or encumbrances upon Contract-related funds, real property, or personal property.
25. *Milestone*—A principal event in the performance of the Work that the Contract requires Contractor to achieve by an intermediate completion date or by a time prior to Substantial Completion of all the Work.
26. *Notice of Award*—The written notice by Owner to a Bidder of Owner's acceptance of the Bid.
27. *Notice to Proceed*—A written notice by Owner to Contractor fixing the date on which the Contract Times will commence to run and on which Contractor shall start to perform the Work.
28. *Owner*—The individual or entity with which Contractor has contracted regarding the Work, and which has agreed to pay Contractor for the performance of the Work, pursuant to the terms of the Contract.
29. *Progress Schedule*—A schedule, prepared and maintained by Contractor, describing the sequence and duration of the activities comprising the Contractor's plan to accomplish the Work within the Contract Times.
30. *Project*—The total undertaking to be accomplished for Owner by engineers, contractors, and others, including planning, study, design, construction, testing, commissioning, and start-up, and of which the Work to be performed under the Contract Documents is a part.
31. *Project Manual*—The written documents prepared for, or made available for, procuring and constructing the Work, including but not limited to the Bidding Documents or other construction procurement documents, geotechnical and existing conditions information, the Agreement, bond forms, General Conditions, Supplementary Conditions, and Specifications. The contents of the Project Manual may be bound in one or more volumes.
32. *Resident Project Representative*—The authorized representative of Engineer assigned to assist Engineer at the Site. As used herein, the term Resident Project Representative or "RPR" includes any assistants or field staff of Resident Project Representative.
33. *Samples*—Physical examples of materials, equipment, or workmanship that are representative of some portion of the Work and that establish the standards by which such portion of the Work will be judged.
34. *Schedule of Submittals*—A schedule, prepared and maintained by Contractor, of required submittals and the time requirements for Engineer's review of the submittals and the performance of related construction activities.
35. *Schedule of Values*—A schedule, prepared and maintained by Contractor, allocating portions of the Contract Price to various portions of the Work and used as the basis for reviewing Contractor's Applications for Payment.
36. *Shop Drawings*—All drawings, diagrams, illustrations, schedules, and other data or information that are specifically prepared or assembled by or for Contractor and

submitted by Contractor to illustrate some portion of the Work. Shop Drawings, whether approved or not, are not Drawings and are not Contract Documents.

37. *Site*—Lands or areas indicated in the Contract Documents as being furnished by Owner upon which the Work is to be performed, including rights-of-way and easements, and such other lands furnished by Owner which are designated for the use of Contractor.
38. *Specifications*—The part of the Contract that consists of written requirements for materials, equipment, systems, standards, and workmanship as applied to the Work, and certain administrative requirements and procedural matters applicable to the Work.
39. *Subcontractor*—An individual or entity having a direct contract with Contractor or with any other Subcontractor for the performance of a part of the Work.
40. *Substantial Completion*—The time at which the Work (or a specified part thereof) has progressed to the point where, in the opinion of Engineer, the Work (or a specified part thereof) is sufficiently complete, in accordance with the Contract Documents, so that the Work (or a specified part thereof) can be utilized for the purposes for which it is intended. The terms “substantially complete” and “substantially completed” as applied to all or part of the Work refer to Substantial Completion thereof.
41. *Successful Bidder*—The Bidder whose Bid the Owner accepts, and to which the Owner makes an award of contract, subject to stated conditions.
42. *Supplementary Conditions*—The part of the Contract that amends or supplements these General Conditions.
43. *Supplier*—A manufacturer, fabricator, supplier, distributor, materialman, or vendor having a direct contract with Contractor or with any Subcontractor to furnish materials or equipment to be incorporated in the Work by Contractor or a Subcontractor.
44. *Technical Data*—Those items expressly identified as Technical Data in the Supplementary Conditions, with respect to either (a) subsurface conditions at the Site, or physical conditions relating to existing surface or subsurface structures at the Site (except Underground Facilities) or (b) Hazardous Environmental Conditions at the Site. If no such express identifications of Technical Data have been made with respect to conditions at the Site, then the data contained in boring logs, recorded measurements of subsurface water levels, laboratory test results, and other factual, objective information regarding conditions at the Site that are set forth in any geotechnical or environmental report prepared for the Project and made available to Contractor are hereby defined as Technical Data with respect to conditions at the Site under Paragraphs 5.03, 5.04, and 5.06.
45. *Underground Facilities*—All underground pipelines, conduits, ducts, cables, wires, manholes, vaults, tanks, tunnels, or other such facilities or attachments, and any encasements containing such facilities, including but not limited to those that convey electricity, gases, steam, liquid petroleum products, telephone or other communications, fiber optic transmissions, cable television, water, wastewater, storm water, other liquids or chemicals, or traffic or other control systems.
46. *Unit Price Work*—Work to be paid for on the basis of unit prices.
47. *Work*—The entire construction or the various separately identifiable parts thereof required to be provided under the Contract Documents. Work includes and is the

result of performing or providing all labor, services, and documentation necessary to produce such construction; furnishing, installing, and incorporating all materials and equipment into such construction; and may include related services such as testing, start-up, and commissioning, all as required by the Contract Documents.

48. *Work Change Directive*—A written directive to Contractor issued on or after the Effective Date of the Contract, signed by Owner and recommended by Engineer, ordering an addition, deletion, or revision in the Work.

## 1.02 Terminology

- A. The words and terms discussed in the following paragraphs are not defined but, when used in the Bidding Requirements or Contract Documents, have the indicated meaning.
- B. *Intent of Certain Terms or Adjectives:*
1. The Contract Documents include the terms “as allowed,” “as approved,” “as ordered,” “as directed” or terms of like effect or import to authorize an exercise of professional judgment by Engineer. In addition, the adjectives “reasonable,” “suitable,” “acceptable,” “proper,” “satisfactory,” or adjectives of like effect or import are used to describe an action or determination of Engineer as to the Work. It is intended that such exercise of professional judgment, action, or determination will be solely to evaluate, in general, the Work for compliance with the information in the Contract Documents and with the design concept of the Project as a functioning whole as shown or indicated in the Contract Documents (unless there is a specific statement indicating otherwise). The use of any such term or adjective is not intended to and shall not be effective to assign to Engineer any duty or authority to supervise or direct the performance of the Work, or any duty or authority to undertake responsibility contrary to the provisions of Article 10 or any other provision of the Contract Documents.
- C. *Day:*
1. The word “day” means a calendar day of 24 hours measured from midnight to the next midnight.
- D. *Defective:*
1. The word “defective,” when modifying the word “Work,” refers to Work that is unsatisfactory, faulty, or deficient in that it:
    - a. does not conform to the Contract Documents; or
    - b. does not meet the requirements of any applicable inspection, reference standard, test, or approval referred to in the Contract Documents; or
    - c. has been damaged prior to Engineer’s recommendation of final payment (unless responsibility for the protection thereof has been assumed by Owner at Substantial Completion in accordance with Paragraph 15.03 or 15.04).
- E. *Furnish, Install, Perform, Provide:*
1. The word “furnish,” when used in connection with services, materials, or equipment, shall mean to supply and deliver said services, materials, or equipment to the Site (or some other specified location) ready for use or installation and in usable or operable condition.

2. The word “install,” when used in connection with services, materials, or equipment, shall mean to put into use or place in final position said services, materials, or equipment complete and ready for intended use.
  3. The words “perform” or “provide,” when used in connection with services, materials, or equipment, shall mean to furnish and install said services, materials, or equipment complete and ready for intended use.
  4. If the Contract Documents establish an obligation of Contractor with respect to specific services, materials, or equipment, but do not expressly use any of the four words “furnish,” “install,” “perform,” or “provide,” then Contractor shall furnish and install said services, materials, or equipment complete and ready for intended use.
- F. Unless stated otherwise in the Contract Documents, words or phrases that have a well-known technical or construction industry or trade meaning are used in the Contract Documents in accordance with such recognized meaning.

## ARTICLE 2 – PRELIMINARY MATTERS

### 2.01 *Delivery of Bonds and Evidence of Insurance*

- A. *Bonds*: When Contractor delivers the executed counterparts of the Agreement to Owner, Contractor shall also deliver to Owner such bonds as Contractor may be required to furnish.
- B. *Evidence of Contractor’s Insurance*: When Contractor delivers the executed counterparts of the Agreement to Owner, Contractor shall also deliver to Owner, with copies to each named insured and additional insured (as identified in the Supplementary Conditions or elsewhere in the Contract), the certificates and other evidence of insurance required to be provided by Contractor in accordance with Article 6.
- C. *Evidence of Owner’s Insurance*: After receipt of the executed counterparts of the Agreement and all required bonds and insurance documentation, Owner shall promptly deliver to Contractor, with copies to each named insured and additional insured (as identified in the Supplementary Conditions or otherwise), the certificates and other evidence of insurance required to be provided by Owner under Article 6.

### 2.02 *Copies of Documents*

- A. Owner shall furnish to Contractor four printed copies of the Contract (including one fully executed counterpart of the Agreement), and one copy in electronic portable document format (PDF). Additional printed copies will be furnished upon request at the cost of reproduction.
- B. Owner shall maintain and safeguard at least one original printed record version of the Contract, including Drawings and Specifications signed and sealed by Engineer and other design professionals. Owner shall make such original printed record version of the Contract available to Contractor for review. Owner may delegate the responsibilities under this provision to Engineer.

### 2.03 *Before Starting Construction*

- A. *Preliminary Schedules*: Within 10 days after the Effective Date of the Contract (or as otherwise specifically required by the Contract Documents), Contractor shall submit to Engineer for timely review:



1. a preliminary Progress Schedule indicating the times (numbers of days or dates) for starting and completing the various stages of the Work, including any Milestones specified in the Contract;
2. a preliminary Schedule of Submittals; and
3. a preliminary Schedule of Values for all of the Work which includes quantities and prices of items which when added together equal the Contract Price and subdivides the Work into component parts in sufficient detail to serve as the basis for progress payments during performance of the Work. Such prices will include an appropriate amount of overhead and profit applicable to each item of Work.

2.04 *Preconstruction Conference; Designation of Authorized Representatives*

- A. Before any Work at the Site is started, a conference attended by Owner, Contractor, Engineer, and others as appropriate will be held to establish a working understanding among the parties as to the Work and to discuss the schedules referred to in Paragraph 2.03.A, procedures for handling Shop Drawings, Samples, and other submittals, processing Applications for Payment, electronic or digital transmittals, and maintaining required records.
- B. At this conference Owner and Contractor each shall designate, in writing, a specific individual to act as its authorized representative with respect to the services and responsibilities under the Contract. Such individuals shall have the authority to transmit and receive information, render decisions relative to the Contract, and otherwise act on behalf of each respective party.

2.05 *Initial Acceptance of Schedules*

- A. At least 10 days before submission of the first Application for Payment a conference, attended by Contractor, Engineer, and others as appropriate, will be held to review for acceptability to Engineer as provided below the schedules submitted in accordance with Paragraph 2.03.A. Contractor shall have an additional 10 days to make corrections and adjustments and to complete and resubmit the schedules. No progress payment shall be made to Contractor until acceptable schedules are submitted to Engineer.
  1. The Progress Schedule will be acceptable to Engineer if it provides an orderly progression of the Work to completion within the Contract Times. Such acceptance will not impose on Engineer responsibility for the Progress Schedule, for sequencing, scheduling, or progress of the Work, nor interfere with or relieve Contractor from Contractor's full responsibility therefor.
  2. Contractor's Schedule of Submittals will be acceptable to Engineer if it provides a workable arrangement for reviewing and processing the required submittals.
  3. Contractor's Schedule of Values will be acceptable to Engineer as to form and substance if it provides a reasonable allocation of the Contract Price to the component parts of the Work.

2.06 *Electronic Transmittals*

- A. Except as otherwise stated elsewhere in the Contract, the Owner, Engineer, and Contractor may transmit, and shall accept, Project-related correspondence, text, data, documents, drawings, information, and graphics, including but not limited to Shop Drawings and other submittals, in electronic media or digital format, either directly, or through access to a secure Project website.

- B. If the Contract does not establish protocols for electronic or digital transmittals, then Owner, Engineer, and Contractor shall jointly develop such protocols.
- C. When transmitting items in electronic media or digital format, the transmitting party makes no representations as to long term compatibility, usability, or readability of the items resulting from the recipient's use of software application packages, operating systems, or computer hardware differing from those used in the drafting or transmittal of the items, or from those established in applicable transmittal protocols.

### **ARTICLE 3 – DOCUMENTS: INTENT, REQUIREMENTS, REUSE**

#### **3.01 *Intent***

- A. The Contract Documents are complementary; what is required by one is as binding as if required by all.
- B. It is the intent of the Contract Documents to describe a functionally complete project (or part thereof) to be constructed in accordance with the Contract Documents.
- C. Unless otherwise stated in the Contract Documents, if there is a discrepancy between the electronic or digital versions of the Contract Documents (including any printed copies derived from such electronic or digital versions) and the printed record version, the printed record version shall govern.
- D. The Contract supersedes prior negotiations, representations, and agreements, whether written or oral.
- E. Engineer will issue clarifications and interpretations of the Contract Documents as provided herein.

#### **3.02 *Reference Standards***

- A. Standards Specifications, Codes, Laws and Regulations
  - 1. Reference in the Contract Documents to standard specifications, manuals, reference standards, or codes of any technical society, organization, or association, or to Laws or Regulations, whether such reference be specific or by implication, shall mean the standard specification, manual, reference standard, code, or Laws or Regulations in effect at the time of opening of Bids (or on the Effective Date of the Contract if there were no Bids), except as may be otherwise specifically stated in the Contract Documents.
  - 2. No provision of any such standard specification, manual, reference standard, or code, or any instruction of a Supplier, shall be effective to change the duties or responsibilities of Owner, Contractor, or Engineer, or any of their subcontractors, consultants, agents, or employees, from those set forth in the part of the Contract Documents prepared by or for Engineer. No such provision or instruction shall be effective to assign to Owner, Engineer, or any of their officers, directors, members, partners, employees, agents, consultants, or subcontractors, any duty or authority to supervise or direct the performance of the Work or any duty or authority to undertake responsibility inconsistent with the provisions of the part of the Contract Documents prepared by or for Engineer.

### 3.03 *Reporting and Resolving Discrepancies*

#### A. *Reporting Discrepancies:*

1. *Contractor's Verification of Figures and Field Measurements:* Before undertaking each part of the Work, Contractor shall carefully study the Contract Documents, and check and verify pertinent figures and dimensions therein, particularly with respect to applicable field measurements. Contractor shall promptly report in writing to Engineer any conflict, error, ambiguity, or discrepancy that Contractor discovers, or has actual knowledge of, and shall not proceed with any Work affected thereby until the conflict, error, ambiguity, or discrepancy is resolved, by a clarification or interpretation by Engineer, or by an amendment or supplement to the Contract Documents issued pursuant to Paragraph 11.01.
2. *Contractor's Review of Contract Documents:* If, before or during the performance of the Work, Contractor discovers any conflict, error, ambiguity, or discrepancy within the Contract Documents, or between the Contract Documents and (a) any applicable Law or Regulation, (b) actual field conditions, (c) any standard specification, manual, reference standard, or code, or (d) any instruction of any Supplier, then Contractor shall promptly report it to Engineer in writing. Contractor shall not proceed with the Work affected thereby (except in an emergency as required by Paragraph 7.15) until the conflict, error, ambiguity, or discrepancy is resolved, by a clarification or interpretation by Engineer, or by an amendment or supplement to the Contract Documents issued pursuant to Paragraph 11.01.
3. Contractor shall not be liable to Owner or Engineer for failure to report any conflict, error, ambiguity, or discrepancy in the Contract Documents unless Contractor had actual knowledge thereof.

#### B. *Resolving Discrepancies:*

1. Except as may be otherwise specifically stated in the Contract Documents, the provisions of the part of the Contract Documents prepared by or for Engineer shall take precedence in resolving any conflict, error, ambiguity, or discrepancy between such provisions of the Contract Documents and:
  - a. the provisions of any standard specification, manual, reference standard, or code, or the instruction of any Supplier (whether or not specifically incorporated by reference as a Contract Document); or
  - b. the provisions of any Laws or Regulations applicable to the performance of the Work (unless such an interpretation of the provisions of the Contract Documents would result in violation of such Law or Regulation).

### 3.04 *Requirements of the Contract Documents*

- A. During the performance of the Work and until final payment, Contractor and Owner shall submit to the Engineer all matters in question concerning the requirements of the Contract Documents (sometimes referred to as requests for information or interpretation—RFIs), or relating to the acceptability of the Work under the Contract Documents, as soon as possible after such matters arise. Engineer will be the initial interpreter of the requirements of the Contract Documents, and judge of the acceptability of the Work thereunder.
- B. Engineer will, with reasonable promptness, render a written clarification, interpretation, or decision on the issue submitted, or initiate an amendment or supplement to the Contract

Documents. Engineer's written clarification, interpretation, or decision will be final and binding on Contractor, unless it appeals by submitting a Change Proposal, and on Owner, unless it appeals by filing a Claim.

- C. If a submitted matter in question concerns terms and conditions of the Contract Documents that do not involve (1) the performance or acceptability of the Work under the Contract Documents, (2) the design (as set forth in the Drawings, Specifications, or otherwise), or (3) other engineering or technical matters, then Engineer will promptly give written notice to Owner and Contractor that Engineer is unable to provide a decision or interpretation. If Owner and Contractor are unable to agree on resolution of such a matter in question, either party may pursue resolution as provided in Article 12.

### 3.05 *Reuse of Documents*

- A. Contractor and its Subcontractors and Suppliers shall not:
1. have or acquire any title to or ownership rights in any of the Drawings, Specifications, or other documents (or copies of any thereof) prepared by or bearing the seal of Engineer or its consultants, including electronic media editions, or reuse any such Drawings, Specifications, other documents, or copies thereof on extensions of the Project or any other project without written consent of Owner and Engineer and specific written verification or adaptation by Engineer; or
  2. have or acquire any title or ownership rights in any other Contract Documents, reuse any such Contract Documents for any purpose without Owner's express written consent, or violate any copyrights pertaining to such Contract Documents.
- B. The prohibitions of this Paragraph 3.05 will survive final payment, or termination of the Contract. Nothing herein shall preclude Contractor from retaining copies of the Contract Documents for record purposes.

## **ARTICLE 4 – COMMENCEMENT AND PROGRESS OF THE WORK**

### 4.01 *Commencement of Contract Times; Notice to Proceed*

- A. The Contract Times will commence to run on the thirtieth day after the Effective Date of the Contract or, if a Notice to Proceed is given, on the day indicated in the Notice to Proceed. A Notice to Proceed may be given at any time within 30 days after the Effective Date of the Contract. In no event will the Contract Times commence to run later than the sixtieth day after the day of Bid opening or the thirtieth day after the Effective Date of the Contract, whichever date is earlier.

### 4.02 *Starting the Work*

- A. Contractor shall start to perform the Work on the date when the Contract Times commence to run. No Work shall be done at the Site prior to such date.

### 4.03 *Reference Points*

- A. Owner shall provide engineering surveys to establish reference points for construction which in Engineer's judgment are necessary to enable Contractor to proceed with the Work. Contractor shall be responsible for laying out the Work, shall protect and preserve the established reference points and property monuments, and shall make no changes or relocations without the prior written approval of Owner. Contractor shall report to Engineer whenever any reference point or property monument is lost or destroyed or

requires relocation because of necessary changes in grades or locations, and shall be responsible for the accurate replacement or relocation of such reference points or property monuments by professionally qualified personnel.

#### 4.04 *Progress Schedule*

- A. Contractor shall adhere to the Progress Schedule established in accordance with Paragraph 2.05 as it may be adjusted from time to time as provided below.
  - 1. Contractor shall submit to Engineer for acceptance (to the extent indicated in Paragraph 2.05) proposed adjustments in the Progress Schedule that will not result in changing the Contract Times.
  - 2. Proposed adjustments in the Progress Schedule that will change the Contract Times shall be submitted in accordance with the requirements of Article 11.
- B. Contractor shall carry on the Work and adhere to the Progress Schedule during all disputes or disagreements with Owner. No Work shall be delayed or postponed pending resolution of any disputes or disagreements, or during any appeal process, except as permitted by Paragraph 16.04, or as Owner and Contractor may otherwise agree in writing.

#### 4.05 *Delays in Contractor's Progress*

- A. If Owner, Engineer, or anyone for whom Owner is responsible, delays, disrupts, or interferes with the performance or progress of the Work, then Contractor shall be entitled to an equitable adjustment in the Contract Times and Contract Price. Contractor's entitlement to an adjustment of the Contract Times is conditioned on such adjustment being essential to Contractor's ability to complete the Work within the Contract Times.
- B. Contractor shall not be entitled to an adjustment in Contract Price or Contract Times for delay, disruption, or interference caused by or within the control of Contractor. Delay, disruption, and interference attributable to and within the control of a Subcontractor or Supplier shall be deemed to be within the control of Contractor.
- C. If Contractor's performance or progress is delayed, disrupted, or interfered with by unanticipated causes not the fault of and beyond the control of Owner, Contractor, and those for which they are responsible, then Contractor shall be entitled to an equitable adjustment in Contract Times. Contractor's entitlement to an adjustment of the Contract Times is conditioned on such adjustment being essential to Contractor's ability to complete the Work within the Contract Times. Such an adjustment shall be Contractor's sole and exclusive remedy for the delays, disruption, and interference described in this paragraph. Causes of delay, disruption, or interference that may give rise to an adjustment in Contract Times under this paragraph include but are not limited to the following:
  - 1. severe and unavoidable natural catastrophes such as fires, floods, epidemics, and earthquakes;
  - 2. abnormal weather conditions;
  - 3. acts or failures to act of utility owners (other than those performing other work at or adjacent to the Site by arrangement with the Owner, as contemplated in Article 8); and
  - 4. acts of war or terrorism.
- D. Delays, disruption, and interference to the performance or progress of the Work resulting from the existence of a differing subsurface or physical condition, an Underground Facility

that was not shown or indicated by the Contract Documents, or not shown or indicated with reasonable accuracy, and those resulting from Hazardous Environmental Conditions, are governed by Article 5.

- E. Paragraph 8.03 governs delays, disruption, and interference to the performance or progress of the Work resulting from the performance of certain other work at or adjacent to the Site.
- F. Contractor shall not be entitled to an adjustment in Contract Price or Contract Times for any delay, disruption, or interference if such delay is concurrent with a delay, disruption, or interference caused by or within the control of Contractor.
- G. Contractor must submit any Change Proposal seeking an adjustment in Contract Price or Contract Times under this paragraph within 30 days of the commencement of the delaying, disrupting, or interfering event.

## **ARTICLE 5 – AVAILABILITY OF LANDS; SUBSURFACE AND PHYSICAL CONDITIONS; HAZARDOUS ENVIRONMENTAL CONDITIONS**

### *5.01 Availability of Lands*

- A. Owner shall furnish the Site. Owner shall notify Contractor of any encumbrances or restrictions not of general application but specifically related to use of the Site with which Contractor must comply in performing the Work.
- B. Upon reasonable written request, Owner shall furnish Contractor with a current statement of record legal title and legal description of the lands upon which permanent improvements are to be made and Owner's interest therein as necessary for giving notice of or filing a mechanic's or construction lien against such lands in accordance with applicable Laws and Regulations.
- C. Contractor shall provide for all additional lands and access thereto that may be required for temporary construction facilities or storage of materials and equipment.

### *5.02 Use of Site and Other Areas*

- A. *Limitation on Use of Site and Other Areas:*
  - 1. Contractor shall confine construction equipment, temporary construction facilities, the storage of materials and equipment, and the operations of workers to the Site, adjacent areas that Contractor has arranged to use through construction easements or otherwise, and other adjacent areas permitted by Laws and Regulations, and shall not unreasonably encumber the Site and such other adjacent areas with construction equipment or other materials or equipment. Contractor shall assume full responsibility for (a) damage to the Site; (b) damage to any such other adjacent areas used for Contractor's operations; (c) damage to any other adjacent land or areas; and (d) for injuries and losses sustained by the owners or occupants of any such land or areas; provided that such damage or injuries result from the performance of the Work or from other actions or conduct of the Contractor or those for which Contractor is responsible.
  - 2. If a damage or injury claim is made by the owner or occupant of any such land or area because of the performance of the Work, or because of other actions or conduct of the Contractor or those for which Contractor is responsible, Contractor shall (a) take immediate corrective or remedial action as required by Paragraph 7.12, or otherwise;

(b) promptly attempt to settle the claim as to all parties through negotiations with such owner or occupant, or otherwise resolve the claim by arbitration or other dispute resolution proceeding, or at law; and (c) to the fullest extent permitted by Laws and Regulations, indemnify and hold harmless Owner and Engineer, and the officers, directors, members, partners, employees, agents, consultants and subcontractors of each and any of them from and against any such claim, and against all costs, losses, and damages (including but not limited to all fees and charges of engineers, architects, attorneys, and other professionals and all court or arbitration or other dispute resolution costs) arising out of or relating to any claim or action, legal or equitable, brought by any such owner or occupant against Owner, Engineer, or any other party indemnified hereunder to the extent caused directly or indirectly, in whole or in part by, or based upon, Contractor's performance of the Work, or because of other actions or conduct of the Contractor or those for which Contractor is responsible.

- B. *Removal of Debris During Performance of the Work:* During the progress of the Work the Contractor shall keep the Site and other adjacent areas free from accumulations of waste materials, rubbish, and other debris. Removal and disposal of such waste materials, rubbish, and other debris shall conform to applicable Laws and Regulations.
- C. *Cleaning:* Prior to Substantial Completion of the Work Contractor shall clean the Site and the Work and make it ready for utilization by Owner. At the completion of the Work Contractor shall remove from the Site and adjacent areas all tools, appliances, construction equipment and machinery, and surplus materials and shall restore to original condition all property not designated for alteration by the Contract Documents.
- D. *Loading of Structures:* Contractor shall not load nor permit any part of any structure to be loaded in any manner that will endanger the structure, nor shall Contractor subject any part of the Work or adjacent structures or land to stresses or pressures that will endanger them.

### 5.03 *Subsurface and Physical Conditions*

- A. *Reports and Drawings:* The Supplementary Conditions identify:
  1. those reports known to Owner of explorations and tests of subsurface conditions at or adjacent to the Site;
  2. those drawings known to Owner of physical conditions relating to existing surface or subsurface structures at the Site (except Underground Facilities); and
  3. Technical Data contained in such reports and drawings.
- B. *Reliance by Contractor on Technical Data Authorized:* Contractor may rely upon the accuracy of the Technical Data expressly identified in the Supplementary Conditions with respect to such reports and drawings, but such reports and drawings are not Contract Documents. If no such express identification has been made, then Contractor may rely upon the accuracy of the Technical Data (as defined in Article 1) contained in any geotechnical or environmental report prepared for the Project and made available to Contractor. Except for such reliance on Technical Data, Contractor may not rely upon or make any claim against Owner or Engineer, or any of their officers, directors, members, partners, employees, agents, consultants, or subcontractors, with respect to:
  1. the completeness of such reports and drawings for Contractor's purposes, including, but not limited to, any aspects of the means, methods, techniques, sequences, and

procedures of construction to be employed by Contractor, and safety precautions and programs incident thereto; or

2. other data, interpretations, opinions, and information contained in such reports or shown or indicated in such drawings; or
3. any Contractor interpretation of or conclusion drawn from any Technical Data or any such other data, interpretations, opinions, or information.

#### 5.04 *Differing Subsurface or Physical Conditions*

A. *Notice by Contractor:* If Contractor believes that any subsurface or physical condition that is uncovered or revealed at the Site either:

1. is of such a nature as to establish that any Technical Data on which Contractor is entitled to rely as provided in Paragraph 5.03 is materially inaccurate; or
2. is of such a nature as to require a change in the Drawings or Specifications; or
3. differs materially from that shown or indicated in the Contract Documents; or
4. is of an unusual nature, and differs materially from conditions ordinarily encountered and generally recognized as inherent in work of the character provided for in the Contract Documents;

then Contractor shall, promptly after becoming aware thereof and before further disturbing the subsurface or physical conditions or performing any Work in connection therewith (except in an emergency as required by Paragraph 7.15), notify Owner and Engineer in writing about such condition. Contractor shall not further disturb such condition or perform any Work in connection therewith (except with respect to an emergency) until receipt of a written statement permitting Contractor to do so.

B. *Engineer's Review:* After receipt of written notice as required by the preceding paragraph, Engineer will promptly review the subsurface or physical condition in question; determine the necessity of Owner's obtaining additional exploration or tests with respect to the condition; conclude whether the condition falls within any one or more of the differing site condition categories in Paragraph 5.04.A above; obtain any pertinent cost or schedule information from Contractor; prepare recommendations to Owner regarding the Contractor's resumption of Work in connection with the subsurface or physical condition in question and the need for any change in the Drawings or Specifications; and advise Owner in writing of Engineer's findings, conclusions, and recommendations.

C. *Owner's Statement to Contractor Regarding Site Condition:* After receipt of Engineer's written findings, conclusions, and recommendations, Owner shall issue a written statement to Contractor (with a copy to Engineer) regarding the subsurface or physical condition in question, addressing the resumption of Work in connection with such condition, indicating whether any change in the Drawings or Specifications will be made, and adopting or rejecting Engineer's written findings, conclusions, and recommendations, in whole or in part.

D. *Possible Price and Times Adjustments:*

1. Contractor shall be entitled to an equitable adjustment in Contract Price or Contract Times, or both, to the extent that the existence of a differing subsurface or physical condition, or any related delay, disruption, or interference, causes an increase or



decrease in Contractor's cost of, or time required for, performance of the Work; subject, however, to the following:

- a. such condition must fall within any one or more of the categories described in Paragraph 5.04.A;
  - b. with respect to Work that is paid for on a unit price basis, any adjustment in Contract Price will be subject to the provisions of Paragraph 13.03; and,
  - c. Contractor's entitlement to an adjustment of the Contract Times is conditioned on such adjustment being essential to Contractor's ability to complete the Work within the Contract Times.
2. Contractor shall not be entitled to any adjustment in the Contract Price or Contract Times with respect to a subsurface or physical condition if:
    - a. Contractor knew of the existence of such condition at the time Contractor made a commitment to Owner with respect to Contract Price and Contract Times by the submission of a Bid or becoming bound under a negotiated contract, or otherwise; or
    - b. the existence of such condition reasonably could have been discovered or revealed as a result of any examination, investigation, exploration, test, or study of the Site and contiguous areas expressly required by the Bidding Requirements or Contract Documents to be conducted by or for Contractor prior to Contractor's making such commitment; or
    - c. Contractor failed to give the written notice as required by Paragraph 5.04.A.
  3. If Owner and Contractor agree regarding Contractor's entitlement to and the amount or extent of any adjustment in the Contract Price or Contract Times, or both, then any such adjustment shall be set forth in a Change Order.
  4. Contractor may submit a Change Proposal regarding its entitlement to or the amount or extent of any adjustment in the Contract Price or Contract Times, or both, no later than 30 days after Owner's issuance of the Owner's written statement to Contractor regarding the subsurface or physical condition in question.

#### 5.05 *Underground Facilities*

- A. *Contractor's Responsibilities:* The information and data shown or indicated in the Contract Documents with respect to existing Underground Facilities at or adjacent to the Site is based on information and data furnished to Owner or Engineer by the owners of such Underground Facilities, including Owner, or by others. Unless it is otherwise expressly provided in the Supplementary Conditions:
  1. Owner and Engineer do not warrant or guarantee the accuracy or completeness of any such information or data provided by others; and
  2. the cost of all of the following will be included in the Contract Price, and Contractor shall have full responsibility for:
    - a. reviewing and checking all information and data regarding existing Underground Facilities at the Site;
    - b. locating all Underground Facilities shown or indicated in the Contract Documents as being at the Site;

- c. coordination of the Work with the owners (including Owner) of such Underground Facilities, during construction; and
  - d. the safety and protection of all existing Underground Facilities at the Site, and repairing any damage thereto resulting from the Work.
- B. *Notice by Contractor:* If Contractor believes that an Underground Facility that is uncovered or revealed at the Site was not shown or indicated in the Contract Documents, or was not shown or indicated with reasonable accuracy, then Contractor shall, promptly after becoming aware thereof and before further disturbing conditions affected thereby or performing any Work in connection therewith (except in an emergency as required by Paragraph 7.15), identify the owner of such Underground Facility and give written notice to that owner and to Owner and Engineer.
- C. *Engineer's Review:* Engineer will promptly review the Underground Facility and conclude whether such Underground Facility was not shown or indicated in the Contract Documents, or was not shown or indicated with reasonable accuracy; obtain any pertinent cost or schedule information from Contractor; prepare recommendations to Owner regarding the Contractor's resumption of Work in connection with the Underground Facility in question; determine the extent, if any, to which a change is required in the Drawings or Specifications to reflect and document the consequences of the existence or location of the Underground Facility; and advise Owner in writing of Engineer's findings, conclusions, and recommendations. During such time, Contractor shall be responsible for the safety and protection of such Underground Facility.
- D. *Owner's Statement to Contractor Regarding Underground Facility:* After receipt of Engineer's written findings, conclusions, and recommendations, Owner shall issue a written statement to Contractor (with a copy to Engineer) regarding the Underground Facility in question, addressing the resumption of Work in connection with such Underground Facility, indicating whether any change in the Drawings or Specifications will be made, and adopting or rejecting Engineer's written findings, conclusions, and recommendations in whole or in part.
- E. *Possible Price and Times Adjustments:*
1. Contractor shall be entitled to an equitable adjustment in the Contract Price or Contract Times, or both, to the extent that any existing Underground Facility at the Site that was not shown or indicated in the Contract Documents, or was not shown or indicated with reasonable accuracy, or any related delay, disruption, or interference, causes an increase or decrease in Contractor's cost of, or time required for, performance of the Work; subject, however, to the following:
    - a. Contractor did not know of and could not reasonably have been expected to be aware of or to have anticipated the existence or actual location of the Underground Facility in question;
    - b. With respect to Work that is paid for on a unit price basis, any adjustment in Contract Price will be subject to the provisions of Paragraph 13.03;
    - c. Contractor's entitlement to an adjustment of the Contract Times is conditioned on such adjustment being essential to Contractor's ability to complete the Work within the Contract Times; and
    - d. Contractor gave the notice required in Paragraph 5.05.B.

2. If Owner and Contractor agree regarding Contractor's entitlement to and the amount or extent of any adjustment in the Contract Price or Contract Times, or both, then any such adjustment shall be set forth in a Change Order.
3. Contractor may submit a Change Proposal regarding its entitlement to or the amount or extent of any adjustment in the Contract Price or Contract Times, or both, no later than 30 days after Owner's issuance of the Owner's written statement to Contractor regarding the Underground Facility in question.

5.06 *Hazardous Environmental Conditions at Site*

- A. *Reports and Drawings:* The Supplementary Conditions identify:
1. those reports and drawings known to Owner relating to Hazardous Environmental Conditions that have been identified at or adjacent to the Site; and
  2. Technical Data contained in such reports and drawings.
- B. *Reliance by Contractor on Technical Data Authorized:* Contractor may rely upon the accuracy of the Technical Data expressly identified in the Supplementary Conditions with respect to such reports and drawings, but such reports and drawings are not Contract Documents. If no such express identification has been made, then Contractor may rely on the accuracy of the Technical Data (as defined in Article 1) contained in any geotechnical or environmental report prepared for the Project and made available to Contractor. Except for such reliance on Technical Data, Contractor may not rely upon or make any claim against Owner or Engineer, or any of their officers, directors, members, partners, employees, agents, consultants, or subcontractors with respect to:
1. the completeness of such reports and drawings for Contractor's purposes, including, but not limited to, any aspects of the means, methods, techniques, sequences and procedures of construction to be employed by Contractor and safety precautions and programs incident thereto; or
  2. other data, interpretations, opinions and information contained in such reports or shown or indicated in such drawings; or
  3. any Contractor interpretation of or conclusion drawn from any Technical Data or any such other data, interpretations, opinions or information.
- C. Contractor shall not be responsible for removing or remediating any Hazardous Environmental Condition encountered, uncovered, or revealed at the Site unless such removal or remediation is expressly identified in the Contract Documents to be within the scope of the Work.
- D. Contractor shall be responsible for controlling, containing, and duly removing all Constituents of Concern brought to the Site by Contractor, Subcontractors, Suppliers, or anyone else for whom Contractor is responsible, and for any associated costs; and for the costs of removing and remediating any Hazardous Environmental Condition created by the presence of any such Constituents of Concern.
- E. If Contractor encounters, uncovers, or reveals a Hazardous Environmental Condition whose removal or remediation is not expressly identified in the Contract Documents as being within the scope of the Work, or if Contractor or anyone for whom Contractor is responsible creates a Hazardous Environmental Condition, then Contractor shall immediately: (1) secure or otherwise isolate such condition; (2) stop all Work in connection with such condition and in any area affected thereby (except in an emergency as required

by Paragraph 7.15); and (3) notify Owner and Engineer (and promptly thereafter confirm such notice in writing). Owner shall promptly consult with Engineer concerning the necessity for Owner to retain a qualified expert to evaluate such condition or take corrective action, if any. Promptly after consulting with Engineer, Owner shall take such actions as are necessary to permit Owner to timely obtain required permits and provide Contractor the written notice required by Paragraph 5.06.F. If Contractor or anyone for whom Contractor is responsible created the Hazardous Environmental Condition in question, then Owner may remove and remediate the Hazardous Environmental Condition, and impose a set-off against payments to account for the associated costs.

- F. Contractor shall not resume Work in connection with such Hazardous Environmental Condition or in any affected area until after Owner has obtained any required permits related thereto, and delivered written notice to Contractor either (1) specifying that such condition and any affected area is or has been rendered safe for the resumption of Work, or (2) specifying any special conditions under which such Work may be resumed safely.
- G. If Owner and Contractor cannot agree as to entitlement to or on the amount or extent, if any, of any adjustment in Contract Price or Contract Times, or both, as a result of such Work stoppage or such special conditions under which Work is agreed to be resumed by Contractor, then within 30 days of Owner's written notice regarding the resumption of Work, Contractor may submit a Change Proposal, or Owner may impose a set-off.
- H. If after receipt of such written notice Contractor does not agree to resume such Work based on a reasonable belief it is unsafe, or does not agree to resume such Work under such special conditions, then Owner may order the portion of the Work that is in the area affected by such condition to be deleted from the Work, following the contractual change procedures in Article 11. Owner may have such deleted portion of the Work performed by Owner's own forces or others in accordance with Article 8.
- I. To the fullest extent permitted by Laws and Regulations, Owner shall indemnify and hold harmless Contractor, Subcontractors, and Engineer, and the officers, directors, members, partners, employees, agents, consultants, and subcontractors of each and any of them from and against all claims, costs, losses, and damages (including but not limited to all fees and charges of engineers, architects, attorneys, and other professionals and all court or arbitration or other dispute resolution costs) arising out of or relating to a Hazardous Environmental Condition, provided that such Hazardous Environmental Condition (1) was not shown or indicated in the Drawings, Specifications, or other Contract Documents, identified as Technical Data entitled to limited reliance pursuant to Paragraph 5.06.B, or identified in the Contract Documents to be included within the scope of the Work, and (2) was not created by Contractor or by anyone for whom Contractor is responsible. Nothing in this Paragraph 5.06.I shall obligate Owner to indemnify any individual or entity from and against the consequences of that individual's or entity's own negligence.
- J. To the fullest extent permitted by Laws and Regulations, Contractor shall indemnify and hold harmless Owner and Engineer, and the officers, directors, members, partners, employees, agents, consultants, and subcontractors of each and any of them from and against all claims, costs, losses, and damages (including but not limited to all fees and charges of engineers, architects, attorneys, and other professionals and all court or arbitration or other dispute resolution costs) arising out of or relating to the failure to control, contain, or remove a Constituent of Concern brought to the Site by Contractor or by anyone for whom Contractor is responsible, or to a Hazardous Environmental Condition created by Contractor or by anyone for whom Contractor is responsible. Nothing in this

Paragraph 5.06.J shall obligate Contractor to indemnify any individual or entity from and against the consequences of that individual's or entity's own negligence.

- K. The provisions of Paragraphs 5.03, 5.04, and 5.05 do not apply to the presence of Constituents of Concern or to a Hazardous Environmental Condition uncovered or revealed at the Site.

## ARTICLE 6 – BONDS AND INSURANCE

### 6.01 *Performance, Payment, and Other Bonds*

- A. Contractor shall furnish a performance bond and a payment bond, each in an amount at least equal to the Contract Price, as security for the faithful performance and payment of all of Contractor's obligations under the Contract. These bonds shall remain in effect until one year after the date when final payment becomes due or until completion of the correction period specified in Paragraph 15.08, whichever is later, except as provided otherwise by Laws or Regulations, the Supplementary Conditions, or other specific provisions of the Contract. Contractor shall also furnish such other bonds as are required by the Supplementary Conditions or other specific provisions of the Contract.
- B. All bonds shall be in the form prescribed by the Contract except as provided otherwise by Laws or Regulations, and shall be executed by such sureties as are named in "Companies Holding Certificates of Authority as Acceptable Sureties on Federal Bonds and as Acceptable Reinsuring Companies" as published in Circular 570 (as amended and supplemented) by the Financial Management Service, Surety Bond Branch, U.S. Department of the Treasury. A bond signed by an agent or attorney-in-fact must be accompanied by a certified copy of that individual's authority to bind the surety. The evidence of authority shall show that it is effective on the date the agent or attorney-in-fact signed the accompanying bond.
- C. Contractor shall obtain the required bonds from surety companies that are duly licensed or authorized in the jurisdiction in which the Project is located to issue bonds in the required amounts.
- D. If the surety on a bond furnished by Contractor is declared bankrupt or becomes insolvent, or its right to do business is terminated in any state or jurisdiction where any part of the Project is located, or the surety ceases to meet the requirements above, then Contractor shall promptly notify Owner and Engineer and shall, within 20 days after the event giving rise to such notification, provide another bond and surety, both of which shall comply with the bond and surety requirements above.
- E. If Contractor has failed to obtain a required bond, Owner may exclude the Contractor from the Site and exercise Owner's termination rights under Article 16.
- F. Upon request, Owner shall provide a copy of the payment bond to any Subcontractor, Supplier, or other person or entity claiming to have furnished labor or materials used in the performance of the Work.

### 6.02 *Insurance—General Provisions*

- A. Owner and Contractor shall obtain and maintain insurance as required in this Article and in the Supplementary Conditions.
- B. All insurance required by the Contract to be purchased and maintained by Owner or Contractor shall be obtained from insurance companies that are duly licensed or

authorized, in the state or jurisdiction in which the Project is located, to issue insurance policies for the required limits and coverages. Unless a different standard is indicated in the Supplementary Conditions, all companies that provide insurance policies required under this Contract shall have an A.M. Best rating of A-VII or better.

- C. Contractor shall deliver to Owner, with copies to each named insured and additional insured (as identified in this Article, in the Supplementary Conditions, or elsewhere in the Contract), certificates of insurance establishing that Contractor has obtained and is maintaining the policies, coverages, and endorsements required by the Contract. Upon request by Owner or any other insured, Contractor shall also furnish other evidence of such required insurance, including but not limited to copies of policies and endorsements, and documentation of applicable self-insured retentions and deductibles. Contractor may block out (redact) any confidential premium or pricing information contained in any policy or endorsement furnished under this provision.
- D. Owner shall deliver to Contractor, with copies to each named insured and additional insured (as identified in this Article, the Supplementary Conditions, or elsewhere in the Contract), certificates of insurance establishing that Owner has obtained and is maintaining the policies, coverages, and endorsements required of Owner by the Contract (if any). Upon request by Contractor or any other insured, Owner shall also provide other evidence of such required insurance (if any), including but not limited to copies of policies and endorsements, and documentation of applicable self-insured retentions and deductibles. Owner may block out (redact) any confidential premium or pricing information contained in any policy or endorsement furnished under this provision.
- E. Failure of Owner or Contractor to demand such certificates or other evidence of the other party's full compliance with these insurance requirements, or failure of Owner or Contractor to identify a deficiency in compliance from the evidence provided, shall not be construed as a waiver of the other party's obligation to obtain and maintain such insurance.
- F. If either party does not purchase or maintain all of the insurance required of such party by the Contract, such party shall notify the other party in writing of such failure to purchase prior to the start of the Work, or of such failure to maintain prior to any change in the required coverage.
- G. If Contractor has failed to obtain and maintain required insurance, Owner may exclude the Contractor from the Site, impose an appropriate set-off against payment, and exercise Owner's termination rights under Article 16.
- H. Without prejudice to any other right or remedy, if a party has failed to obtain required insurance, the other party may elect to obtain equivalent insurance to protect such other party's interests at the expense of the party who was required to provide such coverage, and the Contract Price shall be adjusted accordingly.
- I. Owner does not represent that insurance coverage and limits established in this Contract necessarily will be adequate to protect Contractor or Contractor's interests.
- J. The insurance and insurance limits required herein shall not be deemed as a limitation on Contractor's liability under the indemnities granted to Owner and other individuals and entities in the Contract.

6.03 *Contractor's Insurance*

- A. *Workers' Compensation*: Contractor shall purchase and maintain workers' compensation and employer's liability insurance for:
1. claims under workers' compensation, disability benefits, and other similar employee benefit acts.
  2. United States Longshoreman and Harbor Workers' Compensation Act and Jones Act coverage (if applicable).
  3. claims for damages because of bodily injury, occupational sickness or disease, or death of Contractor's employees (by stop-gap endorsement in monopolist worker's compensation states).
  4. Foreign voluntary worker compensation (if applicable).
- B. *Commercial General Liability—Claims Covered*: Contractor shall purchase and maintain commercial general liability insurance, covering all operations by or on behalf of Contractor, on an occurrence basis, against:
1. claims for damages because of bodily injury, sickness or disease, or death of any person other than Contractor's employees.
  2. claims for damages insured by reasonably available personal injury liability coverage.
  3. claims for damages, other than to the Work itself, because of injury to or destruction of tangible property wherever located, including loss of use resulting therefrom.
- C. *Commercial General Liability—Form and Content*: Contractor's commercial liability policy shall be written on a 1996 (or later) ISO commercial general liability form (occurrence form) and include the following coverages and endorsements:
1. Products and completed operations coverage:
    - a. Such insurance shall be maintained for three years after final payment.
    - b. Contractor shall furnish Owner and each other additional insured (as identified in the Supplementary Conditions or elsewhere in the Contract) evidence of continuation of such insurance at final payment and three years thereafter.
  2. Blanket contractual liability coverage, to the extent permitted by law, including but not limited to coverage of Contractor's contractual indemnity obligations in Paragraph 7.18.
  3. Broad form property damage coverage.
  4. Severability of interest.
  5. Underground, explosion, and collapse coverage.
  6. Personal injury coverage.
  7. Additional insured endorsements that include both ongoing operations and products and completed operations coverage through ISO Endorsements CG 20 10 10 01 and CG 20 37 10 01 (together); or CG 20 10 07 04 and CG 20 37 07 04 (together); or their equivalent.

8. For design professional additional insureds, ISO Endorsement CG 20 32 07 04, "Additional Insured—Engineers, Architects or Surveyors Not Engaged by the Named Insured" or its equivalent.
- D. *Automobile liability*: Contractor shall purchase and maintain automobile liability insurance against claims for damages because of bodily injury or death of any person or property damage arising out of the ownership, maintenance, or use of any motor vehicle. The automobile liability policy shall be written on an occurrence basis.
- E. *Umbrella or excess liability*: Contractor shall purchase and maintain umbrella or excess liability insurance written over the underlying employer's liability, commercial general liability, and automobile liability insurance described in the paragraphs above. Subject to industry-standard exclusions, the coverage afforded shall follow form as to each and every one of the underlying policies.
- F. *Contractor's pollution liability insurance*: Contractor shall purchase and maintain a policy covering third-party injury and property damage claims, including clean-up costs, as a result of pollution conditions arising from Contractor's operations and completed operations. This insurance shall be maintained for no less than three years after final completion.
- G. *Additional insureds*: The Contractor's commercial general liability, automobile liability, umbrella or excess, and pollution liability policies shall include and list as additional insureds Owner and Engineer, and any individuals or entities identified in the Supplementary Conditions; include coverage for the respective officers, directors, members, partners, employees, agents, consultants, and subcontractors of each and any of all such additional insureds; and the insurance afforded to these additional insureds shall provide primary coverage for all claims covered thereby (including as applicable those arising from both ongoing and completed operations) on a non-contributory basis. Contractor shall obtain all necessary endorsements to support these requirements.
- H. *Contractor's professional liability insurance*: If Contractor will provide or furnish professional services under this Contract, through a delegation of professional design services or otherwise, then Contractor shall be responsible for purchasing and maintaining applicable professional liability insurance. This insurance shall provide protection against claims arising out of performance of professional design or related services, and caused by a negligent error, omission, or act for which the insured party is legally liable. It shall be maintained throughout the duration of the Contract and for a minimum of two years after Substantial Completion. If such professional design services are performed by a Subcontractor, and not by Contractor itself, then the requirements of this paragraph may be satisfied through the purchasing and maintenance of such insurance by such Subcontractor.
- I. *General provisions*: The policies of insurance required by this Paragraph 6.03 shall:
1. include at least the specific coverages provided in this Article.
  2. be written for not less than the limits of liability provided in this Article and in the Supplementary Conditions, or required by Laws or Regulations, whichever is greater.
  3. contain a provision or endorsement that the coverage afforded will not be canceled, materially changed, or renewal refused until at least 10 days prior written notice has been given to Contractor. Within three days of receipt of any such written notice, Contractor shall provide a copy of the notice to Owner, Engineer, and each other insured under the policy.



4. remain in effect at least until final payment (and longer if expressly required in this Article) and at all times thereafter when Contractor may be correcting, removing, or replacing defective Work as a warranty or correction obligation, or otherwise, or returning to the Site to conduct other tasks arising from the Contract Documents.
  5. be appropriate for the Work being performed and provide protection from claims that may arise out of or result from Contractor's performance of the Work and Contractor's other obligations under the Contract Documents, whether it is to be performed by Contractor, any Subcontractor or Supplier, or by anyone directly or indirectly employed by any of them to perform any of the Work, or by anyone for whose acts any of them may be liable.
- J. The coverage requirements for specific policies of insurance must be met by such policies, and not by reference to excess or umbrella insurance provided in other policies.

#### 6.04 *Owner's Liability Insurance*

- A. In addition to the insurance required to be provided by Contractor under Paragraph 6.03, Owner, at Owner's option, may purchase and maintain at Owner's expense Owner's own liability insurance as will protect Owner against claims which may arise from operations under the Contract Documents.
- B. Owner's liability policies, if any, operate separately and independently from policies required to be provided by Contractor, and Contractor cannot rely upon Owner's liability policies for any of Contractor's obligations to the Owner, Engineer, or third parties.

#### 6.05 *Property Insurance*

- A. *Builder's Risk*: Unless otherwise provided in the Supplementary Conditions, Contractor shall purchase and maintain builder's risk insurance upon the Work on a completed value basis, in the amount of the full insurable replacement cost thereof (subject to such deductible amounts as may be provided in the Supplementary Conditions or required by Laws and Regulations). This insurance shall:
  1. include the Owner and Contractor as named insureds, and all Subcontractors, and any individuals or entities required by the Supplementary Conditions to be insured under such builder's risk policy, as insureds or named insureds. For purposes of the remainder of this Paragraph 6.05, Paragraphs 6.06 and 6.07, and any corresponding Supplementary Conditions, the parties required to be insured shall collectively be referred to as "insureds."
  2. be written on a builder's risk "all risk" policy form that shall at least include insurance for physical loss or damage to the Work, temporary buildings, falsework, and materials and equipment in transit, and shall insure against at least the following perils or causes of loss: fire; lightning; windstorm; riot; civil commotion; terrorism; vehicle impact; aircraft; smoke; theft; vandalism and malicious mischief; mechanical breakdown, boiler explosion, and artificially generated electric current; earthquake; volcanic activity, and other earth movement; flood; collapse; explosion; debris removal; demolition occasioned by enforcement of Laws and Regulations; water damage (other than that caused by flood); and such other perils or causes of loss as may be specifically required by the Supplementary Conditions. If insurance against mechanical breakdown, boiler explosion, and artificially generated electric current; earthquake; volcanic activity, and other earth movement; or flood, are not commercially available

under builder's risk policies, by endorsement or otherwise, such insurance may be provided through other insurance policies acceptable to Owner and Contractor.

3. cover, as insured property, at least the following: (a) the Work and all materials, supplies, machinery, apparatus, equipment, fixtures, and other property of a similar nature that are to be incorporated into or used in the preparation, fabrication, construction, erection, or completion of the Work, including Owner-furnished or assigned property; (b) spare parts inventory required within the scope of the Contract; and (c) temporary works which are not intended to form part of the permanent constructed Work but which are intended to provide working access to the Site, or to the Work under construction, or which are intended to provide temporary support for the Work under construction, including scaffolding, form work, fences, shoring, falsework, and temporary structures.
  4. cover expenses incurred in the repair or replacement of any insured property (including but not limited to fees and charges of engineers and architects).
  5. extend to cover damage or loss to insured property while in temporary storage at the Site or in a storage location outside the Site (but not including property stored at the premises of a manufacturer or Supplier).
  6. extend to cover damage or loss to insured property while in transit.
  7. allow for partial occupation or use of the Work by Owner, such that those portions of the Work that are not yet occupied or used by Owner shall remain covered by the builder's risk insurance.
  8. allow for the waiver of the insurer's subrogation rights, as set forth below.
  9. provide primary coverage for all losses and damages caused by the perils or causes of loss covered.
  10. not include a co-insurance clause.
  11. include an exception for ensuing losses from physical damage or loss with respect to any defective workmanship, design, or materials exclusions.
  12. include performance/hot testing and start-up.
  13. be maintained in effect, subject to the provisions herein regarding Substantial Completion and partial occupancy or use of the Work by Owner, until the Work is complete.
- B. *Notice of Cancellation or Change*: All the policies of insurance (and the certificates or other evidence thereof) required to be purchased and maintained in accordance with this Paragraph 6.05 will contain a provision or endorsement that the coverage afforded will not be canceled or materially changed or renewal refused until at least 10 days prior written notice has been given to the purchasing policyholder. Within three days of receipt of any such written notice, the purchasing policyholder shall provide a copy of the notice to each other insured.
- C. *Deductibles*: The purchaser of any required builder's risk or property insurance shall pay for costs not covered because of the application of a policy deductible.
- D. *Partial Occupancy or Use by Owner*: If Owner will occupy or use a portion or portions of the Work prior to Substantial Completion of all the Work as provided in Paragraph 15.04, then Owner (directly, if it is the purchaser of the builder's risk policy, or through Contractor) will

provide notice of such occupancy or use to the builder's risk insurer. The builder's risk insurance shall not be canceled or permitted to lapse on account of any such partial use or occupancy; rather, those portions of the Work that are occupied or used by Owner may come off the builder's risk policy, while those portions of the Work not yet occupied or used by Owner shall remain covered by the builder's risk insurance.

- E. *Additional Insurance*: If Contractor elects to obtain other special insurance to be included in or supplement the builder's risk or property insurance policies provided under this Paragraph 6.05, it may do so at Contractor's expense.
- F. *Insurance of Other Property*: If the express insurance provisions of the Contract do not require or address the insurance of a property item or interest, such as tools, construction equipment, or other personal property owned by Contractor, a Subcontractor, or an employee of Contractor or a Subcontractor, then the entity or individual owning such property item will be responsible for deciding whether to insure it, and if so in what amount.

#### 6.06 *Waiver of Rights*

- A. All policies purchased in accordance with Paragraph 6.05, expressly including the builder's risk policy, shall contain provisions to the effect that in the event of payment of any loss or damage the insurers will have no rights of recovery against any insureds thereunder, or against Engineer or its consultants, or their officers, directors, members, partners, employees, agents, consultants, or subcontractors. Owner and Contractor waive all rights against each other and the respective officers, directors, members, partners, employees, agents, consultants, and subcontractors of each and any of them, for all losses and damages caused by, arising out of, or resulting from any of the perils or causes of loss covered by such policies and any other property insurance applicable to the Work; and, in addition, waive all such rights against Engineer, its consultants, all Subcontractors, all individuals or entities identified in the Supplementary Conditions as insureds, and the officers, directors, members, partners, employees, agents, consultants, and subcontractors of each and any of them, under such policies for losses and damages so caused. None of the above waivers shall extend to the rights that any party making such waiver may have to the proceeds of insurance held by Owner or Contractor as trustee or fiduciary, or otherwise payable under any policy so issued.
- B. Owner waives all rights against Contractor, Subcontractors, and Engineer, and the officers, directors, members, partners, employees, agents, consultants and subcontractors of each and any of them, for:
  1. loss due to business interruption, loss of use, or other consequential loss extending beyond direct physical loss or damage to Owner's property or the Work caused by, arising out of, or resulting from fire or other perils whether or not insured by Owner; and
  2. loss or damage to the completed Project or part thereof caused by, arising out of, or resulting from fire or other insured peril or cause of loss covered by any property insurance maintained on the completed Project or part thereof by Owner during partial occupancy or use pursuant to Paragraph 15.04, after Substantial Completion pursuant to Paragraph 15.03, or after final payment pursuant to Paragraph 15.06.
- C. Any insurance policy maintained by Owner covering any loss, damage or consequential loss referred to in Paragraph 6.06.B shall contain provisions to the effect that in the event of payment of any such loss, damage, or consequential loss, the insurers will have no rights of

recovery against Contractor, Subcontractors, or Engineer, or the officers, directors, members, partners, employees, agents, consultants, or subcontractors of each and any of them.

- D. Contractor shall be responsible for assuring that the agreement under which a Subcontractor performs a portion of the Work contains provisions whereby the Subcontractor waives all rights against Owner, Contractor, all individuals or entities identified in the Supplementary Conditions as insureds, the Engineer and its consultants, and the officers, directors, members, partners, employees, agents, consultants, and subcontractors of each and any of them, for all losses and damages caused by, arising out of, relating to, or resulting from any of the perils or causes of loss covered by builder's risk insurance and any other property insurance applicable to the Work.

**6.07** *Receipt and Application of Property Insurance Proceeds*

- A. Any insured loss under the builder's risk and other policies of insurance required by Paragraph 6.05 will be adjusted and settled with the named insured that purchased the policy. Such named insured shall act as fiduciary for the other insureds, and give notice to such other insureds that adjustment and settlement of a claim is in progress. Any other insured may state its position regarding a claim for insured loss in writing within 15 days after notice of such claim.
- B. Proceeds for such insured losses may be made payable by the insurer either jointly to multiple insureds, or to the named insured that purchased the policy in its own right and as fiduciary for other insureds, subject to the requirements of any applicable mortgage clause. A named insured receiving insurance proceeds under the builder's risk and other policies of insurance required by Paragraph 6.05 shall distribute such proceeds in accordance with such agreement as the parties in interest may reach, or as otherwise required under the dispute resolution provisions of this Contract or applicable Laws and Regulations.
- C. If no other special agreement is reached, the damaged Work shall be repaired or replaced, the money so received applied on account thereof, and the Work and the cost thereof covered by Change Order, if needed.

**ARTICLE 7 – CONTRACTOR'S RESPONSIBILITIES**

**7.01** *Supervision and Superintendence*

- A. Contractor shall supervise, inspect, and direct the Work competently and efficiently, devoting such attention thereto and applying such skills and expertise as may be necessary to perform the Work in accordance with the Contract Documents. Contractor shall be solely responsible for the means, methods, techniques, sequences, and procedures of construction.
- B. At all times during the progress of the Work, Contractor shall assign a competent resident superintendent who shall not be replaced without written notice to Owner and Engineer except under extraordinary circumstances.

**7.02** *Labor; Working Hours*

- A. Contractor shall provide competent, suitably qualified personnel to survey and lay out the Work and perform construction as required by the Contract Documents. Contractor shall at all times maintain good discipline and order at the Site.

- B. Except as otherwise required for the safety or protection of persons or the Work or property at the Site or adjacent thereto, and except as otherwise stated in the Contract Documents, all Work at the Site shall be performed during regular working hours, Monday through Friday. Contractor will not perform Work on a Saturday, Sunday, or any legal holiday. Contractor may perform Work outside regular working hours or on Saturdays, Sundays, or legal holidays only with Owner's written consent, which will not be unreasonably withheld.

#### 7.03 *Services, Materials, and Equipment*

- A. Unless otherwise specified in the Contract Documents, Contractor shall provide and assume full responsibility for all services, materials, equipment, labor, transportation, construction equipment and machinery, tools, appliances, fuel, power, light, heat, telephone, water, sanitary facilities, temporary facilities, and all other facilities and incidentals necessary for the performance, testing, start up, and completion of the Work, whether or not such items are specifically called for in the Contract Documents.
- B. All materials and equipment incorporated into the Work shall be of good quality and new, except as otherwise provided in the Contract Documents. All special warranties and guarantees required by the Specifications shall expressly run to the benefit of Owner. If required by Engineer, Contractor shall furnish satisfactory evidence (including reports of required tests) as to the source, kind, and quality of materials and equipment.
- C. All materials and equipment shall be stored, applied, installed, connected, erected, protected, used, cleaned, and conditioned in accordance with instructions of the applicable Supplier, except as otherwise may be provided in the Contract Documents.

#### 7.04 *"Or Equals"*

- A. Whenever an item of material or equipment is specified or described in the Contract Documents by using the name of a proprietary item or the name of a particular Supplier, the Contract Price has been based upon Contractor furnishing such item as specified. The specification or description of such an item is intended to establish the type, function, appearance, and quality required. Unless the specification or description contains or is followed by words reading that no like, equivalent, or "or equal" item is permitted, Contractor may request that Engineer authorize the use of other items of material or equipment, or items from other proposed suppliers under the circumstances described below.
  - 1. If Engineer in its sole discretion determines that an item of material or equipment proposed by Contractor is functionally equal to that named and sufficiently similar so that no change in related Work will be required, Engineer shall deem it an "or equal" item. For the purposes of this paragraph, a proposed item of material or equipment will be considered functionally equal to an item so named if:
    - a. in the exercise of reasonable judgment Engineer determines that:
      - 1) it is at least equal in materials of construction, quality, durability, appearance, strength, and design characteristics;
      - 2) it will reliably perform at least equally well the function and achieve the results imposed by the design concept of the completed Project as a functioning whole;

- 3) it has a proven record of performance and availability of responsive service; and
  - 4) it is not objectionable to Owner.
- b. Contractor certifies that, if approved and incorporated into the Work:
- 1) there will be no increase in cost to the Owner or increase in Contract Times; and
  - 2) it will conform substantially to the detailed requirements of the item named in the Contract Documents.
- B. *Contractor's Expense*: Contractor shall provide all data in support of any proposed "or equal" item at Contractor's expense.
- C. *Engineer's Evaluation and Determination*: Engineer will be allowed a reasonable time to evaluate each "or-equal" request. Engineer may require Contractor to furnish additional data about the proposed "or-equal" item. Engineer will be the sole judge of acceptability. No "or-equal" item will be ordered, furnished, installed, or utilized until Engineer's review is complete and Engineer determines that the proposed item is an "or-equal", which will be evidenced by an approved Shop Drawing or other written communication. Engineer will advise Contractor in writing of any negative determination.
- D. *Effect of Engineer's Determination*: Neither approval nor denial of an "or-equal" request shall result in any change in Contract Price. The Engineer's denial of an "or-equal" request shall be final and binding, and may not be reversed through an appeal under any provision of the Contract Documents.
- E. *Treatment as a Substitution Request*: If Engineer determines that an item of material or equipment proposed by Contractor does not qualify as an "or-equal" item, Contractor may request that Engineer considered the proposed item as a substitute pursuant to Paragraph 7.05.

#### 7.05 Substitutes

- A. Unless the specification or description of an item of material or equipment required to be furnished under the Contract Documents contains or is followed by words reading that no substitution is permitted, Contractor may request that Engineer authorize the use of other items of material or equipment under the circumstances described below. To the extent possible such requests shall be made before commencement of related construction at the Site.
1. Contractor shall submit sufficient information as provided below to allow Engineer to determine if the item of material or equipment proposed is functionally equivalent to that named and an acceptable substitute therefor. Engineer will not accept requests for review of proposed substitute items of material or equipment from anyone other than Contractor.
  2. The requirements for review by Engineer will be as set forth in Paragraph 7.05.B, as supplemented by the Specifications, and as Engineer may decide is appropriate under the circumstances.
  3. Contractor shall make written application to Engineer for review of a proposed substitute item of material or equipment that Contractor seeks to furnish or use. The application:

- a. shall certify that the proposed substitute item will:
    - 1) perform adequately the functions and achieve the results called for by the general design,
    - 2) be similar in substance to that specified, and
    - 3) be suited to the same use as that specified.
  - b. will state:
    - 1) the extent, if any, to which the use of the proposed substitute item will necessitate a change in Contract Times,
    - 2) whether use of the proposed substitute item in the Work will require a change in any of the Contract Documents (or in the provisions of any other direct contract with Owner for other work on the Project) to adapt the design to the proposed substitute item, and
    - 3) whether incorporation or use of the proposed substitute item in connection with the Work is subject to payment of any license fee or royalty.
  - c. will identify:
    - 1) all variations of the proposed substitute item from that specified, and
    - 2) available engineering, sales, maintenance, repair, and replacement services.
  - d. shall contain an itemized estimate of all costs or credits that will result directly or indirectly from use of such substitute item, including but not limited to changes in Contract Price, shared savings, costs of redesign, and claims of other contractors affected by any resulting change.
- B. *Engineer's Evaluation and Determination:* Engineer will be allowed a reasonable time to evaluate each substitute request, and to obtain comments and direction from Owner. Engineer may require Contractor to furnish additional data about the proposed substitute item. Engineer will be the sole judge of acceptability. No substitute will be ordered, furnished, installed, or utilized until Engineer's review is complete and Engineer determines that the proposed item is an acceptable substitute. Engineer's determination will be evidenced by a Field Order or a proposed Change Order accounting for the substitution itself and all related impacts, including changes in Contract Price or Contract Times. Engineer will advise Contractor in writing of any negative determination.
- C. *Special Guarantee:* Owner may require Contractor to furnish at Contractor's expense a special performance guarantee or other surety with respect to any substitute.
- D. *Reimbursement of Engineer's Cost:* Engineer will record Engineer's costs in evaluating a substitute proposed or submitted by Contractor. Whether or not Engineer approves a substitute so proposed or submitted by Contractor, Contractor shall reimburse Owner for the reasonable charges of Engineer for evaluating each such proposed substitute. Contractor shall also reimburse Owner for the reasonable charges of Engineer for making changes in the Contract Documents (or in the provisions of any other direct contract with Owner) resulting from the acceptance of each proposed substitute.
- E. *Contractor's Expense:* Contractor shall provide all data in support of any proposed substitute at Contractor's expense.

- F. *Effect of Engineer's Determination:* If Engineer approves the substitution request, Contractor shall execute the proposed Change Order and proceed with the substitution. The Engineer's denial of a substitution request shall be final and binding, and may not be reversed through an appeal under any provision of the Contract Documents. Contractor may challenge the scope of reimbursement costs imposed under Paragraph 7.05.D, by timely submittal of a Change Proposal.

7.06 *Concerning Subcontractors, Suppliers, and Others*

- A. Contractor may retain Subcontractors and Suppliers for the performance of parts of the Work. Such Subcontractors and Suppliers must be acceptable to Owner.
- B. Contractor shall retain specific Subcontractors, Suppliers, or other individuals or entities for the performance of designated parts of the Work if required by the Contract to do so.
- C. Subsequent to the submittal of Contractor's Bid or final negotiation of the terms of the Contract, Owner may not require Contractor to retain any Subcontractor, Supplier, or other individual or entity to furnish or perform any of the Work against which Contractor has reasonable objection.
- D. Prior to entry into any binding subcontract or purchase order, Contractor shall submit to Owner the identity of the proposed Subcontractor or Supplier (unless Owner has already deemed such proposed Subcontractor or Supplier acceptable, during the bidding process or otherwise). Such proposed Subcontractor or Supplier shall be deemed acceptable to Owner unless Owner raises a substantive, reasonable objection within five days.
- E. Owner may require the replacement of any Subcontractor, Supplier, or other individual or entity retained by Contractor to perform any part of the Work. Owner also may require Contractor to retain specific replacements; provided, however, that Owner may not require a replacement to which Contractor has a reasonable objection. If Contractor has submitted the identity of certain Subcontractors, Suppliers, or other individuals or entities for acceptance by Owner, and Owner has accepted it (either in writing or by failing to make written objection thereto), then Owner may subsequently revoke the acceptance of any such Subcontractor, Supplier, or other individual or entity so identified solely on the basis of substantive, reasonable objection after due investigation. Contractor shall submit an acceptable replacement for the rejected Subcontractor, Supplier, or other individual or entity.
- F. If Owner requires the replacement of any Subcontractor, Supplier, or other individual or entity retained by Contractor to perform any part of the Work, then Contractor shall be entitled to an adjustment in Contract Price or Contract Times, or both, with respect to the replacement; and Contractor shall initiate a Change Proposal for such adjustment within 30 days of Owner's requirement of replacement.
- G. No acceptance by Owner of any such Subcontractor, Supplier, or other individual or entity, whether initially or as a replacement, shall constitute a waiver of the right of Owner to the completion of the Work in accordance with the Contract Documents.
- H. On a monthly basis Contractor shall submit to Engineer a complete list of all Subcontractors and Suppliers having a direct contract with Contractor, and of all other Subcontractors and Suppliers known to Contractor at the time of submittal.
- I. Contractor shall be fully responsible to Owner and Engineer for all acts and omissions of the Subcontractors, Suppliers, and other individuals or entities performing or furnishing any of the Work just as Contractor is responsible for Contractor's own acts and omissions.



- J. Contractor shall be solely responsible for scheduling and coordinating the work of Subcontractors, Suppliers, and all other individuals or entities performing or furnishing any of the Work.
- K. Contractor shall restrict all Subcontractors, Suppliers, and such other individuals or entities performing or furnishing any of the Work from communicating with Engineer or Owner, except through Contractor or in case of an emergency, or as otherwise expressly allowed herein.
- L. The divisions and sections of the Specifications and the identifications of any Drawings shall not control Contractor in dividing the Work among Subcontractors or Suppliers or delineating the Work to be performed by any specific trade.
- M. All Work performed for Contractor by a Subcontractor or Supplier shall be pursuant to an appropriate contractual agreement that specifically binds the Subcontractor or Supplier to the applicable terms and conditions of the Contract Documents for the benefit of Owner and Engineer.
- N. Owner may furnish to any Subcontractor or Supplier, to the extent practicable, information about amounts paid to Contractor on account of Work performed for Contractor by the particular Subcontractor or Supplier.
- O. Nothing in the Contract Documents:
  - 1. shall create for the benefit of any such Subcontractor, Supplier, or other individual or entity any contractual relationship between Owner or Engineer and any such Subcontractor, Supplier, or other individual or entity; nor
  - 2. shall create any obligation on the part of Owner or Engineer to pay or to see to the payment of any money due any such Subcontractor, Supplier, or other individual or entity except as may otherwise be required by Laws and Regulations.

#### 7.07 *Patent Fees and Royalties*

- A. Contractor shall pay all license fees and royalties and assume all costs incident to the use in the performance of the Work or the incorporation in the Work of any invention, design, process, product, or device which is the subject of patent rights or copyrights held by others. If a particular invention, design, process, product, or device is specified in the Contract Documents for use in the performance of the Work and if, to the actual knowledge of Owner or Engineer, its use is subject to patent rights or copyrights calling for the payment of any license fee or royalty to others, the existence of such rights shall be disclosed by Owner in the Contract Documents.
- B. To the fullest extent permitted by Laws and Regulations, Owner shall indemnify and hold harmless Contractor, and its officers, directors, members, partners, employees, agents, consultants, and subcontractors from and against all claims, costs, losses, and damages (including but not limited to all fees and charges of engineers, architects, attorneys, and other professionals, and all court or arbitration or other dispute resolution costs) arising out of or relating to any infringement of patent rights or copyrights incident to the use in the performance of the Work or resulting from the incorporation in the Work of any invention, design, process, product, or device specified in the Contract Documents, but not identified as being subject to payment of any license fee or royalty to others required by patent rights or copyrights.

- C. To the fullest extent permitted by Laws and Regulations, Contractor shall indemnify and hold harmless Owner and Engineer, and the officers, directors, members, partners, employees, agents, consultants and subcontractors of each and any of them from and against all claims, costs, losses, and damages (including but not limited to all fees and charges of engineers, architects, attorneys, and other professionals and all court or arbitration or other dispute resolution costs) arising out of or relating to any infringement of patent rights or copyrights incident to the use in the performance of the Work or resulting from the incorporation in the Work of any invention, design, process, product, or device not specified in the Contract Documents.

#### 7.08 *Permits*

- A. Unless otherwise provided in the Contract Documents, Contractor shall obtain and pay for all construction permits and licenses. Owner shall assist Contractor, when necessary, in obtaining such permits and licenses. Contractor shall pay all governmental charges and inspection fees necessary for the prosecution of the Work which are applicable at the time of the submission of Contractor's Bid (or when Contractor became bound under a negotiated contract). Owner shall pay all charges of utility owners for connections for providing permanent service to the Work

#### 7.09 *Taxes*

- A. Contractor shall pay all sales, consumer, use, and other similar taxes required to be paid by Contractor in accordance with the Laws and Regulations of the place of the Project which are applicable during the performance of the Work.

#### 7.10 *Laws and Regulations*

- A. Contractor shall give all notices required by and shall comply with all Laws and Regulations applicable to the performance of the Work. Except where otherwise expressly required by applicable Laws and Regulations, neither Owner nor Engineer shall be responsible for monitoring Contractor's compliance with any Laws or Regulations.
- B. If Contractor performs any Work or takes any other action knowing or having reason to know that it is contrary to Laws or Regulations, Contractor shall bear all resulting costs and losses, and shall indemnify and hold harmless Owner and Engineer, and the officers, directors, members, partners, employees, agents, consultants, and subcontractors of each and any of them from and against all claims, costs, losses, and damages (including but not limited to all fees and charges of engineers, architects, attorneys, and other professionals and all court or arbitration or other dispute resolution costs) arising out of or relating to such Work or other action. It shall not be Contractor's responsibility to make certain that the Work described in the Contract Documents is in accordance with Laws and Regulations, but this shall not relieve Contractor of Contractor's obligations under Paragraph 3.03.
- C. Owner or Contractor may give notice to the other party of any changes after the submission of Contractor's Bid (or after the date when Contractor became bound under a negotiated contract) in Laws or Regulations having an effect on the cost or time of performance of the Work, including but not limited to changes in Laws or Regulations having an effect on procuring permits and on sales, use, value-added, consumption, and other similar taxes. If Owner and Contractor are unable to agree on entitlement to or on the amount or extent, if any, of any adjustment in Contract Price or Contract Times resulting from such changes, then within 30 days of such notice Contractor may submit a Change Proposal, or Owner may initiate a Claim.

### 7.11 *Record Documents*

- A. Contractor shall maintain in a safe place at the Site one printed record copy of all Drawings, Specifications, Addenda, Change Orders, Work Change Directives, Field Orders, written interpretations and clarifications, and approved Shop Drawings. Contractor shall keep such record documents in good order and annotate them to show changes made during construction. These record documents, together with all approved Samples, will be available to Engineer for reference. Upon completion of the Work, Contractor shall deliver these record documents to Engineer.

### 7.12 *Safety and Protection*

- A. Contractor shall be solely responsible for initiating, maintaining, and supervising all safety precautions and programs in connection with the Work. Such responsibility does not relieve Subcontractors of their responsibility for the safety of persons or property in the performance of their work, nor for compliance with applicable safety Laws and Regulations. Contractor shall take all necessary precautions for the safety of, and shall provide the necessary protection to prevent damage, injury, or loss to:
1. all persons on the Site or who may be affected by the Work;
  2. all the Work and materials and equipment to be incorporated therein, whether in storage on or off the Site; and
  3. other property at the Site or adjacent thereto, including trees, shrubs, lawns, walks, pavements, roadways, structures, other work in progress, utilities, and Underground Facilities not designated for removal, relocation, or replacement in the course of construction.
- B. Contractor shall comply with all applicable Laws and Regulations relating to the safety of persons or property, or to the protection of persons or property from damage, injury, or loss; and shall erect and maintain all necessary safeguards for such safety and protection. Contractor shall notify Owner; the owners of adjacent property, Underground Facilities, and other utilities; and other contractors and utility owners performing work at or adjacent to the Site, when prosecution of the Work may affect them, and shall cooperate with them in the protection, removal, relocation, and replacement of their property or work in progress.
- C. Contractor shall comply with the applicable requirements of Owner's safety programs, if any. The Supplementary Conditions identify any Owner's safety programs that are applicable to the Work.
- D. Contractor shall inform Owner and Engineer of the specific requirements of Contractor's safety program with which Owner's and Engineer's employees and representatives must comply while at the Site.
- E. All damage, injury, or loss to any property referred to in Paragraph 7.12.A.2 or 7.12.A.3 caused, directly or indirectly, in whole or in part, by Contractor, any Subcontractor, Supplier, or any other individual or entity directly or indirectly employed by any of them to perform any of the Work, or anyone for whose acts any of them may be liable, shall be remedied by Contractor at its expense (except damage or loss attributable to the fault of Drawings or Specifications or to the acts or omissions of Owner or Engineer or anyone employed by any of them, or anyone for whose acts any of them may be liable, and not attributable, directly or indirectly, in whole or in part, to the fault or negligence of

Contractor or any Subcontractor, Supplier, or other individual or entity directly or indirectly employed by any of them).

- F. Contractor's duties and responsibilities for safety and protection shall continue until such time as all the Work is completed and Engineer has issued a notice to Owner and Contractor in accordance with Paragraph 15.06.B that the Work is acceptable (except as otherwise expressly provided in connection with Substantial Completion).
- G. Contractor's duties and responsibilities for safety and protection shall resume whenever Contractor or any Subcontractor or Supplier returns to the Site to fulfill warranty or correction obligations, or to conduct other tasks arising from the Contract Documents.

#### 7.13 *Safety Representative*

- A. Contractor shall designate a qualified and experienced safety representative at the Site whose duties and responsibilities shall be the prevention of accidents and the maintaining and supervising of safety precautions and programs.

#### 7.14 *Hazard Communication Programs*

- A. Contractor shall be responsible for coordinating any exchange of material safety data sheets or other hazard communication information required to be made available to or exchanged between or among employers at the Site in accordance with Laws or Regulations.

#### 7.15 *Emergencies*

- A. In emergencies affecting the safety or protection of persons or the Work or property at the Site or adjacent thereto, Contractor is obligated to act to prevent threatened damage, injury, or loss. Contractor shall give Engineer prompt written notice if Contractor believes that any significant changes in the Work or variations from the Contract Documents have been caused thereby or are required as a result thereof. If Engineer determines that a change in the Contract Documents is required because of the action taken by Contractor in response to such an emergency, a Work Change Directive or Change Order will be issued.

#### 7.16 *Shop Drawings, Samples, and Other Submittals*

- A. *Shop Drawing and Sample Submittal Requirements:*
  1. Before submitting a Shop Drawing or Sample, Contractor shall have:
    - a. reviewed and coordinated the Shop Drawing or Sample with other Shop Drawings and Samples and with the requirements of the Work and the Contract Documents;
    - b. determined and verified all field measurements, quantities, dimensions, specified performance and design criteria, installation requirements, materials, catalog numbers, and similar information with respect thereto;
    - c. determined and verified the suitability of all materials and equipment offered with respect to the indicated application, fabrication, shipping, handling, storage, assembly, and installation pertaining to the performance of the Work; and
    - d. determined and verified all information relative to Contractor's responsibilities for means, methods, techniques, sequences, and procedures of construction, and safety precautions and programs incident thereto.

2. Each submittal shall bear a stamp or specific written certification that Contractor has satisfied Contractor's obligations under the Contract Documents with respect to Contractor's review of that submittal, and that Contractor approves the submittal.
  3. With each submittal, Contractor shall give Engineer specific written notice of any variations that the Shop Drawing or Sample may have from the requirements of the Contract Documents. This notice shall be set forth in a written communication separate from the Shop Drawings or Sample submittal; and, in addition, in the case of Shop Drawings by a specific notation made on each Shop Drawing submitted to Engineer for review and approval of each such variation.
- B. *Submittal Procedures for Shop Drawings and Samples:* Contractor shall submit Shop Drawings and Samples to Engineer for review and approval in accordance with the accepted Schedule of Submittals. Each submittal will be identified as Engineer may require.
1. *Shop Drawings:*
    - a. Contractor shall submit the number of copies required in the Specifications.
    - b. Data shown on the Shop Drawings will be complete with respect to quantities, dimensions, specified performance and design criteria, materials, and similar data to show Engineer the services, materials, and equipment Contractor proposes to provide and to enable Engineer to review the information for the limited purposes required by Paragraph 7.16.D.
  2. *Samples:*
    - a. Contractor shall submit the number of Samples required in the Specifications.
    - b. Contractor shall clearly identify each Sample as to material, Supplier, pertinent data such as catalog numbers, the use for which intended and other data as Engineer may require to enable Engineer to review the submittal for the limited purposes required by Paragraph 7.16.D.
  3. Where a Shop Drawing or Sample is required by the Contract Documents or the Schedule of Submittals, any related Work performed prior to Engineer's review and approval of the pertinent submittal will be at the sole expense and responsibility of Contractor.
- C. *Other Submittals:* Contractor shall submit other submittals to Engineer in accordance with the accepted Schedule of Submittals, and pursuant to the applicable terms of the Specifications.
- D. *Engineer's Review:*
1. Engineer will provide timely review of Shop Drawings and Samples in accordance with the Schedule of Submittals acceptable to Engineer. Engineer's review and approval will be only to determine if the items covered by the submittals will, after installation or incorporation in the Work, conform to the information given in the Contract Documents and be compatible with the design concept of the completed Project as a functioning whole as indicated by the Contract Documents.
  2. Engineer's review and approval will not extend to means, methods, techniques, sequences, or procedures of construction or to safety precautions or programs incident thereto.

3. Engineer's review and approval of a separate item as such will not indicate approval of the assembly in which the item functions.
  4. Engineer's review and approval of a Shop Drawing or Sample shall not relieve Contractor from responsibility for any variation from the requirements of the Contract Documents unless Contractor has complied with the requirements of Paragraph 7.16.A.3 and Engineer has given written approval of each such variation by specific written notation thereof incorporated in or accompanying the Shop Drawing or Sample. Engineer will document any such approved variation from the requirements of the Contract Documents in a Field Order.
  5. Engineer's review and approval of a Shop Drawing or Sample shall not relieve Contractor from responsibility for complying with the requirements of Paragraph 7.16.A and B.
  6. Engineer's review and approval of a Shop Drawing or Sample, or of a variation from the requirements of the Contract Documents, shall not, under any circumstances, change the Contract Times or Contract Price, unless such changes are included in a Change Order.
  7. Neither Engineer's receipt, review, acceptance or approval of a Shop Drawing, Sample, or other submittal shall result in such item becoming a Contract Document.
  8. Contractor shall perform the Work in compliance with the requirements and commitments set forth in approved Shop Drawings and Samples, subject to the provisions of Paragraph 7.16.D.4.
- E. *Resubmittal Procedures:*
1. Contractor shall make corrections required by Engineer and shall return the required number of corrected copies of Shop Drawings and submit, as required, new Samples for review and approval. Contractor shall direct specific attention in writing to revisions other than the corrections called for by Engineer on previous submittals.
  2. Contractor shall furnish required submittals with sufficient information and accuracy to obtain required approval of an item with no more than three submittals. Engineer will record Engineer's time for reviewing a fourth or subsequent submittal of a Shop Drawings, sample, or other item requiring approval, and Contractor shall be responsible for Engineer's charges to Owner for such time. Owner may impose a set-off against payments due to Contractor to secure reimbursement for such charges.
  3. If Contractor requests a change of a previously approved submittal item, Contractor shall be responsible for Engineer's charges to Owner for its review time, and Owner may impose a set-off against payments due to Contractor to secure reimbursement for such charges, unless the need for such change is beyond the control of Contractor.

#### 7.17 *Contractor's General Warranty and Guarantee*

- A. Contractor warrants and guarantees to Owner that all Work will be in accordance with the Contract Documents and will not be defective. Engineer and its officers, directors, members, partners, employees, agents, consultants, and subcontractors shall be entitled to rely on Contractor's warranty and guarantee.

- B. Contractor's warranty and guarantee hereunder excludes defects or damage caused by:
1. abuse, modification, or improper maintenance or operation by persons other than Contractor, Subcontractors, Suppliers, or any other individual or entity for whom Contractor is responsible; or
  2. normal wear and tear under normal usage.
- C. Contractor's obligation to perform and complete the Work in accordance with the Contract Documents shall be absolute. None of the following will constitute an acceptance of Work that is not in accordance with the Contract Documents or a release of Contractor's obligation to perform the Work in accordance with the Contract Documents:
1. observations by Engineer;
  2. recommendation by Engineer or payment by Owner of any progress or final payment;
  3. the issuance of a certificate of Substantial Completion by Engineer or any payment related thereto by Owner;
  4. use or occupancy of the Work or any part thereof by Owner;
  5. any review and approval of a Shop Drawing or Sample submittal;
  6. the issuance of a notice of acceptability by Engineer;
  7. any inspection, test, or approval by others; or
  8. any correction of defective Work by Owner.
- D. If the Contract requires the Contractor to accept the assignment of a contract entered into by Owner, then the specific warranties, guarantees, and correction obligations contained in the assigned contract shall govern with respect to Contractor's performance obligations to Owner for the Work described in the assigned contract.

#### 7.18 *Indemnification*

- A. To the fullest extent permitted by Laws and Regulations, and in addition to any other obligations of Contractor under the Contract or otherwise, Contractor shall indemnify and hold harmless Owner and Engineer, and the officers, directors, members, partners, employees, agents, consultants and subcontractors of each and any of them from and against all claims, costs, losses, and damages (including but not limited to all fees and charges of engineers, architects, attorneys, and other professionals and all court or arbitration or other dispute resolution costs) arising out of or relating to the performance of the Work, provided that any such claim, cost, loss, or damage is attributable to bodily injury, sickness, disease, or death, or to injury to or destruction of tangible property (other than the Work itself), including the loss of use resulting therefrom but only to the extent caused by any negligent act or omission of Contractor, any Subcontractor, any Supplier, or any individual or entity directly or indirectly employed by any of them to perform any of the Work or anyone for whose acts any of them may be liable.
- B. In any and all claims against Owner or Engineer or any of their officers, directors, members, partners, employees, agents, consultants, or subcontractors by any employee (or the survivor or personal representative of such employee) of Contractor, any Subcontractor, any Supplier, or any individual or entity directly or indirectly employed by any of them to perform any of the Work, or anyone for whose acts any of them may be liable, the indemnification obligation under Paragraph 7.18.A shall not be limited in any way by any

limitation on the amount or type of damages, compensation, or benefits payable by or for Contractor or any such Subcontractor, Supplier, or other individual or entity under workers' compensation acts, disability benefit acts, or other employee benefit acts.

- C. The indemnification obligations of Contractor under Paragraph 7.18.A shall not extend to the liability of Engineer and Engineer's officers, directors, members, partners, employees, agents, consultants and subcontractors arising out of:
1. the preparation or approval of, or the failure to prepare or approve maps, Drawings, opinions, reports, surveys, Change Orders, designs, or Specifications; or
  2. giving directions or instructions, or failing to give them, if that is the primary cause of the injury or damage.

#### 7.19 *Delegation of Professional Design Services*

- A. Contractor will not be required to provide professional design services unless such services are specifically required by the Contract Documents for a portion of the Work or unless such services are required to carry out Contractor's responsibilities for construction means, methods, techniques, sequences and procedures. Contractor shall not be required to provide professional services in violation of applicable Laws and Regulations.
- B. If professional design services or certifications by a design professional related to systems, materials, or equipment are specifically required of Contractor by the Contract Documents, Owner and Engineer will specify all performance and design criteria that such services must satisfy. Contractor shall cause such services or certifications to be provided by a properly licensed professional, whose signature and seal shall appear on all drawings, calculations, specifications, certifications, and other submittals prepared by such professional. Shop Drawings and other submittals related to the Work designed or certified by such professional, if prepared by others, shall bear such professional's written approval when submitted to Engineer.
- C. Owner and Engineer shall be entitled to rely upon the adequacy, accuracy, and completeness of the services, certifications, or approvals performed by such design professionals, provided Owner and Engineer have specified to Contractor all performance and design criteria that such services must satisfy.
- D. Pursuant to this paragraph, Engineer's review and approval of design calculations and design drawings will be only for the limited purpose of checking for conformance with performance and design criteria given and the design concept expressed in the Contract Documents. Engineer's review and approval of Shop Drawings and other submittals (except design calculations and design drawings) will be only for the purpose stated in Paragraph 7.16.D.1.
- E. Contractor shall not be responsible for the adequacy of the performance or design criteria specified by Owner or Engineer.

## **ARTICLE 8 – OTHER WORK AT THE SITE**

### 8.01 *Other Work*

- A. In addition to and apart from the Work under the Contract Documents, the Owner may perform other work at or adjacent to the Site. Such other work may be performed by Owner's employees, or through contracts between the Owner and third parties. Owner



may also arrange to have third-party utility owners perform work on their utilities and facilities at or adjacent to the Site.

- B. If Owner performs other work at or adjacent to the Site with Owner's employees, or through contracts for such other work, then Owner shall give Contractor written notice thereof prior to starting any such other work. If Owner has advance information regarding the start of any utility work at or adjacent to the Site, Owner shall provide such information to Contractor.
- C. Contractor shall afford each other contractor that performs such other work, each utility owner performing other work, and Owner, if Owner is performing other work with Owner's employees, proper and safe access to the Site, and provide a reasonable opportunity for the introduction and storage of materials and equipment and the execution of such other work. Contractor shall do all cutting, fitting, and patching of the Work that may be required to properly connect or otherwise make its several parts come together and properly integrate with such other work. Contractor shall not endanger any work of others by cutting, excavating, or otherwise altering such work; provided, however, that Contractor may cut or alter others' work with the written consent of Engineer and the others whose work will be affected.
- D. If the proper execution or results of any part of Contractor's Work depends upon work performed by others under this Article 8, Contractor shall inspect such other work and promptly report to Engineer in writing any delays, defects, or deficiencies in such other work that render it unavailable or unsuitable for the proper execution and results of Contractor's Work. Contractor's failure to so report will constitute an acceptance of such other work as fit and proper for integration with Contractor's Work except for latent defects and deficiencies in such other work.

#### 8.02 *Coordination*

- A. If Owner intends to contract with others for the performance of other work at or adjacent to the Site, to perform other work at or adjacent to the Site with Owner's employees, or to arrange to have utility owners perform work at or adjacent to the Site, the following will be set forth in the Supplementary Conditions or provided to Contractor prior to the start of any such other work:
  - 1. the identity of the individual or entity that will have authority and responsibility for coordination of the activities among the various contractors;
  - 2. an itemization of the specific matters to be covered by such authority and responsibility; and
  - 3. the extent of such authority and responsibilities.
- B. Unless otherwise provided in the Supplementary Conditions, Owner shall have sole authority and responsibility for such coordination.

#### 8.03 *Legal Relationships*

- A. If, in the course of performing other work at or adjacent to the Site for Owner, the Owner's employees, any other contractor working for Owner, or any utility owner for whom the Owner is responsible causes damage to the Work or to the property of Contractor or its Subcontractors, or delays, disrupts, interferes with, or increases the scope or cost of the performance of the Work, through actions or inaction, then Contractor shall be entitled to an equitable adjustment in the Contract Price or the Contract Times, or both. Contractor

must submit any Change Proposal seeking an equitable adjustment in the Contract Price or the Contract Times under this paragraph within 30 days of the damaging, delaying, disrupting, or interfering event. The entitlement to, and extent of, any such equitable adjustment shall take into account information (if any) regarding such other work that was provided to Contractor in the Contract Documents prior to the submittal of the Bid or the final negotiation of the terms of the Contract. When applicable, any such equitable adjustment in Contract Price shall be conditioned on Contractor assigning to Owner all Contractor's rights against such other contractor or utility owner with respect to the damage, delay, disruption, or interference that is the subject of the adjustment. Contractor's entitlement to an adjustment of the Contract Times is conditioned on such adjustment being essential to Contractor's ability to complete the Work within the Contract Times.

- B. Contractor shall take reasonable and customary measures to avoid damaging, delaying, disrupting, or interfering with the work of Owner, any other contractor, or any utility owner performing other work at or adjacent to the Site. If Contractor fails to take such measures and as a result damages, delays, disrupts, or interferes with the work of any such other contractor or utility owner, then Owner may impose a set-off against payments due to Contractor, and assign to such other contractor or utility owner the Owner's contractual rights against Contractor with respect to the breach of the obligations set forth in this paragraph.
- C. When Owner is performing other work at or adjacent to the Site with Owner's employees, Contractor shall be liable to Owner for damage to such other work, and for the reasonable direct delay, disruption, and interference costs incurred by Owner as a result of Contractor's failure to take reasonable and customary measures with respect to Owner's other work. In response to such damage, delay, disruption, or interference, Owner may impose a set-off against payments due to Contractor.
- D. If Contractor damages, delays, disrupts, or interferes with the work of any other contractor, or any utility owner performing other work at or adjacent to the Site, through Contractor's failure to take reasonable and customary measures to avoid such impacts, or if any claim arising out of Contractor's actions, inactions, or negligence in performance of the Work at or adjacent to the Site is made by any such other contractor or utility owner against Contractor, Owner, or Engineer, then Contractor shall (1) promptly attempt to settle the claim as to all parties through negotiations with such other contractor or utility owner, or otherwise resolve the claim by arbitration or other dispute resolution proceeding or at law, and (2) indemnify and hold harmless Owner and Engineer, and the officers, directors, members, partners, employees, agents, consultants and subcontractors of each and any of them from and against any such claims, and against all costs, losses, and damages (including but not limited to all fees and charges of engineers, architects, attorneys, and other professionals and all court or arbitration or other dispute resolution costs) arising out of or relating to such damage, delay, disruption, or interference.

## **ARTICLE 9 – OWNER'S RESPONSIBILITIES**

### **9.01 *Communications to Contractor***

- A. Except as otherwise provided in these General Conditions, Owner shall issue all communications to Contractor through Engineer.

9.02 *Replacement of Engineer*

- A. Owner may at its discretion appoint an engineer to replace Engineer, provided Contractor makes no reasonable objection to the replacement engineer. The replacement engineer's status under the Contract Documents shall be that of the former Engineer.

9.03 *Furnish Data*

- A. Owner shall promptly furnish the data required of Owner under the Contract Documents.

9.04 *Pay When Due*

- A. Owner shall make payments to Contractor when they are due as provided in the Agreement.

9.05 *Lands and Easements; Reports, Tests, and Drawings*

- A. Owner's duties with respect to providing lands and easements are set forth in Paragraph 5.01.
- B. Owner's duties with respect to providing engineering surveys to establish reference points are set forth in Paragraph 4.03.
- C. Article 5 refers to Owner's identifying and making available to Contractor copies of reports of explorations and tests of conditions at the Site, and drawings of physical conditions relating to existing surface or subsurface structures at the Site.

9.06 *Insurance*

- A. Owner's responsibilities, if any, with respect to purchasing and maintaining liability and property insurance are set forth in Article 6.

9.07 *Change Orders*

- A. Owner's responsibilities with respect to Change Orders are set forth in Article 11.

9.08 *Inspections, Tests, and Approvals*

- A. Owner's responsibility with respect to certain inspections, tests, and approvals is set forth in Paragraph 14.02.B.

9.09 *Limitations on Owner's Responsibilities*

- A. The Owner shall not supervise, direct, or have control or authority over, nor be responsible for, Contractor's means, methods, techniques, sequences, or procedures of construction, or the safety precautions and programs incident thereto, or for any failure of Contractor to comply with Laws and Regulations applicable to the performance of the Work. Owner will not be responsible for Contractor's failure to perform the Work in accordance with the Contract Documents.

9.10 *Undisclosed Hazardous Environmental Condition*

- A. Owner's responsibility in respect to an undisclosed Hazardous Environmental Condition is set forth in Paragraph 5.06.

9.11 *Evidence of Financial Arrangements*

- A. Upon request of Contractor, Owner shall furnish Contractor reasonable evidence that financial arrangements have been made to satisfy Owner's obligations under the Contract Documents (including obligations under proposed changes in the Work).

### 9.12 *Safety Programs*

- A. While at the Site, Owner's employees and representatives shall comply with the specific applicable requirements of Contractor's safety programs of which Owner has been informed.
- B. Owner shall furnish copies of any applicable Owner safety programs to Contractor.

## **ARTICLE 10 – ENGINEER'S STATUS DURING CONSTRUCTION**

### 10.01 *Owner's Representative*

- A. Engineer will be Owner's representative during the construction period. The duties and responsibilities and the limitations of authority of Engineer as Owner's representative during construction are set forth in the Contract.

### 10.02 *Visits to Site*

- A. Engineer will make visits to the Site at intervals appropriate to the various stages of construction as Engineer deems necessary in order to observe as an experienced and qualified design professional the progress that has been made and the quality of the various aspects of Contractor's executed Work. Based on information obtained during such visits and observations, Engineer, for the benefit of Owner, will determine, in general, if the Work is proceeding in accordance with the Contract Documents. Engineer will not be required to make exhaustive or continuous inspections on the Site to check the quality or quantity of the Work. Engineer's efforts will be directed toward providing for Owner a greater degree of confidence that the completed Work will conform generally to the Contract Documents. On the basis of such visits and observations, Engineer will keep Owner informed of the progress of the Work and will endeavor to guard Owner against defective Work.
- B. Engineer's visits and observations are subject to all the limitations on Engineer's authority and responsibility set forth in Paragraph 10.08. Particularly, but without limitation, during or as a result of Engineer's visits or observations of Contractor's Work, Engineer will not supervise, direct, control, or have authority over or be responsible for Contractor's means, methods, techniques, sequences, or procedures of construction, or the safety precautions and programs incident thereto, or for any failure of Contractor to comply with Laws and Regulations applicable to the performance of the Work.

### 10.03 *Project Representative*

- A. If Owner and Engineer have agreed that Engineer will furnish a Resident Project Representative to represent Engineer at the Site and assist Engineer in observing the progress and quality of the Work, then the authority and responsibilities of any such Resident Project Representative will be as provided in the Supplementary Conditions, and limitations on the responsibilities thereof will be as provided in Paragraph 10.08. If Owner designates another representative or agent to represent Owner at the Site who is not Engineer's consultant, agent, or employee, the responsibilities and authority and limitations thereon of such other individual or entity will be as provided in the Supplementary Conditions.

### 10.04 *Rejecting Defective Work*

- A. Engineer has the authority to reject Work in accordance with Article 14.

10.05 *Shop Drawings, Change Orders and Payments*

- A. Engineer's authority, and limitations thereof, as to Shop Drawings and Samples, are set forth in Paragraph 7.16.
- B. Engineer's authority, and limitations thereof, as to design calculations and design drawings submitted in response to a delegation of professional design services, if any, are set forth in Paragraph 7.19.
- C. Engineer's authority as to Change Orders is set forth in Article 11.
- D. Engineer's authority as to Applications for Payment is set forth in Article 15.

10.06 *Determinations for Unit Price Work*

- A. Engineer will determine the actual quantities and classifications of Unit Price Work performed by Contractor as set forth in Paragraph 13.03.

10.07 *Decisions on Requirements of Contract Documents and Acceptability of Work*

- A. Engineer will render decisions regarding the requirements of the Contract Documents, and judge the acceptability of the Work, pursuant to the specific procedures set forth herein for initial interpretations, Change Proposals, and acceptance of the Work. In rendering such decisions and judgments, Engineer will not show partiality to Owner or Contractor, and will not be liable to Owner, Contractor, or others in connection with any proceedings, interpretations, decisions, or judgments conducted or rendered in good faith.

10.08 *Limitations on Engineer's Authority and Responsibilities*

- A. Neither Engineer's authority or responsibility under this Article 10 or under any other provision of the Contract, nor any decision made by Engineer in good faith either to exercise or not exercise such authority or responsibility or the undertaking, exercise, or performance of any authority or responsibility by Engineer, shall create, impose, or give rise to any duty in contract, tort, or otherwise owed by Engineer to Contractor, any Subcontractor, any Supplier, any other individual or entity, or to any surety for or employee or agent of any of them.
- B. Engineer will not supervise, direct, control, or have authority over or be responsible for Contractor's means, methods, techniques, sequences, or procedures of construction, or the safety precautions and programs incident thereto, or for any failure of Contractor to comply with Laws and Regulations applicable to the performance of the Work. Engineer will not be responsible for Contractor's failure to perform the Work in accordance with the Contract Documents.
- C. Engineer will not be responsible for the acts or omissions of Contractor or of any Subcontractor, any Supplier, or of any other individual or entity performing any of the Work.
- D. Engineer's review of the final Application for Payment and accompanying documentation and all maintenance and operating instructions, schedules, guarantees, bonds, certificates of inspection, tests and approvals, and other documentation required to be delivered by Paragraph 15.06.A will only be to determine generally that their content complies with the requirements of, and in the case of certificates of inspections, tests, and approvals, that the results certified indicate compliance with the Contract Documents.
- E. The limitations upon authority and responsibility set forth in this Paragraph 10.08 shall also apply to the Resident Project Representative, if any.

#### 10.09 *Compliance with Safety Program*

- A. While at the Site, Engineer's employees and representatives will comply with the specific applicable requirements of Owner's and Contractor's safety programs (if any) of which Engineer has been informed.

### **ARTICLE 11 – AMENDING THE CONTRACT DOCUMENTS; CHANGES IN THE WORK**

#### 11.01 *Amending and Supplementing Contract Documents*

- A. The Contract Documents may be amended or supplemented by a Change Order, a Work Change Directive, or a Field Order.

1. *Change Orders:*

- a. If an amendment or supplement to the Contract Documents includes a change in the Contract Price or the Contract Times, such amendment or supplement must be set forth in a Change Order. A Change Order also may be used to establish amendments and supplements of the Contract Documents that do not affect the Contract Price or Contract Times.
- b. Owner and Contractor may amend those terms and conditions of the Contract Documents that do not involve (1) the performance or acceptability of the Work, (2) the design (as set forth in the Drawings, Specifications, or otherwise), or (3) other engineering or technical matters, without the recommendation of the Engineer. Such an amendment shall be set forth in a Change Order.

2. *Work Change Directives:* A Work Change Directive will not change the Contract Price or the Contract Times but is evidence that the parties expect that the modification ordered or documented by a Work Change Directive will be incorporated in a subsequently issued Change Order, following negotiations by the parties as to the Work Change Directive's effect, if any, on the Contract Price and Contract Times; or, if negotiations are unsuccessful, by a determination under the terms of the Contract Documents governing adjustments, expressly including Paragraph 11.04 regarding change of Contract Price. Contractor must submit any Change Proposal seeking an adjustment of the Contract Price or the Contract Times, or both, no later than 30 days after the completion of the Work set out in the Work Change Directive. Owner must submit any Claim seeking an adjustment of the Contract Price or the Contract Times, or both, no later than 60 days after issuance of the Work Change Directive.

3. *Field Orders:* Engineer may authorize minor changes in the Work if the changes do not involve an adjustment in the Contract Price or the Contract Times and are compatible with the design concept of the completed Project as a functioning whole as indicated by the Contract Documents. Such changes will be accomplished by a Field Order and will be binding on Owner and also on Contractor, which shall perform the Work involved promptly. If Contractor believes that a Field Order justifies an adjustment in the Contract Price or Contract Times, or both, then before proceeding with the Work at issue, Contractor shall submit a Change Proposal as provided herein.

#### 11.02 *Owner-Authorized Changes in the Work*

- A. Without invalidating the Contract and without notice to any surety, Owner may, at any time or from time to time, order additions, deletions, or revisions in the Work. Such changes shall be supported by Engineer's recommendation, to the extent the change

involves the design (as set forth in the Drawings, Specifications, or otherwise), or other engineering or technical matters. Such changes may be accomplished by a Change Order, if Owner and Contractor have agreed as to the effect, if any, of the changes on Contract Times or Contract Price; or by a Work Change Directive. Upon receipt of any such document, Contractor shall promptly proceed with the Work involved; or, in the case of a deletion in the Work, promptly cease construction activities with respect to such deleted Work. Added or revised Work shall be performed under the applicable conditions of the Contract Documents. Nothing in this paragraph shall obligate Contractor to undertake work that Contractor reasonably concludes cannot be performed in a manner consistent with Contractor's safety obligations under the Contract Documents or Laws and Regulations.

#### 11.03 *Unauthorized Changes in the Work*

- A. Contractor shall not be entitled to an increase in the Contract Price or an extension of the Contract Times with respect to any work performed that is not required by the Contract Documents, as amended, modified, or supplemented, except in the case of an emergency as provided in Paragraph 7.15 or in the case of uncovering Work as provided in Paragraph 14.05.

#### 11.04 *Change of Contract Price*

- A. The Contract Price may only be changed by a Change Order. Any Change Proposal for an adjustment in the Contract Price shall comply with the provisions of Paragraph 11.06. Any Claim for an adjustment of Contract Price shall comply with the provisions of Article 12.
- B. An adjustment in the Contract Price will be determined as follows:
1. where the Work involved is covered by unit prices contained in the Contract Documents, then by application of such unit prices to the quantities of the items involved (subject to the provisions of Paragraph 13.03); or
  2. where the Work involved is not covered by unit prices contained in the Contract Documents, then by a mutually agreed lump sum (which may include an allowance for overhead and profit not necessarily in accordance with Paragraph 11.04.C.2); or
  3. where the Work involved is not covered by unit prices contained in the Contract Documents and the parties do not reach mutual agreement to a lump sum, then on the basis of the Cost of the Work (determined as provided in Paragraph 13.01) plus a Contractor's fee for overhead and profit (determined as provided in Paragraph 11.04.C).
- C. *Contractor's Fee:* When applicable, the Contractor's fee for overhead and profit shall be determined as follows:
1. a mutually acceptable fixed fee; or
  2. if a fixed fee is not agreed upon, then a fee based on the following percentages of the various portions of the Cost of the Work:
    - a. for costs incurred under Paragraphs 13.01.B.1 and 13.01.B.2, the Contractor's fee shall be 15 percent;
    - b. for costs incurred under Paragraph 13.01.B.3, the Contractor's fee shall be five percent;
    - c. where one or more tiers of subcontracts are on the basis of Cost of the Work plus a fee and no fixed fee is agreed upon, the intent of Paragraphs 11.04.C.2.a and

11.04.C.2.b is that the Contractor's fee shall be based on: (1) a fee of 15 percent of the costs incurred under Paragraphs 13.01.A.1 and 13.01.A.2 by the Subcontractor that actually performs the Work, at whatever tier, and (2) with respect to Contractor itself and to any Subcontractors of a tier higher than that of the Subcontractor that actually performs the Work, a fee of five percent of the amount (fee plus underlying costs incurred) attributable to the next lower tier Subcontractor; provided, however, that for any such subcontracted work the maximum total fee to be paid by Owner shall be no greater than 27 percent of the costs incurred by the Subcontractor that actually performs the work;

- d. no fee shall be payable on the basis of costs itemized under Paragraphs 13.01.B.4, 13.01.B.5, and 13.01.C;
- e. the amount of credit to be allowed by Contractor to Owner for any change which results in a net decrease in cost will be the amount of the actual net decrease in cost plus a deduction in Contractor's fee by an amount equal to five percent of such net decrease; and
- f. when both additions and credits are involved in any one change, the adjustment in Contractor's fee shall be computed on the basis of the net change in accordance with Paragraphs 11.04.C.2.a through 11.04.C.2.e, inclusive.

#### 11.05 *Change of Contract Times*

- A. The Contract Times may only be changed by a Change Order. Any Change Proposal for an adjustment in the Contract Times shall comply with the provisions of Paragraph 11.06. Any Claim for an adjustment in the Contract Times shall comply with the provisions of Article 12.
- B. An adjustment of the Contract Times shall be subject to the limitations set forth in Paragraph 4.05, concerning delays in Contractor's progress.

#### 11.06 *Change Proposals*

- A. Contractor shall submit a Change Proposal to Engineer to request an adjustment in the Contract Times or Contract Price; appeal an initial decision by Engineer concerning the requirements of the Contract Documents or relating to the acceptability of the Work under the Contract Documents; contest a set-off against payment due; or seek other relief under the Contract. The Change Proposal shall specify any proposed change in Contract Times or Contract Price, or both, or other proposed relief, and explain the reason for the proposed change, with citations to any governing or applicable provisions of the Contract Documents.
  - 1. *Procedures:* Contractor shall submit each Change Proposal to Engineer promptly (but in no event later than 30 days) after the start of the event giving rise thereto, or after such initial decision. The Contractor shall submit supporting data, including the proposed change in Contract Price or Contract Time (if any), to the Engineer and Owner within 15 days after the submittal of the Change Proposal. The supporting data shall be accompanied by a written statement that the supporting data are accurate and complete, and that any requested time or price adjustment is the entire adjustment to which Contractor believes it is entitled as a result of said event. Engineer will advise Owner regarding the Change Proposal, and consider any comments or response from Owner regarding the Change Proposal.
  - 2. *Engineer's Action:* Engineer will review each Change Proposal and, within 30 days after receipt of the Contractor's supporting data, either deny the Change Proposal in whole,



approve it in whole, or deny it in part and approve it in part. Such actions shall be in writing, with a copy provided to Owner and Contractor. If Engineer does not take action on the Change Proposal within 30 days, then either Owner or Contractor may at any time thereafter submit a letter to the other party indicating that as a result of Engineer's inaction the Change Proposal is deemed denied, thereby commencing the time for appeal of the denial under Article 12.

3. *Binding Decision*: Engineer's decision will be final and binding upon Owner and Contractor, unless Owner or Contractor appeals the decision by filing a Claim under Article 12.
- B. *Resolution of Certain Change Proposals*: If the Change Proposal does not involve the design (as set forth in the Drawings, Specifications, or otherwise), the acceptability of the Work, or other engineering or technical matters, then Engineer will notify the parties that the Engineer is unable to resolve the Change Proposal. For purposes of further resolution of such a Change Proposal, such notice shall be deemed a denial, and Contractor may choose to seek resolution under the terms of Article 12.

#### 11.07 *Execution of Change Orders*

- A. Owner and Contractor shall execute appropriate Change Orders covering:
1. changes in the Contract Price or Contract Times which are agreed to by the parties, including any undisputed sum or amount of time for Work actually performed in accordance with a Work Change Directive;
  2. changes in Contract Price resulting from an Owner set-off, unless Contractor has duly contested such set-off;
  3. changes in the Work which are: (a) ordered by Owner pursuant to Paragraph 11.02, (b) required because of Owner's acceptance of defective Work under Paragraph 14.04 or Owner's correction of defective Work under Paragraph 14.07, or (c) agreed to by the parties, subject to the need for Engineer's recommendation if the change in the Work involves the design (as set forth in the Drawings, Specifications, or otherwise), or other engineering or technical matters; and
  4. changes in the Contract Price or Contract Times, or other changes, which embody the substance of any final and binding results under Paragraph 11.06, or Article 12.
- B. If Owner or Contractor refuses to execute a Change Order that is required to be executed under the terms of this Paragraph 11.07, it shall be deemed to be of full force and effect, as if fully executed.

#### 11.08 *Notification to Surety*

- A. If the provisions of any bond require notice to be given to a surety of any change affecting the general scope of the Work or the provisions of the Contract Documents (including, but not limited to, Contract Price or Contract Times), the giving of any such notice will be Contractor's responsibility. The amount of each applicable bond will be adjusted to reflect the effect of any such change.

**ARTICLE 12 – CLAIMS****12.01 Claims**

- A. *Claims Process:* The following disputes between Owner and Contractor shall be submitted to the Claims process set forth in this Article:
1. Appeals by Owner or Contractor of Engineer’s decisions regarding Change Proposals;
  2. Owner demands for adjustments in the Contract Price or Contract Times, or other relief under the Contract Documents; and
  3. Disputes that Engineer has been unable to address because they do not involve the design (as set forth in the Drawings, Specifications, or otherwise), the acceptability of the Work, or other engineering or technical matters.
- B. *Submittal of Claim:* The party submitting a Claim shall deliver it directly to the other party to the Contract promptly (but in no event later than 30 days) after the start of the event giving rise thereto; in the case of appeals regarding Change Proposals within 30 days of the decision under appeal. The party submitting the Claim shall also furnish a copy to the Engineer, for its information only. The responsibility to substantiate a Claim shall rest with the party making the Claim. In the case of a Claim by Contractor seeking an increase in the Contract Times or Contract Price, or both, Contractor shall certify that the Claim is made in good faith, that the supporting data are accurate and complete, and that to the best of Contractor’s knowledge and belief the amount of time or money requested accurately reflects the full amount to which Contractor is entitled.
- C. *Review and Resolution:* The party receiving a Claim shall review it thoroughly, giving full consideration to its merits. The two parties shall seek to resolve the Claim through the exchange of information and direct negotiations. The parties may extend the time for resolving the Claim by mutual agreement. All actions taken on a Claim shall be stated in writing and submitted to the other party, with a copy to Engineer.
- D. *Mediation:*
1. At any time after initiation of a Claim, Owner and Contractor may mutually agree to mediation of the underlying dispute. The agreement to mediate shall stay the Claim submittal and response process.
  2. If Owner and Contractor agree to mediation, then after 60 days from such agreement, either Owner or Contractor may unilaterally terminate the mediation process, and the Claim submittal and decision process shall resume as of the date of the termination. If the mediation proceeds but is unsuccessful in resolving the dispute, the Claim submittal and decision process shall resume as of the date of the conclusion of the mediation, as determined by the mediator.
  3. Owner and Contractor shall each pay one-half of the mediator’s fees and costs.
- E. *Partial Approval:* If the party receiving a Claim approves the Claim in part and denies it in part, such action shall be final and binding unless within 30 days of such action the other party invokes the procedure set forth in Article 17 for final resolution of disputes.
- F. *Denial of Claim:* If efforts to resolve a Claim are not successful, the party receiving the Claim may deny it by giving written notice of denial to the other party. If the receiving party does not take action on the Claim within 90 days, then either Owner or Contractor may at any time thereafter submit a letter to the other party indicating that as a result of the inaction,

the Claim is deemed denied, thereby commencing the time for appeal of the denial. A denial of the Claim shall be final and binding unless within 30 days of the denial the other party invokes the procedure set forth in Article 17 for the final resolution of disputes.

- G. *Final and Binding Results*: If the parties reach a mutual agreement regarding a Claim, whether through approval of the Claim, direct negotiations, mediation, or otherwise; or if a Claim is approved in part and denied in part, or denied in full, and such actions become final and binding; then the results of the agreement or action on the Claim shall be incorporated in a Change Order to the extent they affect the Contract, including the Work, the Contract Times, or the Contract Price.

## **ARTICLE 13 – COST OF THE WORK; ALLOWANCES; UNIT PRICE WORK**

### 13.01 *Cost of the Work*

- A. *Purposes for Determination of Cost of the Work*: The term Cost of the Work means the sum of all costs necessary for the proper performance of the Work at issue, as further defined below. The provisions of this Paragraph 13.01 are used for two distinct purposes:
1. To determine Cost of the Work when Cost of the Work is a component of the Contract Price, under cost-plus-fee, time-and-materials, or other cost-based terms; or
  2. To determine the value of a Change Order, Change Proposal, Claim, set-off, or other adjustment in Contract Price. When the value of any such adjustment is determined on the basis of Cost of the Work, Contractor is entitled only to those additional or incremental costs required because of the change in the Work or because of the event giving rise to the adjustment.
- B. *Costs Included*: Except as otherwise may be agreed to in writing by Owner, costs included in the Cost of the Work shall be in amounts no higher than those prevailing in the locality of the Project, shall not include any of the costs itemized in Paragraph 13.01.C, and shall include only the following items:
1. Payroll costs for employees in the direct employ of Contractor in the performance of the Work under schedules of job classifications agreed upon by Owner and Contractor. Such employees shall include, without limitation, superintendents, foremen, and other personnel employed full time on the Work. Payroll costs for employees not employed full time on the Work shall be apportioned on the basis of their time spent on the Work. Payroll costs shall include, but not be limited to, salaries and wages plus the cost of fringe benefits, which shall include social security contributions, unemployment, excise, and payroll taxes, workers' compensation, health and retirement benefits, bonuses, sick leave, and vacation and holiday pay applicable thereto. The expenses of performing Work outside of regular working hours, on Saturday, Sunday, or legal holidays, shall be included in the above to the extent authorized by Owner.
  2. Cost of all materials and equipment furnished and incorporated in the Work, including costs of transportation and storage thereof, and Suppliers' field services required in connection therewith. All cash discounts shall accrue to Contractor unless Owner deposits funds with Contractor with which to make payments, in which case the cash discounts shall accrue to Owner. All trade discounts, rebates, and refunds and returns from sale of surplus materials and equipment shall accrue to Owner, and Contractor shall make provisions so that they may be obtained.

3. Payments made by Contractor to Subcontractors for Work performed by Subcontractors. If required by Owner, Contractor shall obtain competitive bids from subcontractors acceptable to Owner and Contractor and shall deliver such bids to Owner, who will then determine, with the advice of Engineer, which bids, if any, will be acceptable. If any subcontract provides that the Subcontractor is to be paid on the basis of Cost of the Work plus a fee, the Subcontractor's Cost of the Work and fee shall be determined in the same manner as Contractor's Cost of the Work and fee as provided in this Paragraph 13.01.
4. Costs of special consultants (including but not limited to engineers, architects, testing laboratories, surveyors, attorneys, and accountants) employed for services specifically related to the Work.
5. Supplemental costs including the following:
  - a. The proportion of necessary transportation, travel, and subsistence expenses of Contractor's employees incurred in discharge of duties connected with the Work.
  - b. Cost, including transportation and maintenance, of all materials, supplies, equipment, machinery, appliances, office, and temporary facilities at the Site, and hand tools not owned by the workers, which are consumed in the performance of the Work, and cost, less market value, of such items used but not consumed which remain the property of Contractor.
  - c. Rentals of all construction equipment and machinery, and the parts thereof, whether rented from Contractor or others in accordance with rental agreements approved by Owner with the advice of Engineer, and the costs of transportation, loading, unloading, assembly, dismantling, and removal thereof. All such costs shall be in accordance with the terms of said rental agreements. The rental of any such equipment, machinery, or parts shall cease when the use thereof is no longer necessary for the Work.
  - d. Sales, consumer, use, and other similar taxes related to the Work, and for which Contractor is liable, as imposed by Laws and Regulations.
  - e. Deposits lost for causes other than negligence of Contractor, any Subcontractor, or anyone directly or indirectly employed by any of them or for whose acts any of them may be liable, and royalty payments and fees for permits and licenses.
  - f. Losses and damages (and related expenses) caused by damage to the Work, not compensated by insurance or otherwise, sustained by Contractor in connection with the performance of the Work (except losses and damages within the deductible amounts of property insurance established in accordance with Paragraph 6.05), provided such losses and damages have resulted from causes other than the negligence of Contractor, any Subcontractor, or anyone directly or indirectly employed by any of them or for whose acts any of them may be liable. Such losses shall include settlements made with the written consent and approval of Owner. No such losses, damages, and expenses shall be included in the Cost of the Work for the purpose of determining Contractor's fee.
  - g. The cost of utilities, fuel, and sanitary facilities at the Site.
  - h. Minor expenses such as communication service at the Site, express and courier services, and similar petty cash items in connection with the Work.

- i. The costs of premiums for all bonds and insurance that Contractor is required by the Contract Documents to purchase and maintain.
- C. *Costs Excluded:* The term Cost of the Work shall not include any of the following items:
- 1. Payroll costs and other compensation of Contractor's officers, executives, principals (of partnerships and sole proprietorships), general managers, safety managers, engineers, architects, estimators, attorneys, auditors, accountants, purchasing and contracting agents, expeditors, timekeepers, clerks, and other personnel employed by Contractor, whether at the Site or in Contractor's principal or branch office for general administration of the Work and not specifically included in the agreed upon schedule of job classifications referred to in Paragraph 13.01.B.1 or specifically covered by Paragraph 13.01.B.4. The payroll costs and other compensation excluded here are to be considered administrative costs covered by the Contractor's fee.
  - 2. Expenses of Contractor's principal and branch offices other than Contractor's office at the Site.
  - 3. Any part of Contractor's capital expenses, including interest on Contractor's capital employed for the Work and charges against Contractor for delinquent payments.
  - 4. Costs due to the negligence of Contractor, any Subcontractor, or anyone directly or indirectly employed by any of them or for whose acts any of them may be liable, including but not limited to, the correction of defective Work, disposal of materials or equipment wrongly supplied, and making good any damage to property.
  - 5. Other overhead or general expense costs of any kind and the costs of any item not specifically and expressly included in Paragraph 13.01.B.
- D. *Contractor's Fee:* When the Work as a whole is performed on the basis of cost-plus, Contractor's fee shall be determined as set forth in the Agreement. When the value of any Work covered by a Change Order, Change Proposal, Claim, set-off, or other adjustment in Contract Price is determined on the basis of Cost of the Work, Contractor's fee shall be determined as set forth in Paragraph 11.04.C.
- E. *Documentation:* Whenever the Cost of the Work for any purpose is to be determined pursuant to this Article 13, Contractor will establish and maintain records thereof in accordance with generally accepted accounting practices and submit in a form acceptable to Engineer an itemized cost breakdown together with supporting data.

### 13.02 Allowances

- A. It is understood that Contractor has included in the Contract Price all allowances so named in the Contract Documents and shall cause the Work so covered to be performed for such sums and by such persons or entities as may be acceptable to Owner and Engineer.
- B. *Cash Allowances:* Contractor agrees that:
  - 1. the cash allowances include the cost to Contractor (less any applicable trade discounts) of materials and equipment required by the allowances to be delivered at the Site, and all applicable taxes; and
  - 2. Contractor's costs for unloading and handling on the Site, labor, installation, overhead, profit, and other expenses contemplated for the cash allowances have been included in the Contract Price and not in the allowances, and no demand for additional payment on account of any of the foregoing will be valid.

- C. *Contingency Allowance*: Contractor agrees that a contingency allowance, if any, is for the sole use of Owner to cover unanticipated costs.
- D. Prior to final payment, an appropriate Change Order will be issued as recommended by Engineer to reflect actual amounts due Contractor on account of Work covered by allowances, and the Contract Price shall be correspondingly adjusted.

### 13.03 *Unit Price Work*

- A. Where the Contract Documents provide that all or part of the Work is to be Unit Price Work, initially the Contract Price will be deemed to include for all Unit Price Work an amount equal to the sum of the unit price for each separately identified item of Unit Price Work times the estimated quantity of each item as indicated in the Agreement.
- B. The estimated quantities of items of Unit Price Work are not guaranteed and are solely for the purpose of comparison of Bids and determining an initial Contract Price. Payments to Contractor for Unit Price Work will be based on actual quantities.
- C. Each unit price will be deemed to include an amount considered by Contractor to be adequate to cover Contractor's overhead and profit for each separately identified item.
- D. Engineer will determine the actual quantities and classifications of Unit Price Work performed by Contractor. Engineer will review with Contractor the Engineer's preliminary determinations on such matters before rendering a written decision thereon (by recommendation of an Application for Payment or otherwise). Engineer's written decision thereon will be final and binding (except as modified by Engineer to reflect changed factual conditions or more accurate data) upon Owner and Contractor, subject to the provisions of the following paragraph.
- E. Within 30 days of Engineer's written decision under the preceding paragraph, Contractor may submit a Change Proposal, or Owner may file a Claim, seeking an adjustment in the Contract Price if:
  1. the quantity of any item of Unit Price Work performed by Contractor differs materially and significantly from the estimated quantity of such item indicated in the Agreement;
  2. there is no corresponding adjustment with respect to any other item of Work; and
  3. Contractor believes that it is entitled to an increase in Contract Price as a result of having incurred additional expense or Owner believes that Owner is entitled to a decrease in Contract Price, and the parties are unable to agree as to the amount of any such increase or decrease.

## **ARTICLE 14 – TESTS AND INSPECTIONS; CORRECTION, REMOVAL OR ACCEPTANCE OF DEFECTIVE WORK**

### 14.01 *Access to Work*

- A. Owner, Engineer, their consultants and other representatives and personnel of Owner, independent testing laboratories, and authorities having jurisdiction will have access to the Site and the Work at reasonable times for their observation, inspection, and testing. Contractor shall provide them proper and safe conditions for such access and advise them of Contractor's safety procedures and programs so that they may comply therewith as applicable.

#### 14.02 *Tests, Inspections, and Approvals*

- A. Contractor shall give Engineer timely notice of readiness of the Work (or specific parts thereof) for all required inspections and tests, and shall cooperate with inspection and testing personnel to facilitate required inspections and tests.
- B. Owner shall retain and pay for the services of an independent inspector, testing laboratory, or other qualified individual or entity to perform all inspections and tests expressly required by the Contract Documents to be furnished and paid for by Owner, except that costs incurred in connection with tests or inspections of covered Work shall be governed by the provisions of Paragraph 14.05.
- C. If Laws or Regulations of any public body having jurisdiction require any Work (or part thereof) specifically to be inspected, tested, or approved by an employee or other representative of such public body, Contractor shall assume full responsibility for arranging and obtaining such inspections, tests, or approvals, pay all costs in connection therewith, and furnish Engineer the required certificates of inspection or approval.
- D. Contractor shall be responsible for arranging, obtaining, and paying for all inspections and tests required:
  1. by the Contract Documents, unless the Contract Documents expressly allocate responsibility for a specific inspection or test to Owner;
  2. to attain Owner's and Engineer's acceptance of materials or equipment to be incorporated in the Work;
  3. by manufacturers of equipment furnished under the Contract Documents;
  4. for testing, adjusting, and balancing of mechanical, electrical, and other equipment to be incorporated into the Work; and
  5. for acceptance of materials, mix designs, or equipment submitted for approval prior to Contractor's purchase thereof for incorporation in the Work.

Such inspections and tests shall be performed by independent inspectors, testing laboratories, or other qualified individuals or entities acceptable to Owner and Engineer.

- E. If the Contract Documents require the Work (or part thereof) to be approved by Owner, Engineer, or another designated individual or entity, then Contractor shall assume full responsibility for arranging and obtaining such approvals.
- F. If any Work (or the work of others) that is to be inspected, tested, or approved is covered by Contractor without written concurrence of Engineer, Contractor shall, if requested by Engineer, uncover such Work for observation. Such uncovering shall be at Contractor's expense unless Contractor had given Engineer timely notice of Contractor's intention to cover the same and Engineer had not acted with reasonable promptness in response to such notice.

#### 14.03 *Defective Work*

- A. *Contractor's Obligation:* It is Contractor's obligation to assure that the Work is not defective.
- B. *Engineer's Authority:* Engineer has the authority to determine whether Work is defective, and to reject defective Work.

- C. *Notice of Defects*: Prompt notice of all defective Work of which Owner or Engineer has actual knowledge will be given to Contractor.
- D. *Correction, or Removal and Replacement*: Promptly after receipt of written notice of defective Work, Contractor shall correct all such defective Work, whether or not fabricated, installed, or completed, or, if Engineer has rejected the defective Work, remove it from the Project and replace it with Work that is not defective.
- E. *Preservation of Warranties*: When correcting defective Work, Contractor shall take no action that would void or otherwise impair Owner's special warranty and guarantee, if any, on said Work.
- F. *Costs and Damages*: In addition to its correction, removal, and replacement obligations with respect to defective Work, Contractor shall pay all claims, costs, losses, and damages arising out of or relating to defective Work, including but not limited to the cost of the inspection, testing, correction, removal, replacement, or reconstruction of such defective Work, fines levied against Owner by governmental authorities because the Work is defective, and the costs of repair or replacement of work of others resulting from defective Work. Prior to final payment, if Owner and Contractor are unable to agree as to the measure of such claims, costs, losses, and damages resulting from defective Work, then Owner may impose a reasonable set-off against payments due under Article 15.

#### 14.04 *Acceptance of Defective Work*

- A. If, instead of requiring correction or removal and replacement of defective Work, Owner prefers to accept it, Owner may do so (subject, if such acceptance occurs prior to final payment, to Engineer's confirmation that such acceptance is in general accord with the design intent and applicable engineering principles, and will not endanger public safety). Contractor shall pay all claims, costs, losses, and damages attributable to Owner's evaluation of and determination to accept such defective Work (such costs to be approved by Engineer as to reasonableness), and for the diminished value of the Work to the extent not otherwise paid by Contractor. If any such acceptance occurs prior to final payment, the necessary revisions in the Contract Documents with respect to the Work shall be incorporated in a Change Order. If the parties are unable to agree as to the decrease in the Contract Price, reflecting the diminished value of Work so accepted, then Owner may impose a reasonable set-off against payments due under Article 15. If the acceptance of defective Work occurs after final payment, Contractor shall pay an appropriate amount to Owner.

#### 14.05 *Uncovering Work*

- A. Engineer has the authority to require additional inspection or testing of the Work, whether or not the Work is fabricated, installed, or completed.
- B. If any Work is covered contrary to the written request of Engineer, then Contractor shall, if requested by Engineer, uncover such Work for Engineer's observation, and then replace the covering, all at Contractor's expense.
- C. If Engineer considers it necessary or advisable that covered Work be observed by Engineer or inspected or tested by others, then Contractor, at Engineer's request, shall uncover, expose, or otherwise make available for observation, inspection, or testing as Engineer may require, that portion of the Work in question, and provide all necessary labor, material, and equipment.



1. If it is found that the uncovered Work is defective, Contractor shall be responsible for all claims, costs, losses, and damages arising out of or relating to such uncovering, exposure, observation, inspection, and testing, and of satisfactory replacement or reconstruction (including but not limited to all costs of repair or replacement of work of others); and pending Contractor's full discharge of this responsibility the Owner shall be entitled to impose a reasonable set-off against payments due under Article 15.
2. If the uncovered Work is not found to be defective, Contractor shall be allowed an increase in the Contract Price or an extension of the Contract Times, or both, directly attributable to such uncovering, exposure, observation, inspection, testing, replacement, and reconstruction. If the parties are unable to agree as to the amount or extent thereof, then Contractor may submit a Change Proposal within 30 days of the determination that the Work is not defective.

#### 14.06 *Owner May Stop the Work*

- A. If the Work is defective, or Contractor fails to supply sufficient skilled workers or suitable materials or equipment, or fails to perform the Work in such a way that the completed Work will conform to the Contract Documents, then Owner may order Contractor to stop the Work, or any portion thereof, until the cause for such order has been eliminated; however, this right of Owner to stop the Work shall not give rise to any duty on the part of Owner to exercise this right for the benefit of Contractor, any Subcontractor, any Supplier, any other individual or entity, or any surety for, or employee or agent of any of them.

#### 14.07 *Owner May Correct Defective Work*

- A. If Contractor fails within a reasonable time after written notice from Engineer to correct defective Work, or to remove and replace rejected Work as required by Engineer, or if Contractor fails to perform the Work in accordance with the Contract Documents, or if Contractor fails to comply with any other provision of the Contract Documents, then Owner may, after seven days written notice to Contractor, correct or remedy any such deficiency.
- B. In exercising the rights and remedies under this Paragraph 14.07, Owner shall proceed expeditiously. In connection with such corrective or remedial action, Owner may exclude Contractor from all or part of the Site, take possession of all or part of the Work and suspend Contractor's services related thereto, and incorporate in the Work all materials and equipment stored at the Site or for which Owner has paid Contractor but which are stored elsewhere. Contractor shall allow Owner, Owner's representatives, agents and employees, Owner's other contractors, and Engineer and Engineer's consultants access to the Site to enable Owner to exercise the rights and remedies under this paragraph.
- C. All claims, costs, losses, and damages incurred or sustained by Owner in exercising the rights and remedies under this Paragraph 14.07 will be charged against Contractor as set-offs against payments due under Article 15. Such claims, costs, losses and damages will include but not be limited to all costs of repair, or replacement of work of others destroyed or damaged by correction, removal, or replacement of Contractor's defective Work.
- D. Contractor shall not be allowed an extension of the Contract Times because of any delay in the performance of the Work attributable to the exercise by Owner of Owner's rights and remedies under this Paragraph 14.07.

**ARTICLE 15 – PAYMENTS TO CONTRACTOR; SET-OFFS; COMPLETION; CORRECTION PERIOD****15.01 Progress Payments**

- A. *Basis for Progress Payments:* The Schedule of Values established as provided in Article 2 will serve as the basis for progress payments and will be incorporated into a form of Application for Payment acceptable to Engineer. Progress payments on account of Unit Price Work will be based on the number of units completed during the pay period, as determined under the provisions of Paragraph 13.03. Progress payments for cost-based Work will be based on Cost of the Work completed by Contractor during the pay period.
- B. *Applications for Payments:*
1. At least 20 days before the date established in the Agreement for each progress payment (but not more often than once a month), Contractor shall submit to Engineer for review an Application for Payment filled out and signed by Contractor covering the Work completed as of the date of the Application and accompanied by such supporting documentation as is required by the Contract Documents. If payment is requested on the basis of materials and equipment not incorporated in the Work but delivered and suitably stored at the Site or at another location agreed to in writing, the Application for Payment shall also be accompanied by a bill of sale, invoice, or other documentation warranting that Owner has received the materials and equipment free and clear of all Liens, and evidence that the materials and equipment are covered by appropriate property insurance, a warehouse bond, or other arrangements to protect Owner's interest therein, all of which must be satisfactory to Owner.
  2. Beginning with the second Application for Payment, each Application shall include an affidavit of Contractor stating that all previous progress payments received on account of the Work have been applied on account to discharge Contractor's legitimate obligations associated with prior Applications for Payment.
  3. The amount of retainage with respect to progress payments will be as stipulated in the Agreement.
- C. *Review of Applications:*
1. Engineer will, within 10 days after receipt of each Application for Payment, including each resubmittal, either indicate in writing a recommendation of payment and present the Application to Owner, or return the Application to Contractor indicating in writing Engineer's reasons for refusing to recommend payment. In the latter case, Contractor may make the necessary corrections and resubmit the Application.
  2. Engineer's recommendation of any payment requested in an Application for Payment will constitute a representation by Engineer to Owner, based on Engineer's observations of the executed Work as an experienced and qualified design professional, and on Engineer's review of the Application for Payment and the accompanying data and schedules, that to the best of Engineer's knowledge, information and belief:
    - a. the Work has progressed to the point indicated;
    - b. the quality of the Work is generally in accordance with the Contract Documents (subject to an evaluation of the Work as a functioning whole prior to or upon Substantial Completion, the results of any subsequent tests called for in the Contract Documents, a final determination of quantities and classifications for

Unit Price Work under Paragraph 13.03, and any other qualifications stated in the recommendation); and

- c. the conditions precedent to Contractor's being entitled to such payment appear to have been fulfilled in so far as it is Engineer's responsibility to observe the Work.
3. By recommending any such payment Engineer will not thereby be deemed to have represented that:
    - a. inspections made to check the quality or the quantity of the Work as it has been performed have been exhaustive, extended to every aspect of the Work in progress, or involved detailed inspections of the Work beyond the responsibilities specifically assigned to Engineer in the Contract; or
    - b. there may not be other matters or issues between the parties that might entitle Contractor to be paid additionally by Owner or entitle Owner to withhold payment to Contractor.
  4. Neither Engineer's review of Contractor's Work for the purposes of recommending payments nor Engineer's recommendation of any payment, including final payment, will impose responsibility on Engineer:
    - a. to supervise, direct, or control the Work, or
    - b. for the means, methods, techniques, sequences, or procedures of construction, or the safety precautions and programs incident thereto, or
    - c. for Contractor's failure to comply with Laws and Regulations applicable to Contractor's performance of the Work, or
    - d. to make any examination to ascertain how or for what purposes Contractor has used the money paid on account of the Contract Price, or
    - e. to determine that title to any of the Work, materials, or equipment has passed to Owner free and clear of any Liens.
  5. Engineer may refuse to recommend the whole or any part of any payment if, in Engineer's opinion, it would be incorrect to make the representations to Owner stated in Paragraph 15.01.C.2.
  6. Engineer will recommend reductions in payment (set-offs) necessary in Engineer's opinion to protect Owner from loss because:
    - a. the Work is defective, requiring correction or replacement;
    - b. the Contract Price has been reduced by Change Orders;
    - c. Owner has been required to correct defective Work in accordance with Paragraph 14.07, or has accepted defective Work pursuant to Paragraph 14.04;
    - d. Owner has been required to remove or remediate a Hazardous Environmental Condition for which Contractor is responsible; or
    - e. Engineer has actual knowledge of the occurrence of any of the events that would constitute a default by Contractor and therefore justify termination for cause under the Contract Documents.

D. *Payment Becomes Due:*

1. Ten days after presentation of the Application for Payment to Owner with Engineer's recommendation, the amount recommended (subject to any Owner set-offs) will become due, and when due will be paid by Owner to Contractor.

E. *Reductions in Payment by Owner:*

1. In addition to any reductions in payment (set-offs) recommended by Engineer, Owner is entitled to impose a set-off against payment based on any of the following:
  - a. claims have been made against Owner on account of Contractor's conduct in the performance or furnishing of the Work, or Owner has incurred costs, losses, or damages on account of Contractor's conduct in the performance or furnishing of the Work, including but not limited to claims, costs, losses, or damages from workplace injuries, adjacent property damage, non-compliance with Laws and Regulations, and patent infringement;
  - b. Contractor has failed to take reasonable and customary measures to avoid damage, delay, disruption, and interference with other work at or adjacent to the Site;
  - c. Contractor has failed to provide and maintain required bonds or insurance;
  - d. Owner has been required to remove or remediate a Hazardous Environmental Condition for which Contractor is responsible;
  - e. Owner has incurred extra charges or engineering costs related to submittal reviews, evaluations of proposed substitutes, tests and inspections, or return visits to manufacturing or assembly facilities;
  - f. the Work is defective, requiring correction or replacement;
  - g. Owner has been required to correct defective Work in accordance with Paragraph 14.07, or has accepted defective Work pursuant to Paragraph 14.04;
  - h. the Contract Price has been reduced by Change Orders;
  - i. an event that would constitute a default by Contractor and therefore justify a termination for cause has occurred;
  - j. liquidated damages have accrued as a result of Contractor's failure to achieve Milestones, Substantial Completion, or final completion of the Work;
  - k. Liens have been filed in connection with the Work, except where Contractor has delivered a specific bond satisfactory to Owner to secure the satisfaction and discharge of such Liens;
  - l. there are other items entitling Owner to a set off against the amount recommended.
2. If Owner imposes any set-off against payment, whether based on its own knowledge or on the written recommendations of Engineer, Owner will give Contractor immediate written notice (with a copy to Engineer) stating the reasons for such action and the specific amount of the reduction, and promptly pay Contractor any amount remaining after deduction of the amount so withheld. Owner shall promptly pay Contractor the amount so withheld, or any adjustment thereto agreed to by Owner and Contractor, if Contractor remedies the reasons for such action. The reduction

imposed shall be binding on Contractor unless it duly submits a Change Proposal contesting the reduction.

3. Upon a subsequent determination that Owner's refusal of payment was not justified, the amount wrongfully withheld shall be treated as an amount due as determined by Paragraph 15.01.C.1 and subject to interest as provided in the Agreement.

#### 15.02 *Contractor's Warranty of Title*

- A. Contractor warrants and guarantees that title to all Work, materials, and equipment furnished under the Contract will pass to Owner free and clear of (1) all Liens and other title defects, and (2) all patent, licensing, copyright, or royalty obligations, no later than seven days after the time of payment by Owner.

#### 15.03 *Substantial Completion*

- A. When Contractor considers the entire Work ready for its intended use Contractor shall notify Owner and Engineer in writing that the entire Work is substantially complete and request that Engineer issue a certificate of Substantial Completion. Contractor shall at the same time submit to Owner and Engineer an initial draft of punch list items to be completed or corrected before final payment.
- B. Promptly after Contractor's notification, Owner, Contractor, and Engineer shall make an inspection of the Work to determine the status of completion. If Engineer does not consider the Work substantially complete, Engineer will notify Contractor in writing giving the reasons therefor.
- C. If Engineer considers the Work substantially complete, Engineer will deliver to Owner a preliminary certificate of Substantial Completion which shall fix the date of Substantial Completion. Engineer shall attach to the certificate a punch list of items to be completed or corrected before final payment. Owner shall have seven days after receipt of the preliminary certificate during which to make written objection to Engineer as to any provisions of the certificate or attached punch list. If, after considering the objections to the provisions of the preliminary certificate, Engineer concludes that the Work is not substantially complete, Engineer will, within 14 days after submission of the preliminary certificate to Owner, notify Contractor in writing that the Work is not substantially complete, stating the reasons therefor. If Owner does not object to the provisions of the certificate, or if despite consideration of Owner's objections Engineer concludes that the Work is substantially complete, then Engineer will, within said 14 days, execute and deliver to Owner and Contractor a final certificate of Substantial Completion (with a revised punch list of items to be completed or corrected) reflecting such changes from the preliminary certificate as Engineer believes justified after consideration of any objections from Owner.
- D. At the time of receipt of the preliminary certificate of Substantial Completion, Owner and Contractor will confer regarding Owner's use or occupancy of the Work following Substantial Completion, review the builder's risk insurance policy with respect to the end of the builder's risk coverage, and confirm the transition to coverage of the Work under a permanent property insurance policy held by Owner. Unless Owner and Contractor agree otherwise in writing, Owner shall bear responsibility for security, operation, protection of the Work, property insurance, maintenance, heat, and utilities upon Owner's use or occupancy of the Work.
- E. After Substantial Completion the Contractor shall promptly begin work on the punch list of items to be completed or corrected prior to final payment. In appropriate cases Contractor

may submit monthly Applications for Payment for completed punch list items, following the progress payment procedures set forth above.

- F. Owner shall have the right to exclude Contractor from the Site after the date of Substantial Completion subject to allowing Contractor reasonable access to remove its property and complete or correct items on the punch list.

#### 15.04 *Partial Use or Occupancy*

- A. Prior to Substantial Completion of all the Work, Owner may use or occupy any substantially completed part of the Work which has specifically been identified in the Contract Documents, or which Owner, Engineer, and Contractor agree constitutes a separately functioning and usable part of the Work that can be used by Owner for its intended purpose without significant interference with Contractor's performance of the remainder of the Work, subject to the following conditions:
1. At any time Owner may request in writing that Contractor permit Owner to use or occupy any such part of the Work that Owner believes to be substantially complete. If and when Contractor agrees that such part of the Work is substantially complete, Contractor, Owner, and Engineer will follow the procedures of Paragraph 15.03.A through E for that part of the Work.
  2. At any time Contractor may notify Owner and Engineer in writing that Contractor considers any such part of the Work substantially complete and request Engineer to issue a certificate of Substantial Completion for that part of the Work.
  3. Within a reasonable time after either such request, Owner, Contractor, and Engineer shall make an inspection of that part of the Work to determine its status of completion. If Engineer does not consider that part of the Work to be substantially complete, Engineer will notify Owner and Contractor in writing giving the reasons therefor. If Engineer considers that part of the Work to be substantially complete, the provisions of Paragraph 15.03 will apply with respect to certification of Substantial Completion of that part of the Work and the division of responsibility in respect thereof and access thereto.
  4. No use or occupancy or separate operation of part of the Work may occur prior to compliance with the requirements of Paragraph 6.05 regarding builder's risk or other property insurance.

#### 15.05 *Final Inspection*

- A. Upon written notice from Contractor that the entire Work or an agreed portion thereof is complete, Engineer will promptly make a final inspection with Owner and Contractor and will notify Contractor in writing of all particulars in which this inspection reveals that the Work, or agreed portion thereof, is incomplete or defective. Contractor shall immediately take such measures as are necessary to complete such Work or remedy such deficiencies.

#### 15.06 *Final Payment*

- A. *Application for Payment:*
1. After Contractor has, in the opinion of Engineer, satisfactorily completed all corrections identified during the final inspection and has delivered, in accordance with the Contract Documents, all maintenance and operating instructions, schedules, guarantees, bonds, certificates or other evidence of insurance, certificates of

inspection, annotated record documents (as provided in Paragraph 7.11), and other documents, Contractor may make application for final payment.

2. The final Application for Payment shall be accompanied (except as previously delivered) by:
  - a. all documentation called for in the Contract Documents;
  - b. consent of the surety, if any, to final payment;
  - c. satisfactory evidence that all title issues have been resolved such that title to all Work, materials, and equipment has passed to Owner free and clear of any Liens or other title defects, or will so pass upon final payment.
  - d. a list of all disputes that Contractor believes are unsettled; and
  - e. complete and legally effective releases or waivers (satisfactory to Owner) of all Lien rights arising out of the Work, and of Liens filed in connection with the Work.
3. In lieu of the releases or waivers of Liens specified in Paragraph 15.06.A.2 and as approved by Owner, Contractor may furnish receipts or releases in full and an affidavit of Contractor that: (a) the releases and receipts include all labor, services, material, and equipment for which a Lien could be filed; and (b) all payrolls, material and equipment bills, and other indebtedness connected with the Work for which Owner might in any way be responsible, or which might in any way result in liens or other burdens on Owner's property, have been paid or otherwise satisfied. If any Subcontractor or Supplier fails to furnish such a release or receipt in full, Contractor may furnish a bond or other collateral satisfactory to Owner to indemnify Owner against any Lien, or Owner at its option may issue joint checks payable to Contractor and specified Subcontractors and Suppliers.

**B. *Engineer's Review of Application and Acceptance:***

1. If, on the basis of Engineer's observation of the Work during construction and final inspection, and Engineer's review of the final Application for Payment and accompanying documentation as required by the Contract Documents, Engineer is satisfied that the Work has been completed and Contractor's other obligations under the Contract have been fulfilled, Engineer will, within ten days after receipt of the final Application for Payment, indicate in writing Engineer's recommendation of final payment and present the Application for Payment to Owner for payment. Such recommendation shall account for any set-offs against payment that are necessary in Engineer's opinion to protect Owner from loss for the reasons stated above with respect to progress payments. At the same time Engineer will also give written notice to Owner and Contractor that the Work is acceptable, subject to the provisions of Paragraph 15.07. Otherwise, Engineer will return the Application for Payment to Contractor, indicating in writing the reasons for refusing to recommend final payment, in which case Contractor shall make the necessary corrections and resubmit the Application for Payment.

**C. *Completion of Work:*** The Work is complete (subject to surviving obligations) when it is ready for final payment as established by the Engineer's written recommendation of final payment.

**D. *Payment Becomes Due:*** Thirty days after the presentation to Owner of the final Application for Payment and accompanying documentation, the amount recommended by Engineer

(less any further sum Owner is entitled to set off against Engineer's recommendation, including but not limited to set-offs for liquidated damages and set-offs allowed under the provisions above with respect to progress payments) will become due and shall be paid by Owner to Contractor.

#### 15.07 *Waiver of Claims*

- A. The making of final payment will not constitute a waiver by Owner of claims or rights against Contractor. Owner expressly reserves claims and rights arising from unsettled Liens, from defective Work appearing after final inspection pursuant to Paragraph 15.05, from Contractor's failure to comply with the Contract Documents or the terms of any special guarantees specified therein, from outstanding Claims by Owner, or from Contractor's continuing obligations under the Contract Documents.
- B. The acceptance of final payment by Contractor will constitute a waiver by Contractor of all claims and rights against Owner other than those pending matters that have been duly submitted or appealed under the provisions of Article 17.

#### 15.08 *Correction Period*

- A. If within one year after the date of Substantial Completion (or such longer period of time as may be prescribed by the terms of any applicable special guarantee required by the Contract Documents, or by any specific provision of the Contract Documents), any Work is found to be defective, or if the repair of any damages to the Site, adjacent areas that Contractor has arranged to use through construction easements or otherwise, and other adjacent areas used by Contractor as permitted by Laws and Regulations, is found to be defective, then Contractor shall promptly, without cost to Owner and in accordance with Owner's written instructions:
  1. correct the defective repairs to the Site or such other adjacent areas;
  2. correct such defective Work;
  3. if the defective Work has been rejected by Owner, remove it from the Project and replace it with Work that is not defective, and
  4. satisfactorily correct or repair or remove and replace any damage to other Work, to the work of others, or to other land or areas resulting therefrom.
- B. If Contractor does not promptly comply with the terms of Owner's written instructions, or in an emergency where delay would cause serious risk of loss or damage, Owner may have the defective Work corrected or repaired or may have the rejected Work removed and replaced. Contractor shall pay all claims, costs, losses, and damages (including but not limited to all fees and charges of engineers, architects, attorneys, and other professionals and all court or arbitration or other dispute resolution costs) arising out of or relating to such correction or repair or such removal and replacement (including but not limited to all costs of repair or replacement of work of others).
- C. In special circumstances where a particular item of equipment is placed in continuous service before Substantial Completion of all the Work, the correction period for that item may start to run from an earlier date if so provided in the Specifications.
- D. Where defective Work (and damage to other Work resulting therefrom) has been corrected or removed and replaced under this paragraph, the correction period hereunder with



respect to such Work will be extended for an additional period of one year after such correction or removal and replacement has been satisfactorily completed.

- E. Contractor's obligations under this paragraph are in addition to all other obligations and warranties. The provisions of this paragraph shall not be construed as a substitute for, or a waiver of, the provisions of any applicable statute of limitation or repose.

## ARTICLE 16 – SUSPENSION OF WORK AND TERMINATION

### 16.01 *Owner May Suspend Work*

- A. At any time and without cause, Owner may suspend the Work or any portion thereof for a period of not more than 90 consecutive days by written notice to Contractor and Engineer. Such notice will fix the date on which Work will be resumed. Contractor shall resume the Work on the date so fixed. Contractor shall be entitled to an adjustment in the Contract Price or an extension of the Contract Times, or both, directly attributable to any such suspension. Any Change Proposal seeking such adjustments shall be submitted no later than 30 days after the date fixed for resumption of Work.

### 16.02 *Owner May Terminate for Cause*

- A. The occurrence of any one or more of the following events will constitute a default by Contractor and justify termination for cause:
1. Contractor's persistent failure to perform the Work in accordance with the Contract Documents (including, but not limited to, failure to supply sufficient skilled workers or suitable materials or equipment or failure to adhere to the Progress Schedule);
  2. Failure of Contractor to perform or otherwise to comply with a material term of the Contract Documents;
  3. Contractor's disregard of Laws or Regulations of any public body having jurisdiction; or
  4. Contractor's repeated disregard of the authority of Owner or Engineer.
- B. If one or more of the events identified in Paragraph 16.02.A occurs, then after giving Contractor (and any surety) ten days written notice that Owner is considering a declaration that Contractor is in default and termination of the contract, Owner may proceed to:
1. declare Contractor to be in default, and give Contractor (and any surety) notice that the Contract is terminated; and
  2. enforce the rights available to Owner under any applicable performance bond.
- C. Subject to the terms and operation of any applicable performance bond, if Owner has terminated the Contract for cause, Owner may exclude Contractor from the Site, take possession of the Work, incorporate in the Work all materials and equipment stored at the Site or for which Owner has paid Contractor but which are stored elsewhere, and complete the Work as Owner may deem expedient.
- D. Owner may not proceed with termination of the Contract under Paragraph 16.02.B if Contractor within seven days of receipt of notice of intent to terminate begins to correct its failure to perform and proceeds diligently to cure such failure.
- E. If Owner proceeds as provided in Paragraph 16.02.B, Contractor shall not be entitled to receive any further payment until the Work is completed. If the unpaid balance of the Contract Price exceeds the cost to complete the Work, including all related claims, costs,

losses, and damages (including but not limited to all fees and charges of engineers, architects, attorneys, and other professionals) sustained by Owner, such excess will be paid to Contractor. If the cost to complete the Work including such related claims, costs, losses, and damages exceeds such unpaid balance, Contractor shall pay the difference to Owner. Such claims, costs, losses, and damages incurred by Owner will be reviewed by Engineer as to their reasonableness and, when so approved by Engineer, incorporated in a Change Order. When exercising any rights or remedies under this paragraph, Owner shall not be required to obtain the lowest price for the Work performed.

- F. Where Contractor's services have been so terminated by Owner, the termination will not affect any rights or remedies of Owner against Contractor then existing or which may thereafter accrue, or any rights or remedies of Owner against Contractor or any surety under any payment bond or performance bond. Any retention or payment of money due Contractor by Owner will not release Contractor from liability.
- G. If and to the extent that Contractor has provided a performance bond under the provisions of Paragraph 6.01.A, the provisions of that bond shall govern over any inconsistent provisions of Paragraphs 16.02.B and 16.02.D.

#### 16.03 *Owner May Terminate For Convenience*

- A. Upon seven days written notice to Contractor and Engineer, Owner may, without cause and without prejudice to any other right or remedy of Owner, terminate the Contract. In such case, Contractor shall be paid for (without duplication of any items):
  1. completed and acceptable Work executed in accordance with the Contract Documents prior to the effective date of termination, including fair and reasonable sums for overhead and profit on such Work;
  2. expenses sustained prior to the effective date of termination in performing services and furnishing labor, materials, or equipment as required by the Contract Documents in connection with uncompleted Work, plus fair and reasonable sums for overhead and profit on such expenses; and
  3. other reasonable expenses directly attributable to termination, including costs incurred to prepare a termination for convenience cost proposal.
- B. Contractor shall not be paid on account of loss of anticipated overhead, profits, or revenue, or other economic loss arising out of or resulting from such termination.

#### 16.04 *Contractor May Stop Work or Terminate*

- A. If, through no act or fault of Contractor, (1) the Work is suspended for more than 90 consecutive days by Owner or under an order of court or other public authority, or (2) Engineer fails to act on any Application for Payment within 30 days after it is submitted, or (3) Owner fails for 30 days to pay Contractor any sum finally determined to be due, then Contractor may, upon seven days written notice to Owner and Engineer, and provided Owner or Engineer do not remedy such suspension or failure within that time, terminate the contract and recover from Owner payment on the same terms as provided in Paragraph 16.03.
- B. In lieu of terminating the Contract and without prejudice to any other right or remedy, if Engineer has failed to act on an Application for Payment within 30 days after it is submitted, or Owner has failed for 30 days to pay Contractor any sum finally determined to be due, Contractor may, seven days after written notice to Owner and Engineer, stop the

Work until payment is made of all such amounts due Contractor, including interest thereon. The provisions of this paragraph are not intended to preclude Contractor from submitting a Change Proposal for an adjustment in Contract Price or Contract Times or otherwise for expenses or damage directly attributable to Contractor's stopping the Work as permitted by this paragraph.

## **ARTICLE 17 – FINAL RESOLUTION OF DISPUTES**

### **17.01 *Methods and Procedures***

- A. *Disputes Subject to Final Resolution:* The following disputed matters are subject to final resolution under the provisions of this Article:
1. A timely appeal of an approval in part and denial in part of a Claim, or of a denial in full; and
  2. Disputes between Owner and Contractor concerning the Work or obligations under the Contract Documents, and arising after final payment has been made.
- B. *Final Resolution of Disputes:* For any dispute subject to resolution under this Article, Owner or Contractor may:
1. elect in writing to invoke the dispute resolution process provided for in the Supplementary Conditions; or
  2. agree with the other party to submit the dispute to another dispute resolution process; or
  3. if no dispute resolution process is provided for in the Supplementary Conditions or mutually agreed to, give written notice to the other party of the intent to submit the dispute to a court of competent jurisdiction.

## **ARTICLE 18 – MISCELLANEOUS**

### **18.01 *Giving Notice***

- A. Whenever any provision of the Contract Documents requires the giving of written notice, it will be deemed to have been validly given if:
1. delivered in person, by a commercial courier service or otherwise, to the individual or to a member of the firm or to an officer of the corporation for which it is intended; or
  2. delivered at or sent by registered or certified mail, postage prepaid, to the last business address known to the sender of the notice.

### **18.02 *Computation of Times***

- A. When any period of time is referred to in the Contract by days, it will be computed to exclude the first and include the last day of such period. If the last day of any such period falls on a Saturday or Sunday or on a day made a legal holiday by the law of the applicable jurisdiction, such day will be omitted from the computation.

### **18.03 *Cumulative Remedies***

- A. The duties and obligations imposed by these General Conditions and the rights and remedies available hereunder to the parties hereto are in addition to, and are not to be construed in any way as a limitation of, any rights and remedies available to any or all of

them which are otherwise imposed or available by Laws or Regulations, by special warranty or guarantee, or by other provisions of the Contract. The provisions of this paragraph will be as effective as if repeated specifically in the Contract Documents in connection with each particular duty, obligation, right, and remedy to which they apply.

18.04 *Limitation of Damages*

- A. With respect to any and all Change Proposals, Claims, disputes subject to final resolution, and other matters at issue, neither Owner nor Engineer, nor any of their officers, directors, members, partners, employees, agents, consultants, or subcontractors, shall be liable to Contractor for any claims, costs, losses, or damages sustained by Contractor on or in connection with any other project or anticipated project.

18.05 *No Waiver*

- A. A party's non-enforcement of any provision shall not constitute a waiver of that provision, nor shall it affect the enforceability of that provision or of the remainder of this Contract.

18.06 *Survival of Obligations*

- A. All representations, indemnifications, warranties, and guarantees made in, required by, or given in accordance with the Contract, as well as all continuing obligations indicated in the Contract, will survive final payment, completion, and acceptance of the Work or termination or completion of the Contract or termination of the services of Contractor.

18.07 *Controlling Law*

- A. This Contract is to be governed by the law of the state in which the Project is located.

18.08 *Headings*

- A. Article and paragraph headings are inserted for convenience only and do not constitute parts of these General Conditions.

**RD SUPPLEMENTARY GENERAL CONDITIONS TO EJCDC  
GENERAL CONDITIONS**

**RD SUPPLEMENTAL GENERAL CONDITIONS TO EJCDC GENERAL CONDITIONS**

These Supplementary General Conditions amend or supplement the Standard General Conditions of the Construction Contract, EJCDC® C-700 (2013 Edition). All provisions that are not so amended or supplemented remain in full force and effect.

These revisions to the General Conditions are requirements of the funding agency, USDA Rural Development Utilities Service, and are applied in conjunction with the GRW Supplemental General Conditions.

The terms used in these Supplementary General Conditions have the meanings stated in the General Conditions. Additional terms used in these Supplementary General Conditions have the meanings stated below, which are applicable to both the singular and plural thereof.

The address system used in these Supplementary General Conditions is the same as the address system used in the General Conditions, with the prefix "SGC" added thereto.

**SGC-1.01.A.8.**

**Add the following language to the end of Paragraph 1.01.A.8:**

The Change Order form to be used on this Project is EJCDC No. C-941. Agency approval is required before Change Orders are effective.

**SGC-1.01.**

**Add the following language at the end of the last sentence of Paragraph 1.01.A.48:**

A Work Change Directive cannot change Contract Price or Contract Times without a subsequent Change Order.

**SGC-1.01.**

**Add the following new Paragraph after Paragraph 1.01.A.48:**

49. *Abnormal Weather Conditions* – Conditions of extreme or unusual weather for a given region, elevation, or season as determined by Engineer. Extreme or unusual weather that is typical for a given region, elevation, or season should not be considered Abnormal Weather Conditions.

**SGC-1.01**

**Add the following new Paragraph after Paragraph 1.01.A.49:**

50. *Agency* - The Project is financed in whole or in part by USDA Rural Utilities Service pursuant to the Consolidated Farm and Rural Development Act (7 USC Section 1921 et seq.). The Rural Utilities Service programs are administered through the USDA Rural Development offices; therefore, the Agency

for these documents is USDA Rural Development.

#### **SGC-2.02**

**Delete Paragraph 2.02.A in its entirety and insert the following new paragraph in its place:**

- A. Owner shall furnish to Contractor five copies of conformed Contract Documents incorporating and integrating all Addenda and any amendments negotiated prior to the Effective Date of the Contract (including one fully executed counterpart of the Agreement), and one copy in electronic portable document format (PDF). Additional printed copies of the conformed Contract Documents will be furnished upon request at the cost of reproduction.

#### **SGC-4.01**

**Delete the following sentence from Paragraph 4.01A:**

In no event will the Contract Times commence to run later than the ninetieth day after the day of Bid opening or the thirtieth day after the Effective Date of the Agreement, whichever date is earlier.

#### **SGC-4.05**

**Replace the phrase "abnormal weather conditions" from Paragraph 4.05.C.2 and replace with "Abnormal Weather Conditions"**

#### **SGC-5.03**

**Add the following new paragraph after Paragraph 5.03B:**

If any geotechnical exploration for the project was performed and reported, said report will be included as an Appendix. The geotechnical report shall be used as a reference and all recommendations included therein shall be followed in full.

#### **SGC-5.06**

**Add the following new paragraph immediately after Paragraph 5.06.A.2:**

3. If any Hazardous Conditions were reported, said report will be included as an Appendix.

#### **SGC-6.03**

**Add the following paragraphs after Paragraph 6.03.J:**

- K. The insurance required by this Paragraph shall include specific coverage and be written for not less than the limits of liability and coverages tabulated in the prototype Certificate of Insurance included as Section 00 62 16, or as required by law, whichever is greater.

#### **SGC-7.04**

**Amend the third sentence of Paragraph 7.04.A by deleting the following words:**

Unless the specification or description contains or is followed by words reading that no like, equivalent or “or-equal” item is permitted

**SGC-7.04**

**Amend the last sentence of Paragraph 7.04.A.1.a.3 by striking out “and”, and adding a period at the end of said paragraph.**

**SGC-7.04**

**Delete Paragraph 7.04.A.1.a.4 in its entirety and insert the following in its place:**

(Deleted)

**SGC-7.06**

**Amend Paragraph 7.06.A by adding the following text to the end of the Paragraph:**

The contractor shall not award work valued at more than fifty percent of the Contract Price to Subcontractor(s), without prior written approval of the Owner.

**SGC-7.06**

**Delete Paragraph 7.06.B in its entirety and insert the following in its place.**

(Deleted)

**SGC-7.06**

**Amend the second sentence of Paragraph 7.06.E by striking out “Owner may also require Contractor to retain specific replacements; provided, however, that”.**

**SGC-10.03.A.**

The Duties, Responsibilities, and Limitations of Authority of the Resident Project Representative will be as stated in the document attached to these Supplementary General Conditions.

**SGC-11.07**

**Add the following new paragraph immediately after Paragraph 11.07B:**

11.07.C All Contract Change Orders must be concurred in by Agency before they are effective.

**SGC-13.02**

Delete Paragraph 13.02.C in its entirety and insert the following in its place:



(Deleted)

**SGC-15.01**

**Amend the second sentence of Paragraph 15.01B.1 by striking out the following text: “a bill of sale, invoice or other”.**

**SGC-15.01**

**Add the following new paragraph after Paragraph 15.01.B.3:**

4. The Application for Payment form to be used on this Project is EJCDC No. C-620. The Agency must approve all Applications for Payment before payment is made.

**SGC-15.01**

**Add the following language at the end of Paragraph 15.01.B.3:**

No payments will be made that would deplete the retainage, place in escrow any funds that are required for retainage, or invest the retainage for the benefit of the Contractor.

**SGC-15.01**

**Delete Paragraph 15.01.D.1 in its entirety and insert the following in its place:**

The Application for Payment with Engineer’s recommendations will be presented to the Owner and Agency for consideration. If both Owner and Agency find the Application for Payment acceptable, the recommended amount less any reduction under the provisions of Paragraph 15.01.E will become due twenty (20) days after the Application for Payment is presented to the Owner, and the Owner will make payment to the Contractor.

**SGC-15.02**

Amend Paragraph 15.02.A by striking out the following text: “no later than seven days after the time of payment by Owner” and inserting “no later than the time of payment by the Owner.”:

**SGC-18.11**

**Add the following new paragraph after Paragraph 18.10:**

18.11 *Tribal Sovereignty.*

- A. No provision of this Agreement will be construed by any of the signatories as abridging or debilitating any sovereign powers of the named Tribe; affecting the trust-beneficiary relationship between the Secretary of the Interior, Tribe and Indian landowner(s); or interfering with the government-to government relationship between the United States and the Tribe.

**SGC-19 Add a new Article 19, "Federal Requirements," after Article 18.****SGC-19.01****Add the following language at the beginning of Article 18 with the title "Agency Not a Party."**

- A. This Contract is expected to be funded in part with funds provided by Agency. Neither Agency, nor any of its departments, entities, or employees is a party to this Contract.

**SGC-19.02****Add the following language after Article 19.01.A with the title "Contract Approval."**

- A. Owner and Contractor will furnish Owner's attorney such evidence as required so that Owner's attorney can complete and execute the following "Certificate of Owner's Attorney" (Exhibit GC-A) before Owner submits the executed Contract Documents to Agency for approval.
- B. Concurrence by Agency in the award of the Contract is required before the Contract is effective.

**SC 19.03****Add the following language after Article 19.02.B with the title "Conflict of Interest."**

- A. Contractor may not knowingly contract with a supplier or manufacturer if the individual or entity who prepared the plans and specifications has a corporate or financial affiliation with the supplier or manufacturer. Owner's officers, employees, or agents shall not engage in the award or administration of this Contract if a conflict of interest, real or apparent, would be involved. Such a conflict would arise when: (i) the employee, officer or agent; (ii) any member of their immediate family; (iii) their partner or (iv) an organization that employs, or is about to employ, any of the above, has a financial interest in Contractor. Owner's officers, employees, or agents shall neither solicit nor accept gratuities, favors or anything of monetary value from Contractor or subcontractors.

**SC-19.04****Add the following language after Article 19.03.A with the title "Gratuities."**

- A. If Owner finds after a notice and hearing that Contractor, or any of Contractor's agents or representatives, offered or gave gratuities (in the form of entertainment, gifts, or otherwise) to any official, employee, or agent of Owner or Agency in an attempt to secure this Contract or favorable treatment in awarding, amending, or making any determinations related to the performance of this Contract, Owner may, by written notice to Contractor, terminate this Contract. Owner may also pursue other rights and remedies that the law or this Contract provides. However, the existence of the facts on which Owner bases such findings shall be an issue and may be reviewed in proceedings under the dispute resolution provisions of this Contract.
- B. In the event this Contract is terminated as provided in paragraph 19.04.A, Owner may pursue the same remedies against Contractor as it could pursue in the event of a breach of this Contract by Contractor. As a penalty, in addition to any other damages to which it

may be entitled by law, Owner may pursue exemplary damages in an amount (as determined by Owner) which shall not be less than three nor more than ten times the costs Contractor incurs in providing any such gratuities to any such officer or employee.

#### **SC-19.05**

**Add the following language after Article 19.04.B with the title “Audit and Access to Records.”**

- A. Owner, Agency, the Comptroller General of the United States, or any of their duly authorized representatives, shall have access to any books, documents, papers, and records of the Engineer which are pertinent to the Agreement, for the purpose of making audits, examinations, excerpts, and transcriptions. Engineer shall maintain all required records for three years after final payment is made and all other pending matters are closed.

#### **SC-19.06**

**Add the following language after Article 18.05.A with the title “Small, Minority and Women’s Businesses.”**

- A. If Contractor intends to let any subcontracts for a portion of the work, Contractor shall take affirmative steps to assure that small, minority and women’s businesses are used when possible as sources of supplies, equipment, construction, and services. Affirmative steps shall consist of: (1) including qualified small, minority and women’s businesses on solicitation lists; (2) assuring that small, minority and women’s businesses are solicited whenever they are potential sources; (3) dividing total requirements when economically feasible, into small tasks or quantities to permit maximum participation of small, minority, and women’s businesses; (4) establishing delivery schedules, where the requirements of the work permit, which will encourage participation by small, minority and women’s businesses; (5) using the services and assistance of the Small Business Administration and the Minority Business Development Agency of the U.S. Department of Commerce; (6) requiring each party to a subcontract to take the affirmative steps of this section; and (7) Contractor is encouraged to procure goods and services from labor surplus area firms.

**SGC-19.07 Add the following after Article 19.06.A with the title “Anti-Kickback.”**

- A. Contractor shall comply with the Copeland Anti-Kickback Act (18 USC 874 and 40 USC 276c) as supplemented by Department of Labor regulations (29 CFR Part 3, “Contractors and Subcontractors on Public Buildings or Public Works Financed in Whole or in Part by Loans or Grants of the United States”). The Act provides that Contractor or subcontractor shall be prohibited from inducing, by any means, any person employed in the construction, completion, or repair of public facilities, to give up any part of the compensation to which they are otherwise entitled. Owner shall report all suspected or reported violations to Agency.

#### **SGC-19.08**

**Add the following after Article 19.07.A with the title “Clean Air and Pollution Control Acts.”**

- A. If this Contract exceeds \$100,000, Compliance with all applicable standards, orders, or requirements issued under section 306 of the Clean Air Act (42 U.S.C. 1857(h) and 42 USC 7401et. seq.), section 508 of the Clean Water Act (33 U.S.C. 1368) and Federal Water Pollution Control Act (33 USC 1251 et seq.), Executive Order 11738, and

Environmental Protection Agency regulations (40 CFR part 15) is required. Contractor will report violations to the Agency and the Regional Office of the EPA.

#### **SGC-19.09**

##### **Add the following after Article 19.08 with the title "State Energy Policy."**

- A. Contractor shall comply with the Energy Policy and Conservation Act (P.L. 94-163). Mandatory standards and policies relating to energy efficiency, contained in any applicable State Energy Conservation Plan, shall be utilized.

#### SGC-19.10 Add the following after Article 19.09 with the title "Equal Opportunity Requirements."

- A. If this Contract exceeds \$10,000, Contractor shall comply with Executive Order 11246, "Equal Employment Opportunity," as amended by Executive Order 11375, "Amending Executive Order 11246 Relating to Equal Employment Opportunity," and as supplemented by regulations at 41 CFR part 60, "Office of Federal Contract Compliance Programs, Equal Employment Opportunity, Department of Labor."
- B. Contractor's compliance with Executive Order 11246 shall be based on its implementation of the Equal Opportunity Clause, specific affirmative active obligations required by the Standard Federal Equal Employment Opportunity Construction Contract Specifications, as set forth in 41 CFR Part 60-4 and its efforts to meet the goals established for the geographical area where the Contract is to be performed. The hours of minority and female employment and training must be substantially uniform throughout the length of the Contract, and in each trade, and Contractor shall make a good faith effort to employ minorities and women evenly on each of its projects. The transfer of minority or female employees or trainees from Contractor to Contractor or from project to project for the sole purpose of meeting Contractor's goals shall be a violation of the Contract, the Executive Order, and the regulations in 41 CFR Part 60-4. Compliance with the goals will be measured against the total work hours performed.
- C. Contractor shall provide written notification to the Director of the Office of Federal Contract Compliance Programs within 10 working days of award of any construction subcontract in excess of \$10,000 at any tier for construction work under the Contract resulting from this solicitation. The notification shall list the name, address, and telephone number of the subcontractor; employer identification number; estimated dollar amount of subcontract; estimated starting and completion dates of the subcontract; and the geographical area in which the Contract is to be performed.

#### **SGC-19.11**

##### **Add the following after Article 19.10.C:**

##### **19.11 *Restrictions on Lobbying.***

- A. Contractor and each subcontractor shall comply with Restrictions on Lobbying (Public Law 101-121, Section 319) as supplemented by applicable Agency regulations. This Law applies to the recipients of contracts and subcontracts that exceed \$100,000 at any tier under a Federal loan that exceeds \$150,000 or a Federal grant that exceeds \$100,000. If applicable, Contractor must complete a certification form on lobbying activities related to a specific Federal loan or grant that is a funding source for this Contract. Each tier certifies to the tier above that it will not and has not used Federal appropriated funds to pay any person or organization for influencing or attempting to influence an officer or employee of

any agency, a member of Congress, or an employee of a member of Congress in connection with obtaining any Federal contract, grant, or any other award covered by 31 USC 1352. Each tier shall disclose any lobbying with non-Federal funds that takes place in connection with obtaining any Federal award. Certifications and disclosures are forwarded from tier to tier up to the Owner. Necessary certification and disclosure forms shall be provided by Owner.

#### **SGC-19.12**

##### **Add the following after Article 19.11.A :**

##### **19.12 *Environmental Requirements.***

When constructing a project involving trenching and/or other related earth excavations, Contractor shall comply with the following environmental constraints:

- A. Wetlands – When disposing of excess, spoil, or other construction materials on public or private property, Contractor shall not fill in or otherwise convert wetlands.
- B. Floodplains – When disposing of excess, spoil, or other construction materials on public or private property, Contractor shall not fill in or otherwise convert 100 year floodplain areas delineated on the latest Federal Emergency Management Agency Floodplain Maps, or other appropriate maps, i.e., alluvial soils on NRCS Soil Survey Maps.
- C. Historic Preservation – Any excavation by Contractor that uncovers an historical or archaeological artifact shall be immediately reported to Owner and a representative of Agency. Construction shall be temporarily halted pending the notification process and further directions issued by Agency after consultation with the State Historic Preservation Officer (SHPO).
- D. Endangered Species – Contractor shall comply with the Endangered Species Act, which provides for the protection of endangered and/or threatened species and critical habitat. Should any evidence of the presence of endangered and/or threatened species or their critical habitat be brought to the attention of Contractor, Contractor will immediately report this evidence to Owner and a representative of Agency. Construction shall be temporarily halted pending the notification process and further directions issued by Agency after consultation with the U.S. Fish and Wildlife Service.
- E. Mitigation Measures – If the project had an Environmental Report, Environmental Assessment, or Environmental Impact Statement to meet the requirements of the National Environmental Policy Act, compliance with the mitigation measures, if any, in that document are hereby included as a condition of this contract.

**SUPPLEMENTAL GENERAL CONDITIONS**

**FOR**

**CLEAN WATER STATE REVOLVING FUND**

**DRINKING WATER STATE REVOLVING FUND**

**(Drinking Water and Wastewater)**

**Project Name: Grayson County Water District – East-West Interconnect Phase 2 – Contract No. 6 – Water Main Extensions**

**Project Number: \_\_\_\_\_**

The attached instructions and regulations as listed below shall be incorporated into the Specifications and comprise Special Conditions.

	<u>Attachment No.</u>
<b>SRF Special Provisions</b>	<b>1</b>
<b>KRS Chapter 45A Kentucky Model Procurement Code</b>	<b>2</b>
<b>Equal Employment Opportunity (EEO) Documents:</b>	
<b>Notice of Requirement for Affirmative Action</b>	<b>3</b>
<b>Construction Contract Specifications</b>	<b>4</b>
<b>EEO Goals for Region 4 Economic Areas</b>	<b>5</b>
<b>Check List of EEO Documentation for Bidders</b>	<b>6</b>
<b>Employer Information Report EEO-1 (SF 100)</b>	<b>7</b>
<b>Labor Standards Provisions for Federally Assisted Construction</b>	<b>8</b>
<b>Certifications:</b>	
<b>Debarment, Suspension and Other Responsibility Matters</b>	<b>9</b>
<b>Anti-lobbying</b>	<b>10</b>
<b>Disadvantaged Business Enterprise (DBE) Program</b>	<b>11</b>
<b>Bonds and Insurance</b>	<b>12</b>
<b>Storm Water General Permit</b>	<b>13</b>
<b>Davis-Bacon Wage Rate Requirements</b>	<b>14</b>
<b>American Iron and Steel Requirement</b>	<b>15</b>

**SRF SPECIAL PROVISIONS**

- (a) Line crossings of all roads and streets shall be done in accordance with the Kentucky Transportation Cabinet requirements as may be set forth in the Special Conditions.
- (b) Construction is to be carried out so as to prevent by-passing of flows during construction unless a schedule has been approved by the State or EPA, whichever is applicable. Siltation and soil erosion must be minimized during construction. All construction projects with surface disturbance of more than 1 acre during the period of construction must have a KPDES Storm Water General Permit. The permit can be found at this [webpage](#).  
  
If you have any questions regarding the completion of this form call the Surface Water Permits Branch at (502) 564-3410.
- (c) Restore disturbed areas to original or better condition.
- (d) **Use of Chemicals:** All chemicals used during project construction or furnished for project operation, whether herbicide, pesticide, disinfectant, polymer, reactant or of other classification, must show approval of either DOW or EPA. Use of all such chemicals and disposal of residues shall be in conformance with instructions on the manufacturer's label.
- (e) The construction of the project, including the letting of contracts in connection therewith, shall conform to the applicable requirements of state, territorial, and local laws and ordinances to the extent that such requirements do not conflict with Federal laws and this subchapter.
- (f) The owner shall provide and maintain competent and adequate supervision and inspection.
- (g) The Kentucky Infrastructure Authority and Kentucky Division of Water shall have access to the site and the project work at all times.
- (h) In the event Archaeological materials (arrowheads, stone tools, stone axes, prehistoric and historic pottery, bottles, foundations, Civil War artifacts, and other types of artifacts) are uncovered during the construction of this project, work is to immediately cease at the location and the Kentucky Heritage Council shall be contacted. The telephone number is (502) 564-7005. Construction shall commence at this location until a written release is received from the Kentucky Heritage Council. Failure to report a find could result in legal action.
- (i) This procurement will be subject to DOW Procurement Guidance including the Davis-Bacon Act.
- (j) Reasonable care shall be taken during construction to avoid damage to vegetation. Ornamental shrubbery and tree branches shall be temporarily tied back, where appropriate, to minimize damage. Trees which receive damage to branches shall be trimmed of those branches to improve the appearance of the tree. Tree trunks receiving damage from equipment shall be treated with a tree dressing.
- (k) No wastewater bypassing will occur during construction unless a schedule has been approved by the Kentucky Division of Water.
- (l) Change orders to the construction contract (if required) must be negotiated pursuant to DOW/KIA Procurement Guidance for Construction and Equipment Contracts.



**KRS CHAPTER 45A  
KENTUCKY MODEL PROCUREMENT CODE**

**45A.075 Methods of awarding state contracts.**

Except as otherwise authorized by law, all state contracts shall be awarded by:

- (1) Competitive sealed bidding, pursuant to KRS 45A.080; or
- (2) Competitive negotiation, pursuant to KRS 45A.085 and 45A.090 or 45A.180; or
- (3) Noncompetitive negotiation, pursuant to KRS 45A.095; or
- (4) Small purchase procedures, pursuant to KRS 45A.100.

**Effective:** June 24, 2003

**History:** Amended 2003 Ky. Acts ch. 98, sec. 4, effective June 24, 2003. -- Created 1978 Ky. Acts ch. 110, sec. 16, effective January 1, 1979.

**45A.080 Competitive sealed bidding.**

(1) Contracts exceeding the amount provided by KRS 45A.100 shall be awarded by competitive sealed bidding, which may include the use of a reverse auction, unless it is determined in writing that this method is not practicable. Factors to be considered in determining whether competitive sealed bidding is not practicable shall include:

- (a) Whether specifications can be prepared that permit award on the basis of best value; and
- (b) The available sources, the time and place of performance, and other relevant circumstances as are appropriate for the use of competitive sealed bidding.

(2) The invitation for bids shall state that awards shall be made on the basis of best value. In any contract which is awarded under an invitation to bid which requires delivery by a specified date and imposes a penalty for late delivery, if the delivery is late, the contractor shall be given the opportunity to present evidence that the cause of the delay was beyond his control. If it is the opinion of the purchasing officer that there is sufficient justification for delayed delivery, the purchasing officer may adjust or waive any penalty that is provided for in the contract.

(3) Adequate public notice of the invitation for bids and any reverse auction shall be given a sufficient time prior to the date set forth for the opening of bids or beginning of the reverse auction. The notice may include posting on the Internet or publication in a newspaper or newspapers of general circulation in the state as determined by the secretary of the Finance and Administration Cabinet not less than seven (7) days before the date set for the opening of the bids and any reverse auction. The provisions of this subsection shall also apply to price contracts and purchase contracts of state institutions of higher education.

(4) Bids shall be opened publicly or entered through a reverse auction at the time and place designated in the invitation for bids. At the time the bids are opened, or the reverse auction has ended, the purchasing agency shall announce the agency's engineer's estimate, if applicable, and make it a part of the agency records pertaining to the letting of any contract for which bids were received. Each written or reverse auction bid, together with the name of the bidder and the agency's engineer's estimate, shall be recorded and be open to public inspection. Electronic bid opening and posting of the required information for public viewing shall satisfy the requirements of this subsection.

(5) The contract shall be awarded by written notice to the responsive and responsible bidder whose bid offers the best value.

(6) Correction or withdrawal of written or reverse auction bids shall be allowed only to the extent permitted by regulations issued by the secretary.

**Effective:** July 15, 2010

**History:** Amended 2010 Ky. Acts ch. 63, sec. 3, effective July 15, 2010. -- Amended 2000 Ky. Acts ch. 509, sec. 1, effective July 14, 2000. -- Amended 1998 Ky. Acts ch. 120, sec. 10, effective July 15, 1998. -- Amended 1997 (1<sup>st</sup> Extra. Sess.) Ky. Acts ch. 4, sec. 27, effective May 30, 1997. -- Amended 1996 Ky. Acts ch. 60, sec. 2, effective July 15, 1996. -- Amended 1994 Ky. Acts ch. 278, sec. 1, effective July 15, 1994. -- Amended 1982 Ky. Acts ch. 282, sec. 1, effective July 15, 1982. -- Amended 1979 (1<sup>st</sup> Extra. Sess.) Ky. Acts ch. 9, sec. 1, effective February 10, 1979. -- Created 1978 Ky. Acts ch. 110, sec. 17, effective January 1, 1979.

#### **45A.085 Competitive negotiation.**

(1) When, under administrative regulations promulgated by the secretary or under KRS 45A.180, the purchasing officer determines in writing that the use of competitive sealed bidding is not practicable, and except as provided in KRS 45A.095 and 45A.100, a contract may be awarded by competitive negotiation, which may include the use of a reverse auction.

(2) Adequate public notice of the request for proposals and any reverse auction shall be given in the same manner and circumstances as provided in KRS 45A.080(3).

(3) Contracts other than contracts for projects utilizing an alternative project delivery method under KRS 45A.180 may be competitively negotiated when it is determined in writing by the purchasing officer that the bids received by competitive sealed bidding either are unreasonable as to all or part of the requirements, or were not independently reached in open competition, and for which each competitive bidder has been notified of the intention to negotiate and is given reasonable opportunity to negotiate.

(4) Contracts for projects utilizing an alternative project delivery method shall be processed in accordance with KRS 45A.180.

(5) The request for proposals shall indicate the relative importance of price and other evaluation factors, and any reverse auction procedures.

(6) Award shall be made to the responsible and responsive offeror whose proposal is determined in writing to be the most advantageous to the Commonwealth, taking into consideration price and the evaluation factors set forth in the request for proposals and the reciprocal preference for resident bidders required under KRS 45A.494.

(7) Written or oral discussions shall be conducted with all responsible offerors who submit proposals determined in writing to be reasonably susceptible of being selected for award. Discussions shall not disclose any information derived from proposals submitted by competing offerors. Discussions need not be conducted:

(a) With respect to prices, where the prices are fixed by law, reverse auction, or administrative regulation, except that consideration shall be given to competitive terms and conditions;

(b) Where time of delivery or performance will not permit discussions; or

(c) Where it can be clearly demonstrated and documented from the existence of adequate competition or prior experience with the particular supply, service, or construction item, that acceptance of an initial offer without discussion would result in fair and reasonable best value procurement, and the request for proposals notifies all offerors of the possibility that award may be made on the basis of the initial offers.

**Effective:** July 15, 2010

**History:** Amended 2010 Ky. Acts ch. 63, sec. 4, effective July 15, 2010; and ch. 162, sec. 8, effective July 15, 2010. -- Amended 2003 Ky. Acts ch. 98, sec. 5, effective June 24, 2003. -- Amended 1997 (1<sup>st</sup> Extra. Sess.) Ky. Acts ch. 4, sec. 28, effective May 30, 1997. -- Amended 1979 (1<sup>st</sup> Extra. Sess.) Ky. Acts ch. 9, sec. 2, effective February 10, 1979. -- Created 1978 Ky. Acts ch. 110, sec. 18, effective January 1, 1979.

#### **45A.090 Negotiation after competitive sealed bidding when all bids exceed available funds.**

(1) In the event that all bids submitted pursuant to competitive sealed bidding under KRS 45A.080 result in bid prices in excess of the funds available for the purchase, and the chief purchasing officer determines in writing:

(a) That there are no additional funds available from any source so as to permit an award to the responsive and responsible bidder whose bid offers the best value; and

(b) The best interest of the state will not permit the delay attendant to a resolicitation under revised specifications, or for revised quantities, under competitive sealed bidding as provided in KRS 45A.080, then a negotiated award may be made as set forth in subsections (2) or (3) of this section.

(2) Where there is more than one (1) bidder, competitive negotiations pursuant to KRS 45A.085(3) shall be conducted with the three (3) (two (2) if there are only two (2)) bidders determined in writing to be the most responsive and responsible bidders, based on criteria contained in the bid invitation and the reciprocal preference for resident bidders under KRS 45A.494. Such competitive negotiations shall be conducted under the following restrictions:

(a) If discussions pertaining to the revision of the specifications or quantities are held with any potential offeror, all other potential offerors shall be afforded an opportunity to take part in such discussions; and

(b) A request for proposals, based upon revised specifications or quantities, shall be issued as promptly as possible, shall provide for an expeditious response to the revised requirements, and shall be awarded upon the basis of best value.

(3) Where, after competitive sealed bidding, it is determined in writing that there is only one (1) responsive and responsible bidder, a noncompetitive negotiated award may be made with such bidder in accordance with KRS 45A.095.

**Effective:** July 15, 2010

**History:** Amended 2010 Ky. Acts ch. 162, sec. 9, effective July 15, 2010. -- Amended 2003 Ky. Acts ch. 98, sec. 6, effective June 24, 2003. -- Amended 1997 (1<sup>st</sup> Extra. Sess.) Ky. Acts ch. 4, sec. 29, effective May 30, 1997. -- Created 1978 Ky. Acts ch. 110, sec. 19, effective January 1, 1979.

#### **45A.095 Noncompetitive negotiation.**

(1) A contract may be made by noncompetitive negotiation only for sole source purchases, or when competition is not feasible, as determined by the purchasing officer in writing prior to award, under administrative regulations promulgated by the secretary of the Finance and Administration Cabinet or the governing boards of universities operating under KRS Chapter 164A, or when emergency conditions exist. Sole source is a situation in which there is only one (1) known capable supplier of a commodity or service, occasioned by the unique nature of the requirement, the supplier, or market conditions. Insofar as it is practical, no less than three (3) suppliers shall be solicited to submit written or oral quotations whenever it is determined that competitive sealed bidding is not feasible. Award shall be made to the supplier offering the best value. The names of the suppliers submitting quotations and the date and amount of each quotation shall be placed in the procurement file and maintained as a public record.

Competitive bids may not be required:

(a) For contractual services where no competition exists, such as telephone service, electrical energy, and other public utility services;

(b) Where rates are fixed by law or ordinance;

(c) For library books;

(d) For commercial items that are purchased for resale;

(e) For interests in real property;

(f) For visiting speakers, professors, expert witnesses, and performing artists;

(g) For personal service contracts executed pursuant to KRS 45A.690 to 45A.725; and

(h) For agricultural products in accordance with KRS 45A.645.

(2) The chief procurement officer, the head of a using agency, or a person authorized in writing as the designee of either officer may make or authorize others to make emergency procurements when an emergency condition exists.

(3) An emergency condition is a situation which creates a threat or impending threat to public health, welfare, or safety such as may arise by reason of fires, floods, tornadoes, other natural or man-caused disasters, epidemics, riots, enemy attack, sabotage, explosion, power failure, energy shortages, transportation emergencies, equipment failures, state or federal legislative mandates, or similar events. The existence of the emergency condition creates an immediate and serious need for services, construction, or items of tangible personal property that cannot be met through normal procurement methods and the lack of which would seriously threaten the functioning of government, the preservation or protection of property, or the health or safety of any person.

(4) The Finance and Administration Cabinet may negotiate directly for the purchase of contractual services, supplies, materials, or equipment in bona fide emergencies regardless of estimated costs. The existence of the emergency shall be fully explained, in writing, by the head of the agency for which the purchase is to be made. The explanation shall be approved by the secretary of the Finance and Administration Cabinet and shall include the name of the vendor receiving the contract along with any other price quotations and a written determination for selection of the vendor receiving the contract. This information shall be filed with the record of all such purchases and made available to the public. Where practical, standard specifications shall be followed in making emergency purchases. In any event, every effort should be made to effect a competitively established price for purchases made by the state.

**Effective:** July 15, 2002

**History:** Amended 2002 Ky. Acts ch. 344, sec. 9, effective July 15, 2002. -- Amended 1997 (1<sup>st</sup> Extra. Sess.) Ky. Acts ch. 4, sec. 30, effective May 30, 1997. -- Amended 1990 Ky. Acts ch. 496, sec. 4, effective July 13, 1990. -- Created 1978 Ky. Acts ch. 110, sec. 20, effective January 1, 1979

**45A.100 Small purchases by state governmental bodies.**

(1) Procurements may be made in accordance with small purchase administrative regulations promulgated by the secretary of the Finance and Administration Cabinet, pursuant to KRS Chapter 13A, as follows:

(a) Up to ten thousand dollars (\$10,000) per project for construction and one thousand dollars (\$1,000) for purchases by any state governmental body, except for those state administrative bodies specified in paragraph (b) of this subsection; and

(b) Up to forty thousand dollars (\$40,000) per project for construction or purchases by the Finance and Administration Cabinet, state institutions of higher education, and the legislative branch of government.

(2) Procurement requirements shall not be artificially divided so as to constitute a small purchase under this section. Reverse auctions may be used for small purchase procurements. At least every two (2) years, the secretary shall review the prevailing costs of labor and materials and may make recommendations to the next regular session of the General Assembly for the revision of the then current maximum small purchase amount as justified by intervening changes in the cost of labor and materials.

(3) The secretary of the Finance and Administration Cabinet may grant to any state agency with a justifiable need a delegation of small purchasing authority which exceeds the agency's small purchase limit provided in subsection (1) of this section. Delegations of small purchasing authority shall be granted or revoked by the secretary of the Finance and Administration Cabinet, in accordance with administrative regulations promulgated by the cabinet pursuant to KRS Chapter 13A. These administrative regulations shall establish, at a minimum, the criteria for granting and revoking delegations of small purchasing authority, including the requesting agency's past compliance with purchasing regulations, the level of training of the agency's purchasing staff, and the extent to which the agency utilizes the Kentucky Automated Purchasing System. The administrative regulations may permit the secretary of the Finance and Administration Cabinet to delegate small purchase procurements up to the maximum amount specified in subsection (1)(b) of this section.

**Effective:** July 15, 2010

**History:** Amended 2010 Ky. Acts ch. 63, sec. 5, effective July 15, 2010. -- Amended 2002 Ky. Acts ch. 320, sec. 2, effective July 15, 2002. -- Amended 2000 Ky. Acts ch. 225, sec. 1, effective July 14, 2000. -- Amended 1996 Ky. Acts ch. 60, sec. 1, effective July 15, 1996. -- Amended 1994 Ky. Acts ch. 323, sec. 1, effective July 15, 1994. -- Amended 1990 Ky. Acts ch. 496, sec. 5, effective July 13, 1990. -- Amended 1986 Ky. Acts ch. 384, sec. 1, effective July 15, 1986. -- Amended 1984 Ky. Acts ch. 384, sec. 1, effective July 13, 1984. -- Amended 1982 Ky. Acts ch. 282, sec. 2, effective July 15, 1982. -- Amended 1980 Ky. Acts ch. 242, sec. 1, effective July 15, 1980; and ch. 250, sec. 19, effective April 9, 1980. -- Created 1978 Ky. Acts ch. 110, sec. 21, effective January 1, 1979.

**NOTICE OF REQUIREMENT FOR AFFIRMATIVE ACTION TO ENSURE EQUAL EMPLOYMENT OPPORTUNITY (EXECUTIVE ORDER 11246)**

The following excerpts are from 45 FR 65984 (October 3, 1980):

The minority and female goals apply to Federal and federally assisted construction contractors and subcontractors which have covered contracts. The goals are expressed as a percentage of the total hours worked by such a covered or subcontractor's entire onsite construction workforce, which is working on any construction site within a relevant area. The goal applies to each construction craft and trade in the contractor's entire workforce in the relevant area including those employees working on private non-federally involved projects.

Until further notice, the following goals for minority utilization in each construction craft and trade shall be included in all Federal or federally assisted construction contracts and subcontracts in excess of \$10,000 to be performed in the respective geographic area. The goals are applicable to each nonexempt contractor's total onsite construction workforce, regardless of whether or not part of that workforce is performing work on a Federal, federally assisted or non-federally related project, contract or subcontract.

Construction contractors which are participating in an approved Hometown Plan (see 41 CFR 60-4.5) are required to comply with the goals of the Hometown Plan with regard to construction work they perform in the area covered by the Hometown Plan. With regard to all their other covered construction work, such contractors are required to comply as follows:

- Goals for female participation in each trade.....6.9%
- Goals for minority participation in each trade.....Insert goals for each year  
(see Attachment Number 5)

These goals are applicable to all the Contractor's construction work (whether or not it is Federal or Federally assisted) performed in the covered area.

The following excerpts are from 45 FR 65977 (October 3, 1980):

The Contractor's compliance with the Executive Order and the regulations in 41 CFR Part 60-4 shall be based on its implementation of the Equal Opportunity Clause, specific affirmative action obligations required by the specifications set forth in 41 CFR 60-4.3(a), and its efforts to meet the goals established for the geographical area where the contract resulting from this solicitation is to be performed. The hours of minority and female employment and training must be substantially uniform throughout the length of the contract, and in each trade, and the contractor shall make a good faith effort to employ minorities and women evenly on each of its projects. The transfer of minority or female employees or trainees from Contractor to Contractor or from project to project for the sole purpose of meeting the Contractor's goals shall be a violation of the contract, the Executive Order and the regulations in 41 CFR Part 60-4. Compliance with the goals will be measured against the total work hours performed.

The Contractor shall provide written notification to the Director of the Office of Federal Contract Compliance Programs within 10 working days of award of any construction subcontract in excess of \$10,000 at any tier for construction work under the contract resulting from this solicitation. The notification shall list the name, address and telephone number of the subcontractor; employer identification number; estimated dollar amount of the subcontract; estimated starting and completion dates of the subcontract; and the geographical area in which the contract is to be performed.

As used in this Notice, and in the contract resulting from this solicitation, the covered area is (insert description of the geographical areas where the contract is to be performed giving the state, country, and city, if any).

**STANDARD FEDERAL EQUAL EMPLOYMENT OPPORTUNITY  
CONSTRUCTION CONTRACT SPECIFICATIONS (EXECUTIVE ORDER 11246)**

EEO Specifications

Following is the standard language, which must be incorporated into all solicitations for offers and bids on all Federal and Federally assisted construction contracts or subcontracts in excess of \$10,000 to be performed in designated geographical areas:

1. As used in these specifications:
  - (a) Covered Area means the geographical area described in the solicitation from which this contract resulted.
  - (b) Director means Director, Office of Federal Contract Compliance Program, United States Department of Labor, or any person to whom the Director delegates authority;
  - (c) Employer identification number means the Federal Social Security number used on the Employer's Quarterly Federal Tax Return, U.S. Treasury Department Form 941.
  - (d) Minority includes:
    - (i) Black (all persons having origins in any of the Black African racial groups not of Hispanic origin);
    - (ii) Hispanic (all persons of Mexican, Puerto Rican, Cuban, Central or South American or other Spanish Culture or origin, regardless of race);
    - (iii) Asian and Pacific Islander (all persons having origins in any of the original peoples of the Far East, Southeast Asia, the Indian Subcontinent, or the Pacific Islands); and
    - (iv) American Indian or Alaskan Native (all persons having origins in any of the original peoples of North America and maintaining identifiable tribal affiliations through membership and participation or community identification).
2. Whenever the Contractor or any Subcontractor at any tier, subcontracts a portion of the work involving any construction trade, it shall physically include in each subcontract in excess of \$10,000 the provisions of these specifications and the Notice which contains the applicable goals for minority and female participation and which is set forth in the solicitations from which this contract resulted.
3. If the Contractor is participating (pursuant to 41 CFR 60-4.5) in a Hometown Plan approved by the U.S. Department of Labor in the covered area either individually or through an association, its affirmative action obligations on all work in the Plan area (including goals and timetables) shall be in accordance with that Plan for those trades which have unions participating in the Plan. Contractors must be able to demonstrate their participation in and compliance with the provisions of any such Hometown Plan. Each Contractor or Subcontractor participating in an approved Plan is individually required to comply with its obligations under the EEO clause, and to make a good faith effort to achieve each goal under the Plan in each trade in which it has employees. The overall good faith performance by other Contractors or Subcontractors toward a goal in an approved Plan does not excuse any covered Contractor's or Subcontractor's failure to take a good faith efforts to achieve the Plan goals and timetables.

4. The Contractor shall implement the specific affirmative action standards provided in paragraphs 7-a through p of these specifications. The goals set forth in the solicitation from which this contract resulted are expressed as percentages of the total hours of employment and training of minority and female utilization the Contractor should reasonably be able to achieve in each construction trade in which it has employees in the covered area. The Contractor is expected to make substantially uniform progress toward its goals in each craft during the period specified.
5. Neither the provisions of any collective bargaining agreement, nor the failure by a union with whom the Contractor has a collective bargaining agreement, to refer either minorities or women shall excuse the Contractor's obligations under these specifications, Executive Order 11246, or the regulations promulgated pursuant thereto.
6. In order for the non-working training hours of apprentices and trainees to be counted in meeting the goals, such apprentices and trainees must be employed by the contractor during the training period, and the Contractor must have made a commitment to employ the apprentices and trainees at the completion of their training, subject to the availability of employment opportunities. Trainees must be trained pursuant to training programs approved by the U.S. Department of Labor.
7. The Contractor shall take specific affirmative action to ensure equal employment opportunity. The evaluation of the Contractor's compliance with these specifications shall be based upon its effort to achieve maximum results from its actions. The Contractor shall document these efforts fully, and shall implement affirmative action steps at least as extensively as the following:
  - a. Ensure and maintain a working environment free of harassment, intimidation, and coercion at all sites, and in all facilities at which the contractor's employees are assigned to work. The Contractor, where possible, will assign two or more women to each construction project. The Contractor shall specifically ensure that all foremen, superintendents, and other on-site supervisory personnel are aware of and carry out the Contractor's obligation to maintain such a working environment, with specific attention to minority or female individuals working at such sites or in such facilities.
  - b. Establish and maintain a current list of minority and female recruitment sources, provide written notification to minority and female recruitment sources and to community organizations when the contractor or its unions have employment opportunities available, and maintain a record of the organizations responses.
  - c. Maintain a current file of the names, addresses and telephone numbers of each minority and female off-the-street applicant and minority or female referral from a union, a recruitment source or community organization and of what action was taken with respect to each such individual. If such individual was sent to the union hiring hall for referral and was not referred back to the Contractor by the union or, if referred, not employed by the contractor, this shall be documented in the file with the reason therefore, along with whatever additional actions the contractor may have taken.
  - d. Provide immediate written notification to the Director when the union or unions with which the Contractor has a collective bargaining agreement has not referred to the Contractor a minority person or woman sent by the Contractor, or when the Contractor has other information that the union referral process has impeded the Contractor's efforts to meet its obligation.
  - e. Develop on-the-job training opportunities and/or participate in training programs for the area which expressly include minorities and women, including upgrading programs and apprenticeship and trainee programs relevant to the Contractor's employment needs, especially those programs funded or approved by the Department of Labor. The Contractor shall provide notice of these programs to the sources complied under 7-b above.

- f. Disseminate the Contractor's EEO policy by providing notice of the policy to unions and training programs and requesting their cooperation in assisting the Contractor in meeting its EEO obligations; by including it in any policy manual and collective bargaining agreement; by publicizing it in the company newspaper, annual report, etc.; by specific review of the policy with all management personnel and with all minority and female employees at least once a year; and by posting the company EEO policy on bulletin boards accessible to all employees at each location where construction work is performed.
- g. Review, at least annually, the company's EEO policy and affirmative action obligations under these specifications with all employees having any responsibility for hiring, assignment, lay-off, termination or other employment decisions including specific review of these items with on-site supervisory personnel such as Superintendents, General Foreman, etc., prior to the initiation of construction work at any job site. A written record shall be made and maintained identifying the time and place of these meetings, persons attending, subject matter discussed, and disposition of the subject matter.
- h. Disseminate the Contractor's EEO policy externally by including it in any advertising in the news media, specifically including minority and female news media, and providing written notification to and discussing the Contractor's EEO policy with other Contractors and Subcontractors with whom the Contractor does or anticipates doing business.
- i. Direct its recruitment efforts, both oral and written, to minority, female and community organizations, to schools with minority and female students and to minority and female recruitment and training organizations serving the Contractor's recruitment area and employment needs. Not later than one month prior to the date for the acceptance of applications for apprenticeship or other training by any recruitment source, the contractor shall send written notification to organizations such as the above, describing the openings, screening procedures, and tests to be used in the selection process.
- j. Encourage present minority and female employees to recruit other minority persons and women and, where reasonable, provide after school, summer and vacation employment to minority and female youth both on the site and in other areas of a Contractor's workforce.
- k. Validate all tests and other selection requirements where there is an obligation to do so under 41 CFR Part 60-3.
- l. Conduct, at least annually, an inventory and evaluation of all minority and female personnel for promotional opportunities and encourage these employees to seek or to prepare for, through appropriate training, etc., such opportunities.
- m. Ensure that seniority practices, job classifications, work assignments and other personnel practices, do not have a discriminatory effect by continually monitoring all personnel and employment related activities to ensure that EEO policy and the Contractor's obligations under these specifications are being carried out.
- n. Ensure that all facilities and company activities are nonsegregated except that separate or single-user toilet and necessary changing facilities shall be provided to assure privacy between the sexes.
- o. Document and maintain a record of all solicitations of offers for subcontracts from minority and female construction contractors and suppliers, including circulation of solicitations to minority and female contractor associations and other business associations.
- p. Conduct a review, at least annually, of all supervisor's adherence to and performance under the Contractor's EEO policies and affirmative action obligations.



8. Contractors are encouraged to participate in voluntary associations, which assist in fulfilling one or more of their affirmative actions obligations (7 a through p). The efforts of a contractor association, joint contractor-union, contractor-community, or other similar group of which the contractor is a member and participant may be asserted as fulfilling any one or more of its obligations under 7 a through p of these specifications provided that the contractor actively participates in the group, makes every effort to assure that the group has a positive impact on the employment of minorities and women in the industry, ensures that the concrete benefits of the program are reflected in the Contractor's minority and female workforce participation, makes a good faith effort to meet its individual goals and timetables, and can provide access to documentation which demonstrates the effectiveness of actions taken on behalf of the Contractor. The obligation to comply, however, is the Contractor's and failure of such a group to fulfill an obligation shall not be defense for the Contractor's noncompliance.
9. A single goal for minorities and a separate single goal for women have been established. The contractor, however, is required to provide equal employment opportunity and to take affirmative action for all minority groups, both male and female, and all women, both minority and non-minority. Consequently, the Contractor may be in violation of the Executive Order if a particular group is employed in a substantially disparate manner (for example: even though the Contractor has achieved its goal for women generally, the Contractor may be in violation of the Executive Order if a specific minority group of women is underutilized).
10. The Contractor shall not use the goals and timetables for affirmative action standards to discriminate against any person because of race, color, religion, sex or national origin.
11. The Contractor shall not enter into any Subcontract with any person or firm debarred from Government contracts pursuant to Executive Order 11246.
12. The Contractor shall carry out such sanctions and penalties for violation of these specifications and of the Equal Opportunity Clause, including suspension, termination and cancellation of existing subcontracts as may be imposed or ordered pursuant to Executive Order 11246, as amended, and its implementing regulations, by the Office of Federal Contract Compliance Programs. Any Contractor who fails to carry out such sanctions and penalties shall be in violation of these specifications and executive Order 11246, as amended.
13. The Contractor, in fulfilling its obligations under these specifications, shall implement specific affirmative action steps, at least as extensive as those standards prescribed in paragraph 7 of these specifications, so as to achieve maximum results from its efforts to ensure equal employment opportunity. If the Contractor fails to comply with the requirements of the Executive Order, the implementing regulations, or these specifications, the Director shall proceed in accordance with 41 CFR 60-4.8.
14. The Contractor shall designate a responsible official to monitor all employment related activity to ensure that the company EEO policy is being carried out, to submit reports relating to the provisions hereof as may be required by the Government and to keep records. Records shall at least include for each employee the name, address, telephone numbers, construction trade, union affiliation, if any, employee identification number when assigned, social security number, race, sex, status (e.g., mechanic, apprentice, trainee, helper or laborer), dates of changes in status, hours worked per week in the indicated trade, rate of pay, and locations at which the work was performed. Records shall be maintained in an easily understandable and retrievable form; however, to the degree that existing records satisfy this requirement, contractors shall not be required to maintain separate records.
15. Nothing herein provided shall be construed as a limitation upon the application of other laws which establish different standards of compliance or upon the application of requirements for the hiring of local or other area residents (e.g., those under the Public Works Employment Act of 1977 and the Community Development Block Grant Program).

**EEO GOALS FOR ECONOMIC AREAS IN REGION 4  
SOURCE: APPENDIX B-80 IN 45 FR 65984 (OCTOBER 3, 1980)**

**Kentucky:**

053 Knoxville, TN	
SMSA Counties:	
3840 Knoxville, TN.....	6.6
TN Anderson; TN Blount; TN Knox; TN Union.	
Non-SMSA Counties .....	4.5
KY Bell; KY Harlan; KY Knox; KY Laurel; KY McCreary; KY Wayne; KY	
Whitley; TN Campbell; TN Claiborne; TN Cocke; TN Cumberland; TN Fentress;	
TN Grainger, TN Hamblen; TN Jefferson; TN Loudon; TN Morgan; TN Roane;	
TN Scott; TN Sevier.	
054 Nashville, TN:	
SMSA Counties:	
1660 Clarksville - Hopkinsville, TN - KY .....	18.2
KY Christian; TN Montgomery.	
5360 Nashville - Davidson, TN.....	15.8
TN Cheatham, TN Davidson; TN Dickson; TN Robertson; TN Rutherford; TN	
Sumner; TN Williamson; TN Wilson.	
Non-SMSA Counties .....	12.0
KY Allen; KY Barren; KY Butler; KY Clinton; KY Cumberland; KY Edmonson;	
KY Logan; KY Metcalfe; KY Monroe; KY Simpson; KY Todd; KY Trigg; KY	
Warren; TN Bedford; TN Cannon; TN Clay; TN Coffee; TN DeKalb; TN Franklin;	
TN Giles; TN Hickman; TN Houston; TN Humphreys; TN Jackson; TN Lawrence;	
TN Lewis; TN Macon; TN Marshall; TN Maury; TN Moore; TN Overton; TN	
Perry; TN Pickett; TN Putnam; TN Smith; TN Stewart; TN Trousdale; TN Van	
Buren; TN Warren; TN Wayne; TN White.	
056 Paducah, KY:	
Non-SMSA Counties .....	5.2
IL Hardin; IL Massac; IL Pope; KY Ballard; KY Caldwell; KY Calloway. KY	
Carlisle; KY Crittenden; KY Fulton; KY Graves; KY Hickman; KY Livingston;	
KY Lyon. KY McCracken; KY Marshall.	
057 Louisville, KY:	
SMSA Counties:	
4520 Louisville, KY-IN .....	11.2
IN Clark; IN Floyd; KY Bullitt; KY Jefferson; KY Oldham.	
Non-SMSA Counties .....	9.6
IN Crawford; IN Harrison; IN Jefferson; IN Orange; IN Scott; IN Washington; KY	
Breckinridge; KY Grayson; KY Hardin; KY Hart; KY Henry; KY Larue; KY	
Marion; KY Meade; KY Nelson; KY Shelby; KY Spencer; KY Trimble; KY	
Washington.	

058 Lexington, KY	
SMSA Counties	
4280 Lexington-Fayette, KY .....	10.8
KY Bourbon; KY Clark; KY Fayette; KY Jessamine; KY Scott; KY Woodford.	
Non-SMSA Counties .....	7.0
KY Adair KY Anderson; KY Bath; KY Boyle; KY Breathitt; KY Casey; KY Clay;	
KY Estill; KY Franklin; KY Garrard; KY Green; KY Harrison; KY Jackson; KY	
Knott; KY Lee; KY Leslie; KY Letcher; KY Lincoln; KY Madison; KY Magoffin;	
KY Menifee; KY Mercer; KY Montgomery; KY Morgan. KY Nicholas; KY	
Owsley; KY Perry; KY Powell; KY Pulaski; KY Rockcastle; KY Russell; KY	
Taylor; KY Wolfe.	
059 Huntington, WV:	
SMSA Counties:	
3400 Huntington - Ashland, WV-KY-OH .....	2.9
KY Boyd; KY Greenup; OH Lawrence; WV Cabell; WV Wayne.	
Non-SMSA Counties .....	2.5
KY Carter; KY Elliott; KY Floyd; KY Johnson; KY Lawrence; KY Martin; KY	
Pike; KY Rowan; OH Gallia; WV Lincoln; WV Logan; WV Mason; WV Mingo.	
067 Cincinnati, OH:	
SMSA Counties:	
1640 Cincinnati, OH-KY-IN .....	11.0
IN Dearborn; KY Boone; KY Campbell; KY Kenton; OH Clermont; OH Hamilton;	
OH Warren.	
3200 Hamilton - Middletown, OH .....	5.0
OH Butler.	
Non-SMSA Counties .....	9.2
IN Franklin; IN Ohio; IN Ripley; IN Switzerland; KY Bracken; KY Carroll; KY	
Fleming; KY Gallatin; KY Grant; KY Lewis; KY Mason; KY Owen; KY	
Pendleton; KY Robertson; OH Adams; OH Brown; OH Clinton; OH Highland.	
080 Evansville, IN:	
SMSA Counties	
2440 Evansville, IN-KY .....	4.8
IN Gibson; IN Posey; IN Vanderburgh; IN Warrick; KY Henderson.	
5990 Owensboro, KY .....	4.7
KY Daviess.	
Non-SMSA Counties .....	3.5
IL Edwards; IL Gallatin; IL Hamilton; IL Lawrence; IL Saline; IL Wabash; IL	
White; IN Dubois; IN Knox; IN Perry; IN Pike; IN Spencer; KY Hancock; KY	
Hopkins; KY McLean; KY Muhlenberg; KY Ohio; KY Union; KY Webster.	

**CHECK LIST OF EEO DOCUMENTATION FOR BIDDERS ON  
GRANT/LOAN CONSTRUCTION (EXECUTIVE ORDER 11246 AS AMENDED)**

The low, responsive responsible bidder must forward the following items, in duplicate, to the owner no later than ten (10) days after bid opening. The owner shall have one (1) copy available for inspection by the Office of Federal Contracts Compliance (OFCC) within 14 days after the bid opening. More information can be found on the [OFCC](#) webpage.

1. Project Number. Project Location. Type of Construction.
2. Proof of registration with the Joint Reporting Commission. (See Attachment Number 7.)
3. Copy of Affirmative Action Plan of contractor. Indicate company official responsible for EEO.
4. List of current construction contracts, with dollar amount. List contracting Federal Agency, if applicable.
5. Statistics concerning company percent workforce, permanent and temporary, by sex, race, trade, handicapped, and age. 40 CFR Part 7.
6. List of employment sources for project in question. If union sources are utilized, indicate percentage of minority membership within the union crafts.
7. Anticipated employment needs for this project, by sex, race and trade, with estimate of minority participation in specific trades.
8. List of subcontractors (name, address and telephone) with dollar amount and duration of subcontract. Subcontractor contracts over \$10,000 must submit items 1- 7. The following information must be provided for all supplier contracts regardless of contract size: name of company, contact person, address, telephone number, dollar value of the contract, and a list of the materials to be supplied to the prime contractor.
9. List of any subcontract work yet to be committed with estimate of dollar amount and duration of contract.
10. Contract Price. Duration of prime contract.
11. DBE Documents - See special instructions regarding use of Minority, and Women Owned, and Small Businesses.

## EMPLOYER INFORMATION REPORT EEO-1

Under the direction of the US Equal Employment Opportunity Commission, the Joint Reporting Committee is responsible for the full-length, multi-phase processing of employment statistics collected on the Employer Information Report EEO-1. This report, also termed Standard Form 100, details the sex and race/ethnic composition of an employer's work force by job category.

The Employer Information EEO-1 survey is conducted annually under the authority of Public Law 88-352, Title VII of the Civil Rights Act of 1964, as amended by the Equal Employment Opportunity Act of 1972. All employers with 15 or more employees are covered by Public Law 88-352 and are required to keep employment records as specified by Commission regulations. Based on the number of employees and federal contract activities, certain large employers are required to file an EEO-1 Report on an annual basis.

The EEO-1 Report must be filed by:

- (A) All private employers who are: (1) subject to Title VII of the Civil Rights Act of 1964 (as amended by the Equal Employment Opportunity Act of 1972) with 100 or more employees EXCLUDING State and local governments, primary and secondary school systems, institutions of higher education, Indian tribes and tax-exempt private memberships clubs other than labor organizations; OR (2) subject to Title VII who have fewer than 100 employees if the company is owned or affiliated with another company, or there is centralized ownership, control or management (such as central control of personnel policies and labor relations) so that the group legally constitutes a single enterprise and the entire enterprise employs a total of 100 or more employees.
- (B) All federal contractors (private employers), who: (1) are not exempt as provided for by 41 CFR 60-1.5, (2) have 50 or more employees, and (a) are prime contractors or first-tier subcontractors, and have a contract, subcontract, or purchase order amounting to \$50,000 or more; or (b) serve as depository of Government funds in any amount, or (c) is a financial institution which is an issuing an paying agent for U.S. Savings Bonds and Notes.

Only those establishments located in the District of Columbia and the 50 states are required to submit the EEO-1 Report. No Reports should be filed for establishments in Puerto Rico, the Virgin Islands or other American Protectorates.

When filing for the EEO-1 Report for the first time, go to the [U.S. Equal Employment Opportunity Commission](#) webpage and select "First Time Filers". Fill out the electronic questionnaire to enter your company into Joint Reporting Committee (JRC) system. Once you have completed the registration process, you will be contacted on how to proceed with the EEO-1 Report. If you have previously registered with the JRC, follow their instructions to update your information.

**LABOR STANDARDS PROVISIONS FOR  
FEDERALLY ASSISTED CONSTRUCTION**

Labor standards provisions applicable to contracts covering federally financed and assisted construction (29 CFR 5.5, Contract Provisions and Related Matters) that apply to EPA State Revolving Fund loans are:

(a)(4)(iii) *Equal employment opportunity.* The utilization of apprentices, trainees and journeymen under this part shall be in conformity with the equal employment opportunity requirements of Executive Order 11246, as amended, and 29 CFR Part 30.

(a)(5) *Compliance with Copeland Act requirements.* The contractor shall comply with the requirements of 29 CFR Part 3, which are incorporated by reference in this contract.

(a)(6) *Subcontracts.* The contractor or subcontractor shall insert in any subcontracts the clauses contained in 29 CFR 5.5 (a)(1) through (10) and such other clauses as the U.S. Environmental Protection Agency may by appropriate instructions require, and also a clause requiring the subcontractors to include these clauses in any lower tier subcontracts. The prime contractor shall be responsible for the compliance by any subcontractor or lower tier subcontractor with all the contract clauses in 29 CFR 5.5.

(a)(7) *Contract termination: debarment.* A breach of the contract clauses in 29 CFR 5.5 may be grounds for termination of the contract, and for debarment as a contractor and a subcontractor as provided in 29 CFR 5.12.

(b) *Contractor Work Hours and Safety Standards Act.* The Administrator, EPA, shall cause or require the contracting officer to insert the following clauses set forth in paragraphs (b)(1), (2), (3), and (4) of this section in full in any contract in an amount in excess of \$100,000 and subject to the overtime provisions of the Contract Work Hours and Safety Standards Act. These clauses shall be inserted in addition to the clauses required by §5.5(a) or §4.6 of part 4 of this title. As used in this paragraph, the terms *laborers* and *mechanics* include watchmen and guards.

(b)(1) *Overtime requirements.* No contractor or subcontractor contracting for any part of the contract work which may require or involve the employment of laborers or mechanics shall require or permit any such laborer or mechanic in any workweek in which he or she is employed on such work to in excess of forty hours in such workweek unless such laborer or mechanic receives compensation at a rate not less than one and one-half times the basic rate of pay for all hours worked in excess of forty hours in such workweek.

(b)(2) *Violation; liability for unpaid wages; liquidated damages.* In the event of any violation of the clause set forth in paragraph (b)(1) of this section the contractor and any subcontractor responsible therefore shall be liable for the unpaid wages. In addition, such contractor and subcontractor shall be liable to the United States (in the case of work done under contract for the District of Columbia or a territory, to such District or to such territory), for unliquidated damages. Such liquidated damages shall be computed with respect to each individual laborer or mechanic, including watchmen and guards, employed in violation of the clause set forth in paragraph (b)(1) of this section, in the sum of \$27 for each calendar day on which such individual was required or permitted to work in excess of the standard workweek of forty hours without payment of the overtime wages required by the clause set forth in paragraph (b)(1) of this section.

(3) *Withholding for unpaid wages and liquidated damages.* The U.S. Environmental Protection Agency shall upon its own action or upon written request of an authorized representative of the Department of Labor withhold or cause to be withheld, from any moneys payable on account of work performed by the contractor or subcontractor under any such contract or any other Federal contract with the same prime

contractor, or any other federally-assisted contract subject to the Contract Work Hours and Safety Standards Act, which is held by the same prime contractor, such sums as may be determined to be necessary to satisfy any liabilities of such contractor or subcontractor for unpaid wages and liquidated damages as provided in the clause set forth in paragraph (b)(2) of this section.

(4) *Subcontracts.* The contractor or subcontractor shall insert in any subcontracts the clauses set forth in paragraph (b)(1) through (4) of this section and also a clause requiring the subcontractors to include these clauses in any lower tier subcontracts. The prime contractor shall be responsible for compliance by any subcontractor or lower tier subcontractor with the clauses set forth in paragraphs (b)(1) through (4) of this section.

(c) In addition to the clauses contained in paragraph (b), in any contract subject only to the Contract Work Hours and Safety Standards Act and not to any of the other statutes cited in section §5.1, the Administrator of EPA shall cause or require the contracting officer to insert a clause requiring that the contractor or subcontractor shall maintain payrolls and basic payroll records during the course of the work and shall preserve them for a period of three years from the completion of the contract for all laborers and mechanics, including guards and watchmen, working on the contract. Such records shall contain the name and address of each such employee, social security number, correct classifications, hourly rates of wages paid, daily and weekly number of hours worked, deductions made, and actual wages paid. Further, the Administrator of EPA shall cause or require the contracting officer to insert in any such contract a clause providing that the records to be maintained under this paragraph shall be made available by the contractor or subcontractor for inspection, copying, or transcription by authorized representatives of the U.S. Environmental Protection Agency and the Department of Labor, and the contractor or subcontractor will permit such representatives to interview employees during working hours on the job. (Approved by the Office of Management and Budget under OMB control numbers 1215-0140 and 1215-0017.)

## **CERTIFICATIONS**

### **Debarred Firms**

All prime Construction Contractors shall certify that Subcontractors have not and will not be awarded to any firm that is currently on the EPA Master List of Debarred, Suspended and Voluntarily Excluded Persons in accordance with the provisions of 40 CFR 32.500(c). Debarment action is taken against a firm for noncompliance with Federal Law.

All bidders shall complete the attached certification (Attachment Number 9) and submit to the owner with the bid proposal.

### **Anti-lobbying Certification**

All prime Construction Contractors must certify (Attachment Number 10) that no appropriated funds were or will be expended for the purpose of lobbying the Executive or Legislative Branches of the Federal Government or Federal Agency concerning this contract (contract in excess of \$100,000). If the Contractor has made or agreed to make payment to influence any member of Congress in regard to award of this contract, a Disclosure Form must be completed and submitted to the owner with the bid proposal.

All prime Contractors must require all Subcontractors to submit the certification, which must also be submitted to the owner.



**CERTIFICATION REGARDING DEBARMENT,  
SUSPENSION AND OTHER RESPONSIBILITY MATTERS**

The prospective participant certifies to the best of its knowledge and belief that it and its principals:

- (a) Are not presently debarred, suspended, proposed for debarment, declared ineligible, or voluntarily excluded from covered transactions by any Federal department or agency;
- (b) Have not within a three year period preceding this proposal been convicted of or had a civil judgment rendered against them for commission of fraud or a criminal offense in connection with obtaining, attempting to obtain, or performing a public (Federal, State, or local) transaction or contract under a public transaction; violation of Federal or State antitrust statutes or commission of embezzlement, theft, forgery, bribery, falsification or destruction of records, making false statements, or receiving stolen property;
- (c) Are not presently indicted for or otherwise criminally or civilly charged by a government entity (Federal, State, or Local) with commission of any of the offenses enumerated in paragraph (1)(b) of this certification; and
- (d) Have not within a three-year period preceding this application/proposal had one or more public transactions (Federal, State, or local) terminated for cause or default.

I understand that a false statement on this certification may be grounds for rejection of this proposal or termination of the award. In addition, under 18 USC Sec. 1001, a false statement may result in a fine of up to \$10,000 or imprisonment for up to 5 years, or both.

\_\_\_\_\_  
Typed Name & Title of Authorized Representative

\_\_\_\_\_  
Signature of Authorized Representative

\_\_\_\_\_  
Date

\_\_\_\_\_ I am unable to certify to the above statements. My explanation is attached.

**CERTIFICATION REGARDING LOBBYING  
CERTIFICATION FOR CONTRACTS,  
GRANTS, LOANS, AND COOPERATIVE AGREEMENTS**

The undersigned certifies, to the best of his or her knowledge and belief, that:

(1) No Federal appropriated funds have been paid or will be paid, by or on behalf of the undersigned, to any person for influencing or attempting to influence an officer or employee of an agency, a Member of Congress, an officer or employee of Congress, or an employee of a Member of Congress in connection with the awarding of any Federal contract, the making of any Federal grant, the making of any Federal loan, the entering into of any cooperative agreement, and the extension, continuation, renewal, amendment, or modification of any Federal contract, grant, loan, or cooperative agreement.

(2) If any funds other than Federal appropriated funds have been paid or will be paid to any person for influencing or attempting to influence an officer or employee of any agency, a Member of Congress, an officer or employee of Congress, or an employee of a Member of Congress in connection with this Federal contract, grant, loan, or cooperative agreement, the undersigned shall complete and submit Standard Form-LLL, "Disclosure Form to Report Lobbying," in accordance with its instructions.

(3) The undersigned shall require that the language of this certification be included in the award documents for all sub-awards at all tiers (including subcontracts, sub-grants, and contracts under grants, loans, and cooperative agreements) and that all sub-recipients shall certify and disclose accordingly.

This certification is a material representation of fact upon which reliance was placed when this transaction was made or entered into. Submission of this certification is a prerequisite for making or entering into this transaction imposed by section 1352, title 31, U.S. Code. Any person who fails to file the required certification shall be subject to a civil penalty of not less than \$10,000 and not more than \$100,000 for each such failure.

---

Typed Name & Title of Authorized Representative

---

Signature of Authorized Representative

Date

\_\_\_\_\_ I am unable to certify to the above statements. My explanation is attached.

## EPA DISADVANTAGED BUSINESS ENTERPRISE PROGRAM

EPA's Disadvantaged Business Enterprise Program rule applies to contract procurement actions funded in part by EPA assistance agreements awarded after May 27, 2008. The rule is found at Federal regulation Title 40, Part 33. Specific responsibilities are highlighted below.

### Loan recipient responsibilities:

- Include in each contract with a primary contractor the following term and condition:
 

“The contractor shall not discriminate on the basis of race, color, national origin or sex in the performance of this contract. The contractor shall carry out applicable requirements of 40 CFR part 33 in the award and administration of contracts awarded under EPA financial assistance agreements. Failure by the contractor to carry out these requirements is a material breach of this contract which may result in the termination of this contract.” (*Appendix A to Part 33—Term and Condition*)
- Employ the six Good Faith Efforts during prime contractor procurement (§33.301).
- Require the prime contractor to comply with the following prime contractor requirements of Title 40 Part 33:
  - To pay its subcontractor for satisfactory performance no more than 30 days from the prime contractor's receipt of payment from the recipient (§33.302(a)).
  - To notify recipient in writing prior to any termination of a DBE subcontractor for convenience by the prime contractor (§33.302(b)).
  - To employ the six Good Faith Efforts described in §33.301 if soliciting a replacement subcontractor after a DBE subcontractor fails to complete work under the subcontract for any reason (§33.302(c)).
  - To employ the six Good Faith Efforts described in §33.301 even if the prime contractor has achieved its fair share objectives under subpart D of Part 33 (§33.302(d)).
  - To provide EPA Form 6100-2 – *DBE Program Subcontractor Participation Form* to all DBE subcontractors (§33.302(e)). **NOTE: this requirement has been suspended.**
  - To submit EPA Forms 6100-3 – *DBE Program Subcontractor Performance Form* and 6100-4 *DBE Program Subcontractor Utilization Form* as part of the bid package or proposal (§33.302(f) and (g)). **NOTE: this requirement has been suspended.**
  - To employ the six Good Faith Efforts steps in paragraphs (a) through (f) of §33.301 while procuring any subcontracts (§33.302(i)).
- Conduct an Availability Analysis and negotiate fair share objectives with EPA (§33.401), or adopt the fair share objectives of the oversight state agency revolving loan fund for comparable infrastructure (§33.405(b)(3)).
- Maintain all records documenting its compliance with the requirements of Title 40 Part 33, including documentation of its, and its prime contractors', good faith efforts (§33.501(a)).

- Create and maintain a bidders list and require the prime contractor to create and maintain a bidders list (§33.501(b)). This list must include all firms that bid or quote on prime contracts, or bid or quote subcontracts, including both MBE/WBEs and non-MBE/WBEs. This list must be kept until the project period for the identified loan has ended. The following information must be obtained from all prime and subcontractors:
  - (a) Entity's name with point of contact,
  - (b) Entity's mailing address, telephone number, and email address,
  - (c) The procurement on which the entity bid or quoted, and when, and,
  - (d) Entity's status as an MBE/WBE or non-MBE/WBE.

### **Prime Contractor Responsibilities:**

- Include in each contract with a subcontractor the following term and condition:
 

“The contractor shall not discriminate on the basis of race, color, national origin or sex in the performance of this contract. The contractor shall carry out applicable requirements of 40 CFR part 33 in the award and administration of contracts awarded under EPA financial assistance agreements. Failure by the contractor to carry out these requirements is a material breach of this contract which may result in the termination of this contract.” (*Appendix A to Part 33—Term and Condition*)
- Employ the six Good Faith Efforts during subcontractor procurement (§33.301).
- Pay subcontractors for satisfactory performance no more than 30 days from receipt of payment from the recipient (§33.302(a)).
- Notify recipient in writing prior to termination of a DBE subcontractor for convenience (§33.302(b)).
- Employ the six Good Faith Efforts described in §33.301 if soliciting a replacement subcontractor after a DBE subcontractor fails to complete work under the subcontract for any reason. (§33.302(c)).
- Employ the six Good Faith Efforts described in §33.301 even if the fair share objectives have been achieved under subpart D of Part 33 (§33.302(d)).
- Provide EPA Forms 6100-2 – *DBE Program Subcontractor Participation Form* and 6100-3 – *DBE Program Subcontractor Performance Form* to each DBE subcontractor prior to opening of the subcontractor's bid or proposal (§33.302(e) and (f)). **NOTE: this requirement has been suspended.**
- Complete EPA Form 6100-4 – *DBE Program Subcontractor Utilization Form* (§33.302(g)). **NOTE: this requirement has been suspended.**
- Submit to recipient with the bid package or proposal the completed EPA Form 6100-4, plus an EPA Form 6100-3 for each DBE subcontractor used in the bid or proposal (§33.302(f) and (g)). **NOTE: this requirement has been suspended.**
- Maintain all records documenting its compliance with the requirements of Title 40 Part 33, including documentation of its, and its subcontractors', good faith efforts (§33.501(a)).
- Create and maintain a bidders list and require the subcontractor to create and maintain a bidders list (§33.501(b)). This list must include all firms that bid or quote on subcontracts, including both

MBE/WBEs and non-MBE/WBEs. This list must be kept until the project period for the identified loan has ended. The following information must be obtained from all subcontractors:

- (a) Entity's name with point of contact,
- (b) Entity's mailing address, telephone number, and email address,
- (c) The procurement on which the entity bid or quoted, and when, and,
- (d) Entity's status as an MBE/WBE or non-MBE/WBE.

**Subcontractor Responsibilities:**

- May submit EPA Form 6100-2 – *DBE Program Subcontractor Participation Form* directly to DOW Project Manager (§33.302(e)). **NOTE: this requirement has been suspended.**
- Must complete EPA Form 6100-3 – *DBE Program Subcontractor Performance Form* and submit it to the prime contractor soliciting services prior to the prime contractor opening bids or quotes. **NOTE: this requirement has been suspended.**

# DISADVANTAGED BUSINESS ENTERPRISE PARTICIPATION POLICY

**PROJECT NAME:** \_\_\_\_\_ **BID DATE:** \_\_\_\_\_

**1. Name, address and telephone number of contact person on all DBE matters:**

Prime Contractor's Name: \_\_\_\_\_  
Contact Person: \_\_\_\_\_  
Address: \_\_\_\_\_  
Phone: \_\_\_\_\_  
Cell Phone: \_\_\_\_\_  
Email: \_\_\_\_\_  
Total Contract Amount: \_\_\_\_\_

**2. Total dollar amount/percent of contract of MBE participation:** \_\_\_\_\_

**3. Total dollar amount/percent of contract of WBE participation:** \_\_\_\_\_

**4. Are certifications\* for each MBE/WBE/DBE subcontractor enclosed; if no, please explain:**  Yes  No

**5. Are MBE/WBE/DBE subcontracts or letters of intent signed by both parties enclosed; if no, please explain:**  Yes  No

**6. List of MBE Subcontractors:**

Name: \_\_\_\_\_  
Contact Person: \_\_\_\_\_  
Address: \_\_\_\_\_  
Phone: \_\_\_\_\_  
Cell Phone: \_\_\_\_\_  
Email: \_\_\_\_\_  
Type of Contract: \_\_\_\_\_  
Work to be Done: \_\_\_\_\_  
Amount: \_\_\_\_\_

**7. List of WBE Subcontractors:**

Name: \_\_\_\_\_  
Contact Person: \_\_\_\_\_  
Address: \_\_\_\_\_  
Phone: \_\_\_\_\_  
Cell Phone: \_\_\_\_\_  
Email: \_\_\_\_\_  
Type of Contract: \_\_\_\_\_  
Work to be Done: \_\_\_\_\_  
Amount: \_\_\_\_\_

Attach Additional Sheets, If Necessary

\*Self-certification: Self certification of MBE/WBE/DBE firms will NOT be accepted as a valid form of certification of MBE/WBE/DBE status.

**8. Information and documentation concerning efforts taken to comply with EPA’s “six good faith efforts”**

(i). Ensure DBE construction firms or material suppliers are made aware of contracting opportunities to the fullest extent practicable through outreach and recruitment activities; including placing DBEs on solicitation lists and soliciting them whenever they are potential sources. A good source for a list of DBEs is the Kentucky Transportation’s [Certified DBE Directory](#) webpage.

The prime contractor certifies that a solicitation list of qualified DBE vendors was developed for current and future solicitations. *Submit a copy of the list as documentation.*

(ii). Make information on forthcoming opportunities available to DBEs and arrange time frames for contracts and establish delivery schedules, where the requirements permit, in a way that encourages and facilitates participation by DBEs in the competitive process; including, whenever possible, posting solicitation for bids or proposals for a sufficient amount of time as to receive a competitive bid or proposal pool.

The prime contractor certifies that every opportunity was provided to a number of DBEs to encourage their participation in the competitive process and that an adequate amount of time was provided for response. Must do at least one of the below.

a. List each DBE construction firm or material supplier to which a solicitation was attempted. *Submit copies of letters, emails, faxes, telecommunication logs, certified mail receipts, returned envelopes, certified mail return receipts, etc. as documentation.*

Company name and phone number: \_\_\_\_\_

Area of work expertise: \_\_\_\_\_

Date of any follow-ups and person spoke to: \_\_\_\_\_

b. Advertisements, if applicable: List each publication in which an announcement or notification was placed. *Submit original advertisement or a copy of the advertisement with an affidavit of publication for each announcement as documentation.*

Name of publication: \_\_\_\_\_

Date(s) of advertisement: \_\_\_\_\_

Specific subcontract areas announced: \_\_\_\_\_

c. Other, if applicable: List each notification method in which an announcement or outreach was used; list serve, public meeting, etc. *Submit applicable information to document effort.*

Method of notification: \_\_\_\_\_

Date(s) of notification: \_\_\_\_\_

(iii). Consider in the contracting process whether firms competing for large contracts could subcontract with DBEs; including dividing total requirements, when economically feasible, into smaller tasks or quantities to permit maximum participation by DBEs in the competitive process.

The prime contractor certifies that the project was broken into its basic elements (i.e., dirt hauling, landscaping, painting, pipe installation, material supplies, etc.) and that a determination was made whether it’s economically feasible to bid the elements separately and that the analysis of this effort was documented with a short memo to the project file.

- (iv). Establishing delivery schedules, where the requirement permits, which encourage participation by small and minority business, and women’s business enterprises.
  - The prime contractor certifies that they established delivery schedules which would allow DBEs to participate in the project and the effort was documented with a short memo to the project file.
  
- (v). Use the services and assistance of the Small Business Administration (SBA). The easiest way to utilize their services is to visit the [SBA](#) webpage and use the electronic tools available there or you may send the nearest SBA office a certified letter that generally describes the solicitation, the dates it will be open, the types of vendors you are seeking and applicable Standard Industrial Classification (SIC) or North American Industry Classification System (NAIC) codes if known. Or, you may use the services and assistance of the Kentucky Procurement Technical Assistance Center (PTAC) **and** the Kentucky Department of Transportation (KDOT). The easiest way to utilize the services of Kentucky PTAC and KDOT is to send an email to [kyptacinfo@kstc.com](mailto:kyptacinfo@kstc.com) and [Melvin.Bynes2@ky.gov](mailto:Melvin.Bynes2@ky.gov) and generally describe the solicitation, the dates it will be open, the types of vendors you are seeking and applicable SIC or NAIC codes if known.
  - The prime contractor certifies that the assistance of the SBA or PTAC **and** KDOT was utilized. *Submit pages printed off the SBA websites which evidence efforts to register a solicitation on the site or submit copies of the letter sent and certified mail receipt as documentation; or submit copies of emails sent to PTAC and DOT as documentation.*
  
- (vi). If a Prime contractor awards any subcontracts, require the subcontractor to take the steps in numbers (i) through (v) above.
  - The prime contractor certifies that subcontractors used for this project will be required to follow the steps of the “six good faith efforts” as listed above.

**9. Signature and date:**

To the best of my knowledge and belief, all “six good faith efforts” have been met and the information contained in this document is true and correct; the document has been duly authorized by the legal representative.

\_\_\_\_\_  
Signature

\_\_\_\_\_  
Print name and title

\_\_\_\_\_  
Date





## BONDS AND INSURANCE

The minimum requirements shall be as follows:

Bonding requirements for contracts of \$100,000 or less are contained in 40 CFR 31.36(h).

Bond requirements for contracts in excess of \$100,000 are:

- Bid guarantee equivalent to five percent of the bid price. The bid guarantee shall consist of a firm commitment such as a certified check or bid bond submitted with the bid;
- Performance bond equal to 100 percent of the contract price, and
- Payment bond equal to 100 percent of the contract price. Bonds must be obtained from companies holding Certificates of Authority as acceptable sureties, issued by the U.S. Treasury.

Insurance requirements are contained in the General Conditions of the contract. In addition to the other required insurance, the owner or the contractor, as appropriate, must acquire any flood insurance made available by the Federal Emergency Management Agency as required by 44 CFR Parts 59-79, if construction will take place in a flood hazard area identified by the Federal Emergency Management Agency. The owner's requirements on Flood Insurance are contained in the Special Conditions Section of the Contracts Documents.

**STORM WATER GENERAL PERMIT**

All construction projects with surface disturbance of more than 1 acre during the period of construction must have a KPDES Storm Water General Permit. The permit can be found at this [webpage](#).

If you have any questions regarding the completion of this form call the Surface Water Permits Branch, at (502) 564-3410.

## **DAVIS-BACON WAGE RATE REQUIREMENTS**

CWSRF: The recipient agrees to include in all agreements to provide assistance for the construction of treatment works carried out in whole or in part with such assistance made available by a State water pollution control revolving fund as authorized by title VI of the Federal Water Pollution Control Act (33 U.S.C. 1381 et seq.), or with such assistance made available under section 205(m) of that Act (33 U.S.C. 1285(m)), or both, a term and condition requiring compliance with the requirements of section 513 of that Act (33 U.S.C. 1372) in all procurement contracts and sub-grants, and require that loan recipients, procurement contractors and sub-grantees include such a term and condition in subcontracts and other lower tiered transactions. All contracts and subcontracts for the construction of treatment works carried out in whole or in part with assistance made available as stated herein shall insert in full in any contract in excess of \$2,000 the contract clauses as set forth below titled “Wage Rate Requirements Under The Consolidated and Further Continuing Appropriations Act, 2013 (P.L. 113-6)”. This term and condition applies to all agreements to provide assistance under the authorities referenced herein, whether in the form of a loan, bond purchase, grant, or any other vehicle to provide financing for a project, where such agreements are executed on or after October 30, 2009.

DWSRF: The recipient agrees to include in all agreements to provide assistance for any construction project carried out in whole or in part with such assistance made available by a drinking water treatment revolving loan fund as authorized by section 1452 of the Safe Drinking Water Act (42 U.S.C. 300j-12), a term and condition requiring compliance with the requirements of section 1450(e) of the Safe Drinking Water Act (42 U.S.C.300j-9(e)) in all procurement contracts and sub-grants, and require that loan recipients, procurement contractors and sub-grantees include such a term and condition in subcontracts and other lower tiered transactions. All contracts and subcontracts for any construction project carried out in whole or in part with assistance made available as stated herein shall insert in full in any contract in excess of \$2,000 the contract clauses as set forth below entitled “Wage Rate Requirements Under The Consolidated and Further Continuing Appropriations Act, 2013 (P.L. 113-6)”. This term and condition applies to all agreements to provide assistance under the authorities referenced herein, whether in the form of a loan, bond purchase, grant, or any other vehicle to provide financing for a project, where such agreements are executed on or after October 30, 2009.

### **Wage Rate Requirements under the Consolidated and Further Continuing Appropriations Act, 2013 (P.L. 113-6)**

#### **Preamble**

With respect to the Clean Water and Safe Drinking Water State Revolving Funds, EPA provides capitalization grants to each State which in turn provides subgrants or loans to eligible entities within the State. Typically, the subrecipients are municipal or other local governmental entities that manage the funds. For these types of recipients, the provisions set forth under Roman Numeral I, below, shall apply. Although EPA and the State remain responsible for ensuring subrecipients’ compliance with the wage rate requirements set forth herein, those subrecipients shall have the primary responsibility to maintain payroll records as described in Section 3(ii)(A), below and for compliance as described in Section I-5.

Occasionally, the subrecipient may be a private for profit or not for profit entity. For these types of recipients, the provisions set forth in Roman Numeral II, below, shall apply. Although EPA and the State remain responsible for ensuring subrecipients’ compliance with the wage rate requirements set forth herein, those subrecipients shall have the primary responsibility to maintain payroll records as described in Section II-3(ii)(A), below and for compliance as described in Section II-5.

## **I. Requirements under the Consolidated and Further Continuing Appropriations Act, 2013 (P.L. 113-6) for Subrecipients that are Governmental Entities:**

The following terms and conditions specify how recipients will assist EPA in meeting its Davis-Bacon (DB) responsibilities when DB applies to EPA awards of financial assistance under the FY 2013 Continuing Resolution with respect to State recipients and subrecipients that are governmental entities. If a subrecipient has questions regarding when DB applies, obtaining the correct DB wage determinations, DB provisions, or compliance monitoring, it may contact the State recipient. The recipient or subrecipient may also obtain additional guidance from [Department of Labor's](#) webpage.

### **1. Applicability of the Davis- Bacon (DB) prevailing wage requirements.**

Under the FY 2013 Continuing Resolution, DB prevailing wage requirements apply to the construction, alteration, and repair of treatment works carried out in whole or in part with assistance made available by a State water pollution control revolving fund and to any construction project carried out in whole or in part by assistance made available by a drinking water treatment revolving loan fund. If a subrecipient encounters a unique situation at a site that presents uncertainties regarding DB applicability, the subrecipient must discuss the situation with the recipient State before authorizing work on that site.

### **2. Obtaining Wage Determinations.**

(a) Subrecipients shall obtain the wage determination for the locality in which a covered activity subject to DB will take place prior to issuing requests for bids, proposals, quotes or other methods for soliciting contracts (solicitation) for activities subject to DB. These wage determinations shall be incorporated into solicitations and any subsequent contracts. Prime contracts must contain a provision requiring that subcontractors follow the wage determination incorporated into the prime contract.

(i) While the solicitation remains open, the subrecipient shall monitor the [General Services Administration](#) website weekly to ensure that the wage determination contained in the solicitation remains current. The subrecipients shall amend the solicitation if DOL issues a modification more than 10 days prior to the closing date (i.e. bid opening) for the solicitation. If DOL modifies or supersedes the applicable wage determination less than 10 days prior to the closing date, the subrecipients may request a finding from the State recipient that there is not a reasonable time to notify interested contractors of the modification of the wage determination. The State recipient will provide a report of its findings to the subrecipient.

(ii) If the subrecipient does not award the contract within 90 days of the closure of the solicitation, any modifications or supersedes DOL makes to the wage determination contained in the solicitation shall be effective unless the State recipient, at the request of the subrecipient, obtains an extension of the 90 day period from DOL pursuant to 29 CFR 1.6(c)(3)(iv). The subrecipient shall monitor the [General Services Administration](#) website on a weekly basis if it does not award the contract within 90 days of closure of the solicitation to ensure that wage determinations contained in the solicitation remain current.

(b) If the subrecipient carries out activity subject to DB by issuing a task order, work assignment or similar instrument to an existing contractor (ordering instrument) rather than by publishing a solicitation, the subrecipient shall insert the appropriate DOL wage determination from the [General Services Administration](#) website into the ordering instrument.

(c) Subrecipients shall review all subcontracts subject to DB entered into by prime contractors to verify that the prime contractor has required its subcontractors to include the applicable wage determinations.

(d) As provided in 29 CFR 1.6(f), DOL may issue a revised wage determination applicable to a subrecipient's contract after the award of a contract or the issuance of an ordering instrument if DOL determines that the subrecipient has failed to incorporate a wage determination or has used a wage

determination that clearly does not apply to the contract or ordering instrument. If this occurs, the subrecipient shall either terminate the contract or ordering instrument and issue a revised solicitation or ordering instrument or incorporate DOL's wage determination retroactive to the beginning of the contract or ordering instrument by change order. The subrecipient's contractor must be compensated for any increases in wages resulting from the use of DOL's revised wage determination.

### **3. Contract and Subcontract provisions.**

(a) The Recipient shall insure that the subrecipient(s) shall insert in full in any contract in excess of \$2,000 which is entered into for the actual construction, alteration and/or repair, including painting and decorating, of a treatment work under the CWSRF or a construction project under the DWSRF financed in whole or in part from Federal funds or in accordance with guarantees of a Federal agency or financed from funds obtained by pledge of any contract of a Federal agency to make a loan, grant or annual contribution (except where a different meaning is expressly indicated), and which is subject to the labor standards provisions of any of the acts listed in § 5.1 or the FY 2013 Continuing Resolution, the following clauses:

(1) Minimum wages.

(i) All laborers and mechanics employed or working upon the site of the work will be paid unconditionally and not less often than once a week, and without subsequent deduction or rebate on any account (except such payroll deductions as are permitted by regulations issued by the Secretary of Labor under the Copeland Act (29 CFR part 3)), the full amount of wages and bona fide fringe benefits (or cash equivalents thereof) due at time of payment computed at rates not less than those contained in the wage determination of the Secretary of Labor which is attached hereto and made a part hereof, regardless of any contractual relationship which may be alleged to exist between the contractor and such laborers and mechanics.

Contributions made or costs reasonably anticipated for bona fide fringe benefits under section 1(b)(2) of the Davis-Bacon Act on behalf of laborers or mechanics are considered wages paid to such laborers or mechanics, subject to the provisions of paragraph (a)(1)(iv) of this section; also, regular contributions made or costs incurred for more than a weekly period (but not less often than quarterly) under plans, funds, or programs which cover the particular weekly period, are deemed to be constructively made or incurred during such weekly period. Such laborers and mechanics shall be paid the appropriate wage rate and fringe benefits on the wage determination for the classification of work actually performed, without regard to skill, except as provided in § 5.5(a)(4). Laborers or mechanics performing work in more than one classification may be compensated at the rate specified for each classification for the time actually worked therein: Provided, that the employer's payroll records accurately set forth the time spent in each classification in which work is performed. The wage determination (including any additional classification and wage rates conformed under paragraph (a)(1)(ii) of this section) and the Davis-Bacon poster (WH-1321) shall be posted at all times by the contractor and its subcontractors at the site of the work in a prominent and accessible place where it can be easily seen by the workers.

Subrecipients may obtain wage determinations from the U.S. Department of Labor's [General Services Administration](#) website.

(ii)(A) The subrecipient(s), on behalf of EPA, shall require that any class of laborers or mechanics, including helpers, which is not listed in the wage determination and which is to be employed under the contract shall be classified in conformance with the wage determination. The State award official shall approve a request for an additional classification and wage rate and fringe benefits therefore only when the following criteria have been met:

(1) The work to be performed by the classification requested is not performed by a classification in the wage determination; and

(2) The classification is utilized in the area by the construction industry; and

(3) The proposed wage rate, including any bona fide fringe benefits, bears a reasonable relationship to the wage rates contained in the wage determination.

(B) If the contractor and the laborers and mechanics to be employed in the classification (if known), or their representatives, and the subrecipient(s) agree on the classification and wage rate (including the amount designated for fringe benefits where appropriate), documentation of the action taken and the request, including the local wage determination shall be sent by the subrecipient (s) to the State award official. The State award official will transmit the request, to the Administrator of the Wage and Hour Division, Employment Standards Administration, U.S. Department of Labor, Washington, DC 20210 and to the EPA DB Regional Coordinator concurrently. The Administrator, or an authorized representative, will approve, modify, or disapprove every additional classification request within 30 days of receipt and so advise the State award official or will notify the State award official within the 30-day period that additional time is necessary.

(C) In the event the contractor, the laborers or mechanics to be employed in the classification or their representatives, and the subrecipient(s) do not agree on the proposed classification and wage rate (including the amount designated for fringe benefits, where appropriate), the award official shall refer the request and the local wage determination, including the views of all interested parties and the recommendation of the State award official, to the Administrator for determination. The request shall be sent to the EPA DB Regional Coordinator concurrently. The Administrator, or an authorized representative, will issue a determination within 30 days of receipt of the request and so advise the contracting officer or will notify the contracting officer within the 30-day period that additional time is necessary.

(D) The wage rate (including fringe benefits where appropriate) determined pursuant to paragraphs (a)(1)(ii)(B) or (C) of this section, shall be paid to all workers performing work in the classification under this contract from the first day on which work is performed in the classification.

(iii) Whenever the minimum wage rate prescribed in the contract for a class of laborers or mechanics includes a fringe benefit which is not expressed as an hourly rate, the contractor shall either pay the benefit as stated in the wage determination or shall pay another bona fide fringe benefit or an hourly cash equivalent thereof.

(iv) If the contractor does not make payments to a trustee or other third person, the contractor may consider as part of the wages of any laborer or mechanic the amount of any costs reasonably anticipated in providing bona fide fringe benefits under a plan or program, provided, that the Secretary of Labor has found, upon the written request of the contractor, that the applicable standards of the Davis-Bacon Act have been met. The Secretary of Labor may require the contractor to set aside in a separate account assets for the meeting of obligations under the plan or program.

(2) Withholding. The subrecipient(s), shall upon written request of the EPA Award Official or an authorized representative of the Department of Labor, withhold or cause to be withheld from the contractor under this contract or any other Federal contract with the same prime contractor, or any other federally-assisted contract subject to Davis-Bacon prevailing wage requirements, which is held by the same prime contractor, so much of the accrued payments or advances as may be considered necessary to pay laborers and mechanics, including apprentices, trainees, and helpers, employed by the contractor or any subcontractor the full amount of wages required by the contract. In the event of failure to pay any laborer or mechanic, including any apprentice, trainee, or helper, employed or working on the site of the work, all or part of the wages required by the contract, the (Agency) may, after written notice to the contractor, sponsor, applicant, or owner, take such action as may be necessary to cause the suspension of any further payment, advance, or guarantee of funds until such violations have ceased.

(3) Payrolls and basic records.

(i) Payrolls and basic records relating thereto shall be maintained by the contractor during the course of the work and preserved for a period of three years thereafter for all laborers and mechanics working at the site of the work. Such records shall contain the name, address, and social security number of each such worker, his or her correct classification, hourly rates of wages paid (including rates of contributions or costs anticipated for bona fide fringe benefits or cash equivalents thereof of the types described in section 1(b)(2)(B) of the Davis-Bacon Act), daily and weekly number of hours worked, deductions made and actual wages paid. Whenever the Secretary of Labor has found under 29 CFR 5.5(a)(1)(iv) that the wages of any laborer or mechanic include the amount of any costs reasonably anticipated in providing benefits under a plan or program described in section 1(b)(2)(B) of the Davis-Bacon Act, the contractor shall maintain records which show that the commitment to provide such benefits is enforceable, that the plan or program is financially responsible, and that the plan or program has been communicated in writing to the laborers or mechanics affected, and records which show the costs anticipated or the actual cost incurred in providing such benefits. Contractors employing apprentices or trainees under approved programs shall maintain written evidence of the registration of apprenticeship programs and certification of trainee programs, the registration of the apprentices and trainees, and the ratios and wage rates prescribed in the applicable programs.

(ii)(A) The contractor shall submit weekly, for each week in which any contract work is performed, a copy of all payrolls to the subrecipient, that is, the entity that receives the sub-grant or loan from the State capitalization grant recipient. Such documentation shall be available on request of the State recipient or EPA. As to each payroll copy received, the subrecipient shall provide written confirmation in a form satisfactory to the State indicating whether or not the project is in compliance with the requirements of 29 CFR 5.5(a)(1) based on the most recent payroll copies for the specified week. The payrolls shall set out accurately and completely all of the information required to be maintained under 29 CFR 5.5(a)(3)(i), except that full social security numbers and home addresses shall not be included on the weekly payrolls. Instead the payrolls shall only need to include an individually identifying number for each employee (e.g., the last four digits of the employee's social security number). The required weekly payroll information may be submitted in any form desired. Optional Form WH-347 is available for this purpose from the [Wage and Hour Division's](#) webpage or its successor site. The prime contractor is responsible for the submission of copies of payrolls by all subcontractors. Contractors and subcontractors shall maintain the full social security number and current address of each covered worker, and shall provide them upon request to the subrecipient(s) for transmission to the State or EPA if requested by EPA, the State, the contractor, or the Wage and Hour Division of the Department of Labor for purposes of an investigation or audit of compliance with prevailing wage requirements. It is not a violation of this section for a prime contractor to require a subcontractor to provide addresses and social security numbers to the prime contractor for its own records, without weekly submission to the subrecipient(s).

(B) Each payroll submitted shall be accompanied by a "Statement of Compliance," signed by the contractor or subcontractor or his or her agent who pays or supervises the payment of the persons employed under the contract and shall certify the following:

(1) That the payroll for the payroll period contains the information required to be provided under §5.5(a)(3)(ii) of Regulations, 29 CFR part 5, the appropriate information is being maintained under §5.5(a)(3)(i) of Regulations, 29 CFR part 5, and that such information is correct and complete;

(2) That each laborer or mechanic (including each helper, apprentice, and trainee) employed on the contract during the payroll period has been paid the full weekly wages earned, without rebate, either directly or indirectly, and that no deductions have been made either directly or indirectly from the full wages earned, other than permissible deductions as set forth in Regulations, 29 CFR part 3;

(3) That each laborer or mechanic has been paid not less than the applicable wage rates and fringe benefits or cash equivalents for the classification of work performed, as specified in the applicable wage determination incorporated into the contract.



(C) The weekly submission of a properly executed certification set forth on the reverse side of Optional Form WH-347 shall satisfy the requirement for submission of the “Statement of Compliance” required by paragraph (a)(3)(ii)(B) of this section.

(D) The falsification of any of the above certifications may subject the contractor or subcontractor to civil or criminal prosecution under section 1001 of title 18 and section 231 of title 31 of the United States Code.

(iii) The contractor or subcontractor shall make the records required under paragraph (a)(3)(i) of this section available for inspection, copying, or transcription by authorized representatives of the State, EPA or the Department of Labor, and shall permit such representatives to interview employees during working hours on the job. If the contractor or subcontractor fails to submit the required records or to make them available, the Federal agency or State may, after written notice to the contractor, sponsor, applicant, or owner, take such action as may be necessary to cause the suspension of any further payment, advance, or guarantee of funds. Furthermore, failure to submit the required records upon request or to make such records available may be grounds for debarment action pursuant to 29 CFR 5.12.

#### (4) Apprentices and trainees.

(i) Apprentices. Apprentices will be permitted to work at less than the predetermined rate for the work they performed when they are employed pursuant to and individually registered in a bona fide apprenticeship program registered with the U.S. Department of Labor, Employment and Training Administration, Office of Apprenticeship Training, Employer and Labor Services, or with a State Apprenticeship Agency recognized by the Office, or if a person is employed in his or her first 90 days of probationary employment as an apprentice in such an apprenticeship program, who is not individually registered in the program, but who has been certified by the Office of Apprenticeship Training, Employer and Labor Services or a State Apprenticeship Agency (where appropriate) to be eligible for probationary employment as an apprentice. The allowable ratio of apprentices to journeymen on the job site in any craft classification shall not be greater than the ratio permitted to the contractor as to the entire work force under the registered program. Any worker listed on a payroll at an apprentice wage rate, who is not registered or otherwise employed as stated above, shall be paid not less than the applicable wage rate on the wage determination for the classification of work actually performed. In addition, any apprentice performing work on the job site in excess of the ratio permitted under the registered program shall be paid not less than the applicable wage rate on the wage determination for the work actually performed. Where a contractor is performing construction on a project in a locality other than that in which its program is registered, the ratios and wage rates (expressed in percentages of the journeyman’s hourly rate) specified in the contractor’s or subcontractor’s registered program shall be observed. Every apprentice must be paid at not less than the rate specified in the registered program for the apprentice’s level of progress, expressed as a percentage of the journeymen hourly rate specified in the applicable wage determination. Apprentices shall be paid fringe benefits in accordance with the provisions of the apprenticeship program. If the apprenticeship program does not specify fringe benefits, apprentices must be paid the full amount of fringe benefits listed on the wage determination for the applicable classification. If the Administrator determines that a different practice prevails for the applicable apprentice classification, fringes shall be paid in accordance with that determination. In the event the Office of Apprenticeship Training, Employer and Labor Services, or a State Apprenticeship Agency recognized by the Office, withdraws approval of an apprenticeship program, the contractor will no longer be permitted to utilize apprentices at less than the applicable predetermined rate for the work performed until an acceptable program is approved.

(ii) Trainees. Except as provided in 29 CFR 5.16, trainees will not be permitted to work at less than the predetermined rate for the work performed unless they are employed pursuant to and individually registered in a program which has received prior approval, evidenced by formal certification by the U.S. Department of Labor, Employment and Training Administration. The ratio of trainees to journeymen on the job site shall not be greater than permitted under the plan approved by the Employment and Training Administration. Every trainee must be paid at not less than the rate specified in the approved program for

the trainee's level of progress, expressed as a percentage of the journeyman hourly rate specified in the applicable wage determination. Trainees shall be paid fringe benefits in accordance with the provisions of the trainee program. If the trainee program does not mention fringe benefits, trainees shall be paid the full amount of fringe benefits listed on the wage determination unless the Administrator of the Wage and Hour Division determines that there is an apprenticeship program associated with the corresponding journeyman wage rate on the wage determination which provides for less than full fringe benefits for apprentices. Any employee listed on the payroll at a trainee rate who is not registered and participating in a training plan approved by the Employment and Training Administration shall be paid not less than the applicable wage rate on the wage determination for the classification of work actually performed. In addition, any trainee performing work on the job site in excess of the ratio permitted under the registered program shall be paid not less than the applicable wage rate on the wage determination for the work actually performed. In the event the Employment and Training Administration withdraws approval of a training program, the contractor will no longer be permitted to utilize trainees at less than the applicable predetermined rate for the work performed until an acceptable program is approved.

(iii) Equal employment opportunity. The utilization of apprentices, trainees and journeymen under this part shall be in conformity with the equal employment opportunity requirements of Executive Order 11246, as amended, and 29 CFR part 30.

(5) Compliance with Copeland Act requirements. The contractor shall comply with the requirements of 29 CFR part 3, which are incorporated by reference in this contract.

(6) Subcontracts. The contractor or subcontractor shall insert in any subcontracts the clauses contained in 29 CFR 5.5(a)(1) through (10) and such other clauses as the EPA determines may be appropriate, and also a clause requiring the subcontractors to include these clauses in any lower tier subcontracts. The prime contractor shall be responsible for the compliance by any subcontractor or lower tier subcontractor with all the contract clauses in 29 CFR 5.5.

(7) Contract termination; debarment. A breach of the contract clauses in 29 CFR 5.5 may be grounds for termination of the contract, and for debarment as a contractor and a subcontractor as provided in 29 CFR 5.12.

(8) Compliance with Davis-Bacon and Related Act requirements. All rulings and interpretations of the Davis-Bacon and Related Acts contained in 29 CFR parts 1, 3, and 5 are herein incorporated by reference in this contract.

(9) Disputes concerning labor standards. Disputes arising out of the labor standards provisions of this contract shall not be subject to the general disputes clause of this contract. Such disputes shall be resolved in accordance with the procedures of the Department of Labor set forth in 29 CFR parts 5, 6, and 7. Disputes within the meaning of this clause include disputes between the contractor (or any of its subcontractors) and Subrecipient(s), State, EPA, the U.S. Department of Labor, or the employees or their representatives.

(10) Certification of eligibility.

(i) By entering into this contract, the contractor certifies that neither it (nor he or she) nor any person or firm who has an interest in the contractor's firm is a person or firm ineligible to be awarded Government contracts by virtue of section 3(a) of the Davis-Bacon Act or 29 CFR 5.12(a)(1).

(ii) No part of this contract shall be subcontracted to any person or firm ineligible for award of a Government contract by virtue of section 3(a) of the Davis-Bacon Act or 29 CFR 5.12(a)(1).

(iii) The penalty for making false statements is prescribed in the U.S. Criminal Code, 18 U.S.C. 1001.

#### **4. Contract Provision for Contracts in Excess of \$100,000.**

(a) Contract Work Hours and Safety Standards Act. The subrecipient shall insert the following clauses set forth in paragraphs (a)(1), (2), (3), and (4) of this section in full in any contract in an amount in excess of \$100,000 and subject to the overtime provisions of the Contract Work Hours and Safety Standards Act. These clauses shall be inserted in addition to the clauses required by Item 3, above or 29 CFR 4.6. As used in this paragraph, the terms laborers and mechanics include watchmen and guards.

(1) Overtime requirements. No contractor or subcontractor contracting for any part of the contract work which may require or involve the employment of laborers or mechanics shall require or permit any such laborer or mechanic in any workweek in which he or she is employed on such work to work in excess of forty hours in such workweek unless such laborer or mechanic receives compensation at a rate not less than one and one-half times the basic rate of pay for all hours worked in excess of forty hours in such workweek.

(2) Violation; liability for unpaid wages; liquidated damages. In the event of any violation of the clause set forth in paragraph (a)(1) of this section the contractor and any subcontractor responsible therefore shall be liable for the unpaid wages. In addition, such contractor and subcontractor shall be liable to the United States (in the case of work done under contract for the District of Columbia or a territory, to such District or to such territory), for liquidated damages. Such liquidated damages shall be computed with respect to each individual laborer or mechanic, including watchmen and guards, employed in violation of the clause set forth in paragraph (a)(1) of this section, in the sum of \$10 for each calendar day on which such individual was required or permitted to work in excess of the standard workweek of forty hours without payment of the overtime wages required by the clause set forth in paragraph (a)(1) of this section.

(3) Withholding for unpaid wages and liquidated damages. The subrecipient, upon written request of the EPA Award Official or an authorized representative of the Department of Labor, shall withhold or cause to be withheld, from any moneys payable on account of work performed by the contractor or subcontractor under any such contract or any other Federal contract with the same prime contractor, or any other federally-assisted contract subject to the Contract Work Hours and Safety Standards Act, which is held by the same prime contractor, such sums as may be determined to be necessary to satisfy any liabilities of such contractor or subcontractor for unpaid wages and liquidated damages as provided in the clause set forth in paragraph (b)(2) of this section.

(4) Subcontracts. The contractor or subcontractor shall insert in any subcontracts the clauses set forth in paragraph (a)(1) through (4) of this section and also a clause requiring the subcontractors to include these clauses in any lower tier subcontracts. The prime contractor shall be responsible for compliance by any subcontractor or lower tier subcontractor with the clauses set forth in paragraphs (a)(1) through (4) of this section.

(b) In addition to the clauses contained in Item 3, above, in any contract subject only to the Contract Work Hours and Safety Standards Act and not to any of the other statutes cited in 29 CFR 5.1, the Subrecipient shall insert a clause requiring that the contractor or subcontractor shall maintain payrolls and basic payroll records during the course of the work and shall preserve them for a period of three years from the completion of the contract for all laborers and mechanics, including guards and watchmen, working on the contract. Such records shall contain the name and address of each such employee, social security number, correct classifications, hourly rates of wages paid, daily and weekly number of hours worked, deductions made, and actual wages paid. Further, the Subrecipient shall insert in any such contract a clause providing that the records to be maintained under this paragraph shall be made available by the contractor or subcontractor for inspection, copying, or transcription by authorized representatives of the (write the name of agency) and the Department of Labor, and the contractor or subcontractor will permit such representatives to interview employees during working hours on the job.

## 5. Compliance Verification.

(a) The subrecipient shall periodically interview a sufficient number of employees entitled to DB prevailing wages (covered employees) to verify that contractors or subcontractors are paying the appropriate wage rates. As provided in 29 CFR 5.6(a)(6), all interviews must be conducted in confidence. The subrecipient must use Standard Form 1445 (SF 1445) or equivalent documentation to memorialize the interviews. Copies of the SF 1445 are available from EPA on request.

(b) The subrecipient shall establish and follow an interview schedule based on its assessment of the risks of noncompliance with DB posed by contractors or subcontractors and the duration of the contract or subcontract. Subrecipients must conduct more frequent interviews if the initial interviews or other information indicates that there is a risk that the contractor or subcontractor is not complying with DB. Subrecipients shall immediately conduct necessary interviews in response to an alleged violation of the prevailing wage requirements. All interviews shall be conducted in confidence.

(c) The subrecipient shall periodically conduct spot checks of a representative sample of weekly payroll data to verify that contractors or subcontractors are paying the appropriate wage rates. The subrecipient shall establish and follow a spot check schedule based on its assessment of the risks of noncompliance with DB posed by contractors or subcontractors and the duration of the contract or subcontract. At a minimum, if practicable, the subrecipient should spot check payroll data within two weeks of each contractor or subcontractor's submission of its initial payroll data and two weeks prior to the completion date the contract or subcontract. Subrecipients must conduct more frequent spot checks if the initial spot check or other information indicates that there is a risk that the contractor or subcontractor is not complying with DB. In addition, during the examinations the subrecipient shall verify evidence of fringe benefit plans and payments thereunder by contractors and subcontractors who claim credit for fringe benefit contributions.

(d) The subrecipient shall periodically review contractors and subcontractors use of apprentices and trainees to verify registration and certification with respect to apprenticeship and training programs approved by either the U.S Department of Labor or a state, as appropriate, and that contractors and subcontractors are not using disproportionate numbers of, laborers, trainees and apprentices. These reviews shall be conducted in accordance with the schedules for spot checks and interviews described in Item 5(b) and (c) above.

(e) Subrecipients must immediately report potential violations of the DB prevailing wage requirements to the EPA DB contact listed above and to the appropriate DOL Wage and Hour [District Office](#).

## II. Requirements under the Consolidated and Further Continuing Appropriations Act, 2013 (P.L. 113-6) for Subrecipients that are not Governmental Agencies

The following terms and conditions specify how recipients will assist EPA in meeting its DB responsibilities when DB applies to EPA awards of financial assistance under the FY2013 Continuing Resolution with respect to subrecipients that are not governmental entities. If a subrecipient has questions regarding when DB applies, obtaining the correct DB wage determinations, DB provisions, or compliance monitoring, it may contact the State recipient for guidance. The recipient or subrecipient may also obtain additional guidance from [DOL's](#) webpage.

**Under these terms and conditions, the subrecipient must submit its proposed DB wage determinations to the State recipient for approval prior to including the wage determination in any solicitation, contract task orders, work assignments, or similar instruments to existing contractors.**

### 1. Applicability of the Davis- Bacon (DB) prevailing wage requirements.

Under the FY 2013 Continuing Resolution, Davis-Bacon prevailing wage requirements apply to the construction, alteration, and repair of treatment works carried out in whole or in part with assistance made available by a State water pollution control revolving fund and to any construction project carried out in whole or in part by assistance made available by a drinking water treatment revolving loan fund. If a subrecipient encounters a unique situation at a site that presents uncertainties regarding DB applicability, the subrecipient must discuss the situation with the recipient State before authorizing work on that site.

## **2. Obtaining Wage Determinations.**

(a) Subrecipients must obtain proposed wage determinations for specific localities from the U.S. Department of Labor's [General Services Administration](#) website. After the Subrecipient obtains its proposed wage determination, it must submit the wage determination to (insert contact information for State recipient DB point of contact for wage determination) for approval prior to inserting the wage determination into a solicitation, contract or issuing task orders, work assignments or similar instruments to existing contractors (ordering instruments unless subsequently directed otherwise by the State recipient Award Official).

(b) Subrecipients shall obtain the wage determination for the locality in which a covered activity subject to DB will take place prior to issuing requests for bids, proposals, quotes or other methods for soliciting contracts (solicitation) for activities subject to DB. These wage determinations shall be incorporated into solicitations and any subsequent contracts. Prime contracts must contain a provision requiring that subcontractors follow the wage determination incorporated into the prime contract.

(i) While the solicitation remains open, the subrecipient shall monitor the U.S. Department of Labor's [General Services Administration](#) website on a weekly basis to ensure that the wage determination contained in the solicitation remains current. The subrecipients shall amend the solicitation if DOL issues a modification more than 10 days prior to the closing date (i.e. bid opening) for the solicitation. If DOL modifies or supersedes the applicable wage determination less than 10 days prior to the closing date, the subrecipients may request a finding from the State recipient that there is not a reasonable time to notify interested contractors of the modification of the wage determination. The State recipient will provide a report of its findings to the subrecipient.

(ii) If the subrecipient does not award the contract within 90 days of the closure of the solicitation, any modifications or supersedes DOL makes to the wage determination contained in the solicitation shall be effective unless the State recipient, at the request of the subrecipient, obtains an extension of the 90 day period from DOL pursuant to 29 CFR 1.6(c)(3)(iv). The subrecipient shall monitor the U.S. Department of Labor's [General Services Administration](#) website on a weekly basis if it does not award the contract within 90 days of closure of the solicitation to ensure that wage determinations contained in the solicitation remain current.

(c) If the subrecipient carries out activity subject to DB by issuing a task order, work assignment or similar instrument to an existing contractor (ordering instrument) rather than by publishing a solicitation, the subrecipient shall insert the appropriate DOL wage determination from the U.S. Department of Labor's [General Services Administration](#) website into the ordering instrument.

(c) Subrecipients shall review all subcontracts subject to DB entered into by prime contractors to verify that the prime contractor has required its subcontractors to include the applicable wage determinations.

(d) As provided in 29 CFR 1.6(f), DOL may issue a revised wage determination applicable to a subrecipient's contract after the award of a contract or the issuance of an ordering instrument if DOL determines that the subrecipient has failed to incorporate a wage determination or has used a wage determination that clearly does not apply to the contract or ordering instrument. If this occurs, the subrecipient shall either terminate the contract or ordering instrument and issue a revised solicitation or ordering instrument or incorporate DOL's wage determination retroactive to the beginning of the contract

or ordering instrument by change order. The subrecipient's contractor must be compensated for any increases in wages resulting from the use of DOL's revised wage determination.

### **3. Contract and Subcontract provisions.**

(a) The Recipient shall insure that the subrecipient(s) shall insert in full in any contract in excess of \$2,000 which is entered into for the actual construction, alteration and/or repair, including painting and decorating, of a treatment work under the CWSRF or a construction project under the DWSRF financed in whole or in part from Federal funds or in accordance with guarantees of a Federal agency or financed from funds obtained by pledge of any contract of a Federal agency to make a loan, grant or annual contribution (except where a different meaning is expressly indicated), and which is subject to the labor standards provisions of any of the acts listed in § 5.1 or the FY 2013 Continuing Resolution, the following clauses:

(1) Minimum wages.

(i) All laborers and mechanics employed or working upon the site of the work, will be paid unconditionally and not less often than once a week, and without subsequent deduction or rebate on any account (except such payroll deductions as are permitted by regulations issued by the Secretary of Labor under the Copeland Act (29 CFR part 3) ), the full amount of wages and bona fide fringe benefits (or cash equivalents thereof) due at time of payment computed at rates not less than those contained in the wage determination of the Secretary of Labor which is attached hereto and made a part hereof, regardless of any contractual relationship which may be alleged to exist between the contractor and such laborers and mechanics.

Contributions made or costs reasonably anticipated for bona fide fringe benefits under section 1(b)(2) of the Davis-Bacon Act on behalf of laborers or mechanics are considered wages paid to such laborers or mechanics, subject to the provisions of paragraph (a)(1)(iv) of this section; also, regular contributions made or costs incurred for more than a weekly period (but not less often than quarterly) under plans, funds, or programs which cover the particular weekly period, are deemed to be constructively made or incurred during such weekly period. Such laborers and mechanics shall be paid the appropriate wage rate and fringe benefits on the wage determination for the classification of work actually performed, without regard to skill, except as provided in § 5.5(a)(4). Laborers or mechanics performing work in more than one classification may be compensated at the rate specified for each classification for the time actually worked therein: Provided, that the employer's payroll records accurately set forth the time spent in each classification in which work is performed. The wage determination (including any additional classification and wage rates conformed under paragraph (a)(1)(ii) of this section) and the Davis-Bacon poster (WH-1321) shall be posted at all times by the contractor and its subcontractors at the site of the work in a prominent and accessible place where it can be easily seen by the workers.

Subrecipients may obtain wage determinations from the U.S. Department of Labor's [General Services Administration](#) website.

(ii)(A) The subrecipient(s), on behalf of EPA, shall require that any class of laborers or mechanics, including helpers, which is not listed in the wage determination and which is to be employed under the contract shall be classified in conformance with the wage determination. The State award official shall approve a request for an additional classification and wage rate and fringe benefits therefore only when the following criteria have been met:

(1) The work to be performed by the classification requested is not performed by a classification in the wage determination; and

(2) The classification is utilized in the area by the construction industry; and

(3) The proposed wage rate, including any bona fide fringe benefits, bears a reasonable relationship to the wage rates contained in the wage determination.

(B) If the contractor and the laborers and mechanics to be employed in the classification (if known), or their representatives, and the subrecipient(s) agree on the classification and wage rate (including the amount designated for fringe benefits where appropriate), documentation of the action taken and the request, including the local wage determination shall be sent by the subrecipient(s) to the State award official. The State award official will transmit the report, to the Administrator of the Wage and Hour Division, Employment Standards Administration, U.S. Department of Labor, Washington, DC 20210 and to the EPA DB Regional Coordinator concurrently. The Administrator, or an authorized representative, will approve, modify, or disapprove every additional classification request within 30 days of receipt and so advise the State award official or will notify the State award official within the 30-day period that additional time is necessary.

(C) In the event the contractor, the laborers or mechanics to be employed in the classification or their representatives, and the and the subrecipient(s) do not agree on the proposed classification and wage rate (including the amount designated for fringe benefits, where appropriate), the award official shall refer the request, and the local wage determination, including the views of all interested parties and the recommendation of the State award official, to the Administrator for determination. The request shall be sent to the EPA Regional Coordinator concurrently. The Administrator, or an authorized representative, will issue a determination within 30 days of receipt of the request and so advise the contracting officer or will notify the contracting officer within the 30-day period that additional time is necessary.

(D) The wage rate (including fringe benefits where appropriate) determined pursuant to paragraphs (a)(1)(ii)(B) or (C) of this section, shall be paid to all workers performing work in the classification under this contract from the first day on which work is performed in the classification.

(iii) Whenever the minimum wage rate prescribed in the contract for a class of laborers or mechanics includes a fringe benefit which is not expressed as an hourly rate, the contractor shall either pay the benefit as stated in the wage determination or shall pay another bona fide fringe benefit or an hourly cash equivalent thereof.

(iv) If the contractor does not make payments to a trustee or other third person, the contractor may consider as part of the wages of any laborer or mechanic the amount of any costs reasonably anticipated in providing bona fide fringe benefits under a plan or program, Provided, That the Secretary of Labor has found, upon the written request of the contractor, that the applicable standards of the Davis-Bacon Act have been met. The Secretary of Labor may require the contractor to set aside in a separate account assets for the meeting of obligations under the plan or program.

(2) Withholding. The subrecipient(s) shall upon written request of the EPA Award Official or an authorized representative of the Department of Labor, withhold or cause to be withheld from the contractor under this contract or any other Federal contract with the same prime contractor, or any other federally-assisted contract subject to Davis-Bacon prevailing wage requirements, which is held by the same prime contractor, so much of the accrued payments or advances as may be considered necessary to pay laborers and mechanics, including apprentices, trainees, and helpers, employed by the contractor or any subcontractor the full amount of wages required by the contract. In the event of failure to pay any laborer or mechanic, including any apprentice, trainee, or helper, employed or working on the site of the work, all or part of the wages required by the contract, the (Agency) may, after written notice to the contractor, sponsor, applicant, or owner, take such action as may be necessary to cause the suspension of any further payment, advance, or guarantee of funds until such violations have ceased.

(3) Payrolls and basic records.

(i) Payrolls and basic records relating thereto shall be maintained by the contractor during the course of the work and preserved for a period of three years thereafter for all laborers and mechanics working at the

site of the work. Such records shall contain the name, address, and social security number of each such worker, his or her correct classification, hourly rates of wages paid (including rates of contributions or costs anticipated for bona fide fringe benefits or cash equivalents thereof of the types described in section 1(b)(2)(B) of the Davis-Bacon Act), daily and weekly number of hours worked, deductions made and actual wages paid. Whenever the Secretary of Labor has found under 29 CFR 5.5(a)(1)(iv) that the wages of any laborer or mechanic include the amount of any costs reasonably anticipated in providing benefits under a plan or program described in section 1(b)(2)(B) of the Davis-Bacon Act, the contractor shall maintain records which show that the commitment to provide such benefits is enforceable, that the plan or program is financially responsible, and that the plan or program has been communicated in writing to the laborers or mechanics affected, and records which show the costs anticipated or the actual cost incurred in providing such benefits. Contractors employing apprentices or trainees under approved programs shall maintain written evidence of the registration of apprenticeship programs and certification of trainee programs, the registration of the apprentices and trainees, and the ratios and wage rates prescribed in the applicable programs.

(ii)(A) The contractor shall submit weekly, for each week in which any contract work is performed, a copy of all payrolls to the subrecipient, that is, the entity that receives the sub-grant or loan from the State capitalization grant recipient. Such documentation shall be available on request of the State recipient or EPA. As to each payroll copy received, the subrecipient shall provide written confirmation in a form satisfactory to the State indicating whether or not the project is in compliance with the requirements of 29 CFR 5.5(a)(1) based on the most recent payroll copies for the specified week. The payrolls shall set out accurately and completely all of the information required to be maintained under 29 CFR 5.5(a)(3)(i), except that full social security numbers and home addresses shall not be included on the weekly payrolls. Instead the payrolls shall only need to include an individually identifying number for each employee (e.g., the last four digits of the employee's social security number). The required weekly payroll information may be submitted in any form desired. Optional Form WH-347 is available for this purpose from the [Wage and Hour Division's](#) webpage or its successor site. The prime contractor is responsible for the submission of copies of payrolls by all subcontractors. Contractors and subcontractors shall maintain the full social security number and current address of each covered worker, and shall provide them upon request to the subrecipient(s) for transmission to the State or EPA if requested by EPA, the State, the contractor, or the Wage and Hour Division of the Department of Labor for purposes of an investigation or audit of compliance with prevailing wage requirements. It is not a violation of this section for a prime contractor to require a subcontractor to provide addresses and social security numbers to the prime contractor for its own records, without weekly submission to the subrecipient(s).

(B) Each payroll submitted shall be accompanied by a "Statement of Compliance," signed by the contractor or subcontractor or his or her agent who pays or supervises the payment of the persons employed under the contract and shall certify the following:

(1) That the payroll for the payroll period contains the information required to be provided under § 5.5(a)(3)(ii) of Regulations, 29 CFR part 5, the appropriate information is being maintained under § 5.5(a)(3)(i) of Regulations, 29 CFR part 5, and that such information is correct and complete;

(2) That each laborer or mechanic (including each helper, apprentice, and trainee) employed on the contract during the payroll period has been paid the full weekly wages earned, without rebate, either directly or indirectly, and that no deductions have been made either directly or indirectly from the full wages earned, other than permissible deductions as set forth in Regulations, 29 CFR part 3;

(3) That each laborer or mechanic has been paid not less than the applicable wage rates and fringe benefits or cash equivalents for the classification of work performed, as specified in the applicable wage determination incorporated into the contract.

(C) The weekly submission of a properly executed certification set forth on the reverse side of Optional Form WH-347 shall satisfy the requirement for submission of the "Statement of Compliance" required by paragraph (a)(3)(ii)(B) of this section.



(D) The falsification of any of the above certifications may subject the contractor or subcontractor to civil or criminal prosecution under section 1001 of title 18 and section 231 of title 31 of the United States Code.

(iii) The contractor or subcontractor shall make the records required under paragraph (a)(3)(i) of this section available for inspection, copying, or transcription by authorized representatives of the State, EPA or the Department of Labor, and shall permit such representatives to interview employees during working hours on the job. If the contractor or subcontractor fails to submit the required records or to make them available, the Federal agency or State may, after written notice to the contractor, sponsor, applicant, or owner, take such action as may be necessary to cause the suspension of any further payment, advance, or guarantee of funds. Furthermore, failure to submit the required records upon request or to make such records available may be grounds for debarment action pursuant to 29 CFR 5.12.

#### (4) Apprentices and trainees.

(i) Apprentices. Apprentices will be permitted to work at less than the predetermined rate for the work they performed when they are employed pursuant to and individually registered in a bona fide apprenticeship program registered with the U.S. Department of Labor, Employment and Training Administration, Office of Apprenticeship Training, Employer and Labor Services, or with a State Apprenticeship Agency recognized by the Office, or if a person is employed in his or her first 90 days of probationary employment as an apprentice in such an apprenticeship program, who is not individually registered in the program, but who has been certified by the Office of Apprenticeship Training, Employer and Labor Services or a State Apprenticeship Agency (where appropriate) to be eligible for probationary employment as an apprentice. The allowable ratio of apprentices to journeymen on the job site in any craft classification shall not be greater than the ratio permitted to the contractor as to the entire work force under the registered program. Any worker listed on a payroll at an apprentice wage rate, who is not registered or otherwise employed as stated above, shall be paid not less than the applicable wage rate on the wage determination for the classification of work actually performed. In addition, any apprentice performing work on the job site in excess of the ratio permitted under the registered program shall be paid not less than the applicable wage rate on the wage determination for the work actually performed. Where a contractor is performing construction on a project in a locality other than that in which its program is registered, the ratios and wage rates (expressed in percentages of the journeyman's hourly rate) specified in the contractor's or subcontractor's registered program shall be observed. Every apprentice must be paid at not less than the rate specified in the registered program for the apprentice's level of progress, expressed as a percentage of the journeymen hourly rate specified in the applicable wage determination. Apprentices shall be paid fringe benefits in accordance with the provisions of the apprenticeship program. If the apprenticeship program does not specify fringe benefits, apprentices must be paid the full amount of fringe benefits listed on the wage determination for the applicable classification. If the Administrator determines that a different practice prevails for the applicable apprentice classification, fringes shall be paid in accordance with that determination. In the event the Office of Apprenticeship Training, Employer and Labor Services, or a State Apprenticeship Agency recognized by the Office, withdraws approval of an apprenticeship program, the contractor will no longer be permitted to utilize apprentices at less than the applicable predetermined rate for the work performed until an acceptable program is approved.

(ii) Trainees. Except as provided in 29 CFR 5.16, trainees will not be permitted to work at less than the predetermined rate for the work performed unless they are employed pursuant to and individually registered in a program which has received prior approval, evidenced by formal certification by the U.S. Department of Labor, Employment and Training Administration. The ratio of trainees to journeymen on the job site shall not be greater than permitted under the plan approved by the Employment and Training Administration. Every trainee must be paid at not less than the rate specified in the approved program for the trainee's level of progress, expressed as a percentage of the journeyman hourly rate specified in the applicable wage determination. Trainees shall be paid fringe benefits in accordance with the provisions of the trainee program. If the trainee program does not mention fringe benefits, trainees shall be paid the full amount of fringe benefits listed on the wage determination unless the Administrator of the Wage and

Hour Division determines that there is an apprenticeship program associated with the corresponding journeyman wage rate on the wage determination which provides for less than full fringe benefits for apprentices. Any employee listed on the payroll at a trainee rate who is not registered and participating in a training plan approved by the Employment and Training Administration shall be paid not less than the applicable wage rate on the wage determination for the classification of work actually performed. In addition, any trainee performing work on the job site in excess of the ratio permitted under the registered program shall be paid not less than the applicable wage rate on the wage determination for the work actually performed. In the event the Employment and Training Administration withdraws approval of a training program, the contractor will no longer be permitted to utilize trainees at less than the applicable predetermined rate for the work performed until an acceptable program is approved.

(iii) Equal employment opportunity. The utilization of apprentices, trainees and journeymen under this part shall be in conformity with the equal employment opportunity requirements of Executive Order 11246, as amended, and 29 CFR part 30.

(5) Compliance with Copeland Act requirements. The contractor shall comply with the requirements of 29 CFR part 3, which are incorporated by reference in this contract.

(6) Subcontracts. The contractor or subcontractor shall insert in any subcontracts the clauses contained in 29 CFR 5.5(a)(1) through (10) and such other clauses as the EPA determines may be appropriate, and also a clause requiring the subcontractors to include these clauses in any lower tier subcontracts. The prime contractor shall be responsible for the compliance by any subcontractor or lower tier subcontractor with all the contract clauses in 29 CFR 5.5.

(7) Contract termination: debarment. A breach of the contract clauses in 29 CFR 5.5 may be grounds for termination of the contract, and for debarment as a contractor and a subcontractor as provided in 29 CFR 5.12.

(8) Compliance with Davis-Bacon and Related Act requirements. All rulings and interpretations of the Davis-Bacon and Related Acts contained in 29 CFR parts 1, 3, and 5 are herein incorporated by reference in this contract.

(9) Disputes concerning labor standards. Disputes arising out of the labor standards provisions of this contract shall not be subject to the general disputes clause of this contract. Such disputes shall be resolved in accordance with the procedures of the Department of Labor set forth in 29 CFR parts 5, 6, and 7. Disputes within the meaning of this clause include disputes between the contractor (or any of its subcontractors) and Subrecipient(s), State, EPA, the U.S. Department of Labor, or the employees or their representatives.

(10) Certification of eligibility.

(i) By entering into this contract, the contractor certifies that neither it (nor he or she) nor any person or firm who has an interest in the contractor's firm is a person or firm ineligible to be awarded Government contracts by virtue of section 3(a) of the Davis-Bacon Act or 29 CFR 5.12(a)(1).

(ii) No part of this contract shall be subcontracted to any person or firm ineligible for award of a Government contract by virtue of section 3(a) of the Davis-Bacon Act or 29 CFR 5.12(a)(1).

(iii) The penalty for making false statements is prescribed in the U.S. Criminal Code, 18 U.S.C. 1001.

#### **4. Contract Provision for Contracts in Excess of \$100,000.**

(a) Contract Work Hours and Safety Standards Act. The subrecipient shall insert the following clauses set forth in paragraphs (a)(1), (2), (3), and (4) of this section in full in any contract in an amount in excess of \$100,000 and subject to the overtime provisions of the Contract Work Hours and Safety Standards Act.

These clauses shall be inserted in addition to the clauses required by Item 3, above or 29 CFR 4.6. As used in this paragraph, the terms laborers and mechanics include watchmen and guards.

(1) Overtime requirements. No contractor or subcontractor contracting for any part of the contract work which may require or involve the employment of laborers or mechanics shall require or permit any such laborer or mechanic in any workweek in which he or she is employed on such work to work in excess of forty hours in such workweek unless such laborer or mechanic receives compensation at a rate not less than one and one-half times the basic rate of pay for all hours worked in excess of forty hours in such workweek.

(2) Violation; liability for unpaid wages; liquidated damages. In the event of any violation of the clause set forth in paragraph (b)(1) of this section the contractor and any subcontractor responsible therefore shall be liable for the unpaid wages. In addition, such contractor and subcontractor shall be liable to the United States (in the case of work done under contract for the District of Columbia or a territory, to such District or to such territory), for liquidated damages. Such liquidated damages shall be computed with respect to each individual laborer or mechanic, including watchmen and guards, employed in violation of the clause set forth in paragraph (b)(1) of this section, in the sum of \$10 for each calendar day on which such individual was required or permitted to work in excess of the standard workweek of forty hours without payment of the overtime wages required by the clause set forth in paragraph (b)(1) of this section.

(3) Withholding for unpaid wages and liquidated damages. The subrecipient shall upon the request of the EPA Award Official or an authorized representative of the Department of Labor, withhold or cause to be withheld, from any moneys payable on account of work performed by the contractor or subcontractor under any such contract or any other Federal contract with the same prime contractor, or any other federally-assisted contract subject to the Contract Work Hours and Safety Standards Act, which is held by the same prime contractor, such sums as may be determined to be necessary to satisfy any liabilities of such contractor or subcontractor for unpaid wages and liquidated damages as provided in the clause set forth in paragraph (a)(2) of this section.

(4) Subcontracts. The contractor or subcontractor shall insert in any subcontracts the clauses set forth in paragraph (b)(1) through (4) of this section and also a clause requiring the subcontractors to include these clauses in any lower tier subcontracts. The prime contractor shall be responsible for compliance by any subcontractor or lower tier subcontractor with the clauses set forth in paragraphs (b)(1) through (4) of this section.

(c) In addition to the clauses contained in Item 3, above, in any contract subject only to the Contract Work Hours and Safety Standards Act and not to any of the other statutes cited in 29 CFR 5.1, the Subrecipient shall insert a clause requiring that the contractor or subcontractor shall maintain payrolls and basic payroll records during the course of the work and shall preserve them for a period of three years from the completion of the contract for all laborers and mechanics, including guards and watchmen, working on the contract. Such records shall contain the name and address of each such employee, social security number, correct classifications, hourly rates of wages paid, daily and weekly number of hours worked, deductions made, and actual wages paid. Further, the Subrecipient shall insert in any such contract a clause providing that the records to be maintained under this paragraph shall be made available by the contractor or subcontractor for inspection, copying, or transcription by authorized representatives of the (write the name of agency) and the Department of Labor, and the contractor or subcontractor will permit such representatives to interview employees during working hours on the job.

## **5. Compliance Verification.**

(a) The subrecipient shall periodically interview a sufficient number of employees entitled to DB prevailing wages (covered employees) to verify that contractors or subcontractors are paying the appropriate wage rates. As provided in 29 CFR 5.6(a)(6), all interviews must be conducted in confidence. The subrecipient must use Standard Form 1445 (SF 1445) or equivalent documentation to memorialize the interviews. Copies of the SF 1445 are available from EPA on request.

(b) The subrecipient shall establish and follow an interview schedule based on its assessment of the risks of noncompliance with DB posed by contractors or subcontractors and the duration of the contract or subcontract. Subrecipients must conduct more frequent interviews if the initial interviews or other information indicates that there is a risk that the contractor or subcontractor is not complying with DB. Subrecipients shall immediately conduct necessary interviews in response to an alleged violation of the prevailing wage requirements. All interviews shall be conducted in confidence.

(c) The subrecipient shall periodically conduct spot checks of a representative sample of weekly payroll data to verify that contractors or subcontractors are paying the appropriate wage rates. The subrecipient shall establish and follow a spot check schedule based on its assessment of the risks of noncompliance with DB posed by contractors or subcontractors and the duration of the contract or subcontract. At a minimum, if practicable the subrecipient should spot check payroll data within two weeks of each contractor or subcontractor's submission of its initial payroll data and two weeks prior to the completion date the contract or subcontract. Subrecipients must conduct more frequent spot checks if the initial spot check or other information indicates that there is a risk that the contractor or subcontractor is not complying with DB. In addition, during the examinations the subrecipient shall verify evidence of fringe benefit plans and payments thereunder by contractors and subcontractors who claim credit for fringe benefit contributions.

(d) The subrecipient shall periodically review contractors and subcontractors use of apprentices and trainees to verify registration and certification with respect to apprenticeship and training programs approved by either the U.S Department of Labor or a state, as appropriate, and that contractors and subcontractors are not using disproportionate numbers of, laborers, trainees and apprentices. These reviews shall be conducted in accordance with the schedules for spot checks and interviews described in Item 5(b) and (c) above.

(e) Subrecipients must immediately report potential violations of the DB prevailing wage requirements to the EPA DB contact listed above and to the appropriate DOL Wage and Hour [District Office](#) or its successor site.

**AMERICAN IRON AND STEEL REQUIREMENT**

The Contractor acknowledges to and for the benefit of the \_\_\_\_\_ (“Purchaser”) and the State of Kentucky (the “State”) that it understands the goods and services under this Agreement are being funded with monies made available by the Clean Water State Revolving Fund and/or Drinking Water State Revolving Fund that have statutory requirements commonly known as “American Iron and Steel;” that requires all of the iron and steel products used in the project to be produced in the United States (“American Iron and Steel Requirement”) including iron and steel products provided by the Contractor pursuant to this Agreement.

The Contractor hereby represents and warrants to and for the benefit of the Purchaser and the State that (a) the Contractor has reviewed and understands the American Iron and Steel Requirement, (b) all of the iron and steel products used in the project will be and/or have been produced in the United States in a manner that complies with the American Iron and Steel Requirement, unless a waiver of the requirement is approved, and (c) the Contractor will provide any further verified information, certification or assurance of compliance with this paragraph, or information necessary to support a waiver of the American Iron and Steel Requirement, as may be requested by the Purchaser or the State.

Notwithstanding any other provision of this Agreement, any failure to comply with this paragraph by the Contractor shall permit the Purchaser or State to recover as damages against the Contractor any loss, expense, or cost (including without limitation attorney’s fees) incurred by the Purchaser or State resulting from any such failure (including without limitation any impairment or loss of funding, whether in whole or in part, from the State or any damages owed to the State by the Purchaser).

While the Contractor has no direct contractual privity with the State, as a lender to the Purchaser for the funding of its project, the Purchaser and the Contractor agree that the State is a third-party beneficiary and neither this paragraph (nor any other provision of this Agreement necessary to give this paragraph force or effect) shall be amended or waived without the prior written consent of the State.

## Sample Certification

The following information is provided as a sample letter of step certification for AIS compliance. Documentation must be provided on company letterhead.

Date

Company Name  
Company Address  
City, State Zip

Subject: American Iron and Steel Step Certification for Project (XXXXXXXXXXXX)

I, (company representative), certify that the (melting, bending, coating, galvanizing, cutting, etc.) process for (manufacturing or fabricating) the following products and/or materials shipped or provided for the subject project is in full compliance with the American Iron and Steel requirement as mandated in EPA's State Revolving Fund Programs.

Item, Products and/or Materials:

1. XXXX
2. XXXX
3. XXXX

Such process took place at the following location:

\_\_\_\_\_

If any of the above compliance statements change while providing material to this project we will immediately notify the prime contractor and the engineer.

Signed by company representative

**SECTION 01010****SUMMARY****PART 1 - GENERAL****1.01 SUMMARY**

- A. This Section includes the following:
1. Work covered by the Contract Documents.
  2. Sequence of Operations.
  3. Utility Shutdowns
  4. Tie-ins and Disconnections
  5. Temporary Systems
  6. Use of premises.
  7. Specification formats and conventions.

**1.02 WORK COVERED BY CONTRACT DOCUMENTS**

- A. The Contractor shall provide all material, services, labor, tools and equipment, necessary to construct this project. The following is a brief description of the major work items included in the contract: approximately 6,400 LF of 12", 1,650 LF of HDPE Directional Bore, 6,200 LF of 6" and 1,300 LF of 4" water main, two new master meter and all related appurtenances as shown on the DRAWINGS and described in the SPECIFICATIONS.

**1.03 SEQUENCE OF OPERATIONS**

Not used

**1.04 UTILITY SHUTDOWNS**

- A. One-week advance notice to the Owner is required prior to performing any utility shutdown unless of an emergency in nature.
- B. Contractor shall know where all existing valves are located on the water line replacement section and shall be able to shut down expeditiously in case of line breaks.
- C. The existing water line is shown as an approximate location on the plans. The contractor shall use extreme caution while laying line not to break existing line and interrupt service to owner's existing customers.
- D. Length of shutdowns on the existing system should be pre-determined before construction by owner, engineer, and contractor.

**1.05 TIE-INS AND DISCONNECTIONS**

- A. Contractor shall furnish all materials and shall provide excavation, de-watering, scaffolding and support operations to support tie-ins.

**1.06 TEMPORARY SYSTEM (S)**

- A. All temporary water lines and hoses shall be depressurized and all temporary electrical lines and equipment de-energized when not in use and at the end of each workday.

**1.07 SPECIFICATION FORMATS AND CONVENTIONS**

- A. Specification Format: The Specifications are organized into Division and Sections using the 17-division format.

**PART 2 - PRODUCTS**

Not used

**PART 3 - EXECUTION**

Not used

- END OF SECTION -



**SECTION 01015****WORK SEQUENCE****PART 1 - GENERAL****1.01 WORK INCLUDED**

The Contractor shall submit to the Engineer for review and acceptance a complete schedule of his proposed sequence of construction operations and payment prior to commencement of work. However, the Engineer shall not accept a construction schedule that fails to utilize the entire time allocated for the construction of the water treatment plant. This schedule requirement in no way prevents the Contractor from completing the project in a shorter time frame than scheduled. The construction schedule shall be submitted and approved by the Owner prior to the submittal of the first partial payment request. A revised construction schedule shall be submitted with every subsequent partial payment request. This revised schedule must be approved by the Owner prior to payment

**1.02 RELATED WORK**

- A. Section 01010 - Summary of Work.

**PART 2 - PRODUCTS (Not Applicable)****PART 3 - EXECUTION (Not Applicable)**

- END OF SECTION -

**SECTION 01016****OCCUPANCY****PART 1 - GENERAL****1.01 WORK INCLUDED**

- A. The Contractor shall be aware that after each major portion of the project is completed, the Contractor shall notify the Engineer that those specific operations are complete and prior to replacing that portion of the work into service shall request an interim inspection of the work to be returned to or placed into service.
- B. The interim inspection requested by the Contractor shall not preclude or supersede the final inspection of the project or reduce the Contractor's responsibility for the completed portion prior to final acceptance of the work by the Owner.
- C. The Contractor shall provide all necessary temporary controls and other items required for operation of all work placed into service prior to final acceptance as required. At such time as new controls, etc. are complete and functioning, the Contractor shall remove all temporary installed items.

- END OF SECTION -

**SECTION 01025****MEASUREMENT AND PAYMENT****PART 1 - GENERAL****1.01 WORK INCLUDED**

The Contractor shall furnish all necessary labor, machinery, tools, apparatus, equipment, materials, equipment, service, other necessary supplies and perform all work, including all excavation, backfilling, & cleanup (without additional compensation, except where specifically set out in these specifications) at the unit or lump sum prices for the following items.

**1.02 PROGRESS AND PAYMENTS SCHEDULES**

A. Within ten (10) days after the date of formal execution of the AGREEMENT, the Contractor shall prepare and submit to the Engineer, for approval, a construction schedule which depicts the Contractor's plan for completing the contract requirements and show work placement in dollars versus contract time. The Contractor's construction schedule must be approved by the Engineer before any payments will be made on this contract.

B. Within ten (10) days after the date of formal execution of the CONTRACT AGREEMENT, the Contractor shall prepare and submit to the Engineer, for approval, a periodic estimate which depicts the Contractor's cost for completing the contract requirements and show by major unit of the project work, the Contractor's dollar value for the material and the labor (two separate amounts) to be used as a basis for the periodic payments. The Contractor's periodic estimate must be approved by the Engineer before any payments will be made on this contract.

C. The Engineer's decision as to sufficiency and completeness of the Contractor's construction schedule and periodic estimate will be final.

D. The Contractor must make current, to the satisfaction of the Engineer, the construction schedule and periodic estimate each time he requests a payment on this contract.

E. The Contractor's construction schedule and periodic estimate must be maintained at the construction site available for inspection and shall be revised to incorporate approved change orders as they occur.

F. When the Contractor requests a payment on this contract, it must be on the approved periodic estimate and be current. Further, the current periodic estimate and construction schedule (both updated and revised) shall be submitted for review and approval by the Engineer before monthly payments will be made by the Owner. The Contractor shall submit six (6) current copies of each (periodic estimate and construction schedule) when requesting payment.

**1.03 CONDITIONS FOR PAYMENT**

A. The Owner will make payments for acceptable work in place and materials properly stored on-site. The value of payment shall be as established on the approved construction schedule and periodic estimate, EXCEPT the Owner will retain five percent (5%) of the work in place and a percentage as hereinafter listed for items properly stored or untested.

B. No payment will be made for stored materials unless a proper invoice form the supplier is attached to the pay request. Further, no item whose value is less than \$1,000 will be considered as stored materials for pay purposes.

C. Payment for stored materials that are submitted with each monthly pay request will require documentation from the material supplier indicating that those items have been paid. Proof of payment for stored materials shall be in the form of "paid invoice" receipts or cancelled checks. Failure to provide adequate documentation will result in delays in processing subsequent pay requests.

D. Payment for pipeline items shall be limited to eighty percent (80%) of the bid price until the pipeline items have been tested and clean up has been completed and accepted by the Engineer.

E. Payment for equipment items shall be limited to eighty-five percent (85%) of their scheduled value (materials portion only) until they are set in place. Eighty-five percent (85%) for stored materials and equipment shall be contingent on proper on-site storage as recommended by the manufacturer or required by the Engineer.

F. Payment for equipment items set in place shall be limited to ninety percent (90%) of their scheduled value until they are ready for operation and have been certified by the manufacturer. Ninety percent (90%) payment for installed equipment shall be contingent on proper routine maintenance of the equipment in accordance with the manufacturer's recommendations.

G. Payment for equipment items set in place and ready for operation shall be limited to ninety-five percent (95%) of their scheduled value until all acceptance tests have been completed and the required manufacturer's pre-startup operator's training has been completed.

H. Payment for the labor portion of equipment items will be subject only to the degree of completeness and the appropriate retainage.

I. The retainage shall be an amount equal to 5% of said estimate. The retainage on the equipment items shall be 5% as defined hereinbefore.

J. If at any time thereafter when the progress of the WORK is not satisfactory or determine that the Contractor is not making satisfactory progress, additional amounts may be retained.

#### **1.04 DETERMINATION OF THE VALUE OF EXTRA (ADDITIONAL) OR OMITTED WORK**

A. The value of extra (additional) or omitted work shall be determined in one or more of the following ways:

1. On the basis of the actual cost of all the items of labor (including on-the-job supervision), materials and use of equipment, plus a maximum 20% for added work or a minimum 20% for deleted work which shall cover the Contractor's general supervision, overhead and profit. In case of subcontracts, the sum of total overhead amounts of the subcontractors and Contractor, plus total profit amounts for the subcontracts and Contractor shall not exceed 25% of the cost. Subcontractors shall be limited to 15% and Contractors shall be limited to 10% for combined overhead and profit. The cost of labor shall include required insurance, taxes and fringe benefits. Contractor to provide detailed breakdown of all cost as justification of change in work. Equipment costs shall be based on current rental rates in the areas where the work is being performed, but in no case shall such costs be greater than the current rates published by the Associated Equipment Distributors, Chicago, Illinois.

2. By estimate and acceptance in a lump sum.
3. By unit prices named in the Contract or subsequently agreed upon.

B. Provided, however, that the cost or estimated cost of all extra (additional) work shall be determined in advance of authorization by the Engineer and approved by the Owner.

C. All extra (additional) work shall be executed under the conditions of the original Contract. Any claim for extension of time shall be adjusted according to the proportionate increase or decrease in the final total cost of the work unless negotiated on another basis.

D. Except for over-runs in contract unit price items, no extra (additional) work shall be done except upon a written change Order from the Engineer, and no claim on the part of the Contractor for pay for extra (additional) work shall be recognized unless so ordered in writing by the Engineer.

## **PART 2 - PRODUCTS**

### **2.01 WATER MAIN**

A. Payment for installing the water main shall be made at the contract unit price per linear foot, complete in place, which shall include compensation for furnishing pipe, trenching (including rock excavation), earth or Class I material bedding, thrustblocking, earth backfill, fittings, valve markers, tracer wire, (crushed stone, bituminous (HMA), and/or concrete pavement replacement, unless specified on plan sheets), boring without casing under bituminous and concrete drives and roadways, sidewalk repair or replacement, laying in/with/parallel a crushed stone, bituminous, or concrete roadway with appropriate backfill, nitrile gaskets when within 200 LF of a fuel tank/container, disinfecting, clean up and restoration of all disturbed areas, including seeding and mulching as required, testing and all appurtenances required. The quantity of water mains to be paid for shall be the length of the completed line as measured along its centerline without any deduction for lengths of fittings, valves or other appurtenances.

B. Payment for installing Field Lok® gaskets on all major slopes and when going through casing pipes shall be included in this bid item.

C. Payment for installing the water main shall include locating existing water main ahead of (approximately 40' intervals) the new water main installation when running parallel.

D. The temporary removal and re-setting of mailboxes and fencing shall be incidental to laying the water main. There will be no additional compensation for this work.

E. Use of crushed stone bedding on the water main will be determined in the field by the engineer if quality bedding material is not available. Please figure bedding costs into the water line price.

F. Payment for installing the water main shall include grip ring glands for all fittings. Complete in Place.

### **2.02 DIRECTIONAL BORED HDPE PIPE**

A. Payment for all directional bored piping shall include furnishing and installing pipe or conduit, from plan point of beginning to plan point of ending at plan depth, removal of excavated materials and spoils, removal and disposal of drilling fluids, backfilling, and complete restoration of the site. Bundled product in a single bore will be paid for as a single bore based on the required drill bit head or back reamer head size. Separate  
20016/01/2021

MEASUREMENT AND PAYMENT

payment shall not be made for individual products in a bundle. The installation and attachment of tracer wire shall be included in the cost of the bore and will not be paid for separately.

B. No payment shall be made for failed bore paths, injection of flowable fill, products taken out of service or incomplete installations.

### **2.03 HIGHWAY BORE and OPEN CUT W/STEEL CASING PIPE**

A. Payment for water mains crossing the highway, roadway, driveway or other areas shown on the plans shall include the respective encasement pipe and will be paid for at the contract unit price per linear foot of encasement pipe for the various sizes and types. This work shall include the encasement pipe, complete in place with fittings, thrust blocking, spacers, tracer wire, end seals, skids, proper backfill and all items necessary for its construction and installation. Carrier pipe shall be paid separately under item 2.01.

B. No payment shall be made for failed bore paths or incomplete installations.

### **2.04 GATE VALVES AND BOXES**

Payment for furnishing and installing gate valves, valve boxes and lids in water mains shall be made at the contract unit price each, complete in place, which shall include compensation for furnishing, hauling, trenching (including rock excavation), bedding, laying, jointing and backfilling.

### **2.05 CONNECTION TO EXISTING WATER MAIN**

A. Payment for connecting to an existing water main at the location listed shall include all materials and labor necessary for making a connection to the existing water main as shown on the plans. Payment will be made per connection and will include but not limited to, mechanical joint fittings, tapping valve, stainless steel tapping sleeve, and box.

A. Connections at dry tie-ins or without use of wet tap method will be paid per connection to the existing water main and will include but not limited to, mechanical joint fittings and a maximum of 20 LF of pipe. Size of the piping will be paid as one price and will not be differentiated.

### **2.06 FLUSHING/BLOWOFF HYDRANT ASSEMBLY**

A. Payment for flushing assemblies shall be made at the unit price, complete in place, which shall include all piping, fittings, gate valve and valve box and cover, 6 feet of connecting pipe, anchor couplings, drainage bed, wrenches, and all other materials and labor necessary to complete the installation.

### **2.07 CUT AND PLUG EXISTING WATER MAIN**

Payment for cutting and plugging the existing water main shall include all materials and labor necessary for completing the disconnection of the existing water line. This will be paid per cut and plug and will include piping, mechanical joint cap, grip rings, concrete blocking and other appurtenances required to complete the installation. Size of the piping will be paid as one price and will not be differentiated.

### **2.08 PLUG FOR FUTURE CONNECTION**

Payment for plugging for future connection shall include all materials and labor necessary for completing the installation of a plug suitable to be removed in the future without interruption to service. This will be paid per installation and will include stub of one full joint of piping, mechanical joint cap, grip rings, concrete blocking (dead man) and other appurtenances required to complete the installation. Size of the piping will be paid as one price and will not be differentiated.

## **2.09 KY 259 NORTH MASTER METER/CONTROL BUILDING**

Payment shall be lump sum for the master meter station as shown on the drawings, including a concrete block building, master meters, chlorine analyzer, HVAC unit, internal piping including painting, internal valves, external piping and valves within 10ft of building, heater, dehumidifier, electrical service pole including all equipment, site grading, site access road, drainage pipe, backfilling, seeding, cleanup, and all other items shown on the contract drawings necessary for a complete installation.

## **2.10 SCADA IMPROVEMENTS ALLOWANCE**

New SCADA (Supervisory Control and Data Acquisition) control system equipment to be installed at the KY 259 North Master Meter/Control Building. The new SCADA system shall include hardware, software, instrumentation, and other associated installation services. (Refer to Specification Section 01210)

## **PART 3 - EXECUTION**

### **3.01 PAY ITEMS**

A. The pay items listed herein before refer to the items listed in the Bid Schedule and cover all of the pay items under the base bid for this contract.

B. Any and all other items of work listed in the specifications or shown on the Contract Drawings for this contract shall be considered incidental to and included in those pay items.

### **3.02 QUANTITIES OF ESTIMATE**

A. Wherever the estimated quantities of work to be done and materials to be furnished under this Contract are shown in any of the documents, including the Bid Proposal, they are given for use in comparing bids and the right is especially reserved except as herein otherwise specifically limited, to increase or diminish them as may be deemed reasonably necessary or desirable by the Owner to complete the work contemplated by this Contract, and such increase or diminution shall not give cause for claims or liability for damages. The Engineer will not be financially responsible for any omissions from the Contract Documents and therefore not included by the Contractor in his proposal.

B. Aerial photographs utilized for plan sheets in the Contract Documents are indicated at an approximate scale and shall not be scaled for quantity take-offs. The pipeline quantities listed in the Bid Schedule are given for use in comparing bids and may not be the actual quantities to be installed. It is the Contractor's responsibility to field verify the length and quantities of pipeline to be installed prior to the ordering of materials. Payment on unit price contracts are based on actual quantities installed. The Owner or Engineer will not be financially responsible for any shortage of pipe or overrun of pipe ordered for the pipeline quantities.

C. The actual quantities of all materials to be used for this project shall be field verified prior to the Contractor ordering the necessary materials. The quantity listed in the bid schedule is given for use in comparing bids and may increase or diminish as may be deemed necessary or as directed by the Owner. Any such increase or diminution shall not give cause for claims or liability for damages. The Engineer or Owner will not be financially responsible for any charges incurred for restocking of materials ordered.

- END OF SECTION -

**SECTION 01030****LABOR PROVISIONS****PART 1 - GENERAL****1.01 WORK INCLUDED**

- A. The Contractor shall conform to all provisions of the Kentucky Department of Labor, Wage Decisions (latest revisions), relative to minimum wages and hours as they may apply to the work to be accomplished under these specifications.
- B. In addition to the above, certain Federal laws and regulations shall govern the work and shall supplement or supplant the Kentucky Department of Labor Wage Decisions cited above, as the case may be.

**1.02 RELATED SECTIONS**

- A. Section 3 - Part 1 Hours and Wages

**1.03 WAGE RATES**

**Prevailing wage rates DO apply to this project.** The Contractor will utilize, when feasible, local labor and will pay them wages commensurate with the wages prevailing in the Community.

**1.04 LABOR PREFERENCE**

Where feasible, the Contractor will utilize local labor.

**1.05 HOURS OF WORK**

- A. Hours of work shall be as set out in Kentucky Department of Labor Wage Decisions (latest revisions); that is, not more than eight (8) hours in one calendar day, nor more than forty (40) hours in one week, except in case of emergency caused by fire, flood or damage to life and property.
- B. Any laborer, workman, mechanic, helper, assistant or apprentice working in excess of forty (40) hours per week, except in case of emergency, shall be paid not less than 1-1/2 times the wage rate. Whenever overtime work is scheduled, the Contractor shall give prior notice to the Owner.

**1.06 OVERTIME WORK**

- A. Any overtime work (greater than 40 hours in one week) shall require the Contractor to reimburse the Owner for additional resident inspection costs at an hourly rate of \$65.00 per hour.

- END OF SECTION -



**SECTION 01040****COORDINATION****PART 1 - GENERAL****1.01 COORDINATION OF THE WORK**

The Contractor shall coordinate the work of all the crafts, trades and subcontractors engaged on the Work, and he shall have final responsibility as regards the schedule, workmanship and completeness of each and all parts of the Work.

All crafts, trades and subcontractors shall be made to cooperate with each other and with others as they may be involved in the installation of work which adjoins, incorporates, precedes or follows the work of another. It shall be the Contractor's responsibility to point out areas of cooperation prior to the execution of subcontract agreements and the assignment of the parts of the Work. Each craft, trade and subcontractor shall be made responsible to the Owner, for furnishing embedded items, giving directions for doing all cutting and fitting, making all provisions for accommodating the Work, and for protecting, patching, repairing and cleaning as required to satisfactorily perform the Work.

The Contractor shall be responsible for all cutting, digging and other action of his subcontractors and workmen. Where such action impairs the safety or function of any structure or component of the Project, the Contractor shall make such repairs, alterations and additions as will, in the opinion of the Engineer, bring said structure or component back to its original design condition at no additional cost to the Owner.

Each subcontractor is expected to be familiar with the General Requirements and all sections of the Detailed Specifications for all other trades and to study all Drawings applicable to his work to the end that complete coordination between trades will be affected. Each Contractor shall consult with the Engineer if conflicts exist on the Drawings.

The Contractor shall conduct testing of water lines in a timely manner. The Contractor shall make provisions to test all water lines regardless of whether or not planned pump stations have been delivered and/or installed.

- END OF SECTION -

**SECTION 01200****SUBSTITUTIONS****PART 1 - GENERAL****1.01 DESCRIPTION OF REQUIREMENTS**

- A. General: Substitution of materials and/or equipment is defined in Paragraph 6.7.1 of the General Conditions and more fully hereinafter.
- B. Definitions: Definitions used in this paragraph are not intended to negate the meaning of other terms used in the Contract Documents including such terms as "specialties", "systems", "structure", "finishes", "accessories", "furnishings", "special construction" and similar terms. Such terms are self-explanatory and have recognized meanings in the construction industry.
1. "Products" are items purchased for incorporation in the Work, regardless of whether they were specifically purchased for the project or taken from the Contractor's previously purchased stock. The term "product" as used herein includes the terms "material", "equipment", "system" and other terms of similar intent.
  2. "Named Products" are products identified by use of the manufacturer's name for a product, including such items as a make or model designation, as recorded in published product literature, of the latest issue as of the date of the Contract Documents.
  3. "Materials" are products that must be substantially cut, shaped, worked, mixed, finished, refined or otherwise fabricated, processed, or installed to form units of work.
  4. "Equipment" is defined as a product with operational parts, regardless of whether motorized or manually operated, and in particular, a product that requires service connections such as wiring or piping.
- C. Substitutions: The Contractor's requests for changes in the products, materials, equipment and methods of construction required by the Contract Documents are considered requests for "substitutions", and are subject to the requirements specified herein. The following are not considered as substitutions:
1. Revisions to the Contract Documents, where requested by the Owner, Engineer are considered as "changes" not substitutions.
  2. Substitutions requested during the bidding period, which have been accepted prior to the Contract Date, are included in the Contract Documents and are not subject to the requirements for substitutions as herein specified.
  3. Specified Contractor options on products and construction methods included in the Contract Documents are choices available to the Contractor and are not subject to the requirements for substitutions as herein specified.

4. Except as otherwise provided in the Contract Documents, the Contractor's determination of and compliance with governing regulations and orders as issued by governing authorities do not constitute "substitutions" and do not constitute a basis for change orders.
- D. Standards: Refer to Division-1 section "Definitions and Standards" for applicability of industry standards to the products specified for the project, and for acronyms used in the text of the specification sections.

## **1.02 RELATED DOCUMENTS**

- A. Drawings and general provisions of Contract, including General and Supplementary Conditions and other Division-1 Specification sections, apply to Work of this Section.

## **1.03 SUBMITTALS**

The information required to be furnished for evaluation of product substitution will be as follows:

- A. Performance capabilities, and materials and construction details will be evaluated based upon conformance with the Specifications. Products that do not conform with the Specification shall not be accepted.
- B. Manufacturer's production and service capabilities, and evidence of proven reliability will be acceptable if the following is furnished.
1. Written evidence that the manufacturer has not less than (3) years experience in the design and manufacture of the substitute product.
  2. Written evidence of at least one application, of a type and size similar to the proposed substitute product, in successful operation in a wastewater treatment plant for a period of at least one year.
  3. In lieu of furnishing evidence of a manufacturer's Experience and successful operation of an application of the product to be substituted, the Contractor has the option of furnishing a cash deposit or bond which will guarantee replacement if the product the furnished does not satisfy the other requirements specified in this section. The amount of each deposit or bond will be subject to the approval.
- C. Specific reference to characteristics either superior or inferior to specified requirements will be evaluated based on their net effect on the project. Products with any characteristics inferior to those specified will not be acceptable unless offset by characteristics that, in the opinion of the Engineer, will cause the overall effect of the product on the project to be at least equal to that of those specified.

## **1.04 QUALITY ASSURANCE**

- A. Source Limitations: To the fullest extent possible, provide products of the same generic kind, from a single source, for each unit of work.
- B. Compatibility of Options: Compatibility of products is a basic requirement of product selection. When the Contractor is given the option of selecting between two or more products for use on the project, the product selected must be compatible with other products previously selected, even if the products previously selected were also Contractor options. The complete compatibility between the various choices available to the Contractor is not assured by the various requirements of the Contract Documents, but must be provided by the Contractor.

- C. The detailed estimate of operating and maintenance costs will be evaluated based on comparison with similar data on the specified products. Proposed substitute products which have an operating and maintenance cost that, in the opinion of the Engineer, exceeds that of the specified products will not be considered equal and will not be acceptable.

## **1.05 PRODUCT DELIVERY, STORAGE, AND HANDLING**

General: Deliver, store, and handle products in accordance with manufacturer's recommendations, using means and methods that will prevent damage, deterioration and loss, including theft. Control delivery schedules to minimize long-term storage at the site and to prevent overcrowding of construction spaces. In particular coordinate delivery and installation to ensure minimum holding or storage times for items known or recognized to be flammable, hazardous, easily damaged, or sensitive to deterioration, theft and other sources of loss.

- A. Deliver products to the site in the manufacturer's sealed container or other packaging system, complete with labels and instructions for handling, storing, unpacking, protecting and installing.
- B. Store products at the site in a manner that will facilitate inspection and measurement of quantity or counting of units.
- C. Store heavy materials away from the project structure in a manner that will not endanger the supporting construction.

## **PART 2 - PRODUCTS**

### **2.01 GENERAL PRODUCT COMPLIANCE**

- A. General: Requirements for individual products are indicated in the Contract Documents; compliance with these requirements is in itself a Contract Requirement. These requirements may be specified in any one of several different specifying methods, or in any combination of these methods. These methods include the following:
  1. Proprietary.
  2. Descriptive.
  3. Performance.
  4. Compliance with Reference Standards.

Compliance with codes, compliance with graphic details, allowances, and similar provisions of the Contract Documents also have a bearing on the selection process.

- B. Procedures for Selecting Products: Contractor's options in selecting products are limited by requirements of the Contract Documents and governing regulations. They are not controlled by industry traditions or procedures experienced by the Contractor on previous construction projects.

### **2.02 SUBSTITUTIONS**

- A. Conditions: Contractor's request for substitution will be received and considered when extensive revisions to the Contract Documents are not required, when the proposed changes are in keeping with the general intent of the Contract Documents, when the request are timely, fully documented and properly submitted, and when one or more of the following

conditions is satisfied, all as judged by the Engineer; otherwise the requests will be returned without action except to record non-compliance with these requirements.

1. The Engineer will consider a request for substitution where the request is directly related to an "or equal" clause or similar language in the Contract Documents.
  2. The Engineer will consider a request for substitution where the specified product or method cannot be provided within the Contract Time. However, the request will not be considered if the product or method cannot be provided as a result of the Contractor's failure to pursue the work promptly or to coordinate the various activities properly.
  3. The Engineer will consider a request for substitution where the specified product or method cannot receive necessary approval by a governing authority, and the requested substitution can be approved.
  4. The Engineer will consider a request for a substitution where a substantial advantage is offered the Owner, in terms of cost, time, energy conservation or other considerations of merit, after deducting offsetting responsibilities the Owner may be required to bear. These additional responsibilities may include such considerations as additional compensation to the Engineer for redesign and evaluation services, the increased cost of other work by the Owner or separate contractors, and similar considerations.
  5. The Engineer will consider a request for substitution when the specified product or method cannot be provided in a manner which is compatible with other materials of the work, and where the Contractor certifies that the substitution will overcome the incompatibility.
  6. The Engineer will consider a request for substitution when the specified product or method cannot be properly coordinated with other materials in the work, and where the Contractor certifies that the proposed substitution can be properly coordinated.
  7. The Engineer will consider a request for substitution when the specified product or method cannot receive a warranty as required by the Contract Documents and where the Contractor certifies that the proposed substitution receive the required warranty.
  8. The Contractor shall reimburse the Owner any costs for review by the Engineer of proposed product substitutions which require major design changes, as determined by the Owner, to related of adjacent work made necessary by the proposed substitutions.
- B. Work-Related Submittals: Contractor's submittal of and the Engineer's acceptance of shop drawings, product data or samples which relate to work not complying with requirements of the Contract Documents, does not constitute an acceptable or valid request for a substitution, nor approval thereof.

### **2.03 GENERAL PRODUCT REQUIREMENTS**

- A. General: Provide products that comply with the requirements of the Contract Documents and that are undamaged and, unless otherwise indicated, unused at the time of installation. Provide products that are complete with all accessories, trim, finish, safety guards and other devices and details needed for a complete installation and for the intended use and effect.
1. Standard Products: Where they are available, provide standard products of types that have been produced and used successfully in similar situations on other projects.

2. Continued Availability: Where, because of the nature of its application, the Owner is likely to need replacement parts or additional amounts of a product at a later date, either for maintenance and repair or replacement, provide standard, domestically produced products for which the manufacturer has published assurances that the products and its parts are likely to be available to the Owner at a later date.
- B. Nameplates: Except as otherwise indicated for required labels and operating data, do not permanently attach or imprint manufacturer's or producer's nameplates or trademarks on exposed surfaces of products which will be exposed to view either in occupied spaces or on the exterior of the completed project.
1. Labels: Locate required product labels and stamps on a concealed surface or, where required for observation after installation, on an accessible surface which, in occupied spaces, is not conspicuous.
  2. Equipment Nameplates: Provide permanent nameplate on each item of service-connected or power operated equipment. Locate the nameplate on an easily accessible surface which is inconspicuous in occupied spaces. The nameplate shall contain the following information and other essential operating data.
    - a. Name of manufacturer
    - b. Name of product
    - c. Model number
    - d. Serial number
    - e. Capacity
    - f. Speed
    - g. Ratings

## **PART 3 - EXECUTION**

### **3.01 INSTALLATION OF PRODUCTS**

- A. General: Except as otherwise indicated in individual sections of these Specifications, comply with the manufacturer's instructions and recommendations for installation of the products in the applications indicated. Anchor each product securely in place, accurately located and aligned with other work. Clean exposed surfaces and protect surfaces as necessary to ensure freedom from damage and deterioration at Time of Acceptance.

END OF SECTION

**SECTION 01210****ALLOWANCES****PART 1 - GENERAL****1.1 DESCRIPTION**

- A. This Section includes administrative and procedural requirements governing allowances. Certain items are specified in the Contract Documents by allowances. Allowances have been established in lieu of additional requirements and to defer selection of actual materials and equipment to a later date when additional information is available for evaluation. If necessary, additional requirements will be issued by Change Order.
- B. Types of allowances include the following:
1. Lump-sum allowances.
  2. Unit-cost allowances.
- C. The following allowances shall be included in the Contractors Bid:
1. Supervisory Control and Data Acquisition System Improvements:

New SCADA (Supervisory Control and Data Acquisition) control system equipment to be installed at the listed sites for the Grayson County Water District Master. The new SCADA system shall include hardware, software, instrumentation, and other associated installation services as detailed in the attached scope of work. All work under the allowance is to be performed by HTI contact Jeff Morris (270) 274-4632. See attached Scope of Work.

Allowance Amount: **\$ 20,843.00**

**1.2 RELATED DOCUMENTS**

- A. Drawings and general provisions of the Contract, including General and Supplementary Conditions and other Division 1 Specification Sections, apply to this Section

**1.3 ELECTION AND PURCHASE**

- A. At the earliest practical date after award of the Contract, advise Engineer of the date when final selection and purchase of each product or system described by an allowance must be completed to avoid delaying the Work.
- B. At Engineer's request, obtain proposals for each allowance for use in making final selections and include recommendations that are relevant to performing the Work.
- C. Purchase products and systems selected by the Engineer from the designated supplier.
- D. When an allowance is included for a third party, Independent Testing Agency, the Testing Agency shall be determined by the Owner.

**1.4 SUBMITTALS**

- A. Submit proposals for purchase of products or systems included in allowances, in the form specified for Change Orders.
- B. Submit invoices or delivery slips to show actual quantities of materials delivered to the site for use in fulfillment of each allowance.
- C. Coordinate and process submittals for allowance items in same manner as for other portions of the Work.
- D. Submit copy of all testing results as provided by the Testing Agency to the Engineer.

**1.5 COORDINATION**

- A. Coordinate allowance items with other portions of the Work. Furnish templates as required to coordinate installation.

**1.6 LUMP-SUM & UNIT-COST ALLOWANCES**

- A. Allowances shall include cost to Contractor of specific products and materials ordered by Owner under allowance and shall include taxes, freight, and delivery to the project site.
- B. Contractor's costs for receiving and handling at Project site, labor, coordination, concrete cylinder preparation and shipping, installation, overhead and profit, and similar costs related to products and materials ordered by Owner under allowance shall be included as part of the Contract Sum and not part of the allowance.

**1.7 UNUSED MATERIALS**

- A. Contractor shall be responsible for returning unused materials purchased under an allowance to the manufacturer or supplier for credit to Owner, after installation has been completed and accepted.
- B. When it is not economically practical to return material for credit, Contractor shall be responsible for preparing and delivering unused material to Owner's designated storage location. Otherwise, disposal of unused material shall be Contractor's responsibility.

**PART 2 - PRODUCTS (Not Applicable)****PART 3 - EXECUTION****3.1 EXAMINATION**

- A. Examine products covered by an allowance promptly on delivery for damage or defects. Return damaged or defective products to manufacturer for replacement.

**3.2 PREPARATION**

- A. Coordinate materials and their installation for each allowance with related materials and installations to ensure that each allowance item is completely integrated and interfaced with related work.

END OF SECTION



NOTES:

- 1. TWO METERS CONNECTION "TYPICAL" IS SHOWN
- 2. IF AMR/AMI ENDPOINTS ARE NOT USED, DUPLEXER CAN BE ELIMINATED

# ENCODER TYPE FLOW METER SCADA RTU CONNECTIONS WHEN USING AMR/AMI GATEWAY DEVICE

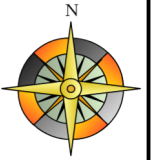

## ONE LINE DIAGRAM "TYPICAL"

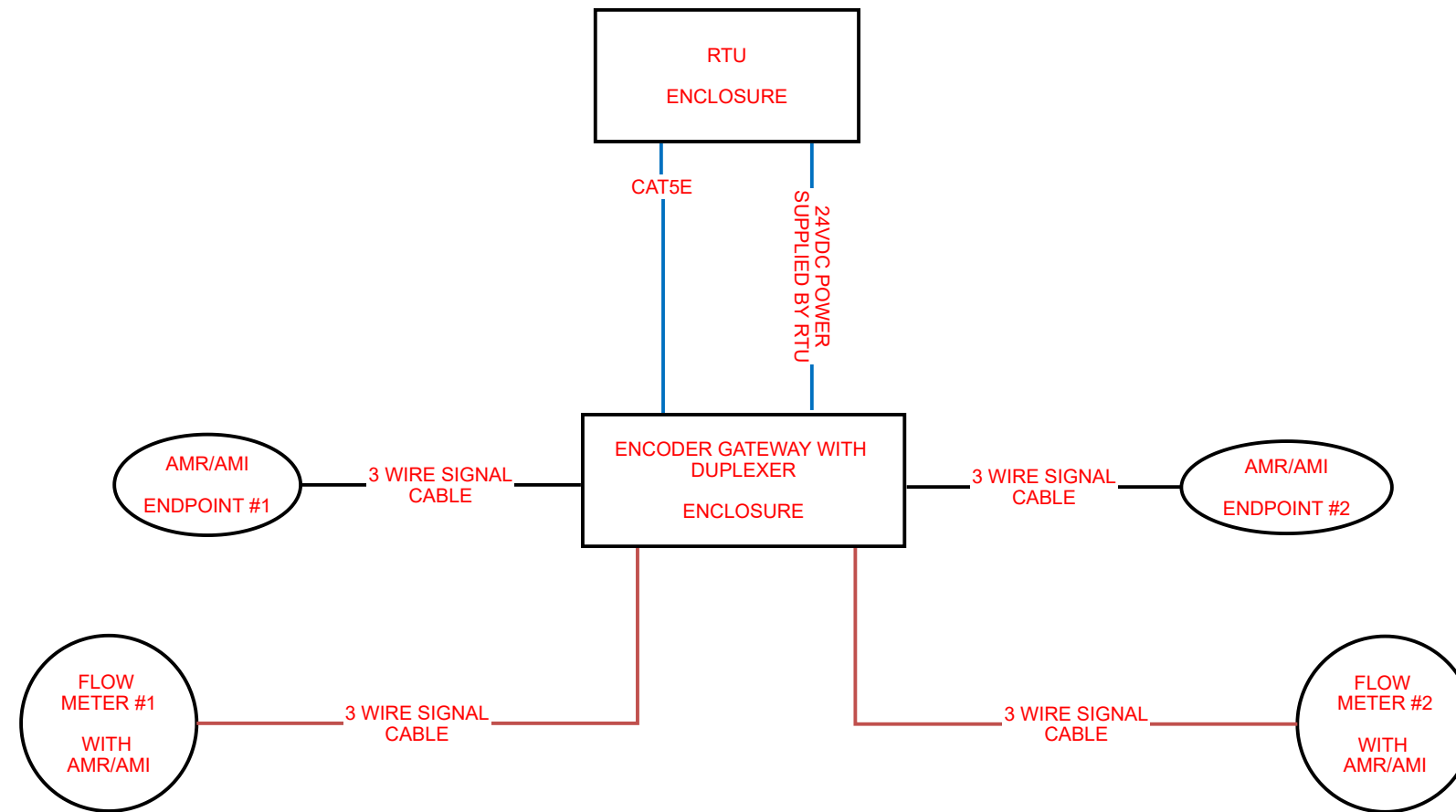

Title: ENCODER TYPE FLOW METER SCADA RTU CONNECTIONS "TYPICAL" * ONE-LINE DIAGRAM	
Author: HTI	
Date: 1-2023	Sheet: 1 of 2
Revision:	

# HTI, Inc.

201 TUNNEL HILL LN  
HORSE BRANCH, KY 42349

# Budgetary Estimate

Date	Estimate #
1/9/2023	01092301

Phone #	270-274-4632/270-274-6700
Fax #	888-252-5654

Name / Address
Grayson County Water District c/o Accounts Payable 21 Shrull White Rd. Leitchfield, Ky. 42754

Terms	Rep
Net 30	JGM

Item	Description	Qty	Rate	Total
	GRAYSON CO., KY WATER DISTRICT PROJECT: EAST-WEST INTERCONNECT PROJECT – PHASE 2 ONE EACH MASTER METER SCADA RTU, WITH FUTURE DUPLEX PUMP I/O "KY259N MASTER METER STATION"			

Thank you for your consideration of our offer!	<b>Total</b>
--	--------------

# HTI, Inc.

201 TUNNEL HILL LN  
HORSE BRANCH, KY 42349

# Budgetary Estimate

Date	Estimate #
1/9/2023	01092301

Phone #	270-274-4632/270-274-6700
Fax #	888-252-5654

Name / Address
Grayson County Water District c/o Accounts Payable 21 Shrull White Rd. Leitchfield, Ky. 42754

Terms	Rep
Net 30	JGM

Item	Description	Qty	Rate	Total
SCADA RTU	<p>A. Materials scope</p> <ul style="list-style-type: none"> <li>&gt; One each Allen-Bradley Micro850 PLC based RTU with radio communications.</li> <li>* PLC I/O and field terminals included for future duplex pump operation</li> <li>* NEMA 12 painted steel enclosure</li> <li>* Operator Interface Terminal: None ( Power supplies and fusing included for future OIT)</li> <li>* I/O Count: 28 Ea: 24VDC discrete inputs, 10 Ea: relay outputs, 8 Ea: 4-20mA field inputs, 4 Ea: 4-20mA outputs</li> <li>&gt; Control functions and monitoring</li> <li>* Monitor two each flow meters using AMR encoder meter data. Includes flow rate and flow totals to SCADA</li> <li>* Includes one each Ethermeter 2 Channel Encoder Gateway with two each duplexers units for AMR endpoint sharing</li> <li>- Ethermeter and duplexers mounted in seperate enclosure for field mount by others</li> <li>* Flow meters and reporting by others</li> <li>&gt; Monitoring of suction and discharge pressure (Includes two each 300 PSIG blind pressure transducers, SS, 4-20mA, 1/4" MNPT</li> <li>&gt; Includes one each: Viper sc+100 radio modem VHF Yagi Antenna Low loss coax and connectors as needed</li> <li>&gt; One each: Temperature Transmitter, 2-Wire, 4-20mA, LCD Display</li> <li>&gt; One each: Door limit switch for building intrusion alarm</li> </ul> <p>B: Services Provided:</p> <ul style="list-style-type: none"> <li>&gt;: RTU design and build. UL508A Listed Ind Control Panel. Includes comprehensive drawing set and Bill of Materials</li> <li>&gt;: Programming for one each RTU/controller and associated radio communications equipment</li> <li>&gt;: MTU Programming and HMI tag list for Master Unit</li> <li>&gt;: One-day/One Trip onsite system startup and Owner Training</li> </ul>	1	19,888.00	19,888.00

Thank you for your consideration of our offer!	<b>Total</b>
--	--------------

# HTI, Inc.

201 TUNNEL HILL LN  
HORSE BRANCH, KY 42349

# Budgetary Estimate

Date	Estimate #
1/9/2023	01092301

Phone #	270-274-4632/270-274-6700
Fax #	888-252-5654

Name / Address
Grayson County Water District c/o Accounts Payable 21 Shrull White Rd. Leitchfield, Ky. 42754

Terms	Rep
Net 30	JGM

Item	Description	Qty	Rate	Total
FCC License and fees	<p>C: FCC License revisions * One fixed site (Add to existing VHF license) * Includes one year construction fee</p> <hr/> <p>** Note: A: All HMI software and screen development to be provided by the Owner. HTI shall provide compatible tag list to match existing system standards. B: Any equipment or services not specifically noted herein shall not be provided by HTI. C: A preliminary computer generated radio path survey has been performed. Preliminary results show adequate signal fade margins to the Detention Center Tank site. D: No guarantees of an available or "clean" frequency is available from the FCC E: It is assumed all existing associated equipment to be used is in good working order and acceptable for use. No provisions are included for repair or replacement of existing controls. F: All HTI equipment will be provided "loose" to be installed, wired and terminated by a qualified electrical contractor provided by others.</p> <p>* A standard one year warranty for defective products and workmanship is included for new equipment. * KY sales tax is included for provided equipment * Federal, Local, or other applicable taxes or fees are NOT Included: Exemptions where applicable must be noted in writing and submitted with Purchase Order. * Inbound shipping and outbound shipping to the job site is included * RTU Estimated Delivery: 20-24 weeks after receipt of approved written order/submittal approval ( Typical lead time for FCC license assignment is 6-8 Weeks from submission of application) * Price valid for 45 days from the date of this estimate * This document is not an offer for contract * All labor and mileage is portal to portal unless noted otherwise * In the event additional costs are incurred due to no fault of HTI, additional fees may apply.</p>	1	955.00	955.00

Thank you for your consideration of our offer!	<b>Total</b>	\$20,843.00
--	--------------	-------------

Signature \_\_\_\_\_

**SECTION 01300****SUBMITTALS****PART 1 - GENERAL****1.01 WORK INCLUDED**

Shop drawings, descriptive literature, project data and samples (when samples are specifically requested) for all manufactured or fabricated items shall be submitted by the Contractor to the Engineer for examination and review in the form and in the manner required by the Engineer. All SUBMITTALS shall be furnished in at least six (6) copies and shall be checked and reviewed by the Contractor before submission to the Engineer. The review of the Drawings by the Engineer shall not be construed as a complete check but only for conformance with the design concept of the Project and for compliance with information given in the Contract Documents. Review of such drawings will not relieve the Contractor of the responsibility for any errors that may exist, as the Contractor shall be responsible for the dimensions and design of adequate connections, details, and satisfactory construction of all work.

**1.02 RELATED REQUIREMENTS SPECIFIED ELSEWHERE**

- A. General Provision.
- B. Section 01720 - Project Record Documents (As-Built).

**1.03 DEFINITIONS**

The term "submittals" shall mean shop drawings, manufacturer's drawings, catalog sheets, brochures, descriptive literature, diagrams, schedules, calculations, material lists, performance charts, test reports, office and field samples, and items of similar nature which are normally submitted for the Engineer's review for conformance with the design concept and compliance with the Contract Documents.

**1.04 GENERAL CONDITIONS**

- A. Review by the Engineer of shop drawings or SUBMITTALS of material and equipment shall not relieve the Contractor from the responsibilities of furnishing same of proper dimension, size, quality, quantity, materials and all performance characteristics to efficiently perform the requirements and intent of the Contract Documents. Review shall not relieve the Contractor from responsibility for errors of any kind on the shop drawings. Review is intended only to assure conformance with the design concept of the Project and compliance with the information given in the Contract Documents.
- B. Review of shop drawings shall not be construed as releasing the Contractor from the responsibility of complying with the Specifications.

**1.05 GENERAL REQUIREMENTS FOR SUBMITTALS**

- A. Shop Drawings:
  - 1. Shop drawings shall be prepared by a qualified detailer. Details shall be identified by reference to sheet and detail numbers shown on Contract Drawings. Where applicable, show fabrication, layout, setting and erection details.
  - 2. Shop drawings are defined as original drawings prepared by the Contractor, subcontractors, suppliers, or distributors performing work under this Contract. Shop

drawings illustrate some portion of the work and show fabrication, layout, setting or erection details of equipment, materials and components. The Contractor shall, except as otherwise noted, have prepared the number of reviewed copies required for his distribution plus two (2) which will be retained by the Engineer. Shop drawings shall be folded to an approximate size of 8-1/2" x 11" and in such manner that the title block will be located in the lower righthand corner of the exposed surface.

- B. Project data shall include manufacturer's standard schematic drawings modified to delete information which is not applicable to the Project, and shall be supplemented to provide additional information applicable to the Project. Each copy of descriptive literature shall be clearly marked to identify pertinent information as it applies to the Project.
- C. Where samples are required, they shall be adequate to illustrate materials, equipment or workmanship, and to establish standards by which completed work is judged. Provide sufficient size and quantity to clearly illustrate functional characteristics of product and material, with integrally related parts and attachment devices, along with a full range of color samples.
- D. All submittals shall be referenced to the applicable item, section and division of the Specifications, and to the applicable Drawing(s) or Drawing schedule(s).
- E. The Contractor shall review and check SUBMITTALS, and shall indicate his review by initials and date.
- F. If the submittals deviate from the Contract Drawings and/or Specifications, the Contractor shall advise the Engineer, in letter of transmittal of the deviation and the reasons therefor. All changes shall be clearly marked on the submittal with a bold red mark. Any additional costs for modifications shall be borne by the Contractor.
- G. In the event the Engineer does not specifically reject the use of material or equipment at variance to that which is shown on the Drawings or specified, the Contractor shall, at no additional expense to the Owner, and using methods reviewed by the Engineer, make any changes to structures, piping, controls, electrical work, mechanical work, etc., that may be necessary to accommodate this equipment or material. Should equipment other than that on which design drawings are based be accepted by the Engineer, shop drawings shall be submitted detailing all modification work and equipment changes made necessary by the substituted item.
- H. Additional information on particular items, such as special drawings, schedules, calculations, performance curves, and material details, shall be provided when specifically requested in the technical Specifications.
- I. Submittals for all electrically operated items (including instrumentation and controls) shall include complete wiring diagrams showing leads, runs, number of wires, wire size, color coding, all terminations and connections, and coordination with related equipment.
- J. Equipment shop drawings shall indicate all factory or shop paint coatings applied by suppliers, manufacturers and fabricators; the Contractor shall be responsible for insuring the compatibility of such coatings with the field-applied paint products and systems.
- K. Fastener specifications of manufacturer shall be indicated on equipment shop drawings.
- L. Where manufacturers' brand names are given in the Specifications for building and construction materials and products, such as grout, bonding compounds, curing compounds, masonry cleaners, waterproofing solutions and similar products, the Contractor shall submit names and descriptive literature of such materials and products he proposes to use in this Contract.

- M. No material shall be fabricated or shipped unless the applicable drawings or submittals have been reviewed by the Engineer and returned to the Contractor.
- N. All bulletins, brochures, instructions, parts lists, and warranties packaged with and accompanying materials and products delivered to and installed in the Project shall be saved and transmitted to the Owner through the Engineer.

**1.06 CONTRACTOR RESPONSIBILITIES**

- A. Verify field measurements, field construction criteria, catalog numbers and similar data.
- B. Coordinate each submittal with requirements of Work and of Contract Documents.
- C. Notify Engineer, in writing at time of submission, of deviations in submittals from requirements of Contract Documents.
- D. Begin no work, and have no material or products fabricated or shipped which required submittals until return of submittals with Engineer's stamp and initials or signature indicating review.

- END OF SECTION -

**SECTION 01380****CONSTRUCTION PHOTOGRAPHY****PART 1 - GENERAL****1.01 WORK INCLUDED**

The Contractor shall be responsible for video taping the entire project site both prior to construction and immediately after completion and acceptance of all work. Video tapes shall be produced by a videographer acceptable to the Engineer and of a professional quality. Video recording shall be included in the contractor's lump sum price.

**1.02 VIDEO TAPE**

The video tape shall be of a high quality DVD format. Video tapes shall show the time, date, and project location on screen during playback.

**1.03 SUBMITTALS**

The Contractor shall provide two copies of the project DVD with jackets. Both the DVDs and jackets shall be clearly labeled with project name start date and completion date as shown below.

Project Name and Contract No.  
Owner Name  
Start Date: \_\_\_\_\_  
Completion Date: \_\_\_\_\_

-END OF SECTION-



**SECTION 01450**  
**QUALITY CONTROL**

**PART 1 - GENERAL**

**1.01 QUALITY CONTROL**

- A. Work of all crafts and trades shall be laid out to lines and elevations as established by the Contractor from the Drawings or from instructions by the Engineer.
- B. Unless otherwise shown, all work shall be plumb and level, in straight lines and true planes, parallel or square to the established lines and levels. The Work shall be accurately measured and fitted to tolerance as established by the best practices of the crafts and trades involved, and shall be as required to fit all parts of the Work carefully and neatly together.
- C. All equipment, materials and articles incorporated into the Work shall be new and of comparable quality as specified. All workmanship shall be first-class and shall be performed by mechanics skilled and regularly employed in their respective trades.

**1.02 TESTS, INSPECTIONS, AND CERTIFICATIONS OF MATERIALS**

- A. Tests, inspections and certifications of materials, equipment, subcontractors or completed work, as required by the various sections of the Specifications shall be obtained by the Contractor and all costs shall be included in the Contract Price.
- B. The Contractor shall submit to the Engineer the name of testing laboratory to be used.
- C. Contractor shall deliver written notice to the Engineer at least 24 hours in advance of any inspections or tests to be made at the Project site. All inspections, tests, samples for water quality or other procedures requiring the Engineer to attest to be conducted in the field shall be done in the presence of the Engineer or his representative.
- D. Certifications by independent testing laboratories may be by copy of the attestation(s) and shall give scientific procedures and results of tests. Certifications by persons having interest in the matter shall be by original attest properly sworn to and notarized.

- END OF SECTION -

**SECTION 01500****TEMPORARY FACILITIES AND CONTROLS****PART 1 - GENERAL****1.01 DESCRIPTION**

- A. The Contractor shall make his own provisions for temporary electricity and water and maintain strict supervision of use of temporary utility services as follows:
  - 1. Enforce compliance with applicable standards.
  - 2. Enforce safety practices
  - 3. Prevent abuse of services.
  - 4. Pay all utility charges required.

**1.02 REQUIREMENTS OF REGULATORY AGENCIES**

- A. The Contractor shall obtain and pay for all permits as required by governing authorities.
- B. Obtain and pay for temporary easements required across property other than that of Owner or that is shown on the Contract Drawings.
- C. The Contractor shall comply with applicable codes.

**1.03 REMOVAL**

- A. The Contractor shall completely remove temporary materials, equipment, and offices upon completion of construction.
- B. The Contractor shall repair damage caused by installation and restore to specified or original condition.

**1.04 TEMPORARY LIGHTING**

- A. The Contractor shall furnish and install temporary lighting required for:
  - 1. Construction needs.
  - 2. Safe and adequate working conditions.
  - 3. Public Safety.
  - 4. Security lighting.
  - 5. Temporary office and storage area lighting.
- B. Service periods for safety lighting shall be as follows:
  - 1. Within construction area: All times that authorized personnel are present.

- 2. Public areas: At all times.
- C. Costs of Installation and Preparation: Contractor shall pay all installation, maintenance and removal costs of temporary lighting.
- D. Maintenance of temporary lighting service (replacement of bulbs, etc.) shall be the sole responsibility of the General Contractor.

#### **1.05 TEMPORARY WATER**

- A. Contractor shall make his own arrangements at his own expense for obtaining the water supply necessary for construction purposes.
- B. Contractor shall pay costs of the furnishing, maintaining and removing all temporary water service equipment, fixtures, hose, piping, etc.

#### **1.06 SANITARY FACILITIES**

- A. Contractor shall provide sanitary facilities as set forth in General Provisions (GP-2.04. Sanitary Regulations).

#### **1.07 FIELD OFFICE (Office Trailer not Required for this Contract)**

- A. The Contractor shall make his own provisions for providing the electricity, telephone, gas, water, sewer, and other utilities to his office trailer that are required or as necessary for completion of the work.
- B. The Contractor shall be responsible for all utility charges.

### **PART 2 - PRODUCTS**

Not used.

### **PART 3 - EXECUTION**

#### **3.01 IMPLEMENTATION**

- A. The Contractor shall provide measures to prevent soil erosion and discharge of soil-bearing water runoff and airborne dust to storm drains, adjacent areas and walkways prior to the start of any site work.
- B. Straw bale dikes, silt fencing and synthetic filter fabric shall be used as necessary to protect adjacent lands, surface waters, and vegetation to achieve environmental objectives.
- C. Provide barriers in and around excavations and subgrade construction to prevent flooding by runoff of stormwater from heavy rains.
- D. Soil deposited on pavement by construction and other contractor vehicles shall be removed and the pavement swept as required.
- E. Plan and execute construction by methods to control surface drainage from cuts and fills, from borrow and waste disposal areas. Prevent erosion and sedimentation.
- F. Minimize amount of bare soil exposed at one time.

- G. Provide temporary measures such as berms, dikes, drains, hay bales, gabions, etc., as directed by the Engineer so as to minimize siltation due to runoff.
- H. Construct fill and waste areas by selective placement to avoid erosive exposed surface of silts or clays.
- I. Periodically inspect earthwork to detect evidence of erosion and sedimentation; promptly apply corrective measures.

### **3.02 OPERATION AND MAINTENANCE**

- A. The Contractor shall inspect, repair, and maintain erosion and sediment control measures until final stabilization has been established.

### **3.03 REMOVAL OF FACILITIES**

- A. The Contractor shall remove the temporary facilities after final stabilization has been established. Used devices (including old straw bales) shall be disposed of as Construction & Demolition debris.

### **3.04 DUST CONTROL**

- A. Execute work by methods to minimize raising dust from construction operations. Provide positive means to prevent air-borne dust from dispersing into atmosphere.

- END OF SECTION -

**SECTION 01550****ACCESS ROADS AND PARKING AREAS****PART 1 - GENERAL****1.01 REQUIREMENTS INCLUDED**

- A. Access roads.
- B. Parking.
- C. Existing pavements and parking areas.
- D. Permanent pavements and parking areas.
- E. Maintenance.
- F. Removal, resurfacing.

**PART 2 - PRODUCTS****2.01 MATERIALS**

- A. For temporary construction: Contractor's option.

**PART 3 - EXECUTION****3.01 ACCESS ROADS**

- A. Construct temporary all-weather access roads from public thoroughfares to serve construction area, of a width and load-bearing capacity to provide unimpeded traffic for construction purposes.
- B. Construct temporary bridges and/or culverts to span low areas and allow unimpeded drainage.
- C. Extend and relocate as work progress requires, provide detours as necessary for unimpeded traffic flow.
- D. Locate temporary access roads as approved by the Owner and/or the Engineer.

**3.02 PARKING**

- A. The Contractor shall construct temporary parking areas to accommodate use of construction personnel in the area.

**3.03 REMOVAL, REPAIR**

- A. Remove temporary materials and construction when permanent facilities are usable, as directed by the Engineer. Repair existing permanent facilities damaged by usage to original and/or specified condition.

- END OF SECTION -

**SECTION 01570**  
**TRAFFIC REGULATION**

**PART 1 - GENERAL**

**1.01 REQUIREMENTS INCLUDED**

- A. Construction parking control.
- B. Flagmen.
- C. Flares and lights.
- D. Haul routes.
- E. Traffic signs and signals.
- F. Removal.

**1.02 RELATED REQUIREMENTS**

- A. Section 01580 - Project Identification and Signs.

**PART 2 - PRODUCTS**

**2.01 SIGNS, SIGNALS AND DEVICES**

- A. Post-mounted and wall-mounted traffic control and informational signs as specified and required by local jurisdictions.
- B. Automatic Traffic Control Signals: As approved by local jurisdictions.
- C. Traffic Cones and Drums, Flares and Lights: As approved by local jurisdictions.
- D. Flagman Equipment: As required by local jurisdictions.

**PART 3 - EXECUTION**

**3.01 CONSTRUCTION PARKING CONTROL**

- A. Control vehicular parking to prevent interference with public traffic and parking, access by emergency vehicles, and Owner's operations.
- B. Monitor parking of construction personnel's vehicles in existing facilities. Maintain vehicular access to and through parking areas.
- C. Prevent parking on or adjacent to access roads or in nondesignated areas.

**3.02 TRAFFIC CONTROL**

- A. Whenever and wherever, in the Engineer's opinion, traffic is sufficiently congested or public safety is endangered, Contractor shall furnish uniformed officers to direct traffic and to keep traffic off the highway area affected by construction operations.
- B. Contractor shall abide by City regulations governing utility construction work.
- C. Traffic control shall be provided according to the Kentucky Department of Highways Manual on Uniform Traffic Control Devices for Streets and Highways.

**3.03 FLAGMEN**

- A. Provide trained and equipped flagmen to regulate traffic when construction operations or traffic encroach on public traffic lanes.

**3.04 FLARES AND LIGHTS**

- A. Use flares and lights during hours of low visibility to delineate traffic lanes and to guide traffic.

**3.05 HAUL ROUTES**

- A. Consult with authorities, establish public thoroughfares to be used for haul routes and site access.
- B. Confine construction traffic to designated haul routes.
- C. Provide traffic control at critical areas of haul routes to regulate traffic and minimize interference with public traffic.

**3.06 TRAFFIC SIGNS AND SIGNALS**

- A. At approaches to site and on site, install appropriate signs at crossroads, detours, parking areas, and elsewhere as needed to direct construction and affected public traffic.
- B. Install and operate traffic control signals to direct and maintain orderly flow of traffic in areas under Contractor's control, and areas affected by Contractor's operations.
- C. Relocate as work progresses, to maintain effective traffic control.

**3.07 REMOVAL**

- A. Remove equipment and devices when no longer required. Repair damage caused by installation. Remove post settings to a depth of 2 feet.

- END OF SECTION -

**SECTION 01580****PROJECT IDENTIFICATION AND SIGNS****PART 1 - GENERAL****1.01 WORK INCLUDED**

A. The Contractor shall provide all signs required by these specifications near the site of the work. The sign shall set forth the description of the work and the names of the Owner, Engineer and Contractor as shown on the Plans or in these Specifications.

B. The Contractor shall furnish and install two (2) sign on the Project. One sign shall conform to the specifications and painted as shown on Figure 1, 01580-2 and one sign shall conform to the specifications and painted as shown on Figure 2, 01580-3.

C. All signs shall be erected level, plumb and in accordance with the specifications prior to the first progress meeting. Signs shall be maintained throughout the contract period as a condition for payment to the contractor.

**PART 2 - PRODUCT****2.01 SIGN**

The signs shall be constructed of 3/4" thick APA A-B Exterior grade or marine plywood. Posts shall be 4" x 4" of fencing type material. Prime all wood with white primer.

**PART 3 - EXECUTION****3.01 MAINTENANCE**

The sign shall be maintained in good condition until completion of the Project.

**3.02 LOCATION**

The location of the project signs shall be one set at each location. The actual location of the project signs shall be determined at the pre-construction conference after the contract has been awarded.



# TEMPORARY CONSTRUCTION SIGN FOR USDA RURAL DEVELOPMENT PROJECTS

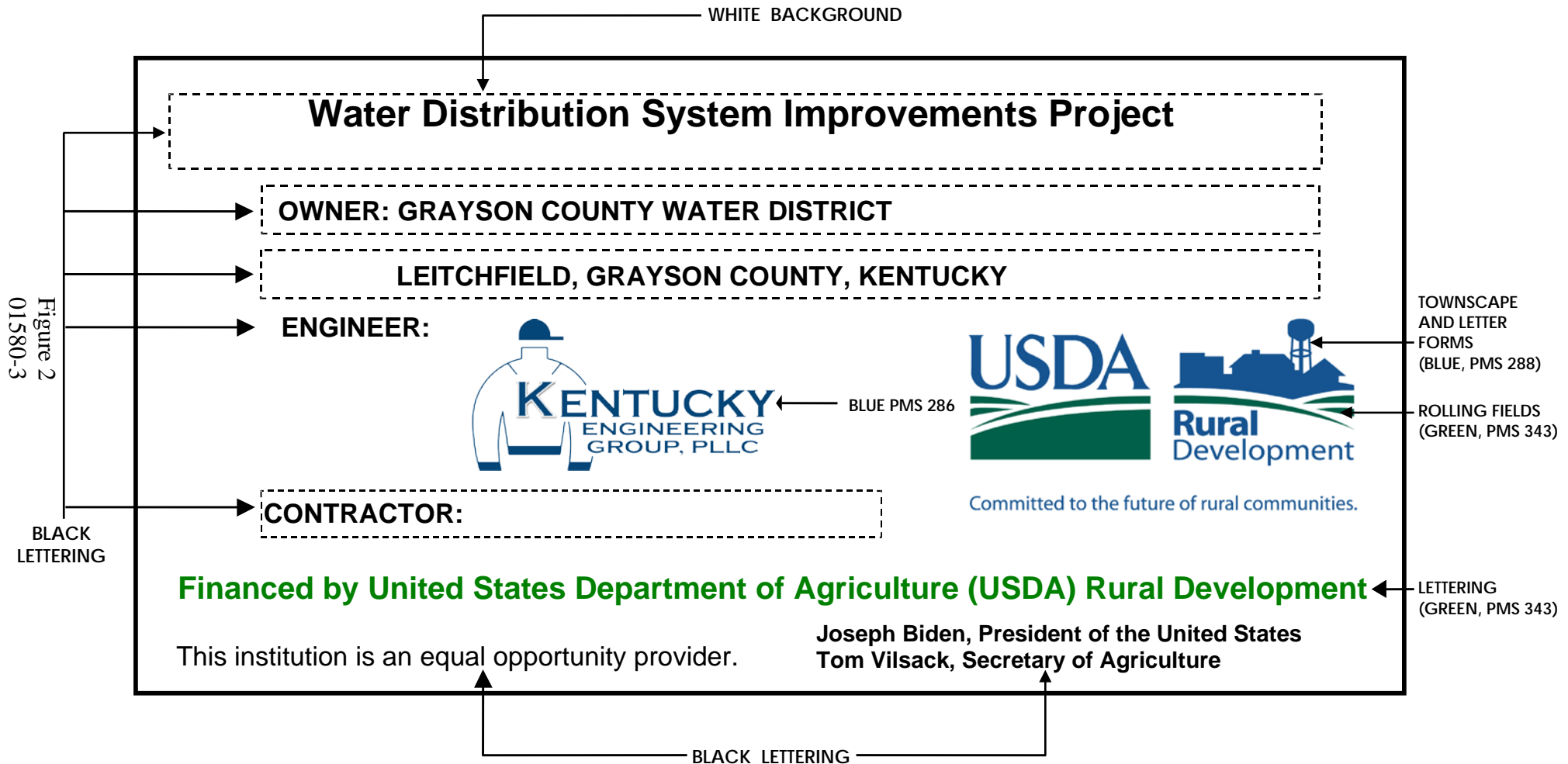

**SIGN DIMENSIONS:** 1200 mm x 2400 mm x 19 mm (approx. 4' x 8' x 3/4")  
PLYWOOD PANEL (APA RATED A-B GRADE-EXTERIOR)

## SECTION 01600

### MATERIAL AND EQUIPMENT

#### PART 1 - GENERAL

##### 1.01 COMPLIANCE WITH SAFETY REGULATIONS

The equipment items furnished shall comply with all governing Federal and State laws regarding safety, including all requirements of the Occupational Safety and Health Act of 1970 (OSHA).

#### PART 2 - PRODUCTS

##### 2.01 REFERENCES

- A. General Provisions: Section 10 Correction and Guarantee of Work, Section 13 Materials and Equipment.
- B. Section 02600 – Pipe, Fittings, and Installation
- C. Section 02640 - Valves.
- D. All material shall meet applicable American Water Works Association (AWWA), American Standard Testing Methods (ASTM), Underwriters Laboratories (UL), Factory Mutual (FM), National Sanitation Foundation (NSF) standards.

##### 2.02 AMERICAN IRON AND STEEL

Under the requirements of Section 746 of Title VII of the Consolidated Appropriations Act of 2017 (Division A-Agriculture, Rural Development, Food and Drug Administration, and Related Agencies, Appropriations Act, 2017) and subsequent statutes mandating domestic preference applies to American Iron and Steel requirement to this project. All listed iron and steel products used in this project must be produced in the United States.

#### GRAYSON COUNTY WATER DISTRICT

The following is a list of approved manufacturers for the materials to be provided on the project. All material shall meet applicable AWWA, ASTM, Underwriters Laboratories, and Factory Mutual standards. The Owner approves this list and the Owner and Engineer shall approve any deviation.

MATERIAL/ITEM	APPROVED MANUFACTURER
Air Release Valve	APCO #50 Series or approved equal
All Brass Fittings (AWWA brass)	Mueller or approved equal
Aluminum Hatch	Haliday S1R or approved equal
Flushing Hydrant Assembly	Mueller A423 5-1/4 3 Way or approved equal
Flanged Coupling Adapter	FORD Style FFCA
Brass Nipples and Pipe	BMI
Brass Service Saddles	Mueller S-13000 Series or approved equal
Butterfly Valves (Class 150)	Mueller LINESEAL III (CLASS150B) or approved equal

<b>MATERIAL/ITEM</b>	<b>APPROVED MANUFACTURER</b>
Butterfly Valves (Class 250)	Mueller LINESEAL XPII (CLASS250B) or approved equal
Casing Spacers	CCI CSP Poly/End Seal Mod Esc or approved equal
End seals	FERNCO adapter two- part doughnut and ring, style 1056
Control Valve	CLA-VAL or approved equal
Gate Valves	Mueller A-2361 or approved equal
Valve Boxes	Mueller, Clow, M&H or approved equal
Restraint Joint MJ Packs	ROMAC Grip Ring or approved equal
MJ Fittings Compact/Full Body MJ Packs	Mueller, Clow, or approved equal
Blow-off & Air Release Boxes	ETI Ultra Rib or approved equal
Copper Tracing Wire	#12 Solid Copper
Mainline Pressure Reducing Valve	CLA-VAL or approved equal
Customer Individual Pressure Reducing Valve	Watts 3/4 LF 25AUB M3-Z6
Mainline Master Meter	Badger E-Series® Ultrasonic or approved equal
Customer Meter	Badger M 25 W/HRE-LCD With ITRON 100W+ endpoint ERS-1300-403 with CFG 1300004 mounting kit
Customer Meter Box	18x24 PVC
Customer Meter Box Cover	FORD A32-T-LB or approved equal
Customer Meter Setter	Mueller B2404R-2-24 N (REGULATED SET) B 2404-R2---N (NON-REGULATED) ¾" x 6" Brass Nipple
Service Tubing – Polyethylene Tubing (CTS Service Tubing)	CTS #200 SDR-9 ENDOPURE POLY
Steel Tapping Valves and Sleeves (Check Working Pressure)	Tapping sleeves for D.I. shall be MuellerH615 or equal and for PVC shall be Mueller H612
Service Saddles	Mueller S-13000
DI Pipe Class 350	Clow or approved equal
Full Circle Repair Clamps	Ford FS1 ss/JCM Model 131
Above Ground Valve Marker	Rhino SD-5401R-K 66" or approved equal
Precast Concrete Manholes	Old Castle Pre-Cast or approved equal ( Round )
PVC Couplings	Harco or approved equal
PVC Pipe Class 200, 250, or C900	Vulcan or approved equal

**SECTION 01610****TRANSPORTATION AND HANDLING****PART 1 - GENERAL****1.01 WORK INCLUDED**

- A. Handling and Distribution:
1. The Contractor shall handle, haul, and distribute all materials and all surplus materials on the different portions of the work, as necessary or required; shall provide suitable and adequate storage room for materials and equipment during the progress of the work, and be responsible for the protection, loss of, or damage to materials and equipment furnished by him, until the final completion and acceptance of the work.
  2. Storage and demurrage charges by transportation companies and vendors shall be borne by the Contractor.
- B. Storage of Materials and Equipment: All excavated materials and equipment to be incorporated in the work shall be placed so as not to injure any part of the work or the existing facilities and so that free access can be had at all times to all parts of the work and to all public utility installations in the vicinity of the work. Materials and equipment shall be kept neatly piled and compactly stored in such locations as will cause a minimum of inconvenience to public travel and adjoining owners, tenants and occupants.

- END OF SECTION -

**SECTION 01700**  
**PROJECT CLOSEOUT**

**PART 1 - GENERAL**

**1.01 RELATED REQUIREMENTS SPECIFIED ELSEWHERE**

- A. Liquidated Damages: Section 00520
- B. Cleaning: Section 01710.
- C. Project Record Documents: Section 01720.

**1.02 SUBSTANTIAL COMPLETION**

- A. Contractor:
  - 1. Submit written certification to Engineer that project is substantially complete.
  - 2. Submit list of major items to be completed or corrected.
- B. Engineer will make an inspection within seven days after receipt of certification, together with Owner's Representative.
- C. Should Engineer consider that work is substantially complete:
  - 1. Contractor shall prepare, and submit to Engineer, a list of items to be completed or corrected, as determined by the inspection.
  - 2. Engineer will prepare and issue a Certificate of Substantial Completion, containing:
    - a. Date of Substantial Completion.
    - b. Contractor's list of items to be completed or corrected, verified and amended by Engineer.
    - c. The time within which Contractor shall complete or correct work of listed items.
    - d. Time and date Owner will assume possession of work or designated portion thereof.
    - e. Responsibilities of Owner and Contractor for:
      - (1) Insurance
      - (2) Utilities
      - (3) Operation of mechanical, electrical and other systems.
      - (4) Maintenance and cleaning.
      - (5) Security

- f. Signatures of:
  - (1) Engineer.
  - (2) Contractor.
  - (3) Owner.
- 3. Owner occupancy of Project or Designated Portion of Project:
  - a. Contractor shall:
    - (1) Obtain certificate of occupancy.
    - (2) Perform final cleaning in accordance with Section 01710.
  - b. Owner will occupy Project, under provisions stated in Certificate of Substantial Completion.
- 4. Contractor shall complete work listed for completion or correction, within designated time.
- D. Should Engineer consider that work is not substantially complete.
  - 1. He shall immediately notify Contractor, in writing, stating reasons.
  - 2. Contractor shall complete work, and send second written notice to Engineer, certifying that Project, or designated portion of Project is substantially complete.
  - 3. Engineer will reinspect work.

### **1.03 FINAL INSPECTION**

- A. Contractor shall submit written certification that:
  - 1. Contract Documents have been reviewed.
  - 2. Project has been inspected for compliance with Contract Documents.
  - 3. Work has been completed in accordance with Contract Documents.
  - 4. Equipment and systems have been tested in presence of Owner's Representative and are operational.
  - 5. Project is completed and ready for final inspection.
- B. Engineer will make final inspection within seven (7) days after receipt of certification.
- C. Should Engineer consider that work is finally complete in accordance with requirements of Contract Documents, he shall request Contractor to make Project Closeout submittals.
- D. Should Engineer consider that work is not finally complete:
  - 1. He shall notify Contractor, in writing, stating reasons.
  - 2. Contractor shall take immediate steps to remedy the stated deficiencies, and send second written notice to Engineer certifying that work is complete.

3. Engineer will reinspect work.

**1.04 FINAL CLEAN UP**

The Work will not be considered as completed and final payment made until all final clean up has been done by the Contractor in a manner satisfactory to the Engineer. See Section 01710 for detailed requirements.

**1.05 CLOSEOUT SUBMITTALS**

Project Record Documents: To requirements of Section 01720.

**1.06 FINAL APPLICATION FOR PAYMENT**

Contractor shall submit final applications in accordance with requirements of GENERAL PROVISIONS.

**1.07 FINAL CERTIFICATE FOR PAYMENT**

- A. Engineer will issue final certificate in accordance with provisions of GENERAL PROVISIONS.
- B. Should final completion be materially delayed through no fault of Contractor, Engineer may issue a Semi-Final Certificate for Payment.

- END OF SECTION -

**SECTION 01710****CLEANING****PART 1 - GENERAL****1.01 WORK INCLUDED**

- A. During its progress the work and the adjacent areas affected thereby shall be kept cleaned up and all rubbish, surplus materials, and unneeded construction equipment shall be removed and all damage repaired so that the public and property owners will be inconvenienced as little as possible.
- B. Where material or debris has washed or flowed into or been placed in existing watercourses, ditches, gutters, drains, pipes, structures, by work done under this contract, or elsewhere during the course of the Contractor's operations, such material or debris shall be entirely removed and satisfactorily disposed of during the progress of the work, and the ditches, channels, drains, pipes, structures, and work, etc., shall, upon completion of the work, be left in a clean and neat condition.
- C. On or before the completion of the work, the Contractor shall, unless otherwise especially directed or permitted in writing, tear down and remove all temporary buildings and structures built by him; shall remove all temporary works, tools, and machinery or other construction equipment furnished by him; shall remove, acceptably disinfect, and cover all organic matter and material containing organics in, under, and around privies, houses, and other buildings used by him; shall remove all rubbish from any grounds which he has occupied; and shall leave the roads and all parts of the premises and adjacent property affected by his operations in a neat and satisfactory condition.
- D. The Contractor shall thoroughly clean all materials and equipment installed by him and his subcontractors, and on completion of the work shall deliver it undamaged and in fresh and new appearing condition.
- E. The Contractor shall restore or replace, when and as directed, any public or private property damaged by his work, equipment, or employees, to a condition equal or better than that existing immediately prior to the beginning of operations. To this end the Contractor shall do as required all necessary highway or driveway, walk, and landscaping work. Suitable materials, equipment, and methods shall be used for such restoration. The restoration of existing property or structures shall be done as promptly as practicable as work progresses and shall not be left until the end of the contract period.

**1.02 DESCRIPTION**

- A. Related Requirements Specified Elsewhere:
  - 1. Project Closeout: Section 01700.
  - 2. Cleaning for Specific Products or Work: Specification Section for that work.
- B. On a continuous basis, maintain premises free from accumulations of waste, debris, and rubbish, caused by operations.



- C. At completion of Work, remove waste materials, rubbish, tools, equipment, machinery and surplus materials, and clean all sight-exposed surfaces; leave Project clean and ready for occupancy.

### **1.03 SAFETY REQUIREMENTS**

- A. Hazards Control:
  - 1. Store volatile wastes in covered metal containers, and remove from premises daily.
  - 2. Prevent accumulation of wastes, which create hazardous conditions.
  - 3. Provide adequate ventilation during use of volatile or noxious substances.
- B. Conduct cleaning and disposal operations in compliance with local ordinances and anti-pollution laws.
  - 1. Do not burn or bury rubbish and waste materials on Project site without written permission from the Owner.
  - 2. Do not dispose of volatile wastes such as mineral spirits, oil, or fuel in open drainage ditches or storm or sanitary drains.
  - 3. Do not dispose of wastes into streams or waterways.

## **PART 2 - PRODUCTS**

### **2.01 MATERIALS**

- A. Use only cleaning materials recommended by manufacturer of surface to be cleaned.
- B. Use cleaning materials only on surfaces recommended by cleaning material manufacturer.

## **PART 3 - EXECUTION**

### **3.01 DURING CONSTRUCTION**

- A. Execute cleaning to ensure that grounds and public properties are maintained free from accumulations of waste materials and rubbish.
- B. Wet down dry materials and rubbish to minimize blowing dust.
- C. At reasonable intervals during progress of Work, clean site and public properties, and dispose of waste materials, debris and rubbish.
- D. Provide on-site containers for collection of waste materials, debris and rubbish.
- E. Remove waste materials, debris and rubbish from site and legally dispose of at public or private dumping areas off construction site.
- F. The Contractor shall thoroughly clean all materials and equipment installed.

**3.02 FINAL CLEANING**

- A. Employ experienced workmen, or professional cleaners, for final cleaning.
- B. In preparation for substantial completion, conduct final inspection of project area(s).
- C. Broom clean paved surfaces; rake clean other surfaces of grounds.
- D. Maintain cleaning until Project, or portion thereof, is accepted by Owner.

- END OF SECTION -

**SECTION 01720****PROJECT RECORD DOCUMENTS****PART 1 - GENERAL****1.01 WORK INCLUDED**

The Contractor shall obtain from the Engineer, one (1) set of prints of the Contract Drawings. These prints shall be kept and maintained in good condition at the project site and a qualified representative of the Contractor shall enter upon these prints, from day-to-day, the actual "as-built" record of the construction progress. Entries and notations shall be made in a neat and legible manner and these prints shall be delivered to the Engineer upon completion of the construction. APPROVAL FOR FINAL PAYMENT WILL BE CONTINGENT UPON COMPLIANCE WITH THIS PROVISION.

**1.02 RELATED REQUIREMENTS SPECIFIED ELSEWHERE:**

- A. SECTION 01300 - SUBMITTALS.
- B. SECTION 0710 - GENERAL CONDITIONS

**1.03 MAINTENANCE OF DOCUMENTS**

- A. Maintain at job site, one copy of:
  - 1. Contract Drawings
  - 2. Specifications
  - 3. Addenda
  - 4. Reviewed Shop Drawings
  - 5. Change Orders
  - 6. Other Modifications to Contract
- B. Store documents in approved location, apart from documents used for construction.
- C. Provide files and racks for storage of documents.
- D. Maintain documents in clean, dry legible condition.
- E. Do not use record documents for construction purposes.
- F. Make documents available at all times for inspection by Engineer and Owner.

**1.04 MARKING DEVICES**

- A. Provide colored pencil or felt-tip marking pen for all marking.

**1.05 RECORDING**

- A. Label each document "PROJECT RECORD" in 2-inch high printed letters.

- B. Keep record documents current.
- C. Do not permanently conceal any work until required information has been recorded.
- D. Contract Drawings: Legibly mark to record actual construction:
  - 1. Horizontal and vertical location of underground utilities and appurtenances referenced to permanent surface improvements.
  - 2. Location of internal utilities and appurtenances concealed in construction referenced to visible and accessible features of structure.
  - 3. Field changes of dimension and detail.
  - 4. Changes made by Change Order or Field Order.
  - 5. Details not on original Contract Drawings.
- E. Specifications and Addenda: Legibly mark up each Section to record:
  - 1. Manufacturer, trade name, catalog number, and supplier of each product and item of equipment actually installed.
  - 2. Changes made by Change Order or Field Order.
  - 3. Other matters not originally specified.
- F. Shop Drawings: Maintain as record documents; legibly annotate Shop Drawings to record changes made after review.

#### **1.06 SUBMITTAL**

- A. At completion of project, deliver record documents to Engineer.
- B. Accompany submittal with transmittal letter, in duplicate, containing:
  - 1. Date.
  - 2. Project Title and Number.
  - 3. Contractor's Name and Address.
  - 4. Title and Number of each Record Document.
  - 5. Certification that each Document as Submitted is Complete and Accurate.
  - 6. Signature of Contractor, or his authorized Representative.

- END OF SECTION -

**SECTION 01730****OPERATING AND MAINTENANCE DATA****PART 1 - GENERAL****1.01 WORK INCLUDED**

- A. Compile product data and related information appropriate for Owner's maintenance and operation of equipment furnished under the contract. Prepare operating and maintenance data as specified.
- B. Instruct Owner's personnel in the maintenance and operation of equipment and systems as outlined herein and/or in other Divisions.
- C. In addition to maintenance and operations data, the manufacturer's printed recommended installation practice shall also be included. If not part of the operations and maintenance manual, separate written installation instructions shall be provided, serving to assist the Contractor in equipment installation.
- D. Related Requirements Specified Elsewhere:
  - 1. Section 01300 - Submittals.
  - 2. Section 01700 - Project Closeout.
  - 3. Section 01720 - Project Record Documents.
  - 4. Section 01740 - Warranties and Bonds.
  - 5. General Provisions

**1.02 MAINTENANCE AND OPERATIONS MANUAL**

- A. Every piece of equipment furnished and installed shall be provided with complete maintenance and operations manuals. These shall be detailed in instructions to the Owner's personnel. They shall be attractively bound for the Owner's records.
- B. The manuals shall be submitted to the Engineer for review as to adequacy and completeness. Provide three (3) copies each.

**1.03 FORM OF SUBMITTALS**

- A. Prepare data in the form of an instructional manual for use by Owner's personnel.
- B. Format:
  - 1. Size: 8-1/2 x 11 in.
  - 2. Paper: 20 pound minimum, white, for typed pages.
  - 3. Text: Manufacturer's printed data, or neatly typewritten.

4. Drawings:
    - a. Provide reinforced punched binder tab, bind with text.
    - b. Fold large drawings to the size of the text pages where feasible.
    - c. For all drawings included within manuals, furnish a 3 mil mylar copy in standard size drawings 36" x 24", 8" x 16" or 8-1/2" x 11".
    - d. For flow or piping diagrams that cannot be detailed on the standard size drawings, a larger, appropriate size drawing may be submitted.
  5. Provide fly-leaf for each separate product, or each piece of operating equipment.
    - a. Provide typed description of product, and major component parts of equipment.
    - b. Provide indexed tabs.
  6. Cover: Identify each volume with types or printed title "OPERATING AND MAINTENANCE INSTRUCTIONS". List:
    - a. Title of Project.
    - b. Identity of separate structure as applicable.
    - c. Identity of general subject matter covered in the manual.
- C. Binders:
1. Commercial quality, durable and cleanable, 3-hole, 3" or 4" post type binders, with oil and moisture resistant hard covers.
  2. When multiple binders are used, correlate the data into related consistent grouping.
  3. Labeled on the front cover and side of each binder shall be the name of the Project, the Contract Number and Volume Number.

#### **1.04 CONTENT OF MANUAL**

- A. Neatly typewritten table of contents for each volume, arranged in systematic order.
  1. Contractor, name of responsible principal, address and telephone number.
  2. A list of each product required to be included, indexed to the content of the volume.
  3. List, with each product, the name, address and telephone number of:
    - a. Subcontractor or installer.
    - b. Maintenance contractor, as appropriate.
    - c. Identify the area of responsibility of each.

- d. Local source of supply for parts and replacement.
  4. Identify each product by product name and other identifying symbols as set forth in Contract Documents.
- B. Product Data:
  1. Include only those sheets which are pertinent to the specific product. References to other sizes and types or models of similar equipment shall be deleted or lined out.
  2. Annotate each sheet to:
    - a. Clearly identify the specific product or part installed.
    - b. Clearly identify the data applicable to the installation.
    - c. Provide a parts list for all new equipment items, with catalog numbers and other data necessary for ordering replacement parts.
    - d. Delete references to inapplicable information.
  3. Clear and concise instructions for the operation, adjustment, lubrication, and other maintenance of the equipment including a lubrication chart.
- C. Drawings:
  1. Supplement product data with drawings as necessary to clearly illustrate:
    - a. Relations of component parts of equipment and systems.
    - b. Control and flow diagrams.
  2. Coordinate drawings with information in Project Record Documents to assure correct illustration of completed installation.
  3. Do not use Project Record Documents as maintenance drawings.
- D. Written text, as required to supplement product data for the particular installation:
  1. Organize in a consistent format under separate headings for different procedures.
  2. Provide a logical sequence of instructions for each procedure.
- E. Copy of each warranty, bond and service contract issued: Provide information sheet for Owner's personnel.
  1. Proper procedures in the event of failure.
  2. Instances which might affect the validity of warranties or bonds.
- F. These manuals shall be delivered to the Engineer at the time designated by the Engineer. The manuals must be approved by the Engineer before final payment on the equipment is made.

- END OF SECTION -

**SECTION 01740**  
**WARRANTIES AND BONDS**

**PART 1 - GENERAL**

**1.01 WORK INCLUDED**

- A. Compile specified warranties and bonds.
- B. Compile specified service and maintenance contracts.
- C. Co-execute submittals when so specified.
- D. Review submittals to verify compliance with Contract Documents.
- E. Related requirements specified elsewhere:
  - 1. Bid Bond: Instructions to Bidders.
  - 2. Performance and Payment Bonds: General Provisions, Section 00600
  - 3. Guaranty: General Provisions.
  - 4. General Warranty of Construction: General Provisions.
  - 5. Project Closeout: SECTION 01700.
  - 6. Warranties and Bonds required for specific products: As listed herein.
  - 7. Provisions of Warranties and Bonds, Duration: Respective specification sections for particular products.
  - 8. Operating and Maintenance Data: SECTION 01730.

**1.02 SUBMITTALS REQUIREMENTS**

- A. Assemble warranties, bonds and service and maintenance contracts, executed by each of the respective manufacturers, suppliers and subcontractors.
- B. Furnish two (2) original signed copies.
- C. Table of Contents: Neatly typed, in orderly sequence. Provide complete information for each item.
  - 1. Product, equipment or work item.
  - 2. Firm name, address and telephone number.
  - 3. Scope
  - 4. Date of beginning of warranty, bond or service and maintenance contract.



5. Duration of warranty, bond or service and maintenance contract.
6. Provide information for Owner's personnel:
  - a. Proper procedure in case of failure.
  - b. Instances which might affect the validity of warranty or bond.
7. Contractor name, address and telephone number.

### **1.03 FORM OF SUBMITTALS**

- A. Prepare in duplicate packets.
- B. Format:
  1. Size 8-1/2 in. x 11 in., punch sheets for 3-ring binder: Fold larger sheets to fit into binders.
  2. Cover: Identify each packet with typed or printed title "WARRANTIES AND BONDS". List:
    - a. Title of Project.
    - b. Name of Contractor.
- C. Binders: Commercial quality, three-ring, with durable and cleanable plastic covers.

### **1.04 TIME OF SUBMITTALS**

- A. For equipment or component parts of equipment put into service during progress of construction: Submit documents within 10 days after inspection and acceptance.
- B. Otherwise, make submittals within 10 days after date of substantial completion, prior to final request for payment.
- C. For items of work, where acceptance is delayed materially beyond the Date of Substantial Completion, provide updated submittal within 10 days after acceptance, listing the date of acceptance as the start of the warranty period.

### **1.05 SUBMITTALS REQUIRED**

- A. Submit warranties, bonds, service and maintenance contracts as specified in the respective sections of the Specifications.

- END OF SECTION -

**SECTION 02228**  
**ROCK REMOVAL BLASTING**

**PART 1 GENERAL**

**1.01 SUMMARY**

- A. This Section includes removal to the widths and depths shown on the Contract Drawings or as directed by the Engineer, including the loosening, removing, transporting, storing and disposal of all materials requiring blasting, barring, or wedging for removal from their original beds, and backfill of rock excavations with acceptable materials
- B. Use of explosives for rock removal shall be used only with prior permission from both the Engineer and Owner.
- C. Rock removal is part of and incidental to unclassified excavation. No separate payment shall be made for rock removal.

**1.02 SUBMITTALS**

- A. In addition to those submittals identified in the General Provisions, the following items shall be submitted:
  - 1. Before any blasting operations begin the Contractor shall obtain all permits and licenses required.

**1.03 DEFINITIONS**

- A. Rock
  - 1. All pieces of ledge or bedrock, boulders or masonry larger than one-half cubic yard in volume.
  - 2. Any material requiring blasting, barring, or wedging for removal from its original bed.

**PART 2 PRODUCTS**

NOT USED

**PART 3 EXECUTION**

**3.01 BLASTING (Use of explosives for rock removal shall be used only with prior permission from both the Engineer and Owner.)**

- A. General
  - 1. Handling of explosives and blasting shall be done only by experienced persons.

2. Handling and blasting shall be in accordance with all Federal, State and local laws, rules and regulations relating to the possession, handling, storage and transportation and use of explosives.
  3. All blasts in open cut shall be properly covered and protected with approved blasting mats.
  4. Charges shall be of such size that the excavation will not be unduly large and shall be so arranged and timed that adjacent rock, upon or against which pipelines or structures are to be built, will not be shattered.
  5. Blasting will not be permitted within 25 feet of pipelines or structures.
  6. All existing pipes or structures exposed during excavation shall be adequately protected from damage before proceeding with the blasting.
  7. NFPA 495 - Code for Manufacture, Transportation, Storage and Use of Explosive Materials.
  8. Commonwealth of Kentucky Department of Mines and Minerals, Laws and Regulations Governing Explosives and Blasting.
- B. Repair of Damages Due to Blasting
1. Any injury or damage to the work or to existing pipes or structures shall be repaired or rebuilt by the Contractor at his expense.
  2. Whenever blasting may damage adjacent rock, pipes or structures, blasting shall be discontinued and the rock removed by drilling, barring, wedging or other methods.
- C. Explosives
1. At no time shall an excessive amount of explosives be kept at the site of the work. Such explosives shall be stored, handled and used in conformity with all applicable laws and regulations.
  2. Accurate daily records shall be kept showing the amounts of explosives on hand, both at the site and at any storage magazine, the quantities received and issued, and the purpose for which issued.
  3. The Contractor shall be responsible for any damage or injury to any persons, property or structures as a result of his handling, storage or use of explosives.
- D. Rock Clearance in Trenches
1. Ledge rock, boulders and large stones shall be removed from the sides and bottom of the trench to provide clearance for the specified embedment of each pipe section, joint or appurtenance; but in no instance shall the clearance be less than 6 inches. Additional clearance at the pipe bell or joint shall be provided to allow for the proper make-up of the joint.
  2. At the transition from an earth bottom to a rock bottom the minimum bottom clearance shall be 12 inches for a distance of not less than 5 feet.

E. Rock Clearance at Structures

1. Concrete for structures shall be placed directly on the rock and the excavation shall be only to the elevations and grades shown on the Contract Drawings.

**3.02 EXCAVATION AND BACKFILL**

- A. Rock removal and backfilling shall be performed in accordance with the applicable provisions of the Section entitled "Earthwork".
- B. The rock excavated which cannot be incorporated into the backfill material, as specified, shall be disposed of as spoil and shall be replaced with the quantity of acceptable material required for backfilling.

-END OF SECTION-

**NOTICE OF AWARD**

---

Date of Issuance:

Owner: City of Hardinsburg Owner's Contract No.:  
Engineer: Kentucky Engineering Group, PLLC Engineer's Project No.: 21028  
Project: Mattingly Sewage Pump Station Contract Name: Mattingly Sewage Pump  
Replacement Station Replacement

Bidder:

Bidder's Address:

**TO BIDDER:**

You are notified that Owner has accepted your Bid dated \_\_\_\_\_ 2022\_ for the above Contract, and that you are the Successful Bidder and are awarded a Contract for:

Mattingly Sewage Pump Station Replacement \_\_\_\_\_ .

The Contract Price of the awarded Contract is: \$\_\_\_\_\_

[ 4 ] unexecuted counterparts of the Agreement accompany this Notice of Award, and one copy of the Contract Documents accompanies this Notice of Award, or has been transmitted or made available to Bidder electronically. *[revise if multiple copies accompany the Notice of Award]*

a set of the Drawings will be delivered separately from the other Contract Documents.

You must comply with the following conditions precedent within 15 days of the date of this Notice of Award:

1. Deliver to Owner [ 4 ] counterparts of the Agreement, fully executed by Bidder.
2. Deliver with the executed Agreement(s) the Contract security *[e.g., performance and payment bonds]* and insurance documentation as specified in the Instructions to Bidders and General Conditions, Articles 2 and 6.
3. Other conditions precedent (if any):

Failure to comply with these conditions within the time specified will entitle Owner to consider you in default, annul this Notice of Award, and declare your Bid security forfeited.

Within ten days after you comply with the above conditions, Owner will return to you one fully executed counterpart of the Agreement, together with any additional copies of the Contract Documents as indicated in Paragraph 2.02 of the General Conditions.

---

Owner: City of Hardinsburg

Authorized Signature

By:  
Title:

Copy: Engineer

**SECTION 02110****SITE CLEARING****PART 1 - GENERAL****1.01 WORK INCLUDED**

- A. Clear site within construction limits of plant life.
- B. Remove grass and topsoil in area of access road and foundation.
- C. Remove root system of trees and shrubs.
- D. Remove surface debris

**1.02 RELATED WORK**

- A. Section 02228 - Rock Removal.
- B. Section 02211 - Rough Grading.

**1.03 REGULATORY REQUIREMENTS**

- A. Conform to applicable local codes and ordinances for disposal of debris.

**PART 2 - PRODUCTS**

Not Used.

**PART 3 - EXECUTION****3.01 CLEARING**

- A. Clear areas required for access to site and execution of work.
- B. Remove trees, shrubs, brush, and other vegetable matter such as snags, bark, and refuse.

**3.02 PROTECTION**

- A. The Contractor shall not cut or injure any trees or other vegetation outside the easement lines and outside the areas to be cleared, as indicated on the Drawings, without written permission from the Engineer. The Contractor shall be responsible for all damage done outside these lines.

**3.03 GRUBBING**

- A. From areas to be grubbed, the Contractor shall remove completely all stumps, remove to a depth of at least 24 inches below subgrade elevation all roots larger than 1 1/2 in. in diameter, and remove to a depth of 12 in. all roots larger than 1/2 in. in diameter. Such depths shall be measured from the existing ground surface, the proposed finished grade or subgrade, whichever is lower.

**3.04 STRIPPING**

- A. All stumps, roots, foreign matter, topsoil, loam, and unsuitable earth shall be stripped from the ground surface. The topsoil and loam shall be utilized insofar as possible, for finished surfacing. Loam shall not be taken from the site.

**3.05 DISPOSAL**

- A. All material resulting from clearing and grubbing and not scheduled for reuse or stockpiling shall become the property of the Contractor and shall be suitably disposed of off site, unless otherwise directed by the Engineer, in accordance with all applicable laws, ordinances, rules and regulations.
- B. Such disposal shall be performed as promptly as possible after removal of the material and shall not be left until the final period of cleaning up.

**3.06 FENCES**

- A. Wherever fences need to be removed to provide access to the work or are damaged during the progress of work, they shall be restored or repaired to as good a condition as existed prior to construction at the Contractor's expense.

-- END OF SECTION --

**SECTION 02200****EARTHWORK****PART 1 - GENERAL****1.01 DESCRIPTION OF WORK**

- A. Extent of earthwork is indicated on the Drawings.
  - 1. Preparation of subgrade for pavements is included as part of this work.
  - 2. Engineered fill for support of building or basin slabs is included as part of this work.
  - 3. Backfilling of tanks, basins, basements and trenches within building line is included as part of this work.
- B. Excavation for Mechanical/Electrical Work: Excavation and backfill required in conjunction with underground mechanical and electrical utilities, and buried mechanical and electrical appurtenances is included as work of this Section.
- C. Definition: "Excavation" consists of removal of all material encountered to subgrade elevations and subsequent disposal or reuse of materials removed.

**1.02 REFERENCES**

- A. Materials and installation shall be in accordance with the latest revisions of the following codes, standards, and specifications, except where more stringent requirements have been specified herein:
  - 1. American Society for Testing and Materials (ASTM)
    - a. A328 Specification for Steel Sheet Piling
    - b. D698 Test Method for Laboratory Compaction Characteristics of Soil Using Standard Effort (12,400 ft-lbf/ft<sup>3</sup>) (600 kN-m/m<sup>3</sup>)
    - c. D1556 Test Method for Density and Unit Weight of Soil in Place by the Sand-Cone Method
    - d. D1760 Specification for Pressure Treatment of Timber Products
    - e. D2922 Test Methods for Density of Soil and Soil Aggregate in Place by Nuclear Methods (Shallow Depth)

**1.03 DEFINITIONS**

- A. Excavation (or Trenching)
  - 1. Grubbing, stripping, removing, storing and rehandling of all materials of every name and nature necessary to be removed for all purposes incidental to the construction and completion of all the work under construction.



2. All sheeting, sheetpiling, bracing and shoring, and the placing, driving, cutting off and removing of the same.
  3. All diking, ditching, fluming, cofferdamming, pumping, bailing, draining, well pointing, or otherwise disposing of water.
  4. The removing and disposing of all surplus materials from the excavations in the manner specified.
  5. The maintenance, accommodation and protection of travel and the temporary paving of highways, roads and driveways.
  6. The supporting and protecting of all tracks, rails, buildings, curbs, sidewalks, pavements, overhead wires, poles, trees, vines, shrubbery, pipes, sewers, conduits or other structures or property in the vicinity of the work, whether over- or underground or which appear within or adjacent to the excavations, and the restoration of the same in case of settlement or other injury.
  7. All temporary bridging and fencing and the removing of same.
- B. Earth
1. All materials such as sand, gravel, clay, loam, ashes, cinders, pavements, muck, roots or pieces of timber, soft or disintegrated rock, not requiring blasting, barring, or wedging from their original beds, and specifically excluding all ledge or bedrock and individual boulders or masonry larger than one-half cubic yard in volume.
- C. Backfill
1. The refilling of excavation and trenches to the line of filling indicated on the Contract Drawings or as directed using materials suitable for refilling of excavations and trenches; and the compacting of all materials used in filling or refilling by rolling, ramming, watering, puddling, etc., as may be required.
- D. Spoil
1. Surplus excavated materials not required or not suitable for backfills or embankments.
- E. Embankments
1. Fills constructed above the original surface of the ground or such other elevation as specified or directed.
- F. Limiting Subgrade
1. The underside of the pipe barrel for pipelines
  2. The underside of footing lines for structures
- G. Excavation Below Subgrade

1. Excavation below the limiting subgrades of structures or pipelines.
2. Where materials encountered at the limiting subgrades are not suitable for proper support of structures or pipelines, the Contractor shall excavate to such new lines and grades as required.

#### **1.04 RELATED WORK**

- A. Dewatering is included in elsewhere in this specification.
- B. Erosion and sedimentation control is included in this Division, Section 02270.
- C. Yard piping is included in this Division, Section 02610.
- D. Seeding is included in this Division, Section 02900.

#### **1.05 QUALITY ASSURANCE**

- A. Codes and Standards: Perform excavation work in compliance with applicable requirements of governing authorities having jurisdiction.
- B. Testing and Inspection Service: The Owner shall engage the services of a qualified geotechnical engineering, inspection, and testing firm for quality control testing during earthwork operations.

#### **1.06 SUBMITTALS**

- A. Test Reports - Excavating: Copies of all test reports and field reports shall be made available to the Owner and the Engineer.
- B. The Contractor shall provide access to site areas, borrow pits and other areas for testing. The Contractor shall also indicate the need for tests to be performed. The Contractor may prepare any tests necessary for the conduct of his work.

#### **1.07 JOB CONDITIONS**

- A. Site Information:
  1. Data on indicated subsurface conditions are not intended as representations or warranties of accuracy or continuity between soil borings. It is expressly understood that the Owner will not be responsible for interpretation or conclusions drawn therefrom by Contractor. Data are made available for convenience of Contractor.
  2. Additional test borings and other exploratory operations may be made by Contractor at no cost to Owner.
  3. A geotechnical investigation has been carried out at the site and a report is available upon request. The Contractor shall obtain a copy of this report and shall read, understand follow all the recommendations and requirements contained therein.
- B. Existing Utilities: Prior to commencement of work, the Contractor shall locate existing underground utilities in areas of the work. If utilities are to remain in place, provide adequate means of protection during earthwork operations where required.

- C. Use of Explosives: SEE SECTION 02228
- D. Protection of Persons and Property: Barricade open excavations occurring as part of this work and post with warning lights.
  - 1. Operate warning lights as recommended by authorities having jurisdiction.
  - 2. Protect structures, utilities, sidewalks, pavements, and other facilities from damage caused by settlement, lateral movement, undermining, washout, and other hazards created by earthwork operations.

## **PART 2 - PRODUCTS**

### **2.01 SOIL MATERIALS - DEFINITIONS**

- A. Subbase Material: Naturally or artificially graded mixture of natural or crushed gravel, crushed stone, crushed slag, natural or crushed sand.
- B. Drainage Fill: Washed, uniformly graded mixture of crushed stone or crushed gravel conforming to No. 57 of Kentucky Department of Highways Standard Specifications.
- C. Backfill and Non-Structural Fill Materials: Satisfactory soil materials free of debris, waste, frozen materials, vegetable, and other deleterious matter. No. 57 stone is also used as backfill material at selected structures.
- D. Granular Structural Fill: Granular structural fill shall be used in areas where indicated in this specification. Granular structural fill shall consist of a crushed stone conforming to gradation requirements of Kentucky Department of Highways and having less than 5% passing the No. 200 sieve. Placing and compaction of the granular structural fill shall be in general accordance with Kentucky Department of Highways Standard Specifications and this specification.

### **2.02 FILTER FABRIC**

- A. Material shall be non-woven polyester or polypropylene geotextile having an equivalent opening size no finer than U.S. Standard Sieve No. 200 and no coarser than a U.S. Standard Sieve No. 140.
- B. An acceptable product is Tytar 3601 manufactured by the Dupont Corporation. Other equivalent products shall be submitted to the Engineer for review and approval prior to usage.

## **PART 3 - EXECUTION**

### **3.01 EXCAVATION**

- A. Excavation includes excavation to subgrade elevations including excavation of earth, rock, bricks, wood, cinders, and other debris. All excavation of materials shall be included in the lump sum portion of the work and will be UNCLASSIFIED AND NO ADDITIONAL PAYMENT WILL BE MADE REGARDLESS OF TYPE OF MATERIAL ENCOUNTERED.
- B. Unauthorized excavation consists of removal of materials beyond indicated subgrade elevations or dimensions without specific direction of Engineer. Unauthorized excavation, as well as remedial work directed by Engineer, shall be at Contractor's expense.

1. Under footings, foundation bases, or retaining walls, fill unauthorized excavation by extending indicated bottom elevation of footing or base to excavation bottom, without altering required top elevation. Lean concrete fill may be used to bring elevations to proper position, when acceptable to the Engineer.
  2. Elsewhere, backfill and compact unauthorized excavations as specified for authorized excavations of same classification.
  3. All material which slides, falls or caves into the established limits of excavations due to any cause whatsoever, shall be removed and disposed of at the Contractor's expense and no extra compensation will be paid the Contractor for any materials ordered for refilling the void areas left by the slide, fall or cave-in.
- C. Additional Excavation: When excavation has reached required subgrade elevations, notify the Geotechnical Engineer who will make an inspection of conditions. The surface of the excavated area shall be "proofrolled" with a loaded truck or other heavy construction equipment.
1. If unsuitable bearing materials are encountered at required subgrade elevations, carry excavation deeper and replace excavated material as directed in writing by the Engineer.
  2. Removal of unsuitable material and its replacement as directed will be paid on basis of Contract conditions relative to changes in work.
- D. Stability of Excavations:
1. Slope sides of excavations to comply with local codes and ordinances having jurisdiction. Shore and brace where sloping is not possible because of space restrictions or stability of material excavated.
  2. Maintain sides and slopes of excavations in safe condition until completion of backfilling.
- E. Shoring and Bracing: Provide materials for shoring and bracing, such as sheet piling, uprights, stringers, and cross-braces, in good serviceable condition.
1. Establish requirements for trench shoring and bracing to comply with local codes and authorities having jurisdiction.
  2. Maintain shoring and bracing in excavations regardless of time period excavations will be open. Carry down shoring and bracing as excavation progresses.
  3. Provide permanent steel sheet piling or pressure crested timber sheet piling wherever subsequent removal of sheet piling might permit lateral movement of soil under adjacent structures. Cut off tops as required and leave permanently in place. In the event the Owner directs the Contractor to leave shoring materials in place, the Owner will reimburse the Contractor for the reasonable cost of leaving such materials in place.
- F. Dewatering: It is anticipated that dewatering may be required at excavations.
- G. Material Storage:
1. Stockpile satisfactory excavated materials where directed, until required for backfill or fill. Place, grade, and shape stockpiles for proper drainage.

2. Dispose of excess soil material and waste materials offsite at no additional cost to the Owner.

H. Excavation for Structures

1. Conform to elevations and dimensions shown within a tolerance of plus or minus 0.10 feet and extending a sufficient distance from footings and foundations to permit placing and removal of concrete formwork, installation of services, other construction, and for inspection.
2. In excavating for footings and foundations, take care not to disturb bottom of excavation. All loose material shall be removed from the excavation just before concrete reinforcement is placed. Trim bottoms to required lines and grades to leave solid base to receive other work.
3. Protruding rock formations that would interfere with uniform footing bearing shall be removed such that the structure will bear upon uniform engineered fill at least 24 inches thick.

I. Excavation for Pavements: Cut surface under pavements to comply with cross-sections, elevations, and grades as shown.

J. Trench Excavation:

1. The Contractor shall include in his lump sum bid all trenching and backfill necessary for installation of all pipe as planned and specified. Trenching shall include clearing and grubbing of all trash, and debris encountered in the trenching. The Contractor shall dispose of such material offsite at no extra cost to the Owner.
2. All existing facilities shall be protected from danger or damage while pipelines are being constructed and backfilled, and from damage due to settlement of the backfill.
3. In the event any existing structure is damaged, repair and restoration shall be made at once and backfill shall not be replaced until this is done. Restoration and repair shall be such that the damaged structure is equal to or better than its original condition and can serve its purpose as completely as before. All such restoration and repair shall be done without extra cost to the Owner.
4. Trenches must be dug to lines and grades shown on the Drawings. Hand trenching may be required in areas where machine trenching would result in undue damage to existing structures and facilities.
5. Sheeting and shoring of trenches shall be provided at the expense of the Contractor where necessary to protect life, property and the new or existing structures from damage or to maintain maximum permissible trench widths at top of pipe. All necessary materials, including, but not limited to, sheeting, sheet piling, trench jacks, braces, shores and stringers, shall be used to hold trench walls. Sheeting and shoring may be withdrawn as the trenches are being backfilled, after backfill has been tamped over top of the pipe at least 18-inches. If removal before backfill is completed to surface endangers adjacent structures, such as buildings, pipelines, street paving, and sidewalks, then the sheeting and shoring shall be left in place until such danger has passed, and then pulled if practical. Voids caused by sheeting withdrawal shall be backfilled and tamped. If not withdrawn, sheeting shall be cut off at least 18-inches

below final surface grade, so there is no obstruction at the ground level. In the event the Owner directs the Contractor to leave shoring materials in place, the Owner will reimburse the Contractor for the reasonable cost of leaving such materials in place.

6. Where subgrade of trench has insufficient stability to support the pipeline and hold it to its original grade, the Engineer may order stabilization by various means. Exclusive of dewatering normally required for construction, and instability caused by neglect of the Contractor, the payment necessary for stabilization shall be negotiated.
7. The location of the pipelines and their appurtenances as shown are those intended for the final construction. However, conditions may present themselves before construction on any line is started that would indicate desirable changes in location. The Owner reserves the right to make reasonable changes in line and structure locations without extra cost, except as may be determined by extra units of materials and construction actually involved. The Owner is under no obligation to locate pipelines, so they may be excavated by machine.
8. The Contractor shall only have sufficient trench open ahead of the pipe laying work as necessary for the prosecution of the work, that day. Dig trenches to the uniform width required for the particular item to be installed, sufficiently wide to provide ample working room. Provide a minimum of 9" clearance on both sides of pipe or conduit.
  - a. Excavate trenches to depth indicated or required. Carry depth of trenches for piping to establish indicated flow lines and invert elevations. Beyond building perimeter, keep bottoms of trenches sufficiently below finish grade to avoid freeze-ups.
  - b. Where rock is encountered, carry excavation 6-inches below required elevation and backfill with a 6-inch layer of crushed stone or gravel prior to installation of pipe.
  - c. For pipes or conduit 3-inches or less in nominal size and for flat-bottomed, multiple-duct conduit units, excavate to subbase depth indicated or, if not indicated, then to 4-inches below bottom of work to be supported.
  - d. For pipes or conduit 6-inches or larger in nominal size, and mechanical/electrical work indicated to receive subbase, excavate to subbase depth indicated or, if not otherwise indicated, to 6-inches below bottom of work to be supported.
  - e. Except as otherwise indicated, excavate for exterior water piping (water, drainage) so top of piping is no less than 3-feet 6-inches below finish grade.
  - f. Grade bottom of trenches as indicated, notching under pipe bells to provide solid bearing for entire body of pipe.
  - g. Encase pipe with concrete (full encasement) where trench excavations pass within 18 inches of column or wall footings and which are carried below bottom of such footings, or which pass under wall footings. Place concrete to level of bottom of adjacent footing(s).
  - h. Concrete is specified in Division 3.

- i. Do not backfill trenches until tests and inspections have been made and backfilling authorized by the Engineer. Use care in backfilling to avoid damage or displacement of pipe systems.
  - j. For piping or conduit less than 3-feet 6-inches below surface of roadways, furnish and install steel casing pipe, minimum wall thickness of 5/16", of sufficient diameter to carry the pipe or conduit to at least two feet beyond outside edge of pavement.
- K. Cold Weather Protection: Protect excavation bottoms against freezing when atmospheric temperature is less than 35°F (1°C).

### 3.02 REMOVAL OF WATER

#### A. General

1. The Contractor shall at all times provide and maintain proper and satisfactory means and devices for the removal of all water entering the excavations, and shall remove all such water as fast as it may collect, in such manner as shall not interfere with the prosecution of the work or the proper placing of pipes, structures, or other work.
2. Unless otherwise specified, all excavations which extend down to or below the static groundwater elevations shall be dewatered by lowering and maintaining the groundwater beneath such excavations at all times when work thereon is in progress, during subgrade preparation and the placing of the structure or pipe thereon.
3. Water shall not be allowed to rise over or come in contact with any masonry, concrete or mortar, until at least 24 hours after placement, and no stream of water shall be allowed to flow over such work until such time as the Engineer may permit.
4. Where the presence of fine grained subsurface materials and a high groundwater table may cause the upward flow of water into the excavation with a resulting quick or unstable condition, the Contractor shall install and operate a well point system to prevent the upward flow of water during construction.
5. Water pumped or drained from excavations, or any sewers, drains or water courses encountered in the work, shall be disposed of in a suitable manner without injury to adjacent property, the work under construction, or to pavements, roads, drives, and water courses. No water shall be discharged to sanitary sewers. Sanitary sewage shall be pumped to sanitary sewers or shall be disposed of by an approved method.
6. Any damage caused by or resulting from dewatering operations shall be the sole responsibility of the Contractor.

#### B. Work Included

1. The construction and removal of cofferdams, sheeting and bracing, and the furnishing of materials and labor necessary therefor.
2. The excavation and maintenance of ditches and sluiceways.

3. The furnishing and operation of pumps, well points, and appliances needed to maintain thorough drainage of the work in a satisfactory manner.

C. Well Point Systems

1. Installation

- a. The well point system shall be designed and installed by or under the supervision of an organization whose principal business is well pointing and which has at least five consecutive years of similar experience and can furnish a representative list of satisfactory similar operations.
- b. Well point headers, points and other pertinent equipment shall not be placed within the limits of the excavation in such a manner or location as to interfere with the laying of pipe or trenching operations or with the excavation and construction of other structures.
- c. Detached observation wells of similar construction to the well points shall be installed at intervals of not less than 50 feet along the opposite side of the excavation from the header pipe and line of well points, to a depth of at least 5 feet below the proposed excavation. In addition, one well point in every 50 feet shall be fitted with a tee, plug and valve so that the well point can be converted for use as an observation well. Observation wells shall be not less than 1-½ inches in diameter.
- d. Standby gasoline or diesel powered equipment shall be provided so that in the event of failure of the operating equipment, the standby equipment can be readily connected to the system. The standby equipment shall be maintained in good order and actuated regularly not less than twice a week.

2. Operation

- a. Where well points are used, the groundwater shall be lowered and maintained continuously (day and night) at a level not less than 2 feet below the bottom of the excavation. Excavation will not be permitted at a level lower than 2 feet above the water level as indicated by the observation wells.
- b. The effluent pumped from the well points shall be examined periodically by qualified personnel to determine if the system is operating satisfactorily without the removal of fines.
- c. The water level shall not be permitted to rise until construction in the immediate area is completed and the excavation backfilled.

### 3.03 BACKFILL AND FILL

A. General:

1. All material to be used as backfill material shall be tested and approved by the Geotechnical Engineer prior to backfilling excavations.
2. With the exception of the organic and inorganic debris, and topsoil, the on-site soil removed from the excavations could be used as non-structural fill or backfill material



provided the moisture content of the soil is within acceptable limits. However, offsite borrow material may be required for use as non-structural fill. The use of off-site borrow material shall not result in additional compensation for the Contractor.

3. Place acceptable backfill material in maximum 6-8" lifts (loose thickness) to required subgrade elevations, for each area classification listed below.
    - a. In excavations, use satisfactory excavated or borrow material.
    - b. Under slabs, use drainage fill material for a minimum depth of 6-inches. Below drainage fill use satisfactory excavated or borrow material.
- B. Backfill excavations as promptly as work permits, but not until completion of the following:
1. Acceptance of construction below finish grade.
  2. Inspection, testing, approval, and recording locations of underground utilities.
  3. Removal of concrete formwork.
  4. Removal of shoring and bracing, and backfilling of voids with satisfactory materials. Cut off temporary sheet piling driven below bottom of structures and remove in manner to prevent settlement of the structure or utilities, or leave in place if required.
  5. Removal of trash and debris.
- C. Compaction:
1. Control soil compaction during construction providing minimum percentage of density specified for each area classification indicated below.
    - a. Fill under slab-on-grade shall be compacted to 98% Standard Proctor Density, ASTM D698, at a moisture content between 2 percent below to 3 percent above the optimum moisture content.
    - b. Granular structural fill under foundation elements, i.e., footings and base slabs for tanks and basins shall be compacted to 98% Standard Proctor Density, ASTM D698, at a moisture content between 2 percent below to 3 percent above the optimum moisture content.
  2. Moisture Control
    - a. Where subgrade or layer of soil material must be moisture conditioned before compaction, uniformly apply water to surface or subgrade, or layer of soil material, to prevent free water appearing on surface during or subsequent to compaction operations. Do not place backfill or fill material on surfaces that are muddy, frozen, or contain frost or ice.
    - b. Remove and replace, or scarify and air dry, soil material that is too wet to permit compaction to specified density.
    - c. Soil material that has been removed because it is too wet to permit compaction may be stockpiled or spread and allowed to dry. Assist drying by dicing,

harrowing, or pulverizing until moisture content is reduced to the optimum moisture for compaction.

3. Place backfill and fill materials evenly adjacent to structures, piping, or conduit to required elevations. Take care to prevent wedging action of backfill against structures or displacement of piping or conduit by carrying material uniformly around structure, piping, or conduit to approximately same elevation in each lift.

D. Backfilling Trenches:

1. Backfilling shall be accomplished as soon as practical after pipe has been laid and jointing and alignment approved. Packing of crushed rock between joints shall be uniform and progress as the pipe laying progresses. This is in order to avoid danger of misalignment from slides, flooding or other causes. The Engineer shall be given a maximum of 24 hours for inspection before backfilling.
2. The backfill over the pipe shall be in accordance with the details shown on the Drawings for bedding and backfilling pipe.
3. In case maximum permissible trench widths (as designated by the pipe manufacturer) are exceeded, the Contractor shall furnish crushed rock backfill to a minimum of 12-inches over the top of pipe at no extra cost to the Owner.
4. If additional earth is required for back filling, it must be obtained and placed by the Contractor.
5. In the case of street, highway, railroad, sidewalk and driveway crossings; or within any roadway paving; or about manholes, valve and meter boxes; the backfill must be mechanically tamped in not over 6 inch layers, measured loose. Alternate method of compacting backfill shall be used, if refill material is in large hard lumps (crushed rock excepted) which cannot be consolidated without leaving voids.
6. Where traffic on streets, driveways, railroads, sidewalks and highways requires temporary surfacing, backfilling shall be terminate 4-inches below original ground level and 4-inches to 6-inches of dense graded aggregate shall be placed on the trench. Backfill shall be maintained easily passable to traffic at original ground level, until acceptance of project or replacement of paving or sidewalks.
7. The Contractor shall protect all sewer, gas, electric, telephone, water, and drain pipes or conduits from damage while pipelines are being constructed and backfilled, and from danger due to settlement of trench backfill.
8. No extra payment shall be made for backfilling of any kind, except as specified hereinbefore. Backfilling shall be included as a part of the lump sum bid. No extra payment will be made to the Contractor for supplying outside materials for backfill.
9. On completion of the project, all backfill shall be dressed; holes filled; and surplus material hauled away. All permanent walks, street paving, roadway, etc., shall be restored and repaved to match existing pavement thickness over a width equal to the trench width plus 2 feet. A compacted subbase of 12" of KDOT DGA crushed stone with less than 5% passing the No. 200 sieve shall be added under concrete pavements (10" under asphalt concrete pavement).

**3.04 GRADING**

- A. General: Uniformly grade areas within limits of grading under this section, including adjacent transition areas. Smooth finished surface within specified tolerances, compact with uniform levels or slopes between points where elevations are indicated, or between such points and existing grades.
- B. Grading Outside Building Lines:
1. All materials used for backfill around structures shall be of a quality acceptable to the Engineer and shall be free from large or frozen lumps, wood and other extraneous material. All spaces excavated and not occupied by footings, foundations, walls or other permanent work shall be refilled with earth up to the surface of the surrounding ground, unless otherwise specified, with sufficient allowance for settlement. In making the fills and terraces around the structures, the fill shall be placed in layers not exceeding 8-inches in depth and shall be kept smooth as the work progresses. Each layer of the fill shall be compacted. Sections of the fill immediately adjacent to buildings or structures shall be thoroughly compacted by means of mechanical tamping or hand tamping as may be required by the conditions encountered. All fills shall be placed so as to load structures symmetrically.
  2. As set out hereinbefore, rough grading shall be held below finished grade and then the topsoil, which has been stockpiled, shall be evenly spread over the surface. The grading shall be brought to the levels shown on the Drawings. Final dressing shall be accomplished by hand work or machine work, or a combination of these methods as may be necessary to produce a uniform and smooth finish to all parts of the regrade. The surface shall be free from clods greater than 2-inches in diameter. Excavated rock may be placed in the fills, but it shall be thoroughly covered. Rock placed in fills shall not be closer than 12-inches from finished grade.
  3. Grade areas adjacent to building lines to drain away from structures and to prevent ponding. Finish surfaces free from irregular surface changes, and as follows:
    - a. Walks: Shape surface of areas under walks to line, grade, and cross-section, with finish surface not above or 1.0 inch below required subgrade elevation.
    - b. Pavements: Shape surface of areas under pavement to line, grade, and cross-section, with finish surface not more than 1.0 in. below required subgrade elevation.
- C. Grading Surface of Fill Under Building Slabs: Grade smooth and even, free of voids, compacted as specified, and to required elevation. Provide final grades within a tolerance of 1.0 in. above or 1.0 in. below required subgrade elevation when tested with a 10-ft. straightedge.
- D. Compaction: After grading, compact subgrade surfaces to the depth and indicated percentage of maximum or standard proctor density for each area classification.
- E. Slope Protection and Erosion Control: Conform to the requirements of Section 02270 for permanent slope protection and erosion control.

**3.05 FIELD QUALITY CONTROL**

- A. Quality Control Testing During Construction:

1. Allow the Geotechnical Engineer to inspect and report to the Engineer on findings and approve subgrades and fill layers before further construction work is performed.
  2. Perform field density tests in accordance with ASTM D 1556 (sand cone method), ASTM D 2167 (rubber balloon method), or ASTM D 2992 (nuclear density method), as applicable and at a frequency necessary to be reasonably assured that adequate compaction is achieved.
- B. If in the opinion of the Engineer, based on testing service reports and inspection, subgrade or fills which have been placed are below specified density, provide additional compaction and testing at no additional expense to the Owner.

### **3.06 MAINTENANCE**

- A. Reconditioning Compacted Areas: Where completed compacted areas are disturbed by subsequent construction operations or adverse weather, scarify surface, reshape, and compact to required density prior to further construction.
- B. Settling: Where settling is measurable or observable at excavated areas during general project warranty period, remove surface (pavement, or other finish), add backfill material, compact, and replace surface treatment. Restore appearance, quality, and condition of surface or finish to match adjacent work, and eliminate evidence of restoration to greatest extent possible.

### **3.07 DISPOSAL OF EXCESS NON-ORGANIC SOIL AND ROCK**

- A. General: All excess excavated material shall become the property of the Contractor and shall be disposed by him outside the project limits. It is the Contractor's responsibility to locate a suitable waste area off-site, obtain necessary permits or use of the waste area and be in compliance with applicable laws and regulations.

-- END OF SECTION --

**SECTION 02211**  
**ROUGH GRADING**

**PART 1 - GENERAL**

**1.01 WORK INCLUDED**

- A. Remove topsoil and stockpile for later reuse.
- B. Grade and rough contour site.

**1.02 RELATED WORK**

- A. Geotechnical investigation report is available upon request.
- B. Section 02228 - Rock Removal.
- C. Section 02220 – Earthwork.

**1.03 PROJECT RECORD DOCUMENTS**

- A. Submit document.
- B. Accurately record location of utilities remaining, rerouted utilities, new utilities by horizontal dimensions, elevations or inverts, and slope gradients.

**1.04 PROTECTION**

- A. Protect trees and other features remaining as portion of final landscaping.
- B. Protect bench marks, existing structures, fences, roads, sidewalks and other features not designated for demolition.
- C. Protect above or below grade utilities which are to remain.
- D. Contractor shall be responsible for repairing any damage to those items not designated for demolition or removal in a manner satisfactory to the Owner at no additional cost to the Owner.

**PART 2 - PRODUCTS**

**2.01 MATERIALS**

- A. Topsoil: Excavated material, graded free of roots, rocks larger than one inch, subsoil, debris, and large weeds.
- B. Subsoil: Excavated material, graded free of lumps larger than 12 inches, rocks larger than 12 inches, and debris.

**PART 3 - EXECUTION****3.01 PREPARATION**

- A. Identify required lines, levels, contours, and datum.
- B. Identify known below grade utilities. Stake and flag locations.
- C. Identify and flag above grade utilities.
- D. Maintain and protect existing utilities remaining which pass through work area.
- E. Upon discovery of unknown utility or concealed conditions, discontinue affected work; notify Engineer.

**3.02 TOPSOIL EXCAVATION**

- A. Excavate topsoil from areas to be further excavated, and stockpile in area designated on site by the Engineer.
- B. Do not excavate wet topsoil.
- C. Stockpile topsoil to depth not exceeding 8 feet.

**3.03 SUBSOIL EXCAVATION**

- A. Excavate subsoil from indicated areas and stockpile in area designated on site. Excess subsoil may be reused according to Section 02220, Backfilling.
- B. Do not excavate wet subsoil.
- C. Stockpile subsoil to depth not exceeding 8 feet.
- D. When excavation through roots is necessary, perform work by hand and cut roots with a sharp axe.

**3.04 TOLERANCES**

- A. Top Surface of Subgrade: Plus or minus three inches.

- END OF SECTION -

**SECTION 02222****EXCAVATION****PART 1 - GENERAL****1.01 WORK INCLUDED**

- A. Structure excavation.
- B. Shoring excavations.

**1.02 RELATED WORK**

- A. Geotechnical Report in these specifications.
- B. Section 01450 - Quality Control.
- C. Section 02228 - Rock Removal.
- D. Section 02211 - Rough Grading.
- E. Section 02220 - Backfilling and Embankments.
- F. Section 02226 - Trenching.

**1.03 REGULATORY REQUIREMENTS**

- A. Protect excavations by shoring, bracing, sheet piling, underpinning, or other methods required to prevent cave-in or loose soil from falling into excavation.
- B. Underpin adjacent structures which may be damaged by excavation work, including service utilities and pipe chases.
- C. Notify Engineer of unexpected subsurface conditions and discontinue affected work in area until notified to resume work.
- D. Protect bottom of excavations and soil adjacent to and beneath foundations from frost.
- E. Grade excavation top perimeter to prevent surface water run-off into excavation.

**PART 2 - PRODUCTS****2.01 MATERIALS**

- A. Subsoil: Excavated material, graded free of lumps larger than 12 inches, rocks larger than 12 inches, and debris.
- B. # 57's or # 9's: Mineral aggregate graded 1/4 inch to 5/8 inch, free of soil, subsoil, clay, shale, or foreign matter.

**PART 3 - EXECUTION****3.01 PREPARATION**

Identify required liens, levels, contours, and datum.

**3.02 EXCAVATION**

- A. Excavate subsoil required for structure foundations, construction operations, and other work. All excavation shall be unclassified excavation.
- B. Contractor is responsible to adequately brace open cuts and protect workmen and equipment from cave-in.
- C. Remove lumped subsoil, boulders, and rock up to 1/3 cu. yd., measured by volume. Remove larger material under Section 02228.
- D. Correct unauthorized excavation at no cost to Owner.
- E. Fill over-excavated areas under structure bearing surfaces in accordance with direction by Engineer.
- F. Stockpile excavated material in area designated on site.

**3.03 FIELD QUALITY CONTROL**

Provide for visual inspection of rock surfaces under provisions of Section 01450.

- END OF SECTION -



**SECTION 02226****TRENCHING, BACKFILLING AND COMPACTING****PART 1 GENERAL****1.01 SUMMARY**

- A. This Section includes excavation and backfill as required for pipe installation or other construction in the trench, and removal and disposal of water, in accordance with the applicable provisions of the Section entitled "Earthwork" unless modified herein.

**PART 2 PRODUCTS**

NOT USED

**PART 3 EXECUTION****3.01 EXCAVATION**

- A. The trench excavation shall be located as shown on the Contract Drawings or as specified. Under ordinary conditions, excavation shall be by open cut from the ground surface. Where the depth of trench and soil conditions permit, tunneling may be required beneath cross walks, curbs, gutters, pavements, trees, driveways, railroad tracks and other surface structures. No additional compensation will be allowed for such tunneling over the price bid for open cut excavation of equivalent depths below the ground surface unless such tunnel excavation is specifically provided for in the Contract Documents.
- B. Trenches shall be excavated to maintain the depths as shown on the Contract Drawings or as specified for the type of pipe to be installed.
- C. The alignment and depth shall be determined and maintained by the use of a string line installed on batter boards above the trench, a double string line installed along side of the trench or a laser beam system.
- D. The minimum width of trench excavation shall be 6-inches on each side of the pipe hub for 21-inch diameter pipe and smaller and 12-inches on each side of the pipe hub for 24-inch diameter pipe and larger.
- E. Trenches shall not be opened for more than 300 feet in advance of pipe installation nor left unfilled for more than 100 feet in the rear of the installed pipe when work is in progress without the consent of the Engineer. Open trenches shall be protected and barricaded as required.
- F. Bridging across open trenches shall be constructed and maintained where required.

**3.02 SUBGRADE PREPARATION FOR PIPE**

- A. Where pipe is to be laid on undisturbed bottom of excavated trench, mechanical excavation shall not extend lower than the finished subgrade elevation at any point.
- B. Where pipe is to be laid on special granular material the excavation below subgrade shall be to the depth specified or directed. The excavation below subgrade shall be

refilled with special granular material as specified or directed, shall be deposited in layers not to exceed 6 inches and shall be thoroughly compacted prior to the preparation of pipe subgrade.

- C. The subgrade shall be prepared by shaping with hand tools to the contour of the pipe barrel to allow for uniform and continuous bearing and support on solid undisturbed ground or embedment for the entire length of the pipe.
- D. Pipe subgrade preparation shall be performed immediately prior to installing the pipe in the trench. Where bell holes are required they shall be made after the subgrade preparation is complete and shall be only of sufficient length to prevent any part of the bell from becoming in contact with the trench bottom and allowing space for joint assembly.

### **3.03 STORAGE OF MATERIALS**

- A. Traffic shall be maintained at all times in accordance with the applicable Highway Permits. Where no Highway Permit is required at least one-half of the street must be kept open for traffic.
- B. Where conditions do not permit storage of materials adjacent to the trench, the material excavated from a length as may be required, shall be removed by the Contractor, at his cost and expense, as soon as excavated. The material subsequently excavated shall be used to refill the trench where the pipe had been built, provided it be of suitable character. The excess material shall be removed to locations selected and obtained by the Contractor.
  - 1. The Contractor shall, at his cost and expense, bring back adequate amounts of satisfactory excavated materials as may be required to properly refill the trenches.
- C. If directed by the Engineer, the Contractor shall refill trenches with select fill or other suitable materials and excess excavated materials shall be disposed of as spoil.

### **3.04 REMOVAL OF WATER AND DRAINAGE**

- A. The Contractor shall at all times provide and maintain proper and satisfactory means and devices for the removal of all water entering the trench, and shall remove all such water as fast as it may collect, in such manner as shall not interfere with the prosecution of the work.
- B. The removal of water shall be in accordance with the Section entitled "Earthwork".

### **3.05 PIPE EMBEDMENT**

- A. All pipe shall be protected from lateral displacement and possible damage resulting from superimposed backfill loads, impact or unbalanced loading during backfilling operations by being adequately embedded in suitable pipe embedment material. To ensure adequate lateral and vertical stability of the installed pipe during pipe jointing and embedment operations, a sufficient amount of the pipe embedment material to hold the pipe in rigid alignment shall be uniformly deposited and thoroughly compacted on each side, and back of the bell, of each pipe as laid.
- B. Concrete cradle and encasement of the class specified shall be installed where and as shown on the Contract Drawings or ordered by the Engineer. Before any concrete is placed, the pipe shall be securely blocked and braced to prevent movement or flotation. The concrete cradle or encasement shall extend the full width of the trench

as excavated unless otherwise authorized by the Engineer. Where concrete is to be placed in a sheeted trench it shall be poured directly against sheeting to be left in place or against a bond-breaker if the sheeting is to be removed.

- C. Embedment materials placed above the centerline of the pipe or above the concrete cradle to a depth of 12 inches above the top of the pipe barrel shall be deposited in such manner as to not damage the pipe. Compaction shall be as required for the type of embedment being installed.

### **3.06 BACKFILL ABOVE EMBEDMENT**

- A. The remaining portion of the pipe trench above the embedment shall be refilled with suitable materials compacted as specified.
  - 1. Where trenches are within the ditch-to-ditch limits of any street or road or within a driveway or sidewalk, or shall be under a structure, the trench shall be refilled in horizontal layers not more than 8 inches in thickness, and compacted to obtain 95% maximum density, and determined as set forth in the Section entitled "Earthwork".
  - 2. Where trenches are in open fields or unimproved areas outside of the ditch limits of roads, the backfilling may be by placing the material in the trench and mounding the surface.
  - 3. Hand tamping shall be required around buried utility lines or other subsurface features that could be damaged by mechanical compaction equipment.
- B. Backfilling of trenches beneath, across or adjacent to drainage ditches and water courses shall be done in such a manner that water will not accumulate in unfilled or partially filled trenches and the backfill shall be protected from surface erosion by adequate means.
  - 1. Where trenches cross waterways, the backfill surface exposed on the bottom and slopes thereof shall be protected by means of stone or concrete rip-rap or pavement.
- C. All settlement of the backfill shall be refilled and compacted as it occurs.

-END OF SECTION-

**SECTION 02255****CRUSHED STONE AND DENSE GRADED AGGREGATE****PART 1 - GENERAL****1.01 SCOPE OF WORK**

- A. Furnish and install crushed stone for miscellaneous uses as shown on the Drawings, as called for in the Specifications.
- B. Sizes, types, and quality of crushed stone are specified in this Section, but its use for replacement of unsuitable material, pavement base, and similar uses is specified in detail elsewhere in the Specifications. The Engineer may order the use of crushed stone for purposes other than those specified in other Sections, if, in his opinion, such use is advisable. Payment for same will be subject to negotiation.

**PART 2 - PRODUCTS****2.01 MATERIALS**

- A. When referred to in these Specifications, crushed stone shall be Number 57 graded in accordance with the Kentucky Department of Highways, Standard Specifications, latest edition, unless otherwise noted.
- B. When referred to in these Specifications, dense graded aggregate (DGA) shall be crushed stone classified by the Kentucky Department of Highways, Standard Specifications, latest edition, and conforming to the following requirements:

<u>Sieve Size</u>	<u>Percent Passing</u>
1 Inch	100
3/4 Inch	70 - 100
1/2 Inch	50 - 80
#4	30 - 65
#10	17 - 50
#40	8 - 30
#200	2 - 10

**PART 3 - EXECUTION****3.01 INSTALLATION**

- A. Crushed stone shall be placed and compacted in accordance with the Kentucky Department of Highways, Standard Specifications.
- B. Crushed stone shall be placed in those areas as shown on the Drawings.

-- END OF SECTION --

# KPDES FORM NOI-SW

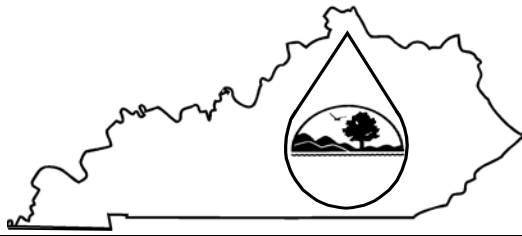

Kentucky Pollutant Discharge Elimination System  
 (KPDES)  
**Notice of Intent (NOI)**  
**for Storm Water Discharges**  
**Associated with Industrial Activity Under the**  
**KPDES General Permit**

Submission of this Notice of Intent constitutes notice that the party identified in Section I of this form intends to be authorized by a KPDES permit issued for storm water discharges associated with industrial activity. Becoming a permittee obligates such discharger to comply with the terms and conditions of the permit.

**ALL NECESSARY INFORMATION MUST BE PROVIDED ON THIS FORM** (See Instructions on back)

### I. Facility Operator Information

<b>Name:</b>		<b>Phone:</b>	
<b>Address:</b>		<b>Status of Owner/Operator:</b>	
<b>City, State, Zip Code:</b>			

### II. Facility/Site Location Information

<b>Name:</b>			
<b>Address:</b>			
<b>City, State, Zip Code:</b>			
<b>County:</b>			
<b>Site Latitude:</b> (degrees/minutes/seconds)		<b>Site Longitude:</b> (degrees/minutes/seconds)	

### III. Site Activity Information

<b>MS4 Operator Name:</b>				
<b>Receiving Water Body:</b>				
<b>Are there existing quantitative data?</b>	Yes <input type="checkbox"/>	If Yes, submit with this form.		
	No <input type="checkbox"/>			
<b>SIC or Designated Activity Code Primary</b>		<b>2nd</b>	<b>3rd</b>	<b>4th</b>
<b>If this facility is a member of a Group Application, enter Group Application Number:</b>				
<b>If you have other existing KPDES Permits, enter Permit Numbers:</b>				

### IV. Additional Information Required FOR CONSTRUCTION ACTIVITIES ONLY

<b>Project Start Date:</b>		<b>Completion Date:</b>	
<b>Estimated Area to be disturbed (in acres):</b>			
<b>Is the Storm Water Pollution Prevention Plan in Compliance with State and/or Local Sediment and Erosion Plans?</b>	Yes <input type="checkbox"/>	No <input type="checkbox"/>	

**V. Certification:** I certify under penalty of law that this document and all attachments were prepared under my direction or supervision in accordance with a system designed to assure that qualified personnel properly gather and evaluate the information submitted. Based on my inquiry of the person or persons who manage the system, or those persons directly responsible for gathering the information, the information submitted is, to the best of my knowledge and belief, true, accurate, and complete. I am aware that there are significant penalties for submitting false information, including the possibility of fine and imprisonment for knowing violations.

<b>Printed or Typed Name:</b>			
<b>Signature:</b>		<b>Date:</b>	

**Kentucky Pollutant Discharge Elimination System (KPDES)  
Instructions  
Notice of Intent (NOI) for Storm Water Discharges Associated with Industrial Activity  
To Be Covered Under The KPDES General Permit**

**WHO MUST FILE A NOTICE OF INTENT (NOI) FORM**

Federal law at 40 CFR Part 122 prohibits point source discharges of stormwater associated with industrial activity to a water body of the Commonwealth of Kentucky without a Kentucky Pollutant Discharge Elimination System (KPDES) permit. The operator of an industrial activity that has such a storm water discharge must submit a NOI to obtain coverage under the KPDES Storm Water General Permit. If you have questions about whether you need a permit under the KPDES Storm Water program, or if you need information as to whether a particular program is administered by the state agency, call the **Storm Water Contact, Industrial Section, Kentucky Division of Water at (502) 564-3410.**

**WHERE TO FILE NOI FORM**

NOIs must be sent to the following address:

**Section Supervisor  
Inventory & Data Management Section  
KPDES Branch, Division of Water  
Frankfort Office Park  
14 Reilly Road  
Frankfort, KY 40601**

**COMPLETING THE FORM**

Type or print legibly in the appropriate areas only. If you have any questions regarding the completion of this form call the **Storm Water Contact, Industrial Section, at (502) 564-3410.**

**SECTION I - FACILITY OPERATOR INFORMATION**

Give the legal name of the person, firm, public organization, or any other entity that operates the facility or site described in this application. The name of the operator may or may not be the same as the name of the facility. The responsible party is the legal entity that controls the facility's operation, rather than the plant or site manager. Do not use a colloquial name. Enter the complete address and telephone number of the operator.

Enter the appropriate letter to indicate the legal status of the operator of the facility.

F = Federal                      M = Public (other than federal or state)  
S = State                         P = Private

**SECTION II - FACILITY/SITE LOCATION INFORMATION**

Enter the facility's or site's official or legal name and complete street address, including city, state, and ZIP code.

**SECTION III - SITE ACTIVITY INFORMATION**

If the storm water discharges to a municipal separate storm sewer system (MS4), enter the name of the operator of the MS4 (e.g., municipality name, county name) and the receiving water of the discharge from the MS4. (A MS4 is defined as a conveyance or system of conveyances (including roads with drainage systems, municipal streets, catch basins, curbs, gutters, ditches, man-made channels, or storm drains) that is owned or operated by a state, city, town, borough, county, parish, district, association, or other public body which is designed or used for collecting or conveying storm water.)

If the facility discharges storm water directly to receiving water(s), enter the name of the receiving water.

Indicate whether or not the owner or operator of the facility has existing quantitative data that represent the characteristics and concentration of pollutants in storm water discharges. If data is available submit with this form.

List, in descending order of significance, up to four 4-digit standard industrial classification (SIC) codes that best describe the principal products or services provided at the facility or site identified in Section II of this application.

If the facility listed in Section II has participated in Part 1 of an approved storm water group application and a group number has been assigned, enter the group application number in the space provided.

If there are other KPDES permits presently issued for the facility or site listed in Section II, list the permit numbers.

**SECTION IV - ADDITIONAL INFORMATION REQUIRED FOR CONSTRUCTION ACTIVITIES ONLY**

Construction activities must complete Section IV in addition of Sections I through III. Only construction activities need to complete Section IV.

Enter the project start date and the estimated completion date for the entire development plan.

Provide an estimate of the total number of acres of the site on which soil will be disturbed (round to the nearest acre).

Indicate whether the storm water pollution prevention plan for the site is in compliance with approved state and/or local sediment and erosion plans, permits, or storm water management plans.

**SECTION V - CERTIFICATION**

Federal statutes provide for severe penalties for submitting false information on this application form. Federal regulations require this application to be signed as follows:

*For a corporation:* by a responsible corporate officer, which means: (i) president, secretary, treasurer, or vice-president of the corporation in charge of a principal business function, or any other person who performs similar policy or decision making functions, or (ii) the manager of one or more manufacturing, production, or operating facilities employing more than 250 persons or having gross annual sales or expenditures exceeding \$25 million (in second-quarter 1980 dollars), if authority to sign documents has been assigned or delegated to the manager in accordance with corporate procedures;

*For a partnership or sole proprietorship:* by a general partner or the proprietor; or

*For a municipality, state, Federal, or other public facility:* by either a principal executive officer or ranking elected official.

# KPDES FORM NOT-SW

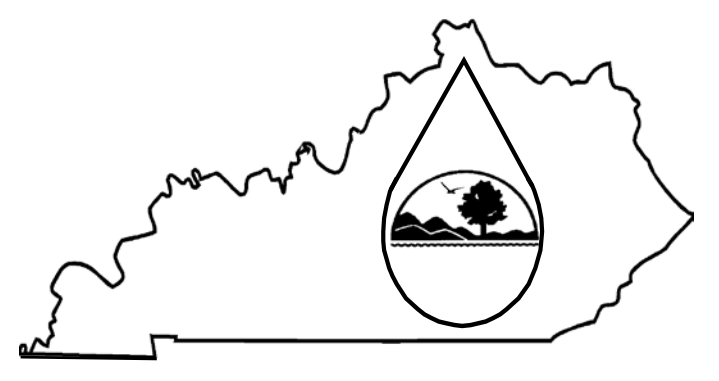
	<p>Kentucky Pollutant Discharge Elimination System (KPDES)</p> <p><b>NOTICE OF TERMINATION (NOT)</b> of Coverage Under the KPDES General Permit for Storm Water Discharges Associated with Industrial Activity</p>
---	--

Submission of this Notice of Termination constitutes notice that the party identified in Section II of this form is no longer authorized to discharge storm water associated with industrial activity under the KPDES program.

ALL NECESSARY INFORMATION MUST BE PROVIDED ON THIS FORM.  
(Please see instructions on back before completing this form.)

**I. PERMIT INFORMATION**

KPDES Storm Water General Permit Number:
Check here if you are no longer the Operator of the Facility: <input type="checkbox"/>
Check here if the Storm Water Discharge is Being Terminated: <input type="checkbox"/>

**II. FACILITY OPERATOR INFORMATION**

Name:
Address:
City/State/Zip Code:
Telephone Number:

**III. FACILITY/SITE LOCATION INFORMATION**

Name:
Address:
City/State/Zip Code:

**Certification:** I certify under penalty of law that all storm water discharges associated with industrial activity from the identified facility that are authorized by a KPDES general permit have been eliminated or that I am no longer the operator of the facility or construction site. I understand that by submitting this Notice of Termination, I am no longer authorized to discharge storm water associated with industrial activity under this general permit, and that discharging pollutants in storm water associated with industrial activity of waters of the Commonwealth is unlawful under the Clean Water Act and Kentucky Regulations where the discharge is not authorized by a KPDES permit. I also understand that the submittal of this Notice of Termination does not release an operator from liability for any violations of this permit or the Kentucky Revised Statutes.

NAME (Print or Type)	TITLE
SIGNATURE	DATE

**INSTRUCTIONS**  
**NOTICE OF TERMINATION (NOT) OF COVERAGE UNDER THE KPDES GENERAL PERMIT**  
**FOR STORM WATER DISCHARGES ASSOCIATED WITH INDUSTRIAL ACTIVITY**

**Who May File a Notice of Termination (NOT) Form**

Permittees who are presently covered under the Kentucky Pollutant Discharge Elimination System (KPDES) General Permit for Storm Water Discharges Associated with Industrial Activity may submit a Notice of Termination (NOT) form when their facilities no longer have any storm water discharges associated with industrial activity as defined in the storm water regulations at 40 CFR 122.26 (b)(14), or when they are no longer the operator of the facilities.

For construction activities, elimination of all storm water discharges associated with industrial activity occurs when disturbed soils at the construction site have been finally stabilized and temporary erosion and sediment control measures have been removed or will be removed at an appropriate time, or that all storm water discharges associated with industrial activity from the construction site that are authorized by a KPDES general permit have otherwise been eliminated. Final stabilization means that all soil-disturbing activities at the site have been completed, and that a uniform perennial vegetative cover with a density of 70% of the cover for unpaved areas and areas not covered by permanent structures has been established, or equivalent permanent stabilization measures (such as the use of riprap, gabions, or geotextiles have been employed.

**Where to File NOT Form**

Send this form to the following address:

**Section Supervisor  
Inventory & Data Management Section  
KPDES Branch, Division of Water  
14 Reilly Road, Frankfort Office Park  
Frankfort, KY 40601**

**Completing the Form**

Type or print legibly in the appropriate areas and according to the instructions given for each section. If you have questions about this form, call the Storm Water Contact, Industrial Section, at (502) 564-3410.

**Section I - Permit Information**

Enter the existing KPDES Storm Water General Permit number assigned to the facility or site identified in Section III. If you do not know the permit number, **call the Storm Water Contact, Industrial Section at (502) 564-3410.**

Indicate your reason for submitting this Notice of Termination by checking the appropriate box:

If there has been a change of operator and you are no longer the operator of the facility or site identified in Section III, check the corresponding box.

If all storm water discharges at the facility or site identified in Section III have been terminated, check the corresponding box.

**Section II - Facility Operator Information**

Give the legal name of the person, firm, public organization, or any other entity that operates the facility or site described in this application. The name of the operator may or may not be the same name as the facility. The operator of the facility is the legal entity which controls the facility's operation, rather than the plant or site manager. Do not use a colloquial name. Enter the complete address and telephone number of the operator.

**Section III - Facility/Site Location Information**

Enter the facility's or site's official or legal name and complete address, including city, state and ZIP code. If the facility lacks a street address, indicate the state, the latitude and longitude of the facility to the nearest 15 seconds, or the quarter, section, township, and range (to the nearest quarter section) of the approximate center of the site.

**Section IV - Certification**

Federal statutes provide for severe penalties for submitting false information on this application form. Federal regulations require this application to be signed as follows:

*For a corporation:* by a responsible corporate officer, which means: (i) president, secretary, treasurer, or vice-president of the corporation in charge of a principal business function, or any other person who performs similar policy or decision making functions, or (ii) the manager of one or more manufacturing, production or operating facilities employing more than 250 persons or having gross annual sales or expenditures exceeding \$25 million (in second-quarter 1980 dollars), if authority to sign documents has been assigned or delegated to the manager in accordance with corporate procedures;

*For a partnership or sole proprietorship:* by a general partner or the proprietor; or

*For a municipality, State, Federal, or other public facility:* by either a principal executive



**SECTION 02270****SLOPE PROTECTION AND EROSION CONTROL****PART 1 - GENERAL****1.01 WORK INCLUDED**

- A. The Contractor shall do all work and take all measures necessary to control soil erosion resulting from construction operations, shall prevent the flow of sediment from the construction site, and shall contain construction materials (including excavation and backfill) within his protected working area so as to prevent damage to adjacent property.
- B. The Contractor shall not employ any construction method that violates a rule, regulation, guideline or procedure established by Federal, State or local agencies having jurisdiction over the environmental effects of construction. The Contractor shall be responsible for obtaining all associated permits.
- C. Pollutants such as chemicals, fuels, lubricants, bitumen, raw sewage and other harmful waste shall not be discharged into or alongside of any body of water or into natural or man-made channels leading thereto.

**PART 2 - PRODUCTS****2.01 MATERIALS**

- A. Temporary Slope Protection and Erosion Control:  
  
Bales may be hay or straw, and shall be reasonably clean and free of noxious weeds and deleterious materials. Filter fabric for sediment traps shall be of suitable materials acceptable to the Engineer.
- B. Permanent Slope Protection and Erosion Control:  
  
On slopes 2H:1V and steeper, and where shown on the drawings place Type A Dumped Rock Fill with a 24-inch minimum thickness over non-woven geotextile filter fabric.

**PART 3 - EXECUTION****3.01 METHODS OF CONSTRUCTION**

- A. The Contractor shall use any of the acceptable methods necessary to control soil erosion and prevent the flow of sediment to the maximum extent possible. These methods shall include, but not be limited to, the use of water diversion structures, diversion ditches and settling basins.
- B. Construction operations shall be restricted to the areas of work indicated on the Drawings and to the area which must be entered for the construction of temporary or permanent facilities. The Engineer has the authority to limit the surface area of erodible earth material exposed by clearing and grubbing, excavation, borrow and fill operations and to direct the Contractor to provide immediate permanent or temporary pollution control measures to prevent contamination of the wetlands and adjacent watercourses. Such work may involve the construction of temporary berms, dikes, dams, sediment basins, slope drains, and use of temporary mulches, mats, or other control devices or methods as necessary to control erosion.

- C. Excavated soil material shall not be placed adjacent to the wetlands or watercourses in a manner that will cause it to be washed away by high water or runoff. Earth berms or diversions shall be constructed to intercept and divert runoff water away from critical areas. Diversion outlets shall be stable or shall be stabilized by means acceptable to the Engineer. If for any reason construction materials are washed away during the course of construction, the Contractor shall remove those materials from the fouled areas as directed by the Engineer.
- D. For work within easements, all materials used in construction such as excavation, backfill, roadway, and pipe bedding and equipment shall be kept within the limits of the easements.
- E. The Contractor shall not pump silt-laden water from trenches or other excavations into the wetlands, or adjacent watercourses. Instead, silt-laden water from his excavations shall be discharged within areas surrounded by baled hay or into sediment traps to ensure that only sediment-free water is returned to the watercourses. Damage to vegetation by excessive watering or silt accumulation in the discharge area shall be avoided.
- F. Prohibited construction procedures include, but are not limited to, the following:
  - 1. Dumping of spoil material into any streams, wetlands, surface waters, or unspecified locations.
  - 2. Indiscriminate, arbitrary, or capricious operation of equipment in wetlands or surface waters.
  - 3. Pumping of silt-laden water from trenches or excavations into surface waters, or wetlands.
  - 4. Damaging vegetation adjacent to or outside of the construction area limits.
  - 5. Disposal of trees, brush, debris, paints, chemicals, asphalt products, concrete curing compounds, fuels, lubricants, insecticides, washwater from concrete trucks or hydroseeders, or any other pollutant in wetlands, surface waters, or unspecified locations.
  - 6. Permanent or unauthorized alteration of the flow line of any stream.
  - 7. Open burning of debris from the construction work.
- G. Any temporary working roadways required shall be clean fill approved by the Engineer. In the event fill is used, the Contractor shall take every precaution to prevent the fill from mixing with native materials of the site. All such foreign fill materials shall be removed from the site following construction.

### **3.02 EROSION CHECKS**

The Contractor shall furnish and install baled hay or straw erosion checks in all locations indicated on the Drawings, surrounding the base of all deposits of stored excavated material outside of the disturbed area, and where indicated by the Engineer. Checks, where indicated on the Drawings, shall be installed immediately after the site is cleared and before trench excavation is begun at the location indicated. Checks located surrounding stored material shall be located approximately 6 ft. from that material. Bales shall be held in place with two 2 in. by 2 in. by 3 ft. wooden stakes. Each bale shall be butted tightly against the adjoining bale to preclude short circuiting of the erosion check.

- END OF SECTION -

**SECTION 02302****RAILROAD OR HIGHWAY CROSSINGS****PART 1 GENERAL****1.01 SUMMARY**

- A. This Section includes railroad or highway crossings including casing pipes for pipelines installed by (jacking), (tunneling) or (boring) method, and installation of the carrier pipe within the casing in the location(s) and to the limits as shown on the Contract Drawings. The engineer has filed for the permits, but it is the responsibility of the contractor to put up the bond for the State Highway crossings.
- B. All work shall be performed in accordance with the applicable rules and regulations of the State and Federal Codes and with the terms and conditions of the permit issued by the railroad or highway having jurisdiction.

**1.02 SUBMITTALS**

- A. In addition to those submittals identified in the General Provisions, the following items shall be submitted:
  - 1. Method of Installation
    - a. Following the award of the Contract, the Contractor shall submit a description of the method and equipment which is proposed to be employed in installing the casing.
    - b. A Professional Engineer licensed in the State of Kentucky shall design all sheeting and bracing at the Contractor's expense. The seal of the Professional Engineer shall appear on all drawings and design sheets submitted for review.
  - 2. Materials
    - a. Drawings and manufacturer's data of the casing materials showing compliance with this specification.
  - 3. Contractor's Data
    - a. The Contractor shall submit such data as may be required as conditions of the Railroad or Highway Permit.

**1.03 QUALITY ASSURANCE**

- A. Contractor's Qualifications
  - 1. The casing shall be installed by a contractor who has experience in this field of construction and can furnish a record of satisfactory performance on at least three projects for work of comparable type.

**PART 2 PRODUCTS****2.01 MATERIALS AND CONSTRUCTION****A. Casings**

1. The casing shall be of the size and type as shown on the Contract Drawings.
  - a. Steel pipe of the thickness specified shall have a minimum yield strength of 35,000 psi and a minimum ultimate strength of 60,000 psi. Steel casing pipe shall be uncoated .
  - b. Liner plate of the gauge specified shall be pressed steel, galvanized and bituminous coated.
  - c. Concrete pipe shall be designed for the purpose of jacking and shall be tongue and grooved.
  - d. All joints in the encasement pipe shall be of continuous solid weld.

**TABLE OF MINIMUM WALL THICKNESS FOR STEEL CASING PIPE**

<u>Minimum Thickness</u> <u>Inches</u>	<u>Normal Diameter</u> <u>Inches</u>
0.250	4 thru 12
0.312	14 thru 18
0.375	20 thru 24
0.500	26 thru 42

- B. The steel casing pipe for all highway crossings shall be as follows:

<u>Carrier Pipe Size</u>	<u>Casing Pipe Size</u>
2"	6"
3"	8"
4"	10"
6"	12"
8"	16"
10"	18"
12"	20
14"	24"
16"	26"
20"	30"
24"	36"
30"	48"

**B. Carrier Pipes**

1. The carrier pipe shall be as specified on the Contract Drawings and in accordance with the Section for the type of pipe.

**C. Signs**

1. Signs shall be weatherproof.

**PART 3 EXECUTION****3.01 INSTALLATION****A. General**

1. Unless otherwise shown or specified, the Contractor may employ any one of jacking, tunneling or boring methods within the limits shown for the installation of the casing.
  - a. The remaining portion of the casing may be constructed by open cut method in a sheeted trench.
2. Installation of the casing pipe shall be carried out without disturbance of the embankment, pavement, tracks or other railroad or highway facilities and without obstructing the passage of traffic at any time.
3. Once the jacking, tunneling or boring operation is started, it shall proceed on a 24-hour basis without interruption until completed.
4. The casing pipe shall be maintained accurately to line and grade during the installation operation.
5. The casing shall be advanced from the lower end.
6. The use of water or other liquid, except bentonite slurry with prior approval of the Engineer, to facilitate casing placement or spoil removal is prohibited.
7. Dewatering shall be in accordance with the Section entitled "Earthwork".

**B. Jacking**

1. The jacking force shall be properly distributed through the jacking frame to the casing and parallel with the axis.
2. The soil shall be trimmed with care and shall not precede the jacking operation, to insure a minimum disturbance to the natural soils adjacent to the casing.
  - a. No augering will be allowed.

**C. Tunneling**

1. Excavation shall be in such a manner that voids behind the liner plates shall be held to a minimum.
2. Poling plates shall be used as necessary to prevent caving of material above the tunnel prior to liner plate installation.
  - a. Poling plates shall not be driven into the unexcavated material.
3. Liner plates shall be installed as soon as excavation proceeds the necessary distance for the next set of plates.
4. Grout plugs shall be placed on approximately 4-foot centers, at the top, bottom and on the spring line.
  - a. Grout holes shall be not less than 1-inch diameter.

- b. Voids between the liner plates and the excavation shall be filled with a 1:6 cement grout placed under pressure.
        - c. Not more than 6 lineal feet of tunnel shall progress beyond the grouting.
  - 5. Tunneled casings shall have a foundation of Class "C" concrete placed for the entire length of the interior of the casing.
    - a. The leveling course shall be at such an elevation that the carrier pipe, when installed, shall be at the grade specified.
- D. Boring
  - 1. Boring shall consist of pushing the casing with an auger rotating within to remove the spoil.
  - 2. The auger or cutting head shall not lead the casing and shall be removable from within the casing.
  - 3. The face of the cutting head shall be arranged to provide reasonable obstruction to the free flow of soft or poor materials.
- E. Pressure Carrier Pipe
  - 1. No contact shall be permitted between the casing and the carrier pipe.
    - a. Casing spacers shall be used between the casing pipe and carrier pipe. Spacers shall be manufactured by Pipeline Seal & Insulator, Inc. (PSI) of Houston Texas, or equal and be of the type to separate dissimilar metals and keep the carrier pipe centered within the casing. The spacers shall be installed within the casing in the quantity and at the locations recommended by the manufacturer.
    - b. Both ends of the casing pipe shall be sealed with rubber boot "End Seals" by PSI or equal, held in place by stainless steel bands/clamps.
- F. Non-Pressure Carrier Pipe
  - 1. No contact shall be permitted between the casing and the carrier pipe.
    - a. Casing spacers shall be used between the casing pipe and carrier pipe. Spacers shall be manufactured by Pipeline Seal & Insulator, Inc. (PSI) of Houston Texas, or equal and be of the type to separate dissimilar metals and keep the carrier pipe centered within the casing. The spacers shall be installed within the casing in the quantity and at the locations recommended by the manufacturer.
    - e. Both ends of the casing pipe shall be sealed with rubber boot "End Seals" by PSI or equal, held in place by stainless steel bands/clamps.

-END OF SECTION-

**SECTION 02500****BITUMINOUS PAVEMENT****PART 1 - GENERAL****1.01 DESCRIPTION OF THE WORK**

- A. Extent of bituminous pavement paving is shown on the Drawings, including roads, driveways and parking areas.

**1.02 RELATED WORK SPECIFIED ELSEWHERE**

- A. Unless noted, all specification designations refer to the Kentucky Department of Highways Standard Specifications, (KDOHSS), latest edition. Appropriate portions of the referenced sections of the Specifications shall apply, but all work shall be included in lump sum bid items described herein unless otherwise specified or shown on the Drawings.
- B. Preparation of subbase is specified in this Division, Section 02200, 02226 and 02230.
- C. Crushed stone and dense graded aggregate are specified in this Division, Section 02255.

**1.03 QUALITY ASSURANCE**

- A. Performance: Bituminous seal coat that fails as the result of not meeting the requirements of these Specification shall be corrected at the Contractor's expense.
- B. The design plant mix shall be submitted to the Engineer for review and acceptance. The submittal shall include the last date the mixture was approved by the Kentucky Department of Highways for use on a state road project; and the location where the mixture was recently used, and the name and address of the paving contractor.

**PART 2 - PRODUCTS****2.01 BITUMINOUS CONCRETE SURFACE MATERIAL**

- A. Aggregates shall meet the applicable requirements of the KDOHSS.
- B. Bituminous materials shall meet the applicable requirements of the KDOHSS.
- C. Bituminous materials for tack coat shall be one of the following: SS-1, SS-1h, CSS-1, CSS-1h, AE-60, RS-1, CRS-1, RC-70 or RC-250.
- D. Steel, wood or other suitable material shall be of size and strength necessary to resist movement during bituminous placement and to retain horizontal and vertical alignment until removal. Use straight forms, free of distortion and defects.

**2.02 BITUMINOUS SEAL COAT MATERIAL**

- A. Coarse aggregate shall be Kentucky Department of Highways Standard Size No. 8, meeting applicable requirements of Section 805 of KDOHSS.

- B. Bituminous materials shall meet applicable requirements of Section 806 of KDOHSS.

### PART 3 - EXECUTION

#### 3.01 SURFACE PREPARATION

The road shall be swept with an approved mechanical sweeper and with wire hand brooms, when necessary. Special care shall be taken to clean the edges of the surface so that full width of the roadway to be treated shall be uniformly clean. Where any mud or earth exists, it shall be removed sufficiently in advance of application of bituminous material to allow the surface to become thoroughly dry.

#### 3.02 BITUMINOUS CONCRETE PAVING

- A. Composition of Mixtures: Surface pavement mixture, meeting requirements of the KDOHSS shall be used as determined by local plant mix availability. The mixture shall have been approved recently by the Kentucky Department of Highways, used recently on a state project, and conform to the requirements below when tested in accordance with ASTM D 1559-76:

Stability, minimum pounds	1200
Flow, 0.01 inch	Min. 6, Max. 16
Percent air voids	Min. 4, Max. 8
Minimum voids in mineral aggregate, percent: 3/4 inch	14
1 inch	13

- B. Construction Methods: Construction requirements shall conform to applicable requirements of the KDOHSS.
- C. A tack coat shall be required to bond new paving to the surface of concrete or brick pavements and bases or existing bituminous surfaces. It shall be applied in accordance with Section 407 of KDOHSS.
- D. Where bituminous paving is placed against vertical surfaces such as curbs, gutters, manhole frames, valve boxes, etc., the vertical face shall be tack coated to seal the surface. Where these surfaces are inaccessible to pressure distributor, the tack coat may be brushed or broomed into place. The tack coat shall not be allowed to spill over onto any horizontal surface outside the area to be paved.
- E. Unless otherwise indicated on the Drawings or in these Specifications, the compacted thickness of the bituminous concrete paving shall be a minimum of 2 inches and the minimum ambient temperature for placing shall be 40 deg F. Mixing and laying temperatures shall be as follows:

Aggregates	Min. 240 deg F	Max. 325 deg F
Asphalt Cement	Min. 225 deg F	Max. 325 deg F
Mixture at Plant (measured in truck)	Min. 240 deg F	Max. 325 deg F
Mixture when Placed (measured in truck when discharging)	275 deg $\pm$ 20 deg F**	

\*\*The 275 deg F + 20 deg F mixture placing temperature is based on 275 deg F being about the ideal temperature for obtaining optimum compaction under average conditions. However, when the distance between asphalt plant and the job is such that specified placing temperatures cannot be maintained even though maximum mixing temperatures are covered, insulated



hauling equipment as described below are used, the minimum placing temperature shall be 225 deg F.

- F. Trucks for hauling bituminous mixtures shall have tight, clean and smooth metal beds that have been sprayed with a minimum amount of soap emulsion, paraffin oil, or other approved material that is not detrimental to the mixture to prevent the mixture from adhering to the beds. All trucks shall be equipped with covers of sufficient size to completely cover the located material and all covers shall be securely fastened in place before the truck leaves the plant. Truck beds shall be insulated, when necessary, to maintain the specified temperature to the point of delivery. Any truck causing excessive segregation of material by its spring suspension or other contributing factors shall be discharged from the work until such conditions are corrected.
- G. The Contractor shall have an accurate thermometer on the job at all times for verifying all temperature requirements and for taking temperature measurements whenever requested by the Engineer or Owner. The Contractor shall closely control temperature and compaction requirements to achieve quality bituminous paving and related work.
- H. Bituminous paving that fails as the result of not meeting the requirements of these Specifications shall be removed and replaced at the Contractor's expense.

-- END OF SECTION --

**SECTION 02600****PIPE, FITTINGS AND INSTALLATION****PART 1 - GENERAL****1.01 SCOPE**

A. Furnish all labor, materials, equipment and incidentals necessary to install and test pipe and fittings as shown on the Drawings and required by the Specifications.

B. Piping shall be located substantially as shown. The Engineer reserves the right to make such modifications in locations as may be found desirable to avoid interference between pipes or for other reasons.

C. Wherever the word pipe or piping is used it shall mean pipe and fittings unless otherwise noted. All ductile iron pipe (D.I.P.), fittings, glands and accessories shall be of the same manufacturer unless approved otherwise.

**PART 2 - PRODUCTS****2.01 DUCTILE IRON PIPE (D.I.P.) AND FITTINGS**

A. Ductile iron pipe (D.I.P.) shall conform to ANSI/AWWA C150/A21.50, ANSI/AWWA C151/A21.51 Standard. The pipe shall conform to thickness class 350 unless noted otherwise. All pipe, fittings and joints should be capable of accommodating pressure up to 350 psi. Joint restraints required. SEE SECTION 01600 MATERIAL AND EQUIPMENT for APPROVED MANUFACTURE.

B. Ductile iron mechanical joint fittings shall have a body thickness and radii of curvature conforming to ANSI A21.10 and have joints in accordance with ANSI/AWWA C111.A21.11. Fittings and joints shall be supplied with all accessories.

C. All pipe and fittings shall be tar coated outside and shall receive a standard cement lining with bituminous seal coat on the inside in accordance with ASA Specification A21.40 (AWWA-C104).

D. Cement mortar lining and seal coating for pipe and fittings, where applicable, shall be in accordance with ANSI/AWWA C104/A21.4. Bituminous outside coating shall be in accordance with ANSI/AWWA C151/A21.51 for pipe and ANSI/AWWA C110/A21.10 for fittings.

E. All ductile fittings shall be rated at 350 psi water working pressure plus water hammer. Ductile iron fittings shall be ductile cast-iron grade 80-60-03 per ASTM Specification A339-55.

F. No separate pay item has been established for fittings and no determination of the number of fittings required on the job has been made. The Contractor, during the bidding phase, shall determine the number of fittings required on the job and include the cost of the fittings and installation in the unit price for pipe.

G. Push-on type joints shall be single rubber gasket, with cast gasket socket and recessed bell with a tapered annular opening and flared socket and shall conform to ANSI/AWWA C111/A21.11. Plain spigot ends shall be suitably beveled to permit easy entry into the bell, centering and compressing the gasket.

H. Ductile iron flanged joint pipe shall conform to ANSI/AWWA C115/A 21.15 Standard and have a Class of 350. The pipe shall have a rated working pressure of 350 psi with Class 125 flanges. Gaskets shall be ring gaskets with a thickness of 1/8-inch. Flange bolts shall conform to ANSI B16.1.

I. Flanged fittings shall meet all requirements of ANSI/AWWA C110/A21.10 and have Class 125 flanges. Fittings shall accommodate a working pressure up to 350 psi and be supplied with all accessories.

J. River crossing pipe shall be ductile iron with ball and socket type joint. The joint shall be boltless with restraint provided by a bayonet-type locking of the retainer over the bell. All pipe components shall be rugged, high strength ductile iron. The barrel is cast of 60-42-10 ductile iron in accordance with American National Standard A21.51. The bell, ball, and retainer are cast of 70-50-05 ductile iron in accordance with the applicable requirements of American National Standard A21.10. The gasket will be of high quality rubber and symmetrical in shape. The first and last section of river crossing pipe shall be furnished with mechanical joint ends suitable for connection to the remaining system piping.

K. No separate pay item has been established for fittings and no determination of the number of fittings required on the job has been made. The Contractor, during the bidding phase, shall determine the number of fittings required on the job and include the cost of the fittings and installation in the unit price for pipe.

L. Restraint glands or fittings shall be either "Meg-a-Lug" or "Series 100" or "Series 1200" as manufactured by EBBA Iron Sales, Inc., Eastland, Texas.

M. Restrained Joint Pipe:

1. Restrained joints for 4" through 16" push-on joint pipe installation is required and indicated in the project plans or specifications, restrained push-on joint pipe and fittings utilizing ductile iron components shall be provided.

2. Restrained joint pipe shall be ductile iron manufactured in accordance with the requirements of ANSI/AWWA C151/A21.51. Push-on joints for such pipe shall be in accordance with ANSI/AWWA C111/A21.11. Pipe thickness shall be designed in accordance with ANSI/AWWA C150/A21.50, and shall be based on laying conditions and internal pressures as stated in the project plans and specifications. Pipe shall be U.S. Pipe TR FLEX pipe or equal.

3. Restrained joint fittings shall be ductile iron in accordance with applicable requirements of ANSI/AWWA C110/A21.10 with the exception of the manufacturer's proprietary design dimensions. Push-on joints for such fittings shall be in accordance with ANSI/AWWA C111/A21.11. Fittings shall be U.S. Pipe TR FLEX fittings or equal.

4. Cement mortar lining and seal coating for pipe and fittings, where applicable, shall be in accordance with ANSI/AWWA C104/A21.4. Bituminous outside coating shall be in accordance with ANSI/AWWA C151/A21.51 for pipe and ANSI/AWWA C110/A21.10 for fittings.

5. Restrained push-on joints for pipe and fittings shall be designed for a water working pressure of 350 psi in sizes 4" through 24" and 250 psi for sizes 30" through 54".

6. Restrained push-on joint pipe and fittings shall be capable of being deflected after assembly.

## **2.02 POLYVINYL CHLORIDE (PVC) PIPE (SDR 21 AND SDR 17)**

A. Polyvinyl chloride (PVC) pipe for water mains shall be Class 200 (SDR 21) or Class 250 (SDR 17) PVC pressure rated pipe as shown on the Drawings or indicated in the proposal form with either twin gasket joints or integral bell joints with rubber O-ring seals.

B. All PVC pipe shall conform to the latest revisions of ASTM D-1784 (PVC Compounds), ASTM D-2241 (PVC Plastic Pipe, SDR) and ASTM D-2672 (Bell-End PVC Pipe). Rubber gasketed joints shall conform to ASTM D-3139. The gaskets for the PVC pipe joint shall conform to ASTM F-477 and D-1869.

C. Couplings shall be furnished by the pipe manufacturer and shall accommodate the pipe for which they are used. Rubber gasket joints shall provide adequate expansion to allow for a 50 degree change in temperature on one length of pipe. Lubrication for rubber connected couplings shall be water soluble, non-toxic, be non-objectionable in taste and odor and have no deteriorating affect on the PVC or rubber gaskets and shall be as supplied by the pipe manufacturer. Couplings shall conform to ASTM D-3139; SDR-21, 200 psi.

D. All pipe and couplings shall bear identification markings that will remain legible during normal handling, storage and installation, which have been applied in a manner that will not reduce the strength of the pipe or coupling or otherwise damage them. Pipe and coupling markings shall include the normal size and OD base, material code designation, dimension ratio number, ASTM Pressure Class, ASTM designation number for this standard, manufacturer's name or trademark, seal (mark) of the testing agency that verified the suitability of the pipe material for potable-water service. Each marking shall be applied at intervals of not more than 5 feet for the pipe and shall be marked on each coupling.

### 2.03 POLYVINYL CHLORINE (PVC) PIPE - C.I. PIPE SIZE DR14 AND DR 18

A. Pipe shall meet the requirements of AWWA C-900 Polyvinyl Chlorine (PVC) Pressure Pipe. All Class 200 pipe shall meet the requirements of DR 14 and all Class 150 pipe shall meet the requirements of DR 18. Joints shall be integral bell or twin gasket joints with rubber O-ring seals.

B. All pipe shall be suitable for use as a pressure conduit. Provisions must be made for expansion and contractions at each joint with an elastomeric ring. The bell shall consist of an integral wall section with a solid cross-section elastomeric ring which meets the requirements of ASTM D-1869 and F-477. The bell section shall be designed to be at least as strong as the pipe wall. Sizes and dimensions shall be as shown in this specification.

C. Gaskets and lubricants intended for use with PVC pipe and couplings shall be made from materials that are compatible with the plastic material and with each other when used together, will not support the growth of bacteria, and will not adversely affect the potable qualities of the water that is to be transported. Gaskets and lubricants shall be supplied by the pipe manufacturer.

#### D. Physical Requirements:

1. Standard Laying Lengths - Standard laying lengths shall be 20 ft. (plus or minus 1") for all sizes. The total footage of pipe of any class and size shall be furnished in standard lengths. Each length of pipe shall be tested to four times the class pressure of the pipe for minimum of 5 second. The integral bell shall be tested with the pipe.

2. Pipe Stiffness - The pipe stiffness using  $F/y$  for PVC class water pipe shall be as follows:

<u>Class</u>	<u>DR</u>	<u>F/y</u>
200	14	815
150	18	364

3. Quick Burst Test - Randomly selected tested in accordance with ASTM D-1599 shall withstand without failure pressures listed below when applied in 60 - 70 seconds. Class 150 shall have a minimum burst pressure of 755 psi and Class 200 shall have a minimum burst pressure of 986 psi at 73 degrees F. for all sizes.

4. Drop Impact Test - Pipe shall withstand without failure at 73 degrees F. an impact of 120 ft/lbs created by a falling 12 lb missile with a 2" radius nose without visible evidence of shattering or splitting.

E. All pipe and couplings shall bear identification markings that will remain legible during normal handling, storage and installation, which have been applied in a manner that will not reduce the strength of the pipe or coupling or otherwise damage them. Pipe and coupling markings shall include the nominal size and OD base, material code designation, dimension ratio number, AWWA Pressure Class, AWWA designation number for this standard, manufacturer's name or trademark, seal (mark) of the testing agency that verified the suitability of the pipe material for potable-water service. Each marking shall be applied at intervals of not more than 5 feet for the pipe and shall be marked on each coupling.

#### **2.04 DUCTILE IRON MECHANICAL JOINT FITTINGS FOR PVC PIPE**

A. General: Cast-iron mechanical joints shall conform to the latest revision of ANSI A21.11 for centrifugally cast-iron water pipe.

1. 3" to 12". All Working Pressures: Fittings shall conform to ASA Specification A21.10 for 250 psi water working pressure plus water hammer.
2. Fittings 12" and Over, for 150 psi and Less WWP: Fittings for use on 150 psi WWP pipe shall be AWWA Class D Pattern.
3. Fittings 12" and Larger, for 200 psi and Above WWP: Fittings shall be ductile iron or gray iron rated at 250 psi water working pressure plus water hammer. Ductile iron fittings only will be used with ductile iron pipe.

B. All ductile iron fittings shall be rated at 250 psi water working pressure plus water hammer. Ductile iron fittings shall be ductile cast-iron grad 80-60-03 per ASTM Specification A33955. All fittings for connection to PVC pipe-all classes, shall be ductile iron.

C. No separate pay item has been established for fittings and no determination of the number of fittings required on the job has been made. The Contractor, during the bidding phase, shall determine the number of fittings required on the job and include the cost of the fittings and installation in the unit price for pipe.

D. Lining and Coating: All mechanical joint fittings shall be cement lined and bituminous seal coated per Federal Specification WW-P-42lb and ASA Specification A421.40 (AWWA C104). Bituminous outside coating shall be in accordance with ANSI/AWWA C110/A21.10.

#### **2.05 HIGH-DENSITY POLYETHYLENE - AWWA APPROVED POTABLE WATER PIPE**

A. General: This section is for High-density Polyethylene AWWA C906 and NSF 14 Approved Pipe for Potable Water Service in Sizes 4" to 24" **IPS (Iron Pipe Size)** and defines the characteristics and properties of high-density polyethylene pipe. This specification governs the material, pipe, fittings, butt fusion, and general construction practice for HDPE piping systems.

Pipe shall have a hydrostatic design stress rating of 800 psi based on a material with a 1,600 psi at 23° hydrostatic design basis as determined in accordance with ASTM D-2837.

Fittings shall be molded or fabricated from material meeting the same standards as the pipe.

Joints shall be made by the thermal butt fusion system. All joints shall be completely watertight, airtight and as strong as or stronger than the pipe wall, in strict accordance with the manufacturer's recommendations.

Sections of polyethylene pipe shall be joined into continuous lengths on the job site above ground. The joining method shall be the heat fusion method and shall be performed in strict accordance with the pipe manufacturer's recommendations. The heat fusion equipment used in the joining procedures shall be capable of meeting all conditions recommended by the pipe manufacturer, including, but not limited to, temperature requirements of 400°F, alignment, and 150 psi interfacial fusion pressure.

Heat fusion joining shall be 100% efficient offering a joint weld strength equal to or greater than the tensile strength of the pipe. Socket fusion shall not be used.

B. References: Where all or part of a Federal, ASTM, ANSI, AWWA, etc., standard specification is incorporated by reference in these Specifications, the reference standard shall be the latest edition and revision and considered a part of these specifications.

C. Material: Materials used for the manufacture of polyethylene pipe and fittings shall be extra high molecular weight, high density PE 3408 polyethylene resin. The material shall be listed by PPI (Plastics Pipe Institute, a division of the Society of the Plastics Industry) in PPI TR-4 with a 73°F hydrostatic design basis of 1,600 psi and a 140°F hydrostatic design basis of 800 psi. The PPI listing shall be in the name of the pipe manufacturer and shall be based on ASTM D 2837 testing.

D. Pipe and Fittings: Qualification of Manufacturers. The Manufacturer shall have manufacturing and quality assurance facilities capable of producing and assuring the quality of the pipe and fittings required by these Specifications. The Manufacturer's production facilities shall be open for inspection by the Owner or his Authorized Representative.

1. Pipe: Pipe supplied under this specification shall have a nominal **IPS (Iron Pipe Size)** unless otherwise specified. **The DR (Dimension Ratio) and the pressure rating of the pipe supplied shall be DR 11 (200 psi)**. The pipe shall be produced from approved HDPE pipe grade resin with the nominal physical properties as specified in the appropriate ASTM specifications for the sizes indicated. Pipe having a diameter 3" and larger will be made to the dimensions and tolerances specified in ASTM F 714.

The pipe shall contain no recycled compound except that generated in the manufacturer's own plant. The pipe shall be homogeneous throughout and free of visible cracks, holes, voids, foreign inclusions, or other defects that may affect the wall integrity.

2. Pipe Performance: The pipe will be extruded from resin meeting the specifications of ASTM D 3350 with a minimum cell classification of 345464C.
3. Fittings: HDPE fittings shall be in accordance with ASTM D 3261 and shall be manufactured by injection molding, a combination of extrusion and machining, or fabrication from HDPE pipe conforming to this specification. The fittings shall be fully pressure rated and provide a working pressure equal to that of the pipe with an included 2:1 safety factor. The fittings shall be manufactured from the same base resin type and cell classification as the pipe itself. The fittings shall be homogeneous throughout and free from cracks, holes, foreign inclusions, voids, or other injurious defects.
4. Molded Fittings. Molded fittings shall be manufactured and tested in accordance with ASTM D 3261 and shall be so marked. Molded fittings shall be tested in accordance with AWWA C906.
5. X-Ray Inspection. The Manufacturer shall submit samples from each molded fittings production lot to x-ray inspection.

6. Fabricated Fittings. Fabricated fittings shall be made by heat fusion joining specially machined shapes cut from pipe, polyethylene sheet stock or molded fittings. Fabricated fittings shall be rated for internal pressure service at least equal to the full service pressure rating of the mating pipe. Fabricated fittings shall be tested in accordance with AWWA C906.
7. Polyethylene Flange Adapters. Flange adapters shall be made with sufficient throughbore length to be clamped in a butt fusion-joining machine without the use of a stub-end holder. The sealing surface of the flange adapter shall be machined with a series of small v-shaped grooves (serrations) to promote gasketless sealing, or restrain the gasket against blowout.

E. Joining - Butt Fusion: Sections of polyethylene pipe shall be joined by the butt fusion process into continuous lengths at the job site. The joining method shall be the heat fusion method and shall be performed in strict accordance with the pipe manufacturer's recommendations. The heat fusion equipment used in the joining procedures should be capable of meeting all conditions recommended by the pipe manufacturer. Properly executed electrofusion fittings may be used. Extrusion welding or hot gas welding of HDPE shall not be used for pressure pipe applications or fabrications where shear or structural strength is important. Mechanical joint adapters, flanges, unions, grooved-couplers, transition fittings, and some mechanical couplings may be used to mechanically connect HDPE pipe. Refer to the manufacturer's recommendations.

F. Joining - Other Means: Polyethylene pipe and fittings may be joined together or to other materials by means of (a) flanged connections (flange adapters and back-up rings), (b) mechanical couplings designed for joining polyethylene pipe or for joining polyethylene pipe to another material, (c) MJ Adapters or (d) electrofusion. When joining by other means, the installation instructions of the joining device manufacturer shall be observed.

ID Stiffener and Restraint. A stiffener shall be installed in the bore of the polyethylene pipe when an OD compression mechanical coupling is used and when connecting plain end PE pipe to a mechanical joint pipe, fitting or appurtenance. External clamp and tie rod restraint shall be installed where PE pipe is connected to the socket of a mechanical joint pipe, fitting or appurtenance except where an MJ Adapter is used.

G. Quality and Workmanship: The pipe and/or fitting manufacturer's production facilities shall be open for inspection by the owner or his designated agents with a reasonable advanced notice. During inspection, the manufacturer shall demonstrate that it has facilities capable of manufacturing and testing the pipe and/or fittings to standards required by this specification. Pipe which has been tested by the manufacturer and falls outside of the appropriate limits set forth in this specification will be cause for rejection.

H. QA Records: QA/QC records shall be maintained intact for a minimum of one year from the date of production.

I. Pipe Marking: During extrusion production, the HDPE pipe shall be continuously marked with durable printing including the following information:

- Nominal Size
- Dimension Ratio
- Pressure Class, psi
- Manufacturer's Name and Product Series
- Cell Class
- ASTM Basis
- "NSF-PW"
- Pipe Test Category
- Plant Code & Extruder
- Production Date
- Operator Number (Shift Letter optional)
- Resin Supplier Code

J. **Pipe Packaging, Handling, & Storage:** The manufacturer shall package the pipe in a manner designed to deliver the pipe to the project neatly, intact, and without physical damage. The transportation carrier shall use appropriate methods and intermittent checks to insure the pipe is properly supported, stacked, and restrained during transport such that the pipe is not nicked, gouged, or physically damaged. Pipe shall be stored on clean, level ground to prevent undue scratching or gouging. If the pipe must be stacked for storage, such stacking shall be done in accordance with the pipe manufacturer's recommendations. The pipe shall be handled in such a manner that it is not pulled over sharp objects or cut by chokers or lifting equipment. Sections of pipe having been discovered with cuts or gouges in excess of 10% of the pipe wall thickness shall be cut out and removed. The undamaged portions of the pipe shall be rejoined using the heat fusion joining method. Fused segments of pipe shall be handled so as to avoid damage to the pipe. Chains or cable type chokers must be avoided when lifting fused sections of pipe. Nylon slings are preferred. Spreader bars are recommended when lifting long fused sections.

K. **Testing:**

- **Fusion Quality.** The Contractor shall ensure the field set-up and operation of the fusion equipment, and the fusion procedure used by the Contractor's fusion operator while on site. Upon request by the Owner, the Contractor shall verify field fusion quality by making and testing a trial fusion. The trial fusion shall be allowed to cool completely; then test straps shall be cut out and bent strap tested in accordance with ASTM D 2657. If the bent strap test of the trial fusion fails at the joint, the field fusions represented by the trial fusion shall be rejected. The Contractor at his expense shall make all necessary corrections to equipment, set-up, operation and fusion procedure, and shall re-make the rejected fusions.
- **Hydro-Test:** Pipelines shall be tested to the requirements and specifications of the engineer of record. HDPE pressure pipe shall be tested in accordance with the specifications and requirements of the engineer of record and/or with the manufacturer's recommendations. The pressure rating of the pipe is a function of temperature at the time of hydro-test. Refer to the manufacturer's temperature related pressure ratings. At a minimum and if not specified elsewhere, hydro-test the piping system at 1.5 times the pressure rating of the pipe for 2 to 3 hours per Driscopipe Technical Note #35. If a system component such as a fabricated or mechanical fitting has a pressure rating less than that of the pipe, the piping system should be pressure tested to manufacturer's guidelines on that component.

### **PART 3 - EXECUTION**

#### **3.01 LAYING DEPTHS FOR WATER MAINS**

In general, water mains shall be laid with a minimum cover of 36" above the top of the main, unless otherwise noted on the Drawings, i.e. for minimum separation between water main and other utilities, connections to existing mains, valve locations, or when required by Kentucky Department of Highways, i.e. ditch lines and borings shall be 42" minimum cover.

#### **3.02 PIPE BEDDING**

A. The foundation for pipes laid in trenches shall be prepared so that the entire load of the backfill on top of the pipe will be carried uniformly on the barrel of the pipe. Pipe bells shall not carry any of the load of the backfill.

B. The Contractor shall use the "Undercutting Method" of pipe bedding.

C. When the "Undercutting Method" is used in rock bottom trenches, Class I granular bedding (No.9 crushed stone aggregate) or earth shall be of such depth that the bottom of the barrel of the pipe will be at least 6" above the bottom of the trench as excavated. Pipe bedding required in this paragraph is NOT considered a separate pay item.



D. In wet, yielding and mucky locations where pipe is in danger of sinking below grade or floating out of line or grade, the pipe must be weighted or secured permanently in place by such means as will prove effective. In areas where a high water table exists, the Contractor is cautioned to exercise extreme care in the placement of the backfill material to prevent flotation of the pipe at any time.

E. Where an unstable (i.e., water, mud, etc.) trench bottom is encountered, stabilization of the trench bottom is required. This is to be accomplished by undercutting the trench depth and replacing to grade with a foundation of crushed stone aggregate. The depth of the foundations dependent upon the severity of the trench bottom. The size of stone aggregate used in the foundation will be determined by the condition of the unstable material. Once the trench bottom has been stabilized, the required Class I bedding can be placed. The amount of crushed stone aggregate required to bring the top of the foundation to the trench bottom prior to the removal of the unstable material will be considered a separate pay item following negotiation between the Contractor and Owner and constitute a change order item. No compensation will be made if the instability of the trench bottom is caused by the Contractor's neglect.

F. The Contractor shall use compacted earth material or Class I granular bedding (No.9 crushed stone aggregate) when the pipe is to be placed in the rock bottom trenches or in trenches with excavated rock present. This type of bedding material shall be placed 12" above and 6" below the pipe as shown on the Contract Drawings as "Class C Bedding Detail".

G. It should be noted that no pipe shall be laid on solid or blasted rock. No rock shall be allowed to rest against the pipe once it is placed in the trench.

H. Pipe bedding as required in Paragraphs C and D of this Article is NOT considered a separate pay item.

### **3.03 PIPE LAYING**

A. All pipe shall be laid with ends abutting and true to the lines and grades indicated on the Plans. Pipe shall be fitted and matched so that when laid in the work, it will provide a smooth and uniform invert. Supporting of pipe shall be as set out hereinbefore under "Pipe Bedding" and in no case shall the supporting of pipe on blocks be permitted.

B. Fittings and specials for the water main shall be provided and laid as and where directed by the Engineer or as shown on the Plans.

C. Before each piece of pipe is lowered into the trench, it shall be thoroughly swabbed out to insure its being clean. Any piece of pipe or fitting which is known to be defective shall not be laid or placed in the lines. If any defective pipe or fitting shall be discovered after the pipe is laid, it shall be removed and replaced with a satisfactory pipe or fitting without additional charge. In case a length of pipe is cut to fit in a line, it shall be so cut as to leave a smooth end at right angles to the longitudinal axis of the pipe.

D. The interior of the pipe, as the work progresses, shall be cleaned of dirt, jointing materials, and superfluous materials of every description. When laying of pipe is topped for any reason, the exposed end of such pipe shall be closed with a plywood plug fitted into the pipe bell so as to exclude earth or other material and precautions shall be taken to prevent flotation of pipe by runoff into trench.

E. No backfilling (except for securing pipe in place) over pipe will be allowed until the Engineer has had an opportunity to make an inspection of the joints, alignment and grade in the section laid, but such inspection shall not relieve the Contractor of further liability in case of defective joints, misalignment caused by backfilling and other such deficiencies that are noted later.

F. Anchorage of Bends, Tees, Plugs and Valves:

1. At all tees, plugs, caps and bends of 11-1/4 degrees and over, and at reducers or in fittings where changes in pipe diameter occur, movement shall be prevented by using suitable harness, thrust blocks or ballast. Valves shall be provided with similar protection. Thrust blocks and supports shall be as shown in the typical details, with sufficient volumes of concrete being provided; however, care shall be taken to leave weep holes unobstructed and allow for future tightening of all nearby joints. Unless otherwise directed by the Engineer, thrust blocks shall be placed so that the pipe and fitting joints will be accessible for repair. Thrust blocks shall bear on undisturbed earth or rock.
2. Bridles, harness or pipe ballasting shall meet with the approval of the Engineer. Steel rods and clamps shall be galvanized.
3. No extra pay shall be allowed for work on proper anchorage of pipe, fittings or other appurtenances; such items shall be included in the unit price bid for the supported item.

### **3.04 HORIZONTAL DIRECTIONAL DRILLING (HDPE)**

Horizontal directional drilling technique shall be used for installing pipes and utility lines below ground using a surface-mounted drill rig that launches and places a drill string at a shallow angle to the surface and has tracking and steering capabilities. The drill shall be advanced underground, creating a borehole along its path. As the destination is reached, the drill string is angled upwards to penetrate the surface. After the borehole has been opened, a backreamer shall be attached to the head of the drill string and the HDPE pipe shall be attached to the backreamer. The drill string shall then be retracted. During retraction, the borehole will be expanded by the backreamer and the HDPE pipe drawn into the borehole. To protect HDPE pipe against excessive pulling load, a weak-link or breakaway device shall always be used at the head of the HDPE pipe. The allowable tensile load for setting weak-link devices shall be determined using ASTM F 1804 Standard Practice for Determining Allowable Tensile Load for Polyethylene (PE) Gas Pipe During Pull-In Installation. Horizontal Directional Drilling (HDD) applications shall be installed in accordance with ASTM F1962 Standard Guide for Use of Maxi-Horizontal Directional Drilling for Placement of Polyethylene Pipe or Conduit under Obstacle, Including river Crossings, Plastic Pipe Institute (PPI) Polyethylene Pipe for Horizontal Directional Drilling, and the Mini Horizontal Directional Drilling Manual published by the North American Society of Trenchless Technology (NASTT). Additional information is available in Plexco® Literature Trenchless Technology Bulletin No. 1 - Horizontal Directional Drilling Note.

### **3.05 WATER MAINS PUSHED UNDER DRIVEWAYS**

The Contractor may be required to tunnel or bore under a bituminous or concrete surface driveway instead of open trenching as requested by the property owner. The opening under the driveway shall be of the smallest diameter possible to accommodate the water main to minimize settlement of the driveway. Should settlement occur, the Contractor shall repair the driveway at his own expense in a manner satisfactory to the Engineer and the property owner.

### **3.06 JOINTING**

Jointing shall be accomplished in accordance with the manufacturer's recommendation.

### **3.07 TYPES OF CRUSHED STONE MATERIAL**

Two classes of crushed stone material are mentioned in the Detailed Specifications. The Type of material used in each class is as follows:

Class I	No. 9 Aggregate
---------	-----------------

Class II                      Dense Graded Aggregate

### 3.08 BACKFILLING

A. Initial Backfill:

1. This backfill is defined as that material which is placed over the water main from the spring line in an earth trench to a point 6" above the top of the pipe or from the trench bottom in a rock trench to a point 12" above the top of the pipe. The initial backfill for Case I situations shall be earth material free of rocks, acceptable to the Engineer or Class I material (No. 9 crushed stone aggregate). The initial backfill for Case II, Case III and Case IV situations shall be compacted earth material or be Class I material (No.9 crushed stone aggregate).
2. In areas where large quantities of rock are excavated, and the excavated earth is insufficient, then the Contractor must either haul in earth or order crushed stone aggregate for backfilling over the top of the pipe. Neither earth nor the crushed stone aggregate used to fulfill the backfill requirements is considered a pay item.

B. Final Backfill: There are four cases where the method final backfilling varies. The various cases and their trench situations are as follows:

1. Case I: Areas not subject to vehicular traffic.
2. Case II: Gravel areas subject to light vehicular traffic such as residential driveways; church and commercial parking lots and entrances; and farm drives.
3. Case III: City and County gravel roads; gravel and bituminous road shoulders; all bituminous surface areas such as City and County streets, residential driveways, church and commercial parking lots, and entrances; City and County road shoulders.
4. Case IV: State maintained streets and roads; road shoulders for State roads and streets.

C. In all cases, walking or working on the completed pipelines, except as may be necessary in backfilling, will not be permitted until the trench has been backfilled to a point twelve (12) inches above the top of the pipe. The method of final backfilling for each of the above cases is as follows:

1. Case I - The trench shall be backfilled from a point 6" (12" for a rock trench) above the top of the pipe to a point 8" below the surface of the ground with earth material free from large rock (over one-half cubic foot in volume), acceptable to the Engineer. The remainder of the trench to existing grade shall be backfilled with earth material reasonably free of any rocks.

Earth backfill used in this Case is not a separate pay item but will be paid under the pay item "Water Main".

2. Case II - The trench shall be backfilled from a point 6" (12" for a rock trench) above the top of the pipe to a point 12" below the surface of the ground with Class I (No. 9 crushed stone aggregate) material. The trench shall be tamped to assure maximum possible compaction (approximately 80 to 85 percent of Standard Proctor density). Extreme care shall be exercised to prevent damage to the pipe during tamping operation. The remainder of the trench to existing grade shall be backfilled with Class II (dense graded aggregate) material with the material being mounded over the trench.

The trench shall be tamped again to assure additional compaction. The trench may be left with a slight mound if permitted by the Engineer.

Class I material used and method of backfilling used in this case is not a separate pay item and is considered incidental to the work and will be paid for under the item "Water Main".

Class II material used in this method of backfill is not a separate pay item and will be included in the unit price per linear foot under the item "Water Main".

Sufficient stockpiles of Class II material shall be placed throughout the project area to insure immediate replacement by the Contractor of any settled areas. No extra payment will be made for the filling of settled areas by the Contractor.

3. Case III - The trench shall be backfilled from a point 6" (12" for a rock trench) above the top of pipe to the height indicated in the "City and County Maintained Streets, Roads and Driveway Pavement Replacement" detail with Class I (No. 9 crushed stone aggregate) material. Said material shall be tamped as described for Case II. A 12-inch layer of Class II (dense graded aggregate) material shall be placed over the compacted backfill before bituminous or concrete surface is placed as shown in the previously mentioned details. The 12-inch layer of Class II material is NOT a separate pay item but such expense will be borne by the Contractor and is considered incidental to the bid items "Bituminous Surface Replacement" and "Concrete Surface Replacement". Also considered incidental is all temporary stone required for a temporary surface between backfilling and pavement replacement.

Sufficient stockpiles of Class II material shall be placed throughout the project area to insure immediate replacement by the Contractor of any settled areas. No extra payment will be made for the filling in of settled areas by the Contractor. Class II material used in this method of backfill is paid for as a support item under item "Bituminous Surface Replacement" or "Concrete Surface Replacement" as its unit price per linear foot.

Class I material used for backfilling is not a separate pay item and is considered incidental to the bid item "Water Main".

4. Case IV - The trench shall be backfilled from the spring line to a point one 12-inches above the top of the pipe with earth material free from rock and acceptable to the Engineer, it shall be carefully and solidly tamped by approved mechanical methods. The remainder of the trench shall be backfilled to the height indicated in the "State Maintained Streets and Roads Pavement Replacement Detail" in the Contract Drawings, with material free from rock and acceptable to the Engineer; said material shall be mechanically tamped in approximately six-inch layers to obtain the maximum possible compaction. The backfilling method is NOT a separate pay item. A 12-inch layer of dense graded aggregate shall be placed over the compacted earth backfill when a bituminous or concrete surface street or road has been trenched. The 12-inch layer of stone is not a separate pay item but such expense will be borne by the Contractor.

D. Excavated materials from trenches and tunnels, in excess of quantity required for trench backfill, shall be disposed of by the Contractor. The Contractor may contact the Owner regarding the location of a suitable disposal site; however, if the Owner cannot recommend a site, it shall be the responsibility of the Contractor to obtain locations or permits for the disposal of the waste material. Unit prices for the various pipe sizes shall include the cost of disposing of excess excavated materials, as set forth herein, no additional compensation being allowed for hauling or overhaul.

### 3.09 CRUSHED STONE BACKFILL

A. The Class I granular material used in Case II and Case III backfill situations shall be No. 9 Crushed Stone aggregate (No.9 Stone). Granular material will not be paid for as a separate bid item.

B. The twelve inches 12-inch of crushed stone backfill that is required in "City and County Maintained Streets, Roads and Driveway Pavement Replacement" or "State Maintained Streets and Roads Pavement Replacement" will not be paid for under the provisions of this article.

### 3.10 BITUMINOUS PAVEMENT REPLACEMENT

A. Sections of pavement shall be replaced as required to install the pipelines under the work of this Section. Disturbed pavement shall be reconstructed to original lines and grades with bituminous binder as detailed on the Drawings and in such manner as to leave all such surfaces in fully as good or better condition than that which existed prior to these operations.

B. Prior to trenching, the pavement shall be scored or cut to straight edges along each side of the proposed trench to avoid unnecessary damage to the remainder of the paving. Edges of the existing pavement shall be recut and trimmed as necessary to square, straight edges after the pipe has been installed and prior to placement of the binder course.

C. Backfilling of trenches shall be in accordance with the applicable portions of this section.

D. Bituminous concrete binder shall be one course construction in accordance with applicable provisions of the Kentucky Department of Highways Standard Specifications, Section 402. Placement and compaction of binder course shall be in accordance with Section 402 of the Kentucky Department of Highways Standard Specifications. Minimum thickness after compaction shall be as shown on the Drawings.

### 3.11 CRUSHED STONE SURFACE REPLACEMENT

The Class II granular material used in Case II backfill situations shall be dense graded aggregate (D.G.A.). Granular material will be included in the unit price per linear foot for "Water Mains".

### 3.12 CONCRETE SEPARATOR FOR UTILITY CROSSING OR CASING PIPE WATER/SAN. SEWER CROSSING

A. At locations shown on the Contract Drawings, or as required by the Specifications and Contract Drawings, concrete separator shall be used when the clearance between the proposed water main and any existing non-contaminating utility pipe is one (1) foot or less. Utility pipe includes underground gas, telephone and electrical conduit, storm sewers, or any other underground utility pipe.

B. There are two cases of non-contaminating utility crossing encasement. Case I is applicable when the proposed water main is below the existing utility line. Case II is applicable when the proposed water main is laid above the utility line. In either case, the concrete shall extend to at least the spring line of each pipe involved.

C. When a water main crosses an existing sanitary sewer line, either above or below and less than two feet vertical or ten feet horizontal separation, the water main shall be encased as shown on the Standard Details, or as required by the Specifications and Contract Documents.

D. Concrete shall be Class B (2500 psi) and shall be mixed sufficiently wet to permit it to flow between the pipes to form a continuous bridge. In tamping the concrete, care shall be taken not to disturb the grade of line of either pipe or damage the joints.

### 3.13 CONCRETE FOR CREEK CROSSING (Type B and C Creek Crossing)

A. At locations shown on the Contract Drawings, or as required by the Specifications and Contract Drawings, concrete encasement shall be used when the water main crosses a stream or creek which is in rock or as directed by the Engineer.

B. All creek crossings (Types B and C) shall be constructed as per the detail shown on the Contract Drawings.

C. Concrete shall be Class B (3000 psi) and shall be mixed sufficiently wet to permit flow around the pipe and to form a continuous bed. In tamping the concrete, care shall be taken not to disturb the grade or line of the pipe or injure the joints. Concrete shall be protected from excess water.

D. Concrete placed outside the specified limits or without authorization from the Engineer will not be subject to payment. Concrete will be paid under the pay items "Crossing Type B and Creek Crossing Type C."

### 3.14 TESTING OF WATER MAINS

The completed work shall comply with the provisions listed below, or similar requirements which will insure equal or better results:

A. Before any allowable leakage calculation are performed the pipeline being tested must pass the hydrostatically test.

B. The pipe shall be hydrostatically tested at 1.5 times the design pressure at the point of testing. The duration of the test(s) shall be at least 2 hours during which time the pressure shall not fall more than 4 psi. The pipe shall be tested for allowable leakage according to AWWA C-600 (latest revision) concurrently with the pressure test.

C. Where practicable, pipelines shall be tested between line valves or plugs in lengths of not more than 3000 feet. Testing shall proceed from the source of water toward the termination of the line. The line shall be tested upon the completion of the first 3000 feet. After the completion of two consecutive tests without failure, the Contractor, at his option and with the Engineer's approval, may discontinue testing until the system is complete.

D. Duration of test shall be not less than 2 hours.

E. Lines which fail to meet tests shall be repaired and retested as necessary until test requirements are complied with.

F. All pipe, fittings and other materials found to be defective under test shall be removed and replaced at the Contractor's expense.

G. Test pressures shall not be less than 1.5 times the working pressure at the highest point along the test section, not exceed pipe or thrust restraint design pressure, not vary more than  $\pm 4$  psi and not exceed twice the rated pressure of the valves when the pressure boundary of the test sections include closed gate valves.

H. Before applying the specified test pressure, air shall be expelled completely from the pipes and valves. If permanent air vents are not located at high points within the test section, the Contractor shall install corporation cocks at such points so that the air can be expelled as the line is filled with water.

### 3.15 LEAKAGE TEST

A. The leakage shall be defined as the quantity of water that must be supplied to the tested section to maintain pressure within 4 psi of the specified test pressure after the air in the pipeline has been expelled and the pipe has been filled with water.

B. The allowable leakage shall not be greater than that determined by the following formula:

$$L = \frac{SD(P)}{133,200}^{1/2}$$

Where L is the allowable leakage in gallons per hour; S is the length of the pipeline tested; D is the nominal diameter of the pipe, in inches; and P is the average test pressure during the leakage test, in pounds per square inch gage.

C. All visible leaks are to be repaired regardless of the amount of leakage.

### 3.16 DISINFECTION OF WATER LINES

A. New potable water lines shall not be placed into service, either temporarily or permanently, until they have been thoroughly disinfected in accordance with the following requirements and to the satisfaction of the OWNER.

B. New or relocated water lines shall be thoroughly disinfected in accordance with AWWA C651, latest version, upon completion of construction and before being placed into service. After pressure testing, a solution of chlorine or chlorine compounds in such amounts shall be introduced into the section of the line being disinfected sufficient to insure a chlorine dosage of at least 50 parts per million (PPM) in the water main. Open and close all valves and cocks while chlorinating agent is in the piping system. The chlorinated water shall remain in the pipe for 24 hours. Disinfection shall be repeated until a minimum chlorine residual of 25 PPM is measured after 24 hours. Once a chlorine residual of 25 PPM is obtained after 24 hours, the water main shall be thoroughly flushed until the residual chlorine content is not greater than 1.0 PPM.

C. Following disinfection of the line, bacteriological samples shall be collected and analyzed in accordance with the requirements of Kentucky Department of Natural Resources and Environmental Protection, 401 KAR 8:150. When the samples have been tested and reported safe from contamination, the water line may be connected to the system. The Contractor shall provide to OWNER written documentation that the water sample passed the bacteriological test and is safe.

D. Bacteriological samples shall be taken in the following manner. A sample shall be taken in the newly-constructed line at each of the following points:

- 1) Within 1,200 feet downstream of each connection point between the existing and new lines;
- 2) One (1) mile intervals; and
- 3) Each dead end, without omitting any branch.

E. All sampling shall be taken in the presence of the Engineer or his representative.. All bacteriological sampling and testing shall be paid for by the Contractor and included in the unit price for the bid item "water main".

### 3.17 DECHLORINATING OF HEAVILY CHLORINATED WATER

A. Dechlorination of heavily chlorinated water shall be in accordance with AWWA C651 and shall be accomplished using sodium bisulfite, sodium thiosulfate, sodium sulfite, or calcium thiosulfate solution of a concentration sufficient to remove all chlorine to a level not to exceed 0.019 mg/l. The solution shall be applied by a metering pump directly into the chlorinated water flow stream by injection into a discharge line or into the free discharge from a hydrant. The treated water may then be conveyed to the nearest sanitary sewer, storm sewer, or local stream.

B. The feed rate (gpm) of solution shall be governed by the chlorine (ppm) concentration of the water to be dechlorinated and the rate (gpm) at which it can be discharged. Constant monitoring of the chlorine residual concentration shall be made using the colorimetric method to ensure the optimum solution feed rate.

a. Feed System

C. The dechlorinating agent shall be fed from prepared carboys utilizing a metering pump equipped with a suitable meter and valve to adjust/monitor the feed rate.

### 3.18 PLACEMENT OF TRACING WIRE

Detectable underground copper tracing wire shall be installed with all utility lines. Insulated copper trace wire shall be attached to the top of the pipe with adhesive tape or other suitable devices. At each hydrant, valve, and end of new pipe installation, the trace wire shall be daylighted and the ends connected together with split bolt connectors covered with waterproof tape or wrap. For long runs of pipe, the maximum unbroken length of the trace wire shall be 2500 feet. Underground splicing shall be made using brass split bolt electrical connectors. The trace wire shall be #12 AWG THWN copper.

### 3.19 PLACEMENT OF IDENTIFICATION TAPE

A. The placement of detectable underground marking tape shall be installed over all utility lines. Care shall be taken to insure that the buried marking tape is not broken when installed. SEE SECTION 01600 MATERIAL AND EQUIPMENT for APPROVED MANUFACTURE.

B. The identification tape shall bear the printed identification of the utility line below it, such as "CAUTION - BURIED WATER LINE BELOW". Tape shall be reverse printed, surface printing will not be acceptable. The tape shall be visible in all types and colors of soil and provide maximum color contrast to the soil. The tape shall meet the APWA color code, and shall be two (2) inches in width. Colors are: yellow - gas, green - sewer, red - electric, blue - water, orange - telephone, brown - force main.

C. The tape shall be the last equipment installed in the ditch so as to be first out. The tape shall be buried 4 - 6 inches below top of grade. After trench backfilling, the tape shall be placed in the backfill and allowed to settle into place with the backfill. The tape may be plowed in after final settlement, installed with a tool during the trench backfilling process, unrolled before final restoration or installed in any other way acceptable to the Owner or his agent or Engineer.

### 3.20 CLEAN-UP

Upon completion of the installation of the piping and appurtenances, the Contractor shall remove all debris and surplus construction materials resulting from the work. The Contractor shall grade the ground along each side of pipe trenches in a uniform and neat manner leaving the construction area in a shape as near as possible to the original ground line.



**3.21 CONNECTING TO THE WATER SYSTEM**

Unless otherwise directed by the OWNER, the CONTRACTOR shall connect the new water main to the existing water system. The CONTRACTOR shall notify the OWNER when the connection is to be made so that representatives of the OWNER may operate existing valves and witness the connection. A minimum notice of at least 24 hours in advance of the connection shall be given to the UTILITY. The Contractor shall coordinate all connections and other work which require disruption of water service so as to minimize the amount of time the affected water lines are out of service.

- END OF SECTION -

**SECTION 02626****CUSTOMER METER SERVICE AND SERVICE TUBING****PART 1 GENERAL****1.01 SUMMARY**

- A. This Section includes service pipelines constructed of seamless copper tube as shown on the Contract Drawings, complete with fittings and accessories.
- B. Certain features of copper tubing shall be as scheduled.
- C. The Contractor shall furnish all labor, tools, equipment, and materials necessary to complete the meter service connections as shown on the Contract Drawings and herein specified.

**1.02 REFERENCES**

- A. Materials and installation shall be in accordance with the latest revisions of the following codes, standards and specifications, except where more stringent requirements have been specified herein:
  - 1. American Society for Testing and Materials (ASTM)
  - 2. American Water Works Association (AWWA)

**1.03 SUBMITTALS**

- A. In addition to those submittals identified in the General Provisions, the following items shall be submitted:
  - 1. Manufacturer's certification that all materials furnished are in compliance with the applicable requirements of the referenced standards and this specification.
  - 2. Layout drawings showing the location of copper tube including details of the support system, sleeves, unions and appurtenances.

**PART 2 PRODUCTS****2.01 SERVICE CLAMPS**

All service connections of all sizes shall be made through the use of service clamps or saddles. Service saddles shall have ductile iron body, double strapped with O-ring resilient gasket, suitable for use on ductile iron pipe or PVC pipe, and tapped with same threads as the corporation stops. Saddles for all mains shall be double strap type saddles and have a maximum working pressure of 350 psi SEE SECTION 01600 MATERIAL AND EQUIPMENT for APPROVED MANUFACTURE.

## 2.02 CORPORATION STOPS

Corporation stops for use in service clamps shall be equal for 3/4", 1" and 2" service tubing and have a maximum working pressure of 300 psi. Corporation stops shall have iron pipe threads with compression coupling connection for copper tubing outlets. A rigid stainless steel insert stiffener shall be used inside the PE tubing, when encountered. SEE SECTION 01600 MATERIAL AND EQUIPMENT for APPROVED MANUFACTURE.

## 2.03 SERVICE TUBING 3/4", 1" AND 2" POLYETHYLENE TUBING (CTS SERVICE TUBING)

A. Pipe shall be made from virgin, ultra-high molecular weight polyethylene resin meeting the requirements of Type III, Class C, Category P34 polyethylene as defined by ASTM D-1248, latest revision, "Polyethylene Plastics Molding and Extrusion Materials".

B. Dimensions and tolerances shall meet the values as listed in AWWA C-901, latest revision, "Polyethylene (PE) Pressure Pipe Tubing and Fittings". Standard dimension ratio shall be DR-7.3 (OD base), Pressure Class 200 psi.

C. Pipe shall be rated for use with water at 73.4 degrees F. at a hydrostatic design stress of 630 psi and a maximum working pressure of 200 psi. The pipe shall sustain a water pressure as defined in ASTM D 1598 for 1000 hours with water at 73.4 degrees F.

D. Surface shall be homogeneous inside and out and completely free of irregularity. Random testing shall be performed at intervals during all production runs to assure uniformity in all respects. The tubing shall carry the National Sanitation Foundation seal of approval for drinking water.

E. Pipe shall be marked in lettering at intervals of not more than five (5) feet and such marking shall include nominal size; manufacturer's name or trademark; pressure rating for water at 73.4 degrees F., 200 psi; applicable ASTM specification,; ASTM material specification, PE 3406; standard dimension ratio, DR-7.3; the National Sanitation Foundation Seal of Approval (NSF mark) and production code.

F. Pipe shall be guaranteed in writing against rot, corrosion and defects for 50 years from date of installation, with pipe replacement and labor cost warranted in writing for 25 years from date of installation.

## 2.04 COPPER SERVICE TUBING

A. Buried, Exterior - Copper Pipe: Type K hard drawn copper per ASTM B-88. Fittings: Wrought copper or cast brass. Joints: Lead free, tin-silver solder.

B. Buried, Below Slab: Copper Pipe, 2" and Smaller: Type K soft drawn copper per ASTM B-88. Fittings and joints shall not be permitted below slab.

C. Buried: Copper Pipe, 2" and Smaller: Type K soft drawn copper per ASTM B-88. Fittings and joints shall not be permitted in the service tubing.

D. All solder joints shall be soldered with an approved, lead free tin-silver solder. Acid core solder shall not be used.

E. Copper tube shall be as specified herein unless otherwise shown on the Contract Drawings or in the pipe schedule.

F. Copper tube shall conform to the following standards:

	<u>ASTM</u>
Seamless Copper Water Tube	B88
Copper Drainage Tube (DWV)	B306
Seamless Copper Tube, Bright Annealed	B68

1. Seamless copper water tube shall be used for hot and cold water and compressed air.
    - a. Type K where installed in concrete, underground or when immersed in liquids.
    - b. Type L where exposed and in concealed locations inside structures.
    - c. Soft temper when installed in concrete or underground.
    - d. Hard temper when installed in exposed and concealed locations.
  2. Copper drainage tube will be permitted only for sanitary waste, drain and vent piping above ground and inside structures.
  3. Bright annealed seamless copper tube shall be used for liquid fuel and refrigerant and all small (3/8 inch and smaller) tubing unless otherwise specified.
- G. Wall thickness shall be at least equal to Type K seamless copper water tube unless heavier walls are specified.

## 2.05 METER SETTING EQUIPMENT

A. Meters shall be placed inside meter boxes using copper setters with 3/4" or 1" saddle nut connection for the meter. SEE SECTION 01600 MATERIAL AND EQUIPMENT for APPROVED MANUFACTURE. All copper setters shall have a ball angle meter valve (lockable) stop at the meter inlet and dual check valve on the outlet. Copper setters shall be 7 inches in height with connections for the appropriate service tubing and have a maximum working pressure of 300 psi.

B. For larger meters (1-1/2" and 2") the meters shall be installed with ball meter valves on inlet side and the meter outlet side and shall have a dual check valve. Meters shall be placed on concrete block or equivalent support inside the meter box.

C. For individual meter with pressure reducing valves or more than one meter the copper setters shall be the Tandem type copper setters as manufactured by Ford, Mueller or Engineer approved equal and 7 inches in height and placed in meter boxes with 18" I.D.

D. A rigid stainless-steel insert stiffener shall be used inside the PE tubing at all connections to the copper setters.

## **2.06 SERVICE METERS**

The service meter main body shall be of high-grade bronze, with hinges, single lid cover and raised characters cast on the body indicating the direction of flow. Meter shall have a working pressure rating of 150 psi. The register shall be straight reading gallon type. The register unit shall be hermetically sealed and driven by permanent magnets. The register shall carry a minimum 10-year warranty.

The meters shall be "**BADGER RADIO READ**". The entire unit is to be pre-assembled in a workmanlike manner with all components fitted snugly into the box and fastened to prevent movement. All joints shall be sealed with Teflon tape. The inlet and outlet is to be equipped with compression couplings.

## **2.07 METER BOXES**

Meter boxes shall be plastic or "Ultra-Rib" circular with dimension as shown on the Drawings. The meter box cover where installation is to be in roadways or sidewalks and shall have heavy duty lid for light vehicular traffic. The meter box where installation is to be roadways or sidewalks shall be of concrete construction for vehicular traffic. The meter box, cover and meter setting shall be constructed as shown on the drawings or as directed by the Owner or Engineer. SEE SECTION 01600 MATERIAL AND EQUIPMENT for APPROVED MANUFACTURE.

## **PART 3 - EXECUTION**

### **3.01 INSTALLATION OF METER SERVICES**

All customer meter services shall be installed as shown on the Contract Drawings and shall be set near the property owner's property line and outside of the highway right-of-way. The Owner reserves the right to change the location of the meter services prior to installation for ease of daily operation of the system and reading the individual meters. Existing customer services must be connected on customer side of meter.

### **3.02 INSTALLATION OF SERVICE TUBING**

A. All service tubing installed beneath bituminous or concrete roads shall be jacked under the roads. When State maintained roads are being jacked and rock is encountered, permission to open cut the road shall be obtained by the Contractor from the Department of Transportation's District Permit Engineer. If permission is refused, the Contractor shall attempt to jack at another location and shall continue to do so until a successful crossing is obtained.

B. Minimum cover for all service lines shall be 36 inches (at all locations) when within the proposed and existing highway right-of-way and construction easements. Additional cover may be required at proposed drainage ditch, storm sewer, or other noted locations.

### **3.03 BACKFILLING SERVICE TUBING**

When service tubing is laid in an open cut across a road of any type surface (crushed stone, bituminous or concrete), the backfill shall consist of Class II granular material (dense graded aggregate) and shall be placed full depth. Payment for Class II material used will not be paid as a separate pay item, but will be included in the price for installing the service tubing.

**3.04 INSTALLATION OF COPPER TUBING**

- A. Install copper tubing, fittings, specials, and accessories in accordance with the applicable configuration shown on the Contract Drawings and the provisions of the Sections entitled "Trenching, Backfilling and Compacting" and "Pipeline Installation".
- B. Exposed copper tube shall be carefully erected and neatly arranged.
  - 1. Copper tube shall be run parallel with walls inside structures and shall be pitched to drain.
  - 2. Drain valves shall be installed at the low points of liquid filled systems.
  - 3. Valved fill connections shall be provided for closed systems.
- C. Copper tube installed for a compressed air or gas system shall be pitched in the direction of flow.
  - 1. Connections shall be at the top of the main.
  - 2. Low points of the system shall have drip pipes not less than 12 inches long and drain pet-cocks unless automatic moisture traps are shown.
- D. Unions shall be provided on copper tube systems with soldered joints.
  - 1. Unions shall be located at control valves, solenoid valves, moisture and steam traps, other items of connected equipment and as shown on Contract Drawings.
  - 2. Unions shall be of cast bronze or brass construction.
  - 3. Dielectric unions shall be used when connecting copper tube to ferrous metals.
- E. Copper tubing shall be supported and anchored in place by the use of copper or brass units spaced not greater than 10 feet on center and each side of each change of direction.

**3.05 FIELD TESTING AND CHLORINATION**

- A. Perform hydrostatic and leakage tests in accordance with the applicable provisions of the Section entitled "Leakage Tests", at the test pressure specified or scheduled.
- B. Disinfect piping and appurtenances in accordance with the Section entitled "Chlorination", where specified or scheduled.

-END OF SECTION-

**SECTION 02630****TAPPED CONNECTIONS****PART 1 GENERAL****1.01 SUMMARY**

- A. This Section includes tapping and installing of corporation stops and valves on existing or newly installed pipes without interruption of service, as shown on the Contract Drawings, complete with connections and accessories.
- B. Installing of curb stops and boxes where specified or directed.

**1.02 REFERENCES**

- A. Materials and installation shall be in accordance with the latest revisions of the following codes, standards and specifications, except where more stringent requirements have been specified herein:
  - 1. American Water Works Association (AWWA)

**1.03 SUBMITTALS**

- A. In addition to those submittals identified in the General Provisions, the following items shall be submitted:
  - 1. Detail drawings for each size corporation stop, curb stop, tapping sleeve and valve, and service box.

**PART 2 PRODUCTS****2.01 CORPORATION STOPS**

- A. Corporation stops shall be threaded to conform to AWWA C800 with standard corporation stop thread at the inlet. The outlet shall be fitted with coupling nut for flared tube service unless otherwise specified.

SEE SECTION 01600 MATERIAL AND EQUIPMENT for APPROVED MANUFACTURE.

**2.02 CURB STOPS**

- A. Curb stops shall be threaded to conform to AWWA C 800 with coupling nuts for flared tube service.
1.  $\frac{3}{4}$ -inch shall be of the inverted new type.
  2. 1-inch to 2-inch shall be of the plug-type with "O" ring seals to withstand a minimum working pressure of 175 psi.
  3. SEE SECTION 01600 MATERIAL AND EQUIPMENT for APPROVED MANUFACTURE.

**2.03 SERVICE CLAMPS**

- A. Service clamps shall be designed for use on the type of pipe to which the connection is being made.
1. Ductile iron and asbestos-cement service clamps shall be the double strap type with neoprene gaskets.
  2. Polyvinyl chloride pipe service clamps shall be of a full circle design with a minimum width of 2 inches.
  3. Prestressed concrete pipe service clamps shall be made by or approved for use by the pipe manufacturer.
  4. SEE SECTION 01600 MATERIAL AND EQUIPMENT for APPROVED MANUFACTURE.

**2.04 SERVICE BOXES**

- A. Service boxes shall be constructed of cast iron and sized for the curb stop upon which it is being installed.
1. Stationary shut-off rod shall be provided unless otherwise specified.
  2. Boxes shall be telescopic with a minimum of 1-foot adjustment.
  3. SEE SECTION 01600 MATERIAL AND EQUIPMENT for APPROVED MANUFACTURE.



## 2.05 TAPPING SLEEVES AND VALVES

- A. Tapping sleeves and valves shall be used for connections larger than 2 inches.
  - 1. Tapping sleeves shall be designed and sized in accordance with the recommendations of the manufacturer.
  - 2. Working pressure shall be 200 psi unless higher pressures are scheduled.
  - 3. The seal of the tapping sleeve shall be mechanical joint or low lead 2.5% or less. Low lead as conforming to current regulations.
  - 4. Valves for tapping sleeves shall be designed for the intended service and shall conform to the requirements of the Section entitled "Valves".
  - 5. SEE SECTION 01600 MATERIAL AND EQUIPMENT for APPROVED MANUFACTURE.

## PART 3 EXECUTION

### 3.01 INSTALLATION

- A. Install connections and accessories under the direction of personnel who have performed at least ten similar connections in accordance with the configuration shown on the Contract Drawings and the applicable provisions of the referenced Standards.
  - 1. Threaded taps shall be made using a machine designed for cutting, threading and inserting the corporation without interruption of service.
    - a. Teflon tape may be used on corporation threads.
  - 2. Tapping sleeve connections shall be made using a machine to cut and remove the segment through the valve without interruption of service.
- B. Service boxes shall be set plumb and shall be independently supported on two bricks so no weight will be transmitted to the curb stop or carrier pipe.
- C. Service clamps and tapping sleeves installed on prestressed concrete pipe shall be encased in a minimum of 2 inches of concrete mortar after installation.

-END OF SECTION-

**SECTION 02640****VALVES****PART 1 - GENERAL****1.01 WORK INCLUDED**

- A. The Contractor shall furnish and install valves and miscellaneous piping appurtenances, as indicated on the Drawings and as herein specified.
- B. The Drawings and Specifications direct attention to certain features of the equipment, but do not purport to cover all the details of their design. The equipment furnished shall be designed and constructed equal to the high quality equipment manufactured by such firms as are mentioned hereinafter, or as permitted by the Engineer. The Contractor shall furnish and install the equipment complete in all details and ready for operation.
- C. Electrical work and equipment specified herein shall conform to the requirements of the applicable electrical sections.
- D. Enclosures shall be of a suitable type for the atmospheres in which they are installed.
- E. Sizes and capacities not specified herein are indicated on the Drawings.
- F. Valves required within pre-engineered pump stations are not covered by this specification section.

**PART 2 - PRODUCTS****2.01 BUTTERFLY VALVES**

- A. Butterfly valves and operators shall conform to the AWWA Standard Specifications for rubber seated butterfly valves, Designation C504, Class 150, except as hereinafter specified. Valves shall have a minimum 150 psi pressure rating.
- B. All butterfly valves shall be of cast iron body per ASTM A-126, Class B. Valve discs shall be of ductile iron per ASTM A-536 and provide uninterrupted 360 degree seating edge. Permanently self-lubricating body bushings shall be provided and shall be sized to withstand bearing loads. Valve shafts shall be Type 304 stainless steel with V-type packing. O-ring seals are not acceptable.
- C. Valve seats shall be full resilient seats of Buna - N or Hycar and retained in the body or on the disc edge. If the resilient seat is in the body, the disc shall conform to ASTM A-436 Type 1 (Ni-Resist) or gray/ductile iron with corrosion resistant seating surface. If the resilient seat is mounted on the disc edge, it shall be securely attached with Type 304 stainless steel retaining ring or pins. The disc seating edge shall be Type 316 stainless steel.
- D. Valve operators shall be electric actuators as specified elsewhere in the specifications. The valve shaft and actuators shall be designed for both torsional and shearing stresses when the valve is operated under its greatest torque.
- E. All valves shall conform with the latest revision of AWWA Standard for Butterfly Valves for Ordinary Water Service, AWWA C504. SEE SECTION 01600 MATERIAL AND EQUIPMENT for APPROVED MANUFACTURE.

## 2.02 GATE VALVES AND BOXES

A. All gate valves shall be of the resilient seat wedge, iron body, non-rising stem, fully bronze mounted with O-ring seals. Valves shall be of standard manufacture and of the highest quality both as to materials and workmanship and shall conform to the latest revisions of AWWA Specification C-500. Valves shall have a rated working pressure of 250 psi.

B. Gate valves for buried service shall be furnished with mechanical joint end connections, unless otherwise shown on the plans or specified herein. The end connections shall be suitable to receive ductile iron or PVC pipe.

C. All gate valves shall have the name or monogram of the manufacturer, the year the valve casting was made, the size of the valve, and the working pressure cast on the body of the valve.

D. Buried service gate valves shall be provided with a 2" square operating nut and shall be opened by turning to the left (counterclockwise).

E. Buried service gate valves shall be installed in a vertical position with valve box as detailed on the plans. They shall be set vertically and properly adjusted so that the cover will be in the same plane as the finished surface of the ground or street. All underground gate valves which have nuts deeper than 36 inches below the valve box top shall have extended stems with nuts located within one foot of the valve box cap.

F. Valve boxes shall be cast iron, two-piece, screw type (as shown on the drawings) with drop-cover marked "Water". They shall be set vertically and properly adjusted so that the cover will be in the same plane as the finished surface of the ground or street. A concrete pad shall be placed around the valve box cover as shown on the drawings.

G. The Contractor shall furnish two (2) T-operating wrenches in the lengths necessary to operate the buried gate valves for an operator of average height in a normal working position.

H. Gate valves for installation in building, drywells, pits or vaults shall be flanged ANSI B16.1, Class 125 with handwheel operator, non-rising stem or OS&Y as indicated on the drawings.

I. Gate valves installed with tapping sleeves shall have a mechanical joint outlet and a flanged joint connection to the sleeves.

J. All valves shall conform with the latest revision of AWWA Standard for Gate Valves for Ordinary Water Works Service, AWWA C500. SEE SECTION 01600 MATERIAL AND EQUIPMENT for APPROVED MANUFACTURE.

K. All 24" or larger gate valves shall be supplied with spur gearing and grease case.

L. All gate valves shall receive a two part thermosetting epoxy protective coating both inside and outside of the valve and shall be listed for use as with potable water by the Federal EPA. The epoxy coating shall meet or exceed ANSI/AWWA C550 Standard and ASTM D1763 Standard.

## 2.03 CONTROL VALVE

A. The control valve shall be a hydraulically operated, single diaphragm-actuated, solenoid controlled, globe pattern design. A 3-way solenoid pilot valve either applies upstream pressure to the upper control chamber to close the main valve or vents the upper control chamber to atmosphere allowing the main valve to open. The solenoid and a limit switch assembly on the main valve are electrically synchronized with the telemetry controls to allow the valve to open or close to fill the tank.

B. In the event of a power failure the valve will open immediately, regardless of the operational mode of the valve at the time of the power failure.

C. The main valve shall be a center guided diaphragm actuated globe valve design. The body and cover shall be ductile iron, ASTM A536, with stainless steel disc guide, seat and cover bearing. The internal and external surfaces of the valve body shall be fusion bonded coated. End connections shall meet the ANSI, or other internationally recognized standard required. The body shall have a replaceable non-threaded seat ring that is held in place by set screws which tighten into a body groove. This seat should be accessible and serviceable without removing the valve from the pipeline. The seat area shall have a flow opening with no stem guides, bearings or supporting ribs.

D. The electric solenoid valve shall be a 3-way solenoid with a manual override system to allow the valve to be operated manually should electrical power be unavailable. The solenoid and limit switch shall be properly rated for the intended service. Liquid to the pilot must be filtered and a cock valve must be provided to isolate the control loop.

F. SEE SECTION 01600 MATERIAL AND EQUIPMENT for APPROVED MANUFACTURE.

#### 2.04 DUAL DISK VALVE

A. Dual Disc Check Valves shall be suitable for pressures up to 250 psig water service. The check valve shall be of the dual disc, wafer style with torsion spring induced closure. The valves shall be provided for installation between ANSI B16.1 Class 125 iron flanges.

B. The body shall be of one piece construction incorporating a vulcanized synthetic seal. Seal design must allow for positive seating at both high and low pressures. This shall be achieved by a minimal seal contact at low pressure with progressively increased contact at higher pressures. The disc shall fully overlap the synthetic seal, preventing pressure indentations. Opening and closing of the valve must utilize a lift and

pivot action to prevent seal wear and ensure long seal life. The stop and pivot pins shall be stabilized by the use of synthetic spheres to prevent wear due to vibration during operating conditions.

C. The valve body shall be constructed of ASTM A536 Grade 65-45-12 ductile iron. The disc shall be constructed of ASTM B584, Alloy C83600 (2"-12") cast bronze or ASTM B148, Alloy C95200 (14" and larger) cast aluminum bronze. The disc pins and stop pins shall be Type 316 stainless steel. The torsion spring shall be ASTM A313 Type 316 stainless steel up to 16 in. sizes and ASTM A313 Type 17-7 PH on 18 in. and larger sizes. The seal shall be Buna - N per ASTM D2000-BG or Viton per D2000-CA.

D. End connections shall be full diameter threaded flanges.

E. The valves shall be hydrostatically tested at 1.5 times their rated cold working pressure. A seat closure test at the valve rating shall be conducted to demonstrate zero leakage. The manufacturer shall provide test certificates, dimensional drawings, parts list drawings, and operation and maintenance manuals.

F. The exterior of the valve shall be coated with a universal alkyd primer.

G. SEE SECTION 01600 MATERIAL AND EQUIPMENT for APPROVED MANUFACTURE

## 2.05 CHECK VALVES

A. The check valves shall be a swing check valve with flanged ends; outside lever and weight and function to prevent reverse flow. The valve shall be tight seating when closed and full ported when open. The hinged shaft shall be completely out of the water way employing a disc with a convex shape facing the normal flow. The valve shall be manufactured where the closing of the valve will not cause water hammer and minimize disc slam. The valve shall be capable of a tight seal at pressures above 5 psi.

B. The valve body shall be cast iron with a bronze seat ring. The valve disc shall be cast iron and suspended from a non-corrosive shaft. Valves shall be rated at a minimum working pressure of 175 psi.

C. SEE SECTION 01600 MATERIAL AND EQUIPMENT for APPROVED MANUFACTURE

## 2.06 TAPPING VALVES AND SLEEVES

A. Tapping valves and sleeves shall be installed in the locations shown the Contract Drawings. The valves shall be a resilient seat wedge, iron body, non-rising stem, gate valve with a mechanical joint outlet and a flanged joint connection to the sleeves. They shall be provided with a valve box, counterclockwise opening and installed as described in detail on the plans.

B. Tapping Sleeves: Tapping sleeves of the sizes indicated for connection to existing main shall be the cast gray, ductile, or malleable-iron, split-sleeve type with flanged outlet, and with bolts, follower rings and gaskets on each end of the sleeve. Construction shall be suitable for a maximum working pressure of 200 psi. Bolts shall have hexagonal heads and nuts. Longitudinal gaskets and mechanical joints with gaskets shall be as recommended by the manufacturer of the sleeve. When using grooved mechanical tee, it shall consist of an upper housing with full locating collar for rigid positioning which engages a machine-cut hole in pipe, encasing an elastomeric gasket which conforms to the pipe outside diameter around the hole and a lower housing with positioning lugs, secured together during assembly by nuts and bolts as specified, pretorqued to 50 foot-pound.

C. SEE SECTION 01600 MATERIAL AND EQUIPMENT for APPROVED MANUFACTURE

D. Tapping valves shall be suitable for a maximum working pressure of 200 psi with 125 lb. flanges

## 2.07 CUSTOMER SERVICE PRESSURE REDUCING VALVE

A. The individual customer service pressure reducing valve shall be hydraulically operated, spring loaded, diaphragm type control regulator. The valve shall be held open by the force of the compression spring above the diaphragm and shall maintain a constant delivery pressure downstream without shock or water hammer. Adjustments shall be made by an adjusting screw on top of the valve. Setting shall be as shown on the plans. The valve shall have a cast brass or bronze body and cover per ASTM B-62, stainless steel seat (Stainless Steel 303) and adjustment ranges of 40 to 300 psi.

B. The individual pressure reducing valve shall be equipped with a built-in by-pass to prevent a closed system on the customer's side of the meter service.

C. All valves shall be preceded by a strainer provided by the valve manufacturer and have a maximum working pressure the same as the pressure reducing valve.

D. SEE SECTION 01600 MATERIAL AND EQUIPMENT for APPROVED MANUFACTURE

## 2.08 MAIN LINE PRESSURE REDUCING VALVE

A. The pressure reducing valve shall maintain a constant downstream pressure regardless of varying inlet pressure. This valve shall be a hydraulically operated, diaphragm actuated, globe pattern valve. It shall contain a resilient, synthetic rubber disc, having a rectangular cross section, contained on three and one-half sides by a disc retainer and forming a tight seal against a single removable seat insert. The diaphragm assembly containing a valve stem shall be fully guided at both ends by a bearing in the valve cover and integral bearing in the valve seat. This diaphragm assembly shall be the only moving part and shall form a sealed chamber in the upper portion of the valve, separating operating pressure from line pressure. The diaphragm shall consist of nylon fabric bonded with synthetic rubber and shall not be used as a seating surface. Packing glands and/or stuffing boxes are not permitted and there shall be no pistons operating the valve or pilot controls. All necessary repairs shall be possible without removing valve from the line.

B. The main valve body and cover shall be Cast Iron per ASTM A48, and the main valve trim shall be 303 stainless steel. The valve shall come equipped with a valve position indicator. The valve shall be equipped with a flow clean strainer, closing speed control, opening speed control and flow stabilizer. The valve shall be equipped with a V-port diaphragm plug for low flow conditions or approved equal by the Engineer.

C. The pilot control shall be a direct acting, adjustable, spring loaded, normally open, diaphragm valve, designed to permit flow when controlled pressure is less than the spring setting. The control system shall include a fixed orifice. The pilot control valve trim shall be 303 stainless steel.

D. The valve shall have a maximum working pressure rating as stated on the Drawings.

E. SEE SECTION 01600 MATERIAL AND EQUIPMENT for APPROVED MANUFACTURE

## 2.09 AIR RELEASE VALVE

A. The valve shall have a 1" screwed inlet diameter with a 1" corporation stop and a minimum of 3/32" size orifice. The body and cover shall be constructed of cast iron while the float shall be stainless steel. All internal parts, such as lever pins, retaining rings, screws, etc. shall be of stainless steel or bronze construction. Valves shall be suitable for use in lines with an operating pressure up to 175 psi. SEE SECTION 01600 MATERIAL AND EQUIPMENT for APPROVED MANUFACTURE

B. A service clamp shall be used to connect the air release valve to the water main. Service clamps and corporation stops shall be those as previously specified in Section 02650, except the corporation stops shall have a female IP thread outlet.

C. The air release valve box shall be a standard meter box with dimensions of 18" I.D. and a height of 36". The valve box cover shall be a standard water meter box cover.

## PART 3 - EXECUTION

### 3.01 INSTALLATION

A. Valves shall be installed as nearly as possible in the positions indicated on the Drawings consistent with conveniences of operating the handwheel or wrench. All valves shall be carefully erected and supported in their respective positions free from all distortion and strain on appurtenances during handling and installation.

B. All material shall be carefully inspected for defects in workmanship and material, all debris and foreign material cleaned out of valve openings and seats, all operating mechanisms operated to check their proper functioning, and all nuts and bolts checked for tightness.

C. Valves and other equipment which do not operate easily or are otherwise defective shall be repaired or replaced at the Contractor's expense.

D. Valves shall be set plumb and supported adequately in conformance with the instructions of the manufacturer. Valves mounted on the face of concrete shall be shimmed vertically and grouted in place. Valves in the control piping shall be installed so as to be easily accessible.

E. All buried valves require a concrete collar for stability. Collar shall be no less than 4" thick and poured to flow water away from the valve. The concrete valve box protector ring is to be with copper locate pin.

### **3.02 INTERIOR PIPING INSTALLATION**

A. It shall be the Contractor's responsibility to furnish a complete system of pipe supports, to provide expansion joints and to anchor all piping. The pipe support system shall be installed complete with all necessary inserts, bolts, nuts, rods, washers, miscellaneous steel, and other accessories.

B. In some instances, expansion joints have been shown on the drawings, but no attempt has been made to indicate every expansion joint for piping included under this portion of the specifications. Portions of the piping are shown on the detail drawings. Some of the piping, however, is shown only on the schematics.

C. Reaction Anchorage and Blocking: All piping exposed in interior locations and subject to internal pressure in which flexible connectors are used shall be blocked, anchored, or harnessed, as shown on the drawings, or as directed by the Engineer to preclude separation of joints.

### **3.03 PAINTING**

Field painting is specified in elsewhere in these specifications.

- END OF SECTION -

**SECTION 02645****HYDRANT ASSEMBLY****PART 1 - GENERAL****1.01 SCOPE**

The Contractor shall furnish and install, where shown on the plans and additional locations as directed by the Owner, hydrant assemblies and blow-hydrants manufactured and equipped as described below.

**PART 2 - PRODUCTS****2.01 FLUSHING HYDRANT ASSEMBLY**

A. Hydrants shall conform in all respects to the requirements of AWWA C502. All hydrants shall have 6-inch mechanical joint shoe connection, two (2) 2-1/2" hose outlets, one (1) 4-1/2" pumper nozzle with caps. Connection threads and operation nuts shall conform to National Standard Specifications as adopted by National Board of Fire Underwriters. The hydrant shall be equipped with safety flanges designed to prevent barrel breakage when struck by a vehicle and an auxiliary gate valve.

B. Each hydrant shall be fully bronze mounted with the main valve having a threaded bronze seat ring assembly of such design that it is easily removable by unscrewing from a threaded bronze drain ring. Bronze drain ring shall have multiple ports providing positive automatic drainage as the main valve is opened or closed. Drainage waterways shall be completely bronze to prevent rust or corrosion.

C. Operating stems shall be equipped with anti-friction thrust bearing to reduce operating torque and assure easy opening. Stops shall be provided to limit stem travel. Stem threads shall be enclosed in a permanently sealed lubricant reservoir protected from weather and the waterway with O-ring seals.

D. Hydrants shall be designed for 250 psi working pressure and shop tested to 1250 psi pressure with main valve both opened and closed. Under test the valve shall not leak, the automatic drain shall function and there shall be no leakage into the bonnet. Hydrants shall have a UL/FM approved rating.

E. Each hydrant shall be installed with an auxiliary shut-off valve and valve box; valve box cover shall be marked "WATER" as required. Hydrants shall be secured to the shut-off valve by AWWA approved restraint joints, rodding with four (4) equally spaced all thread rods and "Duc-Lugs", or other equally approved method.

F. Inlet cover depth shall be 36" and the minimum dimension from ground to centerline of lowest opening shall be 18". Hydrants shall be supported on a poured-in-place concrete thrust block and provided with a drainage pit as indicated on Standard Detail Sheet.

G. All hydrants shall receive two (2) field coats of Koppers Company, Inc. Glamortex enamel (red). The Owner shall be furnished with two (2) hydrant barrel wrenches, four (4) spanner wrenches and two (2) operating nut wrenches.

H. Below ground hydrants shall be flush type with the upper barrel and nozzles contained in a cast iron box with a non locking lid.

I. SEE SECTION 01600 MATERIAL AND EQUIPMENT for APPROVED MANUFACTURE



J. Hydrant assemblies shall include the isolation valve and both valve and hydrant shall have a UL/FM approved rating.

## **2.02 UNDERGROUND BLOW-OFF ASSEMBLY**

A. Blow-off hydrants shall be of non-freezing, self-draining type, with an overall length of 30". Set underground in a 30" meter box, these hydrants will be furnished with a 2½" Main Valve Opening inlet, a non-turning operating rod, 7/16 inch square operating nut, and shall open to the left. All of the working parts shall be of bronze-to-bronze design, and be serviceable from above grade with no digging. The outlet shall also be bronze and be 2-1/2" NST. Hydrants shall be lockable to prevent unauthorized use. SEE SECTION 01600 MATERIAL AND EQUIPMENT for APPROVED MANUFACTURE.

B. The Contractor shall furnish two (2) T-operating wrenches in the lengths necessary to operate the blow-off hydrants for an operator of average height in a normal working position.

## **2.02 BLOWOFF HYDRANT ASSEMBLY**

A. 3-inch Hydrants shall be self-draining, non-freezing, compression type with 2½" main valve opening. Inlet connection shall be MJ. Outlet shall be 2" IP. Hydrants shall be post type SEE SECTION 01600 MATERIAL AND EQUIPMENT for APPROVED MANUFACTURE.

B. Hydrants shall have a ductile iron pipe riser with a cast iron stock top, and non-turning operating rod. Principal interior operating parts shall be brass and removable from the hydrant for servicing without excavating the hydrant.

C. Flushing assembly installation shall also include all excavation, backfill, thrust blocking, and #9 crushed stone.

## **PART 3 - EXECUTION**

### **3.01 INSTALLATION**

A. Hydrants shall be located as shown on the drawings unless otherwise specified by the Owner. Each hydrant shall be connected to the main with a 6-inch branch line having at least as much cover as the distribution main. Hydrants shall be set plumb with pumper nozzle facing the roadway and the cast-iron valve box set flush with the finished surrounding grade. Except where approved otherwise, the backfill around hydrants shall be thoroughly compacted to the finished gradeline immediately after installation to obtain beneficial use of the hydrant as soon as practicable. All hydrants shall be provided with a shut-off valve in the hydrant lateral as shown. All hydrants shall be installed in accordance with the manufacturer's directions and as detailed on the Contract Drawings.

B. Blow-off hydrants shall be located as shown on the drawings unless otherwise specified by the Utility. Each blow-off hydrant shall be connected to the main with at least as much cover as the distribution main. Blow-off hydrants shall be set plumb with nozzle facing the roadway and with the box cover set flush with the finished surrounding grade. The backfill around each hydrant shall be thoroughly compacted to the finished gradeline immediately after installation to obtain beneficial use of the hydrant as soon as practicable. All blow-off hydrants shall be provided with a shut-off valve in the lateral as shown.

- END OF SECTION -

## SECTION 02700

### SITE RESTORATION

#### PART 1 - GENERAL

##### 1.01 CLEAN-UP

- A. Upon completion of the work under this Contract, the Contractor shall remove all debris and surplus construction materials resulting from his work. The Contractor shall grade the ground along each side of the pipe trench and/or structure in a uniform and neat manner leaving the construction area in a shape as near as possible to the original ground line.

#### PART 2 - PRODUCTS

##### 2.01 SEEDING

- A. All graded areas shall be seeded at the rate of six (6) pounds of seed per 1,000 square feet. The mixture shall consist of:
- |                     |     |
|---------------------|-----|
| Kentucky 31 Fescue  | 60% |
| Creeping Red Fescue | 20% |
| Annual Rye Grass    | 20% |
- B. After seed has been distributed, the Contractor shall cover areas with straw to a depth of 1-1/2". Any necessary re-seeding or repairing shall be accomplished by the Contractor before final acceptance. Seeding is not a pay item.

#### PART 3 - EXECUTION

##### 3.01 SITE RESTORATION

- A. After installation of water lines, the construction site will be restored to its original condition or better. All paved streets, roads, sidewalks, curbs, etc. removed or disturbed during construction shall be replaced, and all materials and workmanship shall conform to standard practices and specifications of the Owner, and/or to the Kentucky Department of Highways requirements, and specifications, whichever applies. Gravel, cinder or dirt streets, drives and shoulders shall be replaced and sufficiently compacted to provide a surface suitable for carrying the type of traffic normally imposed at the location.
- B. All seeded areas shall be watered daily during the germination period, unless rain supplies the required moisture. The Contractor shall replace, at his own expense, trees, shrubs, etc. disturbed during construction.
- C. The Contractor shall remove from the site all equipment, unused materials and other items at his expense. The construction site shall be left in a neat, orderly condition, clear of all unsightly items, before the Work is finally accepted.

- END OF SECTION -

**SECTION 02720****VAULTS AND INLETS****PART 1 GENERAL****1.1 SUMMARY**

- A. This Section includes valve and meter vaults, catch basins, curb inlets, surface water inlets, and similar structures, complete with frames and covers, manhole steps and appurtenances as shown on the Contract Drawings.

**1.2 REFERENCES**

- A. Materials and installation shall be in accordance with the latest revisions of the following codes, standards and specifications, except where more stringent requirements have been specified herein:
  - 1. American Society for Testing and Materials (ASTM)
  - 2. American Association of State Highway Transportation Officials (ASHTO)

**PART 2 PRODUCTS****2.1 MATERIALS AND CONSTRUCTION**

- A. Concrete
  - 1. Cast-in-place concrete for vaults and inlets shall be as specified under the Section entitled "Concrete".
  - 2. Precast concrete sections shall be in accordance with ASTM C478 for manhole sections and ASTM C913 for other structures with a minimum wall thickness of 5 inches. Units and top sections shall be designed and constructed to withstand H-20 wheel loads and shall be of the type shown.
    - a. Bell and spigot joints of precast sections shall have an appropriate "O" ring supplied by the manufacturer, or other types of joints as shown on the Contract Drawings.
- B. Masonry Units
  - 1. Brick shall meet the requirements of ASTM C62, Grade SW, and shall be of a hard-burned manufacture.
  - 2. Concrete blocks shall conform to the requirements of ASTM C139 and shall be solid and of the size shown on the Contract Drawings.
- C. Mortar
  - 1. Masonry cement for mortar shall meet the requirements of ASTM C 91, Type II and shall be mixed with a graded quality sand conforming to ASTM C144.
  - 2. Mix shall be one part masonry cement to three parts sand using the minimum amount of clean water required for workability.

- D. Castings
1. Frames and covers, grates, inlets, and other castings shall be as shown on the Contract Drawings and be in accordance with ASTM A48, Class 30. All castings shall be manufactured to withstand H-20 wheel loads. Lettering shall be "Storm Sewer" or other appropriate designation cast as directed. Frames and covers shall have machined bearing surfaces.
- E. Steps
1. Where shown or specified, steps for vaults and inlets shall be composed of ½-inch Grade 60 ASTM A615 deformed steel reinforcing bar completely encapsulated in copolymer polypropylene plastic, Type PS2-PF as manufactured by M.A. Industries, Inc., or equal.
  2. Steps shall be installed in each vault or inlet in vertical alignment spaced 12 inches on center and shall be placed over the largest benchwall of the manhole.
  2. Steps shall have a minimum tread width of 12 inches and shall be cast into the vault sections or other methods of installation with prior acceptance of the Engineer.

## 2.2 AMERICAN IRON AND STEEL

- A. Under the requirements of Section 746 of Title VII of the Consolidated Appropriations Act of 2017 (Division A-Agriculture, Rural Development, Food and Drug Administration, and Related Agencies, Appropriations Act, 2017) and subsequent statutes mandating domestic preference applies to American Iron and Steel requirement to this project. All listed iron and steel products used in this project must be produced in the United States.

## PART 3 EXECUTION

### 3.1 INSTALLATION

- A. Precast Sections
1. Precast sections shall be installed on a flat stable subgrade with select fill as shown in contract documents and geotextile.
  2. Prior to installation of granular material for precast manhole bases, contractor shall prepare flat, stable subgrade. Where an unstable condition exist, the Contractor shall excavate the unstable material and replace with compacted granular material as specified.
  3. All joints shall be filled inside and out with mortar to provide a smooth and continuous surface.
- B. Benchwalls and Inverts
1. Mortar surfaces of benchwalls and concrete floors shall be given a broom finish. Where inverts are required they shall be lined with a half section of pipe of the same type used for the sewer or shall be constructed of Class "C" concrete, shaped and troweled to produce a smooth circular cross-section.
- C. Frames and Castings

1. Frames and castings shall be set in a full bed of mortar a maximum of 1/2" thick. Where required to adjust the frames and castings to grade there shall be installed to a maximum of four brick courses.

D. Steps

1. Steps shall be installed in vertical alignment spaced 12 inches on center.
2. In concrete sections the steps shall be cast into the section or secured with cadmium plated bolts to threaded inserts which are precast into the concrete.
3. In masonry construction the steps shall be built into the masonry walls.

E. Plastering

1. Plaster shall be with mortar not less than 1/2 inch thick and troweled smooth.
2. Outside of masonry structures.
3. Inside and outside of brick courses under frames and castings.

F. Sumps

1. Sumps of the size specified shall be built into the floors of vaults and similar structures. Floors shall be sloped to the sump.

-- END OF SECTION --

**SECTION 02900**  
**SEEDING AND SODDING**

**PART 1 - GENERAL**

**1.01 DESCRIPTION OF WORK**

- A. Landscape development work in this phase shall consist of the installation of ground cover and lawns. "Planting Area" means all areas to be planted with ground cover, erosion control plantings and/or lawns.

**1.02 RELATED WORK**

- A. Subgrade elevations, excavation, fillings, and grading required to establish elevations shown on Drawings are not specified in this Section. Refer to this Division, Section 02200.
- B. Erosion and sediment control are included in this Division, Section 02270.

**1.03 SCOPE**

Furnish all material, labor, transportation and equipment to properly complete the landscaping and turfing of the planting areas, or reasonably implied to complete the construction. Included as a part of the work of this Section, but not necessarily limited by it, are the following items.

- A. Clear and remove from the planting areas all debris, surface growth, or other undesirable material.
- B. Fine grading of all turf and planting areas, including the addition of amended topsoil if required.
- C. Topsoil shall be placed to a minimum compacted depth of 6 inches and on all disturbed areas.
- D. Vinca and/or Vetch shall be planted on all slopes steeper than 4:1, or as otherwise shown on the Drawings.
- E. Furnishing and installation of all lawns and ground covers.
- F. Providing maintenance throughout establishment.
- G. Cleanup and weeding of all landscaped areas.
- H. Seed and mulch all disturbed areas with slopes shallower than 4:1, with grass seed.
- I. Seed and mulch all disturbed areas with slopes steeper than 4:1 with crown vetch.

**1.04 SPECIAL REQUIREMENTS**

- A. All scaled dimensions on the Drawing are approximate. Before proceeding with any work, the Contractor shall carefully check and verify all dimensions, quantities and grade elevations, and shall immediately inform the Engineer of any discrepancies.

- B. During the construction and maintenance period, the contractor shall take every precaution and avoid damage to any underground facilities. The Contractor shall be held responsible for any and all damage to such facilities and shall repair the same at no cost to the Owner.
- C. When conditions are such, by reason of drought, high wind, excessive moisture, or other factors, that satisfactory results are not reasonably attainable, the work shall be stopped and shall be resumed only when conditions are again favorable.
- D. Grading and soil preparation work shall be performed only during periods when beneficial and optimum results may be obtained. If the moisture content of the soil should reach such a level that working it would destroy the soil structure, spreading, grading and tilling operations shall be suspended until the moisture content reaches acceptable levels and the desired results are attainable.

## **PART 2 - MATERIALS**

### **2.01 GENERAL**

- A. All materials shall be of standard, approved and first grade quality and shall be in prime condition when installed and accepted. Any commercially processed or packaged material shall be delivered to the site in the original unopened container bearing the manufacturer's guaranteed analysis.

### **2.02 TOPSOIL**

- A. Topsoil shall be fertile, friable, natural topsoil typical of topsoil of the locality, and shall be obtained from a well drained site that is free of flooding. It shall be without admixture of subsoil or slag and free of stones, lumps, plants or their roots, sticks, clay, peat and other extraneous matter and shall not be delivered to the site or used while in a frozen or muddy condition.
- B. At least 10 days prior to anticipated start of topsoiling operations a 1 pint sample of topsoil material shall be delivered to the Engineer for testing and approval. Based on tests performed by the Engineer, the topsoil shall be identified as acceptable, acceptable with certain fertilizer and limestone applications or unacceptable. If the topsoil is found acceptable the fertilizer and lime requirements will be as specified or as recommended by the Engineer. If the topsoil is found unacceptable, the Contractor shall be responsible for identifying another source of topsoil and shall incur all expenses associated with testing additional samples. All topsoil incorporated into the site work shall match the sample provided to the Engineer for testing.

### **2.03 SOIL CONDITIONERS AND FERTILIZERS**

- A. Soil conditioners may include any or all of the specific conditioners herein specified and shall be applied at rates indicated on the Drawings or in the Special Conditions.
- B. Manure: Manure shall consist of ground, well composted steer manure as taken from feeding pens, which is screened to pass through a one inch screen and which is free of weed seeds, dirt, sawdust, shavings, straw, refuse, harmful chemicals and other foreign matter. The material shall be composted no less than 180 days and no more than one year. The manure shall be subject to inspection prior to delivery.
- C. Lignin Based Soil Conditioners: Lignin based soil conditioners shall be an organic based soil conditioner manufactured under a process which by action of sulphuric acid and hot gases separates cellulose from wood, leaving long lasting lignin particles.

The material shall have the following analysis:

pH	5.5%
Moisture	15.5%
Ash	1.9%
Organic Matter	84.6%
Total Nitrogen	1.0%
Total Phosphoric Acid	0.05%
Total Potash	0.05%

As "Loamite Soil Amendment" or equal in quality.

- D. Redwood Shavings: Redwood shavings shall be leached and nitrogen fortified with the residual nitrogen content of 1%.
- E. Fertilizer: Fertilizer shall be a commercial grade pelleted or chip type, as "Agriform Blue Chip", or equal, uniform in composition, dry and free flowing, of the following analysis.

Nitrogen	24.0% minimum
Nitroform	14.0% minimum
Phosphoric Acid	24.0% minimum
Potash	8.0% minimum
Iron (metallic)	0.4% minimum

Particle size not less than 2% through a number 48 mesh.

And/or

Commercial fertilizers with an analysis of 1584 or approved substitute as required by the specifications.

Fertilizer shall be delivered to the site in the original unopened container bearing the manufacturer's guaranteed analysis. Any fertilizer that becomes caked or damaged, making it unsuitable for use, will not be accepted.

- F. Peat Moss: Peat moss shall be a commercial baled Canadian sphagnum material with a pH of 4.5 to 5.5. The moss shall be free of woody material and minerals or foreign matter harmful to plant life. As "Sunshine" brand or equal.

#### 2.04 GRASS SEED

- A. The seed mixture to be sown shall be in the following proportions:

Common Name	Proportion By Weight	% of Purity	% of Germination
Kentucky Bluegrass	40	90	85
Chewings Fescue	25	90	85
Italian Rye Grass	20	90	85
Red Top	10	90	85
White Clover	5	95	90

- B. All seed shall be fresh and clean and shall be delivered mixed, in unopened packages, bearing a guaranteed analysis of the seed and mixture.



- C. Germination must be certified to conform to the following minimums: 90% pure and 85% germination.

## 2.05 CROWN VETCH (Crown vetch slopes of 3:1 or greater)

The seed mixture to be sown shall be in the following proportions:

<u>Common Name</u>	<u>Botanical Name</u>	<u>Proportion By Weight</u>	<u>Percent of Purity</u>	<u>Percent Of Germination</u>
Penngift Crown Vetch (inoculated)	Coronilla Vetchii "Pennfift"	75%	90%	90%

## 2.06 SOD

- A. Sod shall be well-rooted Kentucky Bluegrass (*Poa pratensis*) completely free of noxious weeds. It shall be mowed to a height not to exceed 3" before lifting, and shall be of uniform thickness, with not over 1-1/2" or less than 1" of soil.
- B. Nursery sod shall meet applicable requirements set out above and shall be a variety or blend of Kentucky Bluegrass. It shall comply with nursery inspections and plant quarantine regulations of the states of origin and destination as well as with Federal regulations governing interstate movement of nursery stock. A valid copy of the certification of nursery inspection shall accompany each shipment.

## PART 3 - EXECUTION

### 3.01 GRADING AND SOIL PREPARATION

- A. Final Grades: After the foregoing specified deep watering, minor modifications to grade may be required to establish the final grade. These areas shall not be worked until the moisture content has been reduced to a point where working it will not destroy the soil structure.
1. Finish grading shall insure proper drainage of the site.
  2. All areas shall be graded so that the final grades will be one inch below adjacent paved areas, sidewalks, valve boxes, headers, cleanouts, drains, manholes, etc.
  3. Surface drainage shall be away from all building foundations.
  4. Eliminate all erosion scars.
  5. The Contractor shall request an inspection by the Engineer for approval of the final grades and elevations before planting operations shall begin.
- B. Lawn: Lawns will be planted by seeding.
1. After preparation of soil in accordance with section on "Grading and Soil Preparation," the areas to be planted to lawn shall be rolled, raked, and floated to finish grade by any method acceptable to the Owner, with the finish grade being smooth and even, free of rocks and clods, and reasonably well firmed. Prior to planting, the surface of the area shall be sufficiently loose and friable to receive the seeds, or sod.

2. Pre-Fertilization: Just prior to the planting of turf, evenly broadcast 15 pounds per thousand square feet of commercial fertilizer, 24/24/8, as specified under materials.
3. Method
  - a. This work consists of furnishing all labor, equipment and materials and in performing all operations in connection with the fertilizing and seeding of all the finished graded areas not specified to be sodded or occupied by structures, roads, concrete slabs, sidewalks, walls, etc., and including grassed areas destroyed or damaged by the Contractor.
  - b. The areas to be seeded shall be thoroughly tilled to a depth of at least 4" by discing, harrowing, or other approved methods until the condition of the soil is acceptable to the Engineer. After harrowing or discing, the seed bed shall be dragged and/or hand raked to finished grade.
  - c. Fertilizer shall be 25 lbs. of 10/20/10 or equivalent per 1,000 square feet. The incorporation of the fertilizer and the agricultural lime may be a part of the tillage operation and shall be applied to less than 24 hours nor more than 48 hours before the seed is to be sown.
  - d. Seed shall be broadcast either by hand or approved sowing equipment at the rate of six pounds per 1,000 square feet, uniformly distributed over the area. Broadcasting seeding during high winds will not be permitted. The seed shall be drilled or raked into a depth of approximately 1/2 inch and the seeded areas shall be lightly raked to cover the seed and rolled. Drill seeding shall be done with approved equipment with drills not more than 3 inches apart. All ridges shall be smoothed out, and all furrows and wheel tracks likely to develop into washes, shall be removed.
  - e. Seed may be sown during the following periods:  
  
February 1 to April 15  
August 15 to October 15
  - f. Seed may not be sown at any other time except with the written approval of the Engineer.
  - g. After the seed has been sown, the areas so seeded shall be mulched with clean straw at the rate of one (1) bale per 2,000 feet (approximately 1 inch loose depth). Mulch on slopes shall be held in place with binder twine staked down at approximately 18 inch centers or by other equally acceptable means.
  - h. Areas seeded shall be protected until a uniform stand develops, when it will be accepted and the Contractor relieved of further responsibility for maintenance. Displaced mulch shall be replaced or any damage to the seeded area shall be repaired promptly, both in a manner to cause minimum disturbance to the existing stand of grass. If necessary to obtain a uniform stand, the Contractor shall refertilize, reseed and remulch as needed. Scattered bare spots up to one (1) square yard in size will be allowed up to a maximum of 10 percent of any area.
  - i. Payment for seeding and mulching shall be included in the lump sum bid.
4. Top Dressing: Top dressing may be applied at the option of the Contractor.

5. Initial Watering: Immediately following planting or top dressing, if applied, apply a light, fine mist spray to anchor the seed, stolons, and/or dressing to the soil, forming a protective crust to prevent wind erosion and drying of the seed or stolons. The lawn areas shall be kept moist, but not glistening wet, until full germination.
  6. Final Compaction: Fully germinated lawn areas shall be allowed to dry sufficiently to permit rolling with approximately two hundred to three hundred pound water weighted roller to satisfactorily compact the soil around the grass roots and to provide a firm, smooth mowing surface.
- C. Sodding:
1. Sod shall be placed as shown on the Drawings.
  2. Edges of sod shall be cut cleanly, either by hand or machine, to a uniform thickness of 1-1/2 inches or more, depending on the nature of the sod, so that practically all of the dense root system of the grasses is retained. The roots shall be exposed in the sod strip to allow the sod to be handled without undue tearing or breaking. The sod strip shall be of a uniform width of no less than 16 inches and no less than 2 feet in length. Sod shall be free from all primary noxious weeds in accordance with Section 827.11 of KDOH Standard Specifications for Road and Bridge Construction. Acceptance in the field before cutting shall not preclude rejection when delivered to the site if such contamination is found.

### 3.03 ESTABLISHMENT AND MAINTENANCE PERIOD

- A. The Contractor shall continuously maintain all areas involved in this contract during the progress of the work and during the establishment period until final acceptance of the work by the Owner.
- B. The contractual establishment period shall be for no less than 30 continuous calendar days.
- C. The contractual establishment period begins on the first day after all planting in this project is completed and accepted and the planted areas are brought to a neat, clean and weed free condition.
- D. Any day upon which no work will be required, as determined by the Engineer will be credited as one of the plant establishment working days regardless of whether or not the Contractor performs plant establishment work.
- E. Any day when the Contractor fails to adequately maintain plantings, replace unsuitable plants or do weed control or other work, as determined necessary by the Engineer, will not be credited as one of the plant establishment working days.
- F. Improper maintenance or possible poor condition of any planting at the termination of the scheduled establishment period may cause postponement of the final completion date of the contract. Maintenance shall be continued by the Contractor until all work is acceptable.
- G. In order to carry out the plant establishment work, the Contractor shall furnish sufficient men and adequate equipment to perform the work during the plant establishment period.
- H. Maintenance shall be according to the following standards:

1. All areas shall be kept free of debris and all planted areas shall be weeded and cultivated at intervals of not more than ten days. Watering, mowing, rolling, edging, trimming, fertilization, spraying and pest control, as may be required, shall be included in the establishment period.
2. The Contractor shall be responsible for maintaining adequate protection of the area. Damaged areas shall be repaired at the Contractor's expense.
3. Between the 15th day and the 20th day of the establishment period, the Contractor shall reseed or resod all spots or areas within the lawn where normal turf growth is not evident.
4. Post fertilize all lawns in planted areas at the end of 30 days of maintenance at the rate of 13 pounds per thousand square feet using fertilizer with the analysis 1584 evenly applied and thoroughly watered in.
5. Mowing of turf will commence when the grass has reached a height of two inches. The height of cut will be 1 1/2 inches. Mowing will be done on an as needed basis. Turf must be well established and free of bare spots and weeds to the satisfaction of the Owner prior to final acceptance.

#### **3.04 GUARANTEE AND REPLACEMENT**

Note: The following guarantees have no affect on the one year guarantee on labor and workmanship.

- A. Any material found to be dead, missing, or in poor condition during the establishment period shall be replaced immediately. The Engineer shall be the sole judge as to the condition of material. Material found to be dead or in poor condition within the guarantee period shall be replaced by the Contractor within 15 days of written notification by the Owner.
- B. Replacement shall be made to the same specifications required for original plantings.
- C. Material and labor involved in the replacing of materials shall be supplied by the Contractor at no additional cost to the Owner.

#### **3.05 INSPECTIONS**

Normal progress inspections shall be requested from the Engineer at least 48 hours in advance of an anticipated inspection. An inspection will be made by the Engineer on each of the steps listed below. The Contractor will not be permitted to initiate the succeeding steps of work until he has received written approval to proceed by the inspector.

- A. Immediately prior to the commencement of work of this section.
- B. Installation of all ground covers.
- C. Planting of all lawn areas.
- D. Final inspection.
- E. Final acceptance of the project.

- END OF SECTION -

**SECTION 04200**  
**CONCRETE UNIT MASONRY**

**PART 1 - GENERAL**

**1.01 SUMMARY**

This section includes all the requirements for providing concrete and brick unit masonry.

**1.02 STANDARDS AND CODES**

Comply with provisions of the following codes, specifications and standards except where more stringent requirements are shown or specified.

- A. Building Code Requirements for Masonry Structures (ACI-530/ASCE 7/TMS 402) and Commentary.
- B. Specifications for Masonry Structures (ACI 530.1/ASCE -6/TMS 602) and Commentary.

**1.03 SUBMITTALS**

- A. The Contractor shall submit for approval the concrete mix design used for the production of concrete masonry units. The concrete mix design shall indicate the replacement rate (%) of fly ash or ground granulated blast furnace slag used in place of cement.
- B. The Contractor shall deliver all submittals required under Specification Section 01610- TRANSPORTATION AND HANDLING.

**PART 2 - PRODUCTS**

**2.01 MASONRY UNITS**

Concrete masonry units are 40CFR247 EPA Designated Construction Products. When purchasing concrete masonry units the Contractor shall make all reasonable efforts to purchase units that contain coal flyash or ground granulated blast furnace slag as a partial replacement for Portland cement. The replacement rates (%) shall be as follows:

Flyash: ASTM C-618, Class F, except that its loss on ignition (LOI) shall not be more than 4 percent. Flyash shall be used as a direct replacement for Portland cement (one for one), ASTM C-595. A minimum of 15 percent by weight of the cementitious material in the concrete mix shall be flyash.

or

Ground Granulated Blast-Furnace (GGBF) Slag: ASTM C 989, Grade 120. GGBF slag may be used as an alternate to flyash as a direct replacement for Portland cement, ASTM C-595. A minimum of 25 percent and no more than 50 percent by weight of the cementitious material in the concrete mix shall be GGBF.

- A. Hollow core concrete masonry blocks shall be Grade N Type I, hollow core, load-bearing type, conforming to ASTM C-90. Moisture content shall not exceed 30 percent.

- B. Solid masonry units shall be ASTM C-145, Grade N, Type I, load bearing. Solid units shall be 100 percent solid or shall have their void space, permitted under this ASTM Standard, filled with mortar.
- C. Solid masonry units for catchbasin and manholes shall conform to ASTM C-139.
- D. Concrete brick shall conform to ASTM C-55, Grade N, Type I.
- E. Brick Masonry units shall be clay manhole bricks conforming to ASTM C-32, Grade SM. Brick shall have plain and smooth surfaces on both ends and on the face side.
- F. Lintels shall be precast, reinforced lintel units of 3000 psi minimum concrete strength, 16 inches longer than the opening they are to span. Lintels shall be reinforced as shown on the drawings or with a minimum of 2 Number 4 bars in each 4 inch wide unit.

## **2.02 MORTAR**

- A. Portland cement shall conform to ASTM C-150, Type I, II or III.
- B. Hydrated lime shall conform to ASTM C-207, Type S.
- C. Mortar aggregates shall conform to ASTM C-144 except that not less than 3 percent of their particles by weight, nor more than 15 percent, shall pass the number 100 sieve.
- D. Mortar shall comply with the property specification for Type S mortar as specified in ASTM C-270.

## **2.03 REINFORCEMENT**

- A. Reinforcement shall be heavy grade, welded, galvanized and of the truss type with diagonal connectors. Crosswire and longitudinal wire shall be 3/16 inch in diameter.

## **2.04 JOINT CONTROL**

- A. Premolded control joint strips shall be made of solid rubber with a Shore A durometer hardness of 60 to 80, designed to fit standard sash block and maintain lateral stability in masonry wall, size and configuration as indicated.

## **2.05 PRODUCTS AND HANDLING**

- A. Handle, store and protect masonry units in a manner to avoid chipping, breakage, or contact with the soil.
- B. Cementitious materials shall be stored in a dry place and kept free from dirt and debris.
- C. Packaged materials shall be stored in their original unbroken package or container.

**PART 3 - EXECUTION****3.01 UNIT MASONRY CONSTRUCTION**

- A. Unit masonry shall be laid plumb, true to line and in level courses on a full bed of mortar, both vertically and horizontally. All masonry work shall meet the following tolerances for completed work:
  - 1. Variation from plumb in lines and surfaces of wall, 1/4 inch in 10 feet and for external corners, expansion or control joints, 1/4 inch in 20 feet maximum.
  - 2. Variation from level, 1/4 inch in 20 feet maximum.
  - 3. Variation in cross sectional dimensions of walls, plus or minus 1/4 inch.
- B. Packing the joints after the block is placed will not be allowed. Each unit shall be adjusted to its final position while the mortar is still soft and plastic. Any unit which is disturbed after the mortar has stiffened shall be removed, the existing mortar removed and the unit relaid with fresh mortar.
- C. The wall shall be laid up in a straight uniform course with a regular running bond.
- D. Cutting of masonry units shall be done with a masonry saw.
- E. Block bond beams shall consist of bond beam units, reinforced as shown on the drawing and filled with 3000 psi concrete per Section 03300.
- F. Block reinforcing shall be continuous every second tier. Lap reinforcing a minimum of 6 inches, break only at expansion joints. Embed reinforcing completely in mortar.
- G. After the mortar has taken its initial set, all joints shall be tooled concave with the mortar thoroughly compacted and pressed against the edges of the units.

**3.02 MORTAR**

- A. In mixing mortar, the minimum amount of water necessary to produce a workable consistency shall be used. Mortar that has stiffened due to hydration shall not be used and shall be discarded. Mortar shall not be retempered.
- B. No admixtures will be permitted.

**3.03 COLD WEATHER MASONRY CONSTRUCTION**

- A. Cement, sand and water shall be heated uniformly to a temperature between 70 degrees F and 120 degrees F before mixing.
- B. Masonry units shall be heated before laying when the temperature is below 30 degrees F. Work shall only be permitted to proceed if the newly laid masonry is protected.
- C. Newly laid masonry shall be heated and protected so that the surface temperature of both sides of the wall does not drop below 40 degrees F for at least 24 hours after laying.

- D. Any masonry work which has frozen shall be removed and redone.

### **3.04 EXPANSION JOINTS**

- A. Provide vertical expansion, control and isolation joints in masonry where shown. If location of control joints is not shown, place vertical joints spaced 30 feet on centers.

### **3.05 CLEANING**

- A. Work in as clean a manner as possible. Remove excess materials and mortar droppings daily. Remove mortar droppings on connecting or adjoining work before its final set.
- B. At completion of work, point holes in joints of exposed masonry surfaces. Fill holes with mortar and tool. Clean concrete masonry units which remain exposed in finished work, with wire brushes or other approved method.
- C. Remove, replace defective materials, correct defective workmanship, leaving masonry clean, free of efflorescence and other staining.

-END OF SECTION-



**SECTION 04200**  
**CONCRETE UNIT MASONRY**

**PART 1 - GENERAL**

**1.01 SUMMARY**

This section includes all the requirements for providing concrete and brick unit masonry.

**1.02 STANDARDS AND CODES**

Comply with provisions of the following codes, specifications and standards except where more stringent requirements are shown or specified.

- A. Building Code Requirements for Masonry Structures (ACI-530/ASCE 7/TMS 402) and Commentary.
- B. Specifications for Masonry Structures (ACI 530.1/ASCE -6/TMS 602) and Commentary.

**1.03 SUBMITTALS**

- A. The Contractor shall submit for approval the concrete mix design used for the production of concrete masonry units. The concrete mix design shall indicate the replacement rate (%) of fly ash or ground granulated blast furnace slag used in place of cement.
- B. The Contractor shall deliver all submittals required under Specification Section 01610- TRANSPORTATION AND HANDLING.

**PART 2 - PRODUCTS**

**2.01 MASONRY UNITS**

Concrete masonry units are 40CFR247 EPA Designated Construction Products. When purchasing concrete masonry units the Contractor shall make all reasonable efforts to purchase units that contain coal flyash or ground granulated blast furnace slag as a partial replacement for Portland cement. The replacement rates (%) shall be as follows:

Flyash: ASTM C-618, Class F, except that its loss on ignition (LOI) shall not be more than 4 percent. Flyash shall be used as a direct replacement for Portland cement (one for one), ASTM C-595. A minimum of 15 percent by weight of the cementitious material in the concrete mix shall be flyash.

or

Ground Granulated Blast-Furnace (GGBF) Slag: ASTM C 989, Grade 120. GGBF slag may be used as an alternate to flyash as a direct replacement for Portland cement, ASTM C-595. A minimum of 25 percent and no more than 50 percent by weight of the cementitious material in the concrete mix shall be GGBF.

- A. Hollow core concrete masonry blocks shall be Grade N Type I, hollow core, load-bearing type, conforming to ASTM C-90. Moisture content shall not exceed 30 percent.

- B. Solid masonry units shall be ASTM C-145, Grade N, Type I, load bearing. Solid units shall be 100 percent solid or shall have their void space, permitted under this ASTM Standard, filled with mortar.
- C. Solid masonry units for catchbasin and manholes shall conform to ASTM C-139.
- D. Concrete brick shall conform to ASTM C-55, Grade N, Type I.
- E. Brick Masonry units shall be clay manhole bricks conforming to ASTM C-32, Grade SM. Brick shall have plain and smooth surfaces on both ends and on the face side.
- F. Lintels shall be precast, reinforced lintel units of 3000 psi minimum concrete strength, 16 inches longer than the opening they are to span. Lintels shall be reinforced as shown on the drawings or with a minimum of 2 Number 4 bars in each 4 inch wide unit.

## **2.02 MORTAR**

- A. Portland cement shall conform to ASTM C-150, Type I, II or III.
- B. Hydrated lime shall conform to ASTM C-207, Type S.
- C. Mortar aggregates shall conform to ASTM C-144 except that not less than 3 percent of their particles by weight, nor more than 15 percent, shall pass the number 100 sieve.
- D. Mortar shall comply with the property specification for Type S mortar as specified in ASTM C-270.

## **2.03 REINFORCEMENT**

- A. Reinforcement shall be heavy grade, welded, galvanized and of the truss type with diagonal connectors. Crosswire and longitudinal wire shall be 3/16 inch in diameter.

## **2.04 JOINT CONTROL**

- A. Premolded control joint strips shall be made of solid rubber with a Shore A durometer hardness of 60 to 80, designed to fit standard sash block and maintain lateral stability in masonry wall, size and configuration as indicated.

## **2.05 PRODUCTS AND HANDLING**

- A. Handle, store and protect masonry units in a manner to avoid chipping, breakage, or contact with the soil.
- B. Cementitious materials shall be stored in a dry place and kept free from dirt and debris.
- C. Packaged materials shall be stored in their original unbroken package or container.

**PART 3 - EXECUTION****3.01 UNIT MASONRY CONSTRUCTION**

- A. Unit masonry shall be laid plumb, true to line and in level courses on a full bed of mortar, both vertically and horizontally. All masonry work shall meet the following tolerances for completed work:
  - 1. Variation from plumb in lines and surfaces of wall, 1/4 inch in 10 feet and for external corners, expansion or control joints, 1/4 inch in 20 feet maximum.
  - 2. Variation from level, 1/4 inch in 20 feet maximum.
  - 3. Variation in cross sectional dimensions of walls, plus or minus 1/4 inch.
- B. Packing the joints after the block is placed will not be allowed. Each unit shall be adjusted to its final position while the mortar is still soft and plastic. Any unit which is disturbed after the mortar has stiffened shall be removed, the existing mortar removed and the unit relaid with fresh mortar.
- C. The wall shall be laid up in a straight uniform course with a regular running bond.
- D. Cutting of masonry units shall be done with a masonry saw.
- E. Block bond beams shall consist of bond beam units, reinforced as shown on the drawing and filled with 3000 psi concrete per Section 03300.
- F. Block reinforcing shall be continuous every second tier. Lap reinforcing a minimum of 6 inches, break only at expansion joints. Embed reinforcing completely in mortar.
- G. After the mortar has taken its initial set, all joints shall be tooled concave with the mortar thoroughly compacted and pressed against the edges of the units.

**3.02 MORTAR**

- A. In mixing mortar, the minimum amount of water necessary to produce a workable consistency shall be used. Mortar that has stiffened due to hydration shall not be used and shall be discarded. Mortar shall not be retempered.
- B. No admixtures will be permitted.

**3.03 COLD WEATHER MASONRY CONSTRUCTION**

- A. Cement, sand and water shall be heated uniformly to a temperature between 70 degrees F and 120 degrees F before mixing.
- B. Masonry units shall be heated before laying when the temperature is below 30 degrees F. Work shall only be permitted to proceed if the newly laid masonry is protected.
- C. Newly laid masonry shall be heated and protected so that the surface temperature of both sides of the wall does not drop below 40 degrees F for at least 24 hours after laying.

- D. Any masonry work which has frozen shall be removed and redone.

### **3.04 EXPANSION JOINTS**

- A. Provide vertical expansion, control and isolation joints in masonry where shown. If location of control joints is not shown, place vertical joints spaced 30 feet on centers.

### **3.05 CLEANING**

- A. Work in as clean a manner as possible. Remove excess materials and mortar droppings daily. Remove mortar droppings on connecting or adjoining work before its final set.
- B. At completion of work, point holes in joints of exposed masonry surfaces. Fill holes with mortar and tool. Clean concrete masonry units which remain exposed in finished work, with wire brushes or other approved method.
- C. Remove, replace defective materials, correct defective workmanship, leaving masonry clean, free of efflorescence and other staining.

-END OF SECTION-

**SECTION 06100**  
**ROUGH CARPENTRY**

**PART 1 - GENERAL**

**1.01 DESCRIPTION OF WORK**

Definition: Rough carpentry includes carpentry work not specified as part of other sections and which is generally not exposed, except as otherwise indicated. Types of work in this section include rough carpentry for the following where applicable and as detailed or indicated on the Drawings:

- A. Erection and construction of project sign as shown on detail in Section 01580 – Project Identification and Signs.
- B. Wood framing, plates, and fascias.
- C. Wood grounds, nailers, blocking and sleepers.
- D. Treated materials connected with covered or roofing area.
- E. Installation of doors, trim and shims.
- F. Installation of finished hardware.
- G. Blocking that may be required for soffits and overhangs.
- H. Blocking for toilet accessories.

**1.02 REFERENCES**

- A. Lumber Standards: Comply with PS 20 and with applicable rules of the respective grading and inspecting agencies for species and products indicated.
- B. Plywood Product Standards: Comply with PS 1 (ANSI A199.1) or, for products not manufactured under PS 1 provisions, with applicable APA Performance Standard for type of panel indicated.

**1.03 SUBMITTALS**

Wood Treatment Data: Submit treatment manufacturer's instructions for proper use of each type of treated material.

- A. Pressure Treatment: For each type specified, include certification by treating plant stating chemicals and process used, net amount of preservative retained and conformance with applicable standards.
- B. For water-borne preservatives, include statement that moisture content of treated materials was reduced to a maximum of 15% prior to shipment to project site.

**1.04 PRODUCT HANDLING**

Delivery and Storage: Keep materials dry at all times. Protect against exposure to weather and contact with damp or wet surfaces. Stack lumber and plywood, and provide air circulation within stacks.

## 1.05 JOB CONDITIONS

Coordination: Fit carpentry work to other work; scribe and cope as required for accurate fit. Correlate location of furring, nailers, blocking, grounds and similar supports to allow proper attachment of other work.

## PART 2 - PRODUCTS

### 2.01 MATERIALS - LUMBER

A. Provide wood for support or attachment of other work including cant strips, buck, nails, blocking, furring, grounds, stripping and similar members. Provide lumber of sizes indicated, worked into shapes shown. Moisture content should be 19% maximum for lumber items not specified to receive wood preservative treatment.

B. Grade: Construction Grade light framing size lumber of any species or board size lumber as required. Provide construction grade boards (RIS or WCLB) or No. 1 boards (SPIB or WWPA).

### 2.02 WOOD TREATMENT

A. Preservative Treatment: Where lumber or plywood is indicated as "Trt-Wd" or "Treated", or is specified herein to be treated, comply with applicable requirements of AWPS Standards C2 (lumber) and C9 (plywood) and of AWPB standards listed below. Mark each treated item with the AWPB Quality Mark Requirements.

B. Pressure-treat above-ground items with water-borne preservatives complying with AWPB LP-2. After treatment, kiln-dry to a maximum moisture content of 15%. Treat indicated items and the following:

1. Nailers, curbs, blocking, stripping, and similar members in connection with roofing, flashing, vapor barriers and waterproofing.
2. Wood sills, sleepers, blocking, furring, stripping and similar concealed members in contact with or embedded in masonry or concrete.

C. Inspect each piece of treated lumber or plywood after drying and discard damaged or defective pieces.

### 2.03 LUMBER, GENERAL

A. Lumber Standards: Manufacture lumber to comply with PS 20 "American Softwood Lumber Standard" and with applicable grading rules of inspection agencies certified by American Lumber Standards Committee's (ALSC) Board of Review.

B. Grade Stamps:

1. Factory-mark each piece of lumber with grade stamp of inspection agency evidencing compliance with grading rule requirements identifying grading agency, grade, species, moisture content at time of surfacing, and mill.
2. For exposed lumber apply grade stamps to end or back of each piece, or omit grade stamps entirely and issue certificate of grade compliance from inspection agency in lieu of grade stamp.

C. Nominal sizes are indicated, except as shown by detail dimensions. Provide actual sizes as required by PS 20, for moisture content spec or each use.

D. Provide dressed lumber, S4S, unless otherwise indicated.

E. Provide seasoned lumber with 19 percent maximum moisture content at time of dressing and shipment for sizes 2" or less in nominal thickness, unless otherwise indicated.

#### **2.04 DIMENSION LUMBER**

A. For structural light framing (2" to 4" thick, 2" to 4" wide), provide the following grade and species:

1. No. 1 grade.
2. Species: Southern Pine

B. For structural framing (2" to 4" thick, 5" and wider), provide the following grade and species:

1. No. 1 grade.
2. Species: Southern Pine.

#### **2.05 BOARDS**

A. Exposed Boards:

1. Where boards will be exposed in the finished work, provide the following:
2. Moisture Content: 19 percent maximum, "S-DRY".

B. Where painted finish is indicated, provide No. 1 Boards per SPIB rules, Select Merchantable Boards per WCLIB rules, or No. 2 Common Boards and Better per WWPA rules.

C. Concealed Boards:

1. Where boards will be concealed by other work, provide lumber of 19 percent maximum moisture content (S-DRY) and of following species and grade:
2. Redwood construction common per RIS rules, Southern Pine No. 2 Boards per SPIB rules, or any species graded construction boards per WCLIB or WWPA rules.

#### **2.06 MISCELLANEOUS LUMBER**

A. Provide wood for support or attachment of other work including bucks, nailers, blocking, furring, grounds, stripping and similar members. Provide lumber of sizes indicated, worked into shapes shown, and as follows:

B. Moisture Content: 19 percent maximum for lumber items not specified to receive wood preservative treatment.

C. Grade: Standard grade light framing size lumber of any species or board size lumber as required. No. 2 Common or Construction grade boards per WCLIB or WWPA rules or No. 2 boards per SPIB rules.

## 2.07 CONSTRUCTION PANELS

A. Construction Panel Standards: Comply with PS 1 "U.S. Product Standard for Construction and Industrial Plywood" for plywood panels, and for products not manufactured under PS 1 provisions, with American Plywood Associates (APA) "Performance Standard and Policies for Structural-Use Panels", Form No. E445.

B. Trademark: Factory-mark each construction panel with APA trademark evidencing compliance with grade requirements.

## 2.08 MISCELLANEOUS MATERIALS

A. Fasteners and Anchorages: Provide size, type, material and finish as indicated and as recommended by applicable standards, complying with applicable Specifications for nails, staples, screws, bolts, nuts, washers and anchoring devices. Provide metal hangers and framing anchors of the size and type recommended by the manufacturer for each use including recommended nails.

B. Where rough carpentry work is exposed to weather, in ground contact, or in area of high relative humidity, provide fasteners and anchorages with a hot-dip zinc coating (ASTM A 153).

## PART 3 - EXECUTION

### 3.01 INSTALLATION

A. Discard units of material with defects which might impair quality of work, and units which are too small to use in fabricating work with minimum joints or optimum joint arrangement.

B. Set carpentry work accurately to required levels and lines, with members plumb and true and accurately cut and fitted.

C. Securely attach carpentry work to substrate by anchoring and fastening as shown and as required by recognized standards. Countersink nail heads on exposed carpentry work and fill holes.

D. Use common wire nails, except as otherwise indicated. Use finishing nails for finish work. Select fasteners of size that will not penetrate members where opposite side will be exposed to view or will receive finish material. Make tight connections between members. Install fasteners without splitting of wood; predrill as required.

E. Wood Grounds, Nailers, Blocking and Sleepers:

1. Provide wherever shown and where required for screeding or attachment of other work. Form to shapes as shown and cut as required for true line and level of work to be attached. Coordinate location with other work involved.
2. Attach to substrates as required to support applied loading. Countersink bolts and nuts flush with surfaces, unless otherwise shown. Build into masonry during installation of masonry work. Where possible, anchor to formwork before concrete placement.
3. Provide permanent grounds of dressed, preservative treated, key-beveled lumber not less than 1-1/2" wide and of thickness required to bring face of ground to exact thickness of finish material involved. Remove temporary grounds when no longer required.



F. Installation of Plywood: Comply with applicable recommendations contained in Form No. E304, "APA Design/Construction Guide - Residential and Commercial", for types of plywood products and applications indicated.

### **3.02 WOOD FRAMING**

A. Provide framing members of sizes and on spacings shown, and frame openings as shown, or if not shown, comply with recommendations of "Manual for House Framing" of National Forest Products Association N.F.A.). Do not splice structural members between supports.

B. Anchor and nail as shown, and to comply with "Recommended Nailing Schedule" of "Manual for House Framing" and "National Design Specifications for Wood Construction" published by N.F.P.A.

### **3.03 RAFTER AND CEILING JOIST FRAMING**

A. Rafters:

1. Provide member size and spacing shown. Notch to fit exterior wall plates and special metal framing anchors as indicated. Double rafters to form headers and trimmers at openings in roof framing (if any), and support with metal hangers.
2. Provide glued and nailed plywood gusset plates as indicated.

B. Provide special framing as shown for eaves, overhangs, dormers and similar conditions, if any.

- END OF SECTION -

**SECTION 11917****HACH CL17 FREE/TOTAL CHLORINE ANALYZER****PART 1 GENERAL****1.1 SUMMARY**

- A. Furnish, install, and test all necessary equipment and appurtenances for the chlorine analyzer for monitoring of free or total residual chlorine

**1.2 MEASUREMENT PROCEDURES**

- A. The method of measuring free or total chlorine will be colorimetric. Instrument chemistry will employ N, N-diethyl-p-phenylenediamine (DPD) method.

**1.3 ALTERNATES**

- A. Other methods of chlorine measurement such as amperometric, potentiometric, and iodometric that employ electrodes or other electrochemical techniques are not acceptable.

**1.4 SYSTEM DESCRIPTION**

- A. Performance Requirements
  1. Measurement range:
    - a. 0 to 5 mg/L (ppm) free or total residual chlorine
  2. Accuracy
    - a.  $\pm 5\%$  of reading or  $\pm 0.03$  mg/L (ppm), whichever is greater
  3. Precision
    - a. 5% of reading or 0.01 mg/L (ppm), whichever is greater
  4. Minimum detection limit
    - a. 0.03 mg/L (ppm)
  5. Resolution
    - a. 0.01 mg/L (ppm)
  6. Repeatability
    - a. 0.05 mg/L (ppm)
  7. Cycle Time
    - a. 2.5 minutes

**1.5 CERTIFICATIONS**

- A. CE compliant for conducted and radiated emissions CISPR 11 (Class A limits), EMC Immunity EN 61326-1 (Industrial limits), and EN 61010-1
- B. General Purpose UL/CSA 61010-1 with cETLus safety mark
- C. IP62 dust and water ingress protection rating
- D. Australian CTICK and Korean KC Marking

**1.6 ENVIRONMENTAL REQUIREMENTS**

- A. Operational Criteria
  1. Sample flow rate
    - a. 200 to 500 mL/minute
  2. Sample pressure (without conditioning kit)
    - a. 1 to 5 psi (0.07 to 0.34 bar)

3. Sample pressure (with conditioning kit)
  - a. 120 psi (8.27 bar)
4. Sample temperature
  - a. 41 to 104 °F (5 to 40 °C)
5. Operating temperature
  - a. 41 to 104 °F (5 to 40 °C)
6. Operating humidity
  - a. 90% at 40 °C maximum

## **1.7 WARRANTY**

- A. The product includes a one-year warranty from the date of shipment

## **1.8 MAINTENANCE SERVICE**

- A. Scheduled Maintenance
  1. Monthly
    - a. Reagent replacement
  2. Annually
    - a. Analyzer tubing replacement
- B. Unscheduled Maintenance
  1. Pump tubing replacement is operating temperature dependent
    - a. Operating temperature below 80 °F: six-month intervals
    - b. Operating temperature above 80 °F: three-month intervals

## **PART 2 PRODUCTS**

### **2.1 MANUFACTURER**

- A. Hach Company, Loveland, CO
  1. Model Cl17 Chlorine Analyzer, Free or Total Chlorine Residual

### **2.2 MANUFACTURED UNIT**

- A. The Cl17 Chlorine analyzer consists of a sample and reagent valve and pump, measurement cell, controller, and is shipped with buffer and indicator solutions.

### **2.3 EQUIPMENT**

- A. The analyzer must be housed in a NEMA 12 enclosure that is IP62 rated with the gasketed door latched.
- B. The analyzer shall be capable of measuring free or total residual chlorine by changing the tubing and indicator and buffer solutions.
- C. A measurement shall be taken every 2.5 minutes and results displayed by a three digit LCD readout in the range of 0 to 5 mg/L.
- D. The analyzer must operate using 115V or 230V selectable AC power.
- E. The analyzer must perform a self-test and auto-blanking between analysis points to compensate for sample color, turbidity, and changes in light intensity due to voltage fluctuations or light source aging.
- F. The analyzer shall operate with an LED light source at a peak wavelength of 510nm.
- G. The analyzer must be able to operate unattended for 30 days between chemical reagent changes and measurement cell cleaning.
- H. The analyzer has two feed control (relay) operation modes to operate chemical feed pumps. Available control options are:

1. On/off control where the concentration alarm outputs activate or deactivate a pump when chlorine levels fall below or exceed acceptable levels.
2. Proportional control where the 4-20mA output current is scaled to pace a feed pump proportional to output.
- I. The analyzer has standard optically isolated analog outputs, selectable as 0/4 to 20mA, field programmable over any portion of the analyzer range
- J. The analyzer has two standard SPDT relay alarms, with contacts rated for 5 amp resistive loads at 230V AC power. Alarm options include concentration set point, analyzer system warning, and analyzer system shut down.

## 2.4 COMPONENTS

- A. Standard Equipment
  1. Cl17 Free or Total Chlorine analyzer
  2. One-Month Supply of reagents
  3. Installation kit
  4. Maintenance kit
  5. Sample conditioning kit
    - a. Pressure regulator, strainer, and shut off valve
  6. Wall mount kit
  7. User manual
- B. Dimensions: 13.5 x 17.9 x 7 inches (343 x 455 x 178 mm)
- C. Shipping weight: 16 lbs (7.3 kg)

## 2.5 OPTIONAL ACCESSORIES

- A. Power Cord
- B. Maintenance kit with preassembled tubing
- C. Pocket Colorimeter II for free and total chlorine (high and low range combination)

## PART 3 EXECUTION

### 3.1 PREPARATION

1. Mounting
  - a. The Cl17 Free or Total Chlorine analyzer shall be wall mounted only.
2. Required Clearances
  - a. Horizontal: 15.2 in (386 mm), 26 inches (686 mm) ideal
  - b. Vertical: 19 inches (483 mm)
  - c. Depth: 20 inches (508 mm)
3. Sample inlet
  - a. 0.25 inch OD polyethylene tubing
4. Sample outlet
  - a. 0.50 inch ID flexible tubing
5. Overflow drain
  - a. 0.50 inch ID flexible tubing
6. Air purge quick connect
  - a. 0.25 inch OD polyethylene tubing (optional)

### 3.2 INSTALLATION

- A. Contractor will install the analyzer in strict accordance with the manufacturer's instructions and recommendation.
- B. Manufacturer's representative will include a half-day of start-up service by a factory-trained

technician, if requested.

1. Contractor will schedule a date and time for start-up.
2. Contractor will require the following people to be present during the start-up procedure.
  - a. General contractor
  - b. Electrical contractor
  - c. Hach Company factory trained representative
  - d. Owner's personnel
  - e. Engineer

### **3.3 MANUFACTURER'S SERVICE AND START-UP**

- A. Contractor will include the manufacturer's services to perform start-up on instrument to include basic operational training and certification of performance of the instrument.
- B. Contractor will include a manufacturer's Service Agreement that covers all the manufacturer's recommended preventative maintenance, regularly scheduled calibration and any necessary repairs beginning from the time of equipment startup through to end user acceptance / plant turnover and the first 12 months of end-user operation post turnover.
- C. Items A and B are to be performed by manufacturer's factory-trained service personnel. Field service and factory repair by personnel not employed by the manufacturer is not allowed.
- D. Use of manufacturer's service parts and reagents is required. Third-party parts and reagents are not approved for use.

END OF SECTION

**SECTION 15243****KY 259 NORTH MASTER METER/CONTROL VALVE BUILDING****PART 1 – GENERAL****1.01 WORK INCLUDED**

A. The contractor shall furnish, provide and construct one (1) built in-place, above ground split faced concrete block, master meter/control valve building, with all the necessary piping, valves, meters, controls and appurtenances as shown on the plans and as specified herein. The station shall be complete with all necessary equipment installed in a concrete block building.

B. All bidders must recognize that, if any alternate equipment is used and does not meet or exceed the physical and dimensional standards nor perform as specified in the judgement of the project Engineer or Owner, the Contractor shall be required to modify or replace the alternate equipment with the original equipment at no additional cost to the Owner or Engineer.

**1.02 RELATED WORK**

- A. Division 4 – Masonry
- B. Division 6 – Woods and Plastics

**1.03 QUALITY ASSURANCE**

A. The equipment and materials covered by these specifications are intended to be standard equipment of proven reliability and as manufactured by reputable manufacturers having experience in the production of such equipment. The equipment furnished shall be designed, constructed, and installed in accordance with the best practices and methods and shall operate satisfactorily when installed as shown on the contract drawings and operated per manufacturer's recommendations.

**PART 2 – PRODUCTS****2.01 CONCRETE BLOCK STRUCTURE**

A. The booster pump station will be complete with a split-faced concrete block building constructed over a concrete slab and with a trussed roof system as shown on the plans and specified elsewhere in these specifications.

- B. Exterior Masonry Finish: Concrete masonry block shall be as specified in Division 4 - Masonry.
- C. Finish:
  - 1. Interior: A minimum of 15-mil waterproof coating shall be applied to all surfaces of the interior walls. The color shall be selected by the owner for the interior finish color.
  - 2, Exterior: A minimum of 15-mil clear waterproof coating shall be applied to all exterior surfaces.
- D. Hinged Entrance Doors and Frames

1. Insulation shall consist of a full 2-inch thick foam polyurethane insulation core. Matching metal jambs shall be furnished to fit prefab panels without adjustment or use of interior framing. Doors shall be supplied with weather stripping and a wiper gasket.  
  
Entrance opening shall be a double door with the following clear opening size: 72" x 96".
2. Hardware for Doors: Hardware shall be Best 300H Series, "B" function mortise lockset with satin chrome finish and deadbolt type locking assembly. Two (2) keys will be provided, on a key ring complete with the manufacturer's identification.
3. Door Hinges: Each door shall have three- (3) SOSS 450 T tamper proof pinned butt hinges.
4. Weatherproof Shields: All doors for outdoor structures shall be supplied with a metal shield above the door to divert rain and snow from the door opening.
5. Sillplates: An extruded aluminum sillplate shall be provided on outdoor buildings with friction-type vinyl weatherseal.
6. Weatherstrip: Jamb and head at door shall have factory-installed vinyl weatherstrip.
7. Frames: The frames for the aluminum doors shall be constructed of extruded aluminum rectangular tubular sections having sharp corners and a wall thickness of not less than 0.125 in. and shall be of the types and sizes indicated. The frames shall be manufactured by Cline Aluminum Doors, Inc. or acceptable equivalent products. The head and jamb frame members shall be provided with integral weatherstripping, or an acceptable equivalent product. The frames for the aluminum doors shall be mortised and reinforced for strike plates. The frames shall have a clear (0.4 mil coating) anodic finish.

E. Roof System: A prefab truss roof system shall be furnished for the structure. The roof shall be as indicated on the drawings. Color charts shall be provided to the Owner to determine the finish color of the roof system.

F. Louvers: Louvers shall be motorized type with insect screen. Exterior of louver shall be protected by a minimum 6-gauge, 1-inch, open wire mesh securely attached to the building exterior and painted for corrosion protection and aesthetic appearance. The size of the louver shall be as indicated on the drawings.

G. Flashing material shall be as follows:

- a. All exterior trim shall be of the same type material and finish and shall be of the extruded aluminum material including the following: Gutters, downspouts, eave trim and gable trim shall be pre-finished color matching exterior walls.
- b. All flashings, trims, closures and similar items shall be as detailed on drawings as supplied by the manufacturer of the panels.

H. Batt Insulation: ASTM C 665, Glass fiber blanket insulation in batt form, Type II (non-reflective face), or Type III (reflective face), Class A (faced surface with a flame-spread index of 25 or less), Category 1 (membrane is a vapor barrier), incombustible type, minimum 9.5" thick, that achieves a thermal resistance (R-value) of 30 minimum.

## 2.02 INTERNAL PIPING

A. Piping shall be in accordance with Section 02610 and shall be flanged ductile iron, Class 350 unless noted otherwise on the drawings.

### B. Pipe Supports

1. Pipe supports by minimum sizing for:
  - a. 4" and smaller piping shall be 2" x 2" x 3/16" wall rectangular tubing;
  - b. 6" through 12" piping shall be 3" x 3" x 1/4" wall rectangular tubing;
  - c. 14" through 24" piping shall be 4" x 4" x 1/4" wall rectangular tubing and, also;
  - d. 6" and larger piping shall be provided with "kick" bracing projecting fully from the underside of the pipe to the floor at an angle of no less than 15° from vertical out at a right angle to the run of the pipe being supported. These "kick" braces shall be in addition to the vertical pipe supports called out above.
2. Pipe supports are to be fully anchored to the concrete floor slab, where required, with concrete anchor bolts..
3. Simple pipe stands made of pipe and upholding a yoke or bracket with or without a threaded jack bolt or a U-bolt are not acceptable.

C. Service Connections on Internal Piping: All plumbed devices within the station eventually requiring service, such as meters, control valves, pumps and like equipment, shall be easily removed from the piping by the presence of appropriately placed and sufficient quantity of adaptors and couplings as shown on the drawings; no less than the quantity of couplings and adaptors shown shall be allowed.

D. All interior piping shall be painted with 2 coats of Tenemc Series 66 epoxy, 3-4 mils each.

1. Preparation of surfaces shall be per the manufacture's recommendation.
2. Contractor shall provide a color chart to the Engineer/Owner as part of the shop drawing review.
3. Contractor shall provide 1 quart of the same paint used to the Owner upon completion of the project.

## 2.03 COMBINATION PRESSURE GAUGES

Combination pressure gauges shall be glycerine filled with a built-in pressure snubber and have 4-1/2 inch minimum diameter faces and be turret style, black phenolic case with clear glass face. The movement shall be rotary, of 400 Series stainless steel with teflon coated pinion gear and segment. The gauge shall be bottom connected & accept a 1/4" NPT female thread. Combination pressure gauge range and scale graduations shall be in psi and feet of water as follows:

0 to 300 psi, 25 psi figure intervals, with graduating marks every 5 psi (0-690 feet).

**All gauges will be panel mounted** off the pipeline and be flexible connected to their respective sensing point. The gauge trim tubing shall be complete with both isolating and vent valves and the tubing shall be so



arranged as to easily vent air and facilitate gauge removal. Gauges mounted directly to the pipeline or at the sensing point **will not** be accepted.

#### **2.04 BUTTERFLY/GATE VALVES**

See Section 02640 – Valves

#### **2.05 ULTRA SONIC FLOW METER**

A. Meter shall be constructed of lead-free bronze with a accuracy of +/- 1.5% normal flow range and a +/- 3.0% from the extended low flow range to the minimum flow value. The meter shall be of open flow tube design that prevents flow obstruction to reduce pressure loss.

B. The meter shall meet or exceed AWWA C715 and the most recent revision of AWWA C750 Standards.

C. The meter shall comply with the lead-free provisions of the Safe Drinking Water Act and NSF/ANSI Standards 61 and 372.

D. Meter shall be Badger E-Series® Ultrasonic Meter or approved equal.

#### **2.06 MAG METER**

A. One (1) each MAG meter shall be provided as shown on the plan. It should have a continuous flow range of 1000 gpm. The accuracy should be 100% of the actual through put +/- 1.5%. Operating pressure shall not exceed 150 psi.

B. The meter shall include an electronic transmitter capable of transmitting a 4 to 20 mA analog signal. The information shall include Totalization, Rate of Flow, Meter identification, Test Mode Totalization, Backflow Totalization, Scaled Pulse Resolution, 20 mA set point, and a Alarm Screen.

B. The water meter installation shall be complete with a size two and one-half (2-1/2) inch test station installed at no less than two (2) pipe diameters downstream from the meter. The test station shall be complete with a bronze ball valve with output side adapter suitable for 2-1/2 inch fire hose connection plus a cap and chain.

C. Mag Meter shall be Badger or approved equal.

#### **2.07 CHLORINE ANALYZER**

A chlorine analyzer shall be furnished, installed along with all appurtenances for monitoring of free or total residual chlorine. See Section 11917 for complete specification.

### **PART 3 – ELECTRICAL**

#### **3.01 EQUIPMENT GROUNDING**

Each electrical equipment item in the station shall be properly grounded per Section 250 of the National Electrical Code. Items to be grounded include, but are not limited to, pump motor frames, control panel, transformer, convenience receptacles, dedicated receptacle for heater, air conditioner, dehumidifier, lights, light switch, exhaust fans and pressure switches.

All ground wires from installed equipment shall be in conduit and shall lead back to the control panel to a copper ground buss specific for grounding purposes and so labeled. The ground buss shall be complete with a lug

large enough to accept the installing electrician's bare copper earth ground wire. The bus shall serve as a bond between the earth ground and the equipment ground wires.

### **3.02 PANEL MOUNTING HARDWARE**

Metal framing channel shall be used exclusively for mounting of all electrical panels and electrical components except for those specifically designated otherwise.

### **3.03 ELECTRICAL APPARATUS - CONTROL PANEL**

**All circuit breakers, motor starters, time delay relays and control relays shall be incorporated into one (1) NEMA 4/12 control panel.**

There shall be provided, thermal-magnetic trip circuit breakers as follows:

One (1) Main Breaker, 100 amps;

Eight (8) Auxiliary Circuit Breakers, as follows:

- |                 |                        |
|-----------------|------------------------|
| 1. Meter        | 5. Convenience Outlets |
| 2. Lights       | 6. Spare               |
| 3. Heater       | 7. Spare               |
| 4. Dehumidifier | 8. Spare               |

### **3.04 ELECTRICAL APPARATUS - RECEPTACLES**

**Two (2) duplex, ground fault circuit interrupter type receptacles** shall be furnished about the periphery of the equipment enclosure, with one (1) receptacle adjacent to the main control panel.

### **3.05 CONVENIENCE GROUP - LIGHTING**

There shall be one or more two-tube, 32 watt per tube, electronic start, enclosed and gasketed, forty-eight (48) inch minimum length fluorescent light fixtures installed within the equipment enclosure, as shown on the plan for this item. One (1) light fixture shall be located directly over the main control panel. The light switch shall be of the night glow type and be located conveniently adjacent to the door. Open fluorescent or incandescent fixtures **will not** be accepted.

### **3.06 CONVENIENCE GROUP - DEHUMIDIFIER**

1. One (1) each, installed as shown.
2. Capacity 25 pints per 24 hours (AHAM Standard DH-1).
3. Compressor rated 1/5 HP, 4.1 amps, 400 watts.
4. Condensate piped direct to sump.
5. 120 volt A.C. operation by dial-controlled adjustable humidistat.
6. UL listed rubber cord.

### **3.07 CONVENIENCE GROUP - HEATING/COOLING/EXHAUST UNIT**

The unit shall be one piece, wall mounted, factory assembled, precharged, prewired, tested and ready to operate. The unit shall have a limited warranty of five years on parts and five years on the compressor. The unit shall be approved and listed by Underwriters' Laboratories, Inc., and Canadian Underwriters' Laboratories (CUL). Unit performance shall be certified in accordance with Air Conditioning and Refrigeration Institute Standard 210/240-89 for Unitary Air-Source air conditioners or latest standard.

1. One (1) each exterior wall mounted, hard-wired as shown;

2. Enclosed weatherproof casing constructed of 20 gauge galvanized steel, finished with baked-on polyester enamel paint;
3. One (1) washable filter;
4. Remote adjustable thermostat;
5. Cooling capacity in tons: 1;
6. Cooling Capacity: 11,100 BTUH at 208 volts, single or 3-phase;
7. Amps: 30;
8. Twin indoor blowers, SCFM maximum/minimum: 325/300 at 0.2" static pressure;
9. Electrical supplemental heater: 5 kW;

## **PART 4 – EXECUTION**

### **4.01 PRESSURE TESTING**

When the station plumbing is completed, the pressure piping within the station (including valves and fittings), connections as make up the entire system shall be hydrostatically tested at a pressure of 150 psi or a pressure equal to the lowest test pressure rating of the equipment within the tested system, whichever is lesser pressure. The test pressure shall be applied for a minimum of 20 minutes, during which time all joints, connections and seams shall be checked for leaking. Any deficiencies found shall be repaired and the system shall be retested.

### **4.02 CONFORMANCE TO BASIC ELECTRICAL STANDARDS**

The manufacturer of electrical control panels and their mounting and installation shall be done in strict accordance with the requirements of UL Standard 508 and the National Electrical Code (NEC) latest revision so as to afford a measure of security as to the ability of the eventual owner to safely operate the equipment. **No exceptions to the requirements of these codes and standards will be allowed; failure to meet these requirements will be cause to remove the equipment and correct the violation.**

### **4.03 U.L. LISTING**

All service entrance, power distribution, control and starting equipment panels shall be constructed and installed in strict accordance with **Underwriter's Laboratories (UL) Standard 508 "Industrial Control Equipment."** The UL label shall also include an **SE "Service Entrance"** rating stating that the main distribution panel is suitable for use as service entrance equipment. The panels shall be shop inspected by UL, or constructed in a UL recognized facility. All panels shall bear a serialized UL label indicating acceptance under Standard 508 and under Enclosed Industrial Control Panel or Service Equipment Panel. In addition, a photocopy of the UL labels for this specific project shall be transmitted to both the project engineer and the contractor for installation within their permanent project files, **prior to shipment of the equipment covered under these specifications.**

### **4.04 E.T.L. LISTING**

All control panels shall be E.T.L. Listed by Interek Testing Services (ITS) under Category 4 - Industrial Control Equipment. Each completed panel shall bear an E.T.L. listing label. The listing label shall include the station manufacturer's name, address and telephone number. The station manufacturer shall have quarterly inspections performed by ITS at the manufacturer's facilities to ensure that the products being listed comply with the report and procedural guide for that product.

### **4.05 CONTRACTOR'S WARRANTY**

Shall at a minimum cover:

1. A period of one (1) year commencing upon **successful start-up.**
3. The contractor's warranty shall cover all equipment, components and systems provided in or with the station, exclusive of those components supplied by and/or installed by others independent of the contractor of record for this station.

4. The warranty shall provide for the contractor to bear the full cost of labor and materials for replacement and/or repair of faulty or defective components so there shall be **no cost** incurred by the Owner for this work during the warranty period.
5. The contractor's warranty policy is amended only by the items considered consumables, i.e., light bulbs, pump seals, pump packing, lubricants and other maintenance items consumed by usage.
6. No assumption of contingent liabilities for any component failure during contractor's warranty is made.

It is the intent of this contractor's warranty to gain for the owner a **single source** responsible party for all components specified herein. "Second party" or "pass through" warranties **will not** be accepted.

- END OF SECTION -

**SECTION 16925****ELECTRICAL****PART 1 - GENERAL****1.01 SCOPE OF WORK**

- A. Work included in this section of the Specification includes the furnishing of all labor, material, tools, approvals, utility connection fees, excavation, backfill, and other equipment necessary to install the electrical system as shown on the Contract Drawings and as specified herein.
- B. It also includes installation and connection of all electrical utilization equipment included in this Contract but furnished by other Contractors or suppliers.
- C. The Contractor shall furnish and install all conduit, wire, control equipment, and miscellaneous material to make all electrical connections to all items of utilization equipment unless as otherwise specified.
- D. The number and size of conductors between motors and control or protective apparatus shall be as required to obtain the operation described in these Specifications, and/or by the Contract Documents, and/or as shown in manufacturer furnished, Engineer reviewed Shop Drawings.
- E. All items of electrical equipment, including those shown on the Contract Drawings but not specifically mentioned in the Specifications or those mentioned in the Specifications but not shown on the contract Drawings, are to be furnished under this section of the Specifications. Any such device or item of equipment, if not defined in quality, shall be equal to similar equipment and/or devices specified herein.
- F. All devices and items of equipment mentioned in this section of the Specifications whether electrical or not or whether furnished under this or other Division of the Specifications, shall be installed under this Division of the Specifications, unless specifically indicated otherwise.
- G. Where wiring diagrams are not shown on the Contract Drawings, they are to be provided by the supplier of the equipment served and such diagrams shall be adhered to except as herein modified.

**1.02 RELATED WORK SPECIFIED ELSEWHERE**

- A. Contractors bidding work under this Contract shall read and understand Division Zero and Division 1 - General Requirements. If any discrepancies are discovered between this Division and the General Requirements, the above mentioned documents shall overrule this section.
- B. The Contractor shall bid as outlined in the above mentioned Specifications and shall be governed by any alternates or unit prices called for in the form of proposal.
- C. Each Contractor bidding on the work included in these Specifications shall view the building site and carefully examine the contract Drawings and Specifications, so that he/she may fully understand what is to be done, and to document existing conditions.

**1.03 SHOP DRAWINGS, DESCRIPTIVE LITERATURE, INSTALLATION, OPERATION AND MAINTENANCE INFORMATION**

- A. Shop Drawings including descriptive literature and/or installation, operation and maintenance instructions shall be submitted in the amount of copies as specified in Division 1. All Shop Drawings shall be submitted in loose-leaf three-ring cardboard reinforced vinyl binders.
- B. Shop Drawings shall be submitted on the following materials specified in this Division:
  - 1. Conduit - all types and sizes.
  - 2. Boxes - all types and sizes.
  - 3. Metal framing system.
  - 4. Conduit fittings, expansion joints, support hardware.
  - 5. Power distribution equipment.
  - 6. Wire - all types and sizes.
  - 7. Light fixtures.

#### **1.04 SYMBOLS AND ABBREVIATIONS**

The symbols and abbreviations general follow standard electrical and architectural practice, however, exceptions to this shall be as shown on the Contract Drawings.

#### **1.05 COORDINATION WITH OTHER TRADES**

The Contractor shall coordinate the electrical work with that of other trades to ensure proper final location of all electrical equipment and/or connections.

#### **1.06 CODES**

- A. The minimum standard for all work shall be the latest revision of the Kentucky Building Code (KBC), and the National Electrical Code (NEC). Whenever and wherever state and/or local laws or ordinances and/or regulations and/or the Engineers design require a higher standard than the current NEC or KBC, then these laws and/or regulations and/or the design shall be followed.
- B. Following is a list of other applicable Standards or Codes:

1.	Kentucky Building Code	KBC
2.	National Electrical Code	NEC
3.	National Electrical Safety Code	NESC
4.	Underwriters Laboratories, Inc.	UL
5.	National Fire Protection Association	NFPA
6.	National Electrical Manufacturers Association	NEMA
7.	Occupational Safety and Health Administration	OSHA
8.	Insulated Cable Engineers Association	ICEA
9.	Instrument Society of America	ISA
10.	American National Standards Institute, Inc.	ANSI
11.	Anti-Friction Bearing Manufacturers Association, Inc.	AFBMA
12.	Federal Communications Commission	FCC

#### **1.07 INSPECTIONS AND PERMITS**

- A. Inspection of the electrical system on all construction projects is required. If the local government has appointed a state licensed inspector, the Contractor shall be required to use that person to perform the inspections. If a locally mandated inspector does not exist, the Contractor shall select and hire a state licensed inspector, who has jurisdiction before any work is concealed.

- B. At the time of completion of the project, there shall be furnished to the Owner a certificate of compliance, from the agency having jurisdiction pursuant to all electrical work performed. The Engineer shall also receive a copy.
- C. All permits necessary for the complete electrical system shall be obtained by the Contractor from the authorities governing such work.

#### **1.08 STORAGE**

- A. All work, equipment, and materials shall be protected against dirt, water, or other injury during the period of construction.
- B. Sensitive electrical equipment, delivered to the jobsite, shall be protected against injury or corrosion due to atmospheric conditions or physical damage by other means. Protection is interpreted to mean that equipment shall be stored under roof, in a structure properly heated in cold weather and ventilated in hot weather. Provision shall be made to control the humidity in the storage area at 50 percent relative. The stored equipment shall be inspected periodically, and if it is found that the protection is inadequate, further protective measures shall be employed.

#### **1.09 MATERIALS**

- A. All materials used shall be new and at least meeting the minimum standards as established by the NEC and/or National Electrical Manufacturers Association. All materials shall be UL listed for the application, where a listing exists. Additional requirements are found in Division 1. All equipment shall meet applicable FCC requirements and restrictions.
- B. The material and equipment described herein has been specified according to a particular trade name or make to set quality standards. However, each Contractor has the right to substitute other material and equipment in lieu of that specified, other than those specifically mentioned at matching or for standardization, providing such material and equipment meets all of the requirements of those specified and is accepted, in writing by the Engineer.
- C. The reuse of salvaged electrical equipment and/or wiring will not be permitted unless specified herein or indicated on the Contract Drawings.
- D. All salvaged or abandoned electrical materials shall become the property of the Contractor and shall be removed from the job site upon completion of the project, unless otherwise noted on the Contract Drawings or specified herein.

#### **1.10 ERRORS, CORRECTIONS, AND/OR OMISSIONS**

- A. Should a piece of utilization equipment be supplied of a different size or horsepower than shown on the Contract Drawings, the Contractor shall be responsible for installing the proper size wiring, conduit, starters, circuit breakers, etc., for proper operation of that unit and the complete electrical system at no extra cost to the Owner.
- B. It is the intent of these Specifications to provide for an electrical system installation complete in every respect, to operate in the manner and under conditions as shown in these Specifications and on the Contract Drawings. The Contractor shall notify the Engineer, in writing, of any omission or error at least 10 days prior to opening of bids. In the event of the Contractor's failure to give such notice, he/she may be required to correct work and/or furnish items omitted without additional cost.
- C. Necessary changes or revisions in electrical work to meet any code or power company requirement shall be made by the Contractor without additional charge.

**1.11 GUARANTEES AND WARRANTIES**

- A. The Contractor shall guarantee all work including equipment, materials, and workmanship. This guarantee shall be against all defects of any of the above and shall run for a period of 1 year from the date of acceptance of the work, concurrent with the one year guarantee period designated for the general construction contract under which electrical work is performed.
- B. Repair and maintenance for the guarantee period is the responsibility of the Contractor and shall include all repairs and maintenance other than that which is considered as routine. (That is oiling, greasing, etc.) The Engineer shall be the judge of what shall be considered as routine maintenance.

**1.12 CLEANUP**

- A. Cleanup shall be performed as soon as possible after the electrical installation is complete. All control panels, switches, etc., shall be free from tags, stickers, etc. All painted enclosures shall be free from scratches or splattered paint. The interior of all enclosures shall be clean from dust, wire strippings, etc. Surplus material, rubbish, and equipment shall be removed from the jobsite upon completion of the work.
- B. During construction, cover all Owner equipment subject to damage.

**1.13 EXCAVATION AND BACKFILL**

- A. Excavation - Excavation for conduits shall be of sufficient width to allow for proper jointing and alignment of the type conduit used. Conduit shall be bedded on original ground. Where conduit is in solid rock, a 6 inch earth cushion must be provided. Conduit shall be laid in straight lines between pull boxes and/or structures unless otherwise notes on the Contract Drawings. The cost of solid rock excavation shall be included in the lump sum bid.
- B. Backfill - Backfill shall be hand placed, loose granular earth for a height of 6 inches above the top of the largest conduit. This material shall be free of rocks over 2 inches in diameter. Above this, large rocks may be included but must be mixed with sufficient earth to fill all voids.

**1.14 POWER COMPANY COORDINATION**

- A. The Contractor is responsible for coordinating all activities onsite by the power company. The Contractor is required to contact the utility prior to bidding to confirm availability of the specified voltage. The Contractor shall contact the electric utility during construction to schedule and order service.
- B. Any special provisions required by the serving electrical utility shall be as outlined on the Contract Drawings or as advised by the utility at the time of construction, and work required by these special provisions shall be furnished, installed, and connected by the Contractor.

**1.15 TEMPORARY ELECTRICAL POWER**

The Contractor shall be responsible for providing temporary electrical power as required during the course of construction and shall remove the temporary service equipment when no longer required.

**1.16 OVERCURRENT PROTECTION**

- A. Circuit breakers or fused switches shall be the size and type as written herein and shown on the Contract Drawings. Any additional overcurrent protection required to maintain an equipment listing by an authority having jurisdiction shall be installed by the Contractor at no extra cost to the Owner.



- B. The Contractor shall submit to the Engineer actual nameplate data from motors shipped to the jobsite, stating motor identification as well as characteristics. Overload relay thermal units shall correspond to actual nameplate data.

#### **1.17 RECORD DRAWINGS**

The Contractor shall maintain 1 set of the Contract Drawings on the job in good condition for examination at all times. The Contractor's qualified representative shall enter upon these Drawings, from day to day, the actual "as-built" record of construction and/or alteration progress. Entries and notes shall be made in a neat and legible manner and these Drawings delivered to the Engineer after completion of the construction, for use in preparation of Record Drawings.

#### **1.18 GROUNDING AND BONDING**

All metallic conduit, cabinets, equipment, and service shall be grounded in accordance with NEC requirements. All supporting framework in contact with electrical conduit, cable, and/or enclosures, shall be properly grounded.

#### **1.19 SERVICE ENTRANCE**

- A. Conductors and terminations for service entrances shall be furnished and installed by the Contractor. Voltage, phase, and number of wires shall be as shown on the Drawings. Clearances for overhead entrance wires shall be per power company, NEC, and NESC requirements.
- B. Any details not shown on the Drawings or written in the Specifications pertaining to the service entrance shall be per power company requirements. It is the Contractor's responsibility to contact the utility prior to bidding and obtain any special requirements or costs they will be imposing. Those costs shall be included in the bid.

#### **1.20 CONTRACTOR LICENSING**

The Contractor performing the electrical work on this project shall be locally licensed, if required by local law or ordinance. If the Contractor has passed the State test, it may not be necessary to meet local testing requirements. It shall be the Contractor's responsibility to investigate these requirements.

#### **1.21 ELECTRICAL COMPONENT MOUNTING HEIGHTS**

Mounting heights shall be as shown on the Contract Drawings. Operators and control devices shall not be mounted higher than 6'6" above finished floor or grade.

#### **1.22 WIRE AND CABLE**

All wire and cable shall have size, grade of insulation, voltage rating, and manufacturer's name permanently marked on the outer covering at regular intervals.

#### **1.23 EQUIPMENT IDENTIFICATION**

- A. All starters, feeder units, disconnects, instruments, etc., shall be marked to indicate the motors, circuit, they control or monitor. Marking is to be done with engraved laminated nameplates. Nameplates shall be fastened to equipment with stainless steel screws, one each side. In no way shall the installation of the mounting screws void the NEMA enclosure rating of the equipment in which

they are installed. If there are more than one number, the equipment shall be number consecutively and labeled as such. Nameplate background color shall be white, with black engraved letters.

- B. Disconnect switches, control panels, transfer switches, etc. shall be labeled with vinyl self-adhesive signs that warn of high voltage. The type of labels to be used shall have orange as the basic color to conform with OSHA requirements.

## **PART 2 - PRODUCTS**

### **2.01 ACCEPTABLE MANUFACTURERS**

- A. Raceways
  - 1. Aluminum, Rigid, Heavy-Wall, Threaded – “Wheatland Tube Co.,” “Thomas and Betts,” “Allied Tube & Conduit Corp.,” or equal.
  - 2. Plastic (PVC); Type A (Thin Wall); Type 40 (or Schedule 40); Type 80 (or Schedule 80) (Heavy -Wall) – “Allied Tube & Conduit Corp.,” “Carlson,” or equal.
  - 3. Liquidtight Flexible Metal Conduit – “Thomas and Betts,” “Allied Tube & Conduit Corp.” “Carlson,” or equal.
- B. Wires and Cables
  - 1. Building Wire (Types THWN and THW) – “Collyer,” “Rome,” “American,” “Carol,” or equal.
  - 2. Control Cables – “Belden,” “Eaton-Dekoron,” “Okonite,” or equal.
  - 3. Instrumentation Cables (Shielded) 600V mx. – “American,” “Belden,” “Okonite,” or equal.
- C. Boxes – “Appleton,” “Crouse-Hinds,” “Hoffman,” “Hennessey,” or equal.

### **2.02 MATERIALS**

- A. Conduit and Fittings
  - 1. Aluminum Conduit
    - a. Aluminum conduit shall be extruded from alloy 6063 and shall be the rigid type, non-toxic, corrosion resistant, and non-staining. It shall be manufactured per UL standards as well as listed/labeled by same.
    - b. Fittings, boxes, and accessories used in conjunction with aluminum conduit shall be die cast, copper free type. They shall be resistant to both chemical and galvanic corrosion. All covers shall have neoprene gaskets.
    - c. Aluminum conduit proposed for concrete slab or underground applications shall be UL listed for the purpose and factory pre-coated.
  - 2. Polyvinylchloride (PVC) Conduit
    - a. PVC conduit and fittings shall be Schedule 40, 80 heavy wall, or thinwall, as indicated in these Specifications manufactured to conform to UL standards. It shall be listed and labeled by UL. It shall have at least the same temperature rating as the conductor insulation. Expansion joints shall be used as recommended by the manufacturer in published literature. PVC systems shall be 90 degrees Celsius minimum UL rated, have a tensile strength of 7,000 psi @ 73.4 degrees Fahrenheit, flexural strength of 11,000 psi and compressive strength of 8,000 psi.
    - 3. All flexible conduit shall be liquidtight with sealtight fittings.
    - 4. Locknuts shall be bonding type with sharp edges for digging into the metal wall of an enclosure.
    - 5. Bushings shall be metallic insulating type, consisting of an insulating insert molded or locked into the metallic body of the fitting. Bushings made entirely of metal or nonmetallic material are not permitted.

B. Low Voltage Power Conductors (600 Volts and Below)

1. All conductors shall be insulated so that they are rated at 600 volts.
2. Insulated conductors minimum #12 AWG and shall be stranded.
3. All conductors brought to the job site shall be new and unused and where no special factory cut lengths are involved, shall be delivered to the job site in standard coils. Contractor shall provide verification to the Engineer of wire condition before wire is installed.
4. All conductors shall be soft drawn, 98% conductivity copper conforming to the latest ASTM Specifications and the requirements of the National Electrical Code.
5. Conductors shall be insulated with THHW or THHN insulation and all conduits shown on the Drawings are sized accordingly. At the Contractor's option, THWN insulation may be substituted. Type THHN may be used only in areas not subject to moisture.
6. Wiring adjacent to heat producing equipment and not subject to dampness or moisture shall be type TFE.

C. Instrument Cable

1. General

- a. All signal lines shall be constructed of individually twisted pairs (6 to 10 twists per foot), including thermocouple extension leads. Cables shall be made of twisted pairs, with all lays and pairs twisted in the same direction for maximum flexibility.
- b. Wire size shall be #16 AWG minimum for exterior runs and lengths over 5,000 feet. Wire size may be #16 - #18 AWG for interior under 5,000 feet in length.
- c. Stranded tinned copper conductor shall be used for all wiring other than thermocouple extension leads.
- d. Insulation resistance at 68 degrees Fahrenheit between conductors and between conductors and ground should be at least 500 megohms per 1,000 feet.
- e. Multi-pair cable should be jacketed with poly-vinyl-chloride, polyethylene or Teflon at least 0.045" thick. Voltage rating shall be 600 volts.

2. Signal Wiring

- a. Low level analog (less than 500 millivolt d-c). Use twisted pairs which may be cabled with other pairs carrying similar voltage levels. Foil wraps or equivalent shielding is required for each cable with the shield insulated from ground.
- b. High level analog (greater than 500 millivolts d-c). Use twisted pairs which may be cabled with other pairs carrying similar voltage levels and current levels less than 100 ma. Shielding is required.
- c. Analog outputs (normally 0-4 d-c or 4-20 ma). Same as b.
- d. Contact inputs - use twisted pairs and run in separate conduit.
- e. Contact outputs - same as d.
- f. Pulse inputs - same as d.

3. Signal and Shield Grounding

- a. All shields must be grounded at one point only as close as possible to the signal source.
- b. Thermocouples may be grounded or ungrounded.
- c. Analog signals, if grounded, should be grounded as near the signal source as possible.
- d. Resistance bulbs should not be grounded.

4. Signal and Wiring Separation

- a. High level analog signals may share the same conduit or run with contact or pulse signals.
- b. Thermocouple and low level signals should be run in a separate conduit.
- c. A minimum separation of 12 inches between analog signal leads and a-c power leads should be maintained. For a-c power leads carrying 100 amps or greater, a 24 inch separation should be maintained. Parallel runs should be limited to less than 500 feet. Perpendicular runs may be as close as 6 inches.

D. Boxes and Enclosures

1. Junction boxes for out of doors use, not mounted in concrete, shall be cast metal, rust and corrosion resistant, NEMA 4X, with at least 5-1/2 full threads for each conduit opening, and shall be suitable for surface mounting as required with drilled external, cast mounting extensions. Box covers shall be hinged or cap screw retained as required, of the same material as the box and provided with stainless steel hardware.

### **PART 3 - EXECUTION**

#### **3.01 INSTALLATION/APPLICATION/ERECTION**

##### **A. Conduit**

1. The Contractor shall be responsible for setting of all sleeves for his work.
2. All conduit 1-1/4 inches and larger shall be sleeved.
3. Where conduit is to be supported from poured concrete slabs, inserts shall be installed on the forms before the concrete is placed. Inserts installed by firing a power type driver shall be used only with prior approval of the Engineer.
4. Concrete encasements of underground conduit shall be installed where shown on the Drawings or specified herein. Concrete shall be 2500 psi in strength, dyed red throughout and shall be sized as detailed on the drawings.
5. During construction, all new conduits shall be kept dry and free of moisture and debris. Before the wire is pulled in, all conduits shall be swabbed to clear all moisture and debris which may have unavoidably accumulated.
6. Rigid conduits, where they entered panelboards, cabinets, pull boxes or outlet boxes shall be secured in place by galvanized, double locknuts (one inside and one outside) and bushings. Conduit bushings shall have insulating material which has been permanently fastened to the fittings. Bushings for conduit 1-1/2 inches trade size and larger shall be complete with grounding lug and shall be bonded to the box by means of bare copper wire.
7. All field bends shall be made with standard tools and bending equipment manufactured especially for this purpose. Bends in metallic conduit shall be made while cold and in no case shall the conduits be heated. Conduits shall not be bent through more than 90 degrees.
8. Size of conduits shall not be less than that required by the National Electrical Code. The Contractor shall install larger size conduits than detailed where there is more than 100 feet of unbroken run or where the total of the angles through which the conduit has been bent during a single run exceeds 270 degrees.
9. The use of flexible conduit shall be minimized. Where absolutely necessary, it shall be liquidtight, with maximum lengths of 3 feet.
10. All conduit joints shall be made up tight and no running threads shall be permitted on threaded connections. No kinked, clogged or deformed conduits shall be permitted on the job.
11. During construction, all installed conduits shall be temporarily capped or corked.
12. All moisture proofing or other material for thread protection shall be removed from conduit threads prior to installation. No material of insulating quality shall be used on the conduit threads or other places which will reduce the overall conductivity of the conduit system.
13. Where conduits are installed in groups on a common channel type support, each conduit shall be secured thereto by Korn's, Unistrut or Kindorf clamps. All mounting hardware shall be stainless steel.
14. Raceways shall be securely and rigidly fastened in place at intervals specified hereinbefore with conduit clamps, or approved conduit hangers. Bolts, screws, etc. used in securing the work shall be stainless steel and of ample size for the service. Assembly bolts, nuts, washers, etc., shall be stainless steel. Raceways shall NOT be welded to steel structures.
15. Horizontal and vertical conduit runs shall be supported by one hole straps with clamp backs, special brackets, or other approved devices with suitable bolts, expansion shields where required. All mounting hardware shall be stainless steel.
16. The use of perforated iron straps or wire for supporting conduits will not be permitted.

17. Where conduit is run in a concrete slab, the conduit shall be installed as close to the middle of the concrete slabs as practicable without disturbing the reinforcement. The outside diameter shall not exceed one-third of the slab thickness and conduits shall be placed not closer than three diameters on centers, except at cabinet locations where the slab thickness shall be increased upon consultation with, and approval by the Engineer.
  18. Depth of bury for all conduit shall be as indicated but a minimum of 24 inches below finished grade.
  19. All conduit shall have an insulated ground wire pulled to all equipment.
  20. The following conduit types are required:
    - a. Exterior below grade - Schedule 80 PVC direct buried 36" minimum or Schedule 40 PVC encased in a minimum of 3" of concrete, buried 24" minimum.
    - b. Interior concealed inside walls - Schedule 80 PVC or aluminum
    - c. Interior exposed - Aluminum
    - d. Exterior exposed - Aluminum
- B. Wire and Cable (600 Volts and Below):
1. Wire shall not be installed until all work of any nature that may cause injury to the wire is completed.
  2. Mechanical means shall not be used in pulling in wires No. 8 or smaller.
  3. Approved wire pulling lubricant shall be used as required to prevent insulation damage and over stressing of the wire while pulling through conduit. In no case shall conductors be greased or coated with any substance injurious to the conductor insulation or sheath.
  4. All wiring in control equipment, cabinets, etc., shall be neatly wrapped, taped, or laced into groups to provide a neat and orderly appearance in the equipment.
  5. Unless specified otherwise herein or shown otherwise on the Drawings, all wiring shall be installed in PVC coated rigid steel conduit.
  6. Where the wire is shown larger than that required for the load, it is done so for voltage drop or other purposes and must be installed as shown. Where the wire is stranded, the removal of strands in order to install the wire into a lug provided on any equipment will not be permitted. A larger lug shall be installed which will accept the wire size indicated.
  7. For the wiring of circuits consisting of AWG No. 10 or smaller wire, self-insulated pressure connectors (wirenuts) shall be utilized for all splices or joints.
  8. Each wire shall be labeled at both termination points. Individual conductor or circuit identification shall be carried throughout, with circuit numbers or other identification clearly stamped on terminal strips and shown in wiring diagrams.
  9. In all junction boxes, cabinets, control compartments and terminal boxes where no terminal board is provided, each wire, including all power wires, shall be properly identified by plastic coated, self-adhesive, wire marker.
  10. In cases similar to the above where the terminal boards are provided for the control, indicating, and metering wires, all wires including motor leads and other power wires shall be identified by wire markers as specified above.
  11. Equipment ground wire insulation shall be colored green or green with two or more yellow stripes
  12. In general and unless otherwise shown on the drawings, no two wires of the same color shall be run in the same conduit except such as control wiring, switch legs, neutral, and ground. Where a conduit run is shown on the drawings to have two or more wires connected to the same phase and, therefore, are the same color, pressure sensitive, plastic marked wire marker identification tape shall be used wherever the wire is accessible (junction boxes, panels, device boxes, etc.). The numbers shall in each case, correspond to the circuit number and panelboard from which the circuit emanates. Control wiring inside any compartment which may be energized from a source outside the compartment shall have insulation. Where yellow insulated wires are used inside any cabinet, compartment, etc., a machine engraved, laminated plastic identification marker shall be installed on the outside of the compartment.

13. Insulation on ungrounded conductors larger than AWG #10 and on grounded (neutral) and grounding (equipment ground) conductors larger than AWG #6 may be black with color coding accomplished with the use of colored plastic tape. Tape shall be installed on the conductors wherever they are visible and shall be wrapped at least three (3) turns around the conductor.
14. No open wiring is allowed.
15. All wiring on this project, except control wiring, shall be identified by color to reflect the phase relationship as follows:
  - a. 120/240 volt, 1-phase 3-wire: black, red for ungrounded conductors, white for neutral, green or bare for ground.

### C. Grounding

1. Ground rods shall be driven vertically into the earth to at least one foot below finished grade. Where a counterpoise or grounding grid is indicated and where rock is encountered at a depth of less than four (4) feet, rods shall be buried in a trench at not less than two feet below finished grade, and at equal angles from any two adjacent sides on the OUTSIDE of the counterpoise or grid. In these cases, at the Contractor's option, equal lengths of bare conductor of the same size as the counterpoise or grid may be used in place of ground rods.
2. Conductors connecting the main ground bars in switchgear to the earth shall be continuous without joints or splices. Connections to the grounding system at the switchgear shall be made with pressure connectors such as defined in Article 100, "Connector, Pressure (Solderless)", of the National Electrical Code.
3. Connections to ground rods and all other ground connections below grade shall have a MINIMUM mechanical contact surface area between the conductor and the ground rod of not less than three (3) square inches.
4. All connections made below finished grade shall be exothermic.
5. Installation of grounding conductors shall be such that they are not exposed to physical damage. All connections shall be firm and tight. Conductors and connectors shall be so arranged and provided so that there is no strain upon the connection. Buried equipment grounding conductors shall be buried at least 24 inches below finished grade and shall not be buried below concrete pads, paving, etc. except where running a tap to the grid or where shown on the contract drawings. Where buried below concrete or paving, grounding conductors shall be in rigid conduit unless shown on the drawings as a part of a grid.
6. Resistance measurements shall be made between the main grounding bar in the switchgear and a good earth ground. If this resistance is not equal to or less than 5 Ohms, an additional grounding electrode system in the form of ground rods installed and connected together in a 10 feet by 10 feet grid shall be added. The rods shall be connected together and this grid connected to the system with AWG #3/0 bare tinned copper. The number of rods shall be as required to register the resistance value mentioned above. Measurements shall be made in normally dry conditions and, in no case, less than 48 hours after rainfall.
7. Where a bare conductor is the only conductor installed in conduit or other raceway, and this conductor is serving as a grounding conductor, it shall be bonded to the raceway that contains it at each end of the raceway. The bond shall be made using a grounding type bushing and bonding jumper. The size of the jumper shall be the maximum size that the grounding bushing lug will accept and it shall be connected to the bushing with the lug and to the grounding conductor with a split bolt connector.
8. All metal electrical equipment cabinets (wireways, panels, switchgear, device boxes, junction and pull boxes, motor control panels, etc.) shall be securely bonded to a grounding conductor running through any conduit terminating at the cabinet or enclosure by use of a grounding lug bushing and jumper wire to the enclosure wall. Switchgear, panelboards and motor control equipment shall be provided with an equipment ground bus (including lugs or screw terminals) securely bonded to the enclosure. Junction boxes and other enclosures shall utilize an equipment ground bus or lug as required to securely bond the equipment grounding conductor to the enclosure. The grounding conductor shall be connected with pressure connectors at the main switchgear to the main grounding system. Where screw

terminals or set screw lugs are used, sufficient lugs shall be provided such that not more than one conductor is installed into each lug or terminal.

9. No raceway (including rigid steel conduit, EMT, etc.) shall serve as a grounding conductor.
10. All main feeder circuits and all branch circuits shall contain a grounding conductor sized according to Table 250-122, Article 250 of the National Electrical Code or as shown on the drawings. This grounding conductor shall be connected to the main grounding conductor in the switchgear from which the circuit emanates. Individual components of the system served by the main feeder circuit shall have their enclosures connected to the main feeder grounding conductor with pressure connectors.
11. Where lightning arresters are furnished and installed either separately or with equipment and the grounding connections are not inherently provided, a suitable, separate, grounding conductor shall connect the lightning arrester with a separate ground rod. This rod shall be interconnected with any adjacent grounding system.
12. Grounded and Grounding Conductor: Connections to the grounding conductor and/or the neutral (grounded) conductor shall be made in such a manner that removal of any device or equipment will not interrupt the continuity of these conductors to any device downstream from the device removed.

**- END OF SECTION -**

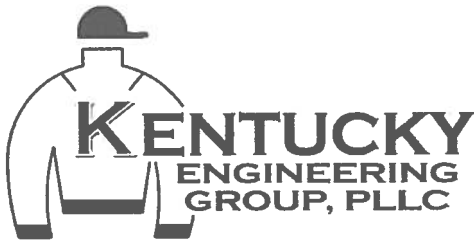

---

**ADDENDUM NO. 1**  
**East-West Interconnect Project – Phase 2**  
**Contract No. 6 – Water Distribution System Improvements**  
**Grayson County Water District**  
**Leitchfield, Grayson County, Kentucky**

**BID DATE:**                    **Thursday, January 19, 2023 - 11:00 a.m. (CST- Local Time)**

This Addendum No.1 and its noted revisions and attachments to the Drawings and Specifications shall supplement, amend, and become a part of the Bidding Documents, Drawings, and Specifications. All Bids and Construction Contracts shall be based on these modifications.

All Bids must be made on the required Bid Forms and must be fully completed and executed with original signatures and corporate seals. All Bid Bonds must be original forms and accompanied by the required certificates, original signatures, and seals. Any Bids without original documents, or a conditional or qualified Bid, will not be accepted.

**CONTRACT NO. 6 - ADDENDUM ITEMS:**

The bid opening is scheduled for **Thursday, January 19, 2023 at 11:00 am local time** at the offices of the Grayson County Water District.

After the bid opening Kentucky Engineering Group will review the bids and a bid tabulation will be created and distributed to all bidding contractors.

**SPECIFICATIONS**

- |                   |  |
|-------------------|--|
| <b>ITEM AD1-1</b> | <b>SECTION 00410 BID FORM</b> – Article 6, Section 6.01 Correct to 455 calendar days and Section 6.02 Correct to 455 calendar days. New Revised section attached. The REVISED Bid Form is included to be used when submitting a bid. |
| <b>ITEM AD1-2</b> | <b>SECTION 00420 EJCDC QUALIFICATIONS STATEMENT</b> – New revised section attached.  |
| <b>ITEM AD1-3</b> | <b>SECTION 00430 EJCDC BID BOND</b> – New revised section attached. The REVISED Bid Bond Form is included to be used when submitting a bid.  |
| <b>ITEM AD1-4</b> | <b>SECTION 00520 AGREEMENT</b> – Article 4, Section 4.02 Correct to 425 calendar days and 455 calendar days.   |
| <b>ITEM AD1-5</b> | <b>SECTION 01210 ALLOWANCES</b> – New revised section attached.  |



**PLANS**

- ITEM AD1-6            **SHEET G-1, REVISED SHEET – Location Map, Utilities, Legend and Index of Drawings.**
- ITEM AD1-7            **SHEET C-20, REVISED SHEET – KY 259 North Master Meter/Control Building – Plan and Details.**
- ITEM AD1-8            **SHEET C-21, NEW SHEET – KY 259 North Master Meter/Control Building – Site Plan and Details.**

**KENTUCKY ENGINEERING GROUP, PLLC**

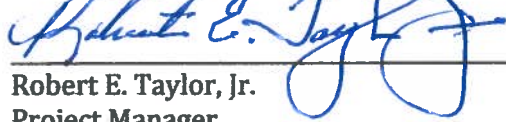
  
Robert E. Taylor, Jr.  
Project Manager

January 10, 2023

# BID FORM

**East-West Interconnect Project – Phase 2**  
**CONTRACT NO. 6 – WATER DISTRIBUTION SYSTEM IMPROVEMENTS PROJECT**  
**Grayson County Water District**

**ARTICLE 1 – BID RECIPIENT**

This Bid is submitted to:

**GRAYSON COUNTY WATER DISTRICT**

**21 Shull White Road**

**Leitchfield, Kentucky 42754**

- 1.01 The undersigned Bidder proposes and agrees, if this Bid is accepted, to enter into an Agreement with Owner in the form included in the Bidding Documents to perform all Work as specified or indicated in the Bidding Documents for the prices and within the times indicated in this Bid and in accordance with the other terms and conditions of the Bidding Documents.

**ARTICLE 2 – BIDDER’S ACKNOWLEDGEMENTS**

- 2.01 Bidder accepts all of the terms and conditions of the Instructions to Bidders, including without limitation those dealing with the disposition of Bid security. This Bid will remain subject to acceptance for 90 days after the Bid opening, or for such longer period of time that Bidder may agree to in writing upon request of Owner.

**ARTICLE 3 – BIDDER’S REPRESENTATIONS**

3.01 In submitting this Bid, Bidder represents that:

- A. Bidder has examined and carefully studied the Bidding Documents, and any data and reference items identified in the Bidding Documents, and hereby acknowledges receipt of the following Addenda:

<u>Addendum No.</u>	<u>Addendum, Date</u>
_____	_____
_____	_____
_____	_____
_____	_____

- B. Bidder has visited the Site, conducted a thorough, alert visual examination of the Site and adjacent areas, and become familiar with and satisfied itself as to the general, local, and Site conditions that may affect cost, progress, and performance of the Work.
- C. Bidder is familiar with and has satisfied itself as to all Laws and Regulations that may affect cost, progress, and performance of the work and including all AIS requirements.
- D. Bidder has carefully studied all: (1) reports of explorations and tests of subsurface conditions at or adjacent to the Site and all drawings of physical conditions relating to

existing surface or subsurface structures at the Site that have been identified in the Supplementary Conditions, especially with respect to Technical Data in such reports and drawings, and (2) reports and drawings relating to Hazardous Environmental Conditions, if any, at or adjacent to the Site that have been identified in the Supplementary Conditions, especially with respect to Technical Data in such reports and drawings.

- E. Bidder has considered the information known to Bidder itself; information commonly known to contractors doing business in the locality of the Site; information and observations obtained from visits to the Site; the Bidding Documents; and any Site-related reports and drawings identified in the Bidding Documents, with respect to the effect of such information, observations, and documents on (1) the cost, progress, and performance of the Work; (2) the means, methods, techniques, sequences, and procedures of construction to be employed by Bidder; and (3) Bidder's safety precautions and programs.
- F. Bidder agrees, based on the information and observations referred to in the preceding paragraph, that no further examinations, investigations, explorations, tests, studies, or data are necessary for the determination of this Bid for performance of the Work at the price bid and within the times required, and in accordance with the other terms and conditions of the Bidding Documents.
- G. Bidder is aware of the general nature of work to be performed by Owner and others at the Site that relates to the Work as indicated in the Bidding Documents.
- H. Bidder has given Engineer written notice of all conflicts, errors, ambiguities, or discrepancies that Bidder has discovered in the Bidding Documents, and confirms that the written resolution thereof by Engineer is acceptable to Bidder.
- I. The Bidding Documents are generally sufficient to indicate and convey understanding of all terms and conditions for the performance and furnishing of the Work.
- J. The submission of this Bid constitutes an incontrovertible representation by Bidder that Bidder has complied with every requirement of this Article, and that without exception the Bid and all prices in the Bid are premised upon performing and furnishing the Work required by the Bidding Documents.

#### **ARTICLE 4 – BIDDER'S CERTIFICATION**

##### **4.01 Bidder certifies that:**

- A. This Bid is genuine and not made in the interest of or on behalf of any undisclosed individual or entity and is not submitted in conformity with any collusive agreement or rules of any group, association, organization, or corporation;
- B. Bidder has not directly or indirectly induced or solicited any other Bidder to submit a false or sham Bid;
- C. Bidder has not solicited or induced any individual or entity to refrain from bidding; and
- D. Bidder has not engaged in corrupt, fraudulent, collusive, or coercive practices in competing for the Contract. For the purposes of this Paragraph 4.01.D:
  - 1. "corrupt practice" means the offering, giving, receiving, or soliciting of any thing of value likely to influence the action of a public official in the bidding process;
  - 2. "fraudulent practice" means an intentional misrepresentation of facts made (a) to influence the bidding process to the detriment of Owner, (b) to establish bid prices at

artificial non-competitive levels, or (c) to deprive Owner of the benefits of free and open competition;

3. "collusive practice" means a scheme or arrangement between two or more Bidders, with or without the knowledge of Owner, a purpose of which is to establish bid prices at artificial, non-competitive levels; and
4. "coercive practice" means harming or threatening to harm, directly or indirectly, persons or their property to influence their participation in the bidding process or affect the execution of the Contract.

**ARTICLE 5 – BASIS OF BID**

5.01 Bidder will complete the Work in accordance with the Contract Documents for the following unit price(s):

**BID SCHEDULE**

Item No.	Description	Unit	Estimated Quantity	Bid Unit Price	Bid Price
1	16-inch Water Main, PVC Pipe, Class 250, SDR 17 with all appurtenances and fittings. Complete in Place.	LF	23,200		
2	12-inch Water Main, PVC Pipe, Class 250, SDR 17 with all appurtenances and fittings. Complete in Place.	LF	26,020		
3	8-inch Water Main, PVC Pipe, Class 250, SDR 17 with all appurtenances and fittings.	LF	6,155		
4	Directional Boring with 18" HDPE Pipe DR 11 for Water Main. Complete in Place.	LF	480		
5	Directional Boring with 14" HDPE Pipe DR 9 for Water Main. Complete in Place.	LF	260		
6	Directional Boring with 10" HDPE Pipe DR 9 for Water Main. Complete in Place.	LF	320		
7	Directional Boring with 8" HDPE Pipe DR 9 for Water Main. Complete in Place.	LF	100		
8	Highway Bore with 24" Steel Casing Pipe Complete in Place.	LF	250		
9	Highway Bore with 20" Steel Casing Pipe Complete in Place.	LF	330		
10	12-inch Gate Valve and Box. Complete in Place.	EA	8		

11	<b>8-inch Gate Valve and Box. Complete in Place.</b>	EA	4		
12	<b>16-inch Gate Valve and Box w/Bypass Meter. Complete in Place.</b>	EA	3		
13	<b>12-inch Gate Valve and Box w/Bypass Meter. Complete in Place.</b>	EA	2		
14	<b>8-inch Gate Valve and Box w/Bypass Meter. Complete in Place.</b>	EA	2		
15	<b>Wet Tap Connection to Existing Water Main, Including Tapping Sleeve and Valve, Complete in Place.</b>	EA	4		
16	<b>Connection to Existing Water Main Complete in Place.</b>	EA	3		
17	<b>Flushing Hydrant Assembly including gate valve. Complete in Place</b>	EA	9		
18	<b>KY 259 North Master Meter/Control Valve Building. Complete in Place.</b>	LS	1		
19	<b>Cash Allowance – SCADA System Improvements. Complete in Place.</b>	LS	1	\$20,843.00	\$20,843.00

**AWARD OF CONTRACT will be based on the lowest responsible, responsive Bidder on the total of the BASE BID.**

**TOTAL AMOUNT BID: \_\_\_\_\_ Dollars and \_\_\_\_\_ (Cents)**

**(\$ \_\_\_\_\_ )**

Bidder acknowledges that (1) each Bid Unit Price includes an amount considered by Bidder to be adequate to cover Contractor's overhead and profit for each separately identified item, and (2) estimated quantities are not guaranteed, and are solely for the purpose of comparison of Bids, and final payment for all unit price Bid items will be based on actual quantities, determined as provided in the Contract Documents.

**ARTICLE 6 – TIME OF COMPLETION**

6.01 Bidder agrees that the Work will be substantially complete within 425 calendar days after the date when the Contract Times commence to run as provided in Paragraph 4.01 of the General Conditions, and will be completed and ready for final payment in accordance with Paragraph 15.06 of the General Conditions within 455 calendar days after the date when the Contract Times commence to run.

6.02 Bidder accepts the provisions of the Agreement as to liquidated damages. Contractor and Owner recognize that time is of the essence of this Agreement and that Owner will suffer financial loss if the Work is not completed within the times specified in Paragraph 6.01 above, plus any extensions thereof allowed in accordance with Article 15 of the General Conditions. The parties also recognize the delays, expense, and difficulties involved in proving in a legal or arbitration proceeding the actual loss suffered by Owner if the Work is not completed on time. Accordingly, instead of requiring any such proof, Owner and Contractor agree that as liquidated damages for delay (but not as a penalty), Contractor shall pay Owner \$500 for each day that expires after the time specified in Paragraph 6.01 for Substantial Completion until the Work is substantially complete. After Substantial Completion, if Contractor shall neglect, refuse, or fail to complete the remaining Work within the Contract Time or any proper extension thereof granted by Owner, Contractor shall pay Owner \$500 for each day that expires after the time specified in Paragraph 6.01 for completion and readiness for final payment until the Work is completed and ready for final payment.

#### **ARTICLE 7 – ATTACHMENTS TO THIS BID**

7.01 The following documents are submitted with and made a condition of this Bid:

- A. Required Bid security SECTION 00430 EJCDC C-430;
- B. List of Proposed Subcontractors;
- C. List of Proposed Suppliers;
- D. List of Project References;
- E. Evidence of authority to do business in the state of the Project; or a written covenant to obtain such license within the time for acceptance of Bids;
- F. Contractor's License No.:  [or] Evidence of Bidder's ability to obtain a State Contractor's License and a covenant by Bidder to obtain said license within the time for acceptance of Bids;
- G. Required Bidder Qualification Statement with supporting data.
- H. If Bid amount exceeds \$10,000, signed Compliance Statement (RD 400-6). Refer to specific equal opportunity requirements set forth in paragraph 18.10 of the General Conditions;
- I. If Bid amount exceeds \$25,000, signed Certification Regarding Debarment, Suspension, Ineligibility and Voluntary Exclusion - Lower Tier Covered Transactions (AD-1048);
- J. If Bid amount exceeds \$100,000, signed RD Instruction 1940-Q, Exhibit A-1, Certification for Contracts, Grants, and Loans. Refer to paragraph 18.11 of the General Conditions;
- K. Manufacturer's Certification Letter (Exhibit D) on any approved "or equal" or substitute request to ensure compliance with AIS requirements and any subsequent statutes mandating domestic preference

#### **ARTICLE 8 – DEFINED TERMS**

8.01 The terms used in this Bid with initial capital letters have the meanings stated in the Instructions to Bidders, the General Conditions, and the Supplementary Conditions.

**ARTICLE 9 – BID SUBMITTAL**

**BIDDER:** *[Indicate correct name of bidding entity]*

By:

*[Signature]* \_\_\_\_\_

*[Printed name]* \_\_\_\_\_

*(If Bidder is a corporation, a limited liability company, a partnership, or a joint venture, attach evidence of authority to sign.)*

Attest:

*[Signature]* \_\_\_\_\_

*[Printed name]* \_\_\_\_\_

Title: \_\_\_\_\_

Submittal Date: \_\_\_\_\_

Address for giving notices:

\_\_\_\_\_  
\_\_\_\_\_  
\_\_\_\_\_

Telephone Number: \_\_\_\_\_

Fax Number: \_\_\_\_\_

Contact Name and e-mail address: \_\_\_\_\_  
\_\_\_\_\_

Bidder's License No.: \_\_\_\_\_

*(where applicable)*

**NOTE TO USER:** *Use in those states or other jurisdictions where applicable or required.*

### QUALIFICATIONS STATEMENT

**THE INFORMATION SUPPLIED IN THIS DOCUMENT IS CONFIDENTIAL TO THE EXTENT PERMITTED BY LAWS AND REGULATIONS**

**1. SUBMITTED BY:**

Official Name of Firm: \_\_\_\_\_

Address: \_\_\_\_\_  
\_\_\_\_\_  
\_\_\_\_\_

**2. SUBMITTED TO:**

\_\_\_\_\_

**3. SUBMITTED FOR:**

\_\_\_\_\_

Owner: Grayson County Water District

Project Name: East - West Interconnect Project - Phase 2

Contract No. 6 - Water Distribution System Improvements Project

**TYPE OF WORK:**

Contract No. 6 – including approximately 480 LF of 18”, 23,200 LF of 16”, 260 LF of 14”, 26,020 LF of 12”, 320 LF of 10” and 6,155 LF of 8” water main, one new master meter and all related appurtenances as shown on the DRAWINGS and described in the SPECIFICATIONS

**CONTRACTOR'S CONTACT INFORMATION**

Contact Person: \_\_\_\_\_

Title: \_\_\_\_\_

Phone: \_\_\_\_\_

Email: \_\_\_\_\_



**4. AFFILIATED COMPANIES:**

Name: \_\_\_\_\_

Address: \_\_\_\_\_

\_\_\_\_\_

\_\_\_\_\_

**5. TYPE OF ORGANIZATION:**

SOLE PROPRIETORSHIP

Name of Owner: \_\_\_\_\_

Doing Business As: \_\_\_\_\_

Date of Organization: \_\_\_\_\_

PARTNERSHIP

Date of Organization: \_\_\_\_\_

Type of Partnership: \_\_\_\_\_

Name of General Partner(s): \_\_\_\_\_

\_\_\_\_\_

\_\_\_\_\_

CORPORATION

State of Organization: \_\_\_\_\_

Date of Organization: \_\_\_\_\_

Executive Officers:

- President: \_\_\_\_\_

- Vice President(s): \_\_\_\_\_

\_\_\_\_\_

\_\_\_\_\_

- Treasurer: \_\_\_\_\_

- Secretary:

\_\_\_\_\_

**LIMITED LIABILITY COMPANY**

State of Organization:

\_\_\_\_\_

Date of Organization:

\_\_\_\_\_

Members:

\_\_\_\_\_

\_\_\_\_\_

\_\_\_\_\_

\_\_\_\_\_

**JOINT VENTURE**

Sate of Organization:

\_\_\_\_\_

Date of Organization:

\_\_\_\_\_

Form of Organization:

\_\_\_\_\_

Joint Venture Managing Partner

- Name:

\_\_\_\_\_

- Address:

\_\_\_\_\_

\_\_\_\_\_

\_\_\_\_\_

Joint Venture Managing Partner

- Name:

\_\_\_\_\_

- Address:

\_\_\_\_\_

\_\_\_\_\_

Joint Venture Managing Partner

- Name:

\_\_\_\_\_

- Address:

\_\_\_\_\_

**6. LICENSING**

Jurisdiction: \_\_\_\_\_

Type of License: \_\_\_\_\_

License Number: \_\_\_\_\_

Jurisdiction: \_\_\_\_\_

Type of License: \_\_\_\_\_

License Number: \_\_\_\_\_

**7. CERTIFICATIONS**

**CERTIFIED BY:**

Disadvantage Business Enterprise: \_\_\_\_\_

Minority Business Enterprise: \_\_\_\_\_

Woman Owned Enterprise: \_\_\_\_\_

Small Business Enterprise: \_\_\_\_\_

Other ( \_\_\_\_\_ ): \_\_\_\_\_

**8. BONDING INFORMATION**

Bonding Company: \_\_\_\_\_

Address: \_\_\_\_\_

Bonding Agent: \_\_\_\_\_

Address: \_\_\_\_\_

Contact Name: \_\_\_\_\_

Phone: \_\_\_\_\_

Aggregate Bonding Capacity: \_\_\_\_\_

Available Bonding Capacity as of date of this submittal: \_\_\_\_\_

## 9. FINANCIAL INFORMATION

Financial Institution: \_\_\_\_\_

Address: \_\_\_\_\_

Account Manager: \_\_\_\_\_

Phone: \_\_\_\_\_

INCLUDE AS AN ATTACHMENT AN AUDITED BALANCE SHEET FOR EACH OF THE  
LAST 3 YEARS

## 10. CONSTRUCTION EXPERIENCE:

Current Experience:

List on **Schedule A** all uncompleted projects currently under contract (If Joint Venture list each participant's projects separately).

Previous Experience:

List on **Schedule B** all projects completed within the last 5 Years (If Joint Venture list each participant's projects separately).

Has firm listed in Section 1 ever failed to complete a construction contract awarded to it?

YES  NO

If YES, attach as an Attachment details including Project Owner's contact information.

Has any Corporate Officer, Partner, Joint Venture participant or Proprietor ever failed to complete a construction contract awarded to them in their name or when acting as a principal of another entity?

YES  NO

If YES, attach as an Attachment details including Project Owner's contact information.

Are there any judgments, claims, disputes or litigation pending or outstanding involving the firm listed in Section 1 or any of its officers (or any of its partners if a partnership or any of the individual entities if a joint venture)?

YES  NO

If YES, attach as an Attachment details including Project Owner's contact information.

**11. SAFETY PROGRAM:**

Name of Contractor's Safety Officer: \_\_\_\_\_

Include the following as attachments:

Provide as an Attachment Contractor's (and Contractor's proposed Subcontractors and Suppliers furnishing or performing Work having a value in excess of 10 percent of the total amount of the Bid) OSHA No. 500- Log & Summary of Occupational Injuries & Illnesses for the past 5 years.

Provide as an Attachment Contractor's (and Contractor's proposed Subcontractors and Suppliers furnishing or performing Work having a value in excess of 10 percent of the total amount of the Bid) list of all OSHA Citations & Notifications of Penalty (monetary or other) received within the last 5 years (indicate disposition as applicable) - IF NONE SO STATE.

Provide as an Attachment Contractor's (and Contractor's proposed Subcontractors and Suppliers furnishing or performing Work having a value in excess of 10 percent of the total amount of the Bid) list of all safety citations or violations under any state all received within the last 5 years (indicate disposition as applicable) - IF NONE SO STATE.

Provide the following for the firm listed in Section V (and for each proposed Subcontractor furnishing or performing Work having a value in excess of 10 percent of the total amount of the Bid) the following (attach additional sheets as necessary):

Workers' compensation Experience Modification Rate (EMR) for the last 5 years:

YEAR	_____	EMR	_____
YEAR	_____	EMR	_____
YEAR	_____	EMR	_____
YEAR	_____	EMR	_____
YEAR	_____	EMR	_____

Total Recordable Frequency Rate (TRFR) for the last 5 years:

YEAR	_____	TRFR	_____
YEAR	_____	TRFR	_____
YEAR	_____	TRFR	_____
YEAR	_____	TRFR	_____
YEAR	_____	TRFR	_____

Total number of man-hours worked for the last 5 Years:

YEAR	_____	TOTAL NUMBER OF MAN-HOURS	_____
YEAR	_____	TOTAL NUMBER OF MAN-HOURS	_____
YEAR	_____	TOTAL NUMBER OF MAN-HOURS	_____
YEAR	_____	TOTAL NUMBER OF MAN-HOURS	_____
YEAR	_____	TOTAL NUMBER OF MAN-HOURS	_____

Provide Contractor's (and Contractor's proposed Subcontractors and Suppliers furnishing or performing Work having a value in excess of 10 percent of the total amount of the Bid) Days Away From Work, Days of Restricted Work Activity or Job Transfer (DART) incidence rate for the particular industry or type of Work to be performed by Contractor and each of Contractor's proposed Subcontractors and Suppliers) for the last 5 years:

YEAR	_____	DART	_____
YEAR	_____	DART	_____
YEAR	_____	DART	_____
YEAR	_____	DART	_____
YEAR	_____	DART	_____

**12. EQUIPMENT:**

**MAJOR EQUIPMENT:**

List on **Schedule C** all pieces of major equipment available for use on Owner's Project.

I HEREBY CERTIFY THAT THE INFORMATION SUBMITTED HEREWITH, INCLUDING ANY ATTACHMENTS, IS TRUE TO THE BEST OF MY KNOWLEDGE AND BELIEF.

NAME OF ORGANIZATION: \_\_\_\_\_

BY: \_\_\_\_\_

TITLE: \_\_\_\_\_

DATED: \_\_\_\_\_

NOTARY ATTEST:

SUBSCRIBED AND SWORN TO BEFORE ME

THIS \_\_\_\_\_ DAY OF \_\_\_\_\_, 20\_\_

NOTARY PUBLIC - STATE OF \_\_\_\_\_

MY COMMISSION EXPIRES: \_\_\_\_\_

**REQUIRED ATTACHMENTS**

1. Schedule A (Current Experience).
2. Schedule B (Previous Experience).
3. Schedule C (Major Equipment).
4. Audited balance sheet for each of the last 3 years for firm named in Section 1.
5. Evidence of authority for individuals listed in Section 7 to bind organization to an agreement.
6. Resumes of officers and key individuals (including Safety Officer) of firm named in Section 1.
7. Required safety program submittals listed in Section 13.
8. Additional items as pertinent.

**SCHEDULE A**

**CURRENT EXPERIENCE**

Project Name	Owner's Contact Person Name: Address: Telephone:	Design Engineer Name: Company: Telephone:	Contract Date	Type of Work	Status	Cost of Work
	Name: Address: Telephone:	Name: Company: Telephone:				
	Name: Address: Telephone:	Name: Company: Telephone:				
	Name: Address: Telephone:	Name: Company: Telephone:				
	Name: Address: Telephone:	Name: Company: Telephone:				
	Name: Address: Telephone:	Name: Company: Telephone:				
	Name: Address: Telephone:	Name: Company: Telephone:				
	Name: Address: Telephone:	Name: Company: Telephone:				



## SCHEDULE B

**PREVIOUS EXPERIENCE (Include ALL Projects Completed within last 5 years)**

Project Name	Owner's Contact Person	Design Engineer	Contract Date	Type of Work	Status	Cost of Work
	Name: Address: Telephone:	Name: Company: Telephone:				
	Name: Address: Telephone:	Name: Company: Telephone:				
	Name: Address: Telephone:	Name: Company: Telephone:				
	Name: Address: Telephone:	Name: Company: Telephone:				
	Name: Address: Telephone:	Name: Company: Telephone:				
	Name: Address: Telephone:	Name: Company: Telephone:				
	Name: Address: Telephone:	Name: Company: Telephone:				

**SCHEDULE B**

**PREVIOUS EXPERIENCE (Include ALL Projects Completed within last 5 years)**

Project Name	Owner's Contact Person	Design Engineer	Contract Date	Type of Work	Status	Cost of Work
Name: Address: Telephone:	Name: Company: Telephone:	Name: Company: Telephone:				
Name: Address: Telephone:	Name: Company: Telephone:	Name: Company: Telephone:				
Name: Address: Telephone:	Name: Company: Telephone:	Name: Company: Telephone:				
Name: Address: Telephone:	Name: Company: Telephone:	Name: Company: Telephone:				
Name: Address: Telephone:	Name: Company: Telephone:	Name: Company: Telephone:				
Name: Address: Telephone:	Name: Company: Telephone:	Name: Company: Telephone:				
Name: Address: Telephone:	Name: Company: Telephone:	Name: Company: Telephone:				



## BID BOND

Any singular reference to Bidder, Surety, Owner or other party shall be considered plural where applicable.

**BIDDER (Name and Address):**

**SURETY (Name, and Address of Principal Place of Business):**

**OWNER (Name and Address):** Grayson County Water District  
21 Shull White Road  
Leitchfield, Kentucky 42754

**BID**

Bid Due Date:

Description: East – West Interconnect Project – Phase 2

Contract No. 6 – Water Distribution System Improvements Project

**BOND**

Bond Number:

Date:

Penal sum \_\_\_\_\_ \$ \_\_\_\_\_  
(Words) (Figures)

Surety and Bidder, intending to be legally bound hereby, subject to the terms set forth below, do each cause this Bid Bond to be duly executed by an authorized officer, agent, or representative.

**BIDDER** \_\_\_\_\_ (Seal) **SURETY** \_\_\_\_\_ (Seal)  
Bidder's Name and Corporate Seal Surety's Name and Corporate Seal

By: \_\_\_\_\_ By: \_\_\_\_\_  
Signature Signature (Attach Power of Attorney)

\_\_\_\_\_  
Print Name Print Name

\_\_\_\_\_  
Title Title

Attest: \_\_\_\_\_ Attest: \_\_\_\_\_  
Signature Signature

\_\_\_\_\_  
Title Title

*Note: Addresses are to be used for giving any required notice.*

*Provide execution by any additional parties, such as joint venturers, if necessary.*

1. Bidder and Surety, jointly and severally, bind themselves, their heirs, executors, administrators, successors, and

assigns to pay to Owner upon default of Bidder the penal sum set forth on the face of this Bond. Payment of the penal sum is the extent of Bidder's and Surety's liability. Recovery of such penal sum under the terms of this Bond shall be Owner's sole and exclusive remedy upon default of Bidder.

2. Default of Bidder shall occur upon the failure of Bidder to deliver within the time required by the Bidding Documents (or any extension thereof agreed to in writing by Owner) the executed Agreement required by the Bidding Documents and any performance and payment bonds required by the Bidding Documents.

3. This obligation shall be null and void if:

3.1 Owner accepts Bidder's Bid and Bidder delivers within the time required by the Bidding Documents (or any extension thereof agreed to in writing by Owner) the executed Agreement required by the Bidding Documents and any performance and payment bonds required by the Bidding Documents, or

3.2 All Bids are rejected by Owner, or

3.3 Owner fails to issue a Notice of Award to Bidder within the time specified in the Bidding Documents (or any extension thereof agreed to in writing by Bidder and, if applicable, consented to by Surety when required by Paragraph 5 hereof).

4. Payment under this Bond will be due and payable upon default of Bidder and within 30 calendar days after receipt by Bidder and Surety of written notice of default from Owner, which notice will be given with reasonable promptness, identifying this Bond and the Project and including a statement of the amount due.

5. Surety waives notice of any and all defenses based on or arising out of any time extension to issue Notice of Award agreed to in writing by Owner and Bidder, provided that the total time for issuing Notice of Award including extensions shall not in the aggregate exceed 120 days from the Bid due date without Surety's written consent.

6. No suit or action shall be commenced under this Bond prior to 30 calendar days after the notice of default required in Paragraph 4 above is received by Bidder and Surety and in no case later than one year after the Bid due date.

7. Any suit or action under this Bond shall be commenced only in a court of competent jurisdiction located in the state in which the Project is located.

8. Notices required hereunder shall be in writing and sent to Bidder and Surety at their respective addresses shown on the face of this Bond. Such notices may be sent by personal delivery, commercial courier, or by United States Registered or Certified Mail, return receipt requested, postage pre-paid, and shall be deemed to be effective upon receipt by the party concerned.

9. Surety shall cause to be attached to this Bond a current and effective Power of Attorney evidencing the authority of the officer, agent, or representative who executed this Bond on behalf of Surety to execute, seal, and deliver such Bond and bind the Surety thereby.

10. This Bond is intended to conform to all applicable statutory requirements. Any applicable requirement of any applicable statute that has been omitted from this Bond shall be deemed to be included herein as if set forth at length. If any provision of this Bond conflicts with any applicable statute, then the provision of said statute shall govern and the remainder of this Bond that is not in conflict therewith shall continue in full force and effect.

11. The term "Bid" as used herein includes a Bid, offer, or proposal as applicable.

**SECTION 01210****ALLOWANCES****PART 1 - GENERAL****1.1 DESCRIPTION**

A. This Section includes administrative and procedural requirements governing allowances. Certain items are specified in the Contract Documents by allowances. Allowances have been established in lieu of additional requirements and to defer selection of actual materials and equipment to a later date when additional information is available for evaluation. If necessary, additional requirements will be issued by Change Order.

B. Types of allowances include the following:

1. Lump-sum allowances.
2. Unit-cost allowances.

C. The following allowances shall be included in the Contractors Bid:

1. Supervisory Control and Data Acquisition System Improvements:

New SCADA (Supervisory Control and Data Acquisition) control system equipment to be installed at the listed sites for the Grayson County Water District Master. The new SCADA system shall include hardware, software, instrumentation, and other associated installation services as detailed in the attached scope of work. All work under the allowance is to be performed by HTI contact Jeff Morris (270) 274-4632. See attached Scope of Work.

Allowance Amount: **\$ 20,843.00**

**1.2 RELATED DOCUMENTS**

A. Drawings and general provisions of the Contract, including General and Supplementary Conditions and other Division 1 Specification Sections, apply to this Section

**1.3 ELECTION AND PURCHASE**

A. At the earliest practical date after award of the Contract, advise Engineer of the date when final selection and purchase of each product or system described by an allowance must be completed to avoid delaying the Work.

B. At Engineer's request, obtain proposals for each allowance for use in making final selections and include recommendations that are relevant to performing the Work.

C. Purchase products and systems selected by the Engineer from the designated supplier.

D. When an allowance is included for a third party, Independent Testing Agency, the Testing Agency shall be determined by the Owner.

**1.4 SUBMITTALS**

- A. Submit proposals for purchase of products or systems included in allowances, in the form specified for Change Orders.
- B. Submit invoices or delivery slips to show actual quantities of materials delivered to the site for use in fulfillment of each allowance.
- C. Coordinate and process submittals for allowance items in same manner as for other portions of the Work.
- D. Submit copy of all testing results as provided by the Testing Agency to the Engineer.

**1.5 COORDINATION**

- A. Coordinate allowance items with other portions of the Work. Furnish templates as required to coordinate installation.

**1.6 LUMP-SUM & UNIT-COST ALLOWANCES**

- A. Allowances shall include cost to Contractor of specific products and materials ordered by Owner under allowance and shall include taxes, freight, and delivery to the project site.
- B. Contractor's costs for receiving and handling at Project site, labor, coordination, concrete cylinder preparation and shipping, installation, overhead and profit, and similar costs related to products and materials ordered by Owner under allowance shall be included as part of the Contract Sum and not part of the allowance.

**1.7 UNUSED MATERIALS**

- A. Contractor shall be responsible for returning unused materials purchased under an allowance to the manufacturer or supplier for credit to Owner, after installation has been completed and accepted.
- B. When it is not economically practical to return material for credit, Contractor shall be responsible for preparing and delivering unused material to Owner's designated storage location. Otherwise, disposal of unused material shall be Contractor's responsibility.

**PART 2 - PRODUCTS (Not Applicable)****PART 3 - EXECUTION****3.1 EXAMINATION**

- A. Examine products covered by an allowance promptly on delivery for damage or defects. Return damaged or defective products to manufacturer for replacement.

**3.2 PREPARATION**

- A. Coordinate materials and their installation for each allowance with related materials and installations to ensure that each allowance item is completely integrated and interfaced with related work.

END OF SECTION

## Robert Taylor

---

**From:** Jim Thompson  
**Sent:** Monday, January 9, 2023 3:56 PM  
**To:** Robert Taylor  
**Subject:** Fwd: Grayson Co Water- KY 259N Master Meter Station RTU  
**Attachments:** Flow Meter Gateway-RTU One-line connection drawing.pdf; HTI Estimate 01092301-Grayson Co Water-KY259N Master Meter Station.pdf

Get [Outlook for iOS](#)

---

**From:** Jeff Morris <jeff@hti-usa.com>  
**Sent:** Monday, January 9, 2023 3:54:38 PM  
**To:** Jim Thompson <jthompson@kyengr.com>  
**Subject:** RE: Grayson Co Water- KY 259N Master Meter Station RTU

Jim

Please find attached estimate for the Grayson Co Water- KY 259N Master Meter Station RTU and related services

### Notes:

1. The proposed RTU will be fully assembled, programmed and ready for installation by the Contractor
  - a. Programming for the WTP Master Unit and tag database development is included for the Owner's HMI development and reporting use
2. The RTU is UL508A labeled (NEMA 12)
3. Radio/Modem and communications equipment is included and configured
  - a. FCC license modifications are included for the new site
4. The RTU will be configured with PLC I/O and field terminals to accommodate future duplex pump control operation with VFDs
  - a. The RTU should be ready to go to operate as duplex pump station in the future in regards to the RTU hardware
    - i. Provisions for an operator interface terminal will need to be added at that time if the Owner wants to include and OIT
  - b. Programming for future pump operation is not included in this estimate
5. The AMR/AMI flow meter gateway and duplexers are included mounted in a separate wall mount enclosure (Flow meters not included)
  - a. The duplexers will allow connection of the customers AMR endpoint to the flow meter to share the flow meter with SCADA
6. I have included the following in this proposal (Let me know if we need to exclude these)



- a. One each: Building temperature transducer
  - b. One each: Building intrusion limit door switch
  - c. Two each: 0-300 PSI pressure transducers ( ¼ inch MNPT, SS, Blind) No valves or plumbing included
7. I have attached a simple one-line drawing to show typical connections needed for the flow meters, encoder gateway and endpoint devices
  8. KY sales tax is included
  9. Inbound/outbound freight are included for delivery to the job site
  10. Current lead times are at ~ 20-24 weeks on PLC equipment delivery

Please feel free to contact me with any questions

Thank you for the opportunity!

Regards

Jeff Morris  
Automation Manager  
HTI Inc.

Ph: 270-274-4632  
Fax: 888-252-5654  
[jeff@hti-usa.com](mailto:jeff@hti-usa.com)

**From:** Jim Thompson <jthompson@kyengr.com>  
**Sent:** Monday, January 9, 2023 8:07 AM  
**To:** Jeff Morris <jeff@hti-usa.com>  
**Subject:** RE: Grayson Co Water- KY 259N Master Meter Station RTU

Thanks so much.



**James C. Thompson, PE**  
**Kentucky Engineering Group, PLLC**  
P.O. Box 1034  
Versailles, KY 40383  
Office: 859.251.4127  
Office Fax: 859.251.4137  
Cell: 859.351.9849  
e-mail: [jthompson@kyengr.com](mailto:jthompson@kyengr.com)  
[www.kyengr.com](http://www.kyengr.com)

Notice: The information contained in this communication is privileged and confidential. It is intended only for the recipient named above. If you have



**ENCODER TYPE FLOW METER  
SCADA RTU CONNECTIONS WHEN  
USING AMR/AMI GATEWAY DEVICE  
"TYPICAL"**

**NOTES:**

- 1. TWO METERS CONNECTION "TYPICAL" IS SHOWN.
- 2. IF AMR/AMI ENDPOINTS ARE NOT USED, DUPLEXER CAN BE ELIMINATED

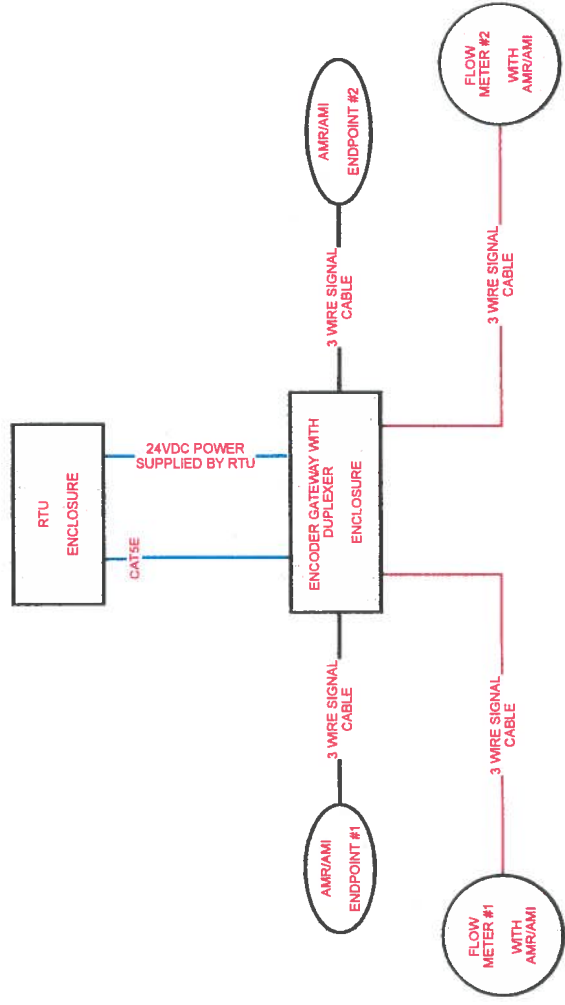

Title: ENCODER TYPE FLOW METER SCADA RTU CONNECTIONS  
"TYPICAL"  
• ONE-LINE DIAGRAM

Author: HTI

Date: 1-2023

Sheet: 1 of 2

Revision:

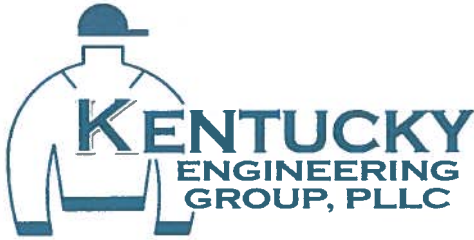

---

**ADDENDUM NO. 2**  
**East-West Interconnect Project – Phase 2**  
**Contract No. 6 – Distribution System Improvements**  
**Grayson County Water District**  
**Leitchfield, Grayson County, Kentucky**

**BID DATE:**                    **Thursday, January 19, 2023 - 11:00 a.m. (CST- Local Time)**

This Addendum No.1 and its noted revisions and attachments to the Drawings and Specifications shall supplement, amend, and become a part of the Bidding Documents, Drawings, and Specifications. All Bids and Construction Contracts shall be based on these modifications.

All Bids must be made on the required Bid Forms and must be fully completed and executed with original signatures and corporate seals. All Bid Bonds must be original forms and accompanied by the required certificates, original signatures, and seals. Any Bids without original documents, or a conditional or qualified Bid, will not be accepted.

**CONTRACT NO. 6 - ADDENDUM ITEMS:**

The bid opening is scheduled for **Thursday, January 19, 2023 at 11:00 am local time** at the offices of the Grayson County Water District.

After the bid opening Kentucky Engineering Group will review the bids and a bid tabulation will be created and distributed to all bidding contractors.

**SPECIFICATIONS**

**ITEM AD1-1                    SECTION 01030 LABOR PROVISIONS – Part 1 – GENERAL, Section 1.03**  
**WAGE RATES – Wage Rates DO apply to this project. The current wage decision**  
**is attached.**

**KENTUCKY ENGINEERING GROUP, PLLC**

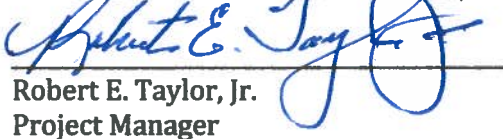
  
Robert E. Taylor, Jr.  
Project Manager

January 10, 2023

**SECTION 01030**  
**LABOR PROVISIONS**

**PART 1 - GENERAL**

**1.01 WORK INCLUDED**

- A. The Contractor shall conform to all provisions of the Kentucky Department of Labor, Wage Decisions (latest revisions), relative to minimum wages and hours as they may apply to the work to be accomplished under these specifications.
- B. In addition to the above, certain Federal laws and regulations shall govern the work and shall supplement or supplant the Kentucky Department of Labor Wage Decisions cited above, as the case may be.

**1.02 RELATED SECTIONS**

- A. Section 3 - Part 1 Hours and Wages

**1.03 WAGE RATES**

**Prevailing wage rates DO apply to this project.** The Contractor will utilize, when feasible, local labor and will pay them wages commensurate with the wages prevailing in the Community.

**1.04 LABOR PREFERENCE**

Where feasible, the Contractor will utilize local labor.

**1.05 HOURS OF WORK**

- A. Hours of work shall be as set out in Kentucky Department of Labor Wage Decisions (latest revisions); that is, not more than eight (8) hours in one calendar day, nor more than forty (40) hours in one week, except in case of emergency caused by fire, flood or damage to life and property.
- B. Any laborer, workman, mechanic, helper, assistant or apprentice working in excess of forty (40) hours per week, except in case of emergency, shall be paid not less than 1-1/2 times the wage rate. Whenever overtime work is scheduled, the Contractor shall give prior notice to the Owner.

**1.06 OVERTIME WORK**

- A. Any overtime work (greater than 40 hours in one week) shall require the Contractor to reimburse the Owner for additional resident inspection costs at an hourly rate of \$65.00 per hour.

- END OF SECTION -

"General Decision Number: KY20230061 01/06/2023

Superseded General Decision Number: KY20220061

State: Kentucky

Construction Type: Heavy

Counties: Breckinridge, Caldwell, Carlisle, Crittenden, Fulton, Grayson, Hickman, Hopkins, Livingston, Muhlenberg, Ohio and Todd Counties in Kentucky.

HEAVY CONSTRUCTION PROJECTS (including sewer/water construction).

Note: Contracts subject to the Davis-Bacon Act are generally required to pay at least the applicable minimum wage rate required under Executive Order 14026 or Executive Order 13658. Please note that these Executive Orders apply to covered contracts entered into by the federal government that are subject to the Davis-Bacon Act itself, but do not apply to contracts subject only to the Davis-Bacon Related Acts, including those set forth at 29 CFR 5.1(a)(2)-(60).

If the contract is entered into on or after January 30, 2022, or the contract is renewed or extended (e.g., an option is exercised) on or after January 30, 2022:	<ul style="list-style-type: none"><li>. Executive Order 14026 generally applies to the contract.</li><li>. The contractor must pay all covered workers at least \$16.20 per hour (or the applicable wage rate listed on this wage determination, if it is higher) for all hours spent performing on the contract in 2023.</li></ul>
If the contract was awarded on or between January 1, 2015 and January 29, 2022, and the contract is not renewed or extended on or after January 30, 2022:	<ul style="list-style-type: none"><li>. Executive Order 13658 generally applies to the contract.</li><li>. The contractor must pay all covered workers at least \$12.15 per hour (or the applicable wage rate listed on this wage determination, if it is higher) for all hours spent performing on that contract in 2023.</li></ul>

The applicable Executive Order minimum wage rate will be adjusted annually. If this contract is covered by one of the Executive Orders and a classification considered necessary for performance of work on the contract does not appear on this wage determination, the contractor must still submit a conformance request.

Additional information on contractor requirements and worker protections under the Executive Orders is available at <http://www.dol.gov/whd/govcontracts>.

Modification Number      Publication Date  
0                              01/06/2023

ENGI0181-009 07/01/2021

	Rates	Fringes
POWER EQUIPMENT OPERATOR		
GROUP 1.....	\$ 34.80	17.85
GROUP 2.....	\$ 31.94	17.85
GROUP 3.....	\$ 32.39	17.85
GROUP 4.....	\$ 31.62	17.85

OPERATING ENGINEER CLASSIFICATIONS

GROUP 1 - Backhoe/Excavator/Trackhoe; Bulldozer; Crane; Drill; Grader/Blade; Loader; Mechanic; Scraper

GROUP 2 - Bobcat/Skid Steer/Skid Loader; Forklift; Tractor (50 H.P. or over)

GROUP 3 - Articulating Truck Operator

GROUP 4 - Oiler; Tractor (under 50 H.P.)

Operators on cranes with booms 150 feet and over (including jib) shall receive \$1.00 above Group 1 rate; 250 feet and over including jib shall receive \$1.50 above Class 1 rate. Combination Rate: All crane operators operating cranes, where the length of the boom in combination with the length of the piling leads equal or exceeds 150 feet, shall receive \$1.00 above the Group 1 rate.

Employees assigned to work below ground level are to be paid 10% above basic wage rate. This does not apply to open cut work.

-----  
IRON0782-010 08/01/2022

	Rates	Fringes
IRONWORKER (Reinforcing & Structural)		
Projects over \$20,000,000.00.....	\$ 31.87	23.22
Projects under \$20,000,000.00.....	\$ 30.28	23.22

-----  
LABO0189-001 07/01/2022

	Rates	Fringes
LABORER		
Concrete Saw (Hand Held/Walk Behind).....	\$ 24.01	17.12

-----  
LABO0561-003 07/01/2022

	Rates	Fringes
LABORER		
Form Worker.....	\$ 24.66	17.10

-----  
LABO1214-001 07/01/2022

	Rates	Fringes
LABORER		
Backfiller, Carpenter Tender, Common or General, Concrete Worker, Dumpman, Fence Erection.....	\$ 23.76	17.12
Pipelayer & Tamper (Hand Held/Walk Behind).....	\$ 24.01	17.12

-----  
UAVG-KY-0001 01/01/2020

	Rates	Fringes
LABORER: Grade Checker.....	\$ 24.08	14.93

-----  
SUKY2011-017 06/25/2014

Rates	Fringes
-------	---------

CEMENT MASON/CONCRETE FINISHER...\$ 20.96	10.53
ELECTRICIAN.....\$ 32.35	2.18
LABORER: Flagger.....\$ 18.31	8.89
OPERATOR: Boring Machine.....\$ 25.35	13.00

-----

WELDERS - Receive rate prescribed for craft performing operation to which welding is incidental.

=====

Note: Executive Order (EO) 13706, Establishing Paid Sick Leave for Federal Contractors applies to all contracts subject to the Davis-Bacon Act for which the contract is awarded (and any solicitation was issued) on or after January 1, 2017. If this contract is covered by the EO, the contractor must provide employees with 1 hour of paid sick leave for every 30 hours they work, up to 56 hours of paid sick leave each year. Employees must be permitted to use paid sick leave for their own illness, injury or other health-related needs, including preventive care; to assist a family member (or person who is like family to the employee) who is ill, injured, or has other health-related needs, including preventive care; or for reasons resulting from, or to assist a family member (or person who is like family to the employee) who is a victim of, domestic violence, sexual assault, or stalking. Additional information on contractor requirements and worker protections under the EO is available at <https://www.dol.gov/agencies/whd/government-contracts>.

Unlisted classifications needed for work not included within the scope of the classifications listed may be added after award only as provided in the labor standards contract clauses (29CFR 5.5 (a) (1) (ii)).

-----

The body of each wage determination lists the classification and wage rates that have been found to be prevailing for the cited type(s) of construction in the area covered by the wage determination. The classifications are listed in alphabetical order of ""identifiers"" that indicate whether the particular rate is a union rate (current union negotiated rate for local), a survey rate (weighted average rate) or a union average rate (weighted union average rate).



## Union Rate Identifiers

A four letter classification abbreviation identifier enclosed in dotted lines beginning with characters other than ""SU"" or ""UAVG"" denotes that the union classification and rate were prevailing for that classification in the survey. Example: PLUM0198-005 07/01/2014. PLUM is an abbreviation identifier of the union which prevailed in the survey for this classification, which in this example would be Plumbers. 0198 indicates the local union number or district council number where applicable, i.e., Plumbers Local 0198. The next number, 005 in the example, is an internal number used in processing the wage determination. 07/01/2014 is the effective date of the most current negotiated rate, which in this example is July 1, 2014.

Union prevailing wage rates are updated to reflect all rate changes in the collective bargaining agreement (CBA) governing this classification and rate.

## Survey Rate Identifiers

Classifications listed under the ""SU"" identifier indicate that no one rate prevailed for this classification in the survey and the published rate is derived by computing a weighted average rate based on all the rates reported in the survey for that classification. As this weighted average rate includes all rates reported in the survey, it may include both union and non-union rates. Example: SULA2012-007 5/13/2014. SU indicates the rates are survey rates based on a weighted average calculation of rates and are not majority rates. LA indicates the State of Louisiana. 2012 is the year of survey on which these classifications and rates are based. The next number, 007 in the example, is an internal number used in producing the wage determination. 5/13/2014 indicates the survey completion date for the classifications and rates under that identifier.

Survey wage rates are not updated and remain in effect until a new survey is conducted.

## Union Average Rate Identifiers

Classification(s) listed under the UAVG identifier indicate that no single majority rate prevailed for those classifications; however, 100% of the data reported for the classifications was union data. EXAMPLE: UAVG-OH-0010 08/29/2014. UAVG indicates that the rate is a weighted union average rate. OH indicates the state. The next number, 0010 in the example, is an internal number used in producing the wage

determination. 08/29/2014 indicates the survey completion date for the classifications and rates under that identifier.

A UAVG rate will be updated once a year, usually in January of each year, to reflect a weighted average of the current negotiated/CBA rate of the union locals from which the rate is based.

---

#### WAGE DETERMINATION APPEALS PROCESS

1.) Has there been an initial decision in the matter? This can be:

- \* an existing published wage determination
- \* a survey underlying a wage determination
- \* a Wage and Hour Division letter setting forth a position on a wage determination matter
- \* a conformance (additional classification and rate) ruling

On survey related matters, initial contact, including requests for summaries of surveys, should be with the Wage and Hour National Office because National Office has responsibility for the Davis-Bacon survey program. If the response from this initial contact is not satisfactory, then the process described in 2.) and 3.) should be followed.

With regard to any other matter not yet ripe for the formal process described here, initial contact should be with the Branch of Construction Wage Determinations. Write to:

Branch of Construction Wage Determinations  
Wage and Hour Division  
U.S. Department of Labor  
200 Constitution Avenue, N.W.  
Washington, DC 20210

2.) If the answer to the question in 1.) is yes, then an interested party (those affected by the action) can request review and reconsideration from the Wage and Hour Administrator (See 29 CFR Part 1.8 and 29 CFR Part 7). Write to:

Wage and Hour Administrator  
U.S. Department of Labor  
200 Constitution Avenue, N.W.  
Washington, DC 20210

The request should be accompanied by a full statement of the interested party's position and by any information (wage payment data, project description, area practice material, etc.) that the requestor considers relevant to the issue.

3.) If the decision of the Administrator is not favorable, an interested party may appeal directly to the Administrative Review Board (formerly the Wage Appeals Board). Write to:

Administrative Review Board  
U.S. Department of Labor  
200 Constitution Avenue, N.W.  
Washington, DC 20210

4.) All decisions by the Administrative Review Board are final.

=====

END OF GENERAL DECISIO"



---

**ADDENDUM NO. 3**  
**East-West Interconnect Project – Phase 2**  
**Contract No. 6 – Distribution System Improvements**  
**Grayson County Water District**  
**Leitchfield, Grayson County, Kentucky**

**BID DATE:**                    **Thursday, January 19, 2023 - 11:00 a.m. (CST- Local Time)**

This Addendum No.1 and its noted revisions and attachments to the Drawings and Specifications shall supplement, amend, and become a part of the Bidding Documents, Drawings, and Specifications. All Bids and Construction Contracts shall be based on these modifications.

All Bids must be made on the required Bid Forms and must be fully completed and executed with original signatures and corporate seals. All Bid Bonds must be original forms and accompanied by the required certificates, original signatures, and seals. Any Bids without original documents, or a conditional or qualified Bid, will not be accepted.

**CONTRACT NO. 6 - ADDENDUM ITEMS:**

The bid opening is scheduled for **Thursday, January 19, 2023 at 11:00 am local time** at the offices of the Grayson County Water District.

After the bid opening Kentucky Engineering Group will review the bids and a bid tabulation will be created and distributed to all bidding contractors.

**SPECIFICATIONS**

**ITEM AD3-1                    SECTION 00410 BID FORM – Part 1 – Revised Bid Form**, the attached form shall be used when submitting a bid on this project.

**KENTUCKY ENGINEERING GROUP, PLLC**

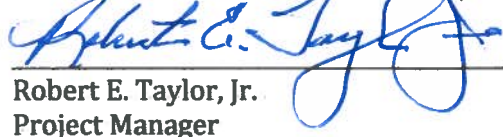
  
Robert E. Taylor, Jr.  
Project Manager

January 11, 2023

# BID FORM

## East-West Interconnect Project – Phase 2 CONTRACT NO. 6 – WATER DISTRIBUTION SYSTEM IMPROVEMENTS PROJECT Grayson County Water District

### ARTICLE 1 – BID RECIPIENT

This Bid is submitted to:

**GRAYSON COUNTY WATER DISTRICT**  
**21 Shull White Road**  
**Leitchfield, Kentucky 42754**

- 1.01 The undersigned Bidder proposes and agrees, if this Bid is accepted, to enter into an Agreement with Owner in the form included in the Bidding Documents to perform all Work as specified or indicated in the Bidding Documents for the prices and within the times indicated in this Bid and in accordance with the other terms and conditions of the Bidding Documents.

### ARTICLE 2 – BIDDER’S ACKNOWLEDGEMENTS

- 2.01 Bidder accepts all of the terms and conditions of the Instructions to Bidders, including without limitation those dealing with the disposition of Bid security. This Bid will remain subject to acceptance for 90 days after the Bid opening, or for such longer period of time that Bidder may agree to in writing upon request of Owner.

### ARTICLE 3 – BIDDER’S REPRESENTATIONS

3.01 In submitting this Bid, Bidder represents that:

- A. Bidder has examined and carefully studied the Bidding Documents, and any data and reference items identified in the Bidding Documents, and hereby acknowledges receipt of the following Addenda:

<u>Addendum No.</u>	<u>Addendum, Date</u>
_____	_____
_____	_____
_____	_____
_____	_____

- B. Bidder has visited the Site, conducted a thorough, alert visual examination of the Site and adjacent areas, and become familiar with and satisfied itself as to the general, local, and Site conditions that may affect cost, progress, and performance of the Work.
- C. Bidder is familiar with and has satisfied itself as to all Laws and Regulations that may affect cost, progress, and performance of the work and including all AIS requirements.
- D. Bidder has carefully studied all: (1) reports of explorations and tests of subsurface conditions at or adjacent to the Site and all drawings of physical conditions relating to

---

EJCDC® C-410, Bid Form for Construction Contracts.

Copyright © 2013 National Society of Professional Engineers, American Council of Engineering Companies, and American Society of Civil Engineers. All rights reserved.

existing surface or subsurface structures at the Site that have been identified in the Supplementary Conditions, especially with respect to Technical Data in such reports and drawings, and (2) reports and drawings relating to Hazardous Environmental Conditions, if any, at or adjacent to the Site that have been identified in the Supplementary Conditions, especially with respect to Technical Data in such reports and drawings.

- E. Bidder has considered the information known to Bidder itself; information commonly known to contractors doing business in the locality of the Site; information and observations obtained from visits to the Site; the Bidding Documents; and any Site-related reports and drawings identified in the Bidding Documents, with respect to the effect of such information, observations, and documents on (1) the cost, progress, and performance of the Work; (2) the means, methods, techniques, sequences, and procedures of construction to be employed by Bidder; and (3) Bidder's safety precautions and programs.
- F. Bidder agrees, based on the information and observations referred to in the preceding paragraph, that no further examinations, investigations, explorations, tests, studies, or data are necessary for the determination of this Bid for performance of the Work at the price bid and within the times required, and in accordance with the other terms and conditions of the Bidding Documents.
- G. Bidder is aware of the general nature of work to be performed by Owner and others at the Site that relates to the Work as indicated in the Bidding Documents.
- H. Bidder has given Engineer written notice of all conflicts, errors, ambiguities, or discrepancies that Bidder has discovered in the Bidding Documents, and confirms that the written resolution thereof by Engineer is acceptable to Bidder.
- I. The Bidding Documents are generally sufficient to indicate and convey understanding of all terms and conditions for the performance and furnishing of the Work.
- J. The submission of this Bid constitutes an incontrovertible representation by Bidder that Bidder has complied with every requirement of this Article, and that without exception the Bid and all prices in the Bid are premised upon performing and furnishing the Work required by the Bidding Documents.

#### **ARTICLE 4 – BIDDER'S CERTIFICATION**

##### **4.01 Bidder certifies that:**

- A. This Bid is genuine and not made in the interest of or on behalf of any undisclosed individual or entity and is not submitted in conformity with any collusive agreement or rules of any group, association, organization, or corporation;
- B. Bidder has not directly or indirectly induced or solicited any other Bidder to submit a false or sham Bid;
- C. Bidder has not solicited or induced any individual or entity to refrain from bidding; and
- D. Bidder has not engaged in corrupt, fraudulent, collusive, or coercive practices in competing for the Contract. For the purposes of this Paragraph 4.01.D:
  - 1. "corrupt practice" means the offering, giving, receiving, or soliciting of any thing of value likely to influence the action of a public official in the bidding process;
  - 2. "fraudulent practice" means an intentional misrepresentation of facts made (a) to influence the bidding process to the detriment of Owner, (b) to establish bid prices at

---

EJCDC® C-410, Bid Form for Construction Contracts.

Copyright © 2013 National Society of Professional Engineers, American Council of Engineering Companies, and American Society of Civil Engineers. All rights reserved.

artificial non-competitive levels, or (c) to deprive Owner of the benefits of free and open competition;

3. "collusive practice" means a scheme or arrangement between two or more Bidders, with or without the knowledge of Owner, a purpose of which is to establish bid prices at artificial, non-competitive levels; and
4. "coercive practice" means harming or threatening to harm, directly or indirectly, persons or their property to influence their participation in the bidding process or affect the execution of the Contract.

#### ARTICLE 5 – BASIS OF BID

5.01 Bidder will complete the Work in accordance with the Contract Documents for the following unit price(s):

#### BID SCHEDULE

Item No.	Description	Unit	Estimated Quantity	Bid Unit Price	Bid Price
1	16-inch Water Main, PVC Pipe, Class 250, SDR 17 with all appurtenances and fittings. Complete in Place.	LF	23,200		
2	12-inch Water Main, PVC Pipe, Class 250, SDR 17 with all appurtenances and fittings. Complete in Place.	LF	26,020		
3	8-inch Water Main, PVC Pipe, Class 250, SDR 17 with all appurtenances and fittings.	LF	6,155		
4	Directional Boring with 18" HDPE Pipe DR 11 for Water Main. Complete in Place.	LF	480		
5	Directional Boring with 14" HDPE Pipe DR 9 for Water Main. Complete in Place.	LF	260		
6	Directional Boring with 10" HDPE Pipe DR 9 for Water Main. Complete in Place.	LF	320		
7	Directional Boring with 8" HDPE Pipe DR 9 for Water Main. Complete in Place.	LF	100		
8	Railroad Bore with 8" HDPE Pipe DR 9 for Water Main with 16" Steel Casing Pipe Complete in Place.	LF	100		
9	Highway Bore with 24" Steel Casing Pipe Complete in Place.	LF	250		
10	Highway Bore with 20" Steel Casing Pipe Complete in Place.	LF	330		

EJCDC® C-410, Bid Form for Construction Contracts.

Copyright © 2013 National Society of Professional Engineers, American Council of Engineering Companies, and American Society of Civil Engineers. All rights reserved.

11	<b>12-inch Gate Valve and Box. Complete in Place.</b>	EA	8		
12	<b>8-inch Gate Valve and Box. Complete in Place.</b>	EA	4		
13	<b>16-inch Gate Valve and Box w/Bypass Meter. Complete in Place.</b>	EA	3		
14	<b>12-inch Gate Valve and Box w/Bypass Meter. Complete in Place.</b>	EA	2		
15	<b>8-inch Gate Valve and Box w/Bypass Meter. Complete in Place.</b>	EA	2		
16	<b>Wet Tap Connection to Existing Water Main, Including Tapping Sleeve and Valve, Complete in Place.</b>	EA	4		
17	<b>Connection to Existing Water Main Complete in Place.</b>	EA	3		
18	<b>Flushing Hydrant Assembly including gate valve. Complete in Place</b>	EA	9		
19	<b>KY 259 North Master Meter/Control Valve Building. Complete in Place.</b>	LS	1		
20	<b>Cash Allowance – SCADA System Improvements. Complete in Place.</b>	LS	1	\$20,843.00	\$20,843.00

**AWARD OF CONTRACT will be based on the lowest responsible, responsive Bidder on the total of the BASE BID.**

**TOTAL AMOUNT BID: \_\_\_\_\_ Dollars and \_\_\_\_\_ (Cents)**

**(\$ \_\_\_\_\_ )**

Bidder acknowledges that (1) each Bid Unit Price includes an amount considered by Bidder to be adequate to cover Contractor’s overhead and profit for each separately identified item, and (2) estimated quantities are not guaranteed, and are solely for the purpose of comparison of Bids, and final payment for all unit price Bid items will be based on actual quantities, determined as provided in the Contract Documents.

**ARTICLE 6 – TIME OF COMPLETION**

6.01 Bidder agrees that the Work will be substantially complete within 425 calendar days after the date when the Contract Times commence to run as provided in Paragraph 4.01 of the General Conditions, and will be completed and ready for final payment in accordance with Paragraph 15.06 of the General Conditions within 455 calendar days after the date when the Contract Times commence to run.



6.02 Bidder accepts the provisions of the Agreement as to liquidated damages. Contractor and Owner recognize that time is of the essence of this Agreement and that Owner will suffer financial loss if the Work is not completed within the times specified in Paragraph 6.01 above, plus any extensions thereof allowed in accordance with Article 15 of the General Conditions. The parties also recognize the delays, expense, and difficulties involved in proving in a legal or arbitration proceeding the actual loss suffered by Owner if the Work is not completed on time. Accordingly, instead of requiring any such proof, Owner and Contractor agree that as liquidated damages for delay (but not as a penalty), Contractor shall pay Owner \$500 for each day that expires after the time specified in Paragraph 6.01 for Substantial Completion until the Work is substantially complete. After Substantial Completion, if Contractor shall neglect, refuse, or fail to complete the remaining Work within the Contract Time or any proper extension thereof granted by Owner, Contractor shall pay Owner \$500 for each day that expires after the time specified in Paragraph 6.01 for completion and readiness for final payment until the Work is completed and ready for final payment.

#### ARTICLE 7 – ATTACHMENTS TO THIS BID

- 7.01 The following documents are submitted with and made a condition of this Bid:
- A. Required Bid security SECTION 00430 EJCDC C-430;
  - B. List of Proposed Subcontractors;
  - C. List of Proposed Suppliers;
  - D. List of Project References;
  - E. Evidence of authority to do business in the state of the Project; or a written covenant to obtain such license within the time for acceptance of Bids;
  - F. Contractor's License No.: \_\_\_\_\_ [or] Evidence of Bidder's ability to obtain a State Contractor's License and a covenant by Bidder to obtain said license within the time for acceptance of Bids;
  - G. Required Bidder Qualification Statement with supporting data.
  - H. If Bid amount exceeds \$10,000, signed Compliance Statement (RD 400-6). Refer to specific equal opportunity requirements set forth in paragraph 18.10 of the General Conditions;
  - I. If Bid amount exceeds \$25,000, signed Certification Regarding Debarment, Suspension, Ineligibility and Voluntary Exclusion - Lower Tier Covered Transactions (AD-1048);
  - J. If Bid amount exceeds \$100,000, signed RD Instruction 1940-Q, Exhibit A-1, Certification for Contracts, Grants, and Loans. Refer to paragraph 18.11 of the General Conditions;
  - K. Manufacturer's Certification Letter (Exhibit D) on any approved "or equal" or substitute request to ensure compliance with AIS requirements and any subsequent statutes mandating domestic preference

#### ARTICLE 8 – DEFINED TERMS

- 8.01 The terms used in this Bid with initial capital letters have the meanings stated in the Instructions to Bidders, the General Conditions, and the Supplementary Conditions.

**ARTICLE 9 – BID SUBMITTAL**

**BIDDER:** *[Indicate correct name of bidding entity]*

By:

*[Signature]* \_\_\_\_\_

*[Printed name]* \_\_\_\_\_

*(If Bidder is a corporation, a limited liability company, a partnership, or a joint venture, attach evidence of authority to sign.)*

Attest:

*[Signature]* \_\_\_\_\_

*[Printed name]* \_\_\_\_\_

Title: \_\_\_\_\_

Submittal Date: \_\_\_\_\_

Address for giving notices:

\_\_\_\_\_  
\_\_\_\_\_  
\_\_\_\_\_

Telephone Number: \_\_\_\_\_

Fax Number: \_\_\_\_\_

Contact Name and e-mail address: \_\_\_\_\_  
\_\_\_\_\_

Bidder's License No.: \_\_\_\_\_

*(where applicable)*

**NOTE TO USER:** *Use in those states or other jurisdictions where applicable or required.*

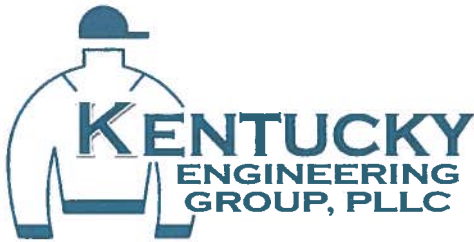

---

**ADDENDUM NO. 4**  
**East-West Interconnect Project – Phase 2**  
**Contract No. 6 – Distribution System Improvements**  
**Grayson County Water District**  
**Leitchfield, Grayson County, Kentucky**

**BID DATE:**                    **Thursday, January 19, 2023 - 11:00 a.m. (CST- Local Time)**

This Addendum No. 4 and its noted revisions and attachments to the Drawings and Specifications shall supplement, amend, and become a part of the Bidding Documents, Drawings, and Specifications. All Bids and Construction Contracts shall be based on these modifications.

All Bids must be made on the required Bid Forms and must be fully completed and executed with original signatures and corporate seals. All Bid Bonds must be original forms and accompanied by the required certificates, original signatures, and seals. Any Bids without original documents, or a conditional or qualified Bid, will not be accepted.

**CONTRACT NO. 6 - ADDENDUM ITEMS:**

The bid opening is scheduled for **Thursday, January 19, 2023 at 11:00 am local time** at the offices of the Grayson County Water District.

After the bid opening Kentucky Engineering Group will review the bids and a bid tabulation will be created and distributed to all bidding contractors.

**SPECIFICATIONS**

**ITEM AD4-1                    SECTION 00410 BID FORM – Part 1 – Revised Bid Form**, the attached form shall be used when submitting a bid on this project.

**PLANS**

**ITEM AD4-2                    ALL PLAN SHEETS** – Any reference to PVC Pipe Class 250, SDR 17 shall be changed to AWWA C900, DR 18.

**KENTUCKY ENGINEERING GROUP, PLLC**

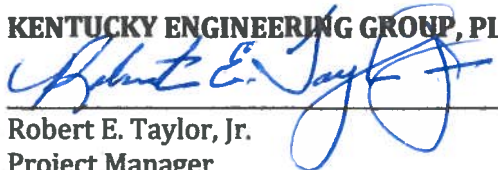

---

Robert E. Taylor, Jr.  
Project Manager

January 12, 2023

# BID FORM

## East-West Interconnect Project – Phase 2 CONTRACT NO. 6 – WATER DISTRIBUTION SYSTEM IMPROVEMENTS PROJECT Grayson County Water District

### ARTICLE 1 – BID RECIPIENT

This Bid is submitted to:

**GRAYSON COUNTY WATER DISTRICT**

**21 Shull White Road**

**Leitchfield, Kentucky 42754**

- 1.01 The undersigned Bidder proposes and agrees, if this Bid is accepted, to enter into an Agreement with Owner in the form included in the Bidding Documents to perform all Work as specified or indicated in the Bidding Documents for the prices and within the times indicated in this Bid and in accordance with the other terms and conditions of the Bidding Documents.

### ARTICLE 2 – BIDDER’S ACKNOWLEDGEMENTS

- 2.01 Bidder accepts all of the terms and conditions of the Instructions to Bidders, including without limitation those dealing with the disposition of Bid security. This Bid will remain subject to acceptance for 90 days after the Bid opening, or for such longer period of time that Bidder may agree to in writing upon request of Owner.

### ARTICLE 3 – BIDDER’S REPRESENTATIONS

3.01 In submitting this Bid, Bidder represents that:

- A. Bidder has examined and carefully studied the Bidding Documents, and any data and reference items identified in the Bidding Documents, and hereby acknowledges receipt of the following Addenda:

<u>Addendum No.</u>	<u>Addendum, Date</u>
_____	_____
_____	_____
_____	_____
_____	_____

- B. Bidder has visited the Site, conducted a thorough, alert visual examination of the Site and adjacent areas, and become familiar with and satisfied itself as to the general, local, and Site conditions that may affect cost, progress, and performance of the Work.
- C. Bidder is familiar with and has satisfied itself as to all Laws and Regulations that may affect cost, progress, and performance of the work and including all AIS requirements.
- D. Bidder has carefully studied all: (1) reports of explorations and tests of subsurface conditions at or adjacent to the Site and all drawings of physical conditions relating to

EJCDC® C-410, Bid Form for Construction Contracts.

Copyright © 2013 National Society of Professional Engineers, American Council of Engineering Companies, and American Society of Civil Engineers. All rights reserved.

existing surface or subsurface structures at the Site that have been identified in the Supplementary Conditions, especially with respect to Technical Data in such reports and drawings, and (2) reports and drawings relating to Hazardous Environmental Conditions, if any, at or adjacent to the Site that have been identified in the Supplementary Conditions, especially with respect to Technical Data in such reports and drawings.

- E. Bidder has considered the information known to Bidder itself; information commonly known to contractors doing business in the locality of the Site; information and observations obtained from visits to the Site; the Bidding Documents; and any Site-related reports and drawings identified in the Bidding Documents, with respect to the effect of such information, observations, and documents on (1) the cost, progress, and performance of the Work; (2) the means, methods, techniques, sequences, and procedures of construction to be employed by Bidder; and (3) Bidder's safety precautions and programs.
- F. Bidder agrees, based on the information and observations referred to in the preceding paragraph, that no further examinations, investigations, explorations, tests, studies, or data are necessary for the determination of this Bid for performance of the Work at the price bid and within the times required, and in accordance with the other terms and conditions of the Bidding Documents.
- G. Bidder is aware of the general nature of work to be performed by Owner and others at the Site that relates to the Work as indicated in the Bidding Documents.
- H. Bidder has given Engineer written notice of all conflicts, errors, ambiguities, or discrepancies that Bidder has discovered in the Bidding Documents, and confirms that the written resolution thereof by Engineer is acceptable to Bidder.
- I. The Bidding Documents are generally sufficient to indicate and convey understanding of all terms and conditions for the performance and furnishing of the Work.
- J. The submission of this Bid constitutes an incontrovertible representation by Bidder that Bidder has complied with every requirement of this Article, and that without exception the Bid and all prices in the Bid are premised upon performing and furnishing the Work required by the Bidding Documents.

#### **ARTICLE 4 – BIDDER'S CERTIFICATION**

##### **4.01 Bidder certifies that:**

- A. This Bid is genuine and not made in the interest of or on behalf of any undisclosed individual or entity and is not submitted in conformity with any collusive agreement or rules of any group, association, organization, or corporation;
- B. Bidder has not directly or indirectly induced or solicited any other Bidder to submit a false or sham Bid;
- C. Bidder has not solicited or induced any individual or entity to refrain from bidding; and
- D. Bidder has not engaged in corrupt, fraudulent, collusive, or coercive practices in competing for the Contract. For the purposes of this Paragraph 4.01.D:
  - 1. "corrupt practice" means the offering, giving, receiving, or soliciting of any thing of value likely to influence the action of a public official in the bidding process;
  - 2. "fraudulent practice" means an intentional misrepresentation of facts made (a) to influence the bidding process to the detriment of Owner, (b) to establish bid prices at

artificial non-competitive levels, or (c) to deprive Owner of the benefits of free and open competition;

3. "collusive practice" means a scheme or arrangement between two or more Bidders, with or without the knowledge of Owner, a purpose of which is to establish bid prices at artificial, non-competitive levels; and
4. "coercive practice" means harming or threatening to harm, directly or indirectly, persons or their property to influence their participation in the bidding process or affect the execution of the Contract.

**ARTICLE 5 – BASIS OF BID**

5.01 Bidder will complete the Work in accordance with the Contract Documents for the following unit price(s):

**BID SCHEDULE**

Item No.	Description	Unit	Estimated Quantity	Bid Unit Price	Bid Price
1	16-inch Water Main, PVC Pipe, C900 DR 18 with all appurtenances and fittings. Complete in Place.	LF	23,200		
2	12-inch Water Main, PVC Pipe, C900 DR 18 with all appurtenances and fittings. Complete in Place.	LF	26,020		
3	8-inch Water Main, PVC Pipe, C900 DR 18 with all appurtenances and fittings.	LF	6,155		
4	Directional Boring with 18" HDPE Pipe DR 11 for Water Main. Complete in Place.	LF	480		
5	Directional Boring with 14" HDPE Pipe DR 9 for Water Main. Complete in Place.	LF	260		
6	Directional Boring with 10" HDPE Pipe DR 9 for Water Main. Complete in Place.	LF	320		
7	Directional Boring with 8" HDPE Pipe DR 9 for Water Main. Complete in Place.	LF	100		
8	Railroad Bore with 8" HDPE Pipe DR 9 for Water Main with 16" Steel Casing Pipe Complete in Place.	LF	100		
9	Highway Bore with 24" Steel Casing Pipe Complete in Place.	LF	250		
10	Highway Bore with 20" Steel Casing Pipe Complete in Place.	LF	330		

11	<b>12-inch Gate Valve and Box. Complete in Place.</b>	EA	8		
12	<b>8-inch Gate Valve and Box. Complete in Place.</b>	EA	4		
13	<b>16-inch Gate Valve and Box w/Bypass Meter. Complete in Place.</b>	EA	3		
14	<b>12-inch Gate Valve and Box w/Bypass Meter. Complete in Place.</b>	EA	2		
15	<b>8-inch Gate Valve and Box w/Bypass Meter. Complete in Place.</b>	EA	2		
16	<b>Wet Tap Connection to Existing Water Main, Including Tapping Sleeve and Valve, Complete in Place.</b>	EA	4		
17	<b>Connection to Existing Water Main Complete in Place.</b>	EA	3		
18	<b>Flushing Hydrant Assembly including gate valve. Complete in Place</b>	EA	9		
19	<b>KY 259 North Master Meter/Control Valve Building. Complete in Place.</b>	LS	1		
20	<b>Cash Allowance – SCADA System Improvements. Complete in Place.</b>	LS	1	\$20,843.00	\$20,843.00

**AWARD OF CONTRACT will be based on the lowest responsible, responsive Bidder on the total of the BASE BID.**

**TOTAL AMOUNT BID: \_\_\_\_\_ Dollars and \_\_\_\_\_ (Cents)**

**(\$ \_\_\_\_\_ )**

Bidder acknowledges that (1) each Bid Unit Price includes an amount considered by Bidder to be adequate to cover Contractor's overhead and profit for each separately identified item, and (2) estimated quantities are not guaranteed, and are solely for the purpose of comparison of Bids, and final payment for all unit price Bid items will be based on actual quantities, determined as provided in the Contract Documents.

**ARTICLE 6 – TIME OF COMPLETION**

6.01 Bidder agrees that the Work will be substantially complete within 425 calendar days after the date when the Contract Times commence to run as provided in Paragraph 4.01 of the General Conditions, and will be completed and ready for final payment in accordance with Paragraph 15.06 of the General Conditions within 455 calendar days after the date when the Contract Times commence to run.

6.02 Bidder accepts the provisions of the Agreement as to liquidated damages. Contractor and Owner recognize that time is of the essence of this Agreement and that Owner will suffer financial loss if the Work is not completed within the times specified in Paragraph 6.01 above, plus any extensions thereof allowed in accordance with Article 15 of the General Conditions. The parties also recognize the delays, expense, and difficulties involved in proving in a legal or arbitration proceeding the actual loss suffered by Owner if the Work is not completed on time. Accordingly, instead of requiring any such proof, Owner and Contractor agree that as liquidated damages for delay (but not as a penalty), Contractor shall pay Owner \$500 for each day that expires after the time specified in Paragraph 6.01 for Substantial Completion until the Work is substantially complete. After Substantial Completion, if Contractor shall neglect, refuse, or fail to complete the remaining Work within the Contract Time or any proper extension thereof granted by Owner, Contractor shall pay Owner \$500 for each day that expires after the time specified in Paragraph 6.01 for completion and readiness for final payment until the Work is completed and ready for final payment.

#### **ARTICLE 7 – ATTACHMENTS TO THIS BID**

- 7.01 The following documents are submitted with and made a condition of this Bid:
- A. Required Bid security SECTION 00430 EJCDC C-430;
  - B. List of Proposed Subcontractors;
  - C. List of Proposed Suppliers;
  - D. List of Project References;
  - E. Evidence of authority to do business in the state of the Project; or a written covenant to obtain such license within the time for acceptance of Bids;
  - F. Contractor's License No.:  [or] Evidence of Bidder's ability to obtain a State Contractor's License and a covenant by Bidder to obtain said license within the time for acceptance of Bids;
  - G. Required Bidder Qualification Statement with supporting data.
  - H. If Bid amount exceeds \$10,000, signed Compliance Statement (RD 400-6). Refer to specific equal opportunity requirements set forth in paragraph 18.10 of the General Conditions;
  - I. If Bid amount exceeds \$25,000, signed Certification Regarding Debarment, Suspension, Ineligibility and Voluntary Exclusion - Lower Tier Covered Transactions (AD-1048);
  - J. If Bid amount exceeds \$100,000, signed RD Instruction 1940-Q, Exhibit A-1, Certification for Contracts, Grants, and Loans. Refer to paragraph 18.11 of the General Conditions;
  - K. Manufacturer's Certification Letter (Exhibit D) on any approved "or equal" or substitute request to ensure compliance with AIS requirements and any subsequent statutes mandating domestic preference

#### **ARTICLE 8 – DEFINED TERMS**

- 8.01 The terms used in this Bid with initial capital letters have the meanings stated in the Instructions to Bidders, the General Conditions, and the Supplementary Conditions.



**ARTICLE 9 – BID SUBMITTAL**

**BIDDER:** *[Indicate correct name of bidding entity]*

By:

*[Signature]* \_\_\_\_\_

*[Printed name]* \_\_\_\_\_

*(If Bidder is a corporation, a limited liability company, a partnership, or a joint venture, attach evidence of authority to sign.)*

Attest:

*[Signature]* \_\_\_\_\_

*[Printed name]* \_\_\_\_\_

Title: \_\_\_\_\_

Submittal Date: \_\_\_\_\_

Address for giving notices:

\_\_\_\_\_  
\_\_\_\_\_  
\_\_\_\_\_

Telephone Number: \_\_\_\_\_

Fax Number: \_\_\_\_\_

Contact Name and e-mail address: \_\_\_\_\_  
\_\_\_\_\_

Bidder's License No.: \_\_\_\_\_

*(where applicable)*

**NOTE TO USER:** *Use in those states or other jurisdictions where applicable or required.*