

**Joint Reliability Coordination Agreement  
Among and Between  
PJM Interconnection, L.L.C.,  
Tennessee Valley Authority, and Louisville  
Gas and Electric Company and Kentucky  
Utilities Company**

June 5, 2023

**TABLE OF CONTENTS**

ARTICLE ONE:	RECITALS
ARTICLE TWO:	ABBREVIATIONS, ACRONYMS, AND DEFINITIONS
ARTICLE THREE:	OVERVIEW AND ADMINISTRATION
ARTICLE FOUR:	EXCHANGE OF INFORMATION AND DATA
ARTICLE FIVE:	AVAILABLE TRANSFER CAPABILITY CALCULATIONS AND RECIPROCAL COORDINATION OF FLOWGATES
ARTICLE SIX:	COORDINATION OF SCHEDULED OUTAGES
ARTICLE SEVEN:	PRINCIPLES CONCERNING JOINT OPERATIONS IN EMERGENCIES
ARTICLE EIGHT:	COORDINATED REGIONAL TRANSMISSION EXPANSION PLANNING
ARTICLE NINE:	JOINT CHECKOUT PROCEDURES
ARTICLE TEN:	ADDITIONAL COORDINATION PROVISIONS
ARTICLE ELEVEN:	DISPUTE RESOLUTION PROCEDURES
ARTICLE TWELVE:	RETAINED RIGHTS OF PARTIES
ARTICLE THIRTEEN:	EFFECTIVE DATE, IMPLEMENTATION, TERM AND TERMINATION
ARTICLE FOURTEEN:	CONFIDENTIAL INFORMATION
ARTICLE FIFTEEN:	ADDITIONAL PROVISIONS
ATTACHMENT 1:	CONGESTION MANAGEMENT PROCESS

**Joint Reliability Coordination Agreement  
Among and Between  
PJM Interconnection, L.L.C.,  
Tennessee Valley Authority,  
Louisville Gas & Electric Company and  
Kentucky Utilities Company**

This Joint Reliability Coordination Agreement (“Agreement”) dated this 5<sup>th</sup> day of June, 2023, among and between PJM Interconnection, L.L.C. (“PJM”) a Delaware limited liability company having a place of business at 2750 Monroe Boulevard, Audubon, Pennsylvania 19403; Tennessee Valley Authority (“TVA”), a corporate entity existing under the Tennessee Valley Authority Act, 16 U.S.C. §§ 831-831ee; Louisville Gas and Electric Company, a Kentucky corporation (“LG&E”) and Kentucky Utilities Company, a Kentucky corporation (“KU”) (KU and LG&E are collectively referred to herein as “LG&E/KU”).

**ARTICLE ONE**  
**RECITALS**

WHEREAS, PJM is the regional transmission organization that provides operating and reliability functions in portions of the mid-Atlantic and Midwest States. PJM also administers an open access tariff for transmission and related services on its grid, and independently operates markets for day-ahead and real-time energy, and financially firm transmission rights;

WHEREAS, TVA is a transmission provider that provides operating and reliability functions in the TVA Reliability Coordinator Area and administers Transmission Service Guidelines for open access transmission and related services on its system. TVA is not subject to regulation by the Federal Energy Regulatory Commission (“FERC”) as a “public utility” under the Federal Power Act;

WHEREAS, LG&E/KU own, among other things, an integrated electric transmission system, over which they currently provide open access transmission service to customers in the LG&E/KU Balancing Authority Area (as defined in Section 1.5 of the LG&E and KU Joint Pro Forma Open Access Transmission Tariff, as on file with the FERC and as may be changed from time to time located within the TVA Reliability Coordinator area;

WHEREAS, FERC has ordered each regional transmission organization to develop mechanisms to address inter-regional coordination;

WHEREAS, PJM and TVA are parties to the Joint Reliability Coordination Agreement dated October 15, 2014;

WHEREAS, the Parties have agreed to revise and expand the Joint Reliability Coordination Agreement to include LG&E/KU and address coordinated Balancing Authority and Transmission Operator operations; and

WHEREAS, in accordance with Good Utility Practice, the Parties seek to establish or confirm other arrangements and protocols in furtherance of the reliability of their systems and efficient market operations, as provided under the terms and conditions of this Agreement, and to incorporate into this Agreement the data and information exchange to which they previously agreed as revised herein.

NOW, THEREFORE, for good and valuable consideration including the Parties’ mutual reliance upon the covenants contained herein, the Parties agree to amend and revise the Agreement to read as follows:

**ARTICLE TWO**  
**ABBREVIATIONS, ACRONYMS, AND DEFINITIONS**

**2.1 Abbreviations and Acronyms.**

**2.1.1** “ATC” shall mean Available Transfer Capability.

**2.1.2** “AFC” shall mean Available Flowgate Capability.

**2.1.3** “BA” shall mean Balancing Authority.

**2.1.4** “BAA” shall mean Balancing Authority Area.

**2.1.5** “BES” shall mean Bulk Electric System.

**2.1.6** “CBM” shall mean Capacity Benefit Margin.

**2.1.7** Reserved.

**2.1.8** “CTPS” shall mean Coordinated Transmission Planning Study.

**2.1.9** “EInet” shall mean the Electric Information network deployed by Eastern Interconnect Data Sharing Network, Inc.

**2.1.10** “EMS” shall mean the respective Energy Management Systems utilized by the Parties to manage the flow of energy within their Regions.

**2.1.11** “FERC” shall mean the Federal Energy Regulatory Commission or any successor agency thereto.

**2.1.12** Reserved.

**2.1.13** Reserved.

**2.1.14** “ICCP”, “ISN,” EInet and “ICCP/ISN” EInet shall mean those common communication protocols adopted to standardize information exchange.

**2.1.15** “IROL” shall mean Interconnection Reliability Operating Limit.

**2.1.16** “JPC” shall mean Joint Planning Committee.

**2.1.17** “kV” shall mean kilovolt of electric potential.

**2.1.18** “LSE” shall mean Load Serving Entity.

- 2.1.19** “MVAR” shall mean megavolt amp of reactive power.
- 2.1.20** “MW” shall mean megawatt of real power
- 2.1.21** “NAESB” shall mean the North American Energy Standards Board or its successor organization.
- 2.1.22** “NERC” shall mean the North American Electricity Reliability Corporation or successor organization.
- 2.1.23** “NSI” shall mean net scheduled interchange.
- 2.1.24** “OASIS” shall mean the Open Access Same-Time Information System required by FERC for the posting of market and transmission data on the Internet.
- 2.1.25** “OATT” shall mean the applicable open access transmission tariff of PJM or LG&E/KU.
- 2.1.26** “OC” shall refer to the Operating Committee under this Agreement.
- 2.1.27** “PSSE” shall mean Power System Simulator for Engineering.
- 2.1.28** “PTDF” shall mean Power Transfer Distribution Factor.
- 2.1.29** “RC” shall mean Reliability Coordinator.
- 2.1.30** “RCF” shall mean a Reciprocal Coordinated Flowgate.
- 2.1.31** “RTO” refers to Regional Transmission Organization as defined in FERC’s Order No. 2000, as applicable.
- 2.1.32** “SCADA” refers to a supervisory control and data acquisition system.
- 2.1.33** “SDX System” shall mean the system used by NERC to exchange system data.
- 2.1.34** “SOL” shall mean System Operating Limit.
- 2.1.35** “TFC” shall mean Total Flowgate Capability.
- 2.1.36** “TLR” shall mean Transmission Loading Relief.
- 2.1.37** “TOP” shall mean Transmission Operator.
- 2.1.38** “TRM” shall mean Transmission Reliability Margin.

- 2.2 Definitions.** Any undefined, capitalized term used in this Agreement that is not defined in this Section shall have the meaning given in the preamble of this Agreement or Attachment 1, the Congestion Management Process, shall have the meaning given under industry custom, and where applicable, in accordance with Good Utility Practice. It is the intent of the Parties that any capitalized term used in this Agreement that is not otherwise defined herein and that is defined in the Glossary of Terms Used in NERC Reliability Standards shall have the same meaning as defined in the Glossary of Terms Used in NERC Reliability Standards.
- 2.2.1** “Affected System” shall mean the electric system of the Party other than the Party to which a request for interconnection or long-term firm delivery service is made and that may be affected by the proposed service.
- 2.2.2** “Agreement” shall mean this document, as amended from time to time, including all attachments, appendices, and schedules.
- 2.2.3** “Allocation” shall mean a calculated share of capability on a Reciprocal Coordinated Flowgate to be used by Reciprocal Entities when coordinating AFC, transmission sales, and dispatch of generation resources.
- 2.2.4** Reserved.
- 2.2.5** “Attaining Balancing Authority Area” of “Attaining BAA” shall mean the Balancing Authority Area of the Attaining Balancing Authority.
- 2.2.6** “Attaining Reliability Coordinator” or “Attaining RC” shall mean the Reliability Coordinator for the Attaining Balancing Authority.
- 2.2.7** “Attaining Transmission Operator” or “Attaining TOP” shall mean the entity that operates or directs operations for the reliability of the Attaining BAA transmission system.
- 2.2.8** Reserved.
- 2.2.9** Reserved.
- 2.2.10** Reserved.
- 2.2.11** Reserved.
- 2.2.12** Reserved.
- 2.2.13** “Confidential Information” shall have the meaning stated in Section 14.1.

- 2.2.14** “Congestion Management Process” shall mean the Congestion Management Process document attached hereto as Attachment 1 and incorporated herein, as it may be amended, revised, or restated from time to time.
- 2.2.15** “Coordinated Flowgate” shall mean a Flowgate impacted by an Operating Entity as determined by one of the five studies detailed in Section 3 of the Congestion Management Process. For a Market-Based Operating Entity, these Flowgates shall be subject to the requirements under the Congestion Management portion of the Congestion Management Process (Sections 4 and 5). A Coordinated Flowgate may be under the operational control of a Third Party.
- 2.2.16** “Coordinated Transmission Planning Study” shall have the meaning stated in Section 8.4.5.
- 2.2.17** “Designated Network Resource” shall mean a resource that has been identified as a designated network resource pursuant to the PJM or LG&E/KU tariffs or Transmission Service Guidelines.
- 2.2.18** “Delivery Year” shall have the meaning in the PJM Governing Documents.
- 2.2.19** “Effective Date” shall have the meaning stated in Section 13.1
- 2.2.20** “Extra High Voltage” shall mean voltages of 230 KV and above.
- 2.2.21** “Facilities Study” shall mean an engineering study conducted to determine the required modifications to the Transmission Owner’s or Transmission Provider’s Transmission System, including the cost and scheduled completion date for such modifications that shall be required to provide the requested transmission service.
- 2.2.22** “Firm Flow” shall mean the estimated impacts of firm transmission service on a particular Coordinated Flowgate.
- 2.2.23** “Firm Flow Limit” shall mean the maximum value of Firm Flows an entity can have on a Coordinated Flowgate based on the procedures defined in Sections 4 and 5 of the Congestion Management Process.
- 2.2.24** “Flowgate” shall mean a representative modeling of facilities or groups of facilities that may act as significant constraint points on the regional system.
- 2.2.25** “Good Utility Practice” shall mean any of the practices, methods, and acts engaged in or approved of by a significant portion of the electric utility industry during the relevant time period, or any of the practices, methods, and acts which, in the exercise of reasonable judgment in light of the facts known at the time the decision was made, could have been expected to accomplish the desired result at a reasonable cost consistent with good business practices, reliability, safety, and expedition. Good Utility Practice is not intended to be limited to the optimum



practice, method, or act to the exclusion of all others, but rather to be acceptable practices, methods, and acts generally accepted in the region.

- 2.2.26** “Governing Document” shall mean the PJM Open Access Transmission Tariff, the PJM Operating Agreement, the PJM Consolidated Transmission Owners Agreement, the PJM Reliability Assurance Agreement, or any other applicable agreement approved by the FERC and intended to govern the relationship by and among PJM and any of its members or market participants, or the LG&E/KU OATT and any appendices or attachments thereto, as applicable.
- 2.2.27** “Governmental Authority” shall mean any federal, state, regional, local, or foreign court, tribunal, government, governmental agency, military, governmental or regulatory body (including any stock exchange, automated quotation system, or self-regulatory body), or authority over the transmission and/or generation facilities of a Party or the Parties, but shall exclude TVA in its capacity as a Party under this Agreement but shall not exclude TVA in any other capacity.
- 2.2.28** “Intellectual Property” shall mean (i) ideas, designs, concepts, techniques, inventions, discoveries, or improvements, regardless of patentability, but including without limitation patents, patent applications, mask works, trade secrets, and know-how; (ii) works of authorship, regardless of copyright ability, including copyrights, and any moral rights recognized by law; and (iii) any other similar rights, in each case on a worldwide basis.
- 2.2.30** “Joint Planning Committee” shall have the meaning referred to in Section 8.2
- 2.2.31** Reserved.
- 2.2.32** “Market-Based Operating Entity” shall mean an Operating Entity that operates a security constrained, bid-based economic dispatch bounded by a clearly defined market area.
- 2.2.33** Reserved.
- 2.2.34** “NAESB Business Practices” shall mean the NAESB business practice standards approved by FERC as mandatory for each electric public utility.
- 2.2.36** “Native Balancing Authority Area” or “Native BAA” shall mean the Balancing Authority Area of the Native Balancing Authority.
- 2.2.37** “Native Reliability Coordinator” or “Native RC” shall mean the Reliability Coordinator for the transmission system where the Pseudo-Tied unit is physically located.
- 2.2.38** “Native Transmission Operator” or “Native TOP” shall mean the entity that operates or directs operations for the reliability of the local transmission system where the pseudo-tied unit is physically located.

**2.2.39** “NERC Compliance Registry” shall mean the official list maintained by NERC of all organizations required to comply with the Reliability Standards approved by FERC.

**2.2.40** “Network Upgrades” shall have the meanings as defined in the PJM and LG&E/KU tariffs or the TVA Transmission Service Guidelines.

**2.2.41** “Notice” shall have the meaning stated in Section 15.11.

**2.2.42** “Operating Committee” shall have the meaning stated in Section 3.2

**2.2.43** “Operating Entity” shall mean an entity that operates and controls a portion of the Bulk Electric System with the goal of ensuring reliable energy interchange between generators, loads, and other operating entities.

**2.2.44** “Outages” shall mean the planned or unplanned unavailability of transmission and/or generation facilities.

**2.2.45** “Party” or “Parties” refers to each party to this Agreement or all, as applicable.

**2.2.46** “Pseudo-Tied Unit” shall mean a generating unit for which a Pseudo-Tie is implemented.

**2.2.47** “Reciprocal Coordinated Flowgate” shall mean a Flowgate that is subject to reciprocal coordination by Operating Entities, under either this Agreement (with respect to the Parties only) or a Reciprocal Coordination Agreement between one or more Parties and one or more Third Party Operating Entities. An RCF is:

- A Coordinated Flowgate that is (a) (i) within the operational control of a Reciprocal Entity or (ii) may be subject to the supervision of a Reciprocal Entity as a RC, and (b) affected by the transmission of energy by the Parties or by one of the Parties and one or more Reciprocal Entities; or
- A Coordinated Flowgate that is (a) affected by the transmission of energy by one or both Parties and one or more Third Party Operating Entities, and (b) expressly made subject to Congestion Management Process reciprocal coordination procedures under a Reciprocal Coordination Agreement between or among such Parties and Third Party Operating Entities; or
- A Coordinated Flowgate that is designated by agreement of the Parties as an RCF.

**2.2.48** “Reciprocal Coordination Agreement” shall mean an agreement between Operating Entities to implement the reciprocal coordination procedures defined in the Congestion Management Process.

**2.2.49** “Reciprocal Entity” shall mean an Operating Entity that coordinates the future-looking management of Flowgate capability in accordance with a Reciprocal Coordination Agreement.

**2.2.50** Reserved.

**2.2.51** Reserved.

**2.2.52** Reserved.

**2.2.53** “SCADA Data” shall mean the electric system data that is used to monitor the electrical state of facilities, as specified in NERC policies and procedures.

**2.2.54** “Scheduled Outages” shall mean the planned unavailability of transmission and/or generation facilities dispatched by a Party, as described in Article Six of this Agreement, and do not include forced or other unplanned outages.

**2.2.55** “System Impact Study” shall mean an engineering study that evaluates the impact of a proposed interconnection or transmission service request on the safety and reliability of a transmission system and, if applicable, an Affected System. The study shall identify and detail the system impacts that would result if the generating facility were interconnected or transmission service commenced without project modifications or system modifications.

**2.2.56** Reserved.

**2.2.57** “Third Party” shall mean any entity other than a Party to this Agreement.

**2.2.58** “Third Party Operating Entity” shall refer to a Third Party entity that operates and controls a portion of the Bulk Electric System with the goal of ensuring reliable energy interchange between generators, loads, and other operating entities.

**2.2.59** Reserved.

**2.2.60** “Transmission Loading Relief” shall mean the procedures used in the Eastern Interconnection as specified in NERC Reliability Standard IRO-006 and the NAESB Business Practice WEQ-008.

**2.2.61** Reserved.

**2.2.62** Reserved.

**2.2.63** Reserved.

**2.2.64** “Transmission Service Guidelines” shall mean the TVA Transmission Service Guidelines, as amended, revised, or restated from time to time. For the purposes of this Agreement, Transmission Service Guidelines also includes TVA Large and Small Generator Interconnection Procedures as applicable.

**2.2.65** “Transmission Service Provider” shall mean the entity that administers the applicable transmission tariff or Transmission Service Guidelines of the Parties and provides transmission service to transmission customers under applicable transmission service agreements.

**2.2.66** “Transmission System Emergencies” shall mean Emergency conditions where there is the potential, either imminently or for the next contingency, for system instability or cascading, or for equipment loading or voltages significantly beyond applicable operating limits, such that stability of the transmission system cannot be assured, or to prevent a condition or situation that in the judgment of a Party is imminently likely to endanger life or property.

**2.2.67** “Voltage and Reactive Power Coordination Procedures” shall have the meaning given under Article Ten.

### **2.3 Rules of Construction.**

**2.3.1 No Interpretation Against Drafter.** Each Party participated in the drafting of this Agreement and each Party agrees that no rule of construction or interpretation against the drafter shall be applied to the construction or the interpretation of this Agreement.

**2.3.2 Incorporation of Preamble and Recitals.** The Preamble and Recitals of this Agreement are incorporated into the terms and conditions of this Agreement and made a part thereof.

**2.3.3 Rules of Interpretation.** Defined terms in the singular shall include the plural and vice versa, and the masculine, feminine, or neuter gender shall include all genders. Whenever the words “include,” “includes,” or “including” are used in this Agreement, they are not limiting and have the meaning as if followed by the words “without limitation.” The word “Section” refers to the applicable section of this Agreement and, unless otherwise stated, includes all subsections thereof. The word “Article” refers to articles of this Agreement.

**2.3.4 NERC Reliability Standards.** All activities under this Agreement shall be conducted in a manner that meets or exceeds the applicable Reliability Standards approved by FERC, as such Reliability Standards may be revised from time to time.

**2.3.5 NAESB Business Practices.** All activities under this Agreement shall be conducted in a manner that meets or exceeds the applicable NAESB Business Practices approved by FERC and incorporated into FERC’s regulations, as such

NAESB Business Practices may be revised from time to time. TVA incorporates NAESB Business Practices as stated in their Transmission Service Guidelines to the extent they are not inconsistent with TVA's obligations under the TVA Act.

**2.3.6 Good Utility Practice.** The Parties shall conduct all activities under this Agreement consistent with Good Utility Practice.

**2.3.7 Geographic Scope.** Each Party shall perform this Agreement with respect to each BA for which the Party serves as Transmission Service Provider, and with respect to each BA for which it serves as RC, provided that a Party be required to perform this Agreement with respect to a BA for which it serves as RC only to the extent that the applicable agreement under which it serves in that capacity permits such performance.

**ARTICLE THREE  
OVERVIEW AND ADMINISTRATION**

- 3.1 Overview and Scope of this Agreement.** This Agreement provides the following:
- 3.1.1** Arrangements for certain exchanges of information and the implementation of reliability and efficiency protocols between the Parties.
  - 3.1.2** The equitable and economical management of congestion on (a) Flowgates affected by flows of TVA, LG&E/KU, and PJM, or (b) in order to encourage and facilitate wide-spread use of the congestion management procedures by Third Parties, on Flowgates affected by the flows of a Party and any Third Party that, by executing a Reciprocal Coordination Agreement, binds itself to the congestion management procedures of this Agreement.
  - 3.1.3** Certain arrangements among all of the Parties for coordination of their systems.
  - 3.1.4** Certain arrangements among all of the Parties for administration of this Agreement.
- 3.2 Establishment and Functions of Operating Committee.** To administer the arrangements under this Agreement, the Parties shall establish an OC.
- 3.2.1** The OC shall have the following duties and responsibilities:
    - 3.2.1.1** Meet as necessary to address any issues associated with this Agreement that a Party may raise and to determine whether any changes to this Agreement, or procedures employed under this Agreement, would enhance coordination under this Agreement;
    - 3.2.1.2** Conduct additional meetings upon Notice given by any Party, provided that the Notice specifies the reason(s) for the requested meeting;
    - 3.2.1.3** Conduct dispute resolution in accordance with Article Eleven of this Agreement;
    - 3.2.1.4** Initiate process reviews at the request of any Party for activities undertaken in the performance of this Agreement;
    - 3.2.1.5** In its discretion, monitor, evaluate, and collaboratively seek to improve the Congestion Management Process; and
    - 3.2.1.6** In its discretion, take other actions, including the establishment of subcommittees and/or task forces, to address any issues that the OC deems necessary in the implementation of this Agreement.

**3.2.2 Operating Committee Representatives.** Upon execution of this Agreement, each Party shall designate a primary and alternate representative to the OC and shall inform the other Parties of its designated representatives by Notice. A Party may change its designated OC representatives at any time, provided that timely Notice is given to the other Parties. Each designated OC representative shall have the authority to make decisions on issues that arise during the performance of this Agreement. The costs and expenses associated with each Party's designated OC representatives shall be the responsibility of the designating Party.

**3.2.3 Limitations upon Authority of Operating Committee.** Any decision to implement new arrangements or protocols under this Agreement that a Party determines, in its sole discretion, would enhance its costs of performance materially, must be by unanimous consent of the Parties' OC representatives.

**3.3 Ongoing Review and Revisions.** The Parties have agreed to the terms and conditions of this Agreement as their respective systems exist and are contemplated as of the Effective Date. The Parties expect that these systems and technology applicable to those systems and to the collection and exchange of data will change from time to time throughout the term of this Agreement, including changes to the boundaries of a Party in its capacity as an RTO or BA, changes to the boundaries of, or identities of, BAs for which a Party serves as RC, changes or additions to transmission facilities for which the Party is a TOP, and changes to the BAs included in the security constrained, bid-based economic dispatch markets administered by PJM. The Parties agree that the objectives of this Agreement can be fulfilled only if the Parties, from time to time, review and, as appropriate, revise the requirements stated herein in response to changes, including deleting, adding, or revising requirements and protocols. Each Party shall negotiate in good faith in response to such revisions the other Parties may propose from time to time. Nothing in this Agreement, however, shall require a Party to reach agreement with respect to any such changes, or to purchase, install, or otherwise implement new equipment, software, or devices, or functions except as required to perform this Agreement.

**ARTICLE FOUR  
EXCHANGE OF INFORMATION AND DATA**

- 4.1 Exchange of Operating Data.** The Parties shall exchange the following types of data and information: (a) Real-time and projected operating data; (b) SCADA Data; and (c) Data used for EMS modeling. The frequency of exchange shall be as stated with respect to specific exchanges provided under this Article or, if no frequency is stated, then the frequency shall be as necessary or appropriate to support the purpose of the exchange. Nothing in this Agreement shall require a Party to provide or exchange information that it does not possess or cannot obtain.

To facilitate the exchange of all such data, each Party shall designate to each other a contact to be available twenty-four (24) hours each day, seven (7) days per week, and an alternate contact to act in the absence or unavailability of the primary contact, to respond to any inquiries. With respect to each contact and alternate, each Party shall provide the name, telephone number, e-mail address, and fax number. Each Party may change a designee from time to time by Notice to the other Parties.

The Parties agree to exchange data in a timely manner consistent with existing defined formats or such other formats to which the Parties may agree. If any required data exchange format has not been agreed upon as of the Effective Date, or if a Party determines that an agreed format should be revised, a Party shall give Notice of the need for an agreed format or revision and the Parties shall jointly seek to complete development of the format within thirty (30) days of such Notice.

Each Party shall provide the data with respect to all of its transmission customers and, to the extent that the Party is a Market-Based Operating Entity, all entities that participate in the markets it administers, during the term of the Agreement. PJM requests for LG&E/KU data and responses to LG&E/KU requests shall be provided by and requested through TVA as the RC for LG&E/KU, and provided by TVA to the PJM as requested.

**4.1.1 Real-Time and Projected Operating Data.**

**4.1.1.1** The Parties shall exchange the following information:

- (a) Real-time operating information:
  - (i) Generation status of the units in each RC's RC Area;
  - (ii) Transmission line status;
  - (iii) Real-time loads;
  - (iv) Scheduled use of reservations;
  - (v) TLR information, including calculation of Market Flows;
  - (vi) Generation block dispatch order to decrement/increment; as applicable



- (b) Projected operating information:
  - (i) Merit order for generators participating in each RC's RC Area;
  - (ii) Maintenance schedules for generators and transmission facilities in each Party's RC Area;
  - (iii) Transmission service reservations;
  - (iv) Independent power producer information including current operating level, projected operating levels, Scheduled Outage start and end dates;
  - (v) The planned and actual operational start-up dates for any permanently added, removed, or significantly altered transmission segments; and
  - (vi) The planned and actual start-up testing and operational start-up dates for any permanently added, removed, or significantly altered generation units.

**4.1.2 Exchange of SCADA Data.** With reference to NERC Reliability Standards TOP-003 (Operational Reliability Data) and IRO-010 (RC Data Specification and Collection) and the sharing of information necessary to perform Operational Planning Analyses, Real-time monitoring, and Real-time Assessments:

**4.1.2.1** The Parties shall exchange requested transmission power flows, measured bus voltages, and breaker equipment statuses of their transmission facilities via ICCP or EInet.

**4.1.2.2** Each Party shall accommodate, as soon as practical, another Party's request for additional existing ICCP/EInet transmission data points, but in any event, no more than two (2) weeks after the request has been submitted.

**4.1.2.3** Each Party shall respond to the another Party's request for additional, unavailable ICCP/EInet transmission data points as soon as practical but no later than two (2) weeks after the request has been submitted, with an expected availability target date for the requested data.

**4.1.2.4** The Parties shall comply with all confidentiality agreements executed by the Parties relating to ICCP/EInet data.

**4.1.2.5** The Parties shall exchange SCADA Data consisting of:

- (a) Status measurements 69 kV and above (breaker and switch statuses) (as available and required to observe for reliability as the respective Parties may determine);

- (b) Analog measurements 69 kV and above (flows and voltages) (as available and required to observe for reliability as the respective Parties may determine);
- (c) Generation point measurements, including generator output for each unit in MW and MVARs, as available;
- (d) Load point measurements, including bus loads, and specific loads at each substation in MW and MVARs, as available;
- (e) BAA net interchange;
- (f) Account for Pseudo-Tie in Actual Net Interchange term of respective Area Control Error calculations in accordance with currently effective Reliability Standard INT-009; and
- (g) Identification of other Real-time data available through ICCP/EInet.

**4.1.3 Models.** The Parties shall exchange their detailed EMS models once a quarterly basis in a mutually agreed upon format, and shall also exchange incremental model updates in a mutually agreed upon format as new data becomes available. The quarterly model exchange shall include the ICCP/ISN mapping files, all the necessary model parameters, identification of individual bus loads, seasonal equipment ratings, and one-line drawings that shall be used to expedite the model update process. The Parties shall also exchange updates that represent the incremental changes that have occurred to the EMS model since the most recent update. In addition, PJM and TVA should exchange ICCP/ISN EInet mapping files on monthly basis in a mutually agreed upon format to reflect metering and ICCP data changes. Incremental updates that would affect the Wide-Area view of the neighboring entity's RC Area should occur in time to ensure all other affected parties can update their models in accordance with their modeling update deadlines.

**4.1.3.1 Pseudo-Tie Requirements:** The Native BA and the Attaining BA shall coordinate unit modeling with respect to the rules of the Native BAA and Attaining BAA for modeling a Pseudo-tie. If the Native BA and Attaining BA do not have this information, modeling data shall be requested from the entity seeking to pseudo-tie the generating unit. This includes coordination of specific technical details for each Pseudo-tie no less than 45 days prior to the Pseudo-Tie in-service date and prior to NAESB Web Registry submission. Article Ten provides more detail on Pseudo-tie requirements.

**4.2 Cost of Data and Information Exchange.** Each Party shall bear its own cost of providing the data and information to the other Parties as required under this Article Four and otherwise under this Agreement.

**ARTICLE FIVE**  
**AVAILABLE TRANSFER CAPABILITY CALCULATIONS AND RECIPROCAL**  
**COORDINATION OF FLOWGATES**

- 5.1 Available Transfer Capability.** The Parties shall be governed by and be in accordance with each Party's Available Transfer Capability Implementation Document. The most up-to-date Available Transfer Capability Implementation Document and associated ATC documents shall be placed on each Party's OASIS for sharing.
- 5.2 Identification of Flowgates.** Each Party shall consider in its TFC and AFC determination process all Flowgates as required under the NERC Reliability Standards. As determined in accordance with Section 3 of the Congestion Management Process, Flowgates that have a response factor equal to or greater than the distribution factor cut-off must be included in the evaluating Party's model to the extent inclusion is practical.
- 5.3 Reciprocal Coordination of Flowgates Operating Protocols.**
- 5.3.1 Obligations to Respect Capability Calculations Applicable to Coordinated Flowgates and Allocations Applicable to RCFs.** Each Party shall respect the other Parties' determinations of AFC and calculations of firmness (firm, non-firm, network, non-firm hourly) for Real-time operations applicable to the other Parties' Coordinated Flowgates. Additionally, each Party shall respect the Allocations defined by the Allocation process set forth in the Congestion Management Process. Due to the provisions of the Tennessee Valley Authority Act, notwithstanding any other provisions of this Agreement, TVA cannot be required to redispatch generation, to the extent that such redispatch involves the sale of energy, to PJM under any circumstances. Any redispatch provided by TVA shall be provided to eligible Third Parties under separate agreements.
- 5.3.2 Coordination Process for Reciprocal Coordinated Flowgates.** The Parties shall maintain the process and timing for exchanging their respective AFC calculations, and Firm Flow calculations/Allocations with respect to all RCFs. The process will allocate Flowgate capability on a future-looking basis, including the allocation of firm capability for use in both internal dispatch and sale of transmission service. The Congestion Management Process sets forth the procedure for reciprocal coordination. For any controllable Flowgate, the historically determined Firm Flow on the Flowgate and any allocated rights to that Flowgate under this process are subject to the operating practices of the controllable device. The operating practices of the controllable device will be made available to each Party before a change is made. To the extent the controllable device is able to maintain the schedule across the controllable Flowgate, there are no parallel flows and a historical allocation based on parallel flows will not occur. In this instance, the use of the controllable Flowgate will be limited to entities that have arranged transmission service across the interface formed by the controllable device. To the extent the controllable

device cannot maintain the schedule across the controllable Flowgate, there will be a historical allocation based on parallel flows.

- 5.3.3 Real-Time Operations Process.** The Parties' capabilities and Real-time actions, and those of any Reciprocal Entities, shall be governed by and be in accordance with the Congestion Management Process.
- 5.4 Costs Arising From Reciprocal Coordination of Flowgates.** Each Party and Reciprocal Entity shall bear its own costs, if any, of compliance with the Congestion Management Process and this Article.
- 5.5 Maintaining Current Flowgate Models.** For operations and operational planning purposes, each Party will maintain a detailed model of those portions of the other Parties' systems with respect to which a Party is required to respect the other Parties' Coordinated Flowgates, or with respect to which the Party has received Allocations. On an ongoing basis, each Party will populate its model with credible data and will keep such models up-to-date.

**ARTICLE SIX  
COORDINATION OF SCHEDULED OUTAGES**

**6.1 Operating Protocols for Coordinating Scheduled Outages.** The Parties have an interregional outage coordination process for coordinating transmission and generation Scheduled Outages to ensure reliability. The following provisions shall govern with respect to transmission and generation Scheduled Outage coordination.

**6.1.1 Exchange of Transmission and Generation Scheduled Outage Data.** Upon a Party's request, the projected status of generation and transmission availability shall be communicated among the Parties. The Parties shall exchange the most current information on proposed Scheduled Outage information and provide a timely response on potential impacts of proposed Scheduled Outages.

The Parties share this information promptly upon its availability, but no less than daily and more often as required by system conditions. The Parties shall utilize a mutually agreed upon format for the exchange of this information, which includes the owning Party's facility name; proposed Scheduled Outage start date and time; proposed facility return date and time; date and time when a response is needed from the impacted Party to modify the proposed schedule; and any other information that may be relevant to the reliability assessment.

Each Party shall also provide information independently on approved and anticipated Scheduled Outages formatted as required for the SDX System.

**6.1.2 Evaluation and Coordination of Transmission and Generation Scheduled Outages.** Each Party shall utilize network applications to analyze planned critical facility maintenance to determine the effects on the reliability of the transmission system. Each Party's Scheduled Outage analysis shall consider the impact of its critical Scheduled Outages on the other Parties' system reliability, in addition to its own. The analysis shall include, at a minimum, an evaluation of contingencies including potential real or reactive power concerns; voltage analysis; and real and reactive power reserve analysis.

On a weekly basis, but daily if requested by a Party acting as RC, the operations staffs of the RCs shall jointly discuss any Scheduled Outages to identify potential impacts. These discussions shall include an indication of either concurrence with the Scheduled Outage or identify significant potential impact due to the Scheduled Outage as scheduled. No Party has the authority to cancel the other Parties' Scheduled Outage (except transmission facilities interconnecting the Parties' transmission systems). However, the Parties shall work together to resolve any identified Scheduled Outage conflicts. Consideration shall be given to Scheduled Outage submittal times and Scheduled Outage criticality when addressing conflicts. If analysis of Scheduled Outages indicates unacceptable system conditions, the Parties shall work with one another and the facility owner(s), as necessary, to

provide remedial steps to be taken in advance of proposed maintenance. If an operating procedure cannot be developed, and a change to the proposed schedule is necessary based on significant impact, the Parties shall discuss the facts involved, and make every effort to effect the requested schedule change. If this change cannot be accommodated, the Party with the Scheduled Outage shall notify the impacted Party. A request to adjust a proposed Scheduled Outage date must identify the facility(s) overloaded and propose a similar time frame of more appropriate dates/times for the Scheduled Outage.

Changes to Scheduled Outages, either before or after the work has started, may require additional review. Each Party shall consider the impact of these changes on the other Parties' system reliability, in addition to its own. The Parties shall contact each other as soon as possible if these changes result in unacceptable system conditions and shall work with one another to develop remedial steps as necessary.

**6.1.3 Unscheduled or Forced Outages.** The Parties shall notify each other of emergency maintenance and forced outages that could potentially significantly impact the other entity(ies) as soon as possible (but not to exceed 30 minutes) after such conditions are identified. Reporting of an outage in SDX or RCIS constitutes notice under this Agreement. The Parties shall evaluate the impact of emergency and forced outages on the Parties' transmission systems and work with one another to develop remedial steps as necessary.

**ARTICLE SEVEN**  
**PRINCIPLES CONCERNING JOINT OPERATIONS IN EMERGENCIES**

**7.1 Emergency Operating Principles.**

- 7.1.1 Coordination of Emergency Response.** In the event an emergency condition is declared in accordance with a Party's published operating protocols, the Parties shall coordinate respective actions to provide immediate relief until the declaring Party eliminates the declaration of emergency. The Parties shall notify each other of emergency maintenance and forced outages that would have a significant impact on another Party as soon as possible after the conditions are known. The Parties shall evaluate the impact of emergency and forced outages on the Parties' transmission systems and coordinate to develop remedial steps as necessary or appropriate. If the emergency response allows for coordinating with the other Party(s) before action must be taken, the normal procedures for action requests shall be followed. The Parties shall conduct joint annual emergency drills, ensure that all operating staffs are trained and certified, if required, and practice the joint emergency drills that include criteria for declaring an emergency, prioritizing action plans, staffing and responsibilities, and communications.
- 7.1.2 Departure from Procedures.** In furtherance of maintaining system stability and providing prompt responses to problems, the Parties agree that in situations where there is an actual IROL violation and/or a transmission system is on the verge of imminent collapse, and when there exists a set of applicable emergency principles or an operating guide, each Party shall allow the affected Party to take immediate steps by modifying the normal procedures for action requests so that the Parties and affected Operating Entities can communicate and coordinate simultaneously via telephone conference call or other appropriate means. After such departures from normal procedures, the requesting Party shall review the event, develop a report, and provide copies thereof to the other Parties and affected Operating Entities.
- 7.1.3 Development of Principles and Operating Guides.** The Parties shall work together and, in the case of PJM and TVA with the Operating Entities with respect to which they serve as RTO or RC, as applicable, to jointly develop and commit to additional emergency principles and operating guides as may be necessary.
- 7.1.4 Transmission System Emergencies.** Transmission System Emergencies may be implemented when, in the judgment of a Party, the system is in an Emergency condition with the potential, either imminently or for the next contingency, for system instability or cascading, or for equipment loading or voltages significantly beyond applicable operating limits, such that stability of the transmission system cannot be assured, or to prevent a condition or situation that in the judgment of a Party is imminently likely to endanger life or property. In the event that it becomes necessary for a Party to declare a Transmission System Emergency for an area that is in close electrical proximity to any of the Parties' RC Areas, the affected Parties

shall either (i) declare a Transmission System Emergency or (ii) redispatch without declaring a Transmission System Emergency. In either case, the Party shall take the necessary action(s) in kind to address the situation that prompted the Transmission System Emergency. These actions may include:

- (a) Curtailment of equivalent amounts of firm point-to-point transactions within the affected Parties;
- (b) Redispatching of generation within the affected Parties; or
- (c) Load shedding within the affected Parties.

**7.1.5 IROL Violations.** In situations where an actual IROL violation exists, or for the next contingency would exist, within a Party's RC Area, as applicable, and the transmission system is currently, or for the next contingency would be, on the verge of imminent collapse, and there is not an existing emergency principle or operating guide, a Party, in its role as RC, as applicable, shall receive and, subject to the next two sentences of this Section, implement the instruction of the affected Party, communicate the instruction to the affected Operating Entity(s) within its own RC or TOP Area as applicable, or utilize telephone conference call capabilities or other appropriate means of communication to allow simultaneous coordination/communication between the Parties and the affected Operating Entity(s). All occurrences of this kind may be reviewed by the Parties after the fact, but the instruction of the affected RC or TOP Area as applicable shall be implemented when issued, except a Party may delay implementation in instances where a Party concludes that the requested action cannot be physically implemented; may result in a more serious condition on the transmission system; would violate safety, equipment, regulatory, or statutory requirements; or is imminently likely to endanger life or property. Any such delay shall be immediately communicated so alternative mitigating actions can be executed. Financial considerations shall have no bearing on actions taken to prevent the collapse of the transmission system.

**7.1.6 SOL Exceedances.** The Parties shall implement monitoring and contingency analysis as necessary to identify SOL exceedances within their respective TOP Areas. If a Party is experiencing an SOL exceedance within its TOP Area that is either caused or contributed to by conditions on another Party's transmission system or otherwise requires another Party, or Operating Entities within that Party's RC Area, to take action to assist in the mitigation of the SOL exceedance, such action shall be requested and coordinated through the RC function. The Parties agree to work together and act, as necessary and appropriate, to address SOL exceedances.

**7.1.7 RC Coordination.** TVA and PJM shall coordinate with each other as RC and, as may be provided under arrangements other than this Agreement, direct emergency action on the part of generation or transmission within their own respective RC



Areas to protect the reliability of the transmission system. Each Party shall exercise such authority as required to resolve emergency conditions in the other Party's RC Area of which it is aware and, in conjunction with any applicable stakeholder processes, shall develop detailed emergency operating procedures.

**7.1.7.1 Power System Restoration.** During any power system restoration, the Parties shall coordinate their actions with each other, as well as with other appropriate entities to restore the transmission system as safely and efficiently as possible. To enhance the effectiveness of actual restoration operations among the Parties, the Parties shall conduct annual coordinated restoration drills that stress cooperation and communication among the Parties.

**7.1.7.2 Joint Voltage Stability Operating Protocol.** To avoid any voltage stability or collapse problems, the Parties shall coordinate their operations to maintain stable voltage profiles throughout their respective RC Areas. The Parties shall also coordinate their established daily voltage/reactive power management plans.

**7.1.7.3 Operating the Most Conservative Result.** When a Party identifies an overload or Emergency that may impact another Party's system and the affected Party's results or systems do not observe a similar situation, the Parties shall operate to the most conservative result until the Parties can identify the reasons for these difference(s).

**7.2 Costs of Compliance with Emergency Principles and Procedures.** In accordance with each Party's OATT, Transmission Service Guidelines, or other agreements, each Party shall bear its own costs of compliance with this Article. Nothing in this Agreement shall require a Party to purchase emergency energy if the Party cannot recover the costs under an OATT, its Transmission Service Guidelines, or other agreement or lawful arrangement. Notwithstanding any other provisions of this Agreement, PJM acknowledges that TVA cannot sell energy, including emergency energy, to any entity that is not an authorized purchaser under the Tennessee Valley Authority Act. Any such sale shall be provided to eligible Third Parties under separate agreements.

**ARTICLE EIGHT**  
**COORDINATED REGIONAL TRANSMISSION EXPANSION PLANNING**

- 8.1 Applicability.** This Article Eight applies to each of the Parties in its role as Planning Coordinator for its respective Planning Coordinator areas.
- 8.2 Joint Planning Committee.** The OC shall form, as a subcommittee of the OC, a JPC. The JPC shall be comprised of representatives of the Parties' respective staffs in numbers and functions to be identified from time to time. The JPC may establish working groups and/or task forces as deemed appropriate to facilitate performance of the transmission planning objectives outlined in this Article. The JPC shall have a Chairman. The Chairman shall be responsible for: the scheduling of meetings; the preparation of agendas for meetings; the production of minutes of meetings; and for chairing JPC meetings. The Chairman shall serve a one-year calendar term, except that the term of the first Chairman shall commence on the Effective Date and terminate at the end of the calendar year of the Effective Date. The OC shall designate the first Chairman. Thereafter, the right to designate the Chairman shall rotate from Party to Party. The JPC shall coordinate planning of the Parties' respective systems under this Agreement, including the following:
- 8.2.1** As needed to conduct a Coordinated Transmission Planning Study, the JPC shall develop common power system analysis models to perform coordinated system reliability planning for the Parties' Planning Coordinator areas, as applicable, including models for power flow analyses, short circuit analyses, and stability analyses, as required.
- 8.2.2** As mutually agreed by at least two of the Parties, conduct a Coordinated Transmission Planning Study, as set forth in Section 8.4.5.
- 8.2.3** Coordinate planning activities under this Article Eight, including the exchange of data under this Article and developing necessary report and study protocols and methods for communication of information related to the coordinated planning process.
- 8.2.4** Meet at least once annually as necessary or as requested by a Party to review and coordinate transmission planning activities. Such meetings shall include, as determined by the Parties to be necessary based on internal discussions, discussion of any system operations or market operations issues as they impact long range planning and the coordination of planning between the systems.
- 8.2.5** Establish working groups as necessary to address specific issues, such as the review and development of the regional plans of each Party and localized seams issues.

**8.2.6** Establish a schedule, as necessary, for the rotation of responsibility for data management, coordination of analysis activities, report preparation, and other activities.

**8.2.7** The JPC may combine with or participate in similarly established joint planning committees amongst multiple entities engaging in coordinated planning studies under tariff provisions or established under joint agreements to which the Parties are signatories, such as the planning meetings with Southeastern Regional Transmission Planning described under Schedule 6-A of the PJM Operating Agreement and under Appendix 8 of Attachment K to the LG&E/KU Open Access Transmission Tariff, for example, for the purpose of providing for broader and more effective inter- regional planning coordination.

**8.3 Data and Information Exchange.** Each Party shall provide the other Parties with the following data and information for its Planning Coordinator area, as applicable, as follows. Unless otherwise indicated, such data and information shall be provided as requested and as available, on a mutually agreed schedule but no longer than 60 days from the date of such request.

**8.3.1** Data required for the development of load flow cases, short-circuit cases, and stability cases for the Parties' Planning Coordinator areas, as applicable, including ten-year load forecasts, including all critical assumptions that are used in the development of these cases.

**8.3.2** Fully detailed planning models (up to the next ten (10) years) for the Parties' Planning Coordinator areas, as applicable, as requested by any of the Parties and on a mutually agreed schedule as a part of the development of any joint planning studies provided for under this Article Eight or as otherwise agreed to.

**8.3.3** The regional plan document produced by the Party, any long-term or short-term reliability assessment documents produced by the Party, and any operating assessment reports produced by the Party.

**8.3.4** The status of expansion studies, System Impact Studies, and generation interconnection studies, such that each Party has knowledge that a commitment has been made to a system enhancement as a result of any such studies.

**8.3.5** Transmission system maps for the Party's bulk transmission system and lower voltage transmission system maps that are relevant to the coordination of planning between or among the systems.

**8.3.6** Contingency lists for use in load flow and stability analyses, including lists of all single contingency events and multiple facility contingencies, as well as breaker diagrams for the portions of the Party's transmission system that are relevant to the coordination of planning between or among the systems.

**8.3.7** The timing of each planned enhancement, including estimated start and completion dates, and indications of the likelihood a system enhancement shall be completed and whether the system enhancement should be included in system expansion studies, System Impact Studies, and generation interconnection studies, and all related applications for regulatory approval and the status thereof.

**8.3.8** Load flow and short-circuit data initially shall be exchanged by the Parties in mutually agreed formats. To the extent practical, the maintenance and exchange of power system modeling data shall be implemented through in mutually agreed formats. When feasible, transmission maps and breaker diagrams shall be provided in an electronic format agreed upon by the Parties. Formats for the exchange of other data shall be agreed upon by the Parties from time to time.

**8.4 Coordinated System Planning.** The Parties shall engage in coordinated system planning to identify inter-regional transmission expansions or enhancements to transmission system capability that may be needed to maintain reliability and/or improve operational performance. The Parties shall coordinate any relevant studies required to assure the reliable, efficient, and effective operation of the transmission systems. The Parties shall conduct such coordinated planning as set forth below. Such coordination shall be consistent with the Order No. 1000 regional and interregional planning procedures in which the Parties participate.

**8.4.1 Single Party Planning.** Each Party shall engage in such transmission planning activities, including expansion planning and System Impact Studies, as necessary to fulfill its obligations under its applicable OATT, Transmission Service Guidelines, or as it otherwise shall deem appropriate. Such planning shall conform to applicable reliability requirements of NERC, applicable regional reliability councils, and any successor organizations thereto. Such planning shall also conform to any and all applicable requirements of Federal or State regulatory authorities. Each Party shall share its annual transmission planning assessments with the other Parties, as well as any information that arises in the performance of such single party planning activities as is necessary or appropriate for effective coordination between the Parties on an ongoing basis.

**8.4.2 Analysis of Interconnection Requests.** In accordance with the procedures under which the Parties provide interconnection service, each Party shall coordinate with the other Parties the conduct of any studies required in determining the impact of a request for generator or transmission interconnection. For the purpose of determining the potential for Affected System impacts and the need to notify Affected Systems, Parties agree to monitor the other Parties' systems when conducting interconnection request studies including all facilities rated 100 kV and above and contingencies on the other systems adjacent Balancing Authority Areas as appropriate in the judgement of the Direct Connect System. Results of any required coordinated studies shall be included in the impacts reported to the interconnection customers as appropriate. Coordination of studies shall include the following:

**8.4.2.1** Upon a Party's request, the Direct Connect System shall provide a complete listing of all interconnection requests and associated information for each interconnection request within 30 days of the Party's request.

**8.4.2.2** Upon either the posting to the OASIS or New Services Queue of a request for interconnection or the review of the study results related to that request for interconnection, the Party receiving the request ("Direct Connect System") shall determine whether the other Parties are potentially impacted. If the other Parties are potentially impacted, the Direct Connect System shall notify such Party and convey the information provided in the posting. The Direct Connect System shall notify the Affected System if any of the following criteria in Sections 8.4.2.2 (a)(i), 8.4.2.2 (a)(ii), or 8.4.2.2 (b) are true:

- a. While performing the analysis of the interconnection request, the Direct Connect System identifies the potential for an adverse system condition through one or both the following tests:
  - i. Thermal powerflow analysis and Associated Criteria: A contingency list for the Affected System shall be agreed upon by the Party for the Direct Connect System and the Party for the adjacent Affected System. Contingencies on both the Affected System and on the Direct Connect System are analyzed. Identify thermal loadings determined to: (1) have a pre and/or post-contingency loading of over 100% of the applicable rating in the modeling software on a monitored facility of 69 kV or above and (2) flow increases by 3% or more on the same monitored facility.
  - ii. PTDF Screen and Associated Criteria (DFAX screen under system intact conditions): When the Direct Connect System: (1) is PJM and identifies a customer's request having a 3% or greater PTDF on any monitored transmission facility 69 kV or above of another Party; (2) is TVA and identifies a customer's request having a 5% or greater PTDF on any monitored transmission facility 69 kV or above of another Party; or (3) is LG&E/KU and identifies a customer's request having a 5% or greater PTDF on any monitored transmission facility 69 kV or above of another Party. Such indication will be determined by modeling the customer's request being delivered or sunked to the Direct Connect System.
- b. The interconnection request is for a point of interconnection on the Direct Connect System's power flow model within two buses of

another Party. For this test, the Parties' power flow models will be reviewed and modified as appropriate to ensure consistency in the vicinity of the point of interconnection.

- 8.4.2.3** Following notice to the potentially impacted system as described above, an Affected System shall contact the Direct Connect System within 30 days of notice by the Direct Connect System and request participation in the applicable interconnection studies as fully described in Section 8.4.2.5 below. Such participation by Affected Systems shall abide by the OATT or Transmission Service Guidelines of the Direct Connect System and reasonable efforts shall be undertaken to meet the timing requirements of the Direct Connect System's interconnection process. The Parties shall coordinate and mutually agree on the nature of the Affected System study(s) to be performed to test the impacts of the interconnection on the Affected System, who shall perform the studies. If the Parties cannot mutually agree on the nature of the studies to be performed they can resolve the differences through the dispute resolution procedures documented in Article Eleven. The Parties shall strive to minimize the costs associated with the coordinated study process.
- 8.4.2.4** Any coordinated studies shall be performed in accordance with Good Utility Practice in accordance with the study scope and timeline mutually agreed to in 8.4.2.3 above utilizing the responsibility options outlined in 8.4.2.5 below.
- 8.4.2.5** The Affected System(s) may participate in the coordinated study at the System Impact Study or preliminary feasibility study stage either by taking responsibility for performance of studies of its system if the Affected System determines that its system may be materially impacted, or by providing input to the studies to be performed by the Direct Connect System. If the constraints found require infrastructure additions to mitigate them, then the Affected System shall also perform its own Facilities Study. The interconnection customer and Affected System shall enter into any study agreements that the Affected System deems necessary to perform its own studies.
- 8.4.2.6** The costs incurred by the Affected System(s) in the performance of any and all of its studies shall be paid by the interconnection customer in accordance with the provisions of the study agreements between the Affected System(s) and the interconnection customer. Where the Direct Connect system has implemented a cluster study approach to new interconnection requests, to facilitate the Affected System process in a manner consistent with the Direct Connect System's interconnection process, the Direct Connect System may enter into the Affected System study agreement with the Affected System on behalf of its interconnection customers. In such instance, the costs of the Affected System study will be paid by the Direct Connect System, with the

expectation that such costs will be recovered by the Direct Connect System from its interconnection customers.

**8.4.2.7** The Direct Connect System and Affected System(s) shall identify any transmission facilities or upgrades pursuant to the Parties' respective OATT or Transmission Service Guidelines required on their respective systems as a result of the proposed interconnection.

**8.4.2.8** Construction and cost responsibility associated with any transmission facilities or upgrades on the Direct Connect System or Affected System required as a result of the proposed interconnection shall be accomplished under the terms of the applicable Party's OATT, Transmission Service Guidelines, or other controlling agreements, and consistent with applicable Federal or State regulatory policy and applicable law.

**8.4.2.9** In the event that the Affected System(s) determine that Network Upgrades are required on its system, then interconnection service shall commence on a schedule mutually agreed upon among the Parties. This schedule shall include milestones with respect to the Network Upgrade construction and the amount of service that can commence after each milestone.

**8.4.2.10** Reserved.

**8.4.2.11** Each Party shall maintain a separate interconnection queue.

**8.4.3 Analysis of Long-Term Firm Transmission Service Requests.** In accordance with applicable procedures under which the Parties provide long-term firm transmission service, the Parties shall coordinate the conduct of any studies required to determine the impact of a request for such service. For the purpose of determining the potential for Affected System impacts and the need to notify Affected Systems, Parties agree to monitor the other Parties' systems when conducting long-term transmission service request studies including all facilities rated 100 kV and above with contingencies on the other system's adjacent Balancing Authority Areas as appropriate in the judgement of the Direct Connect System. Results of any required coordinated studies will be included in the impacts reported to the transmission service customers as appropriate. Coordination of studies shall include the following:

**8.4.3.1** Upon either the posting to the OASIS or New Services Queue of a request for service or review of studies related to the evaluation of that service request, the Party receiving the request shall determine whether the other Parties are potentially impacted as described in this section. If the other Parties are potentially impacted, the Party receiving the request shall notify the Affected System and convey the information provided in the posting. The Direct Connect System shall notify the potentially impacted system(s)

as an Affected System if one or both of the following criteria in Sections 8.4.3.1 (a)(i), 8.4.3.1 (a)(ii), or 8.4.3.1 (b) are true:

- a. While performing the analysis of the transmission service request, the Party receiving the request identifies the potential for an adverse condition on another Party's transmission system through one or both of the following tests:
  - (i) Thermal powerflow analysis and Associated Criteria: A contingency list for the Affected System and Direct Connect System shall be agreed upon by the Party for the Direct Connect System and the Party for the adjacent Affected System. Contingencies on both the Affected System and on the Direct Connect system are analyzed. Identify thermal loadings determined to: (1) have a pre and/or post-contingency loading of over 100% of the applicable rating in the modeling software on a monitored facility of 69 kV or above; and (2) flow increases by 3% or more on the same monitored facility.
  - (ii) PTDF Screen and Associated Criteria (DFAX screen under system intact conditions): When the Direct Connect System: (1) is PJM and identifies a customer's request having a 3% or greater PTDF on any monitored transmission facility 69 kV or above of another Party; (2) is TVA and identifies a customer's request having a 5% or greater PTDF on any monitored transmission facility 69 kV or above of another Party; or (3) is LG&E/KU and identifies a customer's request having a 5% or greater PTDF on any monitored transmission facility 69 kV or above of another Party.
- b. The source of the transmission service request is within two buses of another Party based on the power flow model of the system receiving the request. For this test, the Parties' power flow models will be reviewed and modified as appropriate to ensure consistency in the vicinity of the source.

**8.4.3.2** After notification, if the Affected System determines that its system may be materially impacted by granting the service, and the nature of the service is such that a request on the Affected System's OASIS is unnecessary (i.e., the Affected System is "off the path"), then such Party shall contact the Party that is the source or the sink for the request and request participation in the applicable studies within 30 days of notice by the system receiving the request. Such participation shall abide by the Tariff timing requirements of the Party that receives the request. The Parties shall coordinate with



respect to the nature of studies to be performed to test the impacts of the requested service on the Affected System. The Parties shall strive to minimize the costs associated with the coordinated study process.

- 8.4.3.3** Any coordinated studies shall be performed in accordance with the mutually agreed upon study scope and timeline requirements developed by the Parties. If the Parties cannot mutually agree on the nature and timeline of the studies to be performed, they can resolve the differences through the dispute resolution procedures documented in Article Eleven of this Agreement.
- 8.4.3.4** During the System Impact Study, the Affected System may participate in the coordinated study either by taking responsibility for performance of Affected System study(s) of its system if the Affected System determines that its system may be materially impacted, or by providing input to the studies to be performed by the Party receiving the request. The Affected System shall also conduct its own Facilities Study if it identifies constraints on its system that require infrastructure additions to mitigate the constraints. The Affected System shall engage the transmission service customer to enter into any study agreements that the Affected System deems necessary to perform its own studies.
- 8.4.3.5** The costs incurred by the Affected System in the performance of its studies shall be paid by the transmission service customer in accordance with the provisions of the study agreements between the Affected System and the transmission service customer. Where the Direct Connect system has implemented a cluster study approach to new service / transmission service requests, to facilitate the Affected System process in a manner consistent with the Direct Connect System's new service/transmission service request process, the Direct Connect System may enter into the Affected System study agreement with the Affected System on behalf of its transmission service customers. In such instance, the costs of the Affected System study will be paid by the Direct Connect System, with the expectation that such costs will be recovered by the Direct Connect System from its customers.
- 8.4.3.6** The Party receiving the request and the Affected System shall identify any Network Upgrades required on their respective systems as a result of the transmission service request.
- 8.4.3.7** Construction and cost responsibility associated with any transmission infrastructure improvements on the system of the Party receiving the request and the Affected System required as a result of the transmission service request shall be accomplished under the terms of the applicable OATT, Transmission Service Guidelines, and controlling agreements, and be consistent with applicable Federal or State regulatory policy and applicable law.

**8.4.3.8** In the event that Network Upgrades are required on the Affected System, transmission service shall commence on a schedule mutually agreed upon among the Parties. This schedule shall include milestones with respect to the Network Upgrade construction and the amount of service that can commence after each milestone.

**8.4.4 Analysis for the Integration of Balancing Authority Areas.** Prior to integrating an external entity's Balancing Authority Area or combined system (e.g., a combination of load, generation, and/or transmission) into a Party's Balancing Authority Area, the Party integrating the external entity shall notify the non-integrating Party(s) at least six months prior to the expected effective date of integration, unless otherwise agreed upon by the Parties. The non-integrating Party(s) shall be afforded a reasonable opportunity to evaluate the impacts on the non-integrating Party's system that might result from the flows between the external entity's system and the integrating Party's Balancing Authority Area. The Parties agree that they will use good faith efforts to identify and mitigate adverse impacts on the transmission systems of the non-integrating Party(s) of an integration of other Balancing Authority Areas. In doing so, the Parties will negotiate in good faith to reach an agreement on such mitigation including cost allocation. Provided, however, that the allocation of costs among the Parties for such upgrades may be subject to FERC acceptance pursuant to sections 205 or 206 of the Federal Power Act, as determined to be appropriate based on the Parties' respective jurisdictional analysis. Such a FERC filing will not result of TVA waiving its non-jurisdictional status.

**8.4.4.1** The integrating Party shall provide a new integrated BAA-wide generation dispatch order to the non-integrating Party(s) to allow for the study of change in power flows.

**8.4.4.2** The integrating Party shall provide the results of a deliverability study between the integrating load or generation and the integrating Party's system. The deliverability study shall identify potential impacts on the non-integrating Party's system.

**8.4.4.3** If the non-integrating Party(s) identifies potential adverse impacts, it will coordinate with the integrating Party to propose mitigation or remediation of such potential adverse impacts prior to the integration of the external entity's system into the integrating Party's Balancing Authority Area.

**8.4.4.4** To the extent necessary and appropriate, the impacted non-integrating Party and the integrating Party shall endeavor to develop temporary operating guides to facilitate the integration of the external entity into the integrating Party's Balancing Authority Area pending the completion of any long-term remediation. The cost of implementing such temporary operating guides shall be mutually agreed by the Parties, and subject to FERC acceptance as determined to be appropriate based on the Parties' respective jurisdictional

analysis. Such a FERC filing will not result of TVA waiving its non-jurisdictional status.

**8.4.4.5** If the Party integrating the external entity's system and an impacted non-integrating Party cannot mutually agree on necessary upgrades or other mitigation, they can resolve the differences through the dispute resolution procedures documented in Article 11 of this Agreement.

**8.4.5 Coordinated Transmission Planning Study.** Each Party agrees to assist in the conduct of the CTPS as follows:

**8.4.5.1** When a need is identified by the JPC, the Parties shall conduct a CTPS. This may include sensitivity analyses, as required, based on a review by the JPC of discrete reliability problems or operability issues that arise due to changing system conditions.

**8.4.5.2** The JPC shall identify reliability and expansion issues for joint consideration, and may propose potential resolutions to be considered by the Parties consistent with Order No. 1000 regional and interregional processes.

**8.4.5.3** Nothing in this Agreement shall obligate a Party in any way to construct, finance, operate, or otherwise support any transmission infrastructure improvements or other transmission-related projects identified in the CTPS. Any decision to proceed with any transmission infrastructure improvements or other transmission-related projects identified in the CTPS shall be set forth in a separate agreement executed by the Parties.

**8.4.5.4** Nothing in this Agreement shall give a Party any rights to financial compensation due to the impact of any other Party's transmission plans, including but not limited to its decisions whether or not to construct any transmission infrastructure improvements or other transmission-related projects identified in the CTPS

**8.4.5.5** Each Party shall be responsible for providing the technical support required to complete the analysis for the CTPS.

**8.4.5.6** The JPC shall develop the scope and procedure for the CTPS. The scope of the CTPS shall include evaluations of the transmission systems against reliability criteria, operational performance criteria, and economic performance criteria applicable to each Party.

**8.4.5.7** The Parties shall use planning models that are developed in accordance with the procedures to be established by the JPC. Exchange of power flow models shall be in a format that is acceptable to each Party.

**8.4.5.8** The performance of the combined transmission systems shall be tested against agreed upon operational and economic criteria, where applicable, using the updated baseline model.

**8.4.5.9** Economic criteria applicable to each Party shall be developed by that Party.

**8.4.5.10** To the extent that the JPC agrees to combine with or participate in similarly established coordinated transmission planning studies among multiple planning entities as provided for under Section 8.4.5.5, the CTPS may be integrated into such other coordinated activities, provided that the requirements of the CTPS are integrated into the scope of such other coordinated activities.

**8.4.6 Review and Approval Processes.** To the extent applicable, each Party shall conduct the necessary stakeholder review and approval process associated with transmission system planning, as required by its OATT or Transmission Service Guidelines, Governing Documents, and/or applicable Federal or State regulatory requirements.

**ARTICLE NINE  
JOINT CHECKOUT PROCEDURES**

**9.1 Scheduling Checkout Protocols.**

**9.1.1 Scheduling Protocols.** Each Party shall leverage technology to perform electronic approvals of schedules, and to perform electronic checkouts. The Parties shall follow the following scheduling protocols:

**9.1.1.1** Each Party, acting as the scheduling agent for its respective BAs, shall conduct all checkouts with first-tier BAs. A first-tier BA is any BA that is directly connected to any Party's members' BA or any BA operated by an independent transmission company.

**9.1.1.2** The Parties shall require all schedules to be tagged in accordance with applicable NERC tagging standards and NAESB Business Practices. For reserve sharing and other emergency schedules that are not tagged, the Parties shall enter manual schedules after the fact into their respective scheduling systems to facilitate checkout between the Parties.

**9.1.1.3** When there is a scheduling conflict, the Parties shall work together to modify the schedule as soon as practical. If there is a scheduling conflict that is identified before the schedule has started, then both Parties shall make the correction in Real-time. If the schedule has already started and one Party identifies an error, then the Parties shall make the correction at the earliest possible quarter hour increment. If a scheduling conflict cannot be resolved between the Parties (but the source and sink have agreed to a MW value), then the Parties shall adjust their numbers to that same MW value. If source and sink are unable to agree to a MW value, then the previously tagged value shall stand for both Parties.

**9.1.1.4** For entities that do not use the Parties' electronic scheduling interfaces, the Parties shall contact the non-member first-tier entities by telephone to perform checkouts. When performing checkouts by telephone, three-part communication shall be used to ensure accuracy of NSI values.

**9.1.1.5** The Parties shall perform the following types of checkouts:

- (a) Pre-schedule (day-ahead), daily between 1600 and 2000 (eastern prevailing time) hours.
- (b) Hourly Before-the-Fact (Real-time):
  - (i) Checkout for the next hours shall be net scheduled. Import and export totals may also be verified in addition to NSI if it

is deemed necessary by a Party. The Parties may checkout individual schedules, if deemed necessary by the Parties;

- (ii) Hourly checkout is performed starting at the half hour and ending at the ramp hour;
  - (iii) Intra-hour checkout/schedule confirmation shall occur as required due to intra-hour scheduled changes.
- (c) Daily after-the-fact checkout shall occur no later than ten (10) business days after the fact (via email or a mutually agreed upon method).
- (d) Monthly after-the-fact checkout shall occur no later than one (1) month after the fact (via phone or a mutually agreed upon method).

**9.1.1.6** The Parties shall require that each checkout be performed with first tier BAs. If a checkout discrepancy is discovered, the Parties shall use the NERC tag to determine where the discrepancy exists. The Parties shall require any entity that conducts business within its RC Area to checkout with the applicable Party using NERC tag numbers. Any special naming convention used by that entity or other naming conventions given to schedules by other entities shall not be permitted.

**ARTICLE TEN  
ADDITIONAL COORDINATION PROVISIONS**

- 10.1 Application of Congestion Management Process.** The Parties have agreed to certain operating protocols under this Agreement to ensure system reliability and efficient market operations as systems exist and are contemplated as of the Effective Date. These protocols include the Congestion Management Process and applicable NERC reliability plans. As addressed in Section 3.3, the Parties expect that these systems and the operating protocols applicable to these systems will change and revisions to this Agreement will be required from time to time.
- 10.2 Voltage and Reactive Power Coordination Objectives.** TVA and PJM shall utilize the following procedures (“Voltage and Reactive Power Coordination Procedures”):
- 10.2.1** The Voltage and Reactive Power Coordination Procedures address the following components: (a) procedures to assist PJM and TVA in maintaining a Wide Area view of interconnection conditions by enhancing the coordination of voltage and reactive levels throughout their respective RC Areas; (b) procedures to ensure the maintenance of sufficient reactive reserves to respond to scenarios of high load periods, loss of critical reactive resources, and unusually high transfers; and (c) procedures for sharing of data with other neighboring RCs for their analysis and coordinated operation.
- 10.2.2** The Parties shall review the Voltage and Reactive Power Coordination Procedures from time to time to make revisions and enhancements as appropriate to accommodate additional capabilities or changes to industry reliability requirements.
- 10.3 Voltage and Reactive Power Coordination Procedures.** TVA and PJM shall utilize the following procedures to coordinate the use of voltage control equipment to maintain a reliable bulk power transmission system voltage profile on their respective systems.
- 10.3.1** Under normal conditions, each RC shall coordinate with the Transmission Owners, TOPs, and BAs as necessary and feasible to supply its own reactive load and losses at all load levels.
- 10.3.2** Voltage schedule coordination is the responsibility of each RC. Generally, the voltage schedule is determined based on conditions in the proximity of generating stations and Extra High Voltage stations with voltage regulating capabilities. Each RC works with its respective Transmission Owners, TOPs, and BAs to determine adequate and reliable voltage schedules considering actual and post-contingency conditions.
- 10.3.3** Each RC shall establish voltage limits at critical locations within its own transmission system and exchange this information with the other RC. This

information shall include: normal high voltage limits; normal low voltage limits; post-contingency emergency high voltage limits; and post-contingency emergency low voltage limits; and the voltage limit value (if available) at which load shedding shall be implemented.

- 10.3.4** Each RC shall maintain awareness of the voltage limits in the other RC's areas (where the EMS Model includes sufficient detail to permit this) and awareness of outages and potential contingencies that could result in violation of those voltage limits.
- 10.3.5** The RCs shall clearly communicate the level of voltage support needed during pre- or post-contingency conditions requiring voltage and reactive power coordination.
- 10.3.6** Each RC shall maintain a list of actions that are available to be taken when voltage support is necessary to respond to anticipated or prevailing transmission system conditions.
- 10.3.7** The RCs shall exchange voltage schedule information on an annual basis, or more frequently as necessary to reflect actual operations. The RCs shall coordinate as needed to discuss any issues due to the anticipated conditions and determine any actions that may be required in response to voltage concerns.
- 10.3.8** In conjunction with the coordination of Scheduled Outages addressed in Article Six and the RCs' respective day-ahead reliability analysis processes, the RCs shall coordinate the impact of outages and transmission system conditions on the voltage/reactive profile. Coordination shall include the following elements:
  - 10.3.8.1** Each RC shall review its forecasted loads, transfers, and all information on available generation and transmission reactive power sources at the beginning of each shift.
  - 10.3.8.2** If no reactive problems are anticipated after the review, each RC shall operate independently, in accordance with the above stated criteria and any individual transmission system guidelines for the supply of the RC's reactive power requirements.
  - 10.3.8.3** If an RC anticipates reactive problems after the review, it may request joint implementation of reactive support levels under these Voltage and Reactive Power Coordination Procedures, as it deems appropriate to the situation. When an RC calls for a particular level of support to be implemented under these procedures, it or the applicable TOP or BA must identify the time it shall start adjusting its system, the support level it is implementing, and the voltage problem area.
  - 10.3.8.4** If an RC experiences an actual low or high voltage condition after initial reactive support measures are taken, then the emergency reactive support



level is implemented for the area experiencing the problem. The impacted RC shall also notify applicable RCs as soon as feasible. In addition, the Voltage and Reactive Power Coordination Procedures are to be consulted to determine if further action is necessary to correct an undesirable voltage situation.

**10.3.9** The RCs shall coordinate the use of voltage control equipment to maintain a reliable bulk power transmission system voltage profile on their systems and surrounding systems. The following procedures are intended to ensure that bulk systems voltage levels enhance system reliability.

**10.3.9.1** Each RC shall coordinate operational control of reactive sources within its RC Area, and shall direct adjustments to voltage schedules at appropriate facilities.

- (a) Each RC generally shall adjust its voltage schedules to best utilize its resources for operation, prior to coordinated actions with the other RC.
- (b) If an RC anticipates voltage or reactive problems, it shall inform the other RC of the situation, describe the conditions, and request voltage/reactive support under these procedures. As a part of the request, the RC must identify the specific area where voltage/reactive support is requested, and provide an estimate of the magnitude and time duration of the request as well as the specific requirements for reactive support. The RCs shall determine the appropriate measures to address the condition and develop a plan of action.
- (c) Each RC shall contact its affected Transmission Owners, TOPs, and BAs to ensure that the situation is fully understood and that an effective operating plan to address the situation has been developed. If necessary, the RCs shall convene a conference call with the affected Transmission Owners, TOPs, and BAs.
- (d) Each RC shall implement or direct voltage schedule changes requested by the other RC, provided that an RC may decline a requested change if the change would result in equipment violations or reduce the effective operation of its facilities. An RC that declines a requested change must inform the requesting Party that the request cannot be granted and state the reason for denial.

**10.3.10** Voltage/Reactive Power Transfer Limits.

**10.3.10.1** Each RC may monitor power transfer on interfaces defined as a Flowgate used to control voltage collapse conditions. In cases where

the potential for voltage collapse (or cascading) is identified, prompt voltage support, and generation adjustments may be needed. Where coordinated effort is required for voltage stability interfaces, generation adjustment requests to avoid voltage collapse or cascading conditions must be clearly communicated and implemented promptly. Using these limits, the Parties shall implement the following Real-time coordination:

- (a) At 95 percent of Interface Limit:
  - (i) An RC, which observes the reading, shall contact the other RC to discuss whether further analysis is required.
  - (ii) The RC, managing the applicable Flowgate, shall notify other RCs via the Reliability Coordinator Information System.
  - (iii) The RCs shall contact the affected TOPs and BAs to discuss reactive outputs and any adjustments required.
  - (iv) The affected RC shall take appropriate actions, which may include redispatching generation and directing schedule curtailments.
- (b) Exceeding Interface Limit:
  - (i) The RC managing the applicable Flowgate shall declare an emergency and inform other RCs of the emergency.
  - (ii) The affected RC shall take immediate action, which may include generation redispatch, ordering immediate schedule curtailments, and if required, load shedding.

**10.3.10.2** Where feasible, and if the RCs' EMS models have sufficient detail, each RC shall attempt to duplicate the other RC's power transfer evaluation in order to provide backup limit calculation in the event that the primary RC is unable accurately to determine the appropriate reliability limits.

**10.3.10.3** If a new power transfer interface is determined to exist, and detailed modeling does not exist for the interface, the RCs shall coordinate to determine how their models need to be enhanced and to determine procedures for coordination in furtherance of the enhancement.

#### **10.4 Pseudo-Tie Coordination**

**10.4.1 Authorities for Pseudo-Tied Units into PJM and out of LG&E/KU Balancing Authority Areas.** LG&E/KU shall be the Native TOP and Native BA, and TVA shall be the Native RC, responsible for transmission related congestion (SOLs and IROLs) on the transmission system where the Pseudo-Tied units are physically connected with the LGE/KU transmission system and Pseudo-Tied into PJM. PJM shall be the Attaining RC and BA, responsible for the commitment and dispatch of each pseudo-tied unit or the Pseudo-Tied portion of each partially Pseudo-Tied unit physically located within the LG&E/KU BAA and TVA RC Area that is Pseudo-Tied into the PJM BAA.

PJM shall be the Attaining BA and Attaining RC for all the MW of such generation units that are Pseudo-Tied out of the LG&E/KU BAA and into the PJM BAA.

**10.4.2 Authorities for Pseudo-Tied Units into PJM and out of TVA Balancing Authority Areas.** TVA shall be the Native TOP, Native BA, and Native RC, responsible for transmission related congestion (SOLs and IROLs) on the transmission system where the pseudo-tied units are physically connected with the TVA transmission system and pseudo-tied into PJM. PJM shall be the Attaining RC and BA, responsible for the commitment and dispatch of each pseudo-tied unit or the pseudo-tied portion of a partially pseudo-tied unit physically located within the TVA BAA that are pseudo-tied into the PJM BAA.

PJM shall be the Attaining BA and Attaining RC for all of the MW of such generation units that are pseudo-tied out of the TVA BAA and into the PJM BAA.

**10.4.3 Authorities for Pseudo-Tied Units into LG&E/KU and out of TVA Balancing Authority Areas.** TVA shall be the Native TOP, Native BA, and only RC (Native and Attaining), responsible for transmission related congestion (SOLs and IROLs) on the transmission system where the pseudo-tied units are physically connected with the TVA transmission system and pseudo-tied into LG&E/KU. LG&E/KU shall be the Attaining BA, responsible for the commitment and dispatch of each pseudo-tied unit or the pseudo-tied portion of a partially pseudo-tied unit physically located within the TVA BAA and TVA RC Area that are pseudo-tied into the LG&E/KU BAA.

LG&E/KU shall be the Attaining BA for all of the MW of such generation units that are pseudo-tied out of the TVA BAA and into the LG&E/KU BAA.

**10.4.4 Authorities for Pseudo-Tied Units into TVA and out of LG&E/KU Balancing Authority Areas.** LG&E/KU shall be the Native TOP and Native BA responsible for transmission related congestion (SOLs and IROLs) on the transmission system where the pseudo-tied units are physically connected with the LG&E/KU transmission system and pseudo-tied into TVA. TVA shall be the Attaining BA and only RC (Native and Attaining), responsible for the commitment and dispatch of each pseudo-tied unit or the pseudo-tied portion of a partially pseudo-tied unit

physically located within the LG&E/KU BAA that are pseudo-tied into the TVA BAA.

TVA shall be the Attaining BA for all of the MW of such generation units that are pseudo-tied out of the LG&E/KU BAA and into the TVA BAA.

**10.4.5 Authorities for Pseudo-Tied Units into LG&E/KU and out of PJM Balancing Authority Areas.** PJM shall be the Native TOP, Native BA, and Native RC, responsible for transmission related congestion (SOLs and IROLs) on the transmission system where the pseudo-tied units are physically connected with the PJM transmission system and pseudo-tied into the LGE/KU BA. LG&E/KU shall be the Attaining BA responsible for commitment and dispatch of each pseudo-tied unit or the pseudo-tied portion of a partially pseudo-tied unit physically located within the PJM BAA and RC Area.

LG&E/KU shall be the Attaining BA and TVA shall be the Attaining RC for all of the MWs of such generating units that are pseudo-tied out of the PJM BAA and into the LG&E/KU BAA.

**10.4.6 Authorities for Pseudo-Tied Units into TVA and out of PJM Balancing Authority Area.** PJM will be the Native TOP, Native BA, and Native RC, responsible for transmission related congestion (SOLs and IROLs) on the transmission system where the pseudo-tied units are physically connected with the PJM system and pseudo-tied into TVA. TVA will be the Attaining RC and BA responsible for commitment and dispatch of each pseudo-tied unit or the pseudo-tied portion of a partially pseudo-tied unit physically located within the TVA BAA and RC Area.

TVA will be the Attaining BA and Attaining RC for all of the MW of such generation units that are pseudo-tied out of the PJM BAA and into the TVA BAA.

**10.4.7 Partial Pseudo-Tie.** If only a portion of the installed capacity of a generating unit is pseudo-tied out of the Native BA and into the Attaining BA such that a unique share resides in each Balancing Authority, the Attaining BA shall send dispatch instructions to the portion of the resource committed to the Attaining BA. Approval of Scheduled Outages shall be coordinated between the Native and Attaining BA subject to Section 10.4.8 below. The Native BA shall send dispatch instructions to the portion of the resource committed to the Native BA. The Native BA and TOP shall manage any local issues, including but not limited to local transmission constraints and voltage control. Unit commitment shall be coordinated between the Native and Attaining BAs based on mutually agreed upon operating procedures for managing conflict.

**10.4.8 Unit Outages.** Scheduled or planned outages of partially pseudo-tied units shall be subject to the approval of the Native BA and TOP and submitted in accordance with the outage scheduling procedures and requirements of the Native BA.

Scheduled or planned outages of units that have been pseudo-tied in their entirety shall be coordinated between the Parties in accordance with the Parties' tariffs, business practices, and manuals.

**10.4.9 Voltage and Reactive Power Schedule.** The Native TOP shall provide the voltage schedule for any fully or partially pseudo-tied unit. The Attaining BA shall have no operational control of reactive resources.

**10.4.10 Primary Frequency Response.** The unit shall be capable of meeting the minimum primary frequency response requirements of both the Native and Attaining BA. When the pseudo-tie is in service in the Attaining BA requirements for primary frequency response shall apply to a fully pseudo-tied unit or the pseudo-tied portion of a partially pseudo-tied unit.

**10.4.11 Station Service.** The Parties agree that the entity pseudo-tying the unit from the Native Balancing Authority Area to the Attaining Balancing Authority Area shall obtain station service for the pseudo-tied unit in accordance with the rules of the Native BA.

**10.4.12 Non-recallability.** The Parties agree that the fully pseudo-tied unit or the pseudo-tied portion of a partially pseudo-tied unit is non-recallable to ensure that the unit shall not be directed to serve load in the Native Balancing Authority Area at a time when the Attaining Balancing Authority Area requires the output of the unit. However, a pseudo-tied unit may be committed, de-committed or re-dispatched, for local SOL or IROLs by the Native RC and TOP. If time permits, any instructions to a pseudo-tied unit shall go through the Attaining Balancing Authority. The Parties agree that any energy produced by the pseudo-tied unit during the transmission emergency shall be delivered to the Attaining Balancing Authority as appropriate under the Native TOP's emergency procedures and that the presence of pseudo-ties shall not require prioritization of interconnections in system restoration events.

**10.4.13 Losses.** The parties agree that the entity seeking to Pseudo-Tie shall be responsible for loss compensation to deliver its energy to or receive its energy from the Native Balancing Authority to the Attaining Balancing Authority. Pseudo-tie value(s) shall be calculated net of losses at the high voltage side of the generator step up transformer.

**10.4.14 Reporting.** For a fully pseudo-tied unit, the Attaining RC shall be responsible for reporting generation outages and deratings of the pseudo-tied unit to the NERC SDX. For a partially pseudo-tied unit, the Native and Attaining RCs shall be responsible for reporting the outage or derating information to SDX for the portion of the unit pseudo-tied into their respective RC Area.

**10.4.15 Suspension.** The Parties reserve the right to suspend a pseudo-tie if the entity that pseudo-tied the unit no longer satisfies the Parties' requirements for pseudo-ties,

criteria for participation in the Attaining Authority's BA's markets as an external resource, or other applicable requirements (as detailed in the Parties' respective tariffs, business practices, and manuals), if the entity that pseudo-tied the unit commits a material default under its pseudo-tie agreement or has failed to cure any breach of such agreement, or if a Party reasonably determines that the pseudo-tie poses a risk to system reliability or risk of violation of established reliability criteria, by giving immediate notice of suspension. Suspension shall be coordinated between the Parties and may include but not be limited to decommitting the unit or requiring the unit to follow manual dispatch instructions. During any suspension period, the pseudo-tied generating unit shall remain under the operational control of the Attaining Balancing Authority and shall not be under the operational control of Native Balancing Authority.

**10.4.16 Termination.** The Parties shall each have the right to terminate a pseudo-tie between their respective Balancing Authorities in accordance with their respective tariffs or guidelines and the notice provisions below. The Parties shall coordinate the change to the pseudo-tie status.

**10.4.17 Notice of Termination.** Notification regarding termination of a pseudo-tie shall be provided as follows:

- (a) The Balancing Authority seeking to terminate the pseudo-tie of a PJM Generation Capacity Resource, for any reason other than the reasons described in subsection (b) below, shall give the other Balancing Authority and the entity that pseudo-tied the unit at least forty-two (42) months written notice prior to the commencement of a PJM Delivery Year, for any reason, subject to receiving all necessary regulatory approvals for such termination.
- (b) The Balancing Authority seeking to terminate the pseudo-tie of any Generation Resource for the reasons described in this subsection (b) shall give the other Balancing Authority and the entity that pseudo-tied the unit at least sixty (60) days' written notice of such termination request.
  - (i) The entity that pseudo-tied the unit into the Attaining BA no longer satisfies the Attaining BA's or Native BA's requirements for pseudo-ties, or
  - (ii) The entity that pseudo-tied the unit into the PJM BA no longer satisfies PJM's criteria for participation in its markets for an external resource, or
  - (iii) The entity that pseudo-tied the unit into the Attaining BA commits a material default of the terms of the pseudo-tie agreement with Attaining BA or Native BA, or
  - (iv) The entity that pseudo-tied the unit into the Attaining BA has failed to cure any breach of such agreement, or
  - (v) The Attaining BA or Native BA experiences an emergency or other unforeseen, adverse condition that may impair or degrade the

reliability of the transmission system such as, but not limited to, a transmission constraint that impairs the reliability of the Attaining BA's or Native BA's transmission system or a condition that causes the pseudo-tied unit to become undeliverable, or

- (vi) The Attaining BA or Native BA determines there is risk of or a violation of established reliability criteria.
- (c) A notice of cancellation shall be filed with the Commission, if required. Termination shall be effective as of the date specified in the notification of cancellation, or following acceptance by the Commission, if required.

**ARTICLE ELEVEN  
DISPUTE RESOLUTION PROCEDURES**

**11.1 Dispute Resolution Procedures.** The Parties shall attempt in good faith to achieve consensus with respect to all matters arising under this Agreement and to use reasonable efforts through good faith discussion and negotiation to avoid and resolve disputes that could delay or impede a Party from receiving the benefits of this Agreement. These dispute resolution procedures apply to any dispute that arises from a Party's performance of, or failure to perform, this Agreement and which the applicable Parties are unable to resolve prior to invocation of these procedures.

**11.1.1 Step One.** In the event a dispute arises, a Party shall give Notice of the dispute to the other Parties. Unless otherwise mutually agreed, within ten (10) days of such Notice, the OC shall meet and the Parties shall attempt to resolve the Dispute by reasonable efforts through good faith discussion and negotiation. In addition to a Party's OC representative, a Party shall also be permitted to bring no more than two (2) additional individuals to OC meetings held under this Step One as subject matter experts; however, all such participants must be employees of the Party they represent. In addition, each Party may bring no more than two (2) attorneys. Such meeting may be either in person or virtual.

**11.1.2 Step Two.** Unless otherwise mutually agreed, if the OC is unable to resolve the dispute under Step One within thirty (30) days of the giving of Notice as provided under Section 11.1.1, and only in such event, a Party shall be entitled to invoke Step Two. A Party may invoke Step Two by giving Notice thereof to the OC the later of thirty (30) days after the meeting of the OC under Step One or sixty (60) days after giving Notice as provided under Section 11.1.1. In the event a Party invokes Step Two, the OC shall, in writing, and no later than fourteen (14) days after receipt of the Notice, refer the dispute in writing for consideration to the officers of highest authority of the Parties. Unless otherwise mutually agreed, such officers shall meet in person no later than thirty (30) days after such referral and shall make a good faith effort to resolve the dispute. This meeting may be either in person or virtual. To facilitate resolution, the Parties shall exchange written position papers concerning the dispute no later than forty-eight (48) hours in advance of such meeting; provided, however that the Parties may agree to exchange such papers at an earlier time by mutual agreement. In the event the Parties fail to resolve the dispute under Step Two, a disputing Party shall be entitled to invoke Step Three.

**11.1.3 Step Three.** If unable to resolve the dispute under Steps One and Two, the Parties to the dispute may file, with respect to the dispute, an action in the United States District Court for the District of Columbia, except as provided below, and each Party submits itself to the personal jurisdiction of such Court. The Parties agree that in any such action, each Party shall stipulate to have a United States Magistrate Judge conduct any and all proceedings in the litigation in accordance with 28 U.S.C. § 636(c), and Fed. R. Civ. P. 73, and shall waive any right to a trial of the



dispute by jury. The decision of the Magistrate Judge shall be final and binding on the disputing Parties, and not subject to appeal, and each Party to the dispute may seek to enforce the decision, and any resulting order or judgment by judicial proceedings. In the event the United States District Court dismisses the action for lack of subject matter jurisdiction, and notwithstanding the foregoing, a Party may file an action in any court with jurisdiction in order to obtain a resolution of the dispute, and any right of a Party to the dispute to trial of the action by jury shall be waived.

**11.1.4 Exceptions.** In the event of disputes involving Confidential Information, infringement or ownership of Intellectual Property or rights pertaining thereto, or any dispute where a Party seeks temporary or preliminary injunctive relief to avoid alleged immediate and irreparable harm, the procedures stated in this Article shall apply, but shall not preclude a Party from seeking such temporary or preliminary injunctive relief. If a Party seeks such judicial relief but fails to obtain it, the Party seeking such relief shall pay the reasonable attorneys' fees and costs of the other Party(s) incurred with respect to opposing such relief.

**11.1.5 Effect on FPA 205/206 Rights and Obligations.** Notwithstanding the foregoing, nothing in this Article 11 is intended to supersede or waive the FPA Sections 205 and/or 206 filing rights or obligations of the Parties, as applicable. For the avoidance of doubt, the Parties acknowledge that to the extent a Party is subject to FERC jurisdiction under the FPA, resolution of a dispute as agreed upon by the Parties may require such Party to seek FERC acceptance FPA Section 205 or 206, and such request for acceptance should not itself be considered a breach of these dispute resolution procedures.

**ARTICLE TWELVE**  
**RETAINED RIGHTS OF PARTIES**

- 12.1** Parties Entitled to Act Separately. This Agreement does not create or establish, and shall not be construed to create or establish, any partnership or joint venture between the Parties. This Agreement establishes terms and conditions solely of a contractual relationship, among independent entities, to facilitate the achievement of the joint objectives described in the Agreement. The contractual relationship established hereunder implies no duties or obligations among the Parties except as specified expressly herein. All obligations hereunder shall be subject to, and performed in a manner that complies with each Party's internal requirements; provided, however, this sentence shall not limit any payment obligation or indemnity obligation under Section 15.3.

**ARTICLE THIRTEEN**  
**EFFECTIVE DATE, IMPLEMENTATION, TERM AND TERMINATION**

- 13.1 Effective Date; Implementation.** This Agreement shall become effective on the date it is executed by all Parties (“Effective Date”).
- 13.2 Term.** This Agreement shall continue in full force and effect for a term of five (5) years, and shall continue year to year thereafter, unless terminated earlier in accordance with the provisions of this Agreement.
- 13.3 Right of a Party to Terminate.**
- 13.3.1** Any Party may terminate this Agreement at any time upon not less than twelve (12) months’ Notice to the other Parties.
- 13.3.2** Any Party may terminate this Agreement in accordance with Section 13.4, 13.5, or 13.6.
- 13.4 Termination or Modification Due to Regulatory Action.** In the event that FERC, or any person, takes any action to subject TVA or TVA’s activities under this Agreement to FERC’s jurisdiction under the Federal Power Act, TVA may terminate this Agreement upon thirty (30) days’ Notice. A Party may terminate this Agreement upon thirty (30) days’ Notice if FERC makes, or requires the Parties to make, any substantive modifications to the provisions of this Agreement.
- 13.5 Change in NERC.** This Agreement is premised on the existence of NERC, and the applicability of NERC definitions, policies, and procedures. To the extent that NERC ceases to exist in its current form, and/or is replaced with an entity with authority for reliability over the transmission systems of the Parties, the Parties shall promptly meet to determine whether to revise this Agreement to reflect the new reliability entity and the Parties’ obligations in light of the authority of the new reliability entity or to terminate this Agreement.
- 13.6 Survival.** The applicable provisions of this Agreement shall continue in effect after any termination of this Agreement to provide for adjustments and payments, dispute resolution, determination and enforcement of liability, and indemnification, arising from acts or events that occurred during the period this Agreement was in effect.
- 13.7 Post-Termination Cooperation.** Following any termination of this Agreement, both Parties shall thereafter cooperate fully and work diligently in good faith to achieve an orderly resolution of all matters resulting from such termination.

**ARTICLE FOURTEEN  
CONFIDENTIAL INFORMATION**

**14.1 Definition.** The term “Confidential Information” shall mean: (a) all data and information, whether furnished before or after the execution of this Agreement, whether oral, written, or recorded/electronic, and regardless of the manner in which it is furnished, that is marked “Confidential” or “Proprietary” or which under all of the circumstances should be treated as confidential or proprietary; (b) any data or information deemed confidential under some other form of confidentiality agreement or tariff provided to a Party by a generator; (c) all reports, summaries, compilations, analyses, notes, or any other data or information of a Party hereto which are based on, contain, or reflect any Confidential Information; (d) applicable material deemed Confidential Information pursuant to the PJM Data Confidentiality Regional Stakeholder Group; and (e) any data and information which, if disclosed by a transmission function employee of a utility regulated by the FERC to a market function employee of the same utility system, other than by public posting, would violate the FERC’s Standards of Conduct set forth in 18 C.F.R. §§ 37.1-37.8 and the PJM’s Standards of Conduct on file with the FERC and TVA’s Standard of Conduct. The Parties agree that Confidential Information constitutes commercially sensitive and proprietary trade secret information.

**14.1.1 Confidential Data Exchange.** The Parties agree that various components of the data exchanged under Sections 4.1 and 6.1, including transmission and generation scheduled outage data and unscheduled or forced outage data), are Confidential Information:

- (a) The Party receiving the Confidential Information shall treat the information in the same confidential manner as its Governing Documents require it treat the confidential information of its own members and market participants.
- (b) The receiving Party shall not release the producing Party’s Confidential Information until expiration of the time period controlling the producing Party’s disclosure of the same information, as such period is described in the producing Party’s Governing Documents from time to time. As of the Effective Date, this period is six (6) months with respect to bid or pricing data, and seven (7) calendar days for transmission data after the event ends.
- (c) All other prerequisites applicable to the producing Party’s release of such Confidential Information have been satisfied as determined by the producing Party.
- (d) Notwithstanding any other provision in this Agreement, EMS models and the data used for EMS modeling exchanged pursuant to § 4.1 may be released to the receiving party’s Transmission Owners for operational or reliability compliance purposes. The respective Party’s Transmission Owners shall be required to maintain the EMS models and the data as

confidential in a manner consistent with or superior to the terms and conditions contained herein.

- 14.2 Protection.** During the course of the Parties' performance under this Agreement, a Party may receive or become exposed to Confidential Information. Except as set forth herein, the Parties agree to keep in confidence, and not to copy, disclose, or distribute any Confidential Information or any part thereof, without the prior written permission of the issuing Party. In addition, each Party shall ensure that its employees, its agents, its subcontractors, and its subcontractors' employees, and agents to whom Confidential Information is given or exposed, agree to be bound by the terms and conditions contained herein. Each Party shall be liable for any breach of this Article by its employees, its agents, its subcontractors, and its subcontractors' employees and agents.
- 14.3 Scope.** This obligation of confidentiality shall not extend to data and information that, at no fault of a recipient Party, is or was: (a) in the public domain or generally available or known to the public; (b) disclosed to a recipient by a non-Party who had a legal right to do so; (c) independently developed by a Party or known to such Party prior to its disclosure hereunder; and (d) which is required to be disclosed by subpoena, law, or other directive of a Governmental Authority.
- 14.4 Standard of Care.** Each Party shall protect Confidential Information from disclosure, dissemination, or publication. Regardless of whether a Party is subject to the jurisdiction of the FERC under the Federal Power Act, and regardless of whether a Party is a RTO, each Party agrees to restrict access to all Confidential Information to only those persons authorized to view such information (a) by the FERC's Standards of Conduct, 18 C.F.R. §§ 37.1-37.8 or, if more restrictive, (b) by such Party's board resolutions, tariff provisions, or other internal policies governing access to, and the sharing of, energy market or transmission system information.
- 14.5 Required Disclosure.** If a Governmental Authority requests or requires a Party to disclose any Confidential Information, such Party shall provide the supplying Party with prompt Notice of such request or requirement so that the supplying Party may seek an appropriate protective order or other appropriate remedy or waive compliance with the provisions of this Agreement. Notwithstanding the absence of a protective order or a waiver, a Party shall disclose only such Confidential Information, which it is legally required to disclose. Each Party shall use reasonable efforts to obtain reliable assurances that confidential treatment shall be accorded to Confidential Information required to be disclosed.

In response to any Freedom of Information Act (FOIA) request for information received from or relating to a Party which has been designated Confidential Information, TVA shall evaluate the request and determine the applicability of any FOIA exemptions. TVA shall consult with the affected Party regarding the applicability of the FOIA exemptions, including 5 U.S.C. § 552. Pursuant to its responsibilities under the FOIA, TVA must make the final determination regarding whether the information requested is legally exempt from disclosure under the FOIA, and shall notify PJM in advance of the release of any Confidential Information as part of the response to a FOIA request.

If a Party is required to disclose any Confidential Information (the Disclosing Party) under this Section, a Party supplying such Confidential Information (the Supplying Party) shall have the right to immediately suspend supplying such Confidential Information to the Disclosing Party. In that event, the Parties shall meet as soon as practicable in an effort to resolve any and all issues associated with the required disclosure of such Confidential Information, and the likelihood of additional disclosures of such Confidential Information. If the Parties are unable to resolve those issues within ten (10) days, notwithstanding Section 14.3, the Supplying Party shall have the right to terminate this Agreement immediately.

- 14.6 Return of Confidential Information.** All Confidential Information provided by the supplying Party shall be returned by the receiving Party to the supplying Party promptly upon request. Upon termination or expiration of this Agreement, a Party shall use reasonable efforts to destroy, erase, delete, or return to the supplying Party any and all written or electronic Confidential Information. In no event shall a receiving Party retain copies of any Confidential Information provided by a supplying Party.
- 14.7 Equitable Relief.** Each Party acknowledges that remedies at law are inadequate to protect against breach of the covenants and agreements in this Article, and hereby in advance agrees, without prejudice to any rights to judicial relief that it may otherwise have, to the granting of equitable relief, including injunction, in the supplying Party's favor without proof of actual damages. In addition to the equitable relief referred to in this Section, a supplying Party shall only be entitled to recover from a receiving Party any and all gains wrongfully acquired, directly or indirectly, from a receiving Party's unauthorized disclosure of Confidential Information.

**ARTICLE FIFTEEN  
ADDITIONAL PROVISIONS**

- 15.1 Unauthorized Transfer of Third-Party Intellectual Property.** In the performance of this Agreement, no Party shall transfer to another Party any Intellectual Property, the use of which by that Party would constitute an infringement of the rights of any non-Party. In the event such transfer occurs, whether or not inadvertent, the transferring Party shall, promptly upon learning of the transfer, provide Notice to the receiving Party and upon receipt of such Notice the receiving Party shall take reasonable steps to avoid claims and mitigate losses.
- 15.2 Intellectual Property Developed Under This Agreement.** If during the term of this Agreement, the Parties mutually develop any new Intellectual Property that is reduced to writing, the Parties shall negotiate in good faith concerning the ownership and licensing of such Intellectual Property.
- 15.3 Indemnification.** Each Party shall defend, indemnify, and hold the other Parties harmless from all actual losses, damages, liabilities, claims, expenses, causes of action, and judgments (collectively, "Losses"), brought or obtained by any non-Party against such Party, only to the extent that such Losses arise directly from:
- (a) Gross negligence, recklessness, or willful misconduct of such Party or any of its agents or employees, in the performance of this Agreement, except to the extent the Losses arise (i) from gross negligence, recklessness, willful misconduct or breach of contract or law by another Party or such other Party's agents or employees, or (ii) as a consequence of strict liability imposed as a matter of law upon another Party, or such other Party's agents or employees;
  - (b) Any claim that such Party violated any copyright, patent, trademark, license, or other intellectual property right of a non-Party in the performance of this Agreement;
  - (c) Any claim arising from the transfer of Intellectual Property in violation of Section 15.1; or
  - (d) Any claim that such Party caused bodily injury to an employee of another Party due to gross negligence, recklessness, or willful conduct of such Party.
- 15.4 Limitation of Liability.** Except as set forth in this Article: (a) no Party shall be liable to another Party, directly or indirectly, for any damages or losses of any kind sustained due to any failure to perform its obligations under this Agreement, unless such failure to perform was malicious or reckless; and (b) any liability of a Party to another Party shall be limited to direct damages, and no lost profits, damages to compensate for lost goodwill, consequential damages, or punitive damages shall be sought or awarded.

- 15.5 Permitted Assignments.** This Agreement may not be assigned by a Party except: (a) with the written consent of the non-assigning Parties, which consent may be withheld in each such Party's absolute discretion; and (b) in the case of a merger, consolidation, sale, or spin-off of substantially all of a Party's assets. In the case of a merger, consolidation, sale, reorganization, or spin-off by a Party, such Party shall assure that the successor or purchaser adopts this Agreement, and the other Parties shall be deemed to have consented to such adoption.
- 15.6 Liability to Non-Parties.** Nothing in this Agreement, whether express or implied, is intended to confer any rights or remedies under or by reason of this Agreement on any person or entity that is not a Party or a permitted successor or assign; provided, that nothing in this Section shall affect the rights or obligations of any Reciprocal Entity under a Reciprocal Coordination Agreement.
- 15.7 Force Majeure.** No Party shall be in breach of this Agreement to the extent and during the period that such Party's performance is made impracticable by any unanticipated cause or causes beyond such Party's control, and without such Party's fault or negligence, which may include, but are not limited to, any act, omission, or circumstance occasioned by or in consequence of any act of God, labor dispute, act of the public enemy, war, insurrection, riot, fire, storm or flood, explosion, breakage or accident to machinery or equipment, or curtailment, order, regulation or restriction imposed by a Governmental Authority. Upon the occurrence of an event considered by a Party to constitute a force majeure event, such Party shall use reasonable efforts to endeavor to continue to perform its obligations as far as reasonably practicable and to remedy the event, provided that this Section shall not require a Party to settle any strike or labor dispute. A Party claiming a force majeure event shall notify the other Parties in writing immediately, and in no event later than forty-eight (48) hours after the occurrence of the force majeure event. The foregoing notwithstanding, the occurrence of a cause under this Section shall not excuse a Party from making any payment otherwise required under this Agreement.
- 15.8 Amendment.** No amendment of or modification to this Agreement shall be made or become enforceable except by a written instrument duly executed by all of the Parties.
- 15.9 Headings.** The headings used for the Articles and Sections of this Agreement are for convenience and reference purposes only, and shall not be construed to modify, expand, limit, or restrict the provisions of this Agreement.
- 15.10 Counterparts.** This Agreement may be executed in any number of counterparts, each of which shall be an original, but all of which together shall constitute one instrument, binding upon the Parties hereto, notwithstanding that both Parties may not have executed the same counterpart.
- 15.11 Notices.** A notice ("Notice") shall be effective only if in writing and delivered by: hand; reputable overnight courier; United States mail; or telefacsimile. Electronic mail is not effective Notice. Notice shall be deemed to have been given: (a) when delivered to the



recipient by hand, overnight courier, or telefacsimile or (b) if delivered by United States mail, on the postmark date. Notice shall be addressed as follows:

PJM:  
Michael E. Bryson  
Vice President, Operations  
PJM Interconnection, L.L.C.  
2750 Monroe Boulevard Valley Forge Corporate Center  
Audubon, PA 19403  
Tel: (610) 666-4659  
Fax: (610) 666-4281

TVA:  
Gregory J. Henrich  
Vice President, Transmission Operations & Power Supply  
Tennessee Valley Authority  
1101 Market Street, MR 1 B-C  
Chattanooga, TN 37402-2801  
Tel: (423) 751-2918  
Fax: (423) 751-7116

LG&E/KU:  
Beth McFarland  
Vice President – Transmission  
LG&E/KU Services Inc.  
220 West Main Street  
PO Box 32010  
Louisville, Kentucky 40202  
Tel: (502) 627-3648

A Party may change its designated recipient of Notices, or its address, from time to time, by giving Notice of such change.

- 15.12 Governing Law.** This Agreement and the rights and duties of the Parties relating to this Agreement shall be governed by and construed in accordance with the Federal laws of the United States of America, including but not limited to federal, and general contract law. Subject to Article Eleven (Dispute Resolution).
- 15.13 Prior Agreements; Entire Agreement.** All prior agreements by the Parties relating to the matters contemplated by this Agreement, whether written or oral, are superseded by this Agreement, and shall be of no further force or effect.

PJM INTERCONNECTION, L.L.C.

By: Michael Bryson  
Senior VP, Operations

Michael Bryson, Vice President, Operations

TENNESSEE VALLEY AUTHORITY

By: Aaron P. Melda  
SVP Transmission & Power Supply

Aaron P. Melda, Senior Vice President, Transmission & Power Supply

LOUISVILLE GAS & ELECTRIC COMPANY

kl

By: Beth McFarland  
6/2/23

Beth McFarland, Vice President – Transmission

KENTUCKY UTILITIES COMPANY

kl

By: Beth McFarland  
6/2/23

Beth McFarland, Vice President – Transmission

**ATTACHMENT 1**

**Congestion  
Management  
Process  
(CMP)  
MASTER**

*Executive Summary*

*This Congestion Management Process<sup>1</sup> document provides significant detail in the areas of Market Flow Calculation. These additional details are the result of discussions between multiple Operating Entities.*

*As Operating Entities expand and implement their respective markets, one of the primary seams issues that must be resolved is how different congestion management methodologies (market-based and traditional) will interact to ensure that parallel flows and impacts are recognized and controlled in a manner that consistently ensures system reliability. This proposed solution will greatly enhance current Interchange Distribution Calculator (IDC) granularity by utilizing existing real-time applications to monitor and react to Flowgates external to an Operating Entity's footprint.*

*In brief, the process includes the following concepts:*

- Participating Operating Entities will agree to observe limits on an extensive list of coordinated external Flowgates.*
- Like all Control Areas (CA), Market-Based Operating Entities will have Firm and non-Firm GTL Flows upon those Flowgates.*
- In real-time, Market-Based Operating Entities will calculate and monitor one-hour ahead projected and actual flows.*
- The IDC will calculate GTL flows for Operating Entities using the State Estimator data provided by the entities.*
- Market-Based Operating Entities will calculate the actual and the one-hour ahead projected Firm and Non-Firm limits for both internal and external Coordinated Flowgates.*
- Market-Based Operating Entities will constrain their operations to limit Firm GTL Flows on the Coordinated Flowgates to no more than the calculated Firm Flow Limit established in the analysis.*
- Market-Based Operating Entities will provide to the IDC detailed representation of their marginal units, so that the IDC can continue to effectively compute the effects of all tagged transactions regardless of the size of the market area. These tagged transactions will include transactions into the market, transactions out of the market, transactions through the market, and tagged grandfathered transactions within the market.*

<sup>1</sup> Capitalized terms that are not defined in this Attachment 2 shall have the meaning set forth in the body, appendices, and attachments of the *Joint Reliability Coordination Agreement Between Tennessee Valley Authority, PJM Interconnection, L.L.C., Louisville Gas and Electric Company, and Kentucky Utilities Company*

- *When there is a Transmission Loading Relief (TLR) 3a request or higher called on a Coordinated Flowgate, and the Market-Based Operating Entity's actual/one-hour ahead projected IDC GTL flows exceed the Firm Flow Limits, Market-Based Operating Entities will respond to their relief obligations by redispatching their systems in a manner that is consistent with how non-market entities respond to their share of IDC GTL relief obligations per the IDC congestion management report.*
  
- *The above processes refer to the "Congestion Management" portion of the paper, which will be implemented by Market-Based Operating Entities.*
  
- *Additional entities may choose to enter into similar Reciprocal Coordination Agreements that describe how Available Transfer Capability (ATC)/Available Flowgate Capability (AFC), Firm Flows, and outage maintenance will be coordinated on a forward basis.*
  
- *The complete process will allow participating Operating Entities to address the reliability aspects of congestion management seams issues between all parties whether the seams are between market to non-market operations or market-to-market operations.*

## Change Summary

Generate baseline Congestion Management Process (CMP) document based on CMP documents executed by:

- Manitoba Hydro and Midcontinent Independent System Operator, Inc. (MISO)
- Mid-Continent Area Power Pool (MAPP) and MISO
- MISO and PJM Interconnection, L.L.C. (PJM)
- PJM and Tennessee Valley Authority, Louisville Gas and Electric Company, and Kentucky Utilities Company
- MISO and Southwest Power Pool, Inc. (SPP)

The document also includes subsequent changes agreed upon by a majority of the Congestion Management Process Council (CMPC). For items which are specific to a limited number of agreements, the CMP members have used an approach of documenting these unique items in separate appendices rather than in the base document. The CMPC members reserve all rights with respect to the different options identified in the appendices attached hereto without any obligation to adopt or support such options. The CMPC members reserve the right to oppose any position taken by another CMPC member in a FERC filing or otherwise with respect to the choice of options listed in the appendices. Nothing contained herein shall be construed to indicate the support or agreement by the CMPC members to an option presented in the appendices.

### **Revision 1.1 (November 30, 2007)**

Per FERC Order ER07-1417-000, in the “Forward Coordination Processes” section 6.6 added the word “outage” between “unit” and “scheduling” in the following sentence, “Market-Based Operating Entities will use the Flowgate limit to restrict unit outage scheduling for a Coordinated Flowgate when maintenance outage coordination indicates possible congestion and there is recent TLR activity on a Flowgate.”

### **Revision 1.2 (May 2, 2008)**

The Market Flow Threshold is changing from 3% to 5%. The NERC Standards Committee approved changing the Market Flow Threshold for the field test at its April 10, 2008 meeting.

### **Revision 1.3 (July 16, 2008)**

Per FERC Order issued in Docket Nos. ER08-884-000 and ER08-913-000, *Appendix H (Market Flow Threshold Field Test Terms And Conditions)* was added.

**Revision 1.4 (October 31, 2008)**

The percentages were changed in Sections 4.4 (*Firm Market Flow Calculation Rules*) and 5.5 (*Market-Based Operating Entity Real-time Actions*) to be consistent with changes made under Revision 1.2. *Appendix H – Market Flow Threshold Field Test Terms And Conditions* was updated to reflect the NERC approved Market Flow Threshold Field Test extension to October 31, 2009.

**Revision 1.5 (December 18, 2008)**

Updated Section 5.2 (*Quantify and Provide Data for Market Flow*) and *Appendix B – Determination of Marginal Zone Participation Factors* to support changes to the manner in which MISO uses marginal zones and submits marginal zone information to the IDC.

**Revision 1.6 (February 19, 2009)**

*Appendix H – Market Flow Threshold Field Test Terms And Conditions* was updated to reflect that MISO no longer has a contractual obligation to observe a 0% threshold for MISO Market Flows on Flowgates where both MAPP and MISO are reciprocal.

**Revision 1.7 (November 1, 2009)**

Applied updates based on the results of the Market Flow Threshold Field Test including clarifications that allocations are calculated down to zero percent. Changes have been applied to the *Executive Summary*, *Section 4.1 Market Flow Determination*, *Section 4.4 Firm Market Flow Calculation Rules*, *Section 5.5 Market-Based Operating Entity Real-time Actions*, *Section 6.6 Forward Coordination Processes*, *Section 6.6.3 Limiting Firm Transmission Service*, *Section 6.7 Sharing or Transferring Unused Allocations*, and *Appendix H – Application of Market Flow Threshold Field Test Conditions*.

**Revision 1.8 (May 31, 2010)**

Applied updates to further standardize the “Allocation Adjustment for New Transmission Facilities and/or Designated Network Resources” process. Changes have been made to *Appendix F – FERC Dispute Resolution* and *Appendix G – Allocation Adjustments for New Transmission Facilities and/or Designated Network Resources*.

**Revision 1.9 (January 4, 2011)**

Modified to incorporate the revisions to the JOA, including revisions to Attachments 2 and 3, submitted as part of the Settlement Agreement and Offer of Settlement in Docket Nos. EL10-45-000, EL10-46-000, and EL10-60-000.

**Revision 1.10 (July 25, 2016)**

Generated updated baseline CMP document executed by the following entities:

- Manitoba Hydro and MISO
- Minnkota Power Cooperative, Inc. and MISO
- MISO and PJM
- PJM and TVA
  - o Louisville Gas and Electric Company/Kentucky Utilities Company (LG&E/KU) and Associated Electric Cooperative, Inc. (AECI) executed separate agreements with TVA stipulating the CMP provisions executed by PJM and TVA apply to AECI and LG&E/KU as Reciprocal Entities.
- MISO and SPP
- MISO Attachment LL

Section	Revision Description
3.2	Clarified language on inclusion of Coordinated Flowgates in AFC process. Removed consideration of reverse impacts when performing Flowgate studies.
3.2.1	Revised language to better describe how the four Flowgate studies used to identify Coordinated Flowgates are performed.
3.2.6	Added a new section requiring coordination between Parties before making a Flowgate permanent that includes a Tie Line monitored element.
4.1	Revised language to require a Market-Based Operating Entity to consistently account for export and import tagged transactions in the identified calculations using one of the three methodologies set forth in the new Section 4.1.1. Revisions have previously been accepted by FERC in the CMP documents executed between MISO and PJM, MISO and SPP, and PJM and TVA.
4.1.1	
6.10	Added a new section listing the requirements that must be satisfied for a Combining Party to incorporate a Non-Reciprocal Entity's load and the associated generation serving that load into the Reciprocal's Entity's Allocation calculations.
Appendix A	Added the following defined terms: Agreement, Combining Party, Non-Reciprocal Entity, Party, Third-Party, and Tie Line.
Appendix B	Revised language addressing how a Market-Based Operating Entity using the Marginal Zone methodology will determine marginal zone participation factors. Revisions have previously been accepted by FERC in the CMP documents executed between MISO and PJM, MISO and SPP, and PJM and TVA.
Appendix C	Clarified in Figure C-1 and Table C-1 the steps on inclusion of Coordinated Flowgates in the AFC process.



**Revision 1.11 (June 1, 2017)**

Per NERC Operating Reliability Subcommittee applied updates necessary for MISO to incorporate External Asynchronous Resources into MISO Market Flows.

Section	Revision Description
3.2	Updated the number of Coordination Flowgate studies from four to five.
3.2.1	Clarified Study 4 applies internal CA/CA permutations and added a new Study 5 specific to External Asynchronous Resources.
3.2.2	Updated the number of Coordination Flowgate studies from four to five.
3.2.5	
4.1	Added how the External Asynchronous Resources will be considered in Market Flow and the exclusion of the related tags from IDC.
6.2	Updated the number of Coordination Flowgate studies from four to five.
6.8	Specified the priority of the Market Flow will correspond to the priority of the tag.
Appendix A	Added a new definition specific to MISO, External Asynchronous Resources. Updated the number of Coordination Flowgate studies from four to five.
Appendix C	Updated the number of Coordination Flowgate studies from four to five in Table C-1.

**Revision 1.12 (Mar 2022)**

Updated the reflect the PFV changes as per NAESB standard

## Table of Contents

### SECTION 1 – INTRODUCTION

- 1.1 Problem Definition
  - 1.1.1 The Nature of Energy Flows
  - 1.1.2 Granularity in the IDC
  - 1.1.3 Reduced Data and Granularity Coarseness
  - 1.1.4 Accounting for Loop Flows
  - 1.1.5 Conclusion
- 1.2 Process Scope and Limitations
  - 1.2.1 Vision Statement
  - 1.2.2 Process Scope
- 1.3 Goals and Metrics
- 1.4 Assumptions

### SECTION 2 – PROCESS OVERVIEW

- 2.1 Summary of Process

### SECTION 3 – IMPACTED FLOWGATE DETERMINATION

- 3.1 Flowgates
- 3.2 Coordinated Flowgates
  - 3.2.1 Flowgate Studies
  - 3.2.2 Disputed Flowgates
  - 3.2.3 Third Party Request Flowgate Additions
  - 3.2.4 Frequency of Coordinated Flowgate Determination
  - 3.2.5 Dynamic Creation of Coordinated Flowgates
  - 3.2.6 Coordination of Tie Line Flowgate Additions

### SECTION 4 – MARKET-BASED OPERATING ENTITY FLOW CALCULATIONS: MARKET FLOW, FIRM MARKET FLOW, AND NON-FIRM MARKET FLOW

- 4.1 Market Flow Determination
- 4.2 Firm Flow Determination
- 4.3 Determining the Firm Flow Limit

4.4 Firm Flow Limit Calculation Rules

**SECTION 5 – MARKET-BASED OPERATING ENTITY CONGESTION MANAGEMENT**

**5.1 Calculating Market Flows**

5.2 Quantify and Provide Data for Market Flow

5.3 Day-Ahead Operations Process

5.4 Real-time Operations Process – Operating Entity Capabilities

5.5 Market-Based Operating Entity Real-time Actions

**SECTION 6 – RECIPROCAL OPERATIONS**

6.1 Reciprocal Coordinated Flowgates

6.2 The Relationship Between Coordinated Flowgates and Reciprocal Coordinated Flowgates

6.3 Coordination Process for Reciprocal Flowgates

6.4 Calculating Historic Firm Flows

6.5 Recalculation of Initial Historic Firm Flow Values and Ratios

6.6 Forward Coordination Processes

6.6.1 Determining Firm Transmission Service Impacts

6.6.2 Rules for Considering Firm Transmission Service

6.6.3 Limiting Firm Transmission Service

6.7 Sharing or Transferring Unused Allocations

6.7.1 General Principles

6.7.2 Provisions for Sharing or Transferring of Unused Allocations

6.8 Market-Based Operating Entities Quantify and Provide Data for Market Flow

6.9 Real-time Operations Process for Market-Based Operating Entities

6.9.1 Market-Based Operating Entity Capabilities

6.9.2 Market-Based Operating Entity Real-time Actions

6.10 Requirements to Combine Allocations with Non-Reciprocal Entity

**SECTION 7 – APPENDICES**

Appendix A – Glossary

Appendix B – Determination of Marginal Zone Participation Factors

Appendix C – Flowgate Determination Process

Appendix D – Training

Appendix E – Reserved

Appendix F – FERC Dispute Resolution

Appendix G – Allocation Adjustment for New Transmission Facilities and/or Designated Network Resources

Appendix H – Application of Market Flow Threshold Field Test Conditions

## **Section 1 – Introduction**

It is the intention of the Reciprocal Entities to utilize the processes within this document. It is further the intention to develop this process in a way that will allow other regional entities with similar concerns to utilize the concepts within this process to aid in the resolution of their own seams issues.

## **1.1 Problem Definition**

### **1.1.1 The Nature of Energy Flows**

Energy flows are distinctly different from the manner in which the energy commodity is purchased, sold, and ultimately scheduled. In the current practice of “contract path” scheduling, schedules identify a source point for generation of energy, a series of wheeling agreements being utilized to transport that energy, and a specific sink point where that energy is being consumed by a load. However, due to the electrical characteristics of the Eastern Interconnection, energy flows are more dispersed than what is described within that schedule. This disconnect becomes of concern when there is a need to take actions on contract-path schedules to effect changes on the physical system (for example, the curtailment of schedules to relieve transmission constraints).

In the Eastern Interconnection, much of this concern has been addressed through the use of the North American Electric Reliability Corporation (NERC) and/or North American Energy Standards Board (NAESB) TLR process. Through this process, Reliability Coordinators utilize the IDC to determine appropriate actions to provide that relief. The IDC bases its calculations on the use of transaction tags: electronic documents that specify a source and a sink, which can be used to estimate real power flows through the use of a network model. In order to change flows, the IDC is given a particular constraint and a desired change in flows. The IDC returns back all source to sink transactions that contribute to that constraint and specifies schedule changes to be made that will effect that change in flows.

In other parts of the Eastern Interconnection, however, the use of centralized economic dispatch results in a solution that does not focus on changing entire transactions (effectively redispatching through the use of imbalance energy), but rather redispatch itself. In this procedure, the party attempting to provide relief does not need to know that a balanced source to sink transaction should be adjusted; rather, they are aware of a net generation to load balance and the impacts of different generators on various constraints. Bid-based security constrained central dispatch based on Locational Marginal Pricing is a regional implementation of this practice.

Currently, these two practices are somewhat incompatible. Due to the electrical characteristics of the Interconnection and geographic scope of the regions, this incompatibility has been of limited concern. However, regional market expansion has begun to draw attention to this operational disjoint, as the expansion itself exacerbates the negative effects of the incompatibility.

### **1.1.2 Granularity in the IDC**

The IDC uses an approximation of the Interconnection to identify impacts on a particular transmission constraint that are caused by flows between Control Areas. This approximation allows for a Reliability Coordinator to identify tagged transactions with specific sources and sinks that are contributing to the constraint. While tagged transactions may specify sources and sinks in a very specific manner, the IDC in general cannot respect this detail, and instead

consolidates the impacts of several generators and loads into a homogenous representation of the impacts of a single Control Area. This is referred to as the *granularity* of the IDC. Current granularity is typically defined to the Control Area level; finer granularity is present in certain special situations as deemed necessary by NERC.

### **1.1.3 Reduced Data and Granularity Coarseness**

As centrally dispatched energy markets expand their footprint, two related changes occur with regard to the above process. In some cases, data previously sent to the IDC is no longer sent due to the fact that it is no longer tagged. In others, transactions remain tagged, but the increased market footprint results in an increase in granularity coarseness within the IDC; that is, the apparent Control Area boundary becomes the same as the market boundary so that what had been historically 30 or more Control Areas now appears as one.

In the first change, transactions contained entirely within the market footprint are considered to be utilizing network service (even when the market spans multiple Control Areas). As such, there is no requirement for them to be tagged (or such requirement is waived by NERC), and therefore, no requirement that they be sent to the IDC. This is of concern from a reliability perspective, as the IDC will no longer have a large pool of transactions from which to provide relief, although the energy flows may remain consistent with those prior to the market expansion. In other words, flows subject to TLR curtailment prior to the market expansion are no longer available for that process.

In the second change, the expansion of the footprint itself results in a dilution of the approximation utilized by the IDC. When a market region is relatively small (or isolated), the Control Area to Control Area approximation of that region's impact on transmission constraints is acceptable; actions within the market footprint generally have a similar and consistent impact on all transmission facilities outside the footprint. However, when the market footprint expands significantly, and is co-mingled with non-market Control Areas, the ability to utilize the historic approximation of electrically representative flows fails to effectively predict energy flow. Impacts on external facilities can vary significantly depending on the dispatch of the resources within the market footprint. With regard to the IDC, this information is effectively lost within the expanded footprint, and results in an increase in the level of granularity coarseness, or a "loss of granularity."

### **1.1.4 Accounting for Loop Flows**

The processes for accounting for loop flows caused by uses of the transmission system between Control Areas are different under a market environment. Absent a market, loop flows from Transmission Service reservations between Control Areas are identified and accounted for by importing transmission reservations from surrounding systems. Under a market environment, the market will not have explicit transmission reservations for evolving market dispatch conditions between market Control Areas. Thus, a mechanism for accounting for anticipated Market Flows on non-market systems is necessary.

### **1.1.5 Conclusion**

The net effect of these changes is that reliability must be managed through different processes than those used before the market region's expansion. While relief can still be requested using the current process, both the ability to predict the effectiveness of a curtailment to provide that relief and the general pool of transactions available for curtailment are reduced. This CMP offers a strategy for eliminating this concern through a process that provides more information (finer granularity) to the IDC for the market area. This new congestion management process will ensure that reliability is not adversely affected as markets expand by providing information and relief opportunities previously unavailable to the IDC.



## **1.2 Process Scope and Limitations**

### **1.2.1 Vision Statement**

As Operating Entities become Market-Based Operating Entities, and expand their various markets, one of the primary seams issues that must be resolved is how different congestion management methodologies (market-based and traditional TLR) will interact to ensure parallel flows and impacts are recognized and controlled in a manner that consistently ensures system reliability and equitability. Reliability Coordinators can mandate emergency procedures to maintain safe operating limits, however, without coordination agreements that maintain flow limits in advance, the market would become volatile and the burden for relieving excess flow would ignore the economics of the entities which would be required to redispatch. For these entities, this process will offer a manner in which Market-Based Operating Entities can coordinate parallel flows with Operating Entities that have not yet or do not contemplate implementing markets. This process will provide more proactive management of transmission resources, more accurate information to Reliability Coordinators, and more candidates for providing relief when reliability is threatened due to transmission overload conditions.

### **1.2.2 Process Scope**

This process has been written specifically with the goal of coordinating seams between Reciprocal Entities and their respective neighbors.

### 1.3 Goals and Metrics

This document focuses on a solution to meet the following goals and requirements:

1. Develop a congestion management process whereby transmission overloads can be prevented through a shared and effective reduction in Flowgate or constraint usage by Reciprocal Entities and adjoining Reliability Coordinators.
2. Agree on a predefined set of Flowgates or constraints to be considered by all Reciprocal Entities, and a process to maintain this set as necessary.
3. Determine the best way to calculate flow due to market impacts on a defined set of Flowgates.
4. Develop Reciprocal Coordination Agreements that establish how each Operating Entity will consider its own Flowgate or constraint usage as well as the usage of other Operating Entities when it determines the amount of Flowgate or constraint capacity remaining. This process will include both operating horizon determination as well as forward looking capacity allocation.
5. Develop a procedure for managing congestion when Flowgates are impacted by both tagged and untagged energy flow.
6. Develop a procedure for determining the priorities of untagged energy flows (created through parallel flows from the market).
7. Agree on steps to be taken by Operating Entities to unload a constraint on a shared basis.
8. Determine whether procedure(s) for managing congestion will differ based on where the Flowgate is located (*i.e.*, inside Reciprocal Entity A, inside Reciprocal Entity B, or outside both Reciprocal Entity A and Reciprocal Entity B).
9. Confirm that the solution will be equitable, transparent, auditable, and independent for all parties.
10. Develop methodology to preserve and accommodate grandfathered transmission rights, contract rights, and other joint-use agreements.
11. Develop methodology to address changes in Total Transfer Capability (TTC), such as future system topology changes, new Designated Network Resources (DNRs), facility uprates/derates, prior outage limitations, etc., with respect to Allocation implications.
12. Develop a methodology for releasing Allocations if other parties do not join the process or if there is ATC going unused.

## 1.4 Assumptions

The processes set forth in this document were based on the following assumptions:

- Point-to-point schedules sinking in, sourcing from, or passing through an Operating Entity will be tagged.
- The IDC or a similar repository of schedules is needed at the Interconnection's current state and for the foreseeable future.
- The Operating Entity's Energy Management System (EMS) has the capability to monitor and respond to real-time and projected flows created by its real-time dispatch.
- The Reliability Coordinator of the area in which a Flowgate exists will be responsible for monitoring the Flowgate, determining any amount of relief needed, and entering the required relief in the IDC.
- The IDC has been modified to accept the submitted values of real-time generation, load, and other real-time data
- The IDC calculates the impacts of the untagged dispatch (GTL) on the Flowgates for all Operating Entities using Parallel Flow Visualization (PFV). The IDC will determine the Firm and non-Firm GTL Flow for each Market Based Operating Entity using the Firm and Non-Firm limits calculated in this agreement.
- The IDC can calculate the total amount of MW relief required by the Operating Entity (schedule curtailments required plus the relief provided by redispatch).

## Section 2 - Summary of Process

In order to coordinate congestion management, a bridge must be established that provides for comparable actions between Operating Entities. Without such a bridge, it is difficult, if not impossible, to ensure reliability and system coordination in an efficient and equitable manner. To effect this coordination of congestion management activities, we propose a methodology for determining both firm and non-firm flows resulting from Market-Based Operating Entity dispatch on external parties' Flowgates.

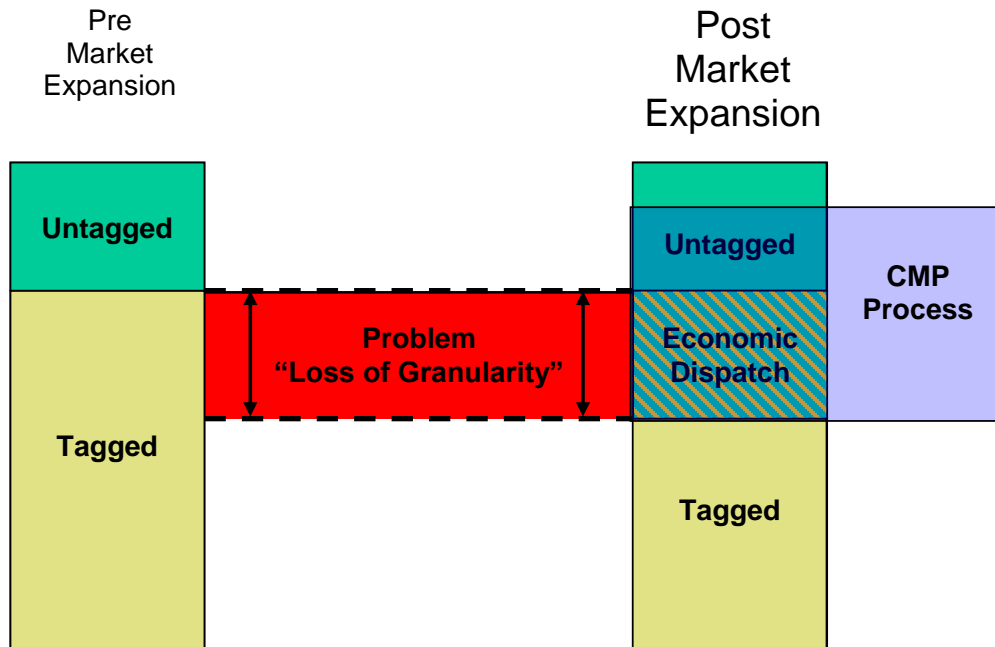

GTL Flows are the calculated energy flows on a specified Flowgate as a result of dispatch of generating resources serving load within a Operating Entity's Control Area . (Note: For the purposes of the Reciprocal Coordination process discussed later, Firm Transmission Service (7F) will be combined with the untagged firm component of Market Flows in the calculation of Historic Firm Flow. The Historic Firm Flow is described later in this document).

The IDC currently calculates GTL Flows for each CA in the Eastern Interconnection and used to determine each Operating Entities curtailment under a TLR. The methodology defined in this document determines how to quantify these GTL flows as Firm and non-Firm for each Market Based Operating Entity. Market Flow is a calculation similar to GTL, but is no longer used to determine relief obligations in the TLR protocol. However, Market Flow may still be used for

congestion management between Market Based Operating Entities, and thus we continue to define it in this agreement for reference.

GTL Flows can be divided into Firm and Non-Firm. Firm GTL Flows are considered as firm use of the transmission system for congestion management purposes and will be curtailed on a proportional basis with other firm uses during periods of firm curtailments and are equivalent to Firm Transmission Service. Non-Firm GTL flows are considered as non-firm use of the transmission system for congestion management purposes and will be curtailed on a proportional basis with other non-firm uses during periods of non-firm curtailments and are equivalent to non-firm Transmission Service. As such, Reliability Coordinators can request Market-Based Operating Entities to provide relief under TLR based on these transmission priorities.

By applying the above philosophy to the problem of coordinating congestion management, we can determine not only the impacts of a Market-Based Operating Entity's dispatch on a particular Flowgate; we can also determine the appropriate firmness of those flows. This results in the ability to coordinate both proactive and reactive congestion management between operating entities in a way that respects the current TLR process, while still allowing for the flexibility of internal congestion management based on market prices.

There are two areas that must be defined in order for this process to work effectively:

- **Coordinated Flowgate Definition.** In order to ensure that impacts of dispatch are properly recognized, a list of Flowgates must be developed around which congestion management may be effected and coordination can be established.
- **Congestion Management.** By coordinating congestion management efforts and enhancing the TLR process to recognize both untagged energy flows and data of finer granularity, we can ensure that when TLR is called, the appropriate non-firm flows are reduced before Firm Flows. This coordination will result in a reduction of TLR 5 events, as more relief will be available in TLR 3 to mitigate a constraint. This is accomplished through the calculation of flows due to economic dispatch, as well as by providing marginal unit information to aid in interchange transaction management.

The next sections of this document discuss each of these areas in detail.

### **Section 3 – Impacted Flowgate Determination**

### **3.1 Flowgates**

Flowgates are facilities or groups of facilities that may act as significant constraint points on the system. As such, they are typically used to analyze or monitor the effects of power flows on the bulk transmission grid. Operating Entities utilize Flowgates in various capacities to coordinate operations and manage reliability. For the purpose of this process, there are three kinds of Flowgates: AFC Flowgates, which are defined in Appendix A, Coordinated Flowgates (CFs), which are defined below, and Reciprocal Coordinated Flowgates (RCFs), which are defined in “Reciprocal Operations” Section 6. A diagram illustrating how these three categories of Flowgates are determined is included as Appendix C.

## 3.2 Coordinated Flowgates

An Operating Entity will conduct sensitivity studies to determine which Flowgates are significantly impacted by the flows of the Operating Entity's Control Zones (historic Control Areas that existed in the IDC). An Operating Entity identifies these Flowgates by performing the following five studies to determine which Flowgates the Operating Entity will monitor and help control. As set forth in Appendix C, a Flowgate passing any one of these studies will be considered a Coordinated Flowgate and AFCs shall be computed for these Flowgates, unless mutually agreed otherwise by the Operating Entities and any Reciprocal Entities for the Flowgate. An Operating Entity shall add a Coordinated Flowgate to its AFC process as soon as practical in accordance with the Operating Entity's processes. Nothing in this section precludes an Operating Entity or Reciprocal Entity from calculating AFCs for any Flowgates.

An Operating Entity may also specify additional Flowgates that have not passed any of the five studies to be Coordinated Flowgates where the Operating Entity expects to utilize the TLR process to manage congestion. For a list of Coordinated Flowgates between Reciprocal Entities, see each Reciprocal Entity's Open Access Same-Time Information System (OASIS) website.

Coordinated Flowgates are identified to determine which Flowgates an entity impacts significantly. This set of Flowgates may then be used in the congestion management processes and/or Reciprocal Operations defined in this document.

When performing the five Flowgate studies, a 5% threshold will be used based on the positive impact. Use of a 5% threshold in the studies may not capture all Flowgates that experience a significant impact due to operations. The Operating Entities have agreed to adopt a lower threshold at the time NERC and/or NAESB implements the use of a lower threshold in the TLR process.

### 3.2.1 Flowgate Studies

#### **Study 1) – IDC GLDF**

*(using the IDC tool)*

Upon request by an Operating Entity, a study will be performed using the IDC reflecting the topology of the system from the System Data Exchange (SDX) or any industry-accepted system with similar capabilities. The IDC can provide a list of Flowgates for any user-specified Control Area whose Generator to Load Distribution Factor (GLDF) NNL impact is 5% or greater. Using the historic Control Area representation in the IDC, if any one generator has a GLDF that is 5% or greater as determined by the IDC, this Flowgate will be considered a Coordinated Flowgate.

#### **Study 2) – IDC PSS/E Base Case GLDF**

*(no transmission outages – offline study)*

Upon request by an Operating Entity, the Operating Entity to which the request is made will perform a generator analysis to determine which Flowgates impacted by those CAs will be included in the list of Coordinated Flowgates. To provide better confidence that the



Operating Entity has effectively captured the subset of Flowgates upon which its generators have a significant impact, the Operating Entity will perform an offline study utilizing Managing and Utilizing System Transmission (MUST) or other industry-accepted software with similar capabilities. The Operating Entity will perform off-line studies using the IDC PSS/E base case. If any generator has a GLDF that is 5% or greater as determined by this Study 2, this Flowgate will be considered a Coordinated Flowgate. Study 1 above and this Study 2 are separate studies. There is no requirement that a Flowgate must pass both studies in order to be coordinated.

### **Study 3) – IDC PSS/E Base Case GLDF**

*(transmission outage - offline study)*

Upon request by an Operating Entity, the Operating Entity to which the request is made will perform a Flowgate analysis to determine which Flowgates impacted by those CAs will be included in the list of Coordinated Flowgates. The Flowgates determined using Study 2 above or Study 4 below that have a 3% to 5% distribution factor will be analyzed in this Study 3 against prior outage conditions. The Operating Entity will perform off-line studies using the IDC PSS/E base case utilizing MUST or other industry-accepted software with similar capabilities. The Operating Entity, in consultation with affected operating authorities, will perform a prior outage analysis, including both internal and external outages, by applying one of the following:

1. transmission facilities operated at 100kV and above, in the CA where the Flowgate's monitored facility(ies) is located and in CAs that are first tier to the CA where the Flowgate's monitored facility(ies) is located; or
2. transmission facilities operated at 100kV and above within 10 buses from the monitored facility(ies).

If any Flowgates with a 3% to 5% distribution factor from Study 2 or Study 4 are impacted by 5% or more from a prior outage condition (Line Outage Distribution Factor (LODF) from this Study 3, the Flowgate will be added to the list of Coordinated Flowgates.

### **Study 4) – IDC Base Case Transfer Distribution Factors**

*(no transmission outages – offline study)*

Upon request by an Operating Entity, the Operating Entity to which the request is made will perform a Flowgate analysis to determine which Flowgates impacted by those CAs will be included in the list of Coordinated Flowgates. The Operating Entity performing this analysis will analyze internal transactions between each historic CA/CA permutation. OTDF Flowgates will be analyzed with the contingent element out of service. The Operating Entity will perform off-line studies using the IDC PSS/E base case utilizing MUST, or other industry-accepted software with similar capabilities to determine the

Transfer Distribution Factors (TDFs). Flowgates that are impacted by 5% or greater by Study 4 will be considered a Coordinated Flowgate.

### **Study 5) – External Asynchronous Resource (EAR)**

Upon request by an Operating Entity, MISO shall rerun Study 4 (no outage scenario) to determine the flowgates impacted by its EAR. Additionally, a second study will be performed using the IDC reflecting the topology of the system from the System Data Exchange (SDX) or any industry-accepted system with similar capabilities. Both studies performed under Study 5 shall utilize the following assumptions: 1) the source to sink TDF calculation of the EAR shall be evaluated in the same way IDC would evaluate the impacts of the associated tag (e.g., source and sink of the EAR); and 2) any flowgate that is determined to be impacted by the EAR by 5% or greater will be considered a Coordinated Flowgate.

### **3.2.2 Disputed Flowgates**

If a Reciprocal Entity believes that another Reciprocal Entity implementing the congestion management portion of this process has a significant impact on one of their Flowgates, but that Flowgate was not included in the Coordinated Flowgate list, the involved Reciprocal Entities will use the following process.

- If an operating emergency exists involving the candidate Flowgate, the Reciprocal Entities shall treat the facilities as a temporary Coordinated Flowgate prior to the study procedure below. If no operating emergency or imminent danger exists, the study procedure below shall be pursued prior to the candidate Flowgate being designated as a Coordinated Flowgate.
- The Reciprocal Entity conducts studies to determine the conditions under which the other Reciprocal Entity would have a significant impact on the Flowgate in question. The Reciprocal Entity conducting the study then submits these studies to the other Reciprocal Entity implementing this process. The Reciprocal Entity's studies should include each of the five studies described above; in addition to any other studies they believe illustrate the validity of their request. The other Reciprocal Entity will review the studies and determine if they appear to support the request of the Reciprocal Entity conducting the study. If they do, the Flowgate will be added to the list of Coordinated Flowgates.
- If, following evaluation of the supplied studies, any Reciprocal Entity still disputes another Reciprocal Entity's request, the Reciprocal Entity will submit a formal request to the NERC Operations Reliability Subcommittee (ORS) asking for further review of the situation. The ORS will review the studies of both the requesting Reciprocal Entity and the other Reciprocal Entity, and direct the participating Reciprocal Entities to take appropriate action.

### **3.2.3 Third Party Request Flowgate Additions**

Each Party shall provide opportunities for Third Parties or other entities to propose additional Coordinated Flowgates and procedures for review of relevant non-confidential data in order to assess the merit of the proposal. The current procedure for the review and maintenance of Coordinated Flowgates is set forth in Appendix C.

#### **3.2.4 Frequency of Coordinated Flowgate Determination**

The determination of Coordinated Flowgates will be performed at the initial implementation of the CMP and then on a periodic basis, as described in Appendix C.

#### **3.2.5 Dynamic Creation of Coordinated Flowgates**

For temporary Flowgates developed “on the fly,” the IDC will calculate GTL relief obligation based on GPS or TSNT method and once market entities submit the Firm Flow limits the GTL relief obligation will be based on submitted firm flow limits on the new Flowgate. Interchange transactions into, out of, or across the Market-Based Operating Entity will continue to be E-tagged and available for curtailment in TLR 3, 4, or 5. Market-Based Operating Entities will study the Flowgate in a timely manner and begin reporting Flowgate data within no more than two business days (where the Flowgate has already been designated as an AFC Flowgate). This will ensure that the Market-Based Operating Entity has the time necessary to properly study the Flowgate using the five studies detailed earlier in this document and determine the Flowgate’s relationship with the Market-Based Operating Entity’s dispatch. For internal Flowgates, the Market-Based Operating Entity will redispatch during a TLR 3 to manage the constraint as necessary until it begins reporting the Firm and Non-Firm Limits; during a TLR 5, the IDC will request GTL relief obligation in the same manner as today. Alternatively, for internal and external Flowgates, an Operating Entity may utilize an appropriate substitute Coordinated Flowgate that has similar Market Flows and tag impacts as the temporary Flowgate. In this case, an Operating Entity would have to realize relief through redispatch and TLR 3. An example of an appropriate substitute would be a Flowgate with a monitored element directly in series with a temporary Flowgate’s monitored element and with the same contingent element. If the Flowgate meets the necessary criteria, the Market-Based Operating Entity will begin to provide the necessary values to the IDC in the same manner as Market Flow values are provided to the IDC for all other Coordinated Flowgates. The necessary criteria for adding a Flowgate are defined in Appendix C. If in the event of a system emergency (TLR 3b or higher) and the situation requires a response faster than the process may provide, the Market-Based Operating Entities will coordinate respective actions to provide immediate relief until final review.

#### **3.2.6 Coordination of Tie Line Flowgate Additions**

The Parties shall follow the coordination process outlined in this section for Flowgates that include a Tie Line between the Parties as a monitored element. The provisions in this section shall not apply to any temporary Flowgates.

#### **Procedures:**

1. Unless otherwise agreed to by the Parties, the managing entity for a Tie Line Flowgate is the Party that has functional control over the most limiting equipment for the Flowgate.
2. The managing entity for a Tie Line Flowgate shall calculate AFCs, post AFCs, process requests for transmission service, manage real-time congestion, and calculate Allocations for the Tie Line Flowgate.
3. Before the creation of a new Tie Line Flowgate in the IDC, the managing entity for the Tie Line Flowgate must notify the other Party no less than sixty (60) days in advance of the addition of the Tie Line Flowgate in the IDC. The new Flowgate will initially be created as a temporary Flowgate in the IDC by the managing entity. If all other requirements outlined in this Section 3.2.6 are completed during the sixty (60) days following notice, the Flowgate can be made permanent before the sixty (60) day deadline by mutual agreement of the Parties.
4. A Party that identifies a new Tie Line Flowgate through a study shall provide the study assumptions, methodology, and all other relevant data to the other Party in a timely manner.
5. AFC Calculation and Posting AFCs:
  - a. The managing entity will calculate and post AFCs for Tie Line Flowgates in accordance with the managing entity's processes (i.e., the managing entity will treat the Flowgates as internal Flowgates).
  - b. The managing entity will post AFC files for Tie Line Flowgates for use by other transmission providers.
  - c. The managing entity will apply AFC factors for Tie Line Flowgates (e.g., TRM, CBM, "a" and "b" multipliers, etc.) using the managing entity's own processes.
6. Upon the completion of items 1 through 5, the managing entity may create a permanent Tie Line Flowgate.
7. The Party that is not the managing entity will replace the temporary Tie Line Flowgate with the permanent Tie Line Flowgate in its applicable operating system(s).

## Section 4 – Market-Based Operating Entity Flow Calculations: Market Flow, Firm Market Flow, and Non-Firm Market Flow

Market Flows on a Coordinated Flowgate can be quantified and considered in each direction. Market Flow is then further designated into two components: Firm Market Flow, which is energy flow related to contributions from the Network and Native Load serving aspects of the dispatch, and Non-Firm Market Flow, which is energy flow related to the Market-Based Operating Entity's market operations.

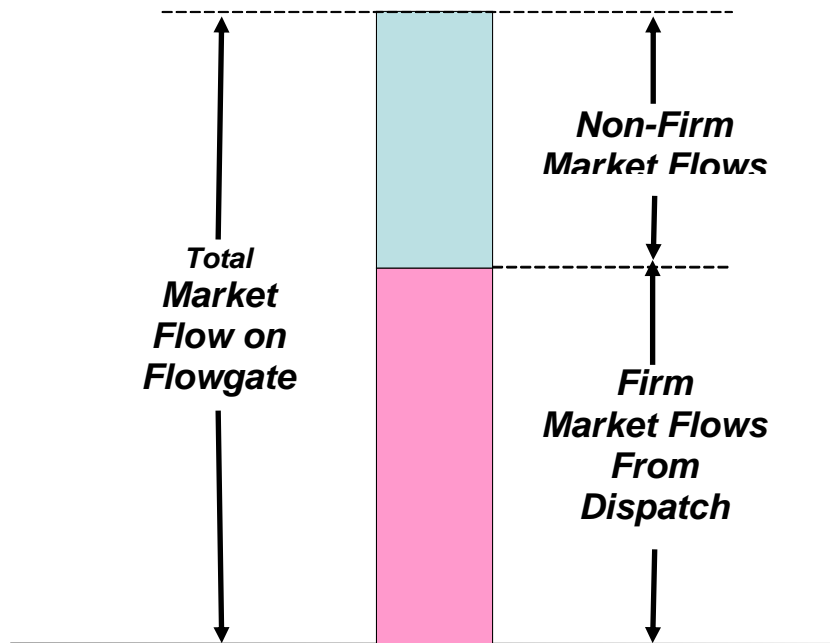

**Note: Market flows equal generation to load flows in market areas.**

Each Market-Based Operating Entity will calculate their actual real-time and projected directional Market Flows, as well as their directional Firm and Non-Firm Market Flows, on each Coordinated Flowgate. The following sections outline how these flows will be computed.

## 4.1 Market Flow Determination

The determination of Market Flows builds on the “Per Generator” methodologies that were developed by the NERC Parallel Flow Task Force. The “Per Generator Method Without Counter Flow” was presented to and approved by both the NERC Security Coordinator Subcommittee (SCS) and the Market Interface Committee (MIC).

Similar to the Per Generator Method, the Market Flow calculation method is based on Generator Shift Factors (GSFs) of a market area’s assigned generation and the Load Shift Factors (LSFs) of its load on a specific Flowgate, relative to a system swing bus. The GSFs are calculated from a single bus location in the base case (e.g. the terminal bus of each generator) while the LSFs are defined as a general scaling of the market area’s load. The Generator to Load Distribution Factor (GLDF) is determined through superposition by subtracting the LSF from the GSF.

The determination of the Market Flow contribution of a unit to a specific Flowgate is the product of the generator’s GLDF multiplied by the actual output (in megawatts) of that generator. The total Market Flow on a specific Flowgate is calculated in each direction; forward Market Flows is the sum of the positive Market Flow contributions of each generator within the market area, while reverse Market Flow is the sum of the negative Market Flow contributions of each generator within the market area.

For purposes of the Market Flow determination, the market area may be either: (1) the entire RTO footprint, as in the following illustration; or (2) a subset of the RTO region, such as a pre-integration NERC-recognized Control Area, as necessary to ensure accurate determinations and consistency with pre-integration flow determinations. Each Market-Based Operating Entity shall choose only one of these two options to calculate its Market Flows. With regard to the second option, the total Market Flow of an RTO shall be the sum of the flows from and between such market areas.

<sup>1</sup> “Parallel Flow Calculation Procedure Reference Document,” NERC Operating Manual. 11 Feb, 2003. <  
[https://www.nerc.com/comm/OC/Operating%20Manual%20DL/Operating\\_Manual\\_20160809.pdf#search=NERC%20Operating%20Manual](https://www.nerc.com/comm/OC/Operating%20Manual%20DL/Operating_Manual_20160809.pdf#search=NERC%20Operating%20Manual)

>

### Calculating the Market Flow Illustration

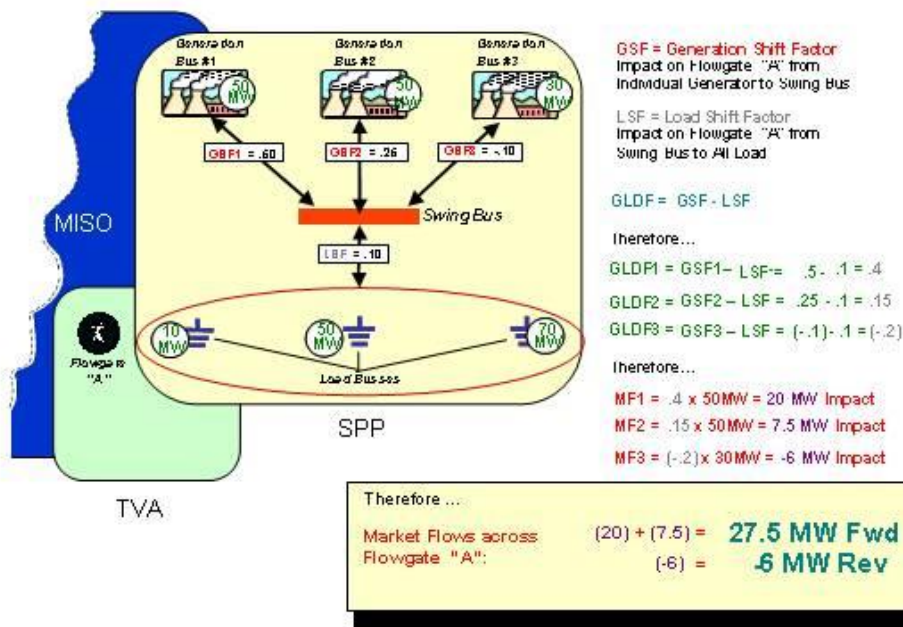

The Market Flow calculation differs from the Per Generator Method in the following ways:

- The contribution from all market area generators will be taken into account.
- In the Per Generator Method, only generators having a GLDF 5% or greater are included in the calculation. Additionally, generators are included only when the sum of the maximum generating capacity at a bus is greater than 20 MW. The Market Flow calculations will use all flows, in both directions, to calculate a Market Flow down to a 5% threshold and to calculate a Market Flow down to a 0% threshold. Forward flows and reverse flows are determined as discrete values.
- The contribution of all market area generators is based on the present output level of each individual unit.
- The contribution of the market area load is based on the present demand at each individual bus.

By expanding on the Per Generator Method, the Market Flow calculation evolves into a methodology very similar to the "Per Generator Method," while providing granularity on the order of the most granular method developed by the IDC Granularity Task Force.

Directional flows are required for this process to ensure a Market-Based Operating Entity can effectively select the most effective generation pattern to control the flows on both internal and external constraints, but are considered as distinct directional flows to ensure comparability with existing NERC and/or NAESB TLR processes. Under this process, the use of real-time values in concert with the Market Flow calculation effectively implements one of the more accurate and

detailed methods of the six IDC Granularity Options considered by the NERC IDC Granularity Task Force.

Each Market-Based Operating Entity shall choose one of the three methodologies set forth in Section 4.1.1 (*Methodologies to Account for Tagged Transactions*) below to account for import and export tagged transactions and shall apply it consistently for each of the following calculations:

1. the Market Flow calculation;
2. the Firm Flow Limit calculation;
3. the Firm Flow Entitlement calculation; and
4. the tagged transaction impact calculation which occurs in the IDC.

Market Flows represent the impacts of internal generation (including generators pseudo-tied into the market area and excluding generators pseudo-tied out of the market area) serving internal load (including load pseudo-tied into the market area and excluding load pseudo-tied out of the market area) and tagged grandfathered transactions within the market area. Market Flows shall not include the impacts from import tagged transaction(s) into and export tagged transaction(s) out of the market area where the impacts of the interchange transactions are accounted for by the IDC. A Market-Based Operating Entity shall utilize the IDC to calculate the impacts of import tagged transactions into and export tagged transactions out of the market area that are not captured in the Market Flow calculation. The impact of the EAR shall be included in the Market Flow calculation using the methodology selected in Section 4.1.1 (*Methodologies to Account for Tagged Transactions*); the related tags will be excluded in IDC. For an import EAR, load will be adjusted, and for an export EAR, generation will be adjusted, in accordance with the methodology selected in Section 4.1.1 (*Methodologies to Account for Tagged Transactions*).

Units assigned to serve a market area's load do not need to reside within the market area's footprint to be considered in the Market Flow calculation. Units outside of the market area that are pseudo-tied into the market to serve the market area's load will be included in the Market Flow calculation. However, units outside of the market area will not be considered when those units will have tags associated with their transfers (i.e., where pseudo-tie does not exist).

Additionally, there may be situations where the participation of a generator in the market that is not modeled as a pseudo-tie may be less than 100% (e.g., a unit jointly owned in which not all of the owners are participating in the market). This situation occurs when the generator output controlled by the non-participating parties is represented as interchange with a corresponding tag(s) and not as a pseudo-tie generator internal to each party's Control Area. Except for the generator output represented by qualifying interchange transactions from jointly owned units described in the following paragraph, such situations will be addressed by including the generator output in that Market-Based Operating Entity's Market Flow calculation with the amount of generator output not participating in the market being scaled down within the Market-Based Operating Entity's region or regions in accordance with one of the following three methodologies described and defined below in Section 4.1.1: the Marginal Zone Method, POR-POD Method, or Slice-of-System Method.



When a jointly owned unit, which is also listed as a Designated Network Resource for the Historic Firm Flow calculation, participates in more than one market, and the generator output from that unit between the two markets is represented as interchange with a corresponding tag(s) that is accounted for by the IDC and not as a pseudo-tie generator internal to each market's Control Area, its modeling in the Market Flow calculation will be aligned with that in the Historic Firm Flow calculation. The amount of generator output from that unit scheduled between the two markets will be treated as a unit-specific export tagged transaction in the Market Flow calculation of the Market-Based Operating Entity where the generator is located and will be treated as a load-specific import tagged transaction in the Market Flow calculation of the other Market-Based Operating Entity.

- For exports out of one market area associated with the jointly owned unit(s), the generator output of jointly owned unit will be scaled down by an amount which is the lesser of the corresponding export tagged transaction(s) and unit ownership of an owner participating in other market area.
- For imports into the other market area associated with the jointly owned external unit(s), the Control Zone load or bus load(s) will be scaled down by an amount which is the lesser of the corresponding import tagged transaction(s) and unit ownership of an owner participating in the market area.

Import tagged transactions, export tagged transactions, and grandfathered tagged transactions within the market area, must be properly accounted for in the determination of Market Flows.

Below is a summary of the calculations discussed above.

For a specified Flowgate, the Market Flow impact of a market area is given as:

**Total Directional "Market Flows" =  $\sum$  (Directional "Market Flow" contribution of each unit in the Market-Based Operating Entity's area), grouped by impact direction**

where,

**"Market Flow" contribution of each unit in the Market-Based Operating Entity's area = (GLDF<sub>Adj</sub>) (Adjusted Real-Time generator output)**

and,

**GLDF<sub>Adj</sub> is the Generator to Load Distribution Factor**

**Where the generator shift factor (GSF<sub>Adj</sub>) uses Adjusted Real-Time generator output and the load shift factor (LSF<sub>Adj</sub>) uses Adjusted Real-Time bus loads.**

**GLDF<sub>Adj</sub> = GSF<sub>Adj</sub> - LSF<sub>Adj</sub>**

**Adjusted Real-Time generator output is the output of an individual generator as reported by the state estimator solution that has been adjusted for exports associated with joint ownership, if any, and then further adjusted for the remaining exports utilizing the chosen methodology in Section 4.1.1.**

**Adjusted Real-Time bus load is the sum of all bus loads in the market as reported by the state estimator solution that have been adjusted for imports associated with joint ownership, if any, and then further adjusted for the remaining imports utilizing the chosen methodology in Section 4.1.1..**

The real-time and one-hour ahead projected “Market Flows” will be calculated on-line utilizing the Market-Based Operating Entity’s state estimator model and solution. This is the same solution presently used to determine real-time market prices as well as providing on-line reliability assessment and the periodicity of the Market Flow calculation will be on the same order. Inputs to the state estimator solution include the topology of the transmission system and actual analog values (e.g., line flows, transformer flows, etc...). This information is provided to the state estimator automatically via SCADA systems such as NERC’s ISN link.

Using an on-line state estimator model to calculate “Market Flows” provides a more accurate assessment than using an off-line representation for a number of reasons. The calculation incorporates a significant amount of real-time data, including:

- **Actual real-time and projected generator output.** Off-line models often assume an output level based on a nominal value (such as unit maximum capability), but there is no guarantee that the unit will be operating at that assumed level, or even on-line. Off-line models may not reflect the impact of pumped-storage units when in pumping mode; these units may be represented as a generator even when pumping. Additionally off-line models may not reflect the impact of units such as wind generators. A real-time calculation explicitly represents the actual operating modes of these units.
- **Actual real-time bus loads.** Off-line assessments may not be able to accurately account for changes in load diversity. Off-line models are often based on seasonal winter and summer peak load base cases. While representative of these peak periods, these cases may not reflect the load diversity that exists during off-peak and shoulder hours as well as off-peak and shoulder months. A real-time calculation explicitly accounts for load diversity. Off-line assessments may also reflect load reduction programs that are only in effect during peak periods.
- **Actual real-time breaker status.** Off-line assessments are often bus models, where individual circuit breakers are not represented. On-line models are typically node models where switching devices are explicitly represented. This allows for the real-time calculation to automatically account for split bus conditions and unusual topology conditions due to circuit breaker outages.

Additionally, the calculation rate of the on-line assessment is much quicker and accurate than an off-line assessment, as the on-line assessment immediately incorporates changes in system topology and generators. Facility outages are automatically incorporated into the real-time assessment.

In order to provide reliable and consistent flow calculations, entities utilizing this process as the basis for coordination must ensure that the modeling data and assumptions used in the calculation process are consistent. Reciprocal Entities will coordinate models to ensure similar computations and analysis. Reciprocal Entities will each utilize real-time ICCP and ISN data for observable areas in each of their respective state estimator models and will utilize SDX data for areas outside the observable areas to ensure their models stay synchronized with each other and the EIDSN IDC.

#### 4.1.1 Methodologies to Account for Tagged Transactions

A Market-Based Operating Entity shall choose one of the following methodologies to account for export and import tagged transactions in the Market Flow calculation utilized for Market-to-Market, and shall also use the same methodology to account for export and import tagged transactions in the Firm Flow Limit and Firm Flow Entitlement calculations, as well as calculated tag impacts by the IDC:

1. Point-of-receipt (POR) / point-of-delivery (POD) Method (POR-POD Method) - Export tagged transactions, excluding tagged transactions associated with jointly owned units participating in more than one market shall be accounted for based on the POR of the transmission service reservation, as the transmission service was originally sold, that is listed on the export tagged transaction by proportionally offsetting the MW output of all units (i) in the Market-Based Operating Entity's Control Area, (ii) pre-integration NERC-recognized Control Area(s), or (iii) sub-regions within its Control Area. Import tagged transactions, excluding tagged transactions associated with jointly owned units participating in more than one market shall be accounted for based on the POD of the transmission service reservation, as the transmission service was originally sold, that is listed on the export tagged transaction by proportionally offsetting the MW load of all load buses (i) in the Market Based Operating Entity's Control Area, (ii) pre-integration NERC-recognized Control Area(s), or (iii) sub-regions within the Control Area; or
2. Marginal Zone Method – Export tagged transactions, excluding tagged transactions associated with jointly owned units participating in more than one market shall be accounted for by adjusting the MW output of the units in the Market-Based Operating Entity's Control Area, regions, or sub regions within its Control Area by the total MW amount of all the Market-Based Operating Entity's export tagged transactions excluding tagged transactions associated with jointly owned units participating in more than one market using: (1) marginal zone participation factors, as defined and calculated in Appendix B (*Determination of Marginal Zone Participation Factors*); and (2) the anticipated availability of a generator to participate in the interchange of the marginal zone. Import tagged transactions, excluding tagged transactions associated with jointly owned units participating in more than one market shall be accounted for by adjusting the MW load of the load buses in the Market-Based Operating Entity's Control Area, regions or sub regions within the Control Area, by the total MW amount of all the Market-Based Operating Entity's import tagged transactions excluding tagged transactions associated with jointly owned units participating in more than one market using marginal zone participation factors, as defined and calculated in Appendix B (*Determination of Marginal Zone Participation Factors*); or
3. Slice of System Method – Export tagged transactions, excluding tagged transactions associated with jointly owned units participating in more than one market shall be accounted for by proportionately adjusting the MW output of each of the units in the Market-Based Operating Entity's Control Area by the total MW amount of all the Market-Based Operating Entity's export tagged transactions excluding tagged transactions associated with jointly owned units participating in more than one market. Import tagged transactions, excluding tagged transactions associated with jointly owned units participating in more than one market shall be accounted for proportionately

adjusting the MW load of each of the load buses in the Market-Based Operating Entity's Control Area by the total MW amount of all the Market-Based Operating Entity's import tagged transactions excluding tagged transactions associated with jointly owned units participating in more than one market (each of which report Market Flow to IDC).

Each Market-Based Operating Entity shall post and maintain a document on its public website that describes calculations and assumptions used in those calculations regarding the chosen methodology and its application to the treatment of import and export transactions to the calculation of Market Flows, Firm Flow Limits, and Firm Flow Entitlements, and tag impacts calculated by the IDC.

## **4.2 Firm Flow Determination**

Firm Flows represent the directional sum of flows created by Designated Network Resources serving designated network loads within a particular market area. They are based primarily on the configuration of the system and its associated flow characteristics; utilizing generation and load values as its primary inputs. Therefore, these Firm Flows can be determined based on expected usage and the Allocation of Flowgate capacity.

An entity can determine Firm Flows on a particular Flowgate using the same process as utilized by the IDC. This process is summarized below:

1. Utilize a reference base case to determine the Generation Shift Factors for all generators in the current Control Areas' respective footprints to a specific swing bus with respect to a specific Flowgate.
2. Utilize the same base case to determine the Load Shift Factors for the Control Area's load to a specific swing bus with respect to that Flowgate.
3. Utilize superposition to calculate the Generation to Load Distribution Factors (GLDF) for the generators with respect to that Flowgate.
4. Multiply the expected output used to serve native load from each generator by the appropriate GLDF to determine that generator's flow on the Flowgate.
5. Sum these individual contributions by direction to create the directional Firm Flow impact on the Flowgate.

### **4.3 Determining the Firm Flow Limit**

Given the Firm Flow determinations described in the previous section, Market-Based Operating Entities can assume them to be their Firm Flow Limits. These limits define the maximum value of the GTL Flows that can be considered as firm in each direction on a particular Flowgate in the IDC, and the maximum value of the Market Flows that can be considered firm on a particular Flowgate for Market-to-Market. Prior to real time, a calculation will be done based on updated hourly forecasted loads and topology. The results should be an hourly forecast of directional Firm Flows.

#### 4.4 Firm Flow Limit Calculation Rules

The Firm Flow Limits for both 0% GTL flows and 5% GTL flows will be calculated for each Market Based Operating Entity based on certain criteria and rules. The calculation will include the effects of firm network service in both forward and reverse directions. The process will be similar to that of the IDC but will include one set of impacts down to 0% and another set down to 5%. The down to 0% impacts will be used to determine Firm Flow Limits on 0% GTL flows. The down to 5% impacts will be used to determine Firm Flow Limits on 5% GTL flows. The following points form the basis for the calculation.

1. The generation-to-load calculation will be made on a Control Area basis. The impact of generation-to-load will be determined for Coordinated Flowgates.
2. The Flowgate impact will be determined based on individual generators serving aggregated CA load. Only generators that are Designated Network Resources for the CA load will be included in the calculation.
3. Forward Firm Flow Limits for 0% GTL flows will consider impacts in the additive direction down to 0%, and reverse Firm Flow Limits for 0% GTL flows will consider impacts in the counter flow direction down to 0%. Forward Firm Flow Limits for 5% GTL flows will be determined by subtracting impacts between 0% and 5% in the additive direction from the Forward Firm Flow Limit for 0% GTL flows. Reverse Firm Flow Limits for 5% GTL flows will be determined by subtracting the impacts between 0% and 5% in the counter-flow direction from the reverse Firm Flow Limit for 0% GTL flows. Flowgate Firm Flow Limits using a 5% threshold are reported to the IDC for it to assign the Firm and non-Firm GTL flows used in TLR curtailments for each Market Based Operating Entity. Flowgate Firm Flow Limits using a 0% threshold are reported to the IDC for information purposes.
4. Designated Network Resources located outside the CA will not be included in the generation-to-load calculation if OASIS reservations exist for these generators.
5. If a generator or a portion of a generator is used to make off-system sales that have an OASIS reservation, that generator or portion of a generator should be excluded from the generation-to-load calculation.
6. Generators that will be off-line during the calculated period will not be included in the generation-to-load calculation for that period.
7. CA net interchange will be computed by summing all Firm Transmission Service reservations and all Designated Network Resources that are in effect throughout the calculation period. Designated Network Resources are included in CA net interchange to the extent they are located outside the CA and have an OASIS reservation. The net interchange will either be positive (exports exceed imports) or negative (imports exceed exports).
8. If the net interchange is negative, the period load is reduced by the net interchange.
9. If the net interchange is positive, the period load is not adjusted for net interchange.

10. The generation-to-load calculation will be made using generation-to-load distribution factors that represent the topology of the system for the period under consideration.
11. P<sub>MAX</sub> of the generators should be net generation (excluding the plant auxiliaries) and the CA load should not include plant auxiliaries.
12. The portion of jointly owned units that are treated, as schedules will not be included in the generation-to-load calculation if an OASIS reservation exists.



## **Section 5 – Market-Based Operating Entity Congestion Management**

Once there has been an establishment of the Firm Flow Limit that is possible given Firm Market Flow calculation, that data will be used in the operating environment in a manner that relates to real time energy flows.

## **5.1 Calculating Market Flows**

On a periodic basis, the Market-Based Operating Entity will calculate directional Market Flows for all Market-to-Market Coordinated Flowgates. These flows will represent the actual flows in each direction at the time of the calculation.

## 5.2 Quantify and Provide Data for Firm Flow Limits

Every fifteen minutes, the Market-Based Operating Entity will be responsible for providing to Reliability Coordinators the following information:

- Firm Flow Limits for all Coordinated Flowgates in each direction
- Non-Firm Flow Limits for all Coordinated Flowgates in each direction

In real time, any GTL flow in excess of the Firm Flow Limit will be reported as Non-Firm GTL flow (Priority 6-NN) (note that under reciprocal operations, some of this Non-Firm GTL flow may be quantified as Priority 2-NH).

These limits will be provided for both current hour and next hour, and is used to communicate to Reliability Coordinators the maximum amount of flows to be considered firm and non-firm on the various Coordinated Flowgates in each direction. When the Firm Flow Limit forecast is calculated to be greater than the GTL flow for current hour or next hour, all GTL flow is firm.

Additionally, as frequently as once an hour, but no less frequently than once every three months, the Market-Based Operating Entity will submit to the Reliability Coordinator sets of data describing the marginal units and associated participation factors for generation within the market footprint. The level of detail of the data may vary, as different Operating Entities will have different unique situations to address. However, this data will at a minimum be supplied for imports to and exports from the market area, and will contain as much information as is determined to be necessary to ensure system reliability. This data will be used by the Reliability Coordinators to determine the impacts of schedule curtailment requests when they result in a shift in the dispatch within the market area.

### **5.3 Day-Ahead Operations Process**

The Market-Based Operating Entities will use a day-ahead operations process to establish the Firm Flow Limit on Coordinated Flowgates. If the Market-Based Operating Entities utilize a day-ahead unit commitment, they will supplement the day-ahead unit commitment with a security constrained economic dispatch tool, which uses a network analysis model that mirrors the real-time model found within their state estimators. As such, the day-ahead unit commitment and its associated Security Constrained Economic Dispatch respects facility limits and forecasted system constraints. Facility limits of Coordinated Flowgates under the functional control of Market-Based Operating Entities and the allocations of all Reciprocal Coordinated Flowgates will be honored.

For Coordinated Flowgates, a Market-Based Operating Entity can only use one of the following two methods to establish Firm Flow Limit. A Market-Based Operating Entity must use either the day-ahead unit commitment and its associated Security Constrained Economic Dispatch, or a Market-Based Operating Entity's GTL and unused Firm Transmission Service impacts, up to the Flowgate Limit, on the Coordinated Flowgate. At any given time, a Market Based Operating Entity must use only one method for all Coordinated Flowgates and must give ninety days notice to all other Reciprocal Entities, if it decides to switch from one method to the other method. On a case by case basis, with agreement by all Reciprocal Entities the ninety-day notice period may be waived.

#### **5.4 Real-time Operations Process – Operating Entity Capabilities**

Operating Entities' real-time EMS have very detailed state estimator and security analysis packages that are able to monitor both thermal and voltage contingencies every few minutes. State estimation models will be at least as detailed as the IDC model for all the Coordinated and Reciprocal Coordinated Flowgates. Additionally, Reciprocal Entities will be continually working to ensure the models used in their calculation of Market Flow are kept up to date.

The Operating Entities' submit various system measurements (load, generator outputs, control device status, etc) from their state estimators and Unit Dispatch Systems (UDS) to the SDX in real-time. These measurements are used by the IDC to calculate both the actual and projected hour ahead flows (i.e., total GTL and tagged impact flows) on the Coordinated Flowgates. The IDC's calculations of system flows will utilize each Operating Entity's actual unit output, updated at least every 15 minutes on an established schedule.

### **5.5 Market-Based Operating Entity Real-time Actions**

The Market-Based Operating Entity will upload the real-time and one-hour ahead projected Firm Flow Limits (7-FN) and Non-Firm Firm Flow Limits (6-NN) on these Flowgates to the IDC every 15 minutes, as requested by the IDCWG and OATI (note that under reciprocal operations, some of this 6-NN may be quantified as Priority 2-NH). Firm Flow Limits will be calculated, down to five percent and down to zero percent, and uploaded to the IDC. When the real-time actual flow exceeds the Flowgate limit and the Reliability Coordinator, who has responsibility for that Flowgate, has declared a TLR 3a or higher, the IDC will determine tag curtailments and GTL relief obligations using a tag impact and GTL impact of 5% or greater. The Market-Based Operating Entity will respond to the GTL relief obligation by redispatching their system. Note the Market-Based Operating Entity may provide relief through either: (1) a reduction of flows on the Flowgate in the direction required, or (2) an increase of reverse flows on the Flowgate.

Operating Entities will make any point-to-point transaction curtailments as specified by the IDC. Additionally, Market-Based Operating Entities will implement this redispatch by binding the Flowgate as a constraint in their Unit Dispatch System (UDS). UDS calculates the most economic solution while simultaneously ensuring that each of the bound constraints is resolved reliably.

The Reliability Coordinator calling the TLR will be able to see the relief provided on the Flowgate in both their EMS and in the IDC, as the IDC GTL calculation will reflect the redispatch of the Operating Entities with relief obligations through their real-time measurements submissions.

## **Section 6 - Reciprocal Operations**

Reciprocal Coordination Agreements can be executed on a market-to-market basis, a market-to-non-market basis, and a non-market-to-non-market basis. While the congestion management portions of this document are intended to apply specifically to Market-Based Operating Entities, the agreement to allocate Flowgate capability is not dependent on an entity operating a centralized energy market. Rather, it simply requires that a set of Flowgates be defined upon which coordination shall occur and an agreement to perform such coordination.

## **6.1 Reciprocal Coordinated Flowgates**

In order to coordinate congestion management on a proactive basis, Operating Entities may agree to respect each other's Flowgate limitations during the determination of AFC/ATC and the calculation of firmness during real-time operations. Entities agreeing to coordinate this future-looking management of Flowgate capacity are Reciprocal Entities. The Flowgates used in that process are Reciprocal Coordinated Flowgates.



## 6.2 The Relationship Between Coordinated Flowgates and Reciprocal Coordinated Flowgates

Coordinated Flowgates are associated with a specific Operating Entity's operational sphere of influence. Reciprocal Coordinated Flowgates are associated with the implementation of a Reciprocal Coordination Agreement between two Reciprocal Entities. By virtue of having executed such an agreement, a Flowgate Allocation can occur between these two Reciprocal Entities as well as all other Reciprocal Entities that have executed Reciprocal Coordination Agreements with at least one of these two Reciprocal Entities. When considering an implementation between two Reciprocal Entities, it is generally expected that each of the Reciprocal Coordinated Flowgates will meet the following three criteria:

- It will meet the criteria for Coordinated Flowgate status for both the Reciprocal Entities,
- It will be under the functional control of one of the two Reciprocal Entities and
- Both Reciprocal Entities have executed Reciprocal Coordination Agreements either with each other or with a Third Party Reciprocal Entity.

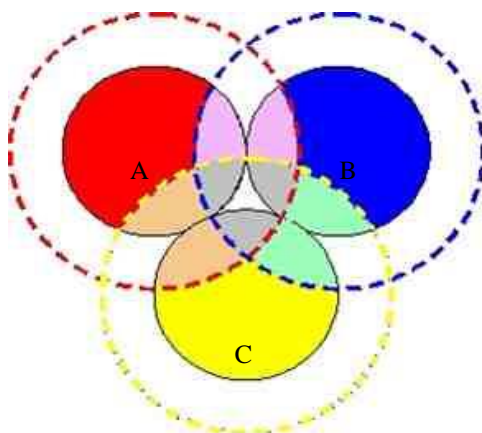

As shown in the illustration above, Operating Entity A, Operating Entity B and Operating Entity C each have their own set of Coordinated Flowgates (represented by the blue, yellow and red dotted-line circles). Where those sets of Coordinated Flowgates overlap AND they are in either Operating Entity A's, Operating Entity B's or Operating Entity C's service territory (the gray area), they will be considered Reciprocal Coordinated Flowgates between all three entities. Where those sets of Coordinated Flowgates overlap AND they are in either Operating Entity A's or Operating Entity B's service territory (the purple area), they will be considered Reciprocal Coordinated Flowgates between Operating Entity B and Operating Entity A only. Where those sets of Coordinated Flowgates overlap AND they are in either Operating Entity B's or Operating Entity C's service territory (the green area), they will be considered Reciprocal Coordinated Flowgates between Operating Entity B and Operating Entity C only. Where those sets of

Coordinated Flowgates overlap AND they are in either Operating Entity A's or Operating Entity C's service territory (the orange area), they will be considered Reciprocal Coordinated Flowgates between Operating Entity A and Operating Entity C only.

To the extent that entities other than Market-Based Operating Entities may enter into a Reciprocal Coordination Agreements, they may offer to coordinate on Flowgates that are Coordinated Flowgates (i.e., have passed one of the five tests defined within this document or otherwise been deemed to be a Coordinated Flowgate).

### **6.3 Coordination Process for Reciprocal Flowgates**

The following process and timing will be used for coordinating the ATC/AFC calculations and Firm Flow Limit calculations/Allocations between Reciprocal Entities. Further, the process quantifies and limits Priority 6 – NN service on the Reciprocal Coordinated Flowgates, as well as determines priority 2-NH service. All Reciprocal Entities' Firm Flow Limits will be calculated on the same basis.

## 6.4 Calculating Historic Firm Flows

As a starting point for identifying Allocations, an understanding must be developed of what Firm Flows would be in the historic Control Area structure. In other words, there must be a quantification of the Firm Flows that would have occurred if all Control Areas maintained their current configuration and continued to: (1) serve their native load with their Designated Network Resources, and (2) import and export energy at historical levels (based upon Firm Transmission Service reservations as of the Freeze Date, which is currently set as April 1, 2004. This flow is referred to as Historic Firm Flow.

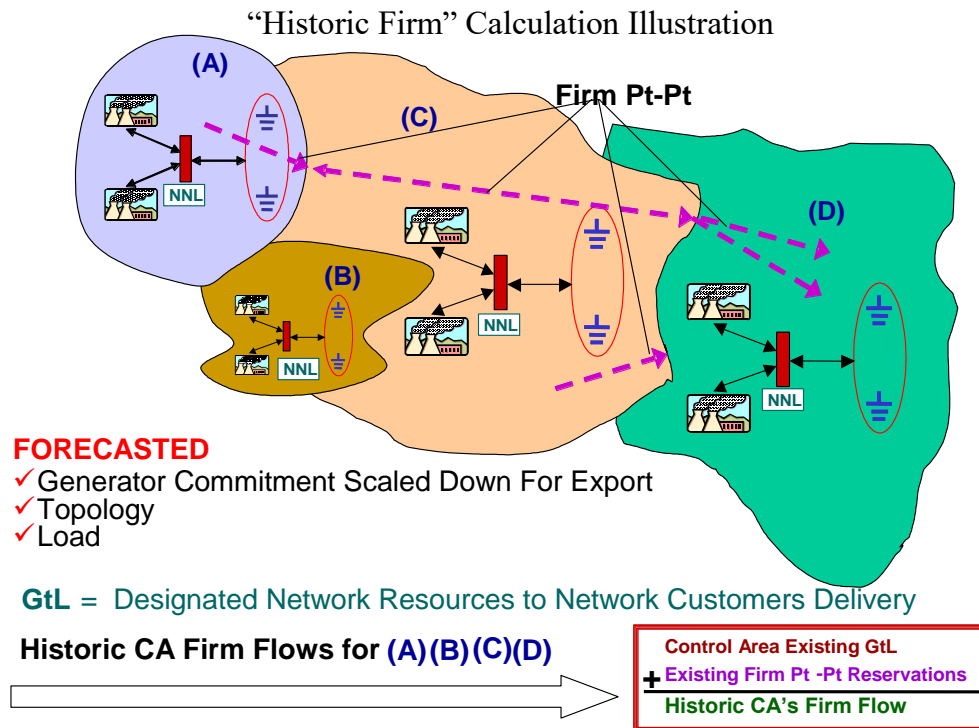

Reciprocal Entities will utilize the IDC Base Case model, or a mutually agreed upon alternative model as the reference base case for these calculations.

## **6.5 Recalculation of Initial Historic Firm Flow Values and Ratios**

The Firm Transmission Service and Designated Network Resource to customer load defined by the Historic Firm Flow calculation will be updated in the recalculation of Historic Firm Flow utilizing any new Designated Network Resources, updated customer loads, and new transmission facilities. The original historic Control Areas will be retained for the recalculation of Historic Firm Flow. New Designated Network Resources will be included in the recalculation to the extent these new Designated Network Resources have been arranged for the exclusive use of load within the historic Control Areas and to the extent the total impact of all Designated Network Resources does not exceed the historic Control Area impact of Designated Network Resources as of a “Freeze Date” (defined as April 1, 2004). Any changes to Designated Network Resources and/or the transmission system that increase transmission capability will be assessed in accordance with the Reciprocal Entities AFC Coordination procedures prior to the increasing of Historic Firm Flow related to those systems.

The initial Historic Firm Flow calculated values and resulting Allocation ratios will be recalculated as seasonal cases are produced. This recalculation will utilize the same Firm Transmission Service reservations that were used in the initial Historic Firm Flow calculation. The same Firm Transmission Service reservations are used so that Market-Based Operating Entities that have their Firm Transmission Service internalized, grant fewer internal Firm Transmission Service reservations, or have their original Firm Transmission Service reservations end, because of their market operations, will retain at least the same level of Firm Transmission Service as in the initial Historic Firm Flow calculation. Therefore, the Firm Transmission Service component of the Historic Firm Flow will be frozen on the “Freeze Date” at the initially calculated level for both market and non-market entities.

Any new Control Areas that are added to the Firm Flow calculation process for any Reciprocal Entity, or another Operating Entity, will use Firm Transmission Service reservations from the initial Historic Firm Flow calculation date to establish their Firm Transmission Service component of the Historic Firm Flow.

As the recalculation for Historic Firm Flow is made for each time period, the higher of allocation value will be retained between the initial Historic Firm Flow calculation and the recalculation (See “Forward Coordination Process” Section 6.6, step 8.f). To the extent an Operating Entity has made commitments based on the higher of Allocation value, a recalculation does not reduce previously calculated Allocations.

When a Flowgate experiences a transitory limit reduction or de-rating, there will be no change made to the historic allocations. In effect, the Operating Entity responsible for the Flowgate is expected to absorb the impact of the de-rating by not reducing the historic allocation of the other Operating Entities. This practice is consistent with the use of the higher-of logic in the historic allocation process. Where a change in system conditions, such as a significant transmission outage, affects flows on a longer term basis the Reciprocal Entities will discuss whether historic allocations, including an over-ride of the higher-of logic, should be rerun to recognize the effects of the change in system conditions in the historic allocations. The historic allocations shall be rerun only if the affected Reciprocal Entities mutually agree.

## 6.6 Forward Coordination Processes

1. For each Reciprocal Coordinated Flowgate, a managing entity and an owning entity will be defined. The manager will be responsible for all calculations regarding that Flowgate; the owner will define the set of Firm Transmission Service reservations to be utilized when determining Firm Transmission Service impacts on that Flowgate.
2. Managing entities will calculate both Historic Firm Gen-to-Load Flow impacts and historic Firm Transmission Service impacts for all entities. These impacts will be used to define the Historic Ratio and the Allocation of transmission capability.
3. The managing entity will utilize the current IDC Base Case (or other mutually agreeable base case) to determine impacts. The case should be updated with the most current set of outage data for the time period being calculated.
4. Managing entities will calculate Allocations on the following schedule:

Allocation Run Type	Allocation Process Start	Range Allocated	Allocation Process Complete
April Seasonal Firm	Every April 1 at 8:00 EST	Twelve monthly values from October 1 of the current year through September 30 of the next year	April 1 at 12:00 EST
<b>October Seasonal Firm</b>	Every October 1 at 8:00 EST	Twelve monthly values from April 1 of next year through March 31 of the following year	October 1 at 12:00 EST
<b>Monthly Firm</b>	Every month on the second day of the month at 8:00 EST	Six monthly values for the next six successive months	2 <sup>nd</sup> of the month at 12:00 EST
<b>Weekly Firm</b>	Every Monday at 8:00 EST	Seven daily values for the next Monday through Sunday	Monday at 12:00 EST
<b>Two-Day Ahead Firm</b>	Every Day at 17:00 EST	One daily value for the day after tomorrow	Current Day at 18:00 EST
<b>Day Ahead Non-Firm</b>	Every Day at 8:00 EST	Twenty-four hourly values for the next 24-hour period (Next Day HE1-HE24 EST)	Current Day at 9:00 EST

5. Historic Ratios are defined during the seasonal runs the first time an impact is calculated. For example, the 2004 April seasonal firm run would define the Historic Ratio for April

2005 – September 2005 (October through March would have been calculated during the 2003 October seasonal firm run). The Historic Ratio is based on the total impacts of the Reciprocal Entity on the Flowgate (Historic Firm Gen-to-Load Flows and historic Firm Transmission Service flows, down to 0%) relative to the total impacts of all other Reciprocal Entities' impacts on the Flowgate. For example, if Reciprocal Entity A had a 30 MW impact on the Flowgate and Reciprocal Entity B had a 70 MW impact on the Flowgate, the Historic Ratios would be 30% and 70%, respectively.

6. The same rules defined in the “Market-Based Operating Entity Congestion Management” Section 5 of this document for use in determining Firm Transmission Service impacts (NNL) shall apply when performing Allocations.
7. Additional rules to be used when considering Firm Transmission Service impacts are defined later within this section.
8. For each firm Allocation run described above, the managing entity will take the following steps to determine Allocations down to 0% for each of the Flowgates, in both the forward and reverse direction, they are assigned to manage:
  - a. Retrieve the Flowgate limit
  - b. Subtract the current Transmission Reliability Margin (TRM) value (may be zero)
  - c. Subtract the sum of all historically determined Firm Flow impacts for all entities based on impacts greater than or equal to 5%
  - d. Accommodation of Capacity Benefit Margin (CBM)
    - If no capacity remains after step (c), entities' firm Allocation is limited to this amount (i.e., their Firm Flow impacts from impacts of 5% or greater), and the firm Allocation for the entity with functional control over the Flowgate is increased by the current CBM value (may be zero).
    - If capacity does remain after step (c), and the sum of all Reciprocal Entities' impacts below 5% plus CBM is less than the remaining capacity from step (c), that capacity is allocated to the Reciprocal Entities pro-rata based on their Firm Flow impacts due to impacts less than 5% up to the total amount of their Firm Flow impacts due to impacts less than 5%.
    - If there is not sufficient capacity for all impacts below 5% plus CBM to be accommodated, the current CBM value is subtracted from the remaining capacity from step (c), and granted to the entity with functional control over the Flowgate. Any capacity remaining is allocated to the Reciprocal Entities pro-rata based on their Firm Flow impacts due to impacts less than 5%.
  - e. Any remaining capacity, after step (d) will be considered firm and allocated to Reciprocal Entities based on their Historic Ratio (as described in step 5). If the remaining capacity allocated to the entity with functional control over the Flowgate meets or exceeds the current CBM value, no further effort is needed. If the remaining capacity is less than the CBM, capacity will first be reduced by the CBM, and the entity with functional control over the Flowgate will be granted the capacity needed to support the CBM. In addition each Reciprocal Entity (including the entity with functional control over the Flowgate) will receive allocations determined as a pro-rata share of the remaining capacity (as described in Step 5).
  - f. Upon completion of the Allocation process, the managing entity will compare the current preliminary Allocation to the previous Allocations. For any given

Flowgate, the larger of the Allocations will be considered the Allocation (i.e., an Allocation cannot decrease). Once all preliminary Allocations have been compared and the final Allocation determined, the managing entity will distribute the Allocations to the appropriate Reciprocal Entities. This Allocation will consist of the firm Gen-to-Load limit and a portion of capability that can be used either for Firm Transmission Service or additional firm Gen-to-Load service.

9. For the non-firm Allocation run described above, the managing entity will take the following steps to determine Allocations down to 0% for each of the Flowgates, in both the forward and reverse direction, they are assigned to manage. For each hour, the managing entity shall:
  - a. Retrieve the Flowgate limit
  - b. Subtract the current TRM value (may be zero)
  - c. Subtract the sum of all hourly historically determined Firm Flow impacts for all entities based on impacts greater than or equal to 5%
  - d. Subtract the sum of all hourly historically-determined Firm Flow impacts for all Reciprocal Entities based on impacts less than 5%.
  - e. Any remaining capacity will be allocated to Reciprocal Entities based on their Historic Ratio (as described in step 5).
  - f. The two-day ahead firm Allocation is subtracted from the total entity Allocation (from steps c, d, and e).
    - If the result is positive, this value will be equivalent to the Priority 6-NN Allocation/limit, and the Firm Flow Limit for 0% Market Flows will be the two-day ahead firm Allocation.
    - If the result is negative or zero, the Priority 6-NN Allocation will be calculated by subtracting the total entity Allocation (from steps c, d and e) from the two-day ahead firm Allocation. The Firm Flow Limit for 0% Market Flows will be the equivalent of the total entity allocation.
  - g. Upon completion of the Allocation process, the managing entity will distribute the Allocations to the appropriate Reciprocal Entities. These Allocations will be considered non-firm network service.

When a Market-Based Operating Entity is uploading Firm Flow Limits to the IDC, they will be responsible for ensuring that any firm Allocations are properly accounted for. If firm Allocations are used to provide additional firm network service, they should be included in the Firm Flow Limit. If they are used to provide additional Firm Transmission Service, they should not be included in the Firm Flow Limit.

The Market-Based Operating Entities will maintain in real-time their Firm Transmission Service and Network Non-Designated service impacts, within their respective firm and Priority 6 total Allocations. The Firm Transmission Service impacts will be based on schedules. The Operating Entities participating in the Coordinated Process for Reciprocal Flowgates will respect their allocations when granting Firm Transmission Service.

Using the derived firm Allocation value, the Market-Based Operating Entity may choose to enter this value as a Flowgate limit for the respective Flowgate. If entered as a Flowgate limit, the Day-



Ahead unit commitment will not permit flows to exceed this value as it selects units for this commitment. Market-Based Operating Entities will use the Flowgate limit to restrict unit outage scheduling for a Coordinated Flowgate when maintenance outage coordination indicates possible congestion and there is recent TLR activity on a Flowgate.

As Reciprocal Entities gain more experience in this process, implement and enhance their systems to perform the Firm Flow calculations and Allocations, they may change the timing requirements for the Forward Coordination Process by mutual agreement.

### **6.6.1 Determining Firm Transmission Service Impacts**

Firm impacts used in the Allocation process incorporate the Firm Transmission Service flows. Similar to the network service calculation described previously, to calculate each Firm Transmission Service transaction's impact on the Flowgate, the following process is utilized:

1. Utilize a base case to determine the Generation Shift Factor for the source Control Area with respect to a specific Flowgate.
2. Utilize the same base case to determine the Generation Shift Factor for the sink Control Area with respect to that Flowgate.
3. Utilize superposition to calculate the TDF for that source to sink pair with respect to that Flowgate.
4. Multiply the transactions energy transfer by the TDF to determine that transactions flow on the Flowgate.

Summing each of these impacts by direction will provide the directional Firm Transmission Service impact on the Flowgate.

Combining the directional Firm Transmission Service impacts with the directional NNL impacts will provide the directional Firm Flows on the Flowgate.

### **6.6.2 Rules for Considering Firm Transmission Service**

1. Firm Transmission Service and Designated Network Resources that have an OASIS reservation are included in the calculation.
2. Reciprocal Entities will utilize a Freeze Date of April 1, 2004. Reciprocal Entities will utilize a reference year of June 1, 2004 through May 31, 2005 for determining the confirmed set of reservations that will be used in the Allocation process. The reference year is used such that reservation impacts in a given month in the reference year are used for each comparable month going forward in the Allocation process. For example, the Allocations for July 2004, July 2005, and July 2006 etc. will always use the July 2004 reservation impacts from the reference year. Confirmed reservations received after the Freeze Date will not be considered.
3. A potential for duplicate reservations exists if a transaction was made on individual CA tariffs (not a regional tariff) and both parties to the transaction (source and sink) are Reciprocal Entities. In this case, each Reciprocal Entity will receive 50% of the transaction impact.

4. To the extent a partial path reservation is known to exist, it will have 100% of its impacts considered on Reciprocal Coordinated Flowgates owned by the party that sold the partial path service, split 50/50 between the Source Reciprocal Entity and the Sink Reciprocal Entity, and 0% of its impacts considered on other Reciprocal Coordinated Flowgates.
5. Because reservations that are totally within the footprint of the regional tariff do not have duplicate reservations, these reservations will have the full impact considered even though both parties to the transaction (source and sink) are within the boundaries of the regional tariff and will be considered Reciprocal Entities, split 50/50 between the Source Reciprocal Entity and the Sink Reciprocal Entity, which in this case are the same. Similar to the firm network service calculation, the Firm Transmission Service calculation:
  - a. Will consider all reservations (including those with less than 5% impact)
  - b. Will base response factors on the topology of the system for the period under consideration.
  - c. In general, will not make a generation-to-load calculation where a reservation exists.

### 6.6.3 Limiting Firm Transmission Service

The Flowgate Allocations down to 0% will represent the share of total Flowgate capacity (STFC) that a particular entity has been allocated. This STFC represents the maximum total impact that entity is allowed to have on that Flowgate.

In order to coordinate with the existing AFC process, it is necessary that this number be converted to an available STFC (ASTFC) which represents how much Flowgate capability remains available on that Flowgate for use as Transmission Service. In order to accomplish this, the entity receiving STFC will do the following:

Step	Example
1.) Start with the STFC	100
2.) Add all forward Gen to Load impacts (down to 0%) and all Reverse Gen to Load impacts (down to 0%) to obtain the Net Gen to Load impacts. The Gen to Load impacts should be based on the <i>best estimate</i> of firm Gen-to-Load Flow for the time period being evaluated.	$42 + (-20) = 22$
3.) Subtract the net Gen to Load impacts from the STFC	$100 - 22 = 78$
4.) Subtract the CBM to produce an interim STFC	$78 - 0 = 78$
5.) Determine the Transmission Service impacts of service that has been sold. By default, it should be assumed that 100% of forward service and 15% of counterflowing	$58 + (0.15 (-45)) =$ $58 + (-6.75) \approx$ $58 + (-7) = 51$

<p>service will be scheduled and used. However, if Flowgate “owner” uses different percentages in their AFC calculation and the Flowgate manager’s calculation engine support it, percentages other than 100% and 15% may be used. Add all forward Transmission Service impacts (down to 0%) and all appropriate reverse Transmission Service impacts (down to 0%) to obtain the weighted net Transmission Service impacts. The Transmission Service impacts should be based on the <i>current</i> set of reservations in effect for the time period being evaluated (<i>not</i> the historic reservation set)</p>	
<p>6.) Subtract the weighted net Transmission Service impacts from the Interim STFC. The result is the ASTFC</p>	<p><math>78 - 51 = 27</math></p>

The ASTFC values for Reciprocal Coordinated Flowgates will be posted on OASIS along with the Allocation results. This ASTFC can then be compared with the AFC calculated through traditional means when evaluating firm requests made on OASIS.

If the AFC value is LOWER than the ASTFC value, the AFC value should be utilized for the purpose of approving/denying service. In this case, while the Allocation process might indicate that the entity has rights to a particular Flowgate through the Allocation process, current conditions on that Flowgate indicate that selling those rights would result in overselling of the Flowgate, introducing a reliability problem.

If the AFC value is HIGHER than the ASTFC value, the ASTFC value should be utilized for the purpose of approving/denying service. In this case, while the AFC process might indicate that the entity can sell more service than the Allocation might indicate, the entity is bound to not sell beyond their Allocation.

If a Reciprocal Entity uses all of its firm Allocation and desires to obtain additional capacity from another Reciprocal Entity who has remaining capacity, that additional capacity may be obtained using the procedures documented below.

## **6.7 Sharing or Transferring Unused Allocations**

Reciprocal Entities shall use the following process for the sharing or transferring of unused Allocations down to 0% between each other.

### **6.7.1 General Principles**

This process includes the following general principles in the treatment of unused Allocations

1. A desire to fully utilize the Reciprocal Entities' Allocations such that in real-time, an unused Allocation by Reciprocal Entities is caused by a lack of commercial need for the Allocation by Reciprocal Entities and not by restrictions on the use of the Allocation.
2. For short-term requests (less than one year) where the lack of an Allocation could otherwise result in the denial of Transmission Service requests, there should be a mechanism to share or acquire a remaining Allocation on a non-permanent basis for the duration of the short-term transmission service requests. The short-term Allocation transfers would revert back to the Reciprocal Entity with the original Allocation after the short term request expires.
3. For long-term requests (one year or longer) where the lack of an Allocation could otherwise cause the construction of new facilities, there should be a mechanism to acquire a remaining Allocation such that new facilities are built only because they are needed by the system to support the transaction and not because of the Allocation split between Reciprocal Entities. Long-term Allocation transfers would apply to the original time period of the request including any roll-over rights that are granted for such requests.
4. Due to limitations on the frequency of transferring updated Allocation values and AFC's between the Reciprocal Entities, the Reciprocal Entities will utilize buffers to reduce the risk of overselling the same service, and to set aside a portion of the unused Allocation for the owner of the unused Allocation to accommodate any request that they may receive. The buffer will be reduced on a Flowgate based upon factors such as the rating of the Flowgate and operational experience, with the goal to maximize the use of the unused Allocation. The rationale for reducing the buffer is that potentially significant amounts of Transmission Service (up to many times the buffer amount) may be denied otherwise by the non-owner of the unused Allocation.

### **6.7.2 Provisions for Sharing or Transferring of Unused Allocations:**

1. Based upon the proposed infrastructure for Allocation calculations, daily Allocations are available for 7 days into the future and Weekly and Monthly Allocations are available up to 18 months into the future. Sharing and transferring of unused Allocations will be limited to the granularity of the Allocation calculations.

2. The Reciprocal Entities will share or transfer their unused firm Allocations during the time periods up until day ahead with the goal to fully utilize the Allocations.
3. This sharing or transfer of the unused Allocation will occur automatically for short-term Transmission Service requests, and manually for long-term (one year or greater) Transmission Service requests. The Reciprocal Entity that has been requested to transfer unused Allocations to the other Reciprocal Entity for a long-term request shall respond within 5 business days of receipt of the transfer request.
4. The Reciprocal Entities will post information available to the other Reciprocal Entity on all requests granted that shared or acquired the other Reciprocal Entity's Allocation on a daily basis for review.
5. Sharing an Unused Allocation During the Near-Term

The Reciprocal Entities will share their Allocations during the near-term (the first 7 days up until day ahead or a mutually agreed upon timeframe) with the goal to fully utilize the Allocations once in real-time through an automated process.

This sharing of the unused Allocation during the near-term will occur such that an unused Allocation that has not already been committed for use by either Firm Transmission Service or for market service will be made available to the other Reciprocal Entities for their use to accommodate Firm Transmission Service requests submitted on OASIS.

Other firm uses of the transmission system involving generation to load deliveries, which are not evaluated via automated request evaluation tools, will be handled via off-line processes. The core principles to be applied in such cases include:

- a. A sharing of Allocation can occur.
- b. The sharing shall be done on a comparable basis for the market and non-market entities.
- c. The sharing is not related to projected Firm Flow Limits absent new DNRs or Transmission Service submitted on OASIS.
- d. The details of the process will include such items as which DNRs are covered, time-lines for designations and comparable evaluation of DNRs. If the details of this process can not be agreed upon, there shall be no sharing of the unused Allocations during the near-term.

A buffer will limit the amount of Allocation that can be shared for short-term requests during automated processing of the Allocation sharing process. The owner of the unused Allocation is not restricted by the buffer. The buffer is defined as a percentage of the last updated unused Allocation, provided that the buffer shall not be allowed to be less than a certain MW value. For example, a 25% or 20 MW buffer would mean that the requesting entity can use the other Reciprocal Entity's unused Allocation while making sure that the other entity's unused Allocation does not become smaller than 25% of the reported unused amount or 20 MW. The specific provisions of the buffer shall be mutually agreed to by the Reciprocal Entities prior to implementing a sharing of unused Allocation. The buffer will not be used in manual processing of Allocation

sharing requests. For manual processing of requests, the owner of the unused Allocation will share the remaining unused Allocation to the extent they do not need the unused Allocation for pending Transmission Service requests.

For the sharing of unused Allocations in the near-term, the Allocations are not changed and should congestion occur, the IDC obligations for the giving Reciprocal Entity will be in accordance with its original Allocation. The receiving Reciprocal Entity will not be required to retract or annul any service previously granted due to the sharing of Allocations.

6. Acquiring an Unused Allocation Beyond the Near Term

When a Reciprocal Entity does not have sufficient Allocation on a Flowgate to approve a firm point-to-point or network service request made on OASIS and evaluated via automated request evaluation tools and the other Reciprocal Entity has a remaining Allocation, the deficient Reciprocal Entity will be able to acquire an Allocation from the Reciprocal Entity with the remaining Allocation. This Allocation must not already be committed for other appropriate uses, as agreed to by the Reciprocal Entities, and sufficient AFC must remain on the Flowgate, or will be created, to accommodate the request. Such cases will be handled via automated processes.

Other firm uses of the transmission system involving generation to load deliveries, which are not evaluated via automated request evaluation tools, will be handled via off-line processes. The core principles to be applied in such cases include:

- a. A transfer of Allocation can occur.
- b. The transfer shall be done on a comparable basis for the market and non-market entities.
- c. The transfer is not related to projected Firm Flow Limit absent new DNRs or Firm Transmission Service submitted on OASIS.
- d. The details of the process will include such items as which DNRs are covered, time-lines for designations and comparable evaluation of DNRs. If the details of this process can not be agreed upon, there shall be no transfer of the Allocation for the time period beyond the near term.

A buffer will limit the amount of Allocation that can be acquired for these requests during automated processing of the Allocation transfer process. The owner of the unused Allocation is not restricted by the buffer. The buffer is defined as a percentage of the last updated unused Allocation, provided that the buffer shall not be allowed to be less than a certain MW value. For example, a 25% or 20 MW buffer would mean that the requesting entity can use the other Reciprocal Entity's unused Allocation while making sure that the other entity's unused Allocation does not become smaller than 25% of the reported unused amount or 20 MW. The specifics of the buffer shall be mutually agreed to by the Reciprocal Entities prior to implementing a transferring of unused Allocation. The buffer will not be used in manual processing of Allocation sharing requests. For manual processing of requests, the owner of the unused Allocation will

transfer the remaining unused Allocation to the extent they do not need the unused Allocation for pending Transmission Service requests.

The determination of whether the remaining Allocation has already been committed will be established based on OASIS queue time. All requests received prior to the queue time will be considered prior commitments to the remaining Allocation, while such requests are in a pending state (e.g. study status) or confirmed state. Requests received after the queue time will be ignored when determining whether remaining capacity has already been committed.

In the event that prior-queued requests are still in a pending state (i.e. not yet confirmed), the Reciprocal Entity requesting a transfer of unused Allocations may await the resolution of any prior-queued requests in the other Reciprocal Entity's OASIS queue before relinquishing its ability to request an Allocation transfer.

For the transfer of unused Allocations, the Reciprocal Entity's Allocations will be changed to reflect the Allocation transfer at the time the Allocation transfer request is processed. To the extent the request is not ultimately confirmed, the Allocation will revert back to the original Reciprocal Entity with the remaining Allocation. For yearly requests, the transfer of the Allocation applies to the original time period of the request including any roll-overs that are granted.

## 6.8 The Application of Firm Flow Limits in the IDC

In addition to the responsibilities described earlier in “Market-Based Operating Entity Congestion Management” Section 5 of this document, Market-Based Operating Entities will have an additional obligation, on Reciprocal Coordinated Flowgates, to further quantify their Non-Firm GTL Flows into two (2) separate priorities in the IDC: Non-Firm Network (6-NN), and Non-Firm Hourly (2-NH). Within the IDC, the priorities will be determined as follows:

1. If the GTL Flow exceeds the sum of the Firm Flow Limit and the 6-NN Allocation, then:  
2-NH = GTL flow – (Firm Flow Limit + 6-NN Allocation)  
6-NN = 6-NN Allocation  
7-FN = Firm Flow Limit
2. If the GTL Flow exceeds the Firm Flow Limit but is less than the 6-NN Allocation, then:  
2-NH = 0  
6-NN = GTL Flow – Firm Flow Limit  
7-FN = Firm Flow Limit
3. If the GTL Flow does not exceed the Firm Flow Limit, then  
2-NH = 0  
6-NN = 0  
7-FN = GTL Flow
4. If the tag associated with EAR is converted to Market Flow and excluded by the IDC, the Market Flow shall have a priority that is no higher than it would have been if the tag was not excluded by IDC. This provision aims to keep the application of these tags consistent between the Market Flow used in market-to-market, and the GTL calculation performed by the IDC and used in TLR.

All other aspects of this data remain identical to those described in “Market-Based Operating Entity Congestion Management” Section 5.



## **6.9 Real-time Operations Process for Market-Based Operating Entities**

### **6.9.1 Market-Based Operating Entity Capabilities**

Capabilities remain as described in “Market-Based Operating Entity Congestion Management” Section 5.

### **6.9.2 Market-Based Operating Entity Real-time Actions**

Procedures remain as described in “Market-Based Operating Entity Congestion Management” Section 5. However, as described above, additional information regarding the firmness of those Non-Firm GTL flows will be communicated as well. A portion will be reported as 6-NN, while the remainder will be reported as 2-NH. This will provide additional ability for the IDC to curtail portions of the Non-Firm GTL flows earlier in the TLR process.

## **6.10 Requirements to Combine Allocations with Non-Reciprocal Entity**

The following requirements must be satisfied for a Combining Party to incorporate a Non-Reciprocal Entity's load and the associated generation serving that load into the Reciprocal Entity's Allocation calculations:

1. The Non-Reciprocal Entity's load and associated generation serving that load participates in the market of the Combining Party pursuant to a FERC-accepted agreement(s).
2. The Non-Reciprocal Entity has not placed its transmission facilities under the Open Access Transmission Tariff of the Combining Party, nor has the Non-Reciprocal Entity executed a transmission owner agreement or membership agreement, or equivalent thereof, of the Combining Party.
3. The Non-Reciprocal Entity is wholly embedded (i.e., the load and associated generation serving that load are included in Allocations, Market Flows, and IDC GTL calculations) into the Combining Party's Control Area footprint in accordance with the CMP.
4. The Combining Party must treat the Non-Reciprocal Entity's impacts in the IDC, Market Flow, Firm Flow Limit, and Firm Flow Entitlement calculations consistently as the Combining Party does its own impacts in accordance with this CMP. The Non-Reciprocal Entity's load and associated generation serving that load otherwise needs to be eligible for inclusion in firm Allocations, Firm Flow Limit, and Firm Flow Entitlement under the terms of this CMP.
5. Any transmission facilities owned by the Non-Reciprocal Entity must be treated comparably to the transmission facilities of other Reciprocal Entities consistent with the terms of the CMP.
6. The Combining Party must provide notice to the other Reciprocal Entities of its plans to combine allocations within sixty (60) calendar days of making a filing at the FERC that would result in a Non-Reciprocal Entity's load and associated generation serving that load being combined with the Combining Party or upon combining Allocations (whichever occurs first). Even though a situation in which a Combining Party has proposed to combine Allocations with a Non-Reciprocal Entity may satisfy requirement numbers 1 through 5 of this list, this does not preclude other Reciprocal Entities from raising any objection pursuant to the dispute resolution process of a joint operating agreement or by filing a Section 206 complaint with the FERC if the proposed combination of Allocations would be inconsistent with this CMP or produces a result that is unjust and unreasonable.

**Section 7 – Appendices**

## Appendix A – Glossary

**Agreement** – Agreement shall mean this Joint Operating Agreement Between the Midcontinent Independent System Operator, Inc. and PJM Interconnection, L.L.C., as amended from time to time, including all attachments, appendices, and schedules.

**Allocation** – A calculated share of capability on a Reciprocal Coordinated Flowgate to be used by Reciprocal Entities when coordinating AFC, transmission sales, and dispatch of generation resources.

**Available Flowgate Capability (AFC)** – The applicable rating of the applicable Flowgate less the projected loading across the applicable Flowgate less TRM and CBM. The firm AFC is calculated with only the appropriate Firm Transmission Service reservations (or interchange schedules) in the model, including recognition of all roll-over Transmission Service rights. Non-firm AFC is determined with appropriate firm and non-firm reservations (or interchange schedules) modeled.

**AFC Flowgate** – A Flowgate for which an entity calculates AFC's.

**Combining Party** – Combining Party shall mean a Reciprocal Entity that is incorporating the load and associated generation serving that load from a Non-Reciprocal Entity into the Reciprocal Entity's Allocations pursuant to Section 6.10 of this CMP.

**Control Area** – Shall mean an electric power system or combination of electric power systems to which a common automatic generation control scheme is applied.

**Control Zones** – Within an Operating Entity Control Area that is operating with a common economic dispatch, the Operating Entity footprint is divided into Control Zones to provide specific zonal regulation and operating reserve requirements in order to facilitate reliability and overall load balancing. The zones must be bounded by adequate telemetry to balance generation and load within the zone utilizing automatic generation control.

**Coordinated Flowgate (CF)** – Shall mean a Flowgate impacted by an Operating Entity as determined by one of the five studies detailed in Section 3 of this document. For a Market-Based Operating Entity, these Flowgates will be subject to the requirements under the Congestion Management portion of this document (Sections 4 and 5). A Coordinated Flowgate may be under the operational control of a Third Party.

**Designated Network Resource** – A resource that has been identified as a designated network resource pursuant to a transmission provider's Open Access Transmission Tariff.

**EIDSN** – Eastern Interconnection Data Sharing Network

**External Asynchronous Resource<sup>1</sup> (EAR)** – A Resource representing an asynchronous DC tie between the synchronous Eastern Interconnection grid and an asynchronous grid that is

---

<sup>1</sup> External Asynchronous Resource is specific to the MISO tariff, MISO, FERC Electric Tariff, Module A, § 1.E "External Asynchronous Resource" (33.0.0).

supported within the Transmission Provider Region through Dynamic Interchange Schedules in the Day-Ahead Energy and Operating Reserve Market and/or Real-Time Energy and Operating Reserve Market. External Asynchronous Resources are located where the asynchronous tie terminates in the synchronous Eastern Interconnection grid.

**Firm Flow** – The estimated impacts of Firm Transmission Service on a particular Coordinated or Reciprocal Coordinated Flowgate.

**Firm Flow Limit** – The maximum value of Firm Flows an entity can have on a Coordinated or Reciprocal Coordinated Flowgate, based on procedures defined in Sections 4 and 5 of this document.

**Firm Market Flow** – The portion of Market Flow on a Coordinated or Reciprocal Coordinated Flowgate related to contributions from the native load serving aspects of the dispatch (constrained as appropriate by the Firm Flow Limit).

**Firm Transmission Service** – The highest quality (priority) service offered to customers under a filed rate schedule that anticipates no planned interruption or similar quality service offered by transmission providers by contract that do not require the filing of a rate schedule. Firm Transmission Service only includes firm point-to-point service, network designated transmission service and grandfather agreements deemed firm by the transmission provider as posted on OASIS.

**Flowgate** – A representative modeling of facilities or groups of facilities that may act as significant constraint points on the regional system.

**Freeze Date** – The cutoff date chosen by Reciprocal Entities to be used in the calculation of Historic Firm Flows.

**Generation-to-Load (GTL)** – The calculated energy flows on a specified Flowgate as a result of dispatch of generating resources serving load within an Operating Entity’s Control Area, as specified in NAESB BPS WEQ-008 starting version 3.3.

**Generator Shift Factor** – A factor to be applied to a generator’s expected change in output to determine the amount of flow contribution that change in output will impose on an identified transmission facility or Flowgate, referenced to a swing bus.

**Generator Priority Schedules (GPS)** – A schedule that indicates the Transmission Service curtailment priority of the generator output, as specified in NAESB BPS WEQ-008-9.1.3

**Historic Firm Flow** – The estimated total impact an entity has on a Reciprocal Coordinated Flowgate when considering the impacts of (1) its historic Designated Network Resources serving native load, and (2) imports and exports, based on Firm Transmission Service reservations that meet the “Freeze Date” criteria.

---

**Historic Firm Gen-to-Load Flow** – The flow associated with the native load serving aspects of dispatch that would have occurred if all Control Areas maintained their current configuration and continued to serve their native load with their generation.

**Historic Ratio** – The ratio of Historic Firm Flow of one Reciprocal Entity compared to the Historic Firm Flow of all Reciprocal Entities on a specific Reciprocal Coordinated Flowgate.

**LMP Based System or Market** – An LMP based system or market utilizes a physical, flow-based pricing system to price internal energy purchases and sales.

**Load Shift Factor** – A factor to be applied to a load's expected change in demand to determine the amount of flow contribution that change in demand will impose on an identified transmission facility or Flowgate, referenced to a swing bus.

**Locational Marginal Pricing (LMP)** – The processes related to the determination of the LMP, which is the market clearing price for energy at a given location in a Market-Based Operating Entity's market area.

**Market Flows** – The calculated energy flows on a specified Flowgate as a result of dispatch of generating resources serving market load within a Market-Based Operating Entity's market.

**Market-Based Operating Entity** – An Operating Entity that operates a security constrained, bid-based economic dispatch bounded by a clearly defined market area.

**Network and Native Load (NNL)** – The impact of generation resources serving internal system load, based on generation the network customer designates for Network Integration Transmission Service (NITS). NNL is also referred to as Gen to Load.

**Non-Firm Market Flow** – That portion of Market Flow related to a Market-Based Operating Entity's market operations in excess of that entity's Firm Market Flow.

**Non-Reciprocal Entity** – Non-Reciprocal Entity shall mean an Operating Entity that is not a Reciprocal Entity.

**Operating Entity** – An entity that operates and controls a portion of the bulk transmission system with the goal of ensuring reliable energy interchange between generators, loads, and other operating entities.

**Party or Parties** – Party or Parties refers to each party to this Agreement or both, as applicable.

**Parallel Flow Visualization (PFV)** – conceptual ideas captured in NAESB BPS WEQ-008 starting with version 3.3

**Reciprocal Coordination Agreement** – An agreement between Operating Entities to implement the reciprocal coordination procedures defined in the CMP.

**Reciprocal Coordinated Flowgate (RCF)** – A Flowgate that is subject to reciprocal coordination by Operating Entities, under either this Agreement (with respect to Parties only) or a Reciprocal Coordination Agreement between one or more Parties and one or more Third Party Operating Entities. An RCF is:

1. A CF that is (a) (i) within the operational control of Reciprocal Entity or (ii) may be subject to the supervision of Reciprocal Entity as Reliability Coordinator, and (b) affected by the transmission of energy by two or more Parties; or
2. A CF that is (a) affected by the transmission of energy by one or more Parties and one or more Third Party Operating Entities, and (b) expressly made subject to CMP reciprocal coordination procedures under a Reciprocal Coordination Agreement between or among such Parties and Third Party Operating Entities; or
3. A CF that is designated by agreement of both Parties as an RCF.

**Reciprocal Entity** – An entity that coordinates the future-looking management of Flowgate capacity in accordance with a Reciprocal Coordination Agreement as developed under Section 6 of this document, or a congestion management process approved by the Federal Energy Regulatory Commission; provided such congestion management process is identical or substantially similar to this CMP.

**Security Constrained Economic Dispatch** – The utilization of the least cost economic dispatch of generating and demand resources while recognizing and solving transmission constraints over a single Market-Based Operating Entity Market.

**Third Party** – Third Party refers to any entity other than a Party to this Agreement.

**Tie Line** – Tie Line shall mean a circuit connecting two Control Areas.

**Transfer Distribution Factor** – The portion of an interchange transaction, typically expressed in per unit, flowing across a Flowgate.

**Transmission Service** – Services provided to the transmission customer by the transmission service provider to move energy from a point of receipt to a point of delivery.

**Tag Secondary Network Transmission Service Method (TSNT)** - A method for determining the Transmission Service curtailment priority of the Secondary Network Transmission Service using e-Tags, as specified in NAESB BPS WEQ-008-1.9.2.

## **Appendix B - Determination of Marginal Zone Participation Factors**

In order for the IDC to properly account for tagged transactions into and out of the market area, a Market-Based Operating Entity using the Marginal Zone methodology will need to provide participation factors representing the facilities contributing to the tagged transactions. The facility or facilities contributing to each export tagged transaction is the source of the export tagged transaction. The facility or facilities contributing to each import tagged transaction is the sink of the import tagged transaction.

The Market-Based Operating Entity will be required to define a set of zones that can be aggregated into a common distribution factor that is representative of the market area. This information must be shared and coordinated with the IDC. Following this step, the Market-Based Operating Entity must then send to the IDC participation factors for those zones. These participation factors represent the percentages of how these zones are providing marginal megawatts as a result of dispatch of resources in market operations to serve transactions. Data sets for each external source/sink are required, which correspond to:

- An IMPORT data set, which indicates the participation of facilities accommodating the energy imported into the market area, and
- An EXPORT data set, which indicates the participation of facilities accommodating the energy exported out of the market area.

The methodology used by the Market-Based Operating Entity to determine the Marginal Zone participating factors will be determined through collaboration of the Market-Based Operating Entity with the IDC working group.

### **Participation Factor Calculation**

The Market-Based Operating Entity will use the real-time system conditions to calculate the marginal zone participation factors, which reflect the impacts of tagged transactions. These will establish, for imports and exports, a set of participation factors that, when summed, will equal 100 percent.



### **Appendix C - Flowgate Determination Process**

This section is has been added to clarify:

- How initial Flowgates are identified (Figure C-1, Table C-1)
  - Process for Flowgates in the Coordinated Flowgate list
  - Process for Flowgates in the Reciprocal Coordinated Flowgate list
  - Process for Flowgates in the AFC List
- How Flowgates will be added (Figure C-2, Table C-2)
- How often Flowgates are changed (Figure C-2, Table C-2)

Figure C -1  
 Determine AFC Flowgates,  
 Coordinated Flowgates, and Reciprocal  
 Coordinated Flowgates

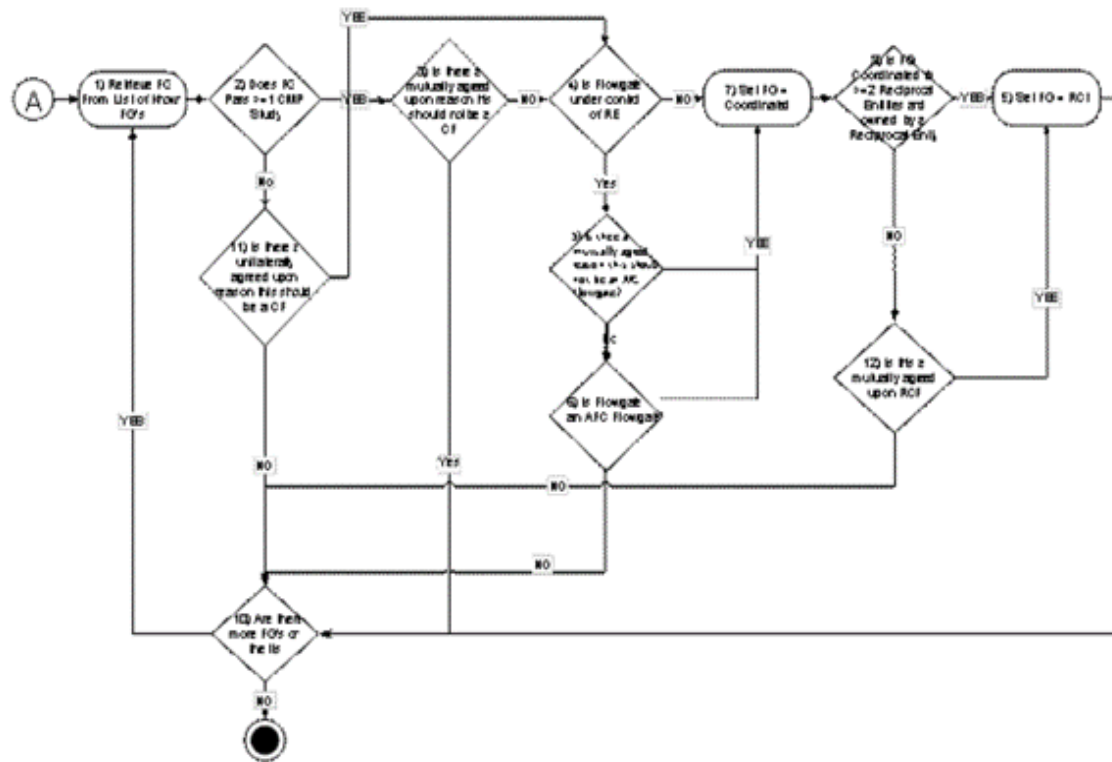

TABLE C-1

Step	Activity	Requirements	Detailed Description	Additional Documentation
1	Retrieve FG From List Of Known FG's	Retrieve FG from AFC list of FGs, NERC Book of FGs, and any other list of FGs.	<ul style="list-style-type: none"> <li>Retrieve the FG from the list of FGs. If a Reciprocal Entity wants us to consider a temporary FG it would go through the same process.</li> </ul>	
2	Determine if FG passes >= 1 CMP Study	The decision determines if the FG passes at least one of the five CMP studies.	<ul style="list-style-type: none"> <li>If the FG passes any of the studies, determine if there is mutually agreed upon reason why this should not be a coordinated FG.</li> <li>If the FG does not pass any of the studies, it will be determined if there is a unilaterally decided reason for inclusion as a CF.</li> </ul>	See Impacted Flowgate Determination -Section 3
3	Is There a Mutually Agreed Upon Reason This Should Not Be A Coordinated Flowgate	Determine if there is a mutually agreed reason, despite passing one of the five tests, why this FG should not be considered Coordinated.	<ul style="list-style-type: none"> <li>If there is no mutually agreed reason why this FG should not be considered coordinated, test whether FG is under control of a Reciprocal Entity.</li> <li>If there is a mutually agreed reason why this FG should not be considered coordinated, record the reason proceed to Step 10.</li> </ul>	
4	Is the Flowgate under control of a Reciprocal Entity	If the Flowgate is under the control of a non-reciprocal entity and the Flowgate passes one of the five tests it will be treated as a Coordinated Flowgate.	<ul style="list-style-type: none"> <li>If the Flowgate is not under control of a Reciprocal Entity proceed to Step 7.</li> <li>If the Flowgate is under control of a Reciprocal Entity Proceed to Step 5.</li> </ul>	
5	Is there a mutually agreed reason this should not be AFC Flowgate?	Determine if there is a mutually agreed reason, despite qualifying as a Coordinated Flowgate, why this Coordinated Flowgate is not included in the AFC process.	<ul style="list-style-type: none"> <li>If there is a mutually agreed reason to not include the Coordinated Flowgate in the AFC process proceed to Step 7.</li> <li>Otherwise proceed to Step 6.</li> </ul>	

Step	Activity	Requirements	Detailed Description	Additional Documentation
6	Is Flowgate an AFC Flowgate	A check is done to determine if the Flowgate controlled by a Reciprocal Entity is in its AFC process.	<ul style="list-style-type: none"> <li>• If the Flowgate is in the AFC process or in the process of being added to the AFC process proceed to Step 7.</li> <li>• Otherwise proceed to Step 10</li> </ul>	
7	Set FG = Coordinated	The FG would be coordinated for the entity.	<ul style="list-style-type: none"> <li>• The FG would be considered a CF.</li> </ul>	

Step	Activity	Requirements	Detailed Description	Additional Documentation
8	Is FG Coordinated for >= 2 Reciprocal Entities and "owned" by a Reciprocal Entity	Determine whether the FG is coordinated for two or more Reciprocal Entities	<ul style="list-style-type: none"> <li>• If the FG is coordinated for two or more Reciprocal Entities and it is "owned" by one of the entities, it will be added to the CMP process as a reciprocal coordinated FG.</li> <li>• If it is not coordinated for two or more Reciprocal Entities and "owned" by one of the entities, determine if it is a mutually agreed upon RCF.</li> </ul>	CM Process -Section 6
9	Set FG = RCF	Set the Flowgate equal to a Reciprocal Coordinated Flowgate.	<ul style="list-style-type: none"> <li>• Set the Flowgate equal to a Reciprocal Coordinated Flowgate.</li> </ul>	
10	Are there more FGs on the list?	Determine if there are any more FGs on the list that need to go through the CMP determination process.	<ul style="list-style-type: none"> <li>• Proceed to Step 10.</li> <li>• If there are no more FGs that need to go through the determination process, the process ends.</li> <li>• If there are more FGs that need to go through the determination process, retrieve the next one.</li> <li>• Proceed to Step 1 if another FG requires evaluation.</li> </ul>	
11	Is There a Unilateral Decision This Should Be A Coordinated FG	This decision determines if an entity wants to make this a Coordinated FG for a reason other than the five tests.	<ul style="list-style-type: none"> <li>• Otherwise, the process ends.</li> <li>• If an entity decides to make this a coordinated FG, proceed to Step 4.</li> <li>• Otherwise, proceed to Step 10.</li> </ul>	
12	Is This a Mutually Agreed Upon RCF	Determine if there is a mutually agreed reason this should be considered a Reciprocal Coordinated Flowgate.	<ul style="list-style-type: none"> <li>• If there is no mutually agreed reason this should be considered an RCF, leave it as coordinated and check for more FGs.</li> <li>• If there is a mutually agreed reason this should be considered an RCF, mark it as such.</li> <li>• If Reciprocal Entities decide to make the Flowgate Reciprocal proceed to Step 9.</li> <li>• Otherwise, proceed to Step 10.</li> </ul>	

Figure C-2  
Flowgate Review and Customer  
Flowgate Request

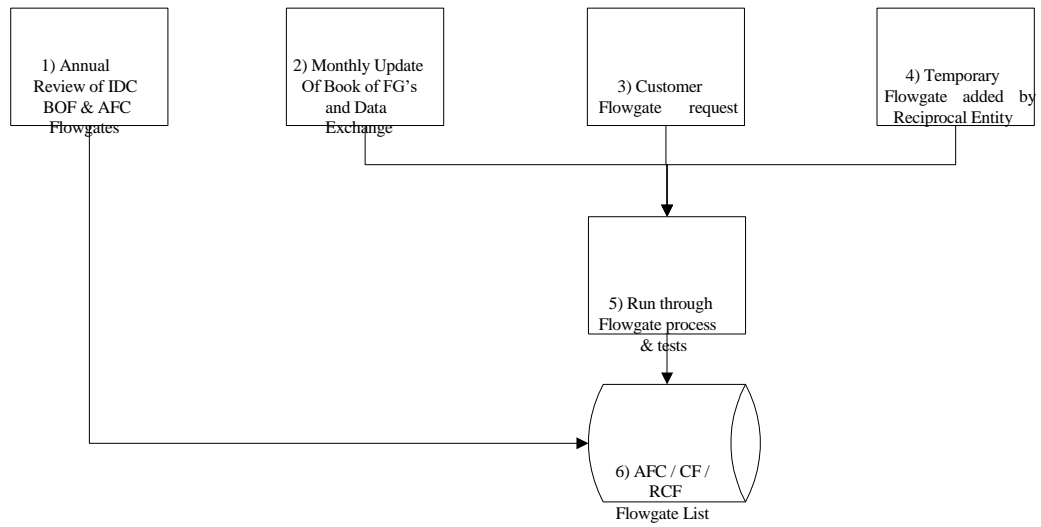

TABLE C-2

Steps	Activity	Requirements	Detailed Description	Additional Documentation
1	Annual Review of the BOFs and AFC FGs	A review will be performed annually or more often as requested by Reciprocal Entities (CMPWG). Retrieve the FG from the list of FGs for the entity running the process. Study 1 in section 3.2.1 of the CMP is not required for this annual review.	<ul style="list-style-type: none"> <li>Except for Study 1 in section 3.2.1 of the CMP, the FGs will be run through the process summarized in figure C-1.</li> </ul>	
2	Customer FG Requests	Any customer FG requests will also be subject to the tests and process above.	<ul style="list-style-type: none"> <li>Any customer FG requests will be run through the process summarized in figure C-1.</li> </ul>	
3	Temporary Flowgate added by Reciprocal Entity	Any temporary Flowgate added by a Reciprocal Entity will also be subject to the tests and processes in Step 5.	<ul style="list-style-type: none"> <li>Any temporary Flowgates added by a Reciprocal Entity will be run through the process summarized in figure C-1</li> </ul>	
4	Run Through FG Process and Tests	Run through FG Determination Process, figure C-1		
5	AFC/CF/RCF List	Any FG additions or modifications would need to be committed to the repository of FGs and their qualifications.		

## **Appendix D – Training**

The concepts in these proposals should not have a significant impact upon system operators beyond the operators of the Operating Entity. The reason that this impact rests upon the Operating Entities is that the Operating Entities Operators will need to be trained to monitor and respond to the external Flowgates.

Reliability Coordinator (RC) Operator Training Impacts include:

1. The ability to recognize and respond to Coordinated Flowgates.
  - a. IDC outputs will show schedule curtailments and possible redispatch requirements.
  - b. Must be able to enter constraint in systems to provide the redispatch relief within 15 minutes.
  - c. Must be able to confirm that the required redispatch relief has been provided and data provided to the IDC.
2. Capability to enter Flowgates on the fly.

Other RC System Operators Training Impacts include:

1. The ability to take projected net system flows between an Operating Entity's Control Zones versus only tag data to run day-ahead analysis (data to be provided by the IDC).
2. Need to develop a working knowledge of how relief on a TLR Flowgate can come from both schedule changes and redispatch on a select set of Coordinated Flowgates.
3. Can coordinate with another RC Operator when the RC System Operator has a temporary Flowgate that they believe requires the implementation of the “Flowgate on the Fly” process.



**Appendix E –Reserved**

## **Appendix F – FERC Dispute Resolution**

### **RCF Dispute Resolution**

If a Party has followed all processes in the disputed Flowgate process outlined in section 3.2 and is dissatisfied with the ORS resolution of the Flowgate dispute, the Party may refer the dispute to FERC's Dispute Resolution Service for mediation, and upon a Party's determination at any point in the mediation that mediation has failed to resolve the dispute, either Party may seek formal resolution by initiating a proceeding before FERC.

### **Allocation Adjustment for New Transmission Dispute Resolution**

If a Party has followed all processes in the Allocation Adjustment Peer Review process outlined in Appendix G and is dissatisfied with the resolution of the CMPC, the Party may refer the dispute to FERC's Dispute Resolution Service for mediation, and upon a Party's determination at any point in the mediation that mediation has failed to resolve the dispute, either Party may seek formal resolution by initiating a proceeding before FERC.

## **Appendix G – Allocation Adjustment for New Transmission Facilities and/or Designated Network Resources**

### **1. Guiding Principles**

The following guiding principles will be used in determining the allocation adjustments for New Transmission Facilities and/or Designated Network Resources.

- Principle 1 (Non-builder held harmless) – To the extent possible, the non-building entity will receive the same overall impacts in its allocations.
- Principle 2 (Builder receives benefits) – To the extent possible, the building entity will receive any benefit to the transmission system that result from the system upgrade.

To the extent these two principles conflict, the Non-Builder Held Harmless Principle will have priority over the Builder Receives Benefit Principle.

### **2. New Transmission Facilities That Do Not Involve New DNR or New Firm Transmission Service**

To the extent a new transmission facility causes a significant decrease in flow on a Reciprocal Coordinated Flowgate, the change in the allocation will be assigned to the Reciprocal Entity with functional control of the new transmission facility. Otherwise, the normal allocation procedures will be followed and no allocation adjustments for new transmission facilities will be made.

Significant impact is defined as a 3% change in flow that occurs to an OTDF Flowgate and a 5% change in flow that occurs to a PTDF Flowgate with the addition of the new facility. The 3% and 5% are measured as a percentage of the Flowgate TTC (sometimes called Total Flowgate Capability (TFC)).

The allocation adjustment will be assigned to the Reciprocal Entity with functional control of the new transmission facility. Both the original allocation and the allocation adjustment are assigned to the Reciprocal Entities. To the extent a group of transmission owners installs a new facility that includes multiple Reciprocal Entities and the new transmission facility results in a change in transfer capability on one or more RCFs, these Reciprocal Entities will work in collaboration to determine appropriate adjustments to each Reciprocal Entity's allocation on all significantly impacted RCFs.

An analysis will be performed both with and without the new facility to determine whether there is a significant impact on one or more RCFs. The analysis and any subsequent allocation adjustments will coincide with the expected in-service date of the new facility. The inclusion of the new transmission facility in such an analysis is dependent on having a commitment that the new facility has or is expected to receive all of the appropriate approvals and will be installed on the date indicated.

In order to qualify for an allocation adjustment, the new transmission facility must not only create a significant change in flows, it must also be a significant change to the transmission system (i.e. a new line or transformer that creates a significant change to flows on one or more RCFs). The addition of a new generator without transmission additions (other than the generation interconnection) is not covered by this process for new transmission facility additions. A change in the rating of an RCF may qualify as a significant change to the transmission system and be eligible to receive an allocation adjustment even though it does not result in a change in flows.

For stability limited Flowgates, a new generator, reactive device or change to a remedial action scheme may contribute to a change in the transfer limitation of stability limited Flowgates. Where this occurs and the addition is being made for the specific purpose of changing the transfer limitation of stability limited Flowgates, an allocation adjustment will be provided to the Reciprocal Entity responsible for the new generator, reactive device or change to a remedial action scheme. By receiving an allocation adjustment, this new generator, reactive device or change to a remedial action scheme will not also be included in the historical usage calculation to avoid double-counting of the impacts.

Not all new transmission facilities that significantly impact RCFs involve a change in flows. A new facility may be added that changes the rating of an RCF but has minimal impact on the flow (i.e. reconductoring, replacing a wave trap (WT) or current transformer (CT), replacing a transformer). In this case, each Reciprocal Entity's historical usage flow will remain constant but the rating of the Flowgate will either increase or decrease. The Reciprocal Entity responsible for the new facility will receive an allocation adjustment for rating increases. There will be no allocation adjustments for rating decreases.

There is an equity issue involving new transmission facilities that result in an increased rating. Where a new facility involves minimal cost change (such as replacing either a WT or CT, replacing a jumper, replacing a switch, changing a CT setting, etc.), there have already been significant costs incurred on a larger conductor that allows the increased rating to occur. As long as the Reciprocal Entity making the minimal cost change is also responsible for the conductor, it is the appropriate Reciprocal Entity to receive the allocation adjustment. However, if different Reciprocal Entities own the conductor versus are responsible for making the minimal cost change, there is an equity issue if the entire allocation adjustment is given to the Reciprocal Entity responsible for making the minimal cost change. The Reciprocal Entities shall negotiate a mechanism to share in the allocation adjustment.

### **3. New Transmission Facilities that Involve New DNR or New Firm Transmission Service**

Where a new transmission facility is added as part of an approved new usage of the transmission system (either a new DNR or a new Firm Transmission Service), the Reciprocal Entity responsible for the new facility has two choices on the treatment of this combination. First, in recognition that they have addressed transmission concerns associated with the new DNR or new Firm Transmission Service, the combination of the new transmission facility and new DNR/Firm Transmission Service will be added to the base model used in the historic usage impact calculation. The new DNR or new Firm Transmission Service will be treated as if it met the Freeze Date. To the extent the new transmission facility and its associated new DNR or new Firm Transmission Service will not occur until a future time period, they will not appear in the historic usage impact calculation until after the in-service/start date. The inclusion of the new transmission facility and associated DNR/Firm Transmission Service is dependent on having a commitment that both have been approved and will occur on the date indicated. If no such commitment exists, these additions will not be included in the historic usage impact calculation. By making this choice to include the new transmission facility and DNR/Firm Transmission Service in the historic usage impact calculation, the NNL allocation will consider the impact of both. This may result in increased NNL allocation to all Reciprocal Entities after considering historic usage impacts (down to 0%). However, the Reciprocal Entity that builds the new transmission facility will not receive any special treatment (NNL allocation adjustment) because

of the new transmission facility. This inclusion of a new DNR or new Firm Transmission Service only applies where associated new transmission facilities have been added to accommodate the new transmission usage.

Second, the Reciprocal Entity that builds the new transmission facility associated with a new DNR or new Firm Transmission Service can receive an NNL allocation adjustment and must honor that allocation when they apply the new DNR or new Firm Transmission Service in their use of NNL allocations. The Reciprocal Entity determines the impact of the new transmission facility without the new DNR or new Firm Transmission Service to calculate any adjustments to the NNL allocations (the same process documented in the previous section “New Transmission Facilities that Do Not Involve New DNRs or New Firm Transmission Service). The Reciprocal Entity will use the remaining NNL allocation that has not been committed to other uses for the new DNRs or new Firm Transmission Service.

The Reciprocal Entity responsible for the combination of new transmission facility and new DNR/Firm Transmission Service will make a single choice (either one or two) that applies to all RCFs that are significantly impacted by the combination. There is no opportunity to have a different selection on different RCFs that are all impacted by the same combination.

#### **4. Allocation Adjustment Peer Review**

When reviewing the allocation adjustments, if an impacted Reciprocal Entity finds a situation where the rule set does not produce a satisfactory outcome, the impacted Reciprocal Entity may request a review by the CMPWG. The impacted Reciprocal Entity will present the unsatisfactory results and a proposed alternative. If the CMPWG agrees to the proposed alternative it will be implemented as an exception, and the CMPC will be notified of the exception prior to implementation. If the CMPWG does not agree, the impacted Reciprocal Entity can seek further review by the CMPC. The impacted Reciprocal Entity will present its proposed alternative and the CMPWG member(s) will present their concerns to the CMPC for the CMPC to take action. All exceptions approved by the CMPWG or CMPC will be documented for future reference.

Depending on the nature of the upgrade, the impact of the new facility will be held in abeyance pending completion of the review. This means for a rating change, the prior rating will continue to be used in the model update process pending completion of the review. This means for a flow change, the new facility will be recognized in the model update process. The impacts will be calculated using the normal (socialized) allocation process and no allocation adjustments will be made pending completion of the review. These reviews should be completed in a timely manner.

#### **Appendix H – Application of Market Flow Threshold Field Test Conditions**

MISO, PJM and SPP participated in a NERC approved Market Flow threshold field test from June 1, 2007 to October 31, 2009. The purpose of the field test was to determine a Market Flow threshold percentage that allows the three Regional Transmission Organizations (RTOs) to consistently meet their relief obligation during TLR without jeopardizing reliability. Although the field test was able to achieve a success rate close to 100% based on MISO data using a 5% threshold, the following conditions were applied to the field test results:

- Market Flows were evaluated 30 minutes after implementation of the TLR curtailment.

- A 5 MW dead-band (or 10% of the relief obligation for relief obligations greater than 50 MW) was applied to the Target Market Flow such that once actual Market Flows were within the dead-band, it was considered a success meeting the relief obligation.
- There were no instances where MISO was able to meet its relief obligation if more than 30 MW must be removed within 30 minutes. The field test found the amount of Market Flow that must be removed in 30 minutes and not the size of the relief obligation is an indicator whether the market will be successful.

Since the NERC ORS applied the three conditions above to the field test results in order to demonstrate a high success rate, these same conditions will be applied when the Market-Based Operating Entities have relief obligations on external Flowgates during TLR.

The field test results are only applicable to Flowgates that are external to each of the RTOs and does not include internal Flowgates (internal to that specific RTO) or market-to-market Flowgates (internal to one of the three RTOs but subject to market-to-market provisions with another RTO). The reason for excluding internal Flowgates and market-to-market Flowgates is because the three RTOs use market redispatch to control total flow and to maintain reliability. As the Reliability Coordinator for the Flowgate, the three RTOs are responsible for the reliability of their own Flowgate and must manage total flow in order to meet their reliability responsibility. As described in the field test final report, by controlling total flow, the three markets effectively meet their relief obligation.