

COMMONWEALTH OF KENTUCKY  
BEFORE THE PUBLIC SERVICE COMMISSION

In the Matter of )  
Application by Water Service Corporation )  
of Kentucky, along with Corix )  
Infrastructure (US) Inc. and SW Merger ) Case No. 2022-00396  
Acquisition Corp., for Approval of Transfer )  
of Control )

---

**APPLICATION**

---

Water Service Corporation of Kentucky (“WSCK” or the “Company”), along with Corix Infrastructure (US) Inc. (“Corix US”) and SW Merger Acquisition Corp. (“SWMAC”) (collectively, the “Joint Applicants”), by and through counsel respectfully request that the Public Service Commission of Kentucky (the “Commission”) approve, pursuant to the provisions of KRS 278.020(6) and (7), a transfer of indirect control of the Company by way of an upstream corporate merger more fully described herein. As demonstrated in detail below and in the accompanying direct testimony of the Joint Applicants’ witnesses, the Company—including its corporate parents—will continue to have the financial, technical, and managerial abilities to provide reasonable service to the customers of the Company, and the transfer is in accordance with law, for a proper purpose, and is consistent with the public interest.

The Joint Applicants state the following in support of this Application:

## Summary

1. The Joint Applicants respectfully request that the Commission authorize a proposed merger of SWMAC and Corix US to create a larger, stronger water and wastewater company. The Proposed Transaction<sup>1</sup> does not involve a change in direct control of WSCK. Nor does the Proposed Transaction involve a transfer of the stock of WSCK. Figure 1 depicts the simplified organization of Corix US and SWMAC before the Proposed Transaction, and Figure 2 provides a simplified organization chart reflecting the combined company after SWMAC merges with and into Corix US. In short, the Proposed Transaction brings together two like-minded water and wastewater businesses that share a common mission, vision and values. The combined company will have additional scale and be well-positioned to make the long-term investments needed to collect and dispose of wastewater and deliver water safely, reliably and sustainably to customers in Kentucky.

**Figure 1**

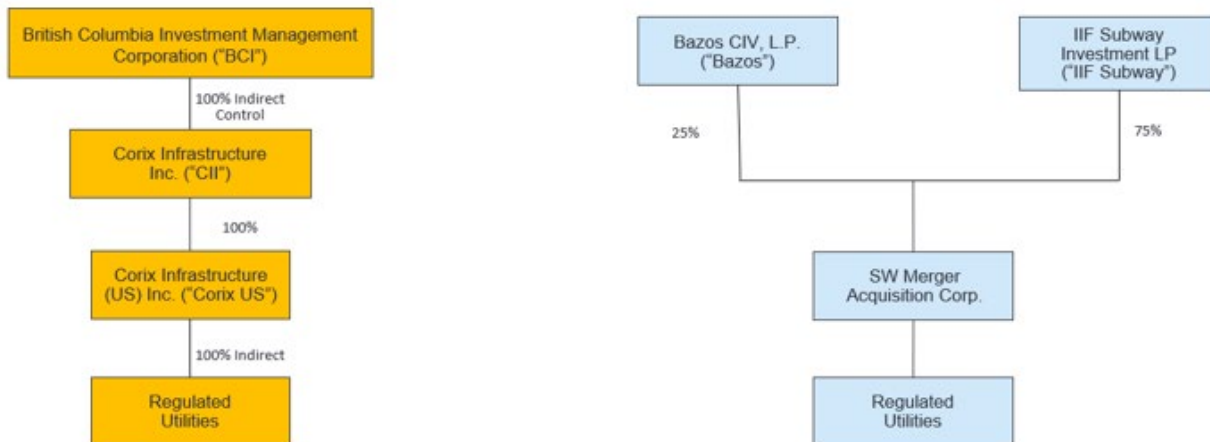

**Figure 2<sup>2</sup>**

<sup>1</sup> As defined in paragraph 12 (Proposed Transaction), see below.

<sup>2</sup> It is anticipated that, as of closing, CII and an affiliate or affiliates of CII will collectively own 50% of Corix US's outstanding stock.

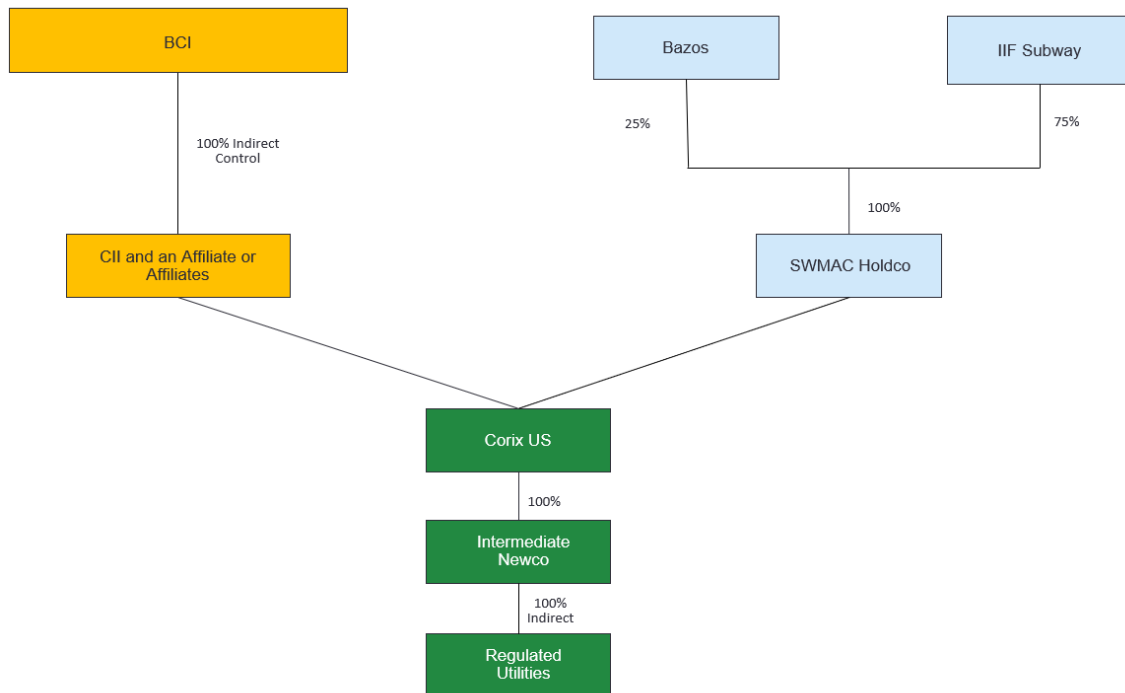

### **Water Service Corporation of Kentucky**

2. WSKC is a corporation organized under the laws of Kentucky, operating in Kentucky, engaged in the provision of water utility service to the public for compensation.<sup>3</sup> The Company’s business address is 102 Water Plant Road, Middlesboro, KY 40965. The contact person for the Company in this matter is Steven M. Lubertozi, Senior Vice President of Rates, Regulatory and Legislative Affairs at [Steve.Lubertozi@uiwater.com](mailto:Steve.Lubertozi@uiwater.com).

3. WSKC is an investor-owned utility pursuant to KRS 278.010, does business as a regulated water utility in Kentucky, and is subject to the regulatory oversight of this

---

<sup>3</sup> A certified copy of the Company’s articles of incorporation was filed in Case No. 2002- 00142. WSKC was incorporated in Kentucky on April 12, 2002. A copy of a recent Certificate of Authorization is attached as Appendix L, and the Company attests that it is a corporation in good standing in Kentucky.

Commission. The Company presently serves approximately 6,150 water customers in Bell and Hickman Counties in Kentucky.

4. Corix US is a corporation incorporated under the laws of Delaware.<sup>4</sup> Corix US is owned by Corix Infrastructure Inc. (“CII”).<sup>5</sup> CII, through its operating subsidiaries, owns and operates approximately 385 water, 310 wastewater, two electricity distribution, one propane, three geothermal, one municipal, and three natural gas distribution systems in the United States and Canada. CII’s water and wastewater utilities and related businesses<sup>6</sup> serve over 800,000 people in 18 U.S. states and two Canadian provinces.

5. Corix US indirectly owns 100% of WSCK.

### SWMAC

6. SWMAC is a Delaware corporation.<sup>7</sup> It owns 100% of SouthWest Water Company (“SouthWest”). SWMAC, through its operating subsidiaries, owns and operates 18 water and wastewater utility companies in the United States. SWMAC’s water and wastewater utilities provide service to over 500,000 people in seven U.S. states.<sup>8</sup> SWMAC is owned by IIF Subway Investment LP (“IIF Subway”) and Bazos CIV, L.P.<sup>9</sup>

---

<sup>4</sup> Corix US attests that it is in good standing as shown by the Certificate of Good Standing from Delaware’s Secretary of State that is attached to this Application as Appendix N. Corix US is not authorized to transact business in Kentucky

<sup>5</sup> British Columbia Investment Management Corporation indirectly controls CII.

<sup>6</sup> CII’s related businesses include the electric, natural gas, and propane distribution, geothermal energy delivery and municipal service operations of CII related to its U.S. and Canadian water and wastewater operations. This Application refers to these CII business activities as the related businesses.

<sup>7</sup> SWMAC attests that it is in good standing as shown by the Certificate of Good Standing from Delaware’s Secretary of State that is attached to this Application as Appendix M. SWMAC does not conduct business in Kentucky and, therefore, is not authorized to transact business in Kentucky.

<sup>8</sup> Alabama, California, Florida, Louisiana, Oregon, South Carolina, and Texas.

<sup>9</sup> IIF Subway is indirectly owned by IIF US Holding 2 LP, and Bazos CIV, L.P. is indirectly owned by the German reinsurer, Munich RE (Münchener Rückversicherungs-Gesellschaft Aktiengesellschaft in München).

Intermediate Newco

7. As part of the business combination, Corix US will organize Intermediate Newco under the laws of Delaware (“Intermediate Newco”).

8. As explained in more detail in paragraph 14 below, Intermediate Newco will be a holding company that will acquire indirect control of WSCK.

Counsel for Joint Applicants

9. The attorneys for WSCK and Corix US, upon whom all pleadings and notices should be served, is:

STURGILL, TURNER, BARKER, AND MOLONEY, PLLC  
M. Todd Osterloh  
James W. Gardner  
Rebecca C. Price  
333 W. Vine Street, Suite 1500  
Lexington, Kentucky 40507  
Telephone No.: (859) 255-8581  
Fax No.: (859) 231-0851  
Tosterloh@sturgillturner.com  
jgardner@sturgillturner.com  
rprice@sturgillturner.com

10. The attorney for SWMAC, upon whom all pleadings and notices should be served, is:

TAFT STETTINIUS & HOLLISTER LLP  
Valerie T. Herring  
2200 IDS Center  
80 South 8th Street  
Minneapolis, Minnesota 55402-2157  
Telephone No.: 612.977.8400  
Fax No.: 612.977.8650  
VHerring@Taftlaw.com

## **Contents of the Application**

11. The contents of this Application are organized as follows:
- Appendix A – Summary of Proposed Transaction with Simplified Pre- and Post-Closing Organizational Charts
  - Appendix B – Transaction Agreement<sup>10</sup>
  - Appendix C – Direct Testimony of Steven M. Lubertozi
  - Appendix D – Direct Testimony of Brian Bahr
  - Appendix E – Direct Testimony of Justin Kersey
  - Appendix F – Direct Testimony of Ellen Lapson, Lapson Advisory
  - Appendix G – Recent Financial Statements for SWMAC
  - Appendix H – Recent Financial Statements for WSCK
  - Appendix I – Recent Financial Statements for Corix US
  - Appendix J – SWMAC Corporate Resolution Authorizing the Proposed Transaction
  - Appendix K – Corix US Corporate Resolution Authorizing the Proposed Transaction
  - Appendix L – WSCK Certificate of Good Standing
  - Appendix M - SWMAC Certificate of Good Standing
  - Appendix N – Corix US Certificate of Good Standing

---

<sup>10</sup> Exhibit A and Appendix I to Exhibit D of the Transaction Agreement, which contain confidential information, are not included with the Transaction Agreement filed with the Application. Unredacted versions and redacted public versions will be provided upon request in accordance with the Commission's rules regarding confidential documents.

## **Proposed Transaction**

12. On August 26, 2022, CII and Corix US (the “Corix Parties”) entered into a transaction agreement (“Transaction Agreement”) with IIF Subway, SWMAC, and SouthWest (the “SouthWest Parties”). The Transaction Agreement provides a framework for combining CII’s water, wastewater, and related businesses, with the water and wastewater businesses owned by SWMAC. When the transactions contemplated by the Transaction Agreement are completed, CII and an affiliate or affiliates of CII will own 50% of Corix US and SWMAC Holdco, an entity that will be formed by SWMAC’s shareholders before closing, will own the other 50% of Corix US (the “Proposed Transaction”). Corix US, in turn, will indirectly own and control all the CII water, wastewater and related businesses and the SWMAC water and wastewater businesses. To prepare for the Proposed Transaction, both the Corix Parties and the SouthWest Parties will undertake pre-closing restructuring transactions. The pre-closing restructuring transactions are described in Appendix A.

13. After the Corix Parties and the SouthWest Parties complete the pre-closing restructuring transactions, SWMAC will merge with and into Corix US, with Corix US being the surviving entity. As a result of this step, SWMAC Holdco will acquire 50% of Corix US’s stock, Corix US will acquire the outstanding stock of SouthWest currently owned by SWMAC, and Corix US will continue to indirectly own WSCK.

14. Corix US then will transfer all of the outstanding equity of SouthWest and certain Corix US entities to Intermediate Newco.<sup>11</sup> In exchange for this contribution of

---

<sup>11</sup> Corix US will transfer all of Inland Pacific Resource Inc.’s stock and all of Corix Utility Systems (Georgia) Inc.’s stock to Intermediate Newco.

stock, Intermediate Newco will issue stock to Corix US and assume all of Corix US's third-party debt, with Intermediate Newco being a wholly owned subsidiary of Corix US.

15. Thus, upon consummation of the Proposed Transaction: (a) CII and an affiliate or affiliates of CII will own 50% of Corix US's stock; and (b) SWMAC Holdco will own the remaining 50% of Corix US's stock. Corix US will own all of the stock of Intermediate Newco, and Intermediate Newco will indirectly own all of the utility operating subsidiaries comprising the CII water, wastewater and related businesses, as well as the SWMAC water and wastewater businesses, completing the merger of equals. Appendix B is a copy of the confidential Transaction Agreement.

16. As Appendix A shows, the proposed combination takes place well above the utility operating company level. For clarity, the proposed business combination does not involve the transfer of WSCK's stock or their assets. Nor will the stock or assets of WSCK be pledged or encumbered as a result of the Proposed Transaction.

17. Intermediate Newco will be headquartered in Sugar Land, Texas, and CII's current office in Chicago, Illinois will serve as the hub of Intermediate Newco's shared service operations. WSCK will maintain offices and facilities consistent with its obligation to serve customers and will intends to maintain a local presence in Kentucky.

18. Justin Kersey will become President of WSCK after closing. The Chief Executive Officer of the combined company will be Rob MacLean, the current CEO of SWMAC and SouthWest.

19. As of closing, the combined company will be governed by a board of nine directors: the combined company's CEO, four shareholder representatives, and four independent directors, one of whom will be the chair.



20. The Transaction Agreement requires certain conditions to be satisfied in order to close the Proposed Transaction. These conditions include, but are not limited to, obtaining all applicable government approvals and consents. Based on the various closing conditions, the final closing is anticipated to occur in late 2023.

### **Applicable Law and Relevant Precedent**

21. KRS 278.040 provides the Commission with exclusive jurisdiction to regulate the rates and services of a utility. KRS 278.010 defines terms used in Chapter 278; based on these definitions, the Company is a “utility” and Corix US and SWMAC are “persons.”

22. KRS 278.020 requires Commission approval when a person acquires ownership or control of a utility. Specifically, subsections (6) and (7) state as follows:

(6) No person shall acquire or transfer ownership of, or control, or the right to control, any utility under the jurisdiction of the commission by sale of assets, transfer of stock, or otherwise, or abandon the same, without prior approval by the commission. The commission shall grant its approval if the person acquiring the utility has the financial, technical, and managerial abilities to provide reasonable service.

(7) No individual, group, syndicate, general or limited partnership, association, corporation, joint stock company, trust, or other entity (an “acquirer”), whether or not organized under the laws of this state, shall acquire control, either directly or indirectly, of any utility furnishing utility service in this state, without having first obtained the approval of the commission. . . . The commission shall approve any proposed acquisition when it finds that the same is to be made in accordance with law, for a proper purpose and is consistent with the public interest. . . .

23. Accordingly, the Commission should approve the Proposed Transaction so long as the Joint Applicants demonstrate that the combined company has the “financial, technical, and managerial abilities to provide reasonable service” and the Proposed

Transaction is “in accordance with law, for a proper purpose, and is consistent with the public interest.”

24. In regard to the “public interest” standard identified in KRS 278.020(7), the Commission has described the standard as follows:

[A]ny party seeking approval of a transfer of control must show that the proposed transfer will not adversely affect the existing level of utility service or rates or that any potentially adverse effects can be avoided through the Commission’s imposition of reasonable conditions on the acquiring party. The acquiring party should also demonstrate that the proposed transfer is likely to benefit the public through improved service quality, enhanced service reliability, the availability of additional services, lower rates, or a reduction in utility expenses to provide present services. Such benefits, however, need not be immediate or readily quantifiable.<sup>12</sup>

25. As the Commission has indicated, in certain cases, applicants may be able to provide the Commission with “immediate or readily quantifiable” public benefits. However, as the Commission has recognized, “most transfers of control that are presented to this Commission would be unable to meet this standard.”<sup>13</sup> Consistent with the 2002 *Kentucky-American Water* rehearing order, the Commission should approve an acquisition even if the applicants cannot demonstrate an immediate net benefit to customers.<sup>14</sup> In the present case, the Company’s customers will recognize the benefits of the Proposed Transaction over time.

**Joint Applicants have the Financial, Technical and Managerial Ability to Continue to Provide Reasonable Service**

---

<sup>12</sup> *Kentucky-American Water*, Case No. 2002-00018 at 9 (Ky. PSC July 10, 2002) (Rehearing Order) (quoting Initial Order dated May 30, 2002); see also *Application of DLR Enterprises, Inc. And Cow Creek Gas, Inc. for Approval of the Transfer of Certain Assets Formerly Owned and Controlled by Sigma Gas Corporation*, Case No. 2007-00419 at 6 (Ky. PSC Nov. 21, 2007) (“The Commission has previously held that a transfer is in the ‘public interest’ if it does not adversely affect the existing level of utility service or rates or that any potentially adverse effects can be avoided through the Commission’s imposition of reasonable conditions on the acquiring party.”).

<sup>13</sup> *Kentucky-American Water Co.*, Rehearing Order, Case No. 2002-00018 at 10.

<sup>14</sup> *Id.*

26. CII and SWMAC – separately and combined – have the financial, technical, and managerial expertise to own and operate water and wastewater utilities in the Commonwealth. CII provides water, wastewater and related utility and municipal services to approximately 800,000 people in 18 U.S. states,<sup>15</sup> including Kentucky, and two Canadian provinces.<sup>16</sup> CII’s subsidiaries employ approximately 800 people in the water, wastewater and related businesses who operate 385 water, 310 wastewater, two electricity distribution, one propane, three geothermal, one municipal, and three natural gas distribution systems in the United States and Canada. Similarly, SWMAC’s operating subsidiaries provide water and wastewater utility services to approximately 500,000 people in seven U.S. states – Alabama, California, Florida, Louisiana, Oregon, South Carolina, and Texas. SWMAC’s subsidiaries have approximately 500 employees operating approximately 170 water systems and 50 wastewater systems across those seven states. The combined company will have more than 1,300 employees serving more than 1.3 million people across 20 U.S. states and two Canadian provinces.

The Proposed Transaction will provide the relevant employees with access to additional experiences and resources, which will benefit WSCK’s customers. The increased scale and enhanced financial foundation of the combined company will improve WSCK’s ability to make significant, long-term investments required to continue providing quality water services to the local communities served by WSCK. The combined company’s investments in water infrastructure improvements will ensure best-in-class service and high-quality water that is safe, reliable, sustainable and affordable.

---

<sup>15</sup> Alabama, Alaska, Arizona, Florida, Georgia, Illinois, Indiana, Kentucky, Louisiana, Maryland, Nevada, New Jersey, North Carolina, Pennsylvania, South Carolina, Tennessee, Texas, and Virginia.

<sup>16</sup> Alberta and British Columbia.

### **The Proposed Transaction is in Accordance with Law and for a Proper Purpose**

27. The Proposed Transaction will be in accordance with law because, as explained in the Joint Applicants' Direct Testimony, the Proposed Transaction will only be consummated once all requisite regulatory approvals are obtained and, as described in this Application and accompanying Appendices, the Proposed Transaction will meet the requirements of KRS 278.020.

28. The Proposed Transaction is for a proper purpose because it is intended to be a merger of equals that will benefit those entities, as well as their operating utilities, which will ensure the Company's customers will continue to receive safe, reliable drinking water.

29. Further, the Proposed Transaction is for a proper purpose because the Joint Applicants share a mission to help people enjoy a better life and to help communities thrive. Their shared vision is to be the preferred utility delivering solutions that customers want. The Joint Applicants also share common values centered on safety, environmental stewardship, integrity, employee empowerment, and excellence in how they serve their customers and communities and deliver on their commitments. As the Joint Applicants have expanded their respective businesses over the years, their commitment to customers and the communities they serve has remained unchanged. That commitment continues today and will continue into the future.

### **The Proposed Transaction is Consistent with the Public Interest**

30. As outlined below and discussed in greater detail in testimony, the Proposed Transaction will result in the combination of two strong water and wastewater utility holding companies that both possess financial, technical, and managerial expertise

in the water and wastewater industries while also having a shared mission and values. The Proposed Transaction is highly complementary and allows for sharing of prudent practices to support the creation of larger, stronger water and wastewater companies. The Proposed Transaction satisfies the standard of approval that has been articulated and applied by the Commission: the Proposed Transaction will (1) produce benefits arising from the advantages of a larger, more diversified company, (2) improve WSCK's access to capital needed to support further investment in facilities and systems that would improve service to Kentucky customers; (3) generate operational benefits to customers, (4) provide additional benefits over time, (5) retain the strong corporate citizenship and presence of WSCK in Kentucky, and (6) support effective state regulation. Accordingly, the Proposed Transaction is consistent with the public interest and should be approved for, among others, the following reasons.

a) Shared Mission and Values. The Joint Applicants share a mission to help people enjoy a better life and to help communities thrive. Their shared vision is to be the preferred utility delivering solutions that customers want. The Joint Applicants also share common values centered on safety, environmental stewardship, integrity, employee empowerment and excellence in how they serve their customers and communities and deliver on their commitments. As the Joint Applicants have expanded their respective businesses over the years, their commitment to customers and the communities they serve has remained unchanged. That commitment continues today and will continue into the future.

b) Continued Local Presence. Consistent with their shared mission and values, the Joint Applicants believe in local governance and community presence.

Just as WSCK today utilizes local employees and facilities to deliver water utility service to their customers, after the Proposed Transaction closes, WSCK will continue to rely on these employees and facilities to provide service to their customers. After the Proposed Transaction is completed, WSCK will continue to actively support and maintain a presence in the communities it serves. In addition, Corix US and SWMAC have committed to refrain from any involuntary reductions in force related to the combination for 12 months after the Proposed Transaction closes. This commitment to ensuring continuity of service and support for its employees recognizes WSCK's value as a steward of a precious resource in the communities it serves.

c) Financial, Technical, and Managerial Expertise. As described above, the Joint Applicants – separately and combined – have the financial, technical, and managerial expertise to own and operate WSCK. This further supports the fact that the Proposed Transaction is consistent with the public interest.

d) Benefits to Customers. As noted above, the combined company's financial resources, increased scale, and enhanced financial foundation will benefit customers in Kentucky by enabling significant, long-term investments needed to continue providing best-in-class water services. These investments, together with the sharing of prudent practices and operating expertise of both companies, will benefit customers through the continued safe, reliable, and sustainable delivery of critical water services and high-quality customer service. The combination will create a more diverse group of employees with more collective knowledge and

expertise in providing quality water services, which will be shared throughout the combined company, including the employees assigned to Kentucky.

In addition, the combination is expected to produce financial benefits, such as reductions in costs of board governance, senior executives, and audits, which will benefit customers. The combination also is expected to produce longer term financial benefits as the integration of CII's and SWMAC's water and wastewater businesses occurs methodically and systematically over time.

e) Impact on Rates. The combination will have no immediate impact on WSCK's rates. As mentioned above, as financial benefits from the combination are achieved over time, the Joint Applicants believe that the combination may lead to lower costs and thereby help WSCK keep its water utility rates lower than they otherwise would have been without the combination. In short, customers will realize the benefits of the Proposed Transaction over time when the combined company's cost structure is reflected in WSCK's revenue requirement.

f) Impact on Commission Regulation of WSCK. The combination will have no impact on the Commission's continuing regulation of WSCK as a regulated water utility in Kentucky. WSCK will remain a public utility subject to regulation by the Commission pursuant to the Kentucky Public Utility Act and the Commission's regulations.

31. As explained in this Application, and in the Direct Testimony attached hereto, the Proposed Transaction is consistent with the public interest. The Proposed Transaction offers numerous benefits to WSCK and its customers. In addition, it presents no adverse impacts to WSCK, its customers, its employees or the Commonwealth of

Kentucky. The Joint Applicants expect that the combined expertise of Corix US and SWMAC will better serve WSCK, its customers, and the Commonwealth of Kentucky and improve the safety, reliability, and quality of WSCK's service. While the Proposed Transaction is not driven by net financial synergies, the Joint Applicants anticipate that the business combination will improve efficiency and the integration of various functions, which may result in cost savings that accrue over time, net of costs to achieve such savings. The Joint Applicants acknowledge that costs and benefits associated with integration will be addressed in future ratemaking proceedings.

32. The Joint Applicants make the following commitments (the "Customer Protection Commitments"), which further support that the Proposed Transaction is consistent with the public interest:

- a) WSCK will continue to provide high-quality water utility service to WSCK's customers.
- b) WSCK will continue to maintain a strong local presence in Kentucky in terms of employees, facilities and offices, and community support.
- c) The Joint Applicants have incurred and will incur transaction costs. The Joint Applicants will not seek to recover transaction costs from customers.
- d) While the Proposed Transaction is not driven by net financial synergies, the Joint Applicants anticipate that the business combination will improve efficiency and the integration of administrative and general functions should result in cost savings. The integration of CII's water, wastewater, and related businesses with SWMAC's water and wastewater business will be a significant, prolonged



undertaking. The Joint Applicants acknowledge that costs and benefits associated with integration will be addressed in future ratemaking proceedings.

e) Without the Commission's prior approval, WSCK will not guarantee any debt or credit instrument of Intermediate Newco or any affiliate of WSCK unless such debt is incurred for the specific purpose of WSCK's system or operations.

f) The proceeds of any debt incurred by WSCK will only be used for purposes specific to WSCK's system or operations.

g) Unless it first obtains the Commission's approval, WSCK will not transfer any material asset to Intermediate Newco or an affiliate except in an arm's length transaction and in compliance with the laws of the Commonwealth of Kentucky.

h) The combined business will be established with a target investment grade capital structure profile and operated in a way that is consistent with maintaining an investment grade profile.

i) The combined company will refrain from any involuntary reductions in force related to the combination for the first 12 months after the Proposed Transaction closes.

j) WSCK will present any new affiliated interest and/or shared services agreements to the Commission for approval pursuant to the Commission's rules.

### **Post-Closing Integration Plans**

33. In order to achieve an efficient and productive integration of CII's water, wastewater, and related businesses with SWMAC's water and wastewater businesses and maximize the longer-term benefits for customers the combined company plans to methodically and systematically address integration opportunities. This will include in-

depth analyses of integration benefits and costs, and development and implementation of plans for integrating systems, operations, processes, and resources.

34. Although CII and SWMAC do not expect significant net financial synergies to result from the proposed combination, the companies do expect, over time, to be able to identify and achieve cost savings as a result of future integration. The integration of CII's water, wastewater and related businesses with SWMAC's water and wastewater businesses will be a significant undertaking and such savings will occur over time as a result of the combination and the integration of various functions. However, as noted above, there will be costs associated with integrating certain functions and activities. Customers will receive the benefits of these efforts, net of integration costs, in future rate proceedings.

35. Until WSCK enters into a new affiliate interest agreement after closing, WSCK will continue to use its existing affiliate interest agreement to allocate corporate shared services costs. When WSCK enters into a new affiliate interest agreement, the agreement will be presented to the Commission for its approval if a deviation is necessitated by KRS 278.2207.

#### **Commitments to the Commission and Stakeholders**

36. Consistent with their shared mission and values, the Joint Applicants make the Customer Protection Commitments described above to the Commission and stakeholders.

WHEREUPON the Joint Applicants hereby request that the Commission find that the Joint Applicants have the financial, technical, and managerial abilities to continue to provide reasonable service and that the Proposed Transaction is in accordance with law, for a proper purpose, and is consistent with the public interest and:

- (1) Pursuant to KRS 278.020(6) and (7), approve the Proposed Transaction that effectuates an indirect transfer of control of WSCK; and
- (2) Grant such other relief as may be appropriate and necessary to allow the Joint Applicants to consummate the Proposed Transaction.

Respectfully submitted this 23rd day of November, 2022.

**Respectfully Submitted,**

STURGILL, TURNER, BARKER, AND  
MOLONEY, PLLC

/s/ M. Todd Osterloh  
M. Todd Osterloh  
James W. Gardner  
Rebecca C. Price  
333 W. Vine Street, Suite 1500  
Lexington, Kentucky 40507  
Telephone No.: (859) 255-8581  
Fax No.: (859) 231-0851  
tosterloh@sturgillturner.com  
jgardner@sturgillturner.com  
rprice@sturgillturner.com  
*Attorneys for Water Service  
Corporation of Kentucky and Corix  
Infrastructure (US) Inc.*

TAFT STETTINIUS &  
HOLLISTER LLP

/s/ Valerie T. Herring  
Valerie T. Herring  
2200 IDS Center  
80 South 8th Street  
Minneapolis, Minnesota 55402  
2157 Telephone No.:  
612.977.8400  
Fax No.: 612.977.8650  
VHerring@Taftlaw.com  
*Attorney for SW Merger  
Acquisition Corp*





## The Transaction

### A. Overview

On August 26, 2022, Corix Infrastructure Inc. (“CII”), Corix Infrastructure (US) Inc. (“Corix US”), IIF Subway Investment LP (“IIF Subway”), SW Merger Acquisition Corp. (“SWMAC”) and SouthWest Water Company (“SouthWest”) entered into a transaction agreement (the “Transaction Agreement”). The Transaction Agreement provides a framework for combining CII’s water, wastewater, and related businesses, with the water and wastewater businesses owned by SWMAC. When CII and Corix US (the “Corix Parties”) and IIF Subway, SWMAC and Southwest (the “SouthWest Parties”) complete the transactions contemplated by the Transaction Agreement, CII (and an affiliate or affiliates) will own 50% of Corix US and SWMAC Holdco, an affiliate of IIF Subway will own 50% of Corix US. Corix US, in turn, will indirectly own and control all the CII water, wastewater, and related businesses,<sup>1</sup> as well as the SWMAC water and wastewater businesses. To prepare for the transaction, both the Corix Parties and the SouthWest Parties will undertake pre-closing restructuring transactions.

### B. CII Pre-closing Restructuring

The CII pre-closing restructuring has two objectives. First, the pre-closing restructuring separates CII’s district energy business from the CII water, wastewater, and related businesses.<sup>2</sup> Second, the pre-closing restructuring results in the inclusion of the Canadian water, wastewater, and related businesses of CII in the deal perimeter, by making Corix Utilities Inc. and Corix Multi-Utility Services Inc. (both of which own water and wastewater assets or are parties to water and wastewater operation and maintenance contracts), West Shore Environmental Services (GP) Inc. and West Shore Environmental Services Limited Partnership (which provides wastewater services pursuant to a contract with the City of Langford), and Corix Utilities (Foothills Water) Inc. and Corix Utilities (Foothills Wastewater) Inc. indirect, wholly-owned subsidiaries of Corix US. This element of the pre-closing restructuring results in a direct change in control of certain of the Canadian water and wastewater utilities.<sup>3</sup> Together, these steps allow the parties to combine their respective water and wastewater businesses to create a platform company focused almost exclusively on the delivery of water and wastewater services to customers.

### C. SWMAC Pre-closing Restructuring

Before the business combination occurs, SWMAC’s shareholders will form a new holding company, SWMAC Holdco. SWMAC’s shareholders will contribute certain assets, including all of SWMAC’s stock, to

---

<sup>1</sup> CII’s related businesses include the electric, natural gas, and propane distribution, geothermal energy delivery and municipal service operations of CII related to its U.S. and Canadian water and wastewater operations.

<sup>2</sup> This multi-step pre-closing reorganization involves, among other things, the direct or indirect transfer of district energy assets, contracts and liabilities to a new entity or entities indirectly controlled by British Columbia Investment Management Corporation. The district energy business includes CII’s investment in Doyon Utilities, LLC and Entegrus Inc.

<sup>3</sup> This part of the pre-closing reorganization involves the formation of a new US holding company (“Intermediate Newco”), a new Canadian corporation (“Canadian Water MidCo”), the conversion of certain entities into unlimited liability companies, and the contribution of Canadian Water MidCo’s equity interests to Intermediate Newco. Corix Utilities Inc., West Shore Environmental Services (GP) Inc., and West Shore Environmental Services Limited Partnership will become wholly owned subsidiaries of Canadian Water MidCo. These steps result in the Canadian water and wastewater utilities becoming indirect, wholly owned subsidiaries of Corix US.

SWMAC Holdco, in exchange for limited partnership interests in SWMAC Holdco. This step will facilitate the contribution of SWMAC's stock to Corix US (in exchange for the issuance of Corix US stock, as described below) and the merger of SWMAC with and into Corix US.

#### D. The Business Combination

The combination of CII's water, wastewater, and related businesses with SouthWest's water and wastewater business will occur through a series of steps. After the completion of the pre-closing restructurings detailed above, all of the outstanding stock of SWMAC will be contributed to Corix US in exchange for stock issued by Corix US ("Step 1"). Step 1 will result in SWMAC Holdco obtaining a 50% interest in Corix US **and** Corix US obtaining indirect control of SouthWest and its operating subsidiaries because SWMAC will be a subsidiary of Corix US.

After Step 1 is completed, SWMAC will merge with and into Corix US ("Step 2"). Corix US will survive the merger. As a result of Step 2, Corix US will directly own all of the outstanding stock of SouthWest, and will continue to directly own the shares of Inland Pacific Resources Inc. ("Inland Pacific") and its subsidiaries. Inland Pacific indirectly owns Corix Regulated Utilities (US) Inc. (f/k/a Utilities, Inc.) which in turn owns regulated water and wastewater utilities that provide services to customers within 17 of the contiguous United States. Inland Pacific also owns Fairbanks Sewer and Water Inc.

After Step 2 is completed, Corix US will transfer all of the outstanding equity of SouthWest and Inland Pacific to Intermediate Newco. ("Step 3"). In exchange for this contribution of stock, Intermediate Newco will issue to Corix US common stock of Intermediate Newco and assume all of Corix US's third-party debt. Step 3 is the last step in the transactions contemplated by the Transaction Agreement. As a result of Step 3, Intermediate Newco will directly control SouthWest and Inland Pacific. After these steps are completed, CII and an affiliate or affiliates will own 50% of Corix US's stock, on the one hand, and SWMAC Holdco will own the remaining 50% of Corix US's stock. Corix US will own all of the stock of Intermediate Newco, and Intermediate Newco will indirectly own all of the utility operating subsidiaries comprising the CII and SWMAC water, wastewater, and related businesses, completing the "merger of equals."

## Corix Simplified Current

---

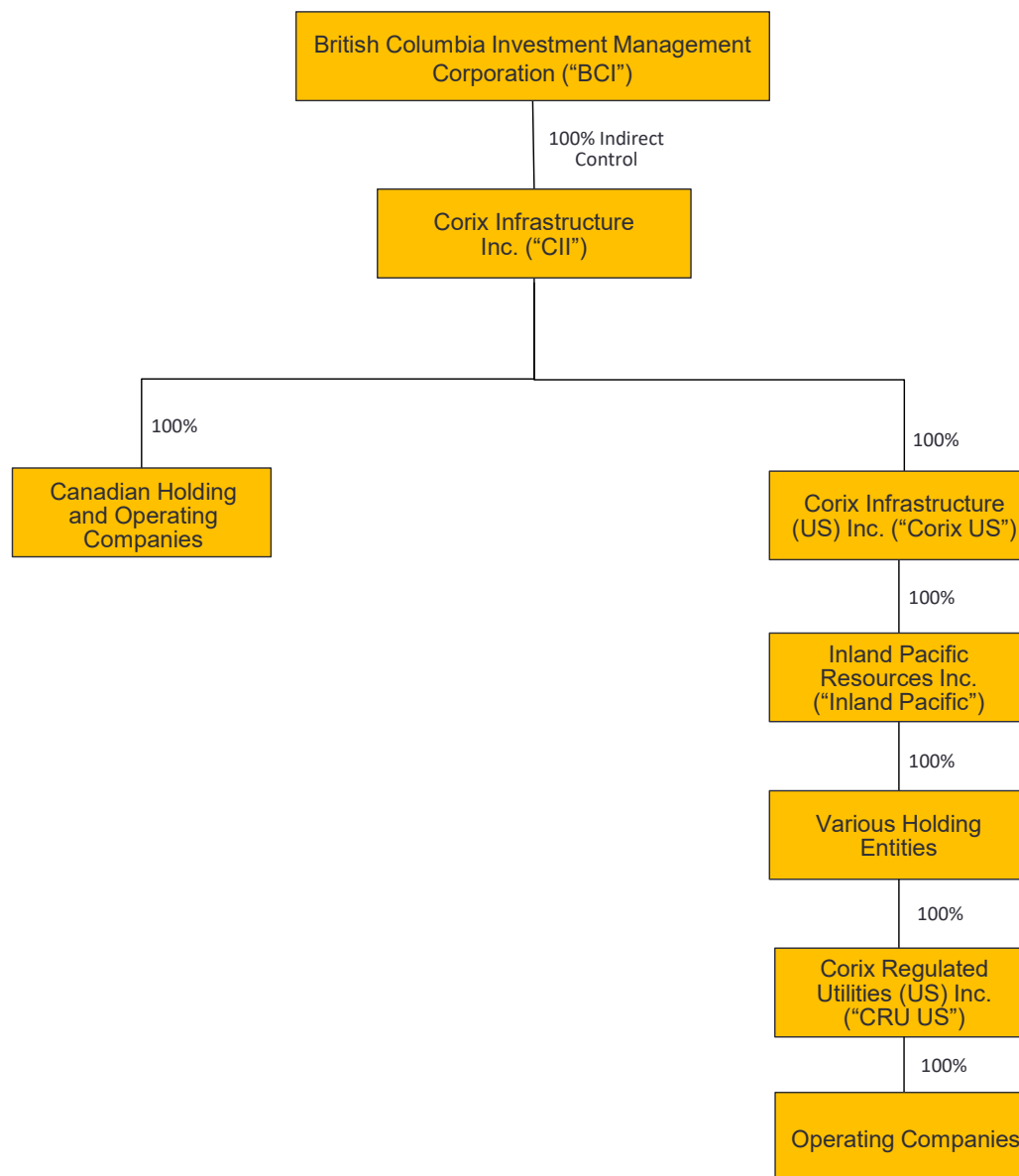



## SWMAC Simplified Current

---

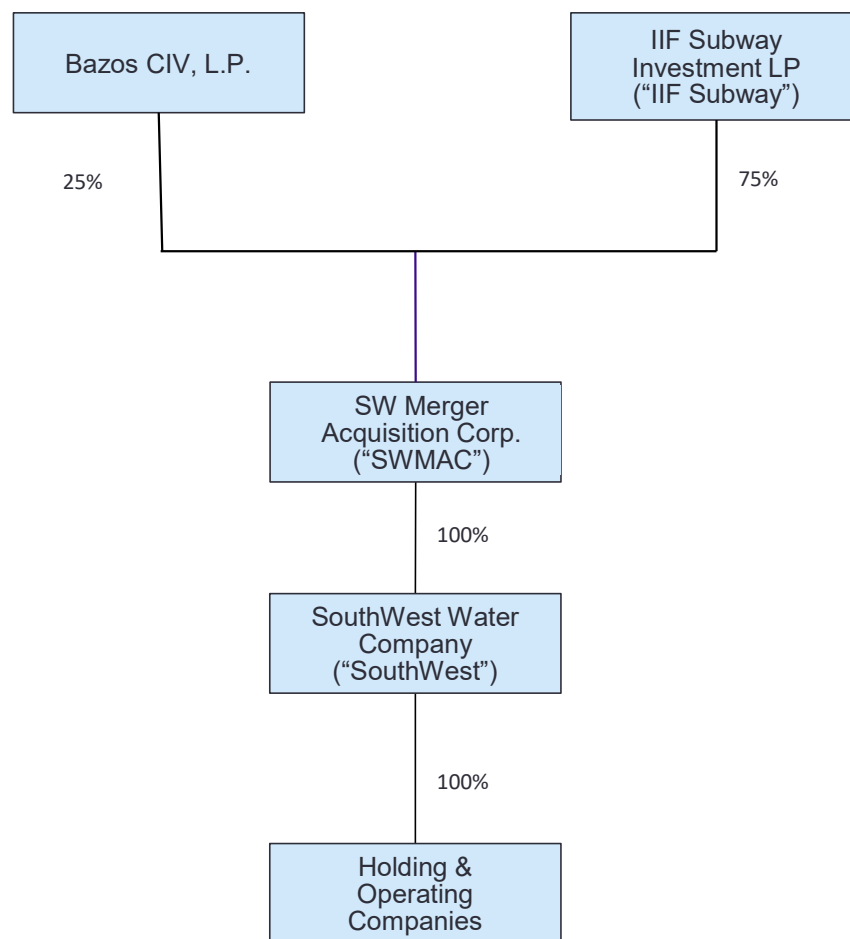

## Corix Simplified Pre-Closing, Post-Restructuring

---

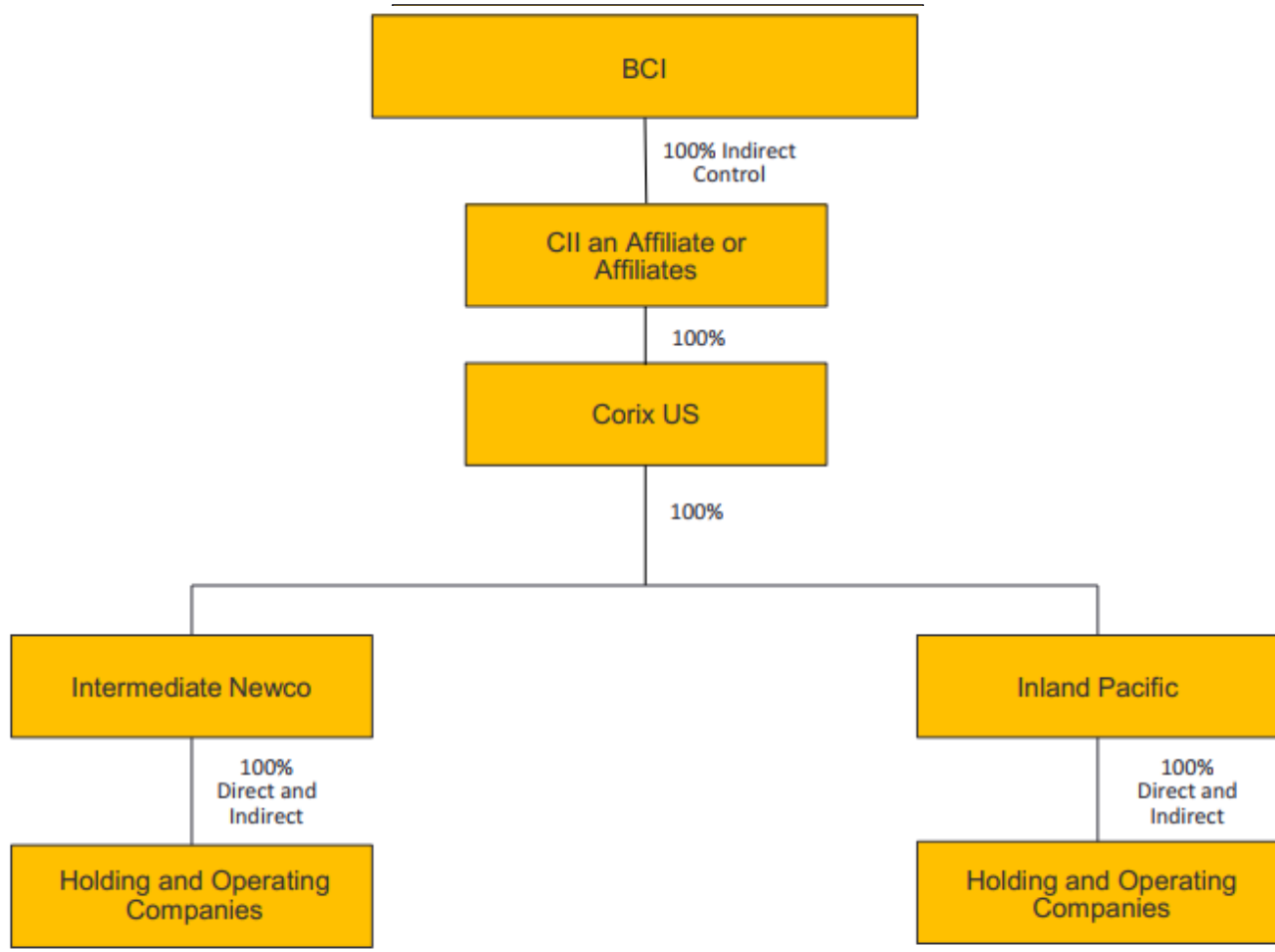

## SWMAC Simplified Pre-Closing, Post-Reorganization

---

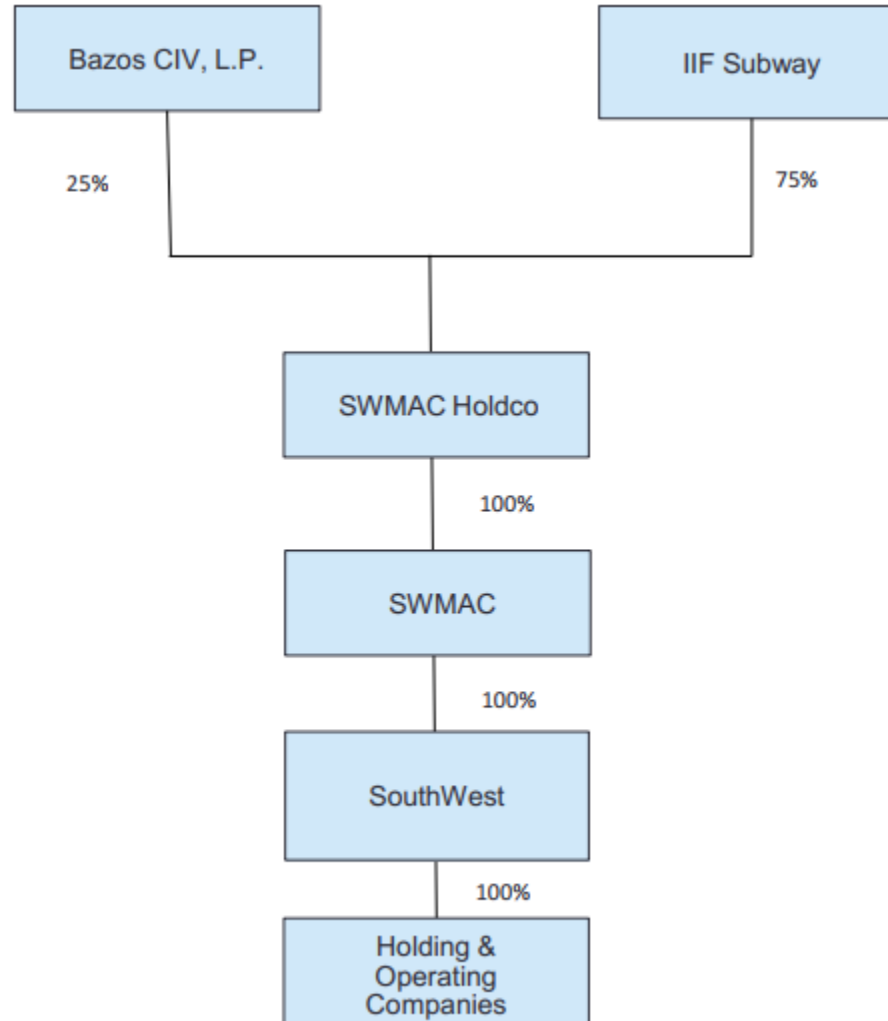

## Combined Company – Simplified Post-Closing

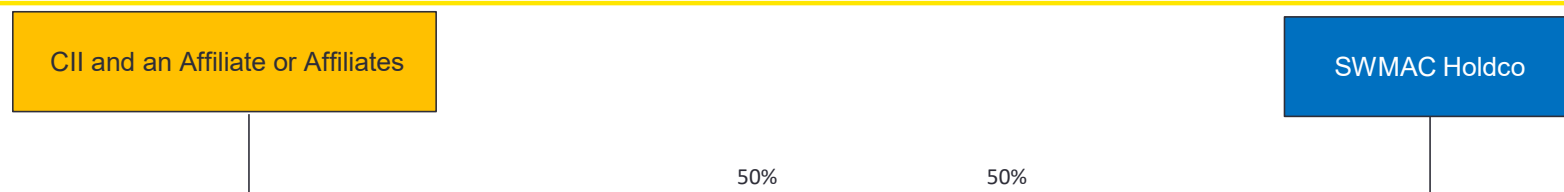

- ▶ **Step 1:** CII and SouthWest complete pre-closing restructuring transactions
- ▶ **Step 2:** SWMAC merges with and into Corix US, and Corix US survives
- ▶ **Step 3:** Corix US contributes the stock of Inland Pacific Resources Inc. and SouthWest to Intermediate Newco, Intermediate Newco assumes Corix US third-party debt and issues stock to Corix US

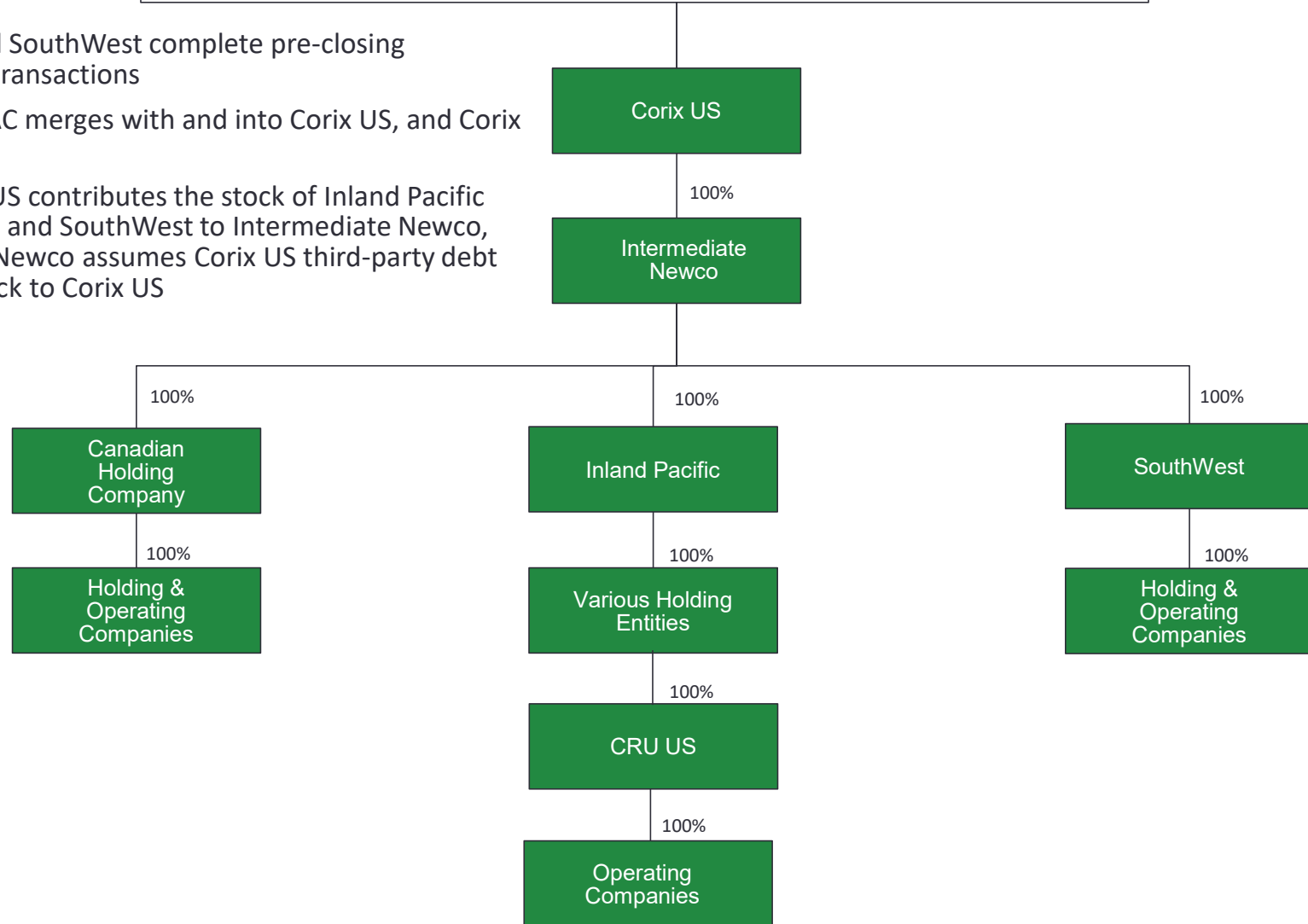

## Corix Simplified Post-Closing

---

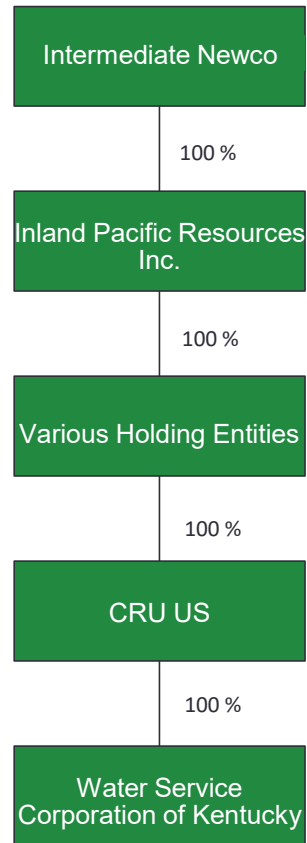

EXECUTION VERSION

TRANSACTION AGREEMENT

dated as of August 26, 2022,

among

CORIX INFRASTRUCTURE INC.,

CORIX INFRASTRUCTURE (US) INC.,

IIF SUBWAY INVESTMENT L.P.,

SW MERGER ACQUISITION CORP.

and

SOUTHWEST WATER COMPANY

---

TABLE OF CONTENTS

Page

ARTICLE I

THE BUSINESS COMBINATION AND RELATED RESTRUCTURING MATTERS

1.1 Restructuring Matters and Business Combination.....4

ARTICLE II

CLOSING; EQUITY BALANCING PAYMENT

2.1 Closing .....5  
2.2 Calculation of SHL Balancing Payment .....7  
2.3 Equity Balancing Payment.....7  
2.4 Post-Closing Adjustment of the Equity Balancing Payment .....9  
2.5 Withholding .....13

ARTICLE III

REPRESENTATIONS AND WARRANTIES OF CORIX

3.1 Due Organization and Good Standing .....13  
3.2 Authority; Binding Nature of Agreement .....13  
3.3 No Conflicts; Consents .....14  
3.4 Title .....14  
3.5 Financing.....15  
3.6 Claims; Orders .....15  
3.7 Brokers .....15  
3.8 Anti-Corruption; Anti-Money Laundering; Sanctions.....15  
3.9 No Additional Representations .....17

ARTICLE IV

REPRESENTATIONS AND WARRANTIES ABOUT THE CONTRIBUTED CORIX  
ENTITIES AND THE CORIX WATER BUSINESS

4.1 Organization, Standing and Power .....17  
4.2 Capital Structure .....17  
4.3 Authority; Execution and Delivery; Enforceability .....18  
4.4 No Conflicts; Consents .....18  
4.5 Financial Statements; Undisclosed Liabilities .....19  
4.6 Regulation as a Utility .....20  
4.7 Absence of Certain Changes or Events.....21  
4.8 Taxes .....21  
4.9 Employee Benefits .....25

4.10	Labor and Employment Matters .....	27
4.11	Litigation.....	28
4.12	Compliance with Applicable Laws .....	28
4.13	Permits .....	28
4.14	Water Quality and Water Rights.....	28
4.15	Environmental Matters.....	29
4.16	Contracts .....	30
4.17	Affiliate Transactions.....	32
4.18	Contributed Corix Entities’ Real Properties .....	32
4.19	Intellectual Property; Information Technology; Privacy and Data Security .....	34
4.20	Sufficiency of Assets .....	35
4.21	Insurance .....	35
4.22	Brokers’ Fees and Expenses .....	35
4.23	Anti-Corruption; Anti-Money Laundering; Sanctions.....	35
4.24	No Additional Representations .....	36

ARTICLE V

REPRESENTATIONS AND WARRANTIES OF IIF SUBWAY

5.1	Due Organization and Good Standing .....	37
5.2	Authority; Binding Nature of Agreement.....	37
5.3	No Conflicts; Consents .....	37
5.4	Title .....	38
5.5	Financing.....	38
5.6	Claims; Orders .....	39
5.7	Brokers.....	39
5.8	Anti-Corruption; Anti-Money Laundering; Sanctions.....	39
5.9	No Additional Representations .....	40

ARTICLE VI

REPRESENTATIONS AND WARRANTIES ABOUT SWWC AND SWMAC

6.1	Organization, Standing and Power .....	41
6.2	Capital Structure .....	41
6.3	Authority; Execution and Delivery; Enforceability .....	42
6.4	No Conflicts; Consents .....	42
6.5	Financial Statements; Undisclosed Liabilities .....	43
6.6	Regulation as a Utility .....	44
6.7	Absence of Certain Changes or Events.....	44
6.8	Taxes .....	45
6.9	Employee Benefits .....	48
6.10	Labor and Employment Matters .....	49
6.11	Litigation.....	50
6.12	Compliance with Applicable Laws .....	50
6.13	Permits .....	51



6.14	Water Quality and Water Rights.....	51
6.15	Environmental Matters.....	51
6.16	Contracts.....	52
6.17	Affiliate Transactions.....	54
6.18	SWWC Real Properties.....	54
6.19	Intellectual Property; Information Technology; Privacy and Data Security .....	56
6.20	Sufficiency of Assets .....	57
6.21	Insurance.....	57
6.22	Brokers' Fees and Expenses .....	57
6.23	Anti-Corruption; Anti-Money Laundering; Sanctions.....	57
6.24	No Other Activities.....	58
6.25	No Additional Representations.....	59

## ARTICLE VII

### COVENANTS

7.1	Conduct of Business .....	59
7.2	Required Actions .....	66
7.3	Access to Information; Confidentiality.....	69
7.4	Public Disclosures.....	71
7.5	Indemnification of Officers and Directors .....	71
7.6	CIUS Shareholders Agreement.....	72
7.7	Transition Services Agreement.....	72
7.8	Corix Restructuring.....	72
7.9	Misallocated Assets .....	74
7.10	Exclusive Dealing .....	75
7.11	Transition from Corix Marks .....	75
7.12	Employee Matters. ....	76
7.13	Section 280G.....	78

## ARTICLE VIII

### CONDITIONS PRECEDENT

8.1	Conditions to Each Party's Obligation to Effect the Business Combination.....	79
8.2	Conditions to Obligations of the Corix Parties .....	79
8.3	Conditions to Obligations of the SWWC Parties.....	81
8.4	Frustration of Closing Conditions.....	82

## ARTICLE IX

### TAX MATTERS

9.1	Allocation of Taxes and Indemnification. ....	82
9.2	Tax Returns and Refunds.....	86
9.3	Transfer Taxes .....	90

9.4	Tax Sharing Agreements.....	91
9.5	Characterization of Indemnification Payments.....	91
9.6	Resolution of All Tax Related Disputes .....	91
9.7	Cooperation, Exchange of Information and Record Retention.....	92
9.8	Survival of Tax Provisions.....	92
9.9	Tax Characterization of Business Combination. ....	93
9.10	BAPA.....	93
9.11	Reportable Transactions and Notifiable Transactions .....	93
9.12	Exclusivity .....	94

ARTICLE X

TERMINATION, AMENDMENT AND WAIVER

10.1	Termination.....	94
10.2	Effect of Termination.....	95
10.3	Amendment.....	96
10.4	Extension; Waiver.....	96

ARTICLE XI

INDEMNIFICATION

11.1	Survival of Representations and Warranties and Covenants .....	96
11.2	Indemnification of Corix by SWMAC Holdco.....	97
11.3	Indemnification of SWMAC Holdco by Corix.....	97
11.4	Indemnification of Corix by CIUS .....	98
11.5	Claims .....	98
11.6	Limitations .....	100
11.7	Insurance .....	101
11.8	Remedies Exclusive .....	101

ARTICLE XII

GENERAL PROVISIONS

12.1	Notices .....	101
12.2	Definitions.....	102
12.3	Interpretation.....	117
12.4	Severability .....	117
12.5	Counterparts.....	118
12.6	Entire Agreement; No Third-Party Beneficiaries .....	118
12.7	Exhibits and Schedules; Article IV Representations and Warranties. ....	118
12.8	Expenses .....	119
12.9	Governing Law .....	119
12.10	Assignment .....	119
12.11	Specific Enforcement; Consent to Jurisdiction.....	120

12.12 Waiver of Jury Trial.....120  
12.13 No Recourse.....120

**Exhibits**

Exhibit A – CIUS Shareholders Agreement Term Sheet

Exhibit B – Transition Services Agreement Term Sheet

Exhibit C – Corix Restructuring

Exhibit D – Accounting Principles

**Disclosure Letters**

Corix Disclosure Letter

SWWC Disclosure Letter

This TRANSACTION AGREEMENT (this “Agreement”), dated as of August 26, 2022, by and among Corix Infrastructure Inc., a corporation incorporated under the laws of the Province of British Columbia (“Corix”), Corix Infrastructure (US) Inc., a Delaware corporation (“CIUS” and together with Corix, the “Corix Parties”), IIF Subway Investment L.P., a Delaware limited partnership (“IIF Subway”), SW Merger Acquisition Corp., a Delaware corporation (“SWMAC”) and South West Water Company, a Delaware corporation (“SWWC” and together with IIF Subway and SWMAC, the “SWWC Parties,” and the SWWC Parties together with the Corix Parties, the “Parties” and each a “Party”).

## WITNESSETH

**WHEREAS**, (a) Corix owns 100% of the Equity Interests of CIUS and the Canadian Water Entities and (b) IIF Subway and Bazos CIV L.P., a Delaware limited partnership (“Bazos”) collectively own 100% of the Equity Interests of SWMAC, which in turn owns 100% of the Equity Interests of SWWC;

**WHEREAS**, pursuant to the terms of this Agreement, the Corix Parties and the SWWC Parties desire to combine (a) the U.S. and Canadian water and wastewater operations of Corix and the Service Business (the “Corix Water Business”) and (b) the business operations of SWWC (the “SWWC Business”), and upon the consummation of the transactions set forth herein, (i) CIUS will hold the Corix Water Business, (ii) IIF Subway will contribute or cause to be contributed to CIUS the SWWC Business (through the contribution of SWMAC) in exchange for CIUS Common Stock to be issued to SWMAC Holdco (as defined below) and, immediately after and in connection with such contribution, SWMAC will merge with and into CIUS with CIUS surviving such merger, as further described in Article I (such transactions, the “Business Combination”);

**WHEREAS**, prior to the consummation of the Business Combination, Corix will, subject to the terms of this Agreement, take or cause to be taken the actions set forth on Exhibit C, substantially in the form described thereon, to (a) distribute, assign and transfer the Excluded Business (the “Excluded Business Carveout”), (b) distribute, assign and transfer to a newly-formed Delaware corporation (“Intermediate Newco”) the Canadian Subsidiaries of Corix whose operations constitute the Corix Water Business (the “Canadian Water Entities”) (the “Canadian Business Restructuring”), whereupon all of the stock of Intermediate Newco will be owned by CIUS and (c) contribute, transfer, assign and convey to one or more Contributed Corix Entities all Contributed Corix Water Assets held by Corix or an Affiliate of Corix other than a Contributed Corix Entity and transfer or cause to be transferred to one or more Contributed Corix Entities all Corix Water Personnel employed by Corix or an Affiliate of Corix other than a Contributed Corix Entity (the transactions described in clauses (a), (b) and (c) immediately above, collectively, the “Corix Restructuring”), in each case, in accordance with the terms of Section 7.8;

**WHEREAS**, prior to the consummation of the Business Combination, IIF Subway shall cause a restructuring to occur of the outstanding Equity Interests in SWMAC such that the shareholders of SWMAC shall cause a new holding company, which is anticipated to be a limited partnership, to be formed under the laws of Delaware or another U.S. state (“SWMAC Holdco”) that will hold 100% of the outstanding Equity Interests in SWMAC (the “SWMAC Restructuring”), and following consummation of the Business Combination, (i) SWMAC Holdco

will hold 50% of the outstanding Equity Interests in CIUS and (ii) SWMAC Holdco (or an Affiliate thereof) will hold 50% of the outstanding Equity Interests in the SHL JV (as defined below);

**WHEREAS**, in connection with the consummation of the Business Combination, (a) Coombs IRR LP (“Coombs”), a shareholder of Corix, will form a new Delaware limited partnership (“SHL JV”) and will contribute, transfer, assign and convey to SHL JV 100% of the receivable of the CIUS Shareholder Loan, (b) SWMAC Holdco (or another entity formed by the owners of the SWWC Shareholder Loan to own the SHL JV equity interests) will contribute, transfer, assign and convey to SHL JV 100% of the receivable of the SWWC Shareholder Loan and shall purchase limited partnership units of SHL JV from Coombs in exchange for cash in an amount equal to 50% of the difference between the Par Value of the SWWC Shareholder Loan and the Par Value of the CIUS Shareholder Loan as determined in accordance with Section 2.2 (the “SHL Balancing Payment”), and (c) Coombs and SWMAC Holdco shall enter into a limited partnership agreement governing SHL JV that will be consistent with the CIUS Shareholders Agreement, taking into account that the purpose of the SHL JV shall be solely to hold such receivables and SHL JV will not conduct any business otherwise (the transactions described in (a), (b) and (c), collectively, the “SHL Restructuring”);

**WHEREAS**, in connection with the Business Combination, (a) IIF Subway, if applicable pursuant to Sections 2.3 or 2.4, may be required to pay or cause to be paid to Corix (or to CIUS or another Person upon mutual agreement of IIF Subway and Corix) an equalization transfer payment in an amount to be determined subject to the applicable terms and conditions of this Agreement (the “Equity Balancing Payment”), which amount may be adjusted following the consummation of the Business Combination in accordance with the terms of this Agreement, and (b) Corix, if applicable pursuant to Sections 2.3 or 2.4, may be required to pay or cause to be paid to IIF Subway (or to CIUS or another Person upon mutual agreement of IIF Subway and Corix) the Equity Balancing Payment, which amount may be adjusted following the consummation of the Business Combination in accordance with the terms of this Agreement;

**WHEREAS**, concurrently with the execution and delivery hereof, (a) as a condition to the willingness of Corix to enter into this Agreement, IIF Subway has delivered or caused to be delivered to Corix a commitment letter (the “IIF Balancing Payment Commitment Letter”) from IIF US Holding 2 LP, a Delaware limited partnership (the “IIF Sponsor”), pursuant to which, and on the terms and conditions thereof, the IIF Sponsor has committed to provide (i) the SHL Balancing Payment and (ii) the Estimated Adjusted Equity Balancing Payment Amount (if payable to Corix (or to CIUS or another Person upon mutual agreement of IIF Subway and Corix) in accordance with the terms of this Agreement) to IIF Subway, as set forth therein (the “IIF Balancing Payment Commitment”); and (b) as a condition to the willingness of IIF Subway to enter into this Agreement, Corix has delivered or caused to be delivered to IIF Subway a Balancing Payment Commitment letter (the “Corix Balancing Payment Commitment Letter”) from Varese IRR LP, a limited partnership formed under the laws of the Province of Manitoba (the “Corix Sponsor”), pursuant to which, and on the terms and conditions thereof, the Corix Sponsor has committed to provide or cause to be provided the Estimated Adjusted Equity Balancing Payment Amount (if payable to IIF Subway (or to CIUS or another Person upon mutual agreement of IIF Subway and Corix) in accordance with the terms of this Agreement) to Corix, as set forth therein (the “Corix Balancing Payment Commitment”);

**WHEREAS**, upon the consummation of the Business Combination, Coombs and Corix will collectively own 50% of the outstanding CIUS Common Stock and SWMAC Holdco will own 50% of the outstanding CIUS Common Stock;

**WHEREAS**, in connection with the Business Combination and subject to the terms of this Agreement, at the Closing, (a) Corix and IIF Subway, or Affiliates thereof, will enter into a shareholders agreement of CIUS in accordance with the terms set forth on Exhibit A (the “CIUS Shareholders Agreement”) and (b) subject to Section 7.7, CIUS, Corix and an Affiliate of Corix that retains ownership of the Excluded Business as of the Closing Date (such Affiliate, “Remainco”), will enter into a transition services agreement in accordance with the terms set forth on Exhibit B and this Agreement (the “Transition Services Agreement”);

**WHEREAS**, (a) the Board of Directors of CIUS (the “CIUS Board”) has approved, adopted, declared advisable and recommended that Corix approve this Agreement and the transactions contemplated hereby, and (b) the Board of Directors of Corix (the “Corix Board”) has approved, adopted, declared advisable this Agreement and the transactions contemplated hereby;

**WHEREAS**, (a) the Board of Directors of SWWC has approved, adopted and declared advisable this Agreement and recommended that SWMAC, as the sole shareholder of SWWC, approve this Agreement and the transactions contemplated hereby, (b) the Board of Directors of SWMAC (the “SWMAC Board”) has approved, adopted and declared advisable this Agreement and recommended that IIF Subway and Bazos, as the shareholders of SWMAC, approve this Agreement and the transactions contemplated hereby, (c) IIF Subway has approved and adopted this Agreement and the transactions contemplated hereby, including the SWMAC Restructuring and (d) MR Bazos LP, as the sole limited partner of Bazos, has consented to the transactions contemplated hereby pursuant to that certain letter agreement entered into by and between IIF Subway and MR Bazos LP on the date hereof (the “Bazos Letter Agreement”); and

**WHEREAS**, for U.S. federal income tax purposes, the Parties intend that (a) the making of the SHL Balancing Payment be treated as a sale of a portion of the equity interests in SHL JV pursuant to Section 1001 of the Code; (b) the making of the Equity Balancing Payment be treated as, in the case of the Equity Balancing Payment made by IIF Subway to Corix (or to CIUS or another Person upon mutual agreement of IIF Subway and Corix), a sale of a portion of the CIUS Common Stock pursuant to Section 1001 of the Code (or, if made to CIUS or another Person upon mutual agreement, a purchase of CIUS Common Stock pursuant to Section 1032 of the Code or another Section of the Code, as applicable), and, in the case of the Equity Balancing Payment made by Corix to IIF Subway (or to CIUS or another Person upon mutual agreement of IIF Subway and Corix), a sale of a portion of the Equity Interests in SWMAC pursuant to Section 1001 of the Code followed by a contribution of such Equity Interests to CIUS; (c) the SWMAC Equity Exchange and the Merger, taken together, be treated as a “reorganization” within the meaning of Section 368(a) of the Code and the Treasury Regulations thereunder, to which each of CIUS and SWMAC are to be parties under Section 368(b) of the Code; and (d) this Agreement constitute a “plan of reorganization” within the meaning of Section 368 of the Code and the Treasury Regulations thereunder.

**NOW, THEREFORE**, in consideration of the mutual covenants contained herein and other good and valuable consideration, the receipt and sufficiency of which are hereby acknowledged, the Parties, intending to be legally bound, hereby agree as follows:

## ARTICLE I

### **THE BUSINESS COMBINATION AND RELATED RESTRUCTURING MATTERS**

1.1 Restructuring Matters and Business Combination. On the terms and subject to the conditions set forth in this Agreement, the following transactions shall occur prior to or in connection with the consummation of the Business Combination.

(a) Corix Restructuring. The Corix Parties shall cause the Corix Restructuring to occur.

(b) SWMAC Restructuring. IIF Subway will cause the SWMAC Restructuring to occur.

(c) The SHL Restructuring. Corix and IIF Subway will cause the SHL Restructuring to occur, including the payment of the SHL Balancing Payment.

(d) The Acquisition of SWMAC.

(i) IIF Subway shall cause SWMAC Holdco to contribute, transfer, assign and convey to CIUS all of the outstanding Equity Interests in SWMAC (the "SWMAC Interests") in exchange for shares of CIUS Common Stock (the "SWMAC Equity Exchange").

(ii) CIUS and SWMAC shall file a certificate of merger (the "Certificate of Merger") with the Delaware Secretary of State and make all other filings or recordings required by the Delaware Law to effect a merger pursuant to which SWMAC will merge with and into CIUS (the "Merger"), with CIUS as the surviving corporation, and the Merger shall become effective at such time (the "Merger Effective Time") as the Certificate of Merger is duly filed with the Delaware Secretary of State (or at such later time as CIUS and SWMAC shall agree and is specified in the Certificate of Merger).

(iii) At the Merger Effective Time, (i) each share of common stock of SWMAC outstanding immediately prior to the Merger Effective Time shall be automatically canceled and retired and shall cease to exist, and (ii) each share of common stock of CIUS outstanding immediately prior to the Merger Effective Time shall remain outstanding as the capital stock of CIUS as the surviving corporation in the Merger.

(e) The Parties shall cause the payment of the Estimated Adjusted Equity Balancing Payment Amount to be made in accordance with the terms of Section 2.3.

(f) To the extent that the outstanding Equity Interests in Inland Pacific Resources Inc. and Corix Utility Systems (Georgia) Inc. are not, following the Merger Effective Time, "excluded property" as defined in subsection 95(1) of the Tax Act, at the request of Corix,

Corix and SWMAC Holdco will reasonably cooperate to cause CIUS to take such actions as may be necessary such that the shares of Inland Pacific Resources Inc. and Corix Utility Systems (Georgia) Inc. are “excluded property” immediately prior to their transfer to Intermediate Newco pursuant to Section 1.1(g) (“Excluded Property Transactions”); *provided* that no such actions shall be taken without IIF Subway’s prior written consent (not to be unreasonably withheld, conditioned or delayed) if such actions could reasonably be expected to result in or give rise to (i) any cost or decrease in value of CIUS or any Affiliate in excess of \$250,000 (individually or in the aggregate), or (ii) result in any material non-monetary adverse impact or any adverse monetary impact in excess of \$250,000 (individually or in the aggregate) in either case on any SWWC Party (including SWMAC Holdco), in each case, taking into account any indemnity or cost reimbursement provided by Corix.

(g) Contributions to Intermediate Newco. Following the Merger Effective Time and the consummation of any Excluded Property Transactions, CIUS shall contribute, transfer, assign and convey to Intermediate Newco all of the outstanding Equity Interests in Inland Pacific Resources Inc., Corix Utility Systems (Georgia) Inc., SWWC and the SWWC Subsidiaries, and in exchange therefor, Intermediate Newco shall (A) issue to CIUS shares of common stock of Intermediate Newco and (B) assume all obligations related to CIUS’ third-party debt including any third-party debt assumed by CIUS from SWMAC pursuant to the Merger.

## ARTICLE II

### CLOSING; EQUITY BALANCING PAYMENT

2.1 Closing. The closing of the Business Combination (the “Closing”) shall take place at the offices of Skadden, Arps, Slate, Meagher & Flom LLP, 1440 New York Avenue, Washington, D.C., 2005, or remotely by electronic exchange of executed documents at 10:00 a.m., New York time, on the day that is no later than fifteen (15) Business Days after the day on which the conditions precedent set forth in Article VIII (other than those conditions that by their nature are to be satisfied at the Closing, but subject to the satisfaction or waiver of those conditions at such time) are satisfied or waived in accordance with this Agreement, or at such other place and time or on such other date as the Parties may mutually agree in writing. The date on which the Closing occurs is referred to in this Agreement as the “Closing Date.”

(a) Certain Corix Deliverables at Closing. At the Closing, Corix shall deliver, or cause to be delivered, to SWMAC Holdco (or, in the case of clause (i) below, to CIUS or another Person upon mutual agreement of IIF Subway and Corix) the following:

(i) the Estimated Adjusted Equity Balancing Payment Amount, if payable by Corix in accordance with Section 2.3;

(ii) the CIUS Shareholders Agreement, duly executed by CIUS, Coombs and Corix;

(iii) if applicable in accordance with Section 7.7, the Transition Services Agreement, duly executed by CIUS, Remainco and Corix;



(iv) a certificate duly executed by an authorized officer of each of the Corix Parties to the effect that the conditions set forth in Sections 8.3(a), 8.3(b) and 8.3(c) are satisfied, in a form and substance reasonably satisfactory to IIF Subway;

(v) copies (or other evidence) of all valid approvals or authorizations of, filings or registrations with, or notifications to, all Governmental Entities required to be obtained, filed or made by Corix in satisfaction of Section 8.1(a);

(vi) an IRS Form W-8 duly completed and executed by Corix and each other entity that will receive payments hereunder;

(vii) evidence of the completion of the Corix Restructuring in accordance with the terms of this Agreement;

(viii) any SWMAC Equity Exchange documentation (to which CIUS is a party) that is necessary to implement the SWMAC Equity Exchange in accordance with the terms of this Agreement, duly executed by CIUS; and

(ix) any SHL Restructuring documentation to which Coombs or another Affiliate of Corix is a party that is necessary to implement the SHL Restructuring in accordance with the terms of this Agreement, duly executed by such entity.

(b) Certain IIF Subway Deliverables at Closing. At the Closing, IIF Subway shall deliver, or cause to be delivered, to Corix (or, in the case of clause (i) below, another Person upon mutual agreement of IIF Subway and Corix) the following:

(i) the Estimated Adjusted Equity Balancing Payment Amount, if payable by IIF Subway in accordance with Section 2.3;

(ii) the SHL Balancing Payment Amount in accordance with Section 1.1(c) and any SHL Restructuring documentation to which SWMAC Holdco or another Affiliate of IIF Subway is a party that is necessary to implement the SHL Restructuring in accordance with the terms of this Agreement, duly executed by such entity;

(iii) the CIUS Shareholders Agreement, duly executed by SWMAC Holdco;

(iv) a certificate duly executed by an authorized officer of each of the SWWC Parties to the effect that the conditions set forth in Sections 8.2(a), 8.2(b) and 8.2(c) are satisfied, in a form and substance reasonably satisfactory to Corix;

(v) an IRS Form W-9 duly completed and executed by each of IIF Subway, Bazos, and SWMAC Holdco;

(vi) copies (or other evidence) of all valid approvals or authorizations of, filings or registrations with, or notifications to, all Governmental Entities required to be obtained, filed or made by the SWWC Parties in satisfaction of Section 8.1(a);

(vii) evidence of the completion of the SWMAC Restructuring in accordance with the terms of this Agreement; and

(viii) any SWMAC Equity Exchange documentation (to which SWMAC Holdco or SWMAC is a party) that is necessary to implement the SWMAC Equity Exchange in accordance with the terms of this Agreement, duly executed by SWMAC Holdco or SWMAC (as applicable).

2.2 Calculation of SHL Balancing Payment. No later than twelve (12) Business Days prior to the Closing Date, the Parties will calculate the SHL Balancing Payment, which calculation will be based on the Par Values of each of the Shareholder Loans as of the Closing.

2.3 Equity Balancing Payment.

(a) Estimated SWWC Payment Statement. No later than twelve (12) Business Days prior to the Closing Date, IIF Subway shall deliver to Corix (i) an initial written statement (the “Initial Estimated SWWC Payment Statement”) setting forth, with reasonable supporting information, estimated values as of the Closing Date of (A) the Closing SWWC Net Indebtedness (the “Estimated SWWC Net Indebtedness”), including calculation of the SWWC Cash, (B) the Closing SWWC Net Working Capital (the “Estimated SWWC Net Working Capital”) and (C) the Closing SWWC Capital Expenditure Amount (the “Estimated SWWC Capital Expenditure Amount”), in each case, determined as of the anticipated Closing Date and calculated in accordance with the Accounting Principles and (ii) wiring instructions for the receipt of any payments receivable by SWMAC Holdco pursuant to this Section 2.3 or Section 2.4. IIF Subway shall prepare the Initial Estimated SWWC Payment Statement in good faith and shall use its reasonable best efforts to give, and cause its Representatives to give, Corix and its Representatives reasonable access to such books, records and SWWC Personnel (including the work papers of IIF Subway, SWMAC and its accountants relating to the preparation of the Initial Estimated SWWC Payment Statement and such calculations based thereon) as may be necessary to enable Corix and its Representatives to review the Initial Estimated SWWC Payment Statement and such calculations based thereon prior to the Closing.

(b) Estimated Corix Payment Statement. No later than twelve (12) Business Days prior to the Closing Date, Corix shall deliver to IIF Subway (i) an initial written statement (the “Initial Estimated Corix Payment Statement”, and together with the Initial Estimated SWWC Payment Statement, the “Initial Estimated Payment Statements”) setting forth, with reasonable supporting information, estimated values as of the Closing Date of (A) the Closing Corix Net Indebtedness (the “Estimated Corix Net Indebtedness”), including calculation of the Corix Cash, (B) the Closing Corix Net Working Capital (the “Estimated Corix Net Working Capital”) and (C) the Closing Corix Capital Expenditure Amount (the “Estimated Corix Capital Expenditure Amount”), in each case, determined as of the anticipated Closing Date and calculated in accordance with the Accounting Principles and (ii) wiring instructions for the receipt of any payments receivable by Corix (or such other Person as appropriate) pursuant to this Section 2.3 or Section 2.4. Corix shall prepare the Initial Estimated Corix Payment Statement in good faith and shall use its reasonable best efforts to give, and cause its Representatives to give, IIF Subway and its Representatives reasonable access to such books, records and Corix Personnel (including the work papers of Corix, CIUS and their accountants relating to the preparation of the Initial

Estimated Corix Payment Statement and such calculations based thereon) as may be necessary to enable IIF Subway and its Representatives to review the Initial Estimated Corix Payment Statement and such calculations based thereon prior to the Closing.

(c) Following the exchange of the Initial Estimated Payment Statements, the Parties shall reasonably consult with each other and, subject to the final sentence of Section 2.3(e)(iv), may seek to make capital contributions or take other actions with respect to their respective businesses in order to cause an adjustment to the components of the Initial Estimated SWWC Payment Statement and the Initial Estimated Corix Payment Statement. Thereafter, no later than three (3) Business Days prior to the Closing, IIF Subway shall deliver to Corix an estimated payment statement for use at the Closing (the “Estimated SWWC Payment Statement”) reflecting any such permitted action and resulting adjustments to the components of the Initial Estimated SWWC Payment Statement, and Corix shall deliver to IIF Subway an estimated payment statement for use at the Closing (the “Estimated Corix Payment Statement”, and together with the Estimated SWWC Payment Statement, the “Estimated Payment Statements”) reflecting any such permitted action and resulting adjustments to the components of the Initial Estimated Corix Payment Statement.

(d) Prior to the Closing, Corix and IIF Subway in good faith shall seek to resolve any differences that they may have with respect to the computation of any of the items in the Estimated Payment Statements, and such statements shall be updated accordingly prior to the Closing; *provided*, that to the extent Corix and IIF Subway are unable to resolve such differences prior to the Closing, the amounts reflected in the Estimated Payment Statements shall be used for purposes of calculating the Estimated Adjusted Equity Balancing Payment Amount in Section 2.3(e).

(e) Calculation of the Estimated Adjusted Equity Balancing Payment Amount.

(i) The adjustments to the Equity Balancing Payment shall be calculated as an amount (which may be positive or negative, the “Estimated Adjustment”) equal to fifty percent (50%) of the total of (A) the Estimated SWWC Net Working Capital Underage, if any, *minus* (B) the Estimated SWWC Net Working Capital Overage, if any, *minus* (C) the Estimated SWWC Net Indebtedness Underage, if any, *plus* (D) the Estimated SWWC Net Indebtedness Overage, if any, *minus* (E) the Estimated SWWC Capital Expenditure Overage, if any, *plus* (F) the Estimated SWWC Capital Expenditure Underage, if any, *minus* (G) the Estimated Corix Net Working Capital Underage, if any, *plus* (H) the Estimated Corix Net Working Capital Overage, if any, *plus* (I) the Estimated Corix Net Indebtedness Underage, if any, *minus* (J) the Estimated Corix Net Indebtedness Overage, if any, *plus* (K) the Estimated Corix Capital Expenditure Overage, if any and *minus* (L) the Estimated Corix Capital Expenditure Underage, if any.

(ii) If the sum of the Base Equity Balancing Payment Amount and the Estimated Adjustment (the “Estimated Adjusted Equity Balancing Payment Amount”) is a positive number, IIF Subway shall pay or cause to be paid to Corix an amount in cash equal to the Estimated Adjusted Equity Balancing Payment Amount (net of any Taxes required to be deducted or withheld under Section 2.5), by wire transfer of immediately available

funds in accordance with the applicable wiring instructions provided by Corix, as provided in Section 2.1(b)(i).

(iii) If the Estimated Adjusted Equity Balancing Payment Amount is a negative number, Corix shall pay or cause to be paid to SWMAC Holdco an amount in cash equal to the absolute value of the Estimated Adjusted Equity Balancing Payment Amount (net of any Taxes required to be deducted or withheld under Section 2.5), by wire transfer of immediately available funds in accordance with the applicable wiring instructions provided by IIF Subway, as provided in Section 2.3(a)(ii).

(iv) Notwithstanding anything to the contrary set forth in this Agreement (but subject to the final sentence of this Section 2.3(e)(iv)), the Parties agree to reasonably cooperate and consult with each other and consider alternative mechanisms to provide the economic benefit of the Estimated Adjusted Equity Balancing Payment Amount that is intended by the terms of this Section 2.3 in a more economically efficient manner. For example, in lieu of direct payments to Corix or SWMAC Holdco, the Parties may agree to cause capital contributions or short term shareholder loans (any such short term loans, “Short Term SH Loans”) to be made to the respective businesses and/or to CIUS, and/or Corix funded repayment of third-party indebtedness by CIUS or any of its Subsidiaries, with any such Short Term SH Loans to be repaid immediately following Closing. Notwithstanding anything to the contrary set forth in this Agreement, neither IIF Subway nor Corix shall make payment of the Estimated Adjusted Equity Balancing Payment Amount through any alternative mechanism (or make capital contributions or Short Term SH Loans or take other actions with respect to their respective businesses to adjust the components of the Initial Estimated SWWC Payment Statement or the Initial Estimated Corix Payment Statement pursuant to Section 2.3(c)) without the prior written approval of Corix or IIF Subway, as applicable (which approval may not be unreasonably withheld, conditioned or delayed).

(f) To the extent permitted pursuant to applicable Law, any payment made (i) by SWMAC Holdco to Corix pursuant to this Section 2.3 shall be treated for all Tax purposes either (as applicable) as consideration for the disposition by Corix of CIUS Common Stock or, if the Parties mutually agree prior to the Closing, the disposition by Corix of an interest in the Canadian Water Entities and (ii) by Corix to SWMAC Holdco pursuant to this Section 2.3 shall be treated for all Tax purposes as consideration for the disposition by SWMAC Holdco of a portion of the SWMAC Interests followed by a contribution of such SWMAC Interests to CIUS.

#### 2.4 Post-Closing Adjustment of the Equity Balancing Payment.

##### (a) Final Closing Statement.

(i) Not later than 75 days after the Closing Date or such other time as is mutually agreed by Corix and IIF Subway (or any Affiliate of Corix or IIF Subway that becomes a shareholder of CIUS, collectively, in such capacities, the “CIUS Shareholders”, and each, a “CIUS Shareholder”), the CIUS Shareholders shall cause CIUS to prepare, or cause to be prepared, and deliver, or cause to be delivered, to the CIUS Shareholders a written statement setting forth calculations in reasonable detail of (A) the Closing SWWC

Net Indebtedness (including calculation of the SWWC Cash), (B) the Closing SWWC Net Working Capital, (C) the Closing SWWC Capital Expenditure Amount, (D) the Closing Corix Net Indebtedness (including calculation of the Corix Cash), (E) the Closing Corix Net Working Capital and (F) the Closing Corix Capital Expenditure Amount (collectively, the “Final Equity Balancing Payment Adjustment Items” and such statement, the “Final Closing Statement”), determined as of the Closing Date (and without giving effect to the transactions contemplated hereby except to the extent the parties agree to adjust the mechanisms for payment of the Estimated Adjusted Equity Balancing Payment Amount and do so through capital contributions to CIUS or to the respective contributed business or through the taking of other actions in accordance with Section 2.3, in which case the Final Closing Statement shall reflect such transactions). The Final Closing Statement shall be prepared on a basis consistent with the Accounting Principles.

(ii) The CIUS Shareholders shall cause CIUS to make available to the CIUS Shareholders its (and shall use their reasonable best efforts to cause CIUS to direct its accountants to make available its) work papers, schedules and other supporting data as may reasonably be requested by the CIUS Shareholders to verify the calculations of the Final Equity Balancing Payment Adjustment Items as or to be set forth in the Final Closing Statement, subject to customary confidentiality agreements. In the event that any of the CIUS Shareholders delivers a Dispute Notice (as defined below) to CIUS and the other CIUS Shareholder pursuant to Section 2.4(a)(iii), the CIUS Shareholders shall cause CIUS to make available to the CIUS Shareholders its (and shall use its reasonable best efforts to cause its accountants to make available their) work papers, schedules and other supporting data as may reasonably be requested by the CIUS Shareholders to enable them to verify the calculations of the Final Equity Balancing Payment Adjustment Items as set forth in such Dispute Notice, subject to customary confidentiality agreements.

(iii) Within 30 days following its receipt of the Final Closing Statement, each CIUS Shareholder shall deliver to CIUS and the other CIUS Shareholder either (A) its agreement as to the calculation of the Final Equity Balancing Payment Adjustment Items as set forth therein or (B) a written dispute notice (a “Dispute Notice”), specifying in reasonable detail the nature of its dispute of the calculation of the Final Equity Balancing Payment Adjustment Items as set forth therein; *provided*, that the CIUS Shareholders may dispute the calculation of the Final Equity Balancing Payment Adjustment Items as set forth in the Final Closing Statement only on the basis that such calculation was not made in accordance with the Accounting Principles, or on the basis of arithmetic error. In the event of a dispute, during the 15 Business Days after the delivery of a Dispute Notice, the CIUS Shareholders shall, and shall cause CIUS to, attempt in good faith to resolve any such dispute and finally determine the amounts, as applicable, of the Final Equity Balancing Payment Adjustment Items as set forth in the Final Closing Statement. If at the end of such 15-Business Day period, the CIUS Shareholders have failed to reach agreement with respect to any such disputed amounts, the matter shall be submitted to an internationally recognized accounting firm that is not the principal independent auditor for any CIUS Shareholder and is otherwise neutral and impartial and mutually agreed upon by the CIUS Shareholders; *provided, however*, that if the CIUS Shareholders are unable to select such accounting firm within 20 Business Days after delivery of a Dispute Notice, any CIUS Shareholder may request the American Arbitration Association to appoint,

within five Business Days following the date of such request, an independent accounting firm meeting the requirements set forth above. The accounting firm so selected shall be referred to herein as the “Accountant”. The Accountant shall be engaged by CIUS, and the Accountant, as an expert and not as an arbitrator, shall resolve the disputed portions of the calculations of the Final Equity Balancing Payment Adjustment Items as set forth in the Final Closing Statement in accordance with the terms and conditions of this Agreement. In making such determination, the Accountant may only consider those items and amounts as to which the CIUS Shareholders have disagreed within the time periods and on the terms specified above and must resolve the matter in accordance with the terms and provisions of this Agreement; *provided*, that the determination by the Accountant will neither be more favorable to any CIUS Shareholder than reflected in the Final Closing Statement nor more favorable to any CIUS Shareholder than reflected in such CIUS Shareholder’s Dispute Notice. The Accountant shall deliver to CIUS and the CIUS Shareholders, as promptly as practicable after its appointment (and in no event later than 30 days), a written report setting forth the resolution of each disputed matter and its determination of the amounts of the Equity Balancing Payment Adjustment Items as set forth in the Final Closing Statement as determined in accordance with the terms of this Agreement. Such report shall be final and binding upon the CIUS Shareholders to the fullest extent permitted under requirements of Law and may be enforced in any court having jurisdiction. Each CIUS Shareholder shall bear its own respective fees and costs incurred in connection with the Accountant’s resolution of any disputed items pursuant to this Section 2.4(a)(iii), except that all fees and expenses relating to the foregoing work by the Accountant shall be borne by CIUS.

(b) Calculation and Payment of the Closing Adjusted Equity Balancing Payment Amount. On the twelfth Business Day after the later of (i) the date that the CIUS Shareholders agree to the calculations of the Final Equity Balancing Payment Adjustment Items as set forth in the Final Closing Statement (which shall be deemed to have occurred if no CIUS Shareholder timely delivers a Dispute Notice pursuant to Section 2.4(a)(iii)) and (ii) if the CIUS Shareholders are unable to agree on such calculations of the Final Equity Balancing Payment Adjustment Items, the date that the CIUS Shareholders receive notice from the Accountant of the final determination of the amount(s) being so disputed, the final adjustments to the Estimated Adjusted Equity Balancing Payment Amount shall be calculated as an amount (which may be positive or negative, the “Closing Adjustment”) equal to fifty percent (50%) of the total of (A) the Closing SWWC Net Working Capital Underage, if any, *minus* (B) the Closing SWWC Net Working Capital Overage, if any, *minus* (C) the Closing SWWC Net Indebtedness Underage, if any, *plus* (D) the Closing SWWC Net Indebtedness Overage, if any, *minus* (E) the Estimated SWWC Capital Expenditure Overage, if any, *plus* (F) the Closing SWWC Capital Expenditure Underage, if any, *minus* (G) the Closing Corix Net Working Capital Underage, if any, *plus* (H) the Closing Corix Net Working Capital Overage, if any, *plus* (I) the Closing Corix Net Indebtedness Underage, if any, *minus* (J) the Closing Corix Net Indebtedness Overage, if any, *plus* (K) the Closing Corix Capital Expenditure Overage, if any, and *minus* (L) the Closing Corix Capital Expenditure Underage, if any.

(i) If the Estimated Adjusted Equity Balancing Payment Amount was a positive number, the sum of the Base Equity Balancing Payment and the Closing Adjustment as calculated using the Final Equity Balancing Payment Adjustment Items (as determined in accordance with Section 2.4(a)) (the “Closing Adjusted Equity Balancing”

Payment Amount”) is also a positive number, and the Closing Adjusted Equity Balancing Payment Amount is greater than the Estimated Adjusted Equity Balancing Payment Amount, SWMAC Holdco shall pay, or cause to be paid, in cash by wire transfer of same day immediately available funds to Corix (or an Affiliate thereof as directed by Corix ) an amount equal to such excess (net of any Taxes required to be deducted or withheld under Section 2.5).

(ii) If the Estimated Adjusted Equity Balancing Payment Amount was a positive number, the Closing Adjusted Equity Balancing Payment Amount is also a positive number, and the Closing Adjusted Equity Balancing Payment Amount is less than the Estimated Adjusted Equity Balancing Payment Amount, Corix shall pay, or cause to be paid, in cash by wire transfer of same day immediately available funds to SWMAC Holdco an amount equal to such difference (net of any Taxes required to be deducted or withheld under Section 2.5).

(iii) If the Estimated Adjusted Equity Balancing Payment Amount was a positive number and the Closing Adjusted Equity Balancing Payment Amount is a negative number, Corix shall pay, or cause to be paid, in cash by wire transfer of same day immediately available funds to SWMAC Holdco an amount equal to the sum of (A) the Estimated Adjusted Equity Balancing Payment Amount, *plus* (B) the absolute value of the Closing Adjusted Equity Balancing Payment Amount (net of any Taxes required to be deducted or withheld under Section 2.5).

(iv) If the Estimated Adjusted Equity Balancing Payment Amount was a negative number, the Closing Adjusted Equity Balancing Payment Amount is also a negative number, and the absolute value of the Closing Adjusted Equity Balancing Payment Amount is less than the absolute value of the Estimated Adjusted Equity Balancing Payment Amount, SWMAC Holdco shall pay, or cause to be paid, in cash by wire transfer of same day immediately available funds to Corix (or an Affiliate thereof as directed by Corix) an amount equal to such difference (net of any Taxes required to be deducted or withheld under Section 2.5).

(v) If the Estimated Adjusted Equity Balancing Payment Amount was a negative number, the Closing Adjusted Equity Balancing Payment Amount is also a negative number, and the absolute value of the Closing Adjusted Equity Balancing Payment Amount is greater than the absolute value of the Estimated Adjusted Equity Balancing Payment Amount, Corix shall pay, or cause to be paid, in cash by wire transfer of same day immediately available funds to SWMAC Holdco an amount equal to such excess (net of any Taxes required to be deducted or withheld under Section 2.5).

(vi) If the Estimated Adjusted Equity Balancing Payment Amount was a negative number and the Closing Adjusted Equity Balancing Payment Amount is a positive number, SWMAC Holdco shall pay, or cause to be paid, in cash by wire transfer of same day immediately available funds to Corix (or an Affiliate thereof as directed by Corix) an amount equal to the sum of (A) the absolute value of the Estimated Adjusted Equity Balancing Payment Amount *plus* (B) the Closing Adjusted Equity Balancing Payment Amount (net of any Taxes required to be deducted or withheld under Section 2.5).

Notwithstanding the foregoing terms of Section 2.4(b), the Party that is due a payment pursuant to this Section 2.4(b) may direct the other Party in writing to make the payment by means of a capital contribution to CIUS and may cause such amount to be used to repay existing indebtedness of CIUS or any of its Subsidiaries to the Party to whom a payment is due (or any of its Affiliates, other than CIUS or any of its Subsidiaries).

2.5 Withholding. Each of Corix, IIF Subway, SWMAC Holdco, CIUS and any other Person making payments described herein, shall be entitled to deduct and withhold any amount from any amounts payable pursuant to this Agreement as it is required to deduct and withhold with respect to the payment of such amounts under the Code, or any provision of federal, state, provincial, local or foreign Law. As soon as reasonably practicable, but in any event at least five (5) Business Days prior to deducting or withholding from any amounts otherwise payable pursuant to this Agreement, the paying Person shall notify the (other) Parties in writing of such intent to deduct and withhold and the basis therefor and shall provide such other Parties with a reasonable opportunity to provide such forms or other evidence as will reduce or eliminate such deduction or withholding. Any withheld amounts shall be duly and timely paid over to the appropriate Taxing Authority and any amounts so paid over shall be treated for all purposes of this Agreement as having been paid to the Person in respect of which such deduction and withholding was made.

### ARTICLE III

#### REPRESENTATIONS AND WARRANTIES OF CORIX

Corix represents and warrants to the SWWC Parties that the statements contained in this Article III are true and correct, except as set forth in the disclosure letter delivered by Corix to the SWWC Parties prior to the execution and delivery by the Corix Parties of this Agreement (the “Corix Disclosure Letter”).

3.1 Due Organization and Good Standing. Corix is duly organized, validly existing and in good standing under the laws of the jurisdiction in which it is organized (in the case of good standing, to the extent such jurisdiction recognizes such concept), except where the failure to be so organized, existing or in good standing, individually or in the aggregate, has not had and would not reasonably be expected to materially impair or delay its ability to (a) perform its obligations under this Agreement and each Ancillary Agreement to which it is or will be a party or (b) to consummate the Business Combination.

3.2 Authority; Binding Nature of Agreement. Corix has all requisite corporate power and authority to execute and deliver this Agreement and the other Ancillary Agreements to which it is or will be a party and to consummate the Business Combination and the other transactions contemplated by this Agreement. The execution and delivery of this Agreement and the consummation of the Business Combination and the transactions contemplated hereby have been duly and validly authorized and no other corporate proceedings are necessary to authorize, adopt or approve this Agreement or to consummate the Business Combination and the other transactions contemplated by this Agreement. Corix has duly executed and delivered this Agreement and, assuming the due authorization, execution and delivery by the other Parties, this Agreement constitutes the legal, valid and binding obligation of Corix, enforceable against Corix in accordance with its terms, except as enforcement may be limited by bankruptcy, insolvency,



reorganization or similar Laws affecting creditors' rights generally and by general principles of equity.

### 3.3 No Conflicts; Consents.

(a) Corix's execution and delivery of this Agreement does not, and Corix's performance of its covenants and agreements hereunder and under each Ancillary Agreement to which it is or will be a party will not, conflict with, or result in any violation of or default (with or without notice or lapse of time, or both) under, or give rise to a right of termination, cancellation or acceleration of any obligation, or result in the creation of any Lien upon any of the properties or assets of Corix under any provision of, (i) its Organizational Documents, (ii) any Contract to which Corix is a party or by which any of its properties or assets is bound or (iii) any Corix Water Permit, other than in the case of clauses (ii) and (iii) above, any matters that, individually or in the aggregate, have not had and would not reasonably be expected to prevent or materially impede, interfere with, hinder or delay the consummation of the Business Combination.

(b) Other than the filings and other matters referred to in Section 4.4(b) no Consent of or from, or registration, declaration, notice or filing made to or with, any Governmental Entity, is required to be obtained or made by or with respect to Corix, other than any Consents that, individually or in the aggregate, have not had and would not reasonably be expected to prevent or materially impede, interfere with, hinder or delay the consummation of the Business Combination.

### 3.4 Title.

(a) As of the date of this Agreement, Corix has good and valid title to its Equity Interests in CIUS, free and clear of all Liens (other than restrictions generally imposed on securities under U.S. or Canadian federal, state or provincial or foreign securities Laws or utility Laws and restrictions created, directly or indirectly, under this Agreement), and after giving effect to the Corix Restructuring, either Corix or an Affiliate of Corix will have good and valid title to the Equity Interests in CIUS, free and clear of all Liens (other than restrictions generally imposed on securities under U.S. or Canadian federal, state or provincial or foreign securities Laws or utility Laws and restrictions created, directly or indirectly, under this Agreement). Except as set forth in CIUS' Organizational Documents and in this Agreement or the Ancillary Agreements, none of the Equity Interests in CIUS are subject to any shareholder agreement, investor rights agreement, registration rights agreement, voting agreement or trust, proxy or other Contract restricting or otherwise relating to the voting, dividend rights or disposition of such Equity Interests.

(b) Upon the consummation of the Business Combination at the Closing and after giving effect to the Canadian Business Restructuring, CIUS will receive good and valid title to the Equity Interests in the Canadian Water Entities (the "Canadian Water Interests"), free and clear of all Liens, except for any Liens created, directly or indirectly, under this Agreement, and the Canadian Water Interests will not be subject to any voting or transfer restrictions (other than restrictions generally imposed on securities under U.S. or Canadian federal, state or provincial or foreign securities Laws or utility Laws and restrictions created, directly or indirectly, under this Agreement).

3.5 Financing. Corix has delivered or caused to be delivered to IIF Subway the Corix Balancing Payment Commitment Letter, pursuant to which, and on the terms and conditions thereof, the Corix Sponsor has agreed and committed to provide or cause to be provided the Corix Balancing Payment Commitment as provided therein. The Corix Balancing Payment Commitment Letter is in full force and effect and has not been amended, restated or otherwise modified or waived, and the respective commitments contained in the Corix Balancing Payment Commitment Letter have not been withdrawn, modified or rescinded in any respect. The Corix Balancing Payment Commitment Letter contains all of the conditions precedent to the obligations of, the Corix Sponsor to fund the Balancing Payment Commitment, if applicable. The Corix Balancing Payment Commitment Letter has been duly and validly executed and delivered by Corix and the Corix Sponsor and is a legal, valid and binding obligation of Corix and the Corix Sponsor enforceable against Corix and the Corix Sponsor in accordance with its terms, except as enforcement may be limited by bankruptcy, insolvency, reorganization or similar Laws affecting creditors' rights generally and by general principles of equity. The aggregate proceeds of the Corix Balancing Payment Commitment shall be sufficient to pay the Estimated Adjusted Equity Balancing Payment Amount on the Closing Date, if payable by Corix or an Affiliate thereof, and Corix has no reason to believe that any of the conditions precedent to the obligations of the Corix Sponsor to fund the Corix Balancing Payment Commitment on the terms therein will not be satisfied or that such amount of the Corix Balancing Payment Commitment will not be available to Corix or an Affiliate thereof as of the Closing. Each of Corix and the Corix Sponsor has the requisite power and authority to execute and deliver, and to perform its covenants, agreements and obligations under, the Corix Balancing Payment Commitment Letter. The execution and delivery of the Corix Balancing Payment Commitment Letter by Corix and the Corix Sponsor and the performance by each of Corix and the Corix Sponsor of their respective covenants and agreements thereunder have been duly and validly authorized by Corix and the Corix Sponsor, respectively. As of the date hereof, no event has occurred that, with or without notice or lapse of time or both, would reasonably be expected to constitute a breach or default of any provision of the Corix Balancing Payment Commitment Letter by Corix, constitute or assuming satisfaction of the conditions to Closing set forth in Article VIII result in a failure to satisfy a condition precedent to or other contingency to be satisfied set forth in the Corix Balancing Payment Commitment Letter or otherwise cause any portion of the Corix Balancing Payment Commitment to be unavailable.

3.6 Claims; Orders. Except as would not reasonably be expected to prevent or materially impede, interfere with, hinder or delay the consummation of the Business Combination, (a) there is no suit, action or other proceeding pending, or, to the Knowledge of Corix, threatened against Corix and (b) Corix is not subject to any Judgment.

3.7 Brokers. Other than RBC Capital Markets, LLC (the "Corix Financial Advisor"), no broker, finder or investment banker is entitled to any brokerage, finder's or other similar fee or commission in connection with the transactions contemplated hereby based on arrangements made by or on behalf of Corix or its Affiliates.

3.8 Anti-Corruption; Anti-Money Laundering; Sanctions.

(a) Neither Corix (solely with respect to its relationship with the Contributed Corix Entities) nor, to the Knowledge of Corix, any of its directors, officers, employees or other

Persons acting on behalf of any of the foregoing, directly or indirectly in relation to the Contributed Corix Entities, has, since the date falling five (5) years prior to the date of this Agreement:

(i) violated any applicable anti-corruption Laws in any material respect, including the Corruption of Foreign Public Officials Act (Canada), the U.S. Foreign Corrupt Practices Act, the UK Bribery Act 2010 or any other applicable anti-corruption Law (collectively, “Anti-Corruption Laws”);

(ii) made, offered or promised to make, or authorized the payment or giving of money, or anything else of value, to any (x) executive, official, employee or Person acting in an official capacity for or on behalf of a Governmental Entity, (y) political party or official thereof, or candidate for political office (each of the foregoing a “Government Official”), or (z) any other Person, while knowing or believing that all or some portion of the money or value will be offered, given or promised to a Government Official or other Person, in the case of clause (x), (y) or (z), for the purposes of obtaining or retaining business or securing any improper advantage in violation of any Anti-Corruption Law or in other circumstances when such offer, payment or promise would be unlawful; or

(iii) been the subject of any suit, action or other proceeding or, to the Knowledge of Corix, investigation with regard to any actual or alleged breach of any Anti-Corruption Law.

(b) Each of Corix and any Person controlling Corix (in each case, solely with respect to their relationship with the Contributed Corix Entities) is in compliance in all material respects with all applicable anti-money laundering Laws related to the prevention of money laundering and terrorist financing, including the Bank Secrecy Act, the USA PATRIOT Act and the Proceeds of Crime (Money Laundering) and Terrorist Financing Act (Canada) (collectively, “AML Laws”) in the jurisdictions in which Corix or any Person controlling Corix and the Contributed Corix Entities, as applicable, operates.

(c) Neither Corix, nor any Person controlling Corix, is a Sanctioned Person.

(d) Neither Corix, nor to Knowledge of Corix, any Person controlling Corix, will use any of the proceeds from any amounts received by such Person under this Agreement, if any, (i) for the purpose of funding, financing or facilitating any activities, business or transaction of or with any Sanctioned Person, or in any country or region that is the subject of comprehensive Sanctions, except to the extent permitted under applicable Sanctions, or (ii) in any manner that would result in the violation of any Sanctions by any Party.

(e) Neither Corix, nor any Person controlling Corix, is a Senior Foreign Political Figure, an immediate family member of a Senior Foreign Political Figure, or a close associate of a Senior Foreign Political Figure.

(f) Neither Corix, nor any Person controlling Corix, is a foreign shell bank, as defined in 31 C.F.R. § 1010.605(g).

3.9 No Additional Representations. Except for those representations and warranties expressly set forth in Articles III and IV and except as otherwise expressly set forth in this Agreement, neither Corix or any other Person acting on behalf of Corix, has made or makes any representation or warranty of any kind or nature, express or implied, with respect to any Contributed Corix Entities, their Affiliates or any of their respective businesses, operations, assets, liabilities, conditions (financial or otherwise) or prospects in connection with this Agreement or the transactions contemplated by this Agreement. In addition, without limiting the generality of the foregoing, Corix has not made and does not make any representation or warranty with respect to any projections, estimates or budgets made available to the SWWC Parties or their respective Affiliates of future revenues, future results of operations (or any component thereof), future cash flows or future financial condition (or any component thereof) of the Contributed Corix Entities or the future business and operations of CIUS or its future Subsidiaries.

## ARTICLE IV

### **REPRESENTATIONS AND WARRANTIES ABOUT THE CONTRIBUTED CORIX ENTITIES AND THE CORIX WATER BUSINESS**

The Corix Parties represent and warrant to the SWWC Parties that the statements contained in this Article IV are true and correct, except as set forth in the Corix Disclosure Letter.

4.1 Organization, Standing and Power. Each of the Contributed Corix Entities is duly organized, validly existing and in good standing under the laws of the jurisdiction in which it is organized (in the case of good standing, to the extent such jurisdiction recognizes such concept), except where the failure to be so organized, existing or in good standing, individually or in the aggregate, is not and would not reasonably be expected to be, individually or in the aggregate, material to the Contributed Corix Entities, taken as a whole. Each Contributed Corix Entity is duly qualified or licensed to do business in each jurisdiction where the nature of its business or the ownership, operation or leasing of its properties and assets makes such qualification necessary, other than in such jurisdictions where the failure to be so qualified or licensed, individually or in the aggregate, has not had and would not reasonably be expected to have a Corix Water Material Adverse Effect. Corix has made available to the SWWC Parties, prior to execution of this Agreement, true, correct and complete copies of the applicable Organizational Documents of each of the Contributed Corix Entities.

#### 4.2 Capital Structure.

(a) All the outstanding Equity Interests in each Contributed Corix Entity have been validly issued and are fully paid and nonassessable and are wholly owned, directly or indirectly, by Corix, CIUS, by another Contributed Corix Entity or by Corix and another Contributed Corix Entity, free and clear of all pledges, liens, claims, charges, mortgages, deeds of trust, security interests, encumbrances, conditions, encroachments, easements, right of way and restrictions of any kind or nature whatsoever (collectively, "Liens"), and free of any other restriction (including any restriction on the right to vote, sell or otherwise dispose of such Equity Interests), except for restrictions set forth in each Contributed Corix Entity's Organizational Documents or restrictions generally imposed on securities under U.S. or Canadian federal, state or provincial or foreign securities Laws applicable to securities generally or utility Laws. Except as

set forth in each Contributed Corix Entity's Organizational Documents and in this Agreement or the Ancillary Agreements, none of the Equity Interests in the Contributed Corix Entities are subject to any shareholder agreement, investor rights agreement, registration rights agreement, voting agreement or trust, proxy or other Contract restricting or otherwise relating to the voting, dividend rights or disposition of such Equity Interests.

(b) Section 4.2(b) of the Corix Disclosure Letter lists the authorized and outstanding capitalization of each Contributed Corix Entity as of the date hereof. Each Contributed Corix Entity holding Equity Interests in any other Contributed Corix Entity, as shown on Section 4.2(b) of the Corix Disclosure Letter, has good and valid title to all such Equity Interests in such other Contributed Corix Entity, free and clear of any Liens (other than restrictions generally imposed on securities under U.S. or Canadian federal, state or provincial or foreign securities Laws applicable to securities generally or utility Laws).

(c) Except for Equity Interests in the Contributed Corix Entities and Equity Interests in the Excluded Business Entities, no Contributed Corix Entity owns, directly or indirectly, any Equity Interests in, or any interest convertible into or exchangeable or exercisable for, any Equity Interests in, any firm, corporation, partnership, company, limited liability company, trust, joint venture, association or other entity other than ordinary course investments in publicly traded securities constituting one percent or less of a class of outstanding securities of any entity.

(d) There are no outstanding securities convertible into or exchangeable for Equity Interests in any Contributed Corix Entity or any options, warrants, phantom stock, stock appreciation rights, profit participation, purchase rights, subscription rights, conversion rights, exchange rights, calls, puts, rights of first refusal or first offer, preemptive rights, convertible securities or other Contracts that could require any Contributed Corix Entity to issue, sell or otherwise cause to become outstanding or to acquire, repurchase or redeem Equity Interests in any Contributed Corix Entity.

4.3 Authority; Execution and Delivery; Enforceability. CIUS has all requisite corporate power and authority to execute and deliver this Agreement, to perform its respective obligations hereunder and to consummate the Business Combination and the other transactions contemplated by this Agreement. The execution and delivery of this Agreement and the consummation of the Business Combination and the transactions contemplated hereby have been duly and validly authorized by each of the CIUS Board, Corix and the shareholders of Corix, and no other corporate proceedings are necessary to authorize, adopt or approve this Agreement or to consummate the Business Combination and the other transactions contemplated by this Agreement. CIUS has duly executed and delivered this Agreement and, assuming the due authorization, execution and delivery by the other Parties, this Agreement constitutes the legal, valid and binding obligation of CIUS, enforceable against CIUS in accordance with its terms, except as enforcement may be limited by bankruptcy, insolvency, reorganization or similar Laws affecting creditors' rights generally and by general principles of equity.

4.4 No Conflicts; Consents.

(a) The execution and delivery by CIUS of this Agreement does not, and the performance by CIUS of its obligations hereunder and the consummation of the Business

Combination and the other transactions contemplated by this Agreement will not, conflict with, or result in any violation of or default (with or without notice or lapse of time, or both) under, or give rise to a right of termination, cancelation or acceleration of any obligation, or result in the creation of any Lien upon any of the properties or assets of any Contributed Corix Entity under, any provision of (i) the Organizational Documents of any Contributed Corix Entity, (ii) subject to the filings and other matters referred to in Section 4.4(b), any legally-binding contract, lease, license, indenture, note, bond, agreement, concession, franchise or other instrument (excluding each Corix Water Benefit Plan and SWWC Benefit Plan, a “Contract”) to which any Contributed Corix Entity is a party or by which any of their respective properties or assets is bound or any Corix Water Permit or (iii) subject to the filings and other matters referred to in Section 4.4(b), any judgment, order or decree of a Governmental Entity or arbitrator (“Judgment”) or Law, in each case applicable to any Contributed Corix Entity or their respective properties or assets, other than, in the case of clauses (ii) and (iii) above, any matters that, individually or in the aggregate, are not and would not reasonably be expected to be material to the Contributed Corix Entities, taken as a whole, and would not prevent or materially impede, interfere with, hinder or delay the consummation of the Business Combination.

(b) No consent, waiver, Permit, registration, declaration, notice or filing (any of the foregoing, a “Consent”), of or from, or made to or with, any federal, national, state, tribal, provincial or local, whether domestic or foreign, government or any court of competent jurisdiction, administrative agency or commission or other governmental entity or instrumentality, whether domestic, foreign or supranational (a “Governmental Entity”), is required to be obtained or made by or with respect to any Corix Party or any Affiliate thereof in connection with the execution and delivery of this Agreement or its performance of its obligations hereunder or the consummation of the Business Combination and the other transactions contemplated by this Agreement (including the Corix Restructuring), other than (i) compliance with and filings under the Hart-Scott-Rodino Antitrust Improvements Act of 1976 (the “HSR Act”), (ii) the Competition Act Approval, (iii) such Consents required by the applicable Governmental Entities with jurisdiction over the Contributed Corix Entities or any Consents in connection with the Corix Restructuring, (iv) CFIUS Approval with respect to the Business Combination, (v) if determined by Corix to be necessary or appropriate to obtain, CFIUS Approval with respect to the Excluded Business Carveout and (vi) any pre-approvals of license transfers by the Federal Communications Commission (the Consents in (i), (ii), (iii), (iv), (v) and (vi) collectively, the “Corix Regulatory Approvals”).

#### 4.5 Financial Statements; Undisclosed Liabilities.

(a) True, correct and complete copies of (i) the audited consolidated balance sheets of each of Corix Regulated Utilities (US) Inc. and Fairbanks Sewer & Water, Inc. (together, the “U.S. Reporting Contributed Corix Entities”) for each of the two fiscal years ended December 31, 2021 and December 31, 2020, and the related audited consolidated statements of income, owners’ equity and cash flows with respect thereto, together with all related notes and schedules thereto (collectively, the “Corix Water Audited Financial Statements”), (ii) the unaudited consolidated balance sheets of each of West Shore Environmental Services Limited Partnership, Corix Utilities (Foothills Water) Inc. and Corix Utilities (Foothills Wastewater) Inc. (collectively, the “Canadian Reporting Contributed Corix Entities”) for each of the two fiscal years ended December 31, 2021 and December 31, 2020, and the related unaudited consolidated statements of

income with respect thereto (collectively, the “Corix Water Unaudited Financial Statements”) and (iii) the unaudited consolidated balance sheets of each of Corix Regulated Utilities (US) Inc., Fairbanks Sewer & Water, Inc., West Shore Environmental Services Limited Partnership, Corix Utilities (Foothills Water) Inc. and Corix Utilities (Foothills Wastewater) Inc. for the six (6) months ended June 30, 2022 (the “Interim Balance Sheet Date”), and the related statements of income with respect thereto (collectively, the “Corix Water Interim Financial Statements,” and together with the Corix Water Audited Financial Statements and the Corix Water Unaudited Financial Statements, the “Corix Water Financial Statements”), have been made available to the SWWC Parties.

(b) The Corix Water Financial Statements (i) present fairly in all material respects the financial condition and results of operations of the applicable Contributed Corix Entities as of the dates thereof or for the periods covered thereby, and (ii) (A) with respect to the U.S. Reporting Contributed Corix Entities, have been prepared in accordance with GAAP and (B) with respect to the Canadian Reporting Contributed Corix Entities, have been prepared in accordance with Canadian GAAP, applied on a basis consistent with the past practices of the applicable Contributed Corix Entities, except, with respect to clauses (i) and (ii), in the case of the Corix Water Interim Financial Statements, for the absence of footnote disclosure and normal and recurring year-end adjustments, none of which would be material (whether individually or in the aggregate).

(c) Except as adequately reserved for in the Corix Water Interim Financial Statements, no Contributed Corix Entity has any liabilities or obligations, contingent or otherwise, other than (i) liabilities incurred in the ordinary course of business subsequent to the Interim Balance Sheet Date (none of which is a liability resulting from breach of contract, breach of warranty, tort, infringement or misappropriation); (ii) obligations under Contracts incurred in the ordinary course of business; (iii) liabilities and obligations of a type or nature not required under GAAP or Canadian GAAP, as applicable, to be reflected in financial statements; and (iv) liabilities or obligations that are not and would not reasonably be expected to be, individually or in the aggregate, material to the Contributed Corix Entities, taken as a whole. Each of the U.S. Reporting Contributed Corix Entities maintains a standard system of accounting established and administered in accordance with GAAP and each of the Canadian Reporting Contributed Corix Entities maintains a standard system of accounting established and administered in accordance with Canadian GAAP.

#### 4.6 Regulation as a Utility.

(a) Each Contributed Corix Entity set forth in Section 4.6(a) of the Corix Disclosure Letter (the “Regulated Contributed Corix Entities”) is a regulated public utility or public service company (or similar designation) in the jurisdiction, and by the Governmental Entity, listed opposite such Contributed Corix Entity. Section 4.6(a) of the Corix Disclosure Letter sets forth, as of the date of this Agreement, a true and complete list of the amount, by province or state, of regulatory adjustments, including regulatory liabilities, except for those adjustments that result in a net impact on such entity in an amount of less than \$250,000 in the aggregate (the “Regulatory Adjustments”), including the amount of such adjustment as of the date of the last order by a Governmental Entity having jurisdiction over the rates of the Regulated Contributed Corix Entities, made to or that directly offset the amounts represented in the balances of property,

plant and equipment at cost, accumulated depreciation, contributions in aid of construction (net), and advances in aid of construction as set forth in the Corix Water Interim Financial Statements. As of the date of the Interim Balance Sheet Date, no amount in excess of \$250,000 represented in the balances of property, plant and equipment at cost, accumulated depreciation, contributions in aid of construction (net), and advances in aid of construction as set forth in the Corix Water Interim Financial Statements is required to be expensed in accordance with Canadian GAAP or GAAP, as applicable, because of an order by a Governmental Entity having jurisdiction over the rates of the Regulated Contributed Corix Entities.

(b) Since December 31, 2020, each Contributed Corix Entity has filed with the appropriate Governmental Entities all documents required to be filed by it under applicable state or provincial utility Laws, except for filings the failure of which are not and would not reasonably be expected to be, individually or in the aggregate, material to the Contributed Corix Entities, taken as a whole. All such documents complied in all material respects, as of the date so filed, with all applicable requirements of the applicable statute and rules and regulations thereunder.

(c) As of the date hereof, no Contributed Corix Entity is subject to regulation as a public utility or public service company (or similar designation) by any state in the United States or province in Canada, other than the Regulated Contributed Corix Entities.

4.7 Absence of Certain Changes or Events. From December 31, 2021, to the date of this Agreement, each Contributed Corix Entity has conducted the Corix Water Business in the ordinary course in all material respects, and during such period there has not occurred:

(a) any fact, circumstance, effect, change, event or development that, individually or in the aggregate, has had or would reasonably be expected to have a Corix Water Material Adverse Effect;

(b) any incurrence of material Indebtedness for borrowed money or any guarantee of such Indebtedness for another Person that is not a Contributed Corix Entity, or any issue or sale of debt securities, warrants or other rights to acquire any debt security of any Contributed Corix Entity other than draws on existing revolving credit facilities in the ordinary course of business;

(c) any change in financial accounting methods, principles or practices by any Contributed Corix Entity, except insofar as may have been required by a change in Canadian GAAP or GAAP, as applicable, or Law; or

(d) any material elections or changes thereto with respect to Taxes by any Contributed Corix Entity or any settlement or compromise by any Contributed Corix Entity of any material Tax liability or refund, other than in the ordinary course of business.

4.8 Taxes.

(a) All income and other material Tax Returns filed or required by applicable Law to be filed with any Taxing Authority by, or on behalf of, any Contributed Corix Entity (each such Tax Return, a "Corix Water Tax Return") have been filed when due in accordance with all applicable Law (taking into account any extension of time within which to file), and all such



income and other material Corix Water Tax Returns are, or shall be at the time of filing, true and complete in all material respects.

(b) Each Contributed Corix Entity has paid (or has had paid on its behalf) to the appropriate Taxing Authority all material Taxes (whether or not shown as due and payable on any Corix Water Tax Return), or, where payment is not yet due, has established (or has had established on its behalf and for its sole benefit and recourse) in accordance with Canadian GAAP or GAAP, as applicable, an adequate accrual for all material Taxes through the end of the last period for which such Contributed Corix Entity ordinarily record items on their respective books.

(c) Each Contributed Corix Entity has duly and timely withheld all material Taxes required to be withheld from any payment or distribution to any Person and such withheld Taxes have been or will be duly and timely paid to the appropriate Taxing Authority.

(d) There is no suit, action, audit, claim, assessment, levy, inquiry, investigation, dispute or other administrative or judicial proceeding or investigation now pending or, to the Knowledge of Corix, threatened against or with respect to any Contributed Corix Entity in respect of any material Taxes.

(e) No deficiency with respect to material Taxes has been proposed, asserted or assessed in writing against any Contributed Corix Entity, which has not been fully paid.

(f) No Contributed Corix Entity (i) is now or has been a member of an “affiliated group” as defined in Section 1504 of the Code (or any similar provision of any applicable Tax Law), other than an “affiliated group” of which a Contributed Corix Entity is the common parent or (ii) has any liability for the Taxes of any other Person (other than an Excluded Business Entity) under Treasury Regulation Section 1.1502-6 or sections 159 or 160 of the Tax Act (or any similar provision of any applicable Law), as a transferee or successor, or by any other applicable provision of applicable Law.

(g) During the preceding two-year period or otherwise as part of a plan (within the meaning of Section 355(e) of the Code) that includes the transactions contemplated hereunder, no Contributed Corix Entity was a distributing corporation or a controlled corporation in a transaction intended to be governed by Section 355 of the Code.

(h) No Contributed Corix Entity (i) is a party to or bound by, or has any liability under any Tax allocation, indemnification, sharing or similar agreement, other than (x) any such agreement solely between one or more of the Contributed Corix Entities or (y) customary indemnifications for Taxes contained in credit or other commercial agreements the primary purposes of which do not relate to Taxes, or (ii) has granted any power of attorney with respect to any matters related to Taxes that is currently in force.

(i) Section 4.8(i) of the Corix Disclosure Letter sets forth the entity classification of each Contributed Corix Entity for U.S. federal income tax purposes.

(j) There are no waivers, extensions or requests for any waivers or extensions of any statute of limitations currently in effect with respect to any material Taxes of any

Contributed Corix Entity (other than extensions granted in connection with extensions of time to file Tax Returns obtained in the ordinary course of business).

(k) No written claim has been made by any Governmental Entity in a jurisdiction where any Contributed Corix Entity does not file Tax Returns that such Contributed Corix Entity is or may be subject to taxation by that jurisdiction.

(l) No Contributed Corix Entity (i) has a permanent establishment (within the meaning of an applicable Tax treaty), branch, or other fixed place of business, or (ii) has otherwise been, or deemed to be, engaged in a trade or business in any jurisdiction, other than its own country of incorporation or formation. No Contributed Corix Entity currently has or has had nexus (within the meaning of the applicable Law of any applicable U.S. state) in any U.S. state where such Contributed Corix Entity, as applicable, does not currently, or did not at the applicable time, file Tax Returns and pay Taxes.

(m) There are no Liens for material Taxes upon any property or assets of any Contributed Corix Entity, except for Liens for Taxes (x) not yet due and payable or (y) which are being contested in good faith by appropriate proceedings and with respect to which adequate reserves have been established in accordance with GAAP and Canadian GAAP.

(n) No Contributed Corix Entity will be required to include material amounts in income, or exclude or reduce material items of deduction, in a taxable period for which a Tax Return has not yet been filed as a result of any (i) change in or improper use of any method of accounting pursuant to Section 481 of the Code (or any corresponding or similar provision of any state, local or non-U.S. Tax Law) prior to the Closing Date, (ii) “closing agreement” within the meaning of Section 7121 of the Code (or any corresponding or similar provision of any state, local or non-U.S. Tax Law) executed prior to the Closing, (iii) installment sale or open transaction made or entered into prior to the Closing, (iv) any prepaid amount received or deferred revenue accrued prior to the Closing, or (v) intercompany transaction consummated or excess loss account existing on or prior to the Closing Date, in either case described in the Treasury Regulations under Section 1502 of the Code (or any corresponding or similar provision of any state, local or non-U.S. Tax Law).

(o) No Contributed Corix Entity is, nor will be, required to include any amount in income for a taxable year ending after December 31, 2017, as a result of the application of Section 965 of the Code, nor has made an election under Section 965(h) of the Code.

(p) No Contributed Corix Entity has made a request for an advance tax ruling, a request for technical advice, a request for a change of any method of accounting or any similar request that is in progress or pending with any Governmental Entity with respect to any material Taxes.

(q) No Contributed Corix Entity has entered into or been a party to any “listed transaction” within the meaning of Treasury Regulations Section 1.6011-4(b)(2) or any “reportable transaction” or “notifiable transaction” as described in subsections 237.3(1) and 237.4(1) of the Tax Act as in effect on the date hereof, respectively, excluding any transactions contemplated by this Agreement.

(r) No Contributed Corix Entity has received any relief, assistance or benefit, including any deferral of Taxes, from any Governmental Entity under any COVID-19 Relief Legislation.

(s) There are no circumstances that exist and are expected to result in, or have existed and resulted in, the application of any of Sections 17(1), 79, 79.1 or 80 to 80.04, inclusive, of the Tax Act to any Contributed Corix Entity.

(t) Contemporaneous documentation as required under Section 247 of the Tax Act substantiating the transfer pricing practices and methodology of the Contributed Corix Entities has been executed and maintained.

(u) Each Contributed Corix Entity has duly and timely collected from all of its past and present customers (or other Persons paying amounts to a Contributed Corix Entity) the amount of all Taxes (including goods and services tax, harmonized sales and provincial or territorial sales taxes) required to be collected and has timely paid such Taxes when due to the appropriate Governmental Entity, in the form required under applicable Laws or made adequate provision for the payment of such amounts to the proper receiving authorities.

(v) No Contributed Corix Entity has made an “excessive eligible dividend election” as defined in subsection 89(1) of the Tax Act in respect of any dividend paid or deemed by any provision of the Tax Act to have been paid, on any class of shares of its capital stock.

(w) No Contributed Corix Entity has made a capital dividend election under subsection 83(2) of the Tax Act in an amount which exceeds the amount in its capital dividend account at the time of such election.

(x) No Contributed Corix Entity has taken any action, nor to the Knowledge of Corix are there any facts or circumstances, that could reasonably be expected to prevent the SWMAC Equity Exchange and the Merger, taken together, from qualifying as a “reorganization” within the meaning of Section 368(a) of the Code and the Treasury Regulations.

(y) Notwithstanding anything to the contrary in this Agreement, this Section 4.8 (and so much of Section 4.7 and Section 4.9 as each relates to Taxes) are the sole representations and warranties given by any Contributed Corix Entity in this Agreement, and no other representation or warranty given by any Contributed Corix Entity in this Agreement shall be construed or interpreted as containing any representation or warranty, in each case with respect to Tax matters. Nothing in this Agreement (including this Section 4.8) shall be construed as providing a representation or warranty with respect to the existence, amount, expiration date or limitations on (or availability of) any net operating loss, net capital loss, Tax credit or any other Tax attribute of Corix or any Contributed Corix Entity. Notwithstanding anything to the contrary in this Agreement, the representations and warranties made in this Section 4.8 (other than Section 4.8(i) and (n)) refer only to the past activities of any Contributed Corix Entity and are not intended to serve as representations to, or a guarantee of, nor can they be relied upon with respect to, Taxes attributable to any Tax periods (or portions thereof) beginning after, or Tax positions taken after, the Closing Date.

#### 4.9 Employee Benefits.

(a) Section 4.9(a) of the Corix Disclosure Letter sets forth a correct and complete list of each material Corix Water Benefit Plan. With respect to each material Corix Water Benefit Plan, to the extent applicable, true, correct and complete copies of the following have been delivered or made available to IIF Subway by the Corix Parties: (i) the Corix Water Benefit Plan, if written (including all amendments and attachments thereto), (ii) a written summary, if the Corix Water Benefit Plan is not in writing, (iii) all related trust documents, (iv) all insurance contracts or other funding arrangements, (v) the most recent annual report (Form 5500 or similar) filed with the IRS or similar Governmental Entity, (vi) the most recent determination, opinion or advisory letter from the IRS, (vii) the most recent summary plan description and any summary of material modifications thereto, (viii) all material filings and communications received from or sent to any Governmental Entity with respect to a Corix Water Benefit Plan and (ix) the most recent audited financial statement and/or actuarial valuation.

(b) Each Corix Water Benefit Plan has been established, registered, operated and administered in accordance with its terms and the requirements of all applicable Laws, including ERISA and the Code, in all material respects. Contributions required to be made to any Corix Water Benefit Plan by applicable Law or by any plan document or other contractual undertaking, and all premiums due or payable with respect to insurance policies funding any Corix Water Benefit Plan, have been timely made or paid in full in all material respects or, to the extent not required to be made or paid on or before the date hereof, have been fully reflected on the books and records of Corix to the extent required under Canadian GAAP. There are no pending or, to the Knowledge of Corix, threatened material claims (other than routine claims for benefits) by, on behalf of or against any of the Corix Water Benefit Plans or any trusts related thereto.

(c) Section 4.9(c) of the Corix Disclosure Letter identifies each Corix Water Benefit Plan that is intended to be qualified under Section 401(a) of the Code (each, a "Corix Water Qualified Plan"). The IRS has issued a favorable determination, opinion or advisory letter with respect to each Corix Water Qualified Plan and its related trust, or with respect to a prototype Corix Water Qualified Plan, the prototype sponsor has received a favorable IRS opinion or advisory letter, or the Corix Water Qualified Plan or prototype sponsor has remaining a period of time under applicable Code regulations or pronouncements of the IRS in which to apply for such a letter and make any amendments necessary to obtain a favorable determination, advisory or opinion as to the qualified status of each such Corix Water Qualified Plan, and, if issued, such determination, advisory or opinion letter has not been revoked (nor has revocation been threatened), and, to the Knowledge of Corix, there are no existing circumstances and no events have occurred that could reasonably be expected to adversely affect the qualified status of any Corix Water Qualified Plan or the related trust.

(d) Each Corix Water Benefit Plan that is intended to qualify for tax-preferred or tax-exempt treatment under the Tax Act has been duly registered in accordance with applicable Laws and to the Knowledge of Corix, there are no existing circumstances and no events have occurred that could reasonably be expected to adversely affect the tax or registered status of any such Corix Water Benefit Plan.

(e) No Corix Water Benefit Plan is subject to Title IV or Section 302 of ERISA or Section 412 of the Code. With respect to each Corix Water Benefit Plan subject to Title IV or Section 302 of ERISA or Section 412 of the Code: (i) each such Corix Water Benefit Plan satisfies all minimum funding requirements under Sections 412 and 430 of the Code and Sections 302 and 303 of ERISA, whether or not waived, (ii) no lien in favor of any such Corix Water Benefit Plan has arisen under Section 430(k) of the Code or Section 303(k) of ERISA, (iii) such Corix Water Benefit Plan is not in “at risk status” within the meaning of Section 430(i) of the Code or Section 303(i) of ERISA, (iv) Corix has delivered or made available to IIF Subway a copy of the most recent actuarial valuation report for such Corix Water Benefit Plan and such report is complete and accurate in all material respects, (v) the Pension Benefit Guaranty Corporation (“PBGC”) has not instituted proceedings to terminate such Corix Water Benefit Plan, and (vi) there has not been any “reportable event” (as that term is defined in Section 4043 of ERISA) during the last six (6) years as to which the 30-day advance notice requirement has not been waived. In the past six (6) years, no material liability (other than for premiums to the PBGC) under Title IV of ERISA has been or is expected to be incurred by any of the Contributed Corix Entities or any of their respective ERISA Affiliates.

(f) None of the Contributed Corix Entities or any of their respective ERISA Affiliates has maintained, established, contributed to, been obligated to contribute to, or has any liability (including a withdrawal liability such as a “withdrawal liability” within the meaning of Title IV of ERISA) with respect to any plan that is a (i) “multiemployer plan” within the meaning of Section 4001(a)(3) of ERISA, (ii) multi-employer pension plan as defined in applicable pension standards legislation, (iii) multi-employer health benefit plan established as an employee life and health trust or health and welfare trust or (iv) plan that has two or more contributing sponsors at least two of whom are not under common control within the meaning of Section 4063 of ERISA (each of the programs listed in subsection (i), (ii), (iii) and (iv) a “Multiemployer Plan”).

(g) No Contributed Corix Entity sponsors, has sponsored or has any obligation with respect to any employee benefit plan that provides for any post-employment or post-retirement medical or death benefits (whether or not insured) with respect to former or current directors or employees, or their respective beneficiaries or dependents, beyond their retirement or other separation from service, except as required by Section 4980B of the Code.

(h) The execution of this Agreement and the consummation of the Business Combination will not, either alone or in combination with another event, (i) entitle any current or former employee, director, consultant or officer of any of the Contributed Corix Entities to severance pay, retention or any other bonus amount or accrued pension benefit or any other payment, (ii) accelerate the time of payment or vesting, or increase the amount of compensation due any such employee, director, consultant or officer, (iii) trigger any funding obligation under any Corix Water Benefit Plan, (iv) result in the forgiveness of Indebtedness for the benefit of any such current or former employee, director, consultant or officer or (v) result in any breach or violation of, or default under, or limit any Contributed Corix Entity’s right to extend, renew, replace, amend, modify or terminate, any Corix Water Benefit Plan. No Corix Water Benefit Plan provides for, and no Contributed Corix Entity otherwise has any obligation to provide, a gross-up or reimbursement of Taxes imposed under Section 4999 of the Code, Section 409A(a)(1)(B) of the Code, or otherwise.

(i) To the Knowledge of Corix, each Corix Water Benefit Plan, and any award thereunder, that is or forms part of a “nonqualified deferred compensation plan” within the meaning of Section 409A of the Code has been maintained, in form and operation, in material compliance with all applicable requirements of Section 409A of the Code.

(j) None of the Contributed Corix Entities sponsors, has sponsored or has any obligation with respect to a plan or arrangement governed by the Tax Act that is: (i) a “registered pension plan” within the meaning of subsection 248(1) of the Tax Act or a pension plan that is required to be funded under applicable pension standards legislation of Canada or a province; (ii) a “retirement compensation arrangement” within the meaning of subsection 248(1) of the Tax Act; (iii) an “employee life and health trust” within the meaning of subsection 248(1) of the Tax Act; or (iv) a “health and welfare trust” within the meaning of Canada Revenue Agency Income Tax Folio S2-F1-C1. No Corix Water Benefit Plan governed by the Tax Act is intended to be or has ever been found or alleged by a Governmental Entity to be a “salary deferral arrangement” within the meaning of subsection 248(1) of the Tax Act.

#### 4.10 Labor and Employment Matters.

(a) No Contributed Corix Entity is a party to or bound by any collective bargaining agreement or other written Contract with any labor union or other similar organization (“Collective Bargaining Agreement”) with respect to any Corix Water Personnel. No Corix Water Personnel are represented by any labor union or other similar organization (“Labor Organization”) with respect to their employment with a Contributed Corix Entity. Except for matters that are not and would not reasonably be expected to be, individually or in the aggregate, material to the Contributed Corix Entities, taken as a whole, (i) there is no, and has not been any, pending or, to the Knowledge of Corix, threatened strike, lockout, slowdown, work stoppage or unfair labor practice by or with respect to any Corix Water Personnel and (ii) to the Knowledge of Corix, there are no, and in the past three (3) years, have not been any, activities or proceedings of any Labor Organization to organize any employees of any Contributed Corix Entity and no demand for recognition as the exclusive bargaining representative of any such employees has been made by or on behalf of any Labor Organization.

(b) Except for instances of noncompliance that are not and would not reasonably be expected to be, individually or in the aggregate, material to the Contributed Corix Entities, taken as a whole, the Contributed Corix Entities are, and at all times in the past three (3) years have been, in compliance with all applicable Laws relating to labor and employment, including those relating to labor management relations, wages, hours, overtime, discrimination, sexual harassment, civil rights, affirmative action, work authorization, child labor, immigration, safety and health, disability rights or benefits, equal employment, plant closures and layoffs, workers’ compensation, employee leave issues, unemployment insurance and continuation coverage under group health plans.

(c) Except for instances of noncompliance that are not and would not reasonably be expected to be, individually or in the aggregate, material to the Contributed Corix Entities, taken as a whole, no Corix Water Personnel is, or has been, in any respect in violation of any term of any employment agreement, nondisclosure agreement, common law nondisclosure obligation, fiduciary duty, non-competition agreement, restrictive covenant or other obligation:

(i) to any Contributed Corix Entity or (ii) to the Knowledge of Corix, to a former employer of any such Corix Water Personnel relating (A) to the right of any such Corix Water Personnel to be employed by any Contributed Corix Entity or (B) to the knowledge or use of trade secrets or proprietary information.

(d) To the Knowledge of Corix, in the last three (3) years, no allegations of sexual harassment or hostile work environment have been made to Corix against any individual in such individual's capacity as (i) an officer of a Contributed Corix Entity, (ii) a member of the CIUS Board or (iii) an employee of any Contributed Corix Entity at a level of Vice President or above.

4.11 Litigation. There is no suit, action or other proceeding pending or, to the Knowledge of Corix, threatened against or affecting any Contributed Corix Entity or any of their respective properties or assets that is or would reasonably be expected to be, individually or in the aggregate, material to the Contributed Corix Entities, taken as a whole, nor is there any Judgment outstanding against or, to the Knowledge of Corix, demand or investigation by any Governmental Entity involving any Contributed Corix Entity or any of their respective properties or assets that is or would reasonably be expected to be, individually or in the aggregate, material to the Contributed Corix Entities, taken as a whole.

4.12 Compliance with Applicable Laws. The Contributed Corix Entities are in compliance with all applicable Laws and the Corix Water Permits in all material respects. There is no demand or investigation by or before any Governmental Entity pending or, to the Knowledge of Corix, threatened alleging that any Contributed Corix Entity is not in compliance with any applicable Law or Corix Water Permit or which challenges or questions the validity of any rights of the holder of any Corix Water Permit. To the Knowledge of Corix, no material noncompliance with any applicable Law or Corix Water Permit exists. This Section 4.12 does not relate to Tax matters, employee benefits matters, labor and employment matters, environmental matters, Intellectual Property Rights or privacy and data security matters, which are the subjects of Sections 4.8, 4.9, 4.10, 4.15 and 4.19, respectively.

4.13 Permits. Each Contributed Corix Entity has all requisite power and authority and possesses all governmental franchises, licenses, permits, authorizations, variances, easements, exemptions, exceptions, consents, certificates, orders, registrations, permissions, qualifications, clearances and other approvals (collectively, "Permits") necessary to enable each Contributed Corix Entity to own, lease and operate its respective properties and assets or to develop, produce, store, distribute, promote, offer and sell its respective products and services or otherwise to carry on the Corix Water Business as it is now being conducted (collectively, the "Corix Water Permits"), and, as of the date of this Agreement, all such Corix Water Permits are in full force and effect and no suspension, revocation, termination, cancellation, non-renewal, or modification not requested by Corix of any of the Corix Water Permits is pending or, to the Knowledge of Corix, threatened, except where the failure to have such power or authority or to possess the Corix Water Permits is not and would not reasonably be expected to be, individually or in the aggregate, material to the Contributed Corix Entities, taken as a whole. The Contributed Corix Entities are in compliance in all material respects with the terms of the Corix Water Permits.

4.14 Water Quality and Water Rights. The drinking water supplied by the Contributed Corix Entities to their respective customers is and has been in material compliance since December

31, 2020, with all applicable federal, state and provincial drinking water standards. The Contributed Corix Entities have all material rights, authorizations, Permits, easements, prescriptive rights and rights of way, whether or not of record, which are necessary to extract and deliver water to their respective customers in a manner adequate and sufficient for the conduct of its business as currently conducted (the “Corix Water Rights”). Except as would not be material to the Contributed Corix Entities, taken as a whole, there is not any existing material breach or material default by any Contributed Corix Entity under any of the Corix Water Rights which (with or without notice, lapse of time or both) would cause any of the Corix Water Rights to be lost, revoked or compromised or not be satisfied, and to the Knowledge of Corix, there is no other reason to believe that any Corix Water Rights will be lost, revoked or compromised or will not be satisfied.

#### 4.15 Environmental Matters.

(a) Each Contributed Corix Entity is, and, except for matters that have been resolved, has been in compliance with all Environmental Laws in all material respects, and no Contributed Corix Entity has received any written or, to the Knowledge of Corix, oral notice alleging that any Contributed Corix Entity is in material violation of, or has any material liability under, any Environmental Law.

(b) Each Contributed Corix Entity possesses and is in material compliance with all material Permits required under Environmental Laws (“Environmental Permits”) for the conduct of the Corix Water Business as presently conducted and all such Environmental Permits are valid and in good standing or, to the extent any such Environmental Permit has expired, have timely applied for renewal of such Environmental Permit to allow the continued operation of such Contributed Corix Entity’s facility in compliance with applicable Environmental Law.

(c) To the Knowledge of Corix, no act or omission of a Contributed Corix Entity (except for an application to renew or modify a material Environmental Permit made in the ordinary course of business) provides a basis for any material Environmental Permits to be amended, revoked, limited or otherwise conditioned in a manner that would be adverse to the Contributed Corix Entities, taken as a whole.

(d) There are no material Environmental Claims pending or, to the Knowledge of Corix, threatened against or affecting any Contributed Corix Entity.

(e) To the Knowledge of Corix, there has been no Release of or exposure to any Materials of Environmental Concern or, to the Knowledge of Corix, other event, fact, incident, activity, circumstance or condition that would reasonably be expected to form the basis of any material Environmental Claim against any Contributed Corix Entity or result in any material liability under Environmental Laws.

(f) No Contributed Corix Entity has retained or assumed, either contractually or by operation of Law, any liabilities or obligations that would reasonably be expected to form the basis of any Environmental Claim against any Contributed Corix Entity, except in respects that, individually or in the aggregate, have not had and would not reasonably be expected to be material to the Contributed Corix Entities, taken as a whole.



(g) Corix has provided or made available to the SWWC Parties true, correct and complete copies of all environmental assessments, reports or studies (“Environmental Reports”) prepared since December 31, 2011, that are in the possession of the Contributed Corix Entities regarding matters pertaining to the environmental condition of the business and properties of the Contributed Corix Entities, and their compliance (or noncompliance) with any Environmental Laws to the extent that any such Environmental Reports remain material.

For all purposes of this Agreement, (i) “Environmental Claims” means any and all administrative, regulatory or judicial suits, actions, other proceedings, demands, investigations, Judgments, directives, Liens or written or oral notices of noncompliance or violation by or from any Person alleging liability of any kind or nature (including liability or responsibility for costs, fees, expenses, damages, fines, penalties and other losses relating to enforcement proceedings, investigations, cleanup, removal, remediation, mitigation, corrective actions, response actions, natural resource damages, property damages, personal injuries, medical monitoring, penalties, contribution, indemnification and injunctive relief) arising out of, based on or resulting from (A) the presence or Release of, or exposure to, any Materials of Environmental Concern at any location or (B) the failure to comply with any Environmental Law; (ii) “Environmental Law” means any Law, Judgment, Permit or legally binding agreement issued, promulgated or entered into by or with any Governmental Entity relating to pollution, contamination, water quality, natural resources, the climate, human health and safety (as it relates to exposure to or handling of Materials of Environmental Concern) or the protection or conservation of the environment (including ambient and indoor air, surface water, groundwater, land surface or subsurface strata, natural resources or endangered or threatened species); (iii) “Materials of Environmental Concern” means any per- and polyfluoroalkyl substances, petroleum or petroleum products, radioactive materials or wastes, asbestos in any form, polychlorinated biphenyls, hazardous or toxic substances and any other chemical, material, pollutant, contaminant, substance or waste that is prohibited, limited or regulated under any Environmental Law; and (iv) “Release” means any actual or threatened release, spill, emission, leaking, dumping, injection, pouring, deposit, disposal, discharge, dispersal, leaching or migration.

#### 4.16 Contracts.

(a) Section 4.16(a) of the Corix Disclosure Letter sets forth, as of the date of this Agreement, a true and complete list of the following (excluding any Corix Water Benefit Plan and any insurance Contract or policy):

(i) each non-competition Contract or other Contract containing terms that expressly (A) limits or otherwise restricts the Corix Water Business operated by any Contributed Corix Entity or (B) would, after the consummation of the Business Combination, limit or otherwise restrict CIUS from, in the case of either (A) or (B), engaging or competing in any water or wastewater line of business or in any geographic area in a manner that would be reasonably likely to be material, to CIUS (excluding Contracts regarding the disclosure or use of confidential information entered into in the ordinary course of business);

(ii) each loan and credit agreement or other Contract pursuant to which any Indebtedness of any Contributed Corix Entity is outstanding or may be incurred, other than any such Contract between or among the Contributed Corix Entities;

(iii) each partnership, joint venture or similar agreement, Contract to which any Contributed Corix Entity is a party relating to the formation, creation, operation, management or control of any partnership or joint venture, in each case material to the Contributed Corix Entities, taken as a whole;

(iv) each Contract Related to the Corix Water Business entered into since December 31, 2020, providing for the purchase or other acquisition or sale or other disposition (directly or indirectly) by any Contributed Corix Entity of an asset or assets or a business or businesses (*provided* that a disposition resulting from a condemnation process shall not be deemed a disposition for the purposes of this Section 4.16(a)) (A) in which the aggregate purchase or sale price (regardless of whether the consideration paid or received (x) was paid upon closing or paid or to be paid over time, (y) involved an earn-out or other contingency (in which case the amount of the consideration subject to any as yet-unrealized earn-out or other contingency shall be estimated reasonably and in good faith) and (z) in the form of cash, stock, assets, a debt instrument or otherwise) was in excess of \$10,000,000 and (B) under which any of the Contributed Corix Entities have or are reasonably likely to have a payment obligation, including any obligation to make any indemnification payment (other than indemnification with respect to directors and officers) or any payment under any guarantee or other financial obligation, in each case, involving consideration in excess of \$2,000,000;

(v) each Contract relating to or arising from the Corix Water Business, including, but not limited to, an operation or management services or a similar agreement, pursuant to which a Contributed Corix Entity receives (A) annual revenue in excess of \$3,000,000 or (B) aggregate consideration in excess of \$15,000,000;

(vi) each material Contract with a Governmental Entity Related to the Corix Water Business to which any Contributed Corix Entity is a party, other than such Contracts in the ordinary course of business, such as franchise agreements;

(vii) each Contract regarding the Corix Water Business to which any Contributed Corix Entity is a party involving the future disposition or acquisition of assets or properties with a fair market value in excess of \$5,000,000; and

(viii) each Contract with any supplier or vendor Related to the Corix Water Business under which any Contributed Corix Entity is obligated to purchase technology, goods or services involving consideration in excess of \$5,000,000 or, in the case of purchases of technology, equipment, materials and goods, including related capitalized services, Related to the Corix Water Business included in any Contributed Corix Entity's capital budget, \$20,000,000 (except with respect to the purchase of water or wastewater treatment and disposal in the ordinary course of business consistent with past practice).

Each Contract of the type described in this Section 4.16(a) or Section 4.17 is referred to herein as a “Corix Water Material Contract.” Each Corix Water Material Contract that has been made available to the SWWC Parties is a true, correct and complete copy thereof.

(b) Except for matters which are not and would not reasonably be expected to be, individually or in the aggregate, material to the Contributed Corix Entities, taken as a whole, (i) each Corix Water Material Contract (including, for purposes of this Section 4.16(b), any Contract entered into after the date of this Agreement that would have been a Corix Water Material Contract if such Contract existed on the date of this Agreement) is, or after giving effect to the Corix Restructuring will be, a valid, binding and legally enforceable obligation of one of the Contributed Corix Entities, as the case may be, and, to the Knowledge of Corix, of the other parties thereto, except, in each case, as enforcement may be limited by bankruptcy, insolvency, reorganization or similar Laws affecting creditors’ rights generally and by general principles of equity and (ii) each such Corix Water Material Contract is in full force and effect. No Contributed Corix Entity is (with or without notice or lapse of time, or both) in material breach or material default under any such Corix Water Material Contract and, to the Knowledge of Corix, no other party to any such Corix Water Material Contract is (with or without notice or lapse of time, or both) in material breach or material default thereunder.

4.17 Affiliate Transactions. Section 4.17 of the Corix Disclosure Letter sets forth a true and complete list of the Contracts that are in existence as of the date of this Agreement between, on the one hand, any Contributed Corix Entity and, on the other hand, any (x) present executive officer or director of any Contributed Corix Entity or any person that has served as an executive officer or director of any Contributed Corix Entity within the last five years or any of such officer’s or director’s immediate family members, (y) to the Knowledge of Corix, any Affiliate of any such officer or director or (z) Corix or any of its Affiliates (other than any Contributed Corix Entity).

4.18 Contributed Corix Entities’ Real Properties.

(a) (i) A Contributed Corix Entity has good and valid fee simple title to all Material Corix Water Owned Property, in each case, free and clear of all Liens except for Permitted Encumbrances, and (ii) except in respects that, individually or in the aggregate, have not had and would not reasonably be expected to be material to the Contributed Corix Entities, taken as a whole, there is no suit, action or other proceeding pending or, to the Knowledge of Corix, threatened against or affecting any Contributed Corix Entity challenging the applicable Contributed Corix Entity’s fee simple title to the Material Corix Water Owned Property.

(b) Except in respects that, individually or in the aggregate, have not had and would not reasonably be expected to have a Corix Water Material Adverse Effect: (i) a Contributed Corix Entity has good and valid title or fee simple title, as applicable, to all Corix Water Owned Properties that are not Material Corix Water Owned Properties (each, a “Non-Material Corix Water Owned Property”), in each case, free and clear of all Liens, except for Permitted Encumbrances and/or Liens that not currently, or would not reasonably be expected to, individually or in the aggregate, impair the value of any Non-Material Corix Water Owned Property or impair the continued use and operation of any Non-Material Corix Water Owned Property, as presently conducted; and (ii) there is no suit, action or other proceeding pending or, to the Knowledge of Corix, threatened against or affecting any Contributed Corix Entity

challenging the applicable Contributed Corix Entity's fee simple title to any Non-Material Corix Water Owned Property.

(c) (i) The applicable Contributed Corix Entity holds, or after giving effect to the Corix Restructuring will hold, good and subsisting leasehold interests in the Corix Water Leased Property, free and clear of all Liens, except for Permitted Encumbrances and/or Liens which do not, individually or in the aggregate, materially impair and would not reasonably be expected to materially impair the continued use and operation of the Corix Water Leased Property, as presently conducted, and (ii) (1) all Corix Water Leases are in full force and effect and (2) there is not any existing material breach of, or material default under, any Corix Water Lease by any Contributed Corix Entity, and there is not any existing circumstance or event which, with or without notice, lapse of time or both, would become a material breach or material default by any Contributed Corix Entity under the Corix Water Leases.

For all purposes of this Agreement, (i) "Corix Water Owned Property" means the real and personal property (other than the Corix Water Rights and the Corix Water Property Easements) owned by a Contributed Corix Entity and necessary to conduct the Corix Water Business, (ii) "Material Corix Water Owned Property" means the Corix Water Owned Property set forth on Section 4.18 of the Corix Disclosure Letter, (iii) "Corix Water Leased Property" means the real property (other than the Corix Water Rights and the Corix Water Property Easements) leased pursuant to the Corix Water Leases, (iv) "Corix Water Leases" means the leases, subleases, licenses or other occupancy agreements for real property material to the Corix Water Business to which Corix or any Contributed Corix Entity is a party that are currently in effect, of which any copies made available to the SWWC Parties are true, correct and complete and (v) "Corix Water Property" means the Corix Water Leased Property and the Corix Water Owned Property.

(d) Corix or the Contributed Corix Entities have fulfilled and performed all of their material obligations with respect to any material authorizations, permits, easements, prescriptive rights and rights of way pertaining to the Corix Water Property and the Corix Water Rights (the "Corix Water Property Easements") in a manner adequate and sufficient for the conduct of its business as currently conducted, and to the Knowledge of Corix, no event has occurred that would allow, with or without notice or lapse of time or both, revocation or termination thereof or would result in any impairment of the rights of any Contributed Corix Entity with respect to any Corix Water Property Easements.

(e) (i) No condemnation, eminent domain, litigation, administrative action, zoning or other similar proceeding is pending or, to the Knowledge of Corix, threatened against any of the Corix Water Property, (ii) the present use of the land, buildings, structures and improvements on the Corix Water Property are in conformity with applicable Law in all material respects, (iii) no Contributed Corix Entity has leased or otherwise granted to any other Person, except for Permitted Encumbrances, the right to use or occupy any Corix Water Property or any portion thereof, (iv) there are no outstanding options, rights of first offer or rights of first refusal for any other Person to purchase any Corix Water Property or any portion thereof or interest therein, (v) the Corix Water Property and the Corix Water Property Easements, taken as a whole, are in all material respects adequate and sufficient for the conduct of the Corix Water Business, as currently conducted by the Contributed Corix Entities, and (vi) except in respects that, are not and would not reasonably be expected to be, individually or in the aggregate, material to the

Contributed Corix Entities, taken as a whole, all of the Corix Water Property is in good condition and repair, reasonable wear and tear excepted, and is suitable for the purpose for which it is now being used in the conduct of the Corix Water Business by the Contributed Corix Entities.

4.19 Intellectual Property; Information Technology; Privacy and Data Security.

(a) Except for matters that are not and would not reasonably be expected to be, individually or in the aggregate, material to the Contributed Corix Entities, taken as a whole (i) each Contributed Corix Entity exclusively owns any Intellectual Property Rights owned or purported to be owned by it, and, after giving effect to the Corix Restructuring and taking into account the services to be provided under the Transition Services Agreement, is validly licensed or otherwise has the right to use and otherwise exploit, all other Intellectual Property Rights used or exploited in or otherwise necessary for the conduct of its business as currently conducted, (ii) no suits, actions or other proceedings are pending or, to the Knowledge of Corix, threatened that any Contributed Corix Entity is infringing, misappropriating or otherwise violating the Intellectual Property Rights of any Person, (iii) to the Knowledge of Corix, no Person is infringing, misappropriating or otherwise violating any Intellectual Property Rights owned by any Contributed Corix Entity, and (iv) to the Knowledge of Corix, the conduct of the business of the Contributed Corix Entities as currently conducted, does not infringe, misappropriate or otherwise violate, and has not in the past three (3) years, infringed, misappropriated or otherwise violated, the Intellectual Property Rights of any other Person.

(b) The Contributed Corix Entities take commercially reasonable steps to maintain the confidentiality of their material trade secrets included in their owned Intellectual Property Rights. To the Knowledge of Corix, there has been no misappropriation, misuse or breach of confidentiality of any material trade secrets by any Person, except for matters that are not and would not reasonably be expected to be, individually or in the aggregate, material to the Contributed Corix Entities, taken as a whole.

(c) Except for matters that are not and would not reasonably be expected to be, individually or in the aggregate, material to Contributed Corix Entities, taken as a whole, and after giving effect to the Corix Restructuring and taking into account the services to be provided under the Transition Services Agreement, (i) the information technology systems of the Contributed Corix Entities are reasonably sufficient for the conduct of their business as currently conducted, and (ii) the Contributed Corix Entities have and maintain a business continuity and disaster recovery plan for the continuance of their businesses in the event of an unplanned interruption in service or unavailability of the information technology systems of any Contributed Corix Entity.

(d) Except for matters that are not and would not reasonably be expected to be, individually or in the aggregate, material to Contributed Corix Entities, taken as a whole, (i) the Contributed Corix Entities are in compliance with all applicable data privacy and data security Laws; (ii) the Contributed Corix Entities maintain and implement, and have in the past three (3) years, maintained and implemented, commercially reasonable administrative, technical and physical safeguards designed to protect information technology systems of any Contributed Corix Entity and personal data and confidential data stored thereon; (iii) during the past three (3) years, to the Knowledge of Corix, there has been no unauthorized access or use of the information technology systems of any Contributed Corix Entity in a manner that has resulted or could

reasonably be expected to result in any material liability to any Contributed Corix Entity, and (iv) during the past three (3) years, to the Knowledge of Corix, none of the Contributed Corix Entities has been subject to any breach of security whereby personally identifiable information or other personal data in the possession of or under the control of any of the Contributed Corix Entities was disclosed or exfiltrated in a manner that requires notice to affected individuals under applicable data privacy and data security Laws.

4.20 Sufficiency of Assets. After giving effect to the Corix Restructuring and taking into account the services to be provided under the Transition Services Agreement, all of the assets of the Contributed Corix Entities, together with the other properties of the Contributed Corix Entities (and any other assets and properties for which the Contributed Corix Entities have a right to use, including pursuant to the Transition Services Agreement and Section 7.11), constitute all of the assets and properties that are necessary for the Contributed Corix Entities to conduct the Corix Water Business immediately following the Closing as such business was conducted during the 12 months prior to the date of this Agreement except as is not and would not reasonably be expected to be, individually or in the aggregate, material to the Contributed Corix Entities, taken as a whole.

4.21 Insurance. Since December 31, 2020, Corix and the Contributed Corix Entities have maintained continuous insurance coverage, in each case, in those amounts and covering those risks as are in accordance, in all material respects, with normal industry practice for companies of the size and financial condition of Corix engaged in businesses similar to those of the Contributed Corix Entities, taken as a whole. All such insurance policies are in full force and effect and all premiums due on such insurance policies have been paid, except as is not and would not reasonably be expected to be, individually or in the aggregate, material to the Contributed Corix Entities, taken as a whole. No written notice of cancellation or termination has been received by Corix, any Contributed Corix Entity or any of their respective Affiliates with respect to any such insurance policy. There is no material claim by Corix, any Contributed Corix Entity or any of their respective Affiliates pending under any such insurance policy. None of Corix, any Contributed Corix Entity or any of their respective Affiliates are in default under any of such insurance policies. Corix, the Contributed Corix Entities and their respective Affiliates have reported to their respective insurers all known claims under any such insurance policy.

4.22 Brokers' Fees and Expenses. No broker, investment banker, financial advisor or other Person, other than the Corix Financial Advisor is entitled to any broker's, finder's, financial advisor's or other similar fee or commission in connection with the Business Combination or any of the other transactions contemplated by this Agreement based upon arrangements made by or on behalf of any Contributed Corix Entity.

4.23 Anti-Corruption; Anti-Money Laundering; Sanctions.

(a) None of the Contributed Corix Entities nor, to the Knowledge of Corix, any of their respective directors, officers, employees or other Persons acting on behalf of any of the foregoing, directly or indirectly in relation to the Contributed Corix Entities, has, since the date falling five (5) years prior to the date of this Agreement:

(i) violated any applicable Anti-Corruption Laws in any material respect;

(ii) made, offered or promised to make, or authorized the payment or giving of money, or anything else of value, to any (x) executive, official, employee or Person acting in an official capacity for or on behalf of a Governmental Entity, (y) Government Official, or (z) any other Person, while knowing or believing that all or some portion of the money or value will be offered, given or promised to a Government Official or other Person, in the case of clause (x), (y) or (z), for the purposes of obtaining or retaining business or securing any improper advantage in violation of any Anti-Corruption Law or in other circumstances when such offer, payment or promise would be unlawful; or

(iii) been the subject of any suit, action or other proceeding or, to the Knowledge of Corix, investigation with regard to any actual or alleged breach of any Anti-Corruption Law.

(b) Each of the Contributed Corix Entities, and to the Knowledge of Corix, any Person controlling any Contributed Corix Entity (in each case, solely with respect to their relationship with such Contributed Corix Entity) is in compliance in all material respects with all applicable AML Laws in the jurisdictions in which each Contributed Corix Entity, or any Person controlling a Contributed Corix Entity, as applicable, operates.

(c) No Contributed Corix Entity is a Sanctioned Person.

(d) No Contributed Corix Entity will use any of the proceeds from any amounts received by any Contributed Corix Entity under this Agreement, if any, (i) for the purpose of funding, financing or facilitating any activities, business or transaction of or with any Sanctioned Person, or in any country or region that is the subject of comprehensive Sanctions, except to the extent permitted under applicable Sanctions, or (ii) in any manner that would result in the violation of any Sanctions by any Party.

(e) None of the Contributed Corix Entities, nor, to the Knowledge of Corix, any Person controlling any Contributed Corix Entity, is a Senior Foreign Political Figure, an immediate family member of a Senior Foreign Political Figure, or a close associate of a Senior Foreign Political Figure.

(f) None of the Contributed Corix Entities, nor, to the Knowledge of Corix, any Person controlling any Contributed Corix Entity is a foreign shell bank, as defined in 31 C.F.R. § 1010.605(g).

4.24 No Additional Representations. Except for those representations and warranties expressly set forth in this Article IV and except as otherwise expressly set forth in this Agreement, none of the Contributed Corix Entities or other Person acting on behalf of the Contributed Corix Entities has made or makes any representation or warranty of any kind or nature, express or implied, with respect to the Contributed Corix Entities or any of their Affiliates or any of their respective businesses, operations, assets, liabilities, conditions (financial or otherwise) or prospects in connection with this Agreement or the transactions contemplated by this Agreement.

In addition, without limiting the generality of the foregoing, none of the Contributed Corix Entities or other Person acting on behalf of the Contributed Corix Entities has made or makes any representation or warranty with respect to any projections, estimates or budgets made available to the SWWC Parties or their respective Affiliates of future revenues, future results of operations (or any component thereof), future cash flows or future financial condition (or any component thereof) of the Contributed Corix Entities or the future business and operations of CIUS or its future Subsidiaries.

## ARTICLE V

### **REPRESENTATIONS AND WARRANTIES OF IIF SUBWAY**

IIF Subway represents and warrants to the Corix Parties that the statements contained in this Article V are true and correct, except as set forth in the disclosure letter delivered by SWWC to the Corix Parties prior to the execution and delivery by the SWWC Parties of this Agreement (the “SWWC Disclosure Letter”).

5.1 Due Organization and Good Standing. IIF Subway is duly organized, validly existing and in good standing under the laws of the jurisdiction in which it is organized (in the case of good standing, to the extent such jurisdiction recognizes such concept), except where the failure to be so organized, existing or in good standing, individually or in the aggregate, has not had and would not reasonably be expected to materially impair or delay its ability to (a) perform its obligations under this Agreement and each Ancillary Agreement to which it is or will be a party or (b) to consummate the Business Combination.

5.2 Authority; Binding Nature of Agreement.

(a) IIF Subway has all requisite corporate power and authority to execute and deliver this Agreement and the other Ancillary Agreements to which it is or will be a party and to consummate the Business Combination and the other transactions contemplated by this Agreement. The execution and delivery of this Agreement and the consummation of the Business Combination and the transactions contemplated hereby have been duly and validly authorized and no other corporate proceedings are necessary to authorize, adopt or approve this Agreement or to consummate the Business Combination and the other transactions contemplated by this Agreement. IIF Subway has duly executed and delivered this Agreement and, assuming the due authorization, execution and delivery by the other Parties, this Agreement constitutes the legal, valid and binding obligation of IIF Subway, enforceable against IIF Subway in accordance with its terms, except as enforcement may be limited by bankruptcy, insolvency, reorganization or similar Laws affecting creditors’ rights generally and by general principles of equity.

(b) IIF Subway has provided Corix with a true and complete copy of the Bazos Letter Agreement (it being understood that the copy of the Bazos Letter Agreement provided to Corix has been redacted to remove commercially sensitive information set forth therein that does not adversely affect the approval by MR Bazos LP of the Business Combination as set forth therein).

5.3 No Conflicts; Consents.



(a) IIF Subway's execution and delivery of this Agreement does not, and IIF Subway's performance of its covenants and agreements hereunder and under each Ancillary Agreement to which it is or will be a party will not, conflict with, or result in any violation of or default (with or without notice or lapse of time, or both) under, or give rise to a right of termination, cancelation or acceleration of any obligation, or result in the creation of any Lien upon any of the properties or assets of IIF Subway under any provision of, (i) its Organizational Documents, (ii) any Contract to which IIF Subway is a party or by which any of its properties or assets is bound or (iii) any SWWC Permit, other than in the case of clauses (ii) and (iii) above, any matters that, individually or in the aggregate, have not had and would not reasonably be expected to prevent or materially impede, interfere with, hinder or delay the consummation of the Business Combination.

(b) Other than the filings and other matters referred to in Section 6.4(b), no Consent of or from, or registration, declaration, notice or filing made to or with, any Governmental Entity, is required to be obtained or made by or with respect to IIF Subway, other than any Consents that, individually or in the aggregate, have not had and would not reasonably be expected to prevent or materially impede, interfere with, hinder or delay the consummation of the Business Combination.

#### 5.4 Title.

(a) As of the date of this agreement, each of IIF Subway and Bazos has good and valid title to its respective Equity Interests in SWMAC, free and clear of all Liens (other than restrictions generally imposed on securities under U.S. or Canadian federal, state or provincial or foreign securities Laws or utility Laws and restrictions created, directly or indirectly, under this Agreement), and after giving effect to the SWMAC Restructuring, SWMAC Holdco will have good and valid title to the Equity Interests in SWMAC, free and clear of all Liens (other than restrictions generally imposed on securities under U.S. or Canadian federal, state or provincial or foreign securities Laws or utility Laws and restrictions created, directly or indirectly, under this Agreement). Except as set forth in SWMAC's Organizational Documents and in this Agreement, none of the Equity Interests in SWMAC are subject to any shareholder agreement, investor rights agreement, registration rights agreement, voting agreement or trust, proxy or other Contract restricting or otherwise relating to the voting, dividend rights or disposition of such Equity Interests.

(b) Upon the consummation of the SWMAC Equity Exchange, CIUS will receive good and valid title to the SWMAC Interests, free and clear of all Liens, except for any Liens created, directly or indirectly, under this Agreement, and the SWMAC Interests will not be subject to any voting or transfer restrictions (other than restrictions generally imposed on securities under U.S. federal or state or foreign securities Laws or utility Laws and restrictions created, directly or indirectly, under this Agreement).

5.5 Financing. IIF Subway has delivered or caused to be delivered to Corix the IIF Balancing Payment Commitment Letter, pursuant to which, and on the terms and conditions thereof, the IIF Sponsor has agreed and committed to provide or cause to be provided the IIF Balancing Payment Commitment as provided therein. The IIF Balancing Payment Commitment Letter is in full force and effect and has not been amended, restated or otherwise modified or waived, and the respective commitments contained in the IIF Balancing Payment Commitment

Letter have not been withdrawn, modified or rescinded in any respect. The IIF Balancing Payment Commitment Letter contains all of the conditions precedent to the obligations of the IIF Sponsor to fund the IIF Balancing Payment Commitment, if applicable. The IIF Balancing Payment Commitment Letter has been duly and validly executed and delivered by IIF Subway and IIF Sponsor and is a legal, valid and binding obligation of IIF Subway and the IIF Sponsor enforceable against IIF Subway and the IIF Sponsor in accordance with its terms, except as enforcement may be limited by bankruptcy, insolvency, reorganization or similar Laws affecting creditors' rights generally and by general principles of equity. The aggregate proceeds of the IIF Balancing Payment Commitment shall be sufficient to pay the SHL Balancing Payment and the Estimated Adjusted Equity Balancing Payment Amount on the Closing Date, if payable by IIF Subway or SWMAC Holdco, and IIF Subway has no reason to believe that any of the conditions precedent to the obligations of the IIF Sponsor to fund the IIF Balancing Payment Commitment on the terms therein will not be satisfied or that such amount of the IIF Balancing Payment Commitment will not be available to IIF Subway or SWMAC Holdco as of the Closing. Each of IIF Subway and the IIF Sponsor has the requisite power and authority to execute and deliver, and to perform its covenants, agreements and obligations under, the IIF Balancing Payment Commitment Letter. The execution and delivery of the IIF Balancing Payment Commitment Letter by IIF Subway and the IIF Sponsor and the performance by each of IIF Subway and the IIF Sponsor of their respective covenants and agreements thereunder have been duly and validly authorized by IIF Subway and the IIF Sponsor, respectively. As of the date hereof, no event has occurred that, with or without notice or lapse of time or both, would reasonably be expected to constitute a breach or default of any provision of the IIF Balancing Payment Commitment Letter by IIF Subway, constitute or assuming satisfaction of the conditions to Closing set forth in Article VIII result in a failure to satisfy a condition precedent to or other contingency to be satisfied set forth in the IIF Balancing Payment Commitment Letter or otherwise cause any portion of the IIF Balancing Payment Commitment to be unavailable.

5.6 Claims; Orders. Except as would not reasonably be expected to prevent or materially impede, interfere with, hinder or delay the consummation of the Business Combination, (a) there is no suit, action or other proceeding pending, or, to the Knowledge of IIF Subway, threatened against IIF Subway, Bazos or SWMAC and (b) none of IIF Subway, Bazos or SWMAC is subject to any Judgment.

5.7 Brokers. Other than CIBC World Markets Corp. (the "IIF Subway Financial Advisor"), no broker, finder or investment banker is entitled to any brokerage, finder's or other similar fee or commission in connection with the transactions contemplated hereby based on arrangements made by or on behalf of IIF Subway or its Affiliates.

5.8 Anti-Corruption; Anti-Money Laundering; Sanctions.

(a) None of IIF Subway or Bazos (each, solely with respect to its respective relationship with SWMAC, SWWC or any SWWC Subsidiary), nor, to the Knowledge of IIF Subway, any of their respective directors, officers, employees or other Persons acting on behalf of any of the foregoing, directly or indirectly in relation to SWMAC, SWWC or any SWWC Subsidiary, has, since the date falling five (5) years prior to the date of this Agreement:

(i) violated any applicable Anti-Corruption Laws in any material respect;

(ii) made, offered or promised to make, or authorized the payment or giving of money, or anything else of value, to any (x) executive, official, employee or Person acting in an official capacity for or on behalf of a Governmental Entity, (y) Government Official, or (z) any other Person, while knowing or believing that all or some portion of the money or value will be offered, given or promised to a Government Official or other Person, in the case of clause (x), (y) or (z), for the purposes of obtaining or retaining business or securing any improper advantage in violation of any Anti-Corruption Law or in other circumstances when such offer, payment or promise would be unlawful; or

(iii) been the subject of any suit, action or other proceeding or, to the Knowledge of IIF Subway, investigation with regard to any actual or alleged breach of any Anti-Corruption Law.

(b) Each of IIF Subway, Bazos and any Person controlling IIF Subway or Bazos (in each case, solely with respect to their relationship with SWMAC) is in compliance in all material respects with all applicable AML Laws in the jurisdictions in which IIF Subway, Bazos or any Person controlling IIF Subway, Bazos or SWMAC, as applicable, operates.

(c) None of IIF Subway, Bazos or any Person controlling IIF Subway or Bazos is a Sanctioned Person.

(d) None of IIF Subway, Bazos or to the Knowledge of IIF Subway, any Person controlling IIF Subway or Bazos, will use any amounts received by such Person under this Agreement, if any, (i) for the purpose of funding, financing or facilitating any activities, business or transaction of or with any Sanctioned Person, or in any country or region that is the subject of comprehensive Sanctions, except to the extent permitted under applicable Sanctions, or (ii) in any manner that would result in the violation of any Sanctions by any Party.

(e) None of IIF Subway, Bazos, or any Person controlling IIF Subway or Bazos is a Senior Foreign Political Figure, an immediate family member of a Senior Foreign Political Figure, or a close associate of a Senior Foreign Political Figure.

(f) None of IIF Subway, Bazos, or any Person controlling IIF Subway or Bazos is a foreign shell bank, as defined in 31 C.F.R. § 1010.605(g).

5.9 No Additional Representations. Except for those representations and warranties expressly set forth in Articles V and VI and except as otherwise expressly set forth in this Agreement, none of IIF Subway or any other Person acting on behalf of IIF Subway, has made or makes any representation or warranty of any kind or nature, express or implied, with respect to SWMAC, SWWC or any of the SWWC Subsidiaries, their Affiliates or any of their respective businesses, operations, assets, liabilities, conditions (financial or otherwise) or prospects in connection with this Agreement or the transactions contemplated by this Agreement. In addition, without limiting the generality of the foregoing, IIF Subway has not made and does not make any representation or warranty with respect to any projections, estimates or budgets made available to

the Corix Parties or their respective Affiliates of future revenues, future results of operations (or any component thereof), future cash flows or future financial condition (or any component thereof) of SWMAC, SWWC or the SWWC Subsidiaries or the future business and operations of CIUS or its future Subsidiaries.

## ARTICLE VI

### **REPRESENTATIONS AND WARRANTIES ABOUT SWWC AND SWMAC**

The SWWC Parties represent and warrant to the Corix Parties that the statements contained in this Article VI are true and correct, except as set forth in the SWWC Disclosure Letter.

6.1 Organization, Standing and Power. Each of SWMAC, SWWC and each of its Subsidiaries (the “SWWC Subsidiaries”) is duly organized, validly existing and in good standing under the laws of the jurisdiction in which it is organized (in the case of good standing, to the extent such jurisdiction recognizes such concept), except where the failure to be so organized, existing or in good standing, individually or in the aggregate, is not and would not reasonably be expected to be, individually or in the aggregate, material to SWMAC, SWWC and the SWWC Subsidiaries, taken as a whole. Each of SWMAC, SWWC and each SWWC Subsidiary is duly qualified or licensed to do business in each jurisdiction where the nature of its business or the ownership, operation or leasing of its properties and assets makes such qualification necessary, other than in such jurisdictions where the failure to be so qualified or licensed, individually or in the aggregate, has not had and would not reasonably be expected to have an SWWC Material Adverse Effect. IIF Subway has made available to the Corix Parties, prior to execution of this Agreement, true, correct and complete copies of the applicable Organizational Documents of SWMAC, SWWC and the SWWC Subsidiaries.

6.2 Capital Structure.

(a) All the outstanding Equity Interests in SWMAC, SWWC and each SWWC Subsidiary have been validly issued and are fully paid and nonassessable and, in the case of SWMAC, are wholly owned by IIF Subway and Bazos, and in the case of SWWC and the SWWC Subsidiaries, are wholly owned by SWMAC, SWWC, by an SWWC Subsidiary or by SWWC and another SWWC Subsidiary, free and clear of all Liens, and free of any other restriction (including any restriction on the right to vote, sell or otherwise dispose of such Equity Interests), except for restrictions set forth in each of SWMAC’s and SWWC’s respective Organizational Documents or restrictions generally imposed on securities under federal and state securities Laws applicable to securities generally or utility Laws. Except as set forth in SWWC Subsidiary’s Organizational Documents and in this Agreement or the Ancillary Agreements, none of the Equity Interests in SWWC or the SWWC Subsidiaries are subject to any shareholder agreement, investor rights agreement, registration rights agreement, voting agreement or trust, proxy or other Contract restricting or otherwise relating to the voting, dividend rights or disposition of such Equity Interests.

(b) Section 6.2(b) of the SWWC Disclosure Letter lists the authorized and outstanding capitalization of SWMAC, SWWC and each SWWC Subsidiary as of the date hereof. Each SWWC Subsidiary holding Equity Interests in any other SWWC Subsidiary, as shown on

Section 6.2(b) of the SWWC Disclosure Letter, has good and valid title to all such Equity Interests in such other SWWC Subsidiary, free and clear of any Liens (other than restrictions generally imposed on securities under federal and state securities Laws applicable to securities generally or utility Laws).

(c) Except for Equity Interests in SWWC and each SWWC Subsidiary, none of SWMAC, SWWC and or any SWWC Subsidiary owns, directly or indirectly, any Equity Interests in, or any interest convertible into or exchangeable or exercisable for, any Equity Interests in, any firm, corporation, partnership, company, limited liability company, trust, joint venture, association or other entity other than ordinary course investments in publicly traded securities constituting one percent or less of a class of outstanding securities of any entity.

(d) There are no outstanding securities convertible into or exchangeable for Equity Interests in SWMAC, SWWC or any SWWC Subsidiary or any options, warrants, phantom stock, stock appreciation rights, profit participation, purchase rights, subscription rights, conversion rights, exchange rights, calls, puts, rights of first refusal or first offer, preemptive rights, convertible securities or other Contracts that could require SWMAC, SWWC or any SWWC Subsidiary to issue, sell or otherwise cause to become outstanding or to acquire, repurchase or redeem Equity Interests in SWMAC, SWWC or any SWWC Subsidiary.

6.3 Authority; Execution and Delivery; Enforceability. Each of SWMAC and SWWC has all requisite corporate power and authority to execute and deliver this Agreement, to perform its respective obligations hereunder and to consummate the Business Combination and the other transactions contemplated by this Agreement. The execution and delivery of this Agreement and the consummation of the Business Combination and the transactions contemplated hereby have been duly and validly authorized by each of the SWWC Board and the SWMAC Board and no other corporate proceedings are necessary to authorize, adopt or approve this Agreement or to consummate the Business Combination and the other transactions contemplated by this Agreement. Each of SWMAC and SWWC has duly executed and delivered this Agreement and, assuming the due authorization, execution and delivery by the other Parties, this Agreement constitutes the legal, valid and binding obligation of SWMAC and SWWC, enforceable against each of SWMAC and SWWC in accordance with its terms, except as enforcement may be limited by bankruptcy, insolvency, reorganization or similar Laws affecting creditors' rights generally and by general principles of equity.

6.4 No Conflicts; Consents.

(a) The execution and delivery by each of SWMAC and SWWC of this Agreement does not, and the performance by each of SWMAC and SWWC of its obligations hereunder and the consummation of the Business Combination and the other transactions contemplated by this Agreement will not, conflict with, or result in any violation of or default (with or without notice or lapse of time, or both) under, or give rise to a right of termination, cancelation or acceleration of any obligation, or result in the creation of any Lien upon any of the properties or assets of SWMAC, SWWC or any SWWC Subsidiary under, any provision of (i) the Organizational Documents of SWMAC, SWWC or any SWWC Subsidiary, (ii) subject to the filings and other matters referred to in Section 6.4(b), any Contract to which SWMAC, SWWC or any SWWC Subsidiary is a party or by which any of their respective properties or assets is bound

or any SWWC Permit or (iii) subject to the filings and other matters referred to in Section 6.4(b), any Judgment or Law, in each case applicable to SWMAC, SWWC or any SWWC Subsidiary or their respective properties or assets, other than, in the case of clauses (ii) and (iii) above, any matters that, individually or in the aggregate, are not and would not reasonably be expected to be material to SWMAC, SWWC and the SWWC Subsidiaries, taken as a whole and would not prevent or materially impede, interfere with, hinder or delay the consummation of the Business Combination.

(b) No Consent of or from, or made to or with, any Governmental Entity, is required to be obtained or made by or with respect to any SWWC Party or any Affiliate thereof in connection with the execution and delivery of this Agreement or its performance of its obligations hereunder or the consummation of the Business Combination and the other transactions contemplated by this Agreement, other than (i) compliance with and filings under the HSR Act, (ii) CFIUS Approval with respect to the Business Combination, (iii) the Competition Act Approval, (iv) the ICA Approval, (v) such Consents required by the applicable Governmental Entities with jurisdiction over the SWWC Subsidiaries, and (vi) any pre-approvals of license transfers by the Federal Communications Commission (the Consents in (i), (ii), (iii), (iv), (v) and (vi) collectively, the “SWWC Regulatory Approvals”).

#### 6.5 Financial Statements; Undisclosed Liabilities.

(a) True, correct and complete copies of (i) the audited consolidated balance sheet of SWWC and the SWWC Subsidiaries for each of the two fiscal years ended December 31, 2021 and December 31, 2020, and the related audited consolidated statements of operations, changes in stockholder’s equity and cash flows of SWWC and the SWWC Subsidiaries, together with all related notes and schedules thereto (collectively, the “SWWC Audited Financial Statements”) and (ii) the unaudited consolidated balance sheet of SWWC and the SWWC Subsidiaries as of the Interim Balance Sheet Date, and the related statements of operations, changes in stockholder’s equity and cash flows of SWWC and the SWWC Subsidiaries for the six (6) months then ended (collectively, the “SWWC Interim Financial Statements,” and together with the SWWC Audited Financial Statements, the “SWWC Financial Statements”), have been made available to the Corix Parties.

(b) The SWWC Financial Statements (i) present fairly in all material respects the financial condition and results of operations of SWWC and the SWWC Subsidiaries as of the dates thereof or for the periods covered thereby, and (ii) have been prepared in accordance with GAAP, applied on a basis consistent with the past practices of SWWC, except, with respect to clauses (i) and (ii), in the case of the SWWC Interim Financial Statements, for the absence of footnote disclosure and normal and recurring year-end adjustments, none of which would be material (whether individually or in the aggregate).

(c) Except as adequately reserved for in the SWWC Interim Financial Statements, SWWC and the SWWC Subsidiaries have no liabilities or obligations, contingent or otherwise, other than (i) liabilities incurred in the ordinary course of business subsequent to the Interim Balance Sheet Date (none of which is a liability resulting from breach of contract, breach of warranty, tort, infringement or misappropriation); (ii) obligations under Contracts incurred in the ordinary course of business; (iii) liabilities and obligations of a type or nature not required

under GAAP to be reflected in financial statements; and (iv) liabilities or obligations that are not and would not reasonably be expected to be, individually or in the aggregate, material to SWWC and the SWWC Subsidiaries, taken as a whole. SWWC maintains a standard system of accounting established and administered in accordance with GAAP.

#### 6.6 Regulation as a Utility.

(a) Each SWWC Subsidiary set forth in Section 6.6(a) of the SWWC Disclosure Letter (the “Regulated SWWC Subsidiaries”) is a regulated public utility or public service company (or similar designation) in the jurisdiction, and by the Governmental Entity, listed opposite such SWWC Subsidiary. Section 6.6(a) of the SWWC Disclosure Letter sets forth, as of the date of this Agreement, a true and complete list of the Regulatory Adjustments, including the amount of such adjustment as of the date of the last order by a Governmental Entity having jurisdiction over the rates of the Regulated SWWC Subsidiaries, made to or that directly offset the amounts represented in the balances of property, plant and equipment at cost, accumulated depreciation, contributions in aid of construction (net), and advances in aid of construction as set forth in the SWWC Interim Financial Statements. As of the date of the Interim Balance Sheet Date, no amount in excess of \$250,000 represented in the balances of property, plant and equipment at cost, accumulated depreciation, contributions in aid of construction (net), and advances in aid of construction as set forth in the SWWC Interim Financial Statements is required to be expensed in accordance with GAAP because of an order by a Governmental Entity having jurisdiction over the rates of the SWWC Subsidiaries.

(b) Since December 31, 2020, SWWC and each SWWC Subsidiary has filed with the appropriate Governmental Entities all documents required to be filed by it under applicable state utility Laws, except for filings the failure of which are not and would not reasonably be expected to be, individually or in the aggregate, material to SWWC and the SWWC Subsidiaries, taken as a whole. All such documents complied in all material respects, as of the date so filed, with all applicable requirements of the applicable statute and rules and regulations thereunder.

(c) As of the date hereof, neither SWWC nor any SWWC Subsidiary is subject to regulation as a public utility or public service company (or similar designation) by any state in the United States or province in Canada, other than the Regulated SWWC Subsidiaries.

6.7 Absence of Certain Changes or Events. From December 31, 2021, to the date of this Agreement, SWWC and each SWWC Subsidiary has conducted the SWWC Business in the ordinary course in all material respects, and during such period there has not occurred:

(a) any fact, circumstance, effect, change, event or development that, individually or in the aggregate, has had or would reasonably be expected to have an SWWC Material Adverse Effect;

(b) any incurrence of material Indebtedness for borrowed money or any guarantee of such Indebtedness for another Person that is not SWWC or an SWWC Subsidiary, or any issue or sale of debt securities, warrants or other rights to acquire any debt security of SWWC

or any SWWC Subsidiary other than draws on existing revolving credit facilities in the ordinary course of business;

(c) any change in financial accounting methods, principles or practices by SWWC or any SWWC Subsidiary, except insofar as may have been required by a change in GAAP or Law; or

(d) any material elections or changes thereto with respect to Taxes by SWWC or any SWWC Subsidiary or any settlement or compromise by SWWC or any SWWC Subsidiary of any material Tax liability or refund, other than in the ordinary course of business.

#### 6.8 Taxes.

(a) All income and other material Tax Returns filed or required by applicable Law to be filed with any Taxing Authority by, or on behalf of, SWMAC, SWWC or any SWWC Subsidiary (each such Tax Return, a “SWWC Tax Return”) have been filed when due in accordance with all applicable Law (taking into account any extension of time within which to file), and all such income and other material SWWC Tax Returns are, or shall be at the time of filing, true and complete in all material respects.

(b) SWMAC, SWWC and each SWWC Subsidiary has paid (or has had paid on its behalf) to the appropriate Taxing Authority all material Taxes (whether or not shown as due and payable on any SWWC Tax Return), or, where payment is not yet due, has established (or has had established on its behalf and for its sole benefit and recourse) in accordance with GAAP an adequate accrual for all material Taxes through the end of the last period for which SWMAC, SWWC and such SWWC Subsidiary ordinarily record items on their respective books.

(c) SWMAC, SWWC and each SWWC Subsidiary has duly and timely withheld all material Taxes required to be withheld from any payment or distribution to any Person and such withheld Taxes have been or will be duly and timely paid to the appropriate Taxing Authority.

(d) There is no suit, action, audit, claim, assessment, levy, inquiry, investigation, dispute or other administrative or judicial proceeding or investigation now pending or, to the Knowledge of SWMAC or SWWC, threatened against or with respect to SWMAC, SWWC or any SWWC Subsidiary in respect of any material Taxes.

(e) No deficiency with respect to material Taxes has been proposed, asserted or assessed in writing against SWMAC, SWWC or any SWWC Subsidiary, which has not been fully paid.

(f) None of SWMAC, SWWC or any SWWC Subsidiary (i) is now or has been a member of an “affiliated group” as defined in Section 1504 of the Code (or any similar provision of any applicable Tax Law), other than an “affiliated group” of which SWWC or SWMAC is the common parent or (ii) has any liability for the Taxes of any other Person under Treasury Regulation Section 1.1502-6 (or any similar provision of any applicable Law), as a transferee or successor, or by any other applicable provision of applicable Law.



(g) During the preceding two-year period or otherwise as part of a plan (within the meaning of Section 355(e) of the Code) that includes the transactions contemplated hereunder, none of SWMAC, SWWC or any SWWC Subsidiary was a distributing corporation or a controlled corporation in a transaction intended to be governed by Section 355 of the Code.

(h) None of SWMAC, SWWC or any of the SWWC Subsidiaries (i) is a party to or bound by, or has any liability under any Tax allocation, indemnification, sharing or similar agreement, other than (x) any such agreement solely between or among SWMAC, SWWC and/or one or more of the SWWC Subsidiaries or (y) customary indemnifications for Taxes contained in credit or other commercial agreements the primary purposes of which do not relate to Taxes, or (ii) has granted any power of attorney with respect to any matters related to Taxes that is currently in force.

(i) Section 6.8(i) of the SWWC Disclosure Letter sets forth the entity classification of each SWWC Subsidiary for U.S. federal income tax purposes.

(j) There are no waivers, extensions or requests for any waivers or extensions of any statute of limitations currently in effect with respect to any material Taxes of SWMAC, SWWC or any SWWC Subsidiary (other than extensions granted in connection with extensions of time to file Tax Returns obtained in the ordinary course of business).

(k) No written claim has been made by any Governmental Entity in a jurisdiction where SWMAC, SWWC or any SWWC Subsidiary does not file Tax Returns that SWMAC, SWWC or such SWWC Subsidiary is or may be subject to taxation by that jurisdiction.

(l) None of SWMAC, SWWC or any SWWC Subsidiary (i) has a permanent establishment (within the meaning of an applicable Tax treaty), branch, or other fixed place of business, or (ii) has otherwise been, or deemed to be, engaged in a trade or business in any jurisdiction, other than its own country of incorporation or formation. None of SWMAC, SWWC or any SWWC Subsidiary currently has or has had nexus (within the meaning of the applicable Law of any applicable U.S. state) in any U.S. state where SWMAC, SWWC or such SWWC Subsidiary, as applicable, does not currently, or did not at the applicable time, file Tax Returns and pay Taxes.

(m) There are no Liens for material Taxes upon any property or assets of SWMAC, SWWC or any SWWC Subsidiary, except for Liens for Taxes (x) not yet due and payable or (y) which are being contested in good faith by appropriate proceedings and with respect to which adequate reserves have been established in accordance with GAAP.

(n) None of SWMAC, SWWC or any SWWC Subsidiary will be required to include material amounts in income, or exclude or reduce material items of deduction, in a taxable period for which a Tax Return has not yet been filed as a result of any (i) change in or improper use of any method of accounting pursuant to Section 481 of the Code (or any corresponding or similar provision of any state, local or non-U.S. Tax Law) prior to the Closing Date, (ii) "closing agreement" within the meaning of Section 7121 of the Code (or any corresponding or similar provision of any state, local or non-U.S. Tax Law) executed prior to the Closing, (iii) installment sale or open transaction made or entered into prior to the Closing, (iv) any prepaid amount received

or deferred revenue accrued prior to the Closing, (v) intercompany transaction consummated or excess loss account existing on or prior to the Closing Date, in either case described in the Treasury Regulations under Section 1502 of the Code (or any corresponding or similar provision of any state, local or non-U.S. Tax Law).

(o) None of SWMAC, SWWC or any SWWC Subsidiary is, nor will be, required to include any amount in income for a taxable year ending after December 31, 2017, as a result of the application of Section 965 of the Code, nor has made an election under Section 965(h) of the Code.

(p) None of SWMAC, SWWC or any SWWC Subsidiary has made a request for an advance tax ruling, a request for technical advice, a request for a change of any method of accounting or any similar request that is in progress or pending with any Governmental Entity with respect to any material Taxes.

(q) None of SWMAC, SWWC or any SWWC Subsidiary has entered into or been a party to any “listed transaction” within the meaning of Treasury Regulations Section 1.6011-4(b)(2).

(r) None of SWMAC, SWWC or any of the SWWC Subsidiaries has received any relief, assistance or benefit, including any deferral of Taxes, from any Governmental Entity under any COVID-19 Relief Legislation.

(s) SWMAC, SWWC and each of the SWWC Subsidiaries has duly and timely collected from all of its past and present customers (or other Persons paying amounts to SWMAC, SWWC or any of the SWWC Subsidiaries) the amount of all Taxes required to be collected and has timely paid such Taxes when due to the appropriate Governmental Entity, in the form required under applicable Laws or made adequate provision for the payment of such amounts to the proper receiving authorities.

(t) None of SWMAC, SWWC or any of the SWWC Subsidiaries has taken any action, nor to the Knowledge of SWMAC or SWWC, are there any facts or circumstances, that could reasonably be expected to prevent the SWMAC Equity Exchange and the Merger, taken together, from qualifying as a “reorganization” within the meaning of Section 368(a) of the Code and the Treasury Regulations.

(u) Notwithstanding anything to the contrary in this Agreement, this Section 6.8 (and so much of Section 6.7 and Section 6.9 as each relates to Taxes) are the sole representations and warranties given by SWMAC, SWWC or any SWWC Subsidiary in this Agreement, and no other representation or warranty given by SWMAC, SWWC or any SWWC Subsidiary in this Agreement shall be construed or interpreted as containing any representation or warranty, in each case with respect to Tax matters. Nothing in this Agreement (including this Section 6.8) shall be construed as providing a representation or warranty with respect to the existence, amount, expiration date or limitations on (or availability of) any net operating loss, net capital loss, Tax credit or any other Tax attribute of SWMAC, SWWC or any SWWC Subsidiary. Notwithstanding anything to the contrary in this Agreement, the representations and warranties made in this Section 6.8 (other than Section 6.8(i) and (n)) refer only to the past activities of

SWMAC, SWWC or any SWWC Subsidiary and are not intended to serve as representations to, or a guarantee of, nor can they be relied upon with respect to, Taxes attributable to any Tax periods (or portions thereof) beginning after, or Tax positions taken after, the Closing Date.

#### 6.9 Employee Benefits.

(a) Section 6.9(a) of the SWWC Disclosure Letter sets forth a correct and complete list of each material SWWC Benefit Plan. With respect to each material SWWC Benefit Plan, to the extent applicable, true, correct and complete copies of the following have been delivered or made available to Corix by the SWWC Parties: (i) the SWWC Benefit Plan, if written (including all amendments and attachments thereto), (ii) a written summary, if the SWWC Benefit Plan is not in writing, (iii) all related trust documents, (iv) all insurance contracts or other funding arrangements, (v) the most recent annual report (Form 5500) filed with the IRS, (vi) the most recent determination, opinion or advisory letter from the IRS, (vii) the most recent summary plan description and any summary of material modifications thereto, (viii) all material filings and communications received from or sent to any Governmental Entity with respect to an SWWC Benefit Plan and (ix) the most recent audited financial statement and/or actuarial valuation.

(b) Each SWWC Benefit Plan has been established, operated and administered in accordance with its terms and the requirements of all applicable Laws, including ERISA and the Code, in all material respects. Contributions required to be made to any SWWC Benefit Plan by applicable Law or by any plan document or other contractual undertaking, and all premiums due or payable with respect to insurance policies funding any SWWC Benefit Plan, have been timely made or paid in full in all material respects or, to the extent not required to be made or paid on or before the date hereof, have been fully reflected on the books and records of SWWC to the extent required under GAAP. There are no pending or, to the Knowledge SWWC, threatened material claims (other than routine claims for benefits) by, on behalf of or against any of the SWWC Benefit Plans or any trusts related thereto.

(c) Section 6.9(c) of the SWWC Disclosure Letter identifies each SWWC Benefit Plan that is intended to be qualified under Section 401(a) of the Code (each, a “SWWC Qualified Plan”). The IRS has issued a favorable determination, opinion or advisory letter with respect to each SWWC Qualified Plan and its related trust, or with respect to a prototype SWWC Qualified Plan, the prototype sponsor has received a favorable IRS opinion or advisory letter, or the SWWC Qualified Plan or prototype sponsor has remaining a period of time under applicable Code regulations or pronouncements of the IRS in which to apply for such a letter and make any amendments necessary to obtain a favorable determination, advisory or opinion as to the qualified status of each such SWWC Qualified Plan, and, if issued, such determination, advisory or opinion letter has not been revoked (nor has revocation been threatened), and, to the Knowledge of SWWC, there are no existing circumstances and no events have occurred that could reasonably be expected to adversely affect the qualified status of any SWWC Qualified Plan or the related trust.

(d) No SWWC Benefit Plan is subject to Title IV or Section 302 of ERISA or Section 412 of the Code. With respect to each SWWC Benefit Plan subject to Title IV or Section 302 of ERISA or Section 412 of the Code: (i) each such SWWC Benefit Plan satisfies all minimum funding requirements under Sections 412 and 430 of the Code and Sections 302 and 303 of ERISA, whether or not waived, (ii) no lien in favor of any such SWWC Benefit Plan has arisen under

Section 430(k) of the Code or Section 303(k) of ERISA, (iii) such SWWC Benefit Plan is not in “at risk status” within the meaning of Section 430(i) of the Code or Section 303(i) of ERISA, (iv) SWWC has delivered or made available to Corix a copy of the most recent actuarial valuation report for such SWWC Benefit Plan and such report is complete and accurate in all material respects, (v) the PBGC has not instituted proceedings to terminate such SWWC Benefit Plan, and (vi) there has not been any “reportable event” (as that term is defined in Section 4043 of ERISA) during the last six (6) years as to which the 30-day advance notice requirement has not been waived. In the past six (6) years, no material liability (other than for premiums to the PBGC) under Title IV of ERISA has been or is expected to be incurred by SWWC or any of the SWWC Subsidiaries or any of their respective ERISA Affiliates.

(e) None of SWMAC, SWWC, any of the SWWC Subsidiaries or any of their respective ERISA Affiliates has maintained, established, contributed to, been obligated to contribute to, or has any liability (including a withdrawal liability such as a “withdrawal liability” within the meaning of Title IV of ERISA) with respect to any plan that is a Multiemployer Plan.

(f) None of SWMAC, SWWC or any of the SWWC Subsidiaries sponsors, has sponsored or has any obligation with respect to any employee benefit plan that provides for any post-employment or post-retirement medical or death benefits (whether or not insured) with respect to former or current directors or employees, or their respective beneficiaries or dependents, beyond their retirement or other separation from service, except as required by Section 4980B of the Code.

(g) The execution of this Agreement and the consummation of the Business Combination will not, either alone or in combination with another event, (i) entitle any current or former employee, director, consultant or officer of SWMAC, SWWC or any of the SWWC Subsidiaries to severance pay, retention or any other bonus amount or accrued pension benefit or any other payment, (ii) accelerate the time of payment or vesting, or increase the amount of compensation due any such employee, director, consultant or officer, (iii) trigger any funding obligation under any SWWC Benefit Plan, (iv) result in the forgiveness of Indebtedness for the benefit of any such current or former employee, director, consultant or officer or (v) result in any breach or violation of, or default under, or limit SWWC’s or any SWWC Subsidiary’s right to extend, renew, replace, amend, modify or terminate, any SWWC Benefit Plan. No SWWC Benefit Plan provides for, and neither SWWC nor any of the SWWC Subsidiaries otherwise has any obligation to provide, a gross-up or reimbursement of Taxes imposed under Section 4999 of the Code, Section 409A(a)(1)(B) of the Code, or otherwise.

(h) To the Knowledge of SWWC, each SWWC Benefit Plan, and any award thereunder, that is or forms part of a “nonqualified deferred compensation plan” within the meaning of Section 409A of the Code has been maintained, in form and operation, in material compliance with all applicable requirements of Section 409A of the Code.

#### 6.10 Labor and Employment Matters.

(a) None of SWMAC, SWWC or any SWWC Subsidiary is a party to or bound by any Collective Bargaining Agreement with respect to any SWWC Personnel. No SWWC Personnel are represented by a Labor Organization with respect to their employment with SWWC.

Except for matters that are not and would not reasonably be expected to be, individually or in the aggregate, material to SWWC and the SWWC Subsidiaries, taken as a whole, (i) there is no, and has not been any, pending or, to the Knowledge of SWWC, threatened strike, lockout, slowdown, work stoppage or unfair labor practice by or with respect to any SWWC Personnel and (ii) to the Knowledge of SWWC, there are no, and in the past three (3) years, have not been any, activities or proceedings of any Labor Organization to organize any employees of SWWC or any SWWC Subsidiary and no demand for recognition as the exclusive bargaining representative of any such employees has been made by or on behalf of any Labor Organization.

(b) Except for instances of noncompliance that are not and would not reasonably be expected to be, individually or in the aggregate, material to SWWC and the SWWC Subsidiaries, taken as a whole, SWWC and the SWWC Subsidiaries are, and at all times in the past three (3) years have been, in compliance with all applicable Laws relating to labor and employment, including those relating to labor management relations, wages, hours, overtime, discrimination, sexual harassment, civil rights, affirmative action, work authorization, child labor, immigration, safety and health, disability rights or benefits, equal employment, plant closures and layoffs, workers' compensation, employee leave issues, unemployment insurance and continuation coverage under group health plans.

(c) Except for instances of noncompliance that are not and would not reasonably be expected to be, individually or in the aggregate, material to SWWC and the SWWC Subsidiaries, taken as a whole, no SWWC Personnel is, or has been, in any respect in violation of any term of any employment agreement, nondisclosure agreement, common law nondisclosure obligation, fiduciary duty, non-competition agreement, restrictive covenant or other obligation: (i) to SWWC or any SWWC Subsidiary or (ii) to the Knowledge of SWWC, to a former employer of any such SWWC Personnel relating (A) to the right of any such SWWC Personnel to be employed by SWWC or any SWWC Subsidiary or (B) to the knowledge or use of trade secrets or proprietary information.

(d) To the Knowledge of SWMAC or SWWC, in the last three (3) years, no allegations of sexual harassment or hostile work environment have been made to SWMAC or SWWC against any individual in such individual's capacity as (i) an officer of SWMAC or SWWC, (ii) a member of the SWMAC Board or the SWWC Board or (iii) an employee of SWWC or any SWWC Subsidiary at a level of Vice President or above.

6.11 Litigation. There is no suit, action or other proceeding pending or, to the Knowledge of SWMAC or SWWC, threatened against or affecting SWMAC, SWWC or any SWWC Subsidiary or any of their respective properties or assets that is or would reasonably be expected to be, individually or in the aggregate, material to SWWC and the SWWC Subsidiaries, taken as a whole, nor is there any Judgment outstanding against or, to the Knowledge of SWMAC or SWWC, demand or investigation by any Governmental Entity involving SWMAC, SWWC or any SWWC Subsidiary or any of their respective properties or assets that is or would be reasonably expected to be, individually or in the aggregate, material to SWWC and the SWWC Subsidiaries, taken as a whole.

6.12 Compliance with Applicable Laws. Each of SWMAC, SWWC and the SWWC Subsidiaries are in compliance with all applicable Laws and the SWWC Permits in all material

respects. There is no demand or investigation by or before any Governmental Entity pending or, to the Knowledge of SWMAC or SWWC, threatened alleging that SWMAC, SWWC or any SWWC Subsidiary is not in compliance with any applicable Law or SWWC Permit or which challenges or questions the validity of any rights of the holder of any SWWC Permit. To the Knowledge of SWWC, no material noncompliance with any applicable Law or SWWC Permit exists. This Section 6.12 does not relate to Tax matters, employee benefits matters, labor and employment matters, environmental matters, Intellectual Property Rights or privacy and data security matters, which are the subjects of Sections 6.8, 6.9, 6.10, 6.15 and 6.19, respectively.

6.13 Permits. SWWC and each SWWC Subsidiary has all requisite power and authority and possesses all Permits necessary to enable SWWC and each SWWC Subsidiary to own, lease and operate its respective properties and assets or to develop, produce, store, distribute, promote, offer and sell its respective products and services or otherwise to carry on the SWWC Business as it is now being conducted (collectively, the “SWWC Permits”), and, as of the date of this Agreement, all such SWWC Permits are in full force and effect and no suspension, revocation, termination, cancellation, non-renewal, or modification not requested by SWWC of any of the SWWC Permits is pending or, to the Knowledge of SWWC, threatened, except where the failure to have such power or authority or to possess the SWWC Permits is not and would not reasonably be expected to be, individually or in the aggregate, material to SWWC and the SWWC Subsidiaries, taken as a whole. SWWC and the SWWC Subsidiaries are in compliance in all material respects with the terms of the SWWC Permits.

6.14 Water Quality and Water Rights. The drinking water supplied by SWWC and the SWWC Subsidiaries to their respective customers is and has been in material compliance since December 31, 2020, with all applicable federal and state drinking water standards. SWWC and the SWWC Subsidiaries have all material rights, authorizations, Permits, easements, prescriptive rights and rights of way, whether or not of record, which are necessary to extract and deliver water to their respective customers in a manner adequate and sufficient for the conduct of its business as currently conducted (the “SWWC Water Rights”). Except as would not be material to SWWC and the SWWC Subsidiaries, taken as a whole, there is not any existing material breach or material default by SWWC or any SWWC Subsidiary under any of the SWWC Water Rights which (with or without notice, lapse of time or both) would cause any of the SWWC Water Rights to be lost, revoked or compromised or not be satisfied, and, to the Knowledge of SWWC, there is no other reason to believe that any SWWC Water Rights will be lost, revoked or compromised or will not be satisfied.

6.15 Environmental Matters.

(a) SWWC and each SWWC Subsidiary is, and except for matters that have been resolved, has been in compliance with all Environmental Laws in all material respects, and neither SWWC nor any SWWC Subsidiary has received any written or, to the Knowledge of SWWC, oral notice alleging that SWWC or any SWWC Subsidiary is in material violation of, or has any material liability under, any Environmental Law.

(b) SWWC and each SWWC Subsidiary possesses and is in material compliance with all material Environmental Permits for the conduct of the SWWC Business as presently conducted and all such Environmental Permits are valid and in good standing or, to the

extent any such Environmental Permit has expired, have timely applied for renewal of such Environmental Permit to allow the continued operation of SWWC's or any such SWWC Subsidiary's facility in compliance with applicable Environmental Law.

(c) To the Knowledge of SWWC, no act or omission of SWWC or any SWWC Subsidiary (except for an application to renew or modify a material Environmental Permit made in the ordinary course of business) provides a basis for any material Environmental Permits to be amended, revoked, limited or otherwise conditioned in a manner that would be adverse to SWWC and the SWWC Subsidiaries, taken as a whole.

(d) There are no material Environmental Claims pending or, to the Knowledge of SWMAC or SWWC, threatened against or affecting SWMAC, SWWC or any SWWC Subsidiary.

(e) To the Knowledge of SWWC, there has been no Release of or exposure to any Materials of Environmental Concern or, to the Knowledge of SWWC, other event, fact, incident, activity, circumstance or condition that would reasonably be expected to form the basis of any material Environmental Claim against SWWC or any SWWC Subsidiary or result in any material liability under Environmental Laws.

(f) Neither SWWC nor any SWWC Subsidiary has retained or assumed, either contractually or by operation of Law, any liabilities or obligations that would reasonably be expected to form the basis of any Environmental Claim against SWWC or any SWWC Subsidiary, except in respects that, individually or in the aggregate, have not had and would not reasonably be expected to be material to SWWC and the SWWC Subsidiaries, taken as a whole.

(g) SWWC has provided or made available to the Corix Parties true, correct and complete copies of all Environmental Reports prepared since December 31, 2011, that are in the possession of SWWC and the SWWC Subsidiaries regarding matters pertaining to the environmental condition of the business and properties of SWWC and the SWWC Subsidiaries, and their compliance (or noncompliance) with any Environmental Laws to the extent that any such Environmental Reports remain material.

#### 6.16 Contracts.

(a) Section 6.16(a) of the SWWC Disclosure Letter sets forth, as of the date of this Agreement, a true and complete list of the following (excluding any SWWC Benefit Plan and any insurance Contract or policy):

(i) each non-competition Contract or other Contract containing terms that expressly (A) limits or otherwise restricts SWMAC, SWWC or any SWWC Subsidiary or (B) would, after the consummation of the Business Combination, limit or otherwise restrict CIUS from, in the case of either (A) or (B), engaging or competing in any water or wastewater line of business or in any geographic area in a manner that would be reasonably likely to be material to CIUS (excluding Contracts regarding the disclosure or use of confidential information entered into in the ordinary course of business).

(ii) each loan and credit agreement or other Contract pursuant to which any Indebtedness of SWMAC, SWWC or any SWWC Subsidiary is outstanding or may be incurred, other than any such Contract between or among SWMAC, SWWC and the SWWC Subsidiaries;

(iii) each partnership, joint venture or similar agreement, Contract to which SWMAC, SWWC or any SWWC Subsidiary is a party relating to the formation, creation, operation, management or control of any partnership or joint venture, in each case material to SWWC and the SWWC Subsidiaries, taken as a whole;

(iv) each Contract entered into since December 31, 2020, providing for the purchase or other acquisition or sale or other disposition (directly or indirectly) by SWMAC, SWWC or any of the SWWC Subsidiaries of an asset or assets or a business or businesses (*provided* that a disposition resulting from a condemnation process shall not be deemed a disposition for the purposes of this Section 6.16)) (A) in which the aggregate purchase or sale price (regardless of whether the consideration paid or received (x) was paid upon closing or paid or to be paid over time, (y) involved an earn-out or other contingency (in which case the amount of the consideration subject to any as yet-unrealized earn-out or other contingency shall be estimated reasonably and in good faith) and (z) in the form of cash, stock, assets, a debt instrument or otherwise) was in excess of \$10,000,000 and (B) under which SWMAC, SWWC or any of the SWWC Subsidiaries have or are reasonably likely to have a payment obligation, including any obligation to make any indemnification payment (other than indemnification with respect to directors and officers) or any payment under any guarantee or other financial obligation, in each case, involving consideration in excess of \$2,000,000;

(v) each Contract relating to or arising from the Core Business, including, but not limited to, an operation or management services or a similar agreement, pursuant to which SWMAC, SWWC or any SWWC Subsidiary receives (A) annual revenue in excess of \$3,000,000 or (B) aggregate consideration in excess of \$15,000,000;

(vi) each material Contract with a Governmental Entity to which SWMAC, SWWC or any SWWC Subsidiary is a party, other than such Contracts in the ordinary course of business, such as franchise agreements;

(vii) each Contract to which SWMAC, SWWC or any SWWC Subsidiary is a party involving the future disposition or acquisition of assets or properties with a fair market value in excess of \$5,000,000; and

(viii) each Contract with any supplier or vendor under which SWMAC, SWWC or any SWWC Subsidiary is obligated to purchase technology, goods or services involving consideration in excess of \$5,000,000 or, in the case of purchases of technology, equipment, materials and goods, including related capitalized services included in SWWC's or any SWWC Subsidiary's capital budget, \$20,000,000 (except with respect to the purchase of water or wastewater treatment and disposal in the ordinary course of business consistent with past practice).



Each Contract of the type described in this Section 6.16(a) and 6.17 is referred to herein as a “SWWC Material Contract.” Each SWWC Material Contract that has been made available to the Corix Parties is a true, correct and complete copy thereof.

(b) Except for matters which are not and would not reasonably be expected to be, individually or in the aggregate, material to SWWC and the SWWC Subsidiaries, taken as a whole, (i) each SWWC Material Contract (including, for purposes of this Section 6.16(b), any Contract entered into after the date of this Agreement that would have been an SWWC Material Contract if such Contract existed on the date of this Agreement) is a valid, binding and legally enforceable obligation of SWMAC, SWWC or one of the SWWC Subsidiaries, as the case may be, and, to the Knowledge of SWWC, of the other parties thereto, except, in each case, as enforcement may be limited by bankruptcy, insolvency, reorganization or similar Laws affecting creditors’ rights generally and by general principles of equity and (ii) each such SWWC Material Contract is in full force and effect. None of SWMAC, SWWC or any SWWC Subsidiary is (with or without notice or lapse of time, or both) in material breach or material default under any such SWWC Material Contract and, to the Knowledge of SWWC, no other party to any such SWWC Material Contract is (with or without notice or lapse of time, or both) in material breach or material default thereunder.

6.17 Affiliate Transactions. Section 6.17 of the SWWC Disclosure Letter sets forth a true and complete list of the Contracts that are in existence as of the date of this Agreement between, on the one hand, SWMAC, SWWC or any SWWC Subsidiary and, on the other hand, any (x) present executive officer or director of SWMAC, SWWC or any SWWC Subsidiary or any person that has served as an executive officer or director of SWMAC, SWWC or any SWWC Subsidiary within the last five years or any of such officer’s or director’s immediate family members, (y) to the Knowledge of SWMAC or SWWC, any Affiliate of any such officer or director or (z) Bazos, IIF Subway or any of their respective Affiliates (other than SWMAC, SWWC or any SWWC Subsidiary).

6.18 SWWC Real Properties.

(a) (i) SWWC or an SWWC Subsidiary has good and valid fee simple title to all Material SWWC Owned Property, in each case, free and clear of all Liens except for Permitted Encumbrances, and (ii) except in respects that, individually or in the aggregate, have not had and would not reasonably be expected to be material to SWWC and the SWWC Subsidiaries, taken as a whole, there is no suit, action or other proceeding pending or, to the Knowledge of SWWC, threatened against or affecting SWWC or any SWWC Subsidiary challenging SWWC’s or the applicable SWWC Subsidiary’s fee simple title to the Material SWWC Owned Property.

(b) Except in respects that, individually or in the aggregate, have not had and would not reasonably be expected to have an SWWC Material Adverse Effect: (i) SWWC or an SWWC Subsidiary has good and valid title or fee simple title, as applicable, to all SWWC Owned Properties that are not Material SWWC Owned Properties (each, a “Non-Material SWWC Owned Property”), in each case, free and clear of all Liens, except for Permitted Encumbrances and/or Liens that do not currently, or would not reasonably be expected to, individually or in the aggregate, impair the value of any Non-Material SWWC Owned Property or impair the continued use and operation of any Non-Material SWWC Owned Property, as presently conducted; and (ii)

there is no suit, action or other proceeding pending or, to the Knowledge of SWWC, threatened against or affecting SWWC or an SWWC Subsidiary challenging SWWC's or an SWWC Subsidiary's fee simple title to any Non-Material SWWC Owned Property.

(c) (i) SWWC or the applicable SWWC Subsidiary holds good and subsisting leasehold interests in the SWWC Leased Property, free and clear of all Liens, except for Permitted Encumbrances and/or Liens which do not, individually or in the aggregate, materially impair and would not reasonably be expected to materially impair the continued use and operation of the SWWC Leased Property, as presently conducted, and (ii) (1) all SWWC Leases are in full force and effect and (2) there is not any existing material breach of, or material default under, any SWWC Lease by SWWC or any SWWC Subsidiary, and there is not any existing circumstance or event which, with or without notice, lapse of time or both, would become a material breach or material default by SWWC or any SWWC Subsidiary under the SWWC Leases.

For all purposes of this Agreement, (i) "SWWC Owned Property" means the real and personal property (other than the SWWC Water Rights and the SWWC Property Easements) owned by SWWC or an SWWC Subsidiary, (ii) "Material SWWC Owned Property" means the SWWC Owned Property set forth on Section 6.18 of the SWWC Disclosure Letter (iii) "SWWC Leased Property" means the real property (other than the SWWC Water Rights and the SWWC Property Easements) leased pursuant to the SWWC Leases, (iv) "SWWC Leases" means the leases, subleases, licenses or other occupancy agreements for real property material to the SWWC Business to which SWWC or any SWWC Subsidiary is a party that are currently in effect, of which any copies made available to the Corix Parties are true, correct and complete and (v) "SWWC Property" means the SWWC Leased Property and the SWWC Owned Property.

(d) SWWC and the SWWC Subsidiaries have fulfilled and performed all of their material obligations with respect to any material authorizations, permits, easements, prescriptive rights and rights of way pertaining to the SWWC Property and the SWWC Water Rights (the "SWWC Property Easements") in a manner adequate and sufficient for the conduct of its business as currently conducted, to the Knowledge of SWWC, no event has occurred that would allow, with or without notice or lapse of time or both, revocation or termination thereof or would result in any impairment of the rights of SWWC or any SWWC Subsidiary with respect to any SWWC Property Easements.

(e) (i) No condemnation, eminent domain, litigation, administrative action, zoning or other similar proceeding is pending or, to the Knowledge of SWWC, threatened against any of the SWWC Property, (ii) the present use of the land, buildings, structures and improvements on the SWWC Property are in conformity with applicable Law in all material respects, (iii) neither SWWC nor any SWWC Subsidiary has leased or otherwise granted to any other Person, except for Permitted Encumbrances, the right to use or occupy any SWWC Property or any portion thereof, (iv) there are no outstanding options, rights of first offer or rights of first refusal for any other Person to purchase any SWWC Property or any portion thereof or interest therein, (v) the SWWC Property and the SWWC Property Easements, taken as a whole, are in all material respects adequate and sufficient for the conduct of the SWWC Business, as currently conducted by SWWC and the SWWC Subsidiaries, and (vi) except in respects that are not and would not reasonably be expected to be, individually or in the aggregate, material to SWWC and the SWWC Subsidiaries, taken as a whole, all of the SWWC Property is in good condition and repair, reasonable wear and

tear excepted, and is suitable for the purpose for which it is now being used in the conduct of the SWWC Business by SWWC and the SWWC Subsidiaries.

6.19 Intellectual Property; Information Technology; Privacy and Data Security.

(a) Except for matters that are not and would not reasonably be expected to be, individually or in the aggregate, material to SWWC and the SWWC Subsidiaries, taken as a whole, (i) SWMAC, SWWC and each SWWC Subsidiary exclusively owns any Intellectual Property Rights owned or purported to be owned by it, and is validly licensed or otherwise has the right to use and otherwise exploit, all other Intellectual Property Rights used or exploited in or otherwise necessary for the conduct of its business as currently conducted, (ii) no suits, actions or other proceedings are pending or, to the Knowledge of SWMAC or SWWC, threatened that SWMAC, SWWC or any SWWC Subsidiary is infringing, misappropriating or otherwise violating the Intellectual Property Rights of any Person, (iii) to the Knowledge of SWMAC or SWWC, no Person is infringing, misappropriating or otherwise violating any Intellectual Property Rights owned by SWMAC, SWWC or any SWWC Subsidiary, and (iv) to the Knowledge of SWMAC or SWWC, the conduct of the business of the SWWC and the SWWC Subsidiaries as currently conducted, does not infringe, misappropriate or otherwise violate, and has not in the past three (3) years, infringed, misappropriated or otherwise violated, the Intellectual Property Rights of any other Person.

(b) SWMAC, SWWC and each SWWC Subsidiary takes commercially reasonable steps to maintain the confidentiality of their material trade secrets included in their owned Intellectual Property Rights. To the Knowledge of SWMAC and SWWC, there has been no misappropriation, misuse or breach of confidentiality of any material trade secrets by any Person, except for matters that are not and would not reasonably be expected to be, individually or in the aggregate, material to SWWC and the SWWC Subsidiaries, taken as a whole.

(c) Except for matters that are not and would not reasonably be expected to be, individually or in the aggregate, material to SWWC and the SWWC Subsidiaries, taken as a whole, (i) the information technology systems of SWWC and each SWWC Subsidiary are reasonably sufficient for the conduct of their business as currently conducted, and (ii) SWWC and each SWWC Subsidiary have and maintain a business continuity and disaster recovery plan for the continuance of their businesses in the event of an unplanned interruption in service or unavailability of the information technology systems of SWWC and each SWWC Subsidiary.

(d) Except for matters that are not and would not reasonably be expected to be, individually or in the aggregate, material to SWWC and the SWWC Subsidiaries, taken as a whole, (i) SWMAC, SWWC and each SWWC Subsidiary are in compliance with all applicable data privacy and data security Laws; (ii) SWMAC, SWWC and each SWWC Subsidiary maintain and implement, and have in the past three (3) years, maintained and implemented, commercially reasonable administrative, technical and physical safeguards designed to protect information technology systems of SWWC and each SWWC Subsidiary and personal data and confidential data stored thereon; (iii) during the past three (3) years, to the Knowledge of SWWC, there has been no unauthorized access or use of the information technology systems of SWWC and each SWWC Subsidiary in a manner that has resulted or could reasonably be expected to result in any material liability to SWWC or any SWWC Subsidiary, and (iv) during the past three (3) years, to

the Knowledge of SWMAC or SWWC, none of SWWC or any SWWC Subsidiary has been subject to any breach of security whereby personally identifiable information or other personal data in the possession of or under the control of any of SWWC or any SWWC Subsidiary was disclosed or exfiltrated in a manner that requires notice to affected individuals under applicable data privacy and data security Laws.

6.20 Sufficiency of Assets. All of the assets of SWWC and the SWWC Subsidiaries, together with the other properties of SWWC and the SWWC Subsidiaries (and any other assets and properties for which SWWC and the SWWC Subsidiaries have a right to use), constitute all of the assets and properties that are necessary for SWWC and the SWWC Subsidiaries to conduct their respective businesses immediately following the Closing as such businesses were conducted during the 12 months prior to the date of this Agreement, except as is not and would not reasonably be expected to be, individually or in the aggregate, material to SWWC and the SWWC Subsidiaries, taken as a whole.

6.21 Insurance. Since December 31, 2020, SWWC and the SWWC Subsidiaries have maintained continuous insurance coverage, in each case, in those amounts and covering those risks as are in accordance, in all material respects, with normal industry practice for companies of the size and financial condition of SWWC engaged in businesses similar to those of SWWC and the SWWC Subsidiaries. All such insurance policies are in full force and effect and all premiums due on such insurance policies have been paid, except as is not and would not reasonably be expected to be, individually or in the aggregate, material to SWWC and the SWWC Subsidiaries, taken as a whole. No written notice of cancellation or termination have been received by SWMAC, SWWC, any SWWC Subsidiary or any of their respective Affiliates with respect to any such insurance policy. There is no material claim by SWMAC, SWWC, any SWWC Subsidiary or any of their respective Affiliates pending under any such insurance policy. None of SWMAC, SWWC, any SWWC Subsidiary or any of their respective Affiliates are in default under any of such insurance policies. SWMAC, SWWC, the SWCC Subsidiaries and their respective Affiliates have reported to their respective insurers all known claims under any such insurance policy.

6.22 Brokers' Fees and Expenses. No broker, investment banker, financial advisor or other Person, other than the IIF Subway Financial Advisor, is entitled to any broker's, finder's, financial advisor's or other similar fee or commission in connection with the Business Combination or any of the other transactions contemplated by this Agreement based upon arrangements made by or on behalf of SWMAC, SWWC or any SWWC Subsidiary.

6.23 Anti-Corruption; Anti-Money Laundering; Sanctions.

(a) None of SWMAC, SWWC, the SWWC Subsidiaries, nor, to the Knowledge of SWMAC or SWWC, any of their respective directors, officers, employees or other Persons acting on behalf of any of the foregoing, directly or indirectly in relation to SWMAC or SWWC, has, since the date falling five (5) years prior to the date of this Agreement:

(i) violated any applicable Anti-Corruption Laws in any material respect;

(ii) made, offered or promised to make, or authorized the payment or giving of money, or anything else of value, to any (x) executive, official, employee or Person acting in an official capacity for or on behalf of a Governmental Entity, (y) Government Official, or (z) any other Person, while knowing or believing that all or some portion of the money or value will be offered, given or promised to a Government Official or other Person, in the case of clause (x), (y) or (z), for the purposes of obtaining or retaining business or securing any improper advantage in violation of any Anti-Corruption Law or in other circumstances when such offer, payment or promise would be unlawful; or

(iii) been the subject of any suit, action or other proceeding or, to the Knowledge of SWMAC or SWWC, investigation with regard to any actual or alleged breach of any Anti-Corruption Law.

(b) Each of SWMAC, SWWC and the SWWC Subsidiaries, and to the Knowledge of SWMAC and SWWC, any Person controlling SWMAC, SWWC or any SWWC Subsidiary (in each case, solely with respect to their relationship with SWMAC, SWWC or any SWWC Subsidiary) is in compliance in all material respects with all applicable AML Laws in the jurisdictions in which each of SWMAC, SWWC or any SWWC Subsidiary or any Person controlling SWMAC, SWWC or any SWWC Subsidiary, as applicable, operates.

(c) None of SWMAC, SWWC nor any SWWC Subsidiary is a Sanctioned Person.

(d) None of SWMAC, SWWC nor any SWWC Subsidiary, will use any amounts received by such Person under this Agreement, if any, (i) for the purpose of funding, financing or facilitating any activities, business or transaction of or with any Sanctioned Person, or in any country or region that is the subject of comprehensive Sanctions, except to the extent permitted under applicable Sanctions, or (ii) in any manner that would result in the violation of any Sanctions by any Party.

(e) None of SWMAC, SWWC, the SWWC Subsidiaries, nor, to the Knowledge of SWMAC or SWWC, any Person controlling SWMAC, SWWC or any SWWC Subsidiary, is a Senior Foreign Political Figure, an immediate family member of a Senior Foreign Political Figure, or a close associate of a Senior Foreign Political Figure.

(f) None of SWMAC, SWWC or any SWWC Subsidiary, nor, to the Knowledge of SWMAC or SWWC, any Person controlling SWMAC, SWWC or any SWWC Subsidiary, is a foreign shell bank, as defined in 31 C.F.R. § 1010.605(g).

6.24 No Other Activities. Since its incorporation, SWMAC (a) has not conducted any business operations or activities other than exclusively related to its ownership of the Equity Interests in SWWC and administrative activities incidental thereto (including the issuance of the SWWC Shareholder Loan), (b) has had no employees, and (c) has had no assets or liabilities other than its ownership of the Equity Interests in SWWC, liabilities under the SWWC Shareholder Loan and other immaterial liabilities that may have arisen in connection with administration activities of SWMAC.

6.25 No Additional Representations. Except for those representations and warranties expressly set forth in this Article VI and except as otherwise expressly set forth in this Agreement, none of SWMAC, SWWC nor any of the SWWC Subsidiaries or other Person acting on behalf of SWMAC, SWWC or any of the SWWC Subsidiaries has made or makes any representation or warranty of any kind or nature, express or implied, with respect to SWMAC, SWWC, the SWWC Subsidiaries or any of their respective Affiliates, or any of their respective businesses, operations, assets, liabilities, conditions (financial or otherwise) or prospects in connection with this Agreement or the transactions contemplated by this Agreement. In addition, without limiting the generality of the foregoing, none of SWMAC, SWWC nor any of the SWWC Subsidiaries or other Person acting on behalf of SWMAC, SWWC or any of the SWWC Subsidiaries has made or makes any representation or warranty with respect to any projections, estimates or budgets made available to the Corix Parties or their respective Affiliates of future revenues, future results of operations (or any component thereof), future cash flows or future financial condition (or any component thereof) of SWMAC, SWWC or the SWWC Subsidiaries or the future business and operations of CIUS or its future Subsidiaries.

## ARTICLE VII

### COVENANTS

#### 7.1 Conduct of Business.

(a) Conduct of Business by Corix. Except for (1) actions taken in connection with the Excluded Business or with respect to Corix (and not with respect to any Contributed Corix Entity), (2) actions taken in connection with the Corix Restructuring as expressly permitted by and in accordance with Section 7.8 or with respect to the BAPA in accordance with and subject to Section 9.10, (3) actions taken in accordance with, or otherwise in furtherance of, the Corix business plan delivered to IIF Subway prior to the date of this Agreement, a copy of which is set forth in Section 7.1(a) of the Corix Disclosure Letter (the “Corix Business Plan”), (4) the matters set forth in Section 7.1(a) of the Corix Disclosure Letter or actions otherwise expressly permitted or required by this Agreement, or (5) subject to Sections 7.1(a)(iii)(A) and 7.1(a)(iii)(E), actions taken with the prior written consent of IIF Subway (which shall not be unreasonably withheld, conditioned or delayed) or as required by applicable Law (the exceptions under clauses (1) through (5) above, the “Corix Conduct of Business Exceptions”), from the date of this Agreement to the Closing Date, Corix shall, and shall cause each Contributed Corix Entity to, (x) conduct the Corix Water Business in the ordinary course consistent with past practice in all material respects, (y) use commercially reasonable efforts to (A) preserve the goodwill and maintain all material relationships of each Contributed Corix Entity with customers, suppliers, Governmental Entities and other Persons with which the Contributed Corix Entities have material business dealings Related to the Corix Water Business, (B) keep available the services of Corix’s (with respect to the Corix Water Business) and each Contributed Corix Entity’s officers and key employees and (C) preserve, maintain and protect the assets of the Corix Water Business and the Contributed Corix Entities (ordinary wear and tear excepted) and (z) maintain in full force and effect the insurance policies currently held by or in effect providing coverage to each Contributed Corix Entity. In addition, and without limiting the generality of the foregoing, subject to the Corix Conduct of Business Exceptions, from the date of this Agreement to the Closing Date, Corix shall not, and shall not permit any Contributed Corix Entity to, do any of the following:

(i) (A) declare, set aside or pay any dividends on, or make any other distributions (whether in cash, stock or property or any combination thereof) in respect of, any of its Equity Interests, other than any dividends or distributions expressly set forth in the Corix Business Plan, or (B) make any payment with respect to the CIUS Shareholder Loan, other than payment of interest in accordance with its terms;

(ii) transfer, issue, deliver, sell, grant, pledge or otherwise encumber or subject to any Lien (A) any Equity Interests in any Contributed Corix Entity, (B) any securities convertible into or exchangeable or exercisable for any Equity Interests in any Contributed Corix Entity or (C) any warrants, calls, options or other rights to acquire any Equity Interests in any Contributed Corix Entity;

(iii) except for actions required pursuant to the terms of any Corix Water Benefit Plan or Collective Bargaining Agreement covering any Corix Water Personnel, (A) increase compensation or benefits for existing Corix Water Personnel with an annual base salary in excess of \$200,000, except for (1) increases in annual base salary or wage rate that do not exceed 5% of such employee's annual base salary as of (x) the date of this Agreement (in the case of any such increases during calendar year 2022) or (y) as of January 1, 2023 or January 1, 2024 (in the case of any such increase during any such calendar year) and (2) increases made in connection with promotions that do not exceed 30% of the applicable employee's annual base salary and maximum bonus opportunity then-in effect (*provided*, that with respect to any employee with an annual base salary in excess of \$200,000 but less than or equal to \$300,000, any such increase in compensation or benefits as provided above shall only require the prior written consent of SWWC's then-current Chief Executive Officer (which shall not be unreasonably withheld, conditioned or delayed)); (B) pay or grant to any Corix Water Personnel any incentive compensation, bonus, change in control, or retention pay, except (1) in connection with new hires (to the extent permitted under subsection (E)) or promotions in an amount not to exceed \$500,000 in the aggregate, (2) the payment of annual bonuses for completed periods based on actual performance in the ordinary course of business consistent with past practice and (3) de minimis cash awards paid periodically outside of the annual bonus process consistent with past practice; (C) grant or amend any equity or equity-based compensation awards; (D) except in connection with new hires permitted under subsection (E) or in connection with promotions, enter into or materially modify any existing Corix Water Benefit Plan; (E) terminate (other than for cause) or hire any employee with an annual base salary in excess of \$200,000, except for the hiring of an employee in replacement of an existing member of Corix Water Personnel (other than senior officers of any Contributed Corix Entity) whose annual compensation would not exceed 105% of the annual base salary and maximum bonus opportunity of the applicable departing employee (*provided*, that with respect to any employee with an annual base salary in excess of \$200,000 but less than or equal to \$300,000, any such termination or hiring as provided above shall only require the prior written consent of SWWC's then-current Chief Executive Officer (which shall not be unreasonably withheld, conditioned or delayed)); (F) take any action to accelerate the time of vesting, funding or payment of any material compensation or benefits under any Corix Water Benefit Plan; or (G) except as may be required by GAAP or Canadian GAAP, materially change any actuarial or other assumptions used to calculate funding obligations with respect to any Corix Water Benefit Plan or materially change the manner in which

contributions to such plans are made or the basis on which such contributions are determined;

(iv) make any change in financial accounting methods, principles or practices, except insofar as may have been required by a change in Canadian GAAP or GAAP, as applicable, after the date of this Agreement;

(v) directly or indirectly acquire or agree to acquire in any transaction (whether by means of merger, share exchange, consolidation, tender offer, asset purchase or otherwise) any Equity Interest in or business of any firm, corporation, partnership, company, limited liability company, trust, joint venture, association or other entity or division thereof or any properties or assets, in each case, (A) outside of the states or provinces in which the Contributed Corix Entities currently operate, and (B) if within the states or provinces in which the Contributed Corix Entities currently operate, (1) any such transaction would result in any Contributed Corix Entity directly or indirectly engaging in any new line of business outside of the Core Business or (2) if the amount of the consideration paid or payable by the Contributed Corix Entities in connection with any such transactions would exceed \$20,000,000, individually, or \$60,000,000 in the aggregate;

(vi) incur any Indebtedness, other than (A) Indebtedness incurred in the ordinary course of business consistent with past practice not to exceed \$20,000,000 in the aggregate, (B) Indebtedness in replacement of existing Indebtedness; *provided* that the Contracts relating to such Indebtedness meet the requirements of Section 7.1(a)(vii) and (C) guarantees by a Contributed Corix Entity of Indebtedness of any other Contributed Corix Entity;

(vii) enter into, extend, renew, replace, amend or modify any material Contract to the extent consummation of the Business Combination or compliance by any Contributed Corix Entity with the provisions of this Agreement would reasonably be expected to (A) conflict with such Contract or (B) result in any violation of or default (with or without notice or lapse of time, or both) under such Contract;

(viii) enter into or materially amend any Collective Bargaining Agreement applicable to any Corix Water Personnel, other than pursuant to the terms of any such Collective Bargaining Agreement;

(ix) make any capital expenditure except (A) in accordance with the capital budget for the relevant fiscal year as set forth in the Corix Business Plan, *plus* a 10% variance with respect to the aggregate capital budget set forth therein, (B) capital expenditures related to operational emergencies, equipment failures or outages and (C) capital expenditures required by prudent industry practices;

(x) voluntarily recognize or certify any Labor Organization as the bargaining representative for any Corix Water Personnel;

(xi) other than in the ordinary course of business consistent with past practice or with respect to a Contract that otherwise would be permitted pursuant to another



subsection of this Section 7.1(a), either (A) extend, renew, replace, amend, modify or terminate any Corix Water Material Contract or (B) enter into, extend, renew, replace, amend, modify or terminate any Contract that would have been a Corix Water Material Contract if it had been entered into prior to the date of this Agreement (except as permitted by Section 7.8(c));

(xii) enter into any new line of business outside of its existing business;

(xiii) dissolve, liquidate, restructure, reorganize, otherwise wind up or make any voluntary bankruptcy or insolvency filing (or consent to any such involuntary filing) as to any Contributed Corix Entity;

(xiv) take any actions or omit to take any actions that would reasonably be expected to result in new or additional material required approvals from any Governmental Entity in connection with the Business Combination or other transactions contemplated by this Agreement;

(xv) (A) make (other than in the ordinary course of business), change or rescind any material Tax election, material method of Tax accounting or any annual Tax accounting period, (B) make a request for a Tax ruling or enter into a closing agreement, or settle or compromise any audit, assessment, Tax claim or other controversy, in each case relating to material Taxes, (C) file any material amended Tax Return, (D) surrender any material right to claim a refund or offset of any Taxes, (E) extend or waive, or agree to extend or waive, any statute of limitation with respect to the assessment, determination or collection of material Taxes (other than pursuant to extensions of time to file Tax Returns obtained in the ordinary course of business), or (F) file any Tax Return other than one prepared in a manner consistent with past practice;

(xvi) initiate, settle or compromise any examination, investigation, claim, suit, action or other proceeding involving an amount equal to or in excess of \$2,500,000, or waive, release or assign any material rights or claims thereunder, excluding, in each case, any such examination, investigation, claim, suit, action or other proceeding that are solely with the control of an insurer; *provided, however*, that this Section 7.1(a)(xvi) shall not prevent a Contributed Corix Entity from initiating any proceeding to change or establish any rate charged by such entity before a Governmental Entity that regulates such entity; or

(xvii) authorize, or commit or agree to take, any of the foregoing actions.

(b) Conduct of Business by SWWC. Except for (1) actions taken in accordance with, or otherwise in furtherance of, the SWWC business plan delivered to the Corix Parties prior to the date of this Agreement, a copy of which is set forth in Section 7.1(b) of the SWWC Disclosure Letter (the “SWWC Business Plan”), (2) the matters set forth in Section 7.1(b) of the SWWC Disclosure Letter or actions otherwise expressly permitted or required by this Agreement or (3) subject to Sections 7.1(b)(iii)(A) and 7.1(b)(iii)(E), actions taken with the prior written consent of Corix (which shall not be unreasonably withheld, conditioned or delayed) or as required by applicable Law (the exceptions under clauses (1) through (3) above, the “SWWC Conduct of

Business Exceptions”), from the date of this Agreement to the Closing Date, SWMAC and SWWC shall, and shall cause each SWWC Subsidiary to, (x) conduct its business in the ordinary course consistent with past practice in all material respects, (y) use commercially reasonable efforts to (A) preserve the goodwill and maintain all material relationships of SWWC and each SWWC Subsidiary with customers, suppliers, Governmental Entities and other Persons with which SWWC and/or each SWWC Subsidiary have material business dealings, (B) keep available the services of SWWC’s and each SWWC Subsidiary’s officers and key employees and (C) preserve, maintain and protect the assets of SWWC and each SWWC Subsidiary (ordinary wear and tear excepted) and (z) maintain in full force and effect the insurance policies currently held by or in effect providing coverage to SWWC and/or each SWWC Subsidiary. In addition, and without limiting the generality of the foregoing, subject to the SWWC Conduct of Business Exceptions, from the date of this Agreement to the Closing Date, SWMAC and SWWC shall not, and shall not permit any SWWC Subsidiary to, do any of the following:

(i) (A) declare, set aside or pay any dividends on, or make any other distributions (whether in cash, stock or property or any combination thereof) in respect of, any of its Equity Interests, other than any dividends or distributions expressly set forth in the SWWC Business Plan, or (B) make any payment with respect to the SWWC Shareholder Loan, other than payment of interest in accordance with its terms;

(ii) transfer, issue, deliver, sell, grant, pledge or otherwise encumber or subject to any Lien (A) any Equity Interests in SWMAC, SWWC or any SWWC Subsidiary, (B) any securities convertible into or exchangeable or exercisable for any Equity Interests in, SWMAC, SWWC or any SWWC Subsidiary or (C) any warrants, calls, options or other rights to acquire any Equity Interests in, SWMAC, SWWC or any SWWC Subsidiary;

(iii) except for actions required pursuant to the terms of any SWWC Benefit Plan or Collective Bargaining Agreement covering any SWWC Personnel, (A) increase compensation or benefits for existing SWWC Personnel with an annual base salary in excess of \$200,000, except for (1) increases in annual base salary or wage rate that do not exceed 5% of such employee’s annual base salary as of (x) the date of this Agreement (in the case of any such increases during calendar year 2022) or (y) as of January 1, 2023 or January 1, 2024 (in the case of any such increase during any such calendar year) and (2) increases made in connection with promotions that do not exceed 30% of the applicable employee’s annual base salary and maximum bonus opportunity then-in effect (*provided*, that with respect to any employee with an annual base salary in excess of \$200,000 but less than or equal to \$300,000, any such increase in compensation or benefits as provided above shall only require the prior written consent of Corix’s then-current Chief Executive Officer (which shall not be unreasonably withheld, conditioned or delayed)); (B) pay or grant to any SWWC Personnel any incentive compensation, bonus, change in control, or retention pay, except (1) in connection with new hires (to the extent permitted under subsection (E)) or promotions in an amount not to exceed \$500,000 in the aggregate, (2) the payment of annual bonuses for completed periods based on actual performance in the ordinary course of business consistent with past practice and (3) de minimis cash awards paid periodically outside of the annual bonus process consistent with past practice; (C) grant or amend any equity or equity-based compensation awards;

(D) except in connection with new hires permitted under subsection (E) or in connection with promotions, enter into or materially modify any existing SWWC Benefit Plan; (E) terminate (other than for cause) or hire any employee with an annual base salary in excess of \$200,000, except for the hiring of an employee in replacement of an existing member of SWWC Personnel (other than senior officers of SWMAC, SWWC or any SWWC Subsidiary) whose annual compensation would not exceed 105% of the annual base salary and maximum bonus opportunity of the applicable departing employee (*provided*, that with respect to any employee with an annual base salary in excess of \$200,000 but less than or equal to \$300,000, any such termination or hiring as provided above shall only require the prior written consent of Corix's then-current Chief Executive Officer (which shall not be unreasonably withheld, conditioned or delayed)); (F) take any action to accelerate the time of vesting, funding or payment of any material compensation or benefits under any SWWC Benefit Plan; or (G) except as may be required by GAAP, materially change any actuarial or other assumptions used to calculate funding obligations with respect to any SWWC Benefit Plan or materially change the manner in which contributions to such plans are made or the basis on which such contributions are determined;

(iv) make any change in financial accounting methods, principles or practices, except insofar as may have been required by a change in GAAP after the date of this Agreement;

(v) directly or indirectly acquire or agree to acquire in any transaction (whether by means of merger, share exchange, consolidation, tender offer, asset purchase or otherwise) any Equity Interest in or business of any firm, corporation, partnership, company, limited liability company, trust, joint venture, association or other entity or division thereof or any properties or assets, in each case, (A) outside of the states in which SWWC and the SWWC Subsidiaries currently operate, and (B) if within the states in which SWWC or any of the SWWC Subsidiaries currently operate, (1) any such transaction would result in SWWC or any of the SWWC Subsidiaries directly or indirectly engaging in any new line of business outside of the Core Business or (2) if the amount of the consideration paid or payable by SWWC and the SWWC Subsidiaries in connection with any such transactions would exceed \$20,000,000, individually, or \$60,000,000 in the aggregate;

(vi) incur any Indebtedness, other than (A) Indebtedness incurred in the ordinary course of business consistent with past practice not to exceed \$20,000,000 in the aggregate, (B) Indebtedness in replacement of existing Indebtedness; *provided* that the Contracts relating to such Indebtedness meet the requirements of Section 7.1(b)(vii) and (C) guarantees by SWWC of Indebtedness of any wholly owned SWWC Subsidiary and guarantees by any SWWC Subsidiary of Indebtedness of SWWC or any other wholly owned SWWC Subsidiary;

(vii) enter into, extend, renew, replace, amend or modify any material Contract to the extent consummation of the Business Combination or compliance by SWMAC, SWWC or any SWWC Subsidiary with the provisions of this Agreement would

reasonably be expected to (A) conflict with such Contract or (B) result in any violation of or default (with or without notice or lapse of time, or both) under such Contract;

(viii) enter into or materially amend any Collective Bargaining Agreement applicable to any SWWC Personnel, other than pursuant to the terms of any such Collective Bargaining Agreement;

(ix) make any capital expenditure except (A) in accordance with the capital budget for the relevant fiscal year as set forth in the SWWC Business Plan, *plus* a 10% variance with respect to the aggregate capital budget set forth therein, (B) capital expenditures related to operational emergencies, equipment failures or outages and (C) capital expenditures required by prudent industry practices;

(x) voluntarily recognize or certify any Labor Organization as the bargaining representative for any SWWC Personnel;

(xi) other than in the ordinary course of business consistent with past practice or with respect to a Contract that otherwise would be permitted pursuant to another subsection of this Section 7.1(b), either (A) extend, renew, replace, amend, modify or terminate any SWWC Material Contract or (B) enter into, extend, renew, replace, amend, modify or terminate any Contract that would have been an SWWC Material Contract if it had been entered into prior to the date of this Agreement;

(xii) enter into any new line of business outside of its existing business;

(xiii) dissolve, liquidate, restructure, reorganize, otherwise wind up or make any voluntary bankruptcy or insolvency filing (or consent to any such involuntary filing) as to any SWWC Subsidiary;

(xiv) take any actions or omit to take any actions that would reasonably be expected to result in new or additional material required approvals from any Governmental Entity in connection with the Business Combination or other transactions contemplated by this Agreement;

(xv) (A) make (other than in the ordinary course of business), change or rescind any material Tax election, material method of Tax accounting or any annual Tax accounting period, (B) make a request for a Tax ruling or enter into a closing agreement, or settle or compromise any audit, assessment, Tax claim or other controversy, in each case relating to material Taxes, (C) file any material amended Tax Return, (D) surrender any material right to claim a refund or offset of any Taxes, (E) extend or waive, or agree to extend or waive, any statute of limitation with respect to the assessment, determination or collection of material Taxes (other than pursuant to extensions of time to file Tax Returns obtained in the ordinary course of business), or (F) file any Tax Return other than one prepared in a manner consistent with past practice;

(xvi) initiate, settle or compromise any examination, investigation, claim, suit, action or other proceeding involving an amount equal to or in excess of \$2,500,000, or waive, release or assign any material rights or claims thereunder, excluding, in each

case, any such examination, investigation, claim, suit, action or other proceeding that are solely with the control of an insurer *provided, however*, that this Section 7.1(b)(xvi) shall not prevent SWWC or any SWWC Subsidiary from initiating any proceeding to change or establish any rate charged by such entity before a Governmental Entity that regulates such entity; or

(xvii) authorize, or commit or agree to take, any of the foregoing actions.

(c) No Control of SWWC's Business. Corix acknowledges and agrees that (i) nothing contained in this Agreement is intended to give Corix, directly or indirectly, the right to control or direct the operations of SWMAC, SWWC or any SWWC Subsidiary prior to the consummation of the Business Combination and (ii) prior to the consummation of the Business Combination, SWMAC shall exercise, consistent with the terms and conditions of this Agreement, complete control and supervision over SWWC and the SWWC Subsidiaries' respective operations.

(d) No Control of Corix's Business. IIF Subway acknowledges and agrees that (i) nothing contained in this Agreement is intended to give IIF Subway, directly or indirectly, the right to control or direct the operations of any Contributed Corix Entity prior to the consummation of the Business Combination and (ii) prior to the consummation of the Business Combination, Corix shall exercise, consistent with the terms and conditions of this Agreement, complete control and supervision over its and the Contributed Corix Entities' respective operations.

## 7.2 Required Actions.

(a) As promptly as reasonably advisable following the date of this Agreement:

(i) the Parties shall file with the United States Federal Trade Commission (the "FTC") and the Antitrust Division of the United States Department of Justice (the "DOJ") Notification and Report Forms relating to the transactions contemplated herein required by the HSR Act. Without limitation of Section 7.2(b) below, each Party shall, as promptly as reasonably practicable, (A) supply the other Parties with any information which may be required in order to effectuate such filings and (B) supply any additional information which reasonably may be required by the FTC or the DOJ; and

(ii) the Parties shall file a request for an advance ruling certificate under section 102 of the Competition Act (an "Advance Ruling Certificate") or, in the alternative, confirmation that the Commissioner of Competition appointed under the Competition Act (including any person designated by the Commissioner on his behalf) (the "Commissioner") does not, at that time, intend to make an application under section 92 of the Competition Act (a "No Action Letter") along with a waiver of the notification obligation under section 113(c) of the Competition Act. If mutually agreed between the Parties, each Party will prepare and submit, within ten (10) Business Days of such agreement, the notification and information required under subsection 114(1) of the Competition Act. The Parties shall use reasonable best efforts to obtain the Competition Act Approval in respect of the Business Combination and will supply as promptly as reasonably practicable any additional information and documentary material that may be reasonably requested by the Commissioner to obtain the Competition Act Approval, as

soon as reasonably practicable and they will respond to any requests for additional information made by the Commissioner in order to cause the waiting periods under the Competition Act to terminate, expire or be waived, at the earliest possible date. Without limiting the foregoing, each Party shall, as promptly as reasonably practicable, (A) supply the other Parties with any information which may be required in order to effectuate such filings and (B) supply any additional information which reasonably may be required by the Commissioner.

(b) The Parties shall use reasonable best efforts to prepare and file, or cause to be prepared and filed, as promptly as reasonably practicable after the date of this Agreement but in no event more than sixty (60) Business Days or by such other time as is mutually agreed to by Corix and IIF Subway, (i) all filings, submissions and registrations required or advisable to be made to CFIUS, and to all applicable Governmental Entities, (ii) in the case of the SWWC Parties, a notification under section 12 of the ICA and (iii) all other applications, notices, registrations, filings, reports and other documents required to be filed with any Governmental Entity with respect to the Business Combination and the other transactions contemplated by this Agreement, including all Corix Regulatory Approvals and all SWWC Regulatory Approvals except for any filings in connection with the HSR Act and the Competition Act which shall be prepared and filed in accordance with Section 7.2(a). Each Party shall, as promptly as reasonably practicable, (A) supply the other Parties with any information which reasonably may be required in order to effectuate such filings, except, with respect to the CFIUS process, any exhibits to such communications providing the personal identifying information required by 31 C.F.R. §800.502(c)(6)(vi), information otherwise requested by CFIUS to remain confidential or information reasonably determined by the Parties to be business confidential information, (B) supply any additional information which reasonably may be required by a Governmental Entity of any jurisdiction and which the Parties may reasonably deem appropriate and (C) subject to applicable Law and the instructions of any Governmental Entity, keep each other apprised of the status of matters relating to the completion of the transactions contemplated thereby, including promptly furnishing the other with copies of notices or other communications received by a Party or any of their respective Subsidiaries, from any third party and/or any Governmental Entity with respect to such transactions. Other than with respect to the Excluded Business Carveout (solely to the extent any such meeting or substantive conversation is reasonably anticipated to be wholly unrelated to the SWWC Parties, the Corix Water Business and the Business Combination), no Party shall independently participate in any meeting, or engage in any substantive conversation, with any Governmental Entity in respect to any such filings, investigation or other inquiry without using reasonable best efforts to give (to the extent feasible and appropriate) the other Parties prior notice of the meeting or conversation and, unless prohibited by such Governmental Entity, a reasonable opportunity to attend or participate. Subject to applicable Law and the instructions of any Governmental Entity, the Parties will consult and cooperate with one another and permit the other Party or its counsel to review in advance, and consider in good faith the views of the other in connection with, any proposed written or oral communication by such Party to any Governmental Entity in connection with any analyses, appearances, presentations, memoranda, briefs, arguments, opinions and proposals made or submitted by or on behalf of any Party in connection with proceedings under or relating to the HSR Act, the Competition Act, other antitrust Laws, Investment Canada, DPA or any applicable state Laws in connection with the Business Combination and the other transactions contemplated by this Agreement (other than with respect

to the Excluded Business Carveout (solely to the extent any such written or oral communication is wholly unrelated to the SWWC Parties, the Corix Water Business and the Business Combination)).

(c) The Corix Parties and the SWWC Parties each shall, and shall cause their Subsidiaries to, (i) use reasonable best efforts to obtain, and to maintain in full force and effect once obtained, any approval, consent, ratification, permission, waiver or authorization required to be obtained from any Governmental Entity with respect to the Business Combination and the other transactions contemplated by this Agreement, including all Corix Regulatory Approvals and all SWWC Regulatory Approvals, prior to the Closing, and (ii) reasonably cooperate with the other in connection therewith. Notwithstanding anything contained in this Agreement (including the immediately preceding sentence and the obligations set forth in Sections 7.2(a) and 7.2(b)), (i) none of the Corix Parties nor any of their respective Affiliates shall be required to, and none of Corix nor any of the Contributed Corix Entities shall be permitted to without IIF Subway's prior written approval, in connection with obtaining any Corix Regulatory Approvals, agree or consent to or accept any terms, conditions, liabilities, obligations, commitments, sanctions or undertakings (including settlements, stipulations, operational restrictions, hold separate orders, divestitures or otherwise) as a condition to obtaining the Corix Regulatory Approvals that would, individually or in the aggregate, have or reasonably be expected to have a Corix Burdensome Effect and (ii) neither the SWWC Parties nor any of their respective Subsidiaries shall be required to, and neither the SWWC Parties nor any of their respective Subsidiaries shall be permitted to without Corix's prior written approval, in connection with obtaining any SWWC Regulatory Approvals, agree or consent to or accept any terms, conditions, liabilities, obligations, commitments, sanctions or undertakings (including settlements, stipulations, operational restrictions, hold separate orders, divestitures or otherwise) as a condition to obtaining the SWWC Regulatory Approvals that would, individually or in the aggregate, have or reasonably be expected to have an SWWC Burdensome Effect. Nothing contained in this Agreement (including the obligations set forth in the first sentence of this Section 7.2(c) and Sections 7.2(a) and 7.2(b)) shall require (x) the Corix Parties or any of their respective Affiliates to agree or consent to or accept any terms, conditions, liabilities, obligations, commitments, sanctions or undertakings (including settlements, stipulations, operational restrictions, hold separate orders, divestitures or otherwise) in connection with obtaining the Corix Regulatory Approvals to take any action or agree to any commitment that is not conditioned on the Closing or (y) the SWWC Parties or any of their respective Subsidiaries to agree or consent to or accept any terms, conditions, liabilities, obligations, commitments, sanctions or undertakings (including settlements, stipulations, operational restrictions, hold separate orders, divestitures or otherwise) in connection with obtaining the SWWC Regulatory Approvals to take any action or agree to any commitment that is not conditioned on the Closing.

(d) The Corix Parties and the SWWC Parties shall each (i) give the other prompt notice of the commencement or threat of commencement of any legal proceeding by or before any Governmental Entity with respect to the Business Combination or any of the other transactions contemplated by this Agreement, (ii) keep the other informed as to the status of any such legal proceeding or threat, and (iii) cooperate in all material respects with each other with respect to any such action or proceeding. Notwithstanding anything to the contrary contained in this Agreement (including the obligations set forth under this Section 7.2), the Parties acknowledge and agree that absent its prior written consent, neither the Corix Parties nor the SWWC Parties shall have any obligation to initiate or defend any such action or proceeding, whether judicial or administrative, challenging the Business Combination or any of the other transactions

contemplated by this Agreement, including any obligation to seek to have any stay or temporary restraining order entered by any court or other Governmental Entity vacated or reversed.

(e) The Corix Parties and the SWWC Parties each shall, and shall cause their Subsidiaries to, (i) use reasonable best efforts to obtain, and to maintain in full force and effect once obtained, any approval, consent, ratification, permission, waiver or authorization required to be obtained from any party to any Corix Water Material Contract identified on Section 7.2(e)(i) of the Corix Disclosure Letter or SWWC Material Contract identified on Section 7.2(e)(ii) of the SWWC Disclosure Letter (collectively, the “Required Third-Party Consents”) prior to the Closing, and (ii) reasonably cooperate with the other in connection therewith; *provided, however*, that the Corix Parties and the SWWC Parties (and each of their respective Subsidiaries) shall not be required to (x) take an action unless the effectiveness of such action is contingent upon the consummation of the Business Combination or (y) make any payments or incur any Loss to obtain any consents of third parties contemplated by this Section 7.2(e). Unless prohibited by Law, each Party shall promptly notify the other of any notice or other communication from any Person alleging that such Person’s approval, authorization, consent or Permit is or may be required in connection with the Business Combination.

(f) The Corix Parties and the SWWC Parties shall each reasonably cooperate with the other, execute and deliver such further documents, certificates, agreements and instruments and take such other actions as may be reasonably requested by the other to evidence or reflect the transactions contemplated by this Agreement (including the execution and delivery of all documents, certificates, agreements and instruments reasonably necessary for all filings hereunder).

### 7.3 Access to Information; Confidentiality; Non-Solicit.

(a) Subject to applicable Law, each of Corix and SWWC shall, and shall cause each Contributed Corix Entity and each SWWC Subsidiary (as applicable) to, afford to the other Parties and to the Representatives of such other Parties reasonable access during the period from the date of this Agreement to the earlier of the consummation of the Business Combination or the earlier termination of this Agreement pursuant to Article X, to all their respective properties (including for purposes of conducting environmental site assessments; *provided* that no subsurface sampling or invasive testing shall be conducted as part of any such assessment), books, contracts, commitments, personnel and records and, during such period, each of Corix and SWWC shall, and shall cause each Contributed Corix Entity and each SWWC Subsidiary (as applicable) to, furnish promptly to the other Parties all other information concerning its business, properties and personnel as such other Party may reasonably request; *provided, however*, that any Party may withhold any document or information (x) that is subject to the terms of a confidentiality agreement with a third party (*provided* that the withholding Party shall use its reasonable best efforts to obtain the required consent of such third party to such access or disclosure), (y) subject to any attorney-client privilege or protections, including attorney work-product protections and confidentiality protections (*provided* that the withholding Party shall use its reasonable best efforts to allow for such access or disclosure (or as much of it as possible) in a manner that does not result in a loss of attorney-client privilege or protections), or (z) if the sharing of such document or information would result in a violation of applicable Law, and *provided, further, however*, that Corix may withhold any document, information or access to properties or personnel to the extent



related solely to the Excluded Business. If any material is withheld by such Party pursuant to the first proviso to the preceding sentence, such Party shall inform the other Parties as to the general nature of what is being withheld. The terms and existence of this Agreement, the Ancillary Agreements, and all information exchanged pursuant to this Section 7.3 shall be deemed Confidential Information (as defined in the Confidentiality Agreement) and be subject to the confidentiality and non-use obligations (including all permitted uses and exceptions, but excluding any obligation to destroy Confidential Information) as set forth in the Confidentiality Agreement (collectively, the “Confidentiality Terms”) which are incorporated herein; *provided* that, notwithstanding the expiration of the Confidentiality Agreement or the termination of this Agreement, the Parties shall remain subject to the Confidentiality Terms until the earlier of (i) the Closing or (ii) twenty-four (24) months after the date that this Agreement is terminated in accordance with Article X.

(b) Until the earlier of (i) the Closing or (ii) twelve (12) months after the date that this Agreement is terminated in accordance with Article X, without the prior written consent of SWWC, Corix shall not, and shall cause its Subsidiaries (each, a “Corix Restricted Person”) not to, whether directly or indirectly, for itself or on behalf of another Person (i) solicit for employment or otherwise induce, influence, or encourage any employee of SWWC or any of the SWWC Subsidiaries with whom the Corix Restricted Persons had contact or who became known to the Corix Restricted Persons in connection with the Parties’ evaluation of the Business Combination (each, an “SWWC Covered Employee”) to terminate their employment with SWWC or any of the SWWC Subsidiaries, or (ii) employ or engage as an independent contractor, any SWWC Covered Employee, except (x) pursuant to a general solicitation through the media or by a search firm, in either case, that is not directed specifically to any employees of SWWC or any of the SWWC Subsidiaries, unless such solicitation is undertaken as a means to circumvent the restrictions contained in or conceal a violation of this Section 7.3(b) or (y) if SWWC or any of the SWWC Subsidiaries terminated the employment of such SWWC Covered Employee before the Corix Restricted Person solicited or otherwise contacted such SWWC Covered Employee or discussed the employment or other engagement of the SWWC Covered Employee.

(c) Until the earlier of (i) the Closing or (ii) twelve (12) months after the date that this Agreement is terminated in accordance with Article X, without the prior written consent of Corix, neither SWMAC nor SWWC shall, nor cause its Subsidiaries (each, an “SWWC Restricted Person”) to, whether directly or indirectly, for itself or on behalf of another Person (i) solicit for employment or otherwise induce, influence, or encourage any employee of Corix or any of its Subsidiaries with whom the SWWC Restricted Person had contact or who became known to the SWWC Restricted Person in connection with the Parties’ evaluation of the Business Combination (each, a “Corix Covered Employee”) to terminate their employment with Corix or any of its Subsidiaries, or (ii) employ or engage as an independent contractor, any Corix Covered Employee, except (x) pursuant to a general solicitation through the media or by a search firm, in either case, that is not directed specifically to any employees of Corix or any of its Subsidiaries, unless such solicitation is undertaken as a means to circumvent the restrictions contained in or conceal a violation of this Section 7.3(c) or (y) if Corix or any of its Subsidiaries terminated the employment of such Corix Covered Employee before the SWWC Restricted Person solicited or otherwise contacted such Corix Covered Employee or discussed the employment or other engagement of the Corix Covered Employee.

(d) Each of Corix, the Corix Parties, SWCC and the SWWC Parties agrees to (i) provide any information or documentation to the other Parties upon reasonable request that such other Parties, in their reasonable discretion, upon the advice of legal counsel, deems necessary to comply with applicable AML Laws and (ii) notify the other Parties promptly if there is any change with respect to the representations and warranties provided in any of Sections 3.8, 4.23, 5.8 or 6.23, as applicable, so long as permitted by applicable Law. Each Party's receipt of information pursuant to this Section 7.3(c) shall not operate as a waiver of or otherwise affect any representation, warranty or agreement given or made by any Party in this Agreement or and the Ancillary Agreements and shall not be deemed to amend or supplement the applicable Disclosure Letter.

(e) Each Party shall promptly, and in no event later than sixty (60) days following the Closing, deliver to CIUS copies of all books and records of or relating to the Contributed Corix Entities, SWMAC, SWWC and the SWWC Subsidiaries (whether in hard copy or electronic format, and wherever located) that are in the possession or control of such Party or any of its Affiliates and are not otherwise in the possession or control of the Contributed Corix Entities, SWMAC, SWWC and the SWWC Subsidiaries as of the Closing Date.

7.4 Public Disclosures. The initial press releases issued by any Party announcing the transactions contemplated by this Agreement shall be in a form that is mutually acceptable to Corix, IIF Subway and SWWC. Thereafter, Corix, IIF Subway and SWWC shall consult with one another before issuing any press release or otherwise making any public announcement with respect to the Business Combination and the other transactions contemplated by this Agreement and the Ancillary Agreements that does not simply repeat the information provided in the initial press release, and except as may be required by applicable Laws, shall not issue any such press release or make any such announcement prior to such consultation, except that Corix, IIF Subway and SWWC shall agree on the content of the first announcement made to Corix Water Personnel and SWWC Personnel regarding the execution of this Agreement and the transactions contemplated in this Agreement and the Ancillary Agreements. Nothing in this Section 7.4 or in Section 7.3 is intended to restrict a Party from disclosing the terms of this Agreement, the Ancillary Agreements or information relating to the transactions contemplated hereby and thereby to its Representatives, actual or potential financing parties, or direct or indirect investors or potential investors, and no press release made by the Corix Parties or the SWWC Parties in accordance with this Section 7.4 shall be deemed a breach of the confidentiality obligations set forth in (a) Section 7.3 or (b) the Confidentiality Agreement.

7.5 Indemnification of Officers and Directors.

(a) The Parties agree that all rights to indemnification, exculpation or advancement of expenses now existing in favor of, and all limitations on the personal liability of each present and former director, officer, employee, or agent of SWMAC, SWWC or any of the SWWC Subsidiaries, or any of the Contributed Corix Entities provided for in their respective Organizational Documents or policies adopted by the respective Boards of Directors of Corix, CIUS or SWWC in effect as of the date hereof, shall continue to be honored and in full force and effect for a period of six (6) years after the Closing Date; *provided, however*, that all rights to indemnification in respect of any claims asserted or made within such period shall continue until the disposition of such claim. The CIUS Shareholders Agreement will contain provisions with

respect to indemnification, exculpation from liability and advancement of expenses that are at least as favorable as those currently in the Organizational Documents of SWMAC, SWWC, the SWWC Subsidiaries, Corix and the Contributed Corix Entities, as applicable, and, during such six (6) year period following the Closing Date, IIF Subway and Corix shall not and shall cause CIUS not to amend, repeal or otherwise modify such provisions in any manner that would materially and adversely affect the rights thereunder of individuals who at any time prior to the Closing Date was a director, officer, employee, or agent of SWMAC, SWWC, an SWWC Subsidiary or a Contributed Corix Entity (as applicable) in respect of actions or omissions occurring at or prior to the Closing Date, unless such modification is required by applicable Laws. From and after the Closing Date, IIF Subway and Corix also agree, to cause CIUS to indemnify and hold harmless the present and former officers, directors, employees, and agents of SWMAC, SWWC, the SWWC Subsidiaries and the Contributed Corix Entities (as applicable) in respect of acts or omissions occurring prior to the Closing Date to the extent (i) provided in any written indemnification agreements with such individuals in effect as of the date hereof or (ii) required by the Organizational Documents of SWMAC, SWWC, the SWWC Subsidiaries or the Contributed Corix Entities, in each case as in effect immediately prior to the Closing Date.

7.6 CIUS Shareholders Agreement. Within 90 days after the date of this Agreement, IIF Subway and Corix shall cooperate in good faith and shall each use commercially reasonable efforts to negotiate and finalize the CIUS Shareholders Agreement in accordance with the terms set forth on Exhibit A.

7.7 Transition Services Agreement. Within 120 days after the date of this Agreement, IIF Subway and Corix shall cooperate in good faith and shall each use commercially reasonable efforts to negotiate and finalize the Transition Services Agreement in accordance with the terms set forth on Exhibit B (the “TSA Terms”). To the extent that Remainco retains ownership of any portion of the Excluded Business as of the Closing Date, the Corix Parties shall cause Corix, CIUS or the applicable Contributed Corix Entities and Remainco to execute and deliver the form of the Transition Services Agreement that is mutually agreed between the Parties. To the extent that the consummation of the sale of any portion of the Excluded Business to an entity that is not an Affiliate of any of the Corix Parties (an “Excluded Business Purchaser”) occurs prior to the Closing Date and such Excluded Business Purchaser requests transition services in connection with such sale, Corix may cause CIUS or the applicable Contributed Corix Entities to execute and deliver a Transition Services Agreement in accordance with the TSA Terms with respect to such portion of the Excluded Business. To the extent that the consummation of the sale of any portion of the Excluded Business to an Excluded Business Purchaser occurs after the Closing, the Transition Services Agreement shall be assignable to such Excluded Business Purchaser.

7.8 Corix Restructuring.

(a) No later than immediately prior to the Closing, the Corix Parties shall (i) take or cause to be taken the actions set forth on Exhibit C, substantially in the form described thereon, to distribute, assign and transfer the Excluded Business Entities and the Canadian Water Entities; *provided* that the Corix Parties may make, or cause to be made, any modifications to such actions so long as such modifications, individually or in the aggregate, would not reasonably be expected to be material and adverse to any Contributed Corix Entity or any SWWC Party, and (ii) use their reasonable best efforts to complete any additional actions necessary to separate the

Excluded Business from the Contributed Corix Entities in connection with the Excluded Business Carveout and complete the Canadian Business Restructuring. The Corix Parties shall keep the SWWC Parties apprised, in reasonable detail, of the status of the Corix Restructuring prior to the Closing; *provided, however*, that the Corix Parties shall be permitted to enter into and may consummate a sale of the Excluded Business prior to the Closing, which transaction shall not require the consent of the SWWC Parties provided it does not impact the allocation of liabilities as between the Parties with respect to the Excluded Business Carveout under this Agreement.

(b) From and after completion of the Excluded Business Carveout, Corix and Remainco, or their Affiliates or assignees (other than the Contributed Corix Entities), shall:

(i) retain all rights, title and interest in and to, and there shall be excluded from the transfer, conveyance, assignment and delivery to CIUS of the Corix Water Business, and the Corix Water Business shall not include, any of the Excluded Business Assets; and

(ii) retain and remain responsible for and satisfy, discharge and perform when due, and CIUS and its Affiliates (including the Contributed Corix Entities) shall have no obligation with respect to, any of the Excluded Business Liabilities.

(c) CIUS and Corix shall be permitted to take such ancillary actions as may be necessary or advisable to effectuate the purpose of the Excluded Business Carveout, including entering into, or causing a Contributed Corix Entity to enter into, an assignable service agreement with Remainco or a third-party acquirer or acquirers of the Excluded Business, in each case consistent with the terms set forth in Exhibit C, without the consent of the other Parties, and Corix shall be permitted to make such modifications to the Excluded Business Carveout, so long as any such modifications, individually or in the aggregate, would not reasonably be expected to be material and adverse to any Contributed Corix Entity or any SWWC Party. Any such services agreement as described in the prior sentence shall be deemed to be a Transition Services Agreement for purposes of Section 7.7.

(d) No later than immediately prior to the Closing, the Corix Parties shall use reasonable best efforts to take or cause to be taken such actions as may be necessary to obtain all Consents required to be obtained from any third party that are necessary to, and to, transfer and assign to one or more of the Contributed Corix Entities any Contributed Corix Water Assets that is held by Corix (or an Affiliate thereof other than a Contributed Corix Entity) as of the Closing Date.

(e) No later than immediately prior to the Closing, the Corix Parties shall use reasonable best efforts to take or cause to be taken such actions as may be necessary to transfer the employment of the Corix Water Personnel employed by Corix and any Excluded Business Entity as at the time of such transfer (the employees who have been offered such transfer of employment, the “Transferred Corix Employees”) from Corix or any Excluded Business Entity to one or more of the Contributed Corix Entities. For the avoidance of doubt, such reasonable best efforts shall not require the Corix Parties to make any payments or take any actions that are not contemplated under any Corix Water Benefit Plan that is applicable to such Transferred Corix Employees.

(f) Unless otherwise expressly indicated, references herein to CIUS or any of its current or future Subsidiaries, including references throughout the representations and warranties, shall be deemed to mean CIUS or the current or future Subsidiary, as applicable, as it shall be constituted after consummation of the Corix Restructuring.

#### 7.9 Misallocated Assets.

(a) Prior to the Closing and until such time as the following assignments, amendments or separations are obtained, the Corix Parties shall use commercially reasonable efforts to take such actions as may be reasonably necessary to assign, amend or separate any contracts to which a Contributed Corix Entity is a party that relate to the Excluded Business (the “Excluded Business Contracts”) to, effective (or retroactive) upon the Closing, (i) remove each Contributed Corix Entity as a party thereto, and to assign or amend to Remainco or its transferee the rights and obligations of the applicable Contributed Corix Entity under such Excluded Business Contract, or (ii) to the extent such Excluded Business Contract relates both to the Excluded Business and the Corix Water Business, otherwise separate the applicable Excluded Business Contract such that the rights and obligations pertaining to the Corix Water Business are held by a Contributed Corix Entity and the rights and obligations pertaining to the Excluded Business are held by Remainco or its transferee (or its Affiliates). In the event the counterparties to any Excluded Business Contract do not consent or agree to such assignment, amendment or separation at or prior to the Closing, or any Contributed Corix Entity remains party to any Excluded Business Contract for any other reason, from all times after the Closing (x) CIUS and each of Contributed Corix Entities that are a party to such Excluded Business Contract shall continue to perform and discharge their respective obligations under such Excluded Business Contract and (y) without the prior consent of the Corix Parties (such consent not to be unreasonably withheld, delayed or conditioned), CIUS and its Affiliates shall take no action (or fail to take any action) under, or in connection with, such Excluded Business Contract if such action (or failure to take any action) would reasonably be expected to result in any costs, expenses, other liability to, or additional obligation of, Remainco or its transferee or its Affiliates that are a party to such Excluded Business Contract. The SWWC Parties shall, and shall cause their Affiliates to, cooperate with the Corix Parties and Remainco or its transferee with respect to obtaining the assignments and amendments contemplated by this Section 7.9(a). For the avoidance of doubt, the proviso in Section 7.2(e)(y) shall apply to the Corix Parties’ (and their respective Subsidiaries’) obligations under this Section 7.9(a).

(b) Prior to the Closing and until such time as the following assignments, amendments or separations are obtained, the Corix Parties and the Contributed Corix Entities shall use commercially reasonable efforts to take such actions as may be reasonably necessary to assign, amend or separate any Contracts to which Corix or an Affiliate thereof other than a Contributed Corix Entity is a party that comprise the Contributed Corix Water Assets (the “Contributed Corix Water Contracts”) to, effective (or retroactive) upon the Closing, (i) remove Corix (and any Affiliate thereof other than a Contributed Corix Entity) as a party thereto, and to assign or amend to a Contributed Corix Entity the rights and obligations of Corix (and any Affiliate thereof other than a Contributed Corix Entity) under such Contributed Corix Water Contract, or (ii) to the extent such Contributed Corix Water Contract relates both to the Excluded Business and the Corix Water Business, otherwise separate the applicable Contributed Corix Water Contract such that the rights and obligations pertaining to the Corix Water Business are held by a Contributed Corix Entity and

the rights and obligations pertaining to the Excluded Business are held by Corix or Remainco or its transferee (or its Affiliates other than any Contributed Corix Entity). In the event the counterparties to any Contributed Corix Water Contract do not consent or agree to such assignment, amendment or separation at or prior to the Closing, or Corix or any of its Affiliates other than any Contributed Corix Entity remains party to any Contributed Corix Water Contract for any other reason, from all times after the Closing (x) Corix and each of its Affiliates other than any Contributed Corix Entities that are a party to such Contributed Corix Water Contract shall continue to perform and discharge their respective obligations under such Contributed Corix Water Contract and (y) without the prior consent of CIUS (such consent not to be unreasonably withheld, delayed or conditioned), Corix and its Affiliates shall take no action (or fail to take any action) under, or in connection with, such Contributed Corix Water Contract if such action (or failure to take any action) would reasonably be expected to result in any costs, expenses, other liability to, or additional obligation of, CIUS or its transferee or its Affiliates that are a party to such Contributed Corix Water Contract. The SWWC Parties shall, and shall cause their Affiliates to, cooperate with the Corix Parties and Remainco or its transferee with respect to obtaining the assignments and amendments contemplated by this Section 7.9(b). For the avoidance of doubt, the proviso in Section 7.2(e)(y) shall apply to the Corix Parties' (and their respective Subsidiaries') obligations under this Section 7.9(b).

(c) Subject to Section 7.8, following the Closing, in the event that any Party becomes aware that (i) record or beneficial ownership or possession of any asset that is an Excluded Business Asset or Contributed Corix Water Asset has not been contributed, assigned, transferred, conveyed or delivered by the applicable Contributed Corix Entity to Remainco, or by Corix or any of its Affiliates to a Contributed Corix Entity, as applicable, prior to the Closing, or (ii) any Excluded Business Liability has been erroneously assumed by CIUS or any of its Affiliates, then it shall promptly notify the applicable Party and the Parties shall thereafter reasonably cooperate to, as promptly as practicable, contribute, assign, transfer, convey or deliver (or cause to be contributed, assigned, transferred, conveyed or delivered), as applicable, without consideration the relevant asset to the relevant entity or assignee or cause the relevant liability to be assumed by the relevant entity or assignee in furtherance of the terms of this Agreement.

7.10 Exclusive Dealing. Prior to the Closing, except in connection with the Excluded Business Carveout to the extent consistent with the terms set forth in Exhibit C, none of the Parties shall take, or permit any controlled Affiliate thereof to take, any action to encourage, initiate or engage in, or permit to exist or continue, any discussions or negotiations with, or provide any information to, any Person (other than the Parties hereto and their Affiliates), or enter into any Contract with any Person (other than the Parties hereto and their Affiliates), concerning (a) any purchase, acquisition, issuance or disposition of any Equity Interest in any of the Contributed Corix Entities, SWMAC, SWWC or the SWWC Subsidiaries, (b) any merger, business combination, recapitalization or similar transaction involving any of the Contributed Corix Entities, SWMAC, SWWC or the SWWC Subsidiaries, or (c) any sale, assignment, transfer, lease, license or other disposition of any material portion of the assets of the Contributed Corix Entities, SWMAC, SWWC or the SWWC Subsidiaries (except to the extent otherwise permitted by Section 7.1).

7.11 Transition from Corix Marks.

(a) In order to facilitate the phase-out of use of the Corix Marks by CIUS and its Affiliates (including the Contributed Corix Entities), Corix or Remainco (or their applicable Affiliates), as applicable, hereby grants (without any representation, warranty or recourse to CIUS or its Affiliates) a non-exclusive, non-sublicensable, non-transferable, royalty-free license to CIUS and its Affiliates to use the Corix Marks in the ordinary course of operating the Corix Water Business, solely to the extent used in the Corix Water Business immediately prior to the Closing Date, and solely during the period from the Closing Date to one (1) year after the Closing Date (the “Cessation Date”), to facilitate the transition by CIUS and its Affiliates from use of the Corix Marks to use of new names and marks in respect of the Corix Water Business, subject at all times to CIUS’ and its Affiliates’ continued compliance with the terms of this Section 7.11. With respect to such use of the Corix Marks prior to the Cessation Date, CIUS and its Affiliates shall only use the Corix Marks in substantially the same form and manner used, and with standards of quality in effect for such Corix Marks and any products or services provided thereunder, as of the Closing Date. By no later than the Cessation Date, CIUS shall (and shall cause its Affiliates to) cease any and all use, licensing or other exploitation of the Corix Marks. In furtherance of the foregoing, prior to the Cessation Date, CIUS shall (and shall cause its Affiliates to) remove, strike over, or otherwise obliterate all Corix Marks from all assets and other materials owned or controlled by CIUS or any of its Affiliates, including any stationery, packaging materials, displays, signs, promotional materials, manuals, forms, websites and other materials and systems. CIUS shall not (and shall cause its Affiliates to not) use the Corix Marks in a manner that may reflect negatively on such Corix Marks or on Corix, Remainco or their respective Affiliates. Corix or Remainco (or their applicable Affiliates), as applicable, shall have the right to terminate the foregoing license and right, effective immediately, if CIUS or any of its Affiliates fail to comply with the terms and conditions of this Section 7.11. CIUS shall indemnify and hold harmless Corix, Remainco and their respective Affiliates for any claims, actions, suits, proceedings, liabilities, judgments, penalties, losses, costs, damages, and expenses (including attorneys’ fees and costs) arising from or relating to the use by CIUS or any of its Affiliates of the Corix Marks pursuant to this Section 7.11. All goodwill associated with the Corix Marks generated by CIUS’ or its Affiliates’ use of the Corix Marks pursuant to this Section 7.11 shall inure solely to the benefit of Corix, Remainco and their applicable Affiliates.

(b) Without limiting the foregoing, no later than twenty (20) Business Days following the Closing Date, CIUS shall cause the Contributed Corix Entities to change their names and cause their respective Organizational Documents to be amended to remove any reference to any Corix Mark.

#### 7.12 Employee Matters.

(a) Except as may be mutually agreed to otherwise by the Parties, for a period of twelve (12) months following the Closing Date (the “Continuation Period”), CIUS or one of its Subsidiaries following the Closing Date, as applicable, shall cause to be provided to each Corix Water Personnel and SWWC Personnel who is or becomes employed by CIUS or one of its Subsidiaries immediately following the Closing (collectively, the “Combined Business Employees”), for so long as such employee remains employed by CIUS or one of its Subsidiaries during the Continuation Period, with (i) an annual base salary or wage rate and, if applicable, annual bonus opportunity, that is no less favorable than the base salary or wage rate and, if applicable, annual bonus opportunity, provided to such employee immediately prior to the Closing

Date, (ii) subject to subclause (i), full recognition of the employee's original service date that applied immediately prior to the Closing Date, and (iii) other terms and conditions of employment, including compensation and benefits (excluding equity compensation, retention bonuses, and transaction-based compensation, and also excluding any defined benefit pension plan, non-qualified deferred compensation benefits, or retiree medical benefits), that are substantially comparable in the aggregate to those provided to such employees immediately prior to the Closing Date.

(b) CIUS will honor the terms of all individual employment, consulting, severance, retention, change in control, incentive and other compensation agreements and arrangements applicable to the Combined Business Employees as in effect immediately prior to the Closing Date.

(c) With respect to employee benefit plans, programs, policies and arrangements that are established or maintained for Combined Business Employees by CIUS or an applicable Subsidiary following the Closing Date (the "Combined Business Benefit Plans"), CIUS shall take or cause to be taken commercially reasonable efforts to provide that: (i) Combined Business Employees (and their eligible dependents) shall be given credit for their service with the Corix Water Business or SWWC, as applicable, for all purposes, including eligibility to participate, vesting and benefit accrual (but not benefit accrual under a defined benefit pension or retiree medical plan), to the same extent such service was taken into account by Corix or SWWC, as applicable, under a corresponding benefit arrangement of Corix or SWWC, as applicable, immediately prior to the Closing Date, (ii) any waiting periods, evidence of insurability requirements, or the application of any pre-existing condition limitations shall be waived for Combined Business Employees (and their eligible dependents) as of the Closing Date or as soon as reasonably practicable thereafter, and (iii) to the extent a Combined Business Employee commences participation in a Combined Business Benefit Plan during an ongoing plan year, such Combined Business Employees (and their eligible dependents) shall be given credit for amounts paid under a corresponding benefit arrangement of Corix or SWWC, as applicable, during the same period for purposes of applying deductibles, copayments and out of pocket maximums as though such amounts had been paid in accordance with the terms and conditions of the applicable Combined Business Benefit Plan. Notwithstanding the foregoing provisions of this Section 7.12, service credit and other amounts shall not be credited to Combined Business Employees (or their eligible dependents) to the extent the crediting of such service or other amounts would result in the duplication of benefits.

(d) Notwithstanding anything in this Section 7.12 to the contrary, the compensation and terms of employment applicable to any Combined Business Employee covered by a Collective Bargaining Agreement shall be governed solely by the terms of the applicable Collective Bargaining Agreement. Further, to the extent the local laws applicable to any non-U.S. Combined Business Employee would require a more favorable treatment than is set forth herein, such more favorable treatment shall apply to such Combined Business Employee.

(e) Following the date of this Agreement, the Parties shall work in good faith to determine an appropriate plan of human resources integration to be applicable to the Combined Business Employees, including with respect to payroll mechanics and the establishment and/or continuation of Combined Business Benefit Plans, which integration plan shall be substantially



final no later than sixty (60) days prior to the Closing Date or within such other timeline as may be mutually agreed to by the Parties following the date of this Agreement. In connection with developing such integration plan and following good faith consultation with SWWC, Corix may, or may cause an Affiliate to, amend, assign or establish any Corix Water Benefit Plan, to the extent deemed necessary or appropriate following good faith consultation with SWWC, to (i) cause such plan (and any corresponding asset(s)) to be sponsored or maintained by CIUS (or a subsidiary thereof) prior to the consummation of the Business Combination for purposes of making post-closing coverage available to certain (or all) Combined Business Employees to the extent consistent with the integration plan and/or (ii) provide that, from and after the consummation of the Business Combination, individuals who are employed by an Excluded Business no longer actively participate in a Corix Water Benefit Plan to the extent it becomes sponsored or maintained by CIUS (or a Subsidiary thereof).

(f) Nothing contained in this Agreement (including this Section 7.12), express or implied (i) shall be construed to establish, amend, or modify any employee benefit plan, program, agreement or arrangement, (ii) subject to Section 7.12(a), shall alter or limit the ability of CIUS to amend, modify or terminate any employee benefit or employment plan, program, agreement, or arrangement after the Closing Date, (iii) is intended to guarantee any current or former employee any right to employment or continued employment for any period of time, or (iv) is intended to confer or shall confer upon any individual or any legal representative of any individual (including employee, retirees, or dependents or benefits of employees or retirees) any right as a third-party beneficiary of this Agreement.

7.13 Section 280G. Following the date of this Agreement, the Parties and their respective counsel shall work in good faith to determine (i) whether the consummation of the Business Combination will constitute a “change in ownership or control” within the meaning of Section 280G of the Code of either Corix or SWWC, and (ii) whether and to what extent any payments or benefits that are required or proposed to be made to any SWWC Personnel or Corix Water Personnel, as applicable, in connection with the consummation of the Business Combination could reasonably be expected to constitute “parachute payments” under Section 280G(b)(2) of the Code (any such payments and benefits, the “Section 280G Payments”, and any such individuals, the “Disqualified Individuals”). Corix or SWWC, as applicable depending on the results of the immediately preceding sentence (the “280G Entity”), shall seek to obtain a waiver from each Disqualified Individual (a “Parachute Payment Waiver”) waiving any such Disqualified Individual’s right to receive some or all of such Section 280G Payments (the “Waived Benefits”), to the extent necessary so that all remaining payments and benefits applicable to such Disqualified Individual shall not be deemed a parachute payment. No later than ten (10) Business Days prior to the Closing Date, the 280G Entity shall submit the Waived Benefits, if any, of each Disqualified Individual who executed a Parachute Payment Waiver for approval of the applicable equityholders of the 280G Entity entitled to vote on such matter and such Disqualified Individual’s right to receive the Waived Benefits shall be conditioned upon receipt of the requisite approval by the equityholders of the 280G Entity entitled to vote on such matter in a manner that is intended to comply with Section 280G(b)(5)(B) of the Code and the Treasury Regulations. Prior to obtaining the Parachute Payment Waivers and seeking the equityholder approval described in this Section 7.13, the 280G Entity shall provide the other Party and its counsel with copies of the 280G Entity’s analysis under Section 280G of the Code, true, correct and complete copies of the duly executed Parachute Payment Waivers, and the disclosure statement and equityholder solicitation materials

contemplated by this Section 7.13 and provide at least five (5) Business Days to review the same, and the 280G Entity shall consider in good faith incorporating any changes reasonably requested by the other Party or their counsel.

## ARTICLE VIII

### CONDITIONS PRECEDENT

8.1 Conditions to Each Party's Obligation to Effect the Business Combination. The respective obligations of the Parties to effect the Business Combination are subject to the satisfaction or, to the extent permitted by Law, the waiver by Corix and IIF Subway on or prior to the Closing Date of each of the following conditions:

(a) Governmental Approvals. All Required Consents (including, in each case, the expiration or termination of the waiting periods (and any extensions thereof) applicable to the Business Combination and the transactions contemplated by this Agreement, including the Excluded Business Carveout) shall have been obtained and shall have become Final Orders and such Final Orders shall not impose terms or conditions that, individually or in the aggregate, could reasonably be expected to have a Regulatory Material Adverse Effect. As used in this Agreement, a "Final Order" means an action by the relevant Governmental Entity that has not been reversed, stayed, enjoined, set aside, annulled or suspended, with respect to which any waiting period prescribed by Law before the transactions contemplated hereby may be consummated has expired, and as to which all conditions (other than any conditions that are within the control of Corix or SWWC, respectively, to satisfy) to the consummation of such transactions prescribed by applicable Law or order have been satisfied.

(b) No Legal Restraints. No Law and no Judgment, preliminary, temporary or permanent, issued by any court or tribunal of competent jurisdiction (collectively, "Legal Restraints") shall be in effect, and no suit, action or other proceeding that has been initiated by a Governmental Entity having jurisdiction over any Contributed Corix Entity, SWWC or the SWWC Subsidiaries shall be pending, in which such Governmental Entity seeks to impose, or has imposed, any Legal Restraint, in each case that, prevents, makes illegal or prohibits the consummation of the Business Combination or the other transactions contemplated by this Agreement.

(c) Consents. All Required Third-Party Consents shall have been received and in full force and effect at the Closing.

8.2 Conditions to Obligations of the Corix Parties. The respective obligations of the Corix Parties to consummate the Business Combination is further subject to the satisfaction or, to the extent permitted by Law, the waiver by Corix on or prior to the Closing Date of each of the following conditions:

(a) Representations and Warranties.

(i) Each of the representations and warranties of the SWWC Parties contained in this Agreement except for (x) the representations and warranties contained in Sections 5.2, 5.4, 5.7, 5.8, 6.1, 6.2, 6.3, 6.22 and 6.23 (the "SWWC Designated Representations") and (y) the representations and warranties set forth in Section 6.7(a),

shall be true and correct (without giving effect to any limitation as to “materiality” or “SWWC Material Adverse Effect” set forth therein) as of the date of this Agreement and as of the Closing as if made at and as of such date and time (except to the extent expressly made as of an earlier date, in which case as of such earlier date), except where the failure of such representations and warranties to be true and correct (without giving effect to any limitation as to “materiality” or “SWWC Material Adverse Effect” set forth therein), has not had or would not reasonably be expected to have, individually or in the aggregate, an SWWC Material Adverse Effect.

(ii) Each of the representations and warranties contained in Sections 5.8, 6.1, 6.3 and 6.23, in each case disregarding all qualifications and exceptions set forth herein relating to “materiality” or “SWWC Material Adverse Effect,” shall be true and correct in all material respects as of the date of this Agreement and as of the Closing (*provided* that, to the extent that any such representation and warranty is made as of an earlier date, such representation and warranty shall be true and correct in all respects as of such earlier date).

(iii) Each of the representations and warranties contained in Sections 5.2, 5.4, 5.7, 6.2 and 6.22 in each case disregarding all qualifications and exceptions set forth herein relating to “materiality” or “SWWC Material Adverse Effect,” shall be true and correct in all respects as of the date of this Agreement and as of the Closing (*provided* that, to the extent that any such representation and warranty is made as of an earlier date, such representation and warranty shall be true and correct in all respects as of such earlier date), in each case, except for any failure to be so true and correct that has only a de minimis impact on the SWWC Business and SWWC and the SWWC Subsidiaries, taken as a whole.

(iv) The representations and warranties set forth in Section 6.7(a) shall be true and correct in all respects as of the date of this Agreement and as of the Closing as if made at and as of such date and time (*provided, however*, that this clause (iv) shall be deemed to be satisfied if any such SWWC Material Adverse Effect that arose during the period from December 31, 2021 through the date of this Agreement has been ameliorated or cured such that an SWWC Material Adverse Effect no longer exists).

(b) Performance of Obligations of the SWWC Parties. The SWWC Parties shall have performed in all material respects all obligations required to be performed by them under this Agreement at or prior to the Closing.

(c) Absence of SWWC Material Adverse Effect. Since the date of this Agreement, there shall not have occurred any fact, circumstance, effect, change, event or development that, individually or in the aggregate, has had or would reasonably be expected to have an SWWC Material Adverse Effect that has not been ameliorated or cured such that an SWWC Material Adverse Effect no longer exists.

(d) The conditions in this Section 8.2 are for the sole benefit of the Corix Parties and may, subject to the terms of this Agreement, be waived by Corix, in whole or in part at any time and from time to time, in the sole discretion of Corix. The failure by Corix at any time to

exercise any of the foregoing rights shall not be deemed a waiver of any such right and each such right shall be deemed an ongoing right which may be asserted at any time and from time to time prior to the Closing Date.

8.3 Conditions to Obligations of the SWWC Parties. The respective obligations of the SWWC Parties to consummate the Business Combination is further subject to the satisfaction or, to the extent permitted by Law, the waiver by IIF Subway on or prior to the Closing Date of each of the following conditions:

(a) Representations and Warranties.

(i) Each of the representations and warranties of the Corix Parties contained in this Agreement except for (x) the representations and warranties contained in Sections 3.2, 3.4 3.7, 3.8, 4.1, 4.2, 4.3, 4.22 and Section 4.23 (the “Corix Designated Representations”) and (y) the representations and warranties set forth in Section 4.7(a), shall be true and correct (without giving effect to any limitation as to “materiality” or “Corix Water Material Adverse Effect” set forth therein) as of the date of this Agreement and as of the Closing as if made at and as of such date and time (except to the extent expressly made as of an earlier date, in which case as of such earlier date), except where the failure of such representations and warranties to be true and correct (without giving effect to any limitation as to “materiality” or “Corix Water Material Adverse Effect” set forth therein), has not had or would not reasonably be expected to have, individually or in the aggregate, a Corix Water Material Adverse Effect.

(ii) Each of the representations and warranties contained in Sections 3.8, 4.1, 4.3 and 4.23, in each case disregarding all qualifications and exceptions set forth herein relating to “materiality” or “Corix Water Material Adverse Effect,” shall be true and correct in all material respects as of the date of this Agreement and as of the Closing (*provided* that, to the extent that any such representation and warranty is made as of an earlier date, such representation and warranty shall be true and correct in all respects as of such earlier date).

(iii) Each of the representations and warranties contained in Sections 3.2, 3.4 3.7, 4.2 and 4.22, in each case disregarding all qualifications and exceptions set forth herein relating to “materiality” or “Corix Water Material Adverse Effect,” shall be true and correct in all respects as of the date of this Agreement and as of the Closing (*provided* that, to the extent that any such representation and warranty is made as of an earlier date, such representation and warranty shall be true and correct in all respects as of such earlier date), in each case, except for any failure to be so true and correct that has only a de minimis impact on the Corix Water Business and the Contributed Corix Entities, taken as a whole.

(iv) The representations and warranties set forth in Section 4.7(a) shall be true and correct in all respects as of the date of this Agreement and as of the Closing as if made at and as of such date and time (provided, however, that this clause (iv) shall be deemed to be satisfied if any such Corix Water Material Adverse Effect that arose during

the period from December 31, 2021 through the date of this Agreement has been ameliorated or cured such that a Corix Water Material Adverse Effect no longer exists).

(b) Performance of Obligations of the Corix Parties. The Corix Parties shall have performed in all material respects all obligations required to be performed by them under this Agreement at or prior to the Closing; *provided* that the Corix Parties shall have substantially performed all obligations of the Corix Parties with respect to the Excluded Business Carveout in accordance with Section 7.8 at or prior to the Closing.

(c) Absence of Corix Water Material Adverse Effect. Since the date of this Agreement, there shall not have occurred any fact, circumstance, effect, change, event or development that, individually or in the aggregate, has had or would reasonably be expected to have a Corix Water Material Adverse Effect that has not been ameliorated or cured such that a Corix Water Material Adverse Effect no longer exists.

(d) The conditions in this Section 8.3 are for the sole benefit of the SWWC Parties and may, subject to the terms of this Agreement, be waived by IIF Subway, in whole or in part at any time and from time to time, in the sole discretion of IIF Subway. The failure by IIF Subway at any time to exercise any of the foregoing rights shall not be deemed a waiver of any such right and each such right shall be deemed an ongoing right which may be asserted at any time and from time to time prior to the Closing Date.

8.4 Frustration of Closing Conditions. No Party may rely, either as a basis for not consummating the Business Combination or terminating this Agreement and abandoning the Business Combination, on the failure of any condition set forth in Sections 8.1, 8.2 or 8.3, as the case may be, to be satisfied if such failure was caused by such Party's material breach of any material provision of this Agreement or failure to use its reasonable best efforts to consummate the Business Combination and the other transactions contemplated hereby, as required by and subject to Section 7.2.

## ARTICLE IX

### TAX MATTERS

#### 9.1 Allocation of Taxes and Indemnification.

(a) From and after the Closing Date, IIF Subway shall, or shall cause SWMAC Holdco to, indemnify, defend, save and hold harmless, CIUS, Corix, their respective Affiliates and each of their respective Representatives, successors and assigns (collectively, the "CIUS-Corix Indemnified Parties") from and against any and all (i) Taxes imposed on or payable by IIF Subway, Bazos, SWMAC Holdco or any of their respective Affiliates for any taxable period (including, for the avoidance of doubt, any Taxes required to be deducted or withheld and any Taxes, including all Transfer Taxes, with respect to the SWMAC Restructuring); (ii) Taxes that are attributable to, or otherwise imposed on or payable by, SWMAC, SWWC or any SWWC Subsidiary with respect to any taxable period ending on or before the Closing Date, and for the portion of any Straddle Period ending on (and including) the Closing Date (as determined under Section 9.1(c)); (iii) Losses and Taxes based upon, attributable to or resulting from any failure or failures to be true of,

or inaccuracy in, any representation or warranty made in Section 6.8; (iv) Taxes arising from or attributable to any breach or non-fulfillment of any covenant or agreement made by IIF Subway, SWMAC Holdco or any of their respective Affiliates (including, prior to the Closing, SWMAC and SWWC) in this Agreement; (v) Taxes imposed on CIUS or any of its Subsidiaries as a result of being a transferee or successor to IIF Subway, Bazos, SWMAC Holdco or any of their respective Affiliates pursuant to applicable Law; (vi) amounts required to be paid by or imposed on CIUS or any of its Subsidiaries pursuant to any Tax allocation, Tax sharing, Tax indemnification or similar agreement or arrangement (other than (A) indemnification or reimbursement provisions in any such agreement or arrangement entered into in the ordinary course of business, the principal subject of which does not relate to Taxes, and (B) Tax allocation, Tax sharing, Tax indemnification or similar agreement or arrangements solely between or among any of SWMAC, SWWC and the SWWC Subsidiaries) to which SWMAC, SWWC or any SWWC Subsidiary is a party or is otherwise subject, in either case, on or prior to the Closing Date; (vii) any Taxes imposed pursuant to U.S. Treasury Regulation Section 1.1502-6 (or any comparable provision under state, local or non-U.S. Law or regulation imposing joint or several liability upon members of a consolidated, combined, affiliated, unitary or other group for Tax purposes) for which SWMAC, SWWC or any SWWC Subsidiary may be liable because of membership in any affiliated group, within the meaning of Section 1504(a) of the Code, or any consolidated group, combined, affiliated or unitary group, at any time on or prior to the Closing Date; and (viii) any costs and expenses, including reasonable out-of-pocket investigatory, legal or accounting fees and expenses, losses, damages, assessments, settlements or judgments arising out of, incident to the imposition, assessment or assertion of, or attributable to any item described in (i) to (vii) (including, subject to Section 9.1(e), the contest of any Tax liability in connection therewith); *provided, however*, that IIF Subway and SWMAC Holdco shall not be liable, and the CIUS-Corix Indemnified Parties shall not seek indemnification, for any Taxes or Losses to the extent recovery for such Taxes or Losses would be duplicative of amounts recovered as an adjustment to (or otherwise taken into account in determining) the Equity Balancing Payment pursuant to Article II. For the avoidance of doubt, (x) in the event of a Loss suffered directly or indirectly by CIUS after the Closing resulting from or arising out of an indemnifiable matter under this Section 9.1(a), IIF Subway shall, or shall cause SWMAC Holdco to, be obligated to contribute (or cause to be contributed) to CIUS an amount equal to the amount of such Loss, and no Equity Interests, or other rights or value with respect to such contribution, shall be issued to SWMAC Holdco or any other Person in exchange for such contribution, and (y) in the event of a Loss suffered by any of the other CIUS-Corix Indemnified Parties not addressed by clause (x) immediately above resulting from or arising out of an indemnifiable matter under this Section 9.1(a), IIF Subway shall, or shall cause SWMAC Holdco to, be obligated to make a direct payment to the applicable CIUS-Corix Indemnified Party in an amount equal to the amount of such Loss (and the calculation of such Loss shall take into account the equity ownership in CIUS by the applicable CIUS-Corix Indemnified Party and the Equity Balancing Payment and SHL Balancing Payment paid under this Agreement).

(b) From and after the Closing Date, Corix shall indemnify, defend, save and hold harmless, CIUS, SWMAC Holdco, their respective Affiliates and each of their respective Representatives, successors and assigns (collectively, the “CIUS-SWMAC Indemnified Parties”) from and against any and all (i) Taxes imposed on or payable by Corix or any of its Affiliates, or with respect to any Excluded Business Entity or the Excluded Business (including all Taxes, including Transfer Taxes, with respect to the Excluded Business Carveout, and all Taxes, excluding Transfer Taxes, with respect to the remainder of the Corix Restructuring), for any

taxable period (including, for the avoidance of doubt, any Taxes required to be deducted or withheld); (ii) Taxes that are attributable to, or otherwise imposed on or payable by, any Contributed Corix Entity with respect to any taxable period ending on or before the Closing Date, and for the portion of any Straddle Period ending on (and including) the Closing Date (as determined under Section 9.1(c)); (iii) Losses and Taxes based upon, attributable to or resulting from any failure or failures to be true of, or inaccuracy in, any representation or warranty made in Section 4.8; (iv) Taxes arising from or attributable to any breach or non-fulfillment of any covenant or agreement made by any of the Corix Parties in this Agreement; (v) Taxes imposed on CIUS or any of its Subsidiaries as a result of being a transferee or successor to Corix or any of its Affiliates pursuant to applicable Law; (vi) amounts required to be paid by or imposed on CIUS or any of its Subsidiaries pursuant to any Tax allocation, Tax sharing, Tax indemnification or similar agreement or arrangement (other than (A) indemnification or reimbursement provisions in any such agreement or arrangement entered into in the ordinary course of business, the principal subject of which does not relate to Taxes, and (B) Tax allocation, Tax sharing, Tax indemnification or similar agreement or arrangements solely between the Contributed Corix Entities) to which any Contributed Corix Entity is a party or is otherwise subject, in either case, on or prior to the Closing Date; (vii) any Taxes imposed pursuant to U.S. Treasury Regulation Section 1.1502-6 (or any comparable provision under state, local or non-U.S. Law or regulation imposing joint or several liability upon members of a consolidated, combined, affiliated, unitary or other group for Tax purposes) for which any Contributed Corix Entity may be liable because of membership in any affiliated group, within the meaning of Section 1504(a) of the Code, or any consolidated group, combined, affiliated or unitary group, at any time on or prior to the Closing Date; and (viii) any costs and expenses, including reasonable out-of-pocket investigatory, legal or accounting fees and expenses, losses, damages, assessments, settlements or judgments arising out of, incident to the imposition, assessment or assertion of, or attributable to any item described in (i) to (vii) (including, subject to Section 9.1(e), the contest of any Tax liability in connection therewith); *provided, however*, that Corix shall not be liable, and the CIUS-SWMAC Indemnified Parties shall not seek indemnification, for any Taxes or Losses to the extent recovery for such Taxes or Losses would be duplicative of amounts recovered as an adjustment to (or otherwise taken into account in determining) the Equity Balancing Payment pursuant to Article II. For the avoidance of doubt, (x) in the event of a Loss suffered directly or indirectly by CIUS after the Closing resulting from or arising out of an indemnifiable matter under this Section 9.1(b), Corix shall be obligated to contribute (or cause to be contributed) to CIUS an amount equal to the amount of such Loss, and no Equity Interests, or other rights or value with respect to such contribution, shall be issued to Corix or any other Person in exchange for such contribution, and (y) in the event of a Loss suffered by any of the other CIUS-SWMAC Indemnified Parties not addressed by clause (x) immediately above resulting from or arising out of an indemnifiable matter under this Section 9.1(b), Corix shall be obligated to make a direct payment to the applicable CIUS-SWMAC Indemnified Party in an amount equal to the amount of such Loss (and the calculation of such Loss shall take into account the equity ownership in CIUS by the applicable CIUS-SWMAC Indemnified Party and the Equity Balancing Payment and the SHL Balancing Payment paid under this Agreement).

(c) Straddle Period Tax Allocation. For purposes of this Article IX, in the case of Taxes that are payable with respect to a taxable period that begins on or before the Closing Date and ends after the Closing Date (a “Straddle Period”), the portion of any such Tax that is allocable to the portion of the period ending on and including the Closing Date shall be:

(i) in the case of Taxes other than those described in clauses (ii) and (iii) (including income, capital gains, and similar Taxes), deemed equal to the amount that would be payable if the taxable year ended with (and included) the Closing Date; *provided* that depreciation and amortization deductions shall be allocated between the period ending on (and including) the Closing Date and the period beginning on the day following the Closing Date in proportion to the number of days in each period to which such deduction is applicable;

(ii) in the case of property Taxes and other Taxes similarly imposed on a periodic basis, deemed to be the amount of such Taxes for the entire period (or, in the case of such Taxes determined on an arrears basis, the amount of such Taxes for the immediately preceding period), *multiplied by* a fraction the numerator of which is the number of calendar days in the period ending on and including the Closing Date and the denominator of which is the number of calendar days in the entire period; *provided* that in the event that such Taxes are attributable to any property which is revalued or re-assessed on or after the Closing Date and as a result of the transactions contemplated under this Agreement, the portion of such Taxes allocated to the taxable period that is deemed to end on (and include) the Closing Date shall be determined without taking into account such revaluation or re-assessment; and

(iii) in the case of Taxes in the form of interest or penalties, all such Taxes to the extent relating to a Tax for a taxable period ending on or before the Closing Date whether such items are incurred, accrued, assessed or similarly charged on, before or after the Closing Date.

(d) Whenever in accordance with this Article IX any Party is required to make a payment, such payment shall be made by the later of (i) thirty (30) days after such payments are requested or (ii) five (5) days before the requesting Party is required to pay the related Tax liability under applicable Law.

(e) Tax Controversies.

(i) If a claim for Taxes, including notice of a pending audit, shall be made by any Governmental Entity in writing, which, if successful, might result in an indemnity payment pursuant to this Section 9.1 (a “Tax Claim”), the Party receiving such notice shall notify any other Parties that may have an indemnification obligation with respect thereto promptly in writing of the Tax Claim. Such notice shall specify in reasonable detail the basis for such Tax Claim and shall include a copy of the relevant portion of any correspondence received from the Governmental Entity. Failure by the Party seeking indemnification to give prompt notice of a Tax Claim shall not relieve any other Party of liability under this Agreement except to the extent that such other Party demonstrates that its position is materially prejudiced as a result thereof (as determined by a court of competent jurisdiction).

(ii) Subject to Section 9.1(e)(iv), the Parties that would be liable to indemnify another Party with respect to such Tax Claim (each a “Tax Indemnifying Party”) pursuant to this Section 9.1 shall have the right to control the defense of any Tax Claim.



Notwithstanding the foregoing, in the event that no Tax Indemnifying Party has assumed the defense of any Tax Claim which it is entitled to control pursuant to the preceding sentence by providing written notice of its intent to assume the defense of such claim to the other Parties within thirty (30) days after the receipt of the notice required under Section 9.1(e)(i), CIUS may defend, or cause to be defended, the same in such manner as it may deem appropriate (acting reasonably and in good faith as if it were the only party in interest in connection with such Tax Claim), including settling such Tax Claim; *provided* that CIUS shall not settle (or allow any Subsidiary to settle) such Tax Claim without the prior written consent of the Tax Indemnifying Party, which consent shall not be unreasonably withheld, delayed or conditioned. For the avoidance of doubt, the Tax Indemnifying Party shall be responsible, in accordance with Section 9.1(a) or Section 9.1(b), as applicable, for any costs and expenses, including reasonable out of pocket legal and accounting fees and expenses, incurred by CIUS or any of its Affiliates in defending a Tax Claim that the Tax Indemnifying Party does not control pursuant to this Section 9.1(e)(ii).

(iii) Subject to Section 9.1(e)(iv), with respect to any Tax Claim for a Straddle Period, (A) each Party may participate, at its expense, in the Tax Claim, (B) such Tax Claim shall be contested and defended by the Party (the “Straddle Controlling Party”) which would bear the burden of the greater portion of the sum of any adjustment and any corresponding adjustments that reasonably may be anticipated (as determined under Section 9.1(c)). Notwithstanding the foregoing, in the event that the Straddle Controlling Party has not assumed the defense of any Tax Claim which it is entitled to control pursuant to the preceding sentence by providing written notice of its intent to assume the defense of such claim to the other Parties within thirty (30) days after the receipt of the notice required under Section 9.1(e)(i), CIUS may defend the same in such manner as it may deem appropriate (acting reasonably and in good faith as if it were the only party in interest in connection with such Tax Claim), including settling such Tax Claim (regardless of whether the Straddle Controlling Party or CIUS is controlling such Tax Claim); *provided* that with respect to any such Tax Claim described in this Section 9.1(e)(iii), such Tax Claim shall not be settled without the prior written consent of the Straddle Controlling Party and the other Party, which consent shall not be unreasonably withheld, delayed or conditioned.

(iv) The Party that is controlling the Tax Claim pursuant to Section 9.1(e)(ii) or Section 9.1(e)(iii) (the “Controlling Party”) shall (A) provide the other Party (the “Non-Controlling Party”) with notice reasonably in advance of, and the Non-Controlling Party shall have the right, at its expense, to participate in such Tax Claim to the extent allowed pursuant to applicable Law including the right to attend any meetings with a Governmental Entity (including meetings with examiners) or hearings or proceedings before any Governmental Entity to the extent they relate to such Tax Claim, and (B) reasonably consult with the Non-Controlling Party before taking any significant action (including submitting written materials) in connection with such Tax Claim, including giving the Non-Controlling Party the opportunity to comment on such written materials prior to their submission.

## 9.2 Tax Returns and Refunds.

(a) SWWC Tax Returns. CIUS shall, in accordance with IIF Subway's direction, prepare or cause to be prepared all Tax Returns required to be filed by or with respect to SWMAC, SWWC and each SWWC Subsidiary for any taxable period which ends on or before the Closing Date that are due after the Closing Date (giving effect to any valid extensions of the due date for filing any such Tax Returns); *provided* that CIUS shall prepare or cause to be prepared and make all elections with respect to all such Tax Returns, to the extent permitted by applicable Law, in a manner consistent with past practice. CIUS shall timely file or cause to be timely filed any Tax Return required to be filed by or with respect to SWMAC, SWWC or any SWWC Subsidiary after the Closing Date that is prepared pursuant to the preceding sentence. CIUS shall prepare or cause to be prepared and timely file or cause to be filed all Tax Returns required to be filed by or with respect to SWMAC, SWWC or any SWWC Subsidiary for taxable periods ending after the Closing Date. All such Tax Returns that relate to Straddle Periods shall be prepared and all elections with respect to such Tax Returns that relate to Straddle Periods shall be made, to the extent permitted by applicable Law, in a manner consistent with past practice. Before filing any Tax Return with respect to any taxable period ending on or before the Closing Date or any Straddle Period, CIUS shall provide IIF Subway or SWMAC Holdco with a copy of such Tax Return at least ten (10) days prior to the last date for timely filing such Tax Return (giving effect to any valid extensions thereof) accompanied by a statement calculating in reasonable detail IIF Subway's indemnification obligation, if any, pursuant to Section 9.1(a). To the extent that SWMAC, its Affiliates, SWWC or any SWWC Subsidiary has paid prior to the Closing Date to a Governmental Entity an amount in excess of IIF Subway's share of Taxes for a Straddle Period pursuant to Section 9.1(a), CIUS shall pay to IIF Subway or SWMAC Holdco the amount of such excess within ten (10) days of filing such Straddle Period Tax Return net of any Taxes required to be deducted or withheld under Section 2.3(f). If for any reason IIF Subway does not agree with CIUS' calculation of IIF Subway's indemnification obligation, IIF Subway and CIUS shall consult and cooperate to resolve in good faith any such disagreements. In the event the Parties are unable to resolve any dispute within sixty (60) days following CIUS making a claim for indemnification to IIF Subway or SWMAC Holdco, the Parties shall consult and cooperate to resolve their dispute by submitting such dispute to the Accountant, which shall attempt to resolve any issue before the due date of a Tax Return, in order that such Tax Return may be timely filed. The scope of the Accountant's review shall be limited to disputed items. If the Accountant does not resolve any differences between IIF Subway and CIUS with respect to a Tax Return at least five (5) days prior to the due date therefor, such Tax Return shall be filed as prepared by CIUS, and CIUS shall subsequently amend the Tax Return to reflect the Accountant's resolution within ten (10) days of the date of such resolution. Each of CIUS and IIF Subway shall bear the fees and expenses of the Accountant in inverse proportion as they may prevail on the matters resolved by the Accountant, which proportionate allocation will also be determined by the Accountant and included in the Accountant's report. For the avoidance of doubt, the preparation and filing of any Tax Return of SWMAC, SWWC or any SWWC Subsidiary that does not relate to a taxable period ending on or before the Closing Date or a Straddle Period shall be exclusively within the control of CIUS. Without the prior written consent of IIF Subway or SWMAC Holdco (which consent shall not be unreasonably withheld, delayed or conditioned), CIUS shall not, and shall not permit any of its Affiliates to, except to the extent required by applicable Law, amend any Tax Returns or make or change any Tax elections or accounting methods, in each case with respect to SWMAC, SWWC or any SWWC Subsidiary and relating to a taxable period ending on or before the Closing Date or the portion of any Straddle Period ending on (and including) the Closing Date (as determined under

Section 9.1(c)), to the extent such amendment or change would reasonably be expected to increase the liability of IIF Subway under Section 2.4 or Section 9.1(a) or reduce IIF Subway's entitlement to any payment under Section 2.4 or Section 9.1.

(b) Corix Water Tax Returns. CIUS shall, in accordance with Corix's direction, prepare or cause to be prepared all Tax Returns required to be filed by or with respect to each Contributed Corix Entity for any taxable period which ends on or before the Closing Date that are due after the Closing Date (giving effect to any valid extensions of the due date for filing any such Tax Returns); *provided* that CIUS shall prepare or cause to be prepared and make all elections with respect to all such Tax Returns, to the extent permitted by applicable Law, in a manner consistent with past practice. CIUS shall timely file or cause to be timely filed any Tax Return required to be filed by or with respect to any Contributed Corix Entity after the Closing Date that is prepared pursuant to the preceding sentence. CIUS shall prepare or cause to be prepared and timely file or cause to be filed all Tax Returns required to be filed by or with respect to any Contributed Corix Entity for taxable periods ending after the Closing Date. All such Tax Returns that relate to Straddle Periods shall be prepared and all elections with respect to such Tax Returns that relate to Straddle Periods shall be made, to the extent permitted by applicable Law, in a manner consistent with past practice. Before filing any Tax Return with respect to any taxable period ending on or before the Closing Date or any Straddle Period, CIUS shall provide Corix with a copy of such Tax Return at least ten (10) days prior to the last date for timely filing such Tax Return (giving effect to any valid extensions thereof) accompanied by a statement calculating in reasonable detail Corix's indemnification obligation, if any, pursuant to Section 9.1(b). To the extent that Corix, its Affiliates, or any Contributed Corix Entity has paid prior to the Closing Date to a Governmental Entity an amount in excess of Corix's share of Taxes for a Straddle Period pursuant to Section 9.1(b), CIUS shall pay to Corix the amount of such excess within ten (10) days of filing such Straddle Period Tax Return net of any Taxes required to be deducted or withheld under Section 2.3(f). If for any reason Corix does not agree with CIUS' calculation of Corix's indemnification obligation, Corix and CIUS shall consult and cooperate to resolve in good faith any such disagreements. In the event the Parties are unable to resolve any dispute within sixty (60) days following CIUS making a claim for indemnification to Corix, the Parties shall consult and cooperate to resolve their dispute by submitting such dispute to the Accountant, which shall attempt to resolve any issue before the due date of a Tax Return, in order that such Tax Return may be timely filed. The scope of the Accountant's review shall be limited to disputed items. If the Accountant does not resolve any differences between Corix and CIUS with respect to a Tax Return at least five (5) days prior to the due date therefor, such Tax Return shall be filed as prepared by CIUS, and CIUS shall subsequently amend the Tax Return to reflect the Accountant's resolution within ten (10) days of the date of such resolution. Each of CIUS, on the one hand, and Corix, on the other hand, shall bear the fees and expenses of the Accountant in inverse proportion as they may prevail on the matters resolved by the Accountant, which proportionate allocation will also be determined by the Accountant and included in the Accountant's report. For the avoidance of doubt, the preparation and filing of any Tax Return of any Contributed Corix Entity that does not relate to a taxable period ending on or before the Closing Date or a Straddle Period shall be exclusively within the control of CIUS. Without the prior written consent of Corix (which consent shall not be unreasonably withheld, delayed or conditioned), CIUS shall not, and shall not permit any of its Affiliates to, except to the extent required by applicable Law, amend any Tax Returns or make or change any Tax elections or accounting methods, in each case with respect to any Contributed Corix Entity and relating to a taxable period ending on or before the Closing Date or

the portion of any Straddle Period ending on (and including) the Closing Date (as determined under Section 9.1(c)), to the extent such amendment or change would reasonably be expected to increase the liability of Corix under Section 2.4 or Section 9.1(b) or reduce Corix's entitlement to any payment under Section 2.4 or Section 9.1.

(c) SWMAC Holdco Refunds. Any refunds or credits of Taxes of SWMAC, SWWC or any SWWC Subsidiary *plus* any interest received with respect thereto from the applicable Governmental Entity, in each case for any taxable period ending on or before the Closing Date (including refunds or credits arising by reason of amended Tax Returns filed after the Closing Date) shall be for the account of SWMAC Holdco and shall be paid by CIUS or any of its Affiliates, net of all out-of-pocket expenses (including any Taxes) incurred by CIUS or any of its Affiliates in obtaining such refund or credit and, for the avoidance of doubt, net of any Taxes required to be deducted or withheld under Section 2.3(f), to SWMAC Holdco within ten (10) days after CIUS or any of its Affiliates receives such refund or after the relevant Tax Return is filed in which the credit is applied against CIUS' or any of its Affiliates' liability for Taxes (other than any refund or credit that is payable to another Person pursuant to any contract to which SWMAC, SWWC or any SWWC Subsidiary is a party as of the Closing); *provided, however*, that SWMAC Holdco shall not be entitled to any such refund or credit to the extent payment to SWMAC Holdco of such refund or credit would be duplicative amounts included as an adjustment to (or otherwise taken into account in determining) the Equity Balancing Payment pursuant to Article II. Notwithstanding the foregoing, any refunds or credits of Taxes of SWMAC, SWWC or any SWWC Subsidiary for any taxable period ending on or before the Closing Date that are attributable to carrybacks of losses or credits from a taxable period beginning after the Closing Date shall be for the account of CIUS. In the event a refund of or credit for Taxes paid by CIUS to SWMAC Holdco, including any amounts included as an adjustment to (or otherwise taken into accounting in determining) the Equity Balancing Payment pursuant to Article II, is subsequently denied by a Governmental Entity, IIF Subway shall, or shall cause SWMAC Holdco to, promptly repay such refund or an amount equal to such credit (including interest) to CIUS. Any refunds or credits of Taxes of SWMAC, SWWC or any SWWC Subsidiary *plus* any interest received with respect thereto from the applicable Governmental Entity, in each case for any taxable period beginning after the Closing Date (including, for the avoidance of doubt, those that are attributable to carryforwards of losses or credits from a taxable period ending on or before the Closing Date) shall be for the account of CIUS. Any refunds or credits of Taxes of SWMAC, SWWC or any SWWC Subsidiary for any Straddle Period shall be apportioned between CIUS and SWMAC Holdco in the same manner as the liability for such Taxes is apportioned pursuant to Section 9.1. For purposes of this Section 9.2(c), any reduction in Tax liability for a period beginning after the Closing Date that is subject to the terms of this Section 9.2(c) shall be treated as a refund for a taxable period ending on or before the Closing Date if such Tax reduction is provided in lieu of such a refund.

(d) Corix Refunds. Any refunds or credits of Taxes of any Contributed Corix Entity *plus* any interest received with respect thereto from the applicable Governmental Entity, in each case for any taxable period ending on or before the Closing Date (including refunds or credits arising by reason of amended Tax Returns filed after the Closing Date) shall be for the account of Corix and shall be paid by CIUS or any of its Affiliates, net of all out-of-pocket expenses (including any Taxes) incurred by CIUS or any of its Affiliates in obtaining such refund or credit and, for the avoidance of doubt, net of any Taxes required to be deducted or withheld under

Section 2.3(f), to Corix within ten (10) days after CIUS or any of its Affiliates receives such refund or after the relevant Tax Return is filed in which the credit is applied against CIUS' or any of its Affiliates' liability for Taxes (other than any refund or credit that is payable to another Person pursuant to any contract to which any Contributed Corix Entity is a party as of the Closing); *provided, however*, that Corix shall not be entitled to any such refund or credit to the extent payment to Corix of such refund or credit would be duplicative of amounts included as an adjustment to (or otherwise taken into account in determining) the Equity Balancing Payment pursuant to Article II. Notwithstanding the foregoing, any refunds or credits of Taxes of any Contributed Corix Entity for any taxable period ending on or before the Closing Date that are attributable to carrybacks of losses or credits from a taxable period beginning after the Closing Date shall be for the account of CIUS. In the event a refund of or credit for Taxes paid by CIUS to Corix, including any amounts included as an adjustment to (or otherwise taken into accounting in determining) the Equity Balancing Payment pursuant to Article II, is subsequently denied by a Governmental Entity, Corix shall promptly repay such refund or an amount equal to such credit (including interest) to CIUS. Any refunds or credits of Taxes of any Contributed Corix Entity *plus* any interest received with respect thereto from the applicable Governmental Entity, in each case for any taxable period beginning after the Closing Date (including, for the avoidance of doubt, those that are attributable to carryforwards of losses or credits from a taxable period ending on or before the Closing Date) shall be for the account of CIUS. Any refunds or credits of Taxes of any Contributed Corix Entity for any Straddle Period shall be apportioned between CIUS, on the one hand, and Corix, on the other hand, in the same manner as the liability for such Taxes is apportioned pursuant to Section 9.1. For purposes of this Section 9.2(d), any reduction in Tax liability for a period beginning after the Closing Date shall be treated as a refund for a taxable period ending on or before the Closing Date that is subject to the terms of this Section 9.2(d) if such Tax reduction is provided in lieu of such a refund.

(e) Refund Request Procedures. At any Party's reasonable request and expense, CIUS shall, or shall cause its relevant Affiliates to, file for and obtain any refunds or credits to which such requesting Party is entitled under this Article IX. In connection therewith, (i) CIUS shall permit such requesting Party to control the prosecution of any such refund claim that relates to refunds or credits to which such Party or any of its Affiliates is entitled under this Article IX and, shall, or shall cause its relevant Affiliates to, authorize by appropriate powers of attorney such Persons as such requesting Party shall designate to represent such Affiliates with respect to such refund claim and (ii) CIUS shall, or shall cause its relevant Affiliates to, forward to such requesting Party any such refund within ten (10) days after the refund is received (or reimburse such requesting Party and any of its Affiliates for any such credit within ten (10) days after the relevant Tax Return is filed in which the credit is applied against any of such relevant Affiliates' liability for Taxes), for the avoidance of doubt, net of any Taxes required to be deducted or withheld under Section 2.3(f). In the event such refund of or credit for Taxes is subsequently denied by a Governmental Entity, such requesting Party shall promptly repay such refund or an amount equal to such credit (including interest) to CIUS.

9.3 Transfer Taxes. Other than (i) any such amounts that are imposed on or in connection with the Excluded Business Carveout, which shall be for the account of Corix in accordance with Section 9.1(b), and (ii) any such amounts that are imposed on or in connection with the SWMAC Restructuring, which shall be for the account of IIF Subway in accordance with Section 9.1(a), CIUS shall be responsible for and shall pay one hundred percent (100%) of all

documentary, sales, use, registration, value added, transfer, stamp and similar Taxes, fees and costs (including interest, penalties and additions to any such Taxes) imposed on or payable in connection with the transactions contemplated under this Agreement (“Transfer Taxes”). CIUS shall prepare and timely file, or cause to be prepared and timely filed, any Tax Returns and other necessary documentation required to be filed with respect to any such Transfer Taxes (other than with respect to the Excluded Business Carveout), and shall timely pay or cause to be timely paid all Transfer Taxes shown as due thereon. CIUS shall provide to Corix and to SWMAC Holdco a true copy of each such Tax Return as filed and evidence of the timely filing thereof. CIUS, Corix and IIF Subway shall, and shall cause their respective Affiliates to, reasonably cooperate in reducing the amount of any Transfer Taxes or obtaining exemptions therefrom.

#### 9.4 Tax Sharing Agreements.

(a) Any and all existing agreements relating to the allocation or sharing of Taxes, other than this Agreement and any such contract or agreement entered into in the ordinary course of business and for which Taxes are not the principal subject matter (“Tax Sharing Agreements”) between or among SWWC, any SWWC Subsidiary, SWMAC, IIF Subway or any of their respective Affiliates (other than those solely between or among, SWMAC, SWWC and/or any SWWC Subsidiary), shall, in each case, be terminated as of the Closing Date solely with respect to SWMAC, SWWC and any SWWC Subsidiary. After the Closing Date, none of SWMAC, SWWC or any SWWC Subsidiary shall have any further rights or obligations under any such Tax Sharing Agreement.

(b) Any and all existing Tax Sharing Agreements between or among Corix, any Contributed Corix Entity, or any of their respective Affiliates (other than those solely between or among any Contributed Corix Entity), shall, in each case, be terminated as of the Closing Date solely with respect to any Contributed Corix Entity. After the Closing Date, no Contributed Corix Entity shall have any further rights or obligations under any such Tax Sharing Agreement.

9.5 Characterization of Indemnification Payments. To the extent permitted pursuant to applicable Law, any payments made pursuant to Section 2.4 and any indemnification payments made under this Article IX or Article XI shall be treated for all Tax purposes, (a) in the case of a payment related to the value of either the SWWC Shareholder Loan or the CIUS Shareholder Loan, as an adjustment to the SHL Balancing Payment; (b) in the case of a payment by IIF Subway, SWMAC Holdco or Corix to CIUS, as a contribution to the capital of CIUS; (c) in the case of a payment by Corix to IIF Subway or SWMAC Holdco, first, as a reduction of the Equity Balancing Payment (to the extent IIF Subway paid the Equity Balancing Payment), and then, if the Equity Balancing Payment shall have been reduced to zero (taking into account any payments made under Section 2.4), as additional consideration for the disposition by IIF Subway or SWMAC Holdco of the SWMAC Interests, and (d) in the case of a payment by IIF Subway or SWMAC Holdco to Corix, first, as a reduction of the Equity Balancing Payment (to the extent Corix paid an Equity Balancing Payment), and then, if the Equity Balancing Payment shall have been reduced to zero (taking into account any payments made under Section 2.4), as consideration for the disposition by Corix of CIUS Common Stock.

9.6 Resolution of All Tax Related Disputes. Except as otherwise provided in this Article IX, with respect to any dispute or disagreement between the Parties relating to Taxes, the

Parties shall cooperate in good faith to resolve such dispute between them; but if the Parties are unable to resolve such dispute, the Parties shall submit the dispute to the Accountant for resolution, which resolution shall be final, conclusive and binding on the Parties. Notwithstanding anything in this Agreement to the contrary, the fees and expenses relating to any dispute as to the amount of Taxes owed by either of the Parties shall be paid by Corix, IIF Subway (or SWMAC Holdco), and CIUS, in proportion to each Party's respective liability for the portion of the Taxes in dispute, as determined by the Accountant.

9.7 Cooperation, Exchange of Information and Record Retention.

(a) (i) Each of Corix and IIF Subway shall provide to CIUS, and shall cause their respective Affiliates and Representatives to provide to CIUS, and (ii) CIUS shall provide to Corix and IIF Subway, and shall cause its Affiliates and Representatives to provide to Corix and IIF Subway, with such cooperation and information relating to Taxes (including cooperation with respect to any audit), as any of them reasonably may request, including in (A) preparing and filing any Tax Return, amended Tax Return or claim for refund, including maintaining and making available to each other all records necessary in connection with Taxes; (B) resolving all disputes and audits with respect to all taxable periods relating to Taxes; (C) contesting or compromising any Tax Claim; (D) determining a Tax liability or a right to a refund of Taxes; (E) participating in or conducting any audit or other proceeding in respect of Taxes; and (F) connection with all other matters covered in this Article IX. Each such Party shall make its employees available on a mutually convenient basis to provide explanations of any documents or information provided hereunder.

(b) The Parties agree that from and after the Closing Date, CIUS and its Affiliates shall (i) retain and maintain all such records including all Tax Returns, schedules and work papers, records and other documents in their possession relating to Tax matters of Corix, each Contributed Corix Entity, SWMAC, SWWC, and each SWWC Subsidiary for taxable periods ending on or prior to the Closing Date and for each Straddle Period for the longer of (A) the seven-year period beginning on the Closing Date or (B) the full period of the applicable statute of limitations, excluding any extension thereof and (ii) allow the Representatives of IIF Subway, SWMAC Holdco, Corix, and their respective Affiliates, upon reasonable notice and at mutually convenient times to inspect, review and make copies of such records (at the expense of the requesting Party) as IIF Subway, SWMAC Holdco, Corix, and CIUS may deem reasonably necessary or appropriate from time to time. Any information obtained under this Section 9.7(b) shall be kept confidential except as may be otherwise necessary in connection with the filing of Tax Returns or claims for refund or in conducting an audit or other proceeding.

9.8 Survival of Tax Provisions. Any claim to be made pursuant to this Article IX must be made before, and the representations and warranties in Section 4.8 and Section 6.8 shall each survive until, sixty (60) days after the expiration (giving effect to any valid extensions, waivers and tolling periods) of the applicable statutes of limitations relating to the Taxes at issue or, solely with respect to a claim for a refund or credit of Taxes (or an adjustment with respect thereto), the later of (a) sixty (60) days after the expiration (giving effect to any valid extensions, waivers and tolling periods) of the applicable statute of limitations relating to the Taxes at issue or (b) one year after the Party making the claim becomes aware of sufficient facts relating to such refund or credit or adjustment to seek indemnification or reimbursement under this Article IX.

## 9.9 Tax Characterization of Business Combination.

(a) The Parties intend that, for U.S. federal income tax purposes, the SWMAC Equity Exchange and the Merger, taken together, will qualify as a “reorganization” within the meaning of Section 368(a) of the Code and the Treasury Regulations promulgated thereunder (the “Intended Tax Treatment”) to which each of CIUS and SWMAC are parties under Section 368(b) of the Code and the Treasury Regulations, and this Agreement is intended to be, and is adopted as, a plan of reorganization for purposes of Sections 354, 361 and 368 of the Code and within the meaning of Treasury Regulations Sections 1.368-2(g) and 1.368-3(a). None of the Parties knows of any fact or circumstance, or has taken or will take any action (nor will they permit any of their Affiliates to take any action), if such fact, circumstance or action would be reasonably expected to cause the Business Combination to fail to qualify for the Intended Tax Treatment. The Parties shall use their respective reasonable best efforts to cause the Business Combination to qualify for the Intended Tax Treatment. Each Party shall promptly notify the other Party in writing if, before the Closing Date, such Party knows or has reason to believe that the SWMAC Equity Exchange and the Merger, taken together, may not qualify for the Intended Tax Treatment (and whether the terms of this Agreement could be reasonably amended in order to facilitate such qualification).

(b) To the extent permitted pursuant to applicable Law, the Parties shall report the SWMAC Equity Exchange and the Merger for all Tax purposes in accordance with the Intended Tax Treatment, unless otherwise required by a Taxing Authority as a result of a “determination” within the meaning of Section 1313(a) of the Code (or any similar provision of any applicable Law). The Parties shall reasonably cooperate with each other and their respective counsel to document and support the Intended Tax Treatment, and each Party shall use its reasonable best efforts to execute and deliver to counsel for each other Party letters of representation customary for transactions of this type and reasonably satisfactory to such counsel at such time and times as such counsel shall reasonably request. For the avoidance of doubt, any tax opinion to be delivered in connection with the transactions contemplated by this Agreement shall not be a condition to the Closing.

9.10 BAPA. CIUS and Corix shall be entitled, and, if not completed prior to the Closing, following the Closing the SWWC Parties (including SWMAC Holdco) shall use commercially reasonable efforts to cooperate with CIUS and Corix as may be necessary or helpful to allow CIUS and Corix, to submit to and finalize with the IRS and the Canada Revenue Agency a Bilateral Advance Pricing Agreement relating to certain transfer pricing methodologies utilized by Corix, CIUS and their respective Affiliates (the “BAPA”); *provided* that no actions shall be permitted pursuant to this Section 9.10 without IIF Subway’s prior written consent (not to be unreasonably withheld, conditioned or delayed) that could reasonably be expected to (i) have an adverse impact on any SWWC Party (including SWMAC Holdco) or (ii) have an adverse impact on CIUS or any of its Affiliates, in each case, taking into account any indemnity or cost reimbursement provided by Corix.

9.11 Reportable Transactions and Notifiable Transactions. If any Party determines (upon advice of counsel), after the date hereof, that any transaction contemplated by this Agreement (including any transaction contemplated as part of the Corix Restructuring or the Business Combination) is more likely than not to constitute a “reportable transaction” or “notifiable transaction” as described in subsections 237.3(1) and 237.4(1) of the Tax Act, respectively, the



Parties shall use commercially reasonable efforts to coordinate to make any necessary filing to a Taxing Authority in a consistent manner.

9.12 Exclusivity. Notwithstanding anything to the contrary in this Agreement, this Article IX shall govern (a) the retention of records with respect to IIF Subway, SWMAC Holdco, Corix, any Contributed Corix Entity, SWMAC, SWWC, and any SWWC Subsidiary and (b) indemnification claims, in each case with respect to Taxes and the procedures relating thereto. For the avoidance of doubt, except as expressly provided in this Article IX, the provisions of Article XI (other than Section 11.8) shall not apply.

## ARTICLE X

### TERMINATION, AMENDMENT AND WAIVER

10.1 Termination. This Agreement may be terminated at any time prior to the Closing Date (unless otherwise specified in this Section 10.1), as follows:

- (a) by mutual written consent of Corix and IIF Subway;
- (b) by either Corix or IIF Subway:

- (i) if the Business Combination is not consummated on or before November 26, 2023 (the “End Date”); *provided* that if, as of 5:00 p.m. New York time on the End Date, all of the conditions to the Closing set forth in Article VIII other than the Required Consents have been satisfied or waived, as applicable, or shall then be capable of being satisfied (except for those conditions that by their nature are to be satisfied at the Closing), the End Date shall be extended automatically to May 26, 2024 (and such date, as so extended, shall be the “End Date”); *provided, further*, that the right to terminate this Agreement under this Section 10.1(b)(i) shall not be available to any Party if such failure of the Business Combination to occur on or before the End Date is the result of a material breach of any representation, warranty, covenant or agreement of this Agreement by such Party; or

- (ii) if the condition set forth in Section 8.1(b) is not satisfied and the Legal Restraint giving rise to such non-satisfaction shall have become final and non-appealable; *provided, however*, that the right to terminate this Agreement under this Section 10.1(b)(ii) shall not be available to any Party if such failure to satisfy the condition set forth in Section 8.1(b) is the result of the failure of such Party to have complied with any of its obligations under Section 7.2.

- (c) by Corix, if the SWWC Parties breach or fail to perform any of their respective obligations under this Agreement, or if any of the representations or warranties of the SWWC Parties contained herein fails to be true and correct, (i) such that the conditions set forth in Section 8.2(a), 8.2(b) or 8.2(c) would not be satisfied and (ii) which breach or failure is not reasonably capable of being cured by the SWWC Parties by the End Date or is not cured by the SWWC Parties within the earlier of (A) 45 days after receiving written notice from Corix and (B) three (3) Business Days prior to the End Date (*provided, however*, that the right to terminate this Agreement under this Section 10.1(c) is not available to Corix if any of the Corix Parties are then

in breach of any covenant or agreement contained in this Agreement or any representation or warranty of the Corix Parties contained in this Agreement fails to be true and correct, in each case such that the conditions set forth in Sections 8.3(a), 8.3(b) or 8.3(c) could not then be satisfied); and

(d) by IIF Subway, if any of the Corix Parties breach or fail to perform any of their respective obligations under this Agreement, or if any of the representations or warranties of the Corix Parties contained herein fails to be true and correct, (i) such that the conditions set forth in Sections 8.3(a), 8.3(b) or 8.3(c) would not be satisfied and (ii) which breach or failure is not reasonably capable of being cured by the Corix Parties by the End Date or is not cured by the Corix Parties within the earlier of (A) 45 days after receiving written notice from IIF Subway and (B) three (3) Business Days prior to the End Date (*provided, however*, that the right to terminate this Agreement under this Section 10.1(d) is not available to IIF Subway if any of the SWWC Parties is then in breach of any covenant or agreement contained in this Agreement or any representation or warranty of the SWWC Parties contained in this Agreement fails to be true and correct, in each case such that the conditions set forth in Sections 8.2(a), 8.2(b) or 8.2(c) could not then be satisfied).

(e) The Party desiring to terminate this Agreement pursuant to this Section 10.1 (other than clause (a)) shall give written notice of such termination to the other Parties in accordance with Section 12.1, specifying the provision of this Agreement pursuant to which such termination is effected.

## 10.2 Effect of Termination.

(a) In the event of termination of this Agreement by Corix or IIF Subway as provided in Section 10.1, this Agreement shall forthwith become void and have no effect, without any liability or obligation on the part of the Parties, other than the last sentence of Section 7.3(a), Section 7.3(b), Section 7.3(c), this Section 10.2 and Article XII, which provisions shall survive such termination and remain valid and binding obligations of the Parties in accordance with their terms. Notwithstanding the foregoing, no termination of this Agreement shall relieve any Party from any liability for money damages resulting from any willful or material breach by such Party of this Agreement prior to such termination or Fraud.

(b) In the event of termination of this Agreement by Corix as provided in Section 10.1(c), IIF Subway shall pay, or cause to be paid, to Corix all of the documented out-of-pocket fees and expenses incurred by Corix and its Affiliates in connection with this Agreement, the Business Combination and the other transactions contemplated by this Agreement up to a maximum of \$15,000,000 (the "Corix Expense Reimbursement"). Any Corix Expense Reimbursement due under this Section 10.2(b) shall be paid by wire transfer of same day funds on the later of (x) the Business Day immediately following the date of termination of this Agreement and (y) thirty (30) days after IIF Subway's receipt of a written statement setting forth the amount of such Corix Expense Reimbursement and attaching any applicable documentation. For the avoidance of doubt, all fees and expenses incurred by Corix and its Affiliates not directly related to the Business Combination and the other transactions contemplated by this Agreement (e.g., any fees and expenses associated with Corix's and its Affiliates' general evaluation of a merger, consolidation, sale, disposition of all or substantially all of Corix's assets, or other strategic

transaction, not involving the SWWC Parties) (collectively, “Unrelated Corix Expenses”) shall be borne solely by Corix and its Affiliates and shall not be covered under the Corix Expense Reimbursement.

(c) In the event of termination of this Agreement by IIF Subway as provided in Section 10.1(d), Corix shall pay to IIF Subway all of the documented out-of-pocket fees and expenses incurred by IIF Subway and its Affiliates in connection with this Agreement, the Business Combination and the other transactions contemplated by this Agreement up to a maximum of \$15,000,000 (the “SWWC Expense Reimbursement”). Any SWWC Expense Reimbursement due under this Section 10.2(c) shall be paid by wire transfer of same day funds on the later of (x) the Business Day immediately following the date of termination of this Agreement and (y) thirty (30) days after Corix’s receipt of a written statement setting forth the amount of such SWWC Expense Reimbursement and attaching any applicable documentation.

10.3 Amendment. This Agreement may not be amended except by an instrument in writing signed by each Party.

10.4 Extension; Waiver. At any time prior to the Closing Date, the Parties may (a) extend the time for the performance of any of the obligations or other acts of the other Parties, (b) waive any inaccuracies in the representations and warranties made by the other Parties contained in this Agreement or in any document delivered pursuant to this Agreement, (c) waive compliance with any covenants and agreements of the other Parties contained in this Agreement or (d) waive the satisfaction of any of the conditions of the applicable Party contained in this Agreement. Any agreement on the part of a Party to any such extension or waiver shall be valid only if set forth in an instrument in writing signed on behalf of such Party. The failure of any Party to assert any of its rights under this Agreement or otherwise shall not constitute a waiver of such rights.

## ARTICLE XI

### INDEMNIFICATION

#### 11.1 Survival of Representations and Warranties and Covenants.

(a) Except for (i) the representations and warranties in Section 4.8 and Section 6.8, the survival of which is governed exclusively by Section 9.8 and (ii) the Designated Representations which shall survive until the date that is four (4) years following the Closing Date, all other representations and warranties set forth in this Agreement and the right to commence any claim with respect thereto shall survive until the date that is 18 months following the Closing Date. Any covenant, agreement or obligation set forth in this Agreement that (i) by its terms is to be performed prior to or at the Closing shall survive until the date that is one (1) year following the Closing Date, and (ii) by its terms contemplates performance, in whole or in part, following the Closing shall survive the Closing and remain in full force and effect in accordance with its terms as provided in this Agreement, or if no term as to survival is provided for, indefinitely or the longer period of time permitted by applicable Law. However, in the event written notice of any claim for indemnification under Section 11.2 or Section 11.3 shall have been given in accordance herewith within the applicable survival period setting forth in reasonable detail the nature of such claim

(including a reasonable specification of the legal and factual basis for such claim), the representations and warranties or covenants that are the subject of such indemnification claim shall survive with respect to such claim until such time as such claim is fully and finally resolved.

(b) This Section 11.1 shall not limit any covenant or agreement of the Parties contained in this Agreement which by its terms contemplates performance after the Closing, which shall survive in accordance with its terms and shall not extend the applicability of any covenant or agreement of the Parties contained in this Agreement which by its terms relates only to a period between the date hereof and the Closing; *provided* that nothing herein shall restrict a Party's right to commence any claim with respect to such covenant or agreement following the Closing, subject to the limitations set forth in Section 11.1(a).

11.2 Indemnification of Corix by SWMAC Holdco. Subject to the terms of Article IX and this Article XI, from and after the Closing, IIF Subway shall, or shall cause SWMAC Holdco to, indemnify, defend, save and hold harmless, Corix, its Affiliates (which for the avoidance of doubt, shall not include the SWWC Parties) and each of their respective Representatives, successors and assigns (collectively, the "Corix Indemnified Parties"), from and against any and all:

(a) Losses to the extent resulting from or arising out of any breach by the SWWC Parties of any representation or warranty in this Agreement or any certificate related thereto; and

(b) Losses to the extent resulting from or arising out of the failure by the SWWC Parties to perform any of their respective covenants or agreements contained in this Agreement.

For the purposes of this Article XI, subject to the other terms and limitations set forth in this Article XI, (i) in the event of a Loss suffered directly or indirectly by CIUS after the Closing resulting from or arising out of an indemnifiable matter under this Section 11.2, IIF Subway shall be obligated to contribute (or cause to be contributed by SWMAC Holdco) to CIUS an amount equal to the amount of such Loss, and no Equity Interests shall be issued by CIUS to SWMAC Holdco or any other Person in exchange for such contribution, and (ii) in the event of a Loss suffered by any of the other Corix Indemnified Parties not addressed by clause (i) immediately above resulting from or arising out of an indemnifiable matter under this Section 11.2, IIF Subway shall be obligated to (or cause SWMAC Holdco to) make a direct payment to the applicable Corix Indemnified Party in an amount equal to the amount of such Loss (and the calculation of such Loss shall take into account the equity ownership in CIUS by the applicable Corix Indemnified Party and the Equity Balancing Payment and the SHL Balancing Payment paid under this Agreement).

11.3 Indemnification of SWMAC Holdco by Corix. Subject to the terms of Article IX and this Article XI, from and after the Closing, Corix shall indemnify, defend, save and hold harmless IIF Subway, SWMAC Holdco, its Affiliates (which for the avoidance of doubt, shall not include the Corix Parties) and each of their respective Representatives, successors and assigns (collectively, the "SWMAC Indemnified Parties" and together with the Corix Indemnified Parties, the "Indemnified Parties," and each an "Indemnified Party"), from and against any and all:

(a) Losses to the extent resulting from or arising out of any breach by the Corix Parties of any representation or warranty in this Agreement or any certificate related thereto; and

(b) Losses to the extent resulting from or arising out of the failure by the Corix Parties to perform any of their respective covenants or agreements contained in this Agreement; and

(c) Losses attributable to the Excluded Business Assets or the Excluded Business Liabilities.

For the purposes of this Article XI, subject to the other terms and limitations set forth in this Article XI, (i) in the event of a Loss suffered directly or indirectly by CIUS after the Closing resulting from or arising out of an indemnifiable matter under this Section 11.3, Corix shall be obligated to contribute (or cause to be contributed) to CIUS an amount equal to the amount of such Loss, and no Equity Interests shall be issued by CIUS to Corix or any other Person in exchange for such contribution, and (ii) in the event of a Loss suffered by any of the other SWMAC Indemnified Parties not addressed by clause (i) immediately above resulting from or arising out of an indemnifiable matter under this Section 11.3, Corix shall be obligated to make (or cause to be made) a direct payment to the applicable SWMAC Indemnified Party in an amount equal to the amount of such Loss (and the calculation of such Loss shall take into account the equity ownership in CIUS by the applicable SWMAC Indemnified Party and the Equity Balancing Payment and the SHL Balancing Payment paid under this Agreement).

11.4 Indemnification of Corix by CIUS. From and after the Closing, CIUS shall indemnify, defend, save and hold harmless the Corix Indemnified Parties from and against any and all Losses incurred by the Corix Indemnified Parties (solely in their capacities as current or former owners of the Excluded Business but not in their capacities as equityholders of CIUS) attributable to (a) the Contributed Corix Water Assets, (b) the Transferred Corix Employees that accept and commence employment with a Contributed Corix Entity or (c) any Transferred Corix Employee that declines a substantially comparable offer of employment from a Contributed Corix Entity and ceases employment with Corix or an Affiliate thereof prior to the date that is two weeks after the Closing, in each case, except to the extent that any such Loss is subject to indemnification under Section 11.3(a) (without regard to limitations imposed by Section 11.6(a)).

#### 11.5 Claims.

(a) Third-Party Claims. Upon receipt by an Indemnified Party of notice of any action, suit, proceedings, claim, demand or assessment made or brought by an unaffiliated third party (a "Third-Party Claim") with respect to a matter for which such Indemnified Party is indemnified under this Article XI which has or is reasonably expected to give rise to a claim for Losses, the Indemnified Party shall as soon as practicable, in the case of a Corix Indemnified Party, notify SWMAC Holdco or CIUS, as applicable, and in the case of an SWMAC Indemnified Party, notify Corix, as the case may be (the "Indemnifying Party"), in writing, indicating the nature of such Third-Party Claim and the basis therefor; *provided, however*, that any delay or failure by the Indemnified Party to give notice to the Indemnifying Party shall relieve the Indemnifying Party of its obligations hereunder only to the extent, if at all, that it is prejudiced by reason of such delay or failure. Such written notice shall (i) describe such Third-Party Claim in reasonable detail

including the sections of this Agreement which form the basis for such Third-Party Claim; *provided* that the failure to identify a particular section in such notice shall not preclude the Indemnified Party from subsequently identifying such section as a basis for such claim, (ii) attach copies of all substantive written evidence thereof and (iii) if possible, set forth an estimate of the amount of Losses that have been or may be sustained by an Indemnified Party; *provided* that such estimate shall not be binding or used in place of the actual amount of Losses subject to this Article XI. The Indemnifying Party shall have sixty (60) days after receipt of notice to elect, at its option, to assume and control the defense of, at its own expense and by its own counsel, any such Third-Party Claim and shall be entitled to assert any and all defenses available to the Indemnified Party to the fullest extent permitted under applicable Law. If the Indemnifying Party shall undertake to defend any such Third-Party Claim, it shall promptly, but in any event within sixty (60) days after the receipt of notice from the Indemnified Party of such Third-Party Claim, notify the Indemnified Party of its intention to do so, and the Indemnified Party agrees to cooperate fully with the Indemnifying Party and its counsel in the defense against, any such Third-Party Claim; *provided, however*, that the Indemnifying Party shall not settle, compromise or discharge, or admit any liability with respect to, any such Third-Party Claim without the prior written consent of the Indemnified Party (which consent will not be unreasonably withheld or delayed), unless the relief consists solely of money Losses to be paid by the Indemnifying Party and includes a provision whereby the plaintiff or claimant in the matter releases the Indemnified Parties from all liability with respect thereto. Notwithstanding an election by the Indemnifying Party to assume the defense of such action or proceeding at its own expense, the Indemnified Party shall have the right to employ separate counsel and to participate in the defense of such action or proceeding, and the Indemnifying Party shall bear the reasonable fees, costs and expenses of such separate counsel if (A) the Indemnified Party shall have determined in good faith that an actual or potential conflict of interest makes representation by the same counsel or the counsel selected by the Indemnifying Party inappropriate or (B) the Indemnifying Party shall have authorized the Indemnified Party to employ separate counsel at the Indemnifying Party's expense. In any event, the Indemnified Party and the Indemnifying Party and their counsel shall cooperate in the defense of any Third-Party Claim subject to this Article XI, keep such Persons informed of all developments relating to any such Third-Party Claims and provide copies of all relevant correspondence and documentation relating thereto. All costs and expenses incurred in connection with the Indemnified Party's cooperation shall be borne by the Indemnifying Party; *provided* that the cost of any counsel of the Indemnified Party shall be borne by the Indemnifying Party only as set forth in this Section 11.5(a). If the Indemnifying Party receiving such notice of a Third-Party Claim does not elect to defend such Third-Party Claim or does not defend such Third-Party Claim in good faith, the Indemnified Party shall have the right, in addition to any other right or remedy it may have hereunder, at the Indemnifying Party's expense, to defend such Third-Party Claim; *provided, however*, that the Indemnified Party shall not settle, compromise or discharge, or admit any liability with respect to, any such Third-Party Claim without the written consent of the Indemnifying Party (which consent will not be unreasonably withheld or delayed).

(b) Direct Claims. In the event any Indemnified Party has a claim with respect to a matter for which such Indemnified Party is indemnified under this Article XI that does not involve a Third-Party Claim being asserted against or sought to be collected from such Indemnified Party (a "Direct Claim"), the Indemnified Party shall as soon as practicable notify the Indemnifying Party in writing, indicating the nature of such Direct Claim and the basis therefor; *provided, however*, that any delay or failure by the Indemnified Party to give notice to the

Indemnifying Party shall relieve the Indemnified Party of its obligations hereunder only to the extent, if at all, that it is prejudiced by reason of such delay or failure. Such written notice shall (i) describe such Direct Claim in reasonable detail including the sections of this Agreement which form the basis for such Direct Claim; *provided* that the failure to identify a particular section in such notice shall not preclude the Indemnified Party from subsequently identifying such section as a basis for such claim, (ii) attach copies of all substantive written evidence thereof and (iii) if possible, set forth an estimate of the amount of Losses that have been or may be sustained by an Indemnified Party; *provided* that such estimate shall not be binding or used in place of the actual amount of Losses subject to this Article XI. The Indemnifying Party shall have sixty (60) days after its receipt of such notice to respond in writing to such Direct Claim. During such sixty (60)-day period, the Indemnified Party shall allow the Indemnifying Party and its Representatives to investigate the matter or circumstance alleged to give rise to the Direct Claim, and the Indemnified Party shall assist the Indemnifying Party's investigation by giving such information and assistance (including reasonable access to the books, records and personnel of such Indemnified Party, if applicable) as the Indemnifying Party or any of its Representatives may reasonably request. If the Indemnifying Party does not respond within sixty (60) days after the receipt of notice from the Indemnified Party of such Direct Claim (or if in its response it disputes such Direct Claim), the Indemnifying Party shall be deemed to have rejected such claim, in which case the Indemnified Party shall be free to pursue such remedies as may be available to the Indemnified Party on the terms and subject to the provisions of this Agreement.

#### 11.6 Limitations.

(a) Other than with respect to breaches of the Designated Representations, any breach of a representation or warranty in this Agreement in connection with any single item or group of related items that results in Losses of less than \$250,000 shall be deemed, for all purposes of this Article XI, not to be a breach of such representation or warranty.

(b) Other than with respect to breaches of the Designated Representations, (i) IIF Subway and SWMAC Holdco shall not have any liability for breaches of representations or warranties in this Agreement under this Article XI until the aggregate amount of all Losses incurred by the Corix Indemnified Parties equals or exceeds \$10,000,000 and (ii) Corix shall not have any liability for breaches of representations or warranties in this Agreement under this Article XI until the aggregate amount of all Losses incurred by the SWMAC Indemnified Parties equals or exceeds \$10,000,000.

(c) In no event shall an Indemnifying Party be obligated to provide indemnification under this Article XI for Losses in excess of (i) \$1,000,000,000 with respect to breaches of the Designated Representations and (ii) \$100,000,000 with respect to breaches of all other representations and warranties.

(d) The amount of any such Losses shall be determined after deducting therefrom the amount of any insurance proceeds actually collected and other third-party recoveries actually received by the Indemnified Party or CIUS with respect to the Loss for which indemnification is sought (any such amounts, the "Recovered Amounts"); *provided* that, if, after an Indemnifying Party indemnifies an Indemnified Party for any Losses under Section 11.2, Section 11.3 or Section 11.4, as applicable, the Indemnified Party recovers any Recovered

Amounts in respect of such Losses, then (i) in the case of a Corix Indemnified Party, Corix shall, or shall cause such Corix Indemnified Party to, without duplication, promptly reimburse IIF Subway (or SWMAC Holdco) or CIUS, as applicable, and (ii) in the case of a SWMAC Indemnified Party, IIF Subway shall, or shall cause SWMAC Holdco to, cause such SWMAC Indemnified Party to, without duplication, promptly reimburse Corix, in each case, for the lesser of (x) such Recovered Amounts and (y) the amount of such Losses.

(e) Corix and IIF Subway shall, and shall cause their respective controlled Affiliates to, use commercially reasonable efforts to mitigate all Losses that are indemnifiable under Section 11.2, Section 11.3 or Section 11.4, as applicable, including by using commercially reasonable efforts to make claims, or otherwise seek recovery, under any insurance policy, or any indemnity, contribution or reimbursement arrangement or Contract, in each case, under which an Indemnified Party has rights to recovery related to such Losses.

(f) Notwithstanding anything contained in this Agreement to the contrary, no Party shall have any liability pursuant to Section 11.2, Section 11.3 or Section 11.4 for any special, indirect, consequential or punitive damages relating to a breach or alleged breach of this Agreement; *provided, however*, that any amounts payable to third parties pursuant to a Third-Party Claim shall not be deemed special, indirect, consequential or punitive damages.

11.7 Insurance. Notwithstanding anything contained in this Agreement to the contrary, Losses shall be net of any insurance or other prior or subsequent recoveries actually received by the Indemnified Party or its Affiliates in connection with the facts giving rise to the claim for indemnification.

11.8 Remedies Exclusive. Except as otherwise specifically provided herein, and except in the case of Fraud with respect to the representations and warranties contained in this Agreement, the remedies provided in Article IX and this Article XI shall be the exclusive monetary remedies (including equitable remedies that involve monetary payment, such as restitution or disgorgement, but excluding specific performance to enforce any payment or performance due hereunder) of the Parties from and after the Closing in connection with any breach of a representation or warranty, or non-performance, partial or total, of any covenant or agreement contained herein.

## ARTICLE XII

### GENERAL PROVISIONS

12.1 Notices. All notices, requests, instructions, claims, demands and other communications under this Agreement shall be sent by email and shall be deemed given or made on the date of receipt by the recipient thereof if received prior to 5:00 p.m. in the place of receipt and such day is a Business Day (or otherwise on the next succeeding Business Day); *provided* that the email transmission is promptly confirmed by email, telephone or otherwise (and such receiving party shall not unreasonably delay in confirming receipt of such email transmission). Such communications must be sent to the respective Parties at the following email address, or at such other email address for a Party as shall be specified by like notice in accordance with this Section 12.1 (it being understood that rejection or other refusal to accept or the inability to deliver



because of a changed email address for which no notice was given shall be deemed to be receipt of such communication as of the date of such inability to deliver):

- (a) if to Corix or CIUS:

Corix Infrastructure Inc.  
1188 West Georgia Street, Suite 1160  
Vancouver, BC V6E 4A2  
Attention: Lisa Sparrow, Chief Executive Officer  
Email: lisa.sparrow@corix.com and legal@corix.com

in each case, with a copy (which shall not constitute notice) to:

British Columbia Investment Management Corporation  
750 Pandora Ave, Victoria BC  
V8W 0E4 CANADA  
Attention: Steve Turner, Managing Director, IRR  
Email: steve.turner@bci.ca and legal.notices@bci.ca

and

Skadden, Arps, Slate, Meagher & Flom LLP  
1440 New York Avenue, N.W.  
Washington, D.C. 20005  
Attention: Pankaj Sinha;  
Katherine D. Ashley  
Email: pankaj.sinha@skadden.com;  
katherine.ashley@skadden.com

- (b) if to any of the SWWC Parties or SWMAC Holdco:

c/o J.P. Morgan Asset Management  
277 Park Avenue  
New York, NY 10172  
Attention: Fund Legal Team  
Email: IIF\_FLT@jpmorgan.com

with a copy (which shall not constitute notice) to:

Milbank LLP  
55 Hudson Yards  
New York, NY 10001  
Attention: John D. Franchini; Aaron Stine  
Email: jfranchini@milbank.com; astine@milbank.com

12.2 Definitions. For purposes of this Agreement:

“Accounting Principles” means the accounting principles, policies and practices set forth on Exhibit D.

“Affiliate” of any particular Person means (a) any other Person controlling, controlled by, or under common control with such particular Person, where “control” means the possession, directly or indirectly, of the power to direct the management and policies of a Person whether through the ownership of voting securities, by contract, or otherwise, and (b) in addition to the foregoing and with respect only to Corix, (i) any existing or subsequently formed investment entity formed, operated, advised or managed, directly or indirectly, by BCI or any of its Affiliates and (ii) any Person that receives, directly or indirectly, investment management or investment advisory services from BCI, or for which BCI acts as agent for investment. For the avoidance of doubt, (A) none of JPMorgan Chase Bank, N.A., J.P. Morgan Investment Management Inc. or any of their Affiliates, or any pension fund or superannuation fund, collective investment fund containing pension funds or superannuation funds, separate account, pooled or co-mingled fund, or other fund or investor, in each case, for which JPMorgan Chase Bank, N.A. or J.P. Morgan Investment Management Inc. (or any of their respective Affiliates) acts as trustee, agent, general partner, investment advisor, manager or responsible Person, is in either case an Affiliate of the SWWC Parties, (B) prior to the Closing, CIUS and SWWC shall not be deemed to be Affiliates of one another, and (C) from and after the Closing, CIUS and SWWC shall be deemed to be Affiliates of one another but not of Corix, BCI, IIF Subway, Bazos or SWMAC Holdco.

“Ancillary Agreements” means the CIUS Shareholders Agreement, the Confidentiality Agreement, the Corix Balancing Payment Commitment Letter, the IIF Balancing Payment Commitment Letter, the Transition Services Agreement (if applicable), the Common Interest Privilege Agreement, dated as of June 3, 2022, and all other agreements, certificates and instruments executed and delivered in connection with the transactions contemplated hereby.

“Base Equity Balancing Payment Amount” means the difference of \$100,000,000 *less* the amount of the SHL Balancing Payment.

“BCI” means British Columbia Investment Management Corporation, including its successors and assigns.

“BP Indebtedness” means, with respect to any Person, without duplication, (a) all obligations of such Person for borrowed money, or with respect to deposits or advances of any kind to such Person, and (b) all obligations of such Person evidenced by bonds, debentures, notes or similar instruments. For the avoidance of doubt, (i) all liabilities in respect of Taxes imposed on or payable by such Person for any taxable period ending on or before the applicable measurement date and for the portion of any applicable Straddle Period and (ii) Intercompany Indebtedness shall, in each case, not be treated as BP Indebtedness for the purposes of this Agreement.

“Business Day” means any day other than (i) a Saturday or a Sunday or (ii) a day on which banking and savings and loan institutions are authorized or required by Law to be closed in New York City or Vancouver, British Columbia.

“Canadian GAAP” means accounting principles generally accepted in Canada as in effect from time to time, consistently applied and maintained throughout the applicable periods both as to classification or items and amounts.

“Capital Expenditure” means (a) any expenditure to add to, repair, restore or replace property, plant, equipment or tools which have a useful life that extends beyond one year or which extends an asset’s estimated useful life related to the Corix Water Business or the SWWC Business as both exist as of the date hereof, which expenditures will include contracted labor, internal direct labor, materials and indirect costs including an allowance for funds used during construction, (b) expenditures and costs incurred related to assets of the Corix Water Business or the SWWC Business under concession arrangements, and (c) any expenditure to acquire an entity, assets or business of the Corix Water Business or the SWWC Business after the date hereof or to add to, repair, restore or replace property, plant, equipment or tools related to an acquisition of an entity, assets or business consummated after the date hereof.

“CFIUS” means the Committee on Foreign Investment in the United States and each member agency thereof acting in such capacity.

“CFIUS Approval” means (i) CFIUS has concluded that the Business Combination or the Excluded Business Carveout, as applicable, contemplated hereunder are not “covered transactions” and not subject to review under the DPA; (ii) CFIUS has issued a written notice that it has completed a review or investigation of the notification voluntarily provided pursuant to the DPA with respect to the Business Combination or the Excluded Business Carveout, as applicable, contemplated by this Agreement, and has concluded all action under the DPA; or (iii) if CFIUS has sent a report to the President of the United States requesting the President’s decision and (x) the President has announced a decision not to take any action to suspend or prohibit the Business Combination or the Excluded Business Carveout, as applicable, contemplated by this Agreement or (y) having received a report from CFIUS requesting the President’s decision, the President has not taken any action after 15 days from the earlier of the date the President received such report from CFIUS or the end of the investigation period.

“CIUS Common Stock” means the common stock, par value \$0.01 per share, of CIUS.

“CIUS Shareholder Loan” means the \$255,000,000 Junior Term Loan Agreement dated as of August 18, 2014, among Corix Infrastructure (US) Inc., as the borrower, and Coombs IRR LP, as the lenders.

“Closing Corix Capital Expenditure Amount” means the cumulative amount of Capital Expenditures made by the Corix Parties or any of their Affiliates from January 1, 2022 until the Closing Date, as determined in accordance with the Accounting Principles.

“Closing Corix Capital Expenditure Overage” shall exist when the Closing Corix Capital Expenditure Amount *exceeds* the Target Corix Capital Expenditure Amount and shall be equal to the amount of such overage on a dollar-for-dollar basis.

“Closing Corix Capital Expenditure Underage” shall exist when the Closing Corix Capital Expenditure Amount is *less* than the Target Corix Capital Expenditure Amount and shall be equal to the amount of such deficiency on a dollar-for-dollar basis.

“Closing Corix Indebtedness” means, as of the Closing Date (without giving effect to the transactions contemplated in this Agreement), as determined in accordance with, and adjusted by, the Accounting Principles, the total amount of (a) BP Indebtedness and (b) such other line items designated for inclusion therein pursuant to the Accounting Principles, held by any of the Contributed Corix Entities.

“Closing Corix Net Indebtedness” means, as of the Closing Date (without giving effect to the transactions contemplated in this Agreement), the Corix Net Indebtedness.

“Closing Corix Net Indebtedness Overage” shall exist when the Closing Corix Net Indebtedness *exceeds* the Target Corix Net Indebtedness and shall be equal to the amount of such overage on a dollar-for-dollar basis.

“Closing Corix Net Indebtedness Underage” shall exist when the Closing Corix Net Indebtedness is *less* than the Target Corix Net Indebtedness and shall be equal to the amount of such deficiency on a dollar-for-dollar basis.

“Closing Corix Net Working Capital” means, as of the Closing Date (without giving effect to the transactions contemplated in this Agreement), as determined in accordance with, and adjusted by, the Accounting Principles, (a) current assets (excluding cash and any deferred Tax assets), *minus* (b) current liabilities of the Contributed Corix Entities (excluding BP Indebtedness, any Intercompany Indebtedness and deferred Tax liabilities).

“Closing Corix Net Working Capital Overage” shall exist when the Closing Corix Net Working Capital *exceeds* the Target Corix Net Working Capital and shall be equal to the amount of such overage on a dollar-for-dollar basis.

“Closing Corix Net Working Capital Underage” shall exist when the Closing Corix Net Working Capital is *less* than the Target Corix Net Working Capital and shall be equal to the amount of such deficiency on a dollar-for-dollar basis.

“Closing SWWC Capital Expenditure Amount” means the cumulative amount of Capital Expenditures made by the SWWC Parties or any of their Affiliates from January 1, 2022 until the Closing Date, as determined in accordance with the Accounting Principles.

“Closing SWWC Capital Expenditure Overage” shall exist when the Closing SWWC Capital Expenditure Amount *exceeds* the Target SWWC Capital Expenditure Amount and shall be equal to the amount of such overage on a dollar-for-dollar basis.

“Closing SWWC Capital Expenditure Underage” shall exist when the Closing SWWC Capital Expenditure Amount is *less* than the Target SWWC Capital Expenditure Amount and shall be equal to the amount of such deficiency on a dollar-for-dollar basis.

“Closing SWWC Indebtedness” means, as of the Closing Date (without giving effect to the transactions contemplated in this Agreement), as determined in accordance with, and adjusted by, the Accounting Principles, the total amount of (a) BP Indebtedness and (b) such other line items designated for inclusion therein pursuant to the Accounting Principles, held by SWWC or any SWWC Subsidiary.

“Closing SWWC Net Indebtedness” means, as of the Closing Date (without giving effect to the transactions contemplated in this Agreement), the SWWC Net Indebtedness.

“Closing SWWC Net Indebtedness Overage” shall exist when the Closing SWWC Net Indebtedness *exceeds* the Target SWWC Net Indebtedness and shall be equal to the amount of such overage on a dollar-for-dollar basis.

“Closing SWWC Net Indebtedness Underage” shall exist when the Closing SWWC Net Indebtedness is *less* than the Target SWWC Net Indebtedness and shall be equal to the amount of such deficiency on a dollar-for-dollar basis.

“Closing SWWC Net Working Capital” means, as of the Closing Date (without giving effect to the transactions contemplated by this Agreement), as determined in accordance with, and adjusted by, the Accounting Principles, the total of (i) current assets (excluding cash and any deferred Tax assets), *minus* (ii) current liabilities of SWWC and any SWWC Subsidiaries (excluding BP Indebtedness, any Intercompany Indebtedness and deferred Tax liabilities).

“Closing SWWC Net Working Capital Overage” shall exist when the Closing SWWC Net Working Capital *exceeds* the Target SWWC Net Working Capital and shall be equal to the amount of such overage on a dollar-for-dollar basis.

“Closing SWWC Net Working Capital Underage” shall exist when the Closing SWWC Net Working Capital is *less* than the Target SWWC Net Working Capital and shall be equal to the amount of such deficiency on a dollar-for-dollar basis.

“Code” means the Internal Revenue Code of 1986.

“Competition Act” means the *Competition Act* (Canada).

“Competition Act Approval” means either (i) that the Commissioner shall have issued (and not rescinded or amended) an advance ruling certificate under Section 102 of the Competition Act with respect to the Business Combination; or (ii) that both (a) the waiting period under Section 123 of the Competition Act shall have expired or been terminated or the notification requirement shall have been waived pursuant to Section 113(c) of the Competition Act, and, (b) the Commissioner shall have issued a letter indicating that the Commissioner does not, as of the date of the letter, intend to make an application under Section 92 of the Competition Act with respect to the Business Combination.

“Confidentiality Agreement” means that certain Confidentiality Agreement, made as of December 10, 2021, as amended by the First Amendment to Confidentiality Agreement made as of March 8, 2022, by and between BCI and IIF Acquisitions LLC, a constituent entity of the Infrastructure Investments Fund, a fund advised by J.P. Morgan Investment Management, Inc.

“Contributed Corix Entities” means (i) CIUS and each of its Subsidiaries and (ii) the Canadian Water Entities, in each case, other than the Excluded Business Entities.

“Contributed Corix Water Assets” means the assets, properties, claims and rights of Corix and any of its Affiliates other than any Contributed Corix Entity set forth on Section 12.2(c) of the Corix Disclosure Letter, in addition to:

- (a) all Permits Related to the Corix Water Business;
- (b) all Contracts Related to the Corix Water Business and all rights or claims related to or arising under the foregoing; and
- (c) all machinery, equipment, office equipment and supplies and all other items of tangible personal property (including all furniture, furnishings, fixtures, vehicles, tools, components, laptops, tablets and smartphones) that are Related to the Corix Water Business or otherwise primarily utilized by the Corix Water Personnel.

“Core Business” means the ownership and operation of regulated, quasi-regulated and unregulated water and wastewater utilities located within the United States and Canada that, as to each such utility, derives at least 95% of its revenues from water or wastewater operations and services.

“Corix Burdensome Effect” means a material adverse effect on the business, properties, financial condition or results of operations of (a) the Corix Water Business, taken as a whole, or (b) Corix and its Affiliates; *provided* that for purposes of this definition, Corix and its Affiliates shall be deemed a consolidated group of entities of the size and scale of a hypothetical company that is the size of the Corix Water Business, taken as a whole, as of the date of this Agreement.

“Corix Cash” means, as at the date of determination, all (a) cash, bank deposits or cash equivalents (whether in hand or credited to any account with any banking, financial, lending or other similar institution or organization), (b) liquid or easily realizable stocks, shares, bonds, treasury bills and other securities (and interest accrued on each of the foregoing) and (c) such other line items designated for inclusion therein pursuant to the Accounting Principles, held by the Contributed Corix Entities on a consolidated basis and without duplication.

“Corix Marks” means the name and mark CORIX and the associated design mark, any name or mark consisting or comprising of, or containing, the term “CORIX,” whether as part of a word mark, design mark or otherwise, and any name or mark confusingly similar to any of the foregoing, and rights to any Internet domain name, social media handle or account, or similar digital account or address containing or comprising any of the foregoing.

“Corix Net Indebtedness” means, as at the date of determination (without giving effect to the transactions contemplated in this Agreement), as determined in accordance with, and adjusted by, the Accounting Principles, (a) the BP Indebtedness of the Contributed Corix Entities on a consolidated basis and without duplication (stated as a positive amount), *minus* (b) the Corix Cash.

“Corix Water Benefit Plan” means each (i) “employee benefit plan” within the meaning of Section 3(3) of ERISA (whether or not subject to ERISA), (ii) other benefit and compensation plan, contract, policy, program, practice, arrangement or agreement, including, but not limited to, pension, profit-sharing, savings, termination, executive compensation, phantom stock, change-in-control, retention, salary continuation, vacation, sick leave, disability, death benefit, insurance,

hospitalization, medical, dental, life, employee loan, educational assistance, fringe benefit, deferred compensation, retirement or post-retirement, severance, supplemental retirement, equity or equity-based, incentive and bonus plan, contract, policy, program, practice, arrangement or agreement, and (iii) other employment, consulting or other individual agreement, and each other benefit or compensation plan, practice, policy, contract, program, and arrangement, in each case of (i), (ii), and (iii) if, (x) it is sponsored, maintained or contributed to by Corix or any Contributed Corix Entities for the benefit of the Corix Water Personnel or independent contractors of any of the Contributed Corix Entities or (y) with respect to which any of the Contributed Corix Entities could have any actual or potential material liability, but excluding any multiemployer pension plan within the meaning of Section 3(37) of ERISA.

“Corix Water Material Adverse Effect” means a Material Adverse Effect with respect to the Corix Water Business.

“Corix Water Personnel” means any current or former director, officer, consultant or employee of Corix or any Contributed Corix Entity, but excluding any Excluded Business Personnel. For the avoidance of doubt, Corix Water Personnel includes all Transferred Corix Employees.

“COVID-19 Relief Legislation” means the Coronavirus Aid, Relief, and Economic Security Act, Pub. L. 116-136, the Consolidated Appropriations Act, 2021, Pub. L. 116-260, the American Rescue Plan Act of 2021, Pub. L. 117-2, and any similar U.S., non-U.S., state or local grant, subsidy, allowance, relief scheme, stimulus fund, program or measure enacted by a Governmental Entity in connection with or in response to COVID-19.

“Designated Representations” means the Corix Designated Representations and the SWWC Designated Representations.

“DPA” means Section 721 of the Defense Production Act of 1950, as amended (50 U.S.C. §4565), and all rules and regulations issued and effective thereunder.

“Equity Interests” means, with respect to any Person, any and all shares, interests, participations, rights in or other equivalents of such Person’s capital stock, partnership interests, membership interests, limited liability company interests or other equivalent equity or ownership interests and any rights, warrants, stock appreciation rights, phantom stock or options exchangeable or exercisable for or convertible into such capital stock or other equity or ownership interests (whether embedded in other securities or not), and all rights, privileges, liabilities and obligations incident thereto (including any put rights, call rights, preemptive rights or rights of first refusal or offer with respect thereto).

“ERISA” means the Employee Retirement Income Security Act of 1974.

“ERISA Affiliate” with respect to an entity shall mean any other entity that, together with such first entity, would be treated as a single employer under Section 414 of the Code.

“Estimated Corix Capital Expenditure Underage” shall exist when the Estimated Corix Capital Expenditure Amount is *less* than the Target Corix Capital Expenditure Amount and shall be equal to the amount of such deficiency on a dollar-for-dollar basis.

“Estimated Corix Net Indebtedness Overage” shall exist when the Estimated Corix Net Indebtedness exceeds the Target Corix Net Indebtedness and shall be equal to the amount of such overage on a dollar-for-dollar basis.

“Estimated Corix Net Indebtedness Underage” shall exist when the Estimated Corix Net Indebtedness is *less* than the Target Corix Net Indebtedness and shall be equal to the amount of such deficiency on a dollar-for-dollar basis.

“Estimated Corix Net Working Capital Overage” shall exist when the Estimated Corix Net Working Capital exceeds the Target Corix Net Working Capital and shall be equal to the amount of such overage on a dollar-for-dollar basis.

“Estimated Corix Net Working Capital Underage” shall exist when the Estimated Corix Net Working Capital is *less* than the Target Corix Net Working Capital and shall be equal to the amount of such deficiency on a dollar-for-dollar basis.

“Estimated SWWC Capital Expenditure Underage” shall exist when the Estimated SWWC Capital Expenditure Amount is *less* than the Target SWWC Capital Expenditure Amount and shall be equal to the amount of such deficiency on a dollar-for-dollar basis.

“Estimated SWWC Net Indebtedness Overage” shall exist when the Estimated SWWC Net Indebtedness exceeds the Target SWWC Net Indebtedness and shall be equal to the amount of such overage on a dollar-for-dollar basis.

“Estimated SWWC Net Indebtedness Underage” shall exist when the Estimated SWWC Net Indebtedness is *less* than the Target SWWC Net Indebtedness and shall be equal to the amount of such deficiency on a dollar-for-dollar basis.

“Estimated SWWC Net Working Capital Overage” shall exist when the Estimated SWWC Net Working Capital exceeds the Target SWWC Net Working Capital and shall be equal to the amount of such overage on a dollar-for-dollar basis.

“Estimated SWWC Net Working Capital Underage” shall exist when the Estimated SWWC Net Working Capital is *less* than the Target SWWC Net Working Capital and shall be equal to the amount of such deficiency on a dollar-for-dollar basis.

“Excluded Business” means the businesses operated by the Excluded Business Entities and the district energy business, including the Excluded Business Assets and the Excluded Business Liabilities, as conducted or operated by Corix and its Subsidiaries prior to the Closing.

“Excluded Business Assets” means the assets, properties, claims and rights of Corix and any of its Affiliates set forth on Section 12.2(e)(1) of the Corix Disclosure Letter, in addition to:

(a) all cash, cash equivalents, credit cards and bank accounts Related to the Excluded Business, including those of the Excluded Business Entities or any of their Affiliates (other than the Contributed Corix Entities);

(b) all Permits Related to the Excluded Business;



(c) all Contracts Related to the Excluded Business, and all rights or claims related to or arising under the foregoing;

(d) all machinery, equipment, office equipment and supplies and all other items of tangible personal property (including all furniture, furnishings, fixtures, vehicles, tools, components, laptops, tablets and smartphones) that are Related to the Excluded Business or otherwise exclusively utilized by Excluded Business Personnel;

(e) the Corix Marks, all goodwill associated therewith or symbolized thereby, all applications and registrations therefor and all rights and remedies against past, present, and future infringement, misappropriation, or other violation thereof; and

(f) intellectual property Related to the Excluded Business.

“Excluded Business Entities” means Corix Contract Utilities (US) Inc., Corix Infrastructure Services (US) Inc., Corix New Holdco Inc., Corix Utilities (Oklahoma) Inc., Corix Utility Systems (Washington) Inc., Corix Utilities (Cleveland) Inc., Cleveland Thermal LLC, Cleveland Thermal Generation, LLC, Cleveland Thermal Steam Distribution, LLC, Cleveland Thermal Chilled Water Distribution, LLC, Corix Utility Systems (US) Inc., Corix Utility Systems Hawaii, Inc., Corix Kaulele Systems, LLC, Corix Utility Systems (Alaska) Inc., Doyon Utilities, LLC, Corix Utility Systems (JBLM), LLC, Entegrus Inc., Oakridge Energy (GP) Inc., Oakridge Energy Limited Partnership, Corix Water Services, Inc., Corix Water Systems, Inc. and any Corix Subsidiary formed after the date of this Agreement for the purpose of engaging in the Excluded Business.

“Excluded Business Liabilities” means the following liabilities of Corix and any of its Affiliates:

(a) all liabilities to the extent Related to the Excluded Business Personnel or arising therefrom;

(b) all liabilities in respect of any claim, whether or not presently threatened, asserted or pending, to the extent Related to the Excluded Business or the operation of the Excluded Business Assets; and

(c) all liabilities to the extent arising out of any noncompliance Related to the Excluded Business Entities or the Excluded Business Personnel with any applicable Law.

“Excluded Business Personnel” means employees of Corix and its Subsidiaries who perform functions Related to the Excluded Business and those employees listed on Section 12.2 (e)(2) of the Corix Disclosure Letter.

“Fraud” means, with respect to a Party, any actual and intentional fraud with respect to the making of representations and warranties or the performance of any covenants and other agreements contained in this Agreement and/or in the Ancillary Agreements, as finally determined by a court of competent jurisdiction, with the specific intent to deceive and mislead (as opposed to reckless indifference to the truth).

“GAAP” means accounting principles generally accepted in the United States of America as in effect from time to time, consistently applied and maintained throughout the applicable periods both as to classification or items and amounts.

“ICA” means the Investment Canada Act.

“ICA Approval” means either (i) the prescribed period under section 25.2 of the ICA shall have expired and no notice shall have been given under subsection 25.2(1) or subsection 25.3(2) of the ICA within the prescribed period, or (ii) if notice has been give under subsection 25.2(1) or subsection 25.3(2) of the ICA, then either: (a) the responsible Minister under the ICA shall have sent a notice under paragraph 25.2(4)(a) or paragraph 25.3(6)(b) of the ICA or (b) the Governor in Council shall have issued an order under paragraph 25.4(1)(b) of the ICA authorizing the Business Combination.

“Indebtedness” means, with respect to any Person, without duplication, (i) all obligations of such Person for borrowed money, or with respect to deposits or advances of any kind to such Person, (ii) all obligations of such Person evidenced by bonds, debentures, notes or similar instruments, (iii) all capitalized lease obligations (as determined by GAAP) of such Person or obligations of such Person to pay the deferred and unpaid purchase price of property or equipment, (iv) all guarantees and arrangements having the economic effect of a guarantee of such Person of any Indebtedness of any other Person, (v) all obligations or undertakings of such Person to maintain or cause to be maintained the financial position or covenants of any other Person or to purchase the obligations or property of any other Person, (vi) net cash payment obligations of such Person under swaps, options, derivatives and other hedging agreements or arrangements that will be payable upon termination thereof (assuming they were terminated on the date of determination) or (vii) letters of credit, bank guarantees and other similar contractual obligations entered into by or on behalf of such Person.

“Intellectual Property Rights” means all patents, trademarks, service marks, copyrights, trade secrets and other proprietary intellectual property.

“Intercompany Indebtedness” means any and all of the following: (a) the CIUS Shareholder Loan, (b) the SWWC Shareholder Loan, (c) any Short Term SH Loans, (d) any indebtedness owed by a Contributed Corix Entity to another Contributed Corix Entity, (e) any indebtedness owed by SWWC to an SWWC Subsidiary or by an SWWC Subsidiary to another SWWC Subsidiary and (f) any indebtedness owed by a Contributed Corix Entity to Corix or an Affiliate thereof, or by SWWC or an SWWC Subsidiary to SWMAC Holdco or an Affiliate thereof, in either case which indebtedness will become the obligation of CIUS under the terms of Section 12.8.

“Investment Canada” means the Investment Review Division of Innovation, Science and Economic Development Canada.

“IRS” means the U.S. Internal Revenue Service.

“Knowledge” of (i) Corix means, with respect to any matter in question, the actual knowledge of the following: Lisa Sparrow (CEO), Catherine Heigel (EVP/COO), Mario Alonso (EVP/CFO) and Jim Devine (EVP/CSSO), (ii) SWWC means, with respect to any matter in

question, the actual knowledge of the following: Rob MacLean (CEO), Richard Rich (COO), Alison Zimlich (CFO), and Mark Rodriguez (VPHR/CHRO), (iii) SWMAC means, with respect to any matter in question, the actual knowledge of the following: Rob MacLean (CEO), Richard Rich (COO), Alison Zimlich (CFO), and Mark Rodriguez (VPHR/CHRO), and (iv) IIF Subway means, with respect to any matter in question, the actual knowledge of the following: Hai-Gi Li, Clara Lequin, and Mauricio Palazzi, in each of (i), (ii), (iii) and (iv) after making reasonable inquiry of such Person's direct reports having primary responsibility for such matter.

“Law” means any statute, law (including common law), ordinance, rule, regulation or other binding legal requirement, as applicable.

“Loss(es)” means any and all judgments, losses, liabilities, amounts paid in settlement, damages, fines, penalties, deficiencies, losses and expenses (including interest, court costs, reasonable fees of attorneys, accountants and other experts or other reasonable expenses of litigation or other proceedings or of any claim, default or assessment).

“Material Adverse Effect” with respect to any Person means any fact, circumstance, effect, change, event or development that has or would reasonably be expected to have, individually or in the aggregate, a material adverse effect on the business, assets, properties, financial condition or results of operations of such Person and its Subsidiaries, taken as a whole, excluding any fact, circumstance, effect, change, event or development to the extent that it results from or arises out of (i) changes or conditions generally affecting the industries in which such Person and any of its Subsidiaries operate, except to the extent such change or condition has a materially disproportionate effect on such Person and its Subsidiaries, taken as a whole, relative to others in the industries in which such Person and any of its Subsidiaries operate, (ii) general economic or political conditions or securities, regulatory, credit, financial or other capital markets conditions, in each case in the United States or any foreign jurisdiction, except to the extent such condition has a materially disproportionate effect on such Person and its Subsidiaries, taken as a whole, relative to others in the industries in which such Person and any of its Subsidiaries operate, (iii) any failure, in and of itself, by such Person to meet any internal or published projections, forecasts, estimates or predictions in respect of revenues, earnings or other financial or operating metrics for any period (it being understood that the facts or occurrences giving rise to or contributing to such failure may be deemed to constitute, or be taken into account in determining whether there has been or will be, a Material Adverse Effect), (iv) the execution and delivery of this Agreement or the public announcement, pendency or consummation or performance of the Business Combination or any of the other transactions contemplated by this Agreement, including the impact thereof on the relationships, contractual or otherwise, of such Person or any of its Subsidiaries with employees, Labor Organizations, customers, suppliers, partners or Governmental Entities, (v) any change in applicable Law or GAAP (or authoritative interpretation thereof), except to the extent such change has a materially disproportionate effect on such Person and its Subsidiaries, taken as a whole, relative to others in the industries in which such Person and any of its Subsidiaries operate, (vi) geopolitical conditions, the outbreak or escalation of hostilities, any acts of war, sabotage or terrorism, or any escalation or worsening of any such acts of war, sabotage or terrorism threatened or underway as of the date of this Agreement, except to the extent such effect has a materially disproportionate effect on such Person and its Subsidiaries, taken as a whole, relative to others in the industries in which such Person and any of its Subsidiaries operate, (vii) any hurricane, tornado, flood, earthquake, tsunami, natural disaster, mudslides, wild fires,

epidemics, pandemics (including COVID-19) or quarantines, acts of God or other natural disasters or comparable events in the United States, Canada or any other country or region in the world, or any escalation of the foregoing, except to the extent such effect has a materially disproportionate effect on such Person and its Subsidiaries, taken as a whole, relative to others in the industries in which such Person and any of its Subsidiaries operate, (viii) changes in interest or currency exchange rates, or (ix) any actions required to be taken, or required to be refrained from taking, pursuant to the express terms of this Agreement.

“Organizational Documents” means any corporate, partnership or limited liability organizational documents, including certificates or articles of incorporation, notice of articles, bylaws, certificates of formation, operating agreements (including limited liability company agreements and agreements of limited partnership), certificates of limited partnership, partnership agreements, shareholder agreements and certificates of existence, as applicable.

“Par Value” means, with respect to any Shareholder Loan as of any date of determination, the principal amount of such Shareholder Loan plus accrued and unpaid interest thereon, in each case as of such date.

“Permitted Encumbrances” means:

(a) those items set forth in Sections 4.18(a)-(e) of the Corix Disclosure Letter and Sections 6.18(a)-(e) of the SWWC Disclosure Letter;

(b) liens for Taxes not yet due or delinquent or the validity of which is being contested in good faith by appropriate proceedings and for which adequate reserves have been established in accordance with GAAP or Canadian GAAP, as applicable;

(c) mechanic’s, carriers’, workmen’s, repairmen’s or other like liens arising or incurred in the ordinary course of business for amounts not yet delinquent or for amounts the validity of which is being contested in good faith by appropriate proceedings and for which adequate reserves have been established in accordance with GAAP or Canadian GAAP, as applicable;

(d) easements, covenants, rights of way, convents, conditions and restrictions and other similar encumbrances or imperfections of title, whether or not shown by the public records that currently do not, and would not reasonably be expected to, individually or in the aggregate, materially impair the value of such real property or materially impair the continued use and operation of such real property, as presently conducted;

(e) matters that are shown in title reports, title commitments, title opinions or title policies that have been made available to the SWWC Parties or the Corix Parties, as applicable, and encroachments, Liens and any matters not of record that would be disclosed by an accurate survey or inspection of such real property that currently do not, and would not reasonably be expected to, individually or in the aggregate, materially impair the value of such real property or materially impair the continued use and operation of the such real property, as presently conducted

(f) zoning, entitlement, environmental or conservation restrictions and other land use and environmental restrictions and ordinances imposed by Governmental Entities (but not violations thereof), if any, so long as such restrictions and ordinances currently do not, and would

not reasonably be expected to, individually or in the aggregate, materially impair the value of such real property or materially impair the continued use and operation of the such real property, as presently conducted;

(g) rights, terms or conditions of any SWWC Lease or Corix Water Lease, as applicable;

(h) with respect to any Corix Water Leased Property or SWWC Leased Property, any Liens affecting solely the interest of the landlord under the applicable SWWC Lease or Corix Water Lease;

(i) Liens that will be released prior to or as of the Closing Date; and

(j) Liens arising under this Agreement.

“Person” means any natural person, firm, corporation, partnership, company, limited liability company, trust, joint venture, association, Governmental Entity or other entity.

“Regulatory Material Adverse Effect” means a Corix Burdensome Effect or an SWWC Burdensome Effect.

“Related to the Corix Water Business” means primarily relating to, primarily held for use with, or primarily used in connection with the Corix Water Business, in each case, as the context requires.

“Related to the Excluded Business” means exclusively relating to, exclusively held for use with, or exclusively used in connection with the Excluded Business, in each case, as the context requires.

“Representatives” means, with respect to a Party, such Party’s Affiliates, and its and their directors, officers, employees, managers, investment advisors, agents or professional and financial advisers.

“Required Consents” means the Corix Regulatory Approvals and the SWWC Regulatory Approvals.

“Sanctioned Person” means, at any time, (a) any Person listed on any Sanctions-related list of designated Persons maintained by the Office of Foreign Assets Control of the U.S. Department of the Treasury, the U.S. Department of State, the government of Canada, Global Affairs Canada, Public Safety Canada, the Department of Justice Canada, the United Nations Security Council, the European Union, any European Union member state, the United Kingdom or other relevant sanctions authority; (b) any Person located, organized or resident in a country or territory that is the subject of comprehensive Sanctions; and (c) any Person which is fifty percent (50%) or more owned or controlled by any such Person or Persons described in clauses (a) or (b) above.

“Sanctions” means any economic or financial sanctions or trade embargoes imposed, administered or enforced by the Office of Foreign Assets Control of the U.S. Department of the Treasury, the U.S. Department of State, the government of Canada, Global Affairs Canada, Public

Safety Canada, the Department of Justice Canada, the United Nations Security Council, the European Union, any European Union member state, or the United Kingdom.

“Senior Foreign Political Figure” has the meaning set forth in 31 C.F.R. § 1010.605(p).

“Service Business” means, with respect to the U.S. and Canadian water and wastewater operations of Corix, the related electric, natural gas, and propane distribution, geothermal energy, and municipal service operations of Corix.

“Shareholder Loans” means the SWWC Shareholder Loan and the CIUS Shareholder Loan.

“Subsidiary” of any Person means another Person, an amount of the voting securities, other voting ownership or voting partnership interests of which is sufficient to elect at least a majority of its board of directors or other governing body (or, if there are no such voting interests, more than 50% of the Equity Interests in which) is owned directly or indirectly by such first Person.

“SWWC Benefit Plan” means each (i) “employee benefit plan” within the meaning of Section 3(3) of ERISA (whether or not subject to ERISA), (ii) other benefit and compensation plan, contract, policy, program, practice, arrangement or agreement, including, but not limited to, pension, profit-sharing, savings, termination, executive compensation, phantom stock, change-in-control, retention, salary continuation, vacation, sick leave, disability, death benefit, insurance, hospitalization, medical, dental, life, employee loan, educational assistance, fringe benefit, deferred compensation, retirement or post-retirement, severance, supplemental retirement, equity or equity-based, incentive and bonus plan, contract, policy, program, practice, arrangement or agreement, and (iii) other employment, consulting or other individual agreement, and each other benefit or compensation plan, practice, policy, contract, program, and arrangement, in each case of (i), (ii) and (iii) if, (x) it is sponsored, maintained or contributed to by SWWC or any SWWC Subsidiaries for the benefit of any current or former employees, directors, or individual independent contractors of SWWC or any of the SWWC Subsidiaries or (y) with respect to which SWWC or any of the SWWC Subsidiaries could have any actual or potential material liability, but excluding any multiemployer pension plan within the meaning of Section 3(37) of ERISA.

“SWWC Burdensome Effect” means a material adverse effect on the business, properties, financial condition or results of operations of SWWC and the SWWC Subsidiaries, taken as a whole.

“SWWC Cash” means, as at the date of determination, all (a) cash, bank deposits or cash equivalents (whether in hand or credited to any account with any banking, financial, lending or other similar institution or organization), (b) liquid or easily realizable stocks, shares, bonds, treasury bills and other securities (and interest accrued on each of the foregoing) and (c) such other line items designated for inclusion therein pursuant to the Accounting Principles, held by SWWC and the SWWC Subsidiaries on a consolidated basis and without duplication.

“SWWC Material Adverse Effect” means a Material Adverse Effect with respect to SWWC Business.

“SWWC Net Indebtedness” means, as at the date of determination (without giving effect to the transactions contemplated in this Agreement), as determined in accordance with, and adjusted by, the Accounting Principles, (a) the BP Indebtedness of SWWC and the SWWC Subsidiaries on a consolidated basis and without duplication (stated as a positive amount), *minus* (b) the SWWC Cash.

“SWWC Personnel” means any current or former director, officer, consultant or employee of SWWC or any SWWC Subsidiary.

“SWWC Shareholder Loan” means (i) that certain Note Purchase Agreement, dated September 13, 2010, by and between SWMAC, IIF Subway and USA Water Services LLC, (ii) that certain Amended and Restated 7.7% Mezzanine Note, dated August 31, 2015, by and between IIF Subway and SWMAC and (iii) that certain Extension to the Maturity date of that Certain Amended and Restated 7.7% Mezzanine Note, dated August 31, 2015, by and between IIF Subway and SWMAC.

“Target Corix Capital Expenditure” means \$305,849,212.

“Target Corix Net Indebtedness” means \$709,040,544.

“Target Corix Net Working Capital” means \$22,895,647.

“Target SWWC Capital Expenditure” means \$299,113,636.

“Target SWWC Net Indebtedness” means \$859,637,678.

“Target SWWC Net Working Capital” means \$7,815,657.

“Tax Act” means the Income Tax Act (Canada).

“Tax Return” means any return, declaration, statement, report, election, claim for refund, information return or similar filing (including the attached schedules) filed or required to be filed with respect to Taxes, including any schedule or attachment thereto, and including any amendment thereof.

“Taxes” means any and all U.S. federal, state, local, or non-U.S. taxes, customs, tariffs, imposts, levies, duties, fees or other like assessments or charges of any kind, including gross income, net income, gross receipts, capital gains, net worth, payroll, employment, excise, severance, stamp, occupation, premium, windfall profits, capital stock, franchise, profits, branch profits, estimated, withholding, social security (or similar, including FICA), unemployment, disability, real property, or personal property, ad valorem, sales, services, digital services, use, transfer, documentary, recording, environmental, registration, value added, alternative or add-on minimum, or other tax, governmental charge, customs duty, tariff, impost, levy or other similar charges, in each case, in the nature of a tax and imposed by a Governmental Entity, together with all interest, penalties and additions imposed with respect to such amounts, and any liability for any of the foregoing resulting from having been a member of a group filing a combined, consolidated, affiliated, unitary or similar tax group, by operation of any other applicable tax Law, or as a transferee or successor.

“Taxing Authority” means any Governmental Entity responsible for the administration or collection of any Tax.

“Treasury Regulations” means regulations promulgated by the IRS under the Code.

12.3 Interpretation. When a reference is made in this Agreement to an Exhibit, an Article or a Section, such reference shall be to an Exhibit, an Article or a Section of this Agreement unless otherwise indicated. The table of contents, index of defined terms and headings contained in this Agreement are for reference purposes only and shall not affect in any way the meaning or interpretation of this Agreement. Whenever the words “include,” “includes” or “including” are used in this Agreement, they shall be deemed to be followed by the words “without limitation.” Any reference herein to any statute shall also be deemed to refer to all rules and regulations promulgated thereunder. The words “hereof,” “hereto,” “hereby,” “herein” and “hereunder” and words of similar import when used in this Agreement shall refer to this Agreement as a whole and not to any particular provision of this Agreement. The term “or” is not exclusive. The word “extent” in the phrase “to the extent” shall mean the degree to which a subject or other thing extends, and such phrase shall not mean simply “if.” The definitions contained in this Agreement are applicable to the singular as well as the plural forms of such terms. Any Law defined or referred to herein means such Law as amended, modified or supplemented as of the applicable date or period of time. Any Contract defined or referred to herein means such Contract as from time to time amended, modified or supplemented, unless otherwise specifically indicated. References to a Person are also to its permitted successors and assigns. Unless otherwise specifically indicated, all references to “dollars” and “\$” will be deemed references to the lawful money of the United States of America. Each of the Parties has participated in the drafting and negotiation of this Agreement. If an ambiguity or question of intent or interpretation arises, this Agreement must be construed as if it is drafted by all the Parties, and no presumption or burden of proof shall arise favoring or disfavoring any Party by virtue of authorship of any of the provisions of this Agreement. The words “made available” and words of similar import, with respect to the Corix Parties or the SWWC Parties, refer to documents which were, at least two (2) Business Days prior to the execution of this Agreement, posted to the data site maintained by such Party or its Representatives in connection with the transactions contemplated by this Agreement. When calculating the period of time before which, within which or after which any act is to be done or step taken pursuant to this Agreement, (i) the date that is the reference date in calculating such period shall be excluded and (ii) if the last day of such period is not a Business Day, the period in question shall end on the next succeeding Business Day. All references in this Agreement to a number of days are to such number of calendar days unless Business Days are specified. References herein to “as of the date hereof,” “as of the date of this Agreement” or words of similar import shall be deemed to mean “as of immediately prior to the execution and delivery of this Agreement.”

12.4 Severability. If any provision of this Agreement (or any portion thereof) or the application of any such provision (or any portion thereof) to any Person or circumstance shall be held invalid, illegal or unenforceable in any respect by a court or other Governmental Entity of competent jurisdiction, such invalidity, illegality or unenforceability shall not affect any other provision of this Agreement (or remaining portion thereof) or the application of such provision to any other Person or circumstances (including for the avoidance of doubt the failure to obtain a Required Consent). Upon such determination that any term or other provision is invalid, illegal or



incapable of being enforced, the Parties shall negotiate in good faith to modify this Agreement and the Ancillary Agreement so as to effect the original intent of the Parties as closely as possible in a mutually acceptable manner in order that the transactions contemplated by this Agreement are consummated as originally contemplated to the greatest extent possible.

12.5 Counterparts. This Agreement may be executed in two or more counterparts, all of which shall be considered one and the same agreement, and each such counterpart shall be deemed an original instrument. A signed copy of this Agreement delivered by facsimile, email or other means of electronic transmission shall be deemed to have the same legal effect as delivery of an original signed copy of this Agreement. This Agreement shall become effective when one or more counterparts have been signed by each of the Parties and delivered to each of the other Parties.

12.6 Entire Agreement; No Third-Party Beneficiaries.

(a) This Agreement, taken together with the Corix Disclosure Letter, the SWWC Disclosure Letter and the terms of the Ancillary Agreements, (i) constitute the entire agreement, and supersedes all prior and contemporaneous agreements, negotiations, understandings, and representations and warranties, both written and oral, between the Parties with respect to the Business Combination and the other transactions contemplated by this Agreement and (ii) is not intended to confer, and does not confer, upon any Person other than the Parties any rights or remedies.

(b) Except for the representations and warranties contained in Article III and IV, the SWWC Parties acknowledge and agree that (i) that neither the Corix Parties nor any other Person on behalf of the Corix Parties has made or makes any other express or implied representation or warranty in connection with the transactions contemplated by this Agreement and (ii) the SWWC Parties expressly disclaim, and have not relied and are not relying on, any representations or warranties regarding Corix, the Contributed Corix Entities or their respective Affiliates or Representatives other than those contained in Article III and IV. Except for the representations and warranties contained in Articles V and VI, the Corix Parties acknowledge and agree that (i) neither the SWWC Parties nor any other Person on behalf of the SWWC Parties has made or makes any other express or implied representation or warranty in connection with the transactions contemplated by this Agreement and (ii) the Corix Parties expressly disclaim, and have not relied and are not relying on, any representations or warranties regarding IIF Subway, SWMAC, SWWC and its Affiliates or Representatives other than those contained in Articles V and VI.

12.7 Exhibits and Schedules; Article IV Representations and Warranties.

(a) All Exhibits and Schedules, or documents expressly incorporated into this Agreement, are hereby incorporated into this Agreement and are hereby made a part hereof as if set out in full in this Agreement. The Schedules shall be arranged in sections and subsections corresponding to the numbered and lettered Sections and subsections set forth in this Agreement. Any item disclosed in the Corix Disclosure Letter or in the SWWC Disclosure Letter corresponding to any Section or subsection of Articles III or IV (in the case of the Corix Disclosure Letter) or Articles V and VI (in the case of the SWWC Disclosure Letter) shall be deemed to have been disclosed with respect to every other section and subsection of Articles III or IV (in the case

of the Corix Disclosure Letter) or Articles V and VI (in the case of the SWWC Disclosure Letter), as applicable, where the relevance of such disclosure to such other Section or subsection is reasonably apparent on the face of the disclosure. The information and disclosures set forth in the Schedules that correspond to the section or subsections of Articles III, IV, V and VI may not be limited to matters required to be disclosed in the Schedules, and any such additional information or disclosure is for informational purposes only and does not necessarily include other matters of a similar nature.

(b) The Parties acknowledge that prior to the completion of the Corix Restructuring in accordance with this Agreement, a portion of the Corix Water Business will have been operated by Corix and certain of its Subsidiaries that are not Contributed Corix Entities. Accordingly, with respect to the representations and warranties set forth in Article IV, to the extent any such representation or warranty relates to Corix's or any such Subsidiary's operation of the Corix Water Business or any other matter (in respect of the Corix Water Business) that is the subject of any such representation or warranty prior to the completion of the Corix Restructuring, such representation or warranty (or applicable portion thereof), shall be made as to Corix or any such Subsidiary (and any applicable disclosures made by Corix with respect to Article III in the Corix Disclosure Letter shall qualify such representations and warranties) and the remedies with respect to any breaches of applicable representations or warranties shall be subject to Article XI.

12.8 Expenses. Upon the consummation of the Closing, CIUS will be responsible for all fees and expenses, including legal expenses, incurred by the Parties or their Affiliates in connection with the Business Combination and arrangements contemplated by this Agreement (including the negotiation hereof), it being understood that all Unrelated Corix Expenses shall be borne solely by Corix and its Affiliates; *provided*, that, except as provided in Section 10.2, if the Business Combination is not consummated, (a) subject to clause (c) below, all fees, costs and expenses incurred by the Corix Parties in connection with the negotiation of this Agreement, the performance of its obligations hereunder and the consummation of the transactions contemplated by this Agreement (including fees and expenses of attorneys', accountants and other advisors) shall be borne by Corix, (b) subject to clause (c) below, all fees, costs and expenses incurred by the SWWC Parties in connection with the negotiation of this Agreement, the performance of its obligations hereunder and the consummation of the transactions contemplated by this Agreement (including fees and expenses of attorneys', accountants and other advisors) shall be borne by IIF Subway and (c) any fees, costs and expenses related to third party advisors jointly engaged by the Parties in respect of the transactions contemplated by this Agreement shall be borne equally between Corix and IIF Subway.

12.9 Governing Law. THIS AGREEMENT SHALL BE GOVERNED BY, AND INTERPRETED AND CONSTRUED IN ACCORDANCE WITH, THE LAWS OF THE STATE OF DELAWARE, REGARDLESS OF THE LAWS, RULES OR PRINCIPLES THAT MIGHT OTHERWISE GOVERN UNDER ANY APPLICABLE PRINCIPLES OF CONFLICTS OF LAWS OF THE STATE OF DELAWARE OR ANY OTHER JURISDICTION.

12.10 Assignment. Neither this Agreement nor any of the rights, interests or obligations under this Agreement shall be assigned, in whole or in part, by operation of Law or otherwise by any of the Parties without the prior written consent of the other Parties. Any purported assignment without such consent shall be void. Subject to the two immediately preceding sentences, this

Agreement will be binding upon, inure to the benefit of, and be enforceable by, the Parties and their respective successors and permitted assigns. Notwithstanding the foregoing, the Parties expressly agree that, following the SWMAC Restructuring and concurrent with the Closing, IIF Subway shall be permitted to assign or transfer to SWMAC Holdco this Agreement and all obligations and rights of IIF Subway under this Agreement, in which event (a) this Agreement will be binding upon, inure to the benefit of, and be enforceable by SWMAC Holdco and (b) IIF Subway will be fully released from all of its obligations under this Agreement.

12.11 Specific Enforcement; Consent to Jurisdiction.

(a) The Parties acknowledge and agree that irreparable damage would occur in the event that any of the provisions of this Agreement were not performed in accordance with their specific terms or were otherwise breached, and that monetary damages, even if available, would not be an adequate remedy therefor. It is accordingly agreed that, prior to the termination of this Agreement pursuant to Article X, the Parties shall be entitled to an injunction or injunctions to prevent breaches of this Agreement and to enforce specifically the performance of terms and provisions of this Agreement in any court referred to in clause (i) of Section 12.11(b), without proof of actual damages (and each Party hereby waives any requirement for the securing or posting of any bond in connection with such remedy), this being in addition to any other remedy to which they are entitled at law or in equity. The Parties further agree not to assert that a remedy of specific enforcement is unenforceable, invalid, contrary to Law or inequitable for any reason, nor to assert that a remedy of monetary damages would provide an adequate remedy for any such breach.

(b) Each of the Parties (i) consents to submit itself to the personal jurisdiction of any Delaware state court or any federal court located in the State of Delaware in the event any dispute arises out of this Agreement, the Business Combination or any of the other transactions contemplated by this Agreement, (ii) agrees that it will not attempt to deny or defeat such personal jurisdiction by motion or other request for leave from any such court and (iii) agrees that it will not bring any action relating to this Agreement, the Business Combination or any of the other transactions contemplated by this Agreement in any court other than any Delaware state court or any federal court sitting in the State of Delaware.

12.12 Waiver of Jury Trial. Each Party hereby irrevocably and unconditionally waives, to the fullest extent permitted by applicable Law, any right it may have to a trial by jury in respect of any suit, action or other proceeding arising out of this Agreement, the Business Combination or any of the other transactions contemplated by this Agreement. Each Party (a) certifies that no representative, agent or attorney of any other Party has represented, expressly or otherwise, that such Party would not, in the event of any action, suit or other proceeding, seek to enforce the foregoing waiver, (b) understands and has considered the implications of this waiver, (c) makes this waiver voluntarily and (d) acknowledges that it and the other Parties have been induced to enter into this Agreement by, among other things, the mutual waiver and certifications in this Section 12.12.

12.13 No Recourse. Except (a) with respect to the Confidentiality Agreement, (b) with respect to the IIF Sponsor under the IIF Balancing Payment Commitment Letter or the Corix Sponsor under the Corix Balancing Payment Commitment Letter, and (c) in the event of Fraud, all claims, obligations, liabilities, or causes of action (whether in contract or in tort, in law or in equity,

or granted by statute) that may be based upon, in respect of, arise under, out or by reason of, be connected with, or relate in any manner to this Agreement, or the negotiation, execution, or performance of this Agreement (including any representation or warranty made in, in connection with, or as an inducement to, this Agreement), may be made only against (and such representations and warranties are those solely of) a Party and then only with respect to the specific obligations set forth herein with respect to such Party. Except in the event of Fraud, no Person who is not a Party, including any current, former or future director, officer, employee, incorporator, member, partner, manager, stockholder, Affiliate, agent, attorney, representative or assignee of, and any financial advisor or lender to, any Party, or any current, former or future director, officer, employee, incorporator, member, partner, manager, stockholder, Affiliate, agent, attorney, representative or assignee of, and any financial advisor or lender to, any of the foregoing (collectively, the “Nonparty Affiliates”), shall have any liability (whether in contract or in tort, in law or in equity, or granted by statute) for any claims, causes of action, obligations, or liabilities arising under, out of, in connection with, or related in any manner to this Agreement or based on, in respect of, or by reason of this Agreement or its negotiation, execution, performance, or breach (other than as set forth in the Confidentiality Agreement, the IIF Balancing Payment Commitment Letter or the Corix Balancing Payment Commitment Letter), and, to the maximum extent permitted by Law, each Party hereby waives and releases all such liabilities, claims, causes of action, and obligations against any such Nonparty Affiliates. Without limiting the foregoing, except (i) with respect to the Confidentiality Agreement, (ii) with respect to the IIF Sponsor under the IIF Balancing Payment Commitment Letter or the Corix Sponsor under the Corix Balancing Payment Commitment Letter, and (iii) in the event of Fraud, to the maximum extent permitted by Law, (x) each Party hereby waives and releases any and all rights, claims, demands, or causes of action that may otherwise be available at law or in equity, or granted by statute, to avoid or disregard the entity form of a Party or otherwise impose liability of a Party on any Nonparty Affiliate, whether granted by statute or based on theories of equity, agency, control, instrumentality, alter ego, domination, sham, single business enterprise, piercing the veil, unfairness, undercapitalization, or otherwise, and (y) each Party disclaims any reliance upon any Nonparty Affiliates with respect to the performance of this Agreement or any representation or warranty made in, in connection with, or as an inducement to this Agreement.

*[Remainder of page left intentionally blank]*

IN WITNESS WHEREOF, the Parties have duly executed this Agreement as of the date first written above.

**CORIX INFRASTRUCTURE INC.**

By:   
Name: Lisa Sparrow  
Title: Chief Executive Officer

**CORIX INFRASTRUCTURE (US) INC.**

By:   
Name: Shawn M. Elicegui  
Title: Corporate Secretary

**IIF SUBWAY INVESTMENT L.P.**

By: IIF Water Manager LLC, its General  
Partner

By   
Name: Hai-Gi Li  
Title: Authorized Signatory

**SW MERGER ACQUISITION CORP.**

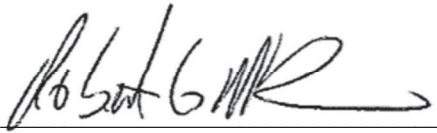
By:   
Name: Robert MacLean  
Title: Authorized Signatory

**SOUTHWEST WATER COMPANY**

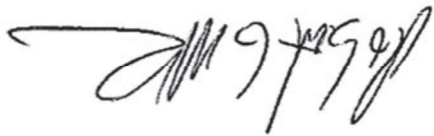

By:

Name: Robert MacLean  
Title: President & CEO



Index of Defined Terms

280G Entity.....	7.13
Accountant.....	Section 2.4(a)(iii)
Advance Ruling Certificate.....	7.2(a)(ii)
Agreement.....	Introduction
AML Laws.....	3.8(b)
Anti-Corruption Laws.....	3.8(a)(i)
BAPA.....	9.10(a)
Bazos.....	Recitals
Bazos Letter Agreement.....	Recitals
Business Combination.....	Recitals
Canadian Business Restructuring.....	Recitals
Canadian Reporting Contributed Corix Entities.....	4.5(a)
Canadian Water Entities.....	Recitals
Canadian Water Interests.....	3.4(b)
Certificate of Merger.....	1.1(d)(ii)
Cessation Date.....	7.11(a)
CIUS.....	Introduction
CIUS Board.....	Recitals
CIUS Shareholder.....	2.4(a)(i)
CIUS Shareholders.....	2.4(a)(i)
CIUS Shareholders Agreement.....	Recitals
CIUS-Corix Indemnified Parties.....	9.1(a)
CIUS-SWMAC Indemnified Parties.....	9.1(b)
Closing.....	2.1
Closing Adjusted Equity Balancing Payment Amount.....	2.4(b)(i)
Closing Adjustment.....	2.4(b)
Closing Date.....	2.1
Collective Bargaining Agreement.....	4.10(a)
Combined Business Benefit Plans.....	7.12(c)
Combined Business Employees.....	7.12(a)
Commissioner.....	7.2(a)(ii)
Confidentiality Terms.....	7.3(a)
Consent.....	4.4(b)
Continuation Period.....	7.12(a)
Contract.....	4.4(a)
Contributed Corix Water Contracts.....	7.9(b)
Controlling Party.....	9.1(e)(iv)
Coombs.....	Recitals
Corix.....	Introduction
Corix Balancing Payment Commitment.....	Recitals
Corix Balancing Payment Commitment Letter.....	Recitals
Corix Board.....	Recitals
Corix Business Plan.....	7.1(a)
Corix Conduct of Business Exceptions.....	7.1(a)

Corix Covered Employee.....	7.3(c)
Corix Designated Representations.....	8.3(a)(i)
Corix Disclosure Letter.....	III
Corix Expense Reimbursement.....	10.2(b)
Corix Financial Advisor.....	3.7
Corix Indemnified Parties.....	11.2
Corix Parties.....	Introduction
Corix Regulatory Approvals.....	4.4(b)
Corix Restricted Person.....	7.3(b)
Corix Restructuring.....	Recitals
Corix Sponsor.....	Recitals
Corix Water Audited Financial Statements.....	4.5(a)
Corix Water Business.....	Recitals
Corix Water Financial Statements.....	4.5(a)
Corix Water Interim Financial Statements.....	4.5(a)
Corix Water Leased Property.....	4.18(c)
Corix Water Leases.....	4.18(c)
Corix Water Material Adverse Effect.....	8.3(a)(i)
Corix Water Material Contract.....	4.16(a)(viii)
Corix Water Owned Property.....	4.18(c)
Corix Water Permits.....	4.13
Corix Water Property.....	4.18(c)
Corix Water Property Easements.....	4.18(d)
Corix Water Qualified Plan.....	4.9(c)
Corix Water Rights.....	4.14
Corix Water Tax Return.....	4.8(a)
Corix Water Unaudited Financial Statements.....	4.5(a)
Direct Claim.....	11.5(b)
Dispute Notice.....	2.4(a)(iii)
Disqualified Individuals.....	7.13
DOJ.....	7.2(a)(i)
End Date.....	10.1(b)(i)
Environmental Claims.....	4.15(g)
Environmental Law.....	4.15(g)
Environmental Permits.....	4.15(b)
Environmental Reports.....	4.15(g)
Equity Balancing Payment.....	Recitals
Estimated Adjusted Equity Balancing Payment Amount.....	2.3(e)(ii)
Estimated Adjustment.....	2.3(e)(i)
Estimated Corix Capital Expenditure Amount.....	2.3(b)
Estimated Corix Net Indebtedness.....	2.3(b)
Estimated Corix Net Working Capital.....	2.3(b)
Estimated Corix Payment Statement.....	2.3(c)
Estimated Payment Statements.....	2.3(c)
Estimated SWWC Capital Expenditure Amount.....	2.3(a)
Estimated SWWC Net Indebtedness.....	2.3(a)

Estimated SWWC Net Working Capital.....	Section 2.3(a)
Estimated SWWC Payment Statement .....	2.3(c)
Excluded Business Carveout.....	Recitals
Excluded Business Contracts.....	7.9(a)
Excluded Business Purchaser .....	7.7
Excluded Property Transactions .....	1.1(f)
Final Closing Statement.....	Section 2.4(a)(i)
Final Equity Balancing Payment Adjustment Items.....	2.4(a)(i)
Final Order.....	8.1(a)
FTC .....	7.2(a)(i)
Government Official .....	3.8(a)(ii)
Governmental Entity.....	4.4(b)
HSR Act.....	4.4(b)
IIF Balancing Payment Commitment .....	Recitals
IIF Balancing Payment Commitment Letter.....	Recitals
IIF Sponsor.....	Recitals
IIF Subway.....	Preamble
IIF Subway Financial Advisor.....	5.7
Indemnified Parties .....	11.3
Indemnified Party.....	11.3
Indemnifying Party .....	11.5(a)
Initial Estimated Corix Payment Statement.....	2.3(b)
Initial Estimated Payment Statements .....	2.3(b)
Initial Estimated SWWC Payment Statement.....	2.3(a)
Intended Tax Treatment.....	9.9(a)
Interim Balance Sheet Date .....	4.5(a)
Intermediate Newco.....	Recitals
Judgment.....	4.4(a)
Labor Organization .....	4.10(a)
Legal Restraints .....	8.1(b)
Liens.....	4.2(a)
Material Corix Water Owned Property.....	4.18(c)
Material SWWC Owned Property .....	6.18(c)
Materials of Environmental Concern.....	4.15(g)
Merger.....	1.1(d)(ii)
Merger Effective Time.....	1.1(d)(ii)
Multiemployer Plan .....	4.9(f)
No Action Letter .....	7.2(a)(ii)
Non-Controlling Party .....	9.1(e)(iv)
Non-Material Corix Water Owned Property.....	4.18(b)
Non-Material SWWC Owned Property.....	6.18(b)
Nonparty Affiliates .....	12.13
Parachute Payment Waiver.....	7.13
Parties.....	Introduction
Party .....	Introduction
PBGC.....	4.9(e)

Permits .....	4.13
Recovered Amounts .....	11.6(d)
Regulated Contributed Corix Entities .....	4.6(a)
Regulated SWWC Subsidiaries .....	6.6(a)
Regulatory Adjustments .....	4.6(a)
Release .....	4.15(g)
Remainco .....	Recitals
Required Third-Party Consents .....	7.2(e)
Section 280G Payments .....	7.13
SHL Balancing Payment .....	Recitals
SHL JV .....	Recitals
SHL Restructuring .....	Recitals
Short Term SH Loans .....	2.3(e)(iv)
Straddle Controlling Party .....	9.1(e)(iii)
Straddle Period .....	9.1(c)
SWMAC .....	Introduction
SWMAC Board .....	Recitals
SWMAC Equity Exchange .....	1.1(d)(i)
SWMAC Holdco .....	Recitals
SWMAC Indemnified Parties .....	11.3
SWMAC Interests .....	1.1(d)(i)
SWMAC Restructuring .....	Recitals
SWWC .....	Introduction
SWWC Audited Financial Statements .....	6.5(a)
SWWC Business .....	Recitals
SWWC Business Plan .....	7.1(b)
SWWC Conduct of Business Exceptions .....	7.1(b)
SWWC Covered Employee .....	7.3(b)
SWWC Designated Representations .....	8.2(a)(i)
SWWC Disclosure Letter .....	V
SWWC Expense Reimbursement .....	10.2(c)
SWWC Financial Statements .....	6.5(a)
SWWC Interim Financial Statements .....	6.5(a)
SWWC Leased Property .....	6.18(c)
SWWC Leases .....	6.18(c)
SWWC Material Adverse Effect .....	8.2(a)(i)
SWWC Material Contract .....	6.16(a)(viii)
SWWC Owned Property .....	6.18(c)
SWWC Parties .....	Introduction
SWWC Permits .....	Section 6.13
SWWC Property .....	6.18(c)
SWWC Property Easements .....	6.18(d)
SWWC Qualified Plan .....	6.9(c)
SWWC Regulatory Approvals .....	6.4(b)
SWWC Restricted Person .....	7.3(c)
SWWC Subsidiaries .....	Section 6.1

SWWC Tax Return ..... 6.8(a)  
SWWC Water Rights ..... Section 6.14  
Tax Claim..... 9.1(e)(i)  
Tax Indemnifying Party ..... 9.1(e)(ii)  
Tax Sharing Agreements..... 9.4(a)  
Third-Party Claim ..... 11.5(a)  
Transfer Taxes ..... 9.3  
Transferred Corix Employees ..... 7.8(e)  
Transition Services Agreement..... Recitals  
TSA Terms..... 7.7  
U.S. Reporting Contributed Corix Entities ..... Section 4.5(a)  
Unrelated Corix Expenses..... 10.2(b)  
Waived Benefits ..... 7.13

Exhibit A

**TopCo Term Sheet**

Exhibit A of the Transaction Agreement, which contain confidential information, is not included with the Transaction Agreement filed with the Application. Unredacted versions and redacted public versions will be provided upon request in accordance with the Commission's rules regarding confidential documents.

**Exhibit B**  
**Transition Services Agreement Term Sheet**

Set forth below in this term sheet (the “Term Sheet”) are the significant terms of the Transition Services Agreement (the “TSA”) to be entered into among an Affiliate of CII that retains ownership of the Excluded Business as of the Closing Date (such Affiliate, “Remainco”), Corix Infrastructure Inc. (“CII”), and Corix Infrastructure (US) Inc. (“CIUS”) in connection with the Excluded Business Carveout and the related transactions contemplated by the Transaction Agreement (the “Agreement”) as of the Closing Date. For the purposes of this Term Sheet, each of Remainco, CII and CIUS are referred to as a “Party” and, together, the “Parties”. Capitalized terms used in this Term Sheet shall have the meanings ascribed thereto in the Agreement.

<p><b><u>Parties</u></b></p>	<p>“<u>Service Provider</u>” means a Party or any Affiliate thereof providing any Services under the TSA as set forth on an exhibit to the TSA. For the purposes of this Term Sheet, the Services that will be set forth on such exhibit are generally described on Schedule A and Schedule B attached hereto.</p> <p>“<u>Service Recipient</u>” means a Party or any Affiliate thereof in the capacity as a recipient of any Services under the TSA in accordance with the Services set forth on Schedule A or Schedule B.</p>
<p><b><u>Services to Be Provided</u></b></p>	<p>Service Provider will provide, or cause its Affiliates to provide, the Services to Service Recipient for the respective periods and on the other terms and conditions set forth in the TSA.</p> <p>The “<u>Services</u>” provided to Remainco as Service Recipient shall consist of the services provided to the Excluded Business Entities or the Excluded Business during the twelve (12)-month period prior to the Closing that are performed by personnel of (or use assets retained by) the Contributed Corix Entities, as identified and set forth on Schedule A. In the event that the Excluded Business is acquired during the Term (as defined below), the Parties will reasonably cooperate in good faith to modify Schedule A in order to add any additional services that may be reasonably requested by any such potential acquirer(s).</p> <p>The “<u>Services</u>” provided to CIUS as Service Recipient shall consist of the services identified and set forth on Schedule B. In the event that Remainco or the Affiliate thereof providing Services to CIUS is acquired during the Term, the Parties will reasonably cooperate in good faith to ensure that such acquiror assumes any remaining obligations to provide such Services for the remainder of the Term.</p> <p>To the extent any service is inadvertently omitted from Schedule A or Schedule B, the Parties will reasonably agree in good faith on a resolution of such omission on mutually satisfactory terms.</p> <p>The Parties acknowledge the transitional nature of the Services. Accordingly, following the Closing, Service Recipient agrees to use commercially reasonable efforts to make a transition off each Service to its own internal organization or to obtain alternate third-party sources to provide the Services. Service Provider will provide to Service Recipient reasonable cooperation and</p>

	<p>assistance in connection with Service Recipient's transition from Services to replacement services.</p>
<b><u>Service Standards</u></b>	<p>Service Provider will use reasonable efforts, skill and judgment in providing the Services to Service Recipient. Service Provider will provide all Services in accordance with applicable Law, including applicable Laws related to anti-corruption, bribery and data protection.</p> <p>The Service Provider will provide the Services at a standard no less favorable in any material respect to the Service Recipient than the standard provided to the Service Recipient or its respective business during the twelve (12)-month period immediately preceding Closing. CIUS will, or will cause its Affiliates to, continue to monitor and manage the applicable Services set forth on Schedule A, including making good faith efforts to perform the Services in accordance with the internal key performance indicators (to be set out in the TSA) monitored by the applicable Contributed Corix Entity prior to the Closing Date.</p>
<b><u>Term of Services</u></b>	<p>Unless the TSA is earlier terminated in accordance with the TSA (or a shorter period is otherwise provided in the TSA with respect to a particular Service), the Services will be provided for a period of twelve (12) months after the Closing Date (the "<u>Initial Term</u>") and, if the Initial Term for the provision of any Service expires and, despite having used its commercially reasonable efforts, the Service Recipient has not been able to complete the transition from or replacement of such Service, the Service Recipient may elect, upon at least sixty (60) days' written notice to the Service Provider, to extend the provision of such Service until the Service Recipient is able to complete the transition from or replace such Service for two (2) additional periods of up to three (3) months each, following the expiration of the Initial Term (each, an "<u>Extension Term</u>") and, together with the Initial Term, the "<u>Term</u>"). Notwithstanding the foregoing, Corix or Remainco, as applicable, shall authorize CIUS to maintain a Microsoft tenant "@corixgroup" for a period of 24 months after the Closing Date. CIUS may, in its sole discretion thereafter, extend the term of use for the "@corixgroup" tenant for 2 additional periods of up to 3 months.</p>
<b><u>Termination Rights</u></b>	<p>Either Party may terminate the TSA for (i) material uncured breach (following a reasonable period to cure) by the other Party, and (ii) for insolvency or bankruptcy of the other Party.</p> <p>Service Recipient may terminate one or more Services on 30 days prior written notice.</p>
<b><u>Fees and Payment;</u></b> <b><u>Reimbursable Expenses</u></b>	<p><u>Fees</u>: Service Recipient shall pay Service Provider's actual cost of providing any Service, taking into account a reasonable allocation of Service Provider's overhead, consistent with past practice as documented in the TSA. The Parties shall cooperate to prepare a budget setting forth a good faith estimate of the cost of the Services. Service Recipient will be responsible for all taxes and similar charges imposed on the Services.</p> <p><u>Expenses</u>: In addition to the fees, for the Initial Term and any Extension Term, Service Recipient shall reimburse Service Provider for all reasonable out-of-</p>



	<p>pocket costs and expenses incurred by Service Provider or its Affiliates in connection with providing the applicable Services hereunder.</p> <p><u>Payment Terms:</u> Service Provider shall provide monthly invoices of the cost of Services provided (including any reimbursable expenses), accompanied by reasonable documentation supporting the charges. Service Recipient shall pay Service Provider within 30 days of receipt of such invoices.</p>
<p><b><u>Limitations on Services</u></b></p>	<p>Notwithstanding anything to the contrary in the TSA, Service Provider shall not be obligated to provide, or cause to be provided, any Service (or portion thereof): (a) to the extent performance of such Service (or portion thereof) would require Service Provider or any of its Affiliates to violate or breach any applicable Law, (b) with respect to services provided by CIUS as Service Provider, in connection with any business other than the Excluded Business, or (c) with respect to services to be provided by Remainco or CII as Service Provider, in connection with any business other than U.S. and Canadian regulated (whether regulated by governmental bodies or agencies, or subject to the mandatory or voluntary rules and regulations of industry groups or administrative bodies), quasi-regulated and unregulated water and wastewater operations of CIUS and its Affiliates following the Closing. To the extent Service Provider is excused from performance due to the performance of the Service requiring a violation or breach of applicable Law, Service Provider will reasonably cooperate with Service Recipient to identify, and will use commercially reasonable efforts to implement in a timely fashion, a work-around or other alternative arrangement to provide an equivalent service for any affected Services, at Service Recipient’s cost.</p> <p>The Services provided by Service Provider through third parties or using third party intellectual property will be subject to the terms and conditions of any agreements between such Service Provider and such third parties. Service Provider shall use commercially reasonable efforts to obtain any necessary consent from such third parties in order for such Services to be provided to the Service Recipient. The Service Recipient shall bear all of the third-party costs of obtaining the Consents and any fees or charges associated with the Consents, including any additional license, sublicense, access or transfer fees; <u>provided, however,</u> that Service Provider shall obtain Service Recipient’s written approval prior to obtaining a Consent that would result in Service Recipient’s being responsible for any such costs. If any consent is not obtained, Service Provider will reasonably cooperate with Service Recipient to identify, and will use commercially reasonable efforts to implement in a timely fashion, a work-around or other alternative arrangement to provide an equivalent service for any affected Services, at Service Recipient’s cost.</p>
<p><b><u>Indemnification</u></b></p>	<p>The Service Recipient shall indemnify the Service Provider against any losses arising from providing the Services, <u>provided</u> that indemnification shall not apply to losses arising out of the gross negligence, willful misconduct, fraud, material breach of the TSA by Service Provider, or violation of law by the Service Provider.</p>
<p><b><u>Disclaimer; Limitation on Liability</u></b></p>	<p>No Party makes any representations or warranties in the TSA, express or implied, and each Party specifically disclaims any other warranties in the TSA, whether written or oral, express or implied, including, without</p>

	<p>limitation, any warranty of quality, merchantability or fitness for a particular use or purpose or any warranty as to the non-infringement of any intellectual property rights of third parties, and without limiting the foregoing, the Services are provided “as-is, where is, with all faults” and without any warranty or representation in the TSA with respect thereto.</p> <p>Service Provider will be liable for errors or other failures to perform only to the extent arising from its gross negligence, willful misconduct, fraud or material breach of the TSA by the Service Provider.</p> <p>Except in the event of fraud, gross negligence, or willful misconduct of the other Party or its Affiliates or with respect to damages awarded to any third party pursuant to indemnification obligations under the TSA with respect to any third-party claims, in no event shall either Party have any liability under any provision of the TSA for any punitive, incidental, consequential, special or indirect damages, or loss of business reputation or opportunity relating to the breach or alleged breach of the TSA.</p>
<p><b><u>Confidential Information</u></b></p>	<p>Customary provisions to protect the confidential and proprietary information of Service Provider and Service Recipient to be included in the TSA.</p>
<p><b><u>Ownership of Data &amp; Intellectual Property</u></b></p>	<p>All data relating to the Excluded Business that is generated or collected by Service Provider in connection with the provision of the Services to Service Recipient shall be owned by the Service Recipient. Upon expiration or termination of the TSA (and from time to time during the term of the TSA, upon Service Recipient’s reasonable request), Service Provider will transfer such data to Service Recipient (and otherwise facilitate the extract or copying of such data), in a reasonably agreed upon form and format.</p> <p>All Intellectual Property that is developed or created by the Service Provider in connection with the provision of Services to Service Recipient shall be owned by the Service Recipient. To the extent that any right, title or interest in or to any such intellectual property vests in Service Provider, by operation of law or otherwise, Service Provider shall perpetually and irrevocably assign to the Service Recipient any and all such right, title, and interest throughout the world in and to such intellectual property, free and clear of all liens and encumbrances without the need for any further action by either Party.</p> <p>Subject to any applicable third party agreements pursuant to which Service Provider obtains rights to intellectual property, Service Provider shall grant to Service Recipient a perpetual, irrevocable, non-exclusive, royalty-free license (with a right to sublicense) to use and otherwise exploit (including the right to make derivative works of) any intellectual property that is owned or licensed from third parties by Service Provider and reasonably necessary for receipt, use or enjoyment of the Services provided by Service Provider and any products or materials emanating therefrom. For the avoidance of doubt, the foregoing license to Service Recipient shall include the right to use, modify, distribute, display, creative derivative works of or otherwise exploit any deliverables of the Services provided to Service Recipient.</p>
<p><b><u>Governing Law</u></b></p>	<p>Delaware.</p>

<b><u>Dispute Resolution:</u></b>	Any disputes under the TSA shall be referred to an executive committee composed of at least the CEO of each of Service Provider and Service Recipient, or their respective designees, and at least one member of the senior management teams of IIF and the BCI Infrastructure & Renewable Resources Department (with the chairperson of such committee being appointed by IIF), which will negotiate in good faith to resolve such disputes. In the event any such dispute is not resolved within thirty (30) days, any Party may seek to enforce its rights and remedies in courts of the state of Delaware, which shall have exclusive jurisdiction over claims and disputes arising out of the Agreement.
<b><u>Assignment</u></b>	<p>Neither Party may assign any of its rights or delegate any of its duties under this Agreement without the prior written consent of the other Party; <u>provided</u> that each Party shall be permitted to assign its rights or duties to any of its Affiliates and that Remainco shall be permitted to assign its rights and duties to any third-party acquirer(s) in connection with a sale of the Excluded Business (in which case CIUS will cooperate and novate the TSA with respect to such rights and duties and Remainco will ensure that such successor agrees to continue to provide Services to CIUS pursuant to the terms of the TSA, if applicable).</p> <p>No assignment to an Affiliate shall relieve the assigning Party of its obligations under the TSA.</p> <p>All of the terms and provisions of this Agreement shall be binding on, and shall inure to the benefit of, the respective legal successors and permitted assigns of the Parties.</p>

**Schedule A**

Services<sup>1</sup>

CIUS as Service Provider will furnish (or cause to be furnished) to Remainco as Service Recipient, upon the terms and conditions set forth in the TSA, the following Services in support of the Excluded Business:

<b>Services</b>	<b>Description</b>	<b>Term</b>
Accounting, Project Accounting	<ul style="list-style-type: none"> <li>• Providing general accounting, project accounting, and audit support services including but not limited to: month end accounting close (preparation and processing of journal entries); management of financial modules that interface with the enterprise resource planning module; project management services including project creation, maintenance, and project close out activities.</li> <li>• Preparing monthly financial statements (prepared on a standalone basis consistent with any new reporting structure), account analysis and reconciliations consistent with existing practices, and providing support during the year-end audit.</li> </ul>	12 months
Billing, Collections, Payment Processing and Call Center Support	<ul style="list-style-type: none"> <li>• Generating bills and customer correspondence; resolving billing exceptions; processing and applying customer payments, including payment returns, rejects, reversal and refunds; and collecting accounts receivable, severance for non-payment, and process rate changes.</li> <li>• Producing month-end financial reports.</li> <li>• Managing and integrating customer portal, including customer self-service functions.</li> <li>• Providing call center support and managing and responding to customer communications.</li> </ul>	12 months
Financial Planning & Analysis	<ul style="list-style-type: none"> <li>• Supporting budgeting, forecasting, regulatory reporting, project financing, internal and external financial reporting, and contract development.</li> </ul>	12 months
Human Resources	<ul style="list-style-type: none"> <li>• Supporting recruiting, onboarding and end-of-employment processes; maintaining employee records until transferred to Remainco.</li> <li>• Managing and administering employee benefit plans; supporting and administering employee leave, compensation [and employee recognition programs].</li> </ul>	12 months

<sup>1</sup> Note to Draft: Following signing of the transactions to which this TSA relates, individuals familiar with the operations/technology of the businesses, along with associated budgeted expenditures, to discuss to confirm details (including as to scope of the Services and associated costs).

	<ul style="list-style-type: none"> <li>Supporting employee training programs; providing employee relations guidance and support; supporting employee performance management and employee inquiries; providing access to employee self-help and other human resources systems and platforms.</li> </ul>	
Health, Safety and Environment	<ul style="list-style-type: none"> <li>Providing access to legacy documents and documentation and maintaining access to shared resources (forms, documents, platforms).</li> <li>Supporting incident management process and providing access to related systems.</li> </ul>	12 months
Information Technology	<ul style="list-style-type: none"> <li>Providing, supporting and managing all existing business, SCADA and end user applications and collaboration tools currently in use, including the hosting and support of websites.</li> <li>Providing service desk including in connection with employee onboarding, ongoing support of, and offboarding of employees including all related identity and access management services; managing end user support tickets for all existing or replacement hardware, business applications and end user software, security and compliance services including end user security training and testing, security event monitoring, and incident investigation and management and vulnerability management.</li> <li>Providing support for regulatory compliance data requests.</li> <li>Providing infrastructure management services including maintenance and support of existing networks, internet access, phone services, capacity and availability management, servers, and regular patching of all infrastructure and end user devices, and support training for existing business applications and tools for new and existing employees.</li> </ul>	12 months
Insurance	<ul style="list-style-type: none"> <li>Managing broker relationships, claim management, annual renewal, and new project insurance placements.</li> </ul>	12 months
Payroll	<ul style="list-style-type: none"> <li>Providing payroll processing support services consistent with existing practices, including time and labor entries and absence requests, completing employee setups for new hires, processing full-cycle hourly and semi-monthly payrolls, completing all remittances to appropriate tax agencies, completing deductions and remittances for all benefits enrollments and retirement contributions, completing monthly/quarterly/annual tax filings (W2, T4, 1095 C, 1094 C, etc.), transferring of time and labor and payroll to accounting, providing related training and process support, supporting audit requests.</li> </ul>	12 months

Accounts Payable	<ul style="list-style-type: none"> <li>• Managing and supporting account payable functions, including invoice processing, issue resolution, payment processing, and vendor maintenance.</li> <li>• Providing 1099 filings.</li> <li>• Managing employee expense reimbursements and administration of the corporate credit card program.</li> <li>• Supporting local procurement activities.</li> </ul>	12 months
Regulatory	<ul style="list-style-type: none"> <li>• Supporting regulatory planning, reporting and filing activities including strategic initiatives, rate changes and notices, rate case preparation and testimony, and regulatory modeling.</li> <li>• Supporting the transition of regulatory point-of-contact relationships, any online accounts (e.g. e-file) and relevant assets.</li> </ul>	12 months
Tax	<ul style="list-style-type: none"> <li>• Supporting all compliance and reporting tax matters and required filings including income taxes, property taxes, commodity tax, GST, PST, carbon taxes, motor fuel taxes and all other general taxes.</li> <li>• Providing (or assisting) with the year-end tax provision and required financial statement disclosures.</li> </ul>	12 months
Treasury	<ul style="list-style-type: none"> <li>• Providing cash management and bank administration services and maintaining banking relationships;</li> <li>• Assisting with financing needs and preparing debt covenant calculations.</li> </ul>	12 months
System Access and Transition Support	<ul style="list-style-type: none"> <li>• Providing access to records stored in CIUS's control or possession.</li> <li>• Responding to requests for information, data or any other resources consistent with contractual agreements.</li> </ul>	[12] months

**Schedule B**

Services<sup>2</sup>

CII or Remainco as Service Provider will furnish (or cause to be furnished) to CIUS as Service Recipient, upon the terms and conditions set forth in the TSA, the following Services in support of the Excluded Business:

<b>Services</b>	<b>Description</b>	<b>Term</b>
	<ul style="list-style-type: none"> <li>• [Specific services to be confirmed. Some may be addressable through direct licenses instead of the TSA. CIUS will need licenses to use IP (names and marks) currently owned by Corix Infrastructure Inc. (“CII”), which might be transferred to Remainco, in connection with the operation of the Canadian Contributed Corix Entities. In addition, CIUS might need transition services from CII such as licenses related to enterprise software, including but not limited to Oracle, O365, Adaptive, and Okta.]</li> <li>• Authority to host and use the “corix.com” domain.</li> <li>• Authority to maintain a Microsoft tenant “@corixgroup”.</li> </ul>	12 months
		24 months

---

<sup>2</sup> Note to Draft: Following signing of the transactions to which this TSA relates, individuals familiar with the operations/technology of the businesses, along with associated budgeted expenditures, to discuss to confirm details (including as to scope of the Services and associated costs).

Exhibit C

# Project Stingray – Pre-Closing Restructuring Proposed Scenario 2 Structure – For Discussion Purposes Only



Draft dated August 25, 2022

1,700 attorneys

50+ practices

22 offices

Beijing / Boston / Brussels / Chicago / Frankfurt / Hong Kong / Houston / London / Los Angeles / Moscow / Munich / New York / Palo Alto / Paris / São Paulo / Seoul / Shanghai / Singapore / Tokyo / Toronto / Washington, D.C. / Wilmington



# Beginning Structure (Simplified)

**U.S. Tax Classification Key:**

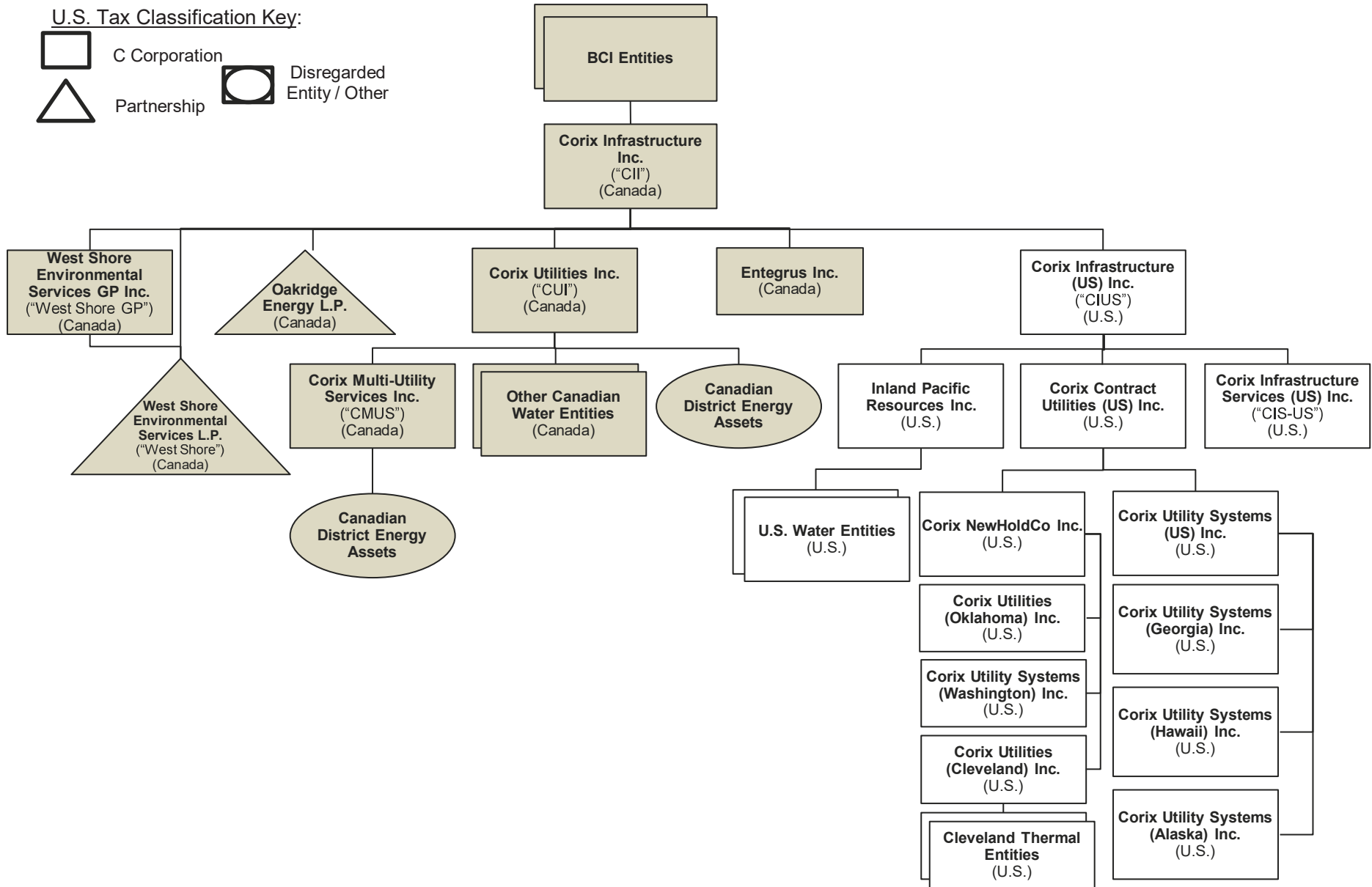
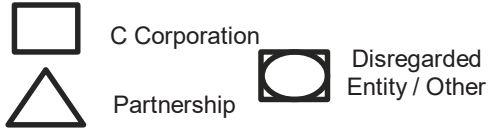

# Wind-up of Certain Entities

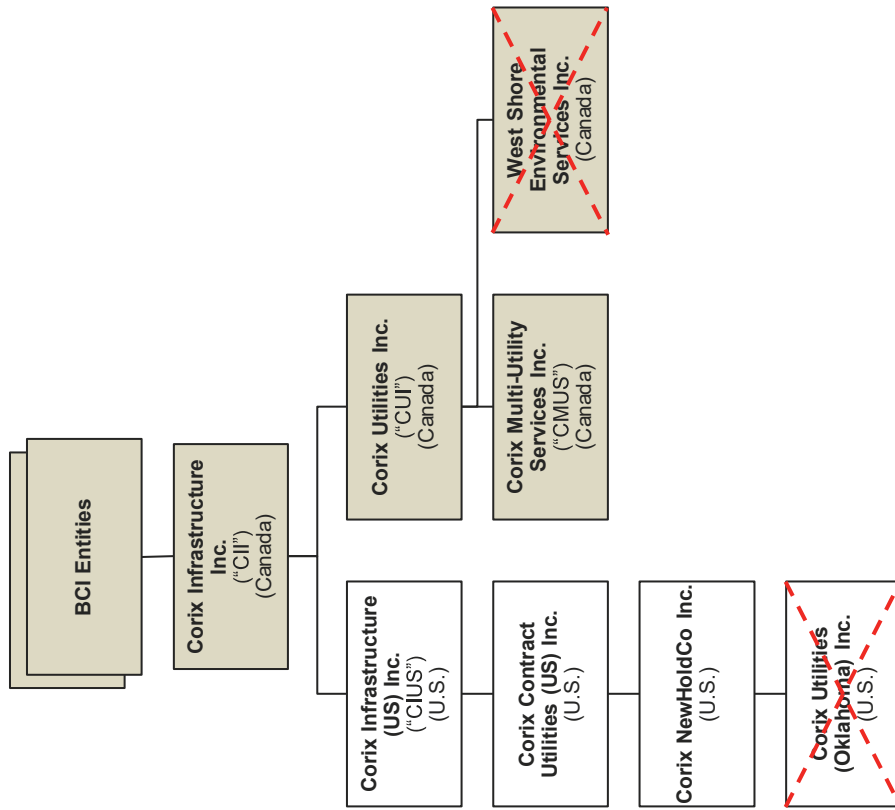

1. Corix Utilities (Oklahoma) Inc. merges, liquidates and/or distributes its assets to Corix NewHoldCo Inc. (Precise mechanics TBD.)
2. West Shore Environmental Services Inc. is wound up into Corix Utilities Inc. ("CUI").

# Incorporation and Capitalization of CMUS Finance Newco

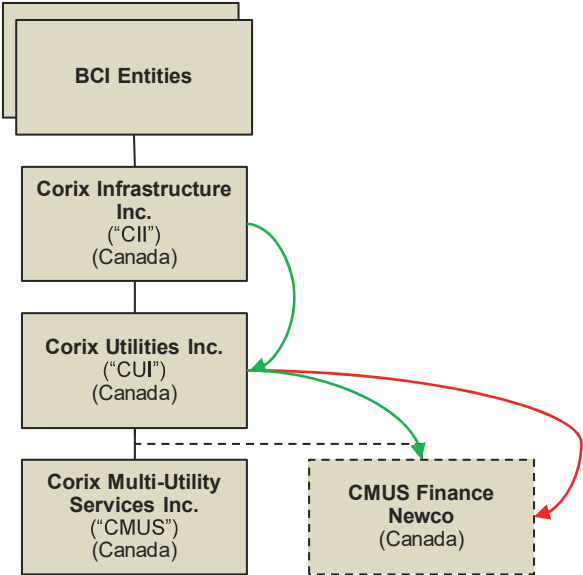

3. CUI forms a new Canadian corporation (“**CMUS Finance Newco**”).\*
4. Corix Infrastructure Inc. (“**CII**”) contributes a payable owing from Corix Multi-Utility Services Inc. (“**CMUS**”) to CII to CUI in exchange for additional shares of CUI.
5. CUI contributes such payable, together with a payable owing from CMUS to CUI, to CMUS Finance Newco in exchange for shares of a CMUS Finance Newco and a note of CMUS Finance Newco.

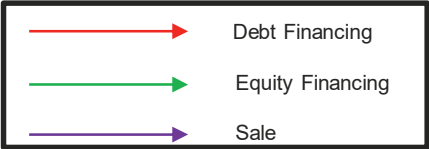

\* Names of new entities are for indicative purposes only and may change.

# Transfer and Wind-Up of CMUS Finance Newco

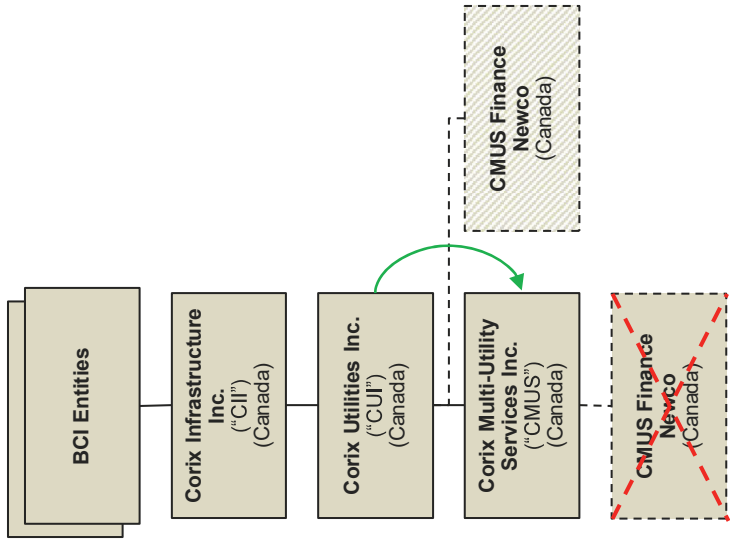

6. CUI transfers the shares of CMUS Finance Newco to CMUS in exchange for additional shares of CMUS.
7. CMUS Finance Newco is wound-up into CMUS.

# New Entity Formation\*

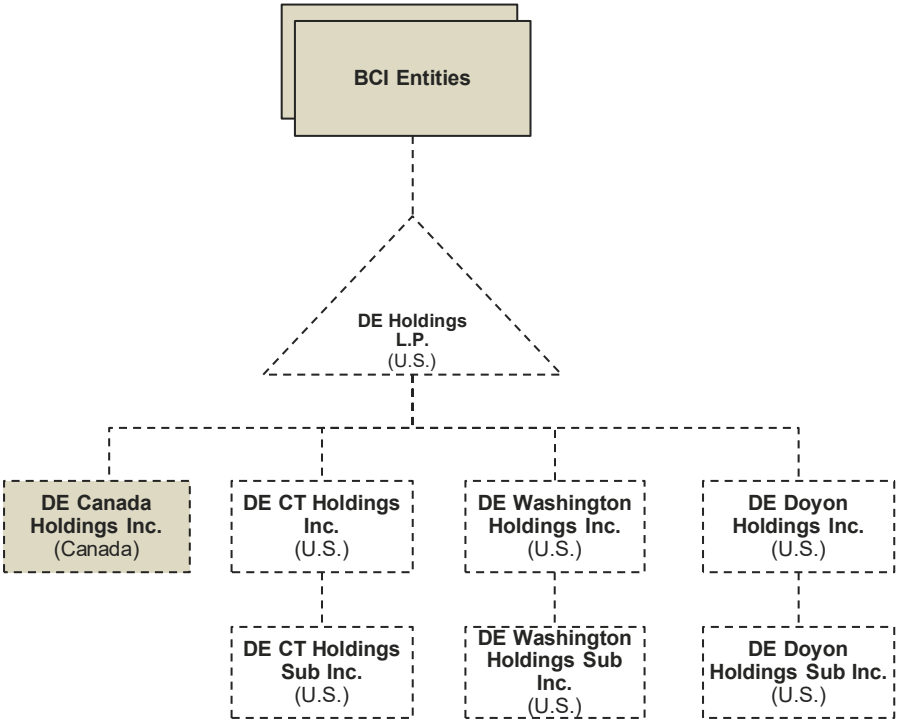

8. The BCI Entities form a new Delaware limited partnership, DE Holdings L.P. (“**DE Holdings LP**”).
9. DE Holdings LP\*\* incorporates three new Delaware corporations, DE CT Holdings Inc. (“**CT Holdings**”), DE Washington Holdings Inc. (“**Washington Holdings**”), and DE Doyon Holdings Inc. (“**Doyon Holdings**”).
10. CT Holdings incorporates a new Delaware corporation, DE CT Holdings Sub Inc. (“**CT Sub**”).
11. Washington Holdings incorporates a new Delaware corporation, DE Washington Holdings Sub Inc. (“**Washington Sub**”).
12. Doyon Holdings incorporates a new Delaware corporation, DE Doyon Holdings Sub Inc. (“**Doyon Sub**”).
13. DE Holdings LP incorporates a new Canadian corporation, DE Canada Holdings Inc. (“**DE Canada Holdings**”).

\* Formations and transfers of general partner entities with nominal economic interests in limited partnerships are not shown throughout.

\*\* Other BCI Entities may hold voting, non-participating shares of the newly incorporated holding companies.

# Bridge Loan Financing

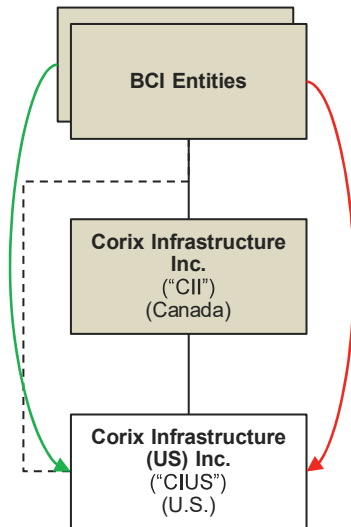

14. One or more BCI Entities acquires shares of Corix Infrastructure (US) Inc. (“**CIUS**”) in exchange for cash and/or makes a bridge loan to CIUS (with the making of any such bridge loan to be subject to the terms of the balancing payment rider).

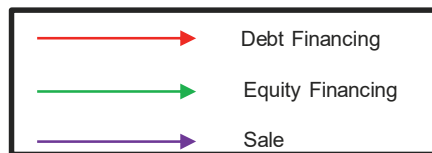

# New Entity Financing

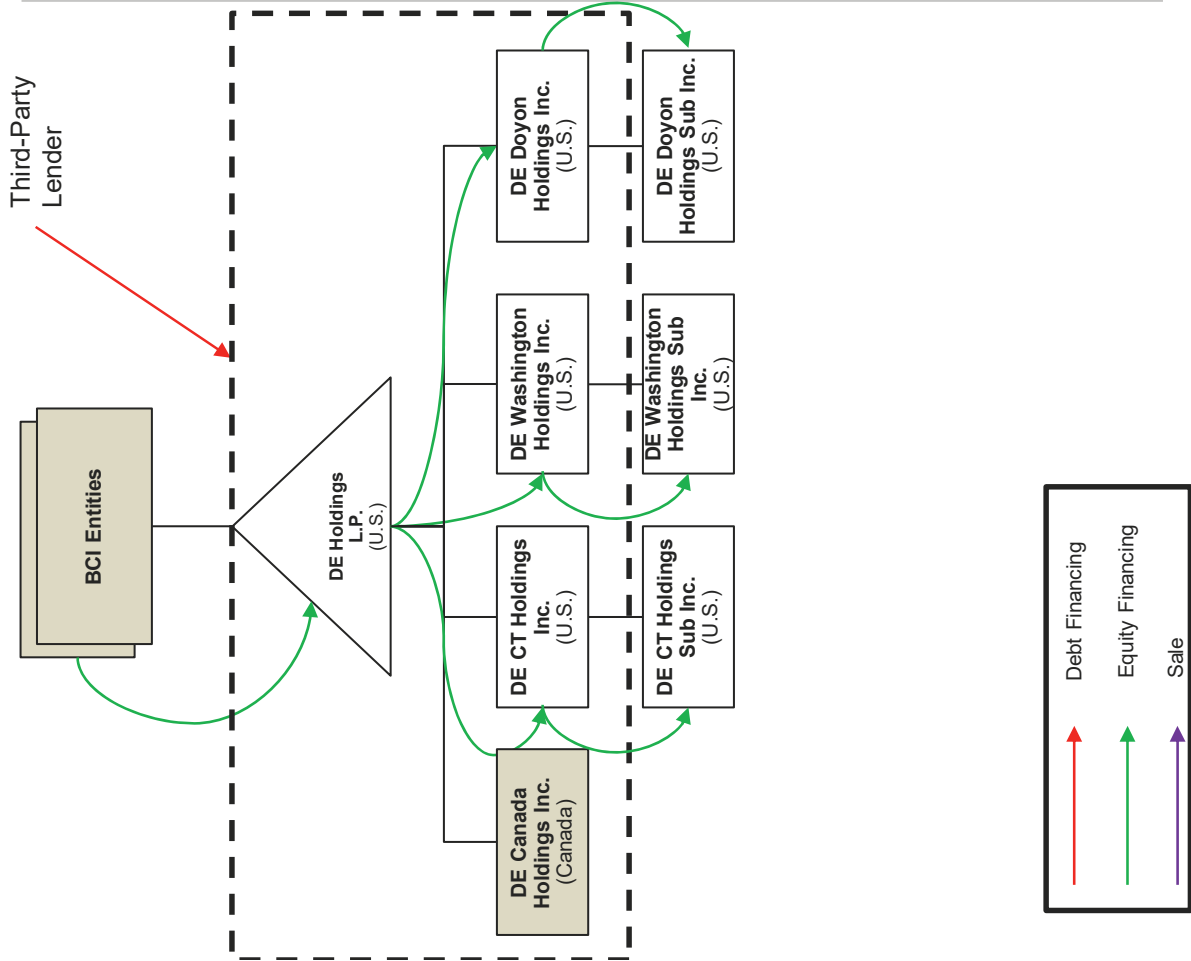

15. The BCI Entities contribute cash to DE Holdings LP.
16. A third party lender lends cash to one or more of DE Holdings LP, CT Holdings, Washington Holdings, and Doyon Holdings.
17. DE Holdings LP contributes cash contributed by the BCI Entities and cash borrowed from the third party lender to CT Holdings, Washington Holdings, and Doyon Holdings; CT Holdings, Washington Holdings and Doyon Holdings contribute a portion of the cash contributed by DE Holdings LP and the cash borrowed from the third party lender to CT Sub, Washington Sub and Doyon Sub, respectively, in each case as necessary to finance the acquisition of the U.S. District Energy business entities.

# Conversion and Liquidation of Certain U.S. DE Entities & Intercompany Distributions Skadden

18. Corix Utility Systems (Alaska) Inc. converts to a limited liability company (“**Alaska LLC**”).
19. Corix Utility Systems (Washington) Inc. converts to a limited liability company (“**Washington LLC**”).
20. Cleveland Thermal LLC makes a distribution of cash to Corix Utilities (Cleveland) Inc., which distributes such cash to Corix NewHoldCo Inc.
21. Each of Cleveland Thermal Generation LLC, Cleveland Thermal Steam Distribution LLC, and Cleveland Thermal Chilled Water Distribution LLC merges, liquidates and/or distributes its assets to Cleveland Thermal LLC and Cleveland Thermal LLC merges, liquidates and/or distributes its assets to Corix Utilities (Cleveland) Inc.
22. Corix Utilities (Cleveland) Inc. converts to a limited liability company (“**Cleveland LLC**”).
23. If required, Cleveland LLC, Alaska LLC and Washington LLC and their subsidiaries, as applicable, undertake the steps necessary for the shares of Cleveland LLC, Alaska LLC and Washington LLC to qualify as excluded property for Canadian income tax purposes. (Details TBD.)

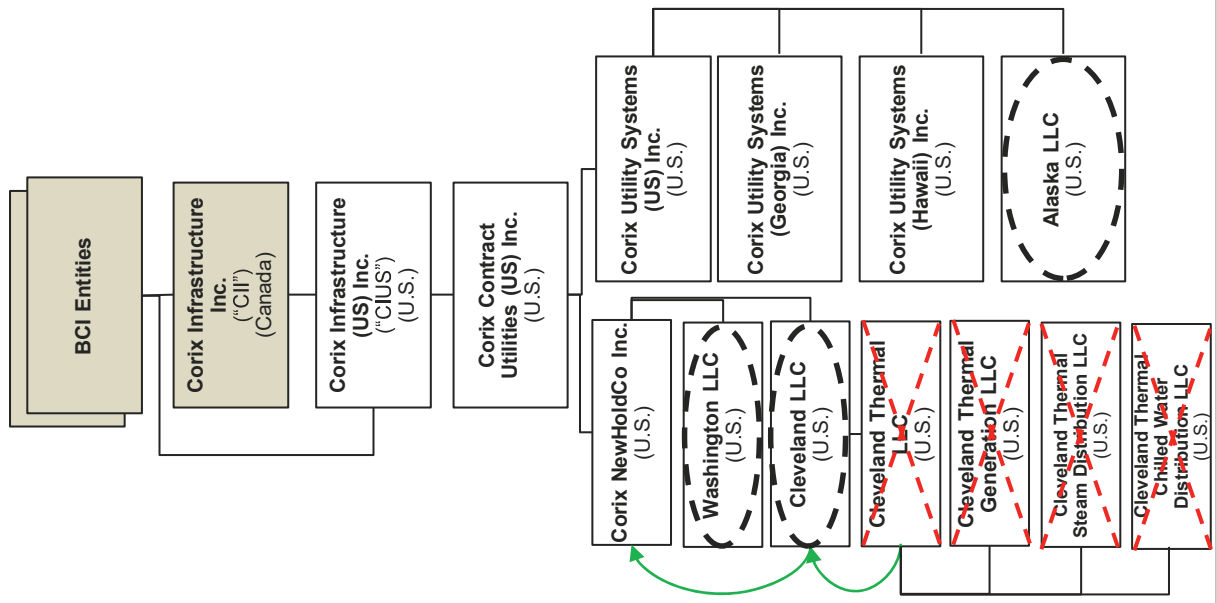



# Sale of Certain U.S. District Energy Entities and Employee Transfer

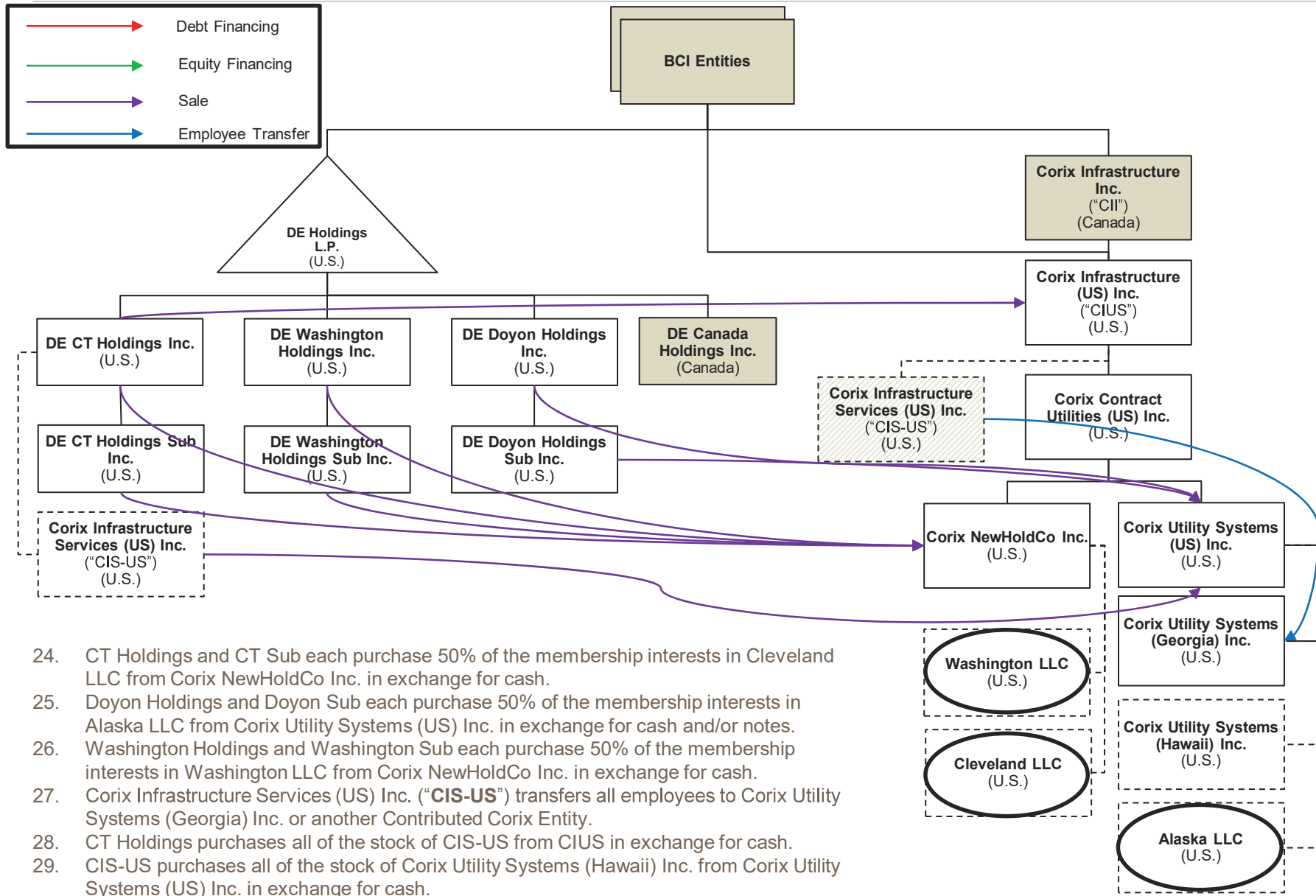

24. CT Holdings and CT Sub each purchase 50% of the membership interests in Cleveland LLC from Corix NewHoldCo Inc. in exchange for cash.
25. Doyon Holdings and Doyon Sub each purchase 50% of the membership interests in Alaska LLC from Corix Utility Systems (US) Inc. in exchange for cash and/or notes.
26. Washington Holdings and Washington Sub each purchase 50% of the membership interests in Washington LLC from Corix NewHoldCo Inc. in exchange for cash.
27. Corix Infrastructure Services (US) Inc. ("CIS-US") transfers all employees to Corix Utility Systems (Georgia) Inc. or another Contributed Corix Entity.
28. CT Holdings purchases all of the stock of CIS-US from CIUS in exchange for cash.
29. CIS-US purchases all of the stock of Corix Utility Systems (Hawaii) Inc. from Corix Utility Systems (US) Inc. in exchange for cash.

# Distribution of Sale Proceeds and Other Cash

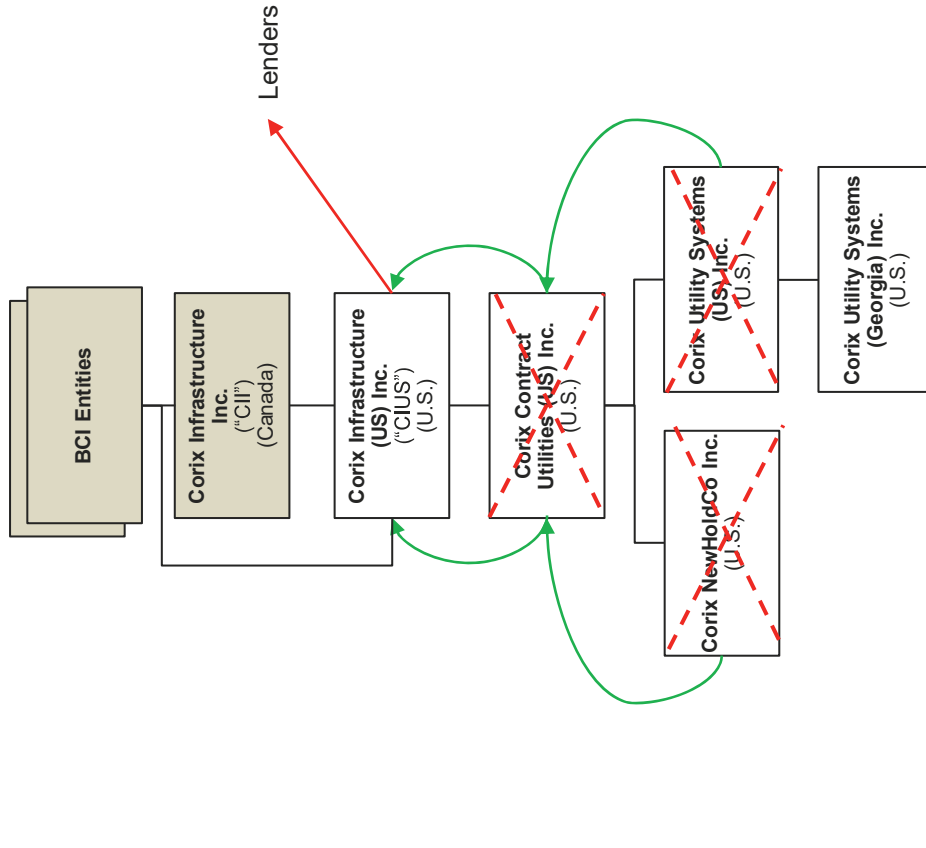

30. Each of Corix NewHoldCo Inc., Corix Utility Systems (US) Inc. and Corix Contract Utilities (US) Inc. merges, liquidates and/or distributes its assets (consisting solely of cash and/or notes, including proceeds from the sales of the District Energy entities) to CIUS. (Precise mechanics TBD.)
31. CIUS uses the proceeds of such distributions (or a portion thereof) to repay debt.

# Transfer of Canadian Non-Water Assets

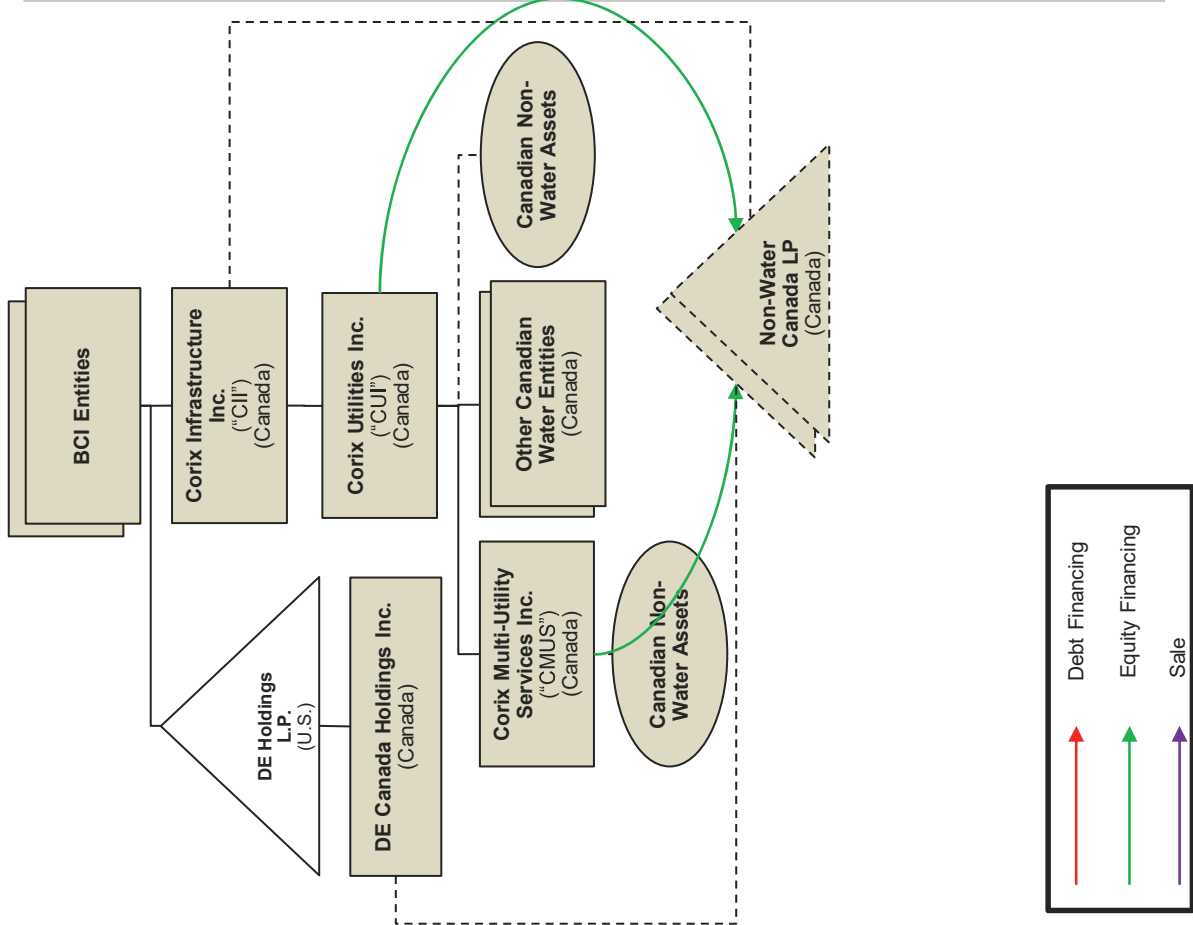

32. CII and/or DE Canada Holdings forms one or more new Canadian limited partnerships (each a **"Non-Water Canada LP"**).
33. CUI and CMUS transfer their respective assets that are not Water business assets (including any District Energy business assets) to a Non-Water Canada LP in exchange for limited partnership interests in such Non-Water Canada LP, the issuance of debt and/or the assumption of liabilities associated with such assets by such Non-Water Canada LP.

# Sale of Non-Water Canada LP Interests to CII

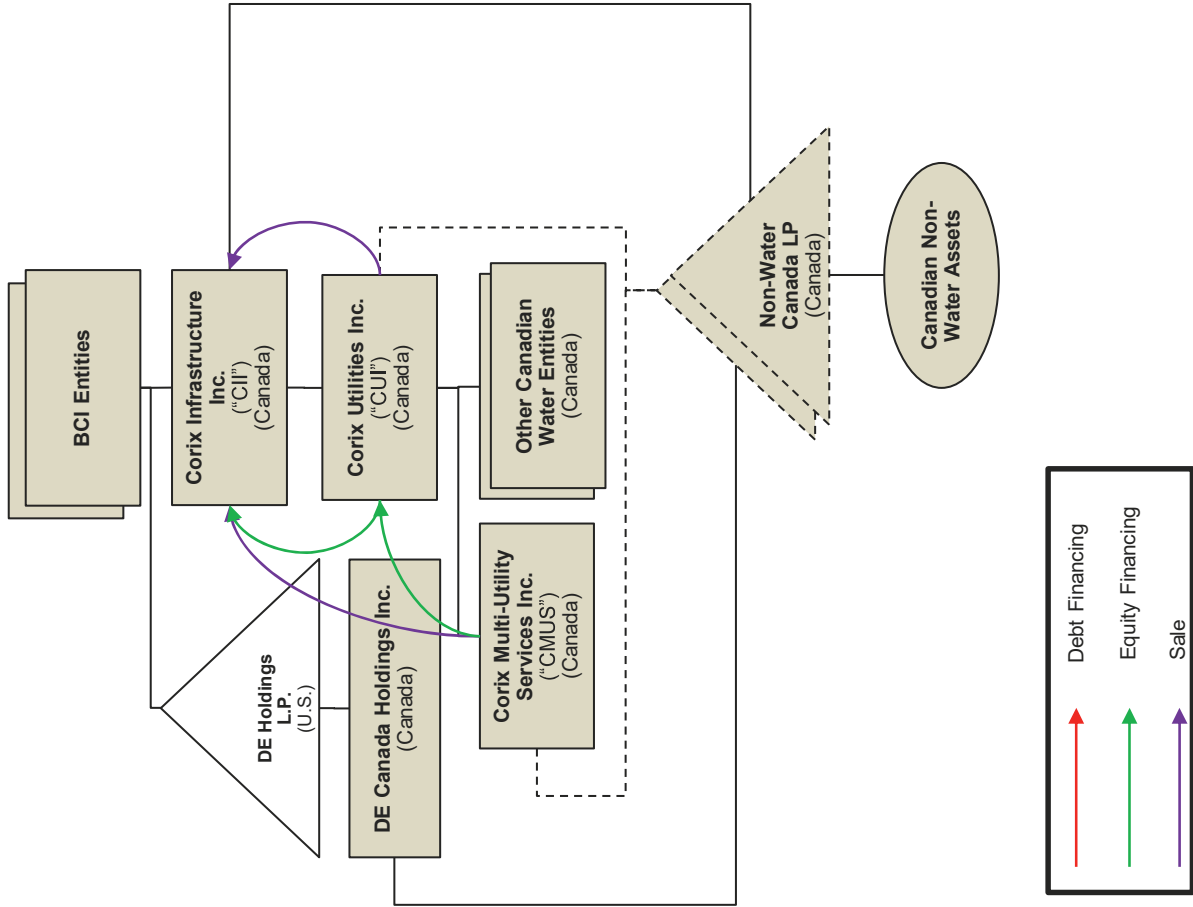

34. CUI and CMUS sell or distribute their limited partnership interests and a receivable in each Non-Water Canada LP to CII; in the case of sale, such sale is in exchange for notes issued by CII.
35. Such notes held by CMUS are distributed to CUI or sold to CUI for an intercompany payable.
36. CUI returns capital to CII by issuance of a note of CUI, which note and other intercompany debt is offset against the notes of CII.

# Sale of Non-Water Canada LP Interests to DE Holdings LP

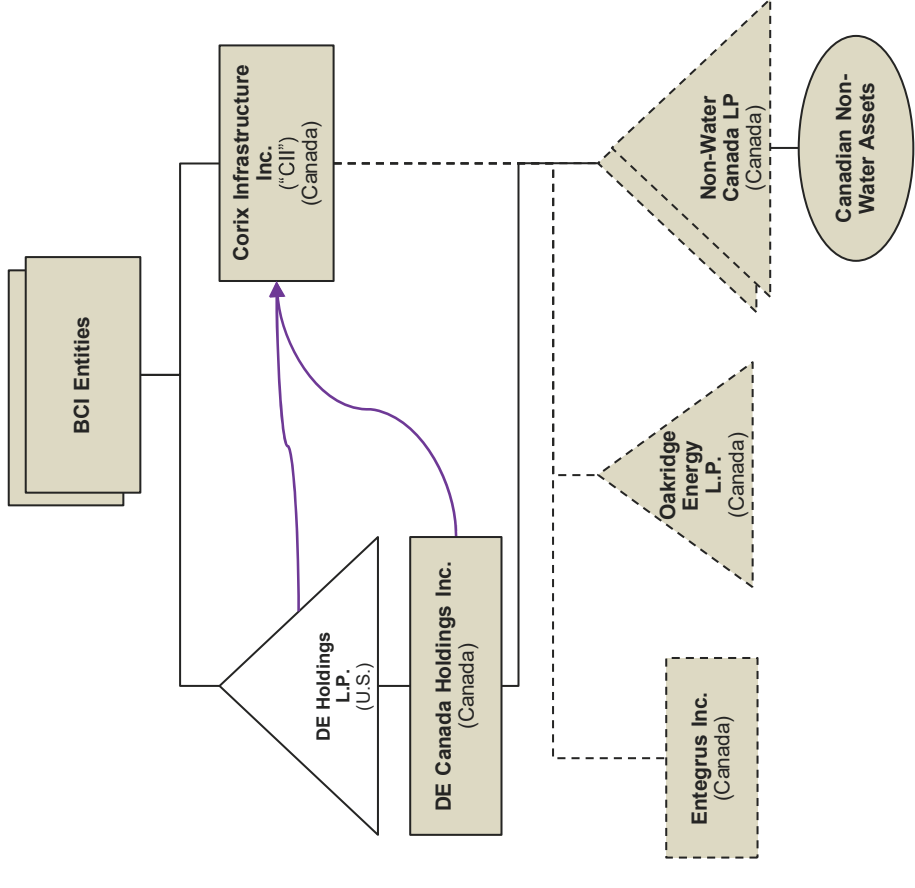

37. CII sells a receivable and its limited partnership interests in each Non-Water Canada LP and Oakridge Energy Limited Partnership to DE Canada Holdings in exchange for a note.
38. CII sells its shares in Entegrus Inc. to DE Holdings LP in exchange for a note.

# Establishment of Services Company

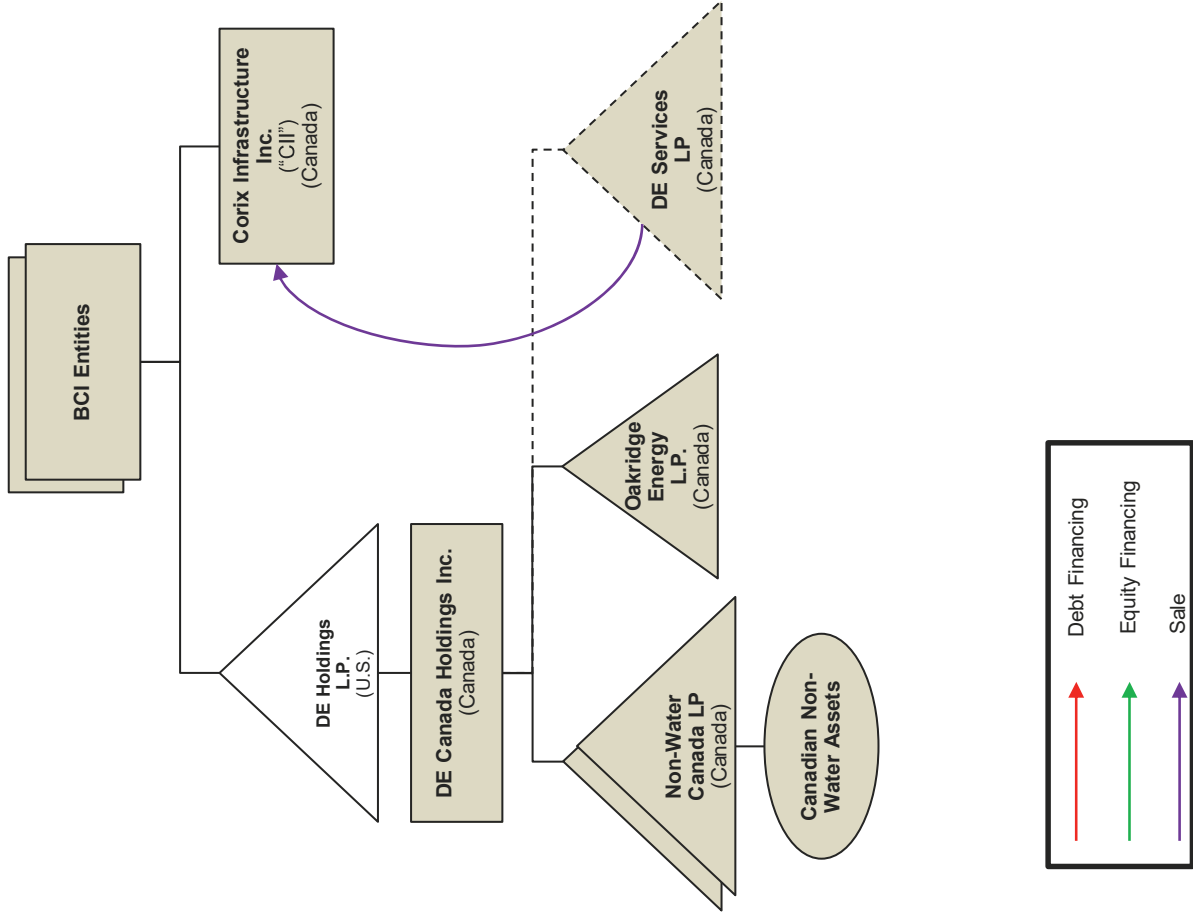

39. DE Canada Holdings forms a new Canadian limited partnership, DE Services LP.
40. CII transfers employees engaged in the District Energy business to DE Services LP in exchange for a note and/or other consideration (including the assumption of obligations associated with such employees).

# Winding Up of Certain Entities (Optional, Timing TBD)

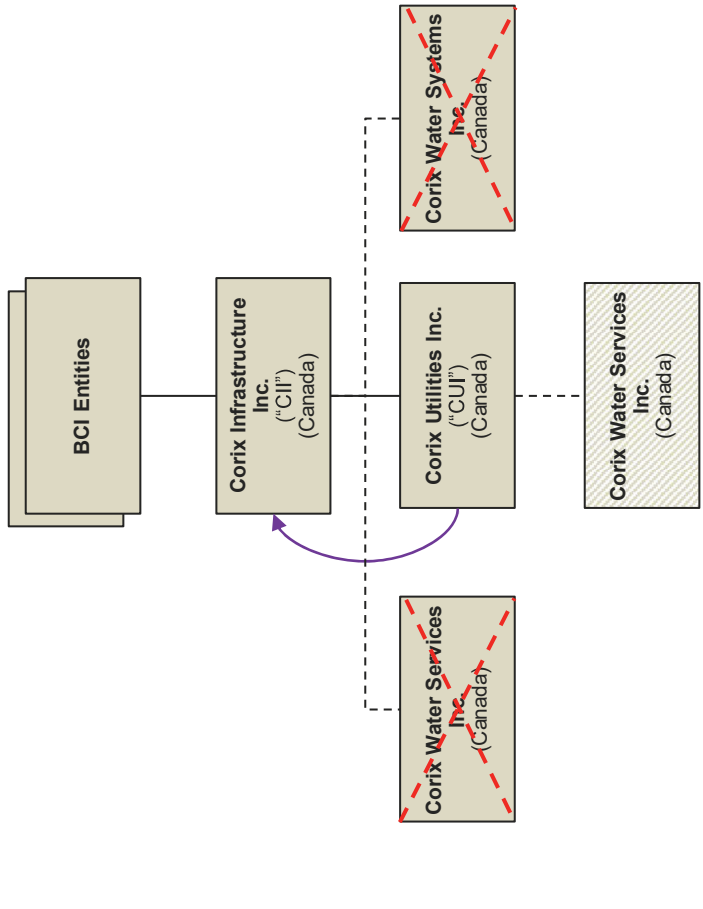

41. Corix Water Systems Inc. is wound-up into CII or amalgamated with CII.
42. CUI sells the shares of Corix Water Services Inc. to CII for a nominal amount.
43. Corix Water Services Inc. is wound-up into CII or amalgamated with CII.

# Establishment of Canadian Regulated Utilities Midco

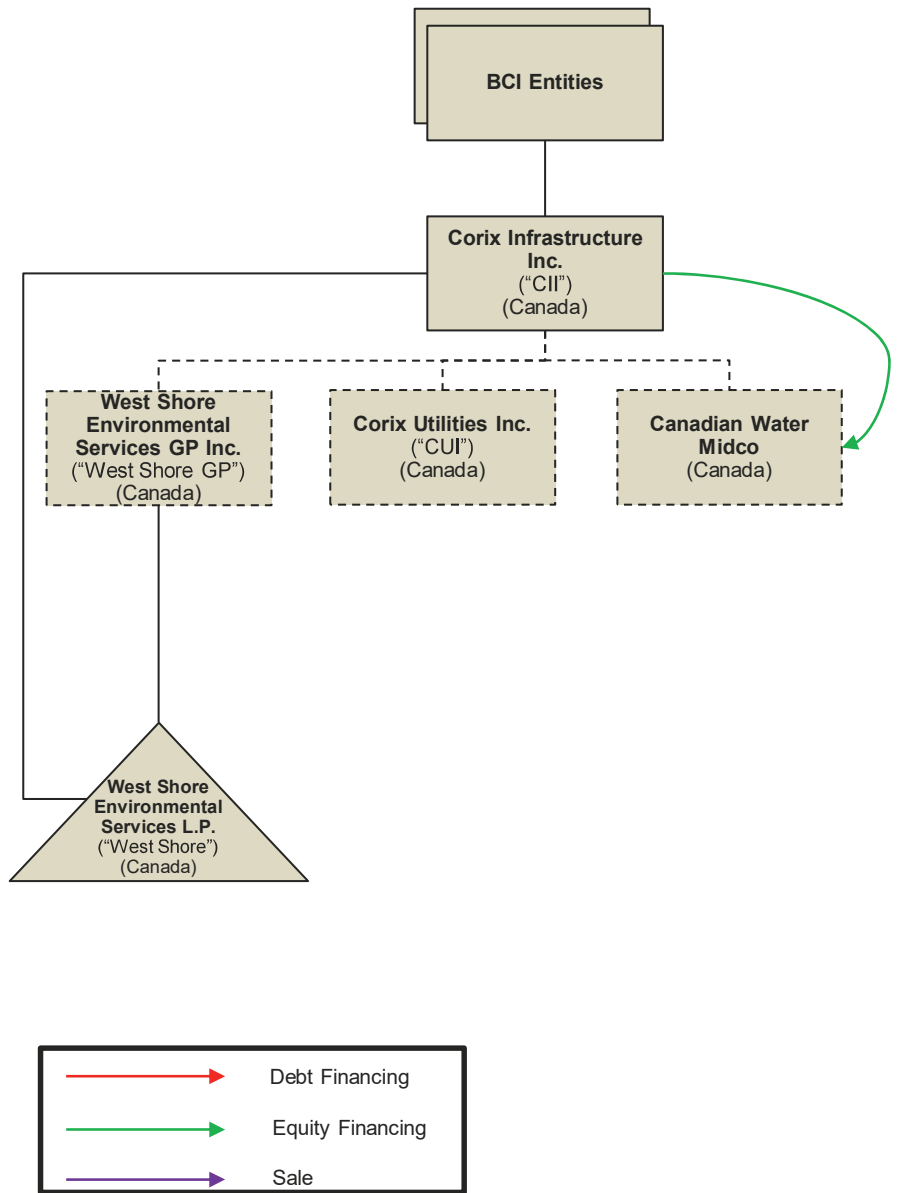

44. CII incorporates a new Canadian corporation (“**Canadian Water Midco**”).
45. CII contributes the shares of CUI and West Shore Environmental Services GP Inc. (“**West Shore GP**”) to Canadian Water Midco in exchange for voting, non-participating and non-voting, participating shares of Canadian Water Midco.



# Conversion of CUI and CMUS

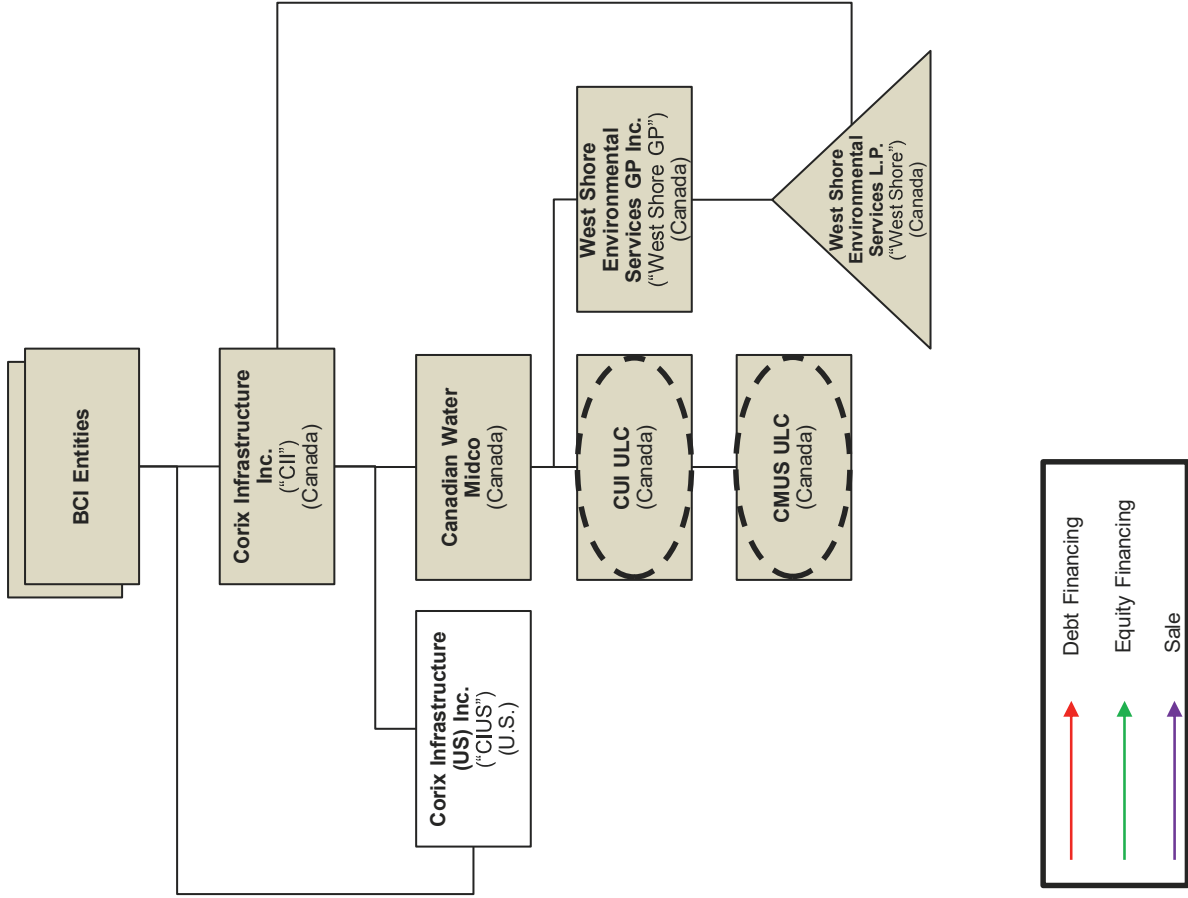

46. CUI converts into an unlimited liability company (“**CUI ULC**”).

47. CMUS converts into an unlimited liability company (“**CMUS ULC**”).

# Formation of and Transfer to Intermediate Newco

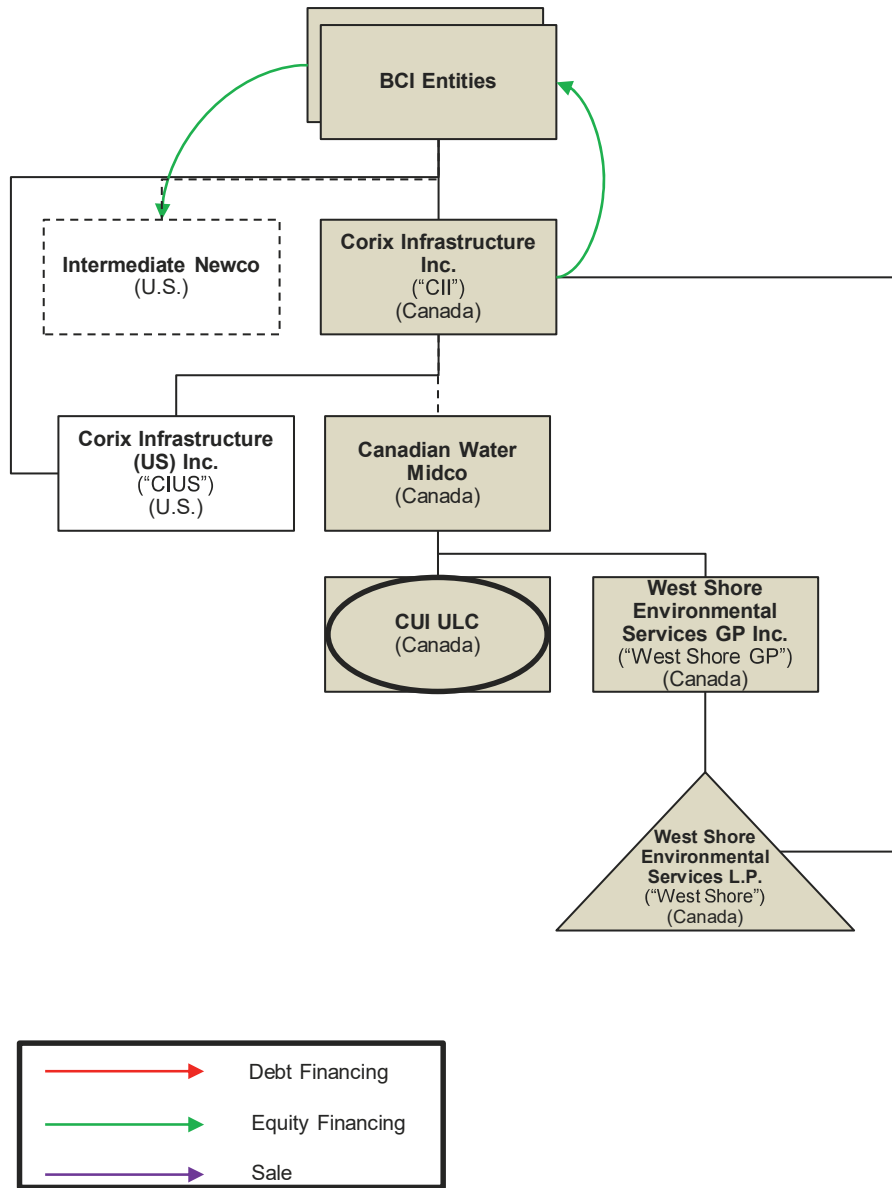

48. CII transfers the non-voting, participating shares of Canadian Water Midco to a BCI Entity as a dividend in kind.
49. Such BCI Entity transfers the non-voting, participating shares of Canadian Water Midco to a newly-formed Delaware corporation ("**Intermediate Newco**")\* in exchange for non-voting, participating shares of Intermediate Newco.

\* Issuance of one voting, non-participating share of Intermediate Newco to CII and one non-voting, participating share of Intermediate Newco to such BCI Entity upon incorporation not pictured.

# Transfer of Canadian Water Midco and Intermediate Newco Shares

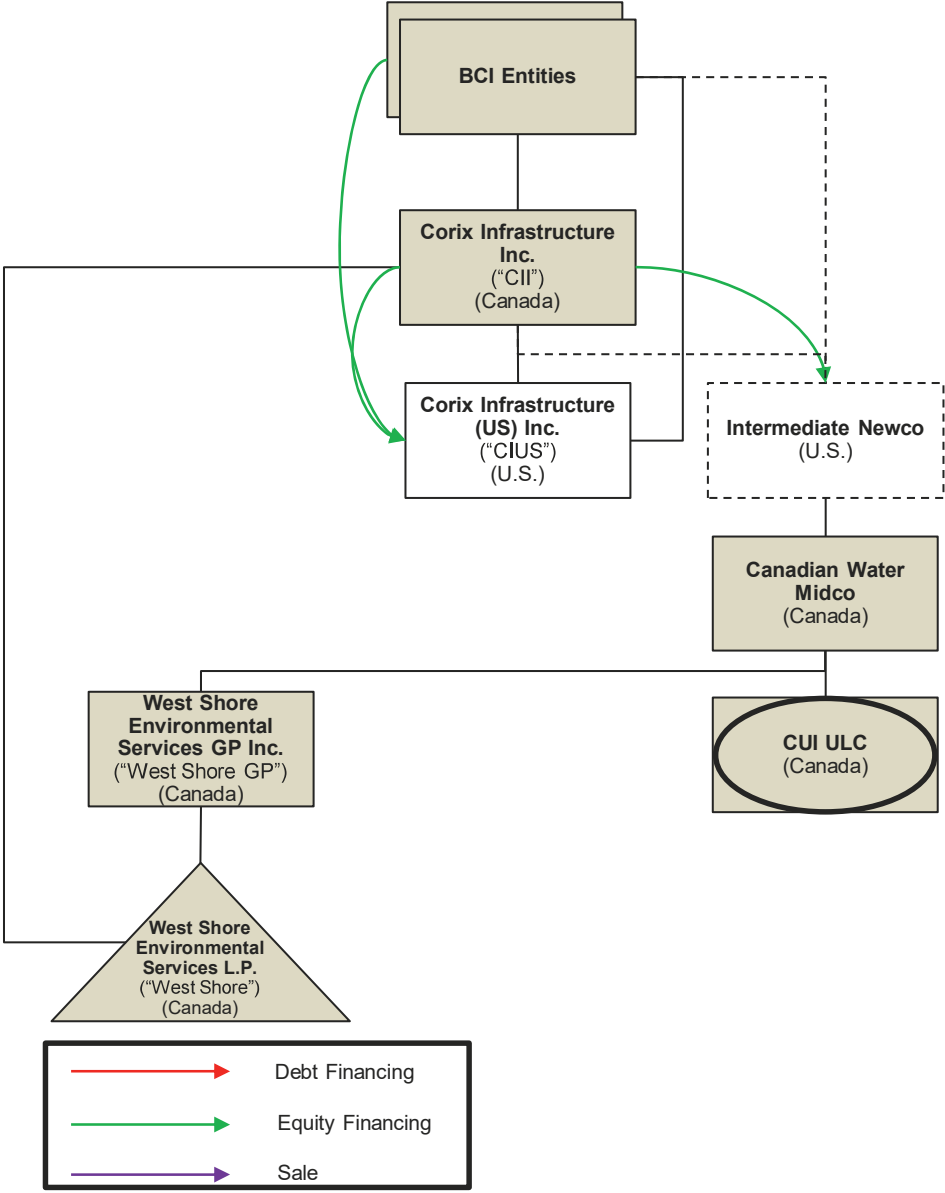

50. CII transfers the voting, non-participating shares of Canadian Water Midco to Intermediate Newco for voting, non-participating shares of Intermediate Newco.
51. Such BCI Entity transfers the non-voting, participating shares of Intermediate Newco to CIUS in exchange for shares of CIUS.
52. CII transfers the voting, non-participating shares of Intermediate Newco to CIUS as a capital contribution.

# Sale of West Shore

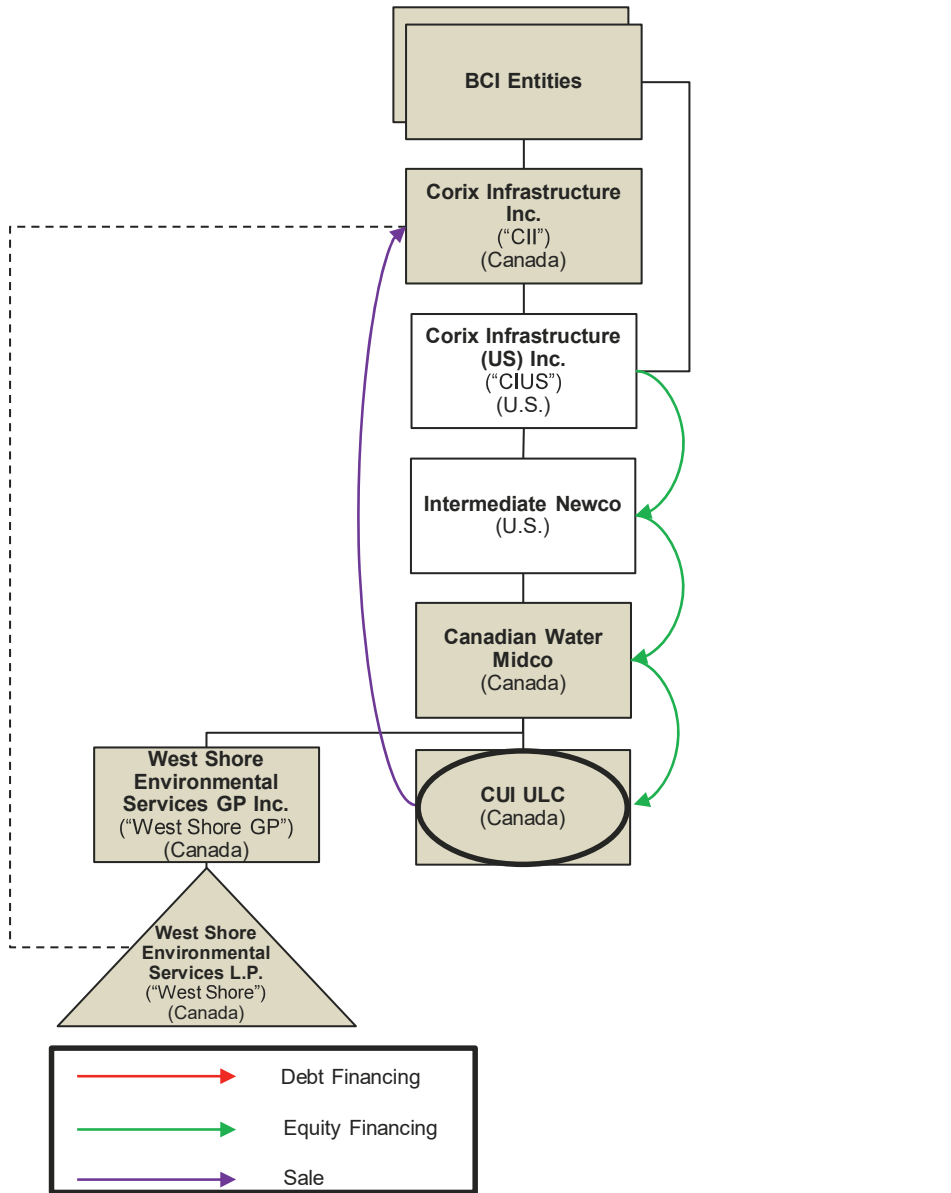

53. CIUS contributes cash and notes to Intermediate Newco in exchange for shares of Intermediate Newco.
54. Intermediate Newco contributes such cash and notes to Canadian Water Midco in exchange for shares of Canadian Water Midco.
55. Canadian Water Midco contributes such cash and notes to CUI ULC in exchange for shares of CUI ULC.
56. CUI ULC purchases the limited partnership interests in West Shore Environmental Services LP ("**West Shore**") from CII in exchange for cash and notes.
57. West Shore makes an election under Section 754 of the Internal Revenue Code of 1986, as amended.

# Resulting Structure – Regulated Business (Simplified)

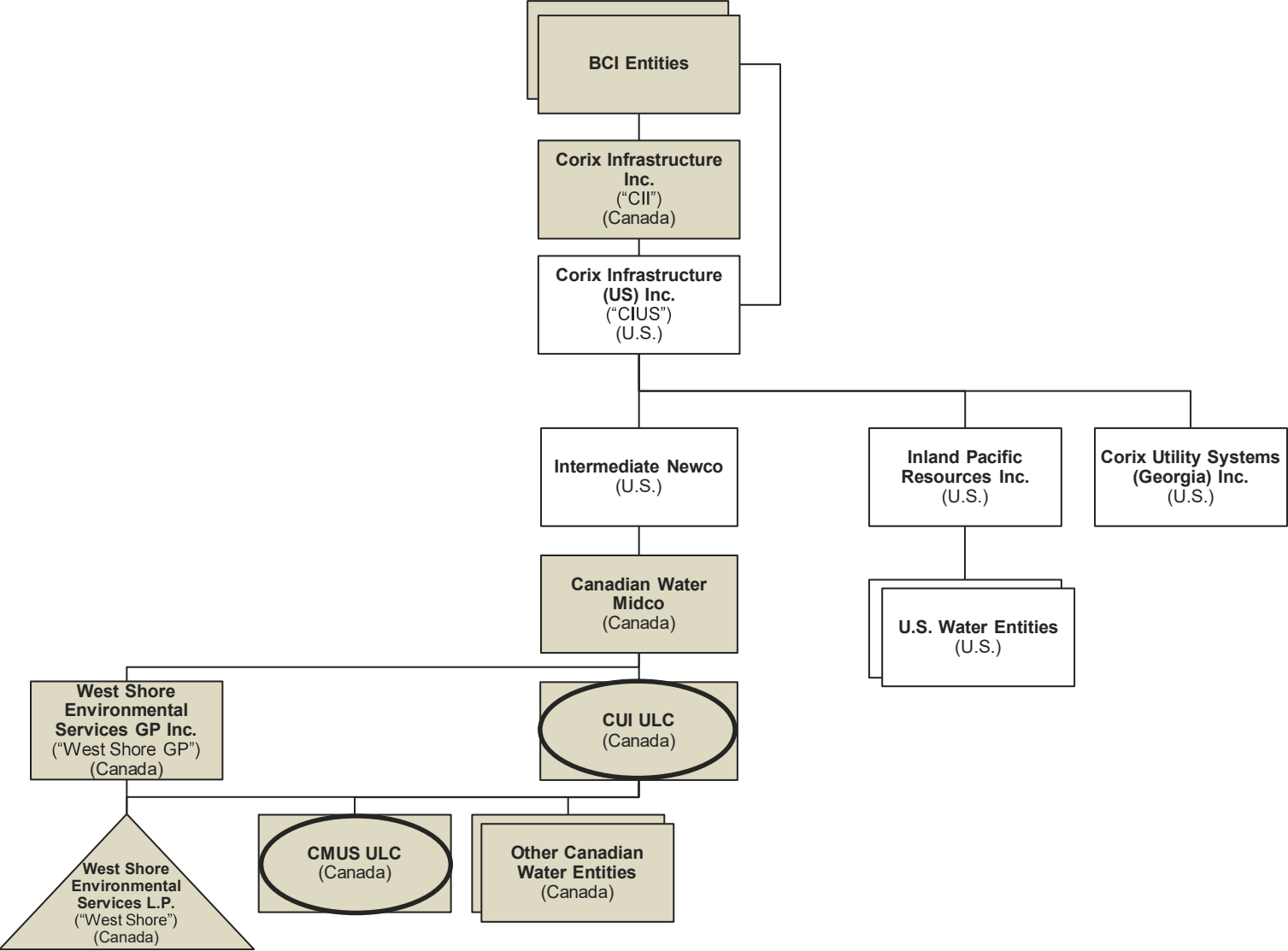

# Resulting Structure – District Energy Business (Simplified)

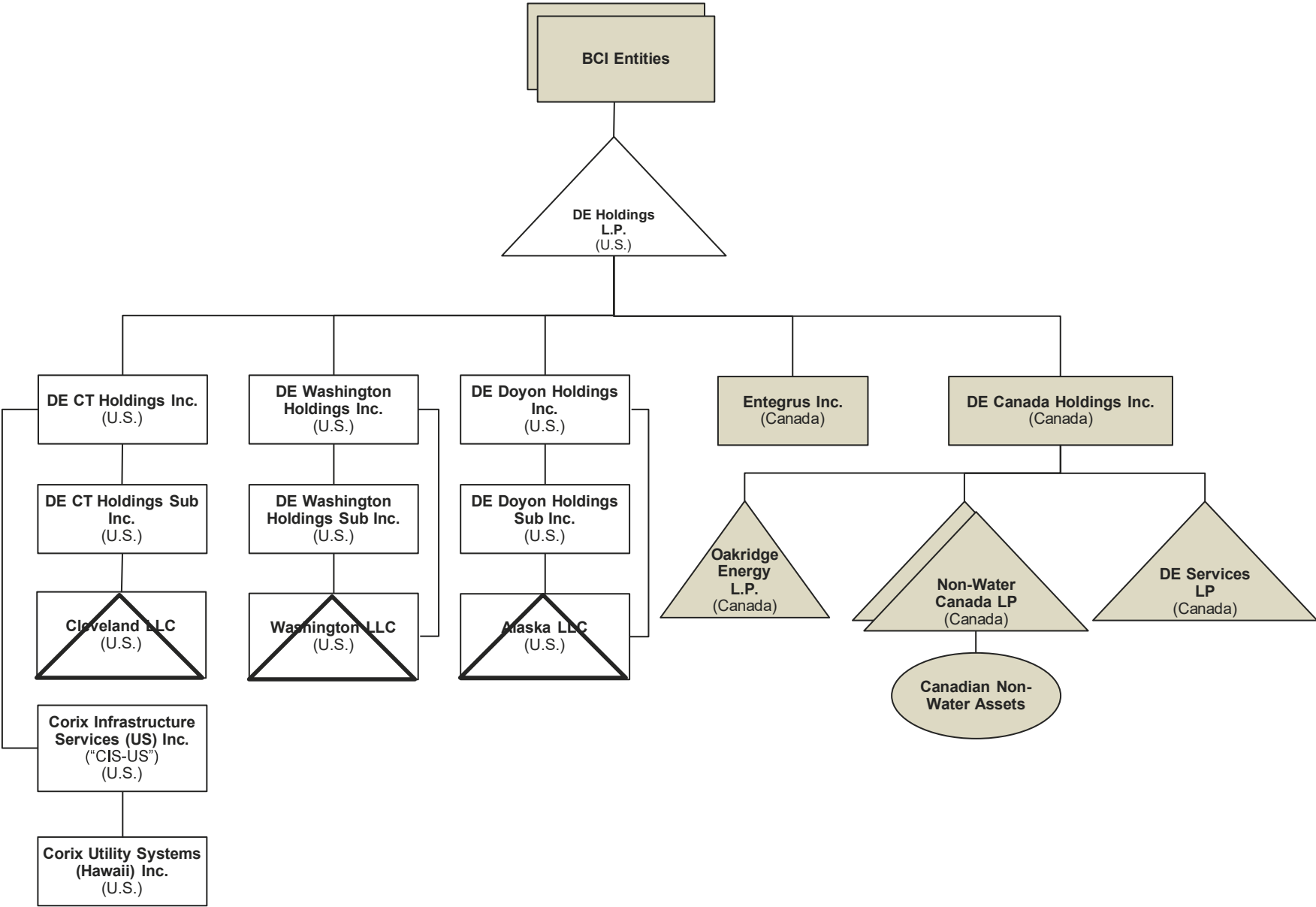

# CIUS Debt Repayment

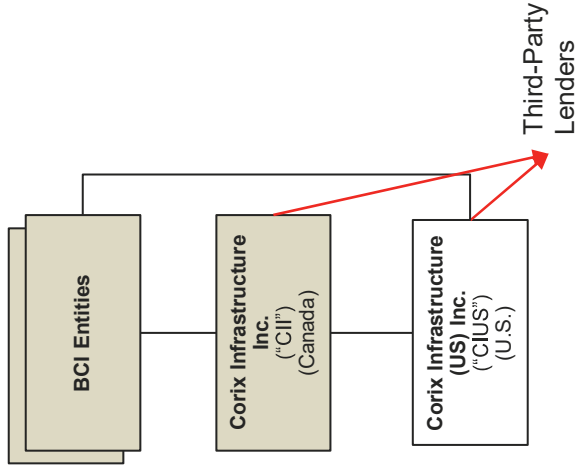

- 58. CIUS uses cash proceeds from the sales of the District Energy entities and cash on hand to repay third party debt.
- 59. CII uses cash proceeds from the sale of West Shore to repay third party debt.
- 60. Additional steps will be necessary in order to settle intercompany accounts.

The slides included herein are preliminary in nature and subject to further discussion and analysis based on the ultimate facts of any transaction. Further consideration should be given to possible regulatory, commercial or legal limitations, or possible changes in law, which may apply to the transactions described herein. Those limitations must be considered prior to any further development or implementation.





Final Form

## **Exhibit D** **Accounting Principles**

Set forth below are certain additional agreements and clarifications of the Corix Parties and the SWWC Parties with respect to the preparation of the Initial Estimated Payment Statements and the Final Closing Statement. Capitalized terms used but not defined herein have the meanings given to them in the Agreement.

### **Part I - "Accounting Principles"**

1. In the case of the Contributed Corix Entities (other than Excluded Business Entities) the "Accounting Principles" means:
  - (i) the accounting principles, policies, procedures and categorizations set forth in Part II below ("Specific Policies");
  - (ii) and to the extent not inconsistent with clause (i) above, the same accounting policies, procedures, methods and practices as applied in the preparation of the most recent Corix Water Audited Financial Statements (the "Corix Historical Policies"); and
  - (iii) to the extent not inconsistent with clauses (i) and (ii) above, GAAP for the U.S. Reporting Contributed Corix Entities or Canadian GAAP for the Canadian Reporting Contributed Corix Entities, as applicable.

In the event of any discrepancy, clause (i) above shall take precedence over clauses (ii) and (iii) above, and clause (ii) above shall take precedence over clause (iii).

2. In the case of SWWC, SWMAC and the SWWC Subsidiaries the "Accounting Principles" means:
  - (i) the Specific Policies;
  - (ii) and to the extent not inconsistent with clause (i) above, the same accounting policies, procedures, methods and practices as applied in the preparation of the most recent SWWC Audited Financial Statements (the "SWWC Historical Policies" and together with the Corix Historical Policies, the "Historical Policies"); and
  - (iii) to the extent not inconsistent with clauses (i) and (ii) above, GAAP.

In the event of any discrepancy, clause (i) above shall take precedence over clauses (ii) and (iii) above, and clause (ii) above shall take precedence over clause (iii).

### **Part II - Specific Policies**

1. The calculation of each of Closing Corix Net Indebtedness and Closing SWWC Net Indebtedness ("Closing Net Indebtedness"), Closing Corix Net Working Capital and Closing SWWC Net Working Capital ("Closing Net Working Capital"), and Closing Corix Capital Expenditure Amount and Closing SWWC Capital Expenditure Amount ("Closing Capital Expenditure Amount") (all of the foregoing calculations, collectively the "Calculations") shall disregard the effects of (i) any expense or liability for which (A) the Corix Parties or (B) the SWWC Parties are expressly responsible under the Agreement and (ii) any purchase accounting adjustments as reflected under GAAP or Canadian GAAP, as

applicable, recorded as a result of the transactions contemplated by the Agreement.

2. The Calculations shall be determined as of the Closing (the “Calculation Time”).
3. The Calculations shall be based on facts and circumstances as they exist up to the Closing in accordance with FASB Accounting Standards Codification Topic 855, Subsequent Events (“ASC 855”), and shall exclude the effect of any act, or decision occurring after the Closing. For purposes of applying ASC 855, the date on which the Final Closing Statement is delivered to the CIUS Shareholders shall be deemed the date on which the financial statements were authorized for issue.
4. The Calculations shall be prepared in U.S. Dollars, and all amounts included in the Estimated Payment Statements and Final Closing Statement denominated in a currency other than U.S. Dollars shall be converted into U.S. Dollars as quoted by the Bank of Canada as of the Calculation Time.
5. No amounts with respect to the Excluded Business Assets or Excluded Business Liabilities shall be included in the Calculations.
6. For the avoidance of doubt, in the event of a mid-month close, assets and liabilities will be recorded for corresponding revenue and costs incurred month to date up to the Calculation Time and will be included in the Calculations.
7. For the determination of Closing Net Working Capital, there shall be no change in the classification (i) of liabilities, either to a current liability of any liability that was previously characterized as a long-term liability in the most recent Corix Water Audited Financial Statements or SWWC Audited Financial Statements (together, the “Audited Financial Statements”) or to a long-term liability of any liability that was previously characterized as a current liability in the most recent Audited Financial Statements, or (ii) of assets, either to a long-term asset of any asset that was previously characterized as a current asset in the most recent Audited Financial Statements or to a current asset of any asset that was previously characterized as a long-term asset in the most recent Audited Financial Statements, in each case, other than any such change resulting solely from the passage of time to the extent consistent with the Historical Policies.
8. For purposes of the preparation of the Calculations, the accruals for salaries, wages, paid time off, pension, severance, retention, bonuses, benefits, payroll Taxes and all other compensatory payments shall be calculated based on the actual amounts earned in respect of Corix Water Personnel or SWWC Personnel (as the case may be) as of the Calculation Time. No amounts shall be included in the Calculations for employees who are not Corix Water Personnel or SWWC Personnel.
9. The calculation of the annual bonus accrual included in Closing Net Working Capital shall consider actual results relative to the plan on which the bonus obligations are based through the Closing Date with the obligation (including payroll Taxes and social security costs) recorded reflecting the pro rata portion of the full-year bonus. For the avoidance of doubt, no transaction bonuses shall be included in such accruals.
10. No amounts for fees, costs or expenses incurred in connection with consummation of the transactions contemplated by the Agreement shall be included in the Calculations.

11. All intercompany accounts (including payables and receivables) solely between (i) a Contributed Corix Entity on the one hand and another Contributed Corix Entity on the other hand or (ii) SWWC or SWMAC on the one hand and either SWWC, SWMAC or any SWWC Subsidiary on the other hand, in each case, shall be reconciled and eliminated for purposes of the Calculations.
12. The provisions of this Exhibit shall be interpreted to avoid double counting (whether positive or negative) of any item included in the Initial Estimate Payment Statements.

### **Part III – Illustrative Calculations**

#### Closing Net Working Capital (Calculations of Estimated Corix Net Working Capital and Estimated SWWC Net Working Capital)

The illustrative calculation of Closing Net Working Capital (including the specific values in the line items) set forth on Appendix I hereto has been included for illustrative purposes only. The line items included therein represent the line items to be included in Closing Net Working Capital; however, the amounts contained within the line items shall not form part of the calculation of Closing Net Working Capital and remain subject to the terms and provisions of the Agreement, including these Accounting Principles.

#### Closing Net Indebtedness (Calculations of Estimated Corix Net Indebtedness and Estimated SWWC Net Indebtedness)

The illustrative calculation of Closing Net Indebtedness (including the specific values in the line items) set forth on Appendix I hereto has been included for illustrative purposes only. The line items included therein represent the line items to be included in Closing Net Indebtedness; however, the amounts contained within the line items shall not form part of the calculation of Closing Net Indebtedness and remain subject to the terms and provisions of the Agreement, including these Accounting Principles.

#### Closing Capital Expenditure Amount (Calculations of Estimated Corix Capital Expenditure Amount and Estimated SWWC Capital Expenditure Amount)

The illustrative calculation of Closing Capital Expenditure Amount (including the specific values in the line items) set forth on Appendix I hereto has been included for illustrative purposes only. The line items included therein represent the line items to be included in Closing Capital Expenditure Amount; however, the amounts contained within the line items shall not form part of the calculation of Closing Capital Expenditure Amount and remain subject to the terms and provisions of the Agreement, including these Accounting Principles.

#### Equity Balancing Payment

The illustrative calculation of the Equity Balancing Payment (including the specific values in the line items) set forth on Appendix I hereto has been included for illustrative purposes only.

**Appendix I**  
[see attached]

Append I to Exhibit D of the Transaction Agreement, which contain confidential information, is not included with the Transaction Agreement filed with the Application. Unredacted versions and redacted public versions will be provided upon request in accordance with the Commission's rules regarding confidential documents.

COMMONWEALTH OF KENTUCKY  
BEFORE THE PUBLIC SERVICE COMMISSION

In the Matter of )  
Application by Water Service Corporation )  
of Kentucky, along with Corix )  
Infrastructure (US) Inc. and SW Merger ) Case No. 2022-00396  
Acquisition Corp., for Approval of Transfer )  
of Control )

---

**DIRECT TESTIMONY OF  
STEVEN LUBERTOZZI**

---

**Table of Contents**

WITNESS INTRODUCTION AND BACKGROUND ..... 1  
CORIX INFRASTRUCTURE INC..... 5  
RESTRUCTURING PRIOR TO CLOSING ..... 7  
PROPOSED TRANSACTION..... 8  
RATIONALE AND BENEFITS OF COMBINATION..... 13  
SATISFACTION OF PUBLIC INTEREST ..... 17

**PREPARED DIRECT TESTIMONY  
OF STEVEN M. LUBERTOZZI  
ON BEHALF OF  
WATER SERVICE CORPORATION OF KENTUCKY**

**WITNESS INTRODUCTION AND BACKGROUND**

1 **Q. PLEASE STATE YOUR NAME, TITLE, AND BUSINESS ADDRESS.**

2 A. My name is Steven M. LubertoZZi. I am Senior Vice President of Rates, Regulatory  
3 and Legislative Affairs for Corix Infrastructure Inc. ("CII"). My business address is  
4 500 W. Monroe, Suite 3600, Chicago, Illinois 60661.

5 **Q. PLEASE DESCRIBE YOUR DUTIES IN YOUR CURRENT POSITION.**

6 A. As Senior Vice President, I am responsible for all aspects of CII's Rates,  
7 Regulatory and Legislative Affairs activities.

8 **Q. PLEASE SUMMARIZE YOUR EDUCATIONAL AND PROFESSIONAL  
9 BACKGROUND.**

10 A. I graduated from Indiana University in 1990, and I am a Certified Public  
11 Accountant. I earned my Master of Business Administration from Northwestern  
12 University's Kellogg School of Management. I am a member of the American  
13 Institute of Certified Public Accountants, and I have been employed by CII or an  
14 affiliate of CII, since June 2001.

15 I am a past Board Member of the National Association of Water Companies,  
16 a past Board Member of the Indiana Chapter of the National Association of Water  
17 Companies, a past Board Member of the Illinois Chapter of the National  
18 Association of Water Companies, and a past Board Member of the Financial  
19 Research Institute.

20 **Q. HAVE YOU PREVIOUSLY TESTIFIED BEFORE ANY PUBLIC UTILITY**  
21 **COMMISSIONS?**

22 A. Yes. I have provided written and oral testimony before public utilities commissions  
23 throughout the United States, on topics ranging from cost of equity, capital  
24 structure, cost of debt, acquisition adjustments, divestment strategies, appropriate  
25 levels of operations and maintenance expense, parent company allocations,  
26 affiliate transactions, income taxes, and almost every aspect of utility operations.  
27 State commissions where I have presented testimony include Florida, Illinois,  
28 Indiana, Kentucky, Maryland, New Jersey, New Mexico, Nevada, North Carolina,  
29 Pennsylvania, South Carolina, and Virginia.

30 **Q. WHAT IS THE PURPOSE OF YOUR TESTIMONY IN THIS PROCEEDING?**

31 A. My testimony describes the proposed merger of SW Merger Acquisition Corp.  
32 (“SWMAC”) with and into Corix Infrastructure (US) Inc. (“Corix US”, which together  
33 with SWMAC, are referred to as the “Companies”). Corix US indirectly owns Corix  
34 Regulated Utilities (US) Inc. (“CRU US”), the direct parent of Water Service  
35 Corporation of Kentucky (“WSCK”). The merger results in the combination of the  
36 water, wastewater, and related businesses currently owned by CII,<sup>1</sup> with the water  
37 and wastewater businesses currently owned by SWMAC (none of which are  
38 located in Kentucky) through SouthWest Water Company (“SouthWest”). This  
39 merger of equals joins two highly complementary businesses to create a leading

---

<sup>1</sup> CII owns Corix US. CII’s related businesses include the electric, natural gas, and propane distribution, geothermal energy delivery and municipal service operations of CII related to its U.S. and Canadian water and wastewater operations.



40 water and wastewater utility with the scale and financial foundation necessary to  
41 better facilitate long-term investments needed to serve customers.

42 My testimony explains why the combination is consistent with the public  
43 interest, will assist the employees supporting WSCK, will have no impact on  
44 competition within its service area, and should allow WSCK to better balance the  
45 needs for capital investment with the rates needed to support those investments.  
46 The testimony also supports the request for Public Service Commission of  
47 Kentucky (“Commission”) approval of the combination. My testimony describes the  
48 CII business involved in the transaction (“Proposed Transaction”), the Proposed  
49 Transaction, the rationale behind the proposed combination, governance of the  
50 combined companies, and other regulatory approvals required for effectuating the  
51 Proposed Transaction. My testimony also addresses CII’s mission, vision and  
52 values and how they are consistent with those of SouthWest. I further discuss the  
53 benefits of the Proposed Transaction, WSCK’s continuing commitment to  
54 Kentucky customers, and its commitment to provide reliable, safe, and high-quality  
55 utility service.

56 **Q. PLEASE IDENTIFY THE OTHER WITNESSES SUBMITTING TESTIMONY IN**  
57 **THIS CASE.**

58 A. In addition to my testimony, the following witnesses provide testimony in this case:  
59 • Brian D. Bahr, who will introduce SouthWest to the Commission, support  
60 the commitments of the Companies in this combination, and discuss certain  
61 requests for confidential treatment in this proceeding;

- 62           • Justin Kersey, who has been asked to serve as the President of WSCK after  
63           closing and who will discuss in greater detail the operational benefits the  
64           Proposed Transaction is expected to produce, as well as WSCK’s  
65           commitment to its local communities; and
- 66           • Ellen Lapson of Lapson Advisory, an expert witness who will discuss the  
67           future financial strength of the combined company, the expected impact of  
68           the Proposed Transaction upon the utility, and the utility’s future access to  
69           equity and debt capital.

70   **Q.   ARE YOU SPONSORING ANY APPENDICES TO THE VERIFIED**  
71   **APPLICATION WHICH IS BEING FILED IN CONNECTION WITH THIS**  
72   **PROCEEDING (THE “APPLICATION”)?**

- 73   A.   Yes, I am sponsoring the following Appendices in this proceeding:
- 74           • Appendix A – Summary of Proposed Transaction with Simplified Pre- and  
75           Post-Closing Organizational Charts
- 76           • Appendix B – Transaction Agreement<sup>2</sup>
- 77           • Appendix H – Recent Financial Statements for WSCK
- 78           • Appendix I – Recent Financial Statements for Corix US
- 79           • Appendix K – Corix US Corporate Resolution Authorizing the Proposed  
80           Transaction
- 81           • Appendix L – WSCK Certificate of Good Standing

---

<sup>2</sup> Exhibit A and Appendix I to Exhibit D of the Transaction Agreement, which contain confidential information, are not included with the Transaction Agreement filed with the Application. Unredacted versions and redacted public versions will be provided upon request in accordance with the Commission’s rules regarding confidential documents.

82           • Appendix N – Corix US Certificate of Good Standing

83   **Q.    ARE YOU ALSO SPONSORING EXHIBITS TO YOUR TESTIMONY?**

84   A.    Yes, I am sponsoring the following Exhibits to my testimony:

85           • Exhibit SML-1 – Background Information on the Announced Executive  
86                                    Leadership Team

87   **Q.    WERE THESE APPENDICES PREPARED BY YOU OR UNDER YOUR  
88           SUPERVISION?**

89   A.    Yes, they were, except for Exhibit B.

90                                    **CORIX INFRASTRUCTURE INC.**

91   **Q.    PLEASE DESCRIBE CII.**

92   A.    CII is the direct parent of Corix US. CII currently has its primary offices in  
93           Vancouver, British Columbia, Canada, and Chicago, Illinois. The utility subsidiaries  
94           of CII provide safe, reliable, and cost-effective water and wastewater services to  
95           approximately 800,000 people in 18 U.S. states<sup>3</sup> and two Canadian provinces<sup>4</sup>,  
96           making CII one of the largest privately-owned water and wastewater utilities in the  
97           U.S. CII’s subsidiaries employ approximately 800 people in the water, wastewater,  
98           and related businesses. CII also owns and operates several district energy  
99           businesses, which are not part of the proposed combination. British Columbia  
100          Investment Management Corporation (“BCI”) indirectly controls CII.

101   **Q.    PLEASE DESCRIBE CII’S PURPOSE, VISION, AND VALUES.**

---

<sup>3</sup> Alabama, Alaska, Arizona, Florida, Georgia, Illinois, Indiana, Kentucky, Louisiana, Maryland, Nevada, New Jersey, North Carolina, Pennsylvania, South Carolina, Tennessee, Texas, and Virginia.

<sup>4</sup> Alberta and British Columbia.

102 A. CII's purpose is: We help people enjoy a better life and communities thrive. Our  
103 vision is: We are the preferred utility delivering solutions our customers want. CII  
104 enables its customers and stakeholders to enjoy a better life by improving utility  
105 infrastructure and operations, while ensuring strong environmental stewardship in  
106 each community served. CII's values emphasize safety, integrity, connection, and  
107 excellence. As Mr. Bahr's direct testimony illustrates, the mission and values of  
108 CII and SouthWest are similar, including our shared commitment to local  
109 management and decision-making, supported by broad corporate-wide resources.

110 **Q. PLEASE DESCRIBE BCI.**

111 A. Founded in 1999, BCI is a statutory corporation created by the Public Sector  
112 Pension Plans Act for the purpose of providing investment management services  
113 to British Columbia's public sector. BCI manages approximately \$211 billion (CAD)  
114 of assets on behalf of its clients, which include 11 public sector pension plans,  
115 three insurance funds and various special purpose funds. Through its  
116 infrastructure and renewable resources program, BCI seeks long-term, stable  
117 investments around the world in regulated utilities, transportation,  
118 telecommunications, and other infrastructure-based industries.

119 **Q. PLEASE EXPLAIN THE STRENGTHS CII BRINGS TO THE PROPOSED**  
120 **TRANSACTION IN TERMS OF FINANCIAL RESOURCES.**

121 A. For the 12-month period ending December 31, 2021, CII had revenue of  
122 approximately \$307 million and \$1.55 billion in assets. In 2021, CII supported  
123 approximately \$114 million in capital investments across its operating areas in  
124 North America.

125 **Q. PLEASE DESCRIBE CII'S OPERATIONAL AND TECHNICAL EXPERTISE.**

126 A. CII has experience in virtually every aspect of water and wastewater system  
127 operation. CII's and its subsidiaries have approximately 800 employees dedicated  
128 to safely providing high-quality water and wastewater services to our customers in  
129 an environmentally compliant manner. Our state-certified water and wastewater  
130 technicians pump and treat millions of gallons of water for hundreds of  
131 communities, assisted by our in-house operations management and quality control  
132 professionals. We also have extensive construction and project management  
133 experience and expertise.

134 **Q. DOES CII ALSO BRING MANAGEMENT EXPERTISE TO THE PROPOSED**  
135 **TRANSACTION?**

136 A. Yes. CII has a strong management team that cumulatively has decades of  
137 experience owning and operating water and wastewater utilities. As described  
138 more fully in my testimony, the Proposed Transaction will result in an executive  
139 leadership team that draws from the strong existing talent pools of both CII and  
140 SouthWest. Please see Exhibit SML-1 for background information on members of  
141 the announced executive leadership team to be effective upon closing of the  
142 proposed business combination.

143 **Q. IN SUMMARY, DOES CII BRING FINANCIAL, OPERATIONAL/TECHNICAL,**  
144 **AND MANAGERIAL STRENGTHS TO THE PROPOSED TRANSACTION?**

145 A. Yes, CII's financial resources, strong leadership team, and extensive managerial  
146 expertise make it an ideal owner of water and wastewater utilities.

147 **RESTRUCTURING PRIOR TO CLOSING**

148 **Q. PLEASE DESCRIBE THE CII AND CORIX US (“CORIX PARTIES”)**  
149 **RESTRUCTURING THAT WILL TAKE PLACE PRIOR TO CLOSING.**

150 A. The Corix Parties pre-closing restructuring has two objectives. First, the pre-  
151 closing restructuring separates CII’s district energy business from the CII water,  
152 wastewater, and related businesses. Second, the pre-closing restructuring results  
153 in the inclusion of CII’s Canadian water, wastewater, and related businesses in the  
154 deal perimeter by making the Canadian companies that provide water, wastewater,  
155 and related services indirect, wholly-owned subsidiaries of Corix US. Together,  
156 these steps allow the parties to combine their respective water and wastewater  
157 businesses to create a platform company focused almost exclusively on the  
158 delivery of water and wastewater services to customers.

159 **PROPOSED TRANSACTION**

160 **Q. PLEASE SUMMARIZE THE PROPOSED TRANSACTION.**

161 A. On August 26, 2022, CII, Corix US, IIF Subway Investment LP (“IIF Subway”),  
162 SWMAC, and SouthWest entered into a Transaction Agreement (the “Transaction  
163 Agreement”). The Transaction Agreement provides a framework for combining  
164 CII’s water, wastewater businesses and related businesses with the water and  
165 wastewater businesses owned by SWMAC. When the transactions contemplated  
166 by the Transaction Agreement are completed, CII and an affiliate or affiliates of CII  
167 will own 50% of Corix US and SWMAC Holdco, an entity to be formed by SWMAC’s  
168 shareholders before closing, will own the other 50% of Corix US (the “Proposed  
169 Transaction”). Corix US, in turn, will indirectly own and control all the CII water,  
170 wastewater, and related businesses, and the SWMAC water and wastewater

171 businesses. To prepare for the Proposed Transaction, both the Corix Parties and  
172 IIF Subway, SWMAC, and SouthWest (the “SouthWest Parties”) will undertake  
173 pre-closing restructuring transactions.

174 **Q. HOW WILL THE PROPOSED TRANSACTION BE EFFECTUATED?**

175 A. Before the business combination occurs, CII will complete the Corix Parties’ pre-  
176 closing restructuring, which is described in Appendix A to the Joint Application.  
177 Likewise, SWMAC will complete a pre-closing restructuring. Then, the Proposed  
178 Transaction will be completed in a series of steps.

179 **Step 1:** SWMAC Holdco will contribute 100% of the outstanding stock of  
180 SWMAC to Corix US in exchange for shares of stock issued by Corix US. Step 1  
181 will result in CII and an affiliate or affiliates and SWMAC Holdco each holding a  
182 50% interest in Corix US, which will hold 100% of the outstanding stock of SWMAC  
183 and also continue to hold 100% of the outstanding stock of Inland Pacific  
184 Resources Inc. (“Inland Pacific”). **Figure 1** depicts this step.

185

**Figure 1**

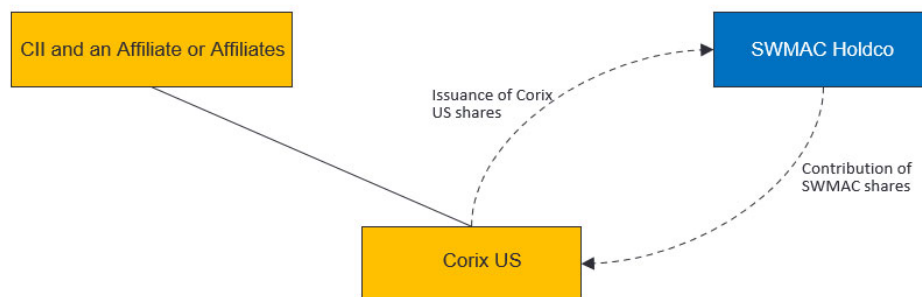

186

187 **Step 2:** After Step 1 is completed, SWMAC will merge with and into Corix  
188 US. Corix US will survive the merger. As a result of Step 2, Corix US will directly

189 hold 100% of the outstanding stock of SouthWest, previously held by SWMAC,  
190 and Corix US will also continue to hold 100% of the shares of Inland Pacific. **Figure**  
191 **2** shows this step.

192

**Figure 2**

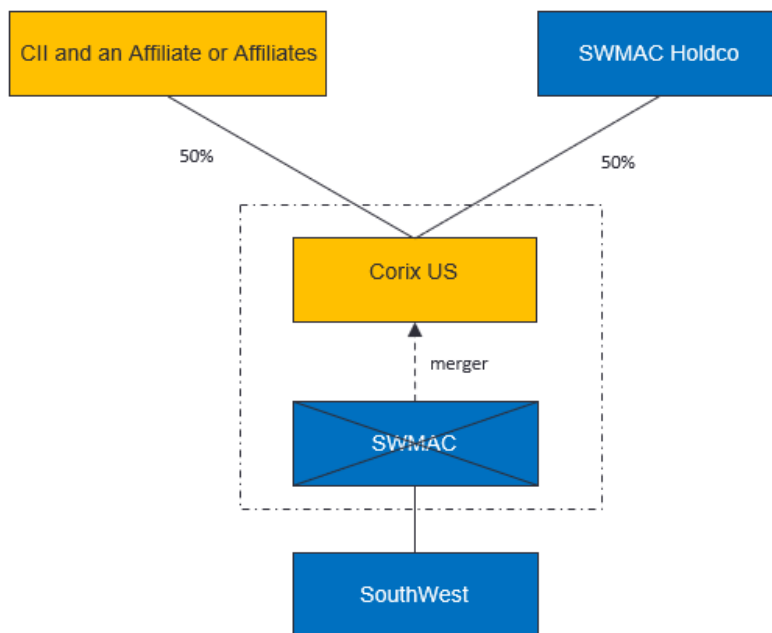

193

194 **Step 3:** After Step 2 is completed, Corix US will transfer 100% of the  
195 outstanding stock of SouthWest and Inland Pacific to Intermediate Newco. In  
196 exchange for this contribution of stock, Intermediate Newco will issue to Corix US  
197 common stock of Intermediate Newco and assume all of Corix US's third-party  
198 debt. Step 3 is the last step in the transactions contemplated by the Transaction  
199 Agreement. **Figure 3** illustrates this step.

200

**Figure 3**



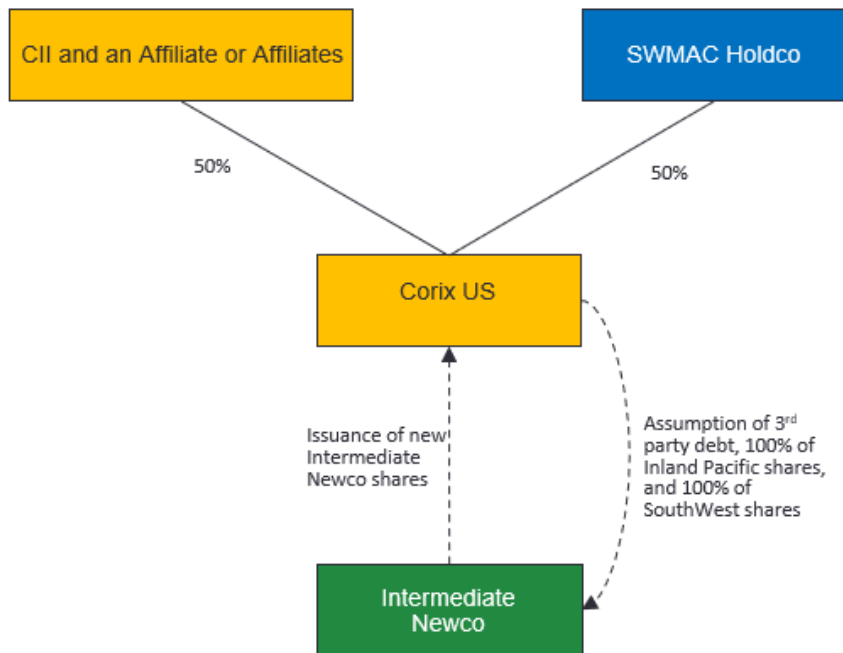

201

202

203

204

205

206

207

As a result of Steps 1 through 3, CII (and an affiliate or affiliates) and SWMAC Holdco will each hold 50% of the outstanding stock of Corix US, which will hold 100% of the outstanding stock of Intermediate Newco, which will hold 100% of the outstanding stock of both SouthWest and Inland Pacific. **Figure 4** illustrates the resulting structure following Steps 1 through 3.

**Figure 4**

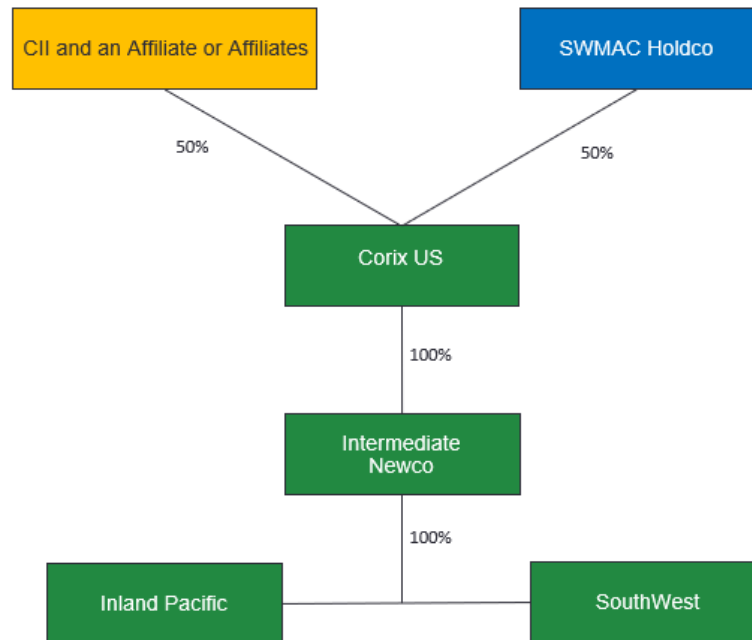

208

209 **Q. HAVE THE JOINT APPLICANTS PROVIDED A SUMMARY OF THE PRE- AND**  
210 **POST-CLOSING ORGANIZATION CHARTS CONSISTENT WITH THE ABOVE-**  
211 **DESCRIBED CHANGES?**

212 A. Yes, please see Appendix A attached to the Application, which provides a  
213 simplified view of the current, pre-closing, post-restructuring and post-closing  
214 organizational structures of CII and SWMAC’s holdings applicable to the  
215 Transaction Agreement.

216 **Q. AFTER THE PROPOSED TRANSACTION CLOSES, HOW WILL THE**  
217 **COMBINED COMPANIES BE GOVERNED AND MANAGED?**

218 A. The combined company will be managed by a board comprised of nine directors  
219 (the “Board”):

- 220 • The combined company’s CEO (i.e., Rob MacLean);
- 221 • Four shareholder representatives; and
- 222 • Four independent directors, one of whom will be the chair

223 The management team of the combined company will be led by Rob MacLean and  
224 will consist of the following senior executives:

- 225 • Chief Operating Officer – Richard Rich
- 226 • Chief Financial Officer – Alison Zimlich
- 227 • Chief Legal Officer – Shawn Elicegui
- 228 • Chief Enterprise Services Officer – Jim Devine
- 229 • Chief Growth Officer – Don Sudduth
- 230 • Chief Human Resources Officer – Joanne Elliott

231 WSCK will continue to be managed locally. Please see the testimony of Justin  
232 Kersey for more details on our local commitments with this Proposed Transaction.

233 **Q. WHAT OTHER APPROVALS ARE REQUIRED IN ORDER TO CLOSE THE**  
234 **PROPOSED TRANSACTION?**

235 A. In addition to the Commission’s approval, similar approvals are being requested  
236 from regulatory commissions in other jurisdictions in which the utility subsidiaries  
237 of CII and SouthWest operate across the US and Canada. The Proposed  
238 Transaction also is subject to review by federal agencies in Canada and the United  
239 States.

240 **RATIONALE AND BENEFITS OF COMBINATION**

241 **Q. WHAT WAS THE IMPETUS FOR THIS PROPOSED TRANSACTION?**

242 A. As the testimony demonstrates, both CII and SouthWest are strong companies –  
243 financially, technically, operationally, and managerially – that share consistent  
244 missions and values. At the same time, CII and SouthWest are geographically  
245 diverse. The Proposed Transaction will allow our approximately 1,300 employees

246 to provide quality water and wastewater services to our customers across 20 U.S.  
247 states and 2 Canadian provinces, building a larger platform to facilitate needed  
248 investments in the communities served by the CII and SouthWest operating  
249 companies, while continuing to add scale and grow in the future. Intermediate  
250 Newco, in short, will have the scale to enhance the ability of the operating utilities,  
251 including WSCK, to make important infrastructure investments that provide long-  
252 term benefits for the communities they serve.

253 **Q. WHAT ARE THE OVERALL BENEFITS OF THE PROPOSED TRANSACTION**  
254 **TO CII, SOUTHWEST, WSCK'S CUSTOMERS, AND THE COMMONWEALTH**  
255 **OF KENTUCKY?**

256 A. The Proposed Transaction joins two highly complementary businesses to create a  
257 leading water and wastewater utility. As one company, SouthWest's and CII's  
258 water and wastewater utilities will have deeper resources and capabilities to invest  
259 and operate in the water and wastewater sector for the long term. The investments  
260 that the combined company can make, together with the leveraging of prudent  
261 practices and operating experience of both companies, will support the safe,  
262 reliable and sustainable delivery of critical resources and services and will enhance  
263 the customer experience.

264 As I will discuss in greater detail in my testimony, and as shown in the  
265 testimony of the Joint Applicants' other witnesses, the Proposed Transaction will  
266 benefit WSCK and its customers in several ways. First, the Proposed Transaction  
267 will create greater diversity and depth of resources through the combining of two  
268 large water and wastewater utilities, allowing a sharing of prudent practices (both

269 at the corporate level and regionally/locally) and an increase in emergency  
270 response resources, which will benefit customers and the Commonwealth. The  
271 testimony of Justin Kersey discusses these benefits in greater detail. Second, the  
272 combination of two boards of directors into the Board and the combination of two  
273 executive leadership teams into a single team is expected to reduce costs. We  
274 also expect a reduction in overall audit expenses (when the separate audit costs  
275 of the two companies are compared to the audit costs of the combined company).  
276 Because these costs – board governance, senior executive, and audit – are  
277 subsequently allocated through the corporate allocation process to individual  
278 utilities (including WSCK) and reflected in customer rates, customers will benefit  
279 as the net savings are allocated to individual utilities and reflected in rates in future  
280 proceedings.

281 Third, the Proposed Transaction will increase the financial resources and  
282 flexibility of the combined company and its subsidiaries. This will facilitate needed  
283 infrastructure investments and continued growth in the water and wastewater  
284 industry. The Companies anticipate their combined financial strength will allow for  
285 improved financing terms compared to present day. The testimony of Ellen Lapson  
286 discusses these benefits – the financial strength of the combined company and the  
287 expected impact of the Proposed Transaction upon the utility and the utility's future  
288 access to equity and debt capital – in more detail.

289 Fourth, while the Proposed Transaction is not driven by synergies, we  
290 anticipate that the business combination will improve efficiency and the integration  
291 of administrative and general functions should eventually result in cost savings.

292 Yet, the integration of CII's water, wastewater, and related businesses with  
293 SouthWest's water and wastewater business will be a significant, prolonged  
294 undertaking. We anticipate that integration will lead, over time, to additional  
295 efficiencies and reduced operating costs in various functional areas. We expect  
296 that the costs and benefits of integration will be addressed in future ratemaking  
297 proceedings and our utility customers will benefit from even more efficient  
298 operations.

299 **Q. HAVE THE COMPANIES INCURRED, OR WILL THE COMPANIES INCUR,**  
300 **COSTS ASSOCIATED WITH PROPOSED TRANSACTION?**

301 A. Yes, the Companies are incurring "transaction costs" and will also incur "integration  
302 costs." As noted in the Application, Corix US, SWMAC, and WSCK will not seek to  
303 recover transaction costs from customers.

304 **Q. HAVE THE COMPANIES IDENTIFIED SPECIFIC AREAS OF INTEGRATION?**

305 A. As detailed above, the Companies plan to consolidate their respective boards and  
306 senior executive teams into the Board and a single executive team, effective at  
307 Proposed Transaction closing. All other areas of the Companies' respective  
308 businesses have not identified potential integration at this time; however, the  
309 Companies anticipate integration activities to be undertaken and implemented  
310 over an extended time in the future. To the extent that any savings are generated  
311 from future integration, the Companies anticipate integration costs will be incurred  
312 in order to achieve such savings. Customers will receive the benefits of these  
313 efforts, net of integration costs, in future rate proceedings.

314 **Q. DOES WSCK PROPOSE ANY RATE CHANGES TO CUSTOMERS AS A**  
315 **RESULT OF THIS COMBINATION?**

316 A. WSCK does not propose any changes to customer rates in this Joint Application,  
317 nor has it proposed any changes to its pending rate case as a result of the  
318 Proposed Transaction. As noted above, to the extent any net savings are  
319 generated through integration, such savings should be reflected through the  
320 regular ratemaking process in future cases.

321 **SATISFACTION OF PUBLIC INTEREST**

322 **Q. IS THE PROPOSED TRANSACTION CONSISTENT WITH THE PUBLIC**  
323 **INTEREST?**

324 A. Yes. The Proposed Transaction will not adversely impact competition,  
325 employment, or WSCK's quality of service. In fact, the consummation of the  
326 Proposed Transaction should provide a positive benefit by improving service over  
327 time due to the sharing of industry expertise and prudent practices between CII  
328 and SouthWest. In addition, the combined financial resources of CII and  
329 SouthWest will facilitate needed utility infrastructure investments. Further, the  
330 Proposed Transaction will have no immediate impact on WSCK's rates. As future  
331 rate cases are processed, reductions in board governance positions and costs,  
332 senior executive positions and costs, and other functional areas will be allocated  
333 to our local operating utilities and reflected in those utilities' rates.

334 WSCK will continue to be locally managed, with local employees, offices and  
335 facilities consistent with its obligations to serve customers. For all the reasons

336 identified in my testimony and in the other witnesses' testimony, I believe Proposed  
337 Transaction is consistent with the public interest.

338 **Q. DOES THE PROPOSED TRANSACTION INVOLVE ANY TRANSFER OF**  
339 **WSCK'S STOCK OR ASSETS?**

340 A. No, it does not.

341 **Q. DOES THE PROPOSED TRANSACTION INVOLVE ANY PLEDGE,**  
342 **ENCUMBRANCE, OR CROSS-COLLATERALIZATION OF WSCK'S ASSETS?**

343 A. No, it does not. WSCK will not guarantee any debt for Intermediate Newco or other  
344 affiliated companies unless the debt is incurred for purposes specific to its system  
345 or operations. Any debt incurred by WSCK will only be used for purposes specific  
346 to its system or operations.

347 **Q. WHAT ARE THE COMPANIES' GOALS WITH RESPECT TO CREDIT**  
348 **QUALITY?**

349 A. The combined business will be established with a target investment grade capital  
350 structure profile and operated in a way that is consistent with maintaining an  
351 investment grade profile.

352 **Q. DO THE COMPANIES PROPOSE OTHER CUSTOMER PROTECTIONS?**

353 A. Yes, our customer protection commitments are discussed in the testimony of Mr.  
354 Bahr.

355 **Q. DOES THE PROPOSED TRANSACTION REQUIRE A CHANGE IN, OR IS**  
356 **WSCK PROPOSING TO CHANGE, ITS EXISTING AFFILIATE AGREEMENT?**

357 A. No, the Proposed Transaction does not require a change in WSCK's affiliate  
358 agreement, and no change is proposed in this Application. As noted above,



359 although the process of planning for integration has begun, implementation cannot  
360 begin until after closing. Therefore, because affiliate activities directly involving  
361 WSCK are not changing for some time, WSCK has no need to change its existing  
362 affiliate agreement. WSCK will file any amendments or new agreements with the  
363 Commission at the appropriate time in the future.

364 **Q. PLEASE SUMMARIZE THE REQUEST FOR RELIEF IN THE CURRENT**  
365 **APPLICATION.**

366 A. The Joint Applicants request approval of the merger of equals contemplated in the  
367 Transaction Agreement as WSCK will continue to have the financial, technical, and  
368 managerial abilities to provide service and it is consistent with the public interest,  
369 in accordance with law, and for a proper purpose. Specifically, the Commission  
370 should find that the requirements of KRS 278.020(6) and (7) have been met.

371 **Q. DOES THIS CONCLUDE YOUR PREPARED DIRECT TESTIMONY?**

372 A. Yes, it does.



## The Executive Leadership Team for Our New Company



### **Rob MacLean, Chief Executive Officer (CEO)**

Rob MacLean has served as SouthWest Water's President and Chief Executive Officer since 2018. He is based at the company's headquarters in Sugar Land, Texas. Rob's career has spanned over 25 years in the water industry, and he has served as a volunteer leader for various regional and national organizations. During his tenure with SouthWest Water, Rob has led the company's continued expansion and growth while focusing on employee empowerment and service excellence. The Company's internal motto, "We've got this!" is emblematic of the culture at SouthWest Water, where employees are empowered to get the job done for our customers.



### **Jim Devine, Chief Enterprise Services Officer (CESO)**

Jim currently serves as Chief Support Services Officer at Corix. Jim joined Utilities, Inc. in 2010, working in Human Resources until he was promoted to lead Shared Services shortly after the Corix acquisition in 2014, and joined the Corix Executive team in 2018. In his new role, he will oversee the combined company's shared technology platforms, Centers of Expertise and enterprise business services. Jim will continue to reside with his husband, Andrew, in Chicago, IL following close of the transaction.



### **Shawn Elicegui, Chief Legal Officer (CLO)**

Shawn currently serves as CLO at Corix. In his role at the new company, he will maintain similar responsibilities overseeing the legal department. He will also have responsibility for the corporate Rates, Regulatory and Legislative Affairs team. Shawn, who joined Corix in 2019, will continue to reside in Reno, NV with his wife, Jennifer, following the close of the transaction.



### **Joanne Elliott, Chief Human Resources Officer (CHRO)**

Joanne currently serves as CHRO at SouthWest Water. At the newly combined company, she will be responsible for all aspects of people and culture. Joanne joined SouthWest Water in 2019, and she will continue to reside in Los Angeles County, CA with her husband Hal.



### **Richard Rich, Chief Operating Officer (COO)**

Richard is currently the COO of SouthWest Water. As COO of the combined company, he will continue to oversee the operations for all business units. Rich began his career at SouthWest Water as a meter reader 20 years ago, and has served in various roles across several states, including in Operations; Customer Care; Regulatory; Financial Planning and Analysis; and as President of the California business. Rich and his wife Kellie, along with their two children, Jaxon (17) and Ella (11), will continue to be based in the Sugar Land, TX area



### **Don Sudduth, Chief Growth Officer (CGO)**

Don currently serves as CGO at Corix. At the combined company, he will continue to be responsible for leading and growing the new company's business. Don has been with Corix for 16 years, first with Corix-acquired Utilities, Inc. and then with Corix. He has served as VP Corporate Development; VP Meter To Cash Operations; President of the South Region; and COO of Energy & Contract Utilities. Don will continue to be based in Florida, where he resides with his wife, Kandi, near their two adult sons, Masen and Jacksen.



### **Alison Zimlich, Chief Financial Officer (CFO)**

Alison currently serves as CFO of SouthWest Water and will continue in that same role with the new company. Alison has been with SouthWest Water since May 2021. She and her husband, Josh, live in the Houston area and are recent empty-nesters. They are looking forward to lots of golf and travel in their new free time. Their daughter, Bonnie, is a junior at Texas State University, and their son, Caden, is a freshman at University of Arkansas.

COMMONWEALTH OF KENTUCKY  
BEFORE THE PUBLIC SERVICE COMMISSION

In the Matter of )  
Application by Water Service Corporation of )  
Kentucky, along with Corix Infrastructure ) Case No. 2022-00396  
(US) Inc. and SW Merger Acquisition Corp., )  
for Approval of Transfer of Control )

---

**DIRECT TESTIMONY OF  
BRIAN D. BAHR**

---

**Table of Contents**

WITNESS INTRODUCTION AND BACKGROUND ..... 1  
SOUTHWEST ..... 3  
RESTRUCTURING PRIOR TO CLOSING ..... 7  
COMMITMENTS FROM THE JOINT APPLICANTS ..... 7  
REQUEST FOR CONFIDENTIAL TREATMENT ..... 9

**PREPARED DIRECT TESTIMONY  
OF BRIAN D. BAHR  
ON BEHALF OF  
SW MERGER ACQUISITION CORP**

**WITNESS INTRODUCTION AND BACKGROUND**

1 **Q. PLEASE STATE YOUR NAME, TITLE, AND BUSINESS ADDRESS.**

2 A. My name is Brian D. Bahr. I am employed by SouthWest Water Company  
3 (“SouthWest”), a subsidiary of SW Merger Acquisition Corp (“SWMAC”), as  
4 Director of Rates and Regulatory Affairs. My business address is 1620 Grand  
5 Avenue Parkway, Suite 140, Pflugerville, Texas 78660.

6 **Q. PLEASE DESCRIBE YOUR DUTIES IN YOUR CURRENT POSITION.**

7 A. My duties primarily consist of preparing and managing regulatory applications and  
8 compliance filings for the non-California regulated operating subsidiaries of  
9 SouthWest.

10 **Q. PLEASE SUMMARIZE YOUR PROFESSIONAL AND EDUCATIONAL**  
11 **BACKGROUND.**

12 A. My professional and educational experience includes the areas of accountancy,  
13 audit, analysis, regulation, and management. I graduated from Brigham Young  
14 University with a BA in Accountancy and subsequently earned the Certificate of  
15 Public Management from Willamette University. I received a Master of Business  
16 Administration from the University of La Verne with an emphasis in Finance. I also  
17 hold Grade II certifications as a Water Distribution Operator and Water Treatment  
18 Operator in the State of California. Prior to joining SouthWest, I was employed by  
19 the Oregon Public Utility Commission as a Senior Utility Analyst, and, previous to

20 that, worked in the audit/assurance practice of PricewaterhouseCoopers LLP in  
21 the field of alternative investments.

22 **Q. HAVE YOU PREVIOUSLY TESTIFIED BEFORE THIS BOARD OR ANY OTHER**  
23 **COMMISSION?**

24 A. Yes, I have previously testified before the California, Oregon, and Texas  
25 commissions.

26 **Q. WHAT IS THE PURPOSE OF YOUR TESTIMONY IN THIS PROCEEDING?**

27 A. My testimony supports the joint application (“Application”) for approval of the  
28 proposed merger of Corix Infrastructure (US) Inc. (“Corix US”) and SWMAC (which  
29 together with Corix US, are referred to as the “Companies”). Corix US indirectly  
30 owns Corix Regulated Utilities US, Inc. (“CRU US”), the direct parent of Water  
31 Service Corporation of Kentucky ( “WSCK” and, together with the Companies, the  
32 “Joint Applicants”). The merger results in the combination of the water, wastewater,  
33 and related businesses currently owned by Corix Infrastructure Inc. (“CII”), with the  
34 water and wastewater businesses currently owned by SWMAC. This merger of  
35 equals joins two highly complementary businesses to create a leading water and  
36 wastewater utility with the scale and financial foundation necessary to better  
37 facilitate long-term investments needed to serve customers.

38 My testimony describes the SouthWest organization, SouthWest’s mission  
39 and values, and the strengths SouthWest brings to the proposed combination. I  
40 also reiterate the Companies’ continuing commitment to Kentucky customers and  
41 our commitment to provide reliable, safe, and high-quality utility service. In  
42 addition, my testimony provides support for the Companies’ request for confidential

43 treatment of certain commercially sensitive information. Finally, I support the  
44 conclusion that the business combination is consistent with the public interest.

45 **Q. ARE YOU SPONSORING ANY APPENDICES TO THE VERIFIED**  
46 **APPLICATION WHICH IS BEING FILED IN CONNECTION WITH THIS**  
47 **PROCEEDING?**

48 A. Yes, I am sponsoring the following Appendices in this proceeding:

- 49 • Appendix G – Recent Financial Statements for SWMAC
- 50 • Appendix J – SWMAC Corporate Resolution Authorizing the Proposed  
51 Transaction
- 52 • Appendix M – SWMAC Certificate of Good Standing

53 **SOUTHWEST**

54 **Q. PLEASE DESCRIBE SOUTHWEST.**

55 A. SouthWest's roots go back over 100 years. We are currently headquartered in  
56 Sugar Land, Texas, with approximately 500 employees. Our utility subsidiaries  
57 own and operate regulated water and wastewater systems serving over half a  
58 million residential and business customers in seven states: Alabama, California,  
59 Florida, Louisiana, Oregon, South Carolina, and Texas. Customer rates, service,  
60 and water quality are generally regulated by state agencies.

61 **Q. PLEASE DESCRIBE SOUTHWEST'S OWNERSHIP.**

62 A. SouthWest is a wholly owned subsidiary of SWMAC. The Infrastructure  
63 Investments Fund ("IIF"), through IIF Subway Investment LP ("IIF Subway", and  
64 together with SWMAC and SouthWest, the "SouthWest Parties"), indirectly owns  
65 75% of SWMAC. Bazos CIV, L.P. ("Bazos") owns the remaining 25%. Bazos is



66 indirectly owned by the German reinsurer, Munich RE (Münchener  
67 Rückversicherungs-Gesellschaft Aktiengesellschaft in München).

68 IIF is an approximately \$26 billion<sup>1</sup> open-ended private investment vehicle  
69 focused on investing in critical infrastructure assets. IIF is responsible for investing  
70 and growing the retirement money of more than 60 million families. IIF is a long-  
71 term owner of companies that provide essential services, including water, natural  
72 gas and electric utility services, renewable energy, and transportation  
73 infrastructure, which are all vital to the communities in which they operate. As of  
74 June 30, 2022, IIF owned 20 companies throughout North America, Europe, and  
75 Australia.

76 Since acquiring SouthWest in 2010, IIF has been an outstanding partner to  
77 SouthWest, including supporting over \$500 million in capital expenditures for  
78 critical infrastructure.

79 **Q. PLEASE DESCRIBE SOUTHWEST'S MISSION AND VALUES.**

80 A. SouthWest's mission is to provide life-sustaining water and wastewater services  
81 to our customers, empowering the communities we serve. We accomplish this  
82 mission by embracing our values, which are as follows:

- 83 • Safety – we make safety our #1 priority by continuously monitoring and  
84 improving our safety practices, protecting the wellness of our most valuable  
85 assets - our people - and safeguarding the public health in delivering safe,  
86 reliable water and wastewater services;

---

<sup>1</sup> As of June 30, 2022.

- 87 • Environmental Stewardship – environmental compliance and protection of  
88 natural resources is achieved through striving to meet all compliance and  
89 regulatory public safety requirements, reducing our carbon footprint, and  
90 meeting the demands of our customers by infrastructure improvement and  
91 efficiency;
- 92 • Customer Care – our commitment to customer care is achieved by  
93 supporting our customers in a timely manner, treating every customer with  
94 respect and honesty, and providing safe and reliable water and wastewater  
95 services;
- 96 • Employee Empowerment – we encourage all employees to participate in  
97 the decisions around their work, providing training and resources for  
98 development, and creating a culture that encourages communication,  
99 collaboration, and inclusiveness;
- 100 • Integrity – this value is demonstrated by showing respect for peers and  
101 customers at all times, building trust, acting with responsibility and  
102 accountability, and leading by example; and
- 103 • Community Partnership – we support the communities we serve by  
104 committing to volunteer in the communities, investing in solutions to improve  
105 communities, and supporting business partners whose efforts mirror our  
106 mission.

107 As Mr. Lubertozi's direct testimony notes, the mission and values of CII  
108 and SouthWest are similar, including our shared commitment to local management  
109 and decision-making, supported by corporate-wide resources.

110 **Q. PLEASE DESCRIBE THE STRENGTHS SOUTHWEST BRINGS TO THE**  
111 **PROPOSED COMBINATION IN TERMS OF FINANCIAL RESOURCES.**

112 A. In 2021, SouthWest had annual revenues of \$248.9 million and had over \$1.4  
113 billion in assets on its balance sheet. The combined business will be established  
114 with a target investment grade capital structure profile and operated in a way that  
115 is consistent with maintaining an investment grade profile.

116 **Q. PLEASE DESCRIBE SOUTHWEST'S OPERATIONAL AND TECHNICAL**  
117 **EXPERTISE.**

118 A. SouthWest has experience in virtually every aspect of water and wastewater  
119 system operation. SouthWest is dedicated to safely providing high-quality water  
120 and wastewater services to our customers in an environmentally compliant  
121 manner. Our state-certified water and wastewater technicians provide service to  
122 hundreds of communities, assisted by our in-house professional engineering and  
123 quality control. We also have extensive construction and project management  
124 experience and expertise. SouthWest is committed to providing excellent customer  
125 service and operational service.

126 **Q. DOES SOUTHWEST ALSO BRING MANAGEMENT EXPERTISE TO THE**  
127 **PROPOSED COMBINATION?**

128 A. Yes. SouthWest has a strong management team that cumulatively has decades of  
129 experience owning and operating water and wastewater utilities. As described  
130 more fully in Mr. Lubertozi's testimony, the proposed business combination will  
131 result in an executive leadership team that draws from the skilled management of  
132 both Corix US and SouthWest.

133 **Q. IN SUMMARY, DOES SOUTHWEST BRING FINANCIAL, OPERATIONAL/  
134 TECHNICAL, AND MANAGERIAL STRENGTHS TO THE PROPOSED  
135 COMBINATION?**

136 A. Yes, SouthWest's financial resources, strong leadership team, managerial  
137 expertise, and commitment to providing safe, adequate, and proper utility service  
138 to its customers make it an ideal owner of water and wastewater utilities.

139 **RESTRUCTURING PRIOR TO CLOSING**

140 **Q. PLEASE DESCRIBE THE SOUTHWEST PARTIES' RESTRUCTURING THAT  
141 WILL TAKE PLACE PRIOR TO CLOSING.**

142 A. Before this business combination occurs, SWMAC's shareholders will form a new  
143 holding company, SWMAC Holdco. SWMAC's shareholders will contribute certain  
144 assets, including SWMAC's stock, to SWMAC Holdco in exchange for limited  
145 partnership interests in SWMAC Holdco. This step will facilitate the contribution of  
146 SWMAC's stock to Corix US in exchange for the issuance of Corix US stock, as  
147 described in Mr. Lubertoizzi's testimony, and the merger of SWMAC with and into  
148 Corix US.

149 **COMMITMENTS FROM THE JOINT APPLICANTS**

150 **Q. PLEASE SUMMARIZE THE CUSTOMER PROTECTION COMMITMENTS THE  
151 JOINT APPLICANTS ARE MAKING TO THE COMMONWEALTH OF  
152 KENTUCKY.**

153 A. To ensure that WSCK's customers are held indifferent as a result of the proposed  
154 business combination, the Joint Applicants make the following commitments:

- 155 • WSKK will continue to provide high-quality water and utility service to its  
156 customers.
- 157 • WSKK will continue to maintain a strong local presence in Kentucky in terms  
158 of employees, offices, facilities, community support and local operations.
- 159 • The Joint Applicants have incurred and will incur transaction costs, but the  
160 Joint Applicants will not seek to recover transaction costs from customers.
- 161 • While the Transaction is not driven by net financial synergies, the Joint  
162 Applicants anticipate that the business combination will improve efficiency,  
163 and the integration of administrative and general functions should result in  
164 cost savings. The integration of CII's water, wastewater, and related  
165 businesses with SWMAC's water and wastewater business will be a  
166 significant, prolonged undertaking. The Joint Applicants acknowledge that  
167 costs and benefits associated with integration will be addressed in future  
168 ratemaking proceedings.
- 169 • Without the Public Service Commission of Kentucky's ("Commission") prior  
170 approval, WSKK will not guarantee any debt or credit instrument of  
171 Intermediate Newco or any affiliate of WSKK.
- 172 • The proceeds of any debt incurred by WSKK will only be used for purposes  
173 specific to their system or operations.
- 174 • Unless it first obtains the Commission's approval, WSKK will not transfer  
175 any material assets to Intermediate Newco or an affiliate except in an arm's  
176 length transaction and in compliance with the laws of Kentucky.

- 177 • The combined business will be established with a target investment grade  
178 capital structure profile and operated in a way that is consistent with  
179 maintaining an investment grade profile.
- 180 • Related to keeping a solid local presence, the Joint Applicants have  
181 committed to refrain from any involuntary reductions in force related to the  
182 combination for the first 12 months after the transaction closes.
- 183 • To present any new or amended affiliated interest agreement to the  
184 Commission for approval pursuant to KRS 278.2207 when required.

185 **REQUEST FOR CONFIDENTIAL TREATMENT**

186 **Q. ARE THE COMPANIES REQUESTING CONFIDENTIAL TREATMENT OF ANY**  
187 **INFORMATION INCLUDED IN THE APPLICATION?**

188 A. Yes, in addition to the request for approval of the proposed business combination,  
189 the Companies are seeking confidential treatment of certain commercially  
190 sensitive information deemed as proprietary. Per Kentucky's Open Records Act,  
191 confidential information may be protected from public disclosure if it is confidential  
192 or proprietary, and when publicly disclosed would permit an unfair commercial  
193 advantage to competitors of the entity that disclosed the records. The Joint  
194 Applicants are not seeking confidential treatment for any information that has been  
195 made public elsewhere, and they will submit redacted copies of documents that  
196 can be part of the public record.

197 **Q. IS THE PROPOSED COMBINATION OF CORIX US AND SWMAC**  
198 **CONSISTENT WITH THE TRANSFER-OF-CONTROL STANDARDS SET**  
199 **FORTH IN KRS 278.020(6) AND (7)?**

200 A. Yes. The combination involves two strong, complementary water and wastewater  
201 utility holding companies that will combine to create an even stronger new  
202 company. Through the combined financial, technical, and managerial resources of  
203 the two companies, the transaction will better facilitate needed infrastructure  
204 investments across our service territories, as well as continued growth of our  
205 businesses. There will be no adverse impact on service to WSCK's customers,  
206 and there will be positive benefits as well. The combination will allow the sharing  
207 of expertise and prudent practices across the various utility companies.  
208 Importantly, WSCK will continue to be locally managed while being supported with  
209 resources and expertise from the combined new company and will continue to  
210 provide support to the communities in which they serve.

211 **Q. DOES THIS CONCLUDE YOUR PREPARED DIRECT TESTIMONY?**

212 A. Yes, it does.





COMMONWEALTH OF KENTUCKY  
BEFORE THE PUBLIC SERVICE COMMISSION

In the Matter of )  
Application by Water Service Corporation )  
of Kentucky, along with Corix )  
Infrastructure (US) Inc. and SW Merger ) Case No. 2022-00396  
Acquisition Corp., for Approval of Transfer )  
of Control )

---

**DIRECT TESTIMONY OF**  
**JUSTIN KERSEY**

---

**Table of Contents**

WITNESS INTRODUCTION AND BACKGROUND ..... 1  
BACKGROUND OF WSCK ..... 3  
WSCK’S VISION AND VALUES ..... 4  
SUMMARY OF THE PROPOSED TRANSACTION ..... 5  
IMPACT ON WSCK..... 5  
OPERATIONAL BENEFITS ..... 7  
COMMITMENTS FROM THE JOINT APPLICANTS ..... 9

**PREPARED DIRECT TESTIMONY  
OF JUSTIN KERSEY  
ON BEHALF OF  
WATER SERVICE CORPORATION OF KENTUCKY**

**WITNESS INTRODUCTION AND BACKGROUND**

1 **Q. PLEASE STATE YOUR NAME, TITLE AND BUSINESS ADDRESS.**

2 A. My name is Justin Kersey. I am the President of Prairie Path Water Company in  
3 Illinois and Community Utilities of Indiana, Inc., and will be President of Water  
4 Service of Corporation of Kentucky (“WSCK” or the “Company”), after closing of  
5 the proposed transaction. All three companies are operating subsidiaries of Corix  
6 Regulated Utilities (US) Inc. (“CRU US”). My business address is 500 W. Monroe,  
7 Suite 3600, Chicago, Illinois 60661.

8 **Q. PLEASE DESCRIBE YOUR DUTIES IN YOUR CURRENT POSITION.**

9 A. As President of certain CRU US subsidiaries, I am responsible for all aspects of  
10 the operating subsidiaries’ business, culminating in the ongoing provision of safe  
11 drinking water and environmentally responsible wastewater service to all our  
12 customers.

13 **Q. PLEASE SUMMARIZE YOUR EDUCATIONAL AND PROFESSIONAL  
14 BACKGROUND.**

15 A. I graduated from Illinois State University in 2007 with a Bachelor of Science degree  
16 in Finance and Economics. I have been employed by CRU US since November of  
17 2008. I began my career with CRU US in the Accounting department and  
18 transitioned into the Finance department, where I assumed the role of Financial  
19 Planning and Analysis Manager in February of 2014. I assumed the role of Vice  
20 President of Operations in June 2016 and, in January 2021, I transitioned to

21 Director of Financial Planning and Analysis for the South Region of CRU US. In  
22 August 2022, I transitioned into my current role as President of Prairie Path Water  
23 Company and Community Utilities of Indiana, Inc.

24 **Q. WHAT ROLE DO YOU ANTICIPATE HAVING WITH WSCK AFTER CLOSING**  
25 **OF THE PROPOSED TRANSACTION?**

26 A. I have been asked to serve as the President of WSCK after closing. Current WSCK  
27 President Seth Whitney will continue to serve as the President of WSCK until the  
28 Proposed Transaction closes. Mr. Whitney will remain with Corix Infrastructure  
29 Inc.'s ("CII") district energy business following the transaction ("Proposed  
30 Transaction").

31 **Q. HAVE YOU PREVIOUSLY BEEN INVOLVED IN WSCK OPERATIONS?**

32 A. Yes. As noted above, I previously held the role of Vice President of Operations for  
33 the Midwest and Mid-Atlantic regions for CRU US, which included the operations  
34 of WSCK.

35 **Q. HAVE YOU PREVIOUSLY TESTIFIED BEFORE ANY PUBLIC UTILITY**  
36 **COMMISSIONS?**

37 A. Yes. I have provided written and oral testimony before public utility commissions  
38 throughout the United States, including the Public Service Commission of  
39 Kentucky ("Commission"). I have also testified before the Indiana Utility Regulatory  
40 Commission, the Public Utility Commission of Texas, the Louisiana Public Service  
41 Commission, the Illinois Commerce Commission, the State Corporation  
42 Commission of Virginia, and the Pennsylvania Public Utility Commission. I have  
43 provided testimony on nearly all topics supporting revenue requirements, including

44 cost of capital, revenue structure and adjustments, forecasted operations and  
45 maintenance (“O&M”) expenses, allocations from parent company and affiliate  
46 companies, income taxes, capital projects, and other plant spending. I have also  
47 provided testimony on nearly all aspects of utility operations, including compliance  
48 and safety, asset management planning, staffing requirements and identification  
49 and justification of capital investments, all to assure reliable, adequate,  
50 environmentally safe and cost-efficient services to our customers.

51 **Q. WHAT IS THE PURPOSE OF YOUR TESTIMONY?**

52 A. My testimony will provide background on the history and structure of WSCK; a brief  
53 summary of the business combination, which is primarily covered by other  
54 witnesses; anticipated impacts on WSCK; and other commitments.

55 **BACKGROUND OF WSCK**

56 **Q. PLEASE DESCRIBE THE HISTORY OF WSCK.**

57 A. WSCK is a Kentucky corporation and wholly owned subsidiary CRU US. CRU US  
58 is an Illinois corporation that owns more than 60 water and sewer utilities, including  
59 WSCK, operating in 17 states. CRU US has been involved in the water and sewer  
60 industry for over 60 years and has approximately 300,000 customers. CRU US  
61 continues to provide WSCK with the necessary funding and seasoned  
62 management through Water Service Corporation.

63 WSCK is an investor-owned utility pursuant to KRS 278.010, does business  
64 as a regulated water utility in Kentucky, and is subject to the regulatory oversight  
65 of this Commission. The Company presently serves approximately 6,150 water  
66 customers in Bell and Hickman counties in Kentucky.

67

**WSCK'S VISION AND VALUES**

68 **Q. WHAT ARE WSCK'S VISION AND VALUES?**

69 A. WSCK's vision is to be the preferred utility delivering solutions our customers want.  
70 WSCK's values include: safety, integrity, connection, and excellence. Our values  
71 enable our customers and stakeholders to enjoy a better life by improving utility  
72 infrastructure and operations while ensuring strong environmental stewardship in  
73 each community served.

74 **Q. HOW DOES WSCK PLAN TO ACHIEVE THIS VISION?**

75 A. We plan to achieve our vision by accomplishing the following strategic goals:

- 76 • Operational and Service Excellence – developing our people, strengthening  
77 our processes, and investing in our technology to support a high-  
78 performance organization and a culture of continuous improvement.
- 79 • Collaboration and Engagement – communicating and engaging with our  
80 team members, customers, and communities with relevant and timely  
81 billing, service, and operational information to improve stakeholder  
82 awareness and collaboration.
- 83 • Strong Financial Performance – managing and planning business costs,  
84 pursuing growth, and prudently mitigating enterprise risks to engender trust  
85 and confidence in our financial responsibility and ensure access to needed  
86 capital.
- 87 • World Class Talent – attracting and retaining top talent to deliver  
88 dependable, timely, courteous, and quality service.

89 **SUMMARY OF THE PROPOSED TRANSACTION**

90 **Q. PLEASE SUMMARIZE YOUR UNDERSTANDING OF THE PROPOSED**  
91 **TRANSACTION.**

92 A. As discussed by other witnesses, on August 26, 2022, Corix Infrastructure Inc.,  
93 Corix Infrastructure (US) Inc. ("Corix US"), IIF Subway Investment LP ("IIF  
94 Subway"), SW Merger Acquisition Corp. ("SWMAC") and SouthWest Water  
95 Company ("SouthWest") entered into a transaction agreement. Upon  
96 consummation of the Proposed Transaction, CII and an affiliate or affiliates of CII  
97 will own 50% of Corix US and SWMAC Holdco, an entity to be formed by SWMAC's  
98 shareholders before closing, will own the remaining 50% of Corix US (the  
99 "Proposed Transaction"). Corix US will own all of the stock of a new holding  
100 company, Intermediate Newco, and Intermediate Newco will indirectly own WSCK.

101 **IMPACT ON WSCK**

102 **Q. HOW WILL WSCK OPERATE AFTER THE PROPOSED TRANSACTION?**

103 A. As other witnesses explain, being locally led and locally operated are important to  
104 both CII and SouthWest. WSCK will continue to operate under its existing name  
105 and brand. Customers in Middlesboro and Clinton will continue to be served by a  
106 team of passionate, dedicated employees and leaders with local responsibility and  
107 accountability.

108 WSCK will continue to provide safe and reliable water service to its  
109 customers. WSCK will maintain employees, offices, and facilities consistent with  
110 its obligation to serve customers and intends to maintain a local presence. Corix

111 US's Chicago office will serve as the hub of the combined company's shared  
112 services operations.

113 **IMPACT ON THE COMMUNITIES SERVED BY WSCK**

114 **Q. PLEASE DESCRIBE WSCK'S COMMUNITY ENGAGEMENT ACTIVITIES.**

115 A. At WSCK, we look to connect with our community members and community  
116 leaders through various initiatives. We encourage employees to support the  
117 communities we serve. Over the past few years, WSCK has been involved in a  
118 variety of projects in our communities. One project that we are particularly proud  
119 of was the installation of a Splash pad in a local public park. WSCK has also  
120 planted trees throughout the community with local partnerships, participated in  
121 various street clean ups, historic church maintenance, even having cookouts for  
122 city employees. Our local manager Colby Wilson has given several presentations  
123 at the local elementary schools on the water cycle and water conservation, as well  
124 as having participated in a community "Pumpkin Drive," which provides a safe  
125 place for children to trick or treat.

126 WSCK prides itself in supporting the communities that support us. We are  
127 a proud sponsor of the Chamber of Commerce, Little League Baseball, and the  
128 Cumberland Mountain Fall festival. One of the more unique programs that has  
129 been a huge success for us is our operations apprenticeship program. We have  
130 employed 3 local high school/college students from our service community. These  
131 apprentices spend weekends and evenings working with our senior operators  
132 learning the water industry. Through this program, we were able to hire one full-  
133 time employee.



134 **Q. WILL WSCK CONTINUE TO ENCOURAGE EMPLOYEES TO SUPPORT**  
135 **COMMUNITY ENGAGEMENT ACTIVITIES?**

136 A. Absolutely. Both CII and SouthWest are dedicated to engaging with our customers  
137 and supporting our communities. The combined company will maintain its shared  
138 commitment to our communities and high customer service levels.

139 **OPERATIONAL BENEFITS**

140 **Q. WHAT OPERATIONAL BENEFITS DO YOU ANTICIPATE THIS BUSINESS**  
141 **COMBINATION WILL PRODUCE?**

142 A. SouthWest and CII share common values centered on safety, environmental  
143 stewardship, integrity, employee empowerment, and excellence in serving our  
144 customers and delivering on our commitments to stakeholders. These shared  
145 values provide an opportunity for operational improvement that follows from  
146 sharing prudent practices and resources.

147 **Q. PLEASE EXPLAIN WHAT YOU MEAN BY SHARING OF PRUDENT**  
148 **PRACTICES.**

149 A. Sharing prudent practices is part of continuous improvement, which we strive for  
150 at CII and our local operations at WSCK. Sharing these practices involves  
151 identifying optimal ways of efficiently performing certain tasks and operations and  
152 then implementing those practices deemed prudent.

153 **Q. HOW CAN SHARING OF PRUDENT PRACTICES BETWEEN CII AND**  
154 **SOUTHWEST IMPROVE THEIR UTILITY SUBSIDIARIES' PERFORMANCE --**  
155 **INCLUDING WSCK?**

156 A. Sharing of prudent practices will bring benefits to our customers. The sharing of  
157 prudent practices increases a company's knowledge base and enables improved  
158 decision-making through enhanced efficiency and competence. Examples of  
159 prudent practices that could benefit our customers include methods of addressing  
160 customer service questions/complaints, compliance with environmental  
161 regulations, safety initiatives, data security programs, and operational techniques.  
162 In short, sharing of prudent practices promotes continuous improvement, which  
163 ultimately leads to benefits for customers.

164 **Q. WILL THE PROPOSED TRANSACTION PROVIDE WSCK ACCESS TO A**  
165 **BROADER NETWORK FOR SHARING OF PRUDENT PRACTICES AND**  
166 **MUTUAL ASSISTANCE?**

167 A. Yes. Each water and wastewater utility within the combined company will have  
168 access to a broader network of knowledge and mutual assistance. Some examples  
169 include knowledge transfer, advanced technology, and greater efficiency.  
170 Likewise, if a natural or man-made disaster (e.g., a hurricane or cyber breach)  
171 were to disrupt WSCK's operations or operations staff, they would be able to draw  
172 from a larger pool of employees familiar with WSCK's processes, and these  
173 employees would be ready, willing, and able to assist our operations.

174 **Q. DOES RESOURCE SHARING REDUCE OPERATIONAL RISK?**

175 A. Yes, being part of a larger organization results in more resources, such as  
176 equipment, tools, inventory, and other assets that can be shared or leveraged in  
177 response to emergencies and natural disasters. Accordingly, sharing can reduce

178 operational risk by connecting to a broader group of vendors, providing for  
179 optionality in day-to-day operations and emergencies.

180 **COMMITMENTS FROM THE JOINT APPLICANTS**

181 **Q. DESCRIBED IN THE APPLICATION ARE SEVERAL CUSTOMER**  
182 **PROTECTION COMMITMENTS. WOULD YOU PLEASE COMMENT ON THESE**  
183 **COMMITMENTS?**

184 A. I agree with all of the commitments included in the Joint Application. WSCK will  
185 continue to focus on providing high-quality water service to its customers while  
186 maintaining a strong local presence in Kentucky in terms of employees, facilities,  
187 offices, and community support. WSCK also reiterates its commitments to refrain  
188 from any involuntary reductions in force related to the combination for the first 12  
189 months after the Proposed Transaction closes, and to present any new or  
190 amended affiliated interest agreement to the Commission for approval pursuant to  
191 KRS 278.2207 when required.

192 **Q. DOES THIS CONCLUDE YOUR PREPARED DIRECT TESTIMONY?**

193 A. Yes, it does.



COMMONWEALTH OF KENTUCKY  
BEFORE THE PUBLIC SERVICE COMMISSION

In the Matter of )  
Application by Water Service Corporation )  
of Kentucky, along with Corix )  
Infrastructure (US) Inc. and SW Merger ) Case No. 2022-00396  
Acquisition Corp., for Approval of Transfer )  
of Control )

---

**DIRECT TESTIMONY OF**  
**ELLEN LAPSON, CFA**

---

**Table of Contents**

- I. INTRODUCTION..... 1
- II. EXECUTIVE SUMMARY AND CONCLUSIONS..... 4
- III. TRANSACTION IMPACT ON THE UTILITY’S FINANCIAL STRENGTH..... 6
  - A. CURRENT OWNERSHIP AND FINANCIAL CIRCUMSTANCES ..... 6
  - B. IMPACT OF THE TRANSACTION ON THE UTILITY’S ACCESS TO EQUITY CAPITAL ..... 9
  - C. TRANSACTION IMPACT ON ACCESS TO DEBT CAPITAL AND CREDIT BY INTERMEDIATE  
NEWCO AND THE CONSOLIDATED GROUP..... 11
- IV. CONCLUSION AND RECOMMENDATIONS ..... 13

**EXHIBITS**

Exhibit EL-1 Lapson Experience and Credentials

**GLOSSARY OF ACRONYMS AND DEFINED TERMS**

<b><u>Acronym/Defined Term</u></b>	<b><u>Meaning</u></b>
BCI	British Columbia Investment Management Corporation. BCI manages assets for clients that include British Columbia public pension funds, insurance reserves and trust funds.
CII	Corix Infrastructure Inc. As of the closing of the Proposed Transaction, CII and an affiliate or affiliates, each directly or indirectly controlled by BCI, will own 50% of the outstanding stock issued by Corix US.
Corix US	Corix Infrastructure (US) Inc. Prior to the Proposed Transaction, Corix US is a subsidiary of CII; after the Proposed Transaction, Corix US is the parent of Intermediate Newco.
Commission	Public Service Commission of Kentucky
CRU US	Corix Regulated Utilities (US) Inc. CRU US owns 100% of the outstanding stock issued by Water Service Corporation of Kentucky (“WSCK”)
EBITDA	Earnings before Interest Expense, Income Tax, Depreciation and Amortization, a measure of cash flow.
FFO	Funds from Operations, calculated by S&P as EBITDA less cash interest paid and less cash tax paid.
IIF	Infrastructure Investments Fund. A private, open-ended investment vehicle focused on long-term critical infrastructure assets.
IIF Subway	IIF Subway Investment LP. Owns 75% of the outstanding stock issued by SWMAC. Bazos CIV, L.P. (“Bazos”) owns the remaining 25% of SWMAC’s stock. Bazos is indirectly owned by the German reinsurer, Munich RE (Münchener Rückversicherungs-Gesellschaft Aktiengesellschaft in München). As of the closing of the Proposed Transaction, a to-be-formed subsidiary of IIF Subway and Bazos, SWMAC Holdco, will own 50% of the outstanding stock issued by Corix US.

<u>Acronym/Defined Term</u>	<u>Meaning</u>
Intermediate Newco	An entity that will be formed for the sole purpose of owning all the water and wastewater businesses previously owned by CII and SouthWest. It will be directly owned by Corix US.
Joint Applicants	WSCK, Corix Infrastructure (US) Inc., and SW Merger Acquisition Corp.
Moody's	Moody's Investors Service
Proposed Transaction	Proposed combination of water, wastewater, and certain related holdings owned by Corix and Corix US with the holdings of SouthWest.
S&P	Standard & Poor's Ratings or S&P Global Ratings
SWMAC	SW Merger Acquisition Corp.
SWMAC Holdco	A to-be-formed entity that will be owned 75% by IIF Subway, with the remaining 25% owned by Bazos. As of the closing of the Proposed Transaction, SWMAC Holdco will own 50% of the outstanding stock issued by Corix US.
SouthWest	SouthWest Water Company
Utility	Water Service Corporation of Kentucky (also "WSCK")



**PREPARED DIRECT TESTIMONY AND EXHIBITS OF ELLEN LAPSON**

**I. INTRODUCTION**

1 **Q. PLEASE STATE YOUR NAME AND BUSINESS ADDRESS.**

2 A. My name is Ellen Lapson, CFA. My business address is 370 Riverside Drive, New  
3 York, New York 10025.

4 **Q. BY WHOM ARE YOU EMPLOYED AND IN WHAT CAPACITY?**

5 A. I am the founder and principal of Lapson Advisory, a private company that is a  
6 division of Trade Resources Analytics, LLC. Through Lapson Advisory, I provide  
7 independent consulting services relating to the financial strength of utilities and  
8 infrastructure companies. I advise client companies on access to capital and debt  
9 markets. I frequently testify as an expert witness relating to utility finance and utility  
10 capital market matters, including utility merger transactions.

11 **Q. PLEASE BRIEFLY DESCRIBE YOUR EDUCATIONAL AND PROFESSIONAL  
12 EXPERIENCE.**

13 A. I am a Chartered Financial Analyst (“CFA”) and earned a Master of Business  
14 Administration from New York University Stern School of Business with a  
15 specialization in accounting. I have worked in the capital markets space with  
16 particular focus on financing or analyzing the finances of regulated public utilities  
17 for the past 50 years. The list of my professional qualifications appears in Exhibit  
18 EL-1.

19 **Q. ON WHOSE BEHALF ARE YOU APPEARING IN THIS PROCEEDING?**

20 A. I am appearing on behalf of joint applicants Water Service Corporation of Kentucky  
21 (“WSCK or “Utility”), Corix Infrastructure (US) Inc. (“Corix US”), Corix Regulated

22 Utilities (US) Inc. (“CRU US”), and SW Merger Acquisition Corp. (“SWMAC”) in an  
23 application (“Application”) regarding a proposed business combination transaction.  
24 I herein refer to WSCK, Corix US, CRU US, and SWMAC as the “Joint Applicants.”

25 **Q. HAVE YOU PREVIOUSLY TESTIFIED BEFORE THIS OR OTHER UTILITY**  
26 **REGULATORY COMMISSIONS?**

27 A. Yes, I have previously testified as a financial expert in 13 state jurisdictions<sup>1</sup>, at the  
28 Federal Energy Regulatory Commission, and in US District Court as summarized  
29 in Exhibit EL-1.

30 **Q. WHAT IS THE BASIS FOR YOUR EXPERTISE IN MATTERS RELATING TO**  
31 **UTILITY MERGERS AND BUSINESS COMBINATIONS?**

32 A. Before I founded Lapson Advisory in 2012, I was a Senior Director and then a  
33 Managing Director at Fitch Ratings (“Fitch”), one of the three prominent credit  
34 rating agencies in the U.S. market. My team established and maintained the credit  
35 ratings of investor-owned electric, gas, and water utilities. For 17 years at Fitch, I  
36 performed credit evaluations and supervised other analysts to rate hundreds of  
37 electric, gas, and water utilities. Also, I supervised and wrote the credit rating  
38 methodologies applied to companies in the investor-owned electric, gas, and water  
39 sector. While at the credit rating agency, I was a member and then the chair of the  
40 Criteria Committee that oversaw Fitch’s global corporate rating criteria, including  
41 its policies on the credit effects of corporate structure. I closely studied the credit  
42 criteria and polices of the two other large credit rating agencies, Moody’s and S&P.

---

<sup>1</sup> Arkansas, Colorado, Delaware, District of Columbia, Hawaii, Illinois, Maryland, Massachusetts, New Jersey, New Mexico, New York, South Carolina, Texas.

43 Prior to joining Fitch, I was employed for 20 years from 1974 to 1994 in  
44 commercial banking and investment banking at Chemical Bank, a predecessor of  
45 JP Morgan Chase. In banking, I specialized in structuring financial transactions  
46 for regulated utilities, utility holding companies, and project-financed energy and  
47 natural resource projects, sometimes including bankruptcy-remote special  
48 purpose funding entities, partnership structures, and limited liability companies.

49 Since founding Lapson Advisory, I have served as an expert witness in  
50 regulatory proceedings involving the merger applications of several large electric  
51 or gas utilities on the financial aspects of the transaction and proposed corporate  
52 structure and governance upon a utility's future viability and financial strength.

53 **Q. WHAT IS THE PURPOSE OF YOUR TESTIMONY IN THIS PROCEEDING?**

54 A. I am testifying as a financial expert on behalf of the Joint Applicants regarding the  
55 future financial strength and suitability of Intermediate Newco as the parent of its  
56 water and wastewater utility subsidiaries. I also testify regarding the expected  
57 impact of the Proposed Transaction upon WSCK's future access to equity capital.  
58 In my view, the Proposed Transaction will have no adverse financial effect on  
59 WSCK and will have favorable financial impact upon WSCK and its customers by  
60 enhancing WSCK's access to capital.

61 **Q. HOW IS YOUR TESTIMONY ORGANIZED?**

62 A. The remainder of my testimony is comprised of the following sections:

63 II. Executive Summary and Conclusions

64 III. Transaction Impact on WSCK's Financial Strength

65 A. Current Ownership and Financial Circumstances

- 66 B. Impact of the Transaction on Utility's Access to Equity Capital  
67 C. Transaction Impact on Access to Debt Capital and Credit by  
68 Intermediate Newco and the Consolidated Group

69 **II. EXECUTIVE SUMMARY AND CONCLUSIONS**

70 **Q. PLEASE SUMMARIZE YOUR TESTIMONY AND CONCLUSIONS.**

71 A. I have reviewed the financial aspects of the Proposed Transaction with a focus  
72 upon how the change in the indirect ownership of WSCK as a result of the  
73 Proposed Transaction will affect the WSCK's ability to carry out its regulated water  
74 and wastewater business for the benefit of customers.

75 Water service is one of the most capital-intensive industrial sectors. WSCK  
76 must make ongoing capital investments in facilities to connect new customers,  
77 access water supplies, and update its assets. To fund its capital expenditures,  
78 WSCK needs access to equity and debt capital.

79 In the testimony that follows, I conduct four distinct analyses. First, I review  
80 the pro forma financial statements of the proposed Intermediate Newco. My  
81 analysis shows that the pro forma financial condition of Intermediate Newco is  
82 similar to the current financial status of the CII water, wastewater and related  
83 businesses.

84 Second, I review the likely effect of the change in owners upon WSCK's  
85 access to capital. As an indirect subsidiary of Intermediate Newco, WSCK will have  
86 access to equity capital funding superior to that which it now has as an indirect  
87 subsidiary of CII and direct subsidiary of Corix Regulated Utilities (US) Inc. ("CRU  
88 US"). The owners of Intermediate Newco will include two complementary sets of

89 private investors which together represent a very large funding pool committed to  
90 investing in essential infrastructure assets. BCI and IIF each manages funds on  
91 behalf of major investors with a long-term orientation, such as public pension  
92 funds.

93 Third, I review the continuing ability of WSCK's direct parent, CRU US to  
94 access the debt capital market to issue its long-term bonds and to obtain bank  
95 credit facilities. The Proposed Transaction will not disrupt CRU US's ongoing  
96 access to debt funding from the debt capital market and bank credit facilities, which  
97 should continue in the same manner as currently. Both CRU US and WSCK may  
98 benefit from the increased scale of Intermediate Newco and the addition of the  
99 strong relationships that IIF Subway and SWMAC have with the lending  
100 community. CRU US, and therefore WSCK, will not only have access to the same  
101 sources of debt capital as it does today, but it may receive additional attention and  
102 consideration from fixed income sources that have relationships with IIF Subway  
103 and SWMAC.

104 Finally, after the consummation of the Proposed Transaction, there are  
105 potential benefits in the form of future cost savings for WSCK due to the increased  
106 scale of the combined enterprise. Even though the transaction is not driven by net  
107 financial synergies, management expects scale and integration to yield financial  
108 benefits over time, which is likely to produce future benefits for WSCK and its  
109 customers.

110 Therefore, I conclude that there is no possibility of any harm to WSCK or its  
111 customers as a consequence of the Proposed Transaction, and in fact

112 Intermediate Newco will have superior capability to supply equity capital to WSCK  
113 for WSCK's future capital improvements.

114 **III. TRANSACTION IMPACT ON THE UTILITY'S FINANCIAL**  
115 **STRENGTH**

116 **A. Current Ownership and Financial Circumstances**

117 **Q. PLEASE DESCRIBE WSCK'S CURRENT OWNERSHIP AND THEIR**  
118 **OWNERSHIP AFTER THE PROPOSED TRANSACTION IS EFFECTIVE.**

119 A. WSCK is an indirect subsidiary of Corix US, which in turn is a direct subsidiary of  
120 CII. BCI indirectly controls CII. At the conclusion of the Proposed Transaction,  
121 WSCK will be indirect subsidiaries of Intermediate Newco.

122 **Q. AFTER THE CONSUMMATION OF THE PROPOSED TRANSACTION, WILL**  
123 **WSCK'S NEW INDIRECT PARENT HAVE A SOUND FINANCIAL CONDITION?**

124 A. Yes. The new indirect parent for all of the system water utilities will be Intermediate  
125 Newco. Intermediate Newco will have the benefit of greater size than either CII's  
126 water, wastewater and related businesses or SouthWest and will have credit  
127 characteristics that are consistent with those of investment grade rated peer  
128 companies in the water and wastewater industry.

129 **Q. UPON WHAT DO YOU BASE YOUR CONCLUSIONS?**

130 A. I reviewed the pro forma 2021 financial statements of Intermediate Newco  
131 prepared by sponsor companies SouthWest and CII. The pro forma income  
132 statement and balance sheet illustrate that the combined company will be  
133 approximately double the size of the CII water, wastewater and related businesses  
134 that are part of the business combination, as shown in Table 2 below. Increased

135 size and scale will give Intermediate Newco greater diversity (e.g., diverse  
136 geography, climate, and regulatory jurisdictions) which investors view as a  
137 favorable qualitative characteristic.

**Table 2: Size of Intermediate Newco Relative to Current SouthWest and Corix**  
(US \$, 000)

	Corix (a)	SouthWest	Intermediate Newco	Relative Size (b)	Relative Size (c)
Operating revenues	273,988	248,906	522,894	2.1	1.9
Operating income	51,331	58,551	109,882	1.9	2.1
Net income	24,265	23,662	47,927	2.0	2.0
Property, Plant & Equipmt.					
Net of Depreciation	1,112,073	768,340	1,880,413	2.4	1.7
Long-Term Capital	818,942	1,116,044	1,934,986	1.7	2.4

a. Adjusted to eliminate Corix businesses not included in the business combination.

138 b. Intermediate Newco divided by SouthWest; c. Divided by original Corix.

139 Second, I compared the pro forma financial ratios of Intermediate Newco relative  
140 to the key financial credit ratios of peer water companies that have investment grade  
141 credit ratings. Table 3 compares Intermediate Newco with two companies, Essential  
142 Utilities and SJW Group, both rated in the investment grade category by S&P. I compared  
143 Intermediate Newco to water companies with S&P ratings because S&P rates more  
144 companies in the water and wastewater sector than any other credit rating agency. I  
145 matched Intermediate Newco's key financial credit ratios with those of these two peer  
146 companies; all three companies have key credit ratios that are in a comparable range.  
147 This analysis confirms my view that Intermediate Newco will have financial ratios and  
148 credit characteristics that are consistent with those of investment grade-rated water utility  
149 peers.

**Table 3: Intermediate Newco Compared to Peer Water Companies**

Period	Intermediate	Essential	SJW Group
	Newco	Utilities	
	12/31/21 PF	12/31/2020(a)	12/31/2020 (b)
<b>RATIOS</b>			
FFO to Debt	10.2%	9.1%	8.4%
Debt to EBITDA	6.8	8.2	7.7
FFO interest coverage	3.4	4.0	3.1
EBITDA Margin	35.2%	48.4%	37.7%

Notes: PF = Pro Forma

a. Source: S&P Global Ratings Direct, "Essential Utilities", Feb. 3, 2022

b. Source: S&P Global Ratings Direct, "SJW Group", Nov. 23, 2021

150

151 **Q. WHAT IS WSCK'S CURRENT FINANCIAL CONDITION?**

152 A. WSCK is a corporation that is in good standing. CRU US also is a corporation that  
 153 is in good standing. It is solvent and financially sound, and not in default of any  
 154 credit agreements or notes.

155 **Q. WHAT ARE WSCK'S CURRENT SOURCES OF EQUITY CAPITAL?**

156 A. WSCK's two sources of equity are retained earnings and equity contributions from  
 157 CRU US. CRU US in turn raises equity through its relationship with CII and,  
 158 ultimately, its relationship with BCI.

159 **Q. UNDER ITS CURRENT OWNERSHIP, WHAT ARE WSCK'S SOURCES OF**  
 160 **DEBT CAPITAL AND CREDIT?**

161 A. CRU US raises debt capital by means of the issuance of long-term collateral trust  
 162 notes in the private placement market. CRU US currently has \$326 million of such  
 163 debt outstanding. In addition, CRU US has a delayed draw term loan in the amount  
 164 of \$75 million, with \$50 million outstanding (and \$25 million available). CRU US  
 165 also has a bank credit agreement and may borrow up to \$80 million under that  
 166 agreement.



167 **B. Impact of the Transaction on the Utility's Access to Equity**  
168 **Capital**

169 **Q. HOW WILL WSCK FULFILL ITS NEEDS FOR EQUITY CAPITAL AFTER THE**  
170 **PROPOSED TRANSACTION?**

171 A. If new equity is needed to fund capital investment, the indirect co-owners SWMAC  
172 Holdco and CII (and an affiliate or affiliates) would likely be able to obtain infusions  
173 of equity to invest in their indirect subsidiary from IIF Subway and Bazos and  
174 investments managed by BCI. The Proposed Transaction increases and  
175 diversifies the base of equity upon which WSCK can draw in the future relative to  
176 the current sources of equity funding.

177 **Q. PLEASE DESCRIBE THE ROLE OF BCI AND IIF WITHIN THE CAPITAL**  
178 **MARKET.**

179 A. BCI is a highly regarded investment management company founded in 1999. BCI  
180 is a statutory corporation created by the Public Sector Pension Plans Act (British  
181 Columbia) for the purpose of providing investment management services to British  
182 Columbia's public sector. BCI manages approximately \$211 billion (CAD) of assets  
183 on behalf of its clients, which include 11 public sector pension plans, three  
184 insurance funds and various special purpose funds. The public sector pension  
185 funds include public sector employees such as teachers, municipal and provincial  
186 employees. Through its infrastructure and renewable resources program, BCI  
187 seeks long-term, stable investments around the world in regulated utilities,  
188 transportation, telecommunications, and other infrastructure-based industries. The  
189 BCI infrastructure and renewable resources program has made net new

190 investments in utility and infrastructure assets in the past five years of  
191 approximately \$4.2 billion (CAD).

192 IIF is an approximately \$26 billion<sup>2</sup> open-ended private investment vehicle  
193 focused on investing in critical infrastructure assets. It is responsible for investing  
194 and growing the retirement money of more than 60 million families. IIF is a long-  
195 term owner of companies that provide essential services, including water, natural  
196 gas and electric utility services, renewable energy, and transportation  
197 infrastructure, which are all vital to the communities in which they operate. As of  
198 June 30, 2022, IIF owned 20 companies throughout North America, Europe, and  
199 Australia. Since acquiring SouthWest in 2010, IIF has supported over \$500 million  
200 in capital expenditures for critical infrastructure for SouthWest's water and  
201 wastewater businesses.

202 In summary, these owners are well respected entities within the capital  
203 markets. The objectives and investment styles of the IIF and BCI investors are in  
204 harmony, with a strong emphasis on long-term, stable, and low-volatility  
205 investment.

206 **Q. DO YOU SEE ANY BENEFITS FOR WSCK FROM THE GREATER SIZE OF THE**  
207 **COMBINED INTERMEDIATE NEWCO AND FROM OWNERSHIP BY IIF**  
208 **SUBWAY IN ADDITION TO BCI?**

209 A. Yes, small water utilities suffer a disadvantage attracting the attention of, and  
210 raising capital in, the equity market. Private investors such as IIF and BCI are

---

<sup>2</sup> As of June 30, 2022.

211 ideally suited to supply common equity to WSCK if equity is needed for future  
212 capital expenditures.

213 There is very little if any overlap between the investors in IIF and the BCI  
214 investor group, so joining these two sets of investors as equity sponsors will  
215 expand the pool of equity capital from which Intermediate Newco's utility  
216 subsidiaries may receive equity infusions when they are needed.

217 Also, there may be scale benefits for WSCK from association with a larger  
218 enterprise, such as more attention from debt lenders and credit providers, as I will  
219 discuss below. Furthermore, the IIF and BCI portfolio companies involved in the  
220 Proposed Transaction have management expertise and strong relationships  
221 throughout the water and utility industry. This combination will broaden the  
222 network of professionals to share best practices on important priorities such as  
223 health and safety, cybersecurity, operational excellence, and other areas of shared  
224 interest.

225 **C. Transaction Impact on Access to Debt Capital and Credit by**  
226 **Intermediate Newco and the Consolidated Group**

227 **Q. WILL THERE BE ANY ADVERSE EFFECT ON INTERMEDIATE NEWCO'S**  
228 **ACCESS TO DEBT OR CREDIT DUE TO THE PROPOSED TRANSACTION?**

229 A. Quite the contrary. Going forward, Intermediate Newco should have access to a  
230 broader and more diverse group of lenders than at present. For example, there  
231 are currently 23 major private placement lenders that invest in bonds of CII or  
232 SWWC-affiliated companies. Only three of those private placement lenders  
233 currently are lenders to both groups, indicating only a 13% overlap among the

234 lender groups. Moreover, CRU US should be able to issue private placement  
235 bonds, in the same manner as in the past and, similar to Intermediate Newco, it  
236 may benefit from an expansion of the field of interested bond investors. The  
237 business combination thus will result in a significant expansion of the potential  
238 lenders that have current relationships.

239 **Q. WILL INTERMEDIATE NEWCO OBTAIN PUBLIC CREDIT RATINGS AFTER**  
240 **THE PROPOSED TRANSACTION?**

241 Not in the near term. I am not aware of any plans by management to seek public  
242 credit ratings at this time. In the future, Intermediate Newco may consider the  
243 economic costs of obtaining and maintaining a public rating versus any market  
244 benefits of obtaining such rating or ratings. Going forward, Intermediate Newco's  
245 needs could be fulfilled with private placement funding that may not require a public  
246 credit rating and with a multi-year bank credit facility. However, as noted in the  
247 Application, it is intended that Intermediate Newco will be established and operated  
248 in a manner that that is consistent with that of investment grade entities in the water  
249 utility industry.

250 **Q. HAVE THE JOINT APPLICANTS MADE ANY COMMITMENTS REGARDING**  
251 **ITS FUTURE FINANCIAL PRACTICES AND POLICIES TO PROTECT THE**  
252 **UTILITY'S FINANCIAL WELL-BEING?**

253 **A.** Yes. A complete set of these commitments can be found in the Application.

254

**IV. CONCLUSION AND RECOMMENDATIONS**

255

**Q. PLEASE SUMMARIZE YOUR DIRECT TESTIMONY.**

256

A. The Proposed Transaction creates no new risks to WSCK or to its customers. After  
257 the closing, WSCK will have superior access to common equity funding via  
258 ownership by BCI plus IIF Subway relative to the current situation with ownership  
259 by BCI alone. Furthermore, going forward WSCK will have comparable access to  
260 the debt capital market and either similar or superior access to bank credit relative  
261 to its current situation as a subsidiary of CII.

262

Also, there are potential benefits in the form of future cost savings for WSCK  
263 due to the doubling of scale of the combined enterprise. I also understand that,  
264 even though the transaction is not driven by net financial synergies, management  
265 expects scale and integration to yield financial benefits over time. Based on the  
266 approximately doubled size of the combined entities, management's intention to  
267 lower costs in overhead categories and shared services seems quite reasonable,  
268 in my professional opinion.

269

Therefore, I recommend that the Commission approve the Proposed  
270 Transaction.

271

**Q. DOES THIS CONCLUDE YOUR DIRECT TESTIMONY?**

272

A. Yes, it does.

**VERIFICATION**

STATE OF NEW YORK                    )  
  )  
COUNTY OF MANHATTEN            )

Ellen Lapson, being duly sworn, deposes and says that she is the founder and principal of Lapson Advisory and that she has personal knowledge of the matters set forth in the foregoing Direct Testimony and the information contained therein is true and correct to the best of his information, knowledge, and belief after reasonable inquiry.

  
Ellen Lapson

Subscribed and sworn to before me, and for the above County and State, on this, the 21<sup>st</sup> day of November, 2022 by Ellen Lapson.

My Commission expires: September 20, 2024

  
NOTARY  
JIMMY MA  
Notary Public, State of New York  
No. 01MA6116017  
Qualified in New York County  
Commission Expires Sept. 20, 2024

**EXPERIENCE AND QUALIFICATIONS**

**ELLEN LAPSON, CFA**

370 Riverside Drive, Apt. 9D

New York, NY 10025-2179

Phone +1-212-866-1040; Mobile +1-646-872-4568

[www.lapsonadvisory.com](http://www.lapsonadvisory.com)

LAPSON ADVISORY: Financial Consulting. Expert Testimony. Financial Training.

**SUMMARY**

Expert on financing utilities and infrastructure projects, with over 50 years of professional MBA Accounting and finance, NYU Stern School of Business; Chartered Financial Analyst

**EMPLOYMENT HISTORY**

<b>Lapson Advisory,</b> Trade Resources Analytics	Financial consulting services to utilities and infrastructure project developers. Financial strategy and credit advisory; expert financial witness.	2012 to present
<b>Fitch Ratings</b> Utilities, Power & Gas Managing Director; Senior Director	Manager or primary analyst on credit ratings of over 200 utility, pipeline, and power generation companies and utility tariff securitizations. Chaired rating committees for energy, utility, and project finance committees. Liaison with major fixed income investors.	1994 - 2011
<b>JP Morgan Chase</b> (formerly Chemical NY Corp.) Vice President, 1975-94 Asst. Vice President, 1974-75	Managed financial advisory transactions, structured debt placements, syndicated credit facilities for utilities, mining and metals, project finance. First of its kind stranded cost securitization for Puget Sound P&L, 1992-94. Led financings for utilities in bankruptcy or reorganizations. Divisional controller, 1981-86.	1974-1994
<b>Argus Research Corp.</b> Equity Analyst, Utilities	Equity analysis of U.S. electric and gas utilities, natural gas pipelines, regulated telephone companies. Research coverage and reports; forecasts and models.	1969-1974

**EDUCATION & PROFESSIONAL ORGANIZATIONS**

Stern School of Business, New York University, MBA. Accounting major; Finance minor	1975
Barnard College, Columbia University, BA. Earned CFA Institute Charter, 1978	1969
Institute of Chartered Financial Analysts	Since 1978
Wall Street Utility Group	Since 1996

**ADVISORY COUNCILS AND BOARD SERVICE**

Electric Power Research Institute, Advisory Council, 2004-2011; Chair, 2009 and 2010.  
 MIT Energy Institute, External Advisory Council, The Future of Solar Energy, 2012-2014.  
 Represented U.S. fixed income investors in responding to proposed financial accounting rules for rate-regulated utilities by the International Accounting Standards Board (IASB) at a panel sponsored by Edison Electric Institute and American Gas Assoc., December, 2014.

**EXPERT TESTIMONY**

<b>Jurisdiction</b>	<b>Proceeding</b>	<b>Topic</b>
Federal Energy Regulatory Commission	Docket No. ER22-2379, Southwest Power Pool, Inc., supporting Southwestern Public Service Co.'s right under Generator Interconnection Agreement (2022)	Application by a transmission owner to fund investment in Network Upgrades
Federal Energy Regulatory Commission	Docket No. ER22-2274, Southwest Power Pool, Inc., supporting Southwestern Public Service Co.'s right under Generator Interconnection Agreement (2022)	Application by a transmission owner to fund investment in Network Upgrades
Massachusetts Department of Public Utilities	DPU Docket No. 22-70, 22-71, 22-72; Long-term purchase contracts for offshore wind energy by Eversource, National Grid, Unitil (2022)	Remuneration to distribution utilities for entering into long-term supply contracts
New Jersey Board of Public Utilities	BPU Docket No. GM 2204, Merger Application of South Jersey Industries, Inc. and Boardwalk Merger Sub, Inc. on behalf of Joint Applicants (2022)	Financial strength in the context of merger proceeding and appropriate corporate commitments.
Public Utilities Commission Texas	Docket No. 53601, Application of Oncor Electric Delivery LLC to Change Rates, on behalf of Oncor. (2022)	Financial strength and appropriate capital structure.
Public Utilities Commission Texas	Docket No. 52487, Application of Entergy Texas to Alter its CCN for Orange County Advanced Power Station, on behalf of Entergy Texas, Inc. (2022)	Impact of a power purchase contract on the balance sheet, financial ratios, and credit ratings of the utility purchaser.
Federal Energy Regulatory Commission	Docket No. ER21-2282, Application re Open Access Transmission Tariff, on behalf of PJM Transmission Owners (2022)	Application by Transmission Owners to invest in Network Upgrades
Federal Energy Regulatory Commission	Docket No. EL-20-72, LA Public Service Comm. et al. vs. System Energy Resources, Inc. on behalf of SERI (2022)	Financial impact of the termination of a support agreement; capital structure.
Federal Energy Regulatory Commission	Docket No. RM20-10-000, Electric Transmission Incentive Policy, on behalf of PJM Transmission Owners (2021)	In support of financial incentives for RTO membership
Public Utilities Commission of Colorado	Proceeding No. No. 21R-0314G, NOPR on Purchased Gas Cost Adjustment on behalf of Public Service Company of CO (2021)	Investor and credit rating impact of proposed gas cost recovery rules
New Mexico Public Regulation Commission	Docket No 20-00222-UT, Application of Public Service Co. of NM, PNM Resources, Avangrid Inc., and NM Green Resources on behalf of Applicants (2020-21)	Financial strength and resilience in the context of merger proceeding



Jurisdiction	Proceeding	Topic
Public Utilities Commission Texas	Docket No 51547, Application of Texas-New Mexico Power Co., Avangrid Inc., and NM Green Resources on behalf of the Joint Applicants (2020-21)	Financial strength and resilience in the context of merger proceeding
Massachusetts Department of Public Utilities	DPU 20-16, 20-17, and 20-18, Long-term purchase contract for offshore wind energy, Eversource, National Grid, Unitil (2020)	Remuneration to utilities for entering into long-term contracts
Public Utilities Commission Texas	Docket No. 49849, Joint Application of El Paso Electric, Sun Jupiter Holdings and IIF US Holding 2 to acquire El Paso Electric... (2019-20)	Conditions & commitments for utility merger and formation of holdco; financial strength
New Mexico Public Regulation Commission	Docket No. 19-00234 UT, Joint Application of El Paso Electric, Sun Jupiter Holdings, and IIF US Holding 2 to acquire El Paso Electric (2019-20)	Conditions & commitments for utility merger and formation of holdco; financial strength
Public Utilities Commission of Colorado	Proceeding No. 19AL-0268E, Filing to Revise Electric Tariff, on behalf of Xcel Public Service Co, of Colorado (2019)	Capital structure and cash flow measures
Public Utilities Commission Texas	Docket No. 49421, Application of CenterPoint Energy Houston to change rates, on behalf of CEHE (2019)	Separateness commitments in the context of a rate proceeding; financial strength
Public Utilities Commission Texas	Docket No. 48929, Application of Oncor Electric Delivery Co. LLC, Sharyland Utilities LP, and Sempra Energy, on behalf of Sharyland Utilities (2019)	Appropriate governance conditions and commitments for partner ownership of an electric transmission utility
Public Utilities Commission of Colorado	Proceeding No. 17AL-0363G, Filing to Revise Gas Tariff, on behalf of Xcel Public Service Co, of Colorado (2018)	Cash flow and credit impacts of tax reform; capital structure
South Carolina Public Service Commission	Docket No. 2017-370-E; Joint Application for Merger and for Prudency Determination, on behalf of South Carolina Electric & Gas Company (2018)	Benefits of merger and proposed rate plan; impact on cash flow and access to capital.
U.S. Federal District Court, District of SC	Civil Action No.: 3:18-cv-01795-JMC, Motion for Preliminary Injunction, on behalf of South Carolina Electric & Gas	Financial harm of rate cut compliant with Act
Public Utilities Commission Texas	Docket No. 48401, Texas-New Mexico Power Co. Application to Change Retail Rates, on behalf of TNMP (2018)	Cash flow and credit impacts of tax reform
Public Utilities Commission Texas	Docket No. 48371, Entergy Texas Inc., Application to Change Retail Rates, on behalf of ETI (2018)	Cash flow and credit impacts of tax reform

<b>Jurisdiction</b>	<b>Proceeding</b>	<b>Topic</b>
Public Utilities Commission Texas	Docket No. 47527, Southwestern Public Service Co. Application for Retail Rates, on behalf of SPS Co. (2018)	Adverse cash flow and credit impacts of tax reform; cap structure
New Mexico Public Regulation Commission	Case No. 17-00255-UT, Southwestern Public Service Co. Application for Retail Rates, on behalf of SPS Co. (2018)	Adverse cash flow and credit impacts of tax reform; cap structure
South Carolina Public Service Commission	Docket No. 2017-305-E, Response to ORS Request for Rate Relief, on behalf of S. Carolina Electric and Gas (2017)	Adverse financial implications of rate reduction sought by ORS
DC Public Service Commission	Formal Case No. 1142, Merger Application of AltaGas Ltd. and Washington Gas Light, Inc. (2017)	Financial strength; Conditions and commitments in a utility merger
Public Service Commission of Maryland	Docket No. 9449, In the Matter of the Merger of AltaGas Ltd. and Washington Gas Light, Inc. (2017)	Financial strength; Conditions and commitments in a utility merger
Public Utilities Commission Texas	Docket No. 46957, Application of Oncor Electric Delivery LLC to Change Rates, on behalf of Oncor. (2017)	Appropriate capital structure. Financial strength.
Public Utilities Commission Texas	Docket No. 46416, Application of Entergy Texas, Inc. for a Certificate of Convenience & Necessity, on behalf of Entergy Texas (2016-2017)	Debt equivalence and capital cost associated with capacity purchase obligations (PPA)
U.S. Federal Energy Regulatory Commission	Dockets No. EL16-29 and EL16-30, NCEMC, et al. vs Duke Energy Carolinas and Duke Energy Progress, on behalf of the Respondents (2016)	Capital market environment affecting the determination of the cost of equity capital
Hawaii Public Utilities Commission	Docket No. 2015-0022, Merger Application on behalf of NextEra Energy and Hawaiian Electric Inc. (2015)	Financial strength and conditions & commitments in merger context
U.S. Federal Energy Regulatory Commission	Dockets No. EL14-12 and EL15-45, ABATE, vs MISO, Inc. et al., on behalf of MISO Transmission Owners (2015)	Capital market environment; capital spending and risk
U.S. Federal Energy Regulatory Commission	Dockets No. EL12-59 and 13-78, Golden Spread Electric Coop., on behalf of Southwestern Public Service Co. (2015)	Capital market environment; capital spending and risk
U.S. Federal Energy Regulatory Commission	Dockets No. EL13-33 and EL14-86, on behalf of New England Transmission Owners. (2015)	Capital market environment affecting the cost of equity capital
U.S. Federal Energy Regulatory Commission	Dockets No. ER13-1508 et alia, Entergy Arkansas, Inc. and other Entergy utility subsidiaries, on behalf of Entergy (2014)	Capital market environment affecting the measurement of the cost of equity capital

<b>Jurisdiction</b>	<b>Proceeding</b>	<b>Topic</b>
Delaware Public Service Commission	DE Case 14-193, Merger of Exelon Corp. and Pepco Holdings, Inc. on behalf of the Joint Applicants (2015)	Financial strength and conditions & commitments in merger context
Maryland Public Service Commission	Case No. 9361, Merger of Exelon Corp. and Pepco Holdings, Inc. on behalf of the Joint Applicants (2015)	Financial strength and conditions & commitments in merger context
New Jersey Board of Public Utilities	BPU Docket No. EM 14060581, Merger of Exelon Corp. and Pepco Holdings, Inc., on behalf of the Joint Applicants (2015)	Financial strength and conditions & commitments in merger context
U.S. Federal Energy Regulatory Commission	Docket ER15-572 Application of New York Transco, LLC, on behalf of NY Transmission Owners (2015)	Incentive compensation for electric transmission; capital market access
U.S. Federal Energy Regulatory Commission	Docket EL 14-90-000 Seminole Electric Cooperative, Inc. and Florida Municipal Power Agency vs. Duke Energy FL on behalf of Duke Energy (2014)	Capital market environment affecting the determination of the cost of equity capital
DC Public Service Commission	Formal Case No. 1119 Merger of Exelon Corp. and Pepco Holdings Inc., on behalf of the Joint Applicants (2014-2015)	Financial strength and conditions & commitments in merger context
U.S. Federal Energy Regulatory Commission	Docket EL14-86-000 Attorney General of Massachusetts et. al. vs. Bangor Hydro-Electric Company, et. al., on behalf of New England Transmission Owners (2014)	Return on Equity; capital market environment
Arkansas Public Service Commission	Docket No. 13-028-U. Rehearing on behalf of Entergy Arkansas. (2014)	Investor and rating agency reactions to ROE set by Order.
Illinois Commerce Commission	Docket No. 12-0560 Rock Island Clean Line LLC, on behalf of Commonwealth Edison Company, an intervenor (2013)	Access to capital for a merchant electric transmission line.
U.S. Federal Energy Regulatory Commission	Docket EL13-48-000 Delaware Public Advocate, et. al. vs. Baltimore Gas and Electric Company and PEPCO Holdings et al., on behalf of (i)Baltimore Gas and Electric; (ii) PEPCO subsidiaries (2013)	Return on Equity; capital market view of transmission investment
U.S. Federal Energy Regulatory Commission	Docket EL11-66-000 Martha Coakley et. al. vs. Bangor Hydro-Electric Company, et. al. on behalf of New England Transmission Owners (2012-13)	Return on Equity; capital market view of transmission investment
New York Public Service Commission	Cases 13-E-0030; 13-G-0031; and 13-S-0032 on behalf of Consolidated Edison Company of New York. (2013)	Cash flow and financial strength; regulatory mechanisms

Jurisdiction	Proceeding	Topic
Public Service Commission of Maryland	Case. 9214 re “New Generating Facilities To Meet Long-Term Demand For Standard Offer Service”, on behalf of Baltimore Gas and Electric Co., Potomac Electric Power Co., and Delmarva Power & Light (2012)	Effect of proposed power contracts on the credit and financial strength of MD utility counterparties

**CONSULTING & ADVISORY ASSIGNMENTS** <sup>(1)</sup>

Client	Assignment	Objective
Utilities (undisclosed)	Credit advisory. 2022	Plan for financial impacts of a merger.
Xcel Energy/ Public Service Co. of CO	Studied likely investor and credit impact of the PSC’s proposed changes in the recovery of purchased gas cost (Docket 21R-0314G). 2021	Analyze financial impacts of regulatory proposal.
Eversource Energy Inc./Public Service Co. of New Hampshire	White paper analyzing the financial implications of two methods for recovering costs of energy efficiency programs (related to Docket DE 20-092). 2020	Analyze feasibility and financial impacts of regulatory proposal; prepare white paper
Washington Gas Light Co.	Quantified the effect of merger upon the cost of long-term and short-term debt. 2019	Comply with regulatory requirement
Cravath, Swaine & Moore LLP	Evaluated factors that influenced utility spending decisions on operations, maintenance, and capital projects. 2019	Support litigation strategy in bankruptcy proceedings.
NJ American Water Co.	Analyzed impacts of tax reform on water utility’s cash flow and ratings. 2018	Support regulatory strategy
AltaGas Ltd.	Credit advisory on ratings under merger and no-merger cases. 2017	Compare strategic alternatives
Entergy Texas, Inc.	Research study on debt equivalence and capital cost associated with capacity purchase obligations. Impact of new GAAP lease accounting standard on PPAs. 2016	Economic comparison of power purchase obligations and self-build options.
Eversource Energy	Evaluated debt equivalence of power purchase obligations. 2014	Clarify credit impact of various contract obligations.
International Money Center Bank (Undisclosed)	Research study and recommendations on estimating Loss Given Default and historical experience of default and recovery in regulated utility sector. 2014	Efficient capital allocation for loan portfolio.
GenOn Energy Inc.	White Paper on appropriate industry peers for a competitive power generation and energy company. 2012	Appropriate peer comparisons in SEC filings and shareholder communications, compensation studies
Transmission utility (Undisclosed)	Recommended the appropriate capital structure and debt leverage during a period of high capital spending. 2012	Efficient book equity during multi-year capex project; preserve existing credit ratings

Jurisdiction	Proceeding	Topic
Toll Highway (Undisclosed)	Advised on adding debt while minimizing risk of downgrade. Recommended strategy for added leverage and rating agency communications. 2012	Free up equity for alternate growth investments via increased leverage while preserving credit ratings
District Thermal Cooling Project (Undisclosed)	Recommended a project loan structure to deal with seasonal cash flow. Optimized payment schedule, form and timing of financial covenants.	Reduce default risk; efficient borrowing structure

1. Confidential assignments are omitted or client's identity is masked, at client request.

### Professional and Executive Training

Southern California Edison Co., Rosemead CA	Designed and delivered in-house training program on evaluation of the credit of energy market counterparties. 2016	
Financial Institution, NYC (Undisclosed)	In-house training. Developed corporate credit case for internal credit training program and coordinated use in training exercise. 2016	
CoBank, Denver CO	Designed and delivered "Midstream Gas and MLPs: Advanced Credit Training". 2014	
Empire District Electric Co., Joppa MO	Designed and delivered in-house executive training session Utility Sector Financial Evaluation. 2014	
PPL Energy Corp, Allentown PA	Designed and delivered in-house Financial Training. 2014	
SNL Knowledge Center Courses, New York NY	Designed and delivered public courses "Credit Analysis for the Power & Gas Sector", 2011-2014	
SNL Knowledge Center Courses, New York NY	Designed and delivered public courses "Analyst Training in the Power & Gas Sectors: Financial Statement Analysis. 2013 -2014	
EEI Transmission and Wholesale Markets	Designed and delivered "Financing and Access to Capital". 2012	
National Rural Utilities Coop Finance Corp.	Designed and delivered in-house training "Credit Analysis for the Power Sector". 2012	
Judicial Institute of Maryland	Designed and delivered "Impact of Court Decisions on Financial Markets and Credit", section of continuing education seminar for MD judges: "Utility Regulation and the Courts", Annapolis MD. 2007	
Edison Electric Institute, New York, NY	"New Analyst Training Institute: Fixed Income Analysis and Credit Ratings", 2008; 2004	

**SW Merger Acquisition Corp.  
Historical Financials**

**Statement of Operations  
(Unaudited)**

	<b>For the Year Ended  December 31, 2021</b>
<b>INCOME</b>	
Equity Income	\$ 23,590,624
<b>Total income</b>	<b>23,590,624</b>
<b>EXPENSES</b>	
Tax Benefit	(3,020,378)
Interest Expense	13,176,079
<b>Total expenses</b>	<b>10,155,700</b>
<b>Total gain</b>	<b>\$ 13,434,923</b>

**Balance Sheet  
(Unaudited)**

	<b>As of December 31,  2021</b>
<b>ASSETS</b>	
Cash	\$ 11,195
Intercompany Receivable	8,929,859
Investment in SouthWest Water Company	443,571,625
<b>Total assets</b>	<b>\$ 452,512,679</b>
<b>LIABILITIES AND EQUITY</b>	
Note Payable	\$ 169,486,595
Accrued interest	3,262,617
Intercompany payable	934,147
<b>Total liabilities</b>	<b>173,683,359</b>
<b>Total Equity</b>	<b>278,829,320</b>
<b>Total liabilities and equity</b>	<b>\$ 452,512,679</b>

**Water Service Corporation of Kentucky**  
**Case No. 2022-00396**  
**Historical Financials**  
**For the twelve months ending December 31, 2021**

Line No.	Description	2021
1	OPERATING INCOME:	
2	Operating Revenues	\$ 3,406,420
3		
4	Operating Expenses	2,855,773
5	Depreciation Expenses	329,285
6	Amortization of Utility Plant Acquisition Adjustment	(3,660)
7	Taxes Other Than Income	164,921
8	Income Taxes	99,295
9	Utility Operating Expenses (Lines 4 to 8)	<u>3,445,614</u>
10		
11	Utility Operating Income (Line 2 - Line 9)	(39,194)
12		
13	Income From Utility Plant Leased to Others	
14	Gains (Losses) from Disposition of Utility Property	
15	Total Utility Operating Income (Line 11 + Lines 13 to 14)	<u>(39,194)</u>
16		
17	OTHER INCOME AND DEDUCTIONS:	
18	Revenues From Merchandising, Jobbing and Contract Work	
19	Costs and Expenses of Merchandising, Jobbing and Contract Work	
20	Interest and Dividend Income	
21	Allowance for funds Used During Constructions	154
22	Nonutility Income	
23	Miscellaneous Nonutility Expenses	
24	Total Other Income and Deductions (Lines 18 to 23)	<u>154</u>
25		
26	INTEREST EXPENSE:	
27	Interest Expense	137,627
28	Amortization of Debt Discount and Exp.	
29	Amortization of Premium on Debt	
30	Total Interest Expense (Lines 27 to 29)	<u>137,627</u>
31		
32	EXTRAORDINARY ITEMS:	
33	Extraordinary Income	
34	Extraordinary Deductions	(5,728)
35	Income Taxes, Extraordinary Items	
36	Total Extraordinary Items (Lines 33 to 35)	<u>(5,728)</u>
37		
38	NET INCOME (Line 15 + Line 24 - Line 30 + Line 36)	<u><u>\$ (182,395)</u></u>

**Water Service Corporation of Kentucky**  
**Case No. 2022-00396**  
**Historical Financials**  
**For the twelve months ending December 31, 2021**

Line No.	Description	2021
1	<b>ASSETS:</b>	
2	<b>UTILITY PLANT:</b>	
3	Utility Plant	\$ 13,602,572
4	Accumulated Depreciation and Amortization	(6,709,374)
5	Net Plant	<u>6,893,198</u>
6		
7	Utility Plant Acquisition Adjustments (Net)	<u>(113,475)</u>
8	Total Net Utility Plant	6,779,723
9		
10	<b>CURRENT AND ACCRUED ASSETS:</b>	
11	Cash	19,709
12	Special Deposits	6,100
	Accounts and Notes Receivable, Less Accumulated Provision for	
13	Uncollectible Accounts	1,039,450
14	Accounts Receivable from Associated Companies	6,265
15	Materials and Supplies	8,536
16	Prepayments	
17	Misc. Current and Accrued Assets	<u>175,009</u>
18	Total Current and Accrued Assets	1,255,069
19		
20	<b>DEFERRED DEBITS:</b>	
21	Unamortized Debt Discount and Expense	
22	Preliminary Survey and Investigation Charges	3,500
23	Misc. Deferred Debits	<u>831,186</u>
24	Total Deferred Debits	834,686
25		
26	<b>TOTAL ASSETS AND OTHER DEBITS</b>	<u><u>\$ 8,869,478</u></u>
27		
28	<b>EQUITY AND LIABILITIES:</b>	
29	<b>EQUITY CAPITAL:</b>	
30	Common Stock Issued	1,000
31	Other Paid-In Capital	2,834,076
32	Retained Earnings	<u>109,708</u>
33	Total Equity Capital	2,944,784
34		
35	<b>LONG-TERM DEBT:</b>	
36	Bonds	
37	Advances from Associated Companies	
38	Other Long-Term Debt	
39	Total Long Term Debt	<u>-</u>
40		



**Water Service Corporation of Kentucky**  
**Case No. 2022-00396**  
**Historical Financials**  
**For the twelve months ending December 31, 2021**

<b>Line No.</b>	<b>Description</b>	<b>2021</b>
41	CURRENT AND ACCRUED LIABILITIES:	
42	Accounts Payable	1,034,178
43	Notes Payable	
44	Accounts Payable to Associated Co.	3,443,359
45	Notes Payable to Associated Co.	
46	Customer Deposits	38,496
47	Accrued Taxes	166,207
48	Accrued Interest	634
49	Misc. Current and Accrued Liabilities	
50	Total Current and Accrued Liabilities	<u>4,682,874</u>
51		
52	DEFERRED CREDITS:	
53	Unamortized Premium on Debt	
54	Advances for Construction	
55	Other Deferred Credits	132,435
56	Accumulated Deferred Investment Tax Credits	
57	Total Deferred Credits	<u>132,435</u>
58		
59	CONTRIBUTIONS IN AID OF CONSTRUCTION:	
60	Contributions In Aid of Construction	405,285
61	Accumulated Amortization of CIAC	<u>(148,849)</u>
62	Total C.I.A.C.	256,436
63		
64	ACCUMULATED DEFERRED INCOME TAXES:	
65	Accumulated Deferred Income Taxes	852,949
66		
67	Total Equity Capital and Liabilities	<u><u>\$ 8,869,478</u></u>
68		
69		

**Corix Infrastructure (US) Inc.**  
**Statement of Operations**  
**Year Ended December 31, 2021**  
(In thousands)

---

	<u>Corix US</u>
Operating revenues	\$ 263,487
Operating expenses:	
Operations and maintenance	165,275
Depreciation and amortization	38,603
Taxes other than income taxes	16,924
Income from joint arrangements	(10,670)
Total	<u>210,131</u>
Operating income	53,356
Non-operating expense (income):	
Interest expense, net	43,834
Allowance for funds used during construction	(1,728)
Loss (gain) on sale of assets	(1,105)
Total	<u>41,002</u>
Income before taxes	12,354
Provision for income taxes	4,713
Net income before discontinued operations	<u>7,642</u>
Income from discontinued operations, net of tax	6,854
<b>Net income before discontinued operations</b>	<b><u>\$ 14,496</u></b>

**Corix Infrastructure (US) Inc.**  
**Balance Sheet**  
**Year Ended December 31, 2021**  
(In thousands)

	<u>Corix US</u>
Property, plant, and equipment, net:	
Property, plant, and equipment, at cost	\$ 1,620,403
Less accumulated depreciation	508,853
Total	<u>1,111,550</u>
Current assets:	
Cash and cash equivalents	6,961
Accounts receivable, net	22,869
Unbilled revenues	15,515
Prepayments and other assets	24,123
Total	<u>69,468</u>
Regulatory and other non-current assets:	
Regulatory assets and deferred charges	61,082
Goodwill	234,580
Intangible assets	37,235
Investment in joint arrangements	142,056
Other assets	17,928
Total	<u>492,881</u>
<b>Total assets</b>	<b><u>\$ 1,673,900</u></b>
Shareholder's equity	\$ 230,880
Long-term debt	729,543
Subordinated debentures	255,000
Current liabilities:	
Current portion of long-term debt	9,788
Accounts payable and accrued liabilities	43,432
Customer deposits	2,909
Accrued taxes	3,374
Accrued interest	28,497
Other current liabilities	1,370
Total	<u>89,370</u>
Deferred credits and other liabilities:	
Deferred income taxes	78,525
Regulatory liabilities	33,425
Due to affiliated companies	3,272
Other liabilities and deferred credits	17,261
Total	<u>132,483</u>
Contributions in aid of construction	235,346
Advances in aid of construction	1,278
<b>Total equity and liabilities</b>	<b><u>\$ 1,673,900</u></b>

**SW MERGER ACQUISITION CORP.**  
**Secretary's Certificate**

The undersigned, the duly elected and incumbent Secretary of SW MERGER ACQUISITION CORP. ("Company") does hereby certify that the following Resolutions were adopted in an action duly taken by the Board of Directors of the Company on August 7, 2022 and that such Resolutions have not been rescinded, modified, or amended in any respect:

WHEREAS, the Board has evaluated a proposed combination (the "Combination") of the U.S. and Canadian regulated water and wastewater operations of Corix Infrastructure Inc. ("Corix") with the business operations of the Company;

WHEREAS, the Company's officers have reviewed and evaluated the information and materials relating to the Combination, including the proposed Transaction Agreement for the Combination (the "**Transaction Agreement**", and together with any documents, instruments, guarantees, certificates and agreements to be entered into by the Company in connection with the Transaction Agreement, the "**Transaction Documents**"), a summary of which is attached hereto as Exhibit A;

WHEREAS, based on their review of the information and materials relating to the Combination, including the results of the due diligence undertaken by the officers and the Company's advisors, the Company's officers recommend and request that the Board authorize and approve the Combination and authorize the Company to enter into, execute and deliver the Transaction Agreement and each of the other Transaction Documents; and

WHEREAS, the Board deems it advisable and in the best interest of the Company that the Company enter into, execute and deliver the Transaction Agreement, the material terms of which were reviewed with outside legal counsel, and each of the other Transaction Documents.

NOW, THEREFORE, BE IT:

RESOLVED, that the execution and delivery of the Transaction Agreement (in substantially the form as summarized in Exhibit A) by the Company and the performance of any and all of its obligations thereunder is hereby approved, ratified and confirmed in all respects; and be it further

RESOLVED, that the Board hereby approves the entry by the Company into any other Transaction Documents and the performance of any and all of its obligations thereunder.

**General Resolutions**

RESOLVED, that the officers of the Company are hereby authorized, empowered and directed to prepare, negotiate, execute and deliver any and all agreements, instruments, consents, certificates, reports, schedules, statements, documents and information, including any amendments thereto, with respect to the transactions contemplated by the Transaction Documents and the foregoing resolutions, to make any filings pursuant to federal, state and foreign laws and to take all other actions that such officer deems necessary, advisable or appropriate in order to carry out the intent and effectuate the purpose of the foregoing resolutions and to permit the transactions contemplated by the Transaction Documents and the

foregoing resolutions to be lawfully consummated, such authorization to be conclusively evidenced by the taking of any such action or the execution and delivery of any such agreement, instrument, consent, certificate or other document by such officer; and be it further

RESOLVED, that all actions heretofore taken by any officer of the Company in connection with the transactions contemplated by the foregoing resolutions or by the Transaction Documents are hereby confirmed, ratified and approved in all respects.

The Exhibit A referenced in the foregoing Resolutions is not attached to this Certificate as it is a privileged document subject to the attorney work product privilege and the attorney-client privilege.

**IN WITNESS WHEREOF**, I have hereunto set my hand, on November 4, 2022.



---

Joseph H. Park  
Secretary

**WRITTEN CONSENT  
OF  
THE BOARD OF DIRECTORS OF CORIX INFRASTRUCTURE (US) INC.**

August 16, 2022

Each of the undersigned, being all of the directors of Corix Infrastructure (US) Inc., a Delaware corporation (the “Corporation”), DO HEREBY UNANIMOUSLY ADOPT the following resolutions and DO HEREBY UNANIMOUSLY CONSENT to the actions therein set forth:

**WHEREAS**, the Corporation, Corix Infrastructure Inc. (“Corix”), IIF Subway Investment L.P., a Delaware limited partnership (“IIF”), SW Merger Acquisition Corp. and SouthWest Water Company (“SWWC”) propose to enter into an agreement (together with all schedules, exhibits thereto and ancillary agreements thereto, the “Transaction Agreement”) pursuant to which, among other things, (i) Corix will agree to combine the Corix Water Business with the SWWC Business (such transaction, the “Business Combination”), and upon the consummation of the Business Combination, the Corix Water Business and the SWWC Business will be held by the Corporation, and Corix (or an Affiliate thereof) and an entity controlled by IIF will each hold 50% of the outstanding common stock of the Corporation, and (ii) prior to the consummation of the Business Combination, Corix will take all actions as defined and set forth in the Transaction Agreement to effect a restructuring pursuant to which, amongst other things, Corix will cause (1) its Subsidiaries whose operations constitute Corix’s district energy business, together with all related assets and liabilities, to be transferred, distributed or assigned to an Affiliate of Corix and (2) its Canadian Subsidiaries whose operations constitute the Corix Water Business to be distributed, assigned and transferred to the Corporation (the “Corix Restructuring”);

**WHEREAS**, capitalized terms used but not defined herein shall have the meanings ascribed to such terms in the Transaction Agreement;

**WHEREAS**, a draft of the Transaction Agreement has been previously presented to the Board of Directors; and,

**WHEREAS**, the Board of Directors has taken such advice of management, Skadden, Arps, Slate, Meagher & Flom LLP and RBC Capital Markets, LLC, as are deemed advisable and has been provided with advice from British Columbia Investment Management Corporation who were engaged in the negotiation of the Transaction Agreement and the transactions contemplated therein.

**NOW THEREFORE BE IT:**

**RESOLVED** that the Transaction Agreement and the transactions contemplated therein together with such amendments and changes thereto as may be approved by any officer of the Corporation (an “Authorized Person”), are approved, adopted and declared advisable for the Corporation and the Transaction Agreement be presented to Corix in its capacity as the sole stockholder of the Corporation for its approval of the Transaction Agreement and the transactions contemplated therein; and it is

**FURTHER RESOLVED** that any Authorized Person is hereby authorized to negotiate, amend, execute and deliver the Transaction Agreement for and on behalf of the Corporation,

in such form and containing such terms and conditions as the Authorized Person executing the Transaction Agreement may approve, and execution of the Transaction Agreement by any Authorized Person shall be conclusive evidence of the approval of such terms and conditions by such Authorized Person;

**FURTHER RESOLVED** that any Authorized Person is hereby authorized, for and on behalf of the Corporation, to take all such actions and to execute and deliver all other agreements, documents and instruments in furtherance of the performance of the Transaction Agreement and the transactions contemplated thereby (the “Other Documents”), under the seal of the Corporation or otherwise, as such Authorized Person may approve and consider necessary or desirable to complete the Business Combination and the Corix Restructuring including those agreements as set forth in the Transaction Agreement, such approval to be conclusively evidenced by the taking of such action or the execution of any such Other Document; and it is

**FURTHER RESOLVED** that any Other Document that is required to be entered into by a Subsidiary of the Corporation in connection with the Transaction Agreement may be executed and delivered for and on behalf of such Subsidiary by any Authorized Person or any officer of such subsidiary (a “**Subsidiary Authorized Person**”), in such form and containing such terms and conditions as the Authorized Person or Subsidiary Authorized Person executing such Other Document may approve, provided such terms are substantially consistent with the Transaction Agreement, and execution of such Other Document by such Authorized Person or Subsidiary Authorized Person shall be conclusive evidence of the approval of such terms and conditions by such Authorized Person or Subsidiary Authorized Person; and it is

**FURTHER RESOLVED** that all actions taken by any Authorized Person prior to the date hereof with respect to the negotiation, execution and delivery of the Transaction Agreement and the Other Documents be, and such actions are, hereby authorized, confirmed and ratified in all respects.

The execution of this consent shall constitute a written waiver of any notice required by Corporation’s organizational documents. This consent may be executed in one or more counterparts which, taken as a whole, shall constitute one and the same document and shall be effective upon the last signature being obtained.

*Remainder of this page is intentionally left blank*

IN WITNESS WHEREOF, the undersigned **Board of Directors** have executed this Written Consent as of the date first written above.

DIRECTORS:



---

Lisa Sparrow

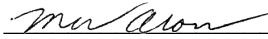

---

Mario Alonso



**Commonwealth of Kentucky**  
**Michael G. Adams, Secretary of State**

Michael G. Adams  
Secretary of State  
P. O. Box 718  
Frankfort, KY 40602-0718  
(502) 564-3490  
<http://www.sos.ky.gov>

**Certificate of Existence**

Authentication number: 270533  
Visit <https://web.sos.ky.gov/ftshow/certvalidate.aspx> to authenticate this certificate.

I, Michael G. Adams, Secretary of State of the Commonwealth of Kentucky, do hereby certify that according to the records in the Office of the Secretary of State,

**WATER SERVICE CORPORATION OF KENTUCKY**

is a corporation duly incorporated and existing under KRS Chapter 14A and KRS Chapter 271B, whose date of incorporation is April 12, 2002 and whose period of duration is perpetual.

I further certify that all fees and penalties owed to the Secretary of State have been paid; that Articles of Dissolution have not been filed; and that the most recent annual report required by KRS 14A.6-010 has been delivered to the Secretary of State.

IN WITNESS WHEREOF, I have hereunto set my hand and affixed my Official Seal at Frankfort, Kentucky, this 13<sup>th</sup> day of May, 2022, in the 230<sup>th</sup> year of the Commonwealth.



*Michael G. Adams*

Michael G. Adams  
Secretary of State  
Commonwealth of Kentucky  
270533/0534921

# Delaware

The First State

*I, JEFFREY W. BULLOCK, SECRETARY OF STATE OF THE STATE OF DELAWARE, DO HEREBY CERTIFY "SOUTHWEST WATER COMPANY" IS DULY INCORPORATED UNDER THE LAWS OF THE STATE OF DELAWARE AND IS IN GOOD STANDING AND HAS A LEGAL CORPORATE EXISTENCE SO FAR AS THE RECORDS OF THIS OFFICE SHOW, AS OF THE TWELFTH DAY OF OCTOBER, A.D. 2022.*

*AND I DO HEREBY FURTHER CERTIFY THAT THE ANNUAL REPORTS HAVE BEEN FILED TO DATE.*

*AND I DO HEREBY FURTHER CERTIFY THAT THE SAID "SOUTHWEST WATER COMPANY" WAS INCORPORATED ON THE SECOND DAY OF FEBRUARY, A.D. 1988.*

*AND I DO HEREBY FURTHER CERTIFY THAT THE FRANCHISE TAXES HAVE BEEN PAID TO DATE.*



  
Jeffrey W. Bullock, Secretary of State

2150876 8300

SR# 20223753116

You may verify this certificate online at [corp.delaware.gov/authver.shtml](http://corp.delaware.gov/authver.shtml)

Authentication: 204604903

Date: 10-12-22

# Delaware

The First State

Page 1

I, JEFFREY W. BULLOCK, SECRETARY OF STATE OF THE STATE OF DELAWARE, DO HEREBY CERTIFY "CORIX INFRASTRUCTURE (US) INC." IS DULY INCORPORATED UNDER THE LAWS OF THE STATE OF DELAWARE AND IS IN GOOD STANDING AND HAS A LEGAL CORPORATE EXISTENCE SO FAR AS THE RECORDS OF THIS OFFICE SHOW, AS OF THE TWENTY-FOURTH DAY OF OCTOBER, A.D. 2022.

AND I DO HEREBY FURTHER CERTIFY THAT THE ANNUAL REPORTS HAVE BEEN FILED TO DATE.

AND I DO HEREBY FURTHER CERTIFY THAT THE SAID "CORIX INFRASTRUCTURE (US) INC." WAS INCORPORATED ON THE FIFTEENTH DAY OF MAY, A.D. 2006.

AND I DO HEREBY FURTHER CERTIFY THAT THE FRANCHISE TAXES HAVE BEEN PAID TO DATE.



4158803 8300

SR# 20223838405

You may verify this certificate online at [corp.delaware.gov/authver.shtml](http://corp.delaware.gov/authver.shtml)

A handwritten signature in black ink, appearing to read "JBULLOCK", is written over a horizontal line. Below the line, the text "Jeffrey W. Bullock, Secretary of State" is printed in a small font.

Authentication: 204683899

Date: 10-24-22