

COMMONWEALTH OF KENTUCKY
BEFORE THE KENTUCKY STATE BOARD ON ELECTRIC GENERATION
AND TRANSMISSION SITING

In the Matter of:

ELECTRONIC APPLICATION OF SEBREE)	
SOLAR II, LLC FOR A CERTIFICATE TO)	
CONSTRUCT AN APPROXIMATELY 150)	
MEGAWATT MERCHANT SOLAR ELECTRIC)	CASE NO. 2022-00131
GENERATING FACILITY IN)	
HENDERSON COUNTY, KENTUCKY AND)	
WEBSTER COUNTY, KENTUCKY PURSUANT)	
TO KRS 278.700 AND 807 KAR 5:110)	

SEBREE SOLAR II, LLC RESPONSES TO SITING BOARD
STAFF’S FIRST REQUEST FOR INFORMATION

Filed: June 16, 2023

COMMONWEALTH OF KENTUCKY
BEFORE THE KENTUCKY STATE BOARD ON ELECTRIC GENERATION
AND TRANSMISSION SITING

In the Matter of:

ELECTRONIC APPLICATION OF SEBREE)
SOLAR II, LLC FOR A CERTIFICATE TO)
CONSTRUCT AN APPROXIMATELY 150)
MEGAWATT MERCHANT SOLAR ELECTRIC) CASE NO. 2022-00131
GENERATING FACILITY IN)
HENDERSON COUNTY, KENTUCKY AND)
WEBSTER COUNTY, KENTUCKY PURSUANT)
TO KRS 278.700 AND 807 KAR 5:110)

VERIFICATION OF JASON ANDREWS

STATE OF FLORIDA)

COUNTY OF ST. JOHNS)

Comes now Jason Andrews, Project Director of NextEra Energy Resources, Inc., being first duly sworn, and states that he has supervised the preparation of certain responses of Sebree Solar II, LLC to the Siting Board Staff's First Request for Information in the above-referenced case dated May 31, 2023, and that the matters and things set forth therein are true and accurate to the best of his knowledge, information and belief, formed after reasonable inquiry.



Jason Andrews

Subscribed and sworn to before me on this 13 day of June 2023.

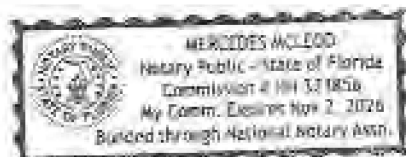



Notary ID: mercedes mcleod
Expires: 11-02-26

COMMONWEALTH OF KENTUCKY
BEFORE THE KENTUCKY STATE BOARD ON ELECTRIC GENERATION
AND TRANSMISSION SITING

In the Matter of:

ELECTRONIC APPLICATION OF SEBREE)
SOLAR II, LLC FOR A CERTIFICATE TO)
CONSTRUCT AN APPROXIMATELY 150)
MEGAWATT MERCHANT SOLAR ELECTRIC) CASE NO. 2022-00131
GENERATING FACILITY IN)
HENDERSON COUNTY, KENTUCKY AND)
WEBSTER COUNTY, KENTUCKY PURSUANT)
TO KRS 278.700 AND 807 KAR 5:110)

VERIFICATION OF BRIAN BARTELS

STATE OF FLORIDA)

COUNTY OF PALM BEACH)

Comes now Brian Bartels, Senior Environmental Specialist of NextEra Energy Resources, Inc., being first duly sworn, and states that he has supervised the preparation of certain responses of Sebree Solar II, LLC to the Siting Board Staff's First Request for Information in the above-referenced case dated May 31, 2023, and that the matters and things set forth therein are true and accurate to the best of his knowledge, information and belief, formed after reasonable inquiry.

Brian Bartels
Brian Bartels

Subscribed and sworn to before me on this 13 day of June 2023.

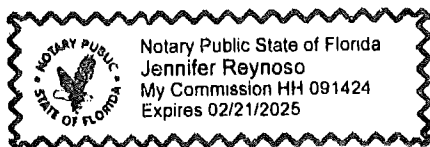

Jennifer Reynoso
Notary ID: 111091424
Expires: 2-21-25

COMMONWEALTH OF KENTUCKY
BEFORE THE KENTUCKY STATE BOARD ON ELECTRIC GENERATION
AND TRANSMISSION SITING

In the Matter of:

ELECTRONIC APPLICATION OF SEBREE)
SOLAR II, LLC FOR A CERTIFICATE TO)
CONSTRUCT AN APPROXIMATELY 150)
MEGAWATT MERCHANT SOLAR ELECTRIC) CASE NO. 2022-00131
GENERATING FACILITY IN)
HENDERSON COUNTY, KENTUCKY AND)
WEBSTER COUNTY, KENTUCKY PURSUANT)
TO KRS 278.700 AND 807 KAR 5:110)

VERIFICATION OF ANDREW LINES

STATE OF COOK)

COUNTY OF ILLINOIS)

Comes now Andrew Lines of CohnReznick, Consultant for Sebree Solar II, LLC, being first duly sworn, and states that he has supervised the preparation of certain responses of Sebree Solar II, LLC to the Siting Board Staff's First Request for Information in the above-referenced case dated May 31, 2023, and that the matters and things set forth therein are true and accurate to the best of his knowledge, information and belief, formed after reasonable inquiry.

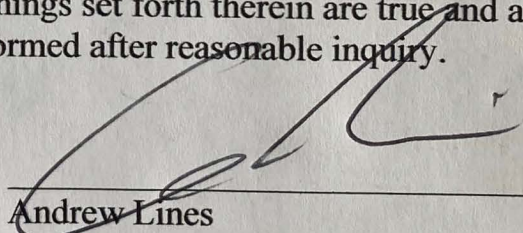

Andrew Lines

Subscribed and sworn to before me on this 15th day of June 2023.

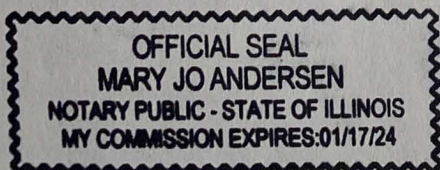

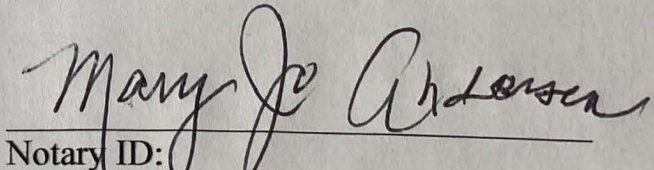

Notary ID:

Expires:

COMMONWEALTH OF KENTUCKY
BEFORE THE KENTUCKY STATE BOARD ON ELECTRIC GENERATION
AND TRANSMISSION SITING

In the Matter of:

ELECTRONIC APPLICATION OF SEBREE)
SOLAR II, LLC FOR A CERTIFICATE TO)
CONSTRUCT AN APPROXIMATELY 150)
MEGAWATT MERCHANT SOLAR ELECTRIC) CASE NO. 2022-00131
GENERATING FACILITY IN)
HENDERSON COUNTY, KENTUCKY AND)
WEBSTER COUNTY, KENTUCKY PURSUANT)
TO KRS 278.700 AND 807 KAR 5:110)

VERIFICATION OF JOSHUA CRAWFORD

STATE OF KENTUCKY)
COUNTY OF JEFFERSON)

Comes now Joshua Crawford of Pegasus Institute, Consultant for Sebree Solar II, LLC, being first duly sworn, and states that he has supervised the preparation of certain responses of Sebree Solar II, LLC to the Siting Board Staff's First Request for Information in the above-referenced case dated May 31, 2023, and that the matters and things set forth therein are true and accurate to the best of his knowledge, information and belief, formed after reasonable inquiry.

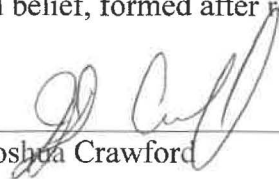

Joshua Crawford

Subscribed and sworn to before me on this 15th day of June 2023.



Notary ID: KYNP63240
Expires: 12/13/2026

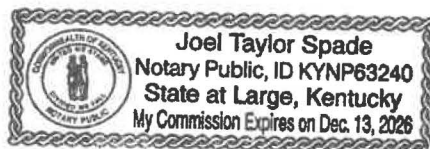

**SEBREE SOLAR II, LLC
CASE NO. 2022-00131
RESPONSE TO INFORMATION REQUEST**

SITING BOARD STAFF'S FIRST REQUEST FOR INFORMATION DATED 5/31/2023

REQUEST 1

RESPONSIBLE PARTY: Jason Andrews

Request 1. Submit a copy of the leases or purchase agreements, including options, separate agreements, or deeds which Sebree Solar II has entered into in connection with the proposed solar facility, including the agreements for each of the parcels of the project.

Response 1.

Please see attached for the redacted copies of the lease and purchase agreements for each parcel of the project, including parcels only used for underground collection. Confidential versions of the lease and purchase agreements are being filed separately under seal pursuant to a Motion for Confidential Treatment.

SOLAR LEASE AND EASEMENT AGREEMENT

1. **Parties.** This Solar Lease and Easement Agreement ("**Agreement**") is made and entered as of the 1st day of August, 2020 ("**Effective Date**"), by and between Cecilia King Abbott and Larry D. Abbott, wife and husband; Carole King Stevenson, Trustee of the Carole King Stevenson Revocable Trust, UTA dated 11/16/2015; Claudia King Green, an unmarried widow; and Cathryn King Manion, single person ("**Owner**") and Sebree Solar, LLC, a Delaware limited liability company ("**Operator**"), which are sometimes individually referred to as a "**Party**" and collectively as the "**Parties**".

2. **Project.** This Agreement relates to the solar-powered electrical power generation and transmission project known as the "Sebree Energy Center" to be located in Henderson County, Kentucky ("**Project**"), which may be wholly or partially located on the Owner's property legally described on the attached **Exhibit A** and depicted on **Exhibit B-1** to this Agreement ("**Owner's Property**"). Upon Operator's exercise of the Option (as defined below), the Project shall include (i) the Lease of Owner's Property described in Section 4, (ii) the Easements referenced in Section 5 that are located on the Owner's Property, and (iii) the Improvements referenced in Section 8 to be constructed on Owner's Property. The Lease, Easements and Improvements are sometimes collectively referred to as the "**Operator Property**".

3. **Option.** Owner grants to Operator an exclusive option ("**Option**") to acquire the Lease and Easements referenced in Sections 4 and 5 in accordance with the following terms and conditions. Operator shall be entitled to acquire the Lease and the Easements in their entirety or in part, as Operator deems appropriate.

3.1 **Option Term.** The period during which Operator may exercise the Option shall be for a term of five (5) years, commencing on the Effective Date ("**Option Term**").

3.2 **Option Payment.** As consideration for the granting of the Option, Operator agrees to pay Owner the Option Payment set forth in **Exhibit D**.

3.3 **Use of Owner's Property.** During the Option Term, Operator and its employees, agents and contractors shall have a right to enter upon the Owner's Property and the right of ingress and egress over and across the Owner's Property for the purposes of (i) surveying the Owner's Property; (ii) performing such other tests and studies as Operator may desire in connection with the Option, including, without limitation, environmental, avian and cultural resource assessments, and geotechnical, foundation and soil tests, provided that such activities do not unreasonably interfere with Owner's use of the Owner's Property; and (iii) installing, maintaining, operating, inspecting and removing one or more weather related instruments ("**Weather Instrument**") and fencing of said Weather Instrument and including the performance of all tests and studies associated therewith. Owner shall not permit any other individual or entity except Operator or its affiliates to install a Weather Instrument on Owner's Property. If Operator damages Owner's Property due to such tests and studies, then Operator will restore the Owner's Property to its original condition prior to such use. In the event that the Project is built, Operator agrees to share any boundary survey documents with Owner.

3.4 **Right to Grant Option.** Owner warrants and represents to Operator that (i) the statements in Section 9 concerning Owner's title to the Owner's Property are true and correct; (ii) Owner has the authority to grant this Option to Operator without the consent or approval of any other party; and (iii) there are no other existing options, rights of first refusal, contracts to purchase, leases or mortgages that would prevent Operator from exercising its rights with respect to the Option.

3.5 **Exercise of Option.** Operator may exercise the Option by giving written notice to Owner ("**Option Notice**") at any time during the Option Term. Operator shall specify in the Option Notice the Commencement Date referenced in Section 6.1.1 and the portion of the Owner's Property that Operator elects to lease hereunder. Operator shall be required to make Annual Installments Payments on all of the acreage included in Section 1 and/or Section 2, as depicted on Exhibit B-1 attached hereto, if any part of such area(s) are selected. On the Commencement Date, the Lease and Easements referenced in Sections 4 and 5 shall automatically become effective, and the Parties shall be subject to all of the terms and conditions of this Agreement with respect to such Lease and Easements and all rights and obligations relating thereto.

3.6 **Termination of Option.** If Operator fails to exercise the Option within the Option Term, the Option and the rights of Operator as the optionee shall automatically terminate.

4. **Lease.** Upon exercise of the Option by Operator, Owner leases to Operator, and Operator leases from Owner, Owner's Property for the Lease and Easement Term (defined in Section 6.1) in accordance with the terms and conditions of this Agreement ("**Lease**"), which Lease grants Operator and its agents, contractors, and employees the right to use the Owner's Property for the following permitted uses:

4.1 **Construction Right.** Operator leases Owner's Property for the purpose of constructing, operating, maintaining, repairing, replacing, and removing all or any part or component of the Improvements whether located on Owner's Property. Operator may exercise its right to use all or any part of the Owner's Property as and when Operator deems it necessary or advisable to do so to perform the activities for which this right is granted, including, without limitation, staging areas and parking for Operator's employees.

4.2 **Access Right.** Operator leases Owner's Property for unobstructed vehicular and pedestrian access and ingress to and egress from the Improvements, Owner's Property and any public roadways, and to construct, maintain, and utilize Roadway Improvements on the Owner's Property. Owner shall not permit others to obstruct or damage the roads or Roadway Improvements located on the Owner's Property or in any other way interfere with Operator's rights under this right. Operator shall repair any damage done to Roadway Improvements which result from use by Operator, its agents, servants or employees. Such roads shall be maintained in the condition necessary for use by Operator's equipment, and with regard to existing roads, shall be maintained in at least the condition that existed prior to Operator's use.

4.3 **Solar Panels Right.** Operator leases Owner's Property for Operator to construct, operate, replace, relocate, remove, and maintain Solar Panels and the appurtenant Collection Facilities, together with associated roads and parking areas on Owner's Property.

4.4 **Collection Facilities Right.** Operator leases Owner's Property for Operator to construct, operate, maintain, replace, relocate or remove Collection Facilities on and under the Owner's Property.

4.5 **Substation Right.** Operator leases Owner's Property for Operator to construct, operate, maintain, replace, relocate or remove one or more Substations on Owner's Property.

4.6 **Telecommunication Right.** Operator leases Owner's Property for Operator to construct, operate, maintain, replace, relocate or remove Telecommunication Facilities on and under the Owner's Property.

4.7 **Weather Instrument Right.** Operator leases Owner's Property in order to construct, operate, replace, relocate, remove, and maintain a Weather Instrument and the appurtenant Collection Facilities on Owner's Property.

4.8 **Battery Facilities Right.** Operator leases Owner's Property in order to construct, operate, replace, relocate, remove, and maintain one or more Battery Facilities on Owner's Property.

5. **Grant of Easements.** Upon the exercise of the Option by Operator, Owner grants to Operator, and Operator accepts from Owner, for the Lease and Easement Term referenced in Section 6.1, the following easements over and across the Owner's Property in accordance with the terms and conditions of this Agreement. The following easements are for the benefit of Operator and Operator's agents, contractors and employees and located on the Owner's Property and are collectively referred to as the "**Easements**".

5.1 **Sun Non-Obstruction Easement.** Owner grants Operator an irrevocable, exclusive easement for the right and privilege to use, maintain and capture the free and unobstructed sunlight over and across the Owner's Property. Owner shall not engage in any activity on Owner's Property or any other neighboring property owned by Owner that might interfere with the sunlight direction over any portion of Owner's Property; cause a decrease in the output or efficiency of any Solar Panel or Weather Instrument; or otherwise interfere with Operator's operation of the Project or exercise of any rights granted in this Agreement (collectively "**Interference**"). This grant of the easement expressly includes the right of Operator to enforce Operator's rights, including the physical removal of trees or structures (except existing trees and structures) causing Interference to the Project contemplated by Operator. Operator shall notify Owner before making any such removals.

5.2 **Effects Easement.** Owner grants to Operator an easement over Owner's Property for visual, view, light, flicker, noise, shadow, vibration, electromagnetic, electrical and radio frequency interference, and any other effects attributable to the Project located on the Owner's Property.

6. **Term.** The term of this Agreement ("**Term**") includes the Option Term referenced in Section 3.1, the Initial Lease and Easement Term as described in Section 6.1.1 and the Extended Lease and Easement Term as described in Section 6.1.2 (together, the Initial Lease and Easement

Term and the Extended Lease and Easement Term, if applicable, is defined as the "**Lease and Easement Term**").

6.1 **Lease and Easement Term.**

6.1.1 **Initial Lease and Easement Term.** The initial term of the Lease and Easements shall commence on the date specified by Operator in the Option Notice ("**Commencement Date**"). The initial term of the Lease and Easements shall end thirty (30) years after the Commencement Date (the "**Initial Lease and Easement Term**"), subject to the rights of renewal and termination as provided in this Agreement.

6.1.2 **Extended Lease and Easement Term.** Operator shall have the right to extend the Term of this Agreement for two (2) consecutive terms of five (5) years each in accordance with the terms and provisions of this Agreement (collectively "**Extended Lease and Easement Term**") by providing written notice to Owner of Operator's intent to extend the Term within one hundred eighty (180) days of the end of the existing Term. Each Extended Lease and Easement Term shall begin on the expiration date of the Initial Lease and Easement Term or previous Extended Lease and Easement Term, as the case may be. During the Extended Lease and Easement Term, Operator shall pay Owner the amounts set forth in **Exhibit D** as the consideration for the Lease and Easements.

6.1.3 **Delays During Lease and Easement Term.** At Operator's option, the Term may be extended for a period of time equal to the period of time during which operation of the Project is delayed or suspended because of the occurrence of a Regulatory Suspension or Force Majeure, which are defined as follows:

(i) "**Regulatory Suspension**" shall mean the enactment or application of any law, order, rule, or regulation of the Kentucky Public Service Commission, Federal Energy Regulatory Commission, or other local, state, or federal government authority having jurisdiction over the Project or Operator, or the failure of any such governmental authority to issue an approval or permit pursuant to any such law, order, rule, or regulation, which results in the delay, interruption, or suspension of the production, sale or transmission of electricity from the Solar Panels; and

(ii) "**Force Majeure**" shall mean causes beyond the reasonable control of and without the fault or negligence of the Party claiming Force Majeure, including but not limited to acts of God, labor unrest (including, but not limited to, slowdowns, picketing, boycotts or strikes), flood, earthquake, storm, fire, lightning, explosion, power failure or power surge, vandalism, theft, the cutting of power, transmission or other lines, wires or cables to the Project by persons other than Operator's employees or contractors, epidemic, war, revolution, riot, civil disturbance, sabotage, change in law or applicable regulation subsequent to the Commencement Date and action or inaction by any federal, state or local legislative, executive, administrative judicial agency or body which in any of the foregoing cases, by exercise of due foresight such Party could not reasonably have expected to avoid, and which, by the exercise of due diligence, it is unable to overcome.

Except for Operator's obligation to make Annual Installment Payments as set forth in **Exhibit D** and payments of Taxes as set forth herein, the Parties shall be excused from performing

their respective obligations under this Agreement and shall not be liable in damages or otherwise if and to the extent that they are unable to so perform or are prevented from performing by a Force Majeure, provided that: (i) the non-performing Party, as promptly as practicable after the occurrence of the Force Majeure, but in no event later than thirty (30) days thereafter, gives the other Party written notice describing the particulars of the occurrence; (ii) the suspension of performance is of no greater scope and of no longer duration than is reasonably required by the Force Majeure; (iii) the non-performing Party uses good faith and commercially reasonable efforts to remedy its inability to perform; and (iv) as soon as the non-performing Party is able to resume performance of its obligations excused as a result of the occurrence, each Party shall give prompt written notification thereof to the other Party.

6.2 **Termination by Operator.** Provided Operator is not in default under any term of this Agreement, Operator, at its option, shall have the right to terminate this Agreement at any time during the Term of the Agreement, as to all or any part of the Operator Property. Termination shall be effective thirty (30) days after written notice of such termination to Owner. If Operator's notice is a full termination of the Operator Property, the Parties shall be relieved of all further duties and obligations under this Agreement, other than (i) the payment of any accrued and unpaid obligations owed by either Party as of the date of termination; (ii) the removal of the Improvements by Operator pursuant to Section 8.11; and (iii) any other obligations and liabilities that are expressly stated in this Agreement to survive such termination. Upon any such partial termination by Operator, the Parties shall be relieved of all further duties and obligations under this Agreement with respect to the portion thereof terminated by Operator, subject to the obligations and liabilities referenced in items (i) through (iii) above that shall continue to be applicable to the terminated portion of this Agreement. The Parties agree to execute an amendment to this Agreement evidencing such partial termination.

7. **Payments.** If Operator exercises the Option referenced in Section 3, Operator agrees to pay Owner the amounts set forth in **Exhibit D** as consideration for the Lease, Easements and Operator's other rights and interests in the Owner's Property.

8. **Improvements.** Operator shall have the right, at its sole cost and expense, to construct, install, maintain, use, operate, repair, replace, relocate and remove all facilities, structures, equipment, machinery, wires, conduit, cables, poles, materials and property of every kind and character required for the construction and operation of portions of the Project on the Owner's Property, including, but not limited to, the Solar Panels, Collection Facilities, Substations, Telecommunication Facilities, Weather Instruments, Roadway Improvements and Battery Facilities referenced in Sections 8.1 through 8.7 (collectively, the "**Improvements**").

8.1 "**Solar Panels**" shall mean any photovoltaic energy system designed for the generation of electrical power from the collection of sunlight, including without limitation, the photovoltaic panels, foundations, support structures, braces and related equipment.

8.2 "**Collection Facilities**" shall mean all Improvements whose purpose is to deliver electrical power generated by the Solar Panels to an electrical power grid or other system, including without limitation transformers, overhead and underground electrical collection lines, telecommunication lines, splice boxes and interconnection facilities.

8.3 "**Substations**" shall mean electrical lines, meters, monitoring and control equipment, switches, transformers, all structures, equipment, enclosures, fencing, security devices, and other electrical and communications equipment necessary to condition and increase the voltage of electricity generated by the Project to make it suitable for transmission on, and to deliver it to, Collection Facilities connected to an electric power grid or other system.

8.4 "**Telecommunication Facilities**" shall mean all Improvements whose purpose is to provide telecommunication services solely relating to the Project or any of Operator's solar powered projects, including telephone, closed-circuit television, microwave, internet, computer data and other telecommunication services.

8.5 "**Weather Instrument**" shall mean instruments used primarily to gather and transmit sunlight and meteorological data relating to the Project, and includes the instrument's foundations, guy wires, sunlight and meteorological data acquisition equipment, power source, and any required data and electrical transmission lines.

8.6 "**Roadway Improvements**" shall mean all improvements that may be necessary to construct, maintain and repair any new and existing roadways and other means of ingress and egress over, across and along the Owner's Property, including paving or surfacing of the roadways with asphalt, gravel or other roadway materials, installation of road signs and the construction and installation of culverts, bridges, drainage ditches, gates, cattle guards and similar structures and facilities.

8.7 "**Battery Facilities**" shall mean a type of equipment that can be given a new charge by passing an electric current through it designed for the storage of electrical power including without limitation, batteries and other devices for storage of electrical energy, foundations, support structures, braces and related equipment.

8.8 **Ownership of Improvements.** Except as otherwise provided in Section 11.7, all Improvements shall at all times remain the property of Operator, and Owner shall have no right, title or interest therein. All Improvements constructed or placed on the Owner's Property by Operator during the Term of this Agreement may be repaired, replaced, relocated, removed, added to or expanded upon by Operator at any time during the Term of this Agreement. Owner expressly waives any statutory lien or common law liens on the Improvements to which Owner might be entitled.

8.9 **Construction Liens.** Operator shall not permit any liens arising out of Operator's use of the Operator Property under this Agreement to be filed against the Owner's Property. Operator shall, within sixty (60) days after it receives notice of the lien, provide a bond or other security that Owner may reasonably request, or remove such lien from the Owner's Property in the manner provided by applicable law.

8.10 **Location of Improvements.** The acreage required from the Owner's Property for the Improvements for which the Lease and Easements are being granted cannot be determined until the completion of Operator's inspection, testing, study and surveying of the Owner's Property during the Option Term. Along with the Option Notice, Operator shall deliver to Owner a proposed plan of development showing the contemplated locations of the Improvements and a

preliminary calculation of the acreage as determined by the area bounded by a perimeter fence required for the Project, which shall serve as the **Exhibit B-2** to this Agreement. During the final development and construction of the Project, such locations may need to be amended. Following construction of the Project, Operator shall provide Owner an "as-built" survey of all Improvements on Owner's Property and the final calculation of the acreage as determined by the area bounded by a perimeter fence required for the Project, which shall serve as **Exhibit C** to this Agreement. Further, following construction, the Improvements may need to be relocated or rerouted by Operator, which Operator may perform, at any time during the Term of this Agreement, so long as the nature and extent of any such relocated or rerouted Improvements are not materially different and impose no materially greater burden on the Owner's Property than the original locations or routes, and so long as Operator takes commercially reasonable efforts to minimize disruption or inconvenience to Owner.

8.11 **Removal of Improvements.** Upon full or partial termination of any of the Lease Rights or Easements, Operator shall remove all Improvements and restore the area formerly occupied by the Improvements to substantially the same physical condition that existed immediately before the construction of the Improvements (the "**Removal Obligations**"). At Owner's request, all or any part of the Roadway Improvements may be left for use by Owner.

9. **Ownership and Title Matters.** Owner warrants and represents to Operator, both as of the Effective Date, and as of the Commencement Date as follows:

9.1 **Authority.** Owner represents that it is the holder of fee simple title and is the sole owner of the Owner's Property and has the unrestricted right and authority to sign this Agreement and to grant Operator the Lease and Easements and other rights granted in this Agreement. When signed by both Parties, this Agreement constitutes a valid and binding agreement enforceable against Owner in accordance with its terms.

9.2 **Other Agreements.** To the best of Owner's knowledge, the Owner's Property is not subject to any other agreements, options, rights of first refusal or other prior right of any party to purchase, lease or acquire easements in the Owner's Property, or create any prior claim or right that would preclude or interfere with Operator's rights and interests under this Agreement and the Lease and Easements. Operator acknowledges that there may be an oil and gas lease and pipeline right of way burdening the Owner's Property as disclosed by Owner.

9.3 **Minerals.** Except as disclosed by Owner to Operator at the time of the execution of this Agreement by Owner, to the best of Owner's knowledge, Owner owns all of the oil, gas and other minerals, and all rights thereto as on or under the Owner's Property.

9.4 **Owner Mortgage.** Except as disclosed by Owner to Operator at the time of the execution of this Agreement by Owner, there are no mortgages encumbering the Owner's Property ("**Owner Mortgage**").

9.5 **Notice and Opportunity to Cure.** If there is an Owner Mortgage encumbering Owner's Property and Owner receives from the holder thereof any notice that payments are overdue, Owner shall notify Operator and each Operator Mortgagee (as defined at Section 13.1) by sending a copy of such overdue payment notice to Operator by the earlier of (i) five (5) days

after receipt, or (ii) three (3) business days prior to the date by which a default under or in respect of such Owner Mortgage could occur. If Operator or any Operator Mortgagee determines that it would be in Operator's interest to make such payments to Owner Mortgagee on Owner's behalf, whether as a result of receiving such notice or otherwise, Operator shall have the right to make such payments and to credit the payments so made against the Annual Installment Payment next due under the Agreement.

9.6 **Subordination, Non-Disturbance & Attornment Agreement.** If there is an Owner Mortgage encumbering Owner's Property, Owner shall cooperate with Operator to obtain a Subordination, Non-Disturbance and Attornment Agreement ("SNDA") in the form prepared and provided by Operator, from each Owner Mortgagee, pursuant to which such Owner Mortgagee agrees, among other things, not to disturb Operator's possession and use of the Owner's Property. Owner shall not incur any loss in income, expense, obligation or liability with regard to the SNDA. Operator shall, at its sole cost and expense, record each such SNDA in the Office of the County Clerk in which Owner's Property is located. If Owner fails to deliver a SNDA from each Owner Mortgagee, Operator may, at its sole option, either (i) terminate this Agreement immediately upon written notice to Owner, or (ii) take such action as Operator deems reasonably necessary to effect the rights granted to Operator hereunder, and off-set all amounts expended in such efforts against the Annual Installment Payments and any other amounts due hereunder or in respect hereof.

10. **Representations and Warranties of Owner.** Owner hereby makes the following further representations and warranties both as of the Effective Date, and as of the Commencement Date:

10.1 **Physical Condition.** Owner has no knowledge of any existing physical conditions of the Owner's Property which would prevent, significantly restrict or make more expensive Operator's development of the Owner's Property for the purposes specified in this Agreement, or which could, with the passage of time, or the giving of notice, constitute a violation of any currently applicable governmental law, ordinance, order, rule or regulation.

10.2 **Legal Restrictions.** This Agreement does not violate any contract, agreement, instrument, judgment or order to which Owner is a party or which affects the Owner's Property. To the best of Owner's knowledge, the Owner's Property is currently in full and complete compliance with all governmental laws, ordinances, orders, rules and regulations applicable to the Owner's Property. To the best of Owner's knowledge and belief, other than the existing farm lease which expires on December 31, 2020, an oil and gas lease, and a pipeline easement, there are no other leases or encumbrances to which Owner is a party which would affect Operator's use of the Owner's Property. Owner may enter into future farm leases without Operator's consent provided that they are terminable by Owner upon Operator's exercise of the Option.

10.3 **No Litigation.** No litigation is pending and, to the best of Owner's knowledge, no litigation or administrative actions are proposed, threatened or anticipated with respect to any matter affecting the Owner's Property. If Owner learns of any litigation or administrative action proposed, threatened or instituted with respect to the Owner's Property, Owner shall give Operator notice within thirty (30) days thereof.

10.4 **Survival.** The representations and warranties set forth in this Section 10 shall survive the execution and delivery hereof.

11. **Use, Operation and Maintenance.**

11.1 **Exclusive Use by Operator.** Operator shall have the exclusive right (i) to use and possess the Owner Property in connection with the Project and other similar solar-powered electrical power generation projects; (ii) to investigate, inspect, survey, and conduct tests of the Owner's Property, including, but not limited to, meteorological, environmental, archeological and geotechnical tests and studies; (iii) to use and convert all of the sunlight resources on the Owner's Property; and (iv) to undertake such other activities on the Owner's Property that may be related to the Project, including, without limitation, the storage of Solar Panels, materials and equipment during the installation and construction of the Improvements; development and operation of communications systems; and site tours of the Project for visitors and other interested parties.

11.2 **No Required Installation or Operation.** Nothing in this Agreement shall be interpreted as imposing on Operator any obligation to install Solar Panels or other Improvements on the Owner's Property, or to operate the Project on the Owner's Property. Operator shall have the sole discretion to determine if and when any Solar Panels and other Improvements may be constructed on Owner's Property, and if and when to commence the operation of the Project on the Owner's Property.

11.3 **Permits and Approvals.** Operator shall be responsible, at its sole cost and expense, for obtaining any governmental permits and approvals necessary for the construction and operation of the Project and the construction and operation of the Improvements. Owner shall cooperate with Operator as necessary to obtain any governmental or utility approvals or permits, including, without limitation, signing any applications for such approvals, provided that Owner shall not incur any loss in income, expense, obligation or liability with respect to Operator obtaining such permits or approvals.

11.4 **Compliance with Laws.** Operator shall comply in all material respects with valid laws applicable to the Owner's Property and the Operator Property. Operator shall have the right, in its sole discretion and at its sole expense, in Operator's name to contest the validity or applicability to the Owner's Property and the Operator Property of any law, ordinance, statute, order, regulation, property assessment or the like made by any governmental agency or entity. Operator shall control any such contest and Owner shall cooperate with Operator in every reasonable way in such contest, provided that Owner shall incur no expense, obligation or liability with regard to such contest.

11.5 **Care and Appearance.** Operator, in its exercise of the lease, easement and other rights granted hereunder shall, at all times, maintain the Owner's Property and the Improvements in a reasonably neat, clean and presentable condition. Operator shall not willfully or negligently damage or destroy the Owner's Property and shall keep the Owner's Property clean and free of debris created by Operator, its contractors, or others brought on to the Owner's Property by Operator. Operator shall not use the Owner's Property for storage, except for materials, construction equipment and vehicles directly associated with construction or maintenance of the Improvements on the Owner's Property or adjacent properties that are part of the Project.

11.6 **Fences and Gates.** At Owner's request, Operator shall repair or replace any fences, gates or cattle guards damaged or removed in connection with Operator's activities on the

Owner's Property. Fences removed from the Owner's Property, if replaced, shall be re-built by Operator at its expense in mutually agreeable locations. All fence repair and construction shall be substantially similar to the construction of existing fences and cattle guards on Owner's Property. Any gates opened for access to Owner's Property by either Party shall be closed immediately after passing through so that livestock may not pass through. Once completed, all replacement fences, gates and cattle guards shall be owned and maintained by Owner. Upon abandonment or termination of the rights granted to Operator in this Agreement, any fences, gates and cattle guards installed by Operator shall remain and become the property of Owner. To minimize the need for temporary fencing, Owner will cooperate with Operator to avoid pasturing animals on or near the Improvements during periods of construction, maintenance or removal activity by Operator. Owner will discuss with Operator what temporary fencing is necessary during the periods of construction, maintenance or removal activity by Operator.

11.7 **Roadway Maintenance and Repairs.** Operator agrees to maintain and repair all Roadway Improvements located on the Operator Property; provided, however, Owner shall reimburse Operator for any costs and expenses incurred by Operator to repair any damage or perform any special maintenance of the Roadway Improvements caused by Owner or any person using the Roadway Improvements with Owner's permission, other than Operator.

12. **Taxes.**

12.1 **Tax Billing.** Owner and Operator shall exert all due diligence to cause the taxing authority to bill Owner separately for Owner's portion of the Taxes and bill Operator separately for Operator's portion of the Taxes. Owner and Operator shall exert all due diligence to cause the taxing authority to further separate and bill separately: 1) That portion of Owner's Property which is ultimately subject to this Agreement; and 2) That portion of Owner's Property which is not subject to this Agreement – that portion of Owner's Property for which Operator pays no Annual Installment Payment.

12.2 **Owner's Taxes.** Owner covenants and agrees to pay prior to delinquency all real and personal property and other taxes, general and special assessments, and other charges of every description ("**Taxes**") levied or assessed by governmental authorities against the Owner's Property and all improvements thereon installed by Owner, other than Operator's Taxes referenced in Section 12.3. Any other provision of this Agreement notwithstanding, only the following shall be included in "**Owner's Taxes**": 1) Taxes on only an amount equal to the Assessed Fair Cash Value of that portion of the of Owner's Property ultimately subject to this Agreement, as of the year immediately preceding filing of the Memorandum by Operator; 2) Any increase in the tax rate, from time to time, on only such amount which is equal to the Assessed Fair Cash Value of that portion of Owner's Property ultimately subject to this Agreement, for the year immediately preceding Operator's filing of the Memorandum, and only then where such increase in tax rate is unrelated to Operator's use of the Property; 3) Any Taxes on improvements Owner makes to that portion of Owner's Property which is ultimately subject to this Agreement, after Operator files the Memorandum; and, 4) All Taxes on that portion of Owner's Property which is not subject to this Agreement.

12.3 **Operator's Taxes.** [REDACTED]

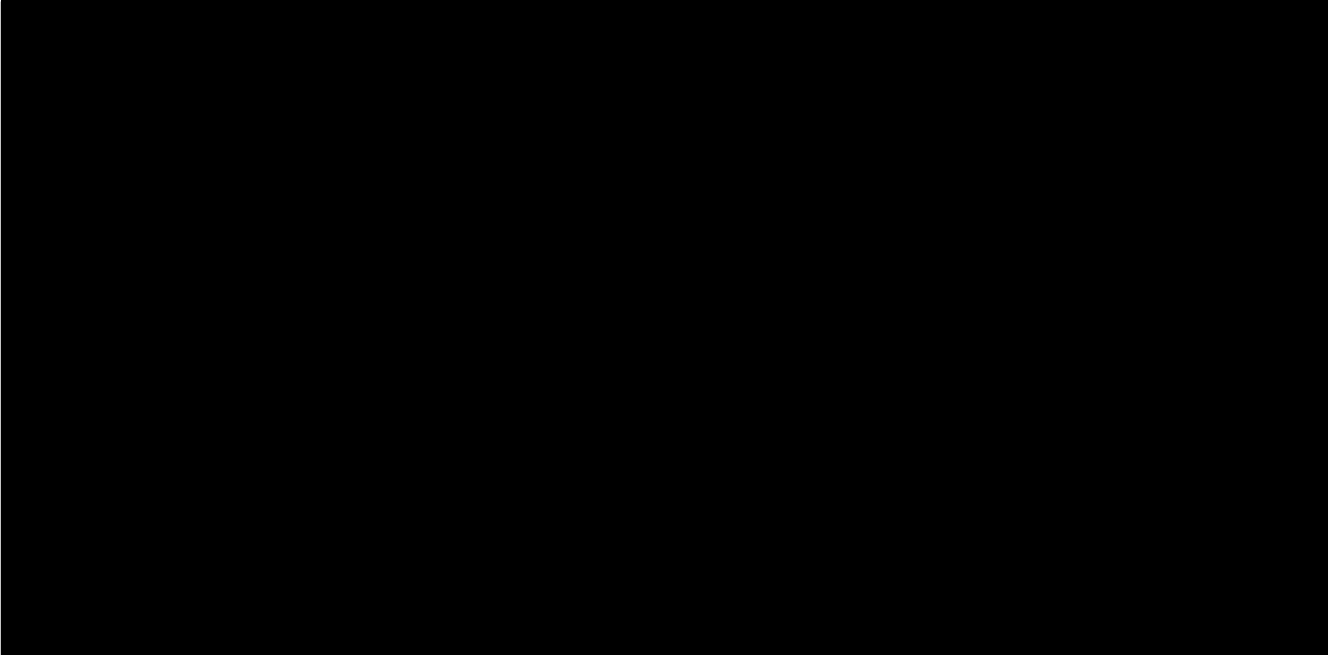

12.4 **Failure to Pay.** In the event either Party fails to pay their share of Taxes prior to delinquency, the other Party shall have the right to pay such Taxes and any accrued penalties or interest, which payments shall increase or be offset against other Payments due under this Agreement.

12.5 **Operator's Right to Contest.** Operator may contest the legal validity or amount of any Operator's Taxes for which it is responsible under this Agreement, and may institute such proceedings as it considers necessary, provided that Operator shall bear all expenses in pursuing such contest or proceeding. With respect to any Taxes which may constitute a lien on the Owner's Property, Operator shall promptly pay such Taxes unless the proceeding in which it contests such Taxes shall operate to prevent or stay the collection of the Taxes so contested or unless Operator removes any such lien by bonding or otherwise. Owner agrees to render to Operator all reasonable assistance in contesting the validity or amount of any such Taxes, with the exception of Taxes levied by Owner, including joining in the signing of any reasonable protests or pleading which Operator may deem advisable to file; provided, however, that Operator shall reimburse Owner for its reasonable out-of-pocket expenses, including reasonable attorneys' fees incurred in connection with providing such assistance.

13. **Mortgage of Operator Property.**

13.1 **Right to Mortgage.** Operator may, upon written notice to Owner, but without requiring Owner's consent or approval, mortgage, collaterally assign, or otherwise encumber and grant security interests in all or any part of its interest in this Agreement and the Operator Property. These various security interests in all or a part of this Agreement and the Operator Property are collectively referred to as an "**Operator Mortgage**" and holder of such security interest, an "**Operator Mortgagee**". Any Operator Mortgagee shall use the Operator Property only for the uses permitted under this Agreement. Whenever Operator has granted a security interest under this Section 13, it will give Owner notice of the Operator Mortgage (including the name and address of the Operator Mortgagee for notice purposes) to Owner within thirty (30) days; provided

that failure to give this notice shall not constitute a default under this Agreement, but rather shall only have the effect of not binding Owner to provide such Operator Mortgage notice until the Operator and its address is given to Owner.

13.2 **Notice of Default and Opportunity to Cure.** As a precondition to exercising any rights or remedies related to any alleged default by Operator under this Agreement, Owner shall give written notice of the default to each Operator Mortgagee at the same time it delivers notice of default to Operator, specifying in detail the alleged event of default and the required remedy. Each Operator Mortgagee or its designee shall have the right, but not the obligation, to cure any default as Operator, and/or the right, but not the obligation, to remove any Improvements or other property owned by Operator or such Operator Mortgagee located on the Owner's Property to the same extent as Operator. The cure period for any Operator Mortgagee shall be the later of (i) the end of the Operator cure period under Section 18; (ii) thirty (30) days after such Operator Mortgagee's receipt of the default notice; or (iii) if applicable, the extended cure period provided for in Section 13.3. Failure by Owner to give an Operator Mortgagee notice of default shall not diminish Owner's rights against Operator, but shall preserve all rights of the Operator Mortgagee or its designee to cure any default and to remove any Improvements or other property of Operator or the Operator Mortgagee located on the Owner's Property.

13.3 **Extended Cure Period.** If any default by Operator under this Agreement cannot be cured without the Operator Mortgagee obtaining possession of all or part of the Operator Property, then any such default shall be deemed remedied if an Operator Mortgagee: (i) within sixty (60) days after receiving notice from Owner as set forth in Section 13.2, acquires possession of all or part of the Operator Property, or begins appropriate judicial or non-judicial proceedings to obtain the same; (ii) diligently prosecutes any such proceedings to completion; and (iii) after gaining possession of all or part of the Operator Property performs all other obligations as and when the same are due in accordance with the terms of this Agreement. If an Operator Mortgagee is prohibited by any court or by operation of any bankruptcy or insolvency laws from commencing or prosecuting the proceedings described above, the sixty (60) day period specified above for commencing proceedings shall be extended for the period of such prohibition.

13.4 **Operator Mortgagee Liability.** Any Operator Mortgagee whose interest in the Operator Property is held solely for security purposes, shall have no obligation or liability under this Agreement unless and until the Operator Mortgagee succeeds to absolute title to the Operator Property and the rights of Operator under this Agreement. An Operator Mortgagee shall be liable to perform obligations under this Agreement only for and during the period it directly holds such absolute title.

13.5 **Certificates.** Owner shall execute any estoppel certificates (certifying as to truthful matters, including without limitation that no default then exists under this Agreement, if such be the case), consents to assignment and non-disturbance agreements as Operator or any Mortgagee may reasonably request from time to time. The Parties shall negotiate in good faith any amendment to this Agreement from time to time to include any provision that may be reasonably requested by Operator or any Operator Mortgagee to implement the provisions contained in this Agreement or to preserve an Operator Mortgagee's security interest.

13.6 **Operator Mortgagee's Right to Enforce Mortgage and Assign.** Each Operator Mortgagee shall have the right, in its sole discretion: (i) to assign its Operator Mortgage; (ii) to enforce its lien and acquire title to all or any portion of the Operator Property by any lawful means; (iii) to take possession of and operate all or any portion of the Operator Property and to perform all obligations to be performed by Operator under this Agreement, or to cause a receiver to be appointed to do so; and (iv) to acquire all or any portion of the Operator Property by foreclosure or by an assignment in lieu of foreclosure and thereafter to assign or transfer all or any portion of the Operator rights under this Agreement to a third party in accordance with Section 14. Any Operator Mortgagee or other party who acquires Operator's interest in all or a portion of the Operator Property pursuant to foreclosure or assignment in lieu of foreclosure shall not be liable to perform the obligations imposed on Operator by this Agreement, which are incurred or accruing after such Operator Mortgagee or other party no longer has ownership or possession of the Operator Property.

13.7 **New Agreement.**

13.7.1 If the Operator Property is foreclosed upon or there is an assignment in lieu of foreclosure, or if this Agreement is rejected or disaffirmed pursuant to bankruptcy law or other law affecting creditor's rights and, within ninety (90) days after such event, Operator or any Operator Mortgagee or other purchaser at a foreclosure sale shall have arranged to the reasonable satisfaction of Owner to cure any material defaults under this Agreement, and for the payment of all Annual Installment Payments or other charges due and payable by Operator as of the date of such event, then Owner shall execute and deliver to Operator or such Operator Mortgagee or other purchaser at a foreclosure sale, or to a designee of one of these parties, as the case may be, a new agreement ("**New Agreement**") which (i) shall be for a term equal to the remainder of the Term of this Agreement before giving effect to such rejection or termination; (ii) shall contain the same covenants, agreements, terms, provisions and limitations as this Agreement (except for any requirements that have been fulfilled by Operator or any Operator Mortgagee or other purchaser at a foreclosure sale prior to rejection or termination of this Agreement); and (iii) shall include that portion of the Operator Property in which Operator or such other Operator Mortgagee or other purchaser at a foreclosure sale had an interest on the date of rejection or termination.

13.7.2 If more than one Operator Mortgagee makes a written request for a New Agreement pursuant to this provision, the New Agreement shall be delivered to the Operator Mortgagee requesting such New Agreement whose Operator Mortgage is prior in time, and the written request of any other Operator Mortgagee whose lien is subordinate shall be void and of no further force or effect. The provisions of this Section 13 shall survive the termination, rejection or disaffirmation of this Agreement and shall continue in full force and effect thereafter to the same extent as if this Section 13 were a separate and independent contract made by Owner, Operator and each Operator Mortgagee, and, from the effective date of such termination, rejection or disaffirmation of this Agreement to the date of execution and delivery of such New Agreement, such Operator Mortgagee or other purchaser at a foreclosure sale may use and enjoy the Operator Property without hindrance by Owner or any person claiming by, through or under Owner; provided that all of the conditions for the New Agreement as set forth above are complied with.

13.8 **Operator Mortgagee's Consent to Amendment, Termination or Surrender.** Notwithstanding any provision of this Agreement to the contrary, the Parties agree that so long as

any Operator Mortgage remains outstanding, this Agreement shall not be modified or amended, and Owner shall not accept a surrender, cancellation or release of all or any part of the Operator Property from Operator, prior to expiration of the Term of this Agreement, without the prior written consent of the Operator Mortgagee holding such Operator Mortgage. This provision is for the express benefit of and shall be enforceable by each Operator Mortgagee as if it were a party named in this Agreement.

14. **Assignment and Sublease.** Operator shall have the right, without Owner's consent, to sell, convey, lease, or assign all or any portion of this Agreement or the Operator Property, on either an exclusive or a non-exclusive basis, or to grant subeasements, co-easements, easements, licenses or similar rights with respect to the Operator Property (collectively, "**Assignment**"), to one or more persons or entities (collectively "**Assignee**"). Each Assignee shall use the Operator Property only for the uses permitted under this Agreement. When Operator makes any Assignment under this Section 14, Operator shall give written notice to Owner of such Assignment (including the interest conveyed by the Assignment and address of the Assignee for notice purposes) to Owner; provided Operator's failure to give such notice shall not constitute a default under this Agreement, but rather shall only have the effect of not binding Owner with respect to such assignment or conveyance until such notice is given. Any Assignment by Operator shall release Operator from obligations subject thereof accruing after the date that liability for such obligations is assumed by the Assignee.

15. **Hazardous Materials.**

15.1 **Owner's Covenants Regarding Hazardous Materials.** Owner represents and warrants that, to the best of Owner's knowledge, the Owner's Property is not and has not been in violation of any federal, state or local environmental health or safety laws, statute, ordinance, rule, regulation or requirement ("**Environmental Laws**"), and Owner has not received any notice or other communication from any governmental authorities alleging that the Owner's Property is in violation of any Environmental Laws. "**Hazardous Materials**" shall mean any asbestos containing materials, petroleum, explosives, toxic materials, or substances regulated as hazardous wastes, hazardous materials, hazardous substances, or toxic substances under any federal, state, or local law or regulation. Owner warrants that Owner has done nothing to contaminate the Operator Property with Hazardous Materials or wastes.

15.2 **Operator's Covenants Regarding Hazardous Materials.** Operator shall, at Operator's sole cost and expense, promptly take removal or remedial action required by Environmental Law with regard to any material violation of any Environmental Law with regard to any Hazardous Materials brought onto the Owner's Property by Operator or its employees, agents, or contractors. Owner shall cooperate with Operator with regard to any scheduling or access to the Owner's Property in connection with any action required hereunder.

15.3 **Operator's Indemnity Regarding Hazardous Materials.** Operator shall indemnify, defend, protect and hold Owner harmless from any liability based on: (i) the release of Hazardous Materials in, on, under or about the Owner's Property caused by Operator or its employees, agents, or contractors, or (ii) the violation by Operator or its employees, agents, or contractors of any Environmental Law. The indemnity obligations set forth herein shall survive termination of this Agreement.

16. **Insurance and Indemnity.**

16.1 **Insurance.** At all times during which Operator is conducting any activities on the Property and at all times during the Term of this Agreement, Operator shall maintain in effect (1) commercial General Liability Insurance, including bodily injury and property damage coverage with minimum limits of \$2 Million Dollars per occurrence and \$4 Million Dollars aggregate and (2) Umbrella Liability Insurance with minimum limits of \$10 Million Dollars per occurrence and \$10 Million Dollars aggregate. Upon a written request by Owner, Operator shall name Owner as additional insured on such insurance policy and provide Owner with a certificate of such insurance.

16.2 **Indemnity by Operator.** Operator shall defend, indemnify, protect and hold Owner harmless from and against all liabilities, costs, expenses, obligations, losses, damages, claims, (collectively "**Claims**") resulting from the negligence, willful misconduct, or breach of this Agreement by Operator, its agents, contractors or employees, invitees, licensees and permittees; provided, however, that such Claims are not due to the sole negligence, willful misconduct, or breach by Owner, its agents, contractors or employees, invitees, licensees or permittees.

16.3 **Indemnity by Owner.** Owner shall defend, indemnify, protect, and hold Operator harmless from and against all Claims resulting from the negligence, willful misconduct, or breach of this Agreement by Owner, its agents, contractors or employees, invitees, licensees and permittees; provided, however, that such Claims are not due to the sole negligence, willful misconduct, or breach by Operator, its agents, contractors, employees, invitees, licensees, or permittees.

16.4 **Survival.** The obligations of the Parties under this Section 16 shall survive expiration or other termination of this Agreement.

17. **Confidentiality.** This Agreement includes confidential and proprietary information relating to Operator and the Project. Owner agrees not to provide copies of the Agreement or disclose the terms of the Agreement to any unauthorized person or entity. Operator authorizes Owner to provide copies of the Agreement and disclose the terms thereof to Owner's family ("family" shall be deemed to include all devisees or descendants of owner by will or intestacy), attorney, accountant, financial advisor and any existing or prospective mortgagee, lessee (including the existing tenant farmer and/or the farm management agent, Field and Main Trust Services), or purchaser for the sole purpose of evaluating and advising Owner and for no other purpose, so long as such authorized parties agree in writing to become subject to the confidentiality provisions hereto and not to provide copies of the Agreement or disclose the terms thereof to any unauthorized person or entity. Any Owner and party shall return all material containing any confidential information to Operator immediately upon its request. Any party agrees to destroy immediately upon request by Operator such analyses, compilation, studies or other documents, and any oral information will continue to be subject to the terms of this Agreement. Owner agrees that Operator will have no adequate remedy at law if any party violates any of the terms of this Agreement. In such event Operator will have the right, in addition to any other rights Operator may have, to obtain injunctive relief to restrain any breach or threatened breach by third party or specific enforcement of such terms plus reimbursement of attorneys' fees, court costs and all associated expenses. No party shall publish, file for public record, reproduce, or otherwise disseminate this document or any of the terms and provisions hereof to any

party, other than the Parties set forth above without the prior written consent of Operator, which consent may be withheld for any reason and in Operator's sole discretion.

18. **Default and Remedies.**

18.1 **Operator Payment Default.**

[REDACTED]

18.1.1 **Collection of Payments.**

[REDACTED]

18.1.2 **Terminate Agreement.**

[REDACTED]

18.2 **Other Operator Default.**

[REDACTED]



18.3 **Owner Default.**

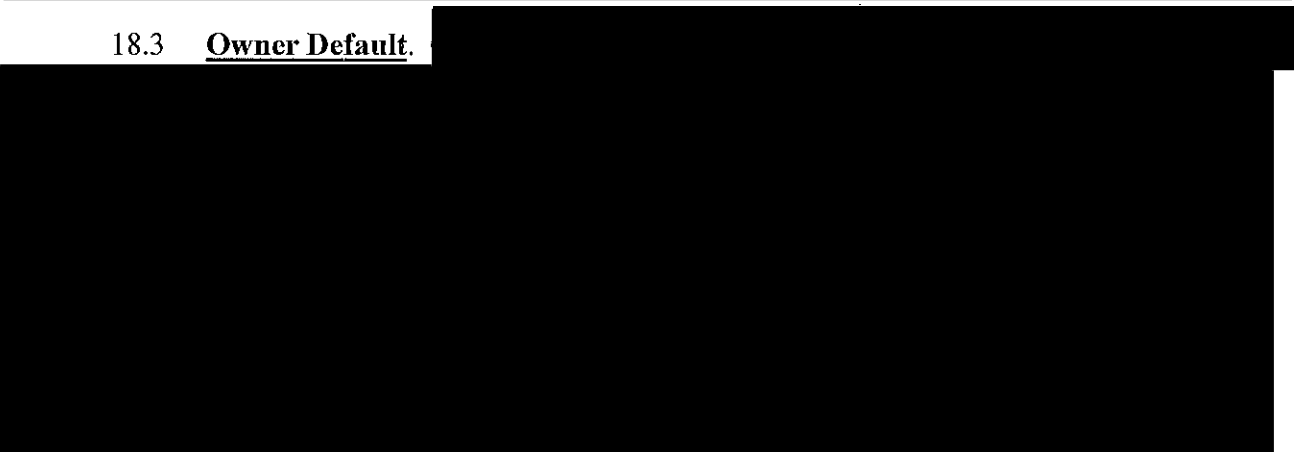

19. **Condemnation.**

19.1 **Complete Taking.** If, at any time, any authority having the power of eminent domain shall condemn all or substantially all of the Operator's Property, or all of the Improvements thereon, for any public use or otherwise, then the interests and obligations of Operator under this Agreement in or affecting the Operator's Property shall cease and terminate upon the earlier of (i) the date that the condemning authority takes physical possession of the Operator's Property or the Improvements thereon, (ii) the date that Operator is, in its sole judgment, no longer able or permitted to operate the Project on the Operator's Property in a commercially viable manner, or (iii) the date of the condemnation judgment. Operator shall continue to pay all amounts payable hereunder to Owner until the earlier of such dates, at which time the Parties shall be relieved of any and all further obligations and conditions to each other under this Agreement.

19.2 **Partial Taking.** If, at any time during the term of this Agreement, any authority having the power of eminent domain shall condemn one or more, but not all, of the Solar Panels, or any portion of the Improvements or the Operator's Property, then the interest and obligations of Operator under this Agreement as to those Solar Panels or any portion of the Improvements or the Operator's Property so taken shall cease and terminate upon the earlier of (i) the date that the condemning authority takes possession of such Solar Panels or any portion of the Improvements or the Operator's Property, (ii) the date that Operator is, in its reasonable judgment, no longer able or permitted to operate the Project on the Operator's Property, or any portion thereof, in a commercially viable manner, or (iii) the date of the condemnation judgment; and, unless this Agreement is terminated as hereinafter provided, this Agreement shall continue in full force and effect as to the remainder of the Solar Panels, Improvements and the Operator's Property. If the

remainder of the Solar Panels or any other portion of the Improvements or the Operator's Property is or becomes insufficient or unsuitable for Operator's purposes hereunder, as determined by Operator in its sole discretion, then, subject to the rights of any Operator Mortgagee under Section 13, Operator shall have the right to terminate this Agreement as to the portion of the Operator's Property to which Operator continues to hold the rights, at which time the Parties shall be relieved of any further obligations and duties to each other under this Agreement.

19.3 **Apportionment, Distribution of Award.** On any taking, all sums awarded, including damages and interest, shall be paid as follows:

- (a) Any portion of the award by the court on account of any cost or loss that Operator may sustain in the removal and relocation of Operator's Improvements, to Operator;
- (b) Any portion of the award by the court for Operator's anticipated or lost revenues or profits, to Operator;
- (c) Any portion of the award by the court for Owner's lost revenues, to Owner;
- (d) All remaining amounts of the award, to Owner or Operator consistent with applicable Kentucky law.

20. **Notice.**

20.1 **Writing.** All notices given or permitted to be given hereunder shall be in writing.

20.2 **Delivery.** Notice is considered given either (i) when delivered in person to the recipient named below, (ii) upon receipt after deposit in the United States mail in a sealed envelope or container, postage and postal charges prepaid, return receipt requested or certified mail, addressed by name and address to the party or person intended, or (iii) twenty-four (24) hours from proper and timely delivery to an overnight courier service addressed by name and address to the party or person intended as follows:

Notice to Owner:

Cecilia King Abbott
2011 Summer Hill Lane
Henderson, KY 42452



Carol King Stevenson, Trustee of the Carole King Stevenson
Revocable Trust, UTA dated 11/16/2015
47 Seawall Road
Rancho Palos Verdes, CA 90275



Claudia King Green
319 Furlong Trace
Versailles, KY 40383

Cathryn King Manion
529 Center Street
Henderson, KY 42420

Tommy Joe Fridy
P. O. Box 468
7106 Main Street
Sebree, KY 42455

Notice to Operator:

Sebree Solar, LLC
700 Universe Blvd
Juno Beach, FL 33408
Attn: Land Services Administration

20.3 **Change of Recipient or Address.** Either Party may, by notice given at any time or from time to time, require subsequent notices to be given to another individual person, whether a party or an officer or representative, or to a different address, or both. Notices given before actual receipt or notice of change shall not be invalidated by the change.

21. **Miscellaneous Provisions.**

21.1 **Successors and Assigns.** The terms and provisions of this Agreement shall run with the land and be binding on and inure to the benefit of the heirs, successors, assigns and personal representatives of the Parties. In accordance with this Agreement, Operator in its discretion may authorize other persons or entities to use the Operator Property for the purposes stated in this Agreement

21.2 **Memorandum**. Simultaneously with the execution of this Agreement, the Parties agree to execute and acknowledge a memorandum of this Agreement ("**Memorandum**"). Operator may record the executed memorandum in the public records of Henderson County, Kentucky.

21.3 **Entire Agreement**. This Agreement and the attached Exhibits shall constitute the entire agreement between the Parties and supersedes all other prior writings and understandings.

21.4 **Amendments**. This Agreement shall not be amended or modified in any way except by an instrument signed by the Parties and consented to by any Operator Mortgagee. The Parties hereto shall at all times hereafter execute any reasonable documents and do any further acts which may be necessary or desirable to carry out the purposes of this Agreement and to give full force and effect to each and all of the provisions hereof.

21.5 **Legal Matters**. This Agreement shall be governed by and interpreted in accordance with the then existing laws of the Commonwealth of Kentucky and the County where the Owner's Property is located shall be considered the proper forum or jurisdiction for any disputes arising in connection with this Agreement. The Parties agree to first attempt to settle any dispute arising out of or in connection with this Agreement by good-faith negotiation. If the Parties are unable to resolve amicably any dispute arising out of or in connection with this Agreement, each shall have all remedies available at law or in equity and as provided by this Agreement. **Each Party waives all right to trial by jury and specifically agrees that trial of suits or causes of action arising out of this Agreement shall be to the court of competent jurisdiction.**

21.6 **Severability**. If any term or provision of this Agreement, or the application thereof to any person or circumstance shall, to any extent, be determined by judicial order or decision to be invalid or unenforceable, the remainder of this Agreement or the application of such term or provision to persons or circumstances other than those as to which it is held to be invalid, shall be enforced to the fullest extent permitted by law.

21.7 **Tax Credits**. If under applicable law Operator becomes ineligible for any currently existing tax credit, benefit or incentive for alternative energy expenditure established by any local, state or federal government, then, at Operator's option and at Operator's sole expense, the Parties shall negotiate in good faith to amend this Agreement or replace it with a different instrument so as to convert Operator's interest in the Operator Property to a substantially similar interest that makes Operator eligible for such tax credit, benefit or incentive. Such amendment or instrument shall not impair any of Owner's rights or increase the burdens or obligations of Owner under this Agreement, nor shall any such change result in any decrease in payments made to Owner hereunder.

21.8 **Approvals**. Whenever in this Agreement the approval or consent of either Party is required or contemplated, unless otherwise specified, such approval or consent shall not be unreasonably withheld or delayed.

21.9 **Authority**. The signatories hereto warrant that each has the authority to execute this Agreement on behalf of any entities which are Parties to this Agreement and that each such

entity has executed this Agreement pursuant to its organizational documents or a resolution or consent of their Board of Directors or other governing body.

21.10 **Time of Essence**. Time is of the essence of each provision of this Agreement.

21.11 **Counterparts**. This Agreement may be executed in multiple counterparts, each of which shall be deemed an original, and all of which together shall constitute a single instrument.

[Signatures on Next Page]

Owner:



Cecilia King Abbott

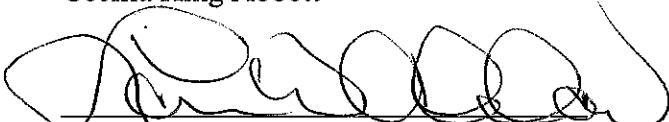

Larry D. Abbott

Carole King Stevenson Revocable Trust, UTA dated 11/16/2015

By: _____
Carole King Stevenson, Trustee

Claudia King Green

Cathryn King Manion

Operator:

Sebree Solar, LLC
a Delaware limited liability company

By: _____
Matthew S. Handel, Vice President

Owner:

Cecilia King Abbott

Larry D. Abbott

Carole King Stevenson Revocable Trust, UTA dated 11/16/2015

By: Carole King Stevenson, Trustee
Carole King Stevenson, Trustee

Claudia King Green

Cathryn King Manion

Operator:

Sebree Solar, LLC
a Delaware limited liability company

By: _____
Matthew S. Handel, Vice President

Owner:

Cecilia King Abbott

Larry D. Abbott

Carole King Stevenson Revocable Trust, UTA dated 11/16/2015

By:

Carole King Stevenson, Trustee



Claudia King Green

Cathym King Manion

Operator:

Sebree Solar, LLC
a Delaware limited liability company

By:

Matthew S. Handel, Vice President

Owner:

Cecilia King Abbott

Larry D. Abbott

Carole King Stevenson Revocable Trust, UTA dated 11/16/2015

By: _____
Carole King Stevenson, Trustee

Claudia King Green

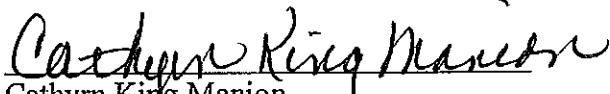

Cathryn King Manion

Operator:

Sebree Solar, LLC
a Delaware limited liability company

By:  _____
Anthony Pedroni, Vice President

EXHIBIT A

Legal Description of Owner's Property

CHERRY HILL FARM

Tract I

Beginning at a large black oak in the Barrons, one of the original corners; thence N 35 225 chains and 68 links to a stone where a black oak stood (now gone) double maple, double black oak, black gum and black oak, corner to M. Book, from which a Black gum bears S 48 30 W distant 7 feet and a maple bearing S 30 15 E distant 9 feet; thence N 59 44 W 28 chains and 63 links to a stone in Michael Book's line and corner to dower; thence with the line of Dower S 29 50 W 14 chains and 32 links to a stone in a lane, black gum bearing S 29 50 W 14 chains and 32 links to a stone in a lane, black gum bearing S 29 50 W marked as pointers; thence with the middle of said lane N 70 W 1 chain and 35 links to a stone corner to dower; thence with the line of dower S 14 55 W 12 chains and 18 links to a stone in Enoch Spencer's line and corner to dower thence with Spencer's line S 61 54 E 4 chains and 76 links to the beginning, containing 74.12 acres.

Tract 2

Also a lot of ground beginning at a stake in the middle of the public road corner to Elliott Denton and Lot No. 1; thence N 72 1/4 W 2.34 chains to a stake in the middle of said public road corner to Dr. Book; thence N 31 1/4 E 15.58 chains to a stake; thence S 72 1/4 E 2.34 chains to a stake; thence S 60 E 13.15 chains to a stake, corner to Byars; thence S 19 W 14.04 chains to a stake in the middle of the public road, corner to Byars; thence with the middle of said public road N 68 3/4 W 11.38 chains, N 57 W 4.33 chains to the beginning, containing 25.20 acres.

LESS &

EXCEPT: It is believed all coal in and underlying the above described property was conveyed to Peabody Coal Company by deeds of record in Deed Book 283, Page 537; Deed Book 276, Page 232 and Deed Book 283, Page 546.

The above described property is burdened by an oil and gas lease.

SUBJECT

TO: A fifty foot (50') Easement and Right Of Way for a ten inch (10") Gas Pipeline granted to Texas Gas Transmission, LLC., by Agreement dated January 13, 2016, of record in Deed Book 615, Page 472 of the Henderson County Clerk's Office; and, Permanent Road Access Agreement grant to Texas

Gas Transmission, LLC, by Agreement dated January 13, 2016, of record in Deed Book 615, Page 846, of the Henderson County Clerk's Office.

Being the same property conveyed to Monroe King by deed from Katie Eblen, widow, dated February 23, 1921, of record in Deed Book 75, Page 147. Monroe King died intestate a resident of Henderson County leaving as his only heirs, his wife, Hattie King, and his children, Rankin King, Cecil King, Arnett King and Ruby King Jones. See Affidavit of Descent of record in Deed Book 191, Page 89. Hattie King died intestate on or about May 3, 1966, leaving as her only heirs her children, Rankin King, Cecil King, Arnett King and Ruby King Jones. See Affidavit of Descent of record in Deed Book 225, Page 336. Rankin King died intestate on or about October 30, 1969 leaving as his only heirs his brothers, Arnett King and Cecil King and his sister Rubye King Jones. See Affidavit of Descent of record in Deed Book 453, Page 762. Rubye King Jones died testate on or about February 7, 1976 and devised the above described property to Cecil King and Arnett King. See Will Book T, Page 442. Arnett King died intestate on or about November 29, 1983, leaving as his only heir his brother Cecil King. Cecil King died testate on or about August 2, 1985. By his will of record in Will Book 5A Page 510 the above described property was devised to Clara Evelyn King, for life with the remainder to Cecilia King Abbott, Carole King (now Carole King Stevenson), Claudia King Green and Cathyrn King Manion. Clara Evelyn King died testate on January 9, 2005. See Will Book 33, Page 107. Also see the 2008 deed from the current owners to themselves of record in Deed Book 562, Page 264 of the Henderson County Clerk's office, describing this and other property. By deed dated July 12, 2016, of record in Deed Book 618, Page 332 of the Henderson County Clerk's Office, Carole King Stevenson and Dr. John Roger Moeller, her husband, conveyed her one-fourth (1/4) interest in the above and other property to Carole King Stevenson, Trustee of the Carole King Stevenson Revocable Trust, UTA dated 11/16/2015.

EXHIBIT B-1

Depiction of Owner's Property

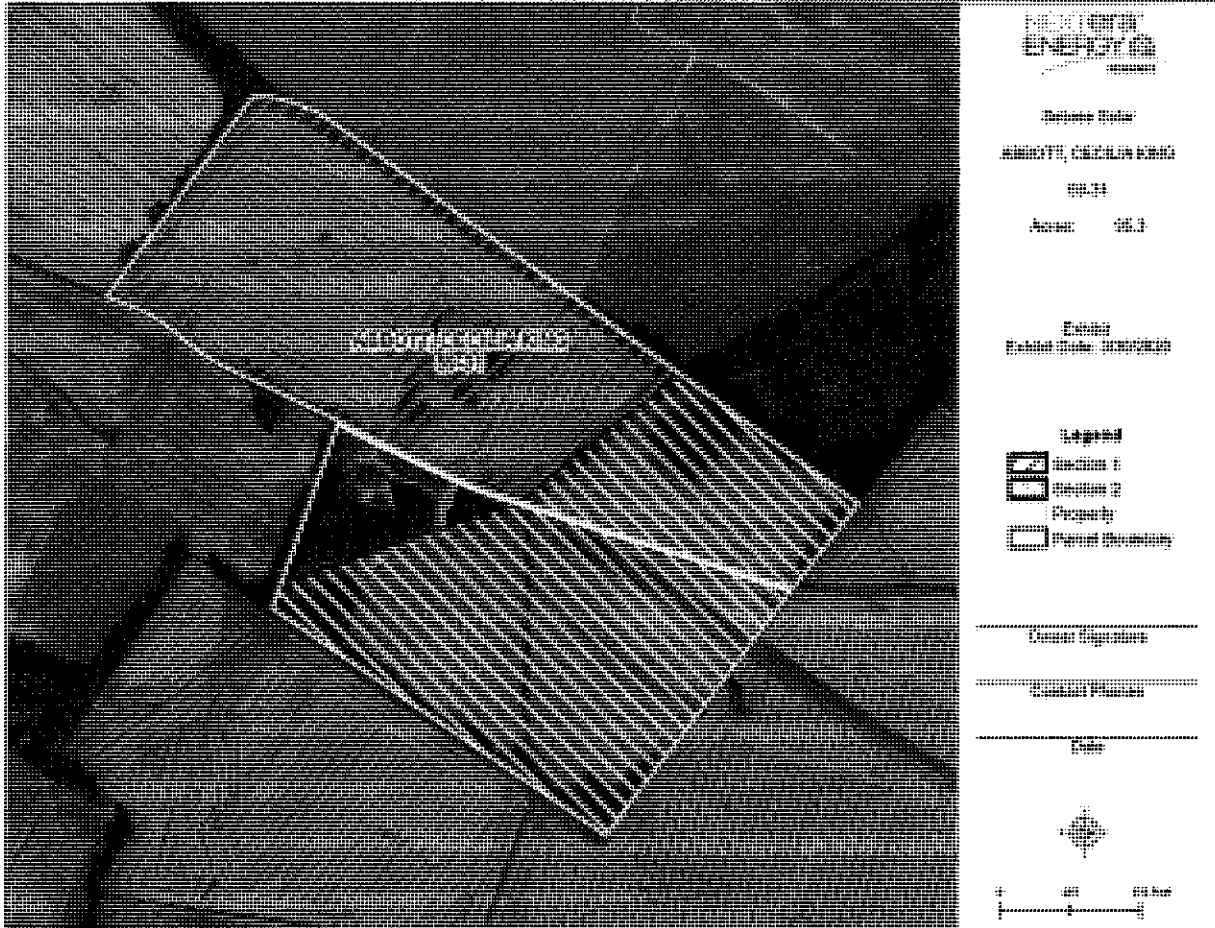

HOLDING PAGE FOR EXHIBIT B-2

Preliminary Lease and Easement Improvement Plan and Acreage Calculation
To be Delivered with Option Notice

HOLDING PAGE FOR EXHIBIT C

As Built Lease and Easement Improvements and Final Acreage Calculation

EXHIBIT D

Lease and Easement Compensation

(1) **Option Payment.**

[REDACTED]

[REDACTED]

(2) **Payment for Lease and Easements.**

[REDACTED]

[REDACTED]



(3) Crop Compensation/Damages.

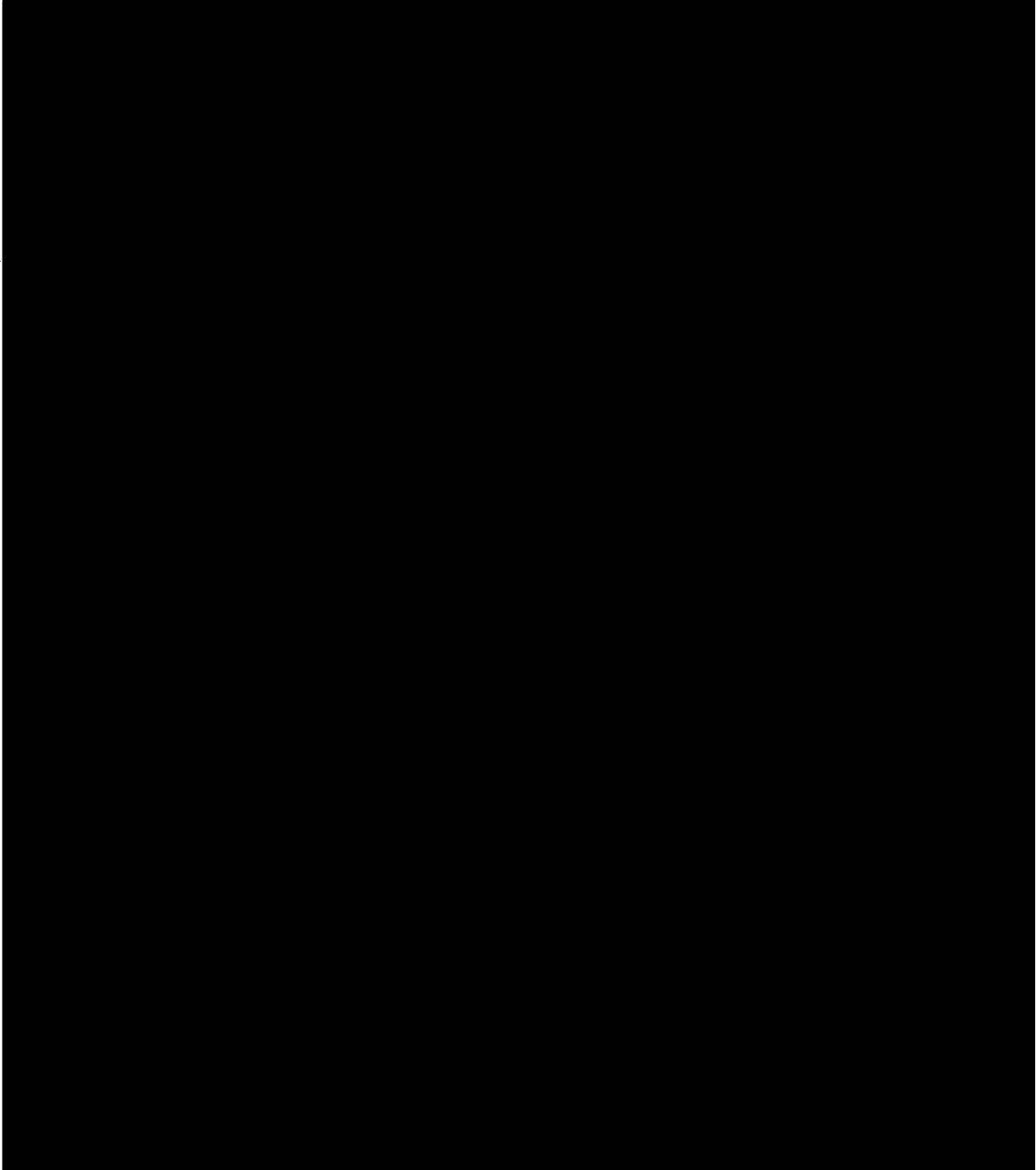

(4) Payment Allocation Schedule.

[Redacted]

[Redacted]

[Redacted]

(5) Warranty.

[Redacted]

(6) Exercise of Option.

[Redacted]

SOLAR LEASE AND EASEMENT AGREEMENT

1. **Parties.** This Solar Lease and Easement Agreement ("**Agreement**") is made and entered as of the 9 day of March, 2023 ("**Effective Date**"), by and between William R. Caton, Jr. and Brenda F. Caton, husband and wife ("**Owner**") and Boulevard Associates, LLC, a Delaware limited liability company ("**Operator**"), which are sometimes individually referred to as a "**Party**" and collectively as the "**Parties**".

2. **Project.** This Agreement relates to the solar-powered electrical power generation and transmission project known as the "Sebree II Solar Energy Center" to be located in Henderson County, Kentucky ("**Project**"), which may be wholly or partially located on the Owner's property legally described on the attached **Exhibit A** to this Agreement ("**Owner's Property**"). Upon Operator's exercise of the Option (as defined below), the Project shall include (i) the Lease of Owner's Property described in Section 4, (ii) the Easements referenced in Section 5 that are located on the Owner's Property, and (iii) the Improvements referenced in Section 8 to be constructed on Owner's Property. The Lease, Easements and Improvements are sometimes collectively referred to as the "**Operator Property**".

3. **Option.** Owner grants to Operator an exclusive option ("**Option**") to acquire the Lease and Easements referenced in Sections 4 and 5 in accordance with the following terms and conditions. Operator shall be entitled to acquire the Lease and the Easements in their entirety or in part, as Operator deems appropriate.

3.1 **Option Term.** The initial period during which Operator may exercise the Option shall be for a term of four (4) years, commencing on the Effective Date ("**Initial Option Term**"). Operator shall have a single election to extend the Initial Option Term for an additional one (1) year ("**Extended Option Term**") by written notice to Owner no later than thirty (30) days prior to the expiration of the Initial Option Term, which notice shall be accompanied by the Option Payment (as defined in **Exhibit D**). References herein to the Option Term shall mean the Initial Option Term and, to the extent exercised by Operator, the Extended Option Term, unless the context otherwise expressly requires.

3.2 **Option Payment.** As consideration for the granting of the Option, Operator agrees to pay Owner the Option Payment set forth in **Exhibit D**.

3.3 **Use of Owner's Property.** During the Option Term, Operator and its employees, agents and contractors shall have a right to enter upon the Owner's Property and the right of ingress and egress over and across the Owner's Property for the purposes of (i) surveying the Owner's Property; (ii) performing such other tests and studies as Operator may desire in connection with the Option, including, without limitation, environmental, avian and cultural resource assessments, and geotechnical, foundation and soil tests, provided that such activities do not unreasonably interfere with Owner's use of the Owner's Property; and (iii) installing, maintaining, operating, inspecting and removing one or more weather related instruments ("**Weather Instrument**") and fencing of said Weather Instrument and including the performance of all tests and studies associated therewith. Owner shall not permit any other individual or entity except Operator or its affiliates to install a Weather Instrument on Owner's Property.

3.4 **Right to Grant Option.** Owner warrants and represents to Operator that (i) the statements in Section 9 concerning Owner's title to the Owner's Property are true and correct; (ii) Owner has the authority to grant this Option to Operator without the consent or approval of any other party; and (iii) there are no other existing options, rights of first refusal, contracts to purchase, leases or mortgages that would prevent Operator from exercising its rights with respect to the Option.

3.5 **Exercise of Option.** Operator may exercise the Option by giving written notice to Owner ("**Option Notice**") at any time during the Option Term. Operator shall specify in the Option Notice the Commencement Date referenced in Section 6.1.1. On the Commencement Date, the Lease and Easements referenced in Sections 4 and 5 shall automatically become effective, and the Parties shall be subject to all of the terms and conditions of this Agreement with respect to such Lease and Easements and all rights and obligations relating thereto.

3.6 **Termination of Option.** If Operator fails to exercise the Option within the Option Term, the Option and the rights of Operator as the optionee shall automatically terminate.

4. **Lease.** Upon exercise of the Option by Operator, Owner leases to Operator, and Operator leases from Owner, Owner's Property for the Lease and Easement Term (defined in Section 6.1) in accordance with the terms and conditions of this Agreement ("**Lease**"), which Lease grants Operator and its agents, contractors, and employees the right to use the Owner's Property for the following permitted uses:

4.1 **Construction Right.** Operator leases Owner's Property for the purpose of constructing, operating, maintaining, repairing, replacing, and removing all or any part or component of the Improvements whether located on Owner's Property. Operator may exercise its right to use all or any part of the Owner's Property as and when Operator deems it necessary or advisable to do so to perform the activities for which this right is granted, including, without limitation, staging areas and parking for Operator's employees.

4.2 **Access Right.** Operator leases Owner's Property for unobstructed vehicular and pedestrian access and ingress to and egress from the Improvements, Owner's Property and any public roadways, and to construct, maintain, and utilize Roadway Improvements on the Owner's Property. Owner shall not permit others to obstruct or damage the roads or Roadway Improvements located on the Owner's Property or in any other way interfere with Operator's rights under this right. Operator shall repair any damage done to Roadway Improvements which result from use by Operator, its agents, servants or employees. Such roads shall be maintained in the condition necessary for use by Operator's equipment, and with regard to existing roads, shall be maintained in at least the condition that existed prior to Operator's use.

4.3 **Solar Panels Right.** Operator leases Owner's Property for Operator to construct, operate, replace, relocate, remove, and maintain Solar Panels and the appurtenant Collection Facilities, together with associated roads and parking areas on Owner's Property.

4.4 **Collection Facilities Right.** Operator leases Owner's Property for Operator to construct, operate, maintain, replace, relocate or remove Collection Facilities on and under the Owner's Property.

4.5 **Substation Right.** Operator leases Owner's Property for Operator to construct, operate, maintain, replace, relocate or remove one or more Substations on Owner's Property.

4.6 **Telecommunication Right.** Operator leases Owner's Property for Operator to construct, operate, maintain, replace, relocate or remove Telecommunication Facilities on and under the Owner's Property.

4.7 **Weather Instrument Right.** Operator leases Owner's Property in order to construct, operate, replace, relocate, remove, and maintain a Weather Instrument and the appurtenant Collection Facilities on Owner's Property.

4.8 **Battery Facilities Right.** Operator leases Owner's Property in order to construct, operate, replace, relocate, remove, and maintain one or more Battery Facilities on Owner's Property.

5. **Grant of Easements.** Upon the exercise of the Option by Operator, Owner grants to Operator, and Operator accepts from Owner, for the Lease and Easement Term referenced in Section 6.1, the following easements over and across the Owner's Property in accordance with the terms and conditions of this Agreement. The following easements are for the benefit of Operator and Operator's agents, contractors and employees and located on the Owner's Property and are collectively referred to as the "**Easements**".

5.1 **Sun Non-Obstruction Easement.** Owner grants Operator an irrevocable, exclusive easement for the right and privilege to use, maintain and capture the free and unobstructed sunlight over and across the Owner's Property. Owner shall not engage in any activity on Owner's Property or any other neighboring property owned by Owner that might interfere with the sunlight direction over any portion of Owner's Property; cause a decrease in the output or efficiency of any Solar Panel or Weather Instrument; or otherwise interfere with Operator's operation of the Project or exercise of any rights granted in this Agreement (collectively "**Interference**"). This grant of the easement expressly includes the right of Operator to enforce Operator's rights, including the physical removal of trees or structures (except existing trees and structures) causing Interference to the Project contemplated by Operator. Operator shall notify Owner before making any such removals.

5.2 **Effects Easement.** Owner grants to Operator an easement over Owner's Property for visual, view, light, flicker, noise, shadow, vibration, electromagnetic, electrical and radio frequency interference, and any other effects attributable to the Project located on the Owner's Property.

6. **Term.** The term of this Agreement ("**Term**") includes the Option Term referenced in Section 3.1, the Initial Lease and Easement Term as described in Section 6.1.1 and the Extended Lease and Easement Term as described in Section 6.1.2 (together, the Initial Lease and Easement Term and the Extended Lease and Easement Term, if applicable, is defined as the "**Lease and Easement Term**").

6.1 **Lease and Easement Term.**

6.1.1 **Initial Lease and Easement Term.** The initial term of the Lease and Easements shall commence on the date specified by Operator in the Option Notice ("**Commencement Date**"). The initial term of the Lease and Easements shall end thirty (30) years after the Commencement Date (the "**Initial Lease and Easement Term**"), subject to the rights of renewal and termination as provided in this Agreement.

Extended Lease and Easement Term. Operator shall have the right to extend the Term of this Agreement for two (2) consecutive terms of five (5) years each in accordance with the terms and provisions of this Agreement (collectively "**Extended Lease and Easement Term**") by providing written notice to Owner of Operator's intent to extend the Term within one hundred eighty (180) days of the end of the existing Term. Each Extended Lease and Easement Term shall begin on the expiration date of the Initial Lease and Easement Term or previous Extended Lease and Easement Term, as the case may be. During the Extended Lease and Easement Term, Operator shall pay Owner the amounts set forth in **Exhibit D** as the consideration for the Lease and Easements.

6.1.2 **Delays During Lease and Easement Term.** At Operator's option, the Term may be extended for a period of time equal to the period of time during which operation of the Project is delayed or suspended because of the occurrence of a Regulatory Suspension or Force Majeure, which are defined as follows:

(i) "**Regulatory Suspension**" shall mean the enactment or application of any law, order, rule, or regulation of the Kentucky Public Service Commission, Federal Energy Regulatory Commission, or other local, state, or federal government authority having jurisdiction over the Project or Operator, or the failure of any such governmental authority to issue an approval or permit pursuant to any such law, order, rule, or regulation, which results in the delay, interruption, or suspension of the production, sale or transmission of electricity from the Solar Panels; and

(ii) "**Force Majeure**" shall mean causes beyond the reasonable control of and without the fault or negligence of the Party claiming Force Majeure, including but not limited to acts of God, labor unrest (including, but not limited to, slowdowns, picketing, boycotts or strikes), flood, earthquake, storm, fire, lightning, explosion, power failure or power surge, vandalism, theft, the cutting of power, transmission or other lines, wires or cables to the Project by persons other than Operator's employees or contractors, epidemic, war, revolution, riot, civil disturbance, sabotage, change in law or applicable regulation subsequent to the Commencement Date and action or inaction by any federal, state or local legislative, executive, administrative judicial agency or body which in any of the foregoing cases, by exercise of due foresight such Party could not reasonably have expected to avoid, and which, by the exercise of due diligence, it is unable to overcome.

The Parties shall be excused from performing their respective obligations under this Agreement and shall not be liable in damages or otherwise if and to the extent that they are unable to so perform or are prevented from performing by a Force Majeure, provided that: (i) the non-performing Party, as promptly as practicable after the occurrence of the Force Majeure, but in no event later than thirty (30) days thereafter, gives the other Party written notice describing the particulars of the occurrence; (ii) the suspension of performance is of no greater scope and of no longer duration than is reasonably required by the Force Majeure; (iii) the non-performing Party uses

good faith and commercially reasonable efforts to remedy its inability to perform; and (iv) as soon as the non-performing Party is able to resume performance of its obligations excused as a result of the occurrence, each Party shall give prompt written notification thereof to the other Party.

6.2 **Termination by Operator.** Provided Operator is not in default under any term of this Agreement, Operator, at its option, shall have the right to terminate this Agreement at any time during the Term of the Agreement, as to all or any part of the Operator Property. Termination shall be effective thirty (30) days after written notice of such termination to Owner. If Operator's notice is a full termination of the Operator Property, the Parties shall be relieved of all further duties and obligations under this Agreement, other than (i) the payment of any accrued and unpaid obligations owed by either Party as of the date of termination; (ii) the removal of the Improvements by Operator pursuant to Section 8.11; and (iii) any other obligations and liabilities that are expressly stated in this Agreement to survive such termination. Upon any such partial termination by Operator, the Parties shall be relieved of all further duties and obligations under this Agreement with respect to the portion thereof terminated by Operator, subject to the obligations and liabilities referenced in items (i) through (iii) above that shall continue to be applicable to the terminated portion of this Agreement. The Parties agree to execute an amendment to this Agreement evidencing such partial termination.

7. **Payments.** If Operator exercises the Option referenced in Section 3, Operator agrees to pay Owner the amounts set forth in **Exhibit D** as consideration for the Lease, Easements and Operator's other rights and interests in the Owner's Property.

8. **Improvements.** Operator shall have the right, at its sole cost and expense, to construct, install, maintain, use, operate, repair, replace, relocate and remove all facilities, structures, equipment, machinery, wires, conduit, cables, poles, materials and property of every kind and character required for the construction and operation of portions of the Project on the Owner's Property, including, but not limited to, the Solar Panels, Collection Facilities, Substations, Telecommunication Facilities, Weather Instruments, Roadway Improvements and Battery Facilities referenced in Sections 8.1 through 8.7 (collectively, the "**Improvements**").

8.1 "**Solar Panels**" shall mean any photovoltaic energy system designed for the generation of electrical power from the collection of sunlight, including without limitation, the photovoltaic panels, foundations, support structures, braces and related equipment.

8.2 "**Collection Facilities**" shall mean all Improvements whose purpose is to deliver electrical power generated by the Solar Panels to an electrical power grid or other system, including without limitation transformers, overhead and underground electrical collection lines, telecommunication lines, splice boxes and interconnection facilities.

8.3 "**Substations**" shall mean electrical lines, meters, monitoring and control equipment, switches, transformers, all structures, equipment, enclosures, fencing, security devices, and other electrical and communications equipment necessary to condition and increase the voltage of electricity generated by the Project to make it suitable for transmission on, and to deliver it to, Collection Facilities connected to an electric power grid or other system.

8.4 "**Telecommunication Facilities**" shall mean all Improvements whose purpose is to provide telecommunication services solely relating to the Project or any of Operator's solar powered projects, including telephone, closed-circuit television, microwave, internet, computer data and other telecommunication services.

8.5 "**Weather Instrument**" shall mean instruments used primarily to gather and transmit sunlight and meteorological data relating to the Project, and includes the instrument's foundations, guy wires, sunlight and meteorological data acquisition equipment, power source, and any required data and electrical transmission lines.

8.6 "**Roadway Improvements**" shall mean all improvements that may be necessary to construct, maintain and repair any new and existing roadways and other means of ingress and egress over, across and along the Owner's Property, including paving or surfacing of the roadways with asphalt, gravel or other roadway materials, installation of road signs and the construction and installation of culverts, bridges, drainage ditches, gates, cattle guards and similar structures and facilities.

8.7 "**Battery Facilities**" shall mean a type of equipment that can be given a new charge by passing an electric current through it designed for the storage of electrical power including without limitation, batteries and other devices for storage of electrical energy, foundations, support structures, braces and related equipment.

8.8 **Ownership of Improvements.** Except as otherwise provided in Section 11.7, all Improvements shall at all times remain the property of Operator, and Owner shall have no right, title or interest therein. All Improvements constructed or placed on the Owner's Property by Operator during the Term of this Agreement may be repaired, replaced, relocated, removed, added to or expanded upon by Operator at any time during the Term of this Agreement. Owner expressly waives any statutory lien or common law liens on the Improvements to which Owner might be entitled.

8.9 **Construction Liens.** Operator shall not permit any liens arising out of Operator's use of the Operator Property under this Agreement to be filed against the Owner's Property. Operator shall, within sixty (60) days after it receives notice of the lien, provide a bond or other security that Owner may reasonably request, or remove such lien from the Owner's Property in the manner provided by applicable law.

8.10 **Location of Improvements.** The acreage required from the Owner's Property for the Improvements for which the Lease and Easements are being granted cannot be determined until the completion of Operator's inspection, testing, study and surveying of the Owner's Property during the Option Term. Along with the Option Notice, Operator shall deliver to Owner a proposed plan of development showing the contemplated locations of the Improvements and a preliminary calculation of the acreage as determined by the area bounded by a perimeter fence required for the Project, which shall serve as the **Exhibit B** to this Agreement. During the final development and construction of the Project, such locations may need to be amended. Following construction of the Project, Operator shall provide Owner an "as-built" survey of all Improvements on Owner's Property and the final calculation of the acreage as determined by the area bounded by a perimeter fence required for the Project, which shall serve as **Exhibit C** to this Agreement.

Further, following construction, the Improvements may need to be relocated or rerouted by Operator, which Operator may perform, at any time during the Term of this Agreement, so long as the nature and extent of any such relocated or rerouted Improvements are not materially different and impose no materially greater burden on the Owner's Property than the original locations or routes, and so long as Operator takes commercially reasonable efforts to minimize disruption or inconvenience to Owner.

8.11 **Removal of Improvements.** Upon full or partial termination of any of the Lease Rights or Easements, Operator shall remove all Improvements and restore the area formerly occupied by the Improvements to substantially the same physical condition that existed immediately before the construction of the Improvements (the "**Removal Obligations**"). At Owner's request, all or any part of the Roadway Improvements may be left for use by Owner.

9. **Ownership and Title Matters.** Owner warrants and represents to Operator, both as of the Effective Date, and as of the Commencement Date as follows:

9.1 **Authority.** Owner represents and warrants that it is the holder of fee simple title and is the sole owner of the Owner's Property and has the unrestricted right and authority to sign this Agreement and to grant Operator the Lease and Easements and other rights granted in this Agreement. When signed by both Parties, this Agreement constitutes a valid and binding agreement enforceable against Owner in accordance with its terms.

9.2 **Other Agreements.** The Owner's Property is not subject to any other agreements, options, rights of first refusal or other prior right of any party to purchase, lease or acquire easements in the Owner's Property, or create any prior claim or right that would preclude or interfere with Operator's rights and interests under this Agreement and the Lease and Easements.

9.3 **Minerals.** Except as disclosed by Owner to Operator at the time of the execution of this Agreement by Owner, Owner owns all of the oil, gas and other minerals, and all rights thereto as on or under the Owner's Property.

9.4 **Owner Mortgage.** Except as disclosed by Owner to Operator at the time of the execution of this Agreement by Owner, there are no mortgages encumbering the Owner's Property ("**Owner Mortgage**").

9.5 **Notice and Opportunity to Cure.** If there is an Owner Mortgage encumbering Owner's Property and Owner receives from the holder thereof any notice that payments are overdue, Owner shall notify Operator and each Operator Mortgagee (as defined at Section 13.1) by sending a copy of such overdue payment notice to Operator by the earlier of (i) five (5) days after receipt, or (ii) three (3) business days prior to the date by which a default under or in respect of such Owner Mortgage could occur. If Operator or any Operator Mortgagee determines that it would be in Operator's interest to make such payments to Owner Mortgagee on Owner's behalf, whether as a result of receiving such notice or otherwise, Operator shall have the right to make such payments and to credit the payments so made against the Annual Installment Payment next due under the Agreement.

9.6 **Subordination, Non-Disturbance & Attornment Agreement.** If there is an Owner Mortgage encumbering Owner's Property, Owner shall cooperate with Operator to obtain a Subordination, Non-Disturbance and Attornment Agreement ("SNDA") in the form prepared and provided by Operator, from each Owner Mortgagee, pursuant to which such Owner Mortgagee agrees, among other things, not to disturb Operator's possession and use of the Owner's Property. Owner shall not incur any loss in income, expense, obligation or liability with regard to the SNDA. Operator shall, at its sole cost and expense, record each such SNDA in the Office of the County Clerk in which Owner's Property is located. If Owner fails to deliver a SNDA from each Owner Mortgagee, Operator may, at its sole option, either (i) terminate this Agreement immediately upon written notice to Owner, or (ii) take such action as Operator deems reasonably necessary to effect the rights granted to Operator hereunder, and off-set all amounts expended in such efforts against the Annual Installment Payments and any other amounts due hereunder or in respect hereof.

10. **Representations and Warranties of Owner.** Owner hereby makes the following further representations and warranties both as of the Effective Date, and as of the Commencement Date:

10.1 **Physical Condition.** Owner has no knowledge of any existing physical conditions of the Owner's Property which would prevent, significantly restrict or make more expensive Operator's development of the Owner's Property for the purposes specified in this Agreement, or which could, with the passage of time, or the giving of notice, constitute a violation of any currently applicable governmental law, ordinance, order, rule or regulation.

10.2 **Legal Restrictions.** Owner has no knowledge of any law, regulation, ordinance or order of any local, state or federal governmental authority which would prohibit or significantly restrict Operator's development of the Owner's Property pursuant to this Agreement. This Agreement does not violate any contract, agreement, instrument, judgment or order to which Owner is a party or which affects the Owner's Property. To the best of Owner's knowledge, the Owner's Property is currently in full and complete compliance with all governmental laws, ordinances, orders, rules and regulations applicable to the Owner's Property.

10.3 **No Litigation.** No litigation is pending and, to the best of Owner's knowledge, no litigation or administrative actions are proposed, threatened or anticipated with respect to any matter affecting the Owner's Property. If Owner learns of any litigation or administrative action proposed, threatened or instituted with respect to the Owner's Property, Owner shall give Operator notice within thirty (30) days thereof.

10.4 **Survival.** The representations and warranties set forth in this Section 10 shall survive the execution and delivery hereof.

11. **Use, Operation and Maintenance.**

11.1 **Exclusive Use by Operator.** Operator shall have the exclusive right (i) to use and possess the Owner Property in connection with the Project and other similar solar-powered electrical power generation projects; (ii) to investigate, inspect, survey, and conduct tests of the Owner's Property, including, but not limited to, meteorological, environmental, archeological and geotechnical tests and studies; (iii) to use and convert all of the sunlight resources on the Owner's Property; and (iv) to undertake such other activities on the Owner's Property that may be related

to the Project, including, without limitation, the storage of Solar Panels, materials and equipment during the installation and construction of the Improvements; development and operation of communications systems; and site tours of the Project for visitors and other interested parties.

11.2 **No Required Installation or Operation.** Nothing in this Agreement shall be interpreted as imposing on Operator any obligation to install Solar Panels or other Improvements on the Owner's Property, or to operate the Project on the Owner's Property. Operator shall have the sole discretion to determine if and when any Solar Panels and other Improvements may be constructed on Owner's Property, and if and when to commence the operation of the Project on the Owner's Property.

11.3 **Permits and Approvals.** Operator shall be responsible, at its sole cost and expense, for obtaining any governmental permits and approvals necessary for the construction and operation of the Project and the construction and operation of the Improvements. Owner shall cooperate with Operator as necessary to obtain any governmental or utility approvals or permits, including, without limitation, signing any applications for such approvals, provided that Owner shall not incur any loss in income, expense, obligation or liability with respect to Operator obtaining such permits or approvals.

11.4 **Compliance with Laws.** Operator shall comply in all material respects with valid laws applicable to the Owner's Property and the Operator Property. Operator shall have the right, in its sole discretion and at its sole expense, in Operator's name to contest the validity or applicability to the Owner's Property and the Operator Property of any law, ordinance, statute, order, regulation, property assessment or the like made by any governmental agency or entity. Operator shall control any such contest and Owner shall cooperate with Operator in every reasonable way in such contest, provided that Owner shall incur no expense, obligation or liability with regard to such contest.

11.5 **Care and Appearance.** Operator, in its exercise of the lease, easement and other rights granted hereunder shall, at all times, maintain the Owner's Property and the Improvements in a reasonably neat, clean and presentable condition. Operator shall not willfully or negligently damage or destroy the Owner's Property and shall keep the Owner's Property clean and free of debris created by Operator, its contractors, or others brought on to the Owner's Property by Operator. Operator shall not use the Owner's Property for storage, except for materials, construction equipment and vehicles directly associated with construction or maintenance of the Improvements on the Owner's Property or adjacent properties that are part of the Project.

11.6 **Fences and Gates.** At Owner's request, Operator shall repair or replace any fences, gates or cattle guards damaged or removed in connection with Operator's activities on the Owner's Property. Fences removed from the Owner's Property, if replaced, shall be re-built by Operator at its expense in mutually agreeable locations. All fence repair and construction shall be substantially similar to the construction of existing fences and cattle guards on Owner's Property. Any gates opened for access to Owner's Property by either Party shall be closed immediately after passing through so that livestock may not pass through. Once completed, all replacement fences, gates and cattle guards shall be owned and maintained by Owner. Upon abandonment or termination of the rights granted to Operator in this Agreement, any fences, gates and cattle guards installed by Operator shall remain and become the property of Owner. To minimize the need for

temporary fencing, Owner will cooperate with Operator to avoid pasturing animals on or near the Improvements during periods of construction, maintenance or removal activity by Operator. Owner will discuss with Operator what temporary fencing is necessary during the periods of construction, maintenance or removal activity by Operator.

11.7 **Roadway Maintenance and Repairs.** Operator agrees to maintain and repair all Roadway Improvements located on the Operator Property; provided, however, Owner shall reimburse Operator for any costs and expenses incurred by Operator to repair any damage or perform any special maintenance of the Roadway Improvements caused by Owner or any person using the Roadway Improvements with Owner's permission, other than Operator.

12. **Taxes.**

12.1 **Owner's Taxes.** Owner covenants and agrees to pay prior to delinquency all real and personal property and other taxes, general and special assessments, and other charges of every description ("**Taxes**") levied or assessed against the Owner's Property and all improvements thereon by governmental authorities, other than Operator's Taxes referenced in Section 12.2 (Taxes, excepting Operator's Taxes, are hereinafter referred to as "**Owner's Taxes**").

12.2 **Operator's Taxes.**

governmental agency of the relevant



12.3 **Failure to Pay.** In the event either Party fails to pay their share of Taxes prior to delinquency, the other Party shall have the right to pay such Taxes and any accrued penalties or interest, which payments shall increase or be offset against other Payments due under this Agreement.

12.4 **Operator's Right to Contest.** Operator may contest the legal validity or amount of any Operator's Taxes for which it is responsible under this Agreement, and may institute such proceedings as it considers necessary, provided that Operator shall bear all expenses in pursuing such contest or proceeding. With respect to any Taxes which may constitute a lien on the Owner's Property, Operator shall promptly pay such Taxes unless the proceeding in which it contests such Taxes shall operate to prevent or stay the collection of the Taxes so contested or unless Operator

removes any such lien by bonding or otherwise. Owner agrees to render to Operator all reasonable assistance in contesting the validity or amount of any such Taxes, with the exception of Taxes levied by Owner, including joining in the signing of any reasonable protests or pleading which Operator may deem advisable to file; provided, however, that Operator shall reimburse Owner for its reasonable out-of-pocket expenses, including reasonable attorneys' fees incurred in connection with providing such assistance.

13. **Mortgage of Operator Property.**

13.1 **Right to Mortgage.** Operator may, upon written notice to Owner, but without requiring Owner's consent or approval, mortgage, collaterally assign, or otherwise encumber and grant security interests in all or any part of its interest in this Agreement and the Operator Property. These various security interests in all or a part of this Agreement and the Operator Property are collectively referred to as an "**Operator Mortgage**" and holder of such security interest, an "**Operator Mortgagee**". Any Operator Mortgagee shall use the Operator Property only for the uses permitted under this Agreement. Whenever Operator has granted a security interest under this Section 13, it will give Owner notice of the Operator Mortgage (including the name and address of the Operator Mortgagee for notice purposes) to Owner within thirty (30) days; provided that failure to give this notice shall not constitute a default under this Agreement, but rather shall only have the effect of not binding Owner to provide such Operator Mortgage notice until the Operator and its address is given to Owner.

13.2 **Notice of Default and Opportunity to Cure.** As a precondition to exercising any rights or remedies related to any alleged default by Operator under this Agreement, Owner shall give written notice of the default to each Operator Mortgagee at the same time it delivers notice of default to Operator, specifying in detail the alleged event of default and the required remedy. Each Operator Mortgagee or its designee shall have the right, but not the obligation, to cure any default as Operator, and/or the right, but not the obligation, to remove any Improvements or other property owned by Operator or such Operator Mortgagee located on the Owner's Property to the same extent as Operator. The cure period for any Operator Mortgagee shall be the later of (i) the end of the Operator cure period under Section 18; (ii) thirty (30) days after such Operator Mortgagee's receipt of the default notice; or (iii) if applicable, the extended cure period provided for in Section 13.3. Failure by Owner to give an Operator Mortgagee notice of default shall not diminish Owner's rights against Operator, but shall preserve all rights of the Operator Mortgagee or its designee to cure any default and to remove any Improvements or other property of Operator or the Operator Mortgagee located on the Owner's Property.

13.3 **Extended Cure Period.** If any default by Operator under this Agreement cannot be cured without the Operator Mortgagee obtaining possession of all or part of the Operator Property, then any such default shall be deemed remedied if an Operator Mortgagee: (i) within sixty (60) days after receiving notice from Owner as set forth in Section 13.2, acquires possession of all or part of the Operator Property, or begins appropriate judicial or nonjudicial proceedings to obtain the same; (ii) diligently prosecutes any such proceedings to completion; and (iii) after gaining possession of all or part of the Operator Property performs all other obligations as and when the same are due in accordance with the terms of this Agreement. If an Operator Mortgagee is prohibited by any court or by operation of any bankruptcy or insolvency laws from commencing

or prosecuting the proceedings described above, the sixty (60) day period specified above for commencing proceedings shall be extended for the period of such prohibition.

13.4 **Operator Mortgagee Liability.** Any Operator Mortgagee whose interest in the Operator Property is held solely for security purposes, shall have no obligation or liability under this Agreement unless and until the Operator Mortgagee succeeds to absolute title to the Operator Property and the rights of Operator under this Agreement. An Operator Mortgagee shall be liable to perform obligations under this Agreement only for and during the period it directly holds such absolute title.

13.5 **Certificates.** Owner shall execute any estoppel certificates (certifying as to truthful matters, including without limitation that no default then exists under this Agreement, if such be the case), consents to assignment and non-disturbance agreements as Operator or any Mortgagee may reasonably request from time to time. The Parties shall negotiate in good faith any amendment to this Agreement from time to time to include any provision that may be reasonably requested by Operator or any Operator Mortgagee to implement the provisions contained in this Agreement or to preserve an Operator Mortgagee's security interest.

13.6 **Operator Mortgagee's Right to Enforce Mortgage and Assign.** Each Operator Mortgagee shall have the right, in its sole discretion: (i) to assign its Operator Mortgage; (ii) to enforce its lien and acquire title to all or any portion of the Operator Property by any lawful means; (iii) to take possession of and operate all or any portion of the Operator Property and to perform all obligations to be performed by Operator under this Agreement, or to cause a receiver to be appointed to do so; and (iv) to acquire all or any portion of the Operator Property by foreclosure or by an assignment in lieu of foreclosure and thereafter to assign or transfer all or any portion of the Operator rights under this Agreement to a third party in accordance with Section 14. Any Operator Mortgagee or other party who acquires Operator's interest in all or a portion of the Operator Property pursuant to foreclosure or assignment in lieu of foreclosure shall not be liable to perform the obligations imposed on Operator by this Agreement, which are incurred or accruing after such Operator Mortgagee or other party no longer has ownership or possession of the Operator Property.

13.7 **New Agreement.**

13.7.1 If the Operator Property is foreclosed upon or there is an assignment in lieu of foreclosure, or if this Agreement is rejected or disaffirmed pursuant to bankruptcy law or other law affecting creditor's rights and, within ninety (90) days after such event, Operator or any Operator Mortgagee or other purchaser at a foreclosure sale shall have arranged to the reasonable satisfaction of Owner to cure any material defaults under this Agreement, and for the payment of all Annual Installment Payments or other charges due and payable by Operator as of the date of such event, then Owner shall execute and deliver to Operator or such Operator Mortgagee or other purchaser at a foreclosure sale, or to a designee of one of these parties, as the case may be, a new agreement ("**New Agreement**") which (i) shall be for a term equal to the remainder of the Term of this Agreement before giving effect to such rejection or termination; (ii) shall contain the same covenants, agreements, terms, provisions and limitations as this Agreement (except for any requirements that have been fulfilled by Operator or any Operator Mortgagee or other purchaser at a foreclosure sale prior to rejection or termination of this Agreement); and (iii) shall include that

portion of the Operator Property in which Operator or such other Operator Mortgagee or other purchaser at a foreclosure sale had an interest on the date of rejection or termination.

13.7.2 If more than one Operator Mortgagee makes a written request for a New Agreement pursuant to this provision, the New Agreement shall be delivered to the Operator Mortgagee requesting such New Agreement whose Operator Mortgage is prior in time, and the written request of any other Operator Mortgagee whose lien is subordinate shall be void and of no further force or effect. The provisions of this Section 13 shall survive the termination, rejection or disaffirmation of this Agreement and shall continue in full force and effect thereafter to the same extent as if this Section 13 were a separate and independent contract made by Owner, Operator and each Operator Mortgagee, and, from the effective date of such termination, rejection or disaffirmation of this Agreement to the date of execution and delivery of such New Agreement, such Operator Mortgagee or other purchaser at a foreclosure sale may use and enjoy the Operator Property without hindrance by Owner or any person claiming by, through or under Owner; provided that all of the conditions for the New Agreement as set forth above are complied with.

13.8 **Operator Mortgagee's Consent to Amendment, Termination or Surrender.** Notwithstanding any provision of this Agreement to the contrary, the Parties agree that so long as any Operator Mortgage remains outstanding, this Agreement shall not be modified or amended, and Owner shall not accept a surrender, cancellation or release of all or any part of the Operator Property from Operator, prior to expiration of the Term of this Agreement, without the prior written consent of the Operator Mortgagee holding such Operator Mortgage. This provision is for the express benefit of and shall be enforceable by each Operator Mortgagee as if it were a party named in this Agreement.

14. **Assignment and Sublease.** Operator shall have the right, without Owner's consent, to sell, convey, lease, or assign all or any portion of this Agreement or the Operator Property, on either an exclusive or a non-exclusive basis, or to grant subeasements, co-easements, easements, licenses or similar rights with respect to the Operator Property (collectively, "**Assignment**"), to one or more persons or entities (collectively "**Assignee**"). Each Assignee shall use the Operator Property only for the uses permitted under this Agreement. When Operator makes any Assignment under this Section 14, Operator shall give written notice to Owner of such Assignment (including the interest conveyed by the Assignment and address of the Assignee for notice purposes) to Owner; provided Operator's failure to give such notice shall not constitute a default under this Agreement, but rather shall only have the effect of not binding Owner with respect to such assignment or conveyance until such notice is given. Any Assignment by Operator shall release Operator from obligations subject thereof accruing after the date that liability for such obligations is assumed by the Assignee.

15. **Hazardous Materials.**

15.1 **Owner's Covenants Regarding Hazardous Materials.** Owner represents and warrants that, to the best of Owner's knowledge, the Owner's Property is not and has not been in violation of any federal, state or local environmental health or safety laws, statute, ordinance, rule, regulation or requirement ("**Environmental Laws**"), and Owner has not received any notice or other communication from any governmental authorities alleging that the Owner's Property is in

violation of any Environmental Laws. "**Hazardous Materials**" shall mean any asbestos containing materials, petroleum, explosives, toxic materials, or substances regulated as hazardous wastes, hazardous materials, hazardous substances, or toxic substances under any federal, state, or local law or regulation. Owner warrants that Owner has done nothing to contaminate the Operator Property with Hazardous Materials or wastes.

15.2 **Operator's Covenants Regarding Hazardous Materials.** Operator shall, at Operator's sole cost and expense, promptly take removal or remedial action required by Environmental Law with regard to any material violation of any Environmental Law with regard to any Hazardous Materials brought onto the Owner's Property by Operator or its employees, agents, or contractors. Owner shall cooperate with Operator with regard to any scheduling or access to the Owner's Property in connection with any action required hereunder.

15.3 **Operator's Indemnity Regarding Hazardous Materials.** Operator shall indemnify, defend, protect and hold Owner harmless from any liability based on: (i) the release of Hazardous Materials in, on, under or about the Owner's Property caused by Operator or its employees, agents, or contractors, or (ii) the violation by Operator or its employees, agents, or contractors of any Environmental Law. The indemnity obligations set forth herein shall survive termination of this Agreement.

16. **Insurance and Indemnity.**

16.1 **Insurance.** At all times during which Operator is conducting any activities on the Property and at all times during the Term of this Agreement, Operator shall maintain in effect (1) commercial General Liability Insurance, including bodily injury and property damage coverage with minimum limits of \$1 Million Dollars per occurrence and \$2 Million Dollars aggregate and (2) Umbrella Liability Insurance with minimum limits of \$5 Million Dollars per occurrence and \$5 Million Dollars aggregate. Upon a written request by Owner, Operator shall name Owner as additional insured on such insurance policy and provide Owner with a certificate of such insurance.

16.2 **Indemnity by Operator.** Operator shall defend, indemnify, protect and hold Owner harmless from and against all liabilities, costs, expenses, obligations, losses, damages, claims, (collectively "**Claims**") resulting from the negligence, willful misconduct, or breach of this Agreement by Operator, its agents, contractors or employees, invitees, licensees and permittees; provided, however, that such Claims are not due to the sole negligence, willful misconduct, or breach by Owner, its agents, contractors or employees, invitees, licensees or permittees.

16.3 **Indemnity by Owner.** Owner shall defend, indemnify, protect, and hold Operator harmless from and against all Claims resulting from the negligence, willful misconduct, or breach of this Agreement by Owner, its agents, contractors or employees, invitees, licensees and permittees; provided, however, that such Claims are not due to the sole negligence, willful misconduct, or breach by Operator, its agents, contractors, employees, invitees, licensees, or permittees.

16.4 **Survival.** The obligations of the Parties under this Section 16 shall survive expiration or other termination of this Agreement.

17. **Confidentiality.** This Agreement includes confidential and proprietary information relating to Operator and the Project. Owner agrees not to provide copies of the Agreement or disclose the terms of the Agreement to any unauthorized person or entity. Operator authorizes Owner to provide copies of the Agreement and disclose the terms thereof to Owner's family ("family" shall be deemed to include all devisees or descendants of owner by will or intestacy), attorney, accountant, financial advisor and any existing or prospective mortgagee, lessee, or purchaser for the sole purpose of evaluating and advising Owner and for no other purpose, so long as such authorized parties agree in writing to become subject to the confidentiality provisions hereto and not to provide copies of the Agreement or disclose the terms thereof to any unauthorized person or entity. Any Owner and party shall return all material containing any confidential information to Operator immediately upon its request. Any party agrees to destroy immediately upon request by Operator such analyses, compilation, studies or other documents, and any oral information will continue to be subject to the terms of this Agreement. Owner agrees that Operator will have no adequate remedy at law if any party violates any of the terms of this Agreement. In such event Operator will have the right, in addition to any other rights Operator may have, to obtain injunctive relief to restrain any breach or threatened breach by third party or specific enforcement of such terms plus reimbursement of attorneys' fees, court costs and all associated expenses. No party shall publish, file for public record, reproduce, or otherwise disseminate this document or any of the terms and provisions hereof to any party, other than the Parties set forth above without the prior written consent of Operator, which consent may be withheld for any reason and in Operator's sole discretion.

18. **Default and Remedies.**

18.1 **Operator Payment Default.**

[REDACTED]

18.1.1 **Collection of Payments.**

[REDACTED]

18.1.2 **Terminate Agreement.**

[REDACTED]



18.2 **Other Operator Default.**

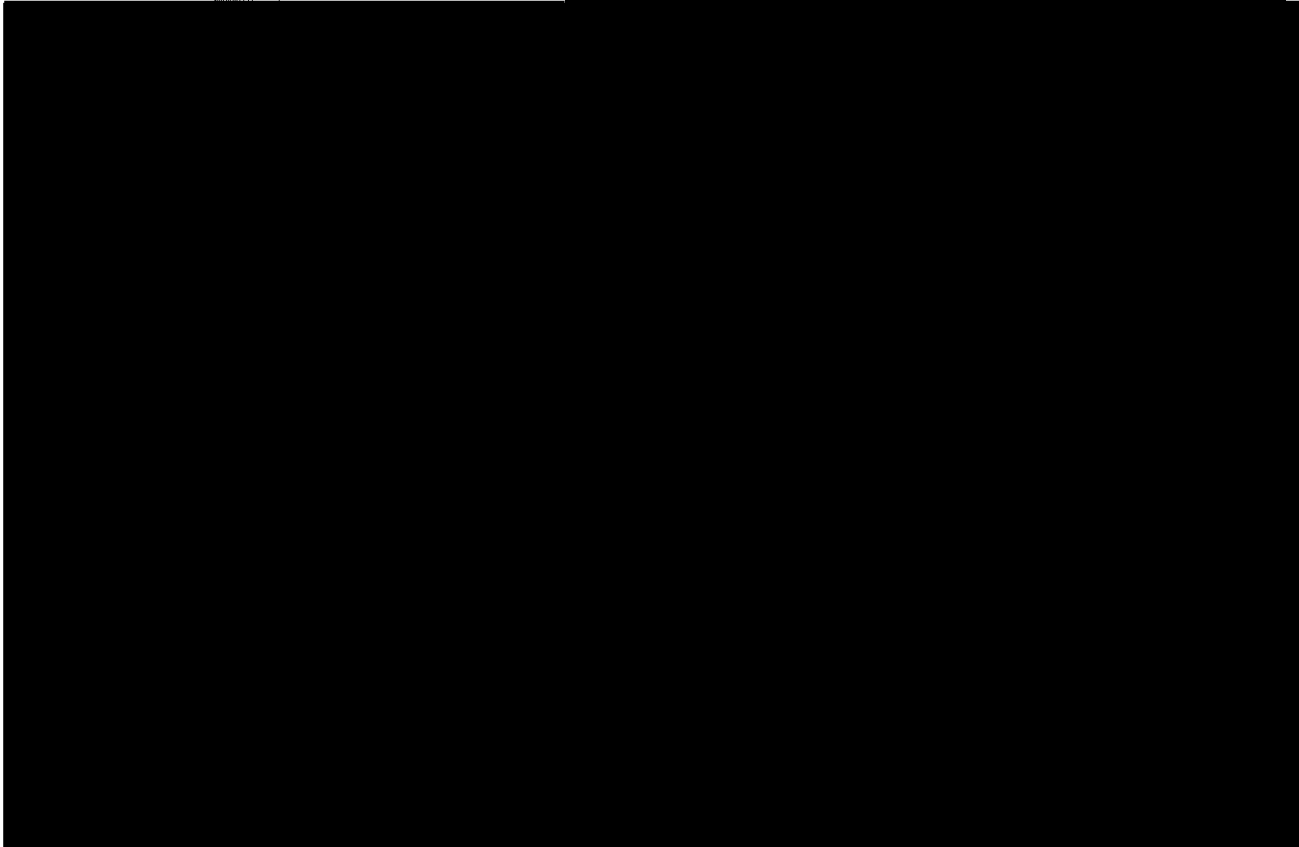

18.3 **Owner Default.**

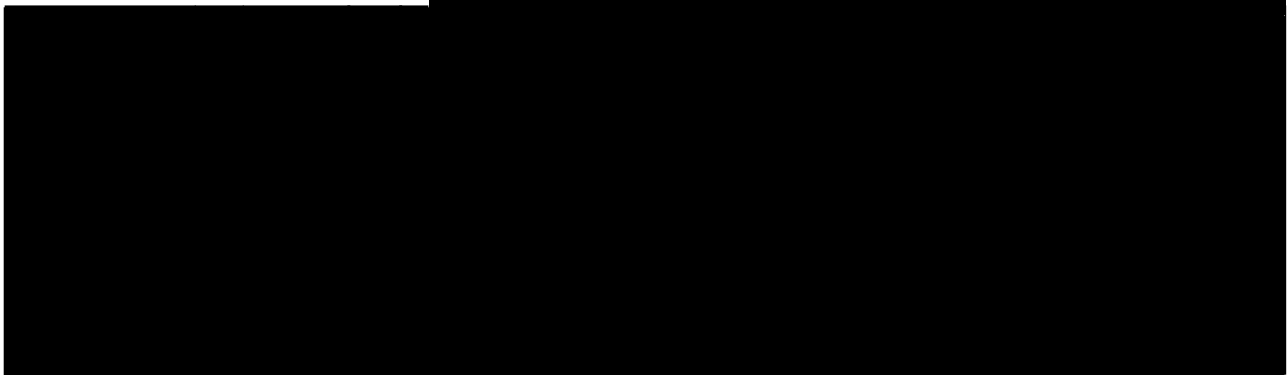

19. **Condemnation.**

19.1 **Complete Taking.** If, at any time, any authority having the power of eminent domain shall condemn all or substantially all of the Operator's Property, or all of the Improvements thereon, for any public use or otherwise, then the interests and obligations of Operator under this Agreement in or affecting the Operator's Property shall cease and terminate upon the earlier of (i)

the date that the condemning authority takes physical possession of the Operator's Property or the Improvements thereon, (ii) the date that Operator is, in its sole judgment, no longer able or permitted to operate the Project on the Operator's Property in a commercially viable manner, or (iii) the date of the condemnation judgment. Operator shall continue to pay all amounts payable hereunder to Owner until the earlier of such dates, at which time the Parties shall be relieved of any and all further obligations and conditions to each other under this Agreement.

19.2 **Partial Taking.** If, at any time during the term of this Agreement, any authority having the power of eminent domain shall condemn one or more, but not all, of the Solar Panels, or any portion of the Improvements or the Operator's Property, then the interest and obligations of Operator under this Agreement as to those Solar Panels or any portion of the Improvements or the Operator's Property so taken shall cease and terminate upon the earlier of (i) the date that the condemning authority takes possession of such Solar Panels or any portion of the Improvements or the Operator's Property, (ii) the date that Operator is, in its reasonable judgment, no longer able or permitted to operate the Project on the Operator's Property, or any portion thereof, in a commercially viable manner, or (iii) the date of the condemnation judgment; and, unless this Agreement is terminated as hereinafter provided, this Agreement shall continue in full force and effect as to the remainder of the Solar Panels, Improvements and the Operator's Property. If the remainder of the Solar Panels or any other portion of the Improvements or the Operator's Property is or becomes insufficient or unsuitable for Operator's purposes hereunder, as determined by Operator in its sole discretion, then, subject to the rights of any Operator Mortgagee under Section 13, Operator shall have the right to terminate this Agreement as to the portion of the Operator's Property to which Operator continues to hold the rights, at which time the Parties shall be relieved of any further obligations and duties to each other under this Agreement.

19.3 **Apportionment, Distribution of Award.** On any taking, all sums awarded, including damages and interest, shall be paid as follows:

- (a) Any portion of the award by the court on account of any cost or loss that Operator may sustain in the removal and relocation of Operator's Improvements, to Operator;
- (b) Any portion of the award by the court for Operator's anticipated or lost revenues or profits, to Operator;
- (c) Any portion of the award by the court for Owner's lost revenues, to Owner;
- (d) All remaining amounts of the award, to Owner or Operator consistent with applicable Kentucky law.

20. **Notice.**

20.1 **Writing.** All notices given or permitted to be given hereunder shall be in writing.

20.2 **Delivery.** Notice is considered given either (i) when delivered in person to the recipient named below, (ii) upon receipt after deposit in the United States mail in a sealed envelope or container, postage and postal charges prepaid, return receipt requested or certified mail, addressed by name and address to the party or person intended, or (iii) twenty-four (24) hours from

proper and timely delivery to an overnight courier service addressed by name and address to the party or person intended as follows:

Notice to Owner: William R. Caton, Jr. and
Brenda F. Caton
5888 J Royster Rd
Corydon, KY 42406



Notice to Operator: Boulevard Associates, LLC
700 Universe Blvd
Juno Beach, FL 33408



20.3 **Change of Recipient or Address.** Either Party may, by notice given at any time or from time to time, require subsequent notices to be given to another individual person, whether a party or an officer or representative, or to a different address, or both. Notices given before actual receipt or notice of change shall not be invalidated by the change.

21. **Miscellaneous Provisions.**

21.1 **Successors and Assigns.** The terms and provisions of this Agreement shall run with the land and be binding on and inure to the benefit of the heirs, successors, assigns and personal representatives of the Parties. In accordance with this Agreement, Operator in its discretion may authorize other persons or entities to use the Operator Property for the purposes stated in this Agreement

21.2 **Memorandum.** Simultaneously with the execution of this Agreement, the Parties agree to execute and acknowledge a memorandum of this Agreement. Operator may record the executed memorandum in the public records of Henderson County, Kentucky.

21.3 **Entire Agreement.** This Agreement and the attached Exhibits shall constitute the entire agreement between the Parties and supersedes all other prior writings and understandings.

21.4 **Amendments.** This Agreement shall not be amended or modified in any way except by an instrument signed by the Parties and consented to by any Operator Mortgagee. The Parties hereto shall at all times hereafter execute any documents and do any further acts which may be necessary or desirable to carry out the purposes of this Agreement and to give full force and effect to each and all of the provisions hereof.

21.5 **Legal Matters.** This Agreement shall be governed by and interpreted in accordance with the then existing laws of the Commonwealth of Kentucky and the County where the Owner's Property is located shall be considered the proper forum or jurisdiction for any disputes arising in connection with this Agreement. The Parties agree to first attempt to settle any dispute arising out of or in connection with this Agreement by good-faith negotiation. If the Parties

are unable to resolve amicably any dispute arising out of or in connection with this Agreement, each shall have all remedies available at law or in equity and as provided by this Agreement. **Each Party waives all right to trial by jury and specifically agrees that trial of suits or causes of action arising out of this Agreement shall be to the court of competent jurisdiction.**

21.6 **Severability**. If any term or provision of this Agreement, or the application thereof to any person or circumstance shall, to any extent, be determined by judicial order or decision to be invalid or unenforceable, the remainder of this Agreement or the application of such term or provision to persons or circumstances other than those as to which it is held to be invalid, shall be enforced to the fullest extent permitted by law.

21.7 **Tax Credits**. If under applicable law Operator becomes ineligible for any currently existing tax credit, benefit or incentive for alternative energy expenditure established by any local, state or federal government, then, at Operator's option, the Parties shall negotiate in good faith to amend this Agreement or replace it with a different instrument so as to convert Operator's interest in the Operator Property to a substantially similar interest that makes Operator eligible for such tax credit, benefit or incentive. Such amendment or instrument shall not impair any of Owner's rights or increase the burdens or obligations of Owner under this Agreement.

21.8 **Approvals**. Whenever in this Agreement the approval or consent of either Party is required or contemplated, unless otherwise specified, such approval or consent shall not be unreasonably withheld or delayed.

21.9 **Authority**. The signatories hereto warrant that each has the authority to execute this Agreement on behalf of any entities which are Parties to this Agreement and that each such entity has executed this Agreement pursuant to its organizational documents or a resolution or consent of their Board of Directors or other governing body.

21.10 **Time of Essence**. Time is of the essence of each provision of this Agreement.

21.11 **Counterparts**. This Agreement may be executed in multiple counterparts, each of which shall be deemed an original, and all of which together shall constitute a single instrument.

[Signatures on Next Page]

Owner:

William R. Caton Jr.
William R. Caton, Jr.

Brenda F. Caton
Brenda F. Caton

Operator:

Boulevard Associates, LLC
a Delaware limited liability company

By: 
Kevin Gildea, Authorized Representative

EXHIBIT A

Legal Description of Owner's Property

The following described real property located about 3 miles southwest of Robards, Henderson County, Kentucky, on the Royster and Eblen Road, to-wit: Beginning at a nail in the center of Royster-Eblen Road, corner with Earl Knight and Willie Eblen's line, runs South 86°-54' East 1962 feet to a post and corner with Forrest Edwards and Eral Knight; thence with said Edwards South 1°-19' West 87 feet to a stake and white oak, corner with Forrest Edwards, thence with said Edwards South 86°- 09' East 610 feet to a stake and red oak corner with Voran Royster in Forrest Edward's line; thence with said Royster's line South 2°-58' West 772 feet to a post and stake, corner with Voran Royster; thence with said Royster's line North 87°-12' West 2556 feet to a nail in the center of Royster-Eblen Road, corner with Voran Royster; thence with center of said road, North 1°- 50' East 881 feet to the place of beginning.

Being the same property conveyed to William R. Caton, Jr. and Brenda F. Caton, husband and wife, by deed from Evadean Mays, unmarried, dated June 30, 1998, of record in Deed Book 477, page 729 in the Henderson County Clerk's office.

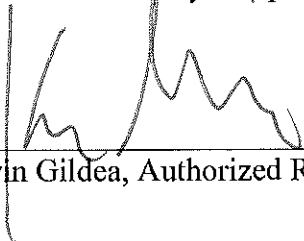
Approximately 49 acres

QLA ID: 18390

HOLDING PAGE FOR EXHIBIT B

Preliminary Lease and Easement Improvement Plan and Acreage Calculation
To be Delivered with Option Notice

HOLDING PAGE FOR EXHIBIT C

As Built Lease and Easement Improvements and Final Acreage Calculation

EXHIBIT D

Lease and Easement Compensation

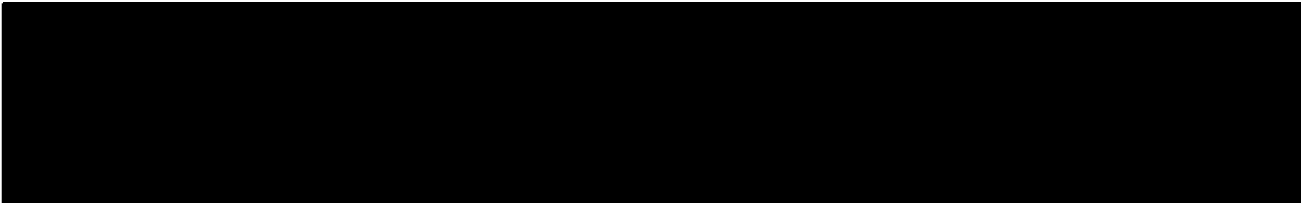

(2) **Option Payment.**

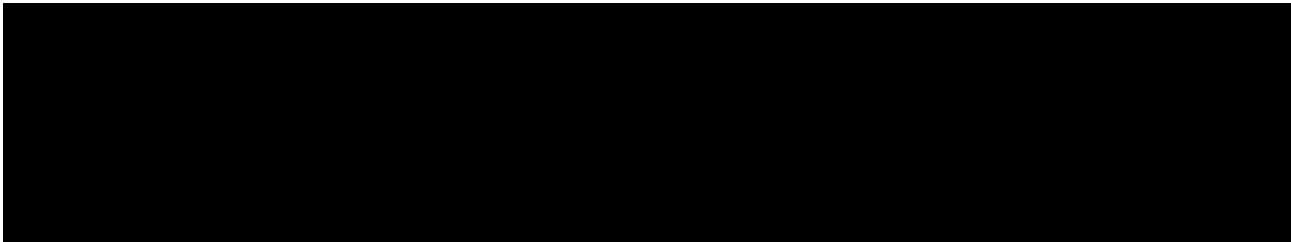

(3) **Payment for Lease and Easements.**

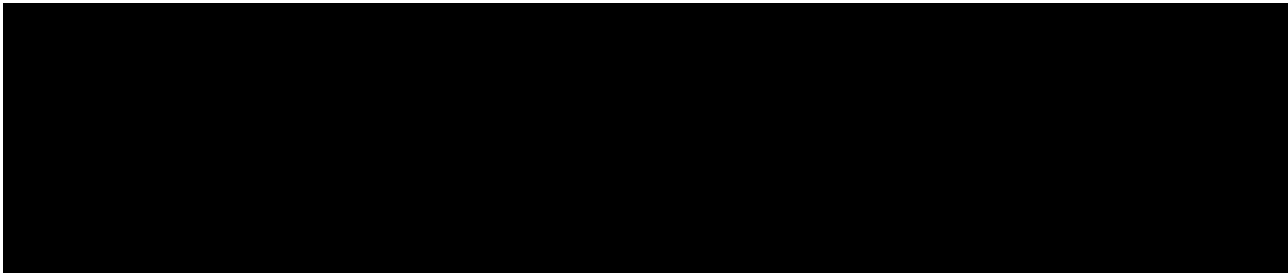
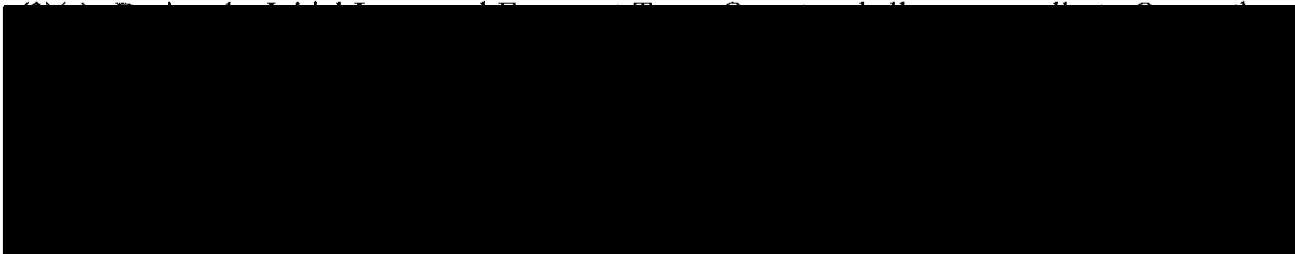

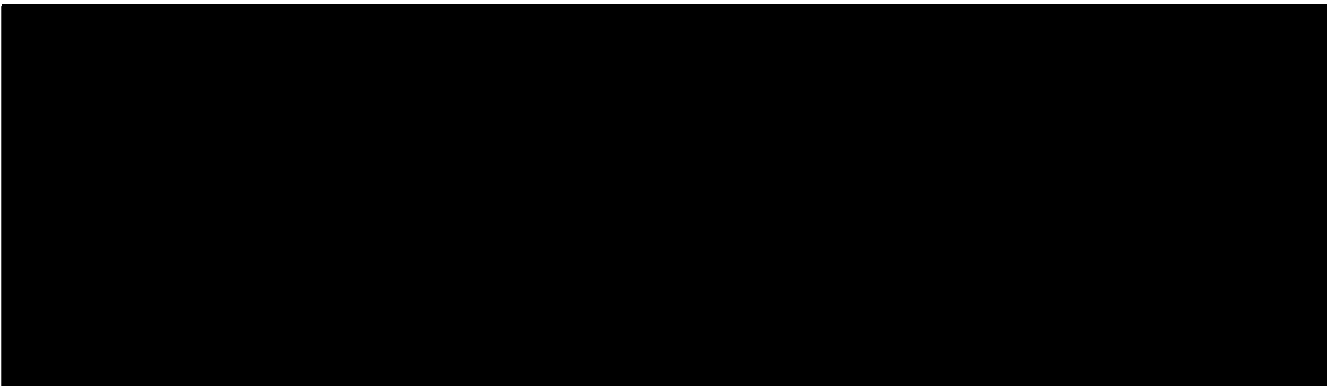

(4) Payment Allocation Schedule.

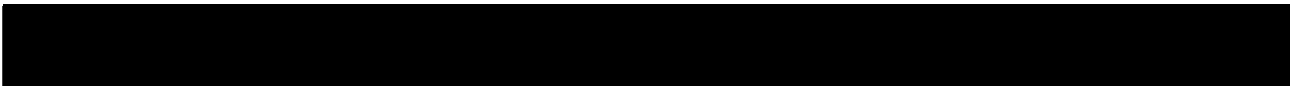

SOLAR LEASE AND EASEMENT AGREEMENT

1. **Parties.** This Solar Lease and Easement Agreement ("**Agreement**") is made and entered as of the 3 day of March, 2021 ("**Effective Date**"), by and between Chris Daniel and Laveta R. Daniel, husband and wife ("**Owner**") and Sebree Solar, LLC, a Delaware limited liability company ("**Operator**"), which are sometimes individually referred to as a "**Party**" and collectively as the "**Parties**".

2. **Project.** This Agreement relates to the solar-powered electrical power generation and transmission project known as the "Sebree Solar Energy Center" to be located in Henderson County, Kentucky ("**Project**"), which may be wholly or partially located on the Owner's property legally described on the attached **Exhibit A**, and depicted on the attached Exhibit B-1 to this Agreement hereto. ("**Owner's Property**"). Upon Operator's exercise of the Option (as defined below), the Project shall include (i) the Lease of Owner's Property described in Section 4, (ii) the Easements referenced in Section 5 that are located on the Owner's Property, and (iii) the Improvements referenced in Section 8 to be constructed on Owner's Property. The Lease, Easements and Improvements are sometimes collectively referred to as the "**Operator Property**".

3. **Option.** Owner grants to Operator an exclusive option ("**Option**") to acquire the Lease and Easements referenced in Sections 4 and 5 in accordance with the following terms and conditions. Operator shall be entitled to acquire the Lease and the Easements in their entirety or in part, as Operator deems appropriate.

3.1 **Option Term.** The period during which Operator may exercise the Option shall be for a term of four (4) years, commencing on the Effective Date ("**Option Term**").

3.2 **Option Payment.** As consideration for the granting of the Option, Operator agrees to pay Owner the Option Payment set forth in **Exhibit D**.

3.3 **Use of Owner's Property.** During the Option Term, Operator and its employees, agents and contractors shall have a right to enter upon the Owner's Property and the right of ingress and egress over and across the Owner's Property for the purposes of (i) surveying the Owner's Property; (ii) performing such other tests and studies as Operator may desire in connection with the Option, including, without limitation, environmental, avian and cultural resource assessments, and geotechnical, foundation and soil tests, provided that such activities do not unreasonably interfere with Owner's use of the Owner's Property; and (iii) installing, maintaining, operating, inspecting and removing one or more weather related instruments ("**Weather Instrument**") and fencing of said Weather Instrument and including the performance of all tests and studies associated therewith. Owner shall not permit any other individual or entity except Operator or its affiliates to install a Weather Instrument on Owner's Property. All topsoil disturbed by the work on the project prior to installation will be segregated and restored as topsoil upon completion of the pre-installation work. Topsoil removed during installation shall be placed elsewhere on Owner's property at Owner's direction. Operator shall give Owner ninety (90) days' notice prior to commencement of installation. If, after giving notice, Operator fails to commence timely, then Operator will be responsible to Owner for the loss of crop rent for the crop season if the subject property lies fallow.

3.4 **Right to Grant Option.** Owner warrants and represents to Operator that (i) the statements in Section 9 concerning Owner's title to the Owner's Property are true and correct; (ii) Owner has the authority to grant this Option to Operator without the consent or approval of any other party; and (iii) there are no other existing options, rights of first refusal, contracts to purchase, leases or mortgages that would prevent Operator from exercising its rights with respect to the Option.

3.5 **Exercise of Option.** Operator may exercise the Option by giving written notice to Owner ("**Option Notice**") at any time during the Option Term. Operator shall specify in the Option Notice the Commencement Date referenced in Section 6.1.1. On the Commencement Date, the Lease and Easements referenced in Sections 4 and 5 shall automatically become effective, and the Parties shall be subject to all of the terms and conditions of this Agreement with respect to such Lease and Easements and all rights and obligations relating thereto.

3.6 **Termination of Option.** If Operator fails to exercise the Option within the Option Term, the Option and the rights of Operator as the optionee shall automatically terminate.

4. **Lease.** Upon exercise of the Option by Operator, Owner leases to Operator, and Operator leases from Owner, Owner's Property for the Lease and Easement Term (defined in Section 6.1) in accordance with the terms and conditions of this Agreement ("**Lease**"), which Lease grants Operator and its agents, contractors, and employees the right to use the Owner's Property for the following permitted uses:

4.1 **Construction Right.** Operator leases Owner's Property for the purpose of constructing, operating, maintaining, repairing, replacing, and removing all or any part or component of the Improvements whether located on Owner's Property. Operator may exercise its right to use all or any part of the Owner's Property as and when Operator deems it necessary or advisable to do so to perform the activities for which this right is granted, including, without limitation, staging areas and parking for Operator's employees.

4.2 **Access Right.** Operator leases Owner's Property for unobstructed vehicular and pedestrian access and ingress to and egress from the Improvements, Owner's Property and any public roadways, and to construct, maintain, and utilize Roadway Improvements on the Owner's Property. In the event that Operator builds roads outside of the fenced area of the project, Operator shall make reasonable efforts to plan and construct any such roads along the boundary of Owner's property unless it is impractical to do so, in Operator's determination. Owner shall not permit others to obstruct or damage the roads or Roadway Improvements located on the Owner's Property or in any other way interfere with Operator's rights under this right. Operator shall repair any damage done to Roadway Improvements which result from use by Operator, its agents, servants or employees. Such roads shall be maintained in the condition necessary for use by Operator's equipment, and with regard to existing roads, shall be maintained in at least the condition that existed prior to Operator's use.

4.3 **Solar Panels Right.** Operator leases Owner's Property for Operator to construct, operate, replace, relocate, remove, and maintain Solar Panels and the appurtenant Collection Facilities, together with associated roads and parking areas on Owner's Property.

4.4 **Collection Facilities Right.** Operator leases Owner's Property for Operator to construct, operate, maintain, replace, relocate or remove Collection Facilities on and under the Owner's Property.

4.5 **Substation Right.** Operator leases Owner's Property for Operator to construct, operate, maintain, replace, relocate or remove one or more Substations on Owner's Property.

4.6 **Telecommunication Right.** Operator leases Owner's Property for Operator to construct, operate, maintain, replace, relocate or remove Telecommunication Facilities on and under the Owner's Property.

4.7 **Weather Instrument Right.** Operator leases Owner's Property in order to construct, operate, replace, relocate, remove, and maintain a Weather Instrument and the appurtenant Collection Facilities on Owner's Property.

4.8 **Battery Facilities Right.** Operator leases Owner's Property in order to construct, operate, replace, relocate, remove, and maintain one or more Battery Facilities on Owner's Property.

5. **Grant of Easements.** Upon the exercise of the Option by Operator, Owner grants to Operator, and Operator accepts from Owner, for the Lease and Easement Term referenced in Section 6.1, the following easements over and across the Owner's Property in accordance with the terms and conditions of this Agreement. The following easements are for the benefit of Operator and Operator's agents, contractors and employees and located on the Owner's Property and are collectively referred to as the "**Easements**".

5.1 **Sun Non-Obstruction Easement.** Owner grants Operator an irrevocable, exclusive easement for the right and privilege to use, maintain and capture the free and unobstructed sunlight over and across the Owner's Property. Owner shall not engage in any activity on Owner's Property or any other neighboring property owned by Owner that might interfere with the sunlight direction over any portion of Owner's Property; cause a decrease in the output or efficiency of any Solar Panel or Weather Instrument; or otherwise interfere with Operator's operation of the Project or exercise of any rights granted in this Agreement (collectively "**Interference**"). This grant of the easement expressly includes the right of Operator to enforce Operator's rights, including the physical removal of trees or structures (except existing trees and structures) causing Interference to the Project contemplated by Operator. Operator shall notify Owner before making any such removals. The Operator has the obligation, including cost, for any maintenance of natural existing vegetation outside of the fence line that it requires in order to preserve its rights under this Section 5.1, for example, trimming existing trees outside of the fence line as they grow if Operator determines that such trees are or may cause interference.

5.2 **Effects Easement.** Owner grants to Operator an easement over Owner's Property for visual, view, light, flicker, noise, shadow, vibration, electromagnetic, electrical and radio frequency interference, and any other effects attributable to the Project located on the Owner's Property.

6. **Term.** The term of this Agreement ("**Term**") includes the Option Term referenced in Section 3.1, the Initial Lease and Easement Term as described in Section 6.1.1 and the Extended Lease and Easement Term as described in Section 6.1.2 (together, the Initial Lease and Easement Term and the Extended Lease and Easement Term, if applicable, is defined as the "**Lease and Easement Term**").

6.1 **Lease and Easement Term.**

6.1.1 **Initial Lease and Easement Term.** The initial term of the Lease and Easements shall commence on the date specified by Operator in the Option Notice ("**Commencement Date**"). The initial term of the Lease and Easements shall end thirty (30) years after the Commencement Date (the "**Initial Lease and Easement Term**"), subject to the rights of renewal and termination as provided in this Agreement.

6.1.2 **Extended Lease and Easement Term.** Operator shall have the right to extend the Term of this Agreement for two consecutive terms of five (5) years each in accordance with the terms and provisions of this Agreement (collectively "**Extended Lease and Easement Term**") by providing written notice to Owner of Operator's intent to extend the Term within one hundred eighty (180) days of the end of the existing Term. Each Extended Lease and Easement Term shall begin on the expiration date of the Initial Lease and Easement Term or previous Extended Lease and Easement Term, as the case may be. During the Extended Lease and Easement Term, Operator shall pay Owner the amounts set forth in **Exhibit D** as the consideration for the Lease and Easements.

6.1.3 **Delays During Lease and Easement Term.** At Operator's option, the Term may be extended for a period of time equal to the period of time during which operation of the Project is delayed or suspended because of the occurrence of a Regulatory Suspension or Force Majeure, which are defined as follows:

(i) "**Regulatory Suspension**" shall mean the enactment or application of any law, order, rule, or regulation of the Kentucky Public Service Commission, Federal Energy Regulatory Commission, or other local, state, or federal government authority having jurisdiction over the Project or Operator, or the failure of any such governmental authority to issue an approval or permit pursuant to any such law, order, rule, or regulation, which results in the delay, interruption, or suspension of the production, sale or transmission of electricity from the Solar Panels; and

(ii) "**Force Majeure**" shall mean causes beyond the reasonable control of and without the fault or negligence of the Party claiming Force Majeure, including but not limited to acts of God, labor unrest (including, but not limited to, slowdowns, picketing, boycotts or strikes), flood, earthquake, storm, fire, lightning, explosion, power failure or power surge, vandalism, theft, the cutting of power, transmission or other lines, wires or cables to the Project by persons other than Operator's employees or contractors, epidemic, war, revolution, riot, civil disturbance, sabotage, change in law or applicable regulation subsequent to the Commencement Date and action or inaction by any federal, state or local legislative, executive, administrative judicial agency or body which in any of the foregoing cases, by exercise of due foresight such

Party could not reasonably have expected to avoid, and which, by the exercise of due diligence, it is unable to overcome.

The Parties shall be excused from performing their respective obligations under this Agreement and shall not be liable in damages or otherwise if and to the extent that they are unable to so perform or are prevented from performing by a Force Majeure, provided that: (i) the non-performing Party, as promptly as practicable after the occurrence of the Force Majeure, but in no event later than thirty (30) days thereafter, gives the other Party written notice describing the particulars of the occurrence; (ii) the suspension of performance is of no greater scope and of no longer duration than is reasonably required by the Force Majeure; (iii) the non-performing Party uses good faith and commercially reasonable efforts to remedy its inability to perform; and (iv) as soon as the non-performing Party is able to resume performance of its obligations excused as a result of the occurrence, each Party shall give prompt written notification thereof to the other Party.

6.2 **Termination by Operator.** Provided Operator is not in default under any term of this Agreement, Operator, at its option, shall have the right to terminate this Agreement at any time during the Term of the Agreement, as to all or any part of the Operator Property. Termination shall be effective thirty (30) days after written notice of such termination to Owner. If Operator's notice is a full termination of the Operator Property, the Parties shall be relieved of all further duties and obligations under this Agreement, other than (i) the payment of any accrued and unpaid obligations owed by either Party as of the date of termination; (ii) the removal of the Improvements by Operator pursuant to Section 8.11; and (iii) any other obligations and liabilities that are expressly stated in this Agreement to survive such termination. Upon any such partial termination by Operator, the Parties shall be relieved of all further duties and obligations under this Agreement with respect to the portion thereof terminated by Operator, subject to the obligations and liabilities referenced in items (i) through (iii) above that shall continue to be applicable to the terminated portion of this Agreement. The Parties agree to execute an amendment to this Agreement evidencing such partial termination.

7. **Payments.** If Operator exercises the Option referenced in Section 3, Operator agrees to pay Owner the amounts set forth in **Exhibit D** as consideration for the Lease, Easements and Operator's other rights and interests in the Owner's Property.

8. **Improvements.** Operator shall have the right, at its sole cost and expense, to construct, install, maintain, use, operate, repair, replace, relocate and remove all facilities, structures, equipment, machinery, wires, conduit, cables, poles, materials and property of every kind and character required for the construction and operation of portions of the Project on the Owner's Property, including, but not limited to, the Solar Panels, Collection Facilities, Substations, Telecommunication Facilities, Weather Instruments, Roadway Improvements and Battery Facilities referenced in Sections 8.1 through 8.7 (collectively, the "**Improvements**").

8.1 **"Solar Panels"** shall mean any photovoltaic energy system designed for the generation of electrical power from the collection of sunlight, including without limitation, the photovoltaic panels, foundations, support structures, braces and related equipment.

8.2 **"Collection Facilities"** shall mean all Improvements whose purpose is to deliver electrical power generated by the Solar Panels to an electrical power grid or other system,

including without limitation transformers, overhead and underground electrical collection lines, telecommunication lines, splice boxes and interconnection facilities.

8.3 "**Substations**" shall mean electrical lines, meters, monitoring and control equipment, switches, transformers, all structures, equipment, enclosures, fencing, security devices, and other electrical and communications equipment necessary to condition and increase the voltage of electricity generated by the Project to make it suitable for transmission on, and to deliver it to, Collection Facilities connected to an electric power grid or other system.

8.4 "**Telecommunication Facilities**" shall mean all Improvements whose purpose is to provide telecommunication services solely relating to the Project or any of Operator's solar powered projects, including telephone, closed-circuit television, microwave, internet, computer data and other telecommunication services.

8.5 "**Weather Instrument**" shall mean instruments used primarily to gather and transmit sunlight and meteorological data relating to the Project, and includes the instrument's foundations, guy wires, sunlight and meteorological data acquisition equipment, power source, and any required data and electrical transmission lines.

8.6 "**Roadway Improvements**" shall mean all improvements that may be necessary to construct, maintain and repair any new and existing roadways and other means of ingress and egress over, across and along the Owner's Property, including paving or surfacing of the roadways with asphalt, gravel or other roadway materials, installation of road signs and the construction and installation of culverts, bridges, drainage ditches, gates, cattle guards and similar structures and facilities.

8.7 "**Battery Facilities**" shall mean a type of equipment that can be given a new charge by passing an electric current through it designed for the storage of electrical power including without limitation, batteries and other devices for storage of electrical energy, foundations, support structures, braces and related equipment.

8.8 "**Ownership of Improvements**". Except as otherwise provided in Section 11.7, all Improvements shall at all times remain the property of Operator, and Owner shall have no right, title or interest therein. All Improvements constructed or placed on the Owner's Property by Operator during the Term of this Agreement may be repaired, replaced, relocated, removed, added to or expanded upon by Operator at any time during the Term of this Agreement. Owner expressly waives any statutory lien or common law liens on the Improvements to which Owner might be entitled.

8.9 "**Construction Liens**". Operator shall not permit any liens arising out of Operator's use of the Operator Property under this Agreement to be filed against the Owner's Property. Operator shall, within sixty (60) days after it receives notice of the lien, provide a bond or other security that Owner may reasonably request, or remove such lien from the Owner's Property in the manner provided by applicable law.

8.10 "**Location of Improvements**". The acreage required from the Owner's Property for the Improvements for which the Lease and Easements are being granted cannot be determined

until the completion of Operator's inspection, testing, study and surveying of the Owner's Property during the Option Term. Operator shall not install any Improvements in the excluded areas of Owner's Property depicted in Exhibit B-1 without obtaining the prior consent of Owner. Along with the Option Notice, Operator shall deliver to Owner a proposed plan of development showing the contemplated locations of the Improvements and a preliminary calculation of the acreage as determined by the area bounded by a perimeter fence required for the Project, and depicting any areas outside the perimeter fence that will be used as vegetative buffer which shall be considered a part of the Owner's Property that is subject to the Lease and Easements, and, at Operator's discretion, any additional setback or similar areas required for permitting that may be included as part of the Owner's Property subject to the Lease and Easement, and identifying any such areas that are to be considered a part of the Owner's Property that is subject to the Lease and Easements, which shall serve as the **Exhibit B** to this Agreement. During the final development and construction of the Project, such locations may need to be amended. Following construction of the Project, Operator shall provide Owner an "as-built" survey of all Improvements on Owner's Property and the final calculation of the acreage as determined by the area bounded by a perimeter fence and any additional areas identified by Operator as required for the Project, which shall serve as **Exhibit C** to this Agreement. Further, following construction, the Improvements may need to be relocated or rerouted by Operator, which Operator may perform, at any time during the Term of this Agreement, so long as the nature and extent of any such relocated or rerouted Improvements are not materially different and impose no materially greater burden on the Owner's Property than the original locations or routes, and so long as Operator takes commercially reasonable efforts to minimize disruption or inconvenience to Owner.

8.11 **Removal of Improvements.** Upon full or partial termination of any of the Lease Rights or Easements, Operator shall remove all Improvements and restore the area formerly occupied by the Improvements to substantially the same physical condition that existed immediately before the construction of the Improvements (the "**Removal Obligations**"). At Owner's request, all or any part of the Roadway Improvements may be left for use by Owner. Operator will continue to make all Annual Installments Payments on a prorated basis until the Removal Obligations are substantially completed. If a governmental authority does not require a performance bond or security for removal of the Improvements, then upon the earlier to occur of: (i) the termination of this Agreement; or (ii) on the twentieth (20th) anniversary of the commercial operations date of the Project, Operator shall obtain and deliver to Owner a bond in form and substance reasonably satisfactory to Owner securing Operator's Removal Obligations (the "**Removal Bond**"). The Removal Bond shall be equal to the estimated amount, if any (the "**Net Removal Costs**"), by which the cost of removing the Improvements on Owner's Property exceeds the salvage value less any outstanding debt on such Improvements, which Net Removal Costs shall be determined as set forth below. Operator shall not be required to deliver such Removal Bond to Owner if Operator has delivered such a bond in connection with the permitting of Owner's Property or any other portion of the Improvements for the Project. Once in place, Operator shall keep such bond, or a like replacement, in force throughout the remainder of the Term. The Net Removal Costs shall be determined by the Parties hereto acting in good faith. If the Parties cannot agree upon the Net Removal Costs within sixty (60) days of their first attempt to do so, then the Net Removal Costs shall be determined by an independent engineer mutually selected by the Parties. If the Parties cannot agree upon such independent engineer within the

next thirty (30) days, then by an independent engineer appointed by a Circuit Judge of Henderson County, Kentucky; and the decision of such an independent engineer (however selected) as to the Net Removal Costs shall be conclusive as between and binding upon, the Parties. If an independent engineer is selected, then the Parties hereto shall equally share all of the costs associated with the independent engineer's determination of the Net Removal Cost. If the Removal Bond is unavailable or an alternate form of security is more economical or desirable, then Operator may substitute an alternate form of security, such as a letter of credit, other form of bond, or guarantee that provides substantially equivalent security as the Removal Bond.

9. **Ownership and Title Matters.** Owner warrants and represents to Operator, both as of the Effective Date, and as of the Commencement Date as follows:

9.1 **Authority.** Owner represents and warrants that it is the holder of fee simple title and is the sole owner of the Owner's Property and has the unrestricted right and authority to sign this Agreement and to grant Operator the Lease and Easements and other rights granted in this Agreement. When signed by both Parties, this Agreement constitutes a valid and binding agreement enforceable against Owner in accordance with its terms.

9.2 **Other Agreements.** The Owner's Property is not subject to any other agreements, options, rights of first refusal or other prior right of any party to purchase, lease or acquire easements in the Owner's Property, or create any prior claim or right that would preclude or interfere with Operator's rights and interests under this Agreement and the Lease and Easements.

9.3 **Minerals.** Except as disclosed by Owner to Operator at the time of the execution of this Agreement by Owner, or as may be shown in the public records, Owner owns all of the oil, gas and other minerals, and all rights thereto as on or under the Owner's Property.

9.4 **Owner Mortgage.** Except as disclosed by Owner to Operator at the time of the execution of this Agreement by Owner, there are no mortgages encumbering the Owner's Property ("**Owner Mortgage**").

9.5 **Notice and Opportunity to Cure.** If there is an Owner Mortgage encumbering Owner's Property and Owner receives from the holder thereof any notice that payments are overdue, Owner shall notify Operator and each Operator Mortgagee (as defined at Section 13.1) by sending a copy of such overdue payment notice to Operator by the earlier of (i) five (5) days after receipt, or (ii) three (3) business days prior to the date by which a default under or in respect of such Owner Mortgage could occur. If Operator or any Operator Mortgagee determines that it would be in Operator's interest to make such payments to Owner Mortgagee on Owner's behalf, whether as a result of receiving such notice or otherwise, Operator shall have the right to make such payments and to credit the payments so made against the Annual Installment Payment next due under the Agreement.

9.6 **Subordination, Non-Disturbance & Attornment Agreement.** If there is an Owner Mortgage encumbering Owner's Property, Owner shall cooperate with Operator to obtain a Subordination, Non-Disturbance and Attornment Agreement ("**SNDA**") in the form prepared

and provided by Operator, from each Owner Mortgagee, pursuant to which such Owner Mortgagee agrees, among other things, not to disturb Operator's possession and use of the Owner's Property. Owner shall not incur any loss in income, expense, obligation or liability with regard to the SNDA. Operator shall, at its sole cost and expense, record each such SNDA in the Office of the County Clerk in which Owner's Property is located. If Owner fails to deliver a SNDA from each Owner Mortgagee, Operator may, at its sole option, either (i) terminate this Agreement immediately upon written notice to Owner, or (ii) take such action as Operator deems reasonably necessary to effect the rights granted to Operator hereunder, and off-set all amounts expended in such efforts against the Annual Installment Payments and any other amounts due hereunder or in respect hereof.

10. **Representations and Warranties of Owner**. Owner hereby makes the following further representations and warranties both as of the Effective Date, and as of the Commencement Date:

10.1 **Physical Condition**. Owner has no knowledge of any existing physical conditions of the Owner's Property which would prevent, significantly restrict or make more expensive Operator's development of the Owner's Property for the purposes specified in this Agreement, or which could, with the passage of time, or the giving of notice, constitute a violation of any currently applicable governmental law, ordinance, order, rule or regulation.

10.2 **Legal Restrictions**. Owner has no knowledge of any law, regulation, ordinance or order of any local, state or federal governmental authority which would prohibit or significantly restrict Operator's development of the Owner's Property pursuant to this Agreement. This Agreement does not violate any contract, agreement, instrument, judgment or order to which Owner is a party or which affects the Owner's Property. To the best of Owner's knowledge, the Owner's Property is currently in full and complete compliance with all governmental laws, ordinances, orders, rules and regulations applicable to the Owner's Property.

10.3 **No Litigation**. No litigation is pending and, to the best of Owner's knowledge, no litigation or administrative actions are proposed, threatened or anticipated with respect to any matter affecting the Owner's Property. If Owner learns of any litigation or administrative action proposed, threatened or instituted with respect to the Owner's Property, Owner shall give Operator notice within thirty (30) days thereof.

10.4 **Survival**. The representations and warranties set forth in this Section 10 shall survive the execution and delivery hereof.

11. **Use, Operation and Maintenance**.

11.1 **Exclusive Use by Operator**. Operator shall have the exclusive right (i) to use and possess the Owner Property in connection with the Project and other similar solar-powered electrical power generation projects; (ii) to investigate, inspect, survey, and conduct tests of the Owner's Property, including, but not limited to, meteorological, environmental, archeological and geotechnical tests and studies; (iii) to use and convert all of the sunlight resources on the Owner's Property; and (iv) to undertake such other activities on the Owner's Property that may be related to the Project, including, without limitation, the storage of Solar Panels, materials and equipment during the installation and construction of the Improvements; development and

operation of communications systems; and site tours of the Project for visitors and other interested parties.

11.2 **No Required Installation or Operation.** Nothing in this Agreement shall be interpreted as imposing on Operator any obligation to install Solar Panels or other Improvements on the Owner's Property, or to operate the Project on the Owner's Property. Operator shall have the sole discretion to determine if and when any Solar Panels and other Improvements may be constructed on Owner's Property, and if and when to commence the operation of the Project on the Owner's Property.

11.3 **Permits and Approvals.** Operator shall be responsible, at its sole cost and expense, for obtaining any governmental permits and approvals necessary for the construction and operation of the Project and the construction and operation of the Improvements. Owner shall cooperate with Operator as necessary to obtain any governmental or utility approvals or permits, including, without limitation, signing any applications for such approvals, provided that Owner shall not incur any loss in income, expense, obligation or liability with respect to Operator obtaining such permits or approvals.

11.4 **Compliance with Laws.** Operator shall comply in all material respects with valid laws applicable to the Owner's Property and the Operator Property. Operator shall have the right, in its sole discretion and at its sole expense, in Operator's name to contest the validity or applicability to the Owner's Property and the Operator Property of any law, ordinance, statute, order, regulation, property assessment or the like made by any governmental agency or entity. Operator shall control any such contest and Owner shall cooperate with Operator in every reasonable way in such contest, provided that Owner shall incur no expense, obligation or liability with regard to such contest.

11.5 **Care and Appearance.** Operator, in its exercise of the lease, easement and other rights granted hereunder shall, at all times, maintain the Owner's Property and the Improvements in a reasonably neat, clean and presentable condition. Operator shall not willfully or negligently damage or destroy the Owner's Property and shall keep the Owner's Property clean and free of debris created by Operator, its contractors, or others brought on to the Owner's Property by Operator. Operator shall not use the Owner's Property for storage, except for materials, construction equipment and vehicles directly associated with construction or maintenance of the Improvements on the Owner's Property or adjacent properties that are part of the Project.

11.6 **Fences and Gates.** At Owner's request, Operator shall repair or replace any fences, gates or cattle guards damaged or removed in connection with Operator's activities on the Owner's Property. Fences removed from the Owner's Property, if replaced, shall be re-built by Operator at its expense in mutually agreeable locations. All fence repair and construction shall be substantially similar to the construction of existing fences and cattle guards on Owner's Property. Any gates opened for access to Owner's Property by either Party shall be closed immediately after passing through so that livestock may not pass through. Once completed, all replacement fences, gates and cattle guards shall be owned and maintained by Owner. Upon abandonment or termination of the rights granted to Operator in this Agreement, any fences, gates and cattle guards installed by Operator shall remain and become the property of Owner. To minimize the need for temporary fencing, Owner will cooperate with Operator to avoid

pasturing animals on or near the Improvements during periods of construction, maintenance or removal activity by Operator. Owner will discuss with Operator what temporary fencing is necessary during the periods of construction, maintenance or removal activity by Operator.

11.7 **Roadway Maintenance and Repairs.** Operator agrees to maintain and repair all Roadway Improvements located on the Operator Property; provided, however, Owner shall reimburse Operator for any costs and expenses incurred by Operator to repair any damage or perform any special maintenance of the Roadway Improvements caused by Owner or any person using the Roadway Improvements with Owner's permission, other than Operator.

12. **Taxes.**

12.1 **Owner's Taxes.** Owner covenants and agrees to pay prior to delinquency all real and personal property and other taxes, general and special assessments, and other charges of every description ("**Taxes**") levied or assessed against the Owner's Property and all improvements thereon by governmental authorities, other than Operator's Taxes referenced in Section 12.2 (Taxes, excepting Operator's Taxes, are hereinafter referred to as "**Owner's Taxes**").

12.2 **Operator's Taxes.**

[REDACTED]

12.3 **Failure to Pay.** In the event either Party fails to pay their share of Taxes prior to delinquency, the other Party shall have the right to pay such Taxes and any accrued penalties or interest, which payments shall increase or be offset against other Payments due under this Agreement.

12.4 **Operator's Right to Contest.** Operator may contest the legal validity or amount of any Operator's Taxes for which it is responsible under this Agreement, and may institute such proceedings as it considers necessary, provided that Operator shall bear all expenses in pursuing such contest or proceeding. With respect to any Taxes which may constitute a lien on the Owner's Property, Operator shall promptly pay such Taxes unless the proceeding in which it contests such Taxes shall operate to prevent or stay the collection of the Taxes so contested or

unless Operator removes any such lien by bonding or otherwise. Owner agrees to render to Operator all reasonable assistance in contesting the validity or amount of any such Taxes, with the exception of Taxes levied by Owner, including joining in the signing of any reasonable protests or pleading which Operator may deem advisable to file; provided, however, that Operator shall reimburse Owner for its reasonable out-of-pocket expenses, including reasonable attorneys' fees incurred in connection with providing such assistance.

13. **Mortgage of Operator Property.**

13.1 **Right to Mortgage.** Operator may, upon written notice to Owner, but without requiring Owner's consent or approval, mortgage, collaterally assign, or otherwise encumber and grant security interests in all or any part of its interest in this Agreement and the Operator Property. These various security interests in all or a part of this Agreement and the Operator Property are collectively referred to as an "**Operator Mortgage**" and holder of such security interest, an "**Operator Mortgagee**". Any Operator Mortgagee shall use the Operator Property only for the uses permitted under this Agreement. Whenever Operator has granted a security interest under this Section 13, it will give Owner notice of the Operator Mortgage (including the name and address of the Operator Mortgagee for notice purposes) to Owner within thirty (30) days; provided that failure to give this notice shall not constitute a default under this Agreement, but rather shall only have the effect of not binding Owner to provide such Operator Mortgage notice until the Operator and its address is given to Owner.

13.2 **Notice of Default and Opportunity to Cure.** As a precondition to exercising any rights or remedies related to any alleged default by Operator under this Agreement, Owner shall give written notice of the default to each Operator Mortgagee at the same time it delivers notice of default to Operator, specifying in detail the alleged event of default and the required remedy. Each Operator Mortgagee or its designee shall have the right, but not the obligation, to cure any default as Operator, and/or the right, but not the obligation, to remove any Improvements or other property owned by Operator or such Operator Mortgagee located on the Owner's Property to the same extent as Operator. The cure period for any Operator Mortgagee shall be the later of (i) the end of the Operator cure period under Section 18; (ii) thirty (30) days after such Operator Mortgagee's receipt of the default notice; or (iii) if applicable, the extended cure period provided for in Section 13.3. Failure by Owner to give an Operator Mortgagee notice of default shall not diminish Owner's rights against Operator, but shall preserve all rights of the Operator Mortgagee or its designee to cure any default and to remove any Improvements or other property of Operator or the Operator Mortgagee located on the Owner's Property.

13.3 **Extended Cure Period.** If any default by Operator under this Agreement cannot be cured without the Operator Mortgagee obtaining possession of all or part of the Operator Property, then any such default shall be deemed remedied if an Operator Mortgagee: (i) within sixty (60) days after receiving notice from Owner as set forth in Section 13.2, acquires possession of all or part of the Operator Property, or begins appropriate judicial or nonjudicial proceedings to obtain the same; (ii) diligently prosecutes any such proceedings to completion; and (iii) after gaining possession of all or part of the Operator Property performs all other obligations as and when the same are due in accordance with the terms of this Agreement. If an Operator Mortgagee is prohibited by any court or by operation of any bankruptcy or insolvency laws from commencing or prosecuting the proceedings described above, the sixty (60) day

period specified above for commencing proceedings shall be extended for the period of such prohibition.

13.4 **Operator Mortgagee Liability.** Any Operator Mortgagee whose interest in the Operator Property is held solely for security purposes, shall have no obligation or liability under this Agreement unless and until the Operator Mortgagee succeeds to absolute title to the Operator Property and the rights of Operator under this Agreement. An Operator Mortgagee shall be liable to perform obligations under this Agreement only for and during the period it directly holds such absolute title.

13.5 **Certificates.** Owner shall execute any estoppel certificates (certifying as to truthful matters, including without limitation that no default then exists under this Agreement, if such be the case), consents to assignment and non-disturbance agreements as Operator or any Mortgagee may reasonably request from time to time. The Parties shall negotiate in good faith any amendment to this Agreement from time to time to include any provision that may be reasonably requested by Operator or any Operator Mortgagee to implement the provisions contained in this Agreement or to preserve an Operator Mortgagee's security interest.

13.6 **Operator Mortgagee's Right to Enforce Mortgage and Assign.** Each Operator Mortgagee shall have the right, in its sole discretion: (i) to assign its Operator Mortgage; (ii) to enforce its lien and acquire title to all or any portion of the Operator Property by any lawful means; (iii) to take possession of and operate all or any portion of the Operator Property and to perform all obligations to be performed by Operator under this Agreement, or to cause a receiver to be appointed to do so; and (iv) to acquire all or any portion of the Operator Property by foreclosure or by an assignment in lieu of foreclosure and thereafter to assign or transfer all or any portion of the Operator rights under this Agreement to a third party in accordance with Section 14. Any Operator Mortgagee or other party who acquires Operator's interest in all or a portion of the Operator Property pursuant to foreclosure or assignment in lieu of foreclosure shall not be liable to perform the obligations imposed on Operator by this Agreement, which are incurred or accruing after such Operator Mortgagee or other party no longer has ownership or possession of the Operator Property.

13.7 **New Agreement.**

13.7.1 If the Operator Property is foreclosed upon or there is an assignment in lieu of foreclosure, or if this Agreement is rejected or disaffirmed pursuant to bankruptcy law or other law affecting creditor's rights and, within ninety (90) days after such event, Operator or any Operator Mortgagee or other purchaser at a foreclosure sale shall have arranged to the reasonable satisfaction of Owner to cure any material defaults under this Agreement, and for the payment of all Annual Installment Payments or other charges due and payable by Operator as of the date of such event, then Owner shall execute and deliver to Operator or such Operator Mortgagee or other purchaser at a foreclosure sale, or to a designee of one of these parties, as the case may be, a new agreement ("**New Agreement**") which (i) shall be for a term equal to the remainder of the Term of this Agreement before giving effect to such rejection or termination; (ii) shall contain the same covenants, agreements, terms, provisions and limitations as this Agreement (except for any requirements that have been fulfilled by Operator or any Operator Mortgagee or other purchaser at a foreclosure sale prior to rejection or termination of this

Agreement); and (iii) shall include that portion of the Operator Property in which Operator or such other Operator Mortgagee or other purchaser at a foreclosure sale had an interest on the date of rejection or termination.

13.7.2 If more than one Operator Mortgagee makes a written request for a New Agreement pursuant to this provision, the New Agreement shall be delivered to the Operator Mortgagee requesting such New Agreement whose Operator Mortgage is prior in time, and the written request of any other Operator Mortgagee whose lien is subordinate shall be void and of no further force or effect. The provisions of this Section 13 shall survive the termination, rejection or disaffirmation of this Agreement and shall continue in full force and effect thereafter to the same extent as if this Section 13 were a separate and independent contract made by Owner, Operator and each Operator Mortgagee, and, from the effective date of such termination, rejection or disaffirmation of this Agreement to the date of execution and delivery of such New Agreement, such Operator Mortgagee or other purchaser at a foreclosure sale may use and enjoy the Operator Property without hindrance by Owner or any person claiming by, through or under Owner; provided that all of the conditions for the New Agreement as set forth above are complied with.

13.8 **Operator Mortgagee's Consent to Amendment, Termination or Surrender.** Notwithstanding any provision of this Agreement to the contrary, the Parties agree that so long as any Operator Mortgage remains outstanding, this Agreement shall not be modified or amended, and Owner shall not accept a surrender, cancellation or release of all or any part of the Operator Property from Operator, prior to expiration of the Term of this Agreement, without the prior written consent of the Operator Mortgagee holding such Operator Mortgage. This provision is for the express benefit of and shall be enforceable by each Operator Mortgagee as if it were a party named in this Agreement.

14. **Assignment and Sublease.** Operator shall have the right, without Owner's consent, to sell, convey, lease or assign all or any portion of this Agreement or the Operator Property, on either an exclusive or non-exclusive basis, or to grant, subleases, co-leases, easements, licenses or similar rights with respect to the Operator Property (collectively, "Assignment") to one or more persons or entities (collectively "Assignee"). Each Assignee shall use the Operator Property only for the uses permitted under this Agreement. Operator may make a complete assignment of this Agreement and be released from liability hereunder in such event from obligations subject thereof accruing after the date the liability for such obligations is assumed by Assignee only in connection with the assignment of all, or substantially all, of the assets of the Operator. Operator may assign this Agreement to any "Affiliate" of Operator unconditionally, including assignment without transferring any other assets of Operator. For purposes hereof, the term "Affiliate" shall mean any entity under common or shared ownership or control with Operator. In the event of a partial assignment of Operator's rights hereunder, Operator shall not be released from liability hereunder without Owner's written consent. When Operator makes any Assignment under this Section 14, Operator shall give written notice to Owner of such Assignment (including the interest conveyed by the Assignment and the address of the Assignee for notice purposes) to Owner; provided Operator's failure to give such notice shall not constitute a default under this Agreement but rather shall only have the effect of not binding Owner with respect to such assignment or conveyance until such notice is given.

15. **Hazardous Materials.**

15.1 **Owner's Covenants Regarding Hazardous Materials.** Owner represents and warrants that, to the best of Owner's knowledge, the Owner's Property is not and has not been in violation of any federal, state or local environmental health or safety laws, statute, ordinance, rule, regulation or requirement ("**Environmental Laws**"), and Owner has not received any notice or other communication from any governmental authorities alleging that the Owner's Property is in violation of any Environmental Laws. "**Hazardous Materials**" shall mean any asbestos containing materials, petroleum, explosives, toxic materials, or substances regulated as hazardous wastes, hazardous materials, hazardous substances, or toxic substances under any federal, state, or local law or regulation. Owner warrants that Owner has done nothing to contaminate the Operator Property with Hazardous Materials or wastes.

15.2 **Operator's Covenants Regarding Hazardous Materials.** Operator shall, at Operator's sole cost and expense, promptly take removal or remedial action required by Environmental Law with regard to any material violation of any Environmental Law with regard to any Hazardous Materials brought onto the Owner's Property by Operator or its employees, agents, or contractors. Owner shall cooperate with Operator with regard to any scheduling or access to the Owner's Property in connection with any action required hereunder.

15.3 **Operator's Indemnity Regarding Hazardous Materials.** Operator shall indemnify, defend, protect and hold Owner harmless from any liability based on: (i) the release of Hazardous Materials in, on, under or about the Owner's Property caused by Operator or its employees, agents, or contractors, or (ii) the violation by Operator or its employees, agents, or contractors of any Environmental Law. The indemnity obligations set forth herein shall survive termination of this Agreement.

16. **Insurance and Indemnity.**

16.1 **Insurance.** At all times during which Operator is conducting any activities on the Property and at all times during the Term of this Agreement, Operator shall maintain in effect (1) commercial General Liability Insurance, including bodily injury and property damage coverage with minimum limits of \$1 Million Dollars per occurrence and \$2 Million Dollars aggregate and (2) Umbrella Liability Insurance with minimum limits of \$5 Million Dollars per occurrence and \$5 Million Dollars aggregate. Upon a written request by Owner, Operator shall name Owner as additional insured on such insurance policy and provide Owner with a certificate of such insurance.

16.2 **Indemnity by Operator.** Operator shall defend, indemnify, protect and hold Owner harmless from and against all liabilities, costs, expenses, obligations, losses, damages, claims, (collectively "**Claims**") resulting from the negligence, willful misconduct, or breach of this Agreement by Operator, its agents, contractors or employees, invitees, licensees and permittees; provided, however, that such Claims are not due to the sole negligence, willful misconduct, or breach by Owner, its agents, contractors or employees, invitees, licensees or permittees.

16.3 **Indemnity by Owner.** Owner shall defend, indemnify, protect, and hold Operator harmless from and against all Claims resulting from the negligence, willful misconduct, or breach of this Agreement by Owner, its agents, contractors or employees, invitees, licensees and permittees; provided, however, that such Claims are not due to the sole negligence, willful misconduct, or breach by Operator, its agents, contractors, employees, invitees, licensees, or permittees.

16.4 **Survival.** The obligations of the Parties under this Section 16 shall survive expiration or other termination of this Agreement.

17. **Confidentiality.** This Agreement includes confidential and proprietary information relating to Operator and the Project. Owner agrees not to provide copies of the Agreement or disclose the terms of the Agreement to any unauthorized person or entity. Operator authorizes Owner to provide copies of the Agreement and disclose the terms thereof to Owner's family ("family" shall be deemed to include all devisees or descendants of owner by will or intestacy), attorney, accountant, financial advisor and any existing or prospective mortgagee, lessee, or purchaser for the sole purpose of evaluating and advising Owner and for no other purpose, so long as such authorized parties agree in writing to become subject to the confidentiality provisions hereto and not to provide copies of the Agreement or disclose the terms thereof to any unauthorized person or entity. Any Owner and party shall return all material containing any confidential information to Operator immediately upon its request. Any party agrees to destroy immediately upon request by Operator such analyses, compilation, studies or other documents, and any oral information will continue to be subject to the terms of this Agreement. Owner agrees that Operator will have no adequate remedy at law if any party violates any of the terms of this Agreement. In such event Operator will have the right, in addition to any other rights Operator may have, to obtain injunctive relief to restrain any breach or threatened breach by third party or specific enforcement of such terms plus reimbursement of attorneys' fees, court costs and all associated expenses. No party shall publish, file for public record, reproduce, or otherwise disseminate this document or any of the terms and provisions hereof to any party, other than the Parties set forth above without the prior written consent of Operator, which consent may be withheld for any reason and in Operator's sole discretion.

18. **Default and Remedies.**

18.1 **Operator Payment Default.** [REDACTED]

[REDACTED]

18.1.1 **Collection of Payments.** [REDACTED]

[REDACTED]

18.1.2 Terminate Agreement.

[Redacted]

18.2 Other Operator Default.

[Redacted]

18.3 Owner Default.

[Redacted]

[REDACTED]

19. **Condemnation.**

19.1 **Complete Taking.** If, at any time, any authority having the power of eminent domain shall condemn all or substantially all of the Operator's Property, or all of the Improvements thereon, for any public use or otherwise, then the interests and obligations of Operator under this Agreement in or affecting the Operator's Property shall cease and terminate upon the earlier of (i) the date that the condemning authority takes physical possession of the Operator's Property or the Improvements thereon, (ii) the date that Operator is, in its sole judgment, no longer able or permitted to operate the Project on the Operator's Property in a commercially viable manner, or (iii) the date of the condemnation judgment. Operator shall continue to pay all amounts payable hereunder to Owner until the earlier of such dates, at which time the Parties shall be relieved of any and all further obligations and conditions to each other under this Agreement.

19.2 **Partial Taking.** If, at any time during the term of this Agreement, any authority having the power of eminent domain shall condemn one or more, but not all, of the Solar Panels, or any portion of the Improvements or the Operator's Property, then the interest and obligations of Operator under this Agreement as to those Solar Panels or any portion of the Improvements or the Operator's Property so taken shall cease and terminate upon the earlier of (i) the date that the condemning authority takes possession of such Solar Panels or any portion of the Improvements or the Operator's Property, (ii) the date that Operator is, in its reasonable judgment, no longer able or permitted to operate the Project on the Operator's Property, or any portion thereof, in a commercially viable manner, or (iii) the date of the condemnation judgment; and, unless this Agreement is terminated as hereinafter provided, this Agreement shall continue in full force and effect as to the remainder of the Solar Panels, Improvements and the Operator's Property. If the remainder of the Solar Panels or any other portion of the Improvements or the Operator's Property is or becomes insufficient or unsuitable for Operator's purposes hereunder, as determined by Operator in its sole discretion, then, subject to the rights of any Operator Mortgagee under Section 13, Operator shall have the right to terminate this Agreement as to the portion of the Operator's Property to which Operator continues to hold the rights, at which time the Parties shall be relieved of any further obligations and duties to each other under this Agreement.

19.3 **Apportionment, Distribution of Award.** On any taking, all sums awarded, including damages and interest, shall be paid as follows:

(a) Any portion of the award by the court on account of any cost or loss that Operator may sustain in the removal and relocation of Operator's Improvements, to Operator;

(b) Any portion of the award by the court for Operator's anticipated or lost revenues or profits, to Operator;

(c) Any portion of the award by the court for Owner's lost revenues, to Owner;

(d) All remaining amounts of the award, to Owner or Operator consistent with applicable Kentucky law.

20. **Notice.**

20.1 **Writing.** All notices given or permitted to be given hereunder shall be in writing.

20.2 **Delivery.** Notice is considered given either (i) when delivered in person to the recipient named below, (ii) upon receipt after deposit in the United States mail in a sealed envelope or container, postage and postal charges prepaid, return receipt requested or certified mail, addressed by name and address to the party or person intended, or (iii) twenty-four (24) hours from proper and timely delivery to an overnight courier service addressed by name and address to the party or person intended as follows:

Notice to Owner: Chris Daniel and Laveta R. Daniel
9260 Route 416 W
Robards, KY42452

[REDACTED]
[REDACTED]

Notice to Operator: Sebree Solar, LLC
700 Universe Blvd
Juno Beach, FL 33408
Attn: Land Services Administration

[REDACTED]

20.3 **Change of Recipient or Address.** Either Party may, by notice given at any time or from time to time, require subsequent notices to be given to another individual person, whether a party or an officer or representative, or to a different address, or both. Notices given before actual receipt or notice of change shall not be invalidated by the change.

21. **Miscellaneous Provisions.**

21.1 **Successors and Assigns.** The terms and provisions of this Agreement shall run with the land and be binding on and inure to the benefit of the heirs, successors, assigns and personal representatives of the Parties. In accordance with this Agreement, Operator in its discretion may authorize other persons or entities to use the Operator Property for the purposes stated in this Agreement

21.2 **Memorandum**. Simultaneously with the execution of this Agreement, the Parties agree to execute and acknowledge a memorandum of this Agreement. Operator may record the executed memorandum in the public records of Henderson County, Kentucky.

21.3 **Entire Agreement**. This Agreement and the attached Exhibits shall constitute the entire agreement between the Parties and supersedes all other prior writings and understandings.

21.4 **Amendments**. This Agreement shall not be amended or modified in any way except by an instrument signed by the Parties and consented to by any Operator Mortgagee. The Parties hereto shall at all times hereafter execute any documents and do any further acts which may be necessary or desirable to carry out the purposes of this Agreement and to give full force and effect to each and all of the provisions hereof.

21.5 **Legal Matters**. This Agreement shall be governed by and interpreted in accordance with the then existing laws of the Commonwealth of Kentucky and the County where the Owner's Property is located shall be considered the proper forum or jurisdiction for any disputes arising in connection with this Agreement. The Parties agree to first attempt to settle any dispute arising out of or in connection with this Agreement by good-faith negotiation. If the Parties are unable to resolve amicably any dispute arising out of or in connection with this Agreement, each shall have all remedies available at law or in equity and as provided by this Agreement. **Each Party waives all right to trial by jury and specifically agrees that trial of suits or causes of action arising out of this Agreement shall be to the court of competent jurisdiction.**

21.6 **Severability**. If any term or provision of this Agreement, or the application thereof to any person or circumstance shall, to any extent, be determined by judicial order or decision to be invalid or unenforceable, the remainder of this Agreement or the application of such term or provision to persons or circumstances other than those as to which it is held to be invalid, shall be enforced to the fullest extent permitted by law.

21.7 **Tax Credits**. If under applicable law Operator becomes ineligible for any currently existing tax credit, benefit or incentive for alternative energy expenditure established by any local, state or federal government, then, at Operator's option, the Parties shall negotiate in good faith to amend this Agreement or replace it with a different instrument so as to convert Operator's interest in the Operator Property to a substantially similar interest that makes Operator eligible for such tax credit, benefit or incentive. Such amendment or instrument shall not impair any of Owner's rights or increase the burdens or obligations of Owner under this Agreement.

21.8 **Approvals**. Whenever in this Agreement the approval or consent of either Party is required or contemplated, unless otherwise specified, such approval or consent shall not be unreasonably withheld or delayed.

21.9 **Authority**. The signatories hereto warrant that each has the authority to execute this Agreement on behalf of any entities which are Parties to this Agreement and that each such entity has executed this Agreement pursuant to its organizational documents or a resolution or consent of their Board of Directors or other governing body.

21.10 **Time of Essence**. Time is of the essence of each provision of this Agreement.

21.11 **Counterparts**. This Agreement may be executed in multiple counterparts, each of which shall be deemed an original, and all of which together shall constitute a single instrument.

[Signatures on Next Page]

Owner:

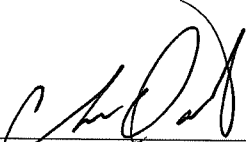

Chris Daniel

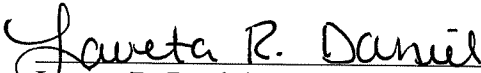

Laveta R. Daniel

Operator:

Sebree Solar, LLC
a Delaware limited liability company

By: 

Anthony Pedroni, Vice President

EXHIBIT A

Legal Description of Owner's Property

Parcel 1

BEGINNING at an iron pin corner to Tract #1, said pin being in the southern R/W of Ky. Hwy. 416, 30 feet from the centerline, and being approximately 1595 feet east of the intersection of W. N. Royster Road in Henderson County, Kentucky; thence with said R/W N 79° 56' 31" E -- 104.50 feet, S 73° 51' 35" E -- 154.97 feet, S 69° 44' 51" E -- 439.82 feet to an iron pin corner to Tract #3; thence with the line of Tract #3 S 8° 41' 19" W -- 2091.63 feet to an iron pin in the line of Tract #5; thence with the line of Tract #5 N 82° 30' 11" W -- 448.26 feet to a post corner to Tract #6; thence with the line of Tract #6 N 80° 25' 40" W -- 89.18 feet to a post corner to Arron Norris; thence with the line of Norris N 79° 57' 06" W -- 386.47 feet to an iron pin at a twin sasafress corner to Tract #1; thence with the line of Tract #1 N 15° 01' 08" E -- 2178.38 feet to the point of beginning and containing 39.802 acres. For a more particular description you are referred to a survey plat prepared by Likins and Musgrave dated _____, 1986, of record in Plat Book 5, Page 2, of the Henderson County Clerk's Office.

The above being the same property acquired by Chris Daniel and Laveta R. Daniel, husband and wife by Warranty Deed dated April 30, 1986, of record in Deed Book 366, Page 403, in the Henderson County Clerk's office.

QLA: 8186

EXHIBIT B-1

Depiction of Parcel and Excluded Area



HOLDING PAGE FOR EXHIBIT B-2

Preliminary Lease and Easement Improvement Plan and Acreage Calculation
To be Delivered with Option Notice

HOLDING PAGE FOR EXHIBIT C

As Built Lease and Easement Improvements and Final Acreage Calculation

EXHIBIT D

Lease and Easement Compensation

[Redacted text block]

[Redacted]	[Redacted]	[Redacted]	[Redacted]
[Redacted]	[Redacted]	[Redacted]	[Redacted]
[Redacted]	[Redacted]	[Redacted]	[Redacted]
[Redacted]	[Redacted]	[Redacted]	[Redacted]
[Redacted]	[Redacted]	[Redacted]	[Redacted]

[Redacted text block]

(2) Payment for Lease and Easements.

[Redacted text block]

[Redacted text block]

[Redacted text block]

[Redacted]

(3) **Crop Compensation.** [Redacted]

[Redacted]

(4) **Timber Removal.** [Redacted]

[Redacted]

(5) **Payment Allocation Schedule.** [Redacted]

[Redacted]

Kentucky

SOLAR LEASE AND EASEMENT AGREEMENT

1. **Parties.** This Solar Lease and Easement Agreement ("**Agreement**") is made and entered as of the 28 day of January, 2020 ("**Effective Date**"), by and between James A. Clary, II, and Mary Clary, husband and wife ("**Owner**") and Boulevard Associates, LLC, a Delaware limited liability company ("**Operator**"), which are sometimes individually referred to as a "**Party**" and collectively as the "**Parties**".

2. **Project.** This Agreement relates to the solar-powered electrical power generation and transmission project known as the "Sebree Solar Energy Center" to be located in Henderson County, Kentucky ("**Project**"), which may be wholly or partially located on the Owner's property legally described on the attached **Exhibit A** to this Agreement ("**Owner's Property**"). Upon Operator's exercise of the Option (as defined below), the Project shall include (i) the Lease of Owner's Property described in Section 4, (ii) the Easements referenced in Section 5 that are located on the Owner's Property, and (iii) the Improvements referenced in Section 8 to be constructed on Owner's Property. The Lease, Easements and Improvements are sometimes collectively referred to as the "**Operator Property**".

3. **Option.** Owner grants to Operator an exclusive option ("**Option**") to acquire the Lease and Easements referenced in Sections 4 and 5 in accordance with the following terms and conditions. Operator shall be entitled to acquire the Lease and the Easements in their entirety or in part, as Operator deems appropriate.

3.1 **Option Term.** The period during which Operator may exercise the Option shall be for a term of five (5) years, commencing on the Effective Date ("**Option Term**").

3.2 **Option Payment.** As consideration for the granting of the Option, Operator agrees to pay Owner the Option Payment set forth in **Exhibit D**.

3.3 **Use of Owner's Property.** During the Option Term, Operator and its employees, agents and contractors shall have a right to enter upon the Owner's Property and the right of ingress and egress over and across the Owner's Property for the purposes of (i) surveying the Owner's Property; (ii) performing such other tests and studies as Operator may desire in connection with the Option, including, without limitation, environmental, avian and cultural resource assessments, and geotechnical, foundation and soil tests, provided that such activities do not unreasonably interfere with Owner's use of the Owner's Property; and (iii) installing, maintaining, operating, inspecting and removing one or more weather related instruments ("**Weather Instrument**") and fencing of said Weather Instrument and including the performance of all tests and studies associated therewith. Owner shall not permit any other individual or entity except Operator or its affiliates to install a Weather Instrument on Owner's Property.

3.4 **Right to Grant Option.** Owner warrants and represents to Operator that (i) the statements in Section 9 concerning Owner's title to the Owner's Property are true and correct; (ii) Owner has the authority to grant this Option to Operator without the consent or approval of any other party; and (iii) there are no other existing options, rights of first refusal, contracts to purchase, leases or mortgages that would prevent Operator from exercising its rights with respect to the Option.

3.5 **Exercise of Option.** Operator may exercise the Option by giving written notice to Owner ("**Option Notice**") at any time during the Option Term. Operator shall specify in the Option Notice the Commencement Date referenced in Section 6.1.1. On the Commencement Date, the Lease and Easements referenced in Sections 4 and 5 shall automatically become effective, and the Parties shall be subject to all of the terms and conditions of this Agreement with respect to such Lease and Easements and all rights and obligations relating thereto.

3.6 **Termination of Option.** If Operator fails to exercise the Option within the Option Term, the Option and the rights of Operator as the optionee shall automatically terminate.

4. **Lease.** Upon exercise of the Option by Operator, Owner leases to Operator, and Operator leases from Owner, Owner's Property for the Lease and Easement Term (defined in Section 6.1) in accordance with the terms and conditions of this Agreement ("**Lease**"), which Lease grants Operator and its agents, contractors, and employees the right to use the Owner's Property for the following permitted uses:

4.1 **Construction Right.** Operator leases Owner's Property for the purpose of constructing, operating, maintaining, repairing, replacing, and removing all or any part or component of the Improvements whether located on Owner's Property. Operator may exercise its right to use all or any part of the Owner's Property as and when Operator deems it necessary or advisable to do so to perform the activities for which this right is granted, including, without limitation, staging areas and parking for Operator's employees. Any such areas being used temporarily by Operator shall be located immediately adjacent to the portion of the Property leased by Operator hereunder.

4.2 **Access Right.** Operator leases Owner's Property for unobstructed vehicular and pedestrian access and ingress to and egress from the Improvements, Owner's Property and any public roadways, and to construct, maintain, and utilize Roadway Improvements on the Owner's Property. Owner shall not permit others to obstruct or damage the roads or Roadway Improvements located on the Owner's Property or in any other way interfere with Operator's rights under this right. Operator shall repair any damage done to Roadway Improvements which result from use by Operator, its agents, servants or employees. Such roads shall be maintained in the condition necessary for use by Operator's equipment, and with regard to existing roads, shall be maintained in at least the condition that existed prior to Operator's use. Any roads inside of the fenced area of the project will be maintained by Operator at Operator's sole cost and expense.

4.3 **Solar Panels Right.** Operator leases Owner's Property for Operator to construct, operate, replace, relocate, remove, and maintain Solar Panels and the appurtenant Collection Facilities, together with associated roads and parking areas on Owner's Property.

4.4 **Collection Facilities Right.** Operator leases Owner's Property for Operator to construct, operate, maintain, replace, relocate or remove Collection Facilities on and under the Owner's Property.

4.5 **Substation Right.** Operator leases Owner's Property for Operator to construct, operate, maintain, replace, relocate or remove one or more Substations on Owner's Property.

4.6 **Telecommunication Right.** Operator leases Owner's Property for Operator to construct, operate, maintain, replace, relocate or remove Telecommunication Facilities on and under the Owner's Property.

4.7 **Weather Instrument Right.** Operator leases Owner's Property in order to construct, operate, replace, relocate, remove, and maintain a Weather Instrument and the appurtenant Collection Facilities on Owner's Property.

4.8 **Battery Facilities Right.** Operator leases Owner's Property in order to construct, operate, replace, relocate, remove, and maintain one or more Battery Facilities on Owner's Property.

5. **Grant of Easements.** Upon the exercise of the Option by Operator, Owner grants to Operator, and Operator accepts from Owner, for the Lease and Easement Term referenced in Section 6.1, the following easements over and across the Owner's Property in accordance with the terms and conditions of this Agreement. The following easements are for the benefit of Operator and Operator's agents, contractors and employees and located on the Owner's Property and are collectively referred to as the "Easements".

5.1 **Sun Non-Obstruction Easement.** Owner grants Operator an irrevocable, exclusive easement for the right and privilege to use, maintain and capture the free and unobstructed sunlight over and across the Owner's Property. Owner shall not engage in any activity on Owner's Property or any other neighboring property owned by Owner that might interfere with the sunlight direction over any portion of Owner's Property; cause a decrease in the output or efficiency of any Solar Panel or Weather Instrument; or otherwise interfere with Operator's operation of the Project or exercise of any rights granted in this Agreement (collectively "Interference"). This grant of the easement expressly includes the right of Operator to enforce Operator's rights, including the physical removal of trees or structures (except existing trees and structures) causing Interference to the Project contemplated by Operator. Operator shall notify Owner before making any such removals.

5.2 **Effects Easement.** Owner grants to Operator an easement over Owner's Property for visual, view, light, flicker, noise, shadow, vibration, electromagnetic, electrical and radio frequency interference, and any other effects attributable to the Project located on the Owner's Property.

6. **Term.** The term of this Agreement ("Term") includes the Option Term referenced in Section 3.1, the Initial Lease and Easement Term as described in Section 6.1.1 and the Extended Lease and Easement Term as described in Section 6.1.2 (together, the Initial Lease and Easement Term and the Extended Lease and Easement Term, if applicable, is defined as the "**Lease and Easement Term**").

6.1 **Lease and Easement Term.**

6.1.1 **Initial Lease and Easement Term.** The initial term of the Lease and Easements shall commence on the date specified by Operator in the Option Notice ("**Commencement Date**"). The initial term of the Lease and Easements shall end thirty (30)

years after the Commencement Date (the "**Initial Lease and Easement Term**"), subject to the rights of renewal and termination as provided in this Agreement.

6.1.2 **Extended Lease and Easement Term.** Operator shall have the right to extend the Term of this Agreement for two (2) consecutive terms of five (5) years each in accordance with the terms and provisions of this Agreement (collectively "**Extended Lease and Easement Term**") by providing written notice to Owner of Operator's intent to extend the Term within one hundred eighty (180) days of the end of the existing Term. Each Extended Lease and Easement Term shall begin on the expiration date of the Initial Lease and Easement Term or previous Extended Lease and Easement Term, as the case may be. During the Extended Lease and Easement Term, Operator shall pay Owner the amounts set forth in **Exhibit D** as the consideration for the Lease and Easements.

6.1.3 **Delays During Lease and Easement Term.** At Operator's option, the Term may be extended for a period of time equal to the period of time during which operation of the Project is delayed or suspended because of the occurrence of a Regulatory Suspension or Force Majeure, which are defined as follows:

(i) "**Regulatory Suspension**" shall mean the enactment or application of any law, order, rule, or regulation of the Kentucky Public Service Commission, Federal Energy Regulatory Commission, or other local, state, or federal government authority having jurisdiction over the Project or Operator, or the failure of any such governmental authority to issue an approval or permit pursuant to any such law, order, rule, or regulation, which results in the delay, interruption, or suspension of the production, sale or transmission of electricity from the Solar Panels; and

(ii) "**Force Majeure**" shall mean causes beyond the reasonable control of and without the fault or negligence of the Party claiming Force Majeure, including but not limited to acts of God, labor unrest (including, but not limited to, slowdowns, picketing, boycotts or strikes), flood, earthquake, storm, fire, lightning, explosion, power failure or power surge, vandalism, theft, the cutting of power, transmission or other lines, wires or cables to the Project by persons other than Operator's employees or contractors, epidemic, war, revolution, riot, civil disturbance, sabotage, change in law or applicable regulation subsequent to the Commencement Date and action or inaction by any federal, state or local legislative, executive, administrative judicial agency or body which in any of the foregoing cases, by exercise of due foresight such Party could not reasonably have expected to avoid, and which, by the exercise of due diligence, it is unable to overcome.

The Parties shall be excused from performing their respective obligations under this Agreement and shall not be liable in damages or otherwise if and to the extent that they are unable to so perform or are prevented from performing by a Force Majeure, provided that: (i) the non-performing Party, as promptly as practicable after the occurrence of the Force Majeure, but in no event later than thirty (30) days thereafter, gives the other Party written notice describing the particulars of the occurrence; (ii) the suspension of performance is of no greater scope and of no longer duration than is reasonably required by the Force Majeure; (iii) the non-performing Party uses good faith and commercially reasonable efforts to remedy its inability to perform; and (iv) as soon as the non-performing Party is able to resume performance of its obligations excused as a

result of the occurrence, each Party shall give prompt written notification thereof to the other Party. Notwithstanding the foregoing, Operator shall pay Owner 50% of the Annual Installment Payments during any period of Force Majeure.

6.2 Termination by Operator. [REDACTED]

[REDACTED]

7. Payments. If Operator exercises the Option referenced in Section 3, Operator agrees to pay Owner the amounts set forth in **Exhibit D** as consideration for the Lease, Easements and Operator's other rights and interests in the Owner's Property.

8. Improvements. Operator shall have the right, at its sole cost and expense, to construct, install, maintain, use, operate, repair, replace, relocate and remove all facilities, structures, equipment, machinery, wires, conduit, cables, poles, materials and property of every kind and character required for the construction and operation of portions of the Project on the Owner's Property, including, but not limited to, the Solar Panels, Collection Facilities, Substations, Telecommunication Facilities, Weather Instruments, Roadway Improvements and Battery Facilities referenced in Sections 8.1 through 8.7 (collectively, the "**Improvements**").

8.1 "Solar Panels" shall mean any photovoltaic energy system designed for the generation of electrical power from the collection of sunlight, including without limitation, the photovoltaic panels, foundations, support structures, braces and related equipment.

8.2 "Collection Facilities" shall mean all Improvements whose purpose is to deliver electrical power generated by the Solar Panels to an electrical power grid or other system, including without limitation transformers, overhead and underground electrical collection lines, telecommunication lines, splice boxes and interconnection facilities.

8.3 "Substations" shall mean electrical lines, meters, monitoring and control equipment, switches, transformers, all structures, equipment, enclosures, fencing, security devices, and other electrical and communications equipment necessary to condition and increase the voltage of electricity generated by the Project to make it suitable for transmission on, and to deliver it to, Collection Facilities connected to an electric power grid or other system.

8.4 "**Telecommunication Facilities**" shall mean all Improvements whose purpose is to provide telecommunication services solely relating to the Project or any of Operator's solar powered projects, including telephone, closed-circuit television, microwave, internet, computer data and other telecommunication services.

8.5 "**Weather Instrument**" shall mean instruments used primarily to gather and transmit sunlight and meteorological data relating to the Project, and includes the instrument's foundations, guy wires, sunlight and meteorological data acquisition equipment, power source, and any required data and electrical transmission lines.

8.6 "**Roadway Improvements**" shall mean all improvements that may be necessary to construct, maintain and repair any new and existing roadways and other means of ingress and egress over, across and along the Owner's Property, including paving or surfacing of the roadways with asphalt, gravel or other roadway materials, installation of road signs and the construction and installation of culverts, bridges, drainage ditches, gates, cattle guards and similar structures and facilities.

8.7 "**Battery Facilities**" shall mean a type of equipment that can be given a new charge by passing an electric current through it designed for the storage of electrical power including without limitation, batteries and other devices for storage of electrical energy, foundations, support structures, braces and related equipment.

8.8 "**Ownership of Improvements**". Except as otherwise provided in Section 11.7, all Improvements shall at all times remain the property of Operator, and Owner shall have no right, title or interest therein. All Improvements constructed or placed on the Owner's Property by Operator during the Term of this Agreement may be repaired, replaced, relocated, removed, added to or expanded upon by Operator at any time during the Term of this Agreement. Owner expressly waives any statutory lien or common law liens on the Improvements to which Owner might be entitled.

8.9 "**Construction Liens**". Operator shall not permit any liens arising out of Operator's use of the Operator Property under this Agreement to be filed against the Owner's Property. Operator shall, within sixty (60) days after it receives notice of the lien, provide a bond or other security that Owner may reasonably request, or remove such lien from the Owner's Property in the manner provided by applicable law.

8.10 "**Location of Improvements**". The acreage required from the Owner's Property for the Improvements for which the Lease and Easements are being granted cannot be determined until the completion of Operator's inspection, testing, study and surveying of the Owner's Property during the Option Term. Along with the Option Notice, Operator shall deliver to Owner a proposed plan of development showing the contemplated locations of the Improvements and a preliminary calculation of the acreage as determined by the area bounded by a perimeter fence required for the Project, which shall serve as the **Exhibit B** to this Agreement. During the final development and construction of the Project, such locations may need to be amended. Following construction of the Project, Operator shall provide Owner an "as-built" survey of all Improvements on Owner's Property and the final calculation of the acreage as determined by the area bounded by a perimeter fence required for the Project, which shall serve as **Exhibit C** to this

Agreement. Further, following construction, the Improvements may need to be relocated or rerouted by Operator, which Operator may perform, at any time during the Term of this Agreement, so long as the nature and extent of any such relocated or rerouted Improvements are not materially different and impose no materially greater burden on the Owner's Property than the original locations or routes, and so long as Operator takes commercially reasonable efforts to minimize disruption or inconvenience to Owner.

8.11 **Removal of Improvements**. Upon full or partial termination of any of the Lease Rights or Easements, Operator shall within one (1) year of such full or partial termination remove all Improvements and restore the area formerly occupied by the Improvements to substantially the same physical condition that existed immediately before the construction of the Improvements (the "**Removal Obligations**"). At Owner's request, all or any part of the Roadway Improvements may be left for use by Owner. Annual Installments Payments shall continue to be made, on a prorated basis, until the Removal Obligations are substantially completed.

8.12 If a governmental authority does not require a performance bond or security for removal of the Improvements, then Operator shall obtain and deliver to Owner a bond in form and substance reasonably satisfactory to Owner securing Operator's Removal Obligations (the "Removal Bond"). prior to the date that the Project first delivers energy in commercial quantities onto the grid. The Removal Bond shall be equal to the estimated amount, if any (the "Net Removal Costs"), of removing the Improvements from Owner's Property, less the salvage value of the Improvements. Operator shall not be required to deliver such Removal Bond to Owner if Operator has delivered such a bond in connection with the permitting of Owner's Property or any other portion of the Improvements for the Project. Once in place, Operator shall keep such bond, or a like replacement, in force throughout the remainder of the Term. The Net Removal Costs shall be determined by the Parties hereto acting in good faith. If the Parties cannot agree upon the Net Removal Costs within sixty (60) days of their first attempt to do so, then the Net Removal Costs shall be determined by an independent engineer mutually selected by the Parties. If the Parties cannot agree upon such independent engineer within the next thirty (30) days, then by an independent engineer appointed by a District Judge of Henderson County, Kentucky; and the decision of such an independent engineer (however selected) as to the Net Removal Costs shall be conclusive as between and binding upon, the Parties. If an independent engineer is selected, then the Parties hereto shall equally share all of the costs associated with the independent engineer's determination of the Net Removal Cost. If the Removal Bond is unavailable or an alternate form of security is more economical or desirable, then Operator may substitute an alternate form of security, such as a letter of credit, other form of bond, or guarantee reasonably acceptable to Owner that provides substantially equivalent security as the Removal Bond. Operator shall redetermine the amount of the Removal Security beginning immediately prior to the tenth (10th) year of the Lease and Easement Term and every five (5) years after the initial posting of the Removal Bond.

9. **Ownership and Title Matters**. Except as otherwise set forth herein, Owner warrants and represents to Operator, both as of the Effective Date, and as of the Commencement Date as follows:

9.1 **Authority.** Owner represents and warrants that it is the holder of fee simple title and is the sole owner of the Owner's Property and has the unrestricted right and authority to sign this Agreement and to grant Operator the Lease and Easements and other rights granted in this Agreement. When signed by both Parties, this Agreement constitutes a valid and binding agreement enforceable against Owner in accordance with its terms.

9.2 **Other Agreements.** The Owner's Property is not subject to any other agreements, options, rights of first refusal or other prior right of any party to purchase, lease or acquire easements in the Owner's Property, or create any prior claim or right that would preclude or interfere with Operator's rights and interests under this Agreement and the Lease and Easements.

9.3 **Minerals.** Except as disclosed by Owner to Operator at the time of the execution of this Agreement by Owner, Owner owns all of the oil, gas and other minerals, and all rights thereto as on or under the Owner's Property.

9.4 **Owner Mortgage.** Except as disclosed by Owner to Operator at the time of the execution of this Agreement by Owner, there are no mortgages encumbering the Owner's Property ("**Owner Mortgage**").

9.5 **Notice and Opportunity to Cure.** If there is an Owner Mortgage encumbering Owner's Property and Owner receives from the holder thereof any notice that payments are overdue, Owner shall notify Operator and each Operator Mortgagee (as defined at Section 13.1) by sending a copy of such overdue payment notice to Operator by the earlier of (i) five (5) days after receipt, or (ii) three (3) business days prior to the date by which a default under or in respect of such Owner Mortgage could occur. If Operator or any Operator Mortgagee determines that it would be in Operator's interest to make such payments to Owner Mortgagee on Owner's behalf, whether as a result of receiving such notice or otherwise, Operator shall have the right to make such payments and to credit the payments so made against the Annual Installment Payment next due under the Agreement.

9.6 **Subordination, Non-Disturbance & Attornment Agreement.** If there is an Owner Mortgage encumbering Owner's Property, Owner shall cooperate with Operator to obtain a Subordination, Non-Disturbance and Attornment Agreement ("SNDA") in the form prepared and provided by Operator, from each Owner Mortgagee, pursuant to which such Owner Mortgagee agrees, among other things, not to disturb Operator's possession and use of the Owner's Property. Owner shall not incur any loss in income, expense, obligation or liability with regard to the SNDA. Operator shall, at its sole cost and expense, record each such SNDA in the Office of the County Clerk in which Owner's Property is located. If Owner fails to deliver a SNDA from each Owner Mortgagee, Operator may, at its sole option, either (i) terminate this Agreement immediately upon written notice to Owner, or (ii) take such action as Operator deems reasonably necessary to effect the rights granted to Operator hereunder, and off-set all amounts expended in such efforts against the Annual Installment Payments and any other amounts due hereunder or in respect hereof.

10. **Representations and Warranties of Owner.** Owner hereby makes the following further representations and warranties both as of the Effective Date, and as of the Commencement Date:

10.1 **Physical Condition.** Owner has no knowledge of any existing physical conditions except for Henderson County Zoning and land use ordinances and restrictions of the Owner's Property which would prevent, significantly restrict or make more expensive Operator's development of the Owner's Property for the purposes specified in this Agreement, or which could, with the passage of time, or the giving of notice, constitute a violation of any currently applicable governmental law, ordinance, order, rule or regulation.

10.2 **Legal Restrictions.** Owner has no knowledge of any law, regulation, ordinance or order of any local, state or federal governmental authority which would prohibit or significantly restrict Operator's development of the Owner's Property pursuant to this Agreement. This Agreement does not violate any contract, agreement, instrument, judgment or order to which Owner is a party or which affects the Owner's Property. To the best of Owner's knowledge, the Owner's Property is currently in full and complete compliance with all governmental laws, ordinances, orders, rules and regulations applicable to the Owner's Property.

10.3 **No Litigation.** No litigation is pending and, to the best of Owner's knowledge, no litigation or administrative actions are proposed, threatened or anticipated with respect to any matter affecting the Owner's Property. If Owner learns of any litigation or administrative action proposed, threatened or instituted with respect to the Owner's Property, Owner shall give Operator notice within thirty (30) days thereof.

10.4 **Survival.** The representations and warranties set forth in this Section 10 shall survive the execution and delivery hereof.

11. **Use, Operation and Maintenance.**

11.1 **Exclusive Use by Operator.** Operator shall have the exclusive right (i) to use and possess the Owner Property in connection with the Project and other similar solar-powered electrical power generation projects; (ii) to investigate, inspect, survey, and conduct tests of the Owner's Property, including, but not limited to, meteorological, environmental, archeological and geotechnical tests and studies; (iii) to use and convert all of the sunlight resources on the Owner's Property; and (iv) to undertake such other activities on the Owner's Property that may be related to the Project, including, without limitation, the storage of Solar Panels, materials and equipment during the installation and construction of the Improvements; development and operation of communications systems; and site tours of the Project for visitors and other interested parties.

11.2 **No Required Installation or Operation.** Nothing in this Agreement shall be interpreted as imposing on Operator any obligation to install Solar Panels or other Improvements on the Owner's Property, or to operate the Project on the Owner's Property. Operator shall have the sole discretion to determine if and when any Solar Panels and other Improvements may be constructed on Owner's Property, and if and when to commence the operation of the Project on the Owner's Property.

11.3 **Permits and Approvals.** Operator shall be responsible, at its sole cost and expense, for obtaining any governmental permits and approvals necessary for the construction and operation of the Project and the construction and operation of the Improvements. Owner

shall cooperate with Operator as necessary to obtain any governmental or utility approvals or permits, including, without limitation, signing any applications for such approvals, provided that Owner shall not incur any loss in income, expense, obligation or liability with respect to Operator obtaining such permits or approvals.

11.4 **Compliance with Laws.** Operator shall comply in all material respects with valid laws applicable to the Owner's Property and the Operator Property. Operator shall have the right, in its sole discretion and at its sole expense, in Operator's name to contest the validity or applicability to the Owner's Property and the Operator Property of any law, ordinance, statute, order, regulation, property assessment or the like made by any governmental agency or entity. Operator shall control any such contest and Owner shall cooperate with Operator in every reasonable way in such contest, provided that Owner shall incur no expense, obligation or liability with regard to such contest.

11.5 **Care and Appearance.** Operator, in its exercise of the lease, easement and other rights granted hereunder shall, at all times, maintain the Owner's Property and the Improvements in a reasonably neat, clean and presentable condition. Operator shall not willfully or negligently damage or destroy the Owner's Property and shall keep the Owner's Property clean and free of debris created by Operator, its contractors, or others brought on to the Owner's Property by Operator. Operator shall not use the Owner's Property for storage, except for materials, construction equipment and vehicles directly associated with construction or maintenance of the Improvements on the Owner's Property or adjacent properties that are part of the Project.

11.6 **Fences and Gates.** At Owner's request, Operator shall repair or replace any fences, gates or cattle guards damaged or removed in connection with Operator's activities on the Owner's Property. Fences removed from the Owner's Property, if replaced, shall be re-built by Operator at its expense in mutually agreeable locations. All fence repair and construction shall be substantially similar to the construction of existing fences and cattle guards on Owner's Property. Any gates opened for access to Owner's Property by either Party shall be closed immediately after passing through so that livestock may not pass through. Once completed, all replacement fences, gates and cattle guards shall be owned and maintained by Owner. Upon abandonment or termination of the rights granted to Operator in this Agreement, any fences, gates and cattle guards installed by Operator shall remain and become the property of Owner. To minimize the need for temporary fencing, Owner will cooperate with Operator to avoid pasturing animals on or near the Improvements during periods of construction, maintenance or removal activity by Operator. Owner will discuss with Operator what temporary fencing is necessary during the periods of construction, maintenance or removal activity by Operator.

11.7 **Roadway Maintenance and Repairs.** Operator agrees to maintain and repair all Roadway Improvements located on the Operator Property; provided, however, Owner shall reimburse Operator for any costs and expenses incurred by Operator to repair any damage or perform any special maintenance of the Roadway Improvements caused by Owner or any person using the Roadway Improvements with Owner's permission, other than Operator.

12. **Taxes.**

12.1 **Owner's Taxes.** Owner covenants and agrees to pay prior to delinquency all real and personal property and other taxes, general and special assessments, and other charges of every description ("**Taxes**") levied or assessed against the Owner's Property and all improvements thereon by governmental authorities, other than Operator's Taxes referenced in Section 12.2 (Taxes, excepting Operator's Taxes, are hereinafter referred to as "**Owner's Taxes**").

12.2 **Operator's Taxes.**

[REDACTED]

12.3 **Failure to Pay.** In the event either Party fails to pay their share of Taxes prior to delinquency, the other Party shall have the right to pay such Taxes and any accrued penalties or interest, which payments shall increase or be offset against other Payments due under this Agreement.

12.4 **Operator's Right to Contest.** Operator may contest the legal validity or amount of any Operator's Taxes for which it is responsible under this Agreement, and may institute such proceedings as it considers necessary, provided that Operator shall bear all expenses in pursuing such contest or proceeding. With respect to any Taxes which may constitute a lien on the Owner's Property, Operator shall promptly pay such Taxes unless the proceeding in which it contests such Taxes shall operate to prevent or stay the collection of the Taxes so contested or unless Operator removes any such lien by bonding or otherwise. Owner agrees to render to Operator all reasonable assistance in contesting the validity or amount of any such Taxes, with the exception of Taxes levied by Owner, including joining in the signing of any reasonable protests or pleading which Operator may deem advisable to file; provided, however, that Operator shall reimburse Owner for its reasonable out-of-pocket expenses, including reasonable attorneys' fees incurred in connection with providing such assistance.

13. **Mortgage of Operator Property.**

13.1 **Right to Mortgage.** Operator may, upon written notice to Owner, but without requiring Owner's consent or approval, mortgage, collaterally assign, or otherwise encumber and grant security interests in all or any part of its interest in this Agreement and the Operator

Property but not in Owner's interest therein. These various security interests in all or a part of this Agreement and the Operator Property are collectively referred to as an "**Operator Mortgage**" and holder of such security interest, an "**Operator Mortgagee**". Any Operator Mortgagee shall use the Operator Property only for the uses permitted under this Agreement. Whenever Operator has granted a security interest under this Section 13, it will give Owner notice of the Operator Mortgage (including the name and address of the Operator Mortgagee for notice purposes) to Owner within thirty (30) days; provided that failure to give this notice shall not constitute a default under this Agreement, but rather shall only have the effect of not binding Owner to provide such Operator Mortgage notice until the Operator and its address is given to Owner.

13.2 **Notice of Default and Opportunity to Cure.** As a precondition to exercising any rights or remedies related to any alleged default by Operator under this Agreement, Owner shall give written notice of the default to each Operator Mortgagee at the same time it delivers notice of default to Operator, specifying in detail the alleged event of default and the required remedy. Each Operator Mortgagee or its designee shall have the right, but not the obligation, to cure any default as Operator, and/or the right, but not the obligation, to remove any Improvements or other property owned by Operator or such Operator Mortgagee located on the Owner's Property to the same extent as Operator. The cure period for any Operator Mortgagee shall be the later of (i) the end of the Operator cure period under Section 18; (ii) thirty (30) days after such Operator Mortgagee's receipt of the default notice; or (iii) if applicable, the extended cure period provided for in Section 13.3. Failure by Owner to give an Operator Mortgagee notice of default shall not diminish Owner's rights against Operator, but shall preserve all rights of the Operator Mortgagee or its designee to cure any default and to remove any Improvements or other property of Operator or the Operator Mortgagee located on the Owner's Property.

13.3 **Extended Cure Period.** If any default by Operator under this Agreement cannot be cured without the Operator Mortgagee obtaining possession of all or part of the Operator Property, then any such default shall be deemed remedied if an Operator Mortgagee: (i) within sixty (60) days after receiving notice from Owner as set forth in Section 13.2, acquires possession of all or part of the Operator Property, or begins appropriate judicial or nonjudicial proceedings to obtain the same; (ii) diligently prosecutes any such proceedings to completion; and (iii) after gaining possession of all or part of the Operator Property performs all other obligations as and when the same are due in accordance with the terms of this Agreement. If an Operator Mortgagee is prohibited by any court or by operation of any bankruptcy or insolvency laws from commencing or prosecuting the proceedings described above, the sixty (60) day period specified above for commencing proceedings shall be extended for the period of such prohibition.

13.4 **Operator Mortgagee Liability.** Any Operator Mortgagee whose interest in the Operator Property is held solely for security purposes, shall have no obligation or liability under this Agreement unless and until the Operator Mortgagee succeeds to absolute title to the Operator Property and the rights of Operator under this Agreement. An Operator Mortgagee shall be liable to perform obligations under this Agreement only for and during the period it directly holds such absolute title.

13.5 **Certificates.** Owner shall execute any estoppel certificates (certifying as to truthful matters, including without limitation that no default then exists under this Agreement, if such be the case), consents to assignment and non-disturbance agreements as Operator or any Mortgagee may reasonably request from time to time. The Parties shall negotiate in good faith any amendment to this Agreement from time to time to include any provision that may be reasonably requested by Operator or any Operator Mortgagee to implement the provisions contained in this Agreement or to preserve an Operator Mortgagee's security interest.

13.6 **Operator Mortgagee's Right to Enforce Mortgage and Assign.** Each Operator Mortgagee shall have the right, in its sole discretion: (i) to assign its Operator Mortgage; (ii) to enforce its lien and acquire title to all or any portion of the Operator Property by any lawful means; (iii) to take possession of and operate all or any portion of the Operator Property and to perform all obligations to be performed by Operator under this Agreement, or to cause a receiver to be appointed to do so; and (iv) to acquire all or any portion of the Operator Property by foreclosure or by an assignment in lieu of foreclosure and thereafter to assign or transfer all or any portion of the Operator rights under this Agreement to a third party in accordance with Section 14. Any Operator Mortgagee or other party who acquires Operator's interest in all or a portion of the Operator Property pursuant to foreclosure or assignment in lieu of foreclosure shall not be liable to perform the obligations imposed on Operator by this Agreement, which are incurred or accruing after such Operator Mortgagee or other party no longer has ownership or possession of the Operator Property.

13.7 **New Agreement.**

13.7.1 If the Operator Property is foreclosed upon or there is an assignment in lieu of foreclosure, or if this Agreement is rejected or disaffirmed pursuant to bankruptcy law or other law affecting creditor's rights and, within ninety (90) days after such event, Operator or any Operator Mortgagee or other purchaser at a foreclosure sale shall have arranged to the reasonable satisfaction of Owner to cure any material defaults under this Agreement, and for the payment of all Annual Installment Payments or other charges due and payable by Operator as of the date of such event, then Owner shall execute and deliver to Operator or such Operator Mortgagee or other purchaser at a foreclosure sale, or to a designee of one of these parties, as the case may be, a new agreement ("**New Agreement**") which (i) shall be for a term equal to the remainder of the Term of this Agreement before giving effect to such rejection or termination; (ii) shall contain the same covenants, agreements, terms, provisions and limitations as this Agreement (except for any requirements that have been fulfilled by Operator or any Operator Mortgagee or other purchaser at a foreclosure sale prior to rejection or termination of this Agreement); and (iii) shall include that portion of the Operator Property in which Operator or such other Operator Mortgagee or other purchaser at a foreclosure sale had an interest on the date of rejection or termination.

13.7.2 If more than one Operator Mortgagee makes a written request for a New Agreement pursuant to this provision, the New Agreement shall be delivered to the Operator Mortgagee requesting such New Agreement whose Operator Mortgage is prior in time, and the written request of any other Operator Mortgagee whose lien is subordinate shall be void and of no further force or effect. The provisions of this Section 13 shall survive the termination, rejection or disaffirmation of this Agreement and shall continue in full force and effect thereafter

to the same extent as if this Section 13 were a separate and independent contract made by Owner, Operator and each Operator Mortgagee, and, from the effective date of such termination, rejection or disaffirmation of this Agreement to the date of execution and delivery of such New Agreement, such Operator Mortgagee or other purchaser at a foreclosure sale may use and enjoy the Operator Property without hindrance by Owner or any person claiming by, through or under Owner; provided that all of the conditions for the New Agreement as set forth above are complied with.

13.8 Operator Mortgagee's Consent to Amendment, Termination or Surrender. Notwithstanding any provision of this Agreement to the contrary, the Parties agree that so long as any Operator Mortgage remains outstanding, this Agreement shall not be modified or amended, and Owner shall not accept a surrender, cancellation or release of all or any part of the Operator Property from Operator, prior to expiration of the Term of this Agreement, without the prior written consent of the Operator Mortgagee holding such Operator Mortgage. This provision is for the express benefit of and shall be enforceable by each Operator Mortgagee as if it were a party named in this Agreement.

14. Assignment and Sublease. Operator shall have the right, without Owner's consent, to sell, convey, lease, or assign all or any portion of this Agreement or the Operator Property, on either an exclusive or a non-exclusive basis, or to grant subleases, co-leases, easements, licenses or similar rights with respect to the Operator Property (collectively, "**Assignment**"), to one or more persons or entities (collectively "**Assignee**"). Each Assignee shall use the Operator Property only for the uses permitted under this Agreement. When Operator makes any Assignment under this Section 14, Operator shall give written notice to Owner of such Assignment (including the interest conveyed by the Assignment and address of the Assignee for notice purposes) to Owner; provided Operator's failure to give such notice shall not constitute a default under this Agreement, but rather shall only have the effect of not binding Owner with respect to such assignment or conveyance until such notice is given. Any Assignment by Operator shall release Operator from obligations subject thereof accruing after the date that liability for such obligations is assumed by the Assignee.

15. Hazardous Materials.

15.1 Owner's Covenants Regarding Hazardous Materials. Owner represents and warrants that, to the best of Owner's knowledge, the Owner's Property is not and has not been in violation of any federal, state or local environmental health or safety laws, statute, ordinance, rule, regulation or requirement ("**Environmental Laws**"), and Owner has not received any notice or other communication from any governmental authorities alleging that the Owner's Property is in violation of any Environmental Laws. "**Hazardous Materials**" shall mean any asbestos containing materials, petroleum, explosives, toxic materials, or substances regulated as hazardous wastes, hazardous materials, hazardous substances, or toxic substances under any federal, state, or local law or regulation. Owner warrants that Owner has done nothing to contaminate the Operator Property with Hazardous Materials or wastes.

15.2 Operator's Covenants Regarding Hazardous Materials. Operator shall, at Operator's sole cost and expense, promptly take removal or remedial action required by Environmental Law with regard to any material violation of any Environmental Law with regard

to any Hazardous Materials brought onto the Owner's Property by Operator or its employees, agents, or contractors. Owner shall cooperate with Operator with regard to any scheduling or access to the Owner's Property in connection with any action required hereunder.

15.3 **Operator's Indemnity Regarding Hazardous Materials.** Operator shall indemnify, defend, protect and hold Owner harmless from any liability based on: (i) the release of Hazardous Materials in, on, under or about the Owner's Property caused by Operator or its employees, agents, or contractors, or (ii) the violation by Operator or its employees, agents, or contractors of any Environmental Law. The indemnity obligations set forth herein shall survive termination of this Agreement.

16. **Insurance and Indemnity.**

16.1 **Insurance.** At all times during which Operator is conducting any activities on the Property and at all times during the Term of this Agreement, Operator shall maintain in effect (1) commercial General Liability Insurance, including bodily injury and property damage coverage with minimum limits of \$1 Million Dollars per occurrence and \$2 Million Dollars aggregate and (2) Umbrella Liability Insurance with minimum limits of \$5 Million Dollars per occurrence and \$5 Million Dollars aggregate. Operator shall name Owner as additional insured on such insurance policy and provide Owner with a certificate of such insurance.

16.2 **Indemnity by Operator.** Operator shall defend, indemnify, protect and hold Owner harmless from and against all liabilities, costs, expenses, obligations, losses, damages, claims, (collectively "Claims") resulting from the negligence, willful misconduct, or breach of this Agreement by Operator, its agents, contractors or employees, invitees, licensees and permittees; provided, however, that such Claims are not due to the sole negligence, willful misconduct, or breach by Owner, its agents, contractors or employees, invitees, licensees or permittees.

16.3 **Indemnity by Owner.** Owner shall defend, indemnify, protect, and hold Operator harmless from and against all Claims resulting from the negligence, willful misconduct, or breach of this Agreement by Owner, its agents, contractors or employees, invitees, licensees and permittees; provided, however, that such Claims are not due to the sole negligence, willful misconduct, or breach by Operator, its agents, contractors, employees, invitees, licensees, or permittees.

16.4 **Survival.** The obligations of the Parties under this Section 16 shall survive expiration or other termination of this Agreement.

17. **Confidentiality.** This Agreement includes confidential and proprietary information relating to Operator and the Project. Owner agrees not to provide copies of the Agreement or disclose the terms of the Agreement to any unauthorized person or entity. Operator authorizes Owner to provide copies of the Agreement and disclose the terms thereof to Owner's family ("family" shall be deemed to include all devisees or descendants of owner by will or intestacy), attorney, accountant, financial advisor and any existing or prospective mortgagee, lessee, or purchaser for the sole purpose of evaluating and advising Owner and for no other purpose, so long as such authorized parties agree in writing to become subject to the confidentiality provisions

hereto and not to provide copies of the Agreement or disclose the terms thereof to any unauthorized person or entity. Any Owner and party shall return all material containing any confidential information to Operator immediately upon its request. Any party agrees to destroy immediately upon request by Operator such analyses, compilation, studies or other documents, and any oral information will continue to be subject to the terms of this Agreement. Owner agrees that Operator will have no adequate remedy at law if any party violates any of the terms of this Agreement. In such event Operator will have the right, in addition to any other rights Operator may have, to obtain injunctive relief to restrain any breach or threatened breach by third party or specific enforcement of such terms plus reimbursement of attorneys' fees, court costs and all associated expenses. No party shall publish, file for public record, reproduce, or otherwise disseminate this document or any of the terms and provisions hereof to any party, other than the Parties set forth above without the prior written consent of Operator, which consent may be withheld for any reason and in Operator's sole discretion.

18. **Default and Remedies.**

18.1 **Operator Payment Default.**

[REDACTED]

[REDACTED]

[REDACTED]

18.2 Other Operator Default.

[REDACTED]

18.3 Owner Default.

[REDACTED]

19. Condemnation.

19.1 Complete Taking. If, at any time, any authority having the power of eminent domain shall condemn all or substantially all of the Operator's Property, or all of the Improvements thereon, for any public use or otherwise, then the interests and obligations of Operator under this Agreement in or affecting the Operator's Property shall cease and terminate upon the earlier of (i) the date that the condemning authority takes physical possession of the Operator's Property or the Improvements thereon, (ii) the date that Operator is, in its sole judgment, no longer able or permitted to operate the Project on the Operator's Property in a commercially viable manner, or (iii) the date of the condemnation judgment. Operator shall

continue to pay all amounts payable hereunder to Owner until the earlier of such dates, at which time the Parties shall be relieved of any and all further obligations and conditions to each other under this Agreement.

19.2 **Partial Taking.** If, at any time during the term of this Agreement, any authority having the power of eminent domain shall condemn one or more, but not all, of the Solar Panels, or any portion of the Improvements or the Operator's Property, then the interest and obligations of Operator under this Agreement as to those Solar Panels or any portion of the Improvements or the Operator's Property so taken shall cease and terminate upon the earlier of (i) the date that the condemning authority takes possession of such Solar Panels or any portion of the Improvements or the Operator's Property, (ii) the date that Operator is, in its reasonable judgment, no longer able or permitted to operate the Project on the Operator's Property, or any portion thereof, in a commercially viable manner, or (iii) the date of the condemnation judgment; and, unless this Agreement is terminated as hereinafter provided, this Agreement shall continue in full force and effect as to the remainder of the Solar Panels, Improvements and the Operator's Property. If the remainder of the Solar Panels or any other portion of the Improvements or the Operator's Property is or becomes insufficient or unsuitable for Operator's purposes hereunder, as determined by Operator in its sole discretion, then, subject to the rights of any Operator Mortgagee under Section 13, Operator shall have the right to terminate this Agreement as to the portion of the Operator's Property to which Operator continues to hold the rights, at which time the Parties shall be relieved of any further obligations and duties to each other under this Agreement.

19.3 **Apportionment, Distribution of Award.** On any taking, all sums awarded, including damages and interest, shall be paid as follows:

- (a) Any portion of the award by the court on account of any cost or loss that Operator may sustain in the removal and relocation of Operator's Improvements, to Operator;
- (b) Any portion of the award by the court for Operator's anticipated or lost revenues or profits, to Operator;
- (c) Any portion of the award by the court for Owner's lost revenues, to Owner;
- (d) All remaining amounts of the award, to Owner or Operator consistent with applicable Kentucky law.

20. **Notice.**

20.1 **Writing.** All notices given or permitted to be given hereunder shall be in writing.

20.2 **Delivery.** Notice is considered given either (i) when delivered in person to the recipient named below, (ii) upon receipt after deposit in the United States mail in a sealed envelope or container, postage and postal charges prepaid, return receipt requested or certified mail, addressed by name and address to the party or person intended, or (iii) twenty-four (24) hours from proper and timely delivery to an overnight courier service addressed by name and address to the party or person intended as follows:

Notice to Owner: James A. Clary II and Mary Clary
5846 Highway 1299
Robards, KY 42452

[REDACTED]
Email: _____

Notice to Operator: Boulevard Associates, LLC
700 Universe Blvd
Juno Beach, FL 33408
Attn: Land Services Administration
[REDACTED]

20.3 **Change of Recipient or Address.** Either Party may, by notice given at any time or from time to time, require subsequent notices to be given to another individual person, whether a party or an officer or representative, or to a different address, or both. Notices given before actual receipt or notice of change shall not be invalidated by the change.

21. **Miscellaneous Provisions.**

21.1 **Successors and Assigns.** The terms and provisions of this Agreement shall run with the land and be binding on and inure to the benefit of the heirs, successors, assigns and personal representatives of the Parties. In accordance with this Agreement, Operator in its discretion may authorize other persons or entities to use the Operator Property for the purposes stated in this Agreement

21.2 **Memorandum.** Simultaneously with the execution of this Agreement, the Parties agree to execute and acknowledge a memorandum of this Agreement. Operator may record the executed memorandum in the public records of Henderson County, Kentucky.

21.3 **Entire Agreement.** This Agreement and the attached Exhibits shall constitute the entire agreement between the Parties and supersedes all other prior writings and understandings.

21.4 **Amendments.** This Agreement shall not be amended or modified in any way except by an instrument signed by the Parties and consented to by any Operator Mortgagee. The Parties hereto shall at all times hereafter execute any documents and do any further acts which may be necessary or desirable to carry out the purposes of this Agreement and to give full force and effect to each and all of the provisions hereof.

21.5 **Legal Matters.** This Agreement shall be governed by and interpreted in accordance with the then existing laws of the Commonwealth of Kentucky and the County where the Owner's Property is located shall be considered the proper forum or jurisdiction for any disputes arising in connection with this Agreement. The Parties agree to first attempt to settle any dispute arising out of or in connection with this Agreement by good-faith negotiation. If the Parties are unable to resolve amicably any dispute arising out of or in connection with this Agreement, each shall have all remedies available at law or in equity and as provided by this

Agreement. **Each Party waives all right to trial by jury and specifically agrees that trial of suits or causes of action arising out of this Agreement shall be to the court of competent jurisdiction.**

21.6 **Severability.** If any term or provision of this Agreement, or the application thereof to any person or circumstance shall, to any extent, be determined by judicial order or decision to be invalid or unenforceable, the remainder of this Agreement or the application of such term or provision to persons or circumstances other than those as to which it is held to be invalid, shall be enforced to the fullest extent permitted by law.

21.7 **Tax Credits.** If under applicable law Operator becomes ineligible for any currently existing tax credit, benefit or incentive for alternative energy expenditure established by any local, state or federal government, then, at Operator's option, the Parties shall negotiate in good faith to amend this Agreement or replace it with a different instrument so as to convert Operator's interest in the Operator Property to a substantially similar interest that makes Operator eligible for such tax credit, benefit or incentive. Such amendment or instrument shall not impair any of Owner's rights or increase the burdens or obligations of Owner under this Agreement.

21.8 **Approvals.** Whenever in this Agreement the approval or consent of either Party is required or contemplated, unless otherwise specified, such approval or consent shall not be unreasonably withheld or delayed.

21.9 **Authority.** The signatories hereto warrant that each has the authority to execute this Agreement on behalf of any entities which are Parties to this Agreement and that each such entity has executed this Agreement pursuant to its organizational documents or a resolution or consent of their Board of Directors or other governing body.

21.10 **Time of Essence.** Time is of the essence of each provision of this Agreement.

21.11 **Counterparts.** This Agreement may be executed in multiple counterparts, each of which shall be deemed an original, and all of which together shall constitute a single instrument.

[Signatures on Next Page]

Owner:

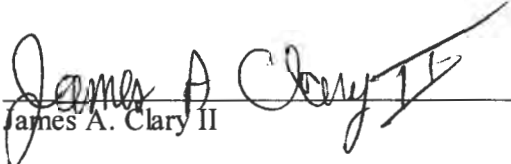
James A. Clary II

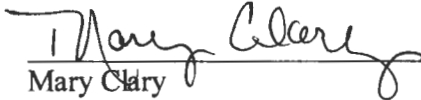
Mary Clary

Operator:

Boulevard Associates, LLC
a Delaware limited liability company

By: 
Matthew S. Handel, Vice President

EXHIBIT A

Legal Description of Owner's Property

A certain tract or parcel located at the southeast intersection of Ky. Hwy. 1299 and Cherry Hill-Busby Station Road, approximately 3.2 miles northwest of the town of Robards in Henderson County, Kentucky, and being more specifically described as follows:

Beginning at an iron pin set at the intersection of the east right-of-way line of said Ky. Hwy. 1299 and the south right-of-way line of said Cherry Hill-Busby Station Road, said iron pin being located 20 feet east of the centerline of the existing pavement of said Ky. Hwy. 1299 and 20 feet south of the centerline of the existing pavement of said Cherry Hill-Busby Station Road; thence with the south right-of-way line of said Cherry Hill-Busby Station Road, running parallel with and 20 feet south of said centerline, South 73°20'38" East, 577.44 feet to an iron pin set in said right-of-way line, and being a corner to the Charles D. Eubank property recorded in Deed Book 279, Page 163, in the Henderson County Court Clerk's Office; thence with said Eubank property, South 22°16'41" West, 592.68 feet to an iron pin set in said Eubank line; thence severing the John N. Pruitt property, of which this description is a part, North 64°26'40" West, 652.16 feet to an iron pin set in the east right-of-way line of said Ky. Hwy. 1299, and being located 20 feet east of said centerline; thence with said right-of-way line, running parallel with and 20 feet east of said centerline, North 30°59'20" East, 504.65 feet to the point of beginning containing 7.670 acres and being subject to all legal written and unwritten easements and rights-of-way. This description was prepared from a physical survey conducted under the direction of Dennis E. Branson, Ky. RLS #2532 on August 31, 1984.

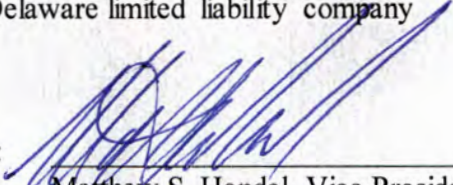
Being the same real property conveyed an undivided one-half (½) interest in Scott T. Clary and an undivided one-half (½) interest in James A. Clary, II, by deed from John N. Pruitt, Jr., unmarried, by and through his agent and attorney-in-fact, Rita B. Trader, dated December 17, 1991, of record in Deed Book 418, page 608, in the Henderson County Clerk's Office. See also deed dated 2006, of record in Deed Book 546, page 10 from Scott T. Clary and wife, Jennifer Clary, to James A. Clary, II, in said Clerk's Office.

HOLDING PAGE FOR EXHIBIT B

Preliminary Lease and Easement Improvement Plan and Acreage Calculation
To be Delivered with Option Notice

HOLDING PAGE FOR EXHIBIT C

As Built Lease and Easement Improvements and Final Acreage Calculation

EXHIBIT D

Lease and Easement Compensation

(1) **Option Payment.** [Redacted]

[Redacted]

[Redacted]

(2) **Payment for Lease and Easements.**

[Redacted]

[Redacted]

[Redacted]

[REDACTED]

(3) Crop Compensation.

[REDACTED]

[REDACTED]

(4) Timber Removal.

[REDACTED]

5. Payment Allocation Schedule.

[REDACTED]

Kentucky

SOLAR LEASE AND EASEMENT AGREEMENT

1. **Parties.** This Solar Lease and Easement Agreement ("**Agreement**") is made and entered as of the 2 day of December, 2019 ("**Effective Date**"), by and between Scott T. Clary a/k/a Scott Thomas Clary and Jennifer Clary, husband and wife; and James A. Clary II a/k/a James Arvel Clary and Mary Clary, husband and wife ("**Owner**") and Boulevard Associates, LLC, a Delaware limited liability company ("**Operator**"), which are sometimes individually referred to as a "**Party**" and collectively as the "**Parties**".

2. **Project.** This Agreement relates to the solar-powered electrical power generation and transmission project known as the "Sebree Solar Energy Center" to be located in Henderson County, Kentucky ("**Project**"), which may be wholly or partially located on the Owner's property legally described on the attached **Exhibit A** to this Agreement ("**Owner's Property**"). Upon Operator's exercise of the Option (as defined below), the Project shall include (i) the Lease of Owner's Property described in Section 4, (ii) the Easements referenced in Section 5 that are located on the Owner's Property, and (iii) the Improvements referenced in Section 8 to be constructed on Owner's Property. The Lease, Easements and Improvements are sometimes collectively referred to as the "**Operator Property**".

3. **Option.** Owner grants to Operator an exclusive option ("**Option**") to acquire the Lease and Easements referenced in Sections 4 and 5 in accordance with the following terms and conditions. Operator shall be entitled to acquire the Lease and the Easements in their entirety or in part, as Operator deems appropriate.

3.1 **Option Term.** The period during which Operator may exercise the Option shall be for a term of four (4) years, commencing on the Effective Date ("**Option Term**").

3.2 **Option Payment.** As consideration for the granting of the Option, Operator agrees to pay Owner the Option Payment set forth in **Exhibit D**.

3.3 **Use of Owner's Property.** During the Option Term, Operator and its employees, agents and contractors shall have a right to enter upon the Owner's Property and the right of ingress and egress over and across the Owner's Property for the purposes of (i) surveying the Owner's Property; (ii) performing such other tests and studies as Operator may desire in connection with the Option, including, without limitation, environmental, avian and cultural resource assessments, and geotechnical, foundation and soil tests, provided that such activities do not unreasonably interfere with Owner's use of the Owner's Property; and (iii) installing, maintaining, operating, inspecting and removing one or more weather related instruments ("**Weather Instrument**") and fencing of said Weather Instrument and including the performance of all tests and studies associated therewith. Owner shall not permit any other individual or entity except Operator or its affiliates to install a Weather Instrument on Owner's Property.

3.4 **Right to Grant Option.** Owner warrants and represents to Operator that (i) the statements in Section 9 concerning Owner's title to the Owner's Property are true and correct; (ii) Owner has the authority to grant this Option to Operator without the consent or approval of any other party; and (iii) there are no other existing options, rights of first refusal, contracts to

purchase, leases or mortgages that would prevent Operator from exercising its rights with respect to the Option.

3.5 **Exercise of Option.** Operator may exercise the Option by giving written notice to Owner ("**Option Notice**") at any time during the Option Term. Operator shall specify in the Option Notice the Commencement Date referenced in Section 6.1.1. On the Commencement Date, the Lease and Easements referenced in Sections 4 and 5 shall automatically become effective, and the Parties shall be subject to all of the terms and conditions of this Agreement with respect to such Lease and Easements and all rights and obligations relating thereto.

3.6 **Termination of Option.** If Operator fails to exercise the Option within the Option Term, the Option and the rights of Operator as the optionee shall automatically terminate.

4. **Lease.** Upon exercise of the Option by Operator, Owner leases to Operator, and Operator leases from Owner. Owner's Property for the Lease and Easement Term (defined in Section 6.1) in accordance with the terms and conditions of this Agreement ("**Lease**"), which Lease grants Operator and its agents, contractors, and employees the right to use the Owner's Property for the following permitted uses:

4.1 **Construction Right.** Operator leases Owner's Property for the purpose of constructing, operating, maintaining, repairing, replacing, and removing all or any part or component of the Improvements whether located on Owner's Property. Operator may exercise its right to use all or any part of the Owner's Property as and when Operator deems it necessary or advisable to do so to perform the activities for which this right is granted, including, without limitation, staging areas and parking for Operator's employees. Any such areas being used temporarily by Operator shall be located immediately adjacent to the portion of the Property leased by Operator hereunder.

4.2 **Access Right.** Operator leases Owner's Property for unobstructed vehicular and pedestrian access and ingress to and egress from the Improvements, Owner's Property and any public roadways, and to construct, maintain, and utilize Roadway Improvements on the Owner's Property. Owner shall not permit others to obstruct or damage the roads or Roadway Improvements located on the Owner's Property or in any other way interfere with Operator's rights under this right. Operator shall repair any damage done to Roadway Improvements which result from use by Operator, its agents, servants or employees. Such roads shall be maintained in the condition necessary for use by Operator's equipment, and with regard to existing roads, shall be maintained in at least the condition that existed prior to Operator's use. Any roads inside of the fenced area of the project will be maintained by Operator at Operator's sole cost and expense.

4.3 **Solar Panels Right.** Operator leases Owner's Property for Operator to construct, operate, replace, relocate, remove, and maintain Solar Panels and the appurtenant Collection Facilities, together with associated roads and parking areas on Owner's Property.

4.4 **Collection Facilities Right.** Operator leases Owner's Property for Operator to construct, operate, maintain, replace, relocate or remove Collection Facilities on and under the Owner's Property.

4.5 **Substation Right.** Operator leases Owner's Property for Operator to construct, operate, maintain, replace, relocate or remove one or more Substations on Owner's Property.

4.6 **Telecommunication Right.** Operator leases Owner's Property for Operator to construct, operate, maintain, replace, relocate or remove Telecommunication Facilities on and under the Owner's Property.

4.7 **Weather Instrument Right.** Operator leases Owner's Property in order to construct, operate, replace, relocate, remove, and maintain a Weather Instrument and the appurtenant Collection Facilities on Owner's Property.

4.8 **Battery Facilities Right.** Operator leases Owner's Property in order to construct, operate, replace, relocate, remove, and maintain one or more Battery Facilities on Owner's Property.

5. **Grant of Easements.** Upon the exercise of the Option by Operator, Owner grants to Operator, and Operator accepts from Owner, for the Lease and Easement Term referenced in Section 6.1, the following easements over and across the Owner's Property in accordance with the terms and conditions of this Agreement. The following easements are for the benefit of Operator and Operator's agents, contractors and employees and located on the Owner's Property and are collectively referred to as the "**Easements**".

5.1 **Sun Non-Obstruction Easement.** Owner grants Operator an irrevocable, exclusive easement for the right and privilege to use, maintain and capture the free and unobstructed sunlight over and across the Owner's Property. Owner shall not engage in any activity on Owner's Property or any other neighboring property owned by Owner that might interfere with the sunlight direction over any portion of Owner's Property; cause a decrease in the output or efficiency of any Solar Panel or Weather Instrument; or otherwise interfere with Operator's operation of the Project or exercise of any rights granted in this Agreement (collectively "**Interference**"). This grant of the easement expressly includes the right of Operator to enforce Operator's rights, including the physical removal of trees or structures (except existing trees and structures) causing Interference to the Project contemplated by Operator. Operator shall notify Owner before making any such removals.

5.2 **Effects Easement.** Owner grants to Operator an easement over Owner's Property for visual, view, light, flicker, noise, shadow, vibration, electromagnetic, electrical and radio frequency interference, and any other effects attributable to the Project located on the Owner's Property.

6. **Term.** The term of this Agreement ("**Term**") includes the Option Term referenced in Section 3.1, the Initial Lease and Easement Term as described in Section 6.1.1 and the Extended Lease and Easement Term as described in Section 6.1.2 (together, the Initial Lease and Easement Term and the Extended Lease and Easement Term, if applicable, is defined as the "**Lease and Easement Term**").

6.1 **Lease and Easement Term.**

6.1.1 **Initial Lease and Easement Term.** The initial term of the Lease and Easements shall commence on the date specified by Operator in the Option Notice ("**Commencement Date**"). The initial term of the Lease and Easements shall end thirty (30) years after the Commencement Date (the "**Initial Lease and Easement Term**"), subject to the rights of renewal and termination as provided in this Agreement.

6.1.2 **Extended Lease and Easement Term.** Operator shall have the right to extend the Term of this Agreement for two (2) consecutive terms of five (5) years each in accordance with the terms and provisions of this Agreement (collectively "**Extended Lease and Easement Term**") by providing written notice to Owner of Operator's intent to extend the Term within one hundred eighty (180) days of the end of the existing Term. Each Extended Lease and Easement Term shall begin on the expiration date of the Initial Lease and Easement Term or previous Extended Lease and Easement Term, as the case may be. During the Extended Lease and Easement Term, Operator shall pay Owner the amounts set forth in **Exhibit D** as the consideration for the Lease and Easements.

6.1.3 **Delays During Lease and Easement Term.** At Operator's option, the Term may be extended for a period of time equal to the period of time during which operation of the Project is delayed or suspended because of the occurrence of a Regulatory Suspension or Force Majeure, which are defined as follows:

(i) "**Regulatory Suspension**" shall mean the enactment or application of any law, order, rule, or regulation of the Kentucky Public Service Commission, Federal Energy Regulatory Commission, or other local, state, or federal government authority having jurisdiction over the Project or Operator, or the failure of any such governmental authority to issue an approval or permit pursuant to any such law, order, rule, or regulation, which results in the delay, interruption, or suspension of the production, sale or transmission of electricity from the Solar Panels; and

(ii) "**Force Majeure**" shall mean causes beyond the reasonable control of and without the fault or negligence of the Party claiming Force Majeure, including but not limited to acts of God, labor unrest (including, but not limited to, slowdowns, picketing, boycotts or strikes), flood, earthquake, storm, fire, lightning, explosion, power failure or power surge, vandalism, theft, the cutting of power, transmission or other lines, wires or cables to the Project by persons other than Operator's employees or contractors, epidemic, war, revolution, riot, civil disturbance, sabotage, change in law or applicable regulation subsequent to the Commencement Date and action or inaction by any federal, state or local legislative, executive, administrative judicial agency or body which in any of the foregoing cases, by exercise of due foresight such Party could not reasonably have expected to avoid, and which, by the exercise of due diligence, it is unable to overcome.

The Parties shall be excused from performing their respective obligations under this Agreement and shall not be liable in damages or otherwise if and to the extent that they are unable to so perform or are prevented from performing by a Force Majeure, provided that: (i) the non-performing Party, as promptly as practicable after the occurrence of the Force Majeure, but in no event later than thirty (30) days thereafter, gives the other Party written notice describing the particulars of the occurrence; (ii) the suspension of performance is of no greater scope and of no

longer duration than is reasonably required by the Force Majeure; (iii) the non-performing Party uses good faith and commercially reasonable efforts to remedy its inability to perform; and (iv) as soon as the non-performing Party is able to resume performance of its obligations excused as a result of the occurrence, each Party shall give prompt written notification thereof to the other Party. Notwithstanding the foregoing, Operator shall pay Owner 50% of the Annual Installment Payments during any period of Force Majeure.

6.2 **Termination by Operator.** Provided Operator is not in default under any term of this Agreement, Operator, at its option, shall have the right to terminate this Agreement at any time during the Term of the Agreement, as to all or any part of the Operator Property. Termination shall be effective thirty (30) days after written notice of such termination to Owner. If Operator's notice is a full termination of the Operator Property, the Parties shall be relieved of all further duties and obligations under this Agreement, other than (i) the payment of any accrued and unpaid obligations owed by either Party as of the date of termination; (ii) the removal of the Improvements by Operator pursuant to Section 8.11; and (iii) any other obligations and liabilities that are expressly stated in this Agreement to survive such termination. Upon any such partial termination by Operator, the Parties shall be relieved of all further duties and obligations under this Agreement with respect to the portion thereof terminated by Operator, subject to the obligations and liabilities referenced in items (i) through (iii) above that shall continue to be applicable to the terminated portion of this Agreement. The Parties agree to execute an amendment to this Agreement evidencing such partial termination.

7. **Payments.** If Operator exercises the Option referenced in Section 3, Operator agrees to pay Owner the amounts set forth in **Exhibit D** as consideration for the Lease, Easements and Operator's other rights and interests in the Owner's Property.

8. **Improvements.** Operator shall have the right, at its sole cost and expense, to construct, install, maintain, use, operate, repair, replace, relocate and remove all facilities, structures, equipment, machinery, wires, conduit, cables, poles, materials and property of every kind and character required for the construction and operation of portions of the Project on the Owner's Property, including, but not limited to, the Solar Panels, Collection Facilities, Substations, Telecommunication Facilities, Weather Instruments, Roadway Improvements and Battery Facilities referenced in Sections 8.1 through 8.7 (collectively, the "**Improvements**").

8.1 "**Solar Panels**" shall mean any photovoltaic energy system designed for the generation of electrical power from the collection of sunlight, including without limitation, the photovoltaic panels, foundations, support structures, braces and related equipment.

8.2 "**Collection Facilities**" shall mean all Improvements whose purpose is to deliver electrical power generated by the Solar Panels to an electrical power grid or other system, including without limitation transformers, overhead and underground electrical collection lines, telecommunication lines, splice boxes and interconnection facilities.

8.3 "**Substations**" shall mean electrical lines, meters, monitoring and control equipment, switches, transformers, all structures, equipment, enclosures, fencing, security devices, and other electrical and communications equipment necessary to condition and increase

the voltage of electricity generated by the Project to make it suitable for transmission on, and to deliver it to, Collection Facilities connected to an electric power grid or other system.

8.4 "**Telecommunication Facilities**" shall mean all Improvements whose purpose is to provide telecommunication services solely relating to the Project or any of Operator's solar powered projects, including telephone, closed-circuit television, microwave, internet, computer data and other telecommunication services.

8.5 "**Weather Instrument**" shall mean instruments used primarily to gather and transmit sunlight and meteorological data relating to the Project, and includes the instrument's foundations, guy wires, sunlight and meteorological data acquisition equipment, power source, and any required data and electrical transmission lines.

8.6 "**Roadway Improvements**" shall mean all improvements that may be necessary to construct, maintain and repair any new and existing roadways and other means of ingress and egress over, across and along the Owner's Property, including paving or surfacing of the roadways with asphalt, gravel or other roadway materials, installation of road signs and the construction and installation of culverts, bridges, drainage ditches, gates, cattle guards and similar structures and facilities.

8.7 "**Battery Facilities**" shall mean a type of equipment that can be given a new charge by passing an electric current through it designed for the storage of electrical power including without limitation, batteries and other devices for storage of electrical energy, foundations, support structures, braces and related equipment.

8.8 "**Ownership of Improvements**". Except as otherwise provided in Section 11.7, all Improvements shall at all times remain the property of Operator, and Owner shall have no right, title or interest therein. All Improvements constructed or placed on the Owner's Property by Operator during the Term of this Agreement may be repaired, replaced, relocated, removed, added to or expanded upon by Operator at any time during the Term of this Agreement. Owner expressly waives any statutory lien or common law liens on the Improvements to which Owner might be entitled.

8.9 "**Construction Liens**". Operator shall not permit any liens arising out of Operator's use of the Operator Property under this Agreement to be filed against the Owner's Property. Operator shall, within sixty (60) days after it receives notice of the lien, provide a bond or other security that Owner may reasonably request, or remove such lien from the Owner's Property in the manner provided by applicable law.

8.10 "**Location of Improvements**". The acreage required from the Owner's Property for the Improvements for which the Lease and Easements are being granted cannot be determined until the completion of Operator's inspection, testing, study and surveying of the Owner's Property during the Option Term. Along with the Option Notice, Operator shall deliver to Owner a proposed plan of development showing the contemplated locations of the Improvements and a preliminary calculation of the acreage as determined by the area bounded by a perimeter fence required for the Project, which shall serve as the **Exhibit B** to this Agreement. During the final development and construction of the Project, such locations may need to be amended.

Following construction of the Project, Operator shall provide Owner an "as-built" survey of all Improvements on Owner's Property and the final calculation of the acreage as determined by the area bounded by a perimeter fence required for the Project, which shall serve as **Exhibit C** to this Agreement. Further, following construction, the Improvements may need to be relocated or rerouted by Operator, which Operator may perform, at any time during the Term of this Agreement, so long as the nature and extent of any such relocated or rerouted Improvements are not materially different and impose no materially greater burden on the Owner's Property than the original locations or routes, and so long as Operator takes commercially reasonable efforts to minimize disruption or inconvenience to Owner.

8.11 **Removal of Improvements**. Upon full or partial termination of any of the Lease Rights or Easements, Operator shall, within one (1) year of such full or partial termination, remove all Improvements and restore the area formerly occupied by the Improvements to substantially the same physical condition that existed immediately before the construction of the Improvements (the "**Removal Obligations**"). At Owner's request, all or any part of the Roadway Improvements may be left for use by Owner. Annual Installments Payments shall continue to be made, on a prorated basis, until the Removal Obligations are substantially completed.

8.12 If a governmental authority does not require a performance bond or security for removal of the Improvements, then, Operator shall obtain and deliver to Owner a bond in form and substance reasonably satisfactory to Owner securing Operator's Removal Obligations (the "Removal Bond") prior to the date that the Project first delivers energy in commercial quantities onto the grid. The Removal Bond shall be equal to the estimated amount, if any (the "Net Removal Costs"), of removing the Improvements from Owner's Property less the salvage value of the Improvements. Operator shall not be required to deliver such Removal Bond to Owner if Operator has delivered such a bond in connection with the permitting of Owner's Property or any other portion of the Improvements for the Project. Once in place, Operator shall keep such bond, or a like replacement, in force throughout the remainder of the Term. The Net Removal Costs shall be determined by the Parties hereto acting in good faith. If the Parties cannot agree upon the Net Removal Costs within sixty (60) days of their first attempt to do so, then the Net Removal Costs shall be determined by an independent engineer mutually selected by the Parties. If the Parties cannot agree upon such independent engineer within the next thirty (30) days, then by an independent engineer appointed by a District Judge of Henderson County, Kentucky; and the decision of such an independent engineer (however selected) as to the Net Removal Costs shall be conclusive as between and binding upon, the Parties. If an independent engineer is selected, then the Parties hereto shall equally share all of the costs associated with the independent engineer's determination of the Net Removal Cost. If the Removal Bond is unavailable or an alternate form of security is more economical or desirable, then Operator may substitute an alternate form of security, such as a letter of credit, other form of bond, or guarantee reasonably acceptable to Owner that provides substantially equivalent security as the Removal Bond. Operator shall redetermine the amount of the Removal Security beginning immediately prior to the tenth (10th) year of the Lease and Easement Term and every five (5) years after the initial posting of the Removal Bond.

9. **Ownership and Title Matters.** Except as otherwise set forth herein, Owner warrants and represents to Operator, both as of the Effective Date, and as of the Commencement Date as follows:

9.1 **Authority.** Owner represents and warrants that it is the holder of fee simple title and is the sole owner of the Owner's Property and has the unrestricted right and authority to sign this Agreement and to grant Operator the Lease and Easements and other rights granted in this Agreement. When signed by both Parties, this Agreement constitutes a valid and binding agreement enforceable against Owner in accordance with its terms.

9.2 **Other Agreements.** The Owner's Property is not subject to any other agreements, options, rights of first refusal or other prior right of any party to purchase, lease or acquire easements in the Owner's Property, or create any prior claim or right that would preclude or interfere with Operator's rights and interests under this Agreement and the Lease and Easements.

9.3 **Minerals.** Except as disclosed by Owner to Operator at the time of the execution of this Agreement by Owner, Owner owns all of the oil, gas and other minerals, and all rights thereto as on or under the Owner's Property.

9.4 **Owner Mortgage.** Except as disclosed by Owner to Operator at the time of the execution of this Agreement by Owner, there are no mortgages encumbering the Owner's Property ("**Owner Mortgage**").

9.5 **Notice and Opportunity to Cure.** If there is an Owner Mortgage encumbering Owner's Property and Owner receives from the holder thereof any notice that payments are overdue, Owner shall notify Operator and each Operator Mortgagee (as defined at Section 13.1) by sending a copy of such overdue payment notice to Operator by the earlier of (i) five (5) days after receipt, or (ii) three (3) business days prior to the date by which a default under or in respect of such Owner Mortgage could occur. If Operator or any Operator Mortgagee determines that it would be in Operator's interest to make such payments to Owner Mortgagee on Owner's behalf, whether as a result of receiving such notice or otherwise, Operator shall have the right to make such payments and to credit the payments so made against the Annual Installment Payment next due under the Agreement.

9.6 **Subordination, Non-Disturbance & Attornment Agreement.** If there is an Owner Mortgage encumbering Owner's Property, Owner shall cooperate with Operator to obtain a Subordination, Non-Disturbance and Attornment Agreement ("SNDA") in the form prepared and provided by Operator, from each Owner Mortgagee, pursuant to which such Owner Mortgagee agrees, among other things, not to disturb Operator's possession and use of the Owner's Property. Owner shall not incur any loss in income, expense, obligation or liability with regard to the SNDA. Operator shall, at its sole cost and expense, record each such SNDA in the Office of the County Clerk in which Owner's Property is located. If Owner fails to deliver a SNDA from each Owner Mortgagee, Operator may, at its sole option, either (i) terminate this Agreement immediately upon written notice to Owner, or (ii) take such action as Operator deems reasonably necessary to effect the rights granted to Operator hereunder, and off-set all amounts

expended in such efforts against the Annual Installment Payments and any other amounts due hereunder or in respect hereof.

10. **Representations and Warranties of Owner.** Owner hereby makes the following further representations and warranties both as of the Effective Date, and as of the Commencement Date:

10.1 **Physical Condition.** Owner has no knowledge of any existing physical conditions except for Henderson County Zoning and land use ordinances and restrictions of the Owner's Property which would prevent, significantly restrict or make more expensive Operator's development of the Owner's Property for the purposes specified in this Agreement, or which could, with the passage of time, or the giving of notice, constitute a violation of any currently applicable governmental law, ordinance, order, rule or regulation.

10.2 **Legal Restrictions.** Owner has no knowledge of any law, regulation, ordinance or order of any local, state or federal governmental authority which would prohibit or significantly restrict Operator's development of the Owner's Property pursuant to this Agreement. This Agreement does not violate any contract, agreement, instrument, judgment or order to which Owner is a party or which affects the Owner's Property. To the best of Owner's knowledge, the Owner's Property is currently in full and complete compliance with all governmental laws, ordinances, orders, rules and regulations applicable to the Owner's Property.

10.3 **No Litigation.** No litigation is pending and, to the best of Owner's knowledge, no litigation or administrative actions are proposed, threatened or anticipated with respect to any matter affecting the Owner's Property. If Owner learns of any litigation or administrative action proposed, threatened or instituted with respect to the Owner's Property, Owner shall give Operator notice within thirty (30) days thereof.

10.4 **Survival.** The representations and warranties set forth in this Section 10 shall survive the execution and delivery hereof.

11. **Use, Operation and Maintenance.**

11.1 **Exclusive Use by Operator.** Operator shall have the exclusive right (i) to use and possess the Owner Property in connection with the Project and other similar solar-powered electrical power generation projects; (ii) to investigate, inspect, survey, and conduct tests of the Owner's Property, including, but not limited to, meteorological, environmental, archeological and geotechnical tests and studies; (iii) to use and convert all of the sunlight resources on the Owner's Property; and (iv) to undertake such other activities on the Owner's Property that may be related to the Project, including, without limitation, the storage of Solar Panels, materials and equipment during the installation and construction of the Improvements; development and operation of communications systems; and site tours of the Project for visitors and other interested parties.

11.2 **No Required Installation or Operation.** Nothing in this Agreement shall be interpreted as imposing on Operator any obligation to install Solar Panels or other Improvements on the Owner's Property, or to operate the Project on the Owner's Property. Operator shall have the sole discretion to determine if and when any Solar Panels and other Improvements may be

constructed on Owner's Property, and if and when to commence the operation of the Project on the Owner's Property.

11.3 **Permits and Approvals.** Operator shall be responsible, at its sole cost and expense, for obtaining any governmental permits and approvals necessary for the construction and operation of the Project and the construction and operation of the Improvements. Owner shall cooperate with Operator as necessary to obtain any governmental or utility approvals or permits, including, without limitation, signing any applications for such approvals, provided that Owner shall not incur any loss in income, expense, obligation or liability with respect to Operator obtaining such permits or approvals.

11.4 **Compliance with Laws.** Operator shall comply in all material respects with valid laws applicable to the Owner's Property and the Operator Property. Operator shall have the right, in its sole discretion and at its sole expense, in Operator's name to contest the validity or applicability to the Owner's Property and the Operator Property of any law, ordinance, statute, order, regulation, property assessment or the like made by any governmental agency or entity. Operator shall control any such contest and Owner shall cooperate with Operator in every reasonable way in such contest, provided that Owner shall incur no expense, obligation or liability with regard to such contest.

11.5 **Care and Appearance.** Operator, in its exercise of the lease, easement and other rights granted hereunder shall, at all times, maintain the Owner's Property and the Improvements in a reasonably neat, clean and presentable condition. Operator shall not willfully or negligently damage or destroy the Owner's Property and shall keep the Owner's Property clean and free of debris created by Operator, its contractors, or others brought on to the Owner's Property by Operator. Operator shall not use the Owner's Property for storage, except for materials, construction equipment and vehicles directly associated with construction or maintenance of the Improvements on the Owner's Property or adjacent properties that are part of the Project.

11.6 **Fences and Gates.** At Owner's request, Operator shall repair or replace any fences, gates or cattle guards damaged or removed in connection with Operator's activities on the Owner's Property. Fences removed from the Owner's Property, if replaced, shall be re-built by Operator at its expense in mutually agreeable locations. All fence repair and construction shall be substantially similar to the construction of existing fences and cattle guards on Owner's Property. Any gates opened for access to Owner's Property by either Party shall be closed immediately after passing through so that livestock may not pass through. Once completed, all replacement fences, gates and cattle guards shall be owned and maintained by Owner. Upon abandonment or termination of the rights granted to Operator in this Agreement, any fences, gates and cattle guards installed by Operator shall remain and become the property of Owner. To minimize the need for temporary fencing, Owner will cooperate with Operator to avoid pasturing animals on or near the Improvements during periods of construction, maintenance or removal activity by Operator. Owner will discuss with Operator what temporary fencing is necessary during the periods of construction, maintenance or removal activity by Operator.

11.7 **Roadway Maintenance and Repairs.** Operator agrees to maintain and repair all Roadway Improvements located on the Operator Property; provided, however, Owner shall reimburse Operator for any costs and expenses incurred by Operator to repair any damage or

perform any special maintenance of the Roadway Improvements caused by Owner or any person using the Roadway Improvements with Owner's permission, other than Operator.

12. **Taxes.**

12.1 **Owner's Taxes.** Owner covenants and agrees to pay prior to delinquency all real and personal property and other taxes, general and special assessments, and other charges of every description ("Taxes") levied or assessed against the Owner's Property and all improvements thereon by governmental authorities, other than Operator's Taxes referenced in Section 12.2 (Taxes, excepting Operator's Taxes, are hereinafter referred to as "**Owner's Taxes**").

12.2 **Operator's Taxes.**

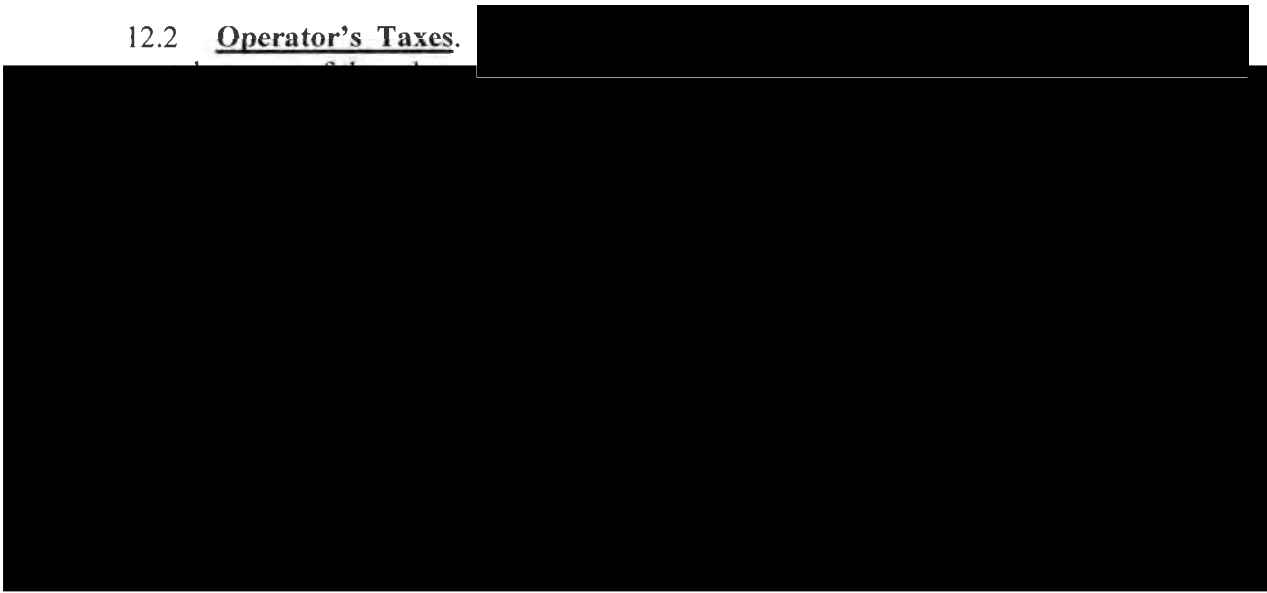

12.3 **Failure to Pay.** In the event either Party fails to pay their share of Taxes prior to delinquency, the other Party shall have the right to pay such Taxes and any accrued penalties or interest, which payments shall increase or be offset against other Payments due under this Agreement.

12.4 **Operator's Right to Contest.** Operator may contest the legal validity or amount of any Operator's Taxes for which it is responsible under this Agreement, and may institute such proceedings as it considers necessary, provided that Operator shall bear all expenses in pursuing such contest or proceeding. With respect to any Taxes which may constitute a lien on the Owner's Property, Operator shall promptly pay such Taxes unless the proceeding in which it contests such Taxes shall operate to prevent or stay the collection of the Taxes so contested or unless Operator removes any such lien by bonding or otherwise. Owner agrees to render to Operator all reasonable assistance in contesting the validity or amount of any such Taxes, with the exception of Taxes levied by Owner, including joining in the signing of any reasonable protests or pleading which Operator may deem advisable to file; provided, however, that Operator shall reimburse Owner for its reasonable out-of-pocket expenses, including reasonable attorneys' fees incurred in connection with providing such assistance.

13. **Mortgage of Operator Property.**

13.1 **Right to Mortgage.** Operator may, upon written notice to Owner, but without requiring Owner's consent or approval, mortgage, collaterally assign, or otherwise encumber and grant security interests in all or any part of its interest in this Agreement and the Operator Property, but not in Owner's interest therein. These various security interests in all or a part of this Agreement and the Operator Property are collectively referred to as an "**Operator Mortgage**" and holder of such security interest, an "**Operator Mortgagee**". Any Operator Mortgage shall use the Operator Property only for the uses permitted under this Agreement. Whenever Operator has granted a security interest under this Section 13, it will give Owner notice of the Operator Mortgage (including the name and address of the Operator Mortgagee for notice purposes) to Owner within thirty (30) days; provided that failure to give this notice shall not constitute a default under this Agreement, but rather shall only have the effect of not binding Owner to provide such Operator Mortgage notice until the Operator and its address is given to Owner.

13.2 **Notice of Default and Opportunity to Cure.** As a precondition to exercising any rights or remedies related to any alleged default by Operator under this Agreement, Owner shall give written notice of the default to each Operator Mortgagee at the same time it delivers notice of default to Operator, specifying in detail the alleged event of default and the required remedy. Each Operator Mortgagee or its designee shall have the right, but not the obligation, to cure any default as Operator, and/or the right, but not the obligation, to remove any Improvements or other property owned by Operator or such Operator Mortgagee located on the Owner's Property to the same extent as Operator. The cure period for any Operator Mortgagee shall be the later of (i) the end of the Operator cure period under Section 18; (ii) thirty (30) days after such Operator Mortgagee's receipt of the default notice; or (iii) if applicable, the extended cure period provided for in Section 13.3. Failure by Owner to give an Operator Mortgagee notice of default shall not diminish Owner's rights against Operator, but shall preserve all rights of the Operator Mortgagee or its designee to cure any default and to remove any Improvements or other property of Operator or the Operator Mortgagee located on the Owner's Property.

13.3 **Extended Cure Period.** If any default by Operator under this Agreement cannot be cured without the Operator Mortgagee obtaining possession of all or part of the Operator Property, then any such default shall be deemed remedied if an Operator Mortgagee: (i) within sixty (60) days after receiving notice from Owner as set forth in Section 13.2, acquires possession of all or part of the Operator Property, or begins appropriate judicial or nonjudicial proceedings to obtain the same; (ii) diligently prosecutes any such proceedings to completion; and (iii) after gaining possession of all or part of the Operator Property performs all other obligations as and when the same are due in accordance with the terms of this Agreement. If an Operator Mortgagee is prohibited by any court or by operation of any bankruptcy or insolvency laws from commencing or prosecuting the proceedings described above, the sixty (60) day period specified above for commencing proceedings shall be extended for the period of such prohibition.

13.4 **Operator Mortgagee Liability.** Any Operator Mortgagee whose interest in the Operator Property is held solely for security purposes, shall have no obligation or liability under this Agreement unless and until the Operator Mortgagee succeeds to absolute title to the

Operator Property and the rights of Operator under this Agreement. An Operator Mortgagee shall be liable to perform obligations under this Agreement only for and during the period it directly holds such absolute title.

13.5 **Certificates.** Owner shall execute any estoppel certificates (certifying as to truthful matters, including without limitation that no default then exists under this Agreement, if such be the case), consents to assignment and non-disturbance agreements as Operator or any Mortgagee may reasonably request from time to time. The Parties shall negotiate in good faith any amendment to this Agreement from time to time to include any provision that may be reasonably requested by Operator or any Operator Mortgagee to implement the provisions contained in this Agreement or to preserve an Operator Mortgagee's security interest.

13.6 **Operator Mortgagee's Right to Enforce Mortgage and Assign.** Each Operator Mortgagee shall have the right, in its sole discretion: (i) to assign its Operator Mortgage; (ii) to enforce its lien and acquire title to all or any portion of the Operator Property by any lawful means; (iii) to take possession of and operate all or any portion of the Operator Property and to perform all obligations to be performed by Operator under this Agreement, or to cause a receiver to be appointed to do so; and (iv) to acquire all or any portion of the Operator Property by foreclosure or by an assignment in lieu of foreclosure and thereafter to assign or transfer all or any portion of the Operator rights under this Agreement to a third party in accordance with Section 14. Any Operator Mortgagee or other party who acquires Operator's interest in all or a portion of the Operator Property pursuant to foreclosure or assignment in lieu of foreclosure shall not be liable to perform the obligations imposed on Operator by this Agreement, which are incurred or accruing after such Operator Mortgagee or other party no longer has ownership or possession of the Operator Property.

13.7 **New Agreement.**

13.7.1 If the Operator Property is foreclosed upon or there is an assignment in lieu of foreclosure, or if this Agreement is rejected or disaffirmed pursuant to bankruptcy law or other law affecting creditor's rights and, within ninety (90) days after such event, Operator or any Operator Mortgagee or other purchaser at a foreclosure sale shall have arranged to the reasonable satisfaction of Owner to cure any material defaults under this Agreement, and for the payment of all Annual Installment Payments or other charges due and payable by Operator as of the date of such event, then Owner shall execute and deliver to Operator or such Operator Mortgagee or other purchaser at a foreclosure sale, or to a designee of one of these parties, as the case may be, a new agreement ("**New Agreement**") which (i) shall be for a term equal to the remainder of the Term of this Agreement before giving effect to such rejection or termination; (ii) shall contain the same covenants, agreements, terms, provisions and limitations as this Agreement (except for any requirements that have been fulfilled by Operator or any Operator Mortgagee or other purchaser at a foreclosure sale prior to rejection or termination of this Agreement); and (iii) shall include that portion of the Operator Property in which Operator or such other Operator Mortgagee or other purchaser at a foreclosure sale had an interest on the date of rejection or termination.

13.7.2 If more than one Operator Mortgagee makes a written request for a New Agreement pursuant to this provision, the New Agreement shall be delivered to the Operator

Mortgagee requesting such New Agreement whose Operator Mortgage is prior in time, and the written request of any other Operator Mortgage whose lien is subordinate shall be void and of no further force or effect. The provisions of this Section 13 shall survive the termination, rejection or disaffirmation of this Agreement and shall continue in full force and effect thereafter to the same extent as if this Section 13 were a separate and independent contract made by Owner, Operator and each Operator Mortgagee, and, from the effective date of such termination, rejection or disaffirmation of this Agreement to the date of execution and delivery of such New Agreement, such Operator Mortgagee or other purchaser at a foreclosure sale may use and enjoy the Operator Property without hindrance by Owner or any person claiming by, through or under Owner; provided that all of the conditions for the New Agreement as set forth above are complied with.

13.8 **Operator Mortgagee's Consent to Amendment, Termination or Surrender.** Notwithstanding any provision of this Agreement to the contrary, the Parties agree that so long as any Operator Mortgage remains outstanding, this Agreement shall not be modified or amended, and Owner shall not accept a surrender, cancellation or release of all or any part of the Operator Property from Operator, prior to expiration of the Term of this Agreement, without the prior written consent of the Operator Mortgagee holding such Operator Mortgage. This provision is for the express benefit of and shall be enforceable by each Operator Mortgagee as if it were a party named in this Agreement.

14. **Assignment and Sublease.** Operator shall have the right, without Owner's consent, to sell, convey, lease, or assign all or any portion of this Agreement or the Operator Property, on either an exclusive or a non-exclusive basis, or to grant subeasements, co-easements, easements, licenses or similar rights with respect to the Operator Property (collectively, "**Assignment**"), to one or more persons or entities (collectively "**Assignee**"). Each Assignee shall use the Operator Property only for the uses permitted under this Agreement. When Operator makes any Assignment under this Section 14, Operator shall give written notice to Owner of such Assignment (including the interest conveyed by the Assignment and address of the Assignee for notice purposes) to Owner; provided Operator's failure to give such notice shall not constitute a default under this Agreement, but rather shall only have the effect of not binding Owner with respect to such assignment or conveyance until such notice is given. Any Assignment by Operator shall release Operator from obligations subject thereof accruing after the date that liability for such obligations is assumed by the Assignee.

15. **Hazardous Materials.**

15.1 **Owner's Covenants Regarding Hazardous Materials.** Owner represents and warrants that, to the best of Owner's knowledge, the Owner's Property is not and has not been in violation of any federal, state or local environmental health or safety laws, statute, ordinance, rule, regulation or requirement ("**Environmental Laws**"), and Owner has not received any notice or other communication from any governmental authorities alleging that the Owner's Property is in violation of any Environmental Laws. "**Hazardous Materials**" shall mean any asbestos containing materials, petroleum, explosives, toxic materials, or substances regulated as hazardous wastes, hazardous materials, hazardous substances, or toxic substances under any

federal, state, or local law or regulation. Owner warrants that Owner has done nothing to contaminate the Operator Property with Hazardous Materials or wastes.

15.2 **Operator's Covenants Regarding Hazardous Materials.** Operator shall, at Operator's sole cost and expense, promptly take removal or remedial action required by Environmental Law with regard to any material violation of any Environmental Law with regard to any Hazardous Materials brought onto the Owner's Property by Operator or its employees, agents, or contractors. Owner shall cooperate with Operator with regard to any scheduling or access to the Owner's Property in connection with any action required hereunder.

15.3 **Operator's Indemnity Regarding Hazardous Materials.** Operator shall indemnify, defend, protect and hold Owner harmless from any liability based on: (i) the release of Hazardous Materials in, on, under or about the Owner's Property caused by Operator or its employees, agents, or contractors, or (ii) the violation by Operator or its employees, agents, or contractors of any Environmental Law. The indemnity obligations set forth herein shall survive termination of this Agreement.

16. **Insurance and Indemnity.**

16.1 **Insurance.** At all times during which Operator is conducting any activities on the Property and at all times during the Term of this Agreement, Operator shall maintain in effect (1) commercial General Liability Insurance, including bodily injury and property damage coverage with minimum limits of \$1 Million Dollars per occurrence and \$2 Million Dollars aggregate and (2) Umbrella Liability Insurance with minimum limits of \$5 Million Dollars per occurrence and \$5 Million Dollars aggregate. Operator shall name Owner as additional insured on such insurance policy and provide Owner with a certificate of such insurance.

16.2 **Indemnity by Operator.** Operator shall defend, indemnify, protect and hold Owner harmless from and against all liabilities, costs, expenses, obligations, losses, damages, claims, (collectively "Claims") resulting from the negligence, willful misconduct, or breach of this Agreement by Operator, its agents, contractors or employees, invitees, licensees and permittees; provided, however, that such Claims are not due to the sole negligence, willful misconduct, or breach by Owner, its agents, contractors or employees, invitees, licensees or permittees.

16.3 **Indemnity by Owner.** Owner shall defend, indemnify, protect, and hold Operator harmless from and against all Claims resulting from the negligence, willful misconduct, or breach of this Agreement by Owner, its agents, contractors or employees, invitees, licensees and permittees; provided, however, that such Claims are not due to the sole negligence, willful misconduct, or breach by Operator, its agents, contractors, employees, invitees, licensees, or permittees.

16.4 **Survival.** The obligations of the Parties under this Section 16 shall survive expiration or other termination of this Agreement.

17. **Confidentiality.** This Agreement includes confidential and proprietary information relating to Operator and the Project. Owner agrees not to provide copies of the Agreement or

disclose the terms of the Agreement to any unauthorized person or entity. Operator authorizes Owner to provide copies of the Agreement and disclose the terms thereof to Owner's family ("family" shall be deemed to include all devisees or descendants of owner by will or intestacy), attorney, accountant, financial advisor and any existing or prospective mortgagee, lessee, or purchaser for the sole purpose of evaluating and advising Owner and for no other purpose, so long as such authorized parties agree in writing to become subject to the confidentiality provisions hereto and not to provide copies of the Agreement or disclose the terms thereof to any unauthorized person or entity. Any Owner and party shall return all material containing any confidential information to Operator immediately upon its request. Any party agrees to destroy immediately upon request by Operator such analyses, compilation, studies or other documents, and any oral information will continue to be subject to the terms of this Agreement. Owner agrees that Operator will have no adequate remedy at law if any party violates any of the terms of this Agreement. In such event Operator will have the right, in addition to any other rights Operator may have, to obtain injunctive relief to restrain any breach or threatened breach by third party or specific enforcement of such terms plus reimbursement of attorneys' fees, court costs and all associated expenses. No party shall publish, file for public record, reproduce, or otherwise disseminate this document or any of the terms and provisions hereof to any party, other than the Parties set forth above without the prior written consent of Operator, which consent may be withheld for any reason and in Operator's sole discretion.

18. Default and Remedies.

18.1 Operator Payment Default.

18.1.1 Collection of Payments.

18.1.2 Terminate Agreement.

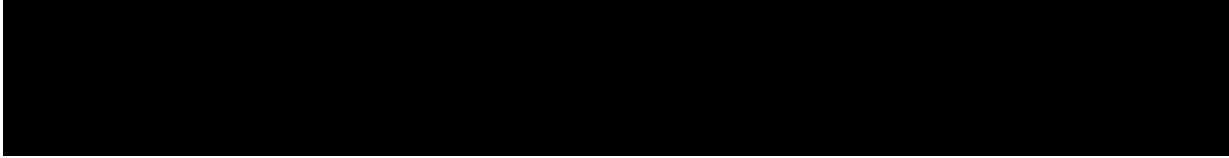

18.2 **Other Operator Default.**

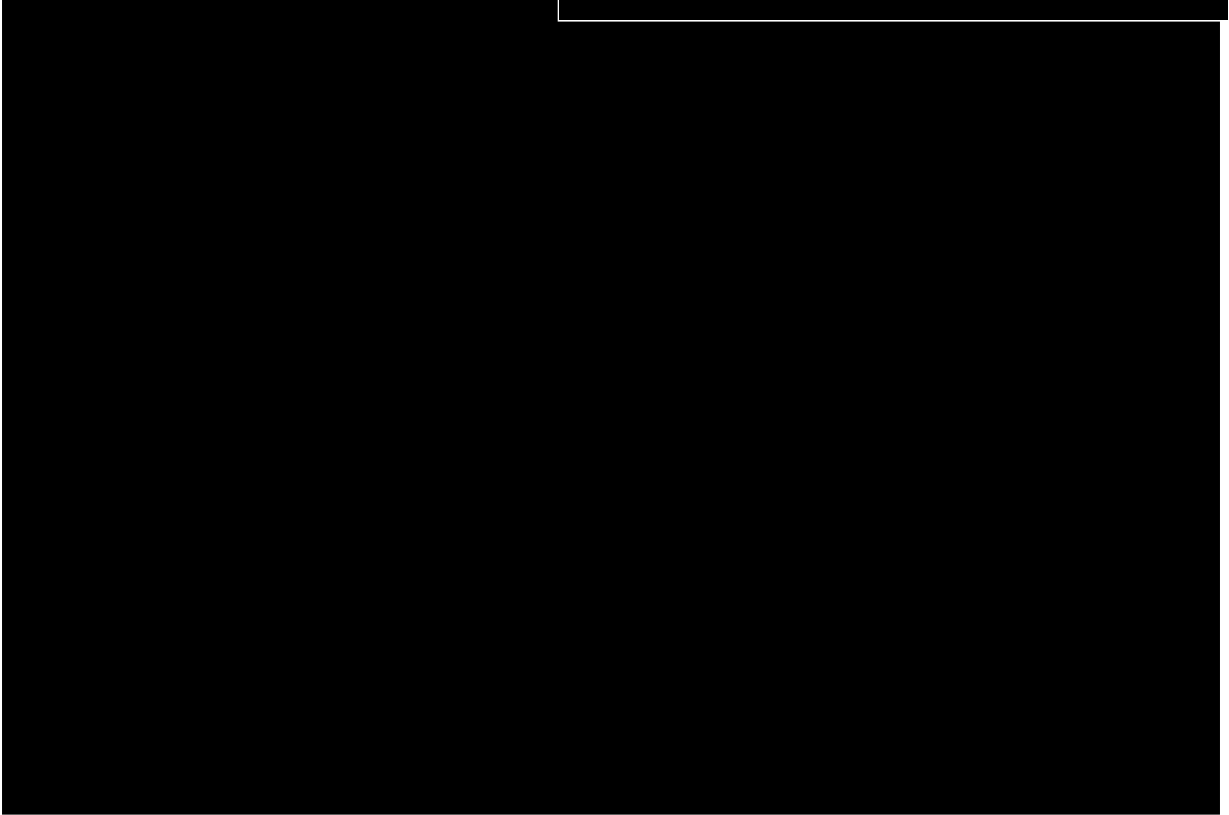
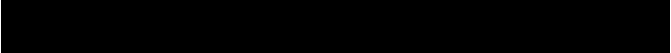

18.3 **Owner Default.**

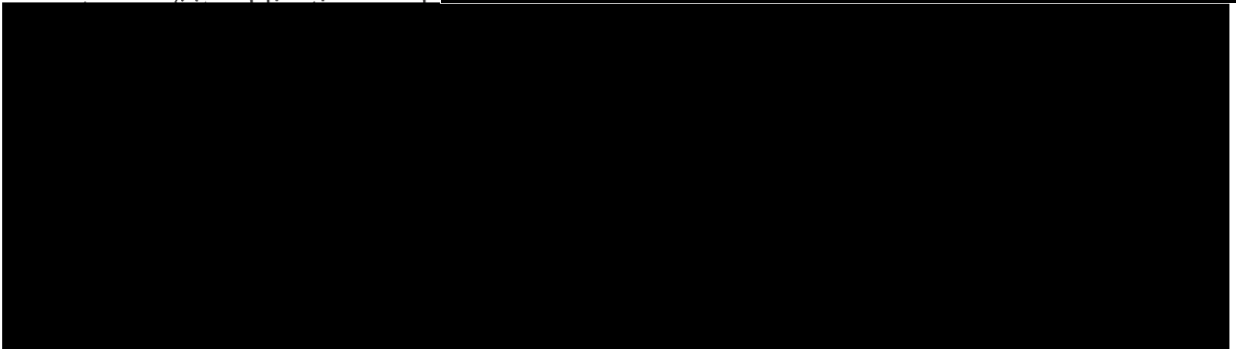

19. **Condemnation.**

19.1 **Complete Taking.** If, at any time, any authority having the power of eminent domain shall condemn all or substantially all of the Operator's Property, or all of the Improvements thereon, for any public use or otherwise, then the interests and obligations of

Operator under this Agreement in or affecting the Operator's Property shall cease and terminate upon the earlier of (i) the date that the condemning authority takes physical possession of the Operator's Property or the Improvements thereon, (ii) the date that Operator is, in its sole judgment, no longer able or permitted to operate the Project on the Operator's Property in a commercially viable manner, or (iii) the date of the condemnation judgment. Operator shall continue to pay all amounts payable hereunder to Owner until the earlier of such dates, at which time the Parties shall be relieved of any and all further obligations and conditions to each other under this Agreement.

19.2 **Partial Taking.** If, at any time during the term of this Agreement, any authority having the power of eminent domain shall condemn one or more, but not all, of the Solar Panels, or any portion of the Improvements or the Operator's Property, then the interest and obligations of Operator under this Agreement as to those Solar Panels or any portion of the Improvements or the Operator's Property so taken shall cease and terminate upon the earlier of (i) the date that the condemning authority takes possession of such Solar Panels or any portion of the Improvements or the Operator's Property, (ii) the date that Operator is, in its reasonable judgment, no longer able or permitted to operate the Project on the Operator's Property, or any portion thereof, in a commercially viable manner, or (iii) the date of the condemnation judgment; and, unless this Agreement is terminated as hereinafter provided, this Agreement shall continue in full force and effect as to the remainder of the Solar Panels, Improvements and the Operator's Property. If the remainder of the Solar Panels or any other portion of the Improvements or the Operator's Property is or becomes insufficient or unsuitable for Operator's purposes hereunder, as determined by Operator in its sole discretion, then, subject to the rights of any Operator Mortgagee under Section 13, Operator shall have the right to terminate this Agreement as to the portion of the Operator's Property to which Operator continues to hold the rights, at which time the Parties shall be relieved of any further obligations and duties to each other under this Agreement.

19.3 **Apportionment, Distribution of Award.** On any taking, all sums awarded, including damages and interest, shall be paid as follows:

- (a) Any portion of the award by the court on account of any cost or loss that Operator may sustain in the removal and relocation of Operator's Improvements, to Operator;
- (b) Any portion of the award by the court for Operator's anticipated or lost revenues or profits, to Operator;
- (c) Any portion of the award by the court for Owner's lost revenues, to Owner;
- (d) All remaining amounts of the award, to Owner or Operator consistent with applicable Kentucky law.

20. **Notice.**

20.1 **Writing.** All notices given or permitted to be given hereunder shall be in writing.

20.2 **Delivery.** Notice is considered given either (i) when delivered in person to the recipient named below, (ii) upon receipt after deposit in the United States mail in a sealed envelope or container, postage and postal charges prepaid, return receipt requested or certified mail, addressed by name and address to the party or person intended, or (iii) twenty-four (24) hours from proper and timely delivery to an overnight courier service addressed by name and address to the party or person intended as follows:

Notice to Owner: Scott Clary and Jennifer Clary
 8030 Meahl Cates Road
 Robards, KY 42452

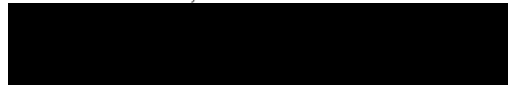

 James A. Clary II and Mary Clary
 5846 Highway 1299
 Robards, KY 42452

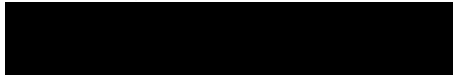

Notice to Operator: Boulevard Associates, LLC
 700 Universe Blvd
 Juno Beach, FL 33408



20.3 **Change of Recipient or Address.** Either Party may, by notice given at any time or from time to time, require subsequent notices to be given to another individual person, whether a party or an officer or representative, or to a different address, or both. Notices given before actual receipt or notice of change shall not be invalidated by the change.

21. **Miscellaneous Provisions.**

21.1 **Successors and Assigns.** The terms and provisions of this Agreement shall run with the land and be binding on and inure to the benefit of the heirs, successors, assigns and personal representatives of the Parties. In accordance with this Agreement, Operator in its discretion may authorize other persons or entities to use the Operator Property for the purposes stated in this Agreement

21.2 **Memorandum.** Simultaneously with the execution of this Agreement, the Parties agree to execute and acknowledge a memorandum of this Agreement. Operator may record the executed memorandum in the public records of Henderson County, Kentucky.

21.3 **Entire Agreement.** This Agreement and the attached Exhibits shall constitute the entire agreement between the Parties and supersedes all other prior writings and understandings.

21.4 **Amendments.** This Agreement shall not be amended or modified in any way except by an instrument signed by the Parties and consented to by any Operator Mortgagee. The

Parties hereto shall at all times hereafter execute any documents and do any further acts which may be necessary or desirable to carry out the purposes of this Agreement and to give full force and effect to each and all of the provisions hereof.

21.5 **Legal Matters.** This Agreement shall be governed by and interpreted in accordance with the then existing laws of the Commonwealth of Kentucky and the County where the Owner's Property is located shall be considered the proper forum or jurisdiction for any disputes arising in connection with this Agreement. The Parties agree to first attempt to settle any dispute arising out of or in connection with this Agreement by good-faith negotiation. If the Parties are unable to resolve amicably any dispute arising out of or in connection with this Agreement, each shall have all remedies available at law or in equity and as provided by this Agreement. **Each Party waives all right to trial by jury and specifically agrees that trial of suits or causes of action arising out of this Agreement shall be to the court of competent jurisdiction.**

21.6 **Severability.** If any term or provision of this Agreement, or the application thereof to any person or circumstance shall, to any extent, be determined by judicial order or decision to be invalid or unenforceable, the remainder of this Agreement or the application of such term or provision to persons or circumstances other than those as to which it is held to be invalid, shall be enforced to the fullest extent permitted by law.

21.7 **Tax Credits.** If under applicable law Operator becomes ineligible for any currently existing tax credit, benefit or incentive for alternative energy expenditure established by any local, state or federal government, then, at Operator's option, the Parties shall negotiate in good faith to amend this Agreement or replace it with a different instrument so as to convert Operator's interest in the Operator Property to a substantially similar interest that makes Operator eligible for such tax credit, benefit or incentive. Such amendment or instrument shall not impair any of Owner's rights or increase the burdens or obligations of Owner under this Agreement.

21.8 **Approvals.** Whenever in this Agreement the approval or consent of either Party is required or contemplated, unless otherwise specified, such approval or consent shall not be unreasonably withheld or delayed.

21.9 **Authority.** The signatories hereto warrant that each has the authority to execute this Agreement on behalf of any entities which are Parties to this Agreement and that each such entity has executed this Agreement pursuant to its organizational documents or a resolution or consent of their Board of Directors or other governing body.

21.10 **Time of Essence.** Time is of the essence of each provision of this Agreement.

21.11 **Counterparts.** This Agreement may be executed in multiple counterparts, each of which shall be deemed an original, and all of which together shall constitute a single instrument.

[Signatures on Next Page]

Owner:

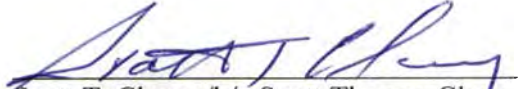

Scott T. Clary a/k/a Scott Thomas Clary



Jennifer Clary

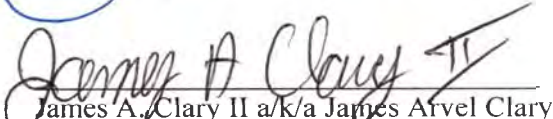

James A. Clary II a/k/a James Arvel Clary



Mary Clary

Operator:

Boulevard Associates, LLC
a Delaware limited liability company

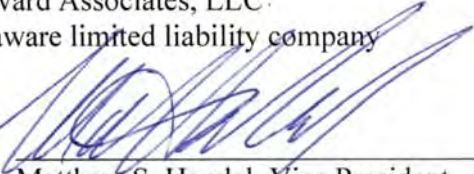
By: 

Matthew S. Handel, Vice President

EXHIBIT A

Legal Description of Owner's Property

Real property thereon situated in Henderson County, Kentucky and being more particularly described as follows:

Lot No. 2 in the division of the Samuel Denton estate: Beginning at a black oak, black gum and dogwood, corner to Lot No. 1 in Mat Denton 's line; thence S 29 W with line of Lot 1, 62 poles to a stake corner to Lot No 3; thence with line of Lot # 3 S 60 E 141 poles and 19 links to a stake in Enoch Spencer 's line 2 poles N 72¼ E from a honey locust pointers and corner to Lot No. 3; thence with said Spencer's line N 29 E 62 poles to 2 post oak stumps near a stone at school house and corner to said Spencer; thence N 60 W 141 poles and 11 links to the beginning, containing 54¾ acres.

ALSO, Lot No. 3 in division of Samuel Denton's land: Beginning at a stake in the line of No. 1 and corner to No.2; thence with line of No. 2 S 60 E 141 poles and 19 links to a stake in Enoch Spencer 's line on the side of public road ad 2 poles from a honey branch pointer and corner to Lot No.2, thence with said Spencer's line S 29 W 58½ poles to a stake near a hickory, a pointer, and corner to Lot No.4, thence with line of No. 4 N 60 W 1 41 poles to a forked white oak in line of Lot No.1, thence with line of Lot No. 1 N 29 E 58 poles and 6¼ links to the beginning containing 51½ acres.

ALSO, the following tract of land, about 3 miles northwest of Robards on the Frog Island Road and more particularly described as follows

Beginning at a stake in the Frog Island Road, corner with H. D. Book, thence with the road N 31-20 E 23 chains and 62 links to a stone in the road, corner to Charles Sheffer thence with Sheffer's line S 61-31 E 12 chains to a stone on a branch , elm pointers; thence with the branch and said Sheffer's line S 51-10 E 1 3 chains and 45 links, Sheffer 's corner ; thence with line of Sheffer and Monroe King S 32 W 15.5 chains to a stone, corner with Elliott Denton; thence with line of Denton, Spencer and H. D. Book N 72-54 W 26 chains and 28 links to the beginning, containing 51.66 acres, from which should be deducted 1 acre fronting on the Frog Island Road on which now stands the Cherry Hill Church and 1 - ½ acres owned by M. Book on the north side of said branch which areas are included in the above 51.66 acres but excluded from this deed, leaving 49.16 acres, more or less.

Approximately 150 acres more or less

HOLDING PAGE FOR EXHIBIT B

Preliminary Lease and Easement Improvement Plan and Acreage Calculation
To be Delivered with Option Notice

HOLDING PAGE FOR EXHIBIT C

As Built Lease and Easement Improvements and Final Acreage Calculation

EXHIBIT D
Lease and Easement Compensation



1(b) Option Payment.

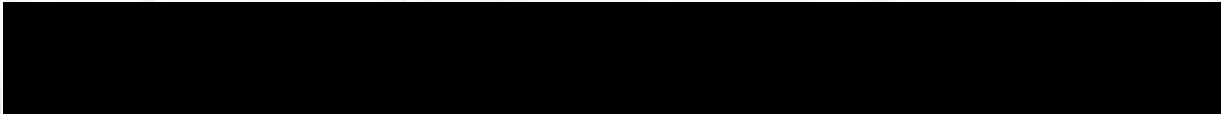
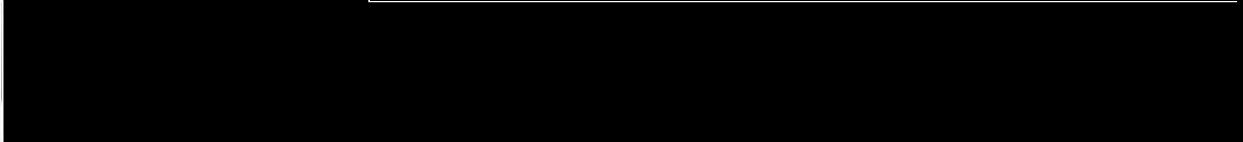

(2) Payment for Lease and Easements.

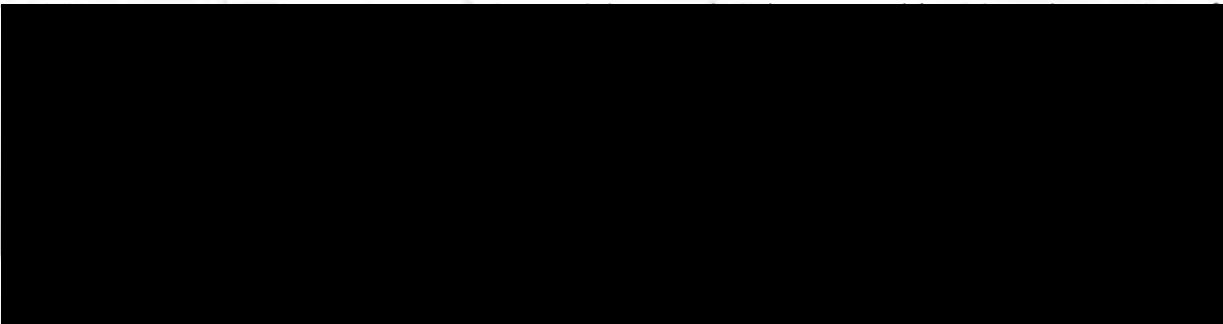
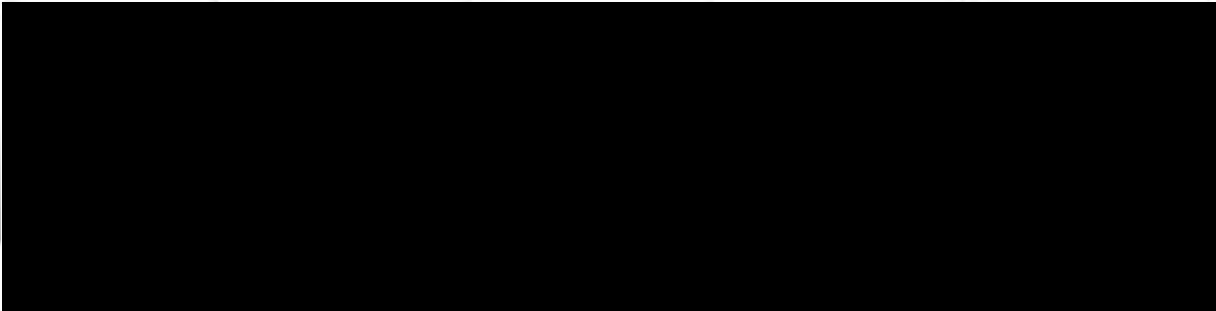



(3) **Crop Compensation**

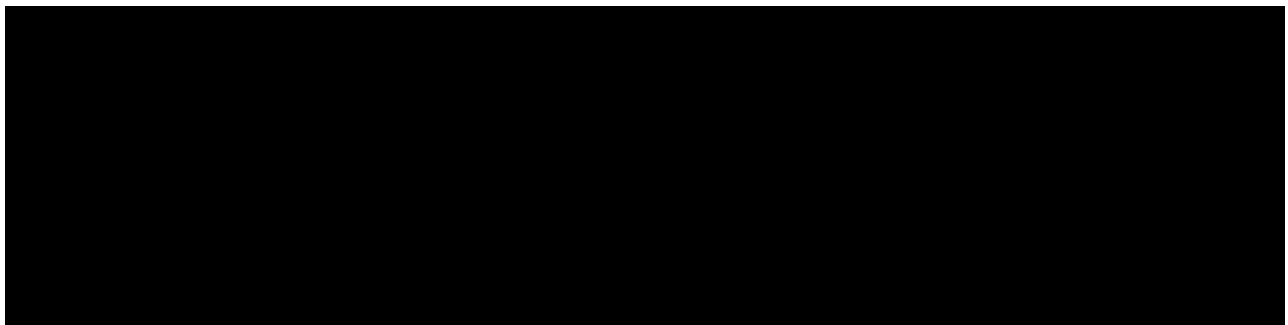
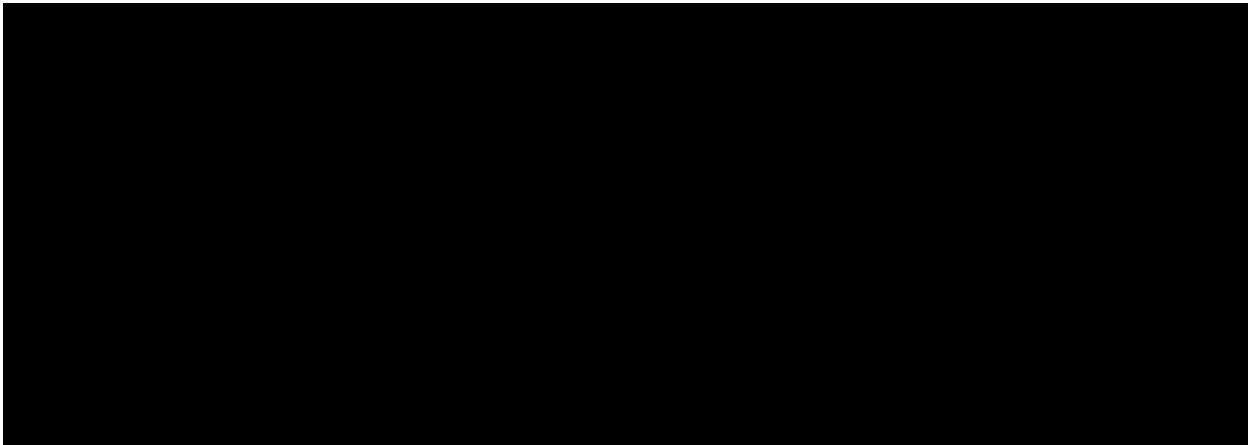

(4) **Timber Removal.**

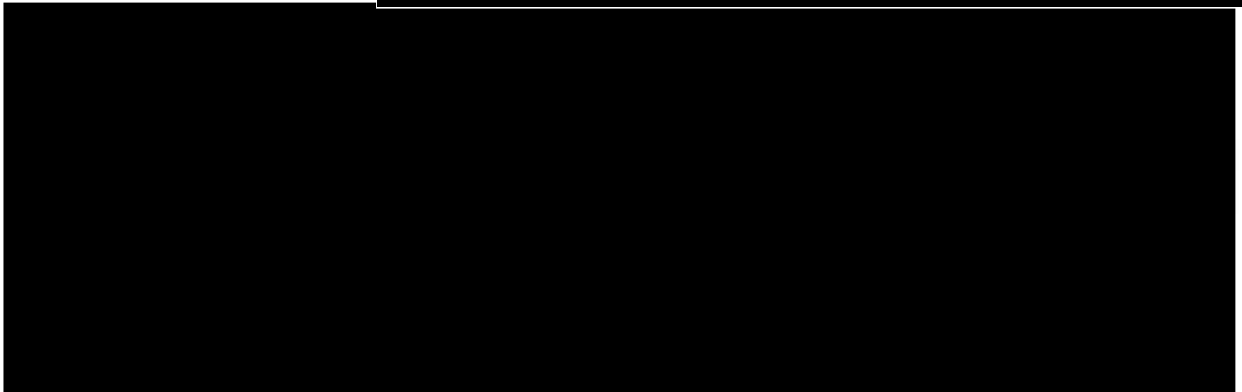

(5) **Payment Allocation Schedule.**

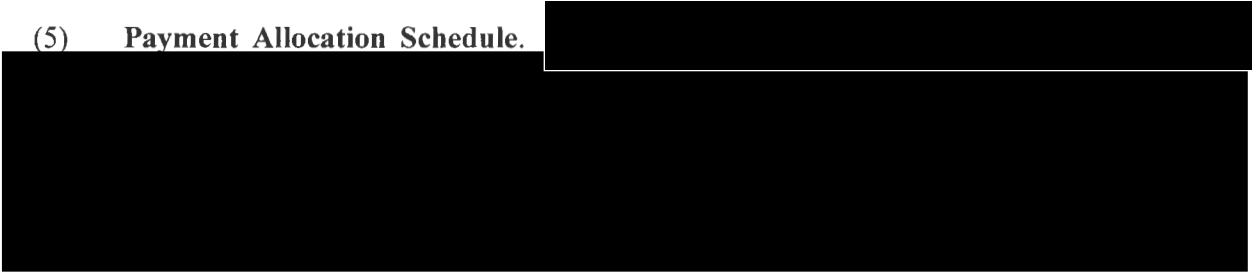

SOLAR LEASE AND EASEMENT AGREEMENT

1. **Parties.** This Solar Lease and Easement Agreement ("**Agreement**") is made and entered as of the 31 day of May, 2023 ("**Effective Date**"), by and between Wade D. Denton and Madison N. Denton, husband and wife ("**Owner**") and Boulevard Associates, LLC, a Delaware limited liability company ("**Operator**"), which are sometimes individually referred to as a "**Party**" and collectively as the "**Parties**".

2. **Project.** This Agreement relates to the solar-powered electrical power generation and transmission project known as the "Sebree II Solar Energy Center" to be located in Henderson County, Kentucky ("**Project**"), which may be wholly or partially located on the Owner's property legally described on the attached **Exhibit A** to this Agreement ("**Owner's Property**"). Upon Operator's exercise of the Option (as defined below), the Project shall include (i) the Lease of Owner's Property described in Section 4, (ii) the Easements referenced in Section 5 that are located on the Owner's Property, and (iii) the Improvements referenced in Section 8 to be constructed on Owner's Property. The Lease, Easements and Improvements are sometimes collectively referred to as the "**Operator Property**".

3. **Option.** Owner grants to Operator an exclusive option ("**Option**") to acquire the Lease and Easements referenced in Sections 4 and 5 in accordance with the following terms and conditions. Operator shall be entitled to acquire the Lease and the Easements in their entirety or in part, as Operator deems appropriate.

3.1 **Option Term.** The initial period during which Operator may exercise the Option shall be for a term of four (4) years, commencing on the Effective Date ("**Initial Option Term**"). Operator shall have a single election to extend the Initial Option Term for an additional one (1) year ("**Extended Option Term**") by written notice to Owner no later than thirty (30) days prior to the expiration of the Initial Option Term, which notice shall be accompanied by the Option Payment (as defined in **Exhibit D**). References herein to the Option Term shall mean the Initial Option Term and, to the extent exercised by Operator, the Extended Option Term, unless the context otherwise expressly requires.

3.2 **Option Payment.** As consideration for the granting of the Option, Operator agrees to pay Owner the Option Payment set forth in **Exhibit D**.

3.3 **Use of Owner's Property.** During the Option Term, Operator and its employees, agents and contractors shall have a right to enter upon the Owner's Property and the right of ingress and egress over and across the Owner's Property for the purposes of (i) surveying the Owner's Property; (ii) performing such other tests and studies as Operator may desire in connection with the Option, including, without limitation, environmental, avian and cultural resource assessments, and geotechnical, foundation and soil tests, provided that such activities do not unreasonably interfere with Owner's use of the Owner's Property; and (iii) installing, maintaining, operating, inspecting and removing one or more weather related instruments ("**Weather Instrument**") and fencing of said Weather Instrument and including the performance of all tests and studies associated therewith. Owner shall not permit any other individual or entity except Operator or its affiliates to install a Weather Instrument on Owner's Property.

3.4 **Right to Grant Option.** Owner warrants and represents to Operator that (i) the statements in Section 9 concerning Owner's title to the Owner's Property are true and correct; (ii) Owner has the authority to grant this Option to Operator without the consent or approval of any other party; and (iii) there are no other existing options, rights of first refusal, contracts to purchase, leases or mortgages that would prevent Operator from exercising its rights with respect to the Option.

3.5 **Exercise of Option.** Operator may exercise the Option by giving written notice to Owner ("**Option Notice**") at any time during the Option Term. Operator shall specify in the Option Notice the Commencement Date referenced in Section 6.1.1. On the Commencement Date, the Lease and Easements referenced in Sections 4 and 5 shall automatically become effective, and the Parties shall be subject to all of the terms and conditions of this Agreement with respect to such Lease and Easements and all rights and obligations relating thereto.

3.6 **Termination of Option.** If Operator fails to exercise the Option within the Option Term, the Option and the rights of Operator as the optionee shall automatically terminate.

4. **Lease.** Upon exercise of the Option by Operator, Owner leases to Operator, and Operator leases from Owner, Owner's Property for the Lease and Easement Term (defined in Section 6.1) in accordance with the terms and conditions of this Agreement ("**Lease**"), which Lease grants Operator and its agents, contractors, and employees the right to use the Owner's Property for the following permitted uses:

4.1 **Construction Right.** Operator leases Owner's Property for the purpose of constructing, operating, maintaining, repairing, replacing, and removing all or any part or component of the Improvements whether located on Owner's Property. Operator may exercise its right to use all or any part of the Owner's Property as and when Operator deems it necessary or advisable to do so to perform the activities for which this right is granted, including, without limitation, staging areas and parking for Operator's employees.

4.2 **Access Right.** Operator leases Owner's Property for unobstructed vehicular and pedestrian access and ingress to and egress from the Improvements, Owner's Property and any public roadways, and to construct, maintain, and utilize Roadway Improvements on the Owner's Property. Owner shall not permit others to obstruct or damage the roads or Roadway Improvements located on the Owner's Property or in any other way interfere with Operator's rights under this right. Operator shall repair any damage done to Roadway Improvements which result from use by Operator, its agents, servants or employees. Such roads shall be maintained in the condition necessary for use by Operator's equipment, and with regard to existing roads, shall be maintained in at least the condition that existed prior to Operator's use.

4.3 **Solar Panels Right.** Operator leases Owner's Property for Operator to construct, operate, replace, relocate, remove, and maintain Solar Panels and the appurtenant Collection Facilities, together with associated roads and parking areas on Owner's Property.

4.4 **Collection Facilities Right.** Operator leases Owner's Property for Operator to construct, operate, maintain, replace, relocate or remove Collection Facilities on and under the Owner's Property.

4.5 **Substation Right.** Operator leases Owner's Property for Operator to construct, operate, maintain, replace, relocate or remove one or more Substations on Owner's Property.

4.6 **Telecommunication Right.** Operator leases Owner's Property for Operator to construct, operate, maintain, replace, relocate or remove Telecommunication Facilities on and under the Owner's Property for Operator's use associated with the Project.

4.7 **Weather Instrument Right.** Operator leases Owner's Property in order to construct, operate, replace, relocate, remove, and maintain a Weather Instrument and the appurtenant Collection Facilities on Owner's Property.

4.8 **Battery Facilities Right.** Operator leases Owner's Property in order to construct, operate, replace, relocate, remove, and maintain one or more Battery Facilities on Owner's Property.

5. **Grant of Easements.** Upon the exercise of the Option by Operator, Owner grants to Operator, and Operator accepts from Owner, for the Lease and Easement Term referenced in Section 6.1, the following easements over and across the Owner's Property in accordance with the terms and conditions of this Agreement. The following easements are for the benefit of Operator and Operator's agents, contractors and employees and located on the Owner's Property and are collectively referred to as the "**Easements**".

5.1 **Sun Non-Obstruction Easement.** Owner grants Operator an irrevocable, exclusive easement for the right and privilege to use, maintain and capture the free and unobstructed sunlight over and across the Owner's Property. Owner shall not engage in any activity on Owner's Property or any other neighboring property owned by Owner that might interfere with the sunlight direction over any portion of Owner's Property; cause a decrease in the output or efficiency of any Solar Panel or Weather Instrument; or otherwise interfere with Operator's operation of the Project or exercise of any rights granted in this Agreement (collectively "**Interference**"). This grant of the easement expressly includes the right of Operator to enforce Operator's rights, including the physical removal of trees or structures (except existing trees and structures) causing Interference to the Project contemplated by Operator. Operator shall notify Owner before making any such removals.

5.2 **Effects Easement.** Owner grants to Operator an easement over Owner's Property for visual, view, light, flicker, noise, shadow, vibration, electromagnetic, electrical and radio frequency interference, and any other effects attributable to the Project located on the Owner's Property.

6. **Term.** The term of this Agreement ("**Term**") includes the Option Term referenced in Section 3.1, the Initial Lease and Easement Term as described in Section 6.1.1 and the Extended Lease and Easement Term as described in Section 6.1.2 (together, the Initial Lease and Easement Term and the Extended Lease and Easement Term, if applicable, is defined as the "**Lease and Easement Term**").

6.1 **Lease and Easement Term.**

6.1.1 **Initial Lease and Easement Term.** The initial term of the Lease and Easements shall commence on the date specified by Operator in the Option Notice ("**Commencement Date**"). The initial term of the Lease and Easements shall end thirty (30) years after the Commencement Date (the "**Initial Lease and Easement Term**"), subject to the rights of renewal and termination as provided in this Agreement.

Extended Lease and Easement Term. Operator shall have the right to extend the Term of this Agreement for two (2) consecutive terms of five (5) years each in accordance with the terms and provisions of this Agreement (collectively "**Extended Lease and Easement Term**") by providing written notice to Owner of Operator's intent to extend the Term within one hundred eighty (180) days of the end of the existing Term. Each Extended Lease and Easement Term shall begin on the expiration date of the Initial Lease and Easement Term or previous Extended Lease and Easement Term, as the case may be. During the Extended Lease and Easement Term, Operator shall pay Owner the amounts set forth in **Exhibit D** as the consideration for the Lease and Easements.

6.1.2 **Delays During Lease and Easement Term.** At Operator's option, the Term may be extended for a period of time equal to the period of time during which operation of the Project is delayed or suspended because of the occurrence of a Regulatory Suspension or Force Majeure, which are defined as follows:

(i) "**Regulatory Suspension**" shall mean the enactment or application of any law, order, rule, or regulation of the Kentucky Public Service Commission, Federal Energy Regulatory Commission, or other local, state, or federal government authority having jurisdiction over the Project or Operator, or the failure of any such governmental authority to issue an approval or permit pursuant to any such law, order, rule, or regulation, which results in the delay, interruption, or suspension of the production, sale or transmission of electricity from the Solar Panels; and

(ii) "**Force Majeure**" shall mean causes beyond the reasonable control of and without the fault or negligence of the Party claiming Force Majeure, including but not limited to acts of God, labor unrest (including, but not limited to, slowdowns, picketing, boycotts or strikes), flood, earthquake, storm, fire, lightning, explosion, power failure or power surge, vandalism, theft, the cutting of power, transmission or other lines, wires or cables to the Project by persons other than Operator's employees or contractors, epidemic, war, revolution, riot, civil disturbance, sabotage, change in law or applicable regulation subsequent to the Commencement Date and action or inaction by any federal, state or local legislative, executive, administrative judicial agency or body which in any of the foregoing cases, by exercise of due foresight such Party could not reasonably have expected to avoid, and which, by the exercise of due diligence, it is unable to overcome.

The Parties shall be excused from performing their respective obligations under this Agreement and shall not be liable in damages or otherwise if and to the extent that they are unable to so perform or are prevented from performing by a Force Majeure, provided that: (i) the non-performing Party, as promptly as practicable after the occurrence of the Force Majeure, but in no event later than thirty (30) days thereafter, gives the other Party written notice describing the particulars of the occurrence; (ii) the suspension of performance is of no greater scope and of no longer duration than is reasonably required by the Force Majeure; (iii) the non-performing Party uses

good faith and commercially reasonable efforts to remedy its inability to perform; and (iv) as soon as the non-performing Party is able to resume performance of its obligations excused as a result of the occurrence, each Party shall give prompt written notification thereof to the other Party.

6.2 **Termination by Operator.** Provided Operator is not in default under any term of this Agreement, Operator, at its option, shall have the right to terminate this Agreement at any time during the Term of the Agreement, as to all or any part of the Operator Property. Termination shall be effective thirty (30) days after written notice of such termination to Owner. If Operator's notice is a full termination of the Operator Property, the Parties shall be relieved of all further duties and obligations under this Agreement, other than (i) the payment of any accrued and unpaid obligations owed by either Party as of the date of termination; (ii) the removal of the Improvements by Operator pursuant to Section 8.11; and (iii) any other obligations and liabilities that are expressly stated in this Agreement to survive such termination. Upon any such partial termination by Operator, the Parties shall be relieved of all further duties and obligations under this Agreement with respect to the portion thereof terminated by Operator, subject to the obligations and liabilities referenced in items (i) through (iii) above that shall continue to be applicable to the terminated portion of this Agreement. The Parties agree to execute an amendment to this Agreement evidencing such partial termination.

7. **Payments.** If Operator exercises the Option referenced in Section 3, Operator agrees to pay Owner the amounts set forth in **Exhibit D** as consideration for the Lease, Easements and Operator's other rights and interests in the Owner's Property.

8. **Improvements.** Operator shall have the right, at its sole cost and expense, to construct, install, maintain, use, operate, repair, replace, relocate and remove all facilities, structures, equipment, machinery, wires, conduit, cables, poles, materials and property of every kind and character required for the construction and operation of portions of the Project on the Owner's Property, including, but not limited to, the Solar Panels, Collection Facilities, Substations, Telecommunication Facilities, Weather Instruments, Roadway Improvements and Battery Facilities referenced in Sections 8.1 through 8.7 (collectively, the "**Improvements**").

8.1 "**Solar Panels**" shall mean any photovoltaic energy system designed for the generation of electrical power from the collection of sunlight, including without limitation, the photovoltaic panels, foundations, support structures, braces and related equipment.

8.2 "**Collection Facilities**" shall mean all Improvements whose purpose is to deliver electrical power generated by the Solar Panels to an electrical power grid or other system, including without limitation transformers, overhead and underground electrical collection lines, telecommunication lines, splice boxes and interconnection facilities.

8.3 "**Substations**" shall mean electrical lines, meters, monitoring and control equipment, switches, transformers, all structures, equipment, enclosures, fencing, security devices, and other electrical and communications equipment necessary to condition and increase the voltage of electricity generated by the Project to make it suitable for transmission on, and to deliver it to, Collection Facilities connected to an electric power grid or other system.

8.4 "**Telecommunication Facilities**" shall mean all Improvements whose purpose is to provide telecommunication services solely relating to the Project or any of Operator's solar powered projects, including telephone, closed-circuit television, microwave, internet, computer data and other telecommunication services.

8.5 "**Weather Instrument**" shall mean instruments used primarily to gather and transmit sunlight and meteorological data relating to the Project, and includes the instrument's foundations, guy wires, sunlight and meteorological data acquisition equipment, power source, and any required data and electrical transmission lines.

8.6 "**Roadway Improvements**" shall mean all improvements that may be necessary to construct, maintain and repair any new and existing roadways and other means of ingress and egress over, across and along the Owner's Property, including paving or surfacing of the roadways with asphalt, gravel or other roadway materials, installation of road signs and the construction and installation of culverts, bridges, drainage ditches, gates, cattle guards and similar structures and facilities.

8.7 "**Battery Facilities**" shall mean a type of equipment that can be given a new charge by passing an electric current through it designed for the storage of electrical power including without limitation, batteries and other devices for storage of electrical energy, foundations, support structures, braces and related equipment.

8.8 **Ownership of Improvements.** Except as otherwise provided in Section 11.7, all Improvements shall at all times remain the property of Operator, and Owner shall have no right, title or interest therein. All Improvements constructed or placed on the Owner's Property by Operator during the Term of this Agreement may be repaired, replaced, relocated, removed, added to or expanded upon by Operator at any time during the Term of this Agreement. Owner expressly waives any statutory lien or common law liens on the Improvements to which Owner might be entitled.

8.9 **Construction Liens.** Operator shall not permit any liens arising out of Operator's use of the Operator Property under this Agreement to be filed against the Owner's Property. Operator shall, within sixty (60) days after it receives notice of the lien, provide a bond or other security that Owner may reasonably request, or remove such lien from the Owner's Property in the manner provided by applicable law.

8.10 **Location of Improvements.** The acreage required from the Owner's Property for the Improvements for which the Lease and Easements are being granted cannot be determined until the completion of Operator's inspection, testing, study and surveying of the Owner's Property during the Option Term. Along with the Option Notice, Operator shall deliver to Owner a proposed plan of development showing the contemplated locations of the Improvements and a preliminary calculation of the acreage as determined by the area bounded by a perimeter fence required for the Project, which shall serve as the **Exhibit B** to this Agreement. During the final development and construction of the Project, such locations may need to be amended. Following construction of the Project, Operator shall provide Owner an "as-built" survey of all Improvements on Owner's Property and the final calculation of the acreage as determined by the area bounded by a perimeter fence required for the Project, which shall serve as **Exhibit C** to this Agreement.

Further, following construction, the Improvements may need to be relocated or rerouted by Operator, which Operator may perform, at any time during the Term of this Agreement, so long as the nature and extent of any such relocated or rerouted Improvements are not materially different and impose no materially greater burden on the Owner's Property than the original locations or routes, and so long as Operator takes commercially reasonable efforts to minimize disruption or inconvenience to Owner.

8.11 **Removal of Improvements.** Upon full or partial termination of any of the Lease Rights or Easements, Operator shall remove all Improvements and restore the area formerly occupied by the Improvements to substantially the same physical condition that existed immediately before the construction of the Improvements (the "**Removal Obligations**"). At Owner's request, all or any part of the Roadway Improvements may be left for use by Owner.

9. **Ownership and Title Matters.** Owner warrants and represents to Operator, both as of the Effective Date, and as of the Commencement Date as follows:

9.1 **Authority.** Owner represents and warrants that it is the holder of fee simple title and is the sole owner of the Owner's Property and has the unrestricted right and authority to sign this Agreement and to grant Operator the Lease and Easements and other rights granted in this Agreement. When signed by both Parties, this Agreement constitutes a valid and binding agreement enforceable against Owner in accordance with its terms.

9.2 **Other Agreements.** The Owner's Property is not subject to any other agreements, options, rights of first refusal or other prior right of any party to purchase, lease or acquire easements in the Owner's Property, or create any prior claim or right that would preclude or interfere with Operator's rights and interests under this Agreement and the Lease and Easements.

9.3 **Minerals.** Except as disclosed by Owner to Operator at the time of the execution of this Agreement by Owner, to the best of Owner's knowledge and belief, Owner owns all of the oil, gas and other minerals, and all rights thereto as on or under the Owner's Property.

9.4 **Owner Mortgage.** Except as disclosed by Owner to Operator at the time of the execution of this Agreement by Owner, there are no mortgages encumbering the Owner's Property ("**Owner Mortgage**").

9.5 **Notice and Opportunity to Cure.** If there is an Owner Mortgage encumbering Owner's Property and Owner receives from the holder thereof any notice that payments are overdue, Owner shall notify Operator and each Operator Mortgagee (as defined at Section 13.1) by sending a copy of such overdue payment notice to Operator by the earlier of (i) five (5) days after receipt, or (ii) three (3) business days prior to the date by which a default under or in respect of such Owner Mortgage could occur. If Operator or any Operator Mortgagee determines that it would be in Operator's interest to make such payments to Owner Mortgagee on Owner's behalf, whether as a result of receiving such notice or otherwise, Operator shall have the right to make such payments and to credit the payments so made against the Annual Installment Payment next due under the Agreement.

9.6 **Subordination, Non-Disturbance & Attornment Agreement.** If there is an Owner Mortgage encumbering Owner's Property, Owner shall cooperate with Operator to obtain a Subordination, Non-Disturbance and Attornment Agreement ("SNDA") in the form prepared and provided by Operator, from each Owner Mortgagee, pursuant to which such Owner Mortgagee agrees, among other things, not to disturb Operator's possession and use of the Owner's Property. Owner shall not incur any loss in income, expense, obligation or liability with regard to the SNDA. Operator shall, at its sole cost and expense, record each such SNDA in the Office of the County Clerk in which Owner's Property is located. If Owner fails to deliver a SNDA from each Owner Mortgagee, Operator may, at its sole option, either (i) terminate this Agreement immediately upon written notice to Owner, or (ii) take such action as Operator deems reasonably necessary to effect the rights granted to Operator hereunder, and off-set all amounts expended in such efforts against the Annual Installment Payments and any other amounts due hereunder or in respect hereof.

10. **Representations and Warranties of Owner.** Owner hereby makes the following further representations and warranties both as of the Effective Date, and as of the Commencement Date:

10.1 **Physical Condition.** Owner has no knowledge of any existing physical conditions of the Owner's Property which would prevent, significantly restrict or make more expensive Operator's development of the Owner's Property for the purposes specified in this Agreement, or which could, with the passage of time, or the giving of notice, constitute a violation of any currently applicable governmental law, ordinance, order, rule or regulation.

10.2 **Legal Restrictions.** Owner has no knowledge of any law, regulation, ordinance or order of any local, state or federal governmental authority which would prohibit or significantly restrict Operator's development of the Owner's Property pursuant to this Agreement. This Agreement does not violate any contract, agreement, instrument, judgment or order to which Owner is a party or which affects the Owner's Property. To the best of Owner's knowledge, the Owner's Property is currently in full and complete compliance with all governmental laws, ordinances, orders, rules and regulations applicable to the Owner's Property.

10.3 **No Litigation.** No litigation is pending and, to the best of Owner's knowledge, no litigation or administrative actions are proposed, threatened or anticipated with respect to any matter affecting the Owner's Property. If Owner learns of any litigation or administrative action proposed, threatened or instituted with respect to the Owner's Property, Owner shall give Operator notice within thirty (30) days thereof.

10.4 **Survival.** The representations and warranties set forth in this Section 10 shall survive the execution and delivery hereof.

11. **Use, Operation and Maintenance.**

11.1 **Exclusive Use by Operator.** Operator shall have the exclusive right (i) to use and possess the Owner Property in connection with the Project and other similar solar-powered electrical power generation projects; (ii) to investigate, inspect, survey, and conduct tests of the Owner's Property, including, but not limited to, meteorological, environmental, archeological and geotechnical tests and studies; (iii) to use and convert all of the sunlight resources on the Owner's Property; and (iv) to undertake such other activities on the Owner's Property that may be related

to the Project, including, without limitation, the storage of Solar Panels, materials and equipment during the installation and construction of the Improvements; development and operation of communications systems; and site tours of the Project for visitors and other interested parties.

11.2 **No Required Installation or Operation.** Nothing in this Agreement shall be interpreted as imposing on Operator any obligation to install Solar Panels or other Improvements on the Owner's Property, or to operate the Project on the Owner's Property. Operator shall have the sole discretion to determine if and when any Solar Panels and other Improvements may be constructed on Owner's Property, and if and when to commence the operation of the Project on the Owner's Property.

11.3 **Permits and Approvals.** Operator shall be responsible, at its sole cost and expense, for obtaining any governmental permits and approvals necessary for the construction and operation of the Project and the construction and operation of the Improvements. Owner shall cooperate with Operator as necessary to obtain any governmental or utility approvals or permits, including, without limitation, signing any applications for such approvals, provided that Owner shall not incur any loss in income, expense, obligation or liability with respect to Operator obtaining such permits or approvals.

11.4 **Compliance with Laws.** Operator shall comply in all material respects with valid laws applicable to the Owner's Property and the Operator Property. Operator shall have the right, in its sole discretion and at its sole expense, in Operator's name to contest the validity or applicability to the Owner's Property and the Operator Property of any law, ordinance, statute, order, regulation, property assessment or the like made by any governmental agency or entity. Operator shall control any such contest and Owner shall cooperate with Operator in every reasonable way in such contest, provided that Owner shall incur no expense, obligation or liability with regard to such contest.

11.5 **Care and Appearance.** Operator, in its exercise of the lease, easement and other rights granted hereunder shall, at all times, maintain the Owner's Property and the Improvements in a reasonably neat, clean and presentable condition. Operator shall not willfully or negligently damage or destroy the Owner's Property and shall keep the Owner's Property clean and free of debris created by Operator, its contractors, or others brought on to the Owner's Property by Operator. Operator shall not use the Owner's Property for storage, except for materials, construction equipment and vehicles directly associated with construction or maintenance of the Improvements on the Owner's Property or adjacent properties that are part of the Project.

11.6 **Fences and Gates.** At Owner's request, Operator shall repair or replace any fences, gates or cattle guards damaged or removed in connection with Operator's activities on the Owner's Property. Fences removed from the Owner's Property, if replaced, shall be re-built by Operator at its expense in mutually agreeable locations. All fence repair and construction shall be substantially similar to the construction of existing fences and cattle guards on Owner's Property. Any gates opened for access to Owner's Property by either Party shall be closed immediately after passing through so that livestock may not pass through. Once completed, all replacement fences, gates and cattle guards shall be owned and maintained by Owner. Upon abandonment or termination of the rights granted to Operator, any fences, gates and cattle guards installed by Operator shall be removed and Operator shall restore the area formerly occupied by the any fences,

gates and cattle guards to substantially the same physical condition that existed immediately before installation of the same. To minimize the need for temporary fencing, Owner will cooperate with Operator to avoid pasturing animals on or near the Improvements during periods of construction, maintenance or removal activity by Operator. Owner will discuss with Operator what temporary fencing is necessary during the periods of construction, maintenance or removal activity by Operator.

11.7 **Roadway Maintenance and Repairs.** Operator agrees to maintain and repair all Roadway Improvements located on the Operator Property; provided, however, Owner shall reimburse Operator for any costs and expenses incurred by Operator to repair any damage or perform any special maintenance of the Roadway Improvements caused by Owner or any person using the Roadway Improvements with Owner's permission, other than Operator.

12. **Taxes.**

12.1 **Owner's Taxes.** Owner covenants and agrees to pay prior to delinquency all real and personal property and other taxes, general and special assessments, and other charges of every description ("**Taxes**") levied or assessed against the Owner's Property and all improvements thereon by governmental authorities, other than Operator's Taxes referenced in Section 12.2 (Taxes, excepting Operator's Taxes, are hereinafter referred to as "**Owner's Taxes**").

12.2 **Operator's Taxes.**



12.3 **Failure to Pay.** In the event either Party fails to pay their share of Taxes prior to delinquency, the other Party shall have the right to pay such Taxes and any accrued penalties or interest, which payments shall increase or be offset against other Payments due under this Agreement.

12.4 **Operator's Right to Contest.** Operator may contest the legal validity or amount of any Operator's Taxes for which it is responsible under this Agreement, and may institute such proceedings as it considers necessary, provided that Operator shall bear all expenses in pursuing such contest or proceeding. With respect to any Taxes which may constitute a lien on the Owner's

Property, Operator shall promptly pay such Taxes unless the proceeding in which it contests such Taxes shall operate to prevent or stay the collection of the Taxes so contested or unless Operator removes any such lien by bonding or otherwise. Owner agrees to render to Operator all reasonable assistance in contesting the validity or amount of any such Taxes, with the exception of Taxes levied by Owner, including joining in the signing of any reasonable protests or pleading which Operator may deem advisable to file; provided, however, that Operator shall reimburse Owner for its reasonable out-of-pocket expenses, including reasonable attorneys' fees incurred in connection with providing such assistance.

13. **Mortgage of Operator Property.**

13.1 **Right to Mortgage.** Operator may, upon written notice to Owner, but without requiring Owner's consent or approval, mortgage, collaterally assign, or otherwise encumber and grant security interests in all or any part of its interest in this Agreement and the Operator Property. These various security interests in all or a part of this Agreement and the Operator Property are collectively referred to as an "**Operator Mortgage**" and holder of such security interest, an "**Operator Mortgagee**". Any Operator Mortgagee shall use the Operator Property only for the uses permitted under this Agreement. Whenever Operator has granted a security interest under this Section 13, it will give Owner notice of the Operator Mortgage (including the name and address of the Operator Mortgagee for notice purposes) to Owner within thirty (30) days; provided that failure to give this notice shall not constitute a default under this Agreement, but rather shall only have the effect of not binding Owner to provide such Operator Mortgage notice until the Operator and its address is given to Owner.

13.2 **Notice of Default and Opportunity to Cure.** As a precondition to exercising any rights or remedies related to any alleged default by Operator under this Agreement, Owner shall give written notice of the default to each Operator Mortgagee at the same time it delivers notice of default to Operator, specifying in detail the alleged event of default and the required remedy. Each Operator Mortgagee or its designee shall have the right, but not the obligation, to cure any default as Operator, and/or the right, but not the obligation, to remove any Improvements or other property owned by Operator or such Operator Mortgagee located on the Owner's Property to the same extent as Operator. The cure period for any Operator Mortgagee shall be the later of (i) the end of the Operator cure period under Section 18; (ii) thirty (30) days after such Operator Mortgagee's receipt of the default notice; or (iii) if applicable, the extended cure period provided for in Section 13.3. Failure by Owner to give an Operator Mortgagee notice of default shall not diminish Owner's rights against Operator, but shall preserve all rights of the Operator Mortgagee or its designee to cure any default and to remove any Improvements or other property of Operator or the Operator Mortgagee located on the Owner's Property.

13.3 **Extended Cure Period.** If any default by Operator under this Agreement cannot be cured without the Operator Mortgagee obtaining possession of all or part of the Operator Property, then any such default shall be deemed remedied if an Operator Mortgagee: (i) within sixty (60) days after receiving notice from Owner as set forth in Section 13.2, acquires possession of all or part of the Operator Property, or begins appropriate judicial or nonjudicial proceedings to obtain the same; (ii) diligently prosecutes any such proceedings to completion; and (iii) after gaining possession of all or part of the Operator Property performs all other obligations as and when the same are due in accordance with the terms of this Agreement. If an Operator Mortgagee

is prohibited by any court or by operation of any bankruptcy or insolvency laws from commencing or prosecuting the proceedings described above, the sixty (60) day period specified above for commencing proceedings shall be extended for the period of such prohibition.

13.4 **Operator Mortgage Liability.** Any Operator Mortgagee whose interest in the Operator Property is held solely for security purposes, shall have no obligation or liability under this Agreement unless and until the Operator Mortgagee succeeds to absolute title to the Operator Property and the rights of Operator under this Agreement. An Operator Mortgagee shall be liable to perform obligations under this Agreement only for and during the period it directly holds such absolute title.

13.5 **Certificates.** Owner shall execute any estoppel certificates (certifying as to truthful matters, including without limitation that no default then exists under this Agreement, if such be the case), consents to assignment and non-disturbance agreements as Operator or any Mortgagee may reasonably request from time to time. The Parties shall negotiate in good faith any amendment to this Agreement from time to time to include any provision that may be reasonably requested by Operator or any Operator Mortgagee to implement the provisions contained in this Agreement or to preserve an Operator Mortgagee's security interest.

13.6 **Operator Mortgagee's Right to Enforce Mortgage and Assign.** Each Operator Mortgagee shall have the right, in its sole discretion: (i) to assign its Operator Mortgage; (ii) to enforce its lien and acquire title to all or any portion of the Operator Property by any lawful means; (iii) to take possession of and operate all or any portion of the Operator Property and to perform all obligations to be performed by Operator under this Agreement, or to cause a receiver to be appointed to do so; and (iv) to acquire all or any portion of the Operator Property by foreclosure or by an assignment in lieu of foreclosure and thereafter to assign or transfer all or any portion of the Operator rights under this Agreement to a third party in accordance with Section 14. Any Operator Mortgagee or other party who acquires Operator's interest in all or a portion of the Operator Property pursuant to foreclosure or assignment in lieu of foreclosure shall not be liable to perform the obligations imposed on Operator by this Agreement, which are incurred or accruing after such Operator Mortgagee or other party no longer has ownership or possession of the Operator Property.

13.7 **New Agreement.**

13.7.1 If the Operator Property is foreclosed upon or there is an assignment in lieu of foreclosure, or if this Agreement is rejected or disaffirmed pursuant to bankruptcy law or other law affecting creditor's rights and, within ninety (90) days after such event, Operator or any Operator Mortgagee or other purchaser at a foreclosure sale shall have arranged to the reasonable satisfaction of Owner to cure any material defaults under this Agreement, and for the payment of all Annual Installment Payments or other charges due and payable by Operator as of the date of such event, then Owner shall execute and deliver to Operator or such Operator Mortgagee or other purchaser at a foreclosure sale, or to a designee of one of these parties, as the case may be, a new agreement ("**New Agreement**") which (i) shall be for a term equal to the remainder of the Term of this Agreement before giving effect to such rejection or termination; (ii) shall contain the same covenants, agreements, terms, provisions and limitations as this Agreement (except for any requirements that have been fulfilled by Operator or any Operator Mortgagee or other purchaser

at a foreclosure sale prior to rejection or termination of this Agreement); and (iii) shall include that portion of the Operator Property in which Operator or such other Operator Mortgagee or other purchaser at a foreclosure sale had an interest on the date of rejection or termination.

13.7.2 If more than one Operator Mortgagee makes a written request for a New Agreement pursuant to this provision, the New Agreement shall be delivered to the Operator Mortgagee requesting such New Agreement whose Operator Mortgage is prior in time, and the written request of any other Operator Mortgagee whose lien is subordinate shall be void and of no further force or effect. The provisions of this Section 13 shall survive the termination, rejection or disaffirmation of this Agreement and shall continue in full force and effect thereafter to the same extent as if this Section 13 were a separate and independent contract made by Owner, Operator and each Operator Mortgagee, and, from the effective date of such termination, rejection or disaffirmation of this Agreement to the date of execution and delivery of such New Agreement, such Operator Mortgagee or other purchaser at a foreclosure sale may use and enjoy the Operator Property without hindrance by Owner or any person claiming by, through or under Owner; provided that all of the conditions for the New Agreement as set forth above are complied with.

13.8 **Operator Mortgagee's Consent to Amendment, Termination or Surrender.** Notwithstanding any provision of this Agreement to the contrary, the Parties agree that so long as any Operator Mortgage remains outstanding, this Agreement shall not be modified or amended, and Owner shall not accept a surrender, cancellation or release of all or any part of the Operator Property from Operator, prior to expiration of the Term of this Agreement, without the prior written consent of the Operator Mortgagee holding such Operator Mortgage. This provision is for the express benefit of and shall be enforceable by each Operator Mortgagee as if it were a party named in this Agreement.

14. **Assignment and Sublease.** Operator shall have the right, without Owner's consent, to sell, convey, lease, or assign all or any portion of this Agreement or the Operator Property, on either an exclusive or a non-exclusive basis, or to grant subeasements, co-easements, easements, licenses or similar rights with respect to the Operator Property (collectively, "**Assignment**"), to one or more persons or entities (collectively "**Assignee**"). Each Assignee shall use the Operator Property only for the uses permitted under this Agreement. When Operator makes any Assignment under this Section 14, Operator shall give written notice to Owner of such Assignment (including the interest conveyed by the Assignment and address of the Assignee for notice purposes) to Owner; provided Operator's failure to give such notice shall not constitute a default under this Agreement, but rather shall only have the effect of not binding Owner with respect to such assignment or conveyance until such notice is given. Any Assignment by Operator shall release Operator from obligations subject thereof accruing after the date that liability for such obligations is assumed by the Assignee.

15. **Hazardous Materials.**

15.1 **Owner's Covenants Regarding Hazardous Materials.** Owner represents and warrants that, to the best of Owner's knowledge, the Owner's Property is not and has not been in violation of any federal, state or local environmental health or safety laws, statute, ordinance, rule, regulation or requirement ("**Environmental Laws**"), and Owner has not received any notice or

other communication from any governmental authorities alleging that the Owner's Property is in violation of any Environmental Laws. "**Hazardous Materials**" shall mean any asbestos containing materials, petroleum, explosives, toxic materials, or substances regulated as hazardous wastes, hazardous materials, hazardous substances, or toxic substances under any federal, state, or local law or regulation. Owner warrants that Owner has done nothing to contaminate the Operator Property with Hazardous Materials or wastes.

15.2 **Operator's Covenants Regarding Hazardous Materials.** Operator shall, at Operator's sole cost and expense, promptly take removal or remedial action required by Environmental Law with regard to any material violation of any Environmental Law with regard to any Hazardous Materials brought onto the Owner's Property by Operator or its employees, agents, or contractors. Owner shall cooperate with Operator with regard to any scheduling or access to the Owner's Property in connection with any action required hereunder.

15.3 **Operator's Indemnity Regarding Hazardous Materials.** Operator shall indemnify, defend, protect and hold Owner harmless from any liability based on: (i) the release of Hazardous Materials in, on, under or about the Owner's Property caused by Operator or its employees, agents, or contractors, or (ii) the violation by Operator or its employees, agents, or contractors of any Environmental Law. The indemnity obligations set forth herein shall survive termination of this Agreement.

16. **Insurance and Indemnity.**

16.1 **Insurance.** At all times during which Operator is conducting any activities on the Property and at all times during the Term of this Agreement, Operator shall maintain in effect (1) commercial General Liability Insurance, including bodily injury and property damage coverage with minimum limits of \$1 Million Dollars per occurrence and \$2 Million Dollars aggregate and (2) Umbrella Liability Insurance with minimum limits of \$5 Million Dollars per occurrence and \$5 Million Dollars aggregate. Upon a written request by Owner, Operator shall name Owner as additional insured on such insurance policy and provide Owner with a certificate of such insurance.

16.2 **Indemnity by Operator.** Operator shall defend, indemnify, protect and hold Owner harmless from and against all liabilities, costs, expenses, obligations, losses, damages, claims, (collectively "**Claims**") resulting from the negligence, willful misconduct, or breach of this Agreement by Operator, its agents, contractors or employees, invitees, licensees and permittees; provided, however, that such Claims are not due to the sole negligence, willful misconduct, or breach by Owner, its agents, contractors or employees, invitees, licensees or permittees.

16.3 **Indemnity by Owner.** Owner shall defend, indemnify, protect, and hold Operator harmless from and against all Claims resulting from the negligence, willful misconduct, or breach of this Agreement by Owner, its agents, contractors or employees, invitees, licensees and permittees; provided, however, that such Claims are not due to the sole negligence, willful misconduct, or breach by Operator, its agents, contractors, employees, invitees, licensees, or permittees.

16.4 **Survival.** The obligations of the Parties under this Section 16 shall survive expiration or other termination of this Agreement.

17. **Confidentiality.** This Agreement includes confidential and proprietary information relating to Operator and the Project. Owner agrees not to provide copies of the Agreement or disclose the terms of the Agreement to any unauthorized person or entity. Operator authorizes Owner to provide copies of the Agreement and disclose the terms thereof to Owner's family ("family" shall be deemed to include all devisees or descendants of owner by will or intestacy), attorney, accountant, financial advisor and any existing or prospective mortgagee, lessee, or purchaser for the sole purpose of evaluating and advising Owner and for no other purpose, so long as such authorized parties agree in writing to become subject to the confidentiality provisions hereto and not to provide copies of the Agreement or disclose the terms thereof to any unauthorized person or entity. Any Owner and party shall return all material containing any confidential information to Operator immediately upon its request. Any party agrees to destroy immediately upon request by Operator such analyses, compilation, studies or other documents, and any oral information will continue to be subject to the terms of this Agreement. Owner agrees that Operator will have no adequate remedy at law if any party violates any of the terms of this Agreement. In such event Operator will have the right, in addition to any other rights Operator may have, to obtain injunctive relief to restrain any breach or threatened breach by third party or specific enforcement of such terms plus reimbursement of attorneys' fees, court costs and all associated expenses. No party shall publish, file for public record, reproduce, or otherwise disseminate this document or any of the terms and provisions hereof to any party, other than the Parties set forth above without the prior written consent of Operator, which consent may be withheld for any reason and in Operator's sole discretion.

18. **Default and Remedies.**

18.1 **Operator Payment Default.**

18.1.1 **Collection of Payments.**

18.1.2 **Terminate Agreement.**

termination. Owner's right to terminate this Agreement pursuant to this Section 18.1.2 is subject to and conditioned upon Owner giving any Operator Mortgagee written notice and opportunity to cure the Operator Payment Default as provided in Section 13.2.

18.2 **Other Operator Default.**

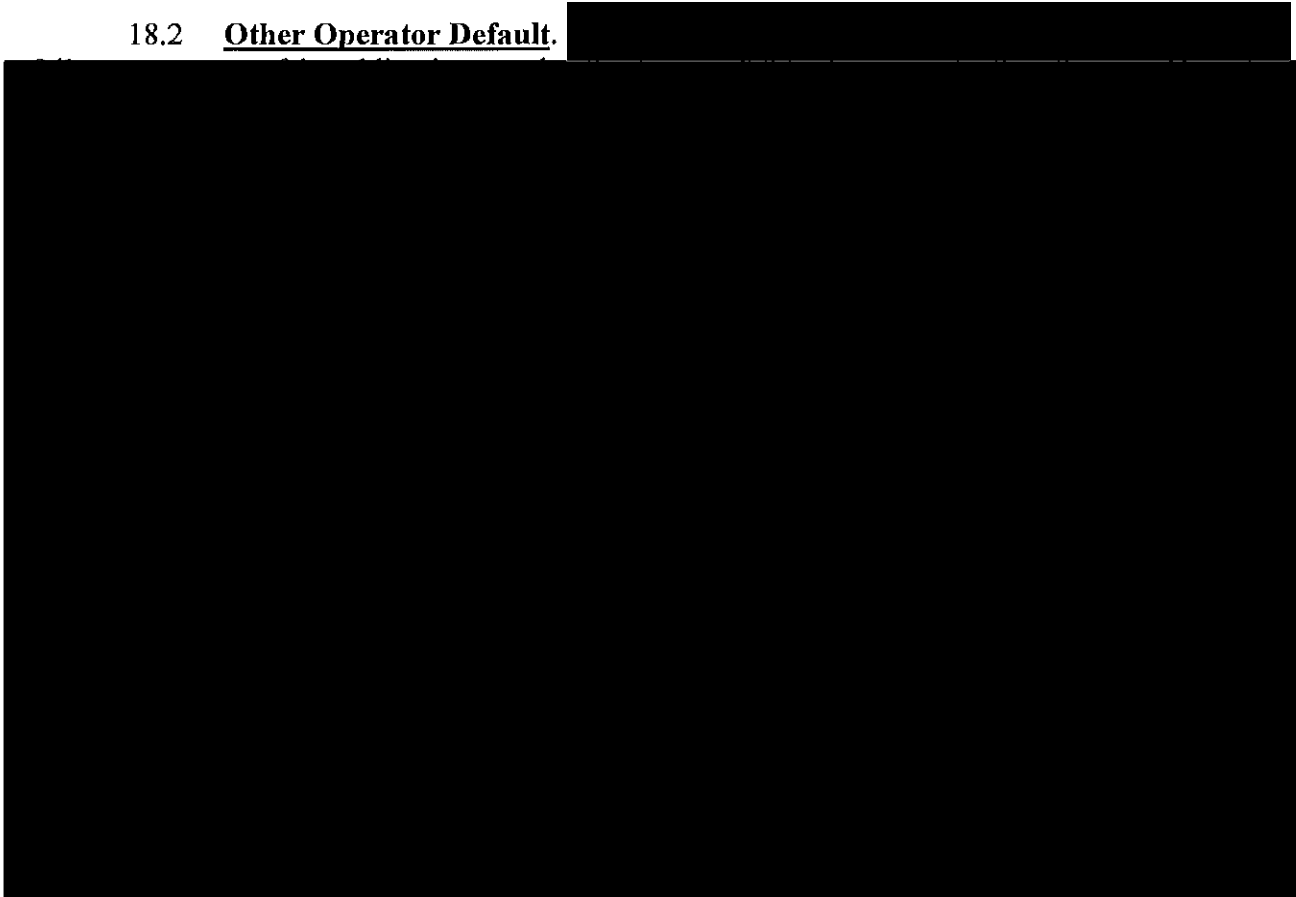

18.3 **Owner Default.**

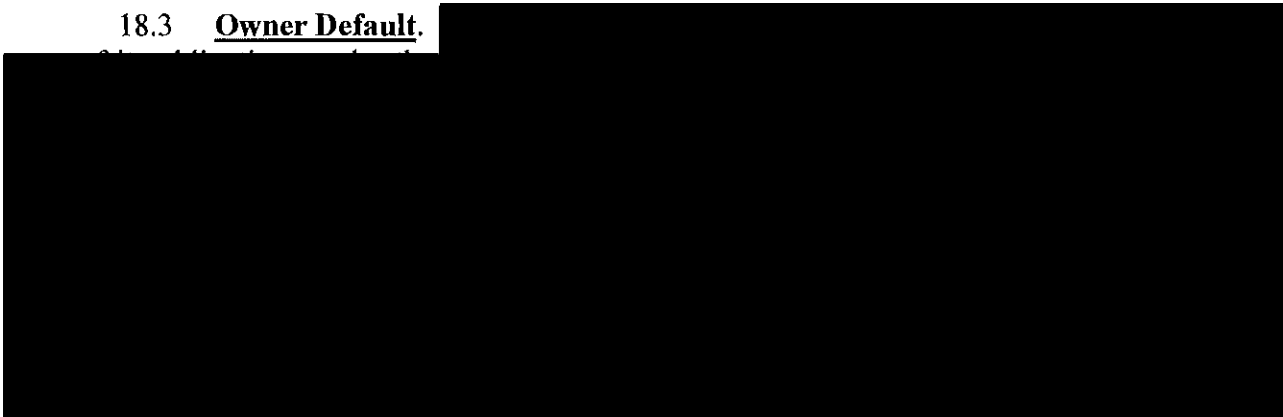

19. **Condemnation.**

19.1 **Complete Taking.** If, at any time, any authority having the power of eminent domain shall condemn all or substantially all of the Operator's Property, or all of the Improvements thereon, for any public use or otherwise, then the interests and obligations of Operator under this Agreement in or affecting the Operator's Property shall cease and terminate upon the earlier of (i)

the date that the condemning authority takes physical possession of the Operator's Property or the Improvements thereon, (ii) the date that Operator is, in its sole judgment, no longer able or permitted to operate the Project on the Operator's Property in a commercially viable manner, or (iii) the date of the condemnation judgment. Operator shall continue to pay all amounts payable hereunder to Owner until the earlier of such dates, at which time the Parties shall be relieved of any and all further obligations and conditions to each other under this Agreement.

19.2 **Partial Taking.** If, at any time during the term of this Agreement, any authority having the power of eminent domain shall condemn one or more, but not all, of the Solar Panels, or any portion of the Improvements or the Operator's Property, then the interest and obligations of Operator under this Agreement as to those Solar Panels or any portion of the Improvements or the Operator's Property so taken shall cease and terminate upon the earlier of (i) the date that the condemning authority takes possession of such Solar Panels or any portion of the Improvements or the Operator's Property, (ii) the date that Operator is, in its reasonable judgment, no longer able or permitted to operate the Project on the Operator's Property, or any portion thereof, in a commercially viable manner, or (iii) the date of the condemnation judgment; and, unless this Agreement is terminated as hereinafter provided, this Agreement shall continue in full force and effect as to the remainder of the Solar Panels, Improvements and the Operator's Property. If the remainder of the Solar Panels or any other portion of the Improvements or the Operator's Property is or becomes insufficient or unsuitable for Operator's purposes hereunder, as determined by Operator in its sole discretion, then, subject to the rights of any Operator Mortgagee under Section 13, Operator shall have the right to terminate this Agreement as to the portion of the Operator's Property to which Operator continues to hold the rights, at which time the Parties shall be relieved of any further obligations and duties to each other under this Agreement.

19.3 **Apportionment, Distribution of Award.** On any taking, all sums awarded, including damages and interest, shall be paid as follows:

- (a) Any portion of the award by the court on account of any cost or loss that Operator may sustain in the removal and relocation of Operator's Improvements, to Operator;
- (b) Any portion of the award by the court for Operator's anticipated or lost revenues or profits, to Operator;
- (c) Any portion of the award by the court for Owner's lost revenues, to Owner;
- (d) All remaining amounts of the award, to Owner or Operator consistent with applicable Kentucky law.

20. **Notice.**

20.1 **Writing.** All notices given or permitted to be given hereunder shall be in writing.

20.2 **Delivery.** Notice is considered given either (i) when delivered in person to the recipient named below, (ii) upon receipt after deposit in the United States mail in a sealed envelope or container, postage and postal charges prepaid, return receipt requested or certified mail, addressed by name and address to the party or person intended, or (iii) twenty-four (24) hours from

proper and timely delivery to an overnight courier service addressed by name and address to the party or person intended as follows:

Notice to Owner: Wade D. Denton and Madison N. Denton
1169 Vine Street
Robards, KY 42452

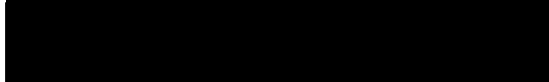

Notice to Operator: Boulevard Associates, LLC
700 Universe Blvd
Juno Beach, FL 33408



20.3 **Change of Recipient or Address.** Either Party may, by notice given at any time or from time to time, require subsequent notices to be given to another individual person, whether a party or an officer or representative, or to a different address, or both. Notices given before actual receipt or notice of change shall not be invalidated by the change.

21. **Miscellaneous Provisions.**

21.1 **Successors and Assigns.** The terms and provisions of this Agreement shall run with the land and be binding on and inure to the benefit of the heirs, successors, assigns and personal representatives of the Parties. In accordance with this Agreement, Operator in its discretion may authorize other persons or entities to use the Operator Property for the purposes stated in this Agreement

21.2 **Memorandum.** Simultaneously with the execution of this Agreement, the Parties agree to execute and acknowledge a memorandum of this Agreement. Operator may record the executed memorandum in the public records of Henderson County, Kentucky.

21.3 **Entire Agreement.** This Agreement and the attached Exhibits shall constitute the entire agreement between the Parties and supersedes all other prior writings and understandings.

21.4 **Amendments.** This Agreement shall not be amended or modified in any way except by an instrument signed by the Parties and consented to by any Operator Mortgagee. The Parties hereto shall at all times hereafter execute any documents and do any further acts which may be necessary or desirable to carry out the purposes of this Agreement and to give full force and effect to each and all of the provisions hereof.

21.5 **Legal Matters.** This Agreement shall be governed by and interpreted in accordance with the then existing laws of the Commonwealth of Kentucky and the County where the Owner's Property is located shall be considered the proper forum or jurisdiction for any disputes arising in connection with this Agreement. The Parties agree to first attempt to settle any dispute arising out of or in connection with this Agreement by good-faith negotiation. If the Parties are unable to resolve amicably any dispute arising out of or in connection with this Agreement,

each shall have all remedies available at law or in equity and as provided by this Agreement. **Each Party waives all right to trial by jury and specifically agrees that trial of suits or causes of action arising out of this Agreement shall be to the court of competent jurisdiction.**

21.6 **Severability**. If any term or provision of this Agreement, or the application thereof to any person or circumstance shall, to any extent, be determined by judicial order or decision to be invalid or unenforceable, the remainder of this Agreement or the application of such term or provision to persons or circumstances other than those as to which it is held to be invalid, shall be enforced to the fullest extent permitted by law.

21.7 **Tax Credits**. If under applicable law Operator becomes ineligible for any currently existing tax credit, benefit or incentive for alternative energy expenditure established by any local, state or federal government, then, at Operator's option, the Parties shall negotiate in good faith to amend this Agreement or replace it with a different instrument so as to convert Operator's interest in the Operator Property to a substantially similar interest that makes Operator eligible for such tax credit, benefit or incentive. Such amendment or instrument shall not impair any of Owner's rights or increase the burdens or obligations of Owner under this Agreement.

21.8 **Approvals**. Whenever in this Agreement the approval or consent of either Party is required or contemplated, unless otherwise specified, such approval or consent shall not be unreasonably withheld or delayed.

21.9 **Authority**. The signatories hereto warrant that each has the authority to execute this Agreement on behalf of any entities which are Parties to this Agreement and that each such entity has executed this Agreement pursuant to its organizational documents or a resolution or consent of their Board of Directors or other governing body.

21.10 **Time of Essence**. Time is of the essence of each provision of this Agreement.

21.11 **Counterparts**. This Agreement may be executed in multiple counterparts, each of which shall be deemed an original, and all of which together shall constitute a single instrument.

[Signatures on Next Page]

Owner:

Wade D. Denton
Wade D. Denton

Madison N. Denton
Madison N. Denton

Operator:

Boulevard Associates, LLC
a Delaware limited liability company

By: Kevin Gilder Authorized Representative

EXHIBIT A

Legal Description of Owner's Property

Beginning at a stake in Mary E. Pooles' line and corner to Lot #3 (E.Y. Thomasses) thence South 1 degree 18 minutes West 108 poles to a stake in the middle of two black oaks and a small white oak; thence North 88 degrees West 64-1/2 poles to a stake between a post oak and a hickory; thence North 1 degree

West 40 poles and 19 links to a stone corner to Lot No. 4, (R.W. McMullins); thence North ¼ degrees East 68 poles and 20 links to a sassafras, corner to Lot No. 4, in the line of Lot #3; thence South 87 ¼ degrees East 67 poles and 4 links to the beginning containing 44-1/2 acres.

LESS AND EXCEPT Lot 1, containing 2.55 acres, more or less, and Lot 2, containing 2.19 acres, more or less, of the Parrish Subdivision and Consolidation appearing of record in Plat Book 11, page 198, and corrected in Plat Book 11, page 199, in the Office of the Henderson County Clerk.

Approximately 40 acres

The above being a part of the same property acquired by Wade D. Denton and Madison N. Denton by Deed dated October 27, 2022, of record in Deed Book 663, Page 348, in the Henderson County Clerk's office.

QLA ID: 17963

HOLDING PAGE FOR EXHIBIT B

Preliminary Lease and Easement Improvement Plan and Acreage Calculation
To be Delivered with Option Notice

HOLDING PAGE FOR EXHIBIT C

As Built Lease and Easement Improvements and Final Acreage Calculation

EXHIBIT D

Lease and Easement Compensation

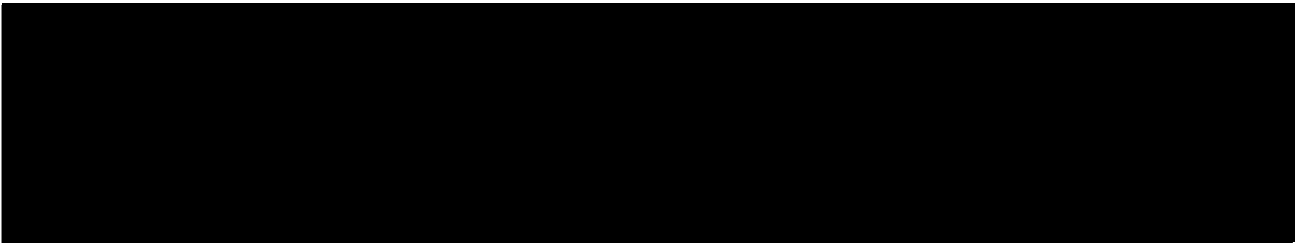

(2) **Option Payment.**

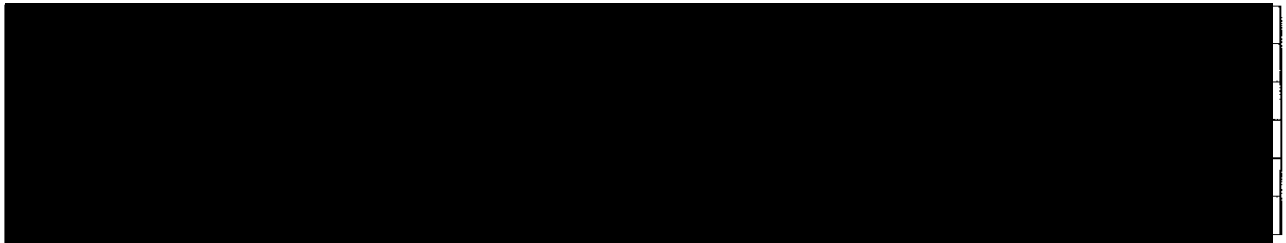
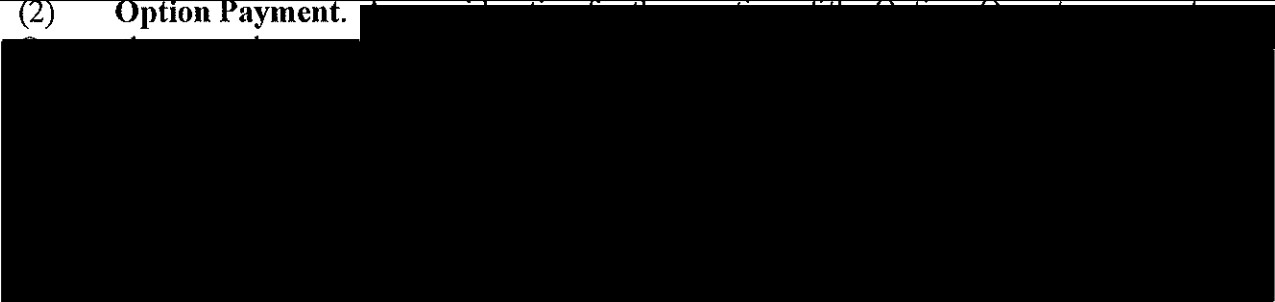

(3) **Payment for Lease and Easements.**

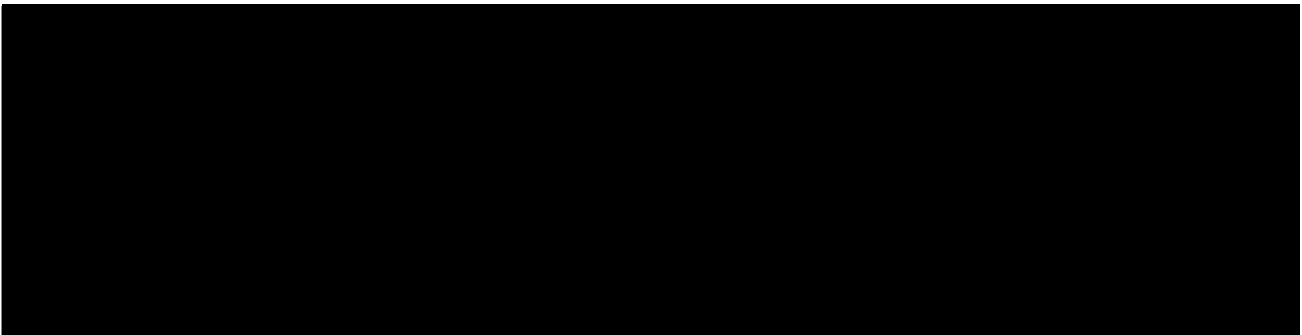
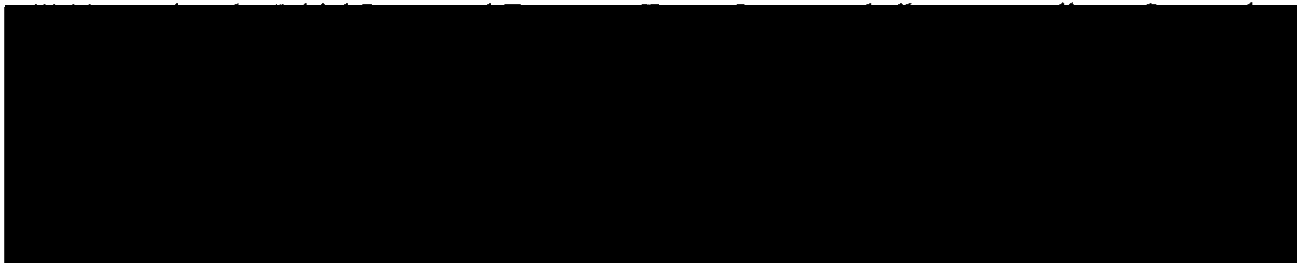



(4) Crop Compensation.

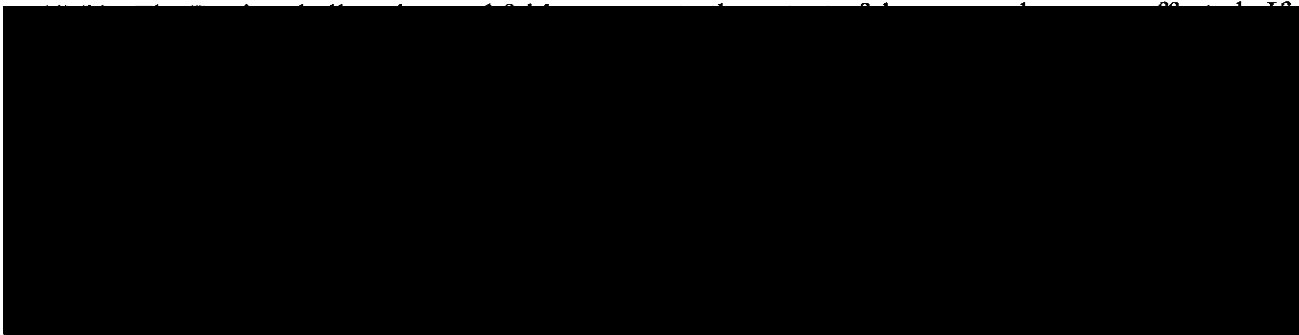
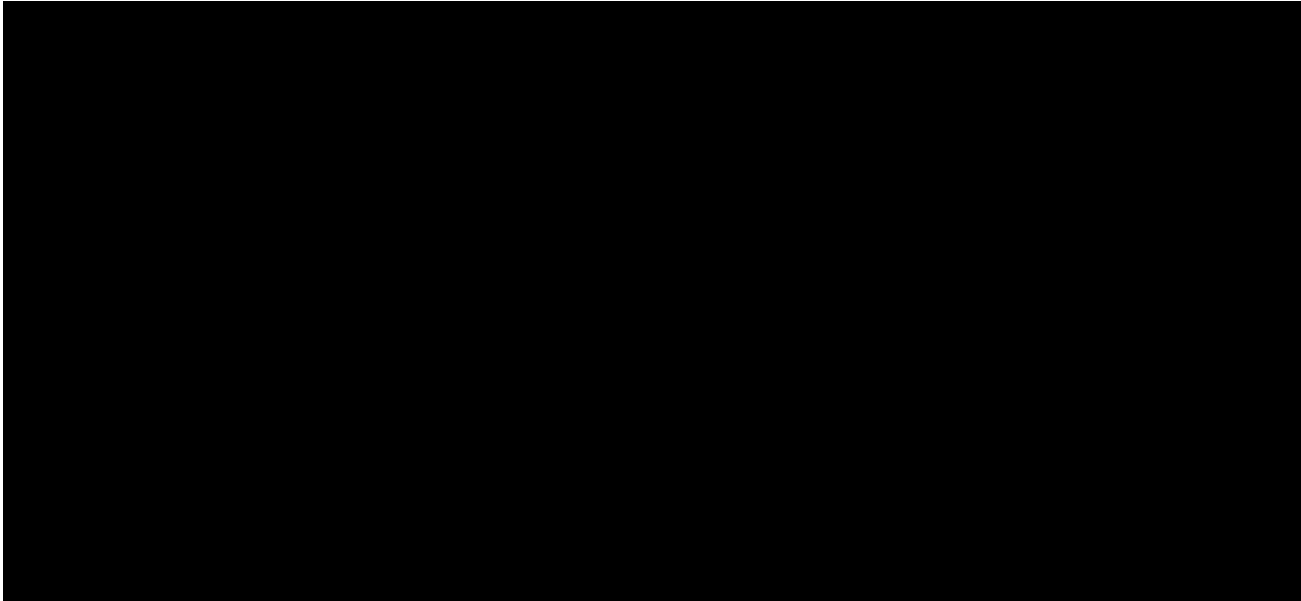

(5) Payment Allocation Schedule.

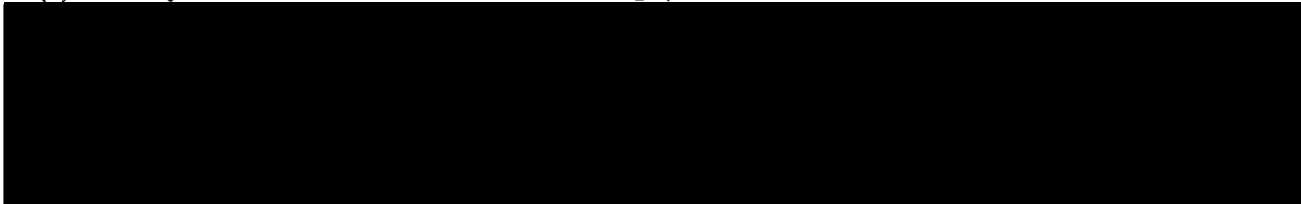

SOLAR LEASE AND EASEMENT AGREEMENT

1. **Parties.** This Solar Lease and Easement Agreement ("**Agreement**") is made and entered as of the 28 day of April, 2023 ("**Effective Date**"), by and between William David Denton, joined by consenting spouse, Sarah M. Denton ("**Owner**") and Boulevard Associates, LLC, a Delaware limited liability company ("**Operator**"), which are sometimes individually referred to as a "**Party**" and collectively as the "**Parties**".

2. **Project.** This Agreement relates to the solar-powered electrical power generation and transmission project known as the "Sebree II Solar Energy Center" to be located in Henderson County, Kentucky ("**Project**"), which may be wholly or partially located on the Owner's property legally described on the attached **Exhibit A** to this Agreement ("**Owner's Property**"). Upon Operator's exercise of the Option (as defined below), the Project shall include (i) the Lease of Owner's Property described in Section 4, (ii) the Easements referenced in Section 5 that are located on the Owner's Property, and (iii) the Improvements referenced in Section 8 to be constructed on Owner's Property. The Lease, Easements and Improvements are sometimes collectively referred to as the "**Operator Property**".

3. **Option.** Owner grants to Operator an exclusive option ("**Option**") to acquire the Lease and Easements referenced in Sections 4 and 5 in accordance with the following terms and conditions. Operator shall be entitled to acquire the Lease and the Easements in their entirety or in part, as Operator deems appropriate.

3.1 **Option Term.** The initial period during which Operator may exercise the Option shall be for a term of four (4) years, commencing on the Effective Date ("**Initial Option Term**"). Operator shall have a single election to extend the Initial Option Term for an additional one (1) year ("**Extended Option Term**") by written notice to Owner no later than thirty (30) days prior to the expiration of the Initial Option Term, which notice shall be accompanied by the Option Payment (as defined in **Exhibit D**). References herein to the Option Term shall mean the Initial Option Term and, to the extent exercised by Operator, the Extended Option Term, unless the context otherwise expressly requires.

3.2 **Option Payment.** As consideration for the granting of the Option, Operator agrees to pay Owner the Option Payment set forth in **Exhibit D**.

3.3 **Use of Owner's Property.** During the Option Term, Operator and its employees, agents and contractors shall have a right to enter upon the Owner's Property and the right of ingress and egress over and across the Owner's Property for the purposes of (i) surveying the Owner's Property; (ii) performing such other tests and studies as Operator may desire in connection with the Option, including, without limitation, environmental, avian and cultural resource assessments, and geotechnical, foundation and soil tests, provided that such activities do not unreasonably interfere with Owner's use of the Owner's Property; and (iii) installing, maintaining, operating, inspecting and removing one or more weather related instruments ("**Weather Instrument**") and fencing of said Weather Instrument and including the performance of all tests and studies associated therewith. Owner shall not permit any other individual or entity except Operator or its affiliates to install a Weather Instrument on Owner's Property.

3.4 **Right to Grant Option.** Owner warrants and represents to Operator that (i) the statements in Section 9 concerning Owner's title to the Owner's Property are true and correct; (ii) Owner has the authority to grant this Option to Operator without the consent or approval of any other party; and (iii) there are no other existing options, rights of first refusal, contracts to purchase, leases or mortgages that would prevent Operator from exercising its rights with respect to the Option.

3.5 **Exercise of Option.** Operator may exercise the Option by giving written notice to Owner ("**Option Notice**") at any time during the Option Term. Operator shall specify in the Option Notice the Commencement Date referenced in Section 6.1.1. On the Commencement Date, the Lease and Easements referenced in Sections 4 and 5 shall automatically become effective, and the Parties shall be subject to all of the terms and conditions of this Agreement with respect to such Lease and Easements and all rights and obligations relating thereto.

3.6 **Termination of Option.** If Operator fails to exercise the Option within the Option Term, the Option and the rights of Operator as the optionee shall automatically terminate.

4. **Lease.** Upon exercise of the Option by Operator, Owner leases to Operator, and Operator leases from Owner, Owner's Property for the Lease and Easement Term (defined in Section 6.1) in accordance with the terms and conditions of this Agreement ("**Lease**"), which Lease grants Operator and its agents, contractors, and employees the right to use the Owner's Property for the following permitted uses:

4.1 **Construction Right.** Operator leases Owner's Property for the purpose of constructing, operating, maintaining, repairing, replacing, and removing all or any part or component of the Improvements whether located on Owner's Property. Operator may exercise its right to use all or any part of the Owner's Property as and when Operator deems it necessary or advisable to do so to perform the activities for which this right is granted, including, without limitation, staging areas and parking for Operator's employees.

4.2 **Access Right.** Operator leases Owner's Property for unobstructed vehicular and pedestrian access and ingress to and egress from the Improvements, Owner's Property and any public roadways, and to construct, maintain, and utilize Roadway Improvements on the Owner's Property. Owner shall not permit others to obstruct or damage the roads or Roadway Improvements located on the Owner's Property or in any other way interfere with Operator's rights under this right. Operator shall repair any damage done to Roadway Improvements which result from use by Operator, its agents, servants or employees. Such roads shall be maintained in the condition necessary for use by Operator's equipment, and with regard to existing roads, shall be maintained in at least the condition that existed prior to Operator's use.

4.3 **Solar Panels Right.** Operator leases Owner's Property for Operator to construct, operate, replace, relocate, remove, and maintain Solar Panels and the appurtenant Collection Facilities, together with associated roads and parking areas on Owner's Property.

4.4 **Collection Facilities Right.** Operator leases Owner's Property for Operator to construct, operate, maintain, replace, relocate or remove Collection Facilities on and under the Owner's Property.

4.5 **Substation Right.** Operator leases Owner's Property for Operator to construct, operate, maintain, replace, relocate or remove one or more Substations on Owner's Property.

4.6 **Telecommunication Right.** Operator leases Owner's Property for Operator to construct, operate, maintain, replace, relocate or remove Telecommunication Facilities on and under the Owner's Property for Operator's use associated with the Project.

4.7 **Weather Instrument Right.** Operator leases Owner's Property in order to construct, operate, replace, relocate, remove, and maintain a Weather Instrument and the appurtenant Collection Facilities on Owner's Property.

4.8 **Battery Facilities Right.** Operator leases Owner's Property in order to construct, operate, replace, relocate, remove, and maintain one or more Battery Facilities on Owner's Property.

5. **Grant of Easements.** Upon the exercise of the Option by Operator, Owner grants to Operator, and Operator accepts from Owner, for the Lease and Easement Term referenced in Section 6.1, the following easements over and across the Owner's Property in accordance with the terms and conditions of this Agreement. The following easements are for the benefit of Operator and Operator's agents, contractors and employees and located on the Owner's Property and are collectively referred to as the "Easements".

5.1 **Sun Non-Obstruction Easement.** Owner grants Operator an irrevocable, exclusive easement for the right and privilege to use, maintain and capture the free and unobstructed sunlight over and across the Owner's Property. Owner shall not engage in any activity on Owner's Property or any other neighboring property owned by Owner that might interfere with the sunlight direction over any portion of Owner's Property; cause a decrease in the output or efficiency of any Solar Panel or Weather Instrument; or otherwise interfere with Operator's operation of the Project or exercise of any rights granted in this Agreement (collectively "Interference"). This grant of the easement expressly includes the right of Operator to enforce Operator's rights, including the physical removal of trees or structures (except existing trees and structures) causing Interference to the Project contemplated by Operator. Operator shall notify Owner before making any such removals.

5.2 **Effects Easement.** Owner grants to Operator an easement over Owner's Property for visual, view, light, flicker, noise, shadow, vibration, electromagnetic, electrical and radio frequency interference, and any other effects attributable to the Project located on the Owner's Property.

6. **Term.** The term of this Agreement ("Term") includes the Option Term referenced in Section 3.1, the Initial Lease and Easement Term as described in Section 6.1.1 and the Extended Lease and Easement Term as described in Section 6.1.2 (together, the Initial Lease and Easement Term and the Extended Lease and Easement Term, if applicable, is defined as the "Lease and Easement Term").

6.1 **Lease and Easement Term.**

6.1.1 **Initial Lease and Easement Term.** The initial term of the Lease and Easements shall commence on the date specified by Operator in the Option Notice ("**Commencement Date**"). The initial term of the Lease and Easements shall end thirty (30) years after the Commencement Date (the "**Initial Lease and Easement Term**"), subject to the rights of renewal and termination as provided in this Agreement.

Extended Lease and Easement Term. Operator shall have the right to extend the Term of this Agreement for two (2) consecutive terms of five (5) years each in accordance with the terms and provisions of this Agreement (collectively "**Extended Lease and Easement Term**") by providing written notice to Owner of Operator's intent to extend the Term within one hundred eighty (180) days of the end of the existing Term. Each Extended Lease and Easement Term shall begin on the expiration date of the Initial Lease and Easement Term or previous Extended Lease and Easement Term, as the case may be. During the Extended Lease and Easement Term, Operator shall pay Owner the amounts set forth in **Exhibit D** as the consideration for the Lease and Easements.

6.1.2 **Delays During Lease and Easement Term.** At Operator's option, the Term may be extended for a period of time equal to the period of time during which operation of the Project is delayed or suspended because of the occurrence of a Regulatory Suspension or Force Majeure, which are defined as follows:

(i) "**Regulatory Suspension**" shall mean the enactment or application of any law, order, rule, or regulation of the Kentucky Public Service Commission, Federal Energy Regulatory Commission, or other local, state, or federal government authority having jurisdiction over the Project or Operator, or the failure of any such governmental authority to issue an approval or permit pursuant to any such law, order, rule, or regulation, which results in the delay, interruption, or suspension of the production, sale or transmission of electricity from the Solar Panels; and

(ii) "**Force Majeure**" shall mean causes beyond the reasonable control of and without the fault or negligence of the Party claiming Force Majeure, including but not limited to acts of God, labor unrest (including, but not limited to, slowdowns, picketing, boycotts or strikes), flood, earthquake, storm, fire, lightning, explosion, power failure or power surge, vandalism, theft, the cutting of power, transmission or other lines, wires or cables to the Project by persons other than Operator's employees or contractors, epidemic, war, revolution, riot, civil disturbance, sabotage, change in law or applicable regulation subsequent to the Commencement Date and action or inaction by any federal, state or local legislative, executive, administrative judicial agency or body which in any of the foregoing cases, by exercise of due foresight such Party could not reasonably have expected to avoid, and which, by the exercise of due diligence, it is unable to overcome.

The Parties shall be excused from performing their respective obligations under this Agreement and shall not be liable in damages or otherwise if and to the extent that they are unable to so perform or are prevented from performing by a Force Majeure, provided that: (i) the non-performing Party, as promptly as practicable after the occurrence of the Force Majeure, but in no event later than thirty (30) days thereafter, gives the other Party written notice describing the particulars of the occurrence; (ii) the suspension of performance is of no greater scope and of no longer duration than is reasonably required by the Force Majeure; (iii) the non-performing Party uses

good faith and commercially reasonable efforts to remedy its inability to perform; and (iv) as soon as the non-performing Party is able to resume performance of its obligations excused as a result of the occurrence, each Party shall give prompt written notification thereof to the other Party.

6.2 **Termination by Operator.** Provided Operator is not in default under any term of this Agreement, Operator, at its option, shall have the right to terminate this Agreement at any time during the Term of the Agreement, as to all or any part of the Operator Property. Termination shall be effective thirty (30) days after written notice of such termination to Owner. If Operator's notice is a full termination of the Operator Property, the Parties shall be relieved of all further duties and obligations under this Agreement, other than (i) the payment of any accrued and unpaid obligations owed by either Party as of the date of termination; (ii) the removal of the Improvements by Operator pursuant to Section 8.11; and (iii) any other obligations and liabilities that are expressly stated in this Agreement to survive such termination. Upon any such partial termination by Operator, the Parties shall be relieved of all further duties and obligations under this Agreement with respect to the portion thereof terminated by Operator, subject to the obligations and liabilities referenced in items (i) through (iii) above that shall continue to be applicable to the terminated portion of this Agreement. The Parties agree to execute an amendment to this Agreement evidencing such partial termination.

7. **Payments.** If Operator exercises the Option referenced in Section 3, Operator agrees to pay Owner the amounts set forth in **Exhibit D** as consideration for the Lease, Easements and Operator's other rights and interests in the Owner's Property.

8. **Improvements.** Operator shall have the right, at its sole cost and expense, to construct, install, maintain, use, operate, repair, replace, relocate and remove all facilities, structures, equipment, machinery, wires, conduit, cables, poles, materials and property of every kind and character required for the construction and operation of portions of the Project on the Owner's Property, including, but not limited to, the Solar Panels, Collection Facilities, Substations, Telecommunication Facilities, Weather Instruments, Roadway Improvements and Battery Facilities referenced in Sections 8.1 through 8.7 (collectively, the "**Improvements**").

8.1 **"Solar Panels"** shall mean any photovoltaic energy system designed for the generation of electrical power from the collection of sunlight, including without limitation, the photovoltaic panels, foundations, support structures, braces and related equipment.

8.2 **"Collection Facilities"** shall mean all Improvements whose purpose is to deliver electrical power generated by the Solar Panels to an electrical power grid or other system, including without limitation transformers, overhead and underground electrical collection lines, telecommunication lines, splice boxes and interconnection facilities.

8.3 **"Substations"** shall mean electrical lines, meters, monitoring and control equipment, switches, transformers, all structures, equipment, enclosures, fencing, security devices, and other electrical and communications equipment necessary to condition and increase the voltage of electricity generated by the Project to make it suitable for transmission on, and to deliver it to, Collection Facilities connected to an electric power grid or other system.

8.4 "**Telecommunication Facilities**" shall mean all Improvements whose purpose is to provide telecommunication services solely relating to the Project or any of Operator's solar powered projects, including telephone, closed-circuit television, microwave, internet, computer data and other telecommunication services.

8.5 "**Weather Instrument**" shall mean instruments used primarily to gather and transmit sunlight and meteorological data relating to the Project, and includes the instrument's foundations, guy wires, sunlight and meteorological data acquisition equipment, power source, and any required data and electrical transmission lines.

8.6 "**Roadway Improvements**" shall mean all improvements that may be necessary to construct, maintain and repair any new and existing roadways and other means of ingress and egress over, across and along the Owner's Property, including paving or surfacing of the roadways with asphalt, gravel or other roadway materials, installation of road signs and the construction and installation of culverts, bridges, drainage ditches, gates, cattle guards and similar structures and facilities.

8.7 "**Battery Facilities**" shall mean a type of equipment that can be given a new charge by passing an electric current through it designed for the storage of electrical power including without limitation, batteries and other devices for storage of electrical energy, foundations, support structures, braces and related equipment.

8.8 "**Ownership of Improvements**". Except as otherwise provided in Section 11.7, all Improvements shall at all times remain the property of Operator, and Owner shall have no right, title or interest therein. All Improvements constructed or placed on the Owner's Property by Operator during the Term of this Agreement may be repaired, replaced, relocated, removed, added to or expanded upon by Operator at any time during the Term of this Agreement. Owner expressly waives any statutory lien or common law liens on the Improvements to which Owner might be entitled.

8.9 "**Construction Liens**". Operator shall not permit any liens arising out of Operator's use of the Operator Property under this Agreement to be filed against the Owner's Property. Operator shall, within sixty (60) days after it receives notice of the lien, provide a bond or other security that Owner may reasonably request, or remove such lien from the Owner's Property in the manner provided by applicable law.

8.10 "**Location of Improvements**". The acreage required from the Owner's Property for the Improvements for which the Lease and Easements are being granted cannot be determined until the completion of Operator's inspection, testing, study and surveying of the Owner's Property during the Option Term. Along with the Option Notice, Operator shall deliver to Owner a proposed plan of development showing the contemplated locations of the Improvements and a preliminary calculation of the acreage as determined by the area bounded by a perimeter fence required for the Project, which shall serve as the **Exhibit B** to this Agreement. During the final development and construction of the Project, such locations may need to be amended. Following construction of the Project, Operator shall provide Owner an "as-built" survey of all Improvements on Owner's Property and the final calculation of the acreage as determined by the area bounded by a perimeter fence required for the Project, which shall serve as **Exhibit C** to this Agreement.

Further, following construction, the Improvements may need to be relocated or rerouted by Operator, which Operator may perform, at any time during the Term of this Agreement, so long as the nature and extent of any such relocated or rerouted Improvements are not materially different and impose no materially greater burden on the Owner's Property than the original locations or routes, and so long as Operator takes commercially reasonable efforts to minimize disruption or inconvenience to Owner.

8.11 **Removal of Improvements**. Upon full or partial termination of any of the Lease Rights or Easements, Operator shall remove all Improvements and restore the area formerly occupied by the Improvements to substantially the same physical condition that existed immediately before the construction of the Improvements (the "**Removal Obligations**"). At Owner's request, all or any part of the Roadway Improvements may be left for use by Owner.

9. **Ownership and Title Matters**. Owner warrants and represents to Operator, both as of the Effective Date, and as of the Commencement Date as follows:

9.1 **Authority**. Owner represents and warrants that it is the holder of fee simple title and is the sole owner of the Owner's Property and has the unrestricted right and authority to sign this Agreement and to grant Operator the Lease and Easements and other rights granted in this Agreement. When signed by both Parties, this Agreement constitutes a valid and binding agreement enforceable against Owner in accordance with its terms.

9.2 **Other Agreements**. The Owner's Property is not subject to any other agreements, options, rights of first refusal or other prior right of any party to purchase, lease or acquire easements in the Owner's Property, or create any prior claim or right that would preclude or interfere with Operator's rights and interests under this Agreement and the Lease and Easements.

9.3 **Minerals**. Except as disclosed by Owner to Operator at the time of the execution of this Agreement by Owner, to the best of Owner's knowledge and belief, Owner owns all of the oil, gas and other minerals, and all rights thereto as on or under the Owner's Property.

9.4 **Owner Mortgage**. Except as disclosed by Owner to Operator at the time of the execution of this Agreement by Owner, there are no mortgages encumbering the Owner's Property ("**Owner Mortgage**").

9.5 **Notice and Opportunity to Cure**. If there is an Owner Mortgage encumbering Owner's Property and Owner receives from the holder thereof any notice that payments are overdue, Owner shall notify Operator and each Operator Mortgagee (as defined at Section 13.1) by sending a copy of such overdue payment notice to Operator by the earlier of (i) five (5) days after receipt, or (ii) three (3) business days prior to the date by which a default under or in respect of such Owner Mortgage could occur. If Operator or any Operator Mortgagee determines that it would be in Operator's interest to make such payments to Owner Mortgagee on Owner's behalf, whether as a result of receiving such notice or otherwise, Operator shall have the right to make such payments and to credit the payments so made against the Annual Installment Payment next due under the Agreement.

9.6 **Subordination, Non-Disturbance & Attornment Agreement.** If there is an Owner Mortgage encumbering Owner's Property, Owner shall cooperate with Operator to obtain a Subordination, Non-Disturbance and Attornment Agreement ("SNDA") in the form prepared and provided by Operator, from each Owner Mortgagee, pursuant to which such Owner Mortgagee agrees, among other things, not to disturb Operator's possession and use of the Owner's Property. Owner shall not incur any loss in income, expense, obligation or liability with regard to the SNDA. Operator shall, at its sole cost and expense, record each such SNDA in the Office of the County Clerk in which Owner's Property is located. If Owner fails to deliver a SNDA from each Owner Mortgagee, Operator may, at its sole option, either (i) terminate this Agreement immediately upon written notice to Owner, or (ii) take such action as Operator deems reasonably necessary to effect the rights granted to Operator hereunder, and off-set all amounts expended in such efforts against the Annual Installment Payments and any other amounts due hereunder or in respect hereof.

10. **Representations and Warranties of Owner.** Owner hereby makes the following further representations and warranties both as of the Effective Date, and as of the Commencement Date:

10.1 **Physical Condition.** Owner has no knowledge of any existing physical conditions of the Owner's Property which would prevent, significantly restrict or make more expensive Operator's development of the Owner's Property for the purposes specified in this Agreement, or which could, with the passage of time, or the giving of notice, constitute a violation of any currently applicable governmental law, ordinance, order, rule or regulation.

10.2 **Legal Restrictions.** Owner has no knowledge of any law, regulation, ordinance or order of any local, state or federal governmental authority which would prohibit or significantly restrict Operator's development of the Owner's Property pursuant to this Agreement. This Agreement does not violate any contract, agreement, instrument, judgment or order to which Owner is a party or which affects the Owner's Property. To the best of Owner's knowledge, the Owner's Property is currently in full and complete compliance with all governmental laws, ordinances, orders, rules and regulations applicable to the Owner's Property.

10.3 **No Litigation.** No litigation is pending and, to the best of Owner's knowledge, no litigation or administrative actions are proposed, threatened or anticipated with respect to any matter affecting the Owner's Property. If Owner learns of any litigation or administrative action proposed, threatened or instituted with respect to the Owner's Property, Owner shall give Operator notice within thirty (30) days thereof.

10.4 **Survival.** The representations and warranties set forth in this Section 10 shall survive the execution and delivery hereof.

11. **Use, Operation and Maintenance.**

11.1 **Exclusive Use by Operator.** Operator shall have the exclusive right (i) to use and possess the Owner Property in connection with the Project and other similar solar-powered electrical power generation projects; (ii) to investigate, inspect, survey, and conduct tests of the Owner's Property, including, but not limited to, meteorological, environmental, archeological and geotechnical tests and studies; (iii) to use and convert all of the sunlight resources on the Owner's Property; and (iv) to undertake such other activities on the Owner's Property that may be related

to the Project, including, without limitation, the storage of Solar Panels, materials and equipment during the installation and construction of the Improvements; development and operation of communications systems; and site tours of the Project for visitors and other interested parties.

11.2 **No Required Installation or Operation.** Nothing in this Agreement shall be interpreted as imposing on Operator any obligation to install Solar Panels or other Improvements on the Owner's Property, or to operate the Project on the Owner's Property. Operator shall have the sole discretion to determine if and when any Solar Panels and other Improvements may be constructed on Owner's Property, and if and when to commence the operation of the Project on the Owner's Property.

11.3 **Permits and Approvals.** Operator shall be responsible, at its sole cost and expense, for obtaining any governmental permits and approvals necessary for the construction and operation of the Project and the construction and operation of the Improvements. Owner shall cooperate with Operator as necessary to obtain any governmental or utility approvals or permits, including, without limitation, signing any applications for such approvals, provided that Owner shall not incur any loss in income, expense, obligation or liability with respect to Operator obtaining such permits or approvals.

11.4 **Compliance with Laws.** Operator shall comply in all material respects with valid laws applicable to the Owner's Property and the Operator Property. Operator shall have the right, in its sole discretion and at its sole expense, in Operator's name to contest the validity or applicability to the Owner's Property and the Operator Property of any law, ordinance, statute, order, regulation, property assessment or the like made by any governmental agency or entity. Operator shall control any such contest and Owner shall cooperate with Operator in every reasonable way in such contest, provided that Owner shall incur no expense, obligation or liability with regard to such contest.

11.5 **Care and Appearance.** Operator, in its exercise of the lease, easement and other rights granted hereunder shall, at all times, maintain the Owner's Property and the Improvements in a reasonably neat, clean and presentable condition. Operator shall not willfully or negligently damage or destroy the Owner's Property and shall keep the Owner's Property clean and free of debris created by Operator, its contractors, or others brought on to the Owner's Property by Operator. Operator shall not use the Owner's Property for storage, except for materials, construction equipment and vehicles directly associated with construction or maintenance of the Improvements on the Owner's Property or adjacent properties that are part of the Project.

11.6 **Fences and Gates.** At Owner's request, Operator shall repair or replace any fences, gates or cattle guards damaged or removed in connection with Operator's activities on the Owner's Property. Fences removed from the Owner's Property, if replaced, shall be re-built by Operator at its expense in mutually agreeable locations. All fence repair and construction shall be substantially similar to the construction of existing fences and cattle guards on Owner's Property. Any gates opened for access to Owner's Property by either Party shall be closed immediately after passing through so that livestock may not pass through. Once completed, all replacement fences, gates and cattle guards shall be owned and maintained by Owner. Upon abandonment or termination of the rights granted to Operator in this Agreement, any fences, gates and cattle guards installed by Operator shall be removed by Operator. To minimize the need for temporary fencing,

Owner will cooperate with Operator to avoid pasturing animals on or near the Improvements during periods of construction, maintenance or removal activity by Operator. Owner will discuss with Operator what temporary fencing is necessary during the periods of construction, maintenance or removal activity by Operator.

11.7 **Roadway Maintenance and Repairs.** Operator agrees to maintain and repair all Roadway Improvements located on the Operator Property; provided, however, Owner shall reimburse Operator for any costs and expenses incurred by Operator to repair any damage or perform any special maintenance of the Roadway Improvements caused by Owner or any person using the Roadway Improvements with Owner's permission, other than Operator.

12. **Taxes.**

12.1 **Owner's Taxes.** Owner covenants and agrees to pay prior to delinquency all real and personal property and other taxes, general and special assessments, and other charges of every description ("**Taxes**") levied or assessed against the Owner's Property and all improvements thereon by governmental authorities, other than Operator's Taxes referenced in Section 12.2 (Taxes, excepting Operator's Taxes, are hereinafter referred to as "**Owner's Taxes**").

12.2 **Operator's Taxes.**

12.3 **Failure to Pay.** In the event either Party fails to pay their share of Taxes prior to delinquency, the other Party shall have the right to pay such Taxes and any accrued penalties or interest, which payments shall increase or be offset against other Payments due under this Agreement.

12.4 **Operator's Right to Contest.** Operator may contest the legal validity or amount of any Operator's Taxes for which it is responsible under this Agreement, and may institute such proceedings as it considers necessary, provided that Operator shall bear all expenses in pursuing such contest or proceeding. With respect to any Taxes which may constitute a lien on the Owner's Property, Operator shall promptly pay such Taxes unless the proceeding in which it contests such Taxes shall operate to prevent or stay the collection of the Taxes so contested or unless Operator

removes any such lien by bonding or otherwise. Owner agrees to render to Operator all reasonable assistance in contesting the validity or amount of any such Taxes, with the exception of Taxes levied by Owner, including joining in the signing of any reasonable protests or pleading which Operator may deem advisable to file; provided, however, that Operator shall reimburse Owner for its reasonable out-of-pocket expenses, including reasonable attorneys' fees incurred in connection with providing such assistance.

13. **Mortgage of Operator Property.**

13.1 **Right to Mortgage.** Operator may, upon written notice to Owner, but without requiring Owner's consent or approval, mortgage, collaterally assign, or otherwise encumber and grant security interests in all or any part of its interest in this Agreement and the Operator Property. These various security interests in all or a part of this Agreement and the Operator Property are collectively referred to as an "**Operator Mortgage**" and holder of such security interest, an "**Operator Mortgagee**". Any Operator Mortgagee shall use the Operator Property only for the uses permitted under this Agreement. Whenever Operator has granted a security interest under this Section 13, it will give Owner notice of the Operator Mortgage (including the name and address of the Operator Mortgagee for notice purposes) to Owner within thirty (30) days; provided that failure to give this notice shall not constitute a default under this Agreement, but rather shall only have the effect of not binding Owner to provide such Operator Mortgage notice until the Operator and its address is given to Owner.

13.2 **Notice of Default and Opportunity to Cure.** As a precondition to exercising any rights or remedies related to any alleged default by Operator under this Agreement, Owner shall give written notice of the default to each Operator Mortgagee at the same time it delivers notice of default to Operator, specifying in detail the alleged event of default and the required remedy. Each Operator Mortgagee or its designee shall have the right, but not the obligation, to cure any default as Operator, and/or the right, but not the obligation, to remove any Improvements or other property owned by Operator or such Operator Mortgagee located on the Owner's Property to the same extent as Operator. The cure period for any Operator Mortgagee shall be the later of (i) the end of the Operator cure period under Section 18; (ii) thirty (30) days after such Operator Mortgagee's receipt of the default notice; or (iii) if applicable, the extended cure period provided for in Section 13.3. Failure by Owner to give an Operator Mortgagee notice of default shall not diminish Owner's rights against Operator, but shall preserve all rights of the Operator Mortgagee or its designee to cure any default and to remove any Improvements or other property of Operator or the Operator Mortgagee located on the Owner's Property.

13.3 **Extended Cure Period.** If any default by Operator under this Agreement cannot be cured without the Operator Mortgagee obtaining possession of all or part of the Operator Property, then any such default shall be deemed remedied if an Operator Mortgagee: (i) within sixty (60) days after receiving notice from Owner as set forth in Section 13.2, acquires possession of all or part of the Operator Property, or begins appropriate judicial or nonjudicial proceedings to obtain the same; (ii) diligently prosecutes any such proceedings to completion; and (iii) after gaining possession of all or part of the Operator Property performs all other obligations as and when the same are due in accordance with the terms of this Agreement. If an Operator Mortgagee is prohibited by any court or by operation of any bankruptcy or insolvency laws from commencing

or prosecuting the proceedings described above, the sixty (60) day period specified above for commencing proceedings shall be extended for the period of such prohibition.

13.4 **Operator Mortgagee Liability.** Any Operator Mortgagee whose interest in the Operator Property is held solely for security purposes, shall have no obligation or liability under this Agreement unless and until the Operator Mortgagee succeeds to absolute title to the Operator Property and the rights of Operator under this Agreement. An Operator Mortgagee shall be liable to perform obligations under this Agreement only for and during the period it directly holds such absolute title.

13.5 **Certificates.** Owner shall execute any estoppel certificates (certifying as to truthful matters, including without limitation that no default then exists under this Agreement, if such be the case), consents to assignment and non-disturbance agreements as Operator or any Mortgagee may reasonably request from time to time. The Parties shall negotiate in good faith any amendment to this Agreement from time to time to include any provision that may be reasonably requested by Operator or any Operator Mortgagee to implement the provisions contained in this Agreement or to preserve an Operator Mortgagee's security interest.

13.6 **Operator Mortgagee's Right to Enforce Mortgage and Assign.** Each Operator Mortgagee shall have the right, in its sole discretion: (i) to assign its Operator Mortgage; (ii) to enforce its lien and acquire title to all or any portion of the Operator Property by any lawful means; (iii) to take possession of and operate all or any portion of the Operator Property and to perform all obligations to be performed by Operator under this Agreement, or to cause a receiver to be appointed to do so; and (iv) to acquire all or any portion of the Operator Property by foreclosure or by an assignment in lieu of foreclosure and thereafter to assign or transfer all or any portion of the Operator rights under this Agreement to a third party in accordance with Section 14. Any Operator Mortgagee or other party who acquires Operator's interest in all or a portion of the Operator Property pursuant to foreclosure or assignment in lieu of foreclosure shall not be liable to perform the obligations imposed on Operator by this Agreement, which are incurred or accruing after such Operator Mortgagee or other party no longer has ownership or possession of the Operator Property.

13.7 **New Agreement.**

13.7.1 If the Operator Property is foreclosed upon or there is an assignment in lieu of foreclosure, or if this Agreement is rejected or disaffirmed pursuant to bankruptcy law or other law affecting creditor's rights and, within ninety (90) days after such event, Operator or any Operator Mortgagee or other purchaser at a foreclosure sale shall have arranged to the reasonable satisfaction of Owner to cure any material defaults under this Agreement, and for the payment of all Annual Installment Payments or other charges due and payable by Operator as of the date of such event, then Owner shall execute and deliver to Operator or such Operator Mortgagee or other purchaser at a foreclosure sale, or to a designee of one of these parties, as the case may be, a new agreement ("**New Agreement**") which (i) shall be for a term equal to the remainder of the Term of this Agreement before giving effect to such rejection or termination; (ii) shall contain the same covenants, agreements, terms, provisions and limitations as this Agreement (except for any requirements that have been fulfilled by Operator or any Operator Mortgagee or other purchaser at a foreclosure sale prior to rejection or termination of this Agreement); and (iii) shall include that

portion of the Operator Property in which Operator or such other Operator Mortgagee or other purchaser at a foreclosure sale had an interest on the date of rejection or termination.

13.7.2 If more than one Operator Mortgagee makes a written request for a New Agreement pursuant to this provision, the New Agreement shall be delivered to the Operator Mortgagee requesting such New Agreement whose Operator Mortgage is prior in time, and the written request of any other Operator Mortgagee whose lien is subordinate shall be void and of no further force or effect. The provisions of this Section 13 shall survive the termination, rejection or disaffirmation of this Agreement and shall continue in full force and effect thereafter to the same extent as if this Section 13 were a separate and independent contract made by Owner, Operator and each Operator Mortgagee, and, from the effective date of such termination, rejection or disaffirmation of this Agreement to the date of execution and delivery of such New Agreement, such Operator Mortgagee or other purchaser at a foreclosure sale may use and enjoy the Operator Property without hindrance by Owner or any person claiming by, through or under Owner; provided that all of the conditions for the New Agreement as set forth above are complied with.

13.8 **Operator Mortgagee's Consent to Amendment, Termination or Surrender.** Notwithstanding any provision of this Agreement to the contrary, the Parties agree that so long as any Operator Mortgage remains outstanding, this Agreement shall not be modified or amended, and Owner shall not accept a surrender, cancellation or release of all or any part of the Operator Property from Operator, prior to expiration of the Term of this Agreement, without the prior written consent of the Operator Mortgagee holding such Operator Mortgage. This provision is for the express benefit of and shall be enforceable by each Operator Mortgagee as if it were a party named in this Agreement.

14. **Assignment and Sublease.** Operator shall have the right, without Owner's consent, to sell, convey, lease, or assign all or any portion of this Agreement or the Operator Property, on either an exclusive or a non-exclusive basis, or to grant subleases, co-leases, easements, licenses or similar rights with respect to the Operator Property (collectively, "Assignment"), to one or more persons or entities (collectively "Assignee"). Each Assignee shall use the Operator Property only for the uses permitted under this Agreement. When Operator makes any Assignment under this Section 14, Operator shall give written notice to Owner of such Assignment (including the interest conveyed by the Assignment and address of the Assignee for notice purposes) to Owner; provided Operator's failure to give such notice shall not constitute a default under this Agreement, but rather shall only have the effect of not binding Owner with respect to such assignment or conveyance until such notice is given. Any Assignment by Operator shall release Operator from obligations subject thereof accruing after the date that liability for such obligations is assumed by the Assignee.

15. **Hazardous Materials.**

15.1 **Owner's Covenants Regarding Hazardous Materials.** Owner represents and warrants that, to the best of Owner's knowledge, the Owner's Property is not and has not been in violation of any federal, state or local environmental health or safety laws, statute, ordinance, rule, regulation or requirement ("**Environmental Laws**"), and Owner has not received any notice or other communication from any governmental authorities alleging that the Owner's Property is in

violation of any Environmental Laws. "**Hazardous Materials**" shall mean any asbestos containing materials, petroleum, explosives, toxic materials, or substances regulated as hazardous wastes, hazardous materials, hazardous substances, or toxic substances under any federal, state, or local law or regulation. Owner warrants that Owner has done nothing to contaminate the Operator Property with Hazardous Materials or wastes.

15.2 **Operator's Covenants Regarding Hazardous Materials**. Operator shall, at Operator's sole cost and expense, promptly take removal or remedial action required by Environmental Law with regard to any material violation of any Environmental Law with regard to any Hazardous Materials brought onto the Owner's Property by Operator or its employees, agents, or contractors. Owner shall cooperate with Operator with regard to any scheduling or access to the Owner's Property in connection with any action required hereunder.

15.3 **Operator's Indemnity Regarding Hazardous Materials**. Operator shall indemnify, defend, protect and hold Owner harmless from any liability based on: (i) the release of Hazardous Materials in, on, under or about the Owner's Property caused by Operator or its employees, agents, or contractors, or (ii) the violation by Operator or its employees, agents, or contractors of any Environmental Law. The indemnity obligations set forth herein shall survive termination of this Agreement.

16. **Insurance and Indemnity**.

16.1 **Insurance**. At all times during which Operator is conducting any activities on the Property and at all times during the Term of this Agreement, Operator shall maintain in effect (1) commercial General Liability Insurance, including bodily injury and property damage coverage with minimum limits of \$1 Million Dollars per occurrence and \$2 Million Dollars aggregate and (2) Umbrella Liability Insurance with minimum limits of \$5 Million Dollars per occurrence and \$5 Million Dollars aggregate. Upon a written request by Owner, Operator shall name Owner as additional insured on such insurance policy and provide Owner with a certificate of such insurance.

16.2 **Indemnity by Operator**. Operator shall defend, indemnify, protect and hold Owner harmless from and against all liabilities, costs, expenses, obligations, losses, damages, claims, (collectively "**Claims**") resulting from the negligence, willful misconduct, or breach of this Agreement by Operator, its agents, contractors or employees, invitees, licensees and permittees; provided, however, that such Claims are not due to the sole negligence, willful misconduct, or breach by Owner, its agents, contractors or employees, invitees, licensees or permittees.

16.3 **Indemnity by Owner**. Owner shall defend, indemnify, protect, and hold Operator harmless from and against all Claims resulting from the negligence, willful misconduct, or breach of this Agreement by Owner, its agents, contractors or employees, invitees, licensees and permittees; provided, however, that such Claims are not due to the sole negligence, willful misconduct, or breach by Operator, its agents, contractors, employees, invitees, licensees, or permittees.

16.4 **Survival**. The obligations of the Parties under this Section 16 shall survive expiration or other termination of this Agreement.

17. **Confidentiality.** This Agreement includes confidential and proprietary information relating to Operator and the Project. Owner agrees not to provide copies of the Agreement or disclose the terms of the Agreement to any unauthorized person or entity. Operator authorizes Owner to provide copies of the Agreement and disclose the terms thereof to Owner's family ("family" shall be deemed to include all devisees or descendants of owner by will or intestacy), attorney, accountant, financial advisor and any existing or prospective mortgagee, lessee, or purchaser for the sole purpose of evaluating and advising Owner and for no other purpose, so long as such authorized parties agree in writing to become subject to the confidentiality provisions hereto and not to provide copies of the Agreement or disclose the terms thereof to any unauthorized person or entity. Any Owner and party shall return all material containing any confidential information to Operator immediately upon its request. Any party agrees to destroy immediately upon request by Operator such analyses, compilation, studies or other documents, and any oral information will continue to be subject to the terms of this Agreement. Owner agrees that Operator will have no adequate remedy at law if any party violates any of the terms of this Agreement. In such event Operator will have the right, in addition to any other rights Operator may have, to obtain injunctive relief to restrain any breach or threatened breach by third party or specific enforcement of such terms plus reimbursement of attorneys' fees, court costs and all associated expenses. No party shall publish, file for public record, reproduce, or otherwise disseminate this document or any of the terms and provisions hereof to any party, other than the Parties set forth above without the prior written consent of Operator, which consent may be withheld for any reason and in Operator's sole discretion.

18. **Default and Remedies.**

18.1 **Operator Payment Default.**

[REDACTED]

18.1.1 **Collection of Payments.**

[REDACTED]

18.1.2 **Terminate Agreement.**

[REDACTED]

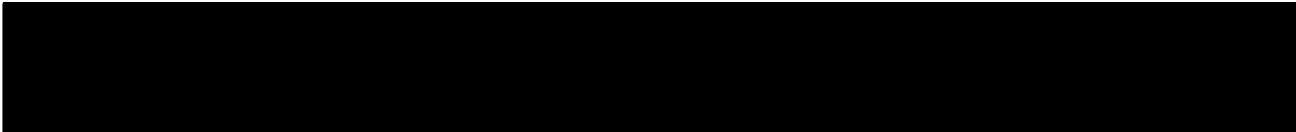

18.2 **Other Operator Default.**

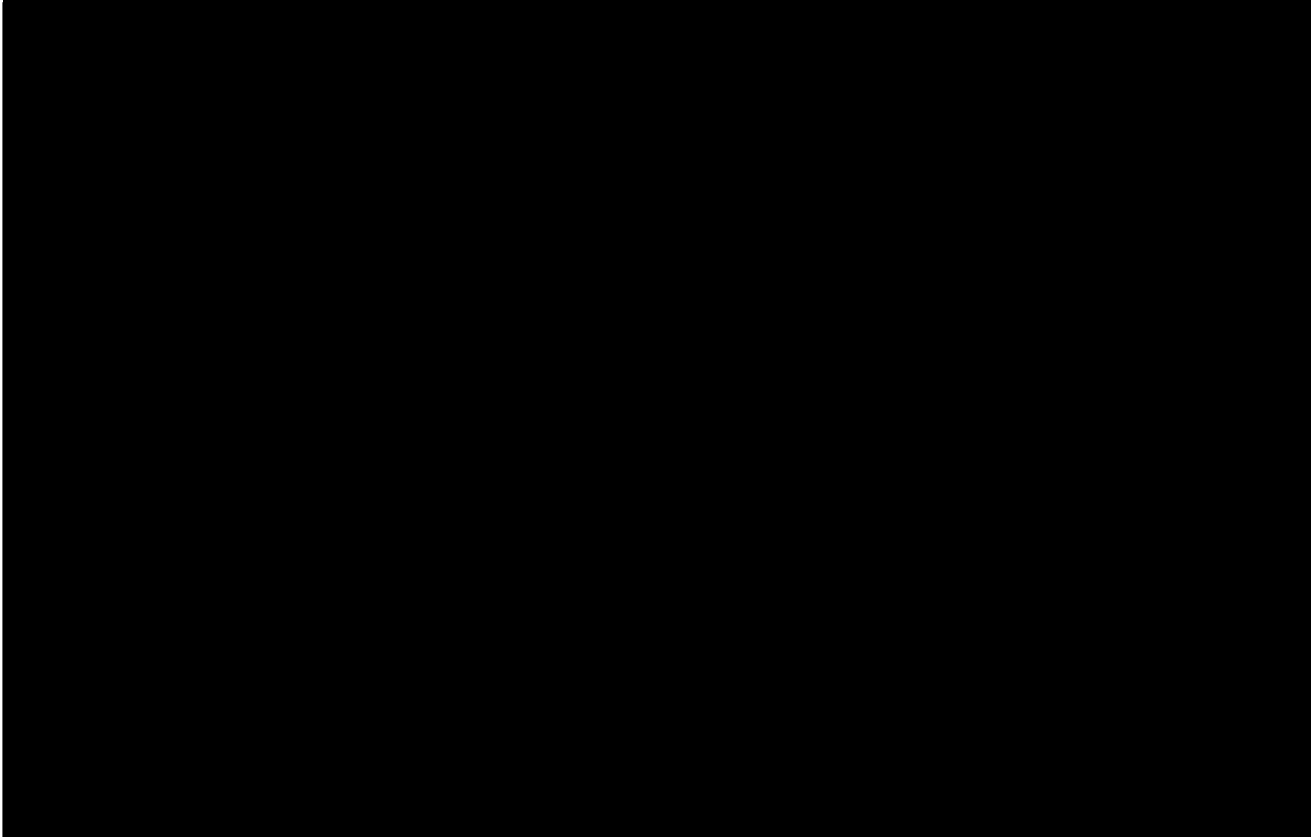

18.3 **Owner Default.**

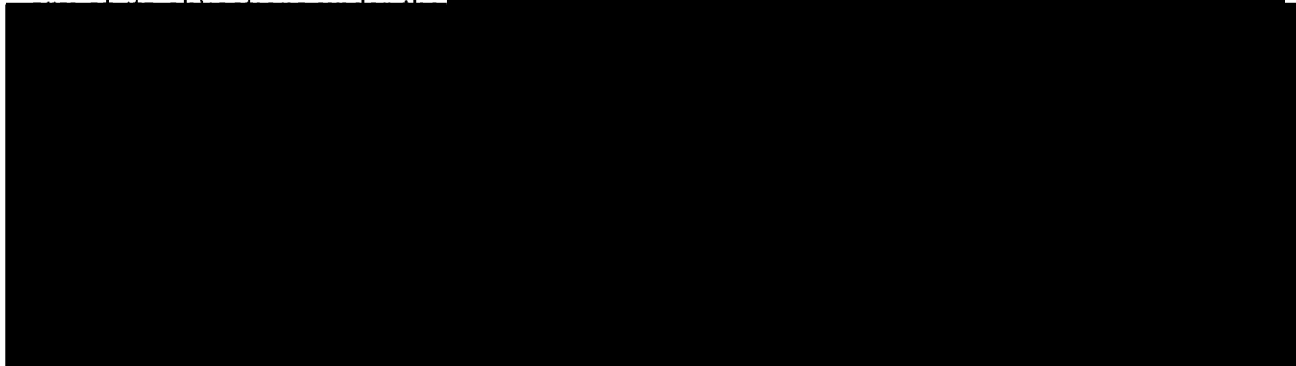

19. **Condemnation.**

19.1 **Complete Taking.** If, at any time, any authority having the power of eminent domain shall condemn all or substantially all of the Operator's Property, or all of the Improvements thereon, for any public use or otherwise, then the interests and obligations of Operator under this Agreement in or affecting the Operator's Property shall cease and terminate upon the earlier of (i)

the date that the condemning authority takes physical possession of the Operator's Property or the Improvements thereon, (ii) the date that Operator is, in its sole judgment, no longer able or permitted to operate the Project on the Operator's Property in a commercially viable manner, or (iii) the date of the condemnation judgment. Operator shall continue to pay all amounts payable hereunder to Owner until the earlier of such dates, at which time the Parties shall be relieved of any and all further obligations and conditions to each other under this Agreement.

19.2 **Partial Taking**. If, at any time during the term of this Agreement, any authority having the power of eminent domain shall condemn one or more, but not all, of the Solar Panels, or any portion of the Improvements or the Operator's Property, then the interest and obligations of Operator under this Agreement as to those Solar Panels or any portion of the Improvements or the Operator's Property so taken shall cease and terminate upon the earlier of (i) the date that the condemning authority takes possession of such Solar Panels or any portion of the Improvements or the Operator's Property, (ii) the date that Operator is, in its reasonable judgment, no longer able or permitted to operate the Project on the Operator's Property, or any portion thereof, in a commercially viable manner, or (iii) the date of the condemnation judgment; and, unless this Agreement is terminated as hereinafter provided, this Agreement shall continue in full force and effect as to the remainder of the Solar Panels, Improvements and the Operator's Property. If the remainder of the Solar Panels or any other portion of the Improvements or the Operator's Property is or becomes insufficient or unsuitable for Operator's purposes hereunder, as determined by Operator in its sole discretion, then, subject to the rights of any Operator Mortgagee under Section 13, Operator shall have the right to terminate this Agreement as to the portion of the Operator's Property to which Operator continues to hold the rights, at which time the Parties shall be relieved of any further obligations and duties to each other under this Agreement.

19.3 **Apportionment, Distribution of Award**. On any taking, all sums awarded, including damages and interest, shall be paid as follows:

- (a) Any portion of the award by the court on account of any cost or loss that Operator may sustain in the removal and relocation of Operator's Improvements, to Operator;
- (b) Any portion of the award by the court for Operator's anticipated or lost revenues or profits, to Operator;
- (c) Any portion of the award by the court for Owner's lost revenues, to Owner;
- (d) All remaining amounts of the award, to Owner or Operator consistent with applicable Kentucky law.

20. **Notice**.

20.1 **Writing**. All notices given or permitted to be given hereunder shall be in writing.

20.2 **Delivery**. Notice is considered given either (i) when delivered in person to the recipient named below, (ii) upon receipt after deposit in the United States mail in a sealed envelope or container, postage and postal charges prepaid, return receipt requested or certified mail, addressed by name and address to the party or person intended, or (iii) twenty-four (24) hours from

proper and timely delivery to an overnight courier service addressed by name and address to the party or person intended as follows:

Notice to Owner: William David Denton and Sarah M. Denton
8653 Thomason Road
Robards, KY 42452



Notice to Operator: Boulevard Associates, LLC
700 Universe Blvd
Juno Beach, FL 33408



20.3 **Change of Recipient or Address.** Either Party may, by notice given at any time or from time to time, require subsequent notices to be given to another individual person, whether a party or an officer or representative, or to a different address, or both. Notices given before actual receipt or notice of change shall not be invalidated by the change.

21. **Miscellaneous Provisions.**

21.1 **Successors and Assigns.** The terms and provisions of this Agreement shall run with the land and be binding on and inure to the benefit of the heirs, successors, assigns and personal representatives of the Parties. In accordance with this Agreement, Operator in its discretion may authorize other persons or entities to use the Operator Property for the purposes stated in this Agreement

21.2 **Memorandum.** Simultaneously with the execution of this Agreement, the Parties agree to execute and acknowledge a memorandum of this Agreement. Operator may record the executed memorandum in the public records of Henderson County, Kentucky.

21.3 **Entire Agreement.** This Agreement and the attached Exhibits shall constitute the entire agreement between the Parties and supersedes all other prior writings and understandings.

21.4 **Amendments.** This Agreement shall not be amended or modified in any way except by an instrument signed by the Parties and consented to by any Operator Mortgagee. The Parties hereto shall at all times hereafter execute any documents and do any further acts which may be necessary or desirable to carry out the purposes of this Agreement and to give full force and effect to each and all of the provisions hereof.

21.5 **Legal Matters.** This Agreement shall be governed by and interpreted in accordance with the then existing laws of the Commonwealth of Kentucky and the County where the Owner's Property is located shall be considered the proper forum or jurisdiction for any disputes arising in connection with this Agreement. The Parties agree to first attempt to settle any dispute arising out of or in connection with this Agreement by good-faith negotiation. If the Parties are unable to resolve amicably any dispute arising out of or in connection with this Agreement,

each shall have all remedies available at law or in equity and as provided by this Agreement. **Each Party waives all right to trial by jury and specifically agrees that trial of suits or causes of action arising out of this Agreement shall be to the court of competent jurisdiction.**

21.6 **Severability.** If any term or provision of this Agreement, or the application thereof to any person or circumstance shall, to any extent, be determined by judicial order or decision to be invalid or unenforceable, the remainder of this Agreement or the application of such term or provision to persons or circumstances other than those as to which it is held to be invalid, shall be enforced to the fullest extent permitted by law.

21.7 **Tax Credits.** If under applicable law Operator becomes ineligible for any currently existing tax credit, benefit or incentive for alternative energy expenditure established by any local, state or federal government, then, at Operator's option, the Parties shall negotiate in good faith to amend this Agreement or replace it with a different instrument so as to convert Operator's interest in the Operator Property to a substantially similar interest that makes Operator eligible for such tax credit, benefit or incentive. Such amendment or instrument shall not impair any of Owner's rights or increase the burdens or obligations of Owner under this Agreement.

21.8 **Approvals.** Whenever in this Agreement the approval or consent of either Party is required or contemplated, unless otherwise specified, such approval or consent shall not be unreasonably withheld or delayed.

21.9 **Authority.** The signatories hereto warrant that each has the authority to execute this Agreement on behalf of any entities which are Parties to this Agreement and that each such entity has executed this Agreement pursuant to its organizational documents or a resolution or consent of their Board of Directors or other governing body.

21.10 **Time of Essence.** Time is of the essence of each provision of this Agreement.

21.11 **Counterparts.** This Agreement may be executed in multiple counterparts, each of which shall be deemed an original, and all of which together shall constitute a single instrument.

[Signatures on Next Page]

Owner:

William David Denton
William David Denton

Sarah M Denton
Sarah M. Denton

Operator:

Boulevard Associates, LLC
a Delaware limited liability company

By: 
Kevin Gildea, Authorized Representative

EXHIBIT A

Legal Description of Owner's Property

Parcel 1:

Being all of Lot 2 of the William Denton Subdivision of record in Plat Book 7, Page 238, Henderson County, Kentucky Clerk's Office.

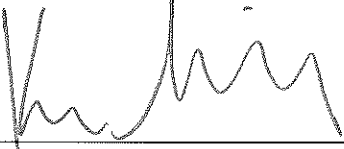
Being the same property conveyed to William T. Denton and Hallie M. Denton, by Deed dated March 21, 1981 from Marvin B. Denton and Ruby Camille Denton, husband and wife, of record in Deed Book 325, Page 182, Henderson County, Kentucky.

Approximately 26 acres

Parcel 2:

Being all of Tract 1 Total Area Consolidated 54.14 acres, more or less, of the Denton & Logsdon Agricultural Division and Consolidation as shown by plat of record in Plat Book 10, page 268, in the Henderson County Court, Kentucky Clerk's Office, and to which plat reference is hereby made for a more particular description.

Being a portion of the same property conveyed to Laura Anne Logsdon and William Denton, as tenants in common, by Deed from William T. Denton and Hallie M. Denton, husband and wife, subject to a life estate retained by William T. Denton and Hallie M. Denton, dated March 3, 2008, of record in Deed Book 561, Page 25, in the Henderson County, Kentucky Clerk's Office. Also see Deed Book 595, Page 141, in the aforesaid Clerk's Office. Also see Deed Book 595, Page 141, in the aforesaid Clerk's Office, extinguishing said life estate.

Approximately 54 acres

QLA ID: 17717

HOLDING PAGE FOR EXHIBIT B

Preliminary Lease and Easement Improvement Plan and Acreage Calculation
To be Delivered with Option Notice

HOLDING PAGE FOR EXHIBIT C

As Built Lease and Easement Improvements and Final Acreage Calculation

EXHIBIT D

Lease and Easement Compensation

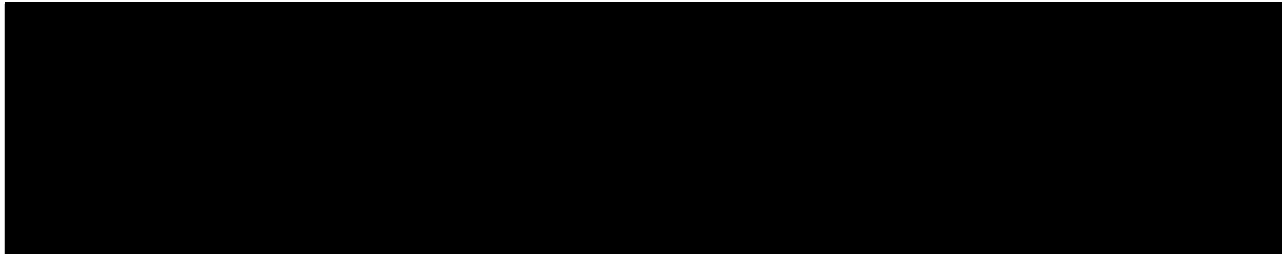
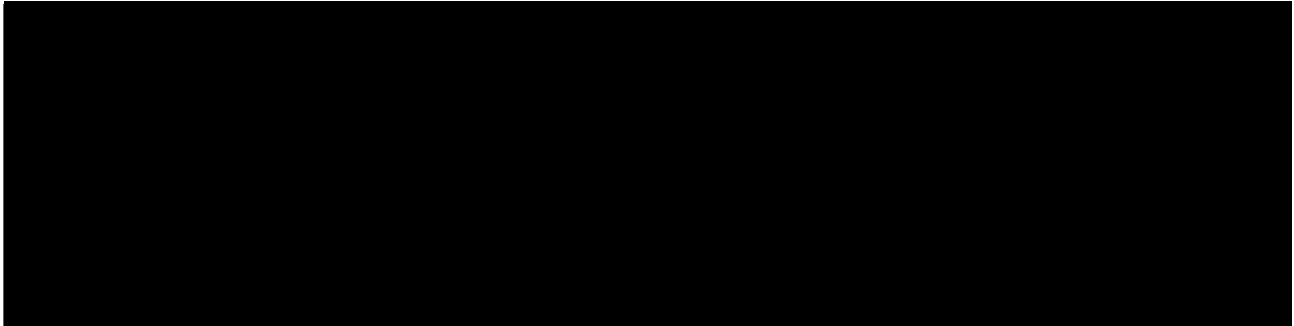
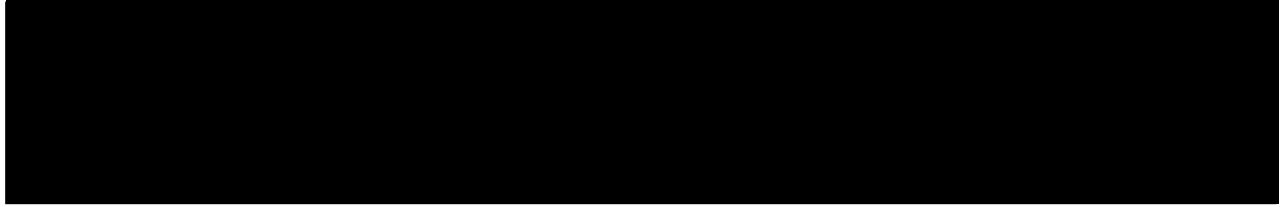

(3) **Payment for Lease and Easements.**

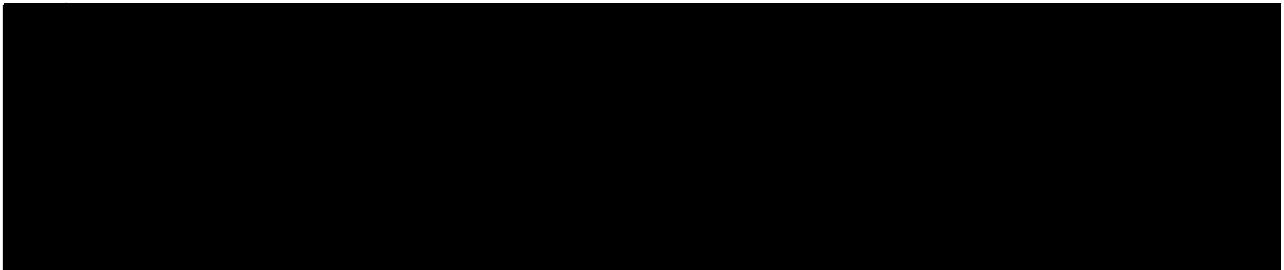
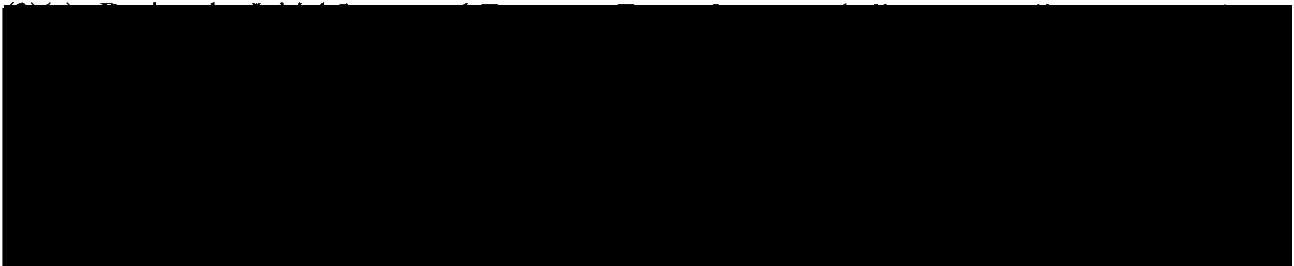

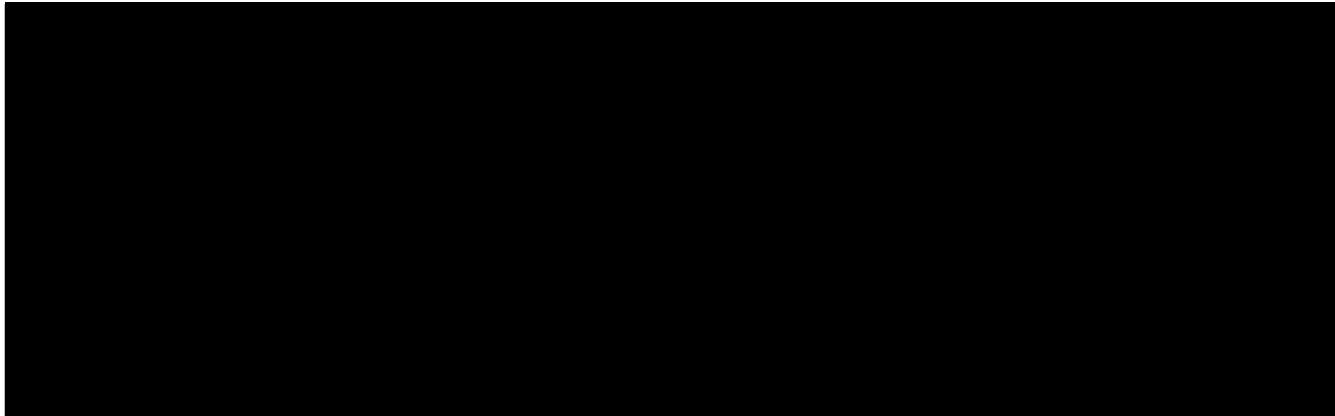

(4) Crop Compensation.

(4)(c) During the Initial Construction Period, Estimated Losses to Agricultural Land

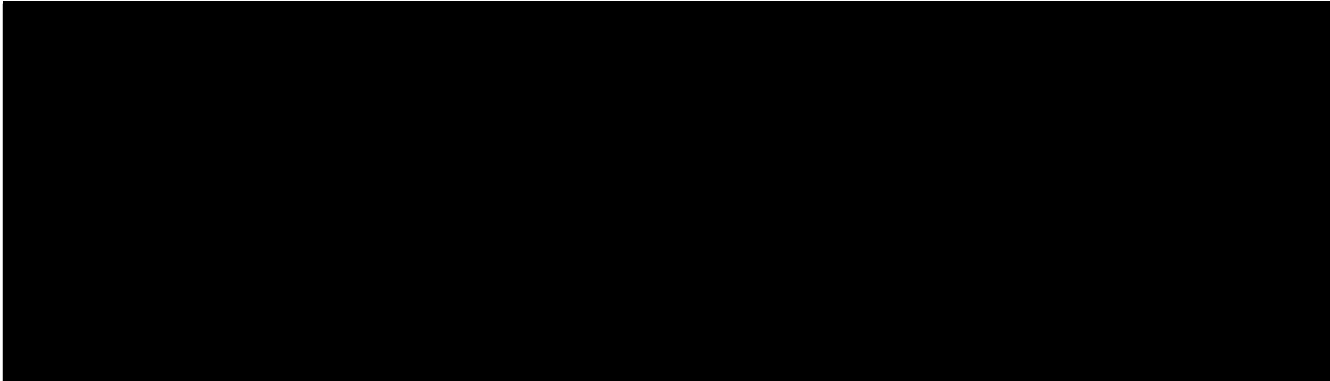
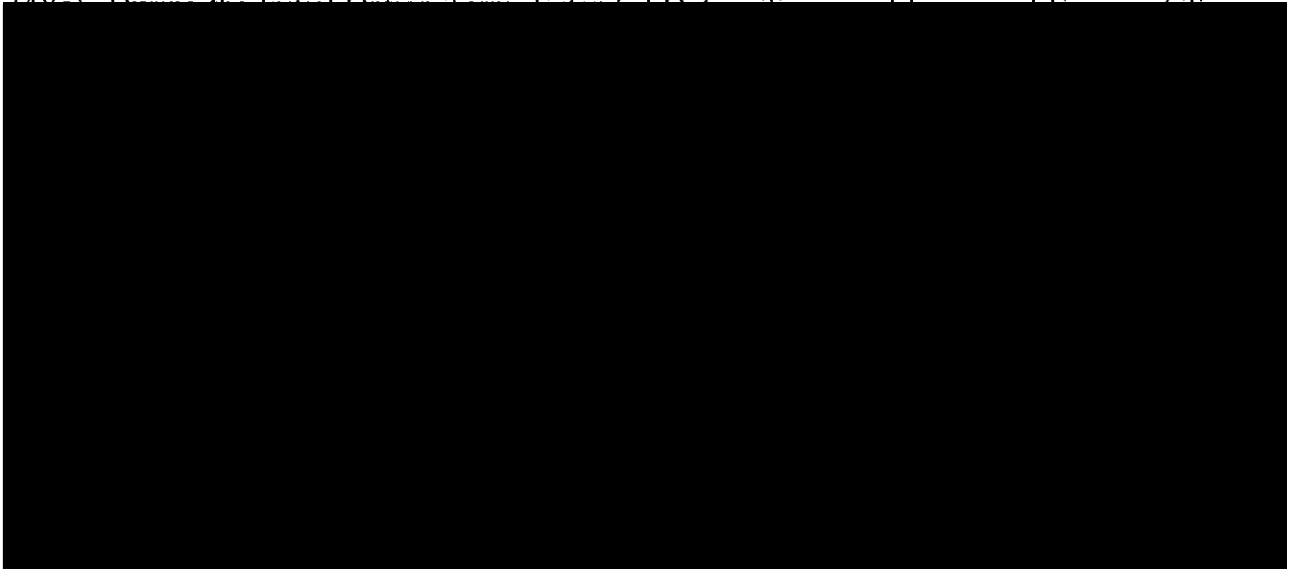

(5) Payment Allocation Schedule.

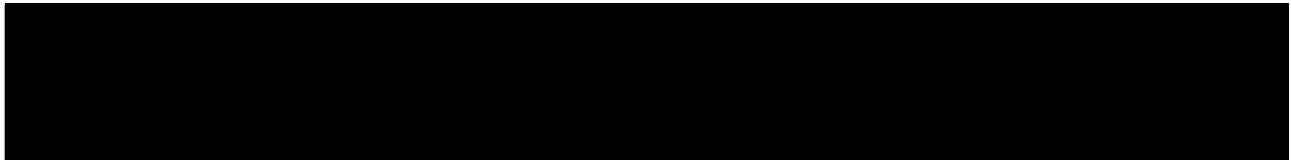

Kentucky

SOLAR LEASE AND EASEMENT AGREEMENT

Parties. This Solar Lease and Easement Agreement ("**Agreement**") is made and entered as of the 19 day of October, 2021 ("**Effective Date**"), by and between Jon Barton Eblen and Marie Eblen, a/k/a Marie Annette Eblen, husband and wife ("**Owner**") and Sebree Solar, LLC, a Delaware limited liability company ("**Operator**"), which are sometimes individually referred to as a "**Party**" and collectively as the "**Parties**".

1. **Project.** This Agreement relates to the solar-powered electrical power generation and transmission project known as the "Sebree Solar Energy Center Energy Center" to be located in Henderson County, Kentucky ("**Project**"), which may be wholly or partially located on the Owner's property legally described on the attached **Exhibit A** to this Agreement, excluding those areas depicted as the "Exclusion Area" on composite Exhibit A-1 attached hereto ("**Owner's Property**"). Upon Operator's exercise of the Option (as defined below), the Project shall include (i) the Lease of Owner's Property described in Section 4, (ii) the Easements referenced in Section 5 that are located on the Owner's Property, and (iii) the Improvements referenced in Section 8 to be constructed on Owner's Property. The Lease, Easements and Improvements are sometimes collectively referred to as the "**Operator Property**".

2. **Option.** Owner grants to Operator an exclusive option ("**Option**") to acquire the Lease and Easements referenced in Sections 4 and 5 in accordance with the following terms and conditions. Operator shall be entitled to acquire the Lease and the Easements in their entirety or in part, as Operator deems appropriate.

2.1 **Option Term.** The period during which Operator may exercise the Option shall be for a term of five (5) years, commencing on the Effective Date ("**Option Term**").

2.2 **Option Payment.** As consideration for the granting of the Option, Operator agrees to pay Owner the Option Payment set forth in **Exhibit D**.

2.3 **Use of Owner's Property.** During the Option Term, Operator and its employees, agents and contractors shall have a right to enter upon the Owner's Property and the right of ingress and egress over and across the Owner's Property for the purposes of (i) surveying the Owner's Property; (ii) performing such other tests and studies as Operator may desire in connection with the Option, including, without limitation, environmental, avian and cultural resource assessments, and geotechnical, foundation and soil tests, provided that such activities do not unreasonably interfere with Owner's use of the Owner's Property; and (iii) installing, maintaining, operating, inspecting and removing one or more weather related instruments ("**Weather Instrument**") and fencing of said Weather Instrument and including the performance of all tests and studies associated therewith. Owner shall not permit any other individual or entity except Operator or its affiliates to install a Weather Instrument on Owner's Property.

All topsoil disturbed by the work on the project prior to installation will be segregated and restored as topsoil upon completion of the pre-installation work. Topsoil removed during installation shall be placed elsewhere on Owner's property at Owner's direction. Operator shall give Owner ninety (90) days' notice prior to commencement of installation. If, after giving notice, Operator fails to

commence timely, then Operator will be responsible to Owner for the loss of crop rent for the crop season if the subject property lies fallow.

2.4 **Right to Grant Option.** Owner warrants and represents to Operator that (i) the statements in Section 9 concerning Owner's title to the Owner's Property are true and correct; (ii) Owner has the authority to grant this Option to Operator without the consent or approval of any other party; and (iii) there are no other existing options, rights of first refusal, contracts to purchase, leases or mortgages that would prevent Operator from exercising its rights with respect to the Option.

2.5 **Exercise of Option.** Operator may exercise the Option by giving written notice to Owner ("**Option Notice**") at any time during the Option Term. Operator shall specify in the Option Notice the Commencement Date referenced in Section 6.1.1. On the Commencement Date, the Lease and Easements referenced in Sections 4 and 5 shall automatically become effective, and the Parties shall be subject to all of the terms and conditions of this Agreement with respect to such Lease and Easements and all rights and obligations relating thereto.

2.6 **Termination of Option.** If Operator fails to exercise the Option within the Option Term, the Option and the rights of Operator as the optionee shall automatically terminate.

3. **Lease.** Upon exercise of the Option by Operator, Owner leases to Operator, and Operator leases from Owner, Owner's Property for the Lease and Easement Term (defined in Section 6.1) in accordance with the terms and conditions of this Agreement ("**Lease**"), which Lease grants Operator and its agents, contractors, and employees the right to use the Owner's Property for the following permitted uses:

3.1 **Construction Right.** Operator leases Owner's Property for the purpose of constructing, operating, maintaining, repairing, replacing, and removing all or any part or component of the Improvements whether located on Owner's Property. Operator may exercise its right to use all or any part of the Owner's Property as and when Operator deems it necessary or advisable to do so to perform the activities for which this right is granted, including, without limitation, staging areas and parking for Operator's employees.

3.2 **Access Right.** Operator leases Owner's Property for unobstructed vehicular and pedestrian access and ingress to and egress from the Improvements, Owner's Property and any public roadways, and to construct, maintain, and utilize Roadway Improvements on the Owner's Property. Owner shall not permit others to obstruct or damage the roads or Roadway Improvements located on the Owner's Property or in any other way interfere with Operator's rights under this right. Operator shall repair any damage done to Roadway Improvements which result from use by Operator, its agents, servants or employees. Such roads shall be maintained in the condition necessary for use by Operator's equipment, and with regard to existing roads, shall be maintained in at least the condition that existed prior to Operator's use.

3.3 **Solar Panels Right.** Operator leases Owner's Property for Operator to construct, operate, replace, relocate, remove, and maintain Solar Panels and the appurtenant Collection Facilities, together with associated roads and parking areas on Owner's Property.

3.4 **Collection Facilities Right.** Operator leases Owner's Property for Operator to construct, operate, maintain, replace, relocate or remove Collection Facilities on and under the Owner's Property. Notwithstanding anything else contained herein to the contrary, the Operator shall have easement rights over the Exclusion Areas depicted on Exhibit A-1 attached hereto, for the purposes of installing and maintaining Collection Facilities thereon, including the right to access such areas.

3.5 **Substation Right.** Operator leases Owner's Property for Operator to construct, operate, maintain, replace, relocate or remove one or more Substations on Owner's Property.

3.6 **Telecommunication Right.** Operator leases Owner's Property for Operator to construct, operate, maintain, replace, relocate or remove Telecommunication Facilities on and under the Owner's Property.

3.7 **Weather Instrument Right.** Operator leases Owner's Property in order to construct, operate, replace, relocate, remove, and maintain a Weather Instrument and the appurtenant Collection Facilities on Owner's Property.

3.8 **Battery Facilities Right.** Operator leases Owner's Property in order to construct, operate, replace, relocate, remove, and maintain one or more Battery Facilities on Owner's Property.

3.9 **Agreed set back & Exclusion Area.** Regardless of the foregoing paragraphs in this Section 3, Operator agrees to a forty foot (40') setback from Owner's existing Morton Building located on the Property as depicted on Exhibit A-1 attached hereto. For the avoidance of doubt, the two exclusion areas are connected by a 25' wide strip exclusion area along the eastern boundary to provide access to the rear exclusion area.

4. **Grant of Easements.** Upon the exercise of the Option by Operator, Owner grants to Operator, and Operator accepts from Owner, for the Lease and Easement Term referenced in Section 6.1, the following easements over and across the Owner's Property in accordance with the terms and conditions of this Agreement. The following easements are for the benefit of Operator and Operator's agents, contractors and employees and located on the Owner's Property and are collectively referred to as the "**Easements**".

4.1 **Sun Non-Obstruction Easement.** Owner grants Operator an irrevocable, exclusive easement for the right and privilege to use, maintain and capture the free and unobstructed sunlight over and across the Owner's Property. Owner shall not engage in any activity on Owner's Property or any other neighboring property owned by Owner that might interfere with the sunlight direction over any portion of Owner's Property; cause a decrease in the output or efficiency of any Solar Panel or Weather Instrument; or otherwise interfere with Operator's operation of the Project or exercise of any rights granted in this Agreement (collectively "**Interference**"). This grant of the easement expressly includes the right of Operator to enforce

Operator's rights, including the physical removal of trees or structures (except existing trees and structures) causing Interference to the Project contemplated by Operator. Operator shall notify Owner before making any such removals.

4.2 **Effects Easement.** Owner grants to Operator an easement over Owner's Property for visual, view, light, flicker, noise, shadow, vibration, electromagnetic, electrical and radio frequency interference, and any other effects attributable to the Project located on the Owner's Property.

5. **Term.** The term of this Agreement ("**Term**") includes the Option Term referenced in Section 3.1, the Initial Lease and Easement Term as described in Section 6.1.1 and the Extended Lease and Easement Term as described in Section 6.1.2 (together, the Initial Lease and Easement Term and the Extended Lease and Easement Term, if applicable, is defined as the "**Lease and Easement Term**").

5.1 **Lease and Easement Term.**

5.1.1 **Initial Lease and Easement Term.** The initial term of the Lease and Easements shall commence on the date specified by Operator in the Option Notice ("**Commencement Date**"). The initial term of the Lease and Easements shall end thirty (30) years after the Commencement Date (the "**Initial Lease and Easement Term**"), subject to the rights of renewal and termination as provided in this Agreement.

5.1.2 **Extended Lease and Easement Term.** Operator shall have the right to extend the Term of this Agreement for two (2) consecutive terms of five (5) years each in accordance with the terms and provisions of this Agreement (collectively "**Extended Lease and Easement Term**") by providing written notice to Owner of Operator's intent to extend the Term within one hundred eighty (180) days of the end of the existing Term. Each Extended Lease and Easement Term shall begin on the expiration date of the Initial Lease and Easement Term or previous Extended Lease and Easement Term, as the case may be. During the Extended Lease and Easement Term, Operator shall pay Owner the amounts set forth in **Exhibit D** as the consideration for the Lease and Easements.

5.1.3 **Delays During Lease and Easement Term.** At Operator's option, the Term may be extended for a period of time equal to the period of time during which operation of the Project is delayed or suspended because of the occurrence of a Regulatory Suspension or Force Majeure, which are defined as follows:

(i) "**Regulatory Suspension**" shall mean the enactment or application of any law, order, rule, or regulation of the Kentucky Public Service Commission, Federal Energy Regulatory Commission, or other local, state, or federal government authority having jurisdiction over the Project or Operator, or the failure of any such governmental authority to issue an approval or permit pursuant to any such law, order, rule, or regulation, which results in the delay, interruption, or suspension of the production, sale or transmission of electricity from the Solar Panels; and

(ii) "**Force Majeure**" shall mean causes beyond the reasonable control of and without the fault or negligence of the Party claiming Force Majeure, including but not limited to acts of God, labor unrest (including, but not limited to, slowdowns, picketing, boycotts or strikes), flood, earthquake, storm, fire, lightning, explosion, power failure or power surge, vandalism, theft, the cutting of power, transmission or other lines, wires or cables to the Project by persons other than Operator's employees or contractors, epidemic, war, revolution, riot, civil disturbance, sabotage, change in law or applicable regulation subsequent to the Commencement Date and action or inaction by any federal, state or local legislative, executive, administrative judicial agency or body which in any of the foregoing cases, by exercise of due foresight such Party could not reasonably have expected to avoid, and which, by the exercise of due diligence, it is unable to overcome.

The Parties shall be excused from performing their respective obligations under this Agreement and shall not be liable in damages or otherwise if and to the extent that they are unable to so perform or are prevented from performing by a Force Majeure, provided that: (i) the non-performing Party, as promptly as practicable after the occurrence of the Force Majeure, but in no event later than thirty (30) days thereafter, gives the other Party written notice describing the particulars of the occurrence; (ii) the suspension of performance is of no greater scope and of no longer duration than is reasonably required by the Force Majeure; (iii) the non-performing Party uses good faith and commercially reasonable efforts to remedy its inability to perform; and (iv) as soon as the non-performing Party is able to resume performance of its obligations excused as a result of the occurrence, each Party shall give prompt written notification thereof to the other Party.

5.2 **Termination by Operator.** Provided Operator is not in default under any term of this Agreement, Operator, at its option, shall have the right to terminate this Agreement at any time during the Term of the Agreement, as to all or any part of the Operator Property. Termination shall be effective thirty (30) days after written notice of such termination to Owner. If Operator's notice is a full termination of the Operator Property, the Parties shall be relieved of all further duties and obligations under this Agreement, other than (i) the payment of any accrued and unpaid obligations owed by either Party as of the date of termination; (ii) the removal of the Improvements by Operator pursuant to Section 8.11; and (iii) any other obligations and liabilities that are expressly stated in this Agreement to survive such termination. Upon any such partial termination by Operator, the Parties shall be relieved of all further duties and obligations under this Agreement with respect to the portion thereof terminated by Operator, subject to the obligations and liabilities referenced in items (i) through (iii) above that shall continue to be applicable to the terminated portion of this Agreement. The Parties agree to execute an amendment to this Agreement evidencing such partial termination.

6. **Payments.** If Operator exercises the Option referenced in Section 3, Operator agrees to pay Owner the amounts set forth in **Exhibit D** as consideration for the Lease, Easements and Operator's other rights and interests in the Owner's Property.

7. **Improvements.** Operator shall have the right, at its sole cost and expense, to construct, install, maintain, use, operate, repair, replace, relocate and remove all facilities, structures, equipment, machinery, wires, conduit, cables, poles, materials and property of every kind and character required for the construction and operation of portions of the Project on the Owner's Property, including, but not limited to, the Solar Panels, Collection Facilities, Substations,

Telecommunication Facilities, Weather Instruments, Roadway Improvements and Battery Facilities referenced in Sections 8.1 through 8.7 (collectively, the "**Improvements**").

7.1 "**Solar Panels**" shall mean any photovoltaic energy system designed for the generation of electrical power from the collection of sunlight, including without limitation, the photovoltaic panels, foundations, support structures, braces and related equipment.

7.2 "**Collection Facilities**" shall mean all Improvements whose purpose is to deliver electrical power generated by the Solar Panels to an electrical power grid or other system, including without limitation transformers, overhead and underground electrical collection lines, telecommunication lines, splice boxes and interconnection facilities.

7.3 "**Substations**" shall mean electrical lines, meters, monitoring and control equipment, switches, transformers, all structures, equipment, enclosures, fencing, security devices, and other electrical and communications equipment necessary to condition and increase the voltage of electricity generated by the Project to make it suitable for transmission on, and to deliver it to, Collection Facilities connected to an electric power grid or other system.

7.4 "**Telecommunication Facilities**" shall mean all Improvements whose purpose is to provide telecommunication services solely relating to the Project or any of Operator's solar powered projects, including telephone, closed-circuit television, microwave, internet, computer data and other telecommunication services.

7.5 "**Weather Instrument**" shall mean instruments used primarily to gather and transmit sunlight and meteorological data relating to the Project, and includes the instrument's foundations, guy wires, sunlight and meteorological data acquisition equipment, power source, and any required data and electrical transmission lines.

7.6 "**Roadway Improvements**" shall mean all improvements that may be necessary to construct, maintain and repair any new and existing roadways and other means of ingress and egress over, across and along the Owner's Property, including paving or surfacing of the roadways with asphalt, gravel or other roadway materials, installation of road signs and the construction and installation of culverts, bridges, drainage ditches, gates, cattle guards and similar structures and facilities.

7.7 "**Battery Facilities**" shall mean a type of equipment that can be given a new charge by passing an electric current through it designed for the storage of electrical power including without limitation, batteries and other devices for storage of electrical energy, foundations, support structures, braces and related equipment.

7.8 **Ownership of Improvements.** Except as otherwise provided in Section 11.7, all Improvements shall at all times remain the property of Operator, and Owner shall have no right, title or interest therein. All Improvements constructed or placed on the Owner's Property by Operator during the Term of this Agreement may be repaired, replaced, relocated, removed, added to or expanded upon by Operator at any time during the Term of this Agreement. Owner expressly waives any statutory lien or common law liens on the Improvements to which Owner might be entitled.

7.9 **Construction Liens.** Operator shall not permit any liens arising out of Operator's use of the Operator Property under this Agreement to be filed against the Owner's Property. Operator shall, within sixty (60) days after it receives notice of the lien, provide a bond or other security that Owner may reasonably request, or remove such lien from the Owner's Property in the manner provided by applicable law.

7.10 **Location of Improvements.** The acreage required from the Owner's Property for the Improvements for which the Lease and Easements are being granted cannot be determined until the completion of Operator's inspection, testing, study and surveying of the Owner's Property during the Option Term. Operator shall not install any Improvements in the excluded areas of Owner's Property depicted in **Exhibit B-1** without obtaining the prior consent of Owner. Owner will consent to underground Collection lines only in the excluded area located on the eastern boundary line of Parcel 3 between the adjoining parcels. Along with the Option Notice, Operator shall deliver to Owner a proposed plan of development showing the contemplated locations of the Improvements and a preliminary calculation of the acreage as determined by the area bounded by a perimeter fence required for the Project, which shall serve as the **Exhibit B-2** to this Agreement. During the final development and construction of the Project, such locations may need to be amended. Following construction of the Project, Operator shall provide Owner an "as-built" survey of all Improvements on Owner's Property and the final calculation of the acreage as determined by the area bounded by a perimeter fence required for the Project, which shall serve as **Exhibit C** to this Agreement. Further, following construction, the Improvements may need to be relocated or rerouted by Operator, which Operator may perform, at any time during the Term of this Agreement, so long as the nature and extent of any such relocated or rerouted Improvements are not materially different and impose no materially greater burden on the Owner's Property than the original locations or routes, and so long as Operator takes commercially reasonable efforts to minimize disruption or inconvenience to Owner. Owner's property may be a portion of the project that encompasses other properties. In the event that the project fence includes any portion of the Owner's property boundary that is not a straight line, corners of Owner's boundaries within the project perimeter fence will be marked by Operator with a pin or similar survey marker. Additionally, Operator will place a fence on both sides of the road that leads to the cemetery on PVA Map Number 71-38 for Owner's family's access. Operator will install a natural screen barrier at a location selected by Owner so as to visually obstruct the project from the Owner's residence. The natural screen barrier will be that required by the Henderson County solar ordinance and the approved conditional use permit for the Operator's Solar Project.

7.11 **Removal of Improvements.** Upon full or partial termination of any of the Lease Rights or Easements, Operator shall remove all Improvements and restore the area formerly occupied by the Improvements to substantially the same physical condition that existed immediately before the construction of the Improvements (the "**Removal Obligations**"). At Owner's request, all or any part of the Roadway Improvements may be left for use by Owner.

8. Intentionally omitted.

9. **Ownership and Title Matters.** Owner warrants and represents to Operator, both as of the Effective Date, and as of the Commencement Date as follows:

9.1 **Authority.** Owner represents and warrants that it is the holder of fee simple title and is the sole owner of the Owner's Property and has the unrestricted right and authority to sign this Agreement and to grant Operator the Lease and Easements and other rights granted in this Agreement. When signed by both Parties, this Agreement constitutes a valid and binding agreement enforceable against Owner in accordance with its terms.

9.2 **Other Agreements.** The Owner's Property is not subject to any other agreements, options, rights of first refusal or other prior right of any party to purchase, lease or acquire easements in the Owner's Property, or create any prior claim or right that would preclude or interfere with Operator's rights and interests under this Agreement and the Lease and Easements.

9.3 **Minerals.** Except as disclosed by Owner to Operator at the time of the execution of this Agreement by Owner, Owner owns all of the oil, gas and other minerals, and all rights thereto as on or under the Owner's Property.

9.4 **Owner Mortgage.** Except as disclosed by Owner to Operator at the time of the execution of this Agreement by Owner, there are no mortgages encumbering the Owner's Property ("**Owner Mortgage**").

9.5 **Notice and Opportunity to Cure.** If there is an Owner Mortgage encumbering Owner's Property and Owner receives from the holder thereof any notice that payments are overdue, Owner shall notify Operator and each Operator Mortgagee (as defined at Section 13.1) by sending a copy of such overdue payment notice to Operator by the earlier of (i) five (5) days after receipt, or (ii) three (3) business days prior to the date by which a default under or in respect of such Owner Mortgage could occur. If Operator or any Operator Mortgagee determines that it would be in Operator's interest to make such payments to Owner Mortgagee on Owner's behalf, whether as a result of receiving such notice or otherwise, Operator shall have the right to make such payments and to credit the payments so made against the Annual Installment Payment next due under the Agreement.

9.6 **Subordination, Non-Disturbance & Attornment Agreement.** If there is an Owner Mortgage encumbering Owner's Property, Owner shall cooperate with Operator to obtain a Subordination, Non-Disturbance and Attornment Agreement ("**SNDA**") in the form prepared and provided by Operator, from each Owner Mortgagee, pursuant to which such Owner Mortgagee agrees, among other things, not to disturb Operator's possession and use of the Owner's Property. Owner shall not incur any loss in income, expense, obligation or liability with regard to the SNDA. Operator shall, at its sole cost and expense, record each such SNDA in the Office of the County Clerk in which Owner's Property is located. If Owner fails to deliver a SNDA from each Owner Mortgagee, Operator may, at its sole option, either (i) terminate this Agreement immediately upon written notice to Owner, or (ii) take such action as Operator deems reasonably necessary to effect the rights granted to Operator hereunder, and off-set all amounts expended in such efforts against the Annual Installment Payments and any other amounts due hereunder or in respect hereof.

10. **Representations and Warranties of Owner.** Owner hereby makes the following further representations and warranties both as of the Effective Date, and as of the Commencement Date:

10.1 **Physical Condition.** Owner has no knowledge of any existing physical conditions of the Owner's Property which would prevent, significantly restrict or make more expensive Operator's development of the Owner's Property for the purposes specified in this Agreement, or which could, with the passage of time, or the giving of notice, constitute a violation of any currently applicable governmental law, ordinance, order, rule or regulation.

10.2 **Legal Restrictions.** Owner has no knowledge of any law, regulation, ordinance or order of any local, state or federal governmental authority which would prohibit or significantly restrict Operator's development of the Owner's Property pursuant to this Agreement. This Agreement does not violate any contract, agreement, instrument, judgment or order to which Owner is a party or which affects the Owner's Property. To the best of Owner's knowledge, the Owner's Property is currently in full and complete compliance with all governmental laws, ordinances, orders, rules and regulations applicable to the Owner's Property.

10.3 **No Litigation.** No litigation is pending and, to the best of Owner's knowledge, no litigation or administrative actions are proposed, threatened or anticipated with respect to any matter affecting the Owner's Property. If Owner learns of any litigation or administrative action proposed, threatened or instituted with respect to the Owner's Property, Owner shall give Operator notice within thirty (30) days thereof.

10.4 **Survival.** The representations and warranties set forth in this Section 10 shall survive the execution and delivery hereof.

11. **Use, Operation and Maintenance.**

11.1 **Exclusive Use by Operator.** Operator shall have the exclusive right (i) to use and possess the Owner Property in connection with the Project and other similar solar-powered electrical power generation projects; (ii) to investigate, inspect, survey, and conduct tests of the Owner's Property, including, but not limited to, meteorological, environmental, archeological and geotechnical tests and studies; (iii) to use and convert all of the sunlight resources on the Owner's Property; and (iv) to undertake such other activities on the Owner's Property that may be related to the Project, including, without limitation, the storage of Solar Panels, materials and equipment during the installation and construction of the Improvements; development and operation of communications systems; and site tours of the Project for visitors and other interested parties.

11.2 **No Required Installation or Operation.** Nothing in this Agreement shall be interpreted as imposing on Operator any obligation to install Solar Panels or other Improvements on the Owner's Property, or to operate the Project on the Owner's Property. Operator shall have the sole discretion to determine if and when any Solar Panels and other Improvements may be constructed on Owner's Property, and if and when to commence the operation of the Project on the Owner's Property.

11.3 **Permits and Approvals.** Operator shall be responsible, at its sole cost and expense, for obtaining any governmental permits and approvals necessary for the construction and operation of the Project and the construction and operation of the Improvements. Owner shall cooperate with Operator as necessary to obtain any governmental or utility approvals or permits, including, without limitation, signing any applications for such approvals, provided that Owner

shall not incur any loss in income, expense, obligation or liability with respect to Operator obtaining such permits or approvals.

11.4 **Compliance with Laws.** Operator shall comply in all material respects with valid laws applicable to the Owner's Property and the Operator Property. Operator shall have the right, in its sole discretion and at its sole expense, in Operator's name to contest the validity or applicability to the Owner's Property and the Operator Property of any law, ordinance, statute, order, regulation, property assessment or the like made by any governmental agency or entity. Operator shall control any such contest and Owner shall cooperate with Operator in every reasonable way in such contest, provided that Owner shall incur no expense, obligation or liability with regard to such contest.

11.5 **Care and Appearance.** Operator, in its exercise of the lease, easement and other rights granted hereunder shall, at all times, maintain the Owner's Property and the Improvements in a reasonably neat, clean and presentable condition. Operator shall not willfully or negligently damage or destroy the Owner's Property and shall keep the Owner's Property clean and free of debris created by Operator, its contractors, or others brought on to the Owner's Property by Operator. Operator shall not use the Owner's Property for storage, except for materials, construction equipment and vehicles directly associated with construction or maintenance of the Improvements on the Owner's Property or adjacent properties that are part of the Project.

11.6 **Fences and Gates.** At Owner's request, Operator shall repair or replace any fences, gates or cattle guards damaged or removed in connection with Operator's activities on the Owner's Property. Fences removed from the Owner's Property, if replaced, shall be re-built by Operator at its expense in mutually agreeable locations. All fence repair and construction shall be substantially similar to the construction of existing fences and cattle guards on Owner's Property. Any gates opened for access to Owner's Property by either Party shall be closed immediately after passing through so that livestock may not pass through. Once completed, all replacement fences, gates and cattle guards shall be owned and maintained by Owner. Upon abandonment or termination of the rights granted to Operator in this Agreement, any fences, gates and cattle guards installed by Operator shall remain and become the property of Owner. To minimize the need for temporary fencing, Owner will cooperate with Operator to avoid pasturing animals on or near the Improvements during periods of construction, maintenance or removal activity by Operator. Owner will discuss with Operator what temporary fencing is necessary during the periods of construction, maintenance or removal activity by Operator.

11.7 **Roadway Maintenance and Repairs.** Operator agrees to maintain and repair all Roadway Improvements located on the Operator Property; provided, however, Owner shall reimburse Operator for any costs and expenses incurred by Operator to repair any damage or perform any special maintenance of the Roadway Improvements caused by Owner or any person using the Roadway Improvements with Owner's permission, other than Operator.

12. **Taxes.**

12.1 **Owner's Taxes.** Owner covenants and agrees to pay prior to delinquency all real and personal property and other taxes, general and special assessments, and other charges of every

description ("**Taxes**") levied or assessed against the Owner's Property and all improvements thereon by governmental authorities, other than Operator's Taxes referenced in Section 12.2 (Taxes, excepting Operator's Taxes, are hereinafter referred to as "**Owner's Taxes**").

12.2 **Operator's Taxes.** [REDACTED]

12.3 **Failure to Pay.** In the event either Party fails to pay their share of Taxes prior to delinquency, the other Party shall have the right to pay such Taxes and any accrued penalties or interest, which payments shall increase or be offset against other Payments due under this Agreement.

12.4 **Operator's Right to Contest.** Operator may contest the legal validity or amount of any Operator's Taxes for which it is responsible under this Agreement, and may institute such proceedings as it considers necessary, provided that Operator shall bear all expenses in pursuing such contest or proceeding. With respect to any Taxes which may constitute a lien on the Owner's Property, Operator shall promptly pay such Taxes unless the proceeding in which it contests such Taxes shall operate to prevent or stay the collection of the Taxes so contested or unless Operator removes any such lien by bonding or otherwise. Owner agrees to render to Operator all reasonable assistance in contesting the validity or amount of any such Taxes, with the exception of Taxes levied by Owner, including joining in the signing of any reasonable protests or pleading which Operator may deem advisable to file; provided, however, that Operator shall reimburse Owner for its reasonable out-of-pocket expenses, including reasonable attorneys' fees incurred in connection with providing such assistance.

13. **Mortgage of Operator Property.**

13.1 **Right to Mortgage.** Operator may, upon written notice to Owner, but without requiring Owner's consent or approval, mortgage, collaterally assign, or otherwise encumber and grant security interests in all or any part of its interest in this Agreement and the Operator Property. These various security interests in all or a part of this Agreement and the Operator Property are collectively referred to as an "**Operator Mortgage**" and holder of such security interest, an "**Operator Mortgagee**". Any Operator Mortgagee shall use the Operator Property only for the

uses permitted under this Agreement. Whenever Operator has granted a security interest under this Section 13, it will give Owner notice of the Operator Mortgage (including the name and address of the Operator Mortgagee for notice purposes) to Owner within thirty (30) days; provided that failure to give this notice shall not constitute a default under this Agreement, but rather shall only have the effect of not binding Owner to provide such Operator Mortgage notice until the Operator and its address is given to Owner.

13.2 **Notice of Default and Opportunity to Cure.** As a precondition to exercising any rights or remedies related to any alleged default by Operator under this Agreement, Owner shall give written notice of the default to each Operator Mortgagee at the same time it delivers notice of default to Operator, specifying in detail the alleged event of default and the required remedy. Each Operator Mortgagee or its designee shall have the right, but not the obligation, to cure any default as Operator, and/or the right, but not the obligation, to remove any Improvements or other property owned by Operator or such Operator Mortgagee located on the Owner's Property to the same extent as Operator. The cure period for any Operator Mortgagee shall be the later of (i) the end of the Operator cure period under Section 18; (ii) thirty (30) days after such Operator Mortgagee's receipt of the default notice; or (iii) if applicable, the extended cure period provided for in Section 13.3. Failure by Owner to give an Operator Mortgagee notice of default shall not diminish Owner's rights against Operator, but shall preserve all rights of the Operator Mortgagee or its designee to cure any default and to remove any Improvements or other property of Operator or the Operator Mortgagee located on the Owner's Property.

13.3 **Extended Cure Period.** If any default by Operator under this Agreement cannot be cured without the Operator Mortgagee obtaining possession of all or part of the Operator Property, then any such default shall be deemed remedied if an Operator Mortgagee: (i) within sixty (60) days after receiving notice from Owner as set forth in Section 13.2, acquires possession of all or part of the Operator Property, or begins appropriate judicial or nonjudicial proceedings to obtain the same; (ii) diligently prosecutes any such proceedings to completion; and (iii) after gaining possession of all or part of the Operator Property performs all other obligations as and when the same are due in accordance with the terms of this Agreement. If an Operator Mortgagee is prohibited by any court or by operation of any bankruptcy or insolvency laws from commencing or prosecuting the proceedings described above, the sixty (60) day period specified above for commencing proceedings shall be extended for the period of such prohibition.

13.4 **Operator Mortgagee Liability.** Any Operator Mortgagee whose interest in the Operator Property is held solely for security purposes, shall have no obligation or liability under this Agreement unless and until the Operator Mortgagee succeeds to absolute title to the Operator Property and the rights of Operator under this Agreement. An Operator Mortgagee shall be liable to perform obligations under this Agreement only for and during the period it directly holds such absolute title.

13.5 **Certificates.** Owner shall execute any estoppel certificates (certifying as to truthful matters, including without limitation that no default then exists under this Agreement, if such be the case), consents to assignment and non-disturbance agreements as Operator or any Mortgagee may reasonably request from time to time. The Parties shall negotiate in good faith any amendment to this Agreement from time to time to include any provision that may be reasonably

requested by Operator or any Operator Mortgagee to implement the provisions contained in this Agreement or to preserve an Operator Mortgagee's security interest.

13.6 **Operator Mortgagee's Right to Enforce Mortgage and Assign.** Each Operator Mortgagee shall have the right, in its sole discretion: (i) to assign its Operator Mortgage; (ii) to enforce its lien and acquire title to all or any portion of the Operator Property by any lawful means; (iii) to take possession of and operate all or any portion of the Operator Property and to perform all obligations to be performed by Operator under this Agreement, or to cause a receiver to be appointed to do so; and (iv) to acquire all or any portion of the Operator Property by foreclosure or by an assignment in lieu of foreclosure and thereafter to assign or transfer all or any portion of the Operator rights under this Agreement to a third party in accordance with Section 14. Any Operator Mortgagee or other party who acquires Operator's interest in all or a portion of the Operator Property pursuant to foreclosure or assignment in lieu of foreclosure shall not be liable to perform the obligations imposed on Operator by this Agreement, which are incurred or accruing after such Operator Mortgagee or other party no longer has ownership or possession of the Operator Property.

13.7 **New Agreement.**

13.7.1 If the Operator Property is foreclosed upon or there is an assignment in lieu of foreclosure, or if this Agreement is rejected or disaffirmed pursuant to bankruptcy law or other law affecting creditor's rights and, within ninety (90) days after such event, Operator or any Operator Mortgagee or other purchaser at a foreclosure sale shall have arranged to the reasonable satisfaction of Owner to cure any material defaults under this Agreement, and for the payment of all Annual Installment Payments or other charges due and payable by Operator as of the date of such event, then Owner shall execute and deliver to Operator or such Operator Mortgagee or other purchaser at a foreclosure sale, or to a designee of one of these parties, as the case may be, a new agreement ("**New Agreement**") which (i) shall be for a term equal to the remainder of the Term of this Agreement before giving effect to such rejection or termination; (ii) shall contain the same covenants, agreements, terms, provisions and limitations as this Agreement (except for any requirements that have been fulfilled by Operator or any Operator Mortgagee or other purchaser at a foreclosure sale prior to rejection or termination of this Agreement); and (iii) shall include that portion of the Operator Property in which Operator or such other Operator Mortgagee or other purchaser at a foreclosure sale had an interest on the date of rejection or termination.

13.7.2 If more than one Operator Mortgagee makes a written request for a New Agreement pursuant to this provision, the New Agreement shall be delivered to the Operator Mortgagee requesting such New Agreement whose Operator Mortgage is prior in time, and the written request of any other Operator Mortgagee whose lien is subordinate shall be void and of no further force or effect. The provisions of this Section 13 shall survive the termination, rejection or disaffirmation of this Agreement and shall continue in full force and effect thereafter to the same extent as if this Section 13 were a separate and independent contract made by Owner, Operator and each Operator Mortgagee, and, from the effective date of such termination, rejection or disaffirmation of this Agreement to the date of execution and delivery of such New Agreement, such Operator Mortgagee or other purchaser at a foreclosure sale may use and enjoy the Operator Property without hindrance by Owner or any person claiming by, through or under Owner; provided that all of the conditions for the New Agreement as set forth above are complied with.

13.8 **Operator Mortgagee's Consent to Amendment, Termination or Surrender.**

Notwithstanding any provision of this Agreement to the contrary, the Parties agree that so long as any Operator Mortgage remains outstanding, this Agreement shall not be modified or amended, and Owner shall not accept a surrender, cancellation or release of all or any part of the Operator Property from Operator, prior to expiration of the Term of this Agreement, without the prior written consent of the Operator Mortgagee holding such Operator Mortgage. This provision is for the express benefit of and shall be enforceable by each Operator Mortgagee as if it were a party named in this Agreement.

14. **Assignment and Sublease.** Operator shall have the right, to sell, convey, lease, or assign all or any portion of this Agreement or the Operator Property, on either an exclusive or a non-exclusive basis, or to grant subeasements, co-easements, easements, licenses or similar rights with respect to the Operator Property (collectively, "**Assignment**"), to one or more persons or entities (collectively "**Assignee**"). Each Assignee shall use the Operator Property only for the uses permitted under this Agreement. Operator may make a complete assignment of this Agreement only in connection with the assignment of all, or substantially all, of the assets of Operator and be released from liability hereunder in such event from obligations subject thereof accruing after the date that liability for such obligations is assumed by the Assignee. In the event of any partial assignment of Operator's rights hereunder, Operator shall not be released from liability hereunder without Owner's written consent. When Operator makes any Assignment under this Section 14, Operator shall give written notice to Owner of such Assignment (including the interest conveyed by the Assignment and address of the Assignee for notice purposes) to Owner; provided Operator's failure to give such notice shall not constitute a default under this Agreement, but rather shall only have the effect of not binding Owner with respect to such assignment or conveyance until such notice is given

15. **Hazardous Materials.**

15.1 **Owner's Covenants Regarding Hazardous Materials.** Owner represents and warrants that, to the best of Owner's knowledge, the Owner's Property is not and has not been in violation of any federal, state or local environmental health or safety laws, statute, ordinance, rule, regulation or requirement ("**Environmental Laws**"), and Owner has not received any notice or other communication from any governmental authorities alleging that the Owner's Property is in violation of any Environmental Laws. "**Hazardous Materials**" shall mean any asbestos containing materials, petroleum, explosives, toxic materials, or substances regulated as hazardous wastes, hazardous materials, hazardous substances, or toxic substances under any federal, state, or local law or regulation. Owner warrants that Owner has done nothing to contaminate the Operator Property with Hazardous Materials or wastes.

15.2 **Operator's Covenants Regarding Hazardous Materials.** Operator shall, at Operator's sole cost and expense, promptly take removal or remedial action required by Environmental Law with regard to any material violation of any Environmental Law with regard to any Hazardous Materials brought onto the Owner's Property by Operator or its employees, agents, or contractors. Owner shall cooperate with Operator with regard to any scheduling or access to the Owner's Property in connection with any action required hereunder.

15.3 **Operator's Indemnity Regarding Hazardous Materials.** Operator shall indemnify, defend, protect and hold Owner harmless from any liability based on: (i) the release of Hazardous Materials in, on, under or about the Owner's Property caused by Operator or its employees, agents, or contractors, or (ii) the violation by Operator or its employees, agents, or contractors of any Environmental Law. The indemnity obligations set forth herein shall survive termination of this Agreement.

16. **Insurance and Indemnity.**

16.1 **Insurance.** At all times during which Operator is conducting any activities on the Property and at all times during the Term of this Agreement, Operator shall maintain in effect (1) commercial General Liability Insurance, including bodily injury and property damage coverage with minimum limits of \$1 Million Dollars per occurrence and \$2 Million Dollars aggregate and (2) Umbrella Liability Insurance with minimum limits of \$5 Million Dollars per occurrence and \$5 Million Dollars aggregate. Upon a written request by Owner, Operator shall name Owner as additional insured on such insurance policy and provide Owner with a certificate of such insurance.

16.2 **Indemnity by Operator.** Operator shall defend, indemnify, protect and hold Owner harmless from and against all liabilities, costs, expenses, obligations, losses, damages, claims, (collectively "**Claims**") resulting from the negligence, willful misconduct, or breach of this Agreement by Operator, its agents, contractors or employees, invitees, licensees and permittees; provided, however, that such Claims are not due to the sole negligence, willful misconduct, or breach by Owner, its agents, contractors or employees, invitees, licensees or permittees.

16.3 **Indemnity by Owner.** Owner shall defend, indemnify, protect, and hold Operator harmless from and against all Claims resulting from the negligence, willful misconduct, or breach of this Agreement by Owner, its agents, contractors or employees, invitees, licensees and permittees; provided, however, that such Claims are not due to the sole negligence, willful misconduct, or breach by Operator, its agents, contractors, employees, invitees, licensees, or permittees.

16.4 **Survival.** The obligations of the Parties under this Section 16 shall survive expiration or other termination of this Agreement.

17. **Confidentiality.** This Agreement includes confidential and proprietary information relating to Operator and the Project. Owner agrees not to provide copies of the Agreement or disclose the terms of the Agreement to any unauthorized person or entity. Operator authorizes Owner to provide copies of the Agreement and disclose the terms thereof to Owner's family ("family" shall be deemed to include all devisees or descendants of owner by will or intestacy), attorney, accountant, financial advisor and any existing or prospective mortgagee, lessee, or purchaser for the sole purpose of evaluating and advising Owner and for no other purpose, so long as such authorized parties agree in writing to become subject to the confidentiality provisions hereto and not to provide copies of the Agreement or disclose the terms thereof to any unauthorized person or entity. Any Owner and party shall return all material containing any confidential information to Operator immediately upon its request. Any party agrees to destroy immediately upon request by Operator such analyses, compilation, studies or other documents, and any oral information will continue to be subject to the terms of this Agreement. Owner agrees that Operator will have no adequate remedy at law if any

party violates any of the terms of this Agreement. In such event Operator will have the right, in addition to any other rights Operator may have, to obtain injunctive relief to restrain any breach or threatened breach by third party or specific enforcement of such terms plus reimbursement of attorneys' fees, court costs and all associated expenses. No party shall publish, file for public record, reproduce, or otherwise disseminate this document or any of the terms and provisions hereof to any party, other than the Parties set forth above without the prior written consent of Operator, which consent may be withheld for any reason and in Operator's sole discretion.

18. **Default and Remedies.**

18.1 **Operator Payment Default.**

[REDACTED]

18.1.1 **Collection of Payments.**

[REDACTED]

18.1.2 **Terminate Agreement.**

[REDACTED]

18.2 **Other Operator Default.**

[REDACTED]

[REDACTED]

18.3 **Owner Default.** [REDACTED]

[REDACTED]

19. **Condemnation.**

19.1 **Complete Taking.** If, at any time, any authority having the power of eminent domain shall condemn all or substantially all of the Operator's Property, or all of the Improvements thereon, for any public use or otherwise, then the interests and obligations of Operator under this Agreement in or affecting the Operator's Property shall cease and terminate upon the earlier of (i) the date that the condemning authority takes physical possession of the Operator's Property or the Improvements thereon, (ii) the date that Operator is, in its sole judgment, no longer able or permitted to operate the Project on the Operator's Property in a commercially viable manner, or (iii) the date of the condemnation judgment. Operator shall continue to pay all amounts payable hereunder to Owner until the earlier of such dates, at which time the Parties shall be relieved of any and all further obligations and conditions to each other under this Agreement.

19.2 **Partial Taking.** If, at any time during the term of this Agreement, any authority having the power of eminent domain shall condemn one or more, but not all, of the Solar Panels, or any portion of the Improvements or the Operator's Property, then the interest and obligations of Operator under this Agreement as to those Solar Panels or any portion of the Improvements or the Operator's Property so taken shall cease and terminate upon the earlier of (i) the date that the condemning authority takes possession of such Solar Panels or any portion of the Improvements

or the Operator's Property, (ii) the date that Operator is, in its reasonable judgment, no longer able or permitted to operate the Project on the Operator's Property, or any portion thereof, in a commercially viable manner, or (iii) the date of the condemnation judgment; and, unless this Agreement is terminated as hereinafter provided, this Agreement shall continue in full force and effect as to the remainder of the Solar Panels, Improvements and the Operator's Property. If the remainder of the Solar Panels or any other portion of the Improvements or the Operator's Property is or becomes insufficient or unsuitable for Operator's purposes hereunder, as determined by Operator in its sole discretion, then, subject to the rights of any Operator Mortgagee under Section 13, Operator shall have the right to terminate this Agreement as to the portion of the Operator's Property to which Operator continues to hold the rights, at which time the Parties shall be relieved of any further obligations and duties to each other under this Agreement.

19.3 **Apportionment, Distribution of Award.** On any taking, all sums awarded, including damages and interest, shall be paid as follows:

- (a) Any portion of the award by the court on account of any cost or loss that Operator may sustain in the removal and relocation of Operator's Improvements, to Operator;
- (b) Any portion of the award by the court for Operator's anticipated or lost revenues or profits, to Operator;
- (c) Any portion of the award by the court for Owner's lost revenues, to Owner;
- (d) All remaining amounts of the award, to Owner or Operator consistent with applicable Kentucky law.

20. **Notice.**

20.1 **Writing.** All notices given or permitted to be given hereunder shall be in writing.

20.2 **Delivery.** Notice is considered given either (i) when delivered in person to the recipient named below, (ii) upon receipt after deposit in the United States mail in a sealed envelope or container, postage and postal charges prepaid, return receipt requested or certified mail, addressed by name and address to the party or person intended, or (iii) twenty-four (24) hours from proper and timely delivery to an overnight courier service addressed by name and address to the party or person intended as follows:

Notice to Owner: Jon Barton Eblen
Marie Eblen
9056 Hwy 416 W
Robards, KY 42452



Notice to Operator: Sebree Solar, LLC
700 Universe Blvd
Juno Beach, FL 33408

Attn: Land Services Administration
Telephone: (855) 552-9872

20.3 **Change of Recipient or Address.** Either Party may, by notice given at any time or from time to time, require subsequent notices to be given to another individual person, whether a party or an officer or representative, or to a different address, or both. Notices given before actual receipt or notice of change shall not be invalidated by the change.

21. **Miscellaneous Provisions.**

21.1 **Successors and Assigns.** The terms and provisions of this Agreement shall run with the land and be binding on and inure to the benefit of the heirs, successors, assigns and personal representatives of the Parties. In accordance with this Agreement, Operator in its discretion may authorize other persons or entities to use the Operator Property for the purposes stated in this Agreement

21.2 **Memorandum.** Simultaneously with the execution of this Agreement, the Parties agree to execute and acknowledge a memorandum of this Agreement. Operator may record the executed memorandum in the public records of Henderson County, Kentucky.

21.3 **Entire Agreement.** This Agreement and the attached Exhibits shall constitute the entire agreement between the Parties and supersedes all other prior writings and understandings.

21.4 **Amendments.** This Agreement shall not be amended or modified in any way except by an instrument signed by the Parties and consented to by any Operator Mortgagee. The Parties hereto shall at all times hereafter execute any documents and do any further acts which may be necessary or desirable to carry out the purposes of this Agreement and to give full force and effect to each and all of the provisions hereof.

21.5 **Legal Matters.** This Agreement shall be governed by and interpreted in accordance with the then existing laws of the Commonwealth of Kentucky and the County where the Owner's Property is located shall be considered the proper forum or jurisdiction for any disputes arising in connection with this Agreement. The Parties agree to first attempt to settle any dispute arising out of or in connection with this Agreement by good-faith negotiation. If the Parties are unable to resolve amicably any dispute arising out of or in connection with this Agreement, each shall have all remedies available at law or in equity and as provided by this Agreement. **Each Party waives all right to trial by jury and specifically agrees that trial of suits or causes of action arising out of this Agreement shall be to the court of competent jurisdiction.**

21.6 **Severability.** If any term or provision of this Agreement, or the application thereof to any person or circumstance shall, to any extent, be determined by judicial order or decision to be invalid or unenforceable, the remainder of this Agreement or the application of such term or provision to persons or circumstances other than those as to which it is held to be invalid, shall be enforced to the fullest extent permitted by law.

21.7 **Tax Credits.** If under applicable law Operator becomes ineligible for any currently existing tax credit, benefit or incentive for alternative energy expenditure established by any local,

state or federal government, then, at Operator's option, the Parties shall negotiate in good faith to amend this Agreement or replace it with a different instrument so as to convert Operator's interest in the Operator Property to a substantially similar interest that makes Operator eligible for such tax credit, benefit or incentive. Such amendment or instrument shall not impair any of Owner's rights or increase the burdens or obligations of Owner under this Agreement.

21.8 **Approvals.** Whenever in this Agreement the approval or consent of either Party is required or contemplated, unless otherwise specified, such approval or consent shall not be unreasonably withheld or delayed.

21.9 **Authority.** The signatories hereto warrant that each has the authority to execute this Agreement on behalf of any entities which are Parties to this Agreement and that each such entity has executed this Agreement pursuant to its organizational documents or a resolution or consent of their Board of Directors or other governing body.

21.10 **Time of Essence.** Time is of the essence of each provision of this Agreement.

21.11 **Counterparts.** This Agreement may be executed in multiple counterparts, each of which shall be deemed an original, and all of which together shall constitute a single instrument.

Owner:

Jon Barton Eblen

Marie Eblen, a/k/a Marie Annette Eblen

Operator:

Sebree Solar, LLC
a Delaware limited liability company

By: 

Matthew S. Handel, Vice President

EXHIBIT A

Legal Description of Owner's Property

Parcel 1

The following property located in the County of Henderson, State of Kentucky, on the Tunnel-Hill Robards Road, as follows:

Beginning at a stake in the Robards and Tunnel Hill Road, corner with lot #4, runs with said roads. 76 15 E. 404 feet to a stake, corner with lot #2, thence S. 35 W. 1881.4 feet to a stake, corner with lot #2 in the W.A. Royster estate's line; thence N. 89 14 W. 398 feet to a stake, carrier with lot #4 in the line of the W.A. Royster estate; thence N. 3 35 E. 1973.2 feet to the beginning.

From the above described tract, there was conveyed to the Commonwealth of Kentucky, for highway purposes, a strip of ground containing approximately ½ acres, as shown by deed dated June 8, 1939, of record in Deed Book 94, Page 517, Henderson County Clerk's office. This conveyance is made subject to said highway deed and all of the property herein conveyed is subject to all legal rights of way.

Containing 17 acres, more or less.

Parcel No.: 61-33

Parcel 2

Beginning at a stake in Robards and Tunnel Hill Road corner with Lot #3; thence with said road S 76-15 E 473.6 feet to a stake, corner to Lot #1; thence S 3-35 W 1775.6 feet to a stake corner with Lot #1 in the line of W.A. Royster Estate; thence N 89-14 W 467.6 feet to a stake corner with Lot #3 in the line of W.A. Royster Estate; thence N 3-35 E 1881.4 feet to the beginning.

Being the same property conveyed to James C. Eblen and Joan Eblen (a/k/a Joan E. Eblen), husband and wife, by deed from Herbert Shaw and Marie Shaw, husband and wife, dated January 8, 1974, of record in Deed Book 270, Page 67, Henderson County Clerk's Office.

Containing 20 acres, more or less.

Parcel No.: 61-32

Parcel 3

Beginning at an iron pin corner to Tract #2, said pin being in the southern R/W of Ky. Hwy. 416, 30 feet from the centerline, and being approximately 2318 feet east of the intersection of W.N. Royster Road in Henderson County, Kentucky; thence with said R/W S 69°44'47" E – 156.98 feet, S 67°26'34" E – 262.92 feet to an iron pin corner to Wimberly C. Royster; thence with the line of Royster S 8°59'52" W – 1988.59 feet to an iron pin in the line of Tract #5; thence with the line of Tract #5 N 82°30'11" W – 398.40 feet to an iron pin corner to Tract #2; thence with the line of Tract #2 N 9°18'03" E – 2087.19 feet to the point of beginning. For a more particular description

you are referred to a survey plat prepared by Likins and Musgrave dated _____, 1986, of record in Plat Book 5, Page 2, of the Henderson County Clerk's Office.

Being the same property conveyed to James C. Eblen and Joan E. Eblen, husband and wife, by deed from W.J. Tillman and Sherry Pl. Tillman, husband and wife, dated April 30, 1986, of record in Deed Book 366, page 548, Henderson County Clerk's Office.

Containing 19 acres, more or less.

Parcel No.: 61-34

Parcel 4

Being the New Lot #3 containing 18.0139 acres of the Consolidation to Lot 5, of the John and JoAnn Haynes Subdivision, of record in a Plat Book 6, page 257, Henderson County Court Clerk's office, and to which plat reference is hereby made for a more particular description.

A certain tract or parcel located on the north side of Ky Hwy 416 approximately 1.1 miles west of the town of Richards in Henderson County, Kentucky and being more specifically described as follows:

BEGINNING at an iron pin set in the north right-of-way line of Ky Hwy 416, said iron pin being located 30 feet north of the centerline of the existing pavement of said Ky Hwy 416, and being a corner to New Lot 1 of the John & Joann Haynes Subdivision & Consolidation, a plat of which is recorded in Plat Book 6, page 257; thence with said Lot 1, North 1° 16 minutes 03 seconds West, a distance of 657.53 feet to an iron pin set in the south line of the James Anderson property recorded in Deed Book 341, page 42; thence with said Anderson property, South 88° 30 minutes 01 seconds East, a distance of 1,253.89 feet to an iron pin set in the west line of the Arnold Taylor property; thence with said Taylor property, South 0° 44 minutes 39 seconds East, a distance of 525.20 feet to an iron pin set in the north right-of-way line of said Ky Hwy 416, and being located 30 feet north of said centerline; thence with said right-of-way line, running parallel with and 30 feet north of said centerline, the following four (4) calls:

- (1) South 80 degrees 25 minutes 31 seconds West, a distance of 787.83 feet to a point in said right-of-way line, said point being located South 21° 54 minutes 59 seconds East, 25.52 feet from an iron pin set on or near the west bank of a ditch;
- (2) South 79° 36 minutes 39 seconds West, a distance of

121.02 feet to the beginning of a curve in said right-of-way line;
(3) thence around said curve in a clockwise direction having a delta angle of 27° 29 minutes 14 seconds, and arc distance of 147.40 feet, a radius of 191.04 feet, and chord of North 86° 38 minutes 43 seconds West, a distance of 155.81 feet to the end of said curve;
(4) North 72° 54 minutes 06 seconds West, a distance of 147.97 feet to the point of beginning containing 785857 square feet or 18.0139 acres and being subject to all legal written and unwritten easements and rights-of-way. This description was prepared from a physical survey conducted under the direction of Bruce K. Bailey, R/S # 2939 on January 25, 1991.

No minerals are included in this conveyance.

Being a portion of the same property conveyed to Grantor herein by a deed from Kay Spencer Thornberry and her husband, E. T. Thornberry to John William Haynes (now deceased) and wife, JoAnn Haynes, dated June 8, 1984, of record in Deed Book 351, page 225, Henderson County Court Clerk's office, and deed dated January 15, 1985 of record in Deed Book 362, page 487, and deed dated January 10, 1986, of record in Deed 372, page 262, all in Henderson County Court Clerk's office. For deed of conveyance to southern portion of Lot 1 (2.928 acres), see Deed Book 393, page 415, same office. Said John William Haynes died September 30, 1991, thereby vesting full ownership in Grantor by virtue of survivorship.

Containing 18 acres, more or less.

Parcel No.: 71-46.2

QLA: 7900

EXHIBIT A-1

Excluded Area of Owner's Property

Excluded Area as to Parcel 3



Excluded Area as to Parcel 4



HOLDING PAGE FOR EXHIBIT B-2

Preliminary Lease and Easement Improvement Plan and Acreage Calculation
To be Delivered with Option Notice

HOLDING PAGE FOR EXHIBIT C

As Built Lease and Easement Improvements and Final Acreage Calculation

EXHIBIT D

Lease and Easement Compensation

[REDACTED]

[REDACTED]

(2) Payment for Lease and Easements.

[REDACTED]

[REDACTED]

[REDACTED]

(3) Crop Compensation.

[REDACTED]

[REDACTED]

(4) Payment Allocation Schedule

[REDACTED]

SOLAR LEASE AND EASEMENT AGREEMENT

1. **Parties.** This Solar Lease and Easement Agreement ("**Agreement**") is made and entered as of the 3 day of March, 2021 ("**Effective Date**"), by and between Laveta Daniel, as Executrix of the Estate of Carolyn G. Whitmore and Laveta Daniel, a married person, joined by consenting spouse, Chris Daniel (collectively "**Owner**") and Sebree Solar, LLC, a Delaware limited liability company ("**Operator**"), which are sometimes individually referred to as a "**Party**" and collectively as the "**Parties**".

2. **Project.** This Agreement relates to the solar-powered electrical power generation and transmission project known as the "Sebree Solar Energy Center" to be located in Henderson County, Kentucky ("**Project**"), which may be wholly or partially located on the Owner's property legally described on the attached **Exhibit A**, and depicted on the attached **Exhibit B-1** to this Agreement hereto ("**Owner's Property**"). Upon Operator's exercise of the Option (as defined below), the Project shall include (i) the Lease of Owner's Property described in Section 4, (ii) the Easements referenced in Section 5 that are located on the Owner's Property, and (iii) the Improvements referenced in Section 8 to be constructed on Owner's Property. The Lease, Easements and Improvements are sometimes collectively referred to as the "**Operator Property**".

3. **Option.** Owner grants to Operator an exclusive option ("**Option**") to acquire the Lease and Easements referenced in Sections 4 and 5 in accordance with the following terms and conditions. Operator shall be entitled to acquire the Lease and the Easements in their entirety or in part, as Operator deems appropriate.

3.1 **Option Term.** The period during which Operator may exercise the Option shall be for a term of four (4) years, commencing on the Effective Date ("**Option Term**").

3.2 **Option Payment.** As consideration for the granting of the Option, Operator agrees to pay Owner the Option Payment set forth in **Exhibit D**.

3.3 **Use of Owner's Property.** During the Option Term, Operator and its employees, agents and contractors shall have a right to enter upon the Owner's Property and the right of ingress and egress over and across the Owner's Property for the purposes of (i) surveying the Owner's Property; (ii) performing such other tests and studies as Operator may desire in connection with the Option, including, without limitation, environmental, avian and cultural resource assessments, and geotechnical, foundation and soil tests, provided that such activities do not unreasonably interfere with Owner's use of the Owner's Property; and (iii) installing, maintaining, operating, inspecting and removing one or more weather related instruments ("**Weather Instrument**") and fencing of said Weather Instrument and including the performance of all tests and studies associated therewith. Owner shall not permit any other individual or entity except Operator or its affiliates to install a Weather Instrument on Owner's Property. All topsoil disturbed by the work on the project prior to installation will be segregated and restored as topsoil upon completion of the pre-installation work. Topsoil removed during installation shall be placed elsewhere on Owner's property at Owner's direction. Operator shall give Owner ninety (90) days' notice prior to commencement of installation. If, after giving notice, Operator fails to commence timely, then

Operator will be responsible to Owner for the loss of crop rent for the crop season if the subject property lies fallow.

3.4 **Right to Grant Option.** Owner warrants and represents to Operator that (i) the statements in Section 9 concerning Owner's title to the Owner's Property are true and correct; (ii) Owner has the authority to grant this Option to Operator without the consent or approval of any other party; and (iii) there are no other existing options, rights of first refusal, contracts to purchase, leases or mortgages that would prevent Operator from exercising its rights with respect to the Option.

3.5 **Exercise of Option.** Operator may exercise the Option by giving written notice to Owner ("**Option Notice**") at any time during the Option Term. Operator shall specify in the Option Notice the Commencement Date referenced in Section 6.1.1. On the Commencement Date, the Lease and Easements referenced in Sections 4 and 5 shall automatically become effective, and the Parties shall be subject to all of the terms and conditions of this Agreement with respect to such Lease and Easements and all rights and obligations relating thereto.

3.6 **Termination of Option.** If Operator fails to exercise the Option within the Option Term, the Option and the rights of Operator as the optionee shall automatically terminate.

4. **Lease.** Upon exercise of the Option by Operator, Owner leases to Operator, and Operator leases from Owner, Owner's Property for the Lease and Easement Term (defined in Section 6.1) in accordance with the terms and conditions of this Agreement ("**Lease**"), which Lease grants Operator and its agents, contractors, and employees the right to use the Owner's Property for the following permitted uses:

4.1 **Construction Right.** Operator leases Owner's Property for the purpose of constructing, operating, maintaining, repairing, replacing, and removing all or any part or component of the Improvements whether located on Owner's Property. Operator may exercise its right to use all or any part of the Owner's Property as and when Operator deems it necessary or advisable to do so to perform the activities for which this right is granted, including, without limitation, staging areas and parking for Operator's employees.

4.2 **Access Right.** Operator leases Owner's Property for unobstructed vehicular and pedestrian access and ingress to and egress from the Improvements, Owner's Property and any public roadways, and to construct, maintain, and utilize Roadway Improvements on the Owner's Property. In the event that Operator builds roads outside of the fenced area of the project, Operator shall make reasonable efforts to plan and construct any such roads along the boundary of Owner's property unless it is impractical to do so, in Operator's determination. Owner shall not permit others to obstruct or damage the roads or Roadway Improvements located on the Owner's Property or in any other way interfere with Operator's rights under this right. Operator shall repair any damage done to Roadway Improvements which result from use by Operator, its agents, servants or employees. Such roads shall be maintained in the condition necessary for use by Operator's equipment, and with regard to existing roads, shall be maintained in at least the condition that existed prior to Operator's use.

4.3 **Solar Panels Right.** Operator leases Owner's Property for Operator to construct, operate, replace, relocate, remove, and maintain Solar Panels and the appurtenant Collection Facilities, together with associated roads and parking areas on Owner's Property.

4.4 **Collection Facilities Right.** Operator leases Owner's Property for Operator to construct, operate, maintain, replace, relocate or remove Collection Facilities on and under the Owner's Property.

4.5 **Substation Right.** Operator leases Owner's Property for Operator to construct, operate, maintain, replace, relocate or remove one or more Substations on Owner's Property.

4.6 **Telecommunication Right.** Operator leases Owner's Property for Operator to construct, operate, maintain, replace, relocate or remove Telecommunication Facilities on and under the Owner's Property.

4.7 **Weather Instrument Right.** Operator leases Owner's Property in order to construct, operate, replace, relocate, remove, and maintain a Weather Instrument and the appurtenant Collection Facilities on Owner's Property.

4.8 **Battery Facilities Right.** Operator leases Owner's Property in order to construct, operate, replace, relocate, remove, and maintain one or more Battery Facilities on Owner's Property.

5. **Grant of Easements.** Upon the exercise of the Option by Operator, Owner grants to Operator, and Operator accepts from Owner, for the Lease and Easement Term referenced in Section 6.1, the following easements over and across the Owner's Property in accordance with the terms and conditions of this Agreement. The following easements are for the benefit of Operator and Operator's agents, contractors and employees and located on the Owner's Property and are collectively referred to as the "**Easements**".

5.1 **Sun Non-Obstruction Easement.** Owner grants Operator an irrevocable, exclusive easement for the right and privilege to use, maintain and capture the free and unobstructed sunlight over and across the Owner's Property. Owner shall not engage in any activity on Owner's Property or any other neighboring property owned by Owner that might interfere with the sunlight direction over any portion of Owner's Property; cause a decrease in the output or efficiency of any Solar Panel or Weather Instrument; or otherwise interfere with Operator's operation of the Project or exercise of any rights granted in this Agreement (collectively "**Interference**"). This grant of the easement expressly includes the right of Operator to enforce Operator's rights, including the physical removal of trees or structures (except existing trees and structures) causing Interference to the Project contemplated by Operator. Operator shall notify Owner before making any such removals. The Operator has the obligation, including cost, for any maintenance of natural existing vegetation outside of the fence line that it requires in order to preserve its rights under this Section 5.1, for example, trimming existing trees outside of the fence line as they grow if Operator determines that such trees are or may cause interference.

5.2 **Effects Easement.** Owner grants to Operator an easement over Owner's Property for visual, view, light, flicker, noise, shadow, vibration, electromagnetic, electrical and radio

frequency interference, and any other effects attributable to the Project located on the Owner's Property.

6. **Term.** The term of this Agreement ("**Term**") includes the Option Term referenced in Section 3.1, the Initial Lease and Easement Term as described in Section 6.1.1 and the Extended Lease and Easement Term as described in Section 6.1.2 (together, the Initial Lease and Easement Term and the Extended Lease and Easement Term, if applicable, is defined as the "**Lease and Easement Term**").

6.1 **Lease and Easement Term.**

6.1.1 **Initial Lease and Easement Term.** The initial term of the Lease and Easements shall commence on the date specified by Operator in the Option Notice ("**Commencement Date**"). The initial term of the Lease and Easements shall end thirty (30) years after the Commencement Date (the "**Initial Lease and Easement Term**"), subject to the rights of renewal and termination as provided in this Agreement.

6.1.2 **Extended Lease and Easement Term.** Operator shall have the right to extend the Term of this Agreement for two consecutive terms of five (5) years each in accordance with the terms and provisions of this Agreement (collectively "**Extended Lease and Easement Term**") by providing written notice to Owner of Operator's intent to extend the Term within one hundred eighty (180) days of the end of the existing Term. Each Extended Lease and Easement Term shall begin on the expiration date of the Initial Lease and Easement Term or previous Extended Lease and Easement Term, as the case may be. During the Extended Lease and Easement Term, Operator shall pay Owner the amounts set forth in **Exhibit D** as the consideration for the Lease and Easements.

6.1.3 **Delays During Lease and Easement Term.** At Operator's option, the Term may be extended for a period of time equal to the period of time during which operation of the Project is delayed or suspended because of the occurrence of a Regulatory Suspension or Force Majeure, which are defined as follows:

(i) "**Regulatory Suspension**" shall mean the enactment or application of any law, order, rule, or regulation of the Kentucky Public Service Commission, Federal Energy Regulatory Commission, or other local, state, or federal government authority having jurisdiction over the Project or Operator, or the failure of any such governmental authority to issue an approval or permit pursuant to any such law, order, rule, or regulation, which results in the delay, interruption, or suspension of the production, sale or transmission of electricity from the Solar Panels; and

(ii) "**Force Majeure**" shall mean causes beyond the reasonable control of and without the fault or negligence of the Party claiming Force Majeure, including but not limited to acts of God, labor unrest (including, but not limited to, slowdowns, picketing, boycotts or strikes), flood, earthquake, storm, fire, lightning, explosion, power failure or power surge, vandalism, theft, the cutting of power, transmission or other lines, wires or cables to the Project by persons other than Operator's employees or contractors, epidemic, war, revolution, riot, civil disturbance, sabotage, change in law or applicable regulation subsequent to the Commencement Date and action or inaction

by any federal, state or local legislative, executive, administrative judicial agency or body which in any of the foregoing cases, by exercise of due foresight such Party could not reasonably have expected to avoid, and which, by the exercise of due diligence, it is unable to overcome.

The Parties shall be excused from performing their respective obligations under this Agreement and shall not be liable in damages or otherwise if and to the extent that they are unable to so perform or are prevented from performing by a Force Majeure, provided that: (i) the non-performing Party, as promptly as practicable after the occurrence of the Force Majeure, but in no event later than thirty (30) days thereafter, gives the other Party written notice describing the particulars of the occurrence; (ii) the suspension of performance is of no greater scope and of no longer duration than is reasonably required by the Force Majeure; (iii) the non-performing Party uses good faith and commercially reasonable efforts to remedy its inability to perform; and (iv) as soon as the non-performing Party is able to resume performance of its obligations excused as a result of the occurrence, each Party shall give prompt written notification thereof to the other Party.

6.2 **Termination by Operator.** Provided Operator is not in default under any term of this Agreement, Operator, at its option, shall have the right to terminate this Agreement at any time during the Term of the Agreement, as to all or any part of the Operator Property. Termination shall be effective thirty (30) days after written notice of such termination to Owner. If Operator's notice is a full termination of the Operator Property, the Parties shall be relieved of all further duties and obligations under this Agreement, other than (i) the payment of any accrued and unpaid obligations owed by either Party as of the date of termination; (ii) the removal of the Improvements by Operator pursuant to Section 8.11; and (iii) any other obligations and liabilities that are expressly stated in this Agreement to survive such termination. Upon any such partial termination by Operator, the Parties shall be relieved of all further duties and obligations under this Agreement with respect to the portion thereof terminated by Operator, subject to the obligations and liabilities referenced in items (i) through (iii) above that shall continue to be applicable to the terminated portion of this Agreement. The Parties agree to execute an amendment to this Agreement evidencing such partial termination.

7. **Payments.** If Operator exercises the Option referenced in Section 3, Operator agrees to pay Owner the amounts set forth in **Exhibit D** as consideration for the Lease, Easements and Operator's other rights and interests in the Owner's Property.

8. **Improvements.** Operator shall have the right, at its sole cost and expense, to construct, install, maintain, use, operate, repair, replace, relocate and remove all facilities, structures, equipment, machinery, wires, conduit, cables, poles, materials and property of every kind and character required for the construction and operation of portions of the Project on the Owner's Property, including, but not limited to, the Solar Panels, Collection Facilities, Substations, Telecommunication Facilities, Weather Instruments, Roadway Improvements and Battery Facilities referenced in Sections 8.1 through 8.7 (collectively, the "**Improvements**").

8.1 "**Solar Panels**" shall mean any photovoltaic energy system designed for the generation of electrical power from the collection of sunlight, including without limitation, the photovoltaic panels, foundations, support structures, braces and related equipment.

8.2 "**Collection Facilities**" shall mean all Improvements whose purpose is to deliver electrical power generated by the Solar Panels to an electrical power grid or other system, including without limitation transformers, overhead and underground electrical collection lines, telecommunication lines, splice boxes and interconnection facilities.

8.3 "**Substations**" shall mean electrical lines, meters, monitoring and control equipment, switches, transformers, all structures, equipment, enclosures, fencing, security devices, and other electrical and communications equipment necessary to condition and increase the voltage of electricity generated by the Project to make it suitable for transmission on, and to deliver it to, Collection Facilities connected to an electric power grid or other system.

8.4 "**Telecommunication Facilities**" shall mean all Improvements whose purpose is to provide telecommunication services solely relating to the Project or any of Operator's solar powered projects, including telephone, closed-circuit television, microwave, internet, computer data and other telecommunication services.

8.5 "**Weather Instrument**" shall mean instruments used primarily to gather and transmit sunlight and meteorological data relating to the Project, and includes the instrument's foundations, guy wires, sunlight and meteorological data acquisition equipment, power source, and any required data and electrical transmission lines.

8.6 "**Roadway Improvements**" shall mean all improvements that may be necessary to construct, maintain and repair any new and existing roadways and other means of ingress and egress over, across and along the Owner's Property, including paving or surfacing of the roadways with asphalt, gravel or other roadway materials, installation of road signs and the construction and installation of culverts, bridges, drainage ditches, gates, cattle guards and similar structures and facilities.

8.7 "**Battery Facilities**" shall mean a type of equipment that can be given a new charge by passing an electric current through it designed for the storage of electrical power including without limitation, batteries and other devices for storage of electrical energy, foundations, support structures, braces and related equipment.

8.8 **Ownership of Improvements.** Except as otherwise provided in Section 11.7, all Improvements shall at all times remain the property of Operator, and Owner shall have no right, title or interest therein. All Improvements constructed or placed on the Owner's Property by Operator during the Term of this Agreement may be repaired, replaced, relocated, removed, added to or expanded upon by Operator at any time during the Term of this Agreement. Owner expressly waives any statutory lien or common law liens on the Improvements to which Owner might be entitled.

8.9 **Construction Liens.** Operator shall not permit any liens arising out of Operator's use of the Operator Property under this Agreement to be filed against the Owner's Property. Operator shall, within sixty (60) days after it receives notice of the lien, provide a bond or other security that Owner may reasonably request, or remove such lien from the Owner's Property in the manner provided by applicable law.

8.10 **Location of Improvements.** The acreage required from the Owner's Property for the Improvements for which the Lease and Easements are being granted cannot be determined until the completion of Operator's inspection, testing, study and surveying of the Owner's Property during the Option Term. Operator shall not install any Improvements in the excluded areas of Owner's Property depicted in Exhibit B-1 without obtaining the prior consent of Owner. Along with the Option Notice, Operator shall deliver to Owner a proposed plan of development showing the contemplated locations of the Improvements and a preliminary calculation of the acreage as determined by the area bounded by a perimeter fence required for the Project, and depicting any areas outside the perimeter fence that will be used as vegetative buffer which shall be considered a part of the Owner's Property that is subject to the Lease and Easements, and, at Operator's discretion, any additional setback or similar areas required for permitting that may be included as part of the Owner's Property subject to the Lease and Easement, and identifying any such areas that are to be considered a part of the Owner's Property that is subject to the Lease and Easements, which shall serve as the **Exhibit B** to this Agreement. During the final development and construction of the Project, such locations may need to be amended. Following construction of the Project, Operator shall provide Owner an "as-built" survey of all Improvements on Owner's Property and the final calculation of the acreage as determined by the area bounded by a perimeter fence and any additional areas identified by Operator as required for the Project, which shall serve as **Exhibit C** to this Agreement. Further, following construction, the Improvements may need to be relocated or rerouted by Operator, which Operator may perform, at any time during the Term of this Agreement, so long as the nature and extent of any such relocated or rerouted Improvements are not materially different and impose no materially greater burden on the Owner's Property than the original locations or routes, and so long as Operator takes commercially reasonable efforts to minimize disruption or inconvenience to Owner.

8.11 **Removal of Improvements.** Upon full or partial termination of any of the Lease Rights or Easements, Operator shall remove all Improvements and restore the area formerly occupied by the Improvements to substantially the same physical condition that existed immediately before the construction of the Improvements (the "**Removal Obligations**"). At Owner's request, all or any part of the Roadway Improvements may be left for use by Owner. Operator will continue to make all Annual Installments Payments on a prorated basis until the Removal Obligations are substantially completed. If a governmental authority does not require a performance bond or security for removal of the Improvements, then upon the earlier to occur of: (i) the termination of this Agreement; or (ii) on the twentieth (20th) anniversary of the commercial operations date of the Project, Operator shall obtain and deliver to Owner a bond in form and substance reasonably satisfactory to Owner securing Operator's Removal Obligations (the "**Removal Bond**"). The Removal Bond shall be equal to the estimated amount, if any (the "**Net Removal Costs**"), by which the cost of removing the Improvements on Owner's Property exceeds the salvage value less any outstanding debt on such Improvements, which Net Removal Costs shall be determined as set forth below. Operator shall not be required to deliver such Removal Bond to Owner if Operator has delivered such a bond in connection with the permitting of Owner's Property or any other portion of the Improvements for the Project. Once in place, Operator shall keep such bond, or a like replacement, in force throughout the remainder of the Term. The Net Removal Costs shall be determined by the Parties hereto acting in good faith. If the Parties cannot agree upon the Net Removal Costs within sixty (60) days of their first attempt to do so, then the Net Removal Costs shall be determined by an independent engineer mutually selected by the

Parties. If the Parties cannot agree upon such independent engineer within the next thirty (30) days, then by an independent engineer appointed by a Circuit Judge of Henderson County, Kentucky; and the decision of such an independent engineer (however selected) as to the Net Removal Costs shall be conclusive as between and binding upon, the Parties. If an independent engineer is selected, then the Parties hereto shall equally share all of the costs associated with the independent engineer's determination of the Net Removal Cost. If the Removal Bond is unavailable or an alternate form of security is more economical or desirable, then Operator may substitute an alternate form of security, such as a letter of credit, other form of bond, or guarantee that provides substantially equivalent security as the Removal Bond.

9. **Ownership and Title Matters.** Owner warrants and represents to Operator, both as of the Effective Date, and as of the Commencement Date as follows:

9.1 **Authority.** Owner represents and warrants that it is the holder of fee simple title and is the sole owner of the Owner's Property and has the unrestricted right and authority to sign this Agreement and to grant Operator the Lease and Easements and other rights granted in this Agreement. When signed by both Parties, this Agreement constitutes a valid and binding agreement enforceable against Owner in accordance with its terms.

9.2 **Other Agreements.** The Owner's Property is not subject to any other agreements, options, rights of first refusal or other prior right of any party to purchase, lease or acquire easements in the Owner's Property, or create any prior claim or right that would preclude or interfere with Operator's rights and interests under this Agreement and the Lease and Easements.

9.3 **Minerals.** Except as disclosed by Owner to Operator at the time of the execution of this Agreement by Owner, or as may be shown in the public records, Owner owns all of the oil, gas and other minerals, and all rights thereto as on or under the Owner's Property.

9.4 **Owner Mortgage.** Except as disclosed by Owner to Operator at the time of the execution of this Agreement by Owner, there are no mortgages encumbering the Owner's Property ("**Owner Mortgage**").

9.5 **Notice and Opportunity to Cure.** If there is an Owner Mortgage encumbering Owner's Property and Owner receives from the holder thereof any notice that payments are overdue, Owner shall notify Operator and each Operator Mortgagee (as defined at Section 13.1) by sending a copy of such overdue payment notice to Operator by the earlier of (i) five (5) days after receipt, or (ii) three (3) business days prior to the date by which a default under or in respect of such Owner Mortgage could occur. If Operator or any Operator Mortgagee determines that it would be in Operator's interest to make such payments to Owner Mortgagee on Owner's behalf, whether as a result of receiving such notice or otherwise, Operator shall have the right to make such payments and to credit the payments so made against the Annual Installment Payment next due under the Agreement.

9.6 **Subordination, Non-Disturbance & Attornment Agreement.** If there is an Owner Mortgage encumbering Owner's Property, Owner shall cooperate with Operator to obtain a Subordination, Non-Disturbance and Attornment Agreement ("**SNDA**") in the form prepared and provided by Operator, from each Owner Mortgagee, pursuant to which such Owner Mortgagee

agrees, among other things, not to disturb Operator's possession and use of the Owner's Property. Owner shall not incur any loss in income, expense, obligation or liability with regard to the SNDA. Operator shall, at its sole cost and expense, record each such SNDA in the Office of the County Clerk in which Owner's Property is located. If Owner fails to deliver a SNDA from each Owner Mortgagee, Operator may, at its sole option, either (i) terminate this Agreement immediately upon written notice to Owner, or (ii) take such action as Operator deems reasonably necessary to effect the rights granted to Operator hereunder, and off-set all amounts expended in such efforts against the Annual Installment Payments and any other amounts due hereunder or in respect hereof.

10. **Representations and Warranties of Owner.** Owner hereby makes the following further representations and warranties both as of the Effective Date, and as of the Commencement Date:

10.1 **Physical Condition.** Owner has no knowledge of any existing physical conditions of the Owner's Property which would prevent, significantly restrict or make more expensive Operator's development of the Owner's Property for the purposes specified in this Agreement, or which could, with the passage of time, or the giving of notice, constitute a violation of any currently applicable governmental law, ordinance, order, rule or regulation.

10.2 **Legal Restrictions.** Owner has no knowledge of any law, regulation, ordinance or order of any local, state or federal governmental authority which would prohibit or significantly restrict Operator's development of the Owner's Property pursuant to this Agreement. This Agreement does not violate any contract, agreement, instrument, judgment or order to which Owner is a party or which affects the Owner's Property. To the best of Owner's knowledge, the Owner's Property is currently in full and complete compliance with all governmental laws, ordinances, orders, rules and regulations applicable to the Owner's Property.

10.3 **No Litigation.** No litigation is pending and, to the best of Owner's knowledge, no litigation or administrative actions are proposed, threatened or anticipated with respect to any matter affecting the Owner's Property. If Owner learns of any litigation or administrative action proposed, threatened or instituted with respect to the Owner's Property, Owner shall give Operator notice within thirty (30) days thereof.

10.4 **Survival.** The representations and warranties set forth in this Section 10 shall survive the execution and delivery hereof.

11. **Use, Operation and Maintenance.**

11.1 **Exclusive Use by Operator.** Operator shall have the exclusive right (i) to use and possess the Owner Property in connection with the Project and other similar solar-powered electrical power generation projects; (ii) to investigate, inspect, survey, and conduct tests of the Owner's Property, including, but not limited to, meteorological, environmental, archeological and geotechnical tests and studies; (iii) to use and convert all of the sunlight resources on the Owner's Property; and (iv) to undertake such other activities on the Owner's Property that may be related to the Project, including, without limitation, the storage of Solar Panels, materials and equipment during the installation and construction of the Improvements; development and operation of communications systems; and site tours of the Project for visitors and other interested parties.

11.2 **No Required Installation or Operation.** Nothing in this Agreement shall be interpreted as imposing on Operator any obligation to install Solar Panels or other Improvements on the Owner's Property, or to operate the Project on the Owner's Property. Operator shall have the sole discretion to determine if and when any Solar Panels and other Improvements may be constructed on Owner's Property, and if and when to commence the operation of the Project on the Owner's Property.

11.3 **Permits and Approvals.** Operator shall be responsible, at its sole cost and expense, for obtaining any governmental permits and approvals necessary for the construction and operation of the Project and the construction and operation of the Improvements. Owner shall cooperate with Operator as necessary to obtain any governmental or utility approvals or permits, including, without limitation, signing any applications for such approvals, provided that Owner shall not incur any loss in income, expense, obligation or liability with respect to Operator obtaining such permits or approvals.

11.4 **Compliance with Laws.** Operator shall comply in all material respects with valid laws applicable to the Owner's Property and the Operator Property. Operator shall have the right, in its sole discretion and at its sole expense, in Operator's name to contest the validity or applicability to the Owner's Property and the Operator Property of any law, ordinance, statute, order, regulation, property assessment or the like made by any governmental agency or entity. Operator shall control any such contest and Owner shall cooperate with Operator in every reasonable way in such contest, provided that Owner shall incur no expense, obligation or liability with regard to such contest.

11.5 **Care and Appearance.** Operator, in its exercise of the lease, easement and other rights granted hereunder shall, at all times, maintain the Owner's Property and the Improvements in a reasonably neat, clean and presentable condition. Operator shall not willfully or negligently damage or destroy the Owner's Property and shall keep the Owner's Property clean and free of debris created by Operator, its contractors, or others brought on to the Owner's Property by Operator. Operator shall not use the Owner's Property for storage, except for materials, construction equipment and vehicles directly associated with construction or maintenance of the Improvements on the Owner's Property or adjacent properties that are part of the Project.

11.6 **Fences and Gates.** At Owner's request, Operator shall repair or replace any fences, gates or cattle guards damaged or removed in connection with Operator's activities on the Owner's Property. Fences removed from the Owner's Property, if replaced, shall be re-built by Operator at its expense in mutually agreeable locations. All fence repair and construction shall be substantially similar to the construction of existing fences and cattle guards on Owner's Property. Any gates opened for access to Owner's Property by either Party shall be closed immediately after passing through so that livestock may not pass through. Once completed, all replacement fences, gates and cattle guards shall be owned and maintained by Owner. Upon abandonment or termination of the rights granted to Operator in this Agreement, any fences, gates and cattle guards installed by Operator shall remain and become the property of Owner. To minimize the need for temporary fencing, Owner will cooperate with Operator to avoid pasturing animals on or near the Improvements during periods of construction, maintenance or removal activity by Operator. Owner will discuss with Operator what temporary fencing is necessary during the periods of construction, maintenance or removal activity by Operator.

11.7 **Roadway Maintenance and Repairs.** Operator agrees to maintain and repair all Roadway Improvements located on the Operator Property; provided, however, Owner shall reimburse Operator for any costs and expenses incurred by Operator to repair any damage or perform any special maintenance of the Roadway Improvements caused by Owner or any person using the Roadway Improvements with Owner's permission, other than Operator.

12. **Taxes.**

12.1 **Owner's Taxes.** Owner covenants and agrees to pay prior to delinquency all real and personal property and other taxes, general and special assessments, and other charges of every description ("**Taxes**") levied or assessed against the Owner's Property and all improvements thereon by governmental authorities, other than Operator's Taxes referenced in Section 12.2 (Taxes, excepting Operator's Taxes, are hereinafter referred to as "**Owner's Taxes**").

12.2 **Operator's Taxes.** [REDACTED]

12.3 **Failure to Pay.** In the event either Party fails to pay their share of Taxes prior to delinquency, the other Party shall have the right to pay such Taxes and any accrued penalties or interest, which payments shall increase or be offset against other Payments due under this Agreement.

12.4 **Operator's Right to Contest.** Operator may contest the legal validity or amount of any Operator's Taxes for which it is responsible under this Agreement, and may institute such proceedings as it considers necessary, provided that Operator shall bear all expenses in pursuing such contest or proceeding. With respect to any Taxes which may constitute a lien on the Owner's Property, Operator shall promptly pay such Taxes unless the proceeding in which it contests such Taxes shall operate to prevent or stay the collection of the Taxes so contested or unless Operator removes any such lien by bonding or otherwise. Owner agrees to render to Operator all reasonable assistance in contesting the validity or amount of any such Taxes, with the exception of Taxes levied by Owner, including joining in the signing of any reasonable protests or pleading which Operator may deem advisable to file; provided, however, that Operator shall reimburse Owner for

its reasonable out-of-pocket expenses, including reasonable attorneys' fees incurred in connection with providing such assistance.

13. **Mortgage of Operator Property.**

13.1 **Right to Mortgage.** Operator may, upon written notice to Owner, but without requiring Owner's consent or approval, mortgage, collaterally assign, or otherwise encumber and grant security interests in all or any part of its interest in this Agreement and the Operator Property. These various security interests in all or a part of this Agreement and the Operator Property are collectively referred to as an "**Operator Mortgage**" and holder of such security interest, an "**Operator Mortgagee**". Any Operator Mortgagee shall use the Operator Property only for the uses permitted under this Agreement. Whenever Operator has granted a security interest under this Section 13, it will give Owner notice of the Operator Mortgage (including the name and address of the Operator Mortgagee for notice purposes) to Owner within thirty (30) days; provided that failure to give this notice shall not constitute a default under this Agreement, but rather shall only have the effect of not binding Owner to provide such Operator Mortgage notice until the Operator and its address is given to Owner.

13.2 **Notice of Default and Opportunity to Cure.** As a precondition to exercising any rights or remedies related to any alleged default by Operator under this Agreement, Owner shall give written notice of the default to each Operator Mortgagee at the same time it delivers notice of default to Operator, specifying in detail the alleged event of default and the required remedy. Each Operator Mortgagee or its designee shall have the right, but not the obligation, to cure any default as Operator, and/or the right, but not the obligation, to remove any Improvements or other property owned by Operator or such Operator Mortgagee located on the Owner's Property to the same extent as Operator. The cure period for any Operator Mortgagee shall be the later of (i) the end of the Operator cure period under Section 18; (ii) thirty (30) days after such Operator Mortgagee's receipt of the default notice; or (iii) if applicable, the extended cure period provided for in Section 13.3. Failure by Owner to give an Operator Mortgagee notice of default shall not diminish Owner's rights against Operator, but shall preserve all rights of the Operator Mortgagee or its designee to cure any default and to remove any Improvements or other property of Operator or the Operator Mortgagee located on the Owner's Property.

13.3 **Extended Cure Period.** If any default by Operator under this Agreement cannot be cured without the Operator Mortgagee obtaining possession of all or part of the Operator Property, then any such default shall be deemed remedied if an Operator Mortgagee: (i) within sixty (60) days after receiving notice from Owner as set forth in Section 13.2, acquires possession of all or part of the Operator Property, or begins appropriate judicial or nonjudicial proceedings to obtain the same; (ii) diligently prosecutes any such proceedings to completion; and (iii) after gaining possession of all or part of the Operator Property performs all other obligations as and when the same are due in accordance with the terms of this Agreement. If an Operator Mortgagee is prohibited by any court or by operation of any bankruptcy or insolvency laws from commencing or prosecuting the proceedings described above, the sixty (60) day period specified above for commencing proceedings shall be extended for the period of such prohibition.

13.4 **Operator Mortgagee Liability.** Any Operator Mortgagee whose interest in the Operator Property is held solely for security purposes, shall have no obligation or liability under

this Agreement unless and until the Operator Mortgagee succeeds to absolute title to the Operator Property and the rights of Operator under this Agreement. An Operator Mortgagee shall be liable to perform obligations under this Agreement only for and during the period it directly holds such absolute title.

13.5 **Certificates.** Owner shall execute any estoppel certificates (certifying as to truthful matters, including without limitation that no default then exists under this Agreement, if such be the case), consents to assignment and non-disturbance agreements as Operator or any Mortgagee may reasonably request from time to time. The Parties shall negotiate in good faith any amendment to this Agreement from time to time to include any provision that may be reasonably requested by Operator or any Operator Mortgagee to implement the provisions contained in this Agreement or to preserve an Operator Mortgagee's security interest.

13.6 **Operator Mortgagee's Right to Enforce Mortgage and Assign.** Each Operator Mortgagee shall have the right, in its sole discretion: (i) to assign its Operator Mortgage; (ii) to enforce its lien and acquire title to all or any portion of the Operator Property by any lawful means; (iii) to take possession of and operate all or any portion of the Operator Property and to perform all obligations to be performed by Operator under this Agreement, or to cause a receiver to be appointed to do so; and (iv) to acquire all or any portion of the Operator Property by foreclosure or by an assignment in lieu of foreclosure and thereafter to assign or transfer all or any portion of the Operator rights under this Agreement to a third party in accordance with Section 14. Any Operator Mortgagee or other party who acquires Operator's interest in all or a portion of the Operator Property pursuant to foreclosure or assignment in lieu of foreclosure shall not be liable to perform the obligations imposed on Operator by this Agreement, which are incurred or accruing after such Operator Mortgagee or other party no longer has ownership or possession of the Operator Property.

13.7 **New Agreement.**

13.7.1 If the Operator Property is foreclosed upon or there is an assignment in lieu of foreclosure, or if this Agreement is rejected or disaffirmed pursuant to bankruptcy law or other law affecting creditor's rights and, within ninety (90) days after such event, Operator or any Operator Mortgagee or other purchaser at a foreclosure sale shall have arranged to the reasonable satisfaction of Owner to cure any material defaults under this Agreement, and for the payment of all Annual Installment Payments or other charges due and payable by Operator as of the date of such event, then Owner shall execute and deliver to Operator or such Operator Mortgagee or other purchaser at a foreclosure sale, or to a designee of one of these parties, as the case may be, a new agreement ("**New Agreement**") which (i) shall be for a term equal to the remainder of the Term of this Agreement before giving effect to such rejection or termination; (ii) shall contain the same covenants, agreements, terms, provisions and limitations as this Agreement (except for any requirements that have been fulfilled by Operator or any Operator Mortgagee or other purchaser at a foreclosure sale prior to rejection or termination of this Agreement); and (iii) shall include that portion of the Operator Property in which Operator or such other Operator Mortgagee or other purchaser at a foreclosure sale had an interest on the date of rejection or termination.

13.7.2 If more than one Operator Mortgagee makes a written request for a New Agreement pursuant to this provision, the New Agreement shall be delivered to the Operator

Mortgagee requesting such New Agreement whose Operator Mortgage is prior in time, and the written request of any other Operator Mortgagee whose lien is subordinate shall be void and of no further force or effect. The provisions of this Section 13 shall survive the termination, rejection or disaffirmation of this Agreement and shall continue in full force and effect thereafter to the same extent as if this Section 13 were a separate and independent contract made by Owner, Operator and each Operator Mortgagee, and, from the effective date of such termination, rejection or disaffirmation of this Agreement to the date of execution and delivery of such New Agreement, such Operator Mortgagee or other purchaser at a foreclosure sale may use and enjoy the Operator Property without hindrance by Owner or any person claiming by, through or under Owner; provided that all of the conditions for the New Agreement as set forth above are complied with.

13.8 **Operator Mortgagee's Consent to Amendment, Termination or Surrender.**

Notwithstanding any provision of this Agreement to the contrary, the Parties agree that so long as any Operator Mortgage remains outstanding, this Agreement shall not be modified or amended, and Owner shall not accept a surrender, cancellation or release of all or any part of the Operator Property from Operator, prior to expiration of the Term of this Agreement, without the prior written consent of the Operator Mortgagee holding such Operator Mortgage. This provision is for the express benefit of and shall be enforceable by each Operator Mortgagee as if it were a party named in this Agreement.

14. **Assignment and Sublease.** Operator shall have the right, without Owner's consent, to sell, convey, lease or assign all or any portion of this Agreement or the Operator Property, on either an exclusive or non-exclusive basis, or to grant subeasements, co-easements, easements, licenses or similar rights with respect to the Operator Property (collectively, "**Assignment**"), to one or more persons or entities (collectively "**Assignee**"). Each Assignee shall use the Operator Property only for the uses permitted under this Agreement. Operator may make a complete assignment of this Agreement and be released from liability hereunder in such event from obligations subject thereof accruing after the date the liability for such obligations is assumed by Assignee only in connection with the assignment of all, or substantially all, of the assets of the Operator. Operator may assign this Agreement to any "Affiliate" of Operator unconditionally, including assignment without transferring any other assets of Operator. For purposes hereof, the term "Affiliate" shall mean any entity under common or shared ownership or control with Operator. In the event of a partial assignment of Operator's rights hereunder, Operator shall not be released from liability hereunder without Owner's written consent. When Operator makes any Assignment under this Section 14, Operator shall give written notice to Owner of such Assignment (including the interest conveyed by the Assignment and the address of the Assignee for notice purposes) to Owner; provided Operator's failure to give such notice shall not constitute a default under this Agreement, but rather shall only have the effect of not binding Owner with respect to such assignment or conveyance until such notice is given.

15. **Hazardous Materials.**

15.1 **Owner's Covenants Regarding Hazardous Materials.** Owner represents and warrants that, to the best of Owner's knowledge, the Owner's Property is not and has not been in violation of any federal, state or local environmental health or safety laws, statute, ordinance, rule, regulation or requirement ("**Environmental Laws**"), and Owner has not received any notice or

other communication from any governmental authorities alleging that the Owner's Property is in violation of any Environmental Laws. "**Hazardous Materials**" shall mean any asbestos containing materials, petroleum, explosives, toxic materials, or substances regulated as hazardous wastes, hazardous materials, hazardous substances, or toxic substances under any federal, state, or local law or regulation. Owner warrants that Owner has done nothing to contaminate the Operator Property with Hazardous Materials or wastes.

15.2 **Operator's Covenants Regarding Hazardous Materials.** Operator shall, at Operator's sole cost and expense, promptly take removal or remedial action required by Environmental Law with regard to any material violation of any Environmental Law with regard to any Hazardous Materials brought onto the Owner's Property by Operator or its employees, agents, or contractors. Owner shall cooperate with Operator with regard to any scheduling or access to the Owner's Property in connection with any action required hereunder.

15.3 **Operator's Indemnity Regarding Hazardous Materials.** Operator shall indemnify, defend, protect and hold Owner harmless from any liability based on: (i) the release of Hazardous Materials in, on, under or about the Owner's Property caused by Operator or its employees, agents, or contractors, or (ii) the violation by Operator or its employees, agents, or contractors of any Environmental Law. The indemnity obligations set forth herein shall survive termination of this Agreement.

16. **Insurance and Indemnity.**

16.1 **Insurance.** At all times during which Operator is conducting any activities on the Property and at all times during the Term of this Agreement, Operator shall maintain in effect (1) commercial General Liability Insurance, including bodily injury and property damage coverage with minimum limits of \$1 Million Dollars per occurrence and \$2 Million Dollars aggregate and (2) Umbrella Liability Insurance with minimum limits of \$5 Million Dollars per occurrence and \$5 Million Dollars aggregate. Upon a written request by Owner, Operator shall name Owner as additional insured on such insurance policy and provide Owner with a certificate of such insurance.

16.2 **Indemnity by Operator.** Operator shall defend, indemnify, protect and hold Owner harmless from and against all liabilities, costs, expenses, obligations, losses, damages, claims, (collectively "**Claims**") resulting from the negligence, willful misconduct, or breach of this Agreement by Operator, its agents, contractors or employees, invitees, licensees and permittees; provided, however, that such Claims are not due to the sole negligence, willful misconduct, or breach by Owner, its agents, contractors or employees, invitees, licensees or permittees.

16.3 **Indemnity by Owner.** Owner shall defend, indemnify, protect, and hold Operator harmless from and against all Claims resulting from the negligence, willful misconduct, or breach of this Agreement by Owner, its agents, contractors or employees, invitees, licensees and permittees; provided, however, that such Claims are not due to the sole negligence, willful misconduct, or breach by Operator, its agents, contractors, employees, invitees, licensees, or permittees.

16.4 **Survival.** The obligations of the Parties under this Section 16 shall survive expiration or other termination of this Agreement.

17. **Confidentiality.** This Agreement includes confidential and proprietary information relating to Operator and the Project. Owner agrees not to provide copies of the Agreement or disclose the terms of the Agreement to any unauthorized person or entity. Operator authorizes Owner to provide copies of the Agreement and disclose the terms thereof to Owner's family ("family" shall be deemed to include all devisees or descendants of owner by will or intestacy), attorney, accountant, financial advisor and any existing or prospective mortgagee, lessee, or purchaser for the sole purpose of evaluating and advising Owner and for no other purpose, so long as such authorized parties agree in writing to become subject to the confidentiality provisions hereto and not to provide copies of the Agreement or disclose the terms thereof to any unauthorized person or entity. Any Owner and party shall return all material containing any confidential information to Operator immediately upon its request. Any party agrees to destroy immediately upon request by Operator such analyses, compilation, studies or other documents, and any oral information will continue to be subject to the terms of this Agreement. Owner agrees that Operator will have no adequate remedy at law if any party violates any of the terms of this Agreement. In such event Operator will have the right, in addition to any other rights Operator may have, to obtain injunctive relief to restrain any breach or threatened breach by third party or specific enforcement of such terms plus reimbursement of attorneys' fees, court costs and all associated expenses. No party shall publish, file for public record, reproduce, or otherwise disseminate this document or any of the terms and provisions hereof to any party, other than the Parties set forth above without the prior written consent of Operator, which consent may be withheld for any reason and in Operator's sole discretion.

18. **Default and Remedies.**

18.1 **Operator Payment Default.** [REDACTED]
[REDACTED]
[REDACTED]
[REDACTED]

18.1.1 **Collection of Payments.** [REDACTED]
[REDACTED]
[REDACTED]
[REDACTED]
[REDACTED]

18.1.2 **Terminate Agreement.** [REDACTED]
[REDACTED]
[REDACTED]
[REDACTED]
[REDACTED]
[REDACTED]
[REDACTED]
[REDACTED]
[REDACTED]
[REDACTED]
[REDACTED]
[REDACTED]
[REDACTED]
[REDACTED]
[REDACTED]

[REDACTED]

18.2 **Other Operator Default.** [REDACTED]

[REDACTED]

18.3 **Owner Default.** [REDACTED]

[REDACTED]

19. **Condemnation.**

19.1 **Complete Taking.** If, at any time, any authority having the power of eminent domain shall condemn all or substantially all of the Operator's Property, or all of the Improvements thereon, for any public use or otherwise, then the interests and obligations of Operator under this Agreement in or affecting the Operator's Property shall cease and terminate upon the earlier of (i)

the date that the condemning authority takes physical possession of the Operator's Property or the Improvements thereon, (ii) the date that Operator is, in its sole judgment, no longer able or permitted to operate the Project on the Operator's Property in a commercially viable manner, or (iii) the date of the condemnation judgment. Operator shall continue to pay all amounts payable hereunder to Owner until the earlier of such dates, at which time the Parties shall be relieved of any and all further obligations and conditions to each other under this Agreement.

19.2 **Partial Taking.** If, at any time during the term of this Agreement, any authority having the power of eminent domain shall condemn one or more, but not all, of the Solar Panels, or any portion of the Improvements or the Operator's Property, then the interest and obligations of Operator under this Agreement as to those Solar Panels or any portion of the Improvements or the Operator's Property so taken shall cease and terminate upon the earlier of (i) the date that the condemning authority takes possession of such Solar Panels or any portion of the Improvements or the Operator's Property, (ii) the date that Operator is, in its reasonable judgment, no longer able or permitted to operate the Project on the Operator's Property, or any portion thereof, in a commercially viable manner, or (iii) the date of the condemnation judgment; and, unless this Agreement is terminated as hereinafter provided, this Agreement shall continue in full force and effect as to the remainder of the Solar Panels, Improvements and the Operator's Property. If the remainder of the Solar Panels or any other portion of the Improvements or the Operator's Property is or becomes insufficient or unsuitable for Operator's purposes hereunder, as determined by Operator in its sole discretion, then, subject to the rights of any Operator Mortgagee under Section 13, Operator shall have the right to terminate this Agreement as to the portion of the Operator's Property to which Operator continues to hold the rights, at which time the Parties shall be relieved of any further obligations and duties to each other under this Agreement.

19.3 **Apportionment, Distribution of Award.** On any taking, all sums awarded, including damages and interest, shall be paid as follows:

- (a) Any portion of the award by the court on account of any cost or loss that Operator may sustain in the removal and relocation of Operator's Improvements, to Operator;
- (b) Any portion of the award by the court for Operator's anticipated or lost revenues or profits, to Operator;
- (c) Any portion of the award by the court for Owner's lost revenues, to Owner;
- (d) All remaining amounts of the award, to Owner or Operator consistent with applicable Kentucky law.

20. **Notice.**

20.1 **Writing.** All notices given or permitted to be given hereunder shall be in writing.

20.2 **Delivery.** Notice is considered given either (i) when delivered in person to the recipient named below, (ii) upon receipt after deposit in the United States mail in a sealed envelope or container, postage and postal charges prepaid, return receipt requested or certified mail, addressed by name and address to the party or person intended, or (iii) twenty-four (24) hours from

proper and timely delivery to an overnight courier service addressed by name and address to the party or person intended as follows:

Notice to Owner: Carolyn G. Whitmore Estate
Laveta Daniel, Executrix
9260 Route 416 W
Robards, KY 42452

[REDACTED]

Laveta Daniel
9260 Route 416 W
Robards, KY 42452

[REDACTED]

Notice to Operator: Sebree Solar, LLC
700 Universe Blvd
Juno Beach, FL 33408
Attn: Land Services Administration

[REDACTED]

20.3 **Change of Recipient or Address.** Either Party may, by notice given at any time or from time to time, require subsequent notices to be given to another individual person, whether a party or an officer or representative, or to a different address, or both. Notices given before actual receipt or notice of change shall not be invalidated by the change.

21. **Miscellaneous Provisions.**

21.1 **Successors and Assigns.** The terms and provisions of this Agreement shall run with the land and be binding on and inure to the benefit of the heirs, successors, assigns and personal representatives of the Parties. In accordance with this Agreement, Operator in its discretion may authorize other persons or entities to use the Operator Property for the purposes stated in this Agreement

21.2 **Memorandum.** Simultaneously with the execution of this Agreement, the Parties agree to execute and acknowledge a memorandum of this Agreement. Operator may record the executed memorandum in the public records of Henderson County, Kentucky.

21.3 **Entire Agreement.** This Agreement and the attached Exhibits shall constitute the entire agreement between the Parties and supersedes all other prior writings and understandings.

21.4 **Amendments.** This Agreement shall not be amended or modified in any way except by an instrument signed by the Parties and consented to by any Operator Mortgagee. The Parties hereto shall at all times hereafter execute any documents and do any further acts which

may be necessary or desirable to carry out the purposes of this Agreement and to give full force and effect to each and all of the provisions hereof.

21.5 **Legal Matters.** This Agreement shall be governed by and interpreted in accordance with the then existing laws of the Commonwealth of Kentucky and the County where the Owner's Property is located shall be considered the proper forum or jurisdiction for any disputes arising in connection with this Agreement. The Parties agree to first attempt to settle any dispute arising out of or in connection with this Agreement by good-faith negotiation. If the Parties are unable to resolve amicably any dispute arising out of or in connection with this Agreement, each shall have all remedies available at law or in equity and as provided by this Agreement. **Each Party waives all right to trial by jury and specifically agrees that trial of suits or causes of action arising out of this Agreement shall be to the court of competent jurisdiction.**

21.6 **Severability.** If any term or provision of this Agreement, or the application thereof to any person or circumstance shall, to any extent, be determined by judicial order or decision to be invalid or unenforceable, the remainder of this Agreement or the application of such term or provision to persons or circumstances other than those as to which it is held to be invalid, shall be enforced to the fullest extent permitted by law.

21.7 **Tax Credits.** If under applicable law Operator becomes ineligible for any currently existing tax credit, benefit or incentive for alternative energy expenditure established by any local, state or federal government, then, at Operator's option, the Parties shall negotiate in good faith to amend this Agreement or replace it with a different instrument so as to convert Operator's interest in the Operator Property to a substantially similar interest that makes Operator eligible for such tax credit, benefit or incentive. Such amendment or instrument shall not impair any of Owner's rights or increase the burdens or obligations of Owner under this Agreement.

21.8 **Approvals.** Whenever in this Agreement the approval or consent of either Party is required or contemplated, unless otherwise specified, such approval or consent shall not be unreasonably withheld or delayed.

21.9 **Authority.** The signatories hereto warrant that each has the authority to execute this Agreement on behalf of any entities which are Parties to this Agreement and that each such entity has executed this Agreement pursuant to its organizational documents or a resolution or consent of their Board of Directors or other governing body.

21.10 **Time of Essence.** Time is of the essence of each provision of this Agreement.

21.11 **Counterparts.** This Agreement may be executed in multiple counterparts, each of which shall be deemed an original, and all of which together shall constitute a single instrument.

[Signatures on Next Page]

Owner:

Estate of Carolyn Whitmore

Laveta Daniel
By: Laveta Daniel as Executrix

Laveta Daniel
Laveta Daniel

Joined by consenting spouse:

Chris Daniel
Chris Daniel

Operator:

Sebree Solar, LLC
a Delaware limited liability company

By: Anthony Pedroni
Anthony Pedroni, Vice President

EXHIBIT A

Legal Description of Owner's Property

Parcel 1

The tract is the remainder portion of J. Leroy Poole's 35 acre tract as described in Deed Book 293 page 383, LESS lot 1 and 2 as shown on the plat and described as follows, being Lot 3 as shown on the plat of record in Deed Book ~~392~~, page ~~367~~, Henderson County Court Clerk's office.

Beginning at an iron pin in the south right of way of Kentucky Highway 416 and at a corner of Maynard Hust, thence S. 79° 45' W. 295.91 feet with the Highway to a pin at a corner of Lot 2; thence S. 2° 39' W. 484.42 feet to a pin and S. 82° 47' W. 364.43 feet to a pin at a corner between Douglas Denton and Billy Parrish, both calls with Lot 2, thence S. 2° 45' W. 1798 feet with Parrish "to a stake in old road," "thence with same S. 85° 20' E. 648 feet to an iron pin in road" at a corner with Maynard Hust, thence N. 2° 45' E. 2460 feet with Hust to the point of beginning and containing 30.9 acres more or less, the accompanying plat providing a more particular description.

The above being the same property acquired by Donald R. Whitmore and wife, Carolyn A. Whitmore by Deed dated June 30, 1994, of record in Deed Book 442, Page 519, in the Henderson County Clerk's office.

Parcel 2

Beginning at a RR spike corner to Tom Melton, said spike being in the centerline of the Spencer-Thornberry Road and being approximately 2750 feet south of the intersection of Ky. Hwy. 416 in Henderson County, Kentucky; thence with the centerline of said road South 57° 37' 24" East - 30.25 feet, South 64° 26' 56" East - 76.32 feet, South 57° 12' 36" East - 61.62 feet, South 39° 01' 56" East - 73.52 feet, South 11° 05' 53" East - 90.14 feet, South 7° 04' 52" West - 236.18 feet to a RR spike corner to Tract 5A of the Jack Tillman Subdivision; thence with the line of said subdivision

North 83° 00' 22" West - 100.47 feet to an iron pin,
North 23° 14' 30" West - 16.04 feet to an iron pin,
North 82° 44' 54" West - 604.19 feet to an iron pin,
South 2° 45' 30" East -- 505.72 feet to an iron pin in
the line of A. F. Royster; thence with the line of
Royster North 83° 18' 14" West - 1106.93 feet to a 12"
Hackberry corner to Terry Duncan; thence with the line
of Duncan North 15° 24' 31" West - 213.17 feet, North 9°
49' 20" West - 256.23 feet, North 8° 52' 57" West -
432.62 feet to a post, North 34° 30' 31" East - 39.03
feet to a post, North 16° 33' 18" West - 1152.37 feet to
a post in the line of Chris Daniels; thence with the
line of Daniels, James Eblen and W. C. Royster South 82°
30' 11" East - 1244.66 feet to an iron pin corner to
James Eblen; thence with the line of Eblen South 83°
23' 26" East - 239.01 feet to a 12" Maple corner to Tom
Melton; thence with the line of Melton South 3° 14' 53"
East -- 1056.85 feet to an iron pin, South 85° 35' 34"
East - 540.95 feet to the point of beginning and

containing 63.413 acres. See plat of record in Plat
Book 5, page 2.

Parcel 3

Being all of the following lots of the Margaret Moore
Minor Subdivision and Consolidation as follows:

Tract 1: Consisting of one lot: Lot 1 (3.1115 acres).

Tract 2: Consisting of one lot: Lot 1 (5.3236 acres).

Both tracts being recorded in Plat Book 6, page 199, in
the Henderson County Court Clerk's Office. For a more
particular description, see Exhibit "A" attached hereto
and made a part hereof.

Being the same property conveyed to Grantors herein by a
deed dated June 3, 1992, from Margaret E. Moore, widow,
of record in Deed Book 423, page 62, in the Henderson
County Court Clerk's Office.

Parcel 4

The tract is the remainder portion of J. Leroy Poole's 35 acre tract as described in Deed Book 293, page 388, LESS Lot 1 and 2 as shown on the plat and described as follows, being Lot 3 as shown on the plat of record in Deed Book 398, page 367, in the Henderson County Court Clerk's Office.

Beginning at an iron pin in the south right-of-way of Kentucky Highway 416 and at a corner of Maynard Hust, thence South 79° 45' West 295.91 feet with the highway to a pin at a corner of Lot 2; thence South 2° 39' West 484.42 feet to a pin and South 82° 47' West 364.43 feet to a pin at a corner between Douglas Denton and Billy Parrish, both calls with Lot 2, thence South 2° 45' West 1798 feet with Parrish "to a stake in old road," "thence with same South 85° 20' East 648 feet to an iron pin in road" at a corner with Maynard Hust, thence North 2° 45' East 2460 feet with Hust to the point of beginning and containing 30.9 acres more or less, the accompanying plat providing a more particular description.

Parcel 5

Beginning at an iron pin corner to Windy Knob Dairy, said pin being the northern R/W of Ky. Hwy. 416, 30 feet from the centerline and being approximately 125 feet east of the intersection of W. N. Royster Road in Henderson County, Kentucky; thence with the line of Windy Knob Dairy North 1° 54' 57" East - 320.64 feet to a post, North 1° 20' 55" East - 467.81 feet to a post, North 1° 24' 29" East 179.47 feet to an iron pin corner to Jack Pryor's remainder; thence with said remainder, South 78° 55' 21" West - 229.63 feet to a post, North 87° 08' 10" West - 159.71 feet to an iron corner to Lot No. 2 of the Jack Pryor Subdivision; thence with the line of Lot No. 2, South 1° 52' 02" West - 909.92 feet to an iron pin in the R/W South 87° 09' 06" East -

191.39 feet, South 86° 22' 55" East - 197.61 feet to the point of beginning and containing 8.242 acres.

Being Lot No. 1 of the Jack Pryor Subdivision appearing of record in Plat Book 5, page 61, in the Henderson County Court Clerk's Office.

LESS & EXCEPT: No minerals are included in this conveyance.

Parcels 2-5 above being the same property acquired by Donald R. Whitmore and wife, Carolyn G. Whitmore by Deed dated November 4, 1999, of record in Deed Book 491, Page 698, in the Henderson County Clerk's office.

Parcel 6

Beginning at a stake in Royster and Thornberry Road, corner with Forrest Edwards, in J. L. Blue line, runs N 88 - 20 W 1359 feet to Red Oak, corner with Forrest Edwards in Mrs. Fannie Royster's line; thence N 1 - 40 E 23 feet to a Black Gum, corner of Mrs. Fannie Royster; thence N 88 - 20 W 618 feet to a post oak; thence north 205 feet to a stake in Earl Knight's line, corner with Olivia Royster Heirs 10 acre tract; thence with line of 10 acre tract S 88 - 20 E 1980 feet to the Royster-Thornberry Road; thence with same S 1 - 15 W 230 feet to the beginning, containing 10 acres.

LESS: The following 7 acres conveyed to Ralph Ray Royster and wife, Barbara Jean Royster, by Cecile Royster, widow, by deed of even date herewith, to-wit:

Beginning at a stake in the Royster and Thornberry Road, at the southeast corner of Tract No. 1 of the property conveyed to Grantor and husband by deed dated July 14, 1951, of record in Deed Book 152, page 312, in the Henderson County Court Clerk's Office; thence North 88 deg. 20' West 1325.756 feet to a point corner to the remainder of Tract No. 1 of the 1951 deed; thence North 1 deg. 40' East 230 feet to a point corner with Tract No. 2 conveyed to Grantor and husband by the 1951 deed; thence with Tract No. 2 South 88 deg. 20' East 1325.756 feet to the Royster and Thornberry Road; thence with said road South 1 deg. 15' West 230 feet more or less to the point of beginning and containing in all 7 acres and being the southeast corner of the property conveyed to Grantor by the 1951 deed.

Parcel 7

Beginning at a stake, corner with V. A. Royster 10 acre tract, runs North 222 feet to a stake in Earl Knight's line, corner with Mrs. Lymer Ligon 25 acre tract; thence South 88 - 20 East 1983 feet to Royster-Thornberry Road,

corner with Mr. and Mrs. Gus Ligon; thence with road S 1 - 15 W 222 feet to a stake in division line, corner with V. A. Royster; thence North 88 - 20 West 1980 feet to the beginning, containing 10 acres.

Parcel 6 & 7 above being the same property acquired by Donald R. Whitmore and wife, Carolyn G. Whitmore by Deed dated August 11, 1998, of record in Deed Book 479, Page 78, in the Henderson County Clerk's office.

Parcel 8

A lot or parcel of land lying in Henderson County, Kentucky, and being Lot No. 1 in the Division of the lands of W.A. Royster, decd., and bounded as follows:

Beginning at a stake in the center of the public road Corner to Olivia Royster and in the line of Powell Eblen, thence with center line of said road North 2 deg. 15' East 4.64 chains to a stake; thence with the center line of said road, North 3 deg. 45' East 9.47 chains to a stake corner with N. E. Royster; thence with E. N. Royster's line South 87 deg. 15' East 36.33 chains to a stake corner with H. K. Betts; thence South 2 deg. 45' West 44.10 chains to a stake, thence North 87 deg. 15' West 36.33 chains to the beginning, containing 51.25 acres.

The above being the same property acquired by Donald R. Whitmore and wife, Carolyn G. Whitmore by Deed dated January 24, 2003, of record in Deed Book 520, Page 382, in the Henderson County Clerk's office.

QLA: 8181

EXHIBIT B-1

Depiction of Parcels

Depiction of Parcel 1



Depiction of Parcel 2

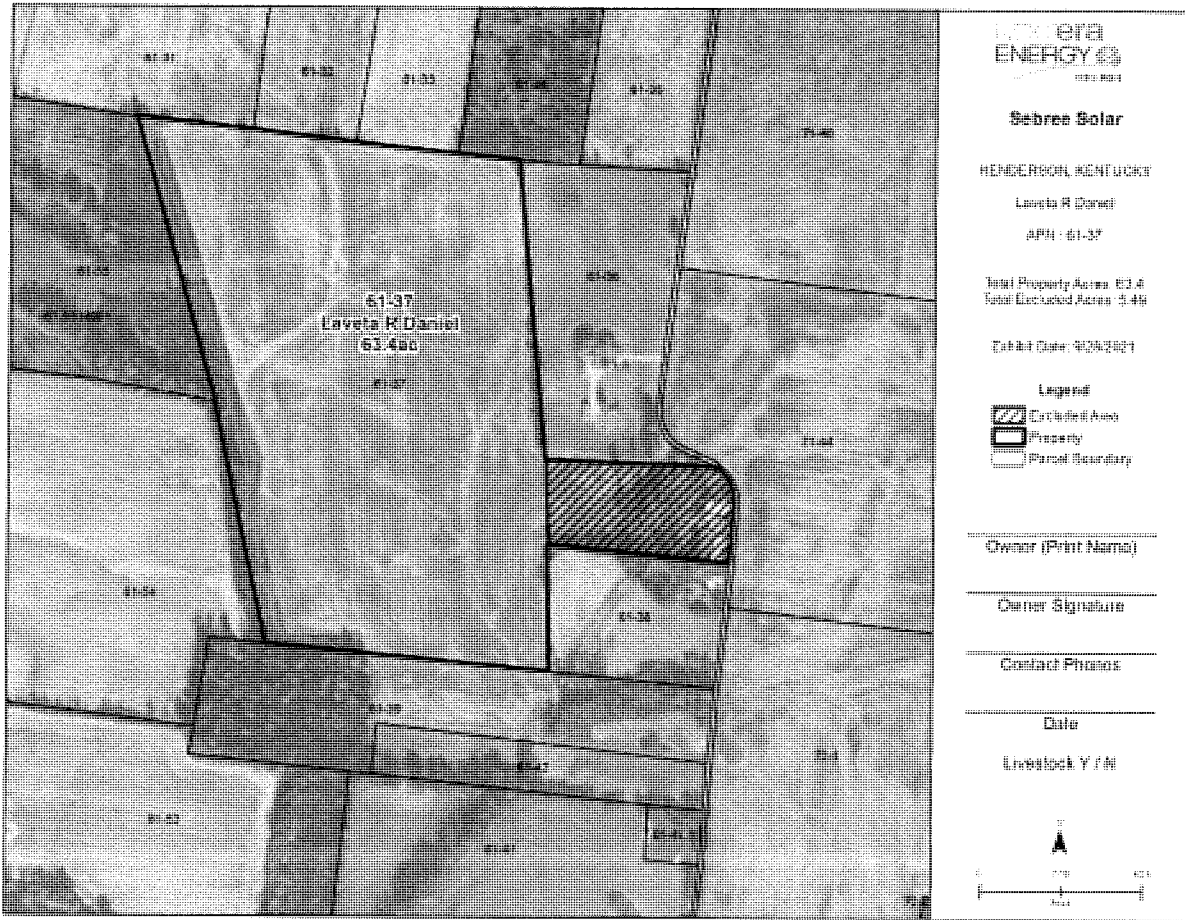

Depiction of Parcel 3-5

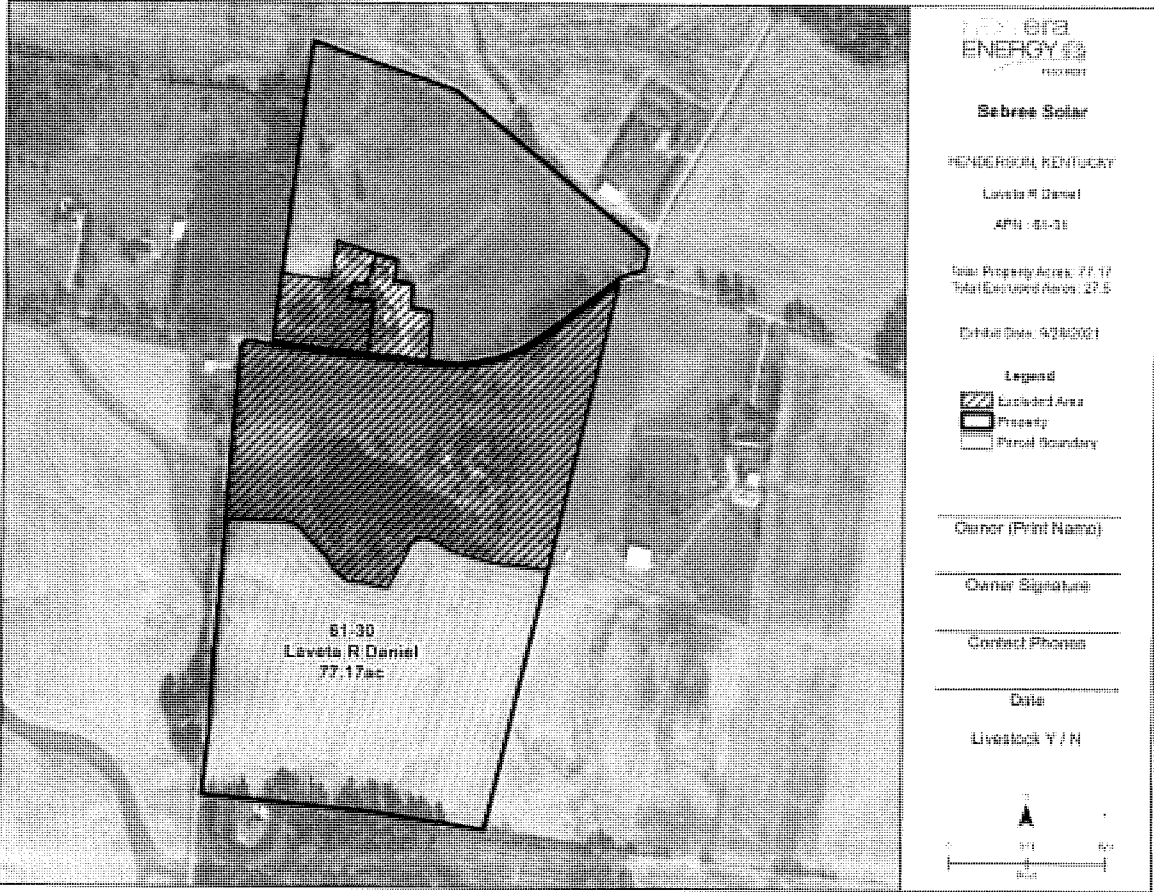

Depiction of Parcel 6-7

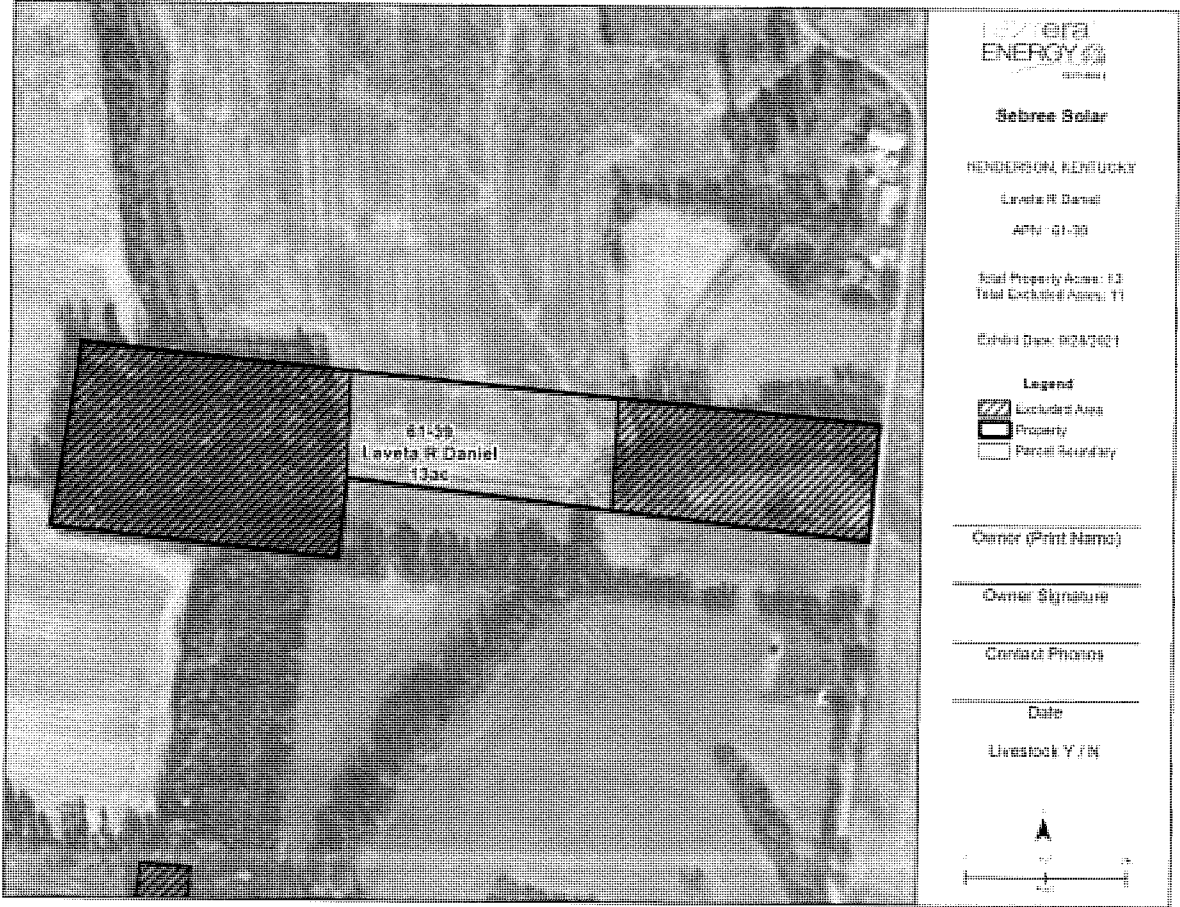

Depiction of Parcel 8

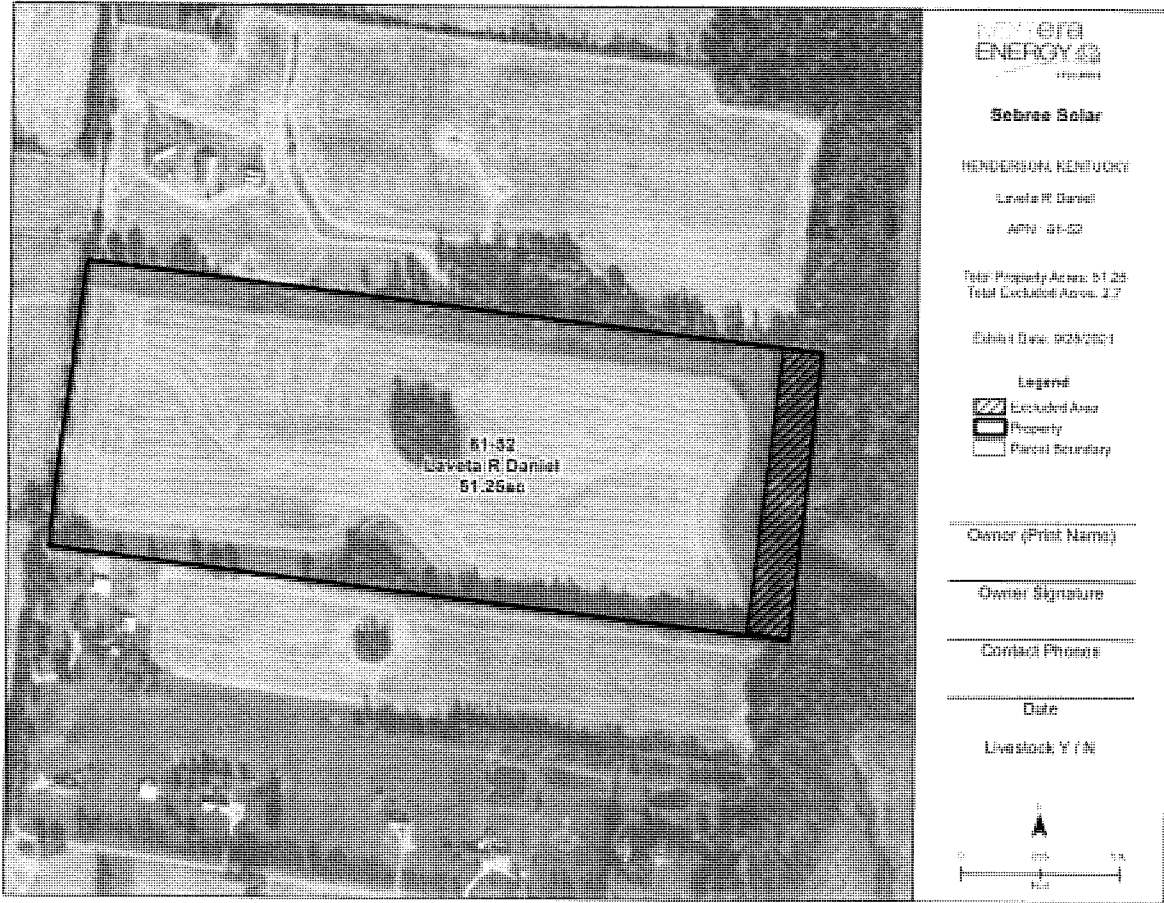

HOLDING PAGE FOR EXHIBIT B-2

Preliminary Lease and Easement Improvement Plan and Acreage Calculation
To be Delivered with Option Notice

HOLDING PAGE FOR EXHIBIT C

As Built Lease and Easement Improvements and Final Acreage Calculation

EXHIBIT D

Lease and Easement Compensation

[REDACTED]

[REDACTED]	[REDACTED]
[REDACTED]	[REDACTED]
[REDACTED]	[REDACTED]
[REDACTED]	[REDACTED]
[REDACTED]	[REDACTED]

[REDACTED]

(2) **Payment for Lease and Easements.**

[REDACTED]

[REDACTED]

[REDACTED]

[REDACTED]

(3) Crop Compensation. [REDACTED]

[REDACTED]

[REDACTED]

(4) Timber Removal. [REDACTED]

[REDACTED]

[REDACTED]

(6) Payment Allocation Schedule. [REDACTED]

[REDACTED]

FINAL *MS*
SAB

REAL ESTATE PURCHASE OPTION AGREEMENT

THIS REAL ESTATE PURCHASE OPTION AGREEMENT ("**Agreement**"), made and entered into as of the 14 day of October, 2021 by and between: (i) **PAMELA J. GARDNER**, unmarried; **JANET KAY GARDNER**, unmarried; **MALCOM EDWARD SELLERS** and **Suzan D. Boyd**, husband and wife; **ASHLEY SELLERS SMITH** and **Todd Smith**, wife and husband; and **HEATHER SELLERS (DENTON) WARWICK** and **Brian Warwick**, wife and husband (collectively, "**Seller**"), and (ii) **BOULEVARD ASSOCIATES, LLC**, a Delaware limited liability company, whose address is 700 Universe Boulevard, Juno Beach, FL., 33408 ("**Purchaser**"), provides as follows:

THAT, FOR AND IN CONSIDERATION of the mutual covenants, promises, conditions, and undertakings set forth herein, the payment of the Option Fee (as hereafter defined), and other good and valuable consideration, the receipt and sufficiency of which the parties hereby acknowledge, Seller and Purchaser covenant and agree as follows:

1. **Grant of Option.** Seller hereby grants to Purchaser an exclusive right and option ("**Option**") to purchase from Seller, upon the terms and conditions hereafter set forth, that certain real property located in the County of Henderson ("**County**"), Commonwealth of Kentucky, and any structures, buildings, and other improvements thereon, together with existing access easements benefiting such real property, all of which is more particularly described on **Exhibit A** attached hereto and incorporated herein by reference together with Seller's right, title and interest, if any, in and to all of the following: streets, alleys and rights-of-way adjacent to the real property, any easement rights, air rights, subsurface development rights, water rights and other rights appurtenant to the real property, any minerals, including oil, gas and other hydrocarbon substances on the real property (for which no representations or warranties are made by Seller), all of which shall be referred to herein as the "**Property**".

2. **Duration of Option.** The term of the Option shall be two (2) years, commencing on the Effective Date ("**Option Term**").

3. **Option Fee.** [REDACTED]

4. **Exercise of Option, Non-Exercise of Option.** Purchaser may elect to exercise the Option at any time during the Option Term by giving written notice of exercise to Seller. If the Option is exercised as provided herein, this Agreement shall become and constitute a binding contract for the purchase and sale of the Property on the terms and conditions set forth in this Agreement. Upon exercise of the Option by the Purchaser, closing on the purchase and sale of the

MS
SAB

Property hereunder ("**Settlement**") will occur on a date mutually agreed to by Purchaser and Seller, but no later than sixty (60) days after the date of such written notice of exercise ("**Settlement Date**"). Purchaser shall have the right to terminate the Agreement at any time during the Option Term in Purchaser's sole discretion for any reason by giving Seller written notice, and in such event Seller shall retain any Option Fee delivered by Purchaser as of the termination date.

5. Purchase Price [REDACTED]

6. Title and Escrow.

A. Escrow. On or before the date Purchaser exercises the Option, Purchaser shall open an escrow ("**Escrow**") with an escrow company acceptable to Purchaser (the "**Escrow Agent**"). This Agreement constitutes escrow instructions to Escrow Agent. Any supplemental instructions shall not conflict with, amend or supersede any portion of this Agreement. If there is any inconsistency between such supplemental instructions and this Agreement, this Agreement shall control, unless otherwise agreed in writing by Purchaser and Seller.

B. State of Title. Seller's title to the Property is, as of the Effective Date, and shall be, at the time of Settlement, marketable, fee simple, indefeasible, and fully insurable at standard rates by a reputable title insurance company selected by Purchaser ("**Title Insurer**"), subject only to those exceptions acceptable to Purchaser, in its sole discretion. Seller shall cause title to the Property to be conveyed to Purchaser by special warranty deed subject only to current taxes and assessments and matters approved by Purchaser in accordance with Section 6(C) (the "**Permitted Exceptions**"). At Settlement, Seller must satisfy all reasonable requirements imposed by the Title Insurer to issue its ALTA standard owner's policy of title insurance, insuring title to the Property in the name of the Purchaser with liability in the amount of the Purchase Price or such higher amount as may be specified by Purchaser (the "**Owner's Policy**"). The Owner's Policy shall list as exceptions to coverage only the foregoing taxes and assessments and the Permitted Exceptions.

C. Title Examination. Within 90 days of the Effective Date, Purchaser, at its expense, may cause a Title Insurer to issue a title insurance commitment ("**Commitment**") to issue an Owner's Policy to Purchaser and within 30 days thereafter (120 days from the Effective Date, Purchaser shall advise Seller in writing ("**Title Objection Notice**") of those exceptions to title in the Commitment, which may include any unrecorded leases disclosed by the Seller in accordance with this Agreement, and those matters shown on the Survey, including zoning, contemplated by this Agreement that are unacceptable to Purchaser ("**Title Defects**"). Any exceptions to title insurance shown on the Commitment and matters shown on the Survey that are not contained in the Title Objection Notice shall be deemed Permitted Exceptions. All exceptions to title, zoning and survey not disclosed within 120 days after the Effective Date shall be Permitted Exceptions, excepting only title matters affecting the Property and arising after the Effective Date shall not be considered Permitted Exceptions without Purchaser's prior written consent in accordance with Section 6(D). Seller shall use its good faith efforts to cure all Title Defects promptly and at its

expense. In the event that Seller is unable to cure any Title Defects (excluding any Monetary Liens) within the thirty (30) day period following the date of the Title Objection Notice or by the Settlement Date, whichever first occurs ("**Title Cure Period**") after good faith efforts to do so, Seller shall notify Purchaser in writing as to which Title Defects remain uncured on or before the end of the Title Cure Period and Purchaser shall have twenty (20) days following such notice to either: (i) elect to accept title to the Property subject to the uncured Title Defects, in which event such Title Defects shall be deemed Permitted Exceptions; (ii) terminate this Agreement by written notice thereof to Seller, whereupon this Agreement shall be terminated, and both parties shall thereafter be released from all further obligations hereunder, except for those obligations specifically stated herein to survive termination of this Agreement; or (iii) elect to extend the Title Cure Period or Settlement Date, if the Option has been exercised, for a reasonable period of time designated by Purchaser (not to exceed thirty (30) days) and, if upon the expiration of such period Seller shall not have cured the Title Defects, Purchaser shall have the options set forth in (i) or (ii) above. Notwithstanding the above, Seller shall be obligated to cure any Title Defects created by Seller and any judgment, lien or encumbrance that can be cured by the payment at Settlement of a liquidated amount ("**Monetary Liens**"). At Settlement, Seller shall provide Purchaser and Title Insurer with all affidavits in form reasonably acceptable to the Title Insurer to permit the Title Insurer to insure against adverse matters caused by Seller and first appearing in the Office of the Clerk of the County on a date subsequent to the effective date of the Commitment and prior to the recording of the deed required by the terms of this Agreement, and to permit Title Insurer to delete the standard exceptions, including parties in possession, mechanics' or materialmen's liens and unrecorded easements

D. Future Title Matters. Seller shall not, after the Effective Date, subject the Property, or consent, to any liens, encumbrances, covenants, conditions, restrictions, easements, or rights-of-way, or seek any zoning changes or take any other action that might affect or modify the status of title to the Property (other than curing or removing title exceptions as contemplated by Section 6(C)) without Purchaser's prior written consent. If Seller violates the provisions of the preceding sentence, Seller shall, prior to Settlement, and at its expense, effect the release of any such liens, encumbrances, covenants, conditions, restrictions, easements and rights-of-way, and take such steps as are necessary to return the zoning and title of the Property to the condition that existed as of the Effective Date or as agreed to by Purchaser. The foregoing shall not apply to actions by a political subdivision for purposes of eminent domain, except as otherwise set forth.

7. Due Diligence.

A. Purchaser's Tests and Inspections. Purchaser shall have the right during the Option Term, to use all existing easements and roads providing access to the Property, including any easements described on **Exhibit A**, and to enter upon the Property and to perform, at its expense, boring tests and economic, engineering, topographic, environmental, survey and marketing tests or any other studies, tests and due diligence as Purchaser elects in its sole discretion. Said tests shall include but not be limited to the installation on the Property of any weather related instruments and fencing of said instruments reasonably required by Purchaser and access to said instruments. Purchaser shall not interfere with Seller's current operations on the Property while conducting any studies, tests and due diligence on the Property but in the event that Purchaser does interfere with Seller's current operations, Purchaser shall use all reasonable efforts



to minimize any impact on Seller's operations. During the Option Term, Seller agrees to make available to Purchaser for inspection, and, at Settlement, to assign to Purchaser without cost, any and all architectural and engineering studies, surveys, and other related materials or information relating to the Property that are in, or come into, Seller's possession or control as more particularly set forth herein. (As of the Effective Date there are no such materials known to Seller.) Within the Option Term, Purchaser may elect, at its option and expense, to cause a survey of the Property ("**Survey**") to be prepared by a reputable surveyor, certifying the acreage of the Property and containing such other information as the Purchaser may direct. Provided Purchaser elects to cause a survey to be prepared, Purchaser may arrange for the preparation of the Survey during the Option Term or at any time prior to Settlement. Purchaser agrees to indemnify against and hold Seller harmless from any claims, damages, costs, or expenses arising from entry upon the Property by Purchaser, or any agents, contractors, or employees of Purchaser with the exception of: (i) any loss, liability, cost or expense to the extent arising from or related to acts of Seller or any tenants, (ii) any diminution in value of the Property arising from or related to matters discovered by Purchaser during its investigation of the Property, (iii) any latent defects in the Property discovered by Purchaser, (iv) liability which results from the release of preexisting toxic or Hazardous Materials on or about the Property resulting from normal environmental testing procedures, and (v) liability which arises from the results or findings of such tests. The provisions of this Section shall survive the Settlement Date or earlier termination of this Agreement. If Settlement does not occur, Purchaser, at its own expense, shall repair any damage to the Property caused by Purchaser's tests and studies. In the event Purchaser does not exercise the Option, Purchaser shall provide to Seller a copy of the Survey it receives in accordance with this Agreement.

B. Delivery of Due Diligence Information. The following instruments and items of information shall be delivered by Seller to Purchaser within fifteen (15) days after the Effective Date to the extent these items are in the Seller's possession or control:

1. All reports covering underground soil and water conditions at the Property and in the possession of Seller or its agent.
2. Copies of any and all licenses, permits and inspection reports issued by governmental authorities with respect to the Property.
3. Copies of the most recent real estate tax bills as to the Property.
4. All current leases and royalty agreements for any portion of the Property.
5. All existing surveys for any portion of the Property.
6. All existing title policies for any portion of the Property.
7. All existing environmental reports for any portion of the Property.
8. Copies of well permits, statements of beneficial use and decrees relating to any ground water wells on or under the surface of the Property.



C. Access to Books and Records. Seller covenants and agrees that its shall give to Purchaser and to Purchaser's counsel, accountants and other representatives full access during normal business hours to the Property and to contracts and commitments of Seller relating to the Property, if any, and shall furnish to Purchaser all such information concerning the Property in the possession of Seller or their agents that Purchaser may reasonably request, excluding any personal financial matters or tax returns.

8. Settlement Deliveries.

A. Seller's Deliveries. At or before Settlement, Seller shall deliver to Escrow Agent all of the following documents and instruments, which shall have been executed by Seller:

1. A special warranty deed ("**Deed**"), in the form attached hereto as **Exhibit B** granting and conveying to Purchaser title to the Property in fee simple absolute, such Deed to be delivered in hand at Settlement and such deed will exclude environmental warranties, and warranties relating to subsurface development rights, water rights and other rights appurtenant to the real property, any minerals, including oil, gas and other hydrocarbon substances on the real property;

2. A bill of sale and general assignment transferring and conveying all of Seller's right, title and interest in and to any personal property at the Property that Purchaser has agreed to accept and all of Seller's right, title and interest in and to all licenses, rights, permits and authorizations pertaining to the Property;

3. Such affidavits, certificates and forms as may be required by the Title Insurer, any lender, or state or local law;

4. A Certification of Non-Foreign Status pursuant to Section 1445 of the Internal Revenue Code ("**Section 1445**") that Seller is not a foreign person, foreign corporation, foreign partnership, foreign trust, or foreign estate (as those terms are defined in the Internal Revenue Code and related regulations), and applicable federal and state tax reporting certificates including, without limitation, any required state withholding or non-foreign status affidavit or certificate;

5. A solar easement encumbering lands owned by Seller within a half-mile radius of the Property, which restricts development or construction on such lands that would overshadow or otherwise block access of the sunlight to the solar collection facilities to be located on the Property;

6. All other documents and instruments referred to herein that are to be provided to Purchaser by Seller;

7. All documents reasonably required by the Escrow Agent, including, but not limited to, an executed settlement statement; and



8. [If corporate Seller] Evidence of authority of persons executing the foregoing documents and instruments on behalf of Seller and of Seller's corporate authority to enter into this Agreement satisfactory to the Title Insurer

B. Purchaser's Deliveries. At or before Settlement, Purchaser shall deliver to Escrow Agent all of the following:

1. The Survey (provided Purchaser elects to cause preparation of the Survey);

2. The Purchase Price subject to credits, prorations and adjustments as provided in this Agreement in cash or other immediately available funds;

3. All other documents and instruments referred to herein that are to be provided to Seller by Purchaser; and

4. All documents reasonably required by the Escrow Agent, including, but not limited to, an executed settlement statement.

9. Settlement Costs: Prorated items and Adjustments.

A.

[REDACTED]

B. Prorations.

[REDACTED]

MAJ
SDB

[REDACTED]

C. Unless (i) Seller is not a "foreign person" as contemplated in Section 1445 and (ii) Seller executes at Settlement an affidavit in the form required by the Internal Revenue Service to exempt Purchaser from the withholding requirements under Section 1445, the delivery of the Purchase Price to Seller shall be subject to the satisfaction of the withholding requirements under Section 1445.

D. [REDACTED]

10. **Seller's Representations and Warranties.** To induce Purchaser to enter into this Agreement and to purchase the Property, and limited to the best of Seller's knowledge, Seller hereby makes the following representations and warranties as to the Property as of the date hereof (upon each of which Seller acknowledges and agrees that Purchaser is entitled to rely and has relied) each and all of which shall be true, correct and complete as of the Settlement Date:

A. **Authority.** Seller has the power and authority to enter into this Agreement and to consummate the transactions contemplated hereby. Seller, and any specific individual parties signing this Agreement on behalf of Seller represent and warrant that the parties signing this Agreement on behalf of the Seller have the full legal power, authority and right to execute and deliver this Agreement. Neither the entering into this Agreement nor the performance of any of Seller's obligations under this Agreement will violate the terms of any contract, agreement or instrument to which Seller is a party.

B. **Accuracy of Documents.** To the best of Seller's knowledge, all documents and papers delivered by Seller to Purchaser pursuant to this Agreement are true, correct and complete as of the dates thereof, and there have been no material changes from the information set forth in any of them.

C. **Special Assessment.** No portion of the Property is subject to or is affected by any special assessment for improvements completed prior to the date hereof, whether or not presently a lien thereon.

D. **Taxes.** No portion of the Property is subject to or affected by any outstanding or delinquent taxes or related financial liabilities.

E. **Litigation.** Seller has not been served (by means of formal, legal service of process as required by law) with any litigation, and no arbitration proceedings have been commenced, which do or will affect any aspect of the Property or Seller's ability to perform its obligations under this Agreement. In addition, within the last two (2) years, Seller has not been threatened with any litigation (or arbitration) by a third party which would affect any aspect of the Property or Seller's ability to perform its obligations under this Agreement.

F. Compliance. Seller has not received any notice of any presently uncured violation of any law, ordinance, rule or regulation (including, but not limited to, those relating to zoning, building, fire, environment, health and safety) of any governmental, quasi-governmental authority bearing on the construction, operation, ownership or use of the Property.

G. Condemnation Proceedings. Neither all nor any portion of the Property has been condemned or conveyed by deed in lieu of condemnation, nor is there now pending or, to the best of Seller's knowledge, threatened any condemnation or similar proceeding affecting the Property or any portion thereof. Seller has no knowledge that any such proceeding is contemplated. Seller has no knowledge of any change or proposed change in the route, grade or width of, or otherwise affecting, any street or road abutting the Property, which change might have a material adverse impact on the Property.

H. Condition of Property. To the best of Seller's knowledge, and without the benefit of a survey or title examination or title insurance commitment, Seller represents that there are no areas within the Property which are subject to any statutes, rules, regulations, conservation easements (or like encumbrances) or ordinances that would adversely affect the Property or Purchaser's ownership and intended use thereof.

I. Subdivision. The Property is not a separate tax lot under applicable laws, ordinances and regulations, and subdivision may be required for the conveyance of the Property to Purchaser. The Property will, on or before the Settlement Date and at Purchaser's expense, be subdivided from the larger tract of land owned by Seller in order to convey the Property to Purchaser. If applicable, Seller, at Purchaser's expense, shall, on or before the Settlement Date, obtain all necessary governmental approvals for a Minor Subdivision Plat delineating the Property as a separate and legal lot of approximately 170 acres in a location and having the size and configuration designated by Purchaser upon the exercise of the Option, or as may be otherwise mutually agreed upon by Purchaser and Seller.

J. Zoning and Dedication. Purchaser intends to use the property to construct and operate a solar power plant. Upon exercise of the option by Purchaser, Seller shall cooperate fully with Purchaser and execute all documents required by Purchaser or governmental or quasi-governmental authority, if any, for the purpose of securing any land use change, re-zoning, zoning variance or special use, if necessary, in order for the Property to be used for Purchaser's intended purpose. Seller has not received any notice of any pending change in zoning from any governmental or quasi-governmental authority, which change would materially affect the present zoning of the Property. Seller has not made any commitment to any governmental or quasi-governmental authority having jurisdiction, or to any third party, to dedicate or grant any portion of the Property for roads, easements, rights of way, park lands or for any restrictions or to incur any other expense or obligation relating to the Property.

K. Flood Plain; Stormwater. To the best of Seller's knowledge, the Property is not the subject or location of any stormwater detention or surface drainage facilities serving any property other than the Property, and the Property is not located in a flood zone which designates the property as being subject to periodic flooding.



L. Property Use. Seller has no knowledge of any actual, pending or threatened designation of any portion of the Property, or the area in which the Property is located, as a historic landmark or archeological district site or structure. Seller has no actual knowledge of any landfill or graveyard lying within the Property. Seller has not received any notice that any of the easements, covenants, conditions, restrictions or agreements to which the Property is subject interferes with or is breached by the use or operation of the Property as presently used.

M. Environmental Laws; Hazardous Materials.

1. To the best of Seller's actual knowledge, the Property is not now, and has not been during the period of Seller's ownership;

(a) in violation of any past or present federal, state, or local statute, regulation, ordinance, administrative order, judicial order or any similar requirement having the force and effect of law, relating to the protection of human health or the environment (an "**Environmental Law**") including, but not limited to, any federal, state or local regulation relating to industrial hygiene or soil or ground water conditions; or

(b) used to generate, manufacture, store, refine, dispose of, or in any manner deal with, any flammable, explosive or radioactive material, hazardous waste, toxic substance or related material, oil, waste oil, or other petroleum based materials, or any other substance or material defined or designated as a hazardous or toxic substance, material or waste by any federal, state or local law or environmental statute, regulation or ordinance presently in effect or as amended or promulgated in the future (a "**Hazardous Material**");

2. Neither Seller nor, to Seller's knowledge, any prior owners or occupants of the Property have received any notice or advice from a governmental agency with regard to Hazardous Materials on, from or affecting the Property that could give rise to any liability under any Environmental Law, and, to Sellers' knowledge, there has been no investigation, notice of violation, request for information or claim of any kind asserted or threatened by any person, including any federal, state or local governmental agency, relating to the storage, disposal, discharge or release of any Hazardous Material in a manner that would give rise to any liability under any Environmental Law.

N. That as of the Effective Date, there are no leases or other agreements for occupancy in effect with respect to the Property other than agricultural leases for a period not exceeding the current crop year, extended through the time at which Seller's option may be exercised. Seller shall deliver exclusive possession of the Property to Purchaser at Settlement free and clear of all claims of tenants and others claiming possessory rights except for any crop lease for the current crop year.

O. With the exception of this Agreement, no person or entity has a right of first refusal, option to purchase, or other right to purchase the Property pursuant to an agreement to which Seller is a party.



P. Seller has not filed for bankruptcy or other proceeding for the protection of debtors under state or federal law and that no similar involuntary proceeding has been filed or threatened against it.

Q. No part of the Property is subject to a special appraisal method that allows for the appraisal of the Property at less than its market value.

11. **Conditions Precedent.**

A. **Conditions for the Protection of Purchaser.** It shall be a condition precedent to Purchaser's obligation to purchase the Property and to perform its other obligations hereunder that each and every one of the conditions set forth under this Section 11(A) shall have been satisfied at or before Settlement, as hereafter provided, except for any such condition waived in writing by Purchaser, in whole or in part.

1. Between the Effective Date and the Settlement Date, the condition of the Property shall not have changed from the condition thereof as of the date of this Agreement, normal wear and tear excepted. Seller shall deliver vacant possession of the Property at Settlement. Prior to the Settlement Date (subject to the current crop lease), Seller shall remove all personal property, equipment from the Property.

2. Seller shall have delivered to Purchaser, on or before the Settlement Date, all of the documents and other information required of it pursuant to the provisions of this Agreement.

3. All of the covenants, representations, warranties, and agreements of Seller set forth in this Agreement shall be true, correct and complete as of the Effective Date and as of the Settlement Date. Notwithstanding that certain of Seller's representations and warranties may be limited to the extent of Seller's knowledge, the conditions precedent to Purchaser's obligation to consummate Settlement set forth in this Subparagraph shall not be so limited, and the satisfaction of such conditions shall depend upon the actual correctness on the Settlement Date of the matters stated in all such representations and warranties.

4. On or prior to the Settlement Date, Seller shall have performed, satisfied, or complied with all of the terms, provisions, covenants, conditions, and agreements of this Agreement.

5. Seller's title to the Property shall be as required by Section 6(B).

6. [REDACTED]

B. **Purchaser's Right to Extend Settlement Date.** In the event that any of the conditions of Settlement set forth in this Agreement is not satisfied as of the Settlement Date,



Purchaser shall have the option to extend the time for Settlement by a period not in excess of thirty (30) days upon written notice to Seller to allow Seller additional time to fully satisfy any unsatisfied condition.

12. **Condemnation and Risk of Loss.**

A. **Condemnation.** In the event of condemnation or receipt of notice of condemnation of all of the Property, or any portion thereof, prior to the Settlement Date, Seller shall give written notice to Purchaser promptly after Seller receives such notice or otherwise learn of such condemnation or conveyance in lieu thereof. If all of the Property is, or is to be, condemned, this Agreement shall terminate. If less than all of the Property is, or is to be, condemned or taken, Purchaser, at its option, may elect either (a) to terminate this Agreement effective upon written notice to Seller not later than thirty (30) days after receipt of notice from Seller or (b) not to terminate this Agreement and proceed to Settlement. If Purchaser elects not to terminate this Agreement, Purchaser shall be entitled to receive, and Seller shall assign to Purchaser all of Seller's interest in, all of the condemnation proceeds and all interest thereon.

B. **Risk of Loss.** The risk of loss or damage to the Property prior to the Settlement, by casualty, act of God or any other event, shall be upon Seller.

13. **Covenants.**

A. **Condition of the Property.** Subject to the provisions of Section 12 hereof concerning condemnation, Seller, at Seller's expense, shall maintain the Property in at least as good condition as on the date hereof. Seller shall not diminish the quality or quantity of maintenance and upkeep services heretofore provided to the Property.

B. **Operation Until Settlement.** Between the Effective Date and the Settlement Date, Seller shall:

1. Not enter into any leases or other agreements for occupancy of the Property, or any part thereof, without Purchaser's prior written consent, which may be withheld in Purchaser's sole discretion.

2. Not transfer, convey, hypothecate, create a security interest in or lien upon, or otherwise dispose of any of the Property;

3. Comply with all federal, state and municipal laws, ordinances, and regulations relating to the Property;

4. Comply with all the terms, conditions and provisions of all agreements and other contractual arrangements referred to herein, or any other documents, agreements or instruments affecting the Property, make all payments required to be paid thereunder and suffer no default therein;



5. Promptly give written notice to Purchaser of the occurrence of any event materially affecting the Property, the Agreement, or the substance of the representations and warranties made hereunder; and

6. Operate and maintain the Property only in the ordinary course of business as currently conducted by Seller on the Property, if any; provided that the Seller shall not bring or store, or permit others to bring or store, any soil or fill material onto the Property that did not exist on the Property as of the Effective Date. Seller shall have the continued right to use the Property for this purpose between the Effective Date and the Settlement Date; provided that:

(a) Purchaser and its employees, representatives, and consultants shall have access to the Property after giving twenty-four (24) hour verbal or written notice to the Seller prior to entry and,

(b) Seller's use shall terminate upon the Settlement Date.

C. Other Acts or Omissions. Except as otherwise permitted herein, from the Effective Date until the Settlement Date, Seller shall not take any action or fail to take any action that would have a material adverse effect on the Property or Purchaser's ability to develop the Property after the Settlement Date, or that would cause any of the representations and warranties contained in Section 10 hereof to be untrue as of Settlement.

14. Default.

A. [REDACTED]

B. Seller's Rights. [REDACTED]

C. LIQUIDATED DAMAGES. [REDACTED]

[REDACTED] *MAES*
[REDACTED] *DB*
June 4, 2021

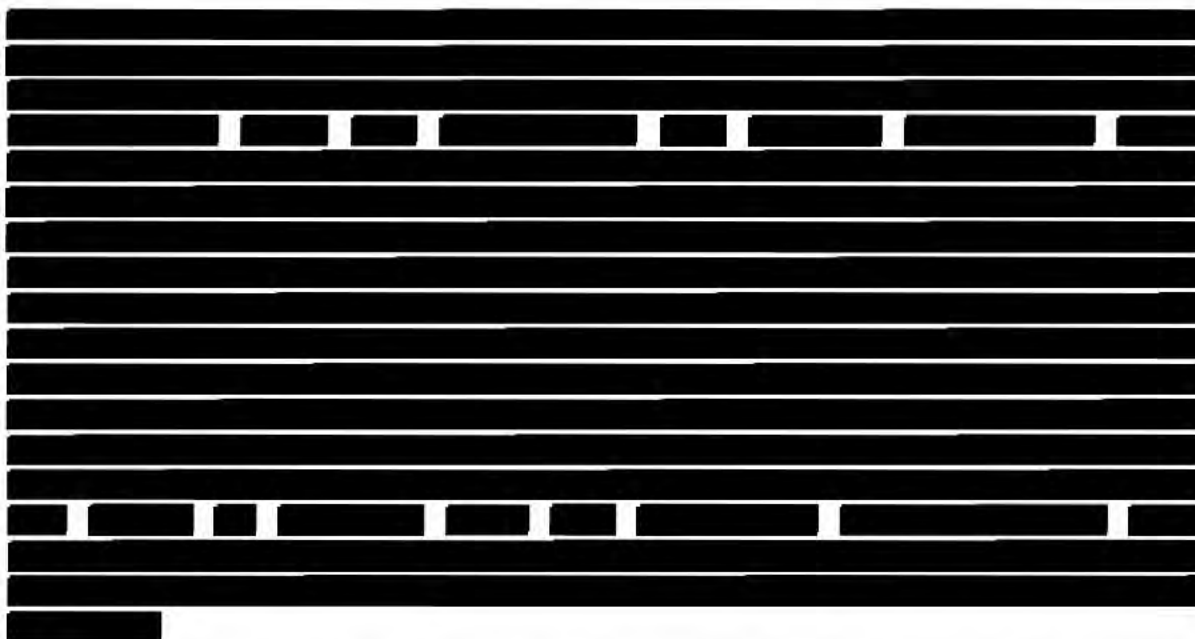

15. **Brokers.** Each party hereto represents to the other that there is no real estate broker involved in this transaction. Except as set forth in the foregoing sentence each party represents to the other that it has not made any agreement or taken any action which may cause any broker, agent or other person to become entitled to a brokerage or other fee or commission as a result of the transactions contemplated by this Agreement. Each party does hereby agree to indemnify and hold harmless the other from and against any and all costs, debts, damages, and claims, including, costs and reasonable attorneys' fees for pre-trial, trial or appellate matters in defending against any claims for brokerage commission or finder's fees arising through it relative to this transaction. The representations, warranties and agreements contained in this section shall survive the Settlement of this transaction.

16. **Seller's Environmental Indemnification:**

After the Settlement, no environmental warranties or representations shall survive closing and Purchaser shall exclusively rely upon its environmental audits, if any, performed prior to closing.

17. **General Provisions.**

A. **Completeness and Modification.** This Agreement constitutes the entire agreement between the parties as to the transactions contemplated herein and supersedes all prior and contemporaneous discussions, understandings and agreements between the parties.

B. **Assignments.** Purchaser may not assign its rights hereunder without the prior written consent of Seller, which consent shall not unreasonably be withheld, delayed or conditioned; provided, however, that Purchaser, without the consent of Seller, may assign, in

whole or in part, its rights hereunder to any entity controlling, controlled by, or under common control with Purchaser.

C. Survival. All of Seller's representations, warranties, covenants, agreements and indemnifications made in, or pursuant to, this Agreement shall survive Settlement and delivery and recordation of the Deed.

D. Governing Law. This Agreement shall be governed by and interpreted in accordance with the laws of the Commonwealth of Kentucky. If the parties are unable to resolve amicably any dispute arising out of or in connection with this Agreement, they agree that such dispute shall be resolved in the circuit court located in Henderson County, Kentucky. The parties agree that any rule of construction to the effect that ambiguities are to be resolved in favor of either party shall not be employed in the interpretation of this Agreement and is hereby waived. Notwithstanding anything to the contrary in this Agreement, neither party shall be entitled to recover punitive or exemplary damages, however arising, whether in contract, in tort, or otherwise, under or with respect to any action taken in connection with this Agreement.

E. Severability. If any term, covenant or condition of this Agreement, or the application thereof to any person or circumstance, shall to any extent be invalid or unenforceable, the remainder of this Agreement, or the application of such term, covenant or condition to other persons or circumstances, shall not be affected thereby, and each term, covenant or condition of this Agreement shall be valid and enforceable to the fullest extent permitted by law.

F. Costs. Regardless of whether Settlement occurs, each party shall be responsible for its own costs in connection with this Agreement and the transactions contemplated hereby, including, without limitation, fees of attorneys, engineers and accountants, except as otherwise expressly provided herein.

G. Notices. Any notice expressly provided for or permitted under this Agreement shall be in writing, shall be given either manually or by mail, overnight delivery service, such as UPS, FedEx, or Purolator, and shall be deemed sufficiently given when received by the party to be notified at its address set forth below, or three (3) business days after being mailed by registered or certified mail, postage prepaid, return receipt requested, or one (1) business day after being sent by such overnight delivery service, addressed to such party at such address, whichever shall first occur. Any party and any representative designated below, by notice to the other party, may change its address for receiving such notices.

If to Seller: Pamela J. Gardner
2400 Cobblestone Road
Henderson, KY 42420



Janet Kay Gardner
31 Notsulga Drive
Rome, GA 30161

[REDACTED]
[REDACTED]

Malcom Edward Sellers
101 Station 18½
Sullivan's Island, SC 29482

[REDACTED]
[REDACTED]

Ashley Sellers Smith
1905 Daniel Green Ct
Smyrna, GA 30080

[REDACTED]
[REDACTED]

Heather Denton Warwick
719 Stonewater Boulevard
Franklin, TN 37064

[REDACTED]
[REDACTED]

If to Purchaser: Boulevard Associates, LLC
700 Universe Blvd.
Juno Beach, FL 33408
Attention: Land Services Administration
Telephone: (855) 552-9872

H. Incorporation by Reference. All of the Exhibits attached or referred to herein and all documents in the nature of such Exhibits are by this reference incorporated herein and made a part of this Agreement.

I. Interpretation. The section and paragraph headings used herein are for reference and convenience only and shall not enter into the interpretation hereof. Wherever used herein, the singular number shall include the plural and vice versa, and the use of any gender shall include all other genders, all as the context may require.

J. Business Days. If any action is required under the provisions of this Agreement to occur by a date that is a Saturday, Sunday or legal holiday, such date shall be extended to the first day thereafter that is not a Saturday, Sunday or legal holiday.

K. Waiver. No waiver or purported waiver by Purchaser of any contingency contained herein shall be valid against Purchaser unless it is in writing and signed by Purchaser.

L. Construction. The parties acknowledge that they and their counsel have reviewed this Agreement and that any rule of construction to the effect that any ambiguities are to

WFO
JD

be resolved against the drafting party shall not be employed in the interpretation of this Agreement or any exhibits or amendments hereto.

M. Memorandum of Option. Within ten (10) days of the Effective Date, Seller shall execute and deliver to Purchaser a Memorandum of this Agreement, which shall be recorded by Purchaser at the expense of Purchaser. In the event Seller fails to execute and deliver the Memorandum within ten (10) days of the Effective Date, Seller hereby authorizes the Purchaser to execute and record the Memorandum without the Seller's signature. In the event this Agreement is terminated by Purchaser or by Seller as a result of a default by Purchaser, in accordance with the terms of this Agreement and after written request by Seller, Purchaser shall execute a recordable document provided by Seller discharging the Memorandum of Option.

N. Confidentiality. Seller shall not disclose the fact or substance of this Agreement to any other persons or entities, other than Seller's counsel, tax advisor, or other consultants regarding this matter, unless and until Purchaser shall exercise its rights hereunder. Recordation of the Memorandum of Option contemplated under this Agreement shall not constitute a waiver of Purchaser's right to confidentiality.

O. Effective Date. The term "**Effective Date**" or such other similar term, shall be the last date on which a duplicate original of this Agreement has been executed by both Purchaser and Seller.

P. Time is of the Essence. The parties hereby agree that time is of the essence with respect to performance of each of the parties' obligations under this Agreement.

Q. Exclusivity of Option. Seller hereby agrees that the Option granted hereby shall be exclusive and agrees that, from and after the date of the Option and for so long thereafter as the Option is in force and effect, or until the Settlement Date occurs, whichever occurs later, Seller shall not offer any portion of the Property for sale to, accept any offer to purchase any portion of the Property from, nor enter into any contract to sell any portion of the Property with, nor enter into any lease, rental, or occupancy agreement affecting any portion of the Property with, nor enter into any agreement permitting any tenant to occupy any portion of the Property with, any person other than the Purchaser hereunder without in each instance first obtaining the prior written consent of the Purchaser.

R. Amendments. The terms of this Agreement may be waived, modified and amended only by and instrument in writing duly executed by Seller and Purchaser.

S. Counterparts. This Agreement may be executed in any number of counterparts and it shall be sufficient that the signature of each party appear on one or more such counterparts. All counterparts shall collectively constitute a single agreement. A facsimile or electronic signature to this Agreement or any amendment hereto shall be sufficient to prove the execution hereby by any person.

T. Waivers. No waiver of any breach of any covenant or provision herein contained shall be deemed a waiver of any preceding or succeeding breach thereof, or of any other covenant or provision herein contained. No extension of time for performance of any obligation



or act shall be deemed an extension of time for performance of any other obligation or act except those of the waiving party, which shall be extended by a period of time equal to the period of the delay.

[Signatures on Next Page]

A handwritten signature in black ink, appearing to be 'MAB' or similar, written over the printed text in the bottom right corner.

IN WITNESS WHEREOF, the parties have executed this Agreement on the day and year written below.

Seller:

Pamela J. Gardner

Date Signed: _____

Janet Kay Gardner

Janet Kay Gardner

Date Signed: *9/29/21*

Malcolm Edward Sellers

Suzan D. Boyd

Date Signed: _____

Ashley Sellers Smith

Todd Smith

Date Signed: _____

Heather Sellers (Denton) Warwick

Brian Warwick

Date Signed: _____

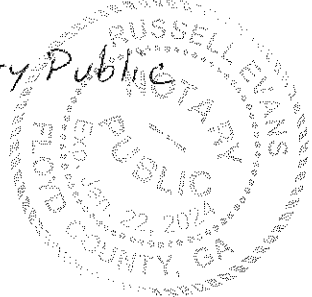
Russell Evans 9/29/2021
Russell Evans, Notary Public

IN WITNESS WHEREOF, the parties have executed this Agreement on the day and year written below.

Seller:

Pamela J. Gardner
Pamela J. Gardner

Date Signed: 9/29/21

Janet Kay Gardner

Date Signed: _____

Malcolm Edward Sellers

Suzan D. Boyd

Date Signed: _____

Ashley Sellers Smith

Todd Smith

Date Signed: _____

Heather Sellers (Denton) Warwick

Brian Warwick

Date Signed: _____

IN WITNESS WHEREOF, the parties have executed this Agreement on the day and year written below.

Seller:

Pamela J. Gardner

Date Signed: _____

Janet Kay Gardner

Date Signed: _____

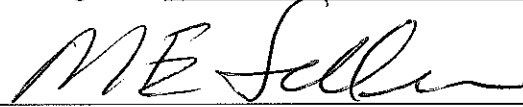

Malcolm Edward Sellers



Suzan D. Boyd

Date Signed: 9/30/21

Ashley Sellers Smith

Todd Smith

Date Signed: _____

Heather Sellers (Denton) Warwick

Brian Warwick

Date Signed: _____

IN WITNESS WHEREOF, the parties have executed this Agreement on the day and year written below.

Seller:

Pamela J. Gardner

Date Signed: _____

Janet Kay Gardner

Date Signed: _____

Malcolm Edward Sellers

Suzan D. Boyd

Date Signed: _____



Ashley Sellers Smith



Todd Smith

Date Signed: Sept 27, 2021

Heather Sellers (Denton) Warwick

Brian Warwick

Date Signed: _____

IN WITNESS WHEREOF, the parties have executed this Agreement on the day and year written below.

Seller:

Pamela J. Gardner

Date Signed: _____

Janet Kay Gardner

Date Signed: _____

Malcolm Edward Sellers

Suzan D. Boyd

Date Signed: _____

Ashley Sellers Smith

Todd Smith

Date Signed: _____

Heather Sellers Warwick

Heather Sellers (Denton) Warwick

Brian Warwick

Brian Warwick

Date Signed: 9/28/2021

Purchaser:

Boulevard Associates, LLC
A Delaware limited liability company

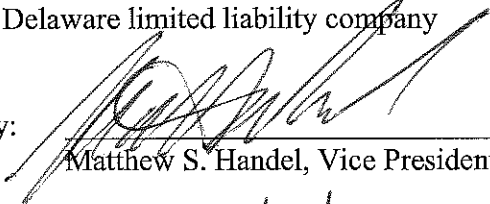
By: 
Matthew S. Handel, Vice President

Date Signed: 10/14/2021

EXHIBIT A

Legal Description of Property

FARM 1

Totaling approximately 127 acres

PVA 60-70

TRACT 1: Beginning at a stake in the original line in the center of the Frog Island road, corner to Enoch Spencer; thence with the center line of the road N. 57-3/4 W. 69 poles to a dead oak in the said road; thence N. 61 W. 8 poles to a stake in the said road and corner to the lot No. 6, thence with a line to said lot No. 6 N. 5-1/4 E. 87 poles to a stake in Enoch Spencer's line corner to lot No. 6; thence with a line of Enoch Spencer S. 65 E. 123 poles and 14 links to a stake corner to Enoch Spencer; thence with said Spencer's line S. 21-23' W. 16 poles and 10 links to a pin oak; thence S. 31 poles and 6 links to a dead black oak corner to said Spencer; thence with a line of the 14 1/2 acre tract described below here-in and N. 65 W. 48 poles and 5 links to a stake where a mulberry and double elm were called for in former survey; thence S. 5 1/2 W. 48 poles to the beginning, containing 53 acres; and being the same land conveyed to J. Elliott Denton by Eddie F. Denton and Henrieta Denton, his wife, by deed dated December 1, 1927, recorded in Deed Book 75 at page 76.

TRACT 2: Beginning at a stone at an angle of the Frog Island road, corner with E. N. Royster in Dick Spencer's line; thence N. 1-3/4 E. 55 poles and 21 links to a stake in Dick Spencer's line; thence with a line of the above described 53 acres and N. 64-9' W. 48 poles to a point where an Elm was called for in a former deed; thence with another line of said 53 acre tract S. 6-24' W. 48 poles and 14 links to a stake in said road; thence with said road S. 59 E. 54 poles and 28 links to the beginning, containing 14 1/2 acres; and being the same land conveyed to J. Elliott Denton by Eddie F. Denton and Henrieta Denton, his wife, by deed dated December 1, 1927, recorded in Deed Book 75 at page 76.

TRACT 3: Beginning at a stake in the middle of the public road corner to Byars; thence S 14 1/2 W. 12.17 chains to a stake corner to Byars in Denton's line; thence N. 60 W. 16.55 chains to stake between and Ash and Elm corner to Elliott Denton; thence N. 32 1/2 E. 10.69 chains to a stake in the middle of the public road corner to Elliott Denton; thence with the middle of the public road S. 57 E. 4.33 chains, S. 68-3/4 E. 8.74 chains to the beginning, containing 17.19 acres, except the graveyard containing about 0.13 of an acre which is reserved; and being the same land conveyed to J. Elliott Denton by Mary Olive Howard and W. W. Howard, her husband, by deed dated April 20, 1917, recorded in Deed Book 55 at page 8.

TRACT 4: Being a parcel of land in Henderson County, Kentucky, beginning on a lane leading from the Frog Island road in the line of E. L. Spencer, running S. 23 1/2 W. 27.70 chains with said Spencer's line; thence S. 62 1/2 E. 19.90 chains with Jane Davis line to Fred Schaeffer's land; thence with Schaeffer's line N. 30 E. 15.90 chains to Book's property; thence N. 32 E. 10.75 chains to a double Ash; thence in a northerly direction to a point in the line of said lane; thence with the line of said lane N. 72 1/2 W. 11.84 chains to the beginning, containing 42.88 acres; and being the same land conveyed to J. Elliott Denton by James Murray, unmarried, by deed dated January 1, 1912, recorded in Deed Book 50 at Page 17.

Being the same property conveyed to Harple L. Denton, by deed from Lucille D. Sellers and M.C. Sellers, her husband, et al, dated July 8, 1954, of record in Deed Book 168, page 395, Henderson County Clerk's Office. Harple Lee Denton, a/k/a Harple L. Denton, a/k/a Harple Royster Denton, died intestate a resident of Henderson County on May 9, 1970, leaving her children, Lucille D. Sellers, Slater A. Denton and Mildred Gardner, as her only heirs at law. See affidavit of descent of record in Deed Book 261, page 14, in the aforesaid clerk's office. Slater A. Denton died testate a resident of Henderson County. His will of record in Will Book 25, page 51, in the aforesaid clerk's office, devised his interest to Lucille Sellers and Mildred Gardner. Lucille D. Sellers, a/k/a Lucille Sellers, died testate a resident of Ocoee County, Georgia, on September 21, 2004. Her will of record in Will Book 33, page 554, in the aforesaid clerk's office, devised her interest to

MSJ
SDB

her children, James Randolph Sellers, a/k/a James R. Sellers, and Malcolm Edward Sellers, a/k/a Malcolm E. Sellers. Mildred Joy Gardner, a/k/a Mildred Gardner, died testate a resident of Henderson County. Her will of record in Will Book 44, page 791, in the aforesaid clerk's office, devised her interest to Pamela Joy Gardner and Janet Kay Gardner. See also affidavit of real property transfer of record in Deed Book 613, page 592, in the aforesaid clerk's office. James Randolph Sellers died, and pursuant to his Last Will and Testament, of record in Will Book 49, page 445, he left all of his interest in the property to his wife, Nena Estes Henry, Grantor herein.

FARM 2

Totalling approximately 43 acres

PVA 60-37.1

Beginning at a stake in Frog Island Road at Road Fork, corner with Josie Handley, runs with Gravel Road and said Handley S. 86 deg. 40 min. E. 1993 feet to a nail in said road, corner with Irvin Hunter in Josie Handley line; thence with said Irvin Hunter as follows, S. 12 deg. 22 min. W. 1111 feet to a stake; and thence N 79 deg. 31 min. W. 1594 feet to a nail in Frog Island Road, corner with Irvin Hunter; thence with said road as follows: S. 24 deg. 45 min. E. 112 feet; and S. 30 deg. 29 min. E. 372 feet to a nail in said road corner with Irvin Hunter and M. F. Puryear; thence with said Puryear as follows: S. 88 deg. 37 min. W. 412 feet to a stake; N. 3 deg. 38 min W. 253 feet to a stake; N. 87 deg. 18 min. W. 319 feet to a stake; and thence South 283 feet to a stake, corner with M. F. Puryear; thence N 57 deg. 33 min. W. 1301 feet; thence N. 57 deg. 38 min. W. 1067 feet to a post and stake corner with Owen Spencer and Liggett Brothers; thence with said Liggett Brothers, N. 28 deg. 52 min. E. 1450 feet to a nail in Frog Island Road, corner with Liggett Brothers and Elliott Denton Heirs; thence with said Frog Island Road and Denton Heirs as follows: S. 54 deg. 53 min. E. 770 feet; and S. 57 deg. 06 min. E. 787 feet to a nail in said Road, corner with Elliott Denton Heirs and Josie Handley; thence with said Handley as follows: S. 6 deg. 49 min. W. 320 feet to a stake; and thence N 88 deg. 41 min. E. 373 feet to the place of beginning, containing 117.5 acres, subject to all legal Highways, in accordance with survey of W. W. Poole Registered Engineer, dated June 19, 1956.

LESS AND EXCEPT: 70.653 acres as shown on plat of record in Plat Book 10, page 158, Henderson County Clerk's Office, and to which plat reference is hereby made for a more particular description of the property.

ALSO LESS AND EXCEPT: 3.56 acres as shown on plat of record in Plat Book 7, page 798, Henderson County Clerk's Office, and to which plat reference is hereby made for a more particular description of the property.

MAB
SDB

This conveyance is subject to easements, restrictions, rights of way and mineral reservations of record.

Being a portion of the same property conveyed to Fannie W. Royster and E. N. Royster, her husband, as tenants in common, by deed from Samuel Spencer and Virginia Spencer, his wife, dated November 5, 1879, of record in Deed Book 5, page 186, in the Henderson County Clerk's Office. Also being a portion of the same property conveyed to Enoch N. Royster, from Thomas Spencer and Mary C. Spencer, his wife, dated April 27, 1881, of record in Deed Book 6, page 406, in the aforesaid clerk's office. Also being the same property conveyed to E. N. Royster, from Thomas Spencer and his wife, Marcy C. Spencer, dated February 13, 1886, of record in Deed Book 11, page 496, in the aforesaid clerk's office. Also being the same property conveyed to E. N. Royster, from W. N. Royster and T. J. Royster, his wife, dated March 21, 1887, of record in Deed Book 12, page 227, in the aforesaid clerk's office. E. N. Royster, a/k/a Enoch N. Royster, died intestate a resident of Henderson County on June 16, 1928, leaving his wife, Fannie Royster, a/k/a Fannie W. Royster, and his children, Charles E. Royster, a/k/a C. E. Royster, and Harple Royster Denton, a/k/a Harple L. Denton, as his only heirs at law. See affidavits of descent of record in Deed Book 128, page 519, and Deed Book 159, page 505, in the aforesaid clerk's office. Fannie W. Royster, a/k/a Fannie Royster, died intestate a resident of Henderson County on October 26, 1946, leaving her children, Charles E. Royster a/k/a C. E. Royster, and Harple Royster Denton, a/k/a Harple L. Denton, as her only heirs at law. See affidavit of descent of record in Deed Book 620, page 205, in the aforesaid clerk's office. C. E. Royster, a/k/a Charles E. Royster, died intestate a resident of Henderson County on July 25, 1955, leaving his wife, Cornelia E. Royster, and his son, Elward N. Royster, as his only heirs at law. See affidavit of descent of record in Deed Book 179, page 12, in the aforesaid clerk's office. See also deed to Elward N. Royster and Freda May Royster, his wife, from Cornelia E. Royster, widow, dated June 26, 1956, of record in Deed Book 179, page 13, in the aforesaid clerk's office. See also deed to Harple L. Denton, from Elward N. Royster and Freda May Royster, his wife, dated November 12, 1956, of record in Deed Book 181, page 173, in the aforesaid clerk's office. Harple Lee Denton, a/k/a Harple L. Denton, a/k/a Harple Royster Denton, died intestate a resident of Henderson County on May 9, 1970, leaving her children, Lucille D. Sellers, Slater A. Denton and Mildred Gardner, as her only heirs at law. See affidavit of descent of record in Deed Book 261, page 14, in the aforesaid clerk's office. Slater A. Denton died testate a resident of Henderson County. His will of record in Will Book 25, page 51, in the aforesaid clerk's office, devised his interest to Lucille Sellers and Mildred Gardner. Lucille D. Seller, a/k/a Lucille Seller, died testate a resident of Ocoee County, Georgia, on September 21, 2004. Her will of record in Will Book 33, page 554, in the aforesaid clerk's office, devised her interest to her children, James Randolph Sellers, a/k/a James R. Sellers, and Malcolm Edward Sellers, a/k/a Malcolm E. Sellers. Mildred Joy Gardner, a/k/a Mildred Gardner, died testate a resident of Henderson County. Her will of record in Will Book 44, page 791, in the aforesaid clerk's office,

devised her interest to Pamela Joy Gardner and Janet Kay Gardner. See also affidavit of real property transfer of record in Deed Book 613, page 592, in the aforesaid clerk's office. James Randolph Sellers died, and pursuant to his Last Will and Testament, of record in Will Book 49, page 445, he left all of his interest in the property to his wife, Nena Estes Henry, Grantor herein.

EXHIBIT B

Form of Special Warranty Deed

Mail Tax Bill in-care-of:
Boulevard Associates, LLC
2400 Cobblestone Road
Henderson, KY 42420

SPECIAL WARRANTY DEED

THIS SPECIAL WARRANTY DEED is made and entered into effective as of the ___ day of _____, 2021, by and between: (i) **PAMELA J. GARDNER**, unmarried; **JANET KAY GARDNER**, unmarried; **MALCOM EDWARD SELLERS** and **SUZAN D. BOYD**, husband and wife; **ASHLEY SELLERS SMITH** and Todd Smith, wife and husband; and **HEATHER SELLERS (DENTON) WARWICK** and Brian Warwick, wife and husband (collectively, "**Grantor**"), and (ii) **BOULEVARD ASSOCIATES, LLC**, a Delaware limited liability company, whose address is 700 Universe Boulevard, Juno Beach, FL., 33408, which is also the in-care-of address to which the property tax bill for the year in which the property is transferred may be sent ("**Grantee**").

W I T N E S S E T H:

That for and in consideration of the total sum of _____ (\$_____), the receipt and sufficiency of which are hereby acknowledged, Grantor does hereby bargain, grant, sell and convey unto Grantee, in fee simple, with covenant of SPECIAL WARRANTY, certain real property, together with all improvements located thereon and all appurtenances thereunto belonging, situated in Henderson County, Kentucky (the "**Property**"), more fully described on **Exhibit A**.

TO HAVE AND TO HOLD, in fee simple, all of the Property, together with all the rights, privileges, appurtenances and improvements thereunto belonging, unto Grantee, its successors and assigns, forever.

Grantor hereby specially covenants with Grantee, its successors and assigns, that Grantor will forever warrant and defend all of the Property so granted to Grantee, its successors and assigns, against every person lawfully claiming the same or any part thereof by, through or under Grantor, but not otherwise; and that the Property is free and clear of all taxes, liens and encumbrances, except (a) governmental laws, rules, regulations and restrictions affecting the Property, (b) the lien of current ad valorem taxes is not yet due and payable, and (c) all easements and restrictions of record.

As required by KRS 382.135, Grantor hereby certifies, and Grantee appears herein solely for the purpose of certifying, that the consideration stated above is correct.

IN TESTIMONY WHEREOF, witness the signatures of Grantor and Grantee effective as of the day, month and year first above written.

GRANTOR:

PAMELA J. GARDNER

COMMONWEALTH OF KENTUCKY)
) SS
COUNTY OF HENDERSON)

The foregoing instrument was acknowledged, subscribed and sworn to before me this _____ day of _____, 2021, by Pamela J. Gardner.

My Commission expires: _____.

NOTARY PUBLIC

Notary ID #: _____

(SEAL)

MJB
5/21

GRANTOR:

JANET KAY GARDNER

STATE OF GEORGIA)
) **SS**
COUNTY OF _____)

The foregoing instrument was acknowledged, subscribed and sworn to before me this _____ day of _____, 2021, by Janet Kay Gardner.

My Commission expires: _____.

NOTARY PUBLIC

(SEAL)

Notary ID #: _____

MAO
SDB

GRANTOR:

ASHLEY SELLERS SMITH

Todd Smith

STATE OF GEORGIA)
) SS
COUNTY OF _____)

The foregoing instrument was acknowledged, subscribed and sworn to before me this _____ day of _____, 2021, by Ashley Sellers Smith and her husband, Todd Smith.

My Commission expires: _____.

NOTARY PUBLIC

(SEAL)

Notary ID #: _____

GRANTOR:

HEATHER SELLERS (DENTON) WARWICK

Brian Warwick

ACKNOWLEDGEMENT

STATE OF TENNESSEE)
COUNTY OF WILLIAMSON)

The foregoing instrument was acknowledged, subscribed and sworn to before me this _____ day of _____, 2021, by Heather Sellers (Denton) Warwick and her husband, Brian Warwick.

Notary Public

My Commission Expires:

MEA
AB

GRANTEE:

BOULEVARD ASSOCIATES, LLC
a Delaware limited liability company

By: _____
Matthew S. Handel, Vice President

STATE OF FLORIDA)
) SS
COUNTY OF PALM BEACH)

The foregoing instrument was acknowledged, subscribed and sworn to before me on _____, ___, 2021 by Matthew S. Handel, acting in his capacity as Vice President of Boulevard Associates, LLC, a Delaware limited liability company, for and on behalf of said limited liability company, the Grantee.

[S E A L]

Notary Public, State of _____

My Commission Expires: _____

This instrument prepared by:

Orin Shakerdge, Esq.
NextEra Energy Resources, LLC
700 Universe Blvd., LAW/JB
Juno Beach, FL 33408
Telephone: (561) 694-4678



EXHIBIT A

to Deed

[insert legal description]

BEING the same property acquired by _____ by Deed dated _____, 20__, of record in Deed Book _____, Page _____, in the Henderson County Clerk's office.

MES
800

ACCEPTANCE BY ESCROW AGENT

The undersigned Escrow Agent hereby acknowledges that on _____, 2021, the undersigned received a fully executed duplicate original of the foregoing Real Estate Purchase Option Agreement between Pamela J. Gardner, unmarried; Janet Kay Gardner, unmarried; Malcolm Edward Sellers and Suzan D. Todd, husband and wife; Ashley Sellers Smith and Todd Smith, wife and husband; and Heather Sellers (Denton) Warwick and her husband, Brian Warwick, wife and husband; as Seller, and Boulevard Associates, LLC, a Delaware limited liability company, as Purchaser. Escrow Agent agrees to act as the Escrow Agent under this Agreement in accordance with the instructions provided therein, and to comply with these instructions. Escrow Agent has assigned Escrow Number _____ to the Property for that purpose.

By: _____
Name: _____
Title: _____
Date: _____

MED
SOB

SOLAR LEASE AND EASEMENT AGREEMENT

1. **Parties.** This Solar Lease and Easement Agreement ("**Agreement**") is made and entered as of the 24 day of March, 2023 ("**Effective Date**"), by and between Victoria Hust, a married woman dealing in her sole and separate property, and Bill Barber, as consenting spouse ("**Owner**") and Sebree Solar, LLC, a Delaware limited liability company ("**Operator**"), which are sometimes individually referred to as a "**Party**" and collectively as the "**Parties**".

2. **Project.** This Agreement relates to the solar-powered electrical power generation and transmission project known as the "Sebree Solar Energy Center Energy Center" to be located in Henderson County, Kentucky ("**Project**"), which may be wholly or partially located on the Leased property legally described on the attached **Exhibit A** and depicted on **Exhibit A-1** to this Agreement, but excluding the "Exclusion Area(s)" as depicted thereon ("**Leased Property**"). Upon Operator's exercise of the Option (as defined below), the Project shall include (i) the Lease of Leased Property described in Section 4, (ii) the Easements referenced in Section 5 that are located on the Leased Property, and (iii) the Improvements referenced in Section 8 to be constructed on Leased Property. The Lease, Easements and Improvements are sometimes collectively referred to as the "**Operator Property**".

3. **Option.** Owner grants to Operator an exclusive option ("**Option**") to acquire the Lease and Easements referenced in Sections 4 and 5 in accordance with the following terms and conditions. Operator shall be entitled to acquire the Lease and the Easements in their entirety or in part, as Operator deems appropriate.

3.1 **Option Term.** The period during which Operator may exercise the Option shall be for a term of four (4) years, commencing on the Effective Date, as defined in the introductory paragraph to this Agreement ("**Option Term**").

3.2 **Option Payment.** As consideration for the granting of the Option, Operator agrees to pay Owner the Option Payment set forth in **Exhibit D**.

3.3 **Use of Leased Property.** During the Option Term, Operator and its employees, agents and contractors shall have a right to enter upon the Leased Property and the right of ingress and egress over and across the Leased Property for the purposes of (i) surveying the Leased Property; (ii) performing such other tests and studies as Operator may desire in connection with the Option, including, without limitation, environmental, avian and cultural resource assessments, and geotechnical, foundation and soil tests, provided that such activities do not unreasonably interfere with Owner's use of the Leased Property; and (iii) installing, maintaining, operating, inspecting and removing one or more weather related instruments ("**Weather Instrument**") and fencing of said Weather Instrument and including the performance of all tests and studies associated therewith. Owner shall not permit any other individual or entity except Operator or its affiliates to install a Weather Instrument on Leased Property.

3.4 **Right to Grant Option.** Owner warrants and represents to Operator that (i) the statements in Section 9 concerning Leased title to the Leased Property are true and correct; (ii) Owner has the authority to grant this Option to Operator without the consent or approval of any other party; and (iii) there are no other existing options, rights of first refusal, contracts to purchase,

leases or mortgages that would prevent Operator from exercising its rights with respect to the Option.

3.5 **Exercise of Option.** Operator may exercise the Option by giving written notice to Owner ("**Option Notice**") at any time during the Option Term. Operator shall specify in the Option Notice the Commencement Date referenced in Section 6.1.1 which shall not be more than ninety (90) days after the date of the Option Notice. On the Commencement Date, the Lease and Easements referenced in Sections 4 and 5 shall automatically become effective, and the Parties shall be subject to all of the terms and conditions of this Agreement with respect to such Lease and Easements and all rights and obligations relating thereto.

3.6 **Termination of Option.** If Operator fails to exercise the Option within the Option Term, the Option and the rights of Operator as the optionee shall automatically terminate and Operator shall record in the Office of the Henderson County Clerk a full and complete Release of this Agreement.

4. **Lease.** Upon exercise of the Option by Operator, Owner leases to Operator, and Operator leases from Owner, Leased Property for the Lease and Easement Term (defined in Section 6.1) in accordance with the terms and conditions of this Agreement ("**Lease**"), which Lease grants Operator and its agents, contractors, and employees the right to use the Leased Property for the following permitted uses:

4.1 **Construction Right.** Operator leases Leased Property for the purpose of constructing, operating, maintaining, repairing, replacing, and removing all or any part or component of the Improvements whether located on Leased Property. Operator may exercise its right to use all or any part of the Leased Property as and when Operator deems it necessary or advisable to do so to perform the activities for which this right is granted, including, without limitation, staging areas and parking for Operator's employees.

4.2 **Access Right.** Operator leases Leased Property for unobstructed vehicular and pedestrian access and ingress to and egress from the Improvements, Leased Property and any public roadways, and to construct, maintain, and utilize Roadway Improvements on the Leased Property. Operator shall consult with owner in advance as to the location, width, and type of any road or roadway; however, the ultimate location of such roadway shall be at Operator's sole discretion. Notwithstanding the foregoing, Operator shall not construct an access road at the northern edge of the exclusion area of Parcel 61-29 bordering State Road 416, as depicted in Exhibit A-1. Owner shall not permit others to obstruct or damage the roads or Roadway Improvements located on the Leased Property or in any other way interfere with Operator's rights under this right. Operator shall repair any damage done to Roadway Improvements which result from use by Operator, its agents, servants or employees. Such roads shall be maintained in the condition necessary for use by Operator's equipment, and with regard to existing roads, shall be maintained in at least the condition that existed prior to Operator's use.

4.3 **Solar Panels Right.** Operator leases Leased Property for Operator to construct, operate, replace, relocate, remove, and maintain Solar Panels and the appurtenant Collection Facilities, together with associated roads and parking areas on Leased Property.

4.4 **Collection Facilities Right.** Operator leases Leased Property for Operator to construct, operate, maintain, replace, relocate or remove Collection Facilities on and under the Leased Property.

4.5 **Substation Right.** Operator leases Leased Property for Operator to construct, operate, maintain, replace, relocate or remove one or more Substations on Leased Property.

4.6 **Telecommunication Right.** Operator leases Leased Property for Operator to construct, operate, maintain, replace, relocate or remove Telecommunication Facilities on and under the Leased Property.

4.7 **Weather Instrument Right.** Operator leases Leased Property in order to construct, operate, replace, relocate, remove, and maintain a Weather Instrument and the appurtenant Collection Facilities on Leased Property.

4.8 **Battery Facilities Right.** Operator leases Leased Property in order to construct, operate, replace, relocate, remove, and maintain one or more Battery Facilities on Leased Property.

5. **Grant of Easements.** Upon the exercise of the Option by Operator, Owner grants to Operator, and Operator accepts from Owner, for the Lease and Easement Term referenced in Section 6.1, the following easements over and across the Leased Property in accordance with the terms and conditions of this Agreement. The following easements are for the benefit of Operator and Operator's agents, contractors and employees and located on the Leased Property and are collectively referred to as the "Easements".

5.1 **Sun Non-Obstruction Easement.** Owner grants Operator an irrevocable, exclusive easement for the right and privilege to use, maintain and capture the free and unobstructed sunlight over and across the Leased Property. Owner shall not engage in any activity on Leased Property or any other neighboring property owned by Owner that might interfere with the sunlight direction over any portion of Leased Property; cause a decrease in the output or efficiency of any Solar Panel or Weather Instrument; or otherwise interfere with Operator's operation of the Project or exercise of any rights granted in this Agreement (collectively "Interference"). This grant of the easement expressly includes the right of Operator to enforce Operator's rights, including the physical removal of trees or structures (except existing trees and structures) causing Interference to the Project contemplated by Operator. Operator shall notify Owner before making any such removals.

5.2 **Effects Easement.** Owner grants to Operator an easement over Leased Property for visual, view, light, flicker, noise, shadow, vibration, electromagnetic, electrical and radio frequency interference, and any other effects attributable to the Project located on the Leased Property.

6. **Term.** The term of this Agreement ("Term") includes the Option Term referenced in Section 3.1, the Initial Lease and Easement Term as described in Section 6.1.1 and the Extended Lease and Easement Term as described in Section 6.1.2 (together, the Initial Lease and Easement Term and the Extended Lease and Easement Term, if applicable, is defined as the "Lease and Easement Term").

6.1 **Lease and Easement Term.**

6.1.1 **Initial Lease and Easement Term.** The initial term of the Lease and Easements shall commence on the date specified by Operator in the Option Notice ("**Commencement Date**"). The initial term of the Lease and Easements shall end thirty (30) years after the Commencement Date (the "**Initial Lease and Easement Term**"), subject to the rights of renewal and termination as provided in this Agreement.

6.1.2 **Extended Lease and Easement Term.** Operator shall have the right to extend the Term of this Agreement for two (2) consecutive terms of five (5) years each in accordance with the terms and provisions of this Agreement (collectively "**Extended Lease and Easement Term**") by providing written notice to Owner of Operator's intent to extend the Term within one hundred eighty (180) days of the end of the existing Term. Each Extended Lease and Easement Term shall begin on the expiration date of the Initial Lease and Easement Term or previous Extended Lease and Easement Term, as the case may be. During the Extended Lease and Easement Term, Operator shall pay Owner the amounts set forth in **Exhibit D** as the consideration for the Lease and Easements.

6.1.3 **Delays During Lease and Easement Term.** At Operator's option, the Term may be extended for a period of time equal to the period of time during which operation of the Project is delayed or suspended because of the occurrence of a Regulatory Suspension or Force Majeure, which are defined as follows:

(i) "**Regulatory Suspension**" shall mean the enactment or application of any law, order, rule, or regulation of the Kentucky Public Service Commission, Federal Energy Regulatory Commission, or other local, state, or federal government authority having jurisdiction over the Project or Operator, or the failure of any such governmental authority to issue an approval or permit pursuant to any such law, order, rule, or regulation, which results in the delay, interruption, or suspension of the production, sale or transmission of electricity from the Solar Panels; and

(ii) "**Force Majeure**" shall mean causes beyond the reasonable control of and without the fault or negligence of the Party claiming Force Majeure, including but not limited to acts of God, labor unrest (including, but not limited to, slowdowns, picketing, boycotts or strikes), flood, earthquake, storm, fire, lightning, explosion, power failure or power surge, vandalism, theft, the cutting of power, transmission or other lines, wires or cables to the Project by persons other than Operator's employees or contractors, epidemic, war, revolution, riot, civil disturbance, sabotage, change in law or applicable regulation subsequent to the Commencement Date and action or inaction by any federal, state or local legislative, executive, administrative judicial agency or body which in any of the foregoing cases, by exercise of due foresight such Party could not reasonably have expected to avoid, and which, by the exercise of due diligence, it is unable to overcome.

The Parties shall be excused from performing their respective obligations under this Agreement and shall not be liable in damages or otherwise if and to the extent that they are unable to so perform or are prevented from performing by a Force Majeure, provided that: (i) the non-performing Party, as promptly as practicable after the occurrence of the Force Majeure, but in no event later than thirty (30) days thereafter, gives the other Party written notice describing the particulars of the occurrence; (ii) the suspension of performance is of no greater scope and of no

longer duration than is reasonably required by the Force Majeure; (iii) the non-performing Party uses good faith and commercially reasonable efforts to remedy its inability to perform; and (iv) as soon as the non-performing Party is able to resume performance of its obligations excused as a result of the occurrence, each Party shall give prompt written notification thereof to the other Party.

Notwithstanding the foregoing, Operator shall be required to make the payments described in Exhibit D in the event of a suspension contemplated by this section.

6.2 **Termination by Operator.** Provided Operator is not in default under any term of this Agreement, Operator, at its option, shall have the right to terminate this Agreement at any time during the Term of the Agreement, as to all or any part of the Operator Property. Termination shall be effective thirty (30) days after written notice of such termination to Owner. If Operator's notice is a full termination of the Operator Property, the Parties shall be relieved of all further duties and obligations under this Agreement, other than (i) the payment of any accrued and unpaid obligations owed by either Party as of the date of termination; (ii) the removal of the Improvements by Operator pursuant to Section 8.11; and (iii) any other obligations and liabilities that are expressly stated in this Agreement to survive such termination. Upon any such partial termination by Operator, the Parties shall be relieved of all further duties and obligations under this Agreement with respect to the portion thereof terminated by Operator, subject to the obligations and liabilities referenced in items (i) through (iii) above that shall continue to be applicable to the terminated portion of this Agreement. The Parties agree to execute an amendment to this Agreement evidencing such partial termination. In the event of any such partial termination shall be designed by Operator to minimize leaving any portions of the land which would be left inaccessible for farming purposes. Operator shall make such determination using industry best practices in its reasonable discretion.

7. **Payments.** If Operator exercises the Option referenced in Section 3, Operator agrees to pay Owner the amounts set forth in **Exhibit D** as consideration for the Lease, Easements and Operator's other rights and interests in the Leased Property.

8. **Improvements.** Operator shall have the right, at its sole cost and expense, to construct, install, maintain, use, operate, repair, replace, relocate and remove all facilities, structures, equipment, machinery, wires, conduit, cables, poles, materials and property of every kind and character required for the construction and operation of portions of the Project on the Leased Property, including, but not limited to, the Solar Panels, Collection Facilities, Substations, Telecommunication Facilities, Weather Instruments, Roadway Improvements and Battery Facilities referenced in Sections 8.1 through 8.7 (collectively, the "**Improvements**").

8.1 "**Solar Panels**" shall mean any photovoltaic energy system designed for the generation of electrical power from the collection of sunlight, including without limitation, the photovoltaic panels, foundations, support structures, braces and related equipment.

8.2 "**Collection Facilities**" shall mean all Improvements whose purpose is to deliver electrical power generated by the Solar Panels to an electrical power grid or other system, including without limitation transformers, overhead and underground electrical collection lines, telecommunication lines, splice boxes and interconnection facilities.

8.3 "**Substations**" shall mean electrical lines, meters, monitoring and control equipment, switches, transformers, all structures, equipment, enclosures, fencing, security devices,

and other electrical and communications equipment necessary to condition and increase the voltage of electricity generated by the Project to make it suitable for transmission on, and to deliver it to, Collection Facilities connected to an electric power grid or other system.

8.4 "**Telecommunication Facilities**" shall mean all Improvements whose purpose is to provide telecommunication services solely relating to the Project or any of Operator's solar powered projects, including telephone, closed-circuit television, microwave, internet, computer data and other telecommunication services.

8.5 "**Weather Instrument**" shall mean instruments used primarily to gather and transmit sunlight and meteorological data relating to the Project, and includes the instrument's foundations, guy wires, sunlight and meteorological data acquisition equipment, power source, and any required data and electrical transmission lines.

8.6 "**Roadway Improvements**" shall mean all improvements that may be necessary to construct, maintain and repair any new and existing roadways and other means of ingress and egress over, across and along the Leased Property, including paving or surfacing of the roadways with asphalt, gravel or other roadway materials, installation of road signs and the construction and installation of culverts, bridges, drainage ditches, gates, cattle guards and similar structures and facilities.

8.7 "**Battery Facilities**" shall mean a type of equipment that can be given a new charge by passing an electric current through it designed for the storage of electrical power including without limitation, batteries and other devices for storage of electrical energy, foundations, support structures, braces and related equipment.

8.8 **Ownership of Improvements.** Except as otherwise provided in Section 11.7, all Improvements shall at all times remain the property of Operator, and Owner shall have no right, title or interest therein. All Improvements constructed or placed on the Leased Property by Operator during the Term of this Agreement may be repaired, replaced, relocated, removed, added to or expanded upon by Operator at any time during the Term of this Agreement. Owner expressly waives any statutory lien or common law liens on the Improvements to which Owner might be entitled.

8.9 **Construction Liens.** Operator shall not permit any liens arising out of Operator's use of the Operator Property under this Agreement to be filed against the Leased Property. Operator shall, within sixty (60) days after it receives notice of the lien, provide a bond or other security that Owner may reasonably request, or remove such lien from the Leased Property in the manner provided by applicable law.

8.10 **Location of Improvements.** The acreage required from the Leased Property for the Improvements for which the Lease and Easements are being granted cannot be determined until the completion of Operator's inspection, testing, study and surveying of the Leased Property during the Option Term. Along with the Option Notice, Operator shall deliver to Owner a proposed plan of development showing the contemplated locations of the Improvements and a preliminary calculation of the acreage as determined by the area bounded by a perimeter fence required for the Project, which shall serve as the **Exhibit B** to this Agreement. During the final development and construction of the Project, such locations may need to be amended. Following

construction of the Project, Operator shall provide Owner an "as-built" survey of all Improvements on Leased Property and the final calculation of the acreage as determined by the area bounded by a perimeter fence required for the Project, which shall serve as **Exhibit C** to this Agreement. Further, following construction, the Improvements may need to be relocated or rerouted by Operator, which Operator may perform, at any time during the Term of this Agreement, so long as the nature and extent of any such relocated or rerouted Improvements are not materially different and impose no materially greater burden on the Leased Property than the original locations or routes, and so long as Operator takes commercially reasonable efforts to minimize disruption or inconvenience to Owner.

8.11 **Removal of Improvements.** Upon full or partial termination of any of the Lease Rights or Easements, Operator shall remove all Improvements and restore the area formerly occupied by the Improvements to substantially the same physical condition that existed immediately before the construction of the Improvements (the "**Removal Obligations**"). At Owner's request, all or any part of the Roadway Improvements may be left for use by Owner.

Upon the start of construction, Operator shall obtain and deliver to Owner a bond in form and substance reasonably satisfactory to Owner securing Operator's Removal Obligations (the "Removal Bond"). The Removal Bond shall be equal to the estimated amount, if any (the "Net Removal Costs"), of removing the Improvements from Owner's Property. Operator shall not be required to deliver such Removal Bond to Owner if Operator has delivered such a bond in connection with the permitting of Owner's Property or any other portion of the Improvements for the Project. Once in place, Operator shall keep such bond, or a like replacement, in force throughout the remainder of the Term. The Net Removal Costs shall be determined by the Parties hereto acting in good faith. If the Parties cannot agree upon the Net Removal Costs within sixty (60) days of their first attempt to do so, then the Net Removal Costs shall be determined by an independent engineer mutually selected by the Parties. If the Parties cannot agree upon such independent engineer within the next thirty (30) days, then by an independent engineer appointed by a District Judge of Henderson County, Kentucky; and the decision of such an independent engineer (however selected) as to the Net Removal Costs shall be conclusive as between and binding upon, the Parties. If an independent engineer is selected, then the Operator shall pay all of the costs associated with the independent engineer's determination of the Net Removal Cost. If an alternate form of security is more economical or desirable, then Operator may substitute an alternate form of security, such as a letter of credit, other form of bond, or guarantee reasonably acceptable to Owner that provides substantially equivalent security as the Removal Bond.

9. **Ownership and Title Matters.** Owner warrants and represents to Operator, both as of the Effective Date, and as of the Commencement Date as follows:

9.1 **Authority.** Owner represents and warrants that it is the holder of fee simple title and is the sole owner of the surface of the Leased Property and has the unrestricted right and authority to sign this Agreement and to grant Operator the Lease and Easements and other rights granted in this Agreement. When signed by both Parties, this Agreement constitutes a valid and binding agreement enforceable against Owner in accordance with its terms. Owner makes no representation or warranty as to ownership of any coal, oil, gas, or other minerals in and underlying the leased property.

9.2 **Other Agreements.** The Leased Property is not subject to any other agreements, options, rights of first refusal or other prior right of any party to purchase, lease or acquire easements in the Leased Property, or create any prior claim or right that would preclude or interfere with Operator's rights and interests under this Agreement and the Lease and Easements.

9.3 **Minerals.** Intentionally deleted.

9.4 **Owner Mortgage.** Except as disclosed by Owner to Operator at the time of the execution of this Agreement by Owner, there are no mortgages encumbering the Leased Property ("**Owner Mortgage**").

9.5 **Notice and Opportunity to Cure.** If there is an Owner Mortgage encumbering Leased Property and Owner receives from the holder thereof any notice that payments are overdue, Owner shall notify Operator and each Operator Mortgagee (as defined at Section 13.1) by sending a copy of such overdue payment notice to Operator by the earlier of (i) five (5) days after receipt, or (ii) three (3) business days prior to the date by which a default under or in respect of such Owner Mortgage could occur. If Operator or any Operator Mortgagee determines that it would be in Operator's interest to make such payments to Owner Mortgagee on Owner's behalf, whether as a result of receiving such notice or otherwise, Operator shall have the right to make such payments and to credit the payments so made against the Annual Installment Payment next due under the Agreement.

9.6 **Subordination, Non-Disturbance & Attornment Agreement.** If there is an Owner Mortgage encumbering Leased Property, Owner shall cooperate with Operator to obtain a Subordination, Non-Disturbance and Attornment Agreement ("SNDA") in the form prepared and provided by Operator, from each Owner Mortgagee, pursuant to which such Owner Mortgagee agrees, among other things, not to disturb Operator's possession and use of the Leased Property. Owner shall not incur any loss in income, expense, obligation or liability with regard to the SNDA. Operator shall, at its sole cost and expense, record each such SNDA in the Office of the County Clerk in which Leased Property is located. If Owner fails to deliver a SNDA from each Owner Mortgagee, Operator may, at its sole option, either (i) terminate this Agreement immediately upon written notice to Owner, or (ii) take such action as Operator deems reasonably necessary to effect the rights granted to Operator hereunder, and off-set all amounts expended in such efforts against the Annual Installment Payments and any other amounts due hereunder or in respect hereof.

10. **Representations and Warranties of Owner.** Owner hereby makes the following further representations and warranties both as of the Effective Date, and as of the Commencement Date:

10.1 **Physical Condition.** Owner has no knowledge of any existing physical conditions of the Leased Property which would prevent, significantly restrict or make more expensive Operator's development of the Leased Property for the purposes specified in this Agreement, or which could, with the passage of time, or the giving of notice, constitute a violation of any currently applicable governmental law, ordinance, order, rule or regulation.

10.2 **Legal Restrictions.** Owner has no knowledge of any law, regulation, ordinance or order of any local, state or federal governmental authority which would prohibit or significantly restrict Operator's development of the Leased Property pursuant to this Agreement. This Agreement does not violate any contract, agreement, instrument, judgment or order to which

Owner is a party or which affects the Leased Property. To the best of Owner's knowledge, the Leased Property is currently in full and complete compliance with all governmental laws, ordinances, orders, rules and regulations applicable to the Leased Property.

10.3 **No Litigation.** No litigation is pending and, to the best of Owner's knowledge, no litigation or administrative actions are proposed, threatened or anticipated with respect to any matter affecting the Leased Property. If Owner learns of any litigation or administrative action proposed, threatened or instituted with respect to the Leased Property, Owner shall give Operator notice within thirty (30) days thereof.

10.4 **Survival.** The representations and warranties set forth in this Section 10 shall survive the execution and delivery hereof.

11. **Use, Operation and Maintenance.**

11.1 **Exclusive Use by Operator.** Operator shall have the exclusive right (i) to use and possess the Owner Property in connection with the Project and other similar solar-powered electrical power generation projects; (ii) to investigate, inspect, survey, and conduct tests of the Leased Property, including, but not limited to, meteorological, environmental, archeological and geotechnical tests and studies; (iii) to use and convert all of the sunlight resources on the Leased Property; and (iv) to undertake such other activities on the Leased Property that may be related to the Project, including, without limitation, the storage of Solar Panels, materials and equipment during the installation and construction of the Improvements; development and operation of communications systems; and site tours of the Project for visitors and other interested parties.

11.2 **No Required Installation or Operation.** Nothing in this Agreement shall be interpreted as imposing on Operator any obligation to install Solar Panels or other Improvements on the Leased Property, or to operate the Project on the Leased Property. Operator shall have the sole discretion to determine if and when any Solar Panels and other Improvements may be constructed on Leased Property, and if and when to commence the operation of the Project on the Leased Property.

11.3 **Permits and Approvals.** Operator shall be responsible, at its sole cost and expense, for obtaining any governmental permits and approvals necessary for the construction and operation of the Project and the construction and operation of the Improvements. Owner shall cooperate with Operator as necessary to obtain any governmental or utility approvals or permits, including, without limitation, signing any applications for such approvals, provided that Owner shall not incur any loss in income, expense, obligation or liability with respect to Operator obtaining such permits or approvals.

11.4 **Compliance with Laws.** Operator shall comply in all material respects with valid laws applicable to the Leased Property and the Operator Property. Operator shall have the right, in its sole discretion and at its sole expense, in Operator's name to contest the validity or applicability to the Leased Property and the Operator Property of any law, ordinance, statute, order, regulation, property assessment or the like made by any governmental agency or entity. Operator shall control any such contest and Owner shall cooperate with Operator in every reasonable way in such contest, provided that Owner shall incur no expense, obligation or liability with regard to such contest.

11.5 **Care and Appearance.** Operator, in its exercise of the lease, easement and other rights granted hereunder shall, at all times, maintain the Leased Property and the Improvements in a reasonably neat, clean and presentable condition. Operator shall not willfully or negligently damage or destroy the Leased Property and shall keep the Leased Property clean and free of debris created by Operator, its contractors, or others brought on to the Leased Property by Operator. Operator shall not use the Leased Property for storage, except for materials, construction equipment and vehicles directly associated with construction or maintenance of the Improvements on the Leased Property or adjacent properties that are part of the Project.

11.6 **Fences and Gates.** At Owner's request, Operator shall repair or replace any fences, gates or cattle guards damaged or removed in connection with Operator's activities on the Leased Property. Fences removed from the Leased Property, if replaced, shall be re-built by Operator at its expense in mutually agreeable locations. All fence repair and construction shall be substantially similar to the construction of existing fences and cattle guards on Leased Property. Any gates opened for access to Leased Property by either Party shall be closed immediately after passing through so that livestock may not pass through. Once completed, all replacement fences, gates and cattle guards shall be owned and maintained by Owner. Upon abandonment or termination of the rights granted to Operator in this Agreement, any fences, gates and cattle guards installed by Operator shall remain and become the property of Owner. To minimize the need for temporary fencing, Owner will cooperate with Operator to avoid pasturing animals on or near the Improvements during periods of construction, maintenance or removal activity by Operator. Owner will discuss with Operator what temporary fencing is necessary during the periods of construction, maintenance or removal activity by Operator.

11.7 **Roadway Maintenance and Repairs.** Operator agrees to maintain and repair all Roadway Improvements located on the Operator Property; provided, however, Owner shall reimburse Operator for any costs and expenses incurred by Operator to repair any damage or perform any special maintenance of the Roadway Improvements caused by Owner or any person using the Roadway Improvements with Leased permission, other than Operator.

12. **Taxes.**

12.1 **Leased Taxes.** Owner covenants and agrees to pay prior to delinquency all real and personal property and other taxes, general and special assessments, and other charges of every description ("**Taxes**") levied or assessed against the Leased Property and all improvements thereon by governmental authorities, other than Operator's Taxes referenced in Section 12.2 (Taxes, excepting Operator's Taxes, are hereinafter referred to as "**Leased Taxes**").

12.2 **Operator's Taxes.**

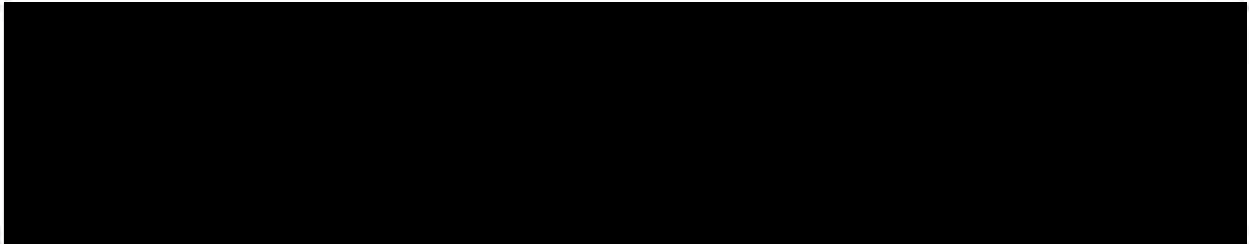

12.3 **Failure to Pay.** In the event either Party fails to pay their share of Taxes prior to delinquency, the other Party shall have the right to pay such Taxes and any accrued penalties or interest, which payments shall increase or be offset against other Payments due under this Agreement.

12.4 **Operator's Right to Contest.** Operator may contest the legal validity or amount of any Operator's Taxes for which it is responsible under this Agreement, and may institute such proceedings as it considers necessary, provided that Operator shall bear all expenses in pursuing such contest or proceeding. With respect to any Taxes which may constitute a lien on the Leased Property, Operator shall promptly pay such Taxes unless the proceeding in which it contests such Taxes shall operate to prevent or stay the collection of the Taxes so contested or unless Operator removes any such lien by bonding or otherwise. Owner agrees to render to Operator all reasonable assistance in contesting the validity or amount of any such Taxes, with the exception of Taxes levied by Owner, including joining in the signing of any reasonable protests or pleading which Operator may deem advisable to file; provided, however, that Operator shall reimburse Owner for its reasonable out-of-pocket expenses, including reasonable attorneys' fees incurred in connection with providing such assistance.

13. **Mortgage of Operator Property.**

13.1 **Right to Mortgage.** Operator may, upon written notice to Owner, but without requiring Owner's consent or approval, mortgage, collaterally assign, or otherwise encumber and grant security interests in all or any part of its interest in this Agreement and the Operator Property. These various security interests in all or a part of this Agreement and the Operator Property are collectively referred to as an "**Operator Mortgage**" and holder of such security interest, an "**Operator Mortgagee**". Any Operator Mortgagee shall use the Operator Property only for the uses permitted under this Agreement. Whenever Operator has granted a security interest under this Section 13, it will give Owner notice of the Operator Mortgage (including the name and address of the Operator Mortgagee for notice purposes) to Owner within thirty (30) days; provided that failure to give this notice shall not constitute a default under this Agreement, but rather shall only have the effect of not binding Owner to provide such Operator Mortgage notice until the Operator and its address is given to Owner.

13.2 **Notice of Default and Opportunity to Cure.** As a precondition to exercising any rights or remedies related to any alleged default by Operator under this Agreement, Owner shall give written notice of the default to each Operator Mortgagee at the same time it delivers notice of default to Operator, specifying in detail the alleged event of default and the required remedy. Each Operator Mortgagee or its designee shall have the right, but not the obligation, to cure any default as Operator, and/or the right, but not the obligation, to remove any Improvements or other property owned by Operator or such Operator Mortgagee located on the Leased Property to the same extent as Operator. The cure period for any Operator Mortgagee shall be the later of (i) the end of the

Operator cure period under Section 18; (ii) thirty (30) days after such Operator Mortgagee's receipt of the default notice; or (iii) if applicable, the extended cure period provided for in Section 13.3. Failure by Owner to give an Operator Mortgagee notice of default shall not diminish Owner's rights against Operator, but shall preserve all rights of the Operator Mortgagee or its designee to cure any default and to remove any Improvements or other property of Operator or the Operator Mortgagee located on the Leased Property.

13.3 **Extended Cure Period.** If any default by Operator under this Agreement cannot be cured without the Operator Mortgagee obtaining possession of all or part of the Operator Property, then any such default shall be deemed remedied if an Operator Mortgagee: (i) within sixty (60) days after receiving notice from Owner as set forth in Section 13.2, acquires possession of all or part of the Operator Property, or begins appropriate judicial or nonjudicial proceedings to obtain the same; (ii) diligently prosecutes any such proceedings to completion; and (iii) after gaining possession of all or part of the Operator Property performs all other obligations as and when the same are due in accordance with the terms of this Agreement. If an Operator Mortgagee is prohibited by any court or by operation of any bankruptcy or insolvency laws from commencing or prosecuting the proceedings described above, the sixty (60) day period specified above for commencing proceedings shall be extended for the period of such prohibition.

13.4 **Operator Mortgagee Liability.** Any Operator Mortgagee whose interest in the Operator Property is held solely for security purposes, shall have no obligation or liability under this Agreement unless and until the Operator Mortgagee succeeds to absolute title to the Operator Property and the rights of Operator under this Agreement. An Operator Mortgagee shall be liable to perform obligations under this Agreement only for and during the period it directly holds such absolute title.

13.5 **Certificates.** Owner shall execute any estoppel certificates (certifying as to truthful matters, including without limitation that no default then exists under this Agreement, if such be the case), consents to assignment and non-disturbance agreements as Operator or any Mortgagee may reasonably request from time to time. The Parties shall negotiate in good faith any amendment to this Agreement from time to time to include any provision that may be reasonably requested by Operator or any Operator Mortgagee to implement the provisions contained in this Agreement or to preserve an Operator Mortgagee's security interest.

13.6 **Operator Mortgagee's Right to Enforce Mortgage and Assign.** Each Operator Mortgagee shall have the right, in its sole discretion: (i) to assign its Operator Mortgage; (ii) to enforce its lien and acquire title to all or any portion of the Operator Property by any lawful means; (iii) to take possession of and operate all or any portion of the Operator Property and to perform all obligations to be performed by Operator under this Agreement, or to cause a receiver to be appointed to do so; and (iv) to acquire all or any portion of the Operator Property by foreclosure or by an assignment in lieu of foreclosure and thereafter to assign or transfer all or any portion of the Operator rights under this Agreement to a third party in accordance with Section 14. Any Operator Mortgagee or other party who acquires Operator's interest in all or a portion of the Operator Property pursuant to foreclosure or assignment in lieu of foreclosure shall not be liable to perform the obligations imposed on Operator by this Agreement, which are incurred or accruing after such Operator Mortgagee or other party no longer has ownership or possession of the Operator Property.

13.7 **New Agreement.**

13.7.1 If the Operator Property is foreclosed upon or there is an assignment in lieu of foreclosure, or if this Agreement is rejected or disaffirmed pursuant to bankruptcy law or other law affecting creditor's rights and, within ninety (90) days after such event, Operator or any Operator Mortgagee or other purchaser at a foreclosure sale shall have arranged to the reasonable satisfaction of Owner to cure any material defaults under this Agreement, and for the payment of all Annual Installment Payments or other charges due and payable by Operator as of the date of such event, then Owner shall execute and deliver to Operator or such Operator Mortgagee or other purchaser at a foreclosure sale, or to a designee of one of these parties, as the case may be, a new agreement ("**New Agreement**") which (i) shall be for a term equal to the remainder of the Term of this Agreement before giving effect to such rejection or termination; (ii) shall contain the same covenants, agreements, terms, provisions and limitations as this Agreement (except for any requirements that have been fulfilled by Operator or any Operator Mortgagee or other purchaser at a foreclosure sale prior to rejection or termination of this Agreement); and (iii) shall include that portion of the Operator Property in which Operator or such other Operator Mortgagee or other purchaser at a foreclosure sale had an interest on the date of rejection or termination.

13.7.2 If more than one Operator Mortgagee makes a written request for a New Agreement pursuant to this provision, the New Agreement shall be delivered to the Operator Mortgagee requesting such New Agreement whose Operator Mortgage is prior in time, and the written request of any other Operator Mortgagee whose lien is subordinate shall be void and of no further force or effect. The provisions of this Section 13 shall survive the termination, rejection or disaffirmation of this Agreement and shall continue in full force and effect thereafter to the same extent as if this Section 13 were a separate and independent contract made by Owner, Operator and each Operator Mortgagee, and, from the effective date of such termination, rejection or disaffirmation of this Agreement to the date of execution and delivery of such New Agreement, such Operator Mortgagee or other purchaser at a foreclosure sale may use and enjoy the Operator Property without hindrance by Owner or any person claiming by, through or under Owner; provided that all of the conditions for the New Agreement as set forth above are complied with.

13.8 **Operator Mortgagee's Consent to Amendment, Termination or Surrender.** Notwithstanding any provision of this Agreement to the contrary, the Parties agree that so long as any Operator Mortgage remains outstanding, this Agreement shall not be modified or amended, and Owner shall not accept a surrender, cancellation or release of all or any part of the Operator Property from Operator, prior to expiration of the Term of this Agreement, without the prior written consent of the Operator Mortgagee holding such Operator Mortgage. This provision is for the express benefit of and shall be enforceable by each Operator Mortgagee as if it were a party named in this Agreement.

14. **Assignment and Sublease.** Operator shall have the right, without Owner's consent, to sell, convey, lease, or assign all or any portion of this Agreement or the Operator Property, on either an exclusive or a non-exclusive basis, or to grant subeasements, co-easements, easements, licenses or similar rights with respect to the Operator Property (collectively, "**Assignment**"), to one or more persons or entities (collectively "**Assignee**"). Each Assignee shall use the Operator Property only for the uses permitted under this Agreement. In the event Operator makes any Assignment under this Section 14, Operator shall give written notice to Owner of such Assignment (including the interest conveyed by the Assignment and address of the Assignee for notice

purposes) to Owner.. Any Assignment by Operator shall release Operator from obligations subject thereof accruing after the date that liability for such obligations, provided only that all such obligations are assumed by the Assignee.

15. **Hazardous Materials.**

15.1 **Owner's Covenants Regarding Hazardous Materials.** Owner represents and warrants that, to the best of Owner's knowledge, the Leased Property is not and has not been in violation of any federal, state or local environmental health or safety laws, statute, ordinance, rule, regulation or requirement ("**Environmental Laws**"), and Owner has not received any notice or other communication from any governmental authorities alleging that the Leased Property is in violation of any Environmental Laws. "**Hazardous Materials**" shall mean any asbestos containing materials, petroleum, explosives, toxic materials, or substances regulated as hazardous wastes, hazardous materials, hazardous substances, or toxic substances under any federal, state, or local law or regulation. Owner warrants that Owner has done nothing to contaminate the Operator Property with Hazardous Materials or wastes.

15.2 **Operator's Covenants Regarding Hazardous Materials.** Operator shall, at Operator's sole cost and expense, promptly take removal or remedial action required by Environmental Law with regard to any material violation of any Environmental Law with regard to any Hazardous Materials brought onto the Leased Property by Operator or its employees, agents, or contractors. Owner shall cooperate with Operator with regard to any scheduling or access to the Leased Property in connection with any action required hereunder.

15.3 **Operator's Indemnity Regarding Hazardous Materials.** Operator shall indemnify, defend, protect and hold Owner harmless from any liability based on: (i) the release of Hazardous Materials in, on, under or about the Leased Property caused by Operator or its employees, agents, or contractors, or (ii) the violation by Operator or its employees, agents, or contractors of any Environmental Law. The indemnity obligations set forth herein shall survive termination of this Agreement.

16. **Insurance and Indemnity.**

16.1 **Insurance.** At all times during which Operator is conducting any activities on the Property and at all times during the Term of this Agreement, Operator shall maintain in effect (1) commercial General Liability Insurance, including bodily injury and property damage coverage with minimum limits of \$1 Million Dollars per occurrence and \$2 Million Dollars aggregate and (2) Umbrella Liability Insurance with minimum limits of \$5 Million Dollars per occurrence and \$5 Million Dollars aggregate. Upon a written request by Owner, Operator shall name Owner as additional insured on such insurance policy and provide Owner with a certificate of such insurance.

16.2 **Indemnity by Operator.** Operator shall defend, indemnify, protect and hold Owner harmless from and against all liabilities, costs, expenses, obligations, losses, damages, claims, reasonable attorney's fees and litigation costs (collectively "**Claims**") resulting from the negligence, willful misconduct, or breach of this Agreement by Operator, its agents, contractors or employees, invitees, licensees and permittees; provided, however, that such Claims are not due

to the sole negligence, willful misconduct, or breach by Owner, its agents, contractors or employees, invitees, licensees or permittees.

16.3 **Indemnity by Owner**. Owner shall defend, indemnify, protect, and hold Operator harmless from and against all Claims resulting from the negligence, willful misconduct, or breach of this Agreement by Owner, its agents, contractors or employees, invitees, licensees and permittees; provided, however, that such Claims are not due to the sole negligence, willful misconduct, or breach by Operator, its agents, contractors, employees, invitees, licensees, or permittees.

16.4 **Survival**. The obligations of the Parties under this Section 16 shall survive expiration or other termination of this Agreement.

17. **Confidentiality**. This Agreement includes confidential and proprietary information relating to Operator and the Project. Owner agrees not to provide copies of the Agreement or disclose the terms of the Agreement to any unauthorized person or entity. Operator authorizes Owner to provide copies of the Agreement and disclose the terms thereof to Owner's family ("family" shall be deemed to include all devisees or descendants of owner by will or intestacy), attorney, accountant, financial advisor and any existing or prospective mortgagee, lessee, or purchaser for the sole purpose of evaluating and advising Owner and for no other purpose, so long as such authorized parties agree in writing to become subject to the confidentiality provisions hereto and not to provide copies of the Agreement or disclose the terms thereof to any unauthorized person or entity. Any Owner and party shall return all material containing any confidential information to Operator immediately upon its request. Any party agrees to destroy immediately upon request by Operator such analyses, compilation, studies or other documents, and any oral information will continue to be subject to the terms of this Agreement. Owner agrees that Operator will have no adequate remedy at law if any party violates any of the terms of this Agreement. In such event Operator will have the right, in addition to any other rights Operator may have, to obtain injunctive relief to restrain any breach or threatened breach by third party or specific enforcement of such terms plus reimbursement of attorneys' fees, court costs and all associated expenses. No party shall publish, file for public record, reproduce, or otherwise disseminate this document or any of the terms and provisions hereof to any party, other than the Parties set forth above without the prior written consent of Operator, which consent may be withheld for any reason and in Operator's sole discretion.

18. **Default and Remedies**.

18.1 **Operator Payment Default**.

18.1.1 **Collection of Payments**.

18.1.2 **Terminate Agreement**. Intentionally deleted.

18.2 Other Operator Default. [REDACTED]

[REDACTED]

18.3 Owner Default. [REDACTED]

[REDACTED]

19. Condemnation.

19.1 Complete Taking. If, at any time, any authority having the power of eminent domain shall condemn all or substantially all of the Operator's Property, or all of the Improvements thereon, for any public use or otherwise, then the interests and obligations of Operator under this Agreement in or affecting the Operator's Property shall cease and terminate upon the earlier of (i) the date that the condemning authority takes physical possession of the Operator's Property or the Improvements thereon, (ii) the date that Operator is, in its sole judgment, no longer able or permitted to operate the Project on the Operator's Property in a commercially viable manner, or (iii) the date of the condemnation judgment. Operator shall continue to pay all amounts payable hereunder to Owner until the earlier of such dates, at which time the Parties shall be relieved of any and all further obligations and conditions to each other under this Agreement.

19.2 **Partial Taking.** If, at any time during the term of this Agreement, any authority having the power of eminent domain shall condemn one or more, but not all, of the Solar Panels, or any portion of the Improvements or the Operator's Property, then the interest and obligations of Operator under this Agreement as to those Solar Panels or any portion of the Improvements or the Operator's Property so taken shall cease and terminate upon the earlier of (i) the date that the condemning authority takes possession of such Solar Panels or any portion of the Improvements or the Operator's Property, (ii) the date that Operator is, in its reasonable judgment, no longer able or permitted to operate the Project on the Operator's Property, or any portion thereof, in a commercially viable manner, or (iii) the date of the condemnation judgment; and, unless this Agreement is terminated as hereinafter provided, this Agreement shall continue in full force and effect as to the remainder of the Solar Panels, Improvements and the Operator's Property. If the remainder of the Solar Panels or any other portion of the Improvements or the Operator's Property is or becomes insufficient or unsuitable for Operator's purposes hereunder, as determined by Operator in its sole discretion, then, subject to the rights of any Operator Mortgagee under Section 13, Operator shall have the right to terminate this Agreement as to the portion of the Operator's Property to which Operator continues to hold the rights, at which time the Parties shall be relieved of any further obligations and duties to each other under this Agreement.

19.3 **Apportionment, Distribution of Award.** On any taking, all sums awarded, including damages and interest, shall be paid in accordance with Kentucky law. Nothing herein shall impair the Operator's right to seek compensation or damages from the applicable condemning authority.

20. **Notice.**

20.1 **Writing.** All notices given or permitted to be given hereunder shall be in writing.

20.2 **Delivery.** Notice is considered given either (i) when delivered in person to the recipient named below, (ii) upon receipt after deposit in the United States mail in a sealed envelope or container, postage and postal charges prepaid, return receipt requested or certified mail, addressed by name and address to the party or person intended, or (iii) twenty-four (24) hours from proper and timely delivery to an overnight courier service addressed by name and address to the party or person intended as follows:

Notice to Owner: Victoria Hust and Bill Barber
226 Spring Street
St. Johnsbury, VT 05819



Notice to Operator: Sebree Solar, LLC
700 Universe Blvd
Juno Beach, FL 33408



20.3 **Change of Recipient or Address.** Either Party may, by notice given at any time or from time to time, require subsequent notices to be given to another individual person, whether

a party or an officer or representative, or to a different address, or both. Notices given before actual receipt or notice of change shall not be invalidated by the change.

21. **Miscellaneous Provisions.**

21.1 **Successors and Assigns.** The terms and provisions of this Agreement shall run with the land and be binding on and inure to the benefit of the heirs, successors, assigns and personal representatives of the Parties. In accordance with this Agreement, Operator in its discretion may authorize other persons or entities to use the Operator Property for the purposes stated in this Agreement

21.2 **Memorandum.** Simultaneously with the execution of this Agreement, the Parties agree to execute and acknowledge a memorandum of this Agreement. Operator may record the executed memorandum in the public records of Henderson County, Kentucky.

21.3 **Entire Agreement.** This Agreement and the attached Exhibits shall constitute the entire agreement between the Parties and supersedes all other prior writings and understandings.

21.4 **Amendments.** This Agreement shall not be amended or modified in any way except by an instrument signed by the Parties and consented to by any Operator Mortgagee. The Parties hereto shall at all times hereafter execute any documents and do any further acts which may be necessary or desirable to carry out the purposes of this Agreement and to give full force and effect to each and all of the provisions hereof.

21.5 **Legal Matters.** This Agreement shall be governed by and interpreted in accordance with the then existing laws of the Commonwealth of Kentucky. Jurisdiction for any litigation concerning the interpretation or enforcement of this Agreement shall be proper in the Henderson Circuit Court or the United States District Court for the Western District of Kentucky, Owensboro Division. The Parties agree to first attempt to settle any dispute arising out of or in connection with this Agreement by good-faith negotiation. If the Parties are unable to resolve amicably any dispute arising out of or in connection with this Agreement, each shall have all remedies available at law or in equity and as provided by this Agreement. **Each Party waives all right to trial by jury and specifically agrees that trial of suits or causes of action arising out of this Agreement shall be to the court of competent jurisdiction.**

21.6 **Severability.** If any term or provision of this Agreement, or the application thereof to any person or circumstance shall, to any extent, be determined by judicial order or decision to be invalid or unenforceable, the remainder of this Agreement or the application of such term or provision to persons or circumstances other than those as to which it is held to be invalid, shall be enforced to the fullest extent permitted by law.

21.7 **Tax Credits.** If under applicable law Operator becomes ineligible for any currently existing tax credit, benefit or incentive for alternative energy expenditure established by any local, state or federal government, then, at Operator's option, the Parties shall negotiate in good faith to amend this Agreement or replace it with a different instrument so as to convert Operator's interest in the Operator Property to a substantially similar interest that makes Operator eligible for such tax credit, benefit or incentive. Such amendment or instrument shall not impair any of Owner's rights or increase the burdens or obligations of Owner under this Agreement.

21.8 **Approvals**. Whenever in this Agreement the approval or consent of either Party is required or contemplated, unless otherwise specified, such approval or consent shall not be unreasonably withheld or delayed.

21.9 **Authority**. The signatories hereto warrant that each has the authority to execute this Agreement on behalf of any entities which are Parties to this Agreement and that each such entity has executed this Agreement pursuant to its organizational documents or a resolution or consent of their Board of Directors or other governing body.

21.10 **Time of Essence**. Time is of the essence of each provision of this Agreement.

21.11 **Counterparts**. This Agreement may be executed in multiple counterparts, each of which shall be deemed an original, and all of which together shall constitute a single instrument.

Owner:



Victoria Hust



Bill Barber, Consenting Spouse

Operator:

Sebree Solar, LLC
a Delaware limited liability company

By:



Anthony Pedroni, Vice President

EXHIBIT A

Legal Description of Leased Property

Parcel 1

Tract #1: Beginning at a stake on the south side of the Cairo-Robards, corner with Warren Poole, runs N 58.45 E 449 feet to a stake in road, corner with Ed Poole; thence S 86.45 E 911 feet to a stone on road side, corner with Hall Heirs; thence S 9.10 W 2767 feet to a stake in road; corner with Hall Heirs; thence N 84.85 W 1414 feet to an iron pin, corner with Warren Poole, thence N 2.45 E 2460 feet to the beginning, containing 83.47 acres.

Tract #2: Beginning at a stone corner with Turner Poole, thence S 9:10 W 2767 feet to a stake in road, corner with Turner Poole; thence S 84:45 E 784 feet to a stone, original corner; thence N 0:12 E 2800 feet to a take in road, original corner; thence N 89 W 784 feet to the beginning, containing 49.77 acres.

LESS and EXCEPTING therefrom 1½ acres of land for burying purposes in and around the present cemetery which is 1500 feet off the Cairo-Robards Road and fronting the public road on the east side.

SOURCE: Being the same property conveyed to Maynard Hust, by deed dated April 1, 1970, from Dorsul, Incorporated of record in Deed Book 247, Page 146, in the Henderson County Court Clerk's Office.

Approximately 131 acres, excluding the areas depicted as Exclusion Areas on Exhibit A-1 attached hereto, and excluding the area depicted as the approximate 4 acre tract around the homestead as depicted on Exhibit A-1, page 2 attached hereto.

Parcel 2

One certain tract of land lying in Henderson County, State of Kentucky, and bounded as follow, to wit: Beginning at a hickory W.N. Royster corner in W.N. Royster's line, running thence with old military line N 82½° W 18.12 chains to a stone corner with Mrs. E.J. Scott; thence with her line S 1¾° E 17.51 chains to a stone, her corner; thence N 84¾ W 6.83 chains to a stone corner with R.L. Scott deed; thence with S.A. Scott's line S 1½ E 27 poles and 7½ links to a stone in a ditch, corner to remaining lot; thence S 82½° E 23.67 chains to a stone in W.N. Royster's line; thence with his line N 1¾° W 110 poles and 172 links to the beginning, containing 55 acres, more or less.

SOURCE: Being the same property conveyed to Maynard Hust and his wife, Jeanne F. Hust, by deed dated September 13, 1974, from George R. Baldwin and wife, Betty J. Baldwin, of record in Deed Book 274, Page 280, in the Henderson County Court Clerk's Office. By deed dated March 16, 1976, Jeanne F. Hust conveyed all her right, title and interest to the described property to Maynard Hust by virtue of agreement in the parties divorce action, being N. 12, 281 in the Henderson Circuit Court. Said deed is of record in Deed Book 284, Page 230 in the aforesaid clerk's office.

Approximately 54 acres, excluding the areas depicted as Exclusion Areas on Exhibit A-1 attached hereto.

EXHIBIT A-1
Depiction of Exclusion Area

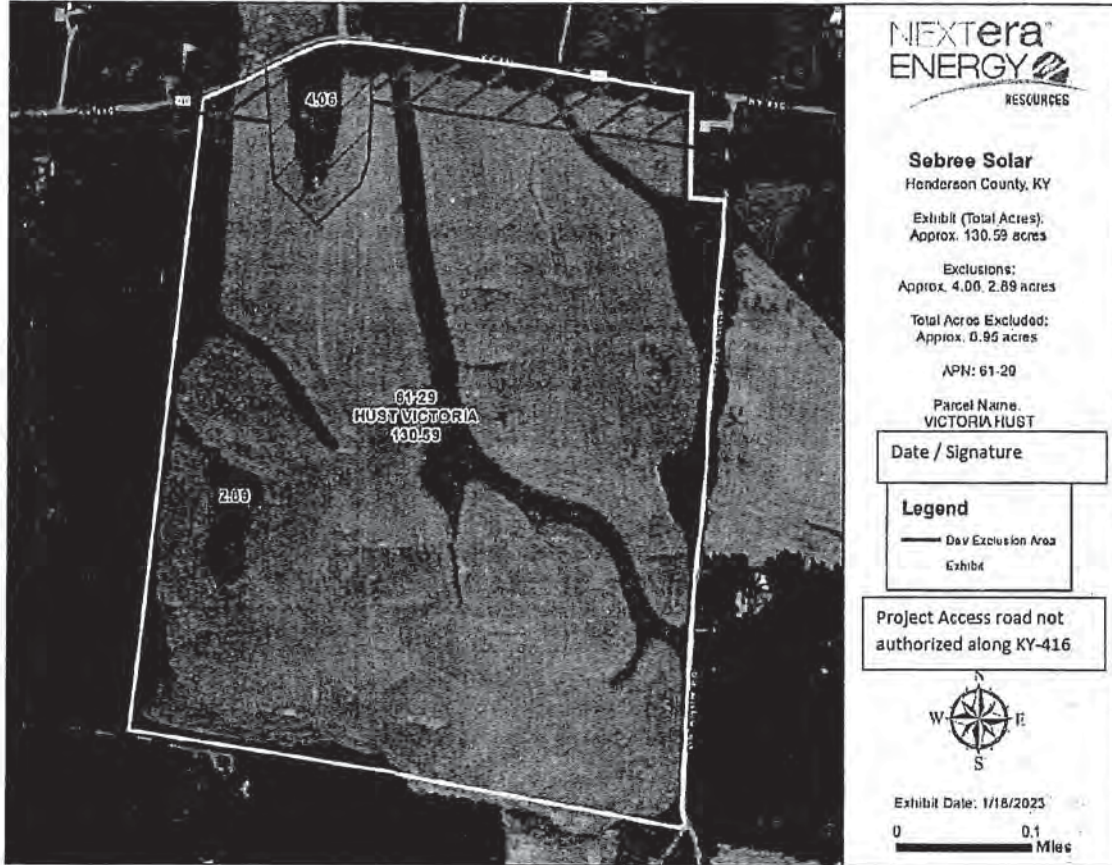

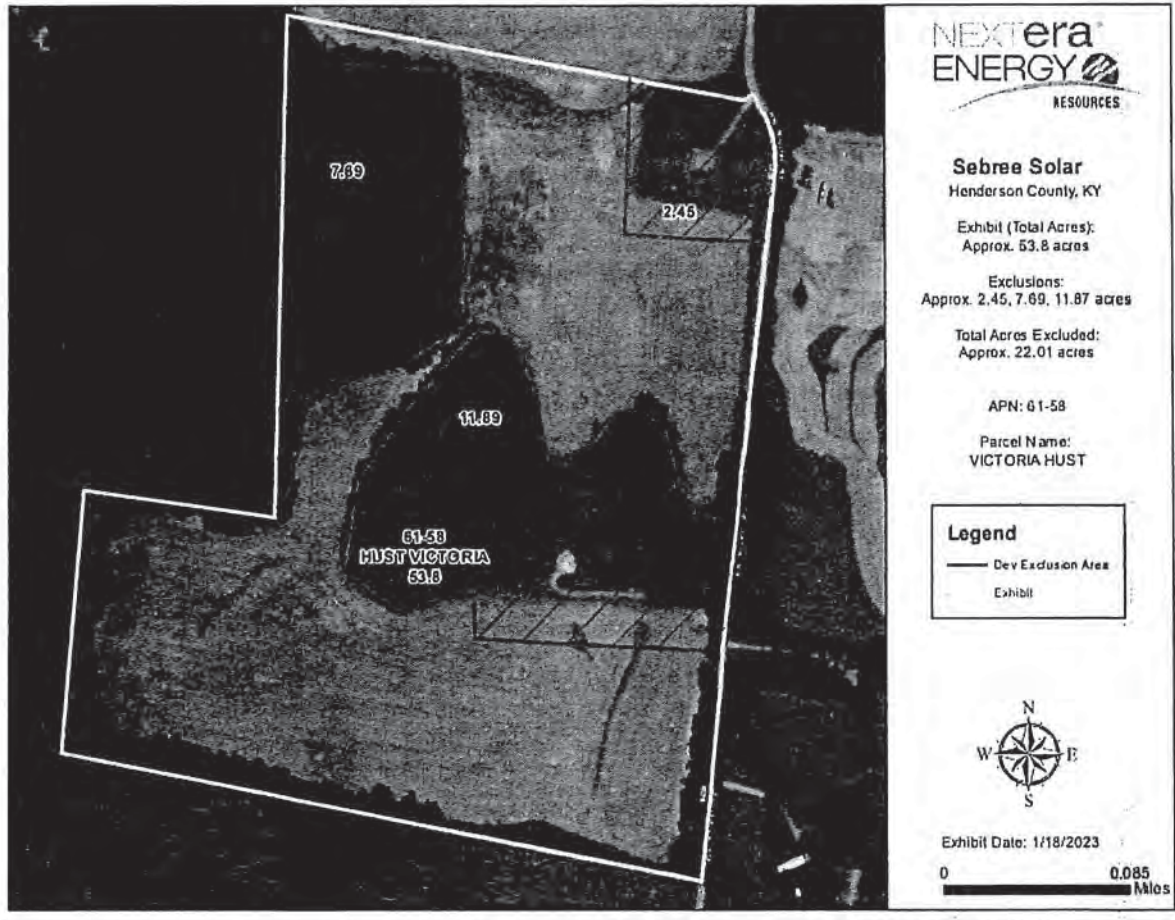

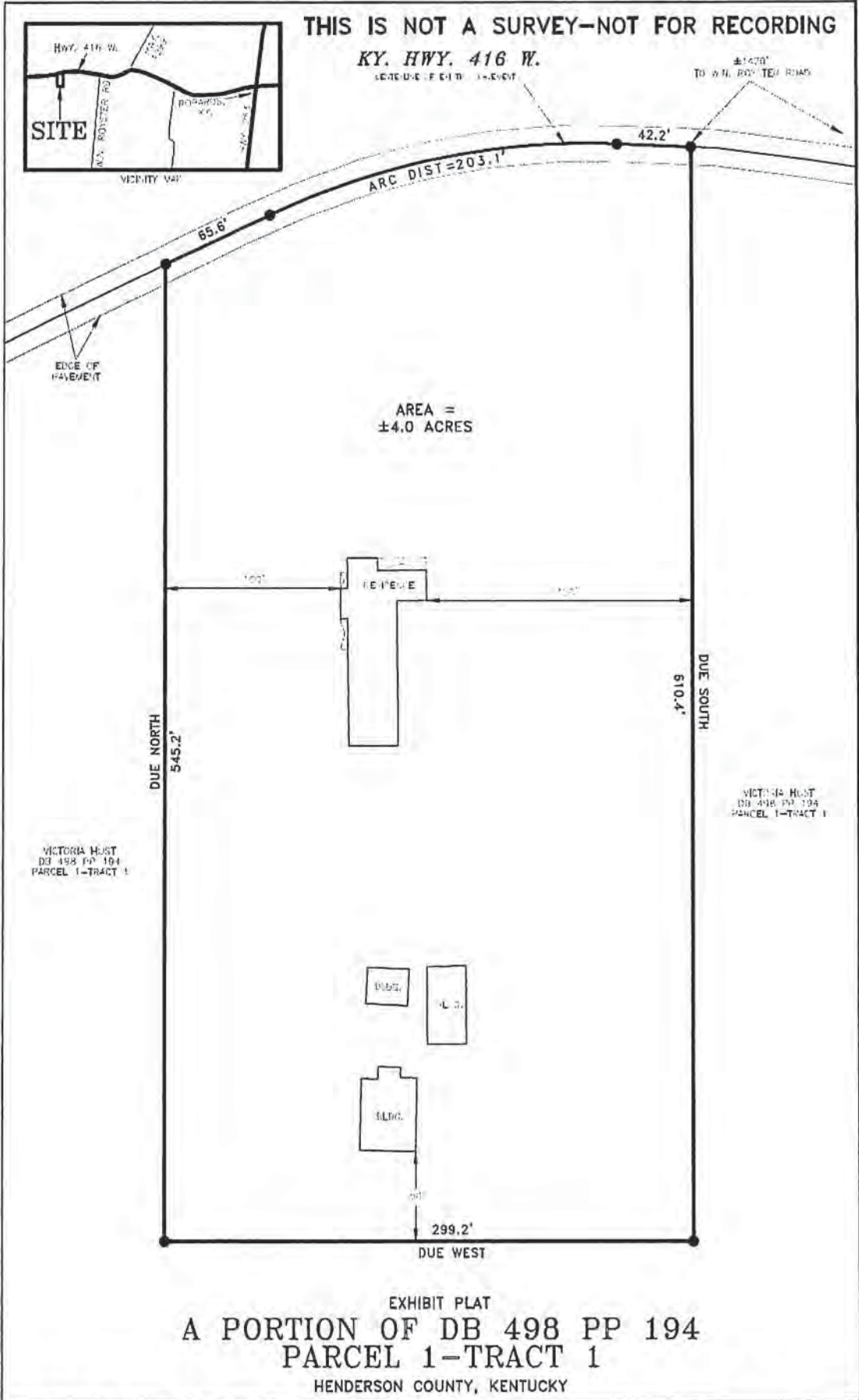

DRAWING NAME: 61-29EX
DATE: 1-5-21

OWNER: VICTORIA HUST
226 SPRING ST.
HENDERSON, KY. 42512

PROPERTY ADDRESS: 9798 HWY 416 W.
ROBARDS, KY. 42452

HOLDING PAGE FOR EXHIBIT B

Preliminary Lease and Easement Improvement Plan and Acreage Calculation
To be Delivered with Option Notice

HOLDING PAGE FOR EXHIBIT C

As Built Lease and Easement Improvements and Final Acreage Calculation

EXHIBIT D

Lease and Easement Compensation

[REDACTED]

(2) **Option Payment.**

[REDACTED]

[REDACTED]

(3) **Payment for Lease and Easements.**

[REDACTED]

[Redacted]

(4) Crop Compensation.

[Redacted]

(5) Timber Removal.

[Redacted]

[Redacted]

(6) Payment Allocation Schedule.

[Redacted]

[Redacted]

[Redacted]

SOLAR LEASE AND EASEMENT AGREEMENT

1. **Parties.** This Solar Lease and Easement Agreement ("**Agreement**") is made and entered as of the 5 day of August, 2020 ("**Effective Date**"), by and between Jarrod Griffin Crowder and Lauren Jennifer Crowder, husband and wife ("**Owner**") and Boulevard Associates, LLC, a Delaware limited liability company ("**Operator**"), which are sometimes individually referred to as a "**Party**" and collectively as the "**Parties**".

2. **Project.** This Agreement relates to the solar-powered electrical power generation and transmission project known as the "Sebree Solar Energy Center" to be located in Henderson County, Kentucky ("**Project**"), which may be wholly or partially located on the Owner's property legally described on the attached **Exhibit A** to this Agreement ("**Owner's Property**"). Upon Operator's exercise of the Option (as defined below), the Project shall include (i) the Lease of Owner's Property described in Section 4, (ii) the Easements referenced in Section 5 that are located on the Owner's Property, and (iii) the Improvements referenced in Section 8 to be constructed on Owner's Property. The Lease, Easements and Improvements are sometimes collectively referred to as the "**Operator Property**".

3. **Option.** Owner grants to Operator an exclusive option ("**Option**") to acquire the Lease and Easements referenced in Sections 4 and 5 in accordance with the following terms and conditions. Operator shall be entitled to acquire the Lease and the Easements in their entirety or in part, as Operator deems appropriate.

3.1 **Option Term.** The period during which Operator may exercise the Option shall be for a term of three (3) years, commencing on the Effective Date ("**Option Term**").

3.2 **Option Payment.** As consideration for the granting of the Option, Operator agrees to pay Owner the Option Payment set forth in **Exhibit D**.

3.3 **Use of Owner's Property.** During the Option Term, Operator and its employees, agents and contractors shall have a right to enter upon the Owner's Property and the right of ingress and egress over and across the Owner's Property for the purposes of (i) surveying the Owner's Property; (ii) performing such other tests and studies as Operator may desire in connection with the Option, including, without limitation, environmental, avian and cultural resource assessments, and geotechnical, foundation and soil tests, provided that such activities do not unreasonably interfere with Owner's use of the Owner's Property; and (iii) installing, maintaining, operating, inspecting and removing one or more weather related instruments ("**Weather Instrument**") and fencing of said Weather Instrument and including the performance of all tests and studies associated therewith. Owner shall not permit any other individual or entity except Operator or its affiliates to install a Weather Instrument on Owner's Property.

3.4 **Right to Grant Option.** Owner warrants and represents to Operator that (i) the statements in Section 9 concerning Owner's title to the Owner's Property are true and correct; (ii) Owner has the authority to grant this Option to Operator without the consent or approval of any other party; and (iii) there are no other existing options, rights of first refusal, contracts to

purchase, leases or mortgages that would prevent Operator from exercising its rights with respect to the Option.

3.5 **Exercise of Option.** Operator may exercise the Option by giving written notice to Owner ("**Option Notice**") at any time during the Option Term. Operator shall specify in the Option Notice the Commencement Date referenced in Section 6.1.1. On the Commencement Date, the Lease and Easements referenced in Sections 4 and 5 shall automatically become effective, and the Parties shall be subject to all of the terms and conditions of this Agreement with respect to such Lease and Easements and all rights and obligations relating thereto.

3.6 **Termination of Option.** If Operator fails to exercise the Option within the Option Term, the Option and the rights of Operator as the optionee shall automatically terminate.

4. **Lease.** Upon exercise of the Option by Operator, Owner leases to Operator, and Operator leases from Owner, Owner's Property for the Lease and Easement Term (defined in Section 6.1) in accordance with the terms and conditions of this Agreement ("**Lease**"), which Lease grants Operator and its agents, contractors, and employees the right to use the Owner's Property for the following permitted uses:

4.1 **Construction Right.** Operator leases Owner's Property for the purpose of constructing, operating, maintaining, repairing, replacing, and removing all or any part or component of the Improvements whether located on Owner's Property. Operator may exercise its right to use all or any part of the Owner's Property as and when Operator deems it necessary or advisable to do so to perform the activities for which this right is granted, including, without limitation, staging areas and parking for Operator's employees.

4.2 **Access Right.** Operator leases Owner's Property for unobstructed vehicular and pedestrian access and ingress to and egress from the Improvements, Owner's Property and any public roadways, and to construct, maintain, and utilize Roadway Improvements on the Owner's Property. Owner shall not permit others to obstruct or damage the roads or Roadway Improvements located on the Owner's Property or in any other way interfere with Operator's rights under this right. Operator shall repair any damage done to Roadway Improvements which result from use by Operator, its agents, servants or employees. Such roads shall be maintained in the condition necessary for use by Operator's equipment, and with regard to existing roads, shall be maintained in at least the condition that existed prior to Operator's use.

4.3 **Solar Panels Right.** Operator leases Owner's Property for Operator to construct, operate, replace, relocate, remove, and maintain Solar Panels and the appurtenant Collection Facilities, together with associated roads and parking areas on Owner's Property.

4.4 **Collection Facilities Right.** Operator leases Owner's Property for Operator to construct, operate, maintain, replace, relocate or remove Collection Facilities on and under the Owner's Property.

4.5 **Substation Right.** Operator leases Owner's Property for Operator to construct, operate, maintain, replace, relocate or remove one or more Substations on Owner's Property.

4.6 **Telecommunication Right.** Operator leases Owner's Property for Operator to construct, operate, maintain, replace, relocate or remove Telecommunication Facilities on and under the Owner's Property.

4.7 **Weather Instrument Right.** Operator leases Owner's Property in order to construct, operate, replace, relocate, remove, and maintain a Weather Instrument and the appurtenant Collection Facilities on Owner's Property.

4.8 **Battery Facilities Right.** Operator leases Owner's Property in order to construct, operate, replace, relocate, remove, and maintain one or more Battery Facilities on Owner's Property.

5. **Grant of Easements.** Upon the exercise of the Option by Operator, Owner grants to Operator, and Operator accepts from Owner, for the Lease and Easement Term referenced in Section 6.1, the following easements over and across the Owner's Property in accordance with the terms and conditions of this Agreement. The following easements are for the benefit of Operator and Operator's agents, contractors and employees and located on the Owner's Property and are collectively referred to as the "**Easements**".

5.1 **Sun Non-Obstruction Easement.** Owner grants Operator an irrevocable, exclusive easement for the right and privilege to use, maintain and capture the free and unobstructed sunlight over and across the Owner's Property. Owner shall not engage in any activity on Owner's Property or any other neighboring property owned by Owner that might interfere with the sunlight direction over any portion of Owner's Property; cause a decrease in the output or efficiency of any Solar Panel or Weather Instrument; or otherwise interfere with Operator's operation of the Project or exercise of any rights granted in this Agreement (collectively "**Interference**"). This grant of the easement expressly includes the right of Operator to enforce Operator's rights, including the physical removal of trees or structures (except existing trees and structures) causing Interference to the Project contemplated by Operator. Operator shall notify Owner before making any such removals.

5.2 **Effects Easement.** Owner grants to Operator an easement over Owner's Property for visual, view, light, flicker, noise, shadow, vibration, electromagnetic, electrical and radio frequency interference, and any other effects attributable to the Project located on the Owner's Property.

6. **Term.** The term of this Agreement ("**Term**") includes the Option Term referenced in Section 3.1, the Initial Lease and Easement Term as described in Section 6.1.1 and the Extended Lease and Easement Term as described in Section 6.1.2 (together, the Initial Lease and Easement Term and the Extended Lease and Easement Term, if applicable, is defined as the "**Lease and Easement Term**").

6.1 **Lease and Easement Term.**

6.1.1 **Initial Lease and Easement Term.** The initial term of the Lease and Easements shall commence on the date specified by Operator in the Option Notice ("**Commencement Date**"). The initial term of the Lease and Easements shall end thirty (30)

years after the Commencement Date (the "**Initial Lease and Easement Term**"), subject to the rights of renewal and termination as provided in this Agreement.

6.1.2 **Extended Lease and Easement Term.** Operator shall have the right to extend the Term of this Agreement for two consecutive terms of five (5) years each in accordance with the terms and provisions of this Agreement (collectively "**Extended Lease and Easement Term**") by providing written notice to Owner of Operator's intent to extend the Term within one hundred eighty (180) days of the end of the existing Term. Each Extended Lease and Easement Term shall begin on the expiration date of the Initial Lease and Easement Term or previous Extended Lease and Easement Term, as the case may be. During the Extended Lease and Easement Term, Operator shall pay Owner the amounts set forth in **Exhibit D** as the consideration for the Lease and Easements.

6.1.3 **Delays During Lease and Easement Term.** At Operator's option, the Term may be extended for a period of time equal to the period of time during which operation of the Project is delayed or suspended because of the occurrence of a Regulatory Suspension or Force Majeure, which are defined as follows:

(i) "**Regulatory Suspension**" shall mean the enactment or application of any law, order, rule, or regulation of the Kentucky Public Service Commission, Federal Energy Regulatory Commission, or other local, state, or federal government authority having jurisdiction over the Project or Operator, or the failure of any such governmental authority to issue an approval or permit pursuant to any such law, order, rule, or regulation, which results in the delay, interruption, or suspension of the production, sale or transmission of electricity from the Solar Panels; and

(ii) "**Force Majeure**" shall mean causes beyond the reasonable control of and without the fault or negligence of the Party claiming Force Majeure, including but not limited to acts of God, labor unrest (including, but not limited to, slowdowns, picketing, boycotts or strikes), flood, earthquake, storm, fire, lightning, explosion, power failure or power surge, vandalism, theft, the cutting of power, transmission or other lines, wires or cables to the Project by persons other than Operator's employees or contractors, epidemic, war, revolution, riot, civil disturbance, sabotage, change in law or applicable regulation subsequent to the Commencement Date and action or inaction by any federal, state or local legislative, executive, administrative judicial agency or body which in any of the foregoing cases, by exercise of due foresight such Party could not reasonably have expected to avoid, and which, by the exercise of due diligence, it is unable to overcome.

The Parties shall be excused from performing their respective obligations under this Agreement and shall not be liable in damages or otherwise if and to the extent that they are unable to so perform or are prevented from performing by a Force Majeure, provided that: (i) the non-performing Party, as promptly as practicable after the occurrence of the Force Majeure, but in no event later than thirty (30) days thereafter, gives the other Party written notice describing the particulars of the occurrence; (ii) the suspension of performance is of no greater scope and of no longer duration than is reasonably required by the Force Majeure; (iii) the non-performing Party uses good faith and commercially reasonable efforts to remedy its inability to perform; and (iv) as soon as the non-performing Party is able to resume performance of its obligations excused as a

result of the occurrence, each Party shall give prompt written notification thereof to the other Party.

6.2 **Termination by Operator.** Provided Operator is not in default under any term of this Agreement, Operator, at its option, shall have the right to terminate this Agreement at any time during the Term of the Agreement, as to all or any part of the Operator Property. Termination shall be effective thirty (30) days after written notice of such termination to Owner. If Operator's notice is a full termination of the Operator Property, the Parties shall be relieved of all further duties and obligations under this Agreement, other than (i) the payment of any accrued and unpaid obligations owed by either Party as of the date of termination; (ii) the removal of the Improvements by Operator pursuant to Section 8.11; and (iii) any other obligations and liabilities that are expressly stated in this Agreement to survive such termination. Upon any such partial termination by Operator, the Parties shall be relieved of all further duties and obligations under this Agreement with respect to the portion thereof terminated by Operator, subject to the obligations and liabilities referenced in items (i) through (iii) above that shall continue to be applicable to the terminated portion of this Agreement. The Parties agree to execute an amendment to this Agreement evidencing such partial termination.

7. **Payments.** If Operator exercises the Option referenced in Section 3, Operator agrees to pay Owner the amounts set forth in **Exhibit D** as consideration for the Lease, Easements and Operator's other rights and interests in the Owner's Property.

8. **Improvements.** Operator shall have the right, at its sole cost and expense, to construct, install, maintain, use, operate, repair, replace, relocate and remove all facilities, structures, equipment, machinery, wires, conduit, cables, poles, materials and property of every kind and character required for the construction and operation of portions of the Project on the Owner's Property, including, but not limited to, the Solar Panels, Collection Facilities, Substations, Telecommunication Facilities, Weather Instruments, Roadway Improvements and Battery Facilities referenced in Sections 8.1 through 8.7 (collectively, the "**Improvements**").

8.1 "**Solar Panels**" shall mean any photovoltaic energy system designed for the generation of electrical power from the collection of sunlight, including without limitation, the photovoltaic panels, foundations, support structures, braces and related equipment.

8.2 "**Collection Facilities**" shall mean all Improvements whose purpose is to deliver electrical power generated by the Solar Panels to an electrical power grid or other system, including without limitation transformers, overhead and underground electrical collection lines, telecommunication lines, splice boxes and interconnection facilities.

8.3 "**Substations**" shall mean electrical lines, meters, monitoring and control equipment, switches, transformers, all structures, equipment, enclosures, fencing, security devices, and other electrical and communications equipment necessary to condition and increase the voltage of electricity generated by the Project to make it suitable for transmission on, and to deliver it to, Collection Facilities connected to an electric power grid or other system.

8.4 "**Telecommunication Facilities**" shall mean all Improvements whose purpose is to provide telecommunication services solely relating to the Project or any of Operator's solar

powered projects, including telephone, closed-circuit television, microwave, internet, computer data and other telecommunication services.

8.5 "**Weather Instrument**" shall mean instruments used primarily to gather and transmit sunlight and meteorological data relating to the Project, and includes the instrument's foundations, guy wires, sunlight and meteorological data acquisition equipment, power source, and any required data and electrical transmission lines.

8.6 "**Roadway Improvements**" shall mean all improvements that may be necessary to construct, maintain and repair any new and existing roadways and other means of ingress and egress over, across and along the Owner's Property, including paving or surfacing of the roadways with asphalt, gravel or other roadway materials, installation of road signs and the construction and installation of culverts, bridges, drainage ditches, gates, cattle guards and similar structures and facilities.

8.7 "**Battery Facilities**" shall mean a type of equipment that can be given a new charge by passing an electric current through it designed for the storage of electrical power including without limitation, batteries and other devices for storage of electrical energy, foundations, support structures, braces and related equipment.

8.8 "**Ownership of Improvements**." Except as otherwise provided in Section 11.7, all Improvements shall at all times remain the property of Operator, and Owner shall have no right, title or interest therein. All Improvements constructed or placed on the Owner's Property by Operator during the Term of this Agreement may be repaired, replaced, relocated, removed, added to or expanded upon by Operator at any time during the Term of this Agreement. Owner expressly waives any statutory lien or common law liens on the Improvements to which Owner might be entitled.

8.9 "**Construction Liens**." Operator shall not permit any liens arising out of Operator's use of the Operator Property under this Agreement to be filed against the Owner's Property. Operator shall, within sixty (60) days after it receives notice of the lien, provide a bond or other security that Owner may reasonably request, or remove such lien from the Owner's Property in the manner provided by applicable law.

8.10 "**Location of Improvements**." The acreage required from the Owner's Property for the Improvements for which the Lease and Easements are being granted cannot be determined until the completion of Operator's inspection, testing, study and surveying of the Owner's Property during the Option Term. Along with the Option Notice, Operator shall deliver to Owner a proposed plan of development showing the contemplated locations of the Improvements and a preliminary calculation of the acreage as determined by the area bounded by a perimeter fence required for the Project, which shall serve as the **Exhibit B** to this Agreement. During the final development and construction of the Project, such locations may need to be amended. Following construction of the Project, Operator shall provide Owner an "as-built" survey of all Improvements on Owner's Property and the final calculation of the acreage as determined by the area bounded by a perimeter fence required for the Project, which shall serve as **Exhibit C** to this Agreement. Further, following construction, the Improvements may need to be relocated or rerouted by Operator, which Operator may perform, at any time during the Term of this

Agreement, so long as the nature and extent of any such relocated or rerouted Improvements are not materially different and impose no materially greater burden on the Owner's Property than the original locations or routes, and so long as Operator takes commercially reasonable efforts to minimize disruption or inconvenience to Owner.

8.11 **Removal of Improvements.** Upon full or partial termination of any of the Lease Rights or Easements, Operator shall remove all Improvements and restore the area formerly occupied by the Improvements to substantially the same physical condition that existed immediately before the construction of the Improvements (the "**Removal Obligations**"). At Owner's request, all or any part of the Roadway Improvements may be left for use by Owner.

9. **Ownership and Title Matters.** Owner warrants and represents to Operator, both as of the Effective Date, and as of the Commencement Date as follows:

9.1 **Authority.** Owner represents and warrants that it is the holder of fee simple title and is the sole owner of the Owner's Property and has the unrestricted right and authority to sign this Agreement and to grant Operator the Lease and Easements and other rights granted in this Agreement. When signed by both Parties, this Agreement constitutes a valid and binding agreement enforceable against Owner in accordance with its terms.

9.2 **Other Agreements.** The Owner's Property is not subject to any other agreements, options, rights of first refusal or other prior right of any party to purchase, lease or acquire easements in the Owner's Property, or create any prior claim or right that would preclude or interfere with Operator's rights and interests under this Agreement and the Lease and Easements.

9.3 **Minerals.** Except as disclosed by Owner to Operator at the time of the execution of this Agreement by Owner, Owner owns all of the oil, gas and other minerals, and all rights thereto as on or under the Owner's Property.

9.4 **Owner Mortgage.** Except as disclosed by Owner to Operator at the time of the execution of this Agreement by Owner, there are no mortgages encumbering the Owner's Property ("**Owner Mortgage**").

9.5 **Notice and Opportunity to Cure.** If there is an Owner Mortgage encumbering Owner's Property and Owner receives from the holder thereof any notice that payments are overdue, Owner shall notify Operator and each Operator Mortgagee (as defined at Section 13.1) by sending a copy of such overdue payment notice to Operator by the earlier of (i) five (5) days after receipt, or (ii) three (3) business days prior to the date by which a default under or in respect of such Owner Mortgage could occur. If Operator or any Operator Mortgagee determines that it would be in Operator's interest to make such payments to Owner Mortgagee on Owner's behalf, whether as a result of receiving such notice or otherwise, Operator shall have the right to make such payments and to credit the payments so made against the Annual Installment Payment next due under the Agreement.

9.6 **Subordination, Non-Disturbance & Attornment Agreement.** If there is an Owner Mortgage encumbering Owner's Property, Owner shall cooperate with Operator to obtain

a Subordination, Non-Disturbance and Attornment Agreement ("SNDA") in the form prepared and provided by Operator, from each Owner Mortgagee, pursuant to which such Owner Mortgagee agrees, among other things, not to disturb Operator's possession and use of the Owner's Property. Owner shall not incur any loss in income, expense, obligation or liability with regard to the SNDA. Operator shall, at its sole cost and expense, record each such SNDA in the Office of the County Clerk in which Owner's Property is located. If Owner fails to deliver a SNDA from each Owner Mortgagee, Operator may, at its sole option, either (i) terminate this Agreement immediately upon written notice to Owner, or (ii) take such action as Operator deems reasonably necessary to effect the rights granted to Operator hereunder, and off-set all amounts expended in such efforts against the Annual Installment Payments and any other amounts due hereunder or in respect hereof.

10. **Representations and Warranties of Owner.** Owner hereby makes the following further representations and warranties both as of the Effective Date, and as of the Commencement Date:

10.1 **Physical Condition.** Owner has no knowledge of any existing physical conditions of the Owner's Property which would prevent, significantly restrict or make more expensive Operator's development of the Owner's Property for the purposes specified in this Agreement, or which could, with the passage of time, or the giving of notice, constitute a violation of any currently applicable governmental law, ordinance, order, rule or regulation.

10.2 **Legal Restrictions.** Owner has no knowledge of any law, regulation, ordinance or order of any local, state or federal governmental authority which would prohibit or significantly restrict Operator's development of the Owner's Property pursuant to this Agreement. This Agreement does not violate any contract, agreement, instrument, judgment or order to which Owner is a party or which affects the Owner's Property. To the best of Owner's knowledge, the Owner's Property is currently in full and complete compliance with all governmental laws, ordinances, orders, rules and regulations applicable to the Owner's Property.

10.3 **No Litigation.** No litigation is pending and, to the best of Owner's knowledge, no litigation or administrative actions are proposed, threatened or anticipated with respect to any matter affecting the Owner's Property. If Owner learns of any litigation or administrative action proposed, threatened or instituted with respect to the Owner's Property, Owner shall give Operator notice within thirty (30) days thereof.

10.4 **Survival.** The representations and warranties set forth in this Section 10 shall survive the execution and delivery hereof.

11. **Use, Operation and Maintenance.**

11.1 **Exclusive Use by Operator.** Operator shall have the exclusive right (i) to use and possess the Owner Property in connection with the Project and other similar solar-powered electrical power generation projects; (ii) to investigate, inspect, survey, and conduct tests of the Owner's Property, including, but not limited to, meteorological, environmental, archeological and geotechnical tests and studies; (iii) to use and convert all of the sunlight resources on the Owner's Property; and (iv) to undertake such other activities on the Owner's Property that may be related to the Project, including, without limitation, the storage of Solar Panels, materials and

equipment during the installation and construction of the Improvements; development and operation of communications systems; and site tours of the Project for visitors and other interested parties.

11.2 **No Required Installation or Operation.** Nothing in this Agreement shall be interpreted as imposing on Operator any obligation to install Solar Panels or other Improvements on the Owner's Property, or to operate the Project on the Owner's Property. Operator shall have the sole discretion to determine if and when any Solar Panels and other Improvements may be constructed on Owner's Property, and if and when to commence the operation of the Project on the Owner's Property.

11.3 **Permits and Approvals.** Operator shall be responsible, at its sole cost and expense, for obtaining any governmental permits and approvals necessary for the construction and operation of the Project and the construction and operation of the Improvements. Owner shall cooperate with Operator as necessary to obtain any governmental or utility approvals or permits, including, without limitation, signing any applications for such approvals, provided that Owner shall not incur any loss in income, expense, obligation or liability with respect to Operator obtaining such permits or approvals.

11.4 **Compliance with Laws.** Operator shall comply in all material respects with valid laws applicable to the Owner's Property and the Operator Property. Operator shall have the right, in its sole discretion and at its sole expense, in Operator's name to contest the validity or applicability to the Owner's Property and the Operator Property of any law, ordinance, statute, order, regulation, property assessment or the like made by any governmental agency or entity. Operator shall control any such contest and Owner shall cooperate with Operator in every reasonable way in such contest, provided that Owner shall incur no expense, obligation or liability with regard to such contest.

11.5 **Care and Appearance.** Operator, in its exercise of the lease, easement and other rights granted hereunder shall, at all times, maintain the Owner's Property and the Improvements in a reasonably neat, clean and presentable condition. Operator shall not willfully or negligently damage or destroy the Owner's Property and shall keep the Owner's Property clean and free of debris created by Operator, its contractors, or others brought on to the Owner's Property by Operator. Operator shall not use the Owner's Property for storage, except for materials, construction equipment and vehicles directly associated with construction or maintenance of the Improvements on the Owner's Property or adjacent properties that are part of the Project.

11.6 **Fences and Gates.** At Owner's request, Operator shall repair or replace any fences, gates or cattle guards damaged or removed in connection with Operator's activities on the Owner's Property. Fences removed from the Owner's Property, if replaced, shall be re-built by Operator at its expense in mutually agreeable locations. All fence repair and construction shall be substantially similar to the construction of existing fences and cattle guards on Owner's Property. Any gates opened for access to Owner's Property by either Party shall be closed immediately after passing through so that livestock may not pass through. Once completed, all replacement fences, gates and cattle guards shall be owned and maintained by Owner. Upon abandonment or termination of the rights granted to Operator in this Agreement, any fences, gates and cattle guards installed by Operator shall remain and become the property of Owner.

To minimize the need for temporary fencing, Owner will cooperate with Operator to avoid pasturing animals on or near the Improvements during periods of construction, maintenance or removal activity by Operator. Owner will discuss with Operator what temporary fencing is necessary during the periods of construction, maintenance or removal activity by Operator.

11.7 **Roadway Maintenance and Repairs.** Operator agrees to maintain and repair all Roadway Improvements located on the Operator Property; provided, however, Owner shall reimburse Operator for any costs and expenses incurred by Operator to repair any damage or perform any special maintenance of the Roadway Improvements caused by Owner or any person using the Roadway Improvements with Owner's permission, other than Operator.

12. **Taxes.**

12.1 **Owner's Taxes.** Owner covenants and agrees to pay prior to delinquency all real and personal property and other taxes, general and special assessments, and other charges of every description ("**Taxes**") levied or assessed against the Owner's Property and all improvements thereon by governmental authorities, other than Operator's Taxes referenced in Section 12.2 (Taxes, excepting Operator's Taxes, are hereinafter referred to as "**Owner's Taxes**").

12.2 **Operator's Taxes.** 



12.3 **Failure to Pay.** In the event either Party fails to pay their share of Taxes prior to delinquency, the other Party shall have the right to pay such Taxes and any accrued penalties or interest, which payments shall increase or be offset against other Payments due under this Agreement.

12.4 **Operator's Right to Contest.** Operator may contest the legal validity or amount of any Operator's Taxes for which it is responsible under this Agreement, and may institute such proceedings as it considers necessary, provided that Operator shall bear all expenses in pursuing such contest or proceeding. With respect to any Taxes which may constitute a lien on the Owner's Property, Operator shall promptly pay such Taxes unless the proceeding in which it

contests such Taxes shall operate to prevent or stay the collection of the Taxes so contested or unless Operator removes any such lien by bonding or otherwise. Owner agrees to render to Operator all reasonable assistance in contesting the validity or amount of any such Taxes, with the exception of Taxes levied by Owner, including joining in the signing of any reasonable protests or pleading which Operator may deem advisable to file; provided, however, that Operator shall reimburse Owner for its reasonable out-of-pocket expenses, including reasonable attorneys' fees incurred in connection with providing such assistance.

13. **Mortgage of Operator Property.**

13.1 **Right to Mortgage.** Operator may, upon written notice to Owner, but without requiring Owner's consent or approval, mortgage, collaterally assign, or otherwise encumber and grant security interests in all or any part of its interest in this Agreement and the Operator Property. These various security interests in all or a part of this Agreement and the Operator Property are collectively referred to as an "**Operator Mortgage**" and holder of such security interest, an "**Operator Mortgagee**". Any Operator Mortgagee shall use the Operator Property only for the uses permitted under this Agreement. Whenever Operator has granted a security interest under this Section 13, it will give Owner notice of the Operator Mortgage (including the name and address of the Operator Mortgagee for notice purposes) to Owner within thirty (30) days; provided that failure to give this notice shall not constitute a default under this Agreement, but rather shall only have the effect of not binding Owner to provide such Operator Mortgage notice until the Operator and its address is given to Owner.

13.2 **Notice of Default and Opportunity to Cure.** As a precondition to exercising any rights or remedies related to any alleged default by Operator under this Agreement, Owner shall give written notice of the default to each Operator Mortgagee at the same time it delivers notice of default to Operator, specifying in detail the alleged event of default and the required remedy. Each Operator Mortgagee or its designee shall have the right, but not the obligation, to cure any default as Operator, and/or the right, but not the obligation, to remove any Improvements or other property owned by Operator or such Operator Mortgagee located on the Owner's Property to the same extent as Operator. The cure period for any Operator Mortgagee shall be the later of (i) the end of the Operator cure period under Section 18; (ii) thirty (30) days after such Operator Mortgagee's receipt of the default notice; or (iii) if applicable, the extended cure period provided for in Section 13.3. Failure by Owner to give an Operator Mortgagee notice of default shall not diminish Owner's rights against Operator, but shall preserve all rights of the Operator Mortgagee or its designee to cure any default and to remove any Improvements or other property of Operator or the Operator Mortgagee located on the Owner's Property.

13.3 **Extended Cure Period.** If any default by Operator under this Agreement cannot be cured without the Operator Mortgagee obtaining possession of all or part of the Operator Property, then any such default shall be deemed remedied if an Operator Mortgagee: (i) within sixty (60) days after receiving notice from Owner as set forth in Section 13.2, acquires possession of all or part of the Operator Property, or begins appropriate judicial or nonjudicial proceedings to obtain the same; (ii) diligently prosecutes any such proceedings to completion; and (iii) after gaining possession of all or part of the Operator Property performs all other obligations as and when the same are due in accordance with the terms of this Agreement. If an Operator Mortgagee is prohibited by any court or by operation of any bankruptcy or insolvency

laws from commencing or prosecuting the proceedings described above, the sixty (60) day period specified above for commencing proceedings shall be extended for the period of such prohibition.

13.4 **Operator Mortgagee Liability.** Any Operator Mortgagee whose interest in the Operator Property is held solely for security purposes, shall have no obligation or liability under this Agreement unless and until the Operator Mortgagee succeeds to absolute title to the Operator Property and the rights of Operator under this Agreement. An Operator Mortgagee shall be liable to perform obligations under this Agreement only for and during the period it directly holds such absolute title.

13.5 **Certificates.** Owner shall execute any estoppel certificates (certifying as to truthful matters, including without limitation that no default then exists under this Agreement, if such be the case), consents to assignment and non-disturbance agreements as Operator or any Mortgagee may reasonably request from time to time. The Parties shall negotiate in good faith any amendment to this Agreement from time to time to include any provision that may be reasonably requested by Operator or any Operator Mortgagee to implement the provisions contained in this Agreement or to preserve an Operator Mortgagee's security interest.

13.6 **Operator Mortgagee's Right to Enforce Mortgage and Assign.** Each Operator Mortgagee shall have the right, in its sole discretion: (i) to assign its Operator Mortgage; (ii) to enforce its lien and acquire title to all or any portion of the Operator Property by any lawful means; (iii) to take possession of and operate all or any portion of the Operator Property and to perform all obligations to be performed by Operator under this Agreement, or to cause a receiver to be appointed to do so; and (iv) to acquire all or any portion of the Operator Property by foreclosure or by an assignment in lieu of foreclosure and thereafter to assign or transfer all or any portion of the Operator rights under this Agreement to a third party in accordance with Section 14. Any Operator Mortgagee or other party who acquires Operator's interest in all or a portion of the Operator Property pursuant to foreclosure or assignment in lieu of foreclosure shall not be liable to perform the obligations imposed on Operator by this Agreement, which are incurred or accruing after such Operator Mortgagee or other party no longer has ownership or possession of the Operator Property.

13.7 **New Agreement.**

13.7.1 If the Operator Property is foreclosed upon or there is an assignment in lieu of foreclosure, or if this Agreement is rejected or disaffirmed pursuant to bankruptcy law or other law affecting creditor's rights and, within ninety (90) days after such event, Operator or any Operator Mortgagee or other purchaser at a foreclosure sale shall have arranged to the reasonable satisfaction of Owner to cure any material defaults under this Agreement, and for the payment of all Annual Installment Payments or other charges due and payable by Operator as of the date of such event, then Owner shall execute and deliver to Operator or such Operator Mortgagee or other purchaser at a foreclosure sale, or to a designee of one of these parties, as the case may be, a new agreement ("**New Agreement**") which (i) shall be for a term equal to the remainder of the Term of this Agreement before giving effect to such rejection or termination; (ii) shall contain the same covenants, agreements, terms, provisions and limitations as this Agreement (except for any requirements that have been fulfilled by Operator or any Operator

Mortgagee or other purchaser at a foreclosure sale prior to rejection or termination of this Agreement); and (iii) shall include that portion of the Operator Property in which Operator or such other Operator Mortgagee or other purchaser at a foreclosure sale had an interest on the date of rejection or termination.

13.7.2 If more than one Operator Mortgagee makes a written request for a New Agreement pursuant to this provision, the New Agreement shall be delivered to the Operator Mortgagee requesting such New Agreement whose Operator Mortgage is prior in time, and the written request of any other Operator Mortgagee whose lien is subordinate shall be void and of no further force or effect. The provisions of this Section 13 shall survive the termination, rejection or disaffirmation of this Agreement and shall continue in full force and effect thereafter to the same extent as if this Section 13 were a separate and independent contract made by Owner, Operator and each Operator Mortgagee, and, from the effective date of such termination, rejection or disaffirmation of this Agreement to the date of execution and delivery of such New Agreement, such Operator Mortgagee or other purchaser at a foreclosure sale may use and enjoy the Operator Property without hindrance by Owner or any person claiming by, through or under Owner; provided that all of the conditions for the New Agreement as set forth above are complied with.

13.8 **Operator Mortgagee's Consent to Amendment, Termination or Surrender.** Notwithstanding any provision of this Agreement to the contrary, the Parties agree that so long as any Operator Mortgage remains outstanding, this Agreement shall not be modified or amended, and Owner shall not accept a surrender, cancellation or release of all or any part of the Operator Property from Operator, prior to expiration of the Term of this Agreement, without the prior written consent of the Operator Mortgagee holding such Operator Mortgage. This provision is for the express benefit of and shall be enforceable by each Operator Mortgagee as if it were a party named in this Agreement.

14. **Assignment and Sublease.** Operator shall have the right, without Owner's consent, to sell, convey, lease, or assign all or any portion of this Agreement or the Operator Property, on either an exclusive or a non-exclusive basis, or to grant subleases, co-leases, easements, licenses or similar rights with respect to the Operator Property (collectively, "**Assignment**"), to one or more persons or entities (collectively "**Assignee**"). Each Assignee shall use the Operator Property only for the uses permitted under this Agreement. When Operator makes any Assignment under this Section 14, Operator shall give written notice to Owner of such Assignment (including the interest conveyed by the Assignment and address of the Assignee for notice purposes) to Owner; provided Operator's failure to give such notice shall not constitute a default under this Agreement, but rather shall only have the effect of not binding Owner with respect to such assignment or conveyance until such notice is given. Any Assignment by Operator shall release Operator from obligations subject thereof accruing after the date that liability for such obligations is assumed by the Assignee.

15. **Hazardous Materials.**

15.1 **Owner's Covenants Regarding Hazardous Materials.** Owner represents and warrants that, to the best of Owner's knowledge, the Owner's Property is not and has not been in

violation of any federal, state or local environmental health or safety laws, statute, ordinance, rule, regulation or requirement ("**Environmental Laws**"), and Owner has not received any notice or other communication from any governmental authorities alleging that the Owner's Property is in violation of any Environmental Laws. "**Hazardous Materials**" shall mean any asbestos containing materials, petroleum, explosives, toxic materials, or substances regulated as hazardous wastes, hazardous materials, hazardous substances, or toxic substances under any federal, state, or local law or regulation. Owner warrants that Owner has done nothing to contaminate the Operator Property with Hazardous Materials or wastes.

15.2 **Operator's Covenants Regarding Hazardous Materials.** Operator shall, at Operator's sole cost and expense, promptly take removal or remedial action required by Environmental Law with regard to any material violation of any Environmental Law with regard to any Hazardous Materials brought onto the Owner's Property by Operator or its employees, agents, or contractors. Owner shall cooperate with Operator with regard to any scheduling or access to the Owner's Property in connection with any action required hereunder.

15.3 **Operator's Indemnity Regarding Hazardous Materials.** Operator shall indemnify, defend, protect and hold Owner harmless from any liability based on: (i) the release of Hazardous Materials in, on, under or about the Owner's Property caused by Operator or its employees, agents, or contractors, or (ii) the violation by Operator or its employees, agents, or contractors of any Environmental Law. The indemnity obligations set forth herein shall survive termination of this Agreement.

16. **Insurance and Indemnity.**

16.1 **Insurance.** At all times during which Operator is conducting any activities on the Property and at all times during the Term of this Agreement, Operator shall maintain in effect (1) commercial General Liability Insurance, including bodily injury and property damage coverage with minimum limits of \$1 Million Dollars per occurrence and \$2 Million Dollars aggregate and (2) Umbrella Liability Insurance with minimum limits of \$5 Million Dollars per occurrence and \$5 Million Dollars aggregate. Upon a written request by Owner, Operator shall name Owner as additional insured on such insurance policy and provide Owner with a certificate of such insurance.

16.2 **Indemnity by Operator.** Operator shall defend, indemnify, protect and hold Owner harmless from and against all liabilities, costs, expenses, obligations, losses, damages, claims, (collectively "**Claims**") resulting from the negligence, willful misconduct, or breach of this Agreement by Operator, its agents, contractors or employees, invitees, licensees and permittees; provided, however, that such Claims are not due to the sole negligence, willful misconduct, or breach by Owner, its agents, contractors or employees, invitees, licensees or permittees.

16.3 **Indemnity by Owner.** Owner shall defend, indemnify, protect, and hold Operator harmless from and against all Claims resulting from the negligence, willful misconduct, or breach of this Agreement by Owner, its agents, contractors or employees, invitees, licensees and permittees; provided, however, that such Claims are not due to the sole negligence, willful

misconduct, or breach by Operator, its agents, contractors, employees, invitees, licensees, or permittees.

16.4 **Survival.** The obligations of the Parties under this Section 16 shall survive expiration or other termination of this Agreement.

17. **Confidentiality.** This Agreement includes confidential and proprietary information relating to Operator and the Project. Owner agrees not to provide copies of the Agreement or disclose the terms of the Agreement to any unauthorized person or entity. Operator authorizes Owner to provide copies of the Agreement and disclose the terms thereof to Owner's family ("family" shall be deemed to include all devisees or descendants of owner by will or intestacy), attorney, accountant, financial advisor and any existing or prospective mortgagee, lessee, or purchaser for the sole purpose of evaluating and advising Owner and for no other purpose, so long as such authorized parties agree in writing to become subject to the confidentiality provisions hereto and not to provide copies of the Agreement or disclose the terms thereof to any unauthorized person or entity. Any Owner and party shall return all material containing any confidential information to Operator immediately upon its request. Any party agrees to destroy immediately upon request by Operator such analyses, compilation, studies or other documents, and any oral information will continue to be subject to the terms of this Agreement. Owner agrees that Operator will have no adequate remedy at law if any party violates any of the terms of this Agreement. In such event Operator will have the right, in addition to any other rights Operator may have, to obtain injunctive relief to restrain any breach or threatened breach by third party or specific enforcement of such terms plus reimbursement of attorneys' fees, court costs and all associated expenses. No party shall publish, file for public record, reproduce, or otherwise disseminate this document or any of the terms and provisions hereof to any party, other than the Parties set forth above without the prior written consent of Operator, which consent may be withheld for any reason and in Operator's sole discretion.

18. **Default and Remedies.**

18.1 **Operator Payment Default.**

[REDACTED]

18.1.1 **Collection of Payments.**

[REDACTED]

18.1.2 **Terminate Agreement.**

[REDACTED]

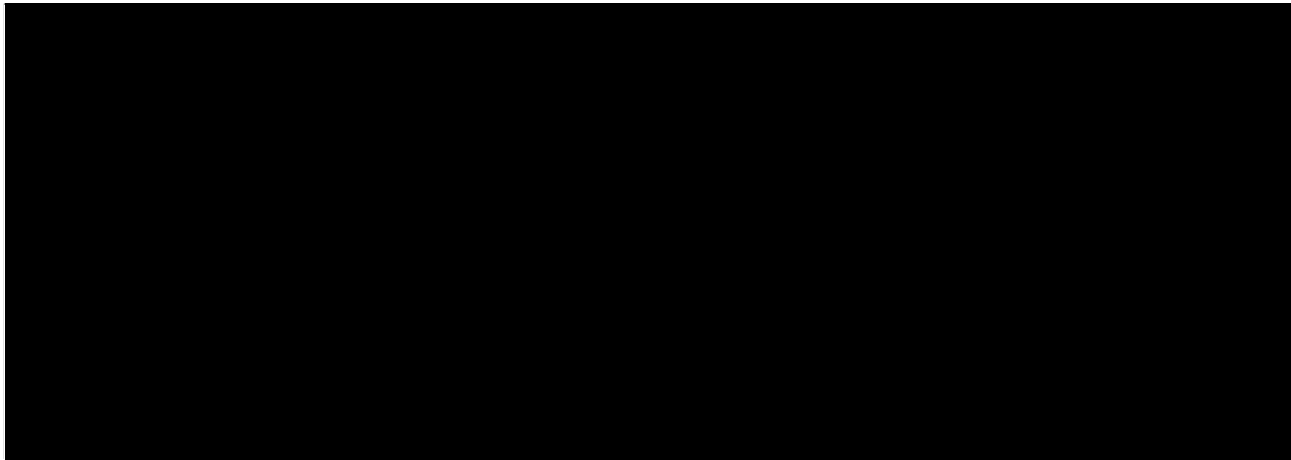

18.2 Other Operator Default.

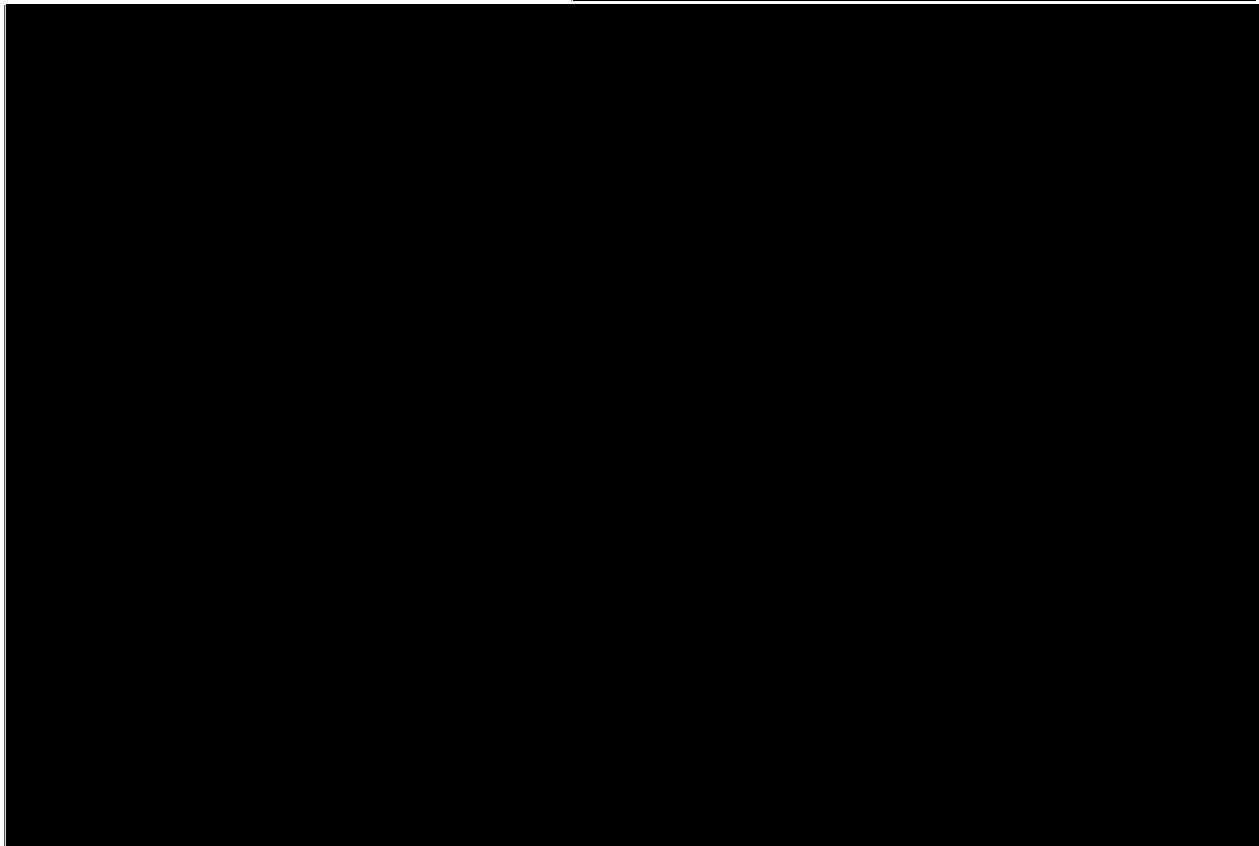

18.3 Owner Default.

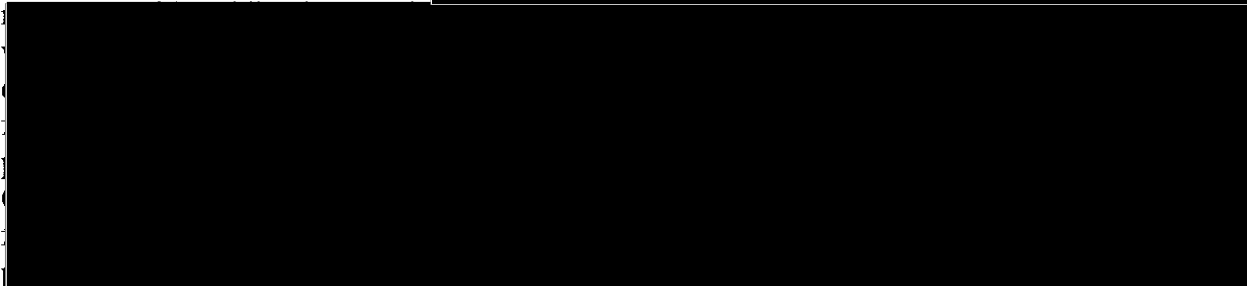

19. **Condemnation.**

19.1 **Complete Taking.** If, at any time, any authority having the power of eminent domain shall condemn all or substantially all of the Operator's Property, or all of the Improvements thereon, for any public use or otherwise, then the interests and obligations of Operator under this Agreement in or affecting the Operator's Property shall cease and terminate upon the earlier of (i) the date that the condemning authority takes physical possession of the Operator's Property or the Improvements thereon, (ii) the date that Operator is, in its sole judgment, no longer able or permitted to operate the Project on the Operator's Property in a commercially viable manner, or (iii) the date of the condemnation judgment. Operator shall continue to pay all amounts payable hereunder to Owner until the earlier of such dates, at which time the Parties shall be relieved of any and all further obligations and conditions to each other under this Agreement.

19.2 **Partial Taking.** If, at any time during the term of this Agreement, any authority having the power of eminent domain shall condemn one or more, but not all, of the Solar Panels, or any portion of the Improvements or the Operator's Property, then the interest and obligations of Operator under this Agreement as to those Solar Panels or any portion of the Improvements or the Operator's Property so taken shall cease and terminate upon the earlier of (i) the date that the condemning authority takes possession of such Solar Panels or any portion of the Improvements or the Operator's Property, (ii) the date that Operator is, in its reasonable judgment, no longer able or permitted to operate the Project on the Operator's Property, or any portion thereof, in a commercially viable manner, or (iii) the date of the condemnation judgment; and, unless this Agreement is terminated as hereinafter provided, this Agreement shall continue in full force and effect as to the remainder of the Solar Panels, Improvements and the Operator's Property. If the remainder of the Solar Panels or any other portion of the Improvements or the Operator's Property is or becomes insufficient or unsuitable for Operator's purposes hereunder, as determined by Operator in its sole discretion, then, subject to the rights of any Operator Mortgagee under Section 13, Operator shall have the right to terminate this Agreement as to the portion of the Operator's Property to which Operator continues to hold the rights, at which time the Parties shall be relieved of any further obligations and duties to each other under this Agreement.

19.3 **Apportionment, Distribution of Award.** On any taking, all sums awarded, including damages and interest, shall be paid as follows:

(a) Any portion of the award by the court on account of any cost or loss that Operator may sustain in the removal and relocation of Operator's Improvements, to Operator;

(b) Any portion of the award by the court for Operator's anticipated or lost revenues or profits, to Operator;

(c) Any portion of the award by the court for Owner's lost revenues, to Owner;

(d) All remaining amounts of the award, to Owner or Operator consistent with applicable Kentucky law.

20. **Notice.**

20.1 **Writing.** All notices given or permitted to be given hereunder shall be in writing.

20.2 **Delivery.** Notice is considered given either (i) when delivered in person to the recipient named below, (ii) upon receipt after deposit in the United States mail in a sealed envelope or container, postage and postal charges prepaid, return receipt requested or certified mail, addressed by name and address to the party or person intended, or (iii) twenty-four (24) hours from proper and timely delivery to an overnight courier service addressed by name and address to the party or person intended as follows:

Notice to Owner: Jarrod Griffin Crowder and Lauren Jennifer Crowder
3136 Sand Castle Drive
Henderson, KY 42420

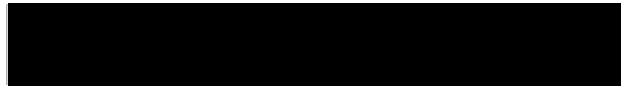

Notice to Operator: Boulevard Associates, LLC
700 Universe Blvd
Juno Beach, FL 33408



20.3 **Change of Recipient or Address.** Either Party may, by notice given at any time or from time to time, require subsequent notices to be given to another individual person, whether a party or an officer or representative, or to a different address, or both. Notices given before actual receipt or notice of change shall not be invalidated by the change.

21. **Miscellaneous Provisions.**

21.1 **Successors and Assigns.** The terms and provisions of this Agreement shall run with the land and be binding on and inure to the benefit of the heirs, successors, assigns and personal representatives of the Parties. In accordance with this Agreement, Operator in its discretion may authorize other persons or entities to use the Operator Property for the purposes stated in this Agreement

21.2 **Memorandum.** Simultaneously with the execution of this Agreement, the Parties agree to execute and acknowledge a memorandum of this Agreement. Operator may record the executed memorandum in the public records of Henderson County, Kentucky.

21.3 **Entire Agreement.** This Agreement and the attached Exhibits shall constitute the entire agreement between the Parties and supersedes all other prior writings and understandings.

21.4 **Amendments.** This Agreement shall not be amended or modified in any way except by an instrument signed by the Parties and consented to by any Operator Mortgagee. The Parties hereto shall at all times hereafter execute any documents and do any further acts which may be necessary or desirable to carry out the purposes of this Agreement and to give full force and effect to each and all of the provisions hereof.

21.5 **Legal Matters.** This Agreement shall be governed by and interpreted in accordance with the then existing laws of the Commonwealth of Kentucky and the County where the Owner's Property is located shall be considered the proper forum or jurisdiction for any disputes arising in connection with this Agreement. The Parties agree to first attempt to settle any dispute arising out of or in connection with this Agreement by good-faith negotiation. If the Parties are unable to resolve amicably any dispute arising out of or in connection with this Agreement, each shall have all remedies available at law or in equity and as provided by this Agreement. **Each Party waives all right to trial by jury and specifically agrees that trial of suits or causes of action arising out of this Agreement shall be to the court of competent jurisdiction.**

21.6 **Severability.** If any term or provision of this Agreement, or the application thereof to any person or circumstance shall, to any extent, be determined by judicial order or decision to be invalid or unenforceable, the remainder of this Agreement or the application of such term or provision to persons or circumstances other than those as to which it is held to be invalid, shall be enforced to the fullest extent permitted by law.

21.7 **Tax Credits.** If under applicable law Operator becomes ineligible for any currently existing tax credit, benefit or incentive for alternative energy expenditure established by any local, state or federal government, then, at Operator's option, the Parties shall negotiate in good faith to amend this Agreement or replace it with a different instrument so as to convert Operator's interest in the Operator Property to a substantially similar interest that makes Operator eligible for such tax credit, benefit or incentive. Such amendment or instrument shall not impair any of Owner's rights or increase the burdens or obligations of Owner under this Agreement.

21.8 **Approvals.** Whenever in this Agreement the approval or consent of either Party is required or contemplated, unless otherwise specified, such approval or consent shall not be unreasonably withheld or delayed.

21.9 **Authority.** The signatories hereto warrant that each has the authority to execute this Agreement on behalf of any entities which are Parties to this Agreement and that each such entity has executed this Agreement pursuant to its organizational documents or a resolution or consent of their Board of Directors or other governing body.

21.10 **Time of Essence.** Time is of the essence of each provision of this Agreement.

21.11 **Counterparts.** This Agreement may be executed in multiple counterparts, each of which shall be deemed an original, and all of which together shall constitute a single instrument.

Owner:

Jarrod Griffin Crowder

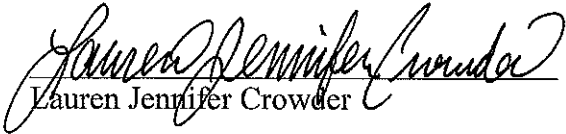
Lauren Jennifer Crowder

Operator:

Boulevard Associates, LLC
a Delaware limited liability company

By: 
Anthony Pedroni, Vice President

EXHIBIT A

Legal Description of Owner's Property

Beginning at a stake in E. N. Royster road corner with Vernon Royster, runs with said road N 55-53 E 224 feet; N 7-34 E 919 feet to a stake, corner with Vernon Royster, thence N 78-45 W 1548 feet to a post, corner with Jim Eblen and L. A. Scott's line; thence S 6-38 W 216 feet to a stake in Creek; corner with L. A. Scott; thence with creek N 61-03 W 107 feet to a stake, corner with L.A. Scott and N 81-19 W 695 feet to a stake, corner with L.A. Scott in Chester Elliott's line; thence S 10-27 W 557 feet to a stake, corner with Chester Elliott; thence N 77-42 W 817 feet to a stone, corner with Chester Elliott; thence S 4-36 W 985 feet to a post, corner with William Eblen in S.T. Denton's line, thence S 78-41 E 1371 feet to a stake corner with Eblen Estate; thence N 1-32 E 521 feet to a stake; and S 81-21 E 1821 feet to the beginning, containing 85.3 acres in accordance with survey made in November 1946, by W. W. Poole, Civil Engineer.

The above being the same property acquired by Jarrod Griffin Crowder and Lauren Jennifer Crowder, husband and wife by Deed dated April 8, 2020, of record in Deed Book 643, Page 160, in the Henderson County Clerk's office.

QLA: 8303

HOLDING PAGE FOR EXHIBIT B

Preliminary Lease and Easement Improvement Plan and Acreage Calculation
To be Delivered with Option Notice

HOLDING PAGE FOR EXHIBIT C

As Built Lease and Easement Improvements and Final Acreage Calculation

EXHIBIT D

Lease and Easement Compensation

(1) **Option Payment.**

[Redacted]

[Redacted]

[Redacted]

(2) **Payment for Lease and Easements.**

[Redacted]

[Redacted]

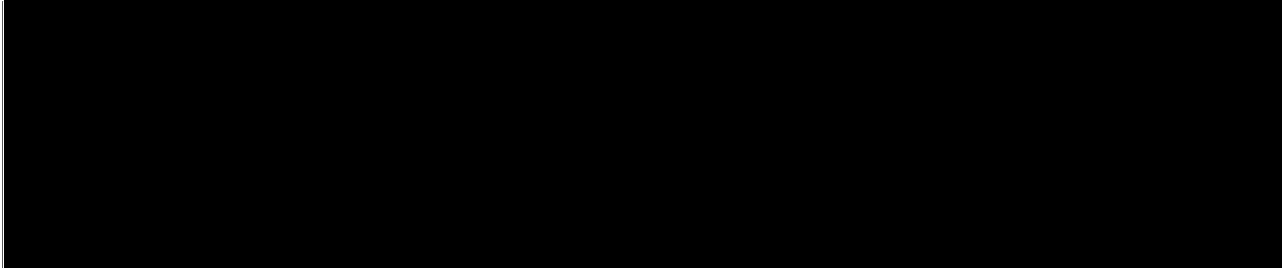

(3) Crop Compensation.

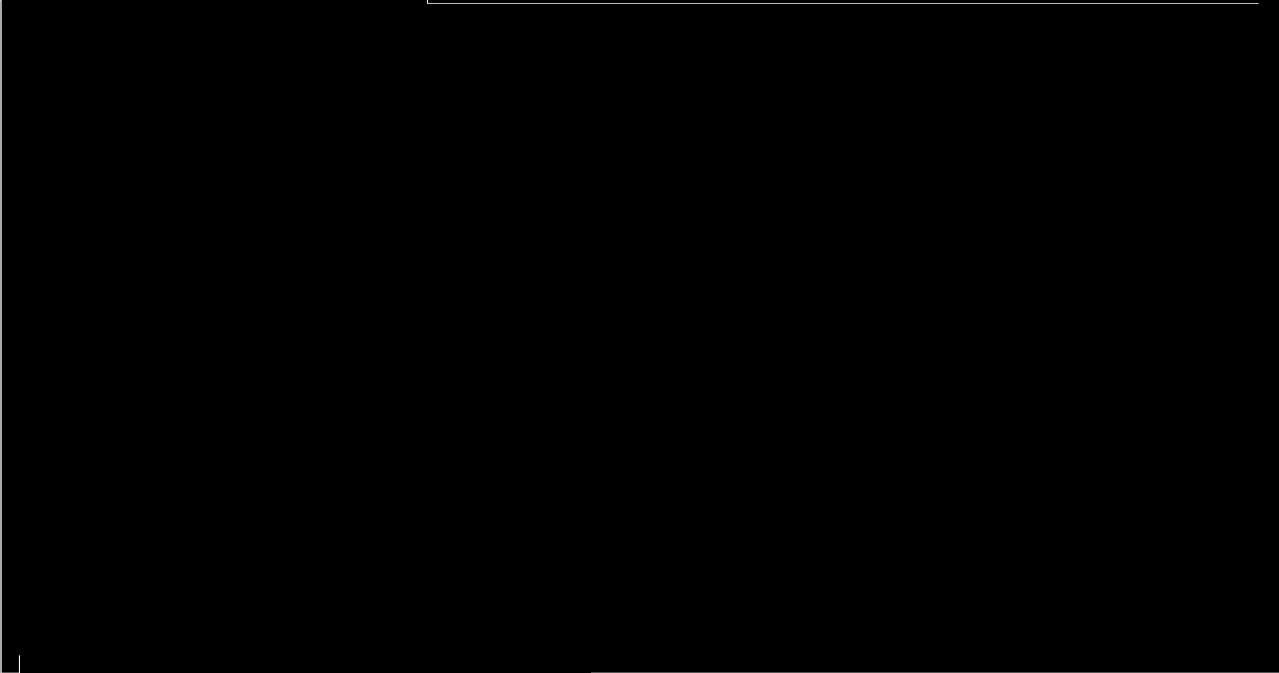

(4) Timber Removal.



(5) Payment Allocation Schedule.

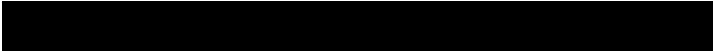

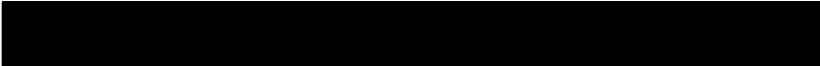

Kentucky

SOLAR LEASE AND EASEMENT AGREEMENT

1. **Parties.** This Solar Lease and Easement Agreement ("**Agreement**") is made and entered as of the 10 day of October 2019 ("**Effective Date**"), by and between Leo King Farm, LLC, a Kentucky limited liability company ("**Owner**") and Boulevard Associates, LLC, a Delaware limited liability company ("**Operator**"), which are sometimes individually referred to as a "**Party**" and collectively as the "**Parties**".

2. **Project.** This Agreement relates to the solar-powered electrical power generation and transmission project known as the "Sebree Solar Energy Center" to be located in Henderson County, Kentucky ("**Project**"), which may be wholly or partially located on the Owner's property legally described on the attached **Exhibit A** to this Agreement ("**Owner's Property**"). Upon Operator's exercise of the Option (as defined below), the Project shall include (i) the Lease of Owner's Property described in Section 4, (ii) the Easements referenced in Section 5 that are located on the Owner's Property, and (iii) the Improvements referenced in Section 8 to be constructed on Owner's Property. The Lease, Easements and Improvements are sometimes collectively referred to as the "**Operator Property**".

3. **Option.** Owner grants to Operator an exclusive option ("**Option**") to acquire the Lease and Easements referenced in Sections 4 and 5 in accordance with the following terms and conditions. Operator shall be entitled to acquire the Lease and the Easements in their entirety or in part, as Operator deems appropriate.

3.1 **Option Term.** The period during which Operator may exercise the Option shall be for a term of five (5) years, commencing on the Effective Date ("**Option Term**").

3.2 **Option Payment.** As consideration for the granting of the Option, Operator agrees to pay Owner the Option Payment set forth in **Exhibit D**.

3.3 **Use of Owner's Property.** During the Option Term, Operator and its employees, agents and contractors shall have a right to enter upon the Owner's Property and the right of ingress and egress over and across the Owner's Property for the purposes of (i) surveying the Owner's Property; (ii) performing such other tests and studies as Operator may desire in connection with the Option, including, without limitation, environmental, avian and cultural resource assessments, and geotechnical, foundation and soil tests, provided that such activities do not unreasonably interfere with Owner's use of the Owner's Property; and (iii) installing, maintaining, operating, inspecting and removing one or more weather related instruments ("**Weather Instrument**") and fencing of said Weather Instrument and including the performance of all tests and studies associated therewith. Owner shall not permit any other individual or entity except Operator or its affiliates to install a Weather Instrument on Owner's Property.

3.4 **Right to Grant Option.** Owner represents to Operator that (i) the statements in Section 9 concerning Owner's title to the Owner's Property are true and correct; (ii) Owner has the authority to grant this Option to Operator without the consent or approval of any other party; and (iii) there are no other existing options, rights of first refusal, contracts to purchase, leases or mortgages that would prevent Operator from exercising its rights with respect to the Option.

3.5 Surface and Drainage Tile Damage.

[REDACTED]

[REDACTED]

[REDACTED]

[REDACTED]

[REDACTED]

[REDACTED]

3.6 Exercise of Option. Operator may exercise the Option by giving written notice to Owner ("**Option Notice**") at any time during the Option Term. Operator shall specify in the Option Notice the Commencement Date referenced in Section 6.1.1. On the Commencement Date, the Lease and Easements referenced in Sections 4 and 5 shall automatically become effective, and the Parties shall be subject to all of the terms and conditions of this Agreement with respect to such Lease and Easements and all rights and obligations relating thereto.

3.7 Termination of Option. If Operator fails to exercise the Option within the Option Term, the Option and the rights of Operator as the optionee shall automatically terminate.

3.8 **Indemnification.** In addition to any other indemnity, defense and/or hold harmless provisions and obligations herein, Operator agrees to defend, indemnify and hold harmless the Owner and the Owner's members, manager, employees, representatives, agents, successors and assigns from and against any and all losses, damages, claims and liabilities for physical damage to Owner's Property and for physical injury to any person, including, without limitation, reasonable attorneys' fees, resulting from or arising out of (i) any operations or activities of or on behalf of the Operator on the Owner's Property arising out of Operator's access to the Owner's Property during the Option Term or (ii) any negligent act or omission or willful misconduct on the part of the Operator, its employees, contractors and agents that occurs as part of Operator's access to the Owner's Property during the Option Term. The foregoing indemnity provisions shall survive the exercise of the Option or the termination of this Agreement.

4. **Lease.** Upon exercise of the Option by Operator, Owner leases to Operator, and Operator leases from Owner, Owner's Property for the Lease and Easement Term (defined in Section 6.1) in accordance with the terms and conditions of this Agreement ("**Lease**"), which Lease grants Operator and its agents, contractors, and employees the right to use the Owner's Property for the following permitted uses:

4.1 **Construction Right.** Operator leases Owner's Property for the purpose of constructing, operating, maintaining, repairing, replacing, and removing all or any part or component of the Improvements whether located on Owner's Property. Operator may exercise its right to use all or any part of the Owner's Property as and when Operator deems it necessary or advisable to do so to perform the activities for which this right is granted, including, without limitation, staging areas and parking for Operator's employees.

4.2 **Access Right.** Operator leases Owner's Property for unobstructed vehicular and pedestrian access and ingress to and egress from the Improvements, Owner's Property and any public roadways, and to construct, maintain, and utilize Roadway Improvements on the Owner's Property. Owner shall not permit others to obstruct or damage the roads or Roadway Improvements located on the Owner's Property or in any other way interfere with Operator's rights under this right. Operator shall repair any damage done to Roadway Improvements which result from use by Operator, its agents, servants or employees. Such roads shall be maintained in the condition necessary for use by Operator's equipment, and with regard to existing roads, shall be maintained in at least the condition that existed prior to Operator's use.

4.3 **Solar Panels Right.** Operator leases Owner's Property for Operator to construct, operate, replace, relocate, remove, and maintain Solar Panels and the appurtenant Collection Facilities, together with associated roads and parking areas on Owner's Property.

4.4 **Collection Facilities Right.** Operator leases Owner's Property for Operator to construct, operate, maintain, replace, relocate or remove Collection Facilities on and under the Owner's Property.

4.5 **Substation Right.** Operator leases Owner's Property for Operator to construct, operate, maintain, replace, relocate or remove one or more Substations on Owner's Property.

4.6 **Telecommunication Right.** Operator leases Owner's Property for Operator to construct, operate, maintain, replace, relocate or remove Telecommunication Facilities on and under the Owner's Property.

4.7 **Weather Instrument Right.** Operator leases Owner's Property in order to construct, operate, replace, relocate, remove, and maintain a Weather Instrument and the appurtenant Collection Facilities on Owner's Property.

4.8 **Battery Facilities Right.** Operator leases Owner's Property in order to construct, operate, replace, relocate, remove, and maintain one or more Battery Facilities on Owner's Property.

5. **Grant of Easements.** Upon the exercise of the Option by Operator, Owner grants to Operator, and Operator accepts from Owner, for the Lease and Easement Term referenced in Section 6.1, the following easements over and across the Owner's Property in accordance with the terms and conditions of this Agreement. The following easements are for the benefit of Operator and Operator's agents, contractors and employees and located on the Owner's Property and are collectively referred to as the "**Easements**".

5.1 **Sun Non-Obstruction Easement.** Owner grants Operator an irrevocable, exclusive easement for the right and privilege to use, maintain and capture the free and unobstructed sunlight over and across the Owner's Property. Owner shall not engage in any activity on Owner's Property or any other neighboring property owned by Owner that might interfere with the sunlight direction over any portion of Owner's Property; cause a decrease in the output or efficiency of any Solar Panel or Weather Instrument; or otherwise interfere with Operator's operation of the Project or exercise of any rights granted in this Agreement (collectively "**Interference**"). This grant of the easement expressly includes the right of Operator to enforce Operator's rights, including the physical removal of trees or structures (except existing trees and structures) causing Interference to the Project contemplated by Operator. Operator shall notify Owner before making any such removals.

5.2 **Effects Easement.** Owner grants to Operator an easement over Owner's Property for visual, view, light, flicker, noise, shadow, vibration, electromagnetic, electrical and radio frequency interference, and any other effects attributable to the Project located on the Owner's Property.

6. **Term.** The term of this Agreement ("**Term**") includes the Option Term referenced in Section 3.1, the Initial Lease and Easement Term as described in Section 6.1.1 and the Extended Lease and Easement Term as described in Section 6.1.2 (together, the Initial Lease and Easement Term and the Extended Lease and Easement Term, if applicable, is defined as the "**Lease and Easement Term**").

6.1 **Lease and Easement Term.**

6.1.1 **Initial Lease and Easement Term.** The initial term of the Lease and Easements shall commence on the date specified by Operator in the Option Notice ("**Commencement Date**"). The initial term of the Lease and Easements shall end thirty (30)

years after the Commencement Date (the "**Initial Lease and Easement Term**"), subject to the rights of renewal and termination as provided in this Agreement.

6.1.2 **Extended Lease and Easement Term**. Operator shall have the right to extend the Term of this Agreement for two consecutive terms of five (5) years each in accordance with the terms and provisions of this Agreement (collectively "**Extended Lease and Easement Term**") by providing written notice to Owner of Operator's intent to extend the Term within one hundred eighty (180) days of the end of the existing Term. Each Extended Lease and Easement Term shall begin on the expiration date of the Initial Lease and Easement Term or previous Extended Lease and Easement Term, as the case may be. During the Extended Lease and Easement Term, Operator shall pay Owner the amounts set forth in **Exhibit D** as the consideration for the Lease and Easements.

6.1.3 **Delays During Lease and Easement Term**. At Operator's option, the Term may be extended for a period of time equal to the period of time during which operation of the Project is delayed or suspended because of the occurrence of a Regulatory Suspension or Force Majeure, which are defined as follows:

(i) "**Regulatory Suspension**" shall mean the enactment or application of any law, order, rule, or regulation of the Kentucky Public Service Commission, Federal Energy Regulatory Commission, or other local, state, or federal government authority having jurisdiction over the Project or Operator, or the failure of any such governmental authority to issue an approval or permit pursuant to any such law, order, rule, or regulation, which results in the delay, interruption, or suspension of the production, sale or transmission of electricity from the Solar Panels; and

(ii) "**Force Majeure**" shall mean causes beyond the reasonable control of and without the fault or negligence of the Party claiming Force Majeure, including but not limited to acts of God, labor unrest (including, but not limited to, slowdowns, picketing, boycotts or strikes), flood, earthquake, storm, fire, lightning, explosion, power failure or power surge, vandalism, theft, the cutting of power, transmission or other lines, wires or cables to the Project by persons other than Operator's employees or contractors, epidemic, war, revolution, riot, civil disturbance, sabotage, change in law or applicable regulation subsequent to the Commencement Date and action or inaction by any federal, state or local legislative, executive, administrative judicial agency or body which in any of the foregoing cases, by exercise of due foresight such Party could not reasonably have expected to avoid, and which, by the exercise of due diligence, it is unable to overcome.

The Parties shall be excused from performing their respective obligations under this Agreement and shall not be liable in damages or otherwise if and to the extent that they are unable to so perform or are prevented from performing by a Force Majeure, provided that: (i) the non-performing Party, as promptly as practicable after the occurrence of the Force Majeure, but in no event later than thirty (30) days thereafter, gives the other Party written notice describing the particulars of the occurrence; (ii) the suspension of performance is of no greater scope and of no longer duration than is reasonably required by the Force Majeure; (iii) the non-performing Party uses good faith and commercially reasonable efforts to remedy its inability to perform; and (iv) as soon as the non-performing Party is able to resume performance of its obligations excused as a

result of the occurrence, each Party shall give prompt written notification thereof to the other Party.

6.2 **Termination by Operator**. Provided Operator is not in default under any term of this Agreement, Operator, at its option, shall have the right to terminate this Agreement at any time during the Term of the Agreement, as to all or any part of the Operator Property. Termination shall be effective thirty (30) days after written notice of such termination to Owner. If Operator's notice is a full termination of the Operator Property, the Parties shall be relieved of all further duties and obligations under this Agreement, other than (i) the payment of any accrued and unpaid obligations owed by either Party as of the date of termination; (ii) the removal of the Improvements by Operator pursuant to Section 8.11; and (iii) any other obligations and liabilities that are expressly stated in this Agreement to survive such termination. Upon any such partial termination by Operator, the Parties shall be relieved of all further duties and obligations under this Agreement with respect to the portion thereof terminated by Operator, subject to the obligations and liabilities referenced in items (i) through (iii) above that shall continue to be applicable to the terminated portion of this Agreement. The Parties agree to execute an amendment to this Agreement evidencing such partial termination. Any such partial termination shall not decrease the Annual Installment Payments below the minimum of such payments set forth in Exhibit D attached hereto.

7. **Payments**. If Operator exercises the Option referenced in Section 3, Operator agrees to pay Owner the amounts set forth in **Exhibit D** as consideration for the Lease, Easements and Operator's other rights and interests in the Owner's Property.

8. **Improvements**. Operator shall have the right, at its sole cost and expense, to construct, install, maintain, use, operate, repair, replace, relocate and remove all facilities, structures, equipment, machinery, wires, conduit, cables, poles, materials and property of every kind and character required for the construction and operation of portions of the Project on the Owner's Property, including, but not limited to, the Solar Panels, Collection Facilities, Substations, Telecommunication Facilities, Weather Instruments, Roadway Improvements and Battery Facilities referenced in Sections 8.1 through 8.7 (collectively, the "**Improvements**").

8.1 "**Solar Panels**" shall mean any photovoltaic energy system designed for the generation of electrical power from the collection of sunlight, including without limitation, the photovoltaic panels, foundations, support structures, braces and related equipment.

8.2 "**Collection Facilities**" shall mean all Improvements whose purpose is to deliver electrical power generated by the Solar Panels to an electrical power grid or other system, including without limitation transformers, overhead and underground electrical collection lines, telecommunication lines, splice boxes and interconnection facilities.

8.3 "**Substations**" shall mean electrical lines, meters, monitoring and control equipment, switches, transformers, all structures, equipment, enclosures, fencing, security devices, and other electrical and communications equipment necessary to condition and increase the voltage of electricity generated by the Project to make it suitable for transmission on, and to deliver it to, Collection Facilities connected to an electric power grid or other system.

8.4 "**Telecommunication Facilities**" shall mean all Improvements whose purpose is to provide telecommunication services solely relating to the Project or any of Operator's solar powered projects, including telephone, closed-circuit television, microwave, internet, computer data and other telecommunication services.

8.5 "**Weather Instrument**" shall mean instruments used primarily to gather and transmit sunlight and meteorological data relating to the Project, and includes the instrument's foundations, guy wires, sunlight and meteorological data acquisition equipment, power source, and any required data and electrical transmission lines.

8.6 "**Roadway Improvements**" shall mean all improvements that may be necessary to construct, maintain and repair any new and existing roadways and other means of ingress and egress over, across and along the Owner's Property, including paving or surfacing of the roadways with asphalt, gravel or other roadway materials, installation of road signs and the construction and installation of culverts, bridges, drainage ditches, gates, cattle guards and similar structures and facilities.

8.7 "**Battery Facilities**" shall mean a type of equipment that can be given a new charge by passing an electric current through it designed for the storage of electrical power including without limitation, batteries and other devices for storage of electrical energy, foundations, support structures, braces and related equipment.

8.8 **Ownership of Improvements.** Except as otherwise provided in Section 11.7, all Improvements shall at all times remain the property of Operator, and Owner shall have no right, title or interest therein. All Improvements constructed or placed on the Owner's Property by Operator during the Term of this Agreement may be repaired, replaced, relocated, removed, added to or expanded upon by Operator at any time during the Term of this Agreement. Owner expressly waives any statutory lien or common law liens on the Improvements to which Owner might be entitled.

8.9 **Construction Liens.** Operator shall not permit any liens arising out of Operator's use of the Operator Property under this Agreement to be filed against the Owner's Property. Operator shall, within sixty (60) days after it receives notice of the lien, provide a bond or other security that Owner may reasonably request, or remove such lien from the Owner's Property in the manner provided by applicable law.

8.10 **Location of Improvements.** The acreage required from the Owner's Property for the Improvements for which the Lease and Easements are being granted cannot be determined until the completion of Operator's inspection, testing, study and surveying of the Owner's Property during the Option Term. Along with the Option Notice, Operator shall deliver to Owner a proposed plan of development showing the contemplated locations of the Improvements and a preliminary calculation of the acreage as determined by the area bounded by a perimeter fence required for the Project, which shall serve as the **Exhibit B** to this Agreement. During the final development and construction of the Project, such locations may need to be amended. Following construction of the Project, Operator shall provide Owner an "as-built" survey of all Improvements on Owner's Property and the final calculation of the acreage as determined by the area bounded by a perimeter fence required for the Project, which shall serve as **Exhibit C** to this

Agreement. Further, following construction, the Improvements may need to be relocated or rerouted by Operator, which Operator may perform, at any time during the Term of this Agreement, so long as the nature and extent of any such relocated or rerouted Improvements are not materially different and impose no materially greater burden on the Owner's Property than the original locations or routes, and so long as Operator takes commercially reasonable efforts to minimize disruption or inconvenience to Owner.

8.11 **Removal of Improvements.**

8.11.1 Upon full or partial termination of any of the Lease Rights or Easements, Operator shall remove all Improvements and restore the area formerly occupied by the Improvements to substantially the same physical condition that existed immediately before the construction of the Improvements (the "**Removal Obligations**"). Such Removal Obligations shall be completed by Operator to Owner's reasonable satisfaction within no more than nine (9) months after such termination, during which time Operator shall continue making payments to Owner in accordance with Exhibit D until such time as removal Obligations are substantially complete. At Owner's request, all or any part of the Roadway Improvements may be left for use by Owner.

8.11.2 If a governmental authority does not require a performance bond or security for removal of the Improvements, then upon the earlier to occur of: (i) the termination of this Agreement; or (ii) on the twentieth (20th) anniversary of the commercial operations date of the Project, Operator shall obtain and deliver to Owner a bond in form and substance reasonably satisfactory to Owner securing Operator's Removal Obligations (the "Removal Bond"). The Removal Bond shall be equal to the estimated amount, if any (the "Net Removal Costs"), of removing the Improvements from Owner's Property. Operator shall not be required to deliver such Removal Bond to Owner if Operator has delivered such a bond in connection with the permitting of Owner's Property or any other portion of the Improvements for the Project. Once in place, Operator shall keep such bond, or a like replacement, in force throughout the remainder of the Term. The Net Removal Costs shall be determined by the Parties hereto acting in good faith. If the Parties cannot agree upon the Net Removal Costs within sixty (60) days of their first attempt to do so, then the Net Removal Costs shall be determined by an independent engineer mutually selected by the Parties. If the Parties cannot agree upon such independent engineer within the next thirty (30) days, then by an independent engineer appointed by a District Judge of Henderson County, Kentucky; and the decision of such an independent engineer (however selected) as to the Net Removal Costs shall be conclusive as between and binding upon, the Parties. If an independent engineer is selected, then the Parties hereto shall equally share all of the costs associated with the independent engineer's determination of the Net Removal Cost. If the Removal Bond is unavailable or an alternate form of security is more economical or desirable, then Operator may substitute an alternate form of security, such as a letter of credit, other form of bond, or guarantee reasonably acceptable to Owner that provides substantially equivalent security as the Removal Bond.

9. **Ownership and Title Matters.** Owner represents to Operator, both as of the Effective Date, and as of the Commencement Date as follows:

9.1 **Authority.** To the extent of Owner's actual knowledge and belief, Owner represents that it is the holder of fee simple title and is the sole owner of the Owner's Property and has the unrestricted right and authority to sign this Agreement and to grant Operator the Lease and Easements and other rights granted in this Agreement. To the extent of Owner's actual knowledge and belief, when signed by both Parties, this Agreement constitutes a valid and binding agreement enforceable against Owner in accordance with its terms.

9.2 **Other Agreements.** To the extent of Owner's actual knowledge and belief, the Owner's Property is not subject to any other agreements, options, rights of first refusal or other prior right of any party to purchase, lease or acquire easements in the Owner's Property, or create any prior claim or right that would preclude or interfere with Operator's rights and interests under this Agreement and the Lease and Easements. Notwithstanding the above, Operator acknowledges that Owner has provided Operator a copy of the current Farm Lease between Owner and L. Hust Farms relating to the Owner's Property (the "Farm Lease").

9.3 **Minerals.** Except as disclosed by Owner to Operator at the time of the execution of this Agreement by Owner, to the extent of Owner's actual knowledge and belief Owner owns all of the oil, gas and other minerals, and all rights thereto as on or under the Owner's Property. Nothing herein shall prohibit the extraction of minerals from the Owner's Property provided that no such extraction shall cause any disturbance to the surface of the Owner's Property or the support of any structures thereon.

9.4 **Owner Mortgage.** Except as disclosed by Owner to Operator at the time of the execution of this Agreement by Owner, there are no mortgages encumbering the Owner's Property ("**Owner Mortgage**").

9.5 **Notice and Opportunity to Cure.** If there is an Owner Mortgage encumbering Owner's Property and Owner receives from the holder thereof any notice that payments are overdue, Owner shall notify Operator and each Operator Mortgagee (as defined at Section 13.1) by sending a copy of such overdue payment notice to Operator by the earlier of (i) five (5) days after receipt, or (ii) three (3) business days prior to the date by which a default under or in respect of such Owner Mortgage could occur. If Operator or any Operator Mortgagee determines that it would be in Operator's interest to make such payments to Owner Mortgagee on Owner's behalf, whether as a result of receiving such notice or otherwise, Operator shall have the right to make such payments and to credit the payments so made against the Annual Installment Payment next due under the Agreement.

9.6 **Subordination, Non-Disturbance & Attornment Agreement.** If there is an Owner Mortgage encumbering Owner's Property, Owner shall cooperate with Operator to obtain a Subordination, Non-Disturbance and Attornment Agreement ("**SNDA**") in the form prepared and provided by Operator, from each Owner Mortgagee, pursuant to which such Owner Mortgagee agrees, among other things, not to disturb Operator's possession and use of the Owner's Property. Owner shall not incur any loss in income, expense, obligation or liability with regard to the SNDA. Operator shall, at its sole cost and expense, record each such SNDA in the Office of the County Clerk in which Owner's Property is located. If Owner fails to deliver a SNDA from each Owner Mortgagee, Operator may, at its sole option, either (i) terminate this Agreement immediately upon written notice to Owner, or (ii) take such action as Operator deems

reasonably necessary to effect the rights granted to Operator hereunder, and off-set all amounts expended in such efforts against the Annual Installment Payments and any other amounts due hereunder or in respect hereof.

9.7 **Amendment to Farm Lease.** Owner shall obtain an amendment to the Farm Lease which provides that it is unilaterally terminable by Owner upon thirty (30) days' notice to the tenant thereunder and is otherwise reasonably acceptable to Operator. Owner further agrees to terminate such Farm Lease and to provide thirty (30) days' notice of such termination to the tenant thereunder upon receipt of the Option Notice, with the termination date of such Farm Lease to be no later than 45 days from the date of receipt of such Option Notice. Any failure by Owner to obtain an amendment shall be governed by the provisions of Exhibit D hereto, i.e., payments will be adjusted accordingly.

10. **Representations and Warranties of Owner.** Owner hereby makes the following further representations and warranties both as of the Effective Date, and as of the Commencement Date:

10.1 **Physical Condition.** Owner has no knowledge of any existing physical conditions of the Owner's Property which would prevent, significantly restrict or make more expensive Operator's development of the Owner's Property for the purposes specified in this Agreement, or which could, with the passage of time, or the giving of notice, constitute a violation of any currently applicable governmental law, ordinance, order, rule or regulation.

10.2 **Legal Restrictions.** Owner has no knowledge of any law, regulation, ordinance or order of any local, state or federal governmental authority which would prohibit or significantly restrict Operator's development of the Owner's Property pursuant to this Agreement. This Agreement does not violate any contract, agreement, instrument, judgment or order to which Owner is a party or which affects the Owner's Property. To the best of Owner's knowledge, the Owner's Property is currently in full and complete compliance with all governmental laws, ordinances, orders, rules and regulations applicable to the Owner's Property.

10.3 **No Litigation.** No litigation is pending and, to the best of Owner's knowledge, no litigation or administrative actions are proposed, threatened or anticipated with respect to any matter affecting the Owner's Property. If Owner learns of any litigation or administrative action proposed, threatened or instituted with respect to the Owner's Property, Owner shall give Operator notice within thirty (30) days thereof.

10.4 **Survival.** The representations and warranties set forth in this Section 10 shall survive the execution and delivery hereof.

10.5 **No Warranty of Title.** Notwithstanding the foregoing provisions of Section 9 or Section 10 hereof, it is hereby definitely and expressly covenanted, agreed and understood by and between the Parties that: Operator is being provided, pursuant to this Agreement, sufficient time and opportunity to conduct its own examination and investigation of the Owner's Property for determining the suitable and feasibility of the same for the Project and title to said Owner's Property; (ii) Operator will have, pursuant to this Agreement, full, complete and uncontrolled access to all of said Owner's Property and ample and sufficient time within which to satisfy itself as to the suitability thereof for its purposes. Owner's representations and warranties contained

above are being relied upon by Operator only as inducement to enter into the Option and Operator may exercise or not exercise the Option as Operator determines in its sole discretion as Operator determines without reliance on any representation or warranty of Owner contained herein as to the status of Owner's title or the character of the Property. In the event that a representation of Owner contained in Sections 9 or 10 is breached (in that Owner made a representation that was untrue to the best of Owner's knowledge at such time), then Operator shall be limited to recovery of amounts paid hereunder as its measure of damages due to such breach or misrepresentation.

11. **Use, Operation and Maintenance.**

11.1 **Exclusive Use by Operator.** Operator shall have the exclusive right (i) to use and possess the Owner Property in connection with the Project and other similar solar-powered electrical power generation projects; (ii) to investigate, inspect, survey, and conduct tests of the Owner's Property, including, but not limited to, meteorological, environmental, archeological and geotechnical tests and studies; (iii) to use and convert all of the sunlight resources on the Owner's Property; and (iv) to undertake such other activities on the Owner's Property that may be related to the Project, including, without limitation, the storage of Solar Panels, materials and equipment during the installation and construction of the Improvements; development and operation of communications systems; and site tours of the Project for visitors and other interested parties.

11.2 **No Required Installation or Operation.** Nothing in this Agreement shall be interpreted as imposing on Operator any obligation to install Solar Panels or other Improvements on the Owner's Property, or to operate the Project on the Owner's Property. Operator shall have the sole discretion to determine if and when any Solar Panels and other Improvements may be constructed on Owner's Property, and if and when to commence the operation of the Project on the Owner's Property.

11.3 **Permits and Approvals.** Operator shall be responsible, at its sole cost and expense, for obtaining any governmental permits and approvals necessary for the construction and operation of the Project and the construction and operation of the Improvements. Owner shall cooperate with Operator as necessary to obtain any governmental or utility approvals or permits, including, without limitation, signing any applications for such approvals, provided that Owner shall not incur any loss in income, expense, obligation or liability with respect to Operator obtaining such permits or approvals.

11.4 **Compliance with Laws.** Operator shall comply in all material respects with valid laws applicable to the Owner's Property and the Operator Property. Operator shall have the right, in its sole discretion and at its sole expense, in Operator's name to contest the validity or applicability to the Owner's Property and the Operator Property of any law, ordinance, statute, order, regulation, property assessment or the like made by any governmental agency or entity. Operator shall control any such contest and Owner shall cooperate with Operator in every reasonable way in such contest, provided that Owner shall incur no expense, obligation or liability with regard to such contest.

11.5 **Care and Appearance.** Operator, in its exercise of the lease, easement and other rights granted hereunder shall, at all times, maintain the Owner's Property and the Improvements in a reasonably neat, clean and presentable condition at Operator's sole cost and expense. Operator shall not willfully or negligently damage or destroy the Owner's Property and shall keep the Owner's Property clean and free of debris created by Operator, its contractors, or others brought on to the Owner's Property by Operator. Operator shall not use the Owner's Property for storage, except for materials, construction equipment and vehicles directly associated with construction or maintenance of the Improvements on the Owner's Property or adjacent properties that are part of the Project. Operator shall be responsible for obtaining and for payment of all charges for all utility services as may be required for the Project.

11.6 **Fences and Gates.** At Owner's request, Operator shall repair or replace any fences, gates or cattle guards damaged or removed in connection with Operator's activities on the Owner's Property. Fences removed from the Owner's Property, if replaced, shall be re-built by Operator at its expense in mutually agreeable locations. All fence repair and construction shall be substantially similar to the construction of existing fences and cattle guards on Owner's Property. Any gates opened for access to Owner's Property by either Party shall be closed immediately after passing through so that livestock may not pass through. Once completed, all replacement fences, gates and cattle guards shall be owned and maintained by Owner. Upon abandonment or termination of the rights granted to Operator in this Agreement, any fences, gates and cattle guards installed by Operator shall remain and become the property of Owner. To minimize the need for temporary fencing, Owner will cooperate with Operator to avoid pasturing animals on or near the Improvements during periods of construction, maintenance or removal activity by Operator. Owner will discuss with Operator what temporary fencing is necessary during the periods of construction, maintenance or removal activity by Operator.

11.7 **Roadway Maintenance and Repairs.** Operator agrees to maintain and repair all Roadway Improvements located on the Operator Property; provided, however, Owner shall reimburse Operator for any costs and expenses incurred by Operator to repair any damage or perform any special maintenance of the Roadway Improvements caused by Owner or any person using the Roadway Improvements with Owner's permission, other than Operator.

12. **Taxes.**

12.1 **Owner's Taxes.** Owner covenants and agrees to pay prior to delinquency all real and personal property and other taxes, general and special assessments, and other charges of every description ("**Taxes**") levied or assessed against the Owner's Property and all improvements thereon by governmental authorities, other than Operator's Taxes referenced in Section 12.2 (Taxes, excepting Operator's Taxes, are hereinafter referred to as "**Owner's Taxes**").

12.2 **Operator's Taxes.** [REDACTED]
[REDACTED]
[REDACTED]
[REDACTED]
[REDACTED]

[REDACTED]

12.3 **Failure to Pay.** In the event either Party fails to pay their share of Taxes prior to delinquency, the other Party shall have the right to pay such Taxes and any accrued penalties or interest, which payments shall increase or be offset against other Payments due under this Agreement.

12.4 **Operator's Right to Contest.** Operator may contest the legal validity or amount of any Operator's Taxes for which it is responsible under this Agreement, and may institute such proceedings as it considers necessary, provided that Operator shall bear all expenses in pursuing such contest or proceeding. With respect to any Taxes which may constitute a lien on the Owner's Property, Operator shall promptly pay such Taxes unless the proceeding in which it contests such Taxes shall operate to prevent or stay the collection of the Taxes so contested or unless Operator removes any such lien by bonding or otherwise. Owner agrees to render to Operator all reasonable assistance in contesting the validity or amount of any such Taxes, with the exception of Taxes levied by Owner, including joining in the signing of any reasonable protests or pleading which Operator may deem advisable to file; provided, however, that Operator shall reimburse Owner for its reasonable out-of-pocket expenses, including reasonable attorneys' fees incurred in connection with providing such assistance.

13. **Mortgage of Operator Property.**

13.1 **Right to Mortgage.** Operator may, upon written notice to Owner, but without requiring Owner's consent or approval, mortgage, collaterally assign, or otherwise encumber and grant security interests in all or any part of its interest in this Agreement and the Operator Property. These various security interests in all or a part of this Agreement and the Operator Property are collectively referred to as an "**Operator Mortgage**" and holder of such security interest, an "**Operator Mortgagee**". Any Operator Mortgagee shall use the Operator Property only for the uses permitted under this Agreement. Whenever Operator has granted a security interest under this Section 13, it will give Owner notice of the Operator Mortgage (including the name and address of the Operator Mortgagee for notice purposes) to Owner within thirty (30) days; provided that failure to give this notice shall not constitute a default under this Agreement, but rather shall only have the effect of not binding Owner to provide such Operator Mortgage notice until the Operator and its address is given to Owner.

13.2 **Notice of Default and Opportunity to Cure.** As a precondition to exercising any rights or remedies related to any alleged default by Operator under this Agreement, Owner

shall give written notice of the default to each Operator Mortgagee at the same time it delivers notice of default to Operator, specifying in detail the alleged event of default and the required remedy. Each Operator Mortgagee or its designee shall have the right, but not the obligation, to cure any default as Operator, and/or the right, but not the obligation, to remove any Improvements or other property owned by Operator or such Operator Mortgagee located on the Owner's Property to the same extent as Operator. The cure period for any Operator Mortgagee shall be the later of (i) the end of the Operator cure period under Section 18; (ii) thirty (30) days after such Operator Mortgagee's receipt of the default notice; or (iii) if applicable, the extended cure period provided for in Section 13.3. Failure by Owner to give an Operator Mortgagee notice of default shall not diminish Owner's rights against Operator, but shall preserve all rights of the Operator Mortgagee or its designee to cure any default and to remove any Improvements or other property of Operator or the Operator Mortgagee located on the Owner's Property.

13.3 **Extended Cure Period.** If any default by Operator under this Agreement cannot be cured without the Operator Mortgagee obtaining possession of all or part of the Operator Property, then any such default shall be deemed remedied if an Operator Mortgagee: (i) within sixty (60) days after receiving notice from Owner as set forth in Section 13.2, acquires possession of all or part of the Operator Property, or begins appropriate judicial or nonjudicial proceedings to obtain the same; (ii) diligently prosecutes any such proceedings to completion; and (iii) after gaining possession of all or part of the Operator Property performs all other obligations as and when the same are due in accordance with the terms of this Agreement. If an Operator Mortgagee is prohibited by any court or by operation of any bankruptcy or insolvency laws from commencing or prosecuting the proceedings described above, the sixty (60) day period specified above for commencing proceedings shall be extended for the period of such prohibition.

13.4 **Operator Mortgagee Liability.** Any Operator Mortgagee whose interest in the Operator Property is held solely for security purposes, shall have no obligation or liability under this Agreement unless and until the Operator Mortgagee succeeds to absolute title to the Operator Property and the rights of Operator under this Agreement. An Operator Mortgagee shall be liable to perform obligations under this Agreement only for and during the period it directly holds such absolute title.

13.5 **Certificates.** Owner shall execute any estoppel certificates (certifying as to truthful matters, including without limitation that no default then exists under this Agreement, if such be the case), consents to assignment and non-disturbance agreements as Operator or any Mortgagee may reasonably request from time to time. The Parties shall negotiate in good faith any amendment to this Agreement from time to time to include any provision that may be reasonably requested by Operator or any Operator Mortgagee to implement the provisions contained in this Agreement or to preserve an Operator Mortgagee's security interest.

13.6 **Operator Mortgagee's Right to Enforce Mortgage and Assign.** Each Operator Mortgagee shall have the right, in its sole discretion: (i) to assign its Operator Mortgage; (ii) to enforce its lien and acquire title to all or any portion of the Operator Property by any lawful means; (iii) to take possession of and operate all or any portion of the Operator Property and to perform all obligations to be performed by Operator under this Agreement, or to cause a receiver to be appointed to do so; and (iv) to acquire all or any portion of the Operator Property by

foreclosure or by an assignment in lieu of foreclosure and thereafter to assign or transfer all or any portion of the Operator rights under this Agreement to a third party in accordance with Section 14. Any Operator Mortgagee or other party who acquires Operator's interest in all or a portion of the Operator Property pursuant to foreclosure or assignment in lieu of foreclosure shall not be liable to perform the obligations imposed on Operator by this Agreement, which are incurred or accruing after such Operator Mortgagee or other party no longer has ownership or possession of the Operator Property.

13.7 **New Agreement.**

13.7.1 If the Operator Property is foreclosed upon or there is an assignment in lieu of foreclosure, or if this Agreement is rejected or disaffirmed pursuant to bankruptcy law or other law affecting creditor's rights and, within ninety (90) days after such event, Operator or any Operator Mortgagee or other purchaser at a foreclosure sale shall have arranged to the reasonable satisfaction of Owner to cure any material defaults under this Agreement, and for the payment of all Annual Installment Payments or other charges due and payable by Operator as of the date of such event, then Owner shall execute and deliver to Operator or such Operator Mortgagee or other purchaser at a foreclosure sale, or to a designee of one of these parties, as the case may be, a new agreement ("**New Agreement**") which (i) shall be for a term equal to the remainder of the Term of this Agreement before giving effect to such rejection or termination; (ii) shall contain the same covenants, agreements, terms, provisions and limitations as this Agreement (except for any requirements that have been fulfilled by Operator or any Operator Mortgagee or other purchaser at a foreclosure sale prior to rejection or termination of this Agreement); and (iii) shall include that portion of the Operator Property in which Operator or such other Operator Mortgagee or other purchaser at a foreclosure sale had an interest on the date of rejection or termination.

13.7.2 If more than one Operator Mortgagee makes a written request for a New Agreement pursuant to this provision, the New Agreement shall be delivered to the Operator Mortgagee requesting such New Agreement whose Operator Mortgage is prior in time, and the written request of any other Operator Mortgagee whose lien is subordinate shall be void and of no further force or effect. The provisions of this Section 13 shall survive the termination, rejection or disaffirmation of this Agreement and shall continue in full force and effect thereafter to the same extent as if this Section 13 were a separate and independent contract made by Owner, Operator and each Operator Mortgagee, and, from the effective date of such termination, rejection or disaffirmation of this Agreement to the date of execution and delivery of such New Agreement, such Operator Mortgagee or other purchaser at a foreclosure sale may use and enjoy the Operator Property without hindrance by Owner or any person claiming by, through or under Owner; provided that all of the conditions for the New Agreement as set forth above are complied with.

13.8 **Operator Mortgagee's Consent to Amendment, Termination or Surrender.** Notwithstanding any provision of this Agreement to the contrary, the Parties agree that so long as any Operator Mortgage remains outstanding, this Agreement shall not be modified or amended, and Owner shall not accept a surrender, cancellation or release of all or any part of the Operator Property from Operator, prior to expiration of the Term of this Agreement, without the prior written consent of the Operator Mortgagee holding such Operator Mortgage. This

provision is for the express benefit of and shall be enforceable by each Operator Mortgagee as if it were a party named in this Agreement.

14. **Assignment and Sublease.** Except as expressly provided herein, Operator will not assign any of its rights, duties or obligations under this Agreement without the prior written consent of the Owner, which consent shall not be unreasonably withheld. Despite the foregoing, Operator may, without securing Owner's consent, assign any of its rights, duties and obligations under this Agreement, provided that any such assignee agrees in writing to be bound by the terms and conditions of this Agreement and such assignment is: (i) to one or more entity that controls, is controlled by, or is under common control with the Operator; (ii) to any present or future purchaser or lessee of the Project and/or power generated by the Project; (iii) to any person or entity succeeding to all or substantially all of the assets of the Operator; (iv) to a successor entity in a merger or acquisition transactions; (v) to an Operator Mortgagee; or (vi) to any successor in interest to an Operator Mortgagee acquiring title through foreclosure or a transfer or deed in lieu of foreclosure. Following any such assignment in subsections i – vi, the assigned Operator shall be released from any obligations arising under this Agreement from and after the date of such assignment. Any person or entity to which Owner assigns all its rights, title and interest under this Agreement or in the Project is referred to herein as, and is included within the definition of, "Operator". The rights contained in this Agreement shall inure to the benefit of Operator and its affiliates, sublessees, successors, assignees, permittees, licensees, lessees, employees and agents. Owner may, at any time, and from time to time, without securing Owner's consent, sublease or grant sub-easements with respect to all or any of Operator's right, title and interest in this Agreement to any person or entity. With respect to any such sublease or sub-easement: (i) the term thereof shall not extend beyond the term of this Agreement; (ii) such sublease or sub-easement shall be expressly made subject to all of the terms and conditions of this Agreement; (iii) no such sublease or sub-easement shall be effective unless in writing; and (iv) no such sublease or sub-easement shall serve to relieve Operator of or from any obligation, duty or liability provided by the terms and conditions of this Agreement.

15. **Hazardous Materials.**

15.1 **Owner's Covenants Regarding Hazardous Materials.** Owner represents and warrants that, to the best of Owner's knowledge, the Owner's Property is not and has not been in violation of any federal, state or local environmental health or safety laws, statute, ordinance, rule, regulation or requirement ("**Environmental Laws**"), and Owner has not received any notice or other communication from any governmental authorities alleging that the Owner's Property is in violation of any Environmental Laws. "**Hazardous Materials**" shall mean any asbestos containing materials, petroleum, explosives, toxic materials, or substances regulated as hazardous wastes, hazardous materials, hazardous substances, or toxic substances under any federal, state, or local law or regulation. Owner warrants that Owner has done nothing to contaminate the Operator Property with Hazardous Materials or wastes.

15.2 **Operator's Covenants Regarding Hazardous Materials.** Operator shall, at Operator's sole cost and expense, promptly take removal or remedial action required by Environmental Law with regard to any material violation of any Environmental Law with regard to any Hazardous Materials brought onto the Owner's Property by Operator or its employees,

agents, or contractors. Owner shall cooperate with Operator with regard to any scheduling or access to the Owner's Property in connection with any action required hereunder.

15.3 **Operator's Indemnity Regarding Hazardous Materials.** OPERATOR SHALL INDEMNIFY AND HOLD HARMLESS OWNER FROM AND AGAINST ANY AND ALL COSTS, EXPENSES, LIABILITIES, LOSSES, DAMAGES, SUITS, ACTIONS, FINES, PENALTIES, CLAIMS OR DEMANDS OF ANY KIND (INCLUDING COURT COSTS, REASONABLE ATTORNEYS' FEES AND EXPERTS' FEES) ASSERTED BY ANY PERSON OR ENTITY THAT IS/ARE CAUSED BY THE PRESENCE OF HAZARDOUS MATERIALS ON THE OWNER'S PROPERTY ARISING OUT OF OPERATOR'S ACTIVITIES ON THE OWNER'S PROPERTY, WHICH RESULTS (I) IN CONTAMINATION OF THE OWNER'S PROPERTY OR ANY OTHER PROPERTY, OR WHICH CAUSES OWNER TO BE LEGALLY LIABLE OR ALLEGED TO BE LEGALLY LIABLE, FOR ANY DAMAGE RESULTING THEREFROM; (II) OWNER INCURRING ANY COSTS IN CONNECTION WITH ANY INVESTIGATION OF SITE CONDITIONS OR CLEANUP, REMEDIATION OR RESTORATION WORK REQUIRED BY ANY FEDERAL, STATE OR LOCAL GOVERNMENTAL AGENCY OR POLITICAL SUBDIVISION CAUSED BY SUCH CONTAMINATION; OR (III) INJURY OR DEATH TO ANY PERSON OR DAMAGE TO ANY PROPERTY CAUSED BY SUCH CONTAMINATION

16. **Insurance and Indemnity.**

16.1 **Insurance.** At all times during which Operator is conducting any activities on the Property and at all times during the Term of this Agreement, Operator shall maintain in effect (1) commercial General Liability Insurance, including bodily injury and property damage coverage with minimum limits of \$1 Million Dollars per occurrence and \$2 Million Dollars aggregate and (2) Umbrella Liability Insurance with minimum limits of \$5 Million Dollars per occurrence and \$5 Million Dollars aggregate. Operator shall name Owner as additional insured on such insurance policy and provide Owner with a certificate of such insurance. In addition, Operator shall provide Owner with a blanket additional insured endorsement.

16.2 **Indemnity by Operator.** Operator shall defend, indemnify, protect and hold Owner harmless from and against all liabilities, costs, expenses, obligations, losses, damages, claims, (collectively "**Claims**") arising out of or resulting from: (i) the acts, omissions, negligence, willful misconduct, or breach of this Agreement by Operator, its agents, contractors or employees, invitees, licensees and permittees; or (ii) any operations or activities of the Operator on the Owner's Property; provided, however, that such Claims are not due to the sole negligence, willful misconduct, or breach by Owner, its agents, contractors or employees, invitees, licensees or permittees.

16.3 **Indemnity by Owner.** Owner shall defend, indemnify, protect, and hold Operator harmless from and against all Claims resulting from the negligence, willful misconduct, or breach of this Agreement by Owner, its agents, contractors or employees, invitees, licensees and permittees; provided, however, that such Claims are not due to the sole negligence, willful misconduct, or breach by Operator, its agents, contractors, employees, invitees, licensees, or permittees.

16.4 **Survival.** The obligations of the Parties under this Section 16 shall survive expiration or other termination of this Agreement.

17. **Confidentiality.** This Agreement includes confidential and proprietary information relating to Operator and the Project. Owner agrees not to provide copies of the Agreement or disclose the terms of the Agreement to any unauthorized person or entity. Operator authorizes Owner to provide copies of the Agreement and disclose the terms thereof to Owner's family ("family" shall be deemed to include all devisees or descendants of owner by will or intestacy), attorney, accountant, financial advisor and any existing or prospective mortgagee, lessee, or purchaser for the sole purpose of evaluating and advising Owner and for no other purpose, so long as such authorized parties agree in writing to become subject to the confidentiality provisions hereto and not to provide copies of the Agreement or disclose the terms thereof to any unauthorized person or entity. Any Owner and party shall return all material containing any confidential information to Operator immediately upon its request. Any party agrees to destroy immediately upon request by Operator such analyses, compilation, studies or other documents, and any oral information will continue to be subject to the terms of this Agreement. Owner agrees that Operator will have no adequate remedy at law if any party violates any of the terms of this Agreement. In such event Operator will have the right, in addition to any other rights Operator may have, to obtain injunctive relief to restrain any breach or threatened breach by third party or specific enforcement of such terms plus reimbursement of attorneys' fees, court costs and all associated expenses. No party shall publish, file for public record, reproduce, or otherwise disseminate this document or any of the terms and provisions hereof to any party, other than the Parties set forth above without the prior written consent of Operator, which consent may be withheld for any reason and in Operator's sole discretion.

18. **Default and Remedies.**

18.1 **Operator Payment Default.** [REDACTED]
[REDACTED]
[REDACTED]
[REDACTED]

18.1.1 **Collection of Payments.** [REDACTED]
[REDACTED]
[REDACTED]
[REDACTED]
[REDACTED]
[REDACTED]

18.1.2 **Terminate Agreement.** [REDACTED]
[REDACTED]
[REDACTED]
[REDACTED]
[REDACTED]
[REDACTED]
[REDACTED]
[REDACTED]

[REDACTED]

18.2 Other Operator Default. [REDACTED]

[REDACTED]

18.3 Owner Default. [REDACTED]

[REDACTED]

19. **Condemnation.**

19.1 **Complete Taking.** If, at any time, any authority having the power of eminent domain shall condemn all or substantially all of the Operator's Property, or all of the Improvements thereon, for any public use or otherwise, then the interests and obligations of Operator under this Agreement in or affecting the Operator's Property shall cease and terminate upon the earlier of (i) the date that the condemning authority takes physical possession of the Operator's Property or the Improvements thereon, (ii) the date that Operator is, in its sole judgment, no longer able or permitted to operate the Project on the Operator's Property in a commercially viable manner, or (iii) the date of the condemnation judgment. Operator shall continue to pay all amounts payable hereunder to Owner until the earlier of such dates, at which time the Parties shall be relieved of any and all further obligations and conditions to each other under this Agreement.

19.2 **Partial Taking.** If, at any time during the term of this Agreement, any authority having the power of eminent domain shall condemn one or more, but not all, of the Solar Panels, or any portion of the Improvements or the Operator's Property, then the interest and obligations of Operator under this Agreement as to those Solar Panels or any portion of the Improvements or the Operator's Property so taken shall cease and terminate upon the earlier of (i) the date that the condemning authority takes possession of such Solar Panels or any portion of the Improvements or the Operator's Property, (ii) the date that Operator is, in its reasonable judgment, no longer able or permitted to operate the Project on the Operator's Property, or any portion thereof, in a commercially viable manner, or (iii) the date of the condemnation judgment; and, unless this Agreement is terminated as hereinafter provided, this Agreement shall continue in full force and effect as to the remainder of the Solar Panels, Improvements and the Operator's Property. If the remainder of the Solar Panels or any other portion of the Improvements or the Operator's Property is or becomes insufficient or unsuitable for Operator's purposes hereunder, as determined by Operator in its sole discretion, then, subject to the rights of any Operator Mortgagee under Section 13, Operator shall have the right to terminate this Agreement as to the portion of the Operator's Property to which Operator continues to hold the rights, at which time the Parties shall be relieved of any further obligations and duties to each other under this Agreement.

19.3 **Apportionment, Distribution of Award.** On any taking, all sums awarded, including damages and interest, shall be paid as follows:

- (a) Any portion of the award by the court on account of any cost or loss that Operator may sustain in the removal and relocation of Operator's Improvements, to Operator;
- (b) Any portion of the award by the court for Operator's anticipated or lost revenues or profits, to Operator;
- (c) Any portion of the award by the court for Owner's lost revenues, to Owner;
- (d) All remaining amounts of the award, to Owner or Operator consistent with applicable Kentucky law.

20. **Notice.**

20.1 **Writing.** All notices given or permitted to be given hereunder shall be in writing.

20.2 **Delivery.** Notice is considered given either (i) when delivered in person to the recipient named below, (ii) upon receipt after deposit in the United States mail in a sealed envelope or container, postage and postal charges prepaid, return receipt requested or certified mail, addressed by name and address to the party or person intended, or (iii) twenty-four (24) hours from proper and timely delivery to an overnight courier service addressed by name and address to the party or person intended as follows:

Notice to Owner: Leo King Farm, LLC
 707 N Main Street
 Henderson, KY 42420

██
██

Notice to Operator: Boulevard Associates, LLC
 700 Universe Blvd
 Juno Beach, FL 33408
 Attn: Land Services Administration

██

20.3 **Change of Recipient or Address.** Either Party may, by notice given at any time or from time to time, require subsequent notices to be given to another individual person, whether a party or an officer or representative, or to a different address, or both. Notices given before actual receipt or notice of change shall not be invalidated by the change.

21. **Miscellaneous Provisions.**

21.1 **Successors and Assigns.** The terms and provisions of this Agreement shall run with the land and be binding on and inure to the benefit of the heirs, successors, assigns and personal representatives of the Parties. In accordance with this Agreement, Operator in its discretion may authorize other persons or entities to use the Operator Property for the purposes stated in this Agreement

21.2 **Memorandum.** Simultaneously with the execution of this Agreement, the Parties agree to execute and acknowledge a memorandum of this Agreement. Operator may record the executed memorandum in the public records of Henderson County, Kentucky.

21.3 **Entire Agreement.** This Agreement and the attached Exhibits shall constitute the entire agreement between the Parties and supersedes all other prior writings and understandings.

21.4 **Amendments.** This Agreement shall not be amended or modified in any way except by an instrument signed by the Parties and consented to by any Operator Mortgagee. The Parties hereto shall at all times hereafter execute any documents and do any further acts which

may be necessary or desirable to carry out the purposes of this Agreement and to give full force and effect to each and all of the provisions hereof.

21.5 **Legal Matters.** This Agreement shall be governed by and interpreted in accordance with the then existing laws of the Commonwealth of Kentucky and the County where the Owner's Property is located shall be considered the proper forum or jurisdiction for any disputes arising in connection with this Agreement. The Parties agree to first attempt to settle any dispute arising out of or in connection with this Agreement by good-faith negotiation. If the Parties are unable to resolve amicably any dispute arising out of or in connection with this Agreement, each shall have all remedies available at law or in equity and as provided by this Agreement. **Each Party waives all right to trial by jury and specifically agrees that trial of suits or causes of action arising out of this Agreement shall be to the court of competent jurisdiction.**

21.6 **Severability.** If any term or provision of this Agreement, or the application thereof to any person or circumstance shall, to any extent, be determined by judicial order or decision to be invalid or unenforceable, the remainder of this Agreement or the application of such term or provision to persons or circumstances other than those as to which it is held to be invalid, shall be enforced to the fullest extent permitted by law.

21.7 **Tax Credits.** If under applicable law Operator becomes ineligible for any currently existing tax credit, benefit or incentive for alternative energy expenditure established by any local, state or federal government, then, at Operator's option, the Parties shall negotiate in good faith to amend this Agreement or replace it with a different instrument so as to convert Operator's interest in the Operator Property to a substantially similar interest that makes Operator eligible for such tax credit, benefit or incentive, provided, however, except for converting Operator's interest as provided above, such amendment or instrument shall not otherwise diminish or alter Operator's obligations, duties or liabilities under this Agreement or modify any other terms or provisions of this Agreement. Such amendment or instrument shall not impair any of Owner's rights or increase the burdens or obligations of Owner under this Agreement. By way of example, conversion of this instrument to an easement interest would not result in a permanent easement, but only an easement for a term of years equal to the term of this agreement, with any applicable extensions as set forth herein.

21.8 **Approvals.** Whenever in this Agreement the approval or consent of either Party is required or contemplated, unless otherwise specified, such approval or consent shall not be unreasonably withheld or delayed.

21.9 **Authority.** The signatories hereto warrant that each has the authority to execute this Agreement on behalf of any entities which are Parties to this Agreement and that each such entity has executed this Agreement pursuant to its organizational documents or a resolution or consent of their Board of Directors or other governing body.

21.10 **Time of Essence.** Time is of the essence of each provision of this Agreement.

21.11 **Counterparts**. This Agreement may be executed in multiple counterparts, each of which shall be deemed an original, and all of which together shall constitute a single instrument.

[Signatures on Next Page]

Owner:

Leo King Farm, LLC,
a Kentucky limited liability company

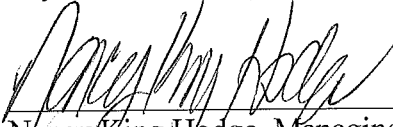
By: 

Nancy King Hodge, Managing Partner

Operator:

Boulevard Associates, LLC
a Delaware limited liability company

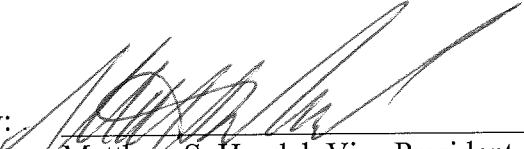
By: 

Matthew S. Handel, Vice President

EXHIBIT A

Legal Description of Owner's Property

The following described tracts are located Henderson County, Oklahoma:

TRACT 1: A certain tract or parcel of land lying in the county of Henderson, state of Kentucky, on the L & N R.R. near Robards, the same being part of a tract of 100 acres of land conveyed to Saml. E. King by S. A. Young, Commissioner, by deed recorded in Commissioner's Deed Book 1, page 215, in the Henderson County Court Clerk's Office, the part hereby conveyed being bounded as follows: Beginning at a point on the L & N R.R. where said R.R. crosses the south line of the original tract of 100 acres, thence with said original line west to a post oak corner to Eblen and original

beginning corner of the tract of which this is a part, thence with another original line of the whole tract N. 29 deg. E. to L & N R.R. thence with said R.R. to the beginning, containing about 30 acres, more or less.

TRACT 2: A certain tract or parcel of land lying in the county and state aforesaid, near the town of Robards, Kentucky, and bounded as follows: Beginning at a stake in line of Lot #1 corner to Lot #4; thence N 65-1/2 W. 170 p. and 8 l to a stake, corner to Lot #4; thence S. 22 W. 23 p and 9 L to a stake corner to Lot #6; thence S. 65-1/2 E. 176 P, and 12 L. to a stake in line Lot #1 corner to Lot #6; thence N. 6-1/2 E. 24 P & 13 links to the beginning, containing 26 acres.

TRACT 3: A certain tract or parcel of land lying the county and state aforesaid near the town of Robards and bounded as follows: Beginning at a stake in Lee Eakins line, corner to Lot No. 3; thence N 65-1/2 deg. W. 163 poles and 10 links to a stake corner to Lot No. 3; thence S. 22 deg. W. 24 poles and 4 links to a stake corner to Lot No. 5; thence S. 65-1/2 deg. E. 170 poles and 8 links to a stake corner to Lot No. 5; thence N. 6-1/2 deg. E. 22 poles and 10 links to a stake corner to Lee Eakins near the gate; thence N. 1-1/2 deg. E. 2 poles and 22 links to the beginning, containing 25 acres.

TRACT 4: Lot No. 1 of the division of the John Curry land being a tract of land in Henderson County, Kentucky, near Robards, Kentucky, and bounded as follows: Beginning at a dead oak, corner to Mollie Eakins and Lee King; thence with King's line N. 31-3/4 E. 124 poles to a stake on East side of L & N R.R.; thence N. 88 W. 54 poles to a stake corner to Lee Eakins (16-1/2 feet left along this line for passway for balance of interests) thence S 6-1/2 W. 111 poles and 15 links to the beginning, containing 18.83 acres.

TRACT 5: A certain tract or parcel of land lying in Henderson County, Kentucky, on the East side of the L. & N.R.R. about one mile north of Robards and bounded as follows: Beginning at a point on the East line of the right of way of L. & N.R.R. Co., corner to W. A. Sandefur tract; thence S. 87 deg. E. 18-07/100 chains to a stake, corner to Ligon's land in the Sandefur line and 8 links S. 20 deg. W. from a sassafras tree 15 inches in diameter (2 black oaks down and gone); thence N. 20 deg. E. 17-44/100 chains to a stake corner to another tract of Samuel E. King and in the Ligon line; thence N. 59 deg. W. 36-45/100 chains to a point in the middle of what is called the Porter Public road a corner to another tract of Samuel E. King 3 small black gums and a dogwood gone, a stake on the east side of said road bears S. 59 deg. E. distant 27 links; thence S. 32-1/2 deg. W. 8-55/100 chains to a post in the east line of right of way of L. & N.R.R. Co.; thence with the east line of said right of way S. 23-1/2 deg. E. 29-60/100 chains to the beginning, containing 71-83/100 acres.

TRACT 6: A certain tract of land in Henderson County, Kentucky, beginning at a stake corner to Lot No. 6 in line No. 1; thence N. 65-1/2 W. 171 poles and 14 links to a stake corner to No. 6; thence S. 22 W 9 poles and 10 links to a stake corner No. 8, 9 and 1/2 of No. 7; thence S. 65-1/2 E. 119 poles and 2 links to a stake corner to Nos. 8, 9 and 1/2 of No. 7; thence N. 6-1/2 E. 10 poles and 10 links to the beginning, and containing 10 acres.

TRACT 7: A certain tract or parcel of land lying and being in the county and state aforesaid, bounded and described as follows: Being Lot No. 3 of the Commissioner's report and division of the lands of the late S. E. King, Lot No. 3 contains a part of Lot No. 2 of the order and part of Lot No. 3 the part of Lot No. 2 is bounded as follows: Beginning at a stone corner to Lot No. 2 of this division and Gus Porter at an angle of the Funston and Porter road; thence S. 58 E. 101 poles to a stake corner to Lot No. 2 in Dr. Ligon's line; thence N. 22 E. 33 poles to a stone corner to Dr. Ligon in the Long line; thence N. 58 W, 94 poles and 20 links to a stone corner to the Long tract in Gus Porter's line; thence S. 32 W. 32 poles and 20 links to the beginning, containing 20 acres, recorded in Deed Book 38, page 228, and dated October 31, 1906.

TRACT 8: A tract of land in the county of Henderson and State of Kentucky, and being Lot #2 of the Commissioner's report of lands of late S. E. King, deceased, and bounded as follows: Beginning at a stake corner to Lot #1 in the middle of the Funston and Porter road; thence S. 58 E. 94 poles to a stake corner to Lot #1; thence N. 32 E. 10 poles and 10 links to a stake corner to Lot #1, thence S. 50 E. 42 poles and 10 links to a stake corner to Lot #1 in Dr. Ligon's line; thence N. 22 E. 40 poles and 20 links to a stake corner to Lot #3, in Dr. Ligon's line, thence N. 58 S. 101 poles to a stake corner to Lot #3 and Gus Porter; thence N. 37 W. 30 poles to a stake corner to Gus Porter; thence S. 32-1/2 W. 36 poles and 24 links to the beginning, containing 37-80/100 acres.

TRACT 9: A certain tract or parcel of land lying and being in the county of Henderson and state of Kentucky, being Lot No. 1 of the commissioner's report of the division of the land of late S. E. King, deceased, and bounded as follows: Beginning at a stake in the middle of Funston and Porter road corner to Lee King's thence S. 58 E. 145 poles to a stone corner to Lee King in Dr. P. Ligon's line; thence N. 22 E. 50 poles and 15 links to a stake corner to Lot No. 2 in Dr. Ligon's line; thence N. 58 W. 42 poles and 10 links to a stake corner to Lot No. 2; thence S. 32 W. 10 poles and 10 links to a stake corner to Lot No. 2; thence N. 58 E. 94 poles to a stake in the middle of the Funston and Porter road corner to Lot No. 2; thence N. 58 E. 94 poles to a stake in the middle of the Funston and Porter road corner to Lot No. 2; thence S. 32-1/2 W. 39 poles and 16 links to the beginning, containing 37-80/100 acres.

TRACT 10: Lot No. 6 of the report of division and allotment aforesaid, the same being a tract of land in Henderson County, Kentucky, near the town of Robards, bounded as follows: Beginning at a stake corner to Lot No. 5; thence N. 65-1/2 W. 176 poles and 12 links to a stake corner to Lot No. 5; thence S. 22 W. 18 poles and 11 links to a stake corner to Lot No. 7; thence S. 65-1/2 E. 171 poles and 14 links to a stake in line of Lot No. 1 corner to No. 7; thence N 6-1/2 E. 19 poles and 15 links to the beginning, containing 20 acres.

TRACT 11: A parcel of land in Henderson County, Kentucky, near the town of Robards and bounded as follows: Beginning at an ash stump corner to J. W. Otey; thence with said Otey's line N 65-1/2 W 140 poles to a rock at the root of an ash tree; thence S. 22 W 28 poles and 13 links to a stake corner to Lot No. 3; thence with line of said lot S 65-1/2 E 151 poles and 20 links to a stake in Lee Eakins line corner to Lot No. 3; thence N 1-1/2 E 30 poles and 20 links to the beginning, containing 26 acres, together with right of way for passway 16-1/2 feet wide along the east line of lots numbers 3, 4, 5, 6, 7, 8, and 9 and along the north side of Lot No. 1.

TRACT 12: A certain piece or parcel of land in Henderson County, Kentucky, said land lies on the west side of the L & N R.R. and is the strip cut off by the said railroad from the 76 acre tract bought by J. W. Ligon from Adkins Wall. This tract is supposed to contain 12 acres. This land is bounded on the East by the L & N R.R. and south and west by Widow Catherine Curry land and J. W. Otey land and runs to a point at the northern extremity.

TRACT 13: Lot 3 of the division of John Curry estate and described as follows: A tract of land in Henderson County, Kentucky near the town of Robards and bounded as follows: Beginning at a stake corner to Lot #2 in the Lee Eakins line; thence N. 65-1/2 W. 151 poles and 20 links to a stake, corner to Lot #2; thence S. 22 W. 27 poles and 12 links to a stake corner to Lot #4; thence S 65-1/2 E. 163 poles and 10 links to a stake corner to Lot #4 in Lee Eakins line; thence N 1-1/2 E. 29 poles and 15 links to the beginning, containing 27 acres, together with right of way for passway 16-1/2 feet wide along the east line of Lots numbers 4, 5, 6, 7, 8, and 9 and north line of Lot #1.

TRACT 14: A certain tract or parcel of land lying in the County of Henderson, State of Kentucky, north of and in the vicinity of Robards and by survey made December 7th, 1898, bounded as follows: Beginning at a dead white oak corner to J. H. Funston, running thence with his line S. 88-1/2 W. 3.62 chains to a stake on the east side of dirt road; thence with east side of road S. 23 E. 41.07 chains to a stake at intersection of road; thence with N. W. Side of road N. 32-3/4 E. 30.88 chains to a stake in F. A. Porter's line 20 links from corner; thence with Funston's line N. 58 W. 36.34 chains to a black oak stump; thence S. 18-1/2 E. 4.44 chains to a white oak stump; thence S 2-1/2 E. 3.13 chains to the beginning, containing 64.88 acres.

The above 14 Tracts being the same property acquired by Leo King Farm, LLC by Deed dated January 1, 2015 of record in Deed Book 610, Page 673, in the Henderson County Clerk's office.

Tract 15: Being all of Lot 1 of the Hillary L. Raley Minor Subdivision as shown on plat of recorded in Plat book 5, Page 189, in the Henderson County Clerk's Office, to which plat reference is made for a more accurate description.

The above being the same property acquired by Leo King Farm, LLC by Deed dated January 1, 2015 of record in Deed Book 610, Page 672, in the Henderson County Clerk's office.

Tract 16:

A certain tract or parcel located approximately 0.7 miles northwest of the City of Robards, Kentucky on Ky Hwy 283 in Henderson County, and being more particularly described as follows:

Beginning at an iron pin set in the west right-of-way line of Ky Hwy 283, said point being located 30 feet west of the centerline of the existing pavement of said highway, being a corner to Doris Jean Hope lot, a plat of which is recorded in Plat Book 7 Page 62 in the Henderson County Court Clerk's Office, said point being located North 63 degrees 05 minutes 50 seconds West, 0.15 feet from a ½ inch rebar by PLS #1733 found near the southeast corner of said Hope lot, and said point being located 30 feet west of State Project (SP) 1278 Station 266+67.61; thence with said right-of-way line, running parallel with and 30 feet west of the centerline of the existing pavement of said Ky Hwy 283, the following six (6) calls:

- (1) SOUTH 07 DEGREES 29 MINUTES 32 SECONDS WEST, a distance of 419.73 feet to an iron pin set in said right-of-way line 30 feet west of Sta. 262+48.01;
- (2) SOUTH 07 DEGREES 02 MINUTES 21 SECONDS WEST, a distance of 488.42 feet to an iron pin set in said right-of-way line 30 feet west of Sta. 257+59.68;
- (3) SOUTH 07 DEGREES 09 MINUTES 31 SECONDS WEST, a distance of 435.64 feet to an iron pin set in said right-of-way line 30 feet west of Sta. 253+24.03;
- (4) SOUTH 07 DEGREES 06 MINUTES 24 SECONDS WEST, a distance of 461.45 feet to an iron pin set in said right-of-way line 30 feet west of Sta. 248+62.55;

- (5) SOUTH 07 DEGREES 13 MINUTES 57 SECONDS WEST, a distance of 608.04 feet to an iron pin set in said right-of-way line 30 feet west of Sta. 242+54.46;
- (6) SOUTH 07 DEGREES 15 MINUTES 43 SECONDS WEST, a distance of 503.65 feet to an iron pin set at the intersection of the west right-of-way line of said Ky Hwy 283, 30 feet west of the centerline of the existing pavement of same, and the north right-of-way line of Ky Hwy 416, 30 feet north of the centerline of the existing pavement of same, said Ky Hwy 416 right-of-way having been conveyed to the Commonwealth of Kentucky by L. B. Eblen in Deed Book 95 Page 364;

Thence with the north right-of-way line of said Ky Hwy 416, running parallel with and 30 feet north of the centerline of the existing pavement, the following three (3) calls:

- (1) SOUTH 88 DEGREES 39 MINUTES 57 SECONDS WEST, a distance of 142.94 feet to an iron pin set in said north right-of-way line;
- (2) around a curve to the left, through a central angle of 16 DEGREES 57 MINUTES 10 SECONDS, an arc distance of 319.26 feet, a chord bearing of SOUTH 80 DEGREES 11 MINUTES 22 SECONDS WEST, a distance of 318.09 feet to an iron pin set in said north right-of-way line;
- (3) SOUTH 71 DEGREES 42 MINUTES 47 SECONDS WEST, a distance of 241.60 feet to an iron pin set in said north right-of-way line, and being in the north line of Tract 3 of the Milton Crowder property recorded in Deed Book 429 Page 192;

Thence with said Crowder Tract 3, NORTH 81 DEGREES 55 MINUTES 09 SECONDS WEST, a distance of 723.82 feet to an iron pin set at the southeast corner of Tract 1 of the Milton Crowder property recorded in Deed Book 429 Page 192; thence with said Crowder Tract 1, the following four (4) calls:

- (1) NORTH 08 DEGREES 49 MINUTES 51 SECONDS EAST, a distance of 709.50 feet to an iron pin set at a corner to said Crowder Tract 1;
- (2) SOUTH 81 DEGREES 55 MINUTES 09 SECONDS EAST, a distance of 27.72 feet to an iron pin set at a corner to said Crowder Tract 1;
- (3) NORTH 15 DEGREES 34 MINUTES 51 SECONDS EAST, a distance of 846.12 feet to an iron pin set at a corner to said Crowder Tract 1;
- (4) NORTH 82 DEGREES 55 MINUTES 09 SECONDS WEST, a distance of 544.50 feet to the northwest corner of said Crowder Tract 1, being in the east line of Tract 2 of the Milton Crowder property recorded in Deed Book 429, Page 192, and being located South 62 degrees 49 minutes 21 seconds West, 25.00 feet from a reference iron pin set inside this, the Katherine Marshall property;

Thence with said Crowder Tract 2 and with Parcel B-Tract 1 of the Leo & Mark Mattingly property recorded in Deed Book 484 Page 281, NORTH 22 DEGREES 04 MINUTES 47 SECONDS EAST, a distance of 2088.00 feet to a wood fence corner post, said fence corner post being located North 19 degrees 15 minutes 25 seconds West, 25.00 feet from an iron pin set inside this, the Katherine Marshall property; thence SOUTH 63 DEGREES 05 MINUTES 50

7

SECONDS EAST, a distance of 840.15 feet to an iron pin set at the southwest corner of said Hope lot; thence with said Hope lot, SOUTH 63 DEGREES 05 MINUTES 50 SECONDS EAST, a distance of 461.07 feet to the point of beginning containing 108.1319 acres and being subject to all legal written and unwritten easements and rights of way. This description was prepared from a physical survey conducted under the direction of Dennis E. Branson, Ky PLS # 2532 on 5-03-03. All references herein to "iron pin set" are 5/8 inch smooth-sided iron pins 24 inches in length with a plastic cap bearing the number 2532. This survey was conducted by the method of closed random traverse, the unadjusted mathematical error of closure ratio of which was 1:97,131 with an angular error of 1 second per angle.

The above being the same property acquired by Leo King Farm, LLC by Deed dated January 1, 2015 of record in Deed Book 610, Page 680, in the Henderson County Clerk's office.

HOLDING PAGE FOR EXHIBIT B

Preliminary Lease and Easement Improvement Plan and Acreage Calculation
To be Delivered with Option Notice

HOLDING PAGE FOR EXHIBIT C

As Built Lease and Easement Improvements and Final Acreage Calculation

EXHIBIT D

Lease and Easement Compensation

[REDACTED]

[REDACTED]	[REDACTED]
[REDACTED]	[REDACTED]
[REDACTED]	[REDACTED]
[REDACTED]	[REDACTED]
[REDACTED]	[REDACTED]
[REDACTED]	[REDACTED]

[REDACTED]

[REDACTED]

(2) **Payment for Lease and Easements.**

[REDACTED]

[REDACTED]

[REDACTED]

[REDACTED]

[REDACTED]

(4) **Payment Allocation Schedule.** [REDACTED]

[REDACTED]

[REDACTED]

SOLAR LEASE AND EASEMENT AGREEMENT

1. **Parties.** This Solar Lease and Easement Agreement ("**Agreement**") is made and entered as of the 31 day of May, 2023 ("**Effective Date**"), by and between Laura Anne Logsdon and Derek H. Logsdon ~~and~~ a Herman Derek Logsdon, wife and husband ("**Owner**") and Sebree Solar II, LLC, a Delaware limited liability company ("**Operator**"), which are sometimes individually referred to as a "**Party**" and collectively as the "**Parties**".

2. **Project.** This Agreement relates to the solar-powered electrical power generation and transmission project known as the "Sebree Solar II Energy Center" to be located in Henderson County, Kentucky ("**Project**"), which may be wholly or partially located on the Owner's property legally described on the attached **Exhibit A** to this Agreement ("**Owner's Property**"). Upon Operator's exercise of the Option (as defined below), the Project shall include (i) the Lease of Owner's Property described in Section 4, (ii) the Easements referenced in Section 5 that are located on the Owner's Property, and (iii) the Improvements referenced in Section 8 to be constructed on Owner's Property. The Lease, Easements and Improvements are sometimes collectively referred to as the "**Operator Property**".

3. **Option.** Owner grants to Operator an exclusive option ("**Option**") to acquire the Lease and Easements referenced in Sections 4 and 5 in accordance with the following terms and conditions. Operator shall be entitled to acquire the Lease and the Easements in their entirety or in part, as Operator deems appropriate.

3.1 **Option Term.** The initial period during which Operator may exercise the Option shall be for a term of four (4) years, commencing on the Effective Date ("**Initial Option Term**"). Operator shall have a single election to extend the Initial Option Term for an additional one (1) year ("**Extended Option Term**") by written notice to Owner no later than thirty (30) days prior to the expiration of the Initial Option Term, which notice shall be accompanied by the Option Payment (as defined in **Exhibit D**). References herein to the Option Term shall mean the Initial Option Term and, to the extent exercised by Operator, the Extended Option Term, unless the context otherwise expressly requires.

3.2 **Option Payment.** As consideration for the granting of the Option, Operator agrees to pay Owner the Option Payment set forth in **Exhibit D**.

3.3 **Use of Owner's Property.** During the Option Term, Operator and its employees, agents and contractors shall have a right to enter upon the Owner's Property and the right of ingress and egress over and across the Owner's Property for the purposes of (i) surveying the Owner's Property; (ii) performing such other tests and studies as Operator may desire in connection with the Option, including, without limitation, environmental, avian and cultural resource assessments, and geotechnical, foundation and soil tests, provided that such activities do not unreasonably interfere with Owner's use of the Owner's Property; and (iii) installing, maintaining, operating, inspecting and removing one or more weather related instruments ("**Weather Instrument**") and fencing of said Weather Instrument and including the performance of all tests and studies associated therewith. Owner shall not permit any other individual or entity except Operator or its affiliates to install a Weather Instrument on Owner's Property.

2/20

3.4 **Right to Grant Option.** Owner warrants and represents to Operator that (i) the statements in Section 9 concerning Owner's title to the Owner's Property are true and correct; (ii) Owner has the authority to grant this Option to Operator without the consent or approval of any other party; and (iii) there are no other existing options, rights of first refusal, contracts to purchase, leases or mortgages that would prevent Operator from exercising its rights with respect to the Option.

3.5 **Exercise of Option.** Operator may exercise the Option by giving written notice to Owner ("**Option Notice**") at any time during the Option Term. Operator shall specify in the Option Notice the Commencement Date referenced in Section 6.1.1. On the Commencement Date, the Lease and Easements referenced in Sections 4 and 5 shall automatically become effective, and the Parties shall be subject to all of the terms and conditions of this Agreement with respect to such Lease and Easements and all rights and obligations relating thereto.

3.6 **Termination of Option.** If Operator fails to exercise the Option within the Option Term, the Option and the rights of Operator as the optionee shall automatically terminate.

4. **Lease.** Upon exercise of the Option by Operator, Owner leases to Operator, and Operator leases from Owner, Owner's Property for the Lease and Easement Term (defined in Section 6.1) in accordance with the terms and conditions of this Agreement ("**Lease**"), which Lease grants Operator and its agents, contractors, and employees the right to use the Owner's Property for the following permitted uses:

4.1 **Construction Right.** Operator leases Owner's Property for the purpose of constructing, operating, maintaining, repairing, replacing, and removing all or any part or component of the Improvements whether located on Owner's Property. Operator may exercise its right to use all or any part of the Owner's Property as and when Operator deems it necessary or advisable to do so to perform the activities for which this right is granted, including, without limitation, staging areas and parking for Operator's employees.

4.2 **Access Right.** Operator leases Owner's Property for unobstructed vehicular and pedestrian access and ingress to and egress from the Improvements, Owner's Property and any public roadways, and to construct, maintain, and utilize Roadway Improvements on the Owner's Property. Owner shall not permit others to obstruct or damage the roads or Roadway Improvements located on the Owner's Property or in any other way interfere with Operator's rights under this right. Operator shall repair any damage done to Roadway Improvements which result from use by Operator, its agents, servants or employees. Such roads shall be maintained in the condition necessary for use by Operator's equipment, and with regard to existing roads, shall be maintained in at least the condition that existed prior to Operator's use.

4.3 **Solar Panels Right.** Operator leases Owner's Property for Operator to construct, operate, replace, relocate, remove, and maintain Solar Panels and the appurtenant Collection Facilities, together with associated roads and parking areas on Owner's Property.

4.4 **Collection Facilities Right.** Operator leases Owner's Property for Operator to construct, operate, maintain, replace, relocate or remove Collection Facilities on and under the Owner's Property.

4.5 **Substation Right.** Operator leases Owner's Property for Operator to construct, operate, maintain, replace, relocate or remove one or more Substations on Owner's Property.

4.6 **Telecommunication Right.** Operator leases Owner's Property for Operator to construct, operate, maintain, replace, relocate or remove Telecommunication Facilities on and under the Owner's Property.

4.7 **Weather Instrument Right.** Operator leases Owner's Property in order to construct, operate, replace, relocate, remove, and maintain a Weather Instrument and the appurtenant Collection Facilities on Owner's Property.

4.8 **Battery Facilities Right.** Operator leases Owner's Property in order to construct, operate, replace, relocate, remove, and maintain one or more Battery Facilities on Owner's Property.

5. **Grant of Easements.** Upon the exercise of the Option by Operator, Owner grants to Operator, and Operator accepts from Owner, for the Lease and Easement Term referenced in Section 6.1, the following easements over and across the Owner's Property in accordance with the terms and conditions of this Agreement. The following easements are for the benefit of Operator and Operator's agents, contractors and employees and located on the Owner's Property and are collectively referred to as the "**Easements**".

5.1 **Sun Non-Obstruction Easement.** Owner grants Operator an irrevocable, exclusive easement for the right and privilege to use, maintain and capture the free and unobstructed sunlight over and across the Owner's Property. Owner shall not engage in any activity on Owner's Property or any other neighboring property owned by Owner that might interfere with the sunlight direction over any portion of Owner's Property; cause a decrease in the output or efficiency of any Solar Panel or Weather Instrument; or otherwise interfere with Operator's operation of the Project or exercise of any rights granted in this Agreement (collectively "**Interference**"). This grant of the easement expressly includes the right of Operator to enforce Operator's rights, including the physical removal of trees or structures (except existing trees and structures) causing Interference to the Project contemplated by Operator. Operator shall notify Owner before making any such removals.

5.2 **Effects Easement.** Owner grants to Operator an easement over Owner's Property for visual, view, light, flicker, noise, shadow, vibration, electromagnetic, electrical and radio frequency interference, and any other effects attributable to the Project located on the Owner's Property.

6. **Term.** The term of this Agreement ("**Term**") includes the Option Term referenced in Section 3.1, the Initial Lease and Easement Term as described in Section 6.1.1 and the Extended Lease and Easement Term as described in Section 6.1.2 (together, the Initial Lease and Easement Term and the Extended Lease and Easement Term, if applicable, is defined as the "**Lease and Easement Term**").

6.1 **Lease and Easement Term.**

6.1.1 **Initial Lease and Easement Term.** The initial term of the Lease and Easements shall commence on the date specified by Operator in the Option Notice ("**Commencement Date**"). The initial term of the Lease and Easements shall end thirty (30) years after the Commencement Date (the "**Initial Lease and Easement Term**"), subject to the rights of renewal and termination as provided in this Agreement.

Extended Lease and Easement Term. Operator shall have the right to extend the Term of this Agreement for two (2) consecutive terms of five (5) years each in accordance with the terms and provisions of this Agreement (collectively "**Extended Lease and Easement Term**") by providing written notice to Owner of Operator's intent to extend the Term within one hundred eighty (180) days of the end of the existing Term. Each Extended Lease and Easement Term shall begin on the expiration date of the Initial Lease and Easement Term or previous Extended Lease and Easement Term, as the case may be. During the Extended Lease and Easement Term, Operator shall pay Owner the amounts set forth in **Exhibit D** as the consideration for the Lease and Easements.

6.1.2 **Delays During Lease and Easement Term.** At Operator's option, the Term may be extended for a period of time equal to the period of time during which operation of the Project is delayed or suspended because of the occurrence of a Regulatory Suspension or Force Majeure, which are defined as follows:

(i) "**Regulatory Suspension**" shall mean the enactment or application of any law, order, rule, or regulation of the Kentucky Public Service Commission, Federal Energy Regulatory Commission, or other local, state, or federal government authority having jurisdiction over the Project or Operator, or the failure of any such governmental authority to issue an approval or permit pursuant to any such law, order, rule, or regulation, which results in the delay, interruption, or suspension of the production, sale or transmission of electricity from the Solar Panels; and

(ii) "**Force Majeure**" shall mean causes beyond the reasonable control of and without the fault or negligence of the Party claiming Force Majeure, including but not limited to acts of God, labor unrest (including, but not limited to, slowdowns, picketing, boycotts or strikes), flood, earthquake, storm, fire, lightning, explosion, power failure or power surge, vandalism, theft, the cutting of power, transmission or other lines, wires or cables to the Project by persons other than Operator's employees or contractors, epidemic, war, revolution, riot, civil disturbance, sabotage, change in law or applicable regulation subsequent to the Commencement Date and action or inaction by any federal, state or local legislative, executive, administrative judicial agency or body which in any of the foregoing cases, by exercise of due foresight such Party could not reasonably have expected to avoid, and which, by the exercise of due diligence, it is unable to overcome.

The Parties shall be excused from performing their respective obligations under this Agreement and shall not be liable in damages or otherwise if and to the extent that they are unable to so perform or are prevented from performing by a Force Majeure, provided that: (i) the non-performing Party, as promptly as practicable after the occurrence of the Force Majeure, but in no event later than thirty (30) days thereafter, gives the other Party written notice describing the particulars of the occurrence; (ii) the suspension of performance is of no greater scope and of no longer duration than is reasonably required by the Force Majeure; (iii) the non-performing Party uses

good faith and commercially reasonable efforts to remedy its inability to perform; and (iv) as soon as the non-performing Party is able to resume performance of its obligations excused as a result of the occurrence, each Party shall give prompt written notification thereof to the other Party.

6.2 **Termination by Operator.** Provided Operator is not in default under any term of this Agreement, Operator, at its option, shall have the right to terminate this Agreement at any time during the Term of the Agreement, as to all or any part of the Operator Property. Termination shall be effective thirty (30) days after written notice of such termination to Owner. If Operator's notice is a full termination of the Operator Property, the Parties shall be relieved of all further duties and obligations under this Agreement, other than (i) the payment of any accrued and unpaid obligations owed by either Party as of the date of termination; (ii) the removal of the Improvements by Operator pursuant to Section 8.11; and (iii) any other obligations and liabilities that are expressly stated in this Agreement to survive such termination. Upon any such partial termination by Operator, the Parties shall be relieved of all further duties and obligations under this Agreement with respect to the portion thereof terminated by Operator, subject to the obligations and liabilities referenced in items (i) through (iii) above that shall continue to be applicable to the terminated portion of this Agreement. The Parties agree to execute an amendment to this Agreement evidencing such partial termination.

7. **Payments.** If Operator exercises the Option referenced in Section 3, Operator agrees to pay Owner the amounts set forth in **Exhibit D** as consideration for the Lease, Easements and Operator's other rights and interests in the Owner's Property.

8. **Improvements.** Operator shall have the right, at its sole cost and expense, to construct, install, maintain, use, operate, repair, replace, relocate and remove all facilities, structures, equipment, machinery, wires, conduit, cables, poles, materials and property of every kind and character required for the construction and operation of portions of the Project on the Owner's Property, including, but not limited to, the Solar Panels, Collection Facilities, Substations, Telecommunication Facilities, Weather Instruments, Roadway Improvements and Battery Facilities referenced in Sections 8.1 through 8.7 (collectively, the "**Improvements**").

8.1 "**Solar Panels**" shall mean any photovoltaic energy system designed for the generation of electrical power from the collection of sunlight, including without limitation, the photovoltaic panels, foundations, support structures, braces and related equipment.

8.2 "**Collection Facilities**" shall mean all Improvements whose purpose is to deliver electrical power generated by the Solar Panels to an electrical power grid or other system, including without limitation transformers, overhead and underground electrical collection lines, telecommunication lines, splice boxes and interconnection facilities.

8.3 "**Substations**" shall mean electrical lines, meters, monitoring and control equipment, switches, transformers, all structures, equipment, enclosures, fencing, security devices, and other electrical and communications equipment necessary to condition and increase the voltage of electricity generated by the Project to make it suitable for transmission on, and to deliver it to, Collection Facilities connected to an electric power grid or other system.

8.4 "**Telecommunication Facilities**" shall mean all Improvements whose purpose is to provide telecommunication services solely relating to the Project or any of Operator's solar powered projects, including telephone, closed-circuit television, microwave, internet, computer data and other telecommunication services.

8.5 "**Weather Instrument**" shall mean instruments used primarily to gather and transmit sunlight and meteorological data relating to the Project, and includes the instrument's foundations, guy wires, sunlight and meteorological data acquisition equipment, power source, and any required data and electrical transmission lines.

8.6 "**Roadway Improvements**" shall mean all improvements that may be necessary to construct, maintain and repair any new and existing roadways and other means of ingress and egress over, across and along the Owner's Property, including paving or surfacing of the roadways with asphalt, gravel or other roadway materials, installation of road signs and the construction and installation of culverts, bridges, drainage ditches, gates, cattle guards and similar structures and facilities.

8.7 "**Battery Facilities**" shall mean a type of equipment that can be given a new charge by passing an electric current through it designed for the storage of electrical power including without limitation, batteries and other devices for storage of electrical energy, foundations, support structures, braces and related equipment.

8.8 **Ownership of Improvements.** Except as otherwise provided in Section 11.7, all Improvements shall at all times remain the property of Operator, and Owner shall have no right, title or interest therein. All Improvements constructed or placed on the Owner's Property by Operator during the Term of this Agreement may be repaired, replaced, relocated, removed, added to or expanded upon by Operator at any time during the Term of this Agreement. Owner expressly waives any statutory lien or common law liens on the Improvements to which Owner might be entitled.

8.9 **Construction Liens.** Operator shall not permit any liens arising out of Operator's use of the Operator Property under this Agreement to be filed against the Owner's Property. Operator shall, within sixty (60) days after it receives notice of the lien, provide a bond or other security that Owner may reasonably request, or remove such lien from the Owner's Property in the manner provided by applicable law.

8.10 **Location of Improvements.** The acreage required from the Owner's Property for the Improvements for which the Lease and Easements are being granted cannot be determined until the completion of Operator's inspection, testing, study and surveying of the Owner's Property during the Option Term. Along with the Option Notice, Operator shall deliver to Owner a proposed plan of development showing the contemplated locations of the Improvements and a preliminary calculation of the acreage as determined by the area bounded by a perimeter fence required for the Project, which shall serve as the **Exhibit B** to this Agreement. During the final development and construction of the Project, such locations may need to be amended. Following construction of the Project, Operator shall provide Owner an "as-built" survey of all Improvements on Owner's Property and the final calculation of the acreage as determined by the area bounded by a perimeter fence required for the Project, which shall serve as **Exhibit C** to this Agreement.

Further, following construction, the Improvements may need to be relocated or rerouted by Operator, which Operator may perform, at any time during the Term of this Agreement, so long as the nature and extent of any such relocated or rerouted Improvements are not materially different and impose no materially greater burden on the Owner's Property than the original locations or routes, and so long as Operator takes commercially reasonable efforts to minimize disruption or inconvenience to Owner. Operator shall not install any Improvements in the Exclusion Area depicted in Exhibit B-1 without obtaining the consent of Owner. Operator shall not construct access roads in the Exclusion Area depicted in Exhibit B-1. After construction of Improvements, Owner shall retain access, subject to Operator's review and approval, to unused areas outside of Project perimeter fence, for the purpose of farming and crop maintenance.

8.11 **Removal of Improvements.** Upon full or partial termination of any of the Lease Rights or Easements, Operator shall remove all Improvements and restore the area formerly occupied by the Improvements to substantially the same physical condition that existed immediately before the construction of the Improvements (the "**Removal Obligations**"). At Owner's request, all or any part of the Roadway Improvements may be left for use by Owner.

9. **Ownership and Title Matters.** Owner warrants and represents to Operator, both as of the Effective Date, and as of the Commencement Date as follows:

9.1 **Authority.** Owner represents and warrants that it is the holder of fee simple title and is the sole owner of the Owner's Property and has the unrestricted right and authority to sign this Agreement and to grant Operator the Lease and Easements and other rights granted in this Agreement. When signed by both Parties, this Agreement constitutes a valid and binding agreement enforceable against Owner in accordance with its terms.

9.2 **Other Agreements.** The Owner's Property is not subject to any other agreements, options, rights of first refusal or other prior right of any party to purchase, lease or acquire easements in the Owner's Property, or create any prior claim or right that would preclude or interfere with Operator's rights and interests under this Agreement and the Lease and Easements.

9.3 **Minerals.** Except as disclosed by Owner to Operator at the time of the execution of this Agreement by Owner, Owner owns all of the oil, gas and other minerals, and all rights thereto as on or under the Owner's Property.

9.4 **Owner Mortgage.** Except as disclosed by Owner to Operator at the time of the execution of this Agreement by Owner, there are no mortgages encumbering the Owner's Property ("**Owner Mortgage**").

9.5 **Notice and Opportunity to Cure.** If there is an Owner Mortgage encumbering Owner's Property and Owner receives from the holder thereof any notice that payments are overdue, Owner shall notify Operator and each Operator Mortgagee (as defined at Section 13.1) by sending a copy of such overdue payment notice to Operator by the earlier of (i) five (5) days after receipt, or (ii) three (3) business days prior to the date by which a default under or in respect of such Owner Mortgage could occur. If Operator or any Operator Mortgagee determines that it would be in Operator's interest to make such payments to Owner Mortgagee on Owner's behalf, whether as a result of receiving such notice or otherwise, Operator shall have the right to make

such payments and to credit the payments so made against the Annual Installment Payment next due under the Agreement.

9.6 **Subordination, Non-Disturbance & Attornment Agreement.** If there is an Owner Mortgage encumbering Owner's Property, Owner shall cooperate with Operator to obtain a Subordination, Non-Disturbance and Attornment Agreement ("SNDA") in the form prepared and provided by Operator, from each Owner Mortgagee, pursuant to which such Owner Mortgagee agrees, among other things, not to disturb Operator's possession and use of the Owner's Property. Owner shall not incur any loss in income, expense, obligation or liability with regard to the SNDA. Operator shall, at its sole cost and expense, record each such SNDA in the Office of the County Clerk in which Owner's Property is located. If Owner fails to deliver a SNDA from each Owner Mortgagee, Operator may, at its sole option, either (i) terminate this Agreement immediately upon written notice to Owner, or (ii) take such action as Operator deems reasonably necessary to effect the rights granted to Operator hereunder, and off-set all amounts expended in such efforts against the Annual Installment Payments and any other amounts due hereunder or in respect hereof.

10. **Representations and Warranties of Owner.** Owner hereby makes the following further representations and warranties both as of the Effective Date, and as of the Commencement Date:

10.1 **Physical Condition.** Owner has no knowledge of any existing physical conditions of the Owner's Property which would prevent, significantly restrict or make more expensive Operator's development of the Owner's Property for the purposes specified in this Agreement, or which could, with the passage of time, or the giving of notice, constitute a violation of any currently applicable governmental law, ordinance, order, rule or regulation.

10.2 **Legal Restrictions.** Owner has no knowledge of any law, regulation, ordinance or order of any local, state or federal governmental authority which would prohibit or significantly restrict Operator's development of the Owner's Property pursuant to this Agreement. This Agreement does not violate any contract, agreement, instrument, judgment or order to which Owner is a party or which affects the Owner's Property. To the best of Owner's knowledge, the Owner's Property is currently in full and complete compliance with all governmental laws, ordinances, orders, rules and regulations applicable to the Owner's Property.

10.3 **No Litigation.** No litigation is pending and, to the best of Owner's knowledge, no litigation or administrative actions are proposed, threatened or anticipated with respect to any matter affecting the Owner's Property. If Owner learns of any litigation or administrative action proposed, threatened or instituted with respect to the Owner's Property, Owner shall give Operator notice within thirty (30) days thereof.

10.4 **Survival.** The representations and warranties set forth in this Section 10 shall survive the execution and delivery hereof.

11. **Use, Operation and Maintenance.**

11.1 **Exclusive Use by Operator.** Operator shall have the exclusive right (i) to use and possess the Owner Property in connection with the Project and other similar solar-powered electrical power generation projects; (ii) to investigate, inspect, survey, and conduct tests of the

Owner's Property, including, but not limited to, meteorological, environmental, archeological and geotechnical tests and studies; (iii) to use and convert all of the sunlight resources on the Owner's Property; and (iv) to undertake such other activities on the Owner's Property that may be related to the Project, including, without limitation, the storage of Solar Panels, materials and equipment during the installation and construction of the Improvements; development and operation of communications systems; and site tours of the Project for visitors and other interested parties.

11.2 **No Required Installation or Operation**. Nothing in this Agreement shall be interpreted as imposing on Operator any obligation to install Solar Panels or other Improvements on the Owner's Property, or to operate the Project on the Owner's Property. Operator shall have the sole discretion to determine if and when any Solar Panels and other Improvements may be constructed on Owner's Property, and if and when to commence the operation of the Project on the Owner's Property.

11.3 **Permits and Approvals**. Operator shall be responsible, at its sole cost and expense, for obtaining any governmental permits and approvals necessary for the construction and operation of the Project and the construction and operation of the Improvements. Owner shall cooperate with Operator as necessary to obtain any governmental or utility approvals or permits, including, without limitation, signing any applications for such approvals, provided that Owner shall not incur any loss in income, expense, obligation or liability with respect to Operator obtaining such permits or approvals.

11.4 **Compliance with Laws**. Operator shall comply in all material respects with valid laws applicable to the Owner's Property and the Operator Property. Operator shall have the right, in its sole discretion and at its sole expense, in Operator's name to contest the validity or applicability to the Owner's Property and the Operator Property of any law, ordinance, statute, order, regulation, property assessment or the like made by any governmental agency or entity. Operator shall control any such contest and Owner shall cooperate with Operator in every reasonable way in such contest, provided that Owner shall incur no expense, obligation or liability with regard to such contest.

11.5 **Care and Appearance**. Operator, in its exercise of the lease, easement and other rights granted hereunder shall, at all times, maintain the Owner's Property and the Improvements in a reasonably neat, clean and presentable condition. Operator shall not willfully or negligently damage or destroy the Owner's Property and shall keep the Owner's Property clean and free of debris created by Operator, its contractors, or others brought on to the Owner's Property by Operator. Operator shall not use the Owner's Property for storage, except for materials, construction equipment and vehicles directly associated with construction or maintenance of the Improvements on the Owner's Property or adjacent properties that are part of the Project.

11.6 **Fences and Gates**. At Owner's request, Operator shall repair or replace any fences, gates or cattle guards damaged or removed in connection with Operator's activities on the Owner's Property. Fences removed from the Owner's Property, if replaced, shall be re-built by Operator at its expense in mutually agreeable locations. All fence repair and construction shall be substantially similar to the construction of existing fences and cattle guards on Owner's Property. Any gates opened for access to Owner's Property by either Party shall be closed immediately after passing through so that livestock may not pass through. Once completed, all replacement fences,

gates and cattle guards shall be owned and maintained by Owner. To minimize the need for temporary fencing, Owner will cooperate with Operator to avoid pasturing animals on or near the Improvements during periods of construction, maintenance or removal activity by Operator. Owner will discuss with Operator what temporary fencing is necessary during the periods of construction, maintenance or removal activity by Operator. Upon abandonment or termination of the rights granted to Operator, any fences, gates and cattle guards installed by Operator shall be removed and Operator shall restore the area formerly occupied by the any fences, gates and cattle guards to substantially the same physical condition that existed immediately before installation of the same.

11.7 **Roadway Maintenance and Repairs.** Operator agrees to maintain and repair all Roadway Improvements located on the Operator Property; provided, however, Owner shall reimburse Operator for any costs and expenses incurred by Operator to repair any damage or perform any special maintenance of the Roadway Improvements caused by Owner or any person using the Roadway Improvements with Owner's permission, other than Operator.

12. **Taxes.**

12.1 **Owner's Taxes.** Owner covenants and agrees to pay prior to delinquency all real and personal property and other taxes, general and special assessments, and other charges of every description ("**Taxes**") levied or assessed against the Owner's Property and all improvements thereon by governmental authorities, other than Operator's Taxes referenced in Section 12.2 (Taxes, excepting Operator's Taxes, are hereinafter referred to as "**Owner's Taxes**").

12.2 **Operator's Taxes.** 



12.3 **Failure to Pay.** In the event either Party fails to pay their share of Taxes prior to delinquency, the other Party shall have the right to pay such Taxes and any accrued penalties or interest, which payments shall increase or be offset against other Payments due under this Agreement.

2020

12.4 **Operator's Right to Contest.** Operator may contest the legal validity or amount of any Operator's Taxes for which it is responsible under this Agreement, and may institute such proceedings as it considers necessary, provided that Operator shall bear all expenses in pursuing such contest or proceeding. With respect to any Taxes which may constitute a lien on the Owner's Property, Operator shall promptly pay such Taxes unless the proceeding in which it contests such Taxes shall operate to prevent or stay the collection of the Taxes so contested or unless Operator removes any such lien by bonding or otherwise. Owner agrees to render to Operator all reasonable assistance in contesting the validity or amount of any such Taxes, with the exception of Taxes levied by Owner, including joining in the signing of any reasonable protests or pleading which Operator may deem advisable to file; provided, however, that Operator shall reimburse Owner for its reasonable out-of-pocket expenses, including reasonable attorneys' fees incurred in connection with providing such assistance.

13. **Mortgage of Operator Property.**

13.1 **Right to Mortgage.** Operator may, upon written notice to Owner, but without requiring Owner's consent or approval, mortgage, collaterally assign, or otherwise encumber and grant security interests in all or any part of its interest in this Agreement and the Operator Property. These various security interests in all or a part of this Agreement and the Operator Property are collectively referred to as an "**Operator Mortgage**" and holder of such security interest, an "**Operator Mortgagee**". Any Operator Mortgagee shall use the Operator Property only for the uses permitted under this Agreement. Whenever Operator has granted a security interest under this Section 13, it will give Owner notice of the Operator Mortgage (including the name and address of the Operator Mortgagee for notice purposes) to Owner within thirty (30) days; provided that failure to give this notice shall not constitute a default under this Agreement, but rather shall only have the effect of not binding Owner to provide such Operator Mortgage notice until the Operator and its address is given to Owner.

13.2 **Notice of Default and Opportunity to Cure.** As a precondition to exercising any rights or remedies related to any alleged default by Operator under this Agreement, Owner shall give written notice of the default to each Operator Mortgagee at the same time it delivers notice of default to Operator, specifying in detail the alleged event of default and the required remedy. Each Operator Mortgagee or its designee shall have the right, but not the obligation, to cure any default as Operator, and/or the right, but not the obligation, to remove any Improvements or other property owned by Operator or such Operator Mortgagee located on the Owner's Property to the same extent as Operator. The cure period for any Operator Mortgagee shall be the later of (i) the end of the Operator cure period under Section 18; (ii) thirty (30) days after such Operator Mortgagee's receipt of the default notice; or (iii) if applicable, the extended cure period provided for in Section 13.3. Failure by Owner to give an Operator Mortgagee notice of default shall not diminish Owner's rights against Operator, but shall preserve all rights of the Operator Mortgagee or its designee to cure any default and to remove any Improvements or other property of Operator or the Operator Mortgagee located on the Owner's Property.

13.3 **Extended Cure Period.** If any default by Operator under this Agreement cannot be cured without the Operator Mortgagee obtaining possession of all or part of the Operator Property, then any such default shall be deemed remedied if an Operator Mortgagee: (i) within sixty (60) days after receiving notice from Owner as set forth in Section 13.2, acquires possession

Set 11

of all or part of the Operator Property, or begins appropriate judicial or nonjudicial proceedings to obtain the same; (ii) diligently prosecutes any such proceedings to completion; and (iii) after gaining possession of all or part of the Operator Property performs all other obligations as and when the same are due in accordance with the terms of this Agreement. If an Operator Mortgagee is prohibited by any court or by operation of any bankruptcy or insolvency laws from commencing or prosecuting the proceedings described above, the sixty (60) day period specified above for commencing proceedings shall be extended for the period of such prohibition.

13.4 **Operator Mortgagee Liability.** Any Operator Mortgagee whose interest in the Operator Property is held solely for security purposes, shall have no obligation or liability under this Agreement unless and until the Operator Mortgagee succeeds to absolute title to the Operator Property and the rights of Operator under this Agreement. An Operator Mortgagee shall be liable to perform obligations under this Agreement only for and during the period it directly holds such absolute title.

13.5 **Certificates.** Owner shall execute any estoppel certificates (certifying as to truthful matters, including without limitation that no default then exists under this Agreement, if such be the case), consents to assignment and non-disturbance agreements as Operator or any Mortgagee may reasonably request from time to time. The Parties shall negotiate in good faith any amendment to this Agreement from time to time to include any provision that may be reasonably requested by Operator or any Operator Mortgagee to implement the provisions contained in this Agreement or to preserve an Operator Mortgagee's security interest.

13.6 **Operator Mortgagee's Right to Enforce Mortgage and Assign.** Each Operator Mortgagee shall have the right, in its sole discretion: (i) to assign its Operator Mortgage; (ii) to enforce its lien and acquire title to all or any portion of the Operator Property by any lawful means; (iii) to take possession of and operate all or any portion of the Operator Property and to perform all obligations to be performed by Operator under this Agreement, or to cause a receiver to be appointed to do so; and (iv) to acquire all or any portion of the Operator Property by foreclosure or by an assignment in lieu of foreclosure and thereafter to assign or transfer all or any portion of the Operator rights under this Agreement to a third party in accordance with Section 14. Any Operator Mortgagee or other party who acquires Operator's interest in all or a portion of the Operator Property pursuant to foreclosure or assignment in lieu of foreclosure shall not be liable to perform the obligations imposed on Operator by this Agreement, which are incurred or accruing after such Operator Mortgagee or other party no longer has ownership or possession of the Operator Property.

13.7 **New Agreement.**

13.7.1 If the Operator Property is foreclosed upon or there is an assignment in lieu of foreclosure, or if this Agreement is rejected or disaffirmed pursuant to bankruptcy law or other law affecting creditor's rights and, within ninety (90) days after such event, Operator or any Operator Mortgagee or other purchaser at a foreclosure sale shall have arranged to the reasonable satisfaction of Owner to cure any material defaults under this Agreement, and for the payment of all Annual Installment Payments or other charges due and payable by Operator as of the date of such event, then Owner shall execute and deliver to Operator or such Operator Mortgagee or other purchaser at a foreclosure sale, or to a designee of one of these parties, as the case may be, a new

agreement ("**New Agreement**") which (i) shall be for a term equal to the remainder of the Term of this Agreement before giving effect to such rejection or termination; (ii) shall contain the same covenants, agreements, terms, provisions and limitations as this Agreement (except for any requirements that have been fulfilled by Operator or any Operator Mortgagee or other purchaser at a foreclosure sale prior to rejection or termination of this Agreement); and (iii) shall include that portion of the Operator Property in which Operator or such other Operator Mortgagee or other purchaser at a foreclosure sale had an interest on the date of rejection or termination.

13.7.2 If more than one Operator Mortgagee makes a written request for a New Agreement pursuant to this provision, the New Agreement shall be delivered to the Operator Mortgagee requesting such New Agreement whose Operator Mortgage is prior in time, and the written request of any other Operator Mortgagee whose lien is subordinate shall be void and of no further force or effect. The provisions of this Section 13 shall survive the termination, rejection or disaffirmation of this Agreement and shall continue in full force and effect thereafter to the same extent as if this Section 13 were a separate and independent contract made by Owner, Operator and each Operator Mortgagee, and, from the effective date of such termination, rejection or disaffirmation of this Agreement to the date of execution and delivery of such New Agreement, such Operator Mortgagee or other purchaser at a foreclosure sale may use and enjoy the Operator Property without hindrance by Owner or any person claiming by, through or under Owner; provided that all of the conditions for the New Agreement as set forth above are complied with.

13.8 **Operator Mortgagee's Consent to Amendment, Termination or Surrender.** Notwithstanding any provision of this Agreement to the contrary, the Parties agree that so long as any Operator Mortgage remains outstanding, this Agreement shall not be modified or amended, and Owner shall not accept a surrender, cancellation or release of all or any part of the Operator Property from Operator, prior to expiration of the Term of this Agreement, without the prior written consent of the Operator Mortgagee holding such Operator Mortgage. This provision is for the express benefit of and shall be enforceable by each Operator Mortgagee as if it were a party named in this Agreement.

14. **Assignment and Sublease.** Operator shall have the right, without Owner's consent, to sell, convey, lease, or assign all or any portion of this Agreement or the Operator Property, on either an exclusive or a non-exclusive basis, or to grant subeasements, co-easements, easements, licenses or similar rights with respect to the Operator Property (collectively, "**Assignment**"), to one or more persons or entities (collectively "**Assignee**"). Each Assignee shall use the Operator Property only for the uses permitted under this Agreement. When Operator makes any Assignment under this Section 14, Operator shall give written notice to Owner of such Assignment (including the interest conveyed by the Assignment and address of the Assignee for notice purposes) to Owner; provided Operator's failure to give such notice shall not constitute a default under this Agreement, but rather shall only have the effect of not binding Owner with respect to such assignment or conveyance until such notice is given. Any Assignment by Operator shall release Operator from obligations subject thereof accruing after the date that liability for such obligations is assumed by the Assignee.

15. **Hazardous Materials.**

15.1 **Owner's Covenants Regarding Hazardous Materials.** Owner represents and warrants that, to the best of Owner's knowledge, the Owner's Property is not and has not been in violation of any federal, state or local environmental health or safety laws, statute, ordinance, rule, regulation or requirement ("**Environmental Laws**"), and Owner has not received any notice or other communication from any governmental authorities alleging that the Owner's Property is in violation of any Environmental Laws. "**Hazardous Materials**" shall mean any asbestos containing materials, petroleum, explosives, toxic materials, or substances regulated as hazardous wastes, hazardous materials, hazardous substances, or toxic substances under any federal, state, or local law or regulation. Owner warrants that Owner has done nothing to contaminate the Operator Property with Hazardous Materials or wastes.

15.2 **Operator's Covenants Regarding Hazardous Materials.** Operator shall, at Operator's sole cost and expense, promptly take removal or remedial action required by Environmental Law with regard to any material violation of any Environmental Law with regard to any Hazardous Materials brought onto the Owner's Property by Operator or its employees, agents, or contractors. Owner shall cooperate with Operator with regard to any scheduling or access to the Owner's Property in connection with any action required hereunder.

15.3 **Operator's Indemnity Regarding Hazardous Materials.** Operator shall indemnify, defend, protect and hold Owner harmless from any liability based on: (i) the release of Hazardous Materials in, on, under or about the Owner's Property caused by Operator or its employees, agents, or contractors, or (ii) the violation by Operator or its employees, agents, or contractors of any Environmental Law. The indemnity obligations set forth herein shall survive termination of this Agreement.

16. **Insurance and Indemnity.**

16.1 **Insurance.** At all times during which Operator is conducting any activities on the Property and at all times during the Term of this Agreement, Operator shall maintain in effect (1) commercial General Liability Insurance, including bodily injury and property damage coverage with minimum limits of \$1 Million Dollars per occurrence and \$2 Million Dollars aggregate and (2) Umbrella Liability Insurance with minimum limits of \$5 Million Dollars per occurrence and \$5 Million Dollars aggregate. Upon a written request by Owner, Operator shall name Owner as additional insured on such insurance policy and provide Owner with a certificate of such insurance.

16.2 **Indemnity by Operator.** Operator shall defend, indemnify, protect and hold Owner harmless from and against all liabilities, costs, expenses, obligations, losses, damages, claims, (collectively "**Claims**") resulting from the negligence, willful misconduct, or breach of this Agreement by Operator, its agents, contractors or employees, invitees, licensees and permittees; provided, however, that such Claims are not due to the sole negligence, willful misconduct, or breach by Owner, its agents, contractors or employees, invitees, licensees or permittees.

16.3 **Indemnity by Owner.** Owner shall defend, indemnify, protect, and hold Operator harmless from and against all Claims resulting from the negligence, willful misconduct, or breach of this Agreement by Owner, its agents, contractors or employees, invitees, licensees and permittees; provided, however, that such Claims are not due to the sole negligence, willful

misconduct, or breach by Operator, its agents, contractors, employees, invitees, licensees, or permittees.

16.4 **Survival.** The obligations of the Parties under this Section 16 shall survive expiration or other termination of this Agreement.

17. **Confidentiality.** This Agreement includes confidential and proprietary information relating to Operator and the Project. Owner agrees not to provide copies of the Agreement or disclose the terms of the Agreement to any unauthorized person or entity. Operator authorizes Owner to provide copies of the Agreement and disclose the terms thereof to Owner's family ("family" shall be deemed to include all devisees or descendants of owner by will or intestacy), attorney, accountant, financial advisor and any existing or prospective mortgagee, lessee, or purchaser for the sole purpose of evaluating and advising Owner and for no other purpose, so long as such authorized parties agree in writing to become subject to the confidentiality provisions hereto and not to provide copies of the Agreement or disclose the terms thereof to any unauthorized person or entity. Any Owner and party shall return all material containing any confidential information to Operator immediately upon its request. Any party agrees to destroy immediately upon request by Operator such analyses, compilation, studies or other documents, and any oral information will continue to be subject to the terms of this Agreement. Owner agrees that Operator will have no adequate remedy at law if any party violates any of the terms of this Agreement. In such event Operator will have the right, in addition to any other rights Operator may have, to obtain injunctive relief to restrain any breach or threatened breach by third party or specific enforcement of such terms plus reimbursement of attorneys' fees, court costs and all associated expenses. No party shall publish, file for public record, reproduce, or otherwise disseminate this document or any of the terms and provisions hereof to any party, other than the Parties set forth above without the prior written consent of Operator, which consent may be withheld for any reason and in Operator's sole discretion.

18. **Default and Remedies.**

18.1 **Operator Payment Default.** [REDACTED]

18.1.1 **Collection of Payments.** [REDACTED]

18.1.2 **Terminate Agreement.** [REDACTED]

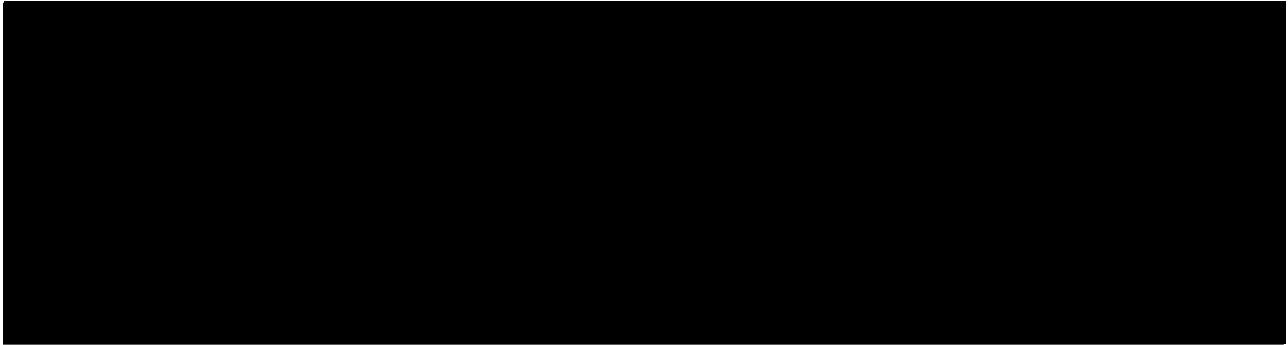

18.2 **Other Operator Default.**

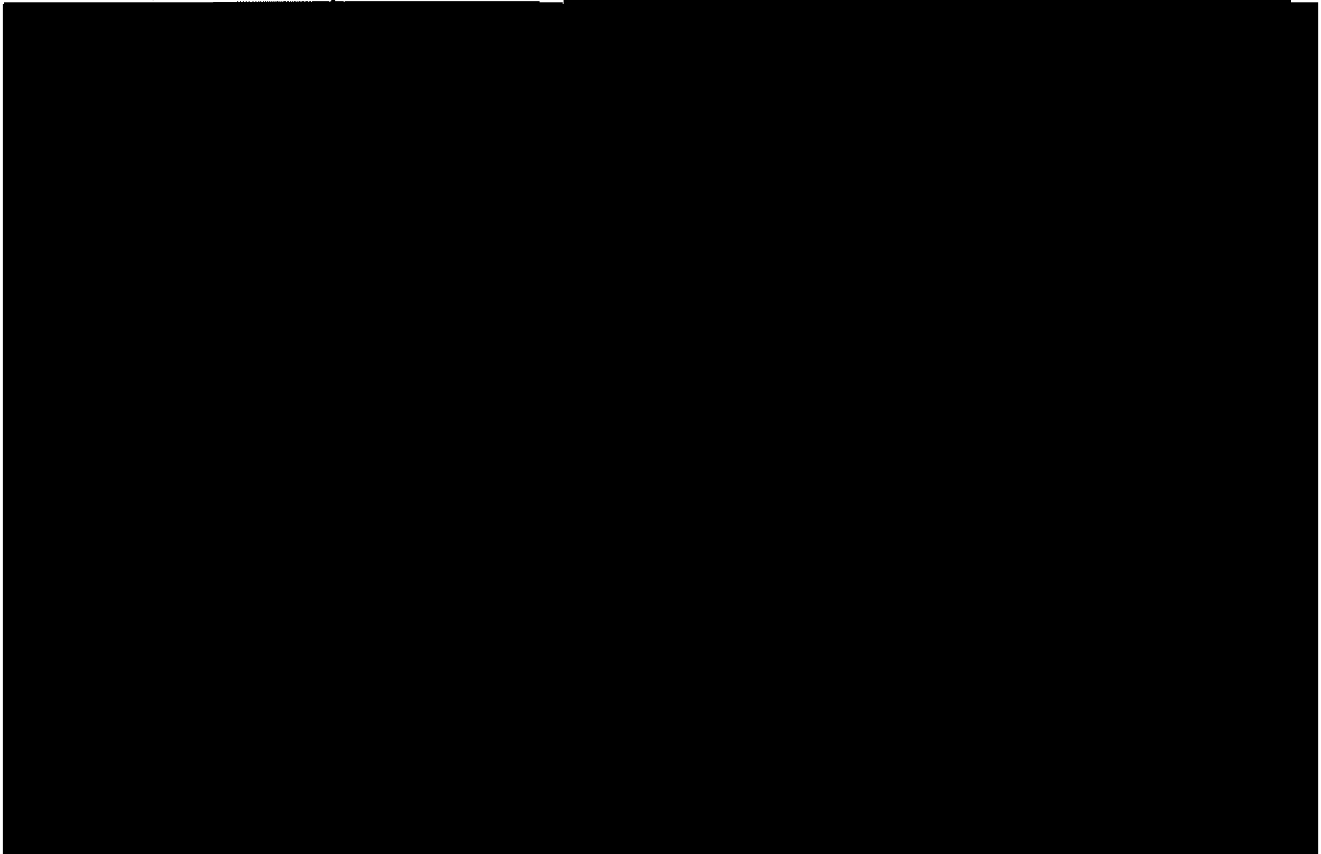

18.3 **Owner Default.**

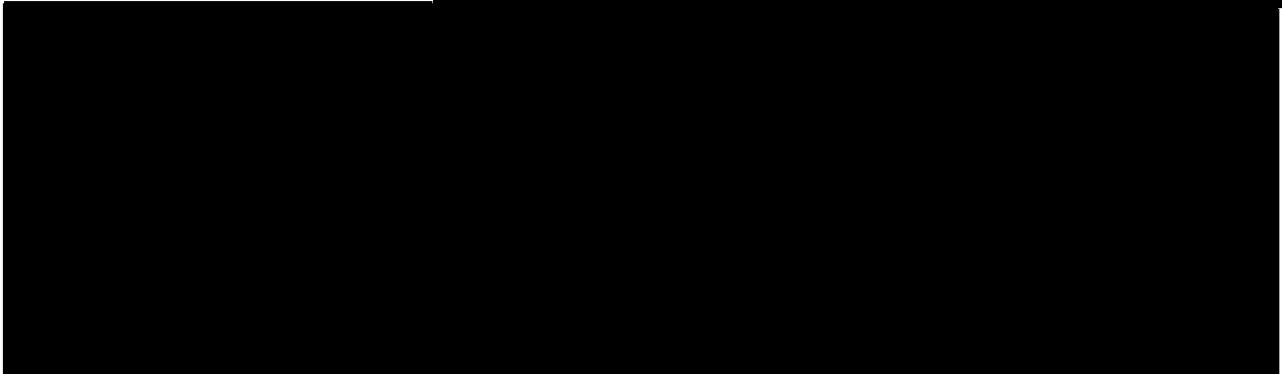
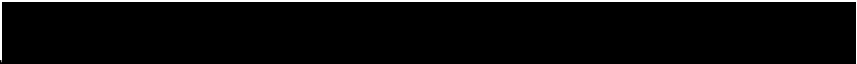

19. **Condemnation.**

19.1 **Complete Taking.** If, at any time, any authority having the power of eminent domain shall condemn all or substantially all of the Operator's Property, or all of the Improvements thereon, for any public use or otherwise, then the interests and obligations of Operator under this Agreement in or affecting the Operator's Property shall cease and terminate upon the earlier of (i) the date that the condemning authority takes physical possession of the Operator's Property or the Improvements thereon, (ii) the date that Operator is, in its sole judgment, no longer able or permitted to operate the Project on the Operator's Property in a commercially viable manner, or (iii) the date of the condemnation judgment. Operator shall continue to pay all amounts payable hereunder to Owner until the earlier of such dates, at which time the Parties shall be relieved of any and all further obligations and conditions to each other under this Agreement.

19.2 **Partial Taking.** If, at any time during the term of this Agreement, any authority having the power of eminent domain shall condemn one or more, but not all, of the Solar Panels, or any portion of the Improvements or the Operator's Property, then the interest and obligations of Operator under this Agreement as to those Solar Panels or any portion of the Improvements or the Operator's Property so taken shall cease and terminate upon the earlier of (i) the date that the condemning authority takes possession of such Solar Panels or any portion of the Improvements or the Operator's Property, (ii) the date that Operator is, in its reasonable judgment, no longer able or permitted to operate the Project on the Operator's Property, or any portion thereof, in a commercially viable manner, or (iii) the date of the condemnation judgment; and, unless this Agreement is terminated as hereinafter provided, this Agreement shall continue in full force and effect as to the remainder of the Solar Panels, Improvements and the Operator's Property. If the remainder of the Solar Panels or any other portion of the Improvements or the Operator's Property is or becomes insufficient or unsuitable for Operator's purposes hereunder, as determined by Operator in its sole discretion, then, subject to the rights of any Operator Mortgagee under Section 13, Operator shall have the right to terminate this Agreement as to the portion of the Operator's Property to which Operator continues to hold the rights, at which time the Parties shall be relieved of any further obligations and duties to each other under this Agreement.

19.3 **Apportionment, Distribution of Award.** On any taking, all sums awarded, including damages and interest, shall be paid as follows:

- (a) Any portion of the award by the court on account of any cost or loss that Operator may sustain in the removal and relocation of Operator's Improvements, to Operator;
- (b) Any portion of the award by the court for Operator's anticipated or lost revenues or profits, to Operator;
- (c) Any portion of the award by the court for Owner's lost revenues, to Owner;
- (d) All remaining amounts of the award, to Owner or Operator consistent with applicable Kentucky law.

20. **Notice.**

20.1 **Writing**. All notices given or permitted to be given hereunder shall be in writing.

20.2 **Delivery**. Notice is considered given either (i) when delivered in person to the recipient named below, (ii) upon receipt after deposit in the United States mail in a sealed envelope or container, postage and postal charges prepaid, return receipt requested or certified mail, addressed by name and address to the party or person intended, or (iii) twenty-four (24) hours from proper and timely delivery to an overnight courier service addressed by name and address to the party or person intended as follows:

Notice to Owner: Laura Anne Logsdon & Derek H. Logsdon,
a/k/a Herman Derek Logsdon
8619 Thomason Rd
Robards, KY 42452

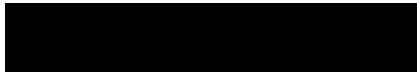

Notice to Operator: Sebree Solar II, LLC
700 Universe Blvd
Juno Beach, FL 33408



20.3 **Change of Recipient or Address**. Either Party may, by notice given at any time or from time to time, require subsequent notices to be given to another individual person, whether a party or an officer or representative, or to a different address, or both. Notices given before actual receipt or notice of change shall not be invalidated by the change.

21. **Miscellaneous Provisions**.

21.1 **Successors and Assigns**. The terms and provisions of this Agreement shall run with the land and be binding on and inure to the benefit of the heirs, successors, assigns and personal representatives of the Parties. In accordance with this Agreement, Operator in its discretion may authorize other persons or entities to use the Operator Property for the purposes stated in this Agreement

21.2 **Memorandum**. Simultaneously with the execution of this Agreement, the Parties agree to execute and acknowledge a memorandum of this Agreement. Operator may record the executed memorandum in the public records of Henderson County, Kentucky.

21.3 **Entire Agreement**. This Agreement and the attached Exhibits shall constitute the entire agreement between the Parties and supersedes all other prior writings and understandings.

21.4 **Amendments**. This Agreement shall not be amended or modified in any way except by an instrument signed by the Parties and consented to by any Operator Mortgagee. The Parties hereto shall at all times hereafter execute any documents and do any further acts which may be necessary or desirable to carry out the purposes of this Agreement and to give full force and effect to each and all of the provisions hereof.

21.5 **Legal Matters.** This Agreement shall be governed by and interpreted in accordance with the then existing laws of the Commonwealth of Kentucky and the County where the Owner's Property is located shall be considered the proper forum or jurisdiction for any disputes arising in connection with this Agreement. The Parties agree to first attempt to settle any dispute arising out of or in connection with this Agreement by good-faith negotiation. If the Parties are unable to resolve amicably any dispute arising out of or in connection with this Agreement, each shall have all remedies available at law or in equity and as provided by this Agreement. **Each Party waives all right to trial by jury and specifically agrees that trial of suits or causes of action arising out of this Agreement shall be to the court of competent jurisdiction.**

21.6 **Severability.** If any term or provision of this Agreement, or the application thereof to any person or circumstance shall, to any extent, be determined by judicial order or decision to be invalid or unenforceable, the remainder of this Agreement or the application of such term or provision to persons or circumstances other than those as to which it is held to be invalid, shall be enforced to the fullest extent permitted by law.

21.7 **Tax Credits.** If under applicable law Operator becomes ineligible for any currently existing tax credit, benefit or incentive for alternative energy expenditure established by any local, state or federal government, then, at Operator's option, the Parties shall negotiate in good faith to amend this Agreement or replace it with a different instrument so as to convert Operator's interest in the Operator Property to a substantially similar interest that makes Operator eligible for such tax credit, benefit or incentive. Such amendment or instrument shall not impair any of Owner's rights or increase the burdens or obligations of Owner under this Agreement.

21.8 **Approvals.** Whenever in this Agreement the approval or consent of either Party is required or contemplated, unless otherwise specified, such approval or consent shall not be unreasonably withheld or delayed.

21.9 **Authority.** The signatories hereto warrant that each has the authority to execute this Agreement on behalf of any entities which are Parties to this Agreement and that each such entity has executed this Agreement pursuant to its organizational documents or a resolution or consent of their Board of Directors or other governing body.

21.10 **Time of Essence.** Time is of the essence of each provision of this Agreement.

21.11 **Counterparts.** This Agreement may be executed in multiple counterparts, each of which shall be deemed an original, and all of which together shall constitute a single instrument.

Owner:

Laura Anne Logsdon
Laura Anne Logsdon

Derek H. Logsdon
Derek H. Logsdon, a/k/a Herman Derek Logsdon

Operator:

Sebree Solar II, LLC
a Delaware limited liability company

By: Anthony Redroni
Anthony Redroni, Vice President

EXHIBIT A

Legal Description of Owner's Property

Being all of Lot 1 of the William Denton Subdivision of record in Plat Book 7, Page 238, Henderson County, Kentucky.

The above being the same property acquired by Laura Anne Logsdon and Derek H. Logsdon a/k/a Herman Derek Logsdon by Deed dated June 28, 1996 of record in Deed Book 460, Page 555, in the Henderson County Clerk's office.

Approximately 26 acres

QLA ID: 18569

HOLDING PAGE FOR EXHIBIT B

Preliminary Lease and Easement Improvement Plan and Acreage Calculation
To be Delivered with Option Notice

edp

EXHIBIT B-1
EXCLUSION AREA

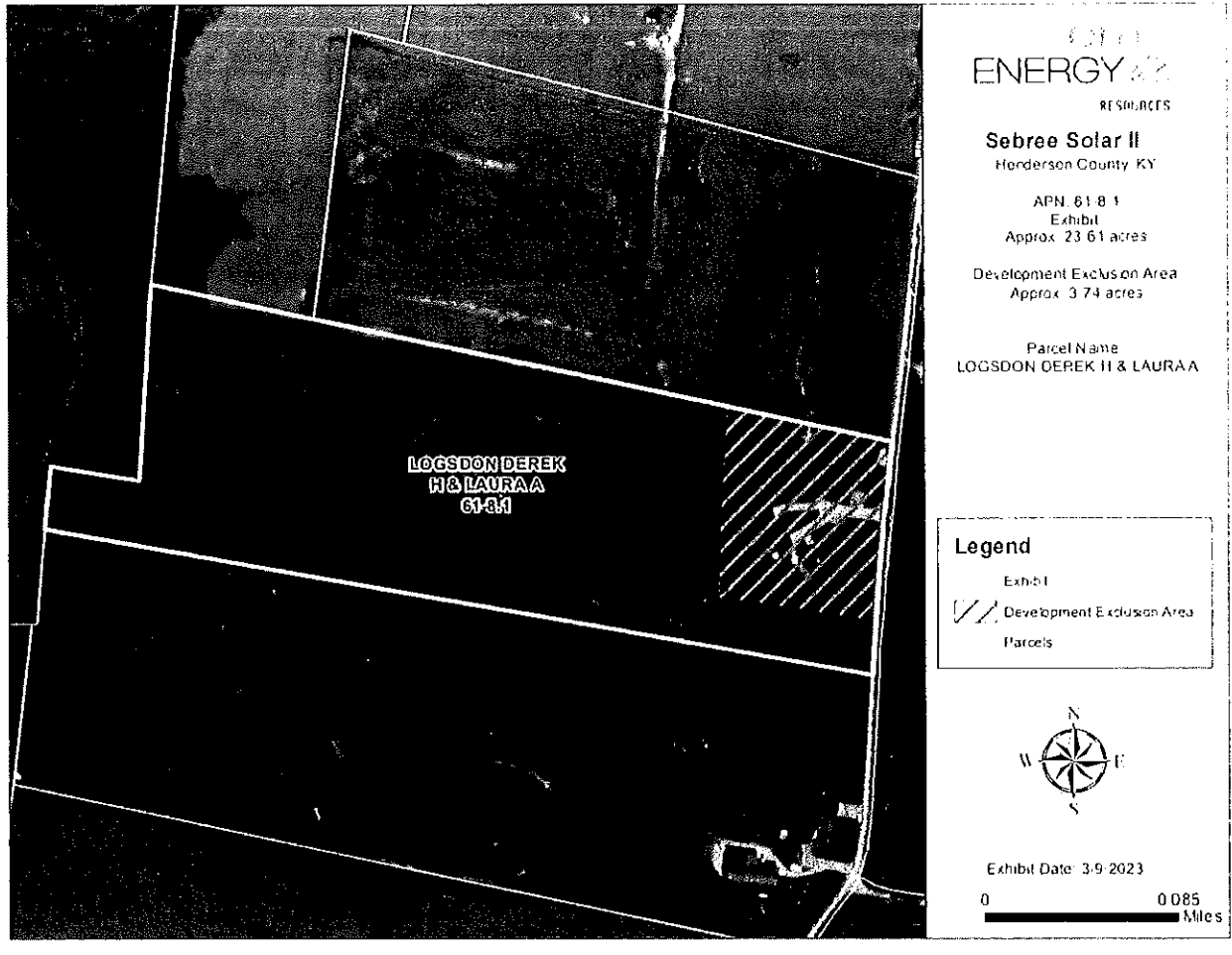

2022

HOLDING PAGE FOR EXHIBIT C

As Built Lease and Easement Improvements and Final Acreage Calculation

EXHIBIT D

Lease and Easement Compensation

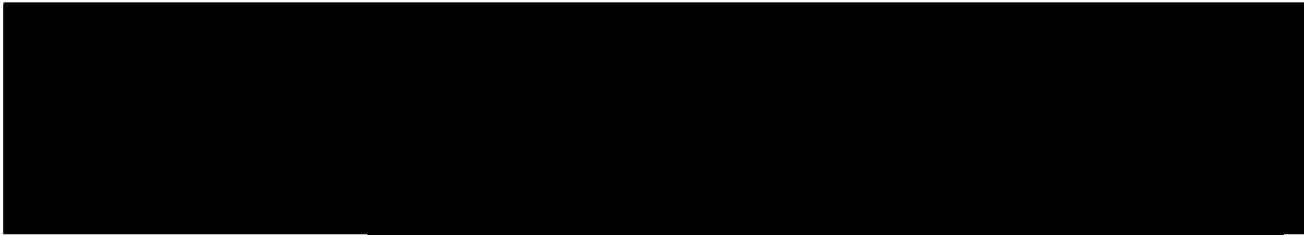

(2) **Option Payment.**

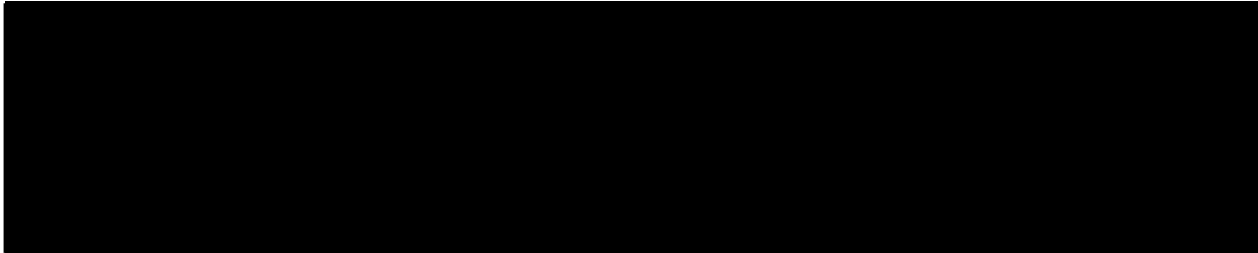
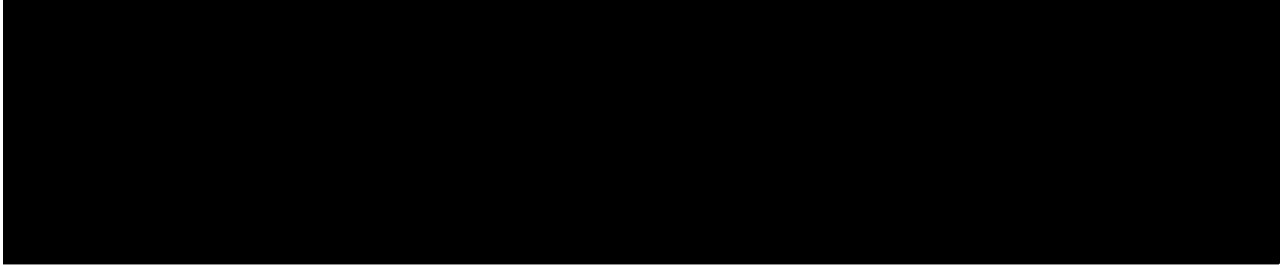

(3) **Payment for Lease and Easements.**

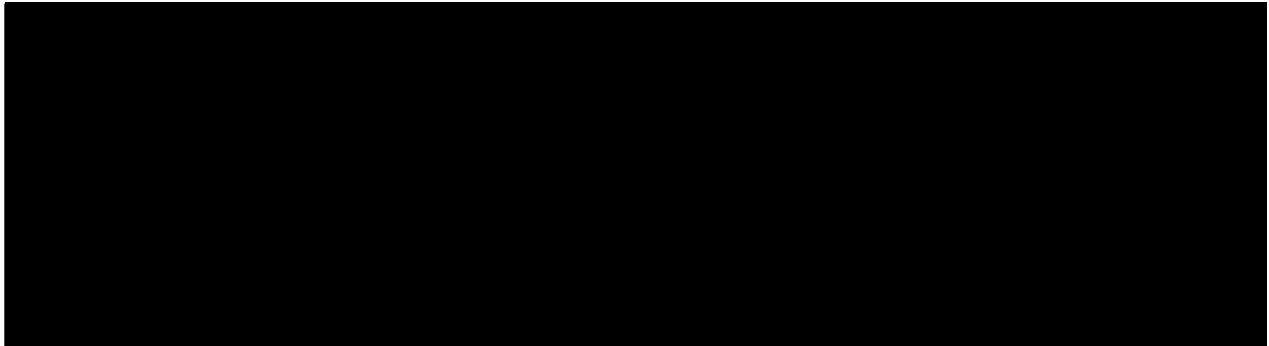

Red



(4) Crop Compensation.

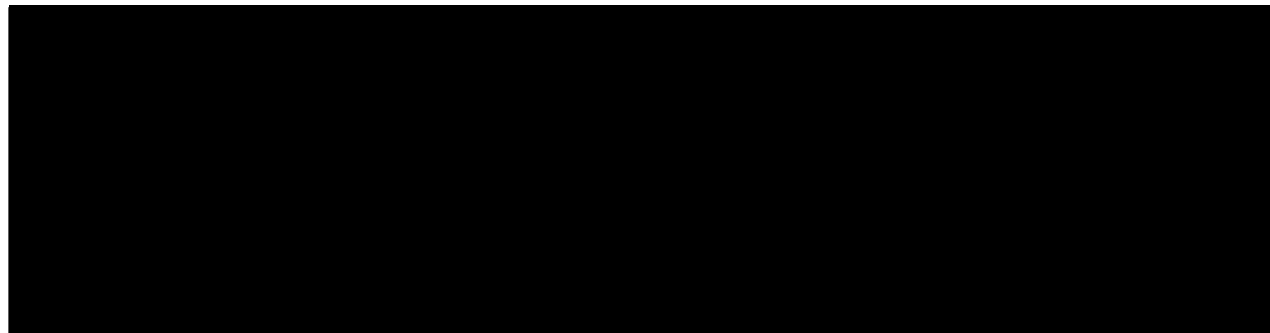
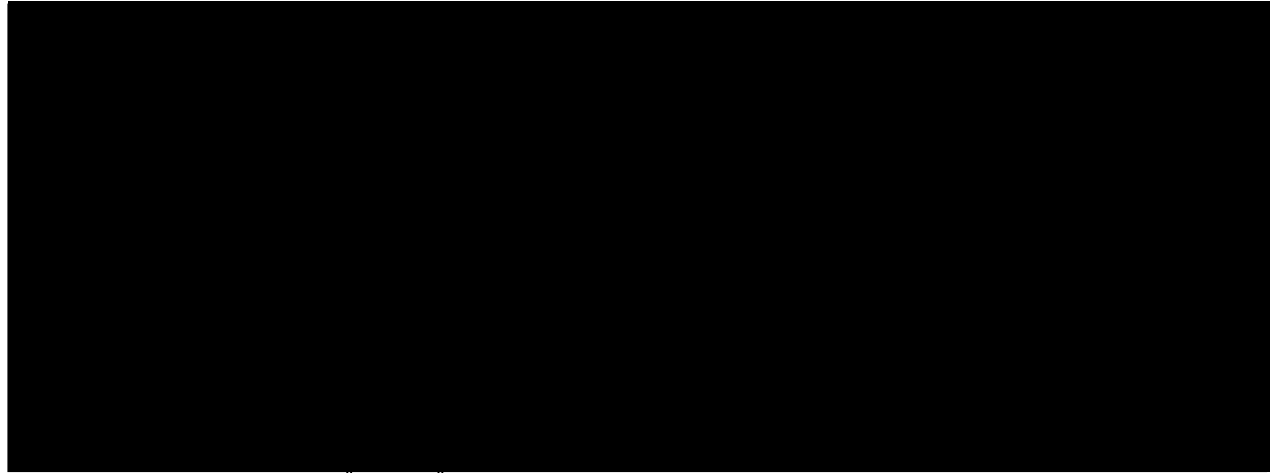

(5) Payment Allocation Schedule.

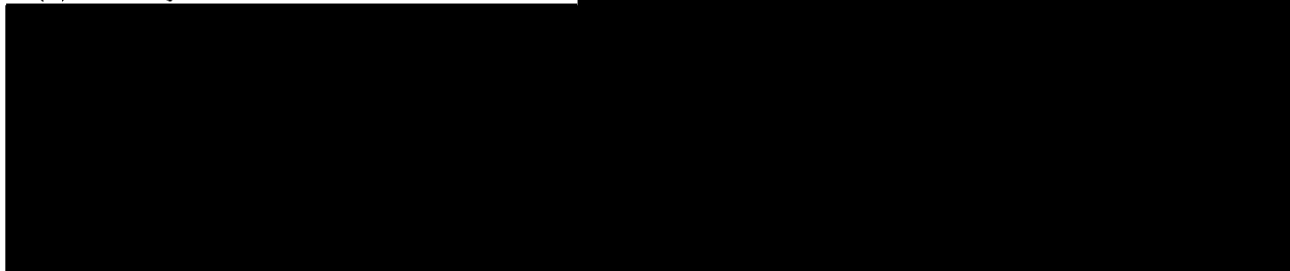
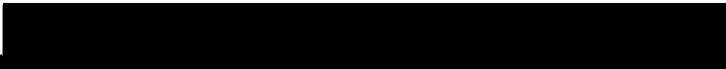

red

SOLAR LEASE AND EASEMENT AGREEMENT

1. **Parties.** This Solar Lease and Easement Agreement ("**Agreement**") is made and entered as of the 31 day of May, 2023 ("**Effective Date**"), by and between Laura Anne Logsdon, joined by consenting spouse, Derek H. Logsdon a/k/a Herman D. Logsdon ("**Owner**") and Sebree Solar II, LLC, a Delaware limited liability company ("**Operator**"), which are sometimes individually referred to as a "**Party**" and collectively as the "**Parties**".

2. **Project.** This Agreement relates to the solar-powered electrical power generation and transmission project known as the "Sebree Solar II Energy Center" to be located in Henderson County, Kentucky ("**Project**"), which may be wholly or partially located on the Owner's property legally described on the attached **Exhibit A** to this Agreement ("**Owner's Property**"). Upon Operator's exercise of the Option (as defined below), the Project shall include (i) the Lease of Owner's Property described in Section 4, (ii) the Easements referenced in Section 5 that are located on the Owner's Property, and (iii) the Improvements referenced in Section 8 to be constructed on Owner's Property. The Lease, Easements and Improvements are sometimes collectively referred to as the "**Operator Property**".

3. **Option.** Owner grants to Operator an exclusive option ("**Option**") to acquire the Lease and Easements referenced in Sections 4 and 5 in accordance with the following terms and conditions. Operator shall be entitled to acquire the Lease and the Easements in their entirety or in part, as Operator deems appropriate.

3.1 **Option Term.** The initial period during which Operator may exercise the Option shall be for a term of four (4) years, commencing on the Effective Date ("**Initial Option Term**"). Operator shall have a single election to extend the Initial Option Term for an additional one (1) year ("**Extended Option Term**") by written notice to Owner no later than thirty (30) days prior to the expiration of the Initial Option Term, which notice shall be accompanied by the Option Payment (as defined in **Exhibit D**). References herein to the Option Term shall mean the Initial Option Term and, to the extent exercised by Operator, the Extended Option Term, unless the context otherwise expressly requires.

3.2 **Option Payment.** As consideration for the granting of the Option, Operator agrees to pay Owner the Option Payment set forth in **Exhibit D**.

3.3 **Use of Owner's Property.** During the Option Term, Operator and its employees, agents and contractors shall have a right to enter upon the Owner's Property and the right of ingress and egress over and across the Owner's Property for the purposes of (i) surveying the Owner's Property; (ii) performing such other tests and studies as Operator may desire in connection with the Option, including, without limitation, environmental, avian and cultural resource assessments, and geotechnical, foundation and soil tests, provided that such activities do not unreasonably interfere with Owner's use of the Owner's Property; and (iii) installing, maintaining, operating, inspecting and removing one or more weather related instruments ("**Weather Instrument**") and fencing of said Weather Instrument and including the performance of all tests and studies associated therewith. Owner shall not permit any other individual or entity except Operator or its affiliates to install a Weather Instrument on Owner's Property.

200

3.4 **Right to Grant Option.** Owner warrants and represents to Operator that (i) the statements in Section 9 concerning Owner's title to the Owner's Property are true and correct; (ii) Owner has the authority to grant this Option to Operator without the consent or approval of any other party; and (iii) there are no other existing options, rights of first refusal, contracts to purchase, leases or mortgages that would prevent Operator from exercising its rights with respect to the Option.

3.5 **Exercise of Option.** Operator may exercise the Option by giving written notice to Owner ("**Option Notice**") at any time during the Option Term. Operator shall specify in the Option Notice the Commencement Date referenced in Section 6.1.1. On the Commencement Date, the Lease and Easements referenced in Sections 4 and 5 shall automatically become effective, and the Parties shall be subject to all of the terms and conditions of this Agreement with respect to such Lease and Easements and all rights and obligations relating thereto.

3.6 **Termination of Option.** If Operator fails to exercise the Option within the Option Term, the Option and the rights of Operator as the optionee shall automatically terminate.

4. **Lease.** Upon exercise of the Option by Operator, Owner leases to Operator, and Operator leases from Owner, Owner's Property for the Lease and Easement Term (defined in Section 6.1) in accordance with the terms and conditions of this Agreement ("**Lease**"), which Lease grants Operator and its agents, contractors, and employees the right to use the Owner's Property for the following permitted uses:

4.1 **Construction Right.** Operator leases Owner's Property for the purpose of constructing, operating, maintaining, repairing, replacing, and removing all or any part or component of the Improvements whether located on Owner's Property. Operator may exercise its right to use all or any part of the Owner's Property as and when Operator deems it necessary or advisable to do so to perform the activities for which this right is granted, including, without limitation, staging areas and parking for Operator's employees.

4.2 **Access Right.** Operator leases Owner's Property for unobstructed vehicular and pedestrian access and ingress to and egress from the Improvements, Owner's Property and any public roadways, and to construct, maintain, and utilize Roadway Improvements on the Owner's Property. Owner shall not permit others to obstruct or damage the roads or Roadway Improvements located on the Owner's Property or in any other way interfere with Operator's rights under this right. Operator shall repair any damage done to Roadway Improvements which result from use by Operator, its agents, servants or employees. Such roads shall be maintained in the condition necessary for use by Operator's equipment, and with regard to existing roads, shall be maintained in at least the condition that existed prior to Operator's use.

4.3 **Solar Panels Right.** Operator leases Owner's Property for Operator to construct, operate, replace, relocate, remove, and maintain Solar Panels and the appurtenant Collection Facilities, together with associated roads and parking areas on Owner's Property.

4.4 **Collection Facilities Right.** Operator leases Owner's Property for Operator to construct, operate, maintain, replace, relocate or remove Collection Facilities on and under the Owner's Property.

edp

4.5 **Substation Right.** Operator leases Owner's Property for Operator to construct, operate, maintain, replace, relocate or remove one or more Substations on Owner's Property.

4.6 **Telecommunication Right.** Operator leases Owner's Property for Operator to construct, operate, maintain, replace, relocate or remove Telecommunication Facilities on and under the Owner's Property.

4.7 **Weather Instrument Right.** Operator leases Owner's Property in order to construct, operate, replace, relocate, remove, and maintain a Weather Instrument and the appurtenant Collection Facilities on Owner's Property.

4.8 **Battery Facilities Right.** Operator leases Owner's Property in order to construct, operate, replace, relocate, remove, and maintain one or more Battery Facilities on Owner's Property.

5. **Grant of Easements.** Upon the exercise of the Option by Operator, Owner grants to Operator, and Operator accepts from Owner, for the Lease and Easement Term referenced in Section 6.1, the following easements over and across the Owner's Property in accordance with the terms and conditions of this Agreement. The following easements are for the benefit of Operator and Operator's agents, contractors and employees and located on the Owner's Property and are collectively referred to as the "**Easements**".

5.1 **Sun Non-Obstruction Easement.** Owner grants Operator an irrevocable, exclusive easement for the right and privilege to use, maintain and capture the free and unobstructed sunlight over and across the Owner's Property. Owner shall not engage in any activity on Owner's Property or any other neighboring property owned by Owner that might interfere with the sunlight direction over any portion of Owner's Property; cause a decrease in the output or efficiency of any Solar Panel or Weather Instrument; or otherwise interfere with Operator's operation of the Project or exercise of any rights granted in this Agreement (collectively "**Interference**"). This grant of the easement expressly includes the right of Operator to enforce Operator's rights, including the physical removal of trees or structures (except existing trees and structures) causing Interference to the Project contemplated by Operator. Operator shall notify Owner before making any such removals.

5.2 **Effects Easement.** Owner grants to Operator an easement over Owner's Property for visual, view, light, flicker, noise, shadow, vibration, electromagnetic, electrical and radio frequency interference, and any other effects attributable to the Project located on the Owner's Property.

6. **Term.** The term of this Agreement ("**Term**") includes the Option Term referenced in Section 3.1, the Initial Lease and Easement Term as described in Section 6.1.1 and the Extended Lease and Easement Term as described in Section 6.1.2 (together, the Initial Lease and Easement Term and the Extended Lease and Easement Term, if applicable, is defined as the "**Lease and Easement Term**").

6.1 **Lease and Easement Term.**

6.1.1 **Initial Lease and Easement Term.** The initial term of the Lease and Easements shall commence on the date specified by Operator in the Option Notice ("**Commencement Date**"). The initial term of the Lease and Easements shall end thirty (30) years after the Commencement Date (the "**Initial Lease and Easement Term**"), subject to the rights of renewal and termination as provided in this Agreement.

Extended Lease and Easement Term. Operator shall have the right to extend the Term of this Agreement for two (2) consecutive terms of five (5) years each in accordance with the terms and provisions of this Agreement (collectively "**Extended Lease and Easement Term**") by providing written notice to Owner of Operator's intent to extend the Term within one hundred eighty (180) days of the end of the existing Term. Each Extended Lease and Easement Term shall begin on the expiration date of the Initial Lease and Easement Term or previous Extended Lease and Easement Term, as the case may be. During the Extended Lease and Easement Term, Operator shall pay Owner the amounts set forth in **Exhibit D** as the consideration for the Lease and Easements.

6.1.2 **Delays During Lease and Easement Term.** At Operator's option, the Term may be extended for a period of time equal to the period of time during which operation of the Project is delayed or suspended because of the occurrence of a Regulatory Suspension or Force Majeure, which are defined as follows:

(i) "**Regulatory Suspension**" shall mean the enactment or application of any law, order, rule, or regulation of the Kentucky Public Service Commission, Federal Energy Regulatory Commission, or other local, state, or federal government authority having jurisdiction over the Project or Operator, or the failure of any such governmental authority to issue an approval or permit pursuant to any such law, order, rule, or regulation, which results in the delay, interruption, or suspension of the production, sale or transmission of electricity from the Solar Panels; and

(ii) "**Force Majeure**" shall mean causes beyond the reasonable control of and without the fault or negligence of the Party claiming Force Majeure, including but not limited to acts of God, labor unrest (including, but not limited to, slowdowns, picketing, boycotts or strikes), flood, earthquake, storm, fire, lightning, explosion, power failure or power surge, vandalism, theft, the cutting of power, transmission or other lines, wires or cables to the Project by persons other than Operator's employees or contractors, epidemic, war, revolution, riot, civil disturbance, sabotage, change in law or applicable regulation subsequent to the Commencement Date and action or inaction by any federal, state or local legislative, executive, administrative judicial agency or body which in any of the foregoing cases, by exercise of due foresight such Party could not reasonably have expected to avoid, and which, by the exercise of due diligence, it is unable to overcome.

The Parties shall be excused from performing their respective obligations under this Agreement and shall not be liable in damages or otherwise if and to the extent that they are unable to so perform or are prevented from performing by a Force Majeure, provided that: (i) the non-performing Party, as promptly as practicable after the occurrence of the Force Majeure, but in no event later than thirty (30) days thereafter, gives the other Party written notice describing the particulars of the occurrence; (ii) the suspension of performance is of no greater scope and of no longer duration than is reasonably required by the Force Majeure; (iii) the non-performing Party uses

good faith and commercially reasonable efforts to remedy its inability to perform; and (iv) as soon as the non-performing Party is able to resume performance of its obligations excused as a result of the occurrence, each Party shall give prompt written notification thereof to the other Party.

6.2 **Termination by Operator.** Provided Operator is not in default under any term of this Agreement, Operator, at its option, shall have the right to terminate this Agreement at any time during the Term of the Agreement, as to all or any part of the Operator Property. Termination shall be effective thirty (30) days after written notice of such termination to Owner. If Operator's notice is a full termination of the Operator Property, the Parties shall be relieved of all further duties and obligations under this Agreement, other than (i) the payment of any accrued and unpaid obligations owed by either Party as of the date of termination; (ii) the removal of the Improvements by Operator pursuant to Section 8.11; and (iii) any other obligations and liabilities that are expressly stated in this Agreement to survive such termination. Upon any such partial termination by Operator, the Parties shall be relieved of all further duties and obligations under this Agreement with respect to the portion thereof terminated by Operator, subject to the obligations and liabilities referenced in items (i) through (iii) above that shall continue to be applicable to the terminated portion of this Agreement. The Parties agree to execute an amendment to this Agreement evidencing such partial termination.

7. **Payments.** If Operator exercises the Option referenced in Section 3, Operator agrees to pay Owner the amounts set forth in **Exhibit D** as consideration for the Lease, Easements and Operator's other rights and interests in the Owner's Property.

8. **Improvements.** Operator shall have the right, at its sole cost and expense, to construct, install, maintain, use, operate, repair, replace, relocate and remove all facilities, structures, equipment, machinery, wires, conduit, cables, poles, materials and property of every kind and character required for the construction and operation of portions of the Project on the Owner's Property, including, but not limited to, the Solar Panels, Collection Facilities, Substations, Telecommunication Facilities, Weather Instruments, Roadway Improvements and Battery Facilities referenced in Sections 8.1 through 8.7 (collectively, the "**Improvements**").

8.1 **"Solar Panels"** shall mean any photovoltaic energy system designed for the generation of electrical power from the collection of sunlight, including without limitation, the photovoltaic panels, foundations, support structures, braces and related equipment.

8.2 **"Collection Facilities"** shall mean all Improvements whose purpose is to deliver electrical power generated by the Solar Panels to an electrical power grid or other system, including without limitation transformers, overhead and underground electrical collection lines, telecommunication lines, splice boxes and interconnection facilities.

8.3 **"Substations"** shall mean electrical lines, meters, monitoring and control equipment, switches, transformers, all structures, equipment, enclosures, fencing, security devices, and other electrical and communications equipment necessary to condition and increase the voltage of electricity generated by the Project to make it suitable for transmission on, and to deliver it to, Collection Facilities connected to an electric power grid or other system.

8.4 **"Telecommunication Facilities"** shall mean all Improvements whose purpose is to provide telecommunication services solely relating to the Project or any of Operator's solar powered projects, including telephone, closed-circuit television, microwave, internet, computer data and other telecommunication services.

8.5 **"Weather Instrument"** shall mean instruments used primarily to gather and transmit sunlight and meteorological data relating to the Project, and includes the instrument's foundations, guy wires, sunlight and meteorological data acquisition equipment, power source, and any required data and electrical transmission lines.

8.6 **"Roadway Improvements"** shall mean all improvements that may be necessary to construct, maintain and repair any new and existing roadways and other means of ingress and egress over, across and along the Owner's Property, including paving or surfacing of the roadways with asphalt, gravel or other roadway materials, installation of road signs and the construction and installation of culverts, bridges, drainage ditches, gates, cattle guards and similar structures and facilities.

8.7 **"Battery Facilities"** shall mean a type of equipment that can be given a new charge by passing an electric current through it designed for the storage of electrical power including without limitation, batteries and other devices for storage of electrical energy, foundations, support structures, braces and related equipment.

8.8 **Ownership of Improvements.** Except as otherwise provided in Section 11.7, all Improvements shall at all times remain the property of Operator, and Owner shall have no right, title or interest therein. All Improvements constructed or placed on the Owner's Property by Operator during the Term of this Agreement may be repaired, replaced, relocated, removed, added to or expanded upon by Operator at any time during the Term of this Agreement. Owner expressly waives any statutory lien or common law liens on the Improvements to which Owner might be entitled.

8.9 **Construction Liens.** Operator shall not permit any liens arising out of Operator's use of the Operator Property under this Agreement to be filed against the Owner's Property. Operator shall, within sixty (60) days after it receives notice of the lien, provide a bond or other security that Owner may reasonably request, or remove such lien from the Owner's Property in the manner provided by applicable law.

8.10 **Location of Improvements.** The acreage required from the Owner's Property for the Improvements for which the Lease and Easements are being granted cannot be determined until the completion of Operator's inspection, testing, study and surveying of the Owner's Property during the Option Term. Along with the Option Notice, Operator shall deliver to Owner a proposed plan of development showing the contemplated locations of the Improvements and a preliminary calculation of the acreage as determined by the area bounded by a perimeter fence required for the Project, which shall serve as the **Exhibit B** to this Agreement. During the final development and construction of the Project, such locations may need to be amended. Following construction of the Project, Operator shall provide Owner an "as-built" survey of all Improvements on Owner's Property and the final calculation of the acreage as determined by the area bounded by a perimeter fence required for the Project, which shall serve as **Exhibit C** to this Agreement.

Further, following construction, the Improvements may need to be relocated or rerouted by Operator, which Operator may perform, at any time during the Term of this Agreement, so long as the nature and extent of any such relocated or rerouted Improvements are not materially different and impose no materially greater burden on the Owner's Property than the original locations or routes, and so long as Operator takes commercially reasonable efforts to minimize disruption or inconvenience to Owner. After construction of Improvements, Owner shall retain access to unused areas outside of areas bounded by Project perimeter fence, for the purpose of farming and crop maintenance, provided that no such farming or crop maintenance activities unreasonably interfere with Operator's use of Operator Property.

8.11 **Removal of Improvements.** Upon full or partial termination of any of the Lease Rights or Easements, Operator shall remove all Improvements and restore the area formerly occupied by the Improvements to substantially the same physical condition that existed immediately before the construction of the Improvements (the "**Removal Obligations**"). At Owner's request, all or any part of the Roadway Improvements may be left for use by Owner.

9. **Ownership and Title Matters.** Owner warrants and represents to Operator, both as of the Effective Date, and as of the Commencement Date as follows:

9.1 **Authority.** Owner represents and warrants that it is the holder of fee simple title and is the sole owner of the Owner's Property and has the unrestricted right and authority to sign this Agreement and to grant Operator the Lease and Easements and other rights granted in this Agreement. When signed by both Parties, this Agreement constitutes a valid and binding agreement enforceable against Owner in accordance with its terms.

9.2 **Other Agreements.** The Owner's Property is not subject to any other agreements, options, rights of first refusal or other prior right of any party to purchase, lease or acquire easements in the Owner's Property, or create any prior claim or right that would preclude or interfere with Operator's rights and interests under this Agreement and the Lease and Easements.

9.3 **Minerals.** Except as disclosed by Owner to Operator at the time of the execution of this Agreement by Owner, Owner owns all of the oil, gas and other minerals, and all rights thereto as on or under the Owner's Property.

9.4 **Owner Mortgage.** Except as disclosed by Owner to Operator at the time of the execution of this Agreement by Owner, there are no mortgages encumbering the Owner's Property ("**Owner Mortgage**").

9.5 **Notice and Opportunity to Cure.** If there is an Owner Mortgage encumbering Owner's Property and Owner receives from the holder thereof any notice that payments are overdue, Owner shall notify Operator and each Operator Mortgagee (as defined at Section 13.1) by sending a copy of such overdue payment notice to Operator by the earlier of (i) five (5) days after receipt, or (ii) three (3) business days prior to the date by which a default under or in respect of such Owner Mortgage could occur. If Operator or any Operator Mortgagee determines that it would be in Operator's interest to make such payments to Owner Mortgagee on Owner's behalf, whether as a result of receiving such notice or otherwise, Operator shall have the right to make

such payments and to credit the payments so made against the Annual Installment Payment next due under the Agreement.

9.6 **Subordination, Non-Disturbance & Attornment Agreement.** If there is an Owner Mortgage encumbering Owner's Property, Owner shall cooperate with Operator to obtain a Subordination, Non-Disturbance and Attornment Agreement ("SNDA") in the form prepared and provided by Operator, from each Owner Mortgagee, pursuant to which such Owner Mortgagee agrees, among other things, not to disturb Operator's possession and use of the Owner's Property. Owner shall not incur any loss in income, expense, obligation or liability with regard to the SNDA. Operator shall, at its sole cost and expense, record each such SNDA in the Office of the County Clerk in which Owner's Property is located. If Owner fails to deliver a SNDA from each Owner Mortgagee, Operator may, at its sole option, either (i) terminate this Agreement immediately upon written notice to Owner, or (ii) take such action as Operator deems reasonably necessary to effect the rights granted to Operator hereunder, and off-set all amounts expended in such efforts against the Annual Installment Payments and any other amounts due hereunder or in respect hereof.

10. **Representations and Warranties of Owner.** Owner hereby makes the following further representations and warranties both as of the Effective Date, and as of the Commencement Date:

10.1 **Physical Condition.** Owner has no knowledge of any existing physical conditions of the Owner's Property which would prevent, significantly restrict or make more expensive Operator's development of the Owner's Property for the purposes specified in this Agreement, or which could, with the passage of time, or the giving of notice, constitute a violation of any currently applicable governmental law, ordinance, order, rule or regulation.

10.2 **Legal Restrictions.** Owner has no knowledge of any law, regulation, ordinance or order of any local, state or federal governmental authority which would prohibit or significantly restrict Operator's development of the Owner's Property pursuant to this Agreement. This Agreement does not violate any contract, agreement, instrument, judgment or order to which Owner is a party or which affects the Owner's Property. To the best of Owner's knowledge, the Owner's Property is currently in full and complete compliance with all governmental laws, ordinances, orders, rules and regulations applicable to the Owner's Property.

10.3 **No Litigation.** No litigation is pending and, to the best of Owner's knowledge, no litigation or administrative actions are proposed, threatened or anticipated with respect to any matter affecting the Owner's Property. If Owner learns of any litigation or administrative action proposed, threatened or instituted with respect to the Owner's Property, Owner shall give Operator notice within thirty (30) days thereof.

10.4 **Survival.** The representations and warranties set forth in this Section 10 shall survive the execution and delivery hereof.

11. **Use, Operation and Maintenance.**

11.1 **Exclusive Use by Operator.** Operator shall have the exclusive right (i) to use and possess the Owner Property in connection with the Project and other similar solar-powered electrical power generation projects; (ii) to investigate, inspect, survey, and conduct tests of the

Owner's Property, including, but not limited to, meteorological, environmental, archeological and geotechnical tests and studies; (iii) to use and convert all of the sunlight resources on the Owner's Property; and (iv) to undertake such other activities on the Owner's Property that may be related to the Project, including, without limitation, the storage of Solar Panels, materials and equipment during the installation and construction of the Improvements; development and operation of communications systems; and site tours of the Project for visitors and other interested parties.

11.2 **No Required Installation or Operation.** Nothing in this Agreement shall be interpreted as imposing on Operator any obligation to install Solar Panels or other Improvements on the Owner's Property, or to operate the Project on the Owner's Property. Operator shall have the sole discretion to determine if and when any Solar Panels and other Improvements may be constructed on Owner's Property, and if and when to commence the operation of the Project on the Owner's Property.

11.3 **Permits and Approvals.** Operator shall be responsible, at its sole cost and expense, for obtaining any governmental permits and approvals necessary for the construction and operation of the Project and the construction and operation of the Improvements. Owner shall cooperate with Operator as necessary to obtain any governmental or utility approvals or permits, including, without limitation, signing any applications for such approvals, provided that Owner shall not incur any loss in income, expense, obligation or liability with respect to Operator obtaining such permits or approvals.

11.4 **Compliance with Laws.** Operator shall comply in all material respects with valid laws applicable to the Owner's Property and the Operator Property. Operator shall have the right, in its sole discretion and at its sole expense, in Operator's name to contest the validity or applicability to the Owner's Property and the Operator Property of any law, ordinance, statute, order, regulation, property assessment or the like made by any governmental agency or entity. Operator shall control any such contest and Owner shall cooperate with Operator in every reasonable way in such contest, provided that Owner shall incur no expense, obligation or liability with regard to such contest.

11.5 **Care and Appearance.** Operator, in its exercise of the lease, easement and other rights granted hereunder shall, at all times, maintain the Owner's Property and the Improvements in a reasonably neat, clean and presentable condition. Operator shall not willfully or negligently damage or destroy the Owner's Property and shall keep the Owner's Property clean and free of debris created by Operator, its contractors, or others brought on to the Owner's Property by Operator. Operator shall not use the Owner's Property for storage, except for materials, construction equipment and vehicles directly associated with construction or maintenance of the Improvements on the Owner's Property or adjacent properties that are part of the Project.

11.6 **Fences and Gates.** At Owner's request, Operator shall repair or replace any fences, gates or cattle guards damaged or removed in connection with Operator's activities on the Owner's Property. Fences removed from the Owner's Property, if replaced, shall be re-built by Operator at its expense in mutually agreeable locations. All fence repair and construction shall be substantially similar to the construction of existing fences and cattle guards on Owner's Property. Any gates opened for access to Owner's Property by either Party shall be closed immediately after passing through so that livestock may not pass through. Once completed, all replacement fences,

gates and cattle guards shall be owned and maintained by Owner. To minimize the need for temporary fencing, Owner will cooperate with Operator to avoid pasturing animals on or near the Improvements during periods of construction, maintenance or removal activity by Operator. Owner will discuss with Operator what temporary fencing is necessary during the periods of construction, maintenance or removal activity by Operator. Upon abandonment or termination of the rights granted to Operator, any fences, gates and cattle guards installed by Operator shall be removed and Operator shall restore the area formerly occupied by the any fences, gates and cattle guards to substantially the same physical condition that existed immediately before installation of the same.

11.7 **Roadway Maintenance and Repairs.** Operator agrees to maintain and repair all Roadway Improvements located on the Operator Property; provided, however, Owner shall reimburse Operator for any costs and expenses incurred by Operator to repair any damage or perform any special maintenance of the Roadway Improvements caused by Owner or any person using the Roadway Improvements with Owner's permission, other than Operator.

12. **Taxes.**

12.1 **Owner's Taxes.** Owner covenants and agrees to pay prior to delinquency all real and personal property and other taxes, general and special assessments, and other charges of every description ("**Taxes**") levied or assessed against the Owner's Property and all improvements thereon by governmental authorities, other than Operator's Taxes referenced in Section 12.2 (Taxes, excepting Operator's Taxes, are hereinafter referred to as "**Owner's Taxes**").

12.2 **Operator's Taxes.**



12.3 **Failure to Pay.** In the event either Party fails to pay their share of Taxes prior to delinquency, the other Party shall have the right to pay such Taxes and any accrued penalties or interest, which payments shall increase or be offset against other Payments due under this Agreement.

edw

12.4 **Operator's Right to Contest.** Operator may contest the legal validity or amount of any Operator's Taxes for which it is responsible under this Agreement, and may institute such proceedings as it considers necessary, provided that Operator shall bear all expenses in pursuing such contest or proceeding. With respect to any Taxes which may constitute a lien on the Owner's Property, Operator shall promptly pay such Taxes unless the proceeding in which it contests such Taxes shall operate to prevent or stay the collection of the Taxes so contested or unless Operator removes any such lien by bonding or otherwise. Owner agrees to render to Operator all reasonable assistance in contesting the validity or amount of any such Taxes, with the exception of Taxes levied by Owner, including joining in the signing of any reasonable protests or pleading which Operator may deem advisable to file; provided, however, that Operator shall reimburse Owner for its reasonable out-of-pocket expenses, including reasonable attorneys' fees incurred in connection with providing such assistance.

13. **Mortgage of Operator Property.**

13.1 **Right to Mortgage.** Operator may, upon written notice to Owner, but without requiring Owner's consent or approval, mortgage, collaterally assign, or otherwise encumber and grant security interests in all or any part of its interest in this Agreement and the Operator Property. These various security interests in all or a part of this Agreement and the Operator Property are collectively referred to as an "**Operator Mortgage**" and holder of such security interest, an "**Operator Mortgagee**". Any Operator Mortgagee shall use the Operator Property only for the uses permitted under this Agreement. Whenever Operator has granted a security interest under this Section 13, it will give Owner notice of the Operator Mortgage (including the name and address of the Operator Mortgagee for notice purposes) to Owner within thirty (30) days; provided that failure to give this notice shall not constitute a default under this Agreement, but rather shall only have the effect of not binding Owner to provide such Operator Mortgage notice until the Operator and its address is given to Owner.

13.2 **Notice of Default and Opportunity to Cure.** As a precondition to exercising any rights or remedies related to any alleged default by Operator under this Agreement, Owner shall give written notice of the default to each Operator Mortgagee at the same time it delivers notice of default to Operator, specifying in detail the alleged event of default and the required remedy. Each Operator Mortgagee or its designee shall have the right, but not the obligation, to cure any default as Operator, and/or the right, but not the obligation, to remove any Improvements or other property owned by Operator or such Operator Mortgagee located on the Owner's Property to the same extent as Operator. The cure period for any Operator Mortgagee shall be the later of (i) the end of the Operator cure period under Section 18; (ii) thirty (30) days after such Operator Mortgagee's receipt of the default notice; or (iii) if applicable, the extended cure period provided for in Section 13.3. Failure by Owner to give an Operator Mortgagee notice of default shall not diminish Owner's rights against Operator, but shall preserve all rights of the Operator Mortgagee or its designee to cure any default and to remove any Improvements or other property of Operator or the Operator Mortgagee located on the Owner's Property.

13.3 **Extended Cure Period.** If any default by Operator under this Agreement cannot be cured without the Operator Mortgagee obtaining possession of all or part of the Operator Property, then any such default shall be deemed remedied if an Operator Mortgagee: (i) within sixty (60) days after receiving notice from Owner as set forth in Section 13.2, acquires possession

of all or part of the Operator Property, or begins appropriate judicial or nonjudicial proceedings to obtain the same; (ii) diligently prosecutes any such proceedings to completion; and (iii) after gaining possession of all or part of the Operator Property performs all other obligations as and when the same are due in accordance with the terms of this Agreement. If an Operator Mortgagee is prohibited by any court or by operation of any bankruptcy or insolvency laws from commencing or prosecuting the proceedings described above, the sixty (60) day period specified above for commencing proceedings shall be extended for the period of such prohibition.

13.4 **Operator Mortgagee Liability.** Any Operator Mortgagee whose interest in the Operator Property is held solely for security purposes, shall have no obligation or liability under this Agreement unless and until the Operator Mortgagee succeeds to absolute title to the Operator Property and the rights of Operator under this Agreement. An Operator Mortgagee shall be liable to perform obligations under this Agreement only for and during the period it directly holds such absolute title.

13.5 **Certificates.** Owner shall execute any estoppel certificates (certifying as to truthful matters, including without limitation that no default then exists under this Agreement, if such be the case), consents to assignment and non-disturbance agreements as Operator or any Mortgagee may reasonably request from time to time. The Parties shall negotiate in good faith any amendment to this Agreement from time to time to include any provision that may be reasonably requested by Operator or any Operator Mortgagee to implement the provisions contained in this Agreement or to preserve an Operator Mortgagee's security interest.

13.6 **Operator Mortgagee's Right to Enforce Mortgage and Assign.** Each Operator Mortgagee shall have the right, in its sole discretion: (i) to assign its Operator Mortgage; (ii) to enforce its lien and acquire title to all or any portion of the Operator Property by any lawful means; (iii) to take possession of and operate all or any portion of the Operator Property and to perform all obligations to be performed by Operator under this Agreement, or to cause a receiver to be appointed to do so; and (iv) to acquire all or any portion of the Operator Property by foreclosure or by an assignment in lieu of foreclosure and thereafter to assign or transfer all or any portion of the Operator rights under this Agreement to a third party in accordance with Section 14. Any Operator Mortgagee or other party who acquires Operator's interest in all or a portion of the Operator Property pursuant to foreclosure or assignment in lieu of foreclosure shall not be liable to perform the obligations imposed on Operator by this Agreement, which are incurred or accruing after such Operator Mortgagee or other party no longer has ownership or possession of the Operator Property.

13.7 **New Agreement.**

13.7.1 If the Operator Property is foreclosed upon or there is an assignment in lieu of foreclosure, or if this Agreement is rejected or disaffirmed pursuant to bankruptcy law or other law affecting creditor's rights and, within ninety (90) days after such event, Operator or any Operator Mortgagee or other purchaser at a foreclosure sale shall have arranged to the reasonable satisfaction of Owner to cure any material defaults under this Agreement, and for the payment of all Annual Installment Payments or other charges due and payable by Operator as of the date of such event, then Owner shall execute and deliver to Operator or such Operator Mortgagee or other purchaser at a foreclosure sale, or to a designee of one of these parties, as the case may be, a new

agreement ("**New Agreement**") which (i) shall be for a term equal to the remainder of the Term of this Agreement before giving effect to such rejection or termination; (ii) shall contain the same covenants, agreements, terms, provisions and limitations as this Agreement (except for any requirements that have been fulfilled by Operator or any Operator Mortgagee or other purchaser at a foreclosure sale prior to rejection or termination of this Agreement); and (iii) shall include that portion of the Operator Property in which Operator or such other Operator Mortgagee or other purchaser at a foreclosure sale had an interest on the date of rejection or termination.

13.7.2 If more than one Operator Mortgagee makes a written request for a New Agreement pursuant to this provision, the New Agreement shall be delivered to the Operator Mortgagee requesting such New Agreement whose Operator Mortgage is prior in time, and the written request of any other Operator Mortgagee whose lien is subordinate shall be void and of no further force or effect. The provisions of this Section 13 shall survive the termination, rejection or disaffirmation of this Agreement and shall continue in full force and effect thereafter to the same extent as if this Section 13 were a separate and independent contract made by Owner, Operator and each Operator Mortgagee, and, from the effective date of such termination, rejection or disaffirmation of this Agreement to the date of execution and delivery of such New Agreement, such Operator Mortgagee or other purchaser at a foreclosure sale may use and enjoy the Operator Property without hindrance by Owner or any person claiming by, through or under Owner; provided that all of the conditions for the New Agreement as set forth above are complied with.

13.8 **Operator Mortgagee's Consent to Amendment, Termination or Surrender.** Notwithstanding any provision of this Agreement to the contrary, the Parties agree that so long as any Operator Mortgage remains outstanding, this Agreement shall not be modified or amended, and Owner shall not accept a surrender, cancellation or release of all or any part of the Operator Property from Operator, prior to expiration of the Term of this Agreement, without the prior written consent of the Operator Mortgagee holding such Operator Mortgage. This provision is for the express benefit of and shall be enforceable by each Operator Mortgagee as if it were a party named in this Agreement.

14. **Assignment and Sublease.** Operator shall have the right, without Owner's consent, to sell, convey, lease, or assign all or any portion of this Agreement or the Operator Property, on either an exclusive or a non-exclusive basis, or to grant subeasements, co-easements, easements, licenses or similar rights with respect to the Operator Property (collectively, "**Assignment**"), to one or more persons or entities (collectively "**Assignee**"). Each Assignee shall use the Operator Property only for the uses permitted under this Agreement. When Operator makes any Assignment under this Section 14, Operator shall give written notice to Owner of such Assignment (including the interest conveyed by the Assignment and address of the Assignee for notice purposes) to Owner; provided Operator's failure to give such notice shall not constitute a default under this Agreement, but rather shall only have the effect of not binding Owner with respect to such assignment or conveyance until such notice is given. Any Assignment by Operator shall release Operator from obligations subject thereof accruing after the date that liability for such obligations is assumed by the Assignee.

15. **Hazardous Materials.**

15.1 **Owner's Covenants Regarding Hazardous Materials.** Owner represents and warrants that, to the best of Owner's knowledge, the Owner's Property is not and has not been in violation of any federal, state or local environmental health or safety laws, statute, ordinance, rule, regulation or requirement ("**Environmental Laws**"), and Owner has not received any notice or other communication from any governmental authorities alleging that the Owner's Property is in violation of any Environmental Laws. "**Hazardous Materials**" shall mean any asbestos containing materials, petroleum, explosives, toxic materials, or substances regulated as hazardous wastes, hazardous materials, hazardous substances, or toxic substances under any federal, state, or local law or regulation. Owner warrants that Owner has done nothing to contaminate the Operator Property with Hazardous Materials or wastes.

15.2 **Operator's Covenants Regarding Hazardous Materials.** Operator shall, at Operator's sole cost and expense, promptly take removal or remedial action required by Environmental Law with regard to any material violation of any Environmental Law with regard to any Hazardous Materials brought onto the Owner's Property by Operator or its employees, agents, or contractors. Owner shall cooperate with Operator with regard to any scheduling or access to the Owner's Property in connection with any action required hereunder.

15.3 **Operator's Indemnity Regarding Hazardous Materials.** Operator shall indemnify, defend, protect and hold Owner harmless from any liability based on: (i) the release of Hazardous Materials in, on, under or about the Owner's Property caused by Operator or its employees, agents, or contractors, or (ii) the violation by Operator or its employees, agents, or contractors of any Environmental Law. The indemnity obligations set forth herein shall survive termination of this Agreement.

16. **Insurance and Indemnity.**

16.1 **Insurance.** At all times during which Operator is conducting any activities on the Property and at all times during the Term of this Agreement, Operator shall maintain in effect (1) commercial General Liability Insurance, including bodily injury and property damage coverage with minimum limits of \$1 Million Dollars per occurrence and \$2 Million Dollars aggregate and (2) Umbrella Liability Insurance with minimum limits of \$5 Million Dollars per occurrence and \$5 Million Dollars aggregate. Upon a written request by Owner, Operator shall name Owner as additional insured on such insurance policy and provide Owner with a certificate of such insurance.

16.2 **Indemnity by Operator.** Operator shall defend, indemnify, protect and hold Owner harmless from and against all liabilities, costs, expenses, obligations, losses, damages, claims, (collectively "**Claims**") resulting from the negligence, willful misconduct, or breach of this Agreement by Operator, its agents, contractors or employees, invitees, licensees and permittees; provided, however, that such Claims are not due to the sole negligence, willful misconduct, or breach by Owner, its agents, contractors or employees, invitees, licensees or permittees.

16.3 **Indemnity by Owner.** Owner shall defend, indemnify, protect, and hold Operator harmless from and against all Claims resulting from the negligence, willful misconduct, or breach of this Agreement by Owner, its agents, contractors or employees, invitees, licensees and permittees; provided, however, that such Claims are not due to the sole negligence, willful

misconduct, or breach by Operator, its agents, contractors, employees, invitees, licensees, or permittees.

16.4 **Survival.** The obligations of the Parties under this Section 16 shall survive expiration or other termination of this Agreement.

17. **Confidentiality.** This Agreement includes confidential and proprietary information relating to Operator and the Project. Owner agrees not to provide copies of the Agreement or disclose the terms of the Agreement to any unauthorized person or entity. Operator authorizes Owner to provide copies of the Agreement and disclose the terms thereof to Owner's family ("family" shall be deemed to include all devisees or descendants of owner by will or intestacy), attorney, accountant, financial advisor and any existing or prospective mortgagee, lessee, or purchaser for the sole purpose of evaluating and advising Owner and for no other purpose, so long as such authorized parties agree in writing to become subject to the confidentiality provisions hereto and not to provide copies of the Agreement or disclose the terms thereof to any unauthorized person or entity. Any Owner and party shall return all material containing any confidential information to Operator immediately upon its request. Any party agrees to destroy immediately upon request by Operator such analyses, compilation, studies or other documents, and any oral information will continue to be subject to the terms of this Agreement. Owner agrees that Operator will have no adequate remedy at law if any party violates any of the terms of this Agreement. In such event Operator will have the right, in addition to any other rights Operator may have, to obtain injunctive relief to restrain any breach or threatened breach by third party or specific enforcement of such terms plus reimbursement of attorneys' fees, court costs and all associated expenses. No party shall publish, file for public record, reproduce, or otherwise disseminate this document or any of the terms and provisions hereof to any party, other than the Parties set forth above without the prior written consent of Operator, which consent may be withheld for any reason and in Operator's sole discretion.

18. **Default and Remedies.**

18.1 **Operator Payment Default.** [REDACTED]

18.1.1 **Collection of Payments.** [REDACTED]

18.1.2 **Terminate Agreement.** Owner may not terminate this Agreement because [REDACTED]

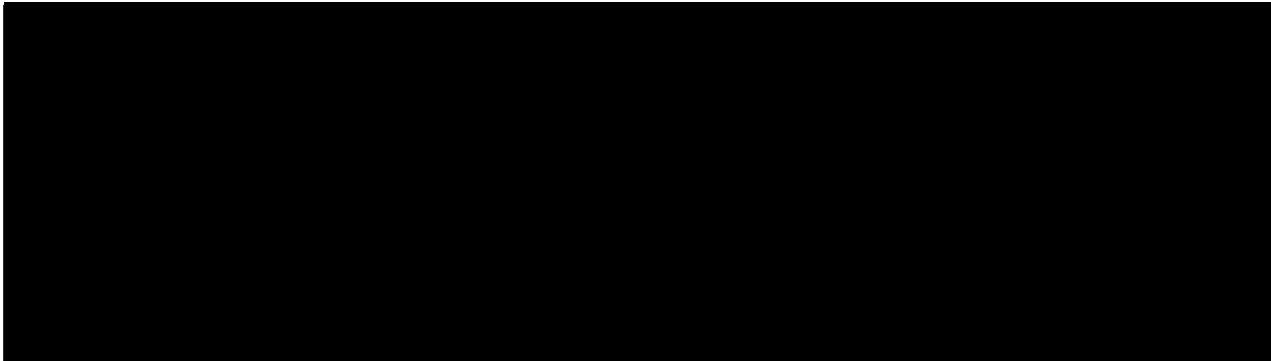

18.2 Other Operator Default.

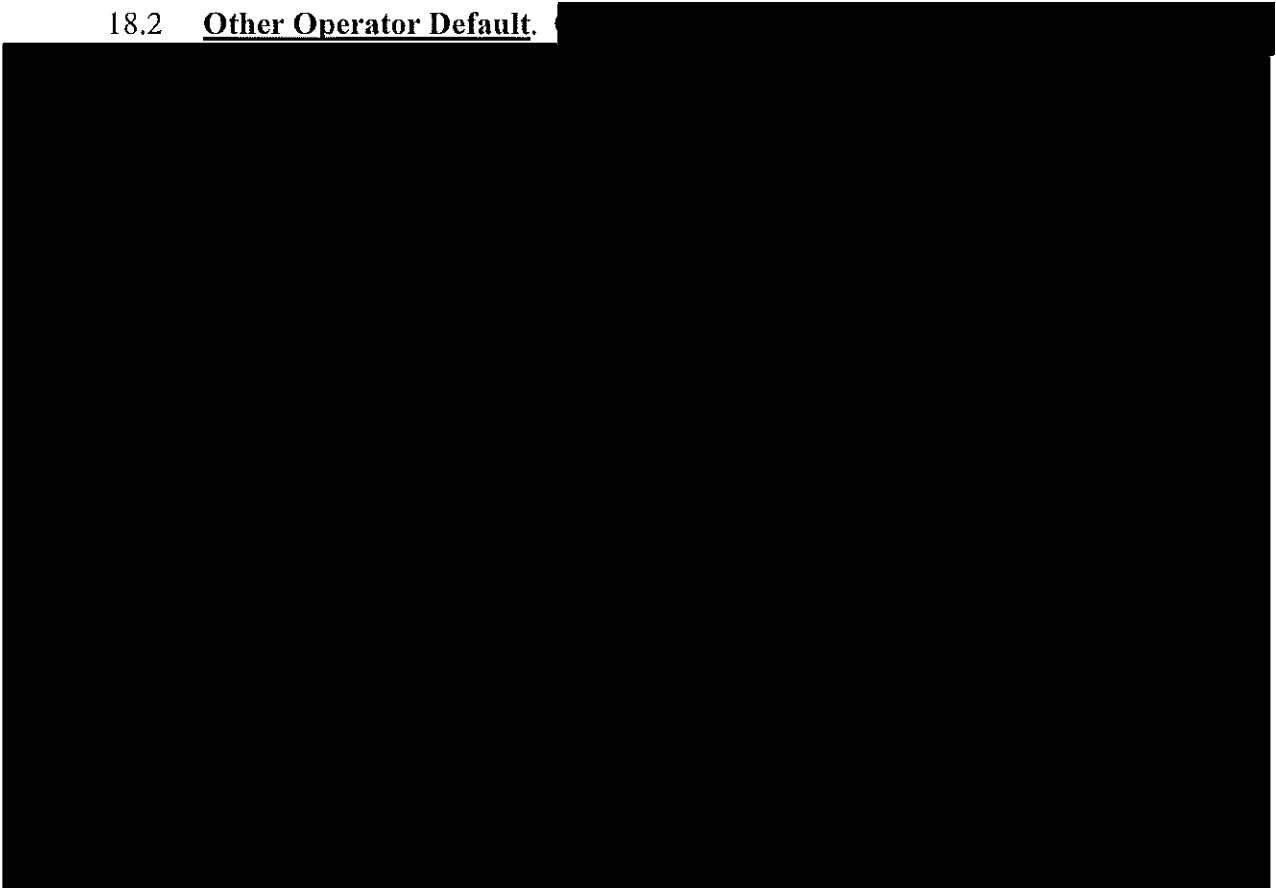

18.3 Owner Default.

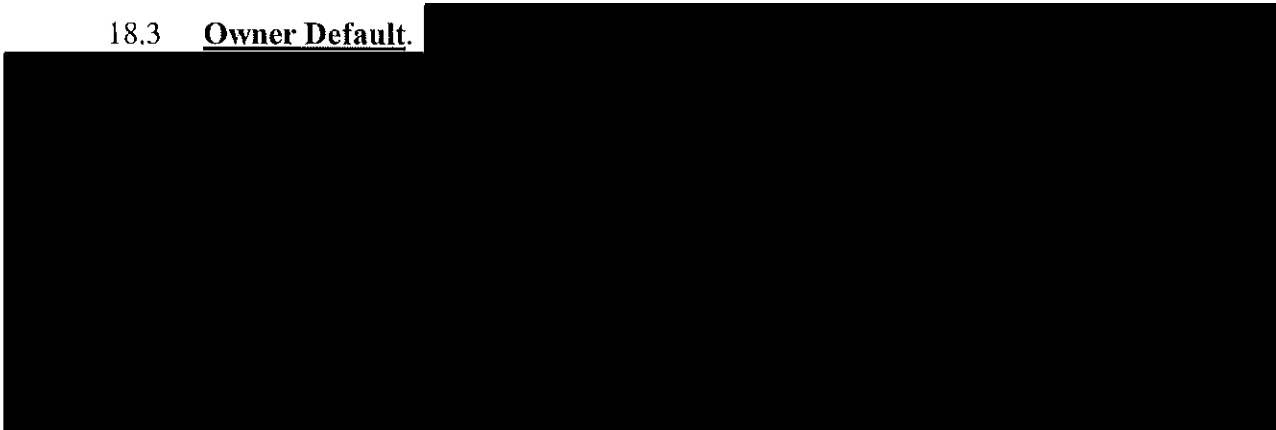

19. **Condemnation.**

19.1 **Complete Taking.** If, at any time, any authority having the power of eminent domain shall condemn all or substantially all of the Operator's Property, or all of the Improvements thereon, for any public use or otherwise, then the interests and obligations of Operator under this Agreement in or affecting the Operator's Property shall cease and terminate upon the earlier of (i) the date that the condemning authority takes physical possession of the Operator's Property or the Improvements thereon, (ii) the date that Operator is, in its sole judgment, no longer able or permitted to operate the Project on the Operator's Property in a commercially viable manner, or (iii) the date of the condemnation judgment. Operator shall continue to pay all amounts payable hereunder to Owner until the earlier of such dates, at which time the Parties shall be relieved of any and all further obligations and conditions to each other under this Agreement.

19.2 **Partial Taking.** If, at any time during the term of this Agreement, any authority having the power of eminent domain shall condemn one or more, but not all, of the Solar Panels, or any portion of the Improvements or the Operator's Property, then the interest and obligations of Operator under this Agreement as to those Solar Panels or any portion of the Improvements or the Operator's Property so taken shall cease and terminate upon the earlier of (i) the date that the condemning authority takes possession of such Solar Panels or any portion of the Improvements or the Operator's Property, (ii) the date that Operator is, in its reasonable judgment, no longer able or permitted to operate the Project on the Operator's Property, or any portion thereof, in a commercially viable manner, or (iii) the date of the condemnation judgment; and, unless this Agreement is terminated as hereinafter provided, this Agreement shall continue in full force and effect as to the remainder of the Solar Panels, Improvements and the Operator's Property. If the remainder of the Solar Panels or any other portion of the Improvements or the Operator's Property is or becomes insufficient or unsuitable for Operator's purposes hereunder, as determined by Operator in its sole discretion, then, subject to the rights of any Operator Mortgagee under Section 13, Operator shall have the right to terminate this Agreement as to the portion of the Operator's Property to which Operator continues to hold the rights, at which time the Parties shall be relieved of any further obligations and duties to each other under this Agreement.

19.3 **Apportionment, Distribution of Award.** On any taking, all sums awarded, including damages and interest, shall be paid as follows:

- (a) Any portion of the award by the court on account of any cost or loss that Operator may sustain in the removal and relocation of Operator's Improvements, to Operator;
- (b) Any portion of the award by the court for Operator's anticipated or lost revenues or profits, to Operator;
- (c) Any portion of the award by the court for Owner's lost revenues, to Owner;
- (d) All remaining amounts of the award, to Owner or Operator consistent with applicable Kentucky law.

20. **Notice.**

20.1 **Writing.** All notices given or permitted to be given hereunder shall be in writing.

20.2 **Delivery.** Notice is considered given either (i) when delivered in person to the recipient named below, (ii) upon receipt after deposit in the United States mail in a sealed envelope or container, postage and postal charges prepaid, return receipt requested or certified mail, addressed by name and address to the party or person intended, or (iii) twenty-four (24) hours from proper and timely delivery to an overnight courier service addressed by name and address to the party or person intended as follows:

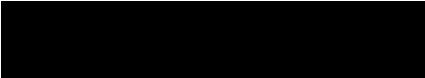
Notice to Owner: Laura Anne Logsdon and
Derek H. Logsdon a/k/a Herman D. Logsdon
8619 Thomason Rd
Robards, KY 42452

Notice to Operator: Sebree Solar II, LLC
700 Universe Blvd
Juno Beach, FL 33408

20.3 **Change of Recipient or Address.** Either Party may, by notice given at any time or from time to time, require subsequent notices to be given to another individual person, whether a party or an officer or representative, or to a different address, or both. Notices given before actual receipt or notice of change shall not be invalidated by the change.

21. **Miscellaneous Provisions.**

21.1 **Successors and Assigns.** The terms and provisions of this Agreement shall run with the land and be binding on and inure to the benefit of the heirs, successors, assigns and personal representatives of the Parties. In accordance with this Agreement, Operator in its discretion may authorize other persons or entities to use the Operator Property for the purposes stated in this Agreement

21.2 **Memorandum.** Simultaneously with the execution of this Agreement, the Parties agree to execute and acknowledge a memorandum of this Agreement. Operator may record the executed memorandum in the public records of Henderson County, Kentucky.

21.3 **Entire Agreement.** This Agreement and the attached Exhibits shall constitute the entire agreement between the Parties and supersedes all other prior writings and understandings.

21.4 **Amendments.** This Agreement shall not be amended or modified in any way except by an instrument signed by the Parties and consented to by any Operator Mortgagee. The Parties hereto shall at all times hereafter execute any documents and do any further acts which may be necessary or desirable to carry out the purposes of this Agreement and to give full force and effect to each and all of the provisions hereof.

recd

21.5 **Legal Matters.** This Agreement shall be governed by and interpreted in accordance with the then existing laws of the Commonwealth of Kentucky and the County where the Owner's Property is located shall be considered the proper forum or jurisdiction for any disputes arising in connection with this Agreement. The Parties agree to first attempt to settle any dispute arising out of or in connection with this Agreement by good-faith negotiation. If the Parties are unable to resolve amicably any dispute arising out of or in connection with this Agreement, each shall have all remedies available at law or in equity and as provided by this Agreement. **Each Party waives all right to trial by jury and specifically agrees that trial of suits or causes of action arising out of this Agreement shall be to the court of competent jurisdiction.**

21.6 **Severability.** If any term or provision of this Agreement, or the application thereof to any person or circumstance shall, to any extent, be determined by judicial order or decision to be invalid or unenforceable, the remainder of this Agreement or the application of such term or provision to persons or circumstances other than those as to which it is held to be invalid, shall be enforced to the fullest extent permitted by law.

21.7 **Tax Credits.** If under applicable law Operator becomes ineligible for any currently existing tax credit, benefit or incentive for alternative energy expenditure established by any local, state or federal government, then, at Operator's option, the Parties shall negotiate in good faith to amend this Agreement or replace it with a different instrument so as to convert Operator's interest in the Operator Property to a substantially similar interest that makes Operator eligible for such tax credit, benefit or incentive. Such amendment or instrument shall not impair any of Owner's rights or increase the burdens or obligations of Owner under this Agreement.

21.8 **Approvals.** Whenever in this Agreement the approval or consent of either Party is required or contemplated, unless otherwise specified, such approval or consent shall not be unreasonably withheld or delayed.

21.9 **Authority.** The signatories hereto warrant that each has the authority to execute this Agreement on behalf of any entities which are Parties to this Agreement and that each such entity has executed this Agreement pursuant to its organizational documents or a resolution or consent of their Board of Directors or other governing body.

21.10 **Time of Essence.** Time is of the essence of each provision of this Agreement.

21.11 **Counterparts.** This Agreement may be executed in multiple counterparts, each of which shall be deemed an original, and all of which together shall constitute a single instrument.

Owner:

Laura Anne Logsdon
Laura Anne Logsdon

Derek H. Logsdon a/k/a Herman D. Logsdon
Derek H. Logsdon a/k/a Herman D. Logsdon

Operator:

Sebree Solar II, LLC
a Delaware limited liability company

By: Anthony Pedroni
Anthony Pedroni, Vice President

2020

EXHIBIT A

Legal Description of Owner's Property

Being all of Tract 2 Total Area Consolidated 43.37 acres, more or less, of the Denton & Logsdon Agricultural Division and Consolidation as shown by plat of record in Plat Book 10, page 268, in the Henderson County Clerk's Office, and to which plat and reference is hereby made for a more particular description.

The above being the same property acquired by Laura Anne Logsdon by Deed dated June 7, 2018, of record in Deed Book 631, Page 293, in the Henderson County Clerk's Office and by Deed dated March 3, 2008, of record in Deed Book 561, page 25, in the Henderson County Clerk's Office, subject to a life estate. Also see Deed Book 595, page 141, in the aforesaid clerk's office, extinguishing said life estate.

Approximately 43 acres

QLA ID: 18502

HOLDING PAGE FOR EXHIBIT B

Preliminary Lease and Easement Improvement Plan and Acreage Calculation
To be Delivered with Option Notice

HOLDING PAGE FOR EXHIBIT C

As Built Lease and Easement Improvements and Final Acreage Calculation

EXHIBIT D

Lease and Easement Compensation

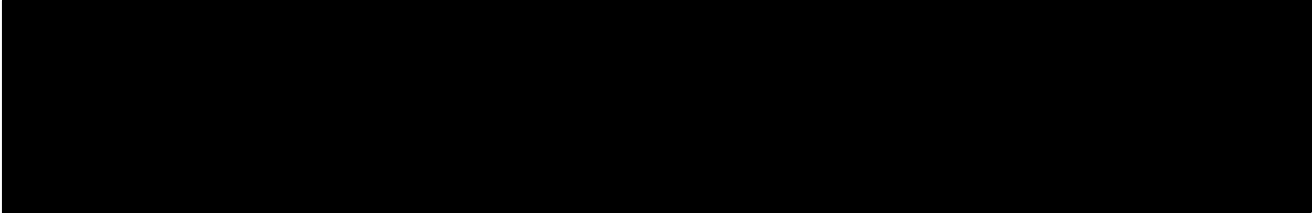

(2) **Option Payment.**

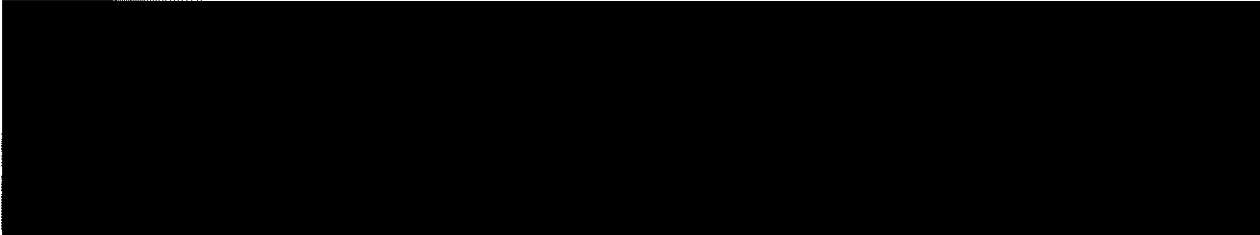
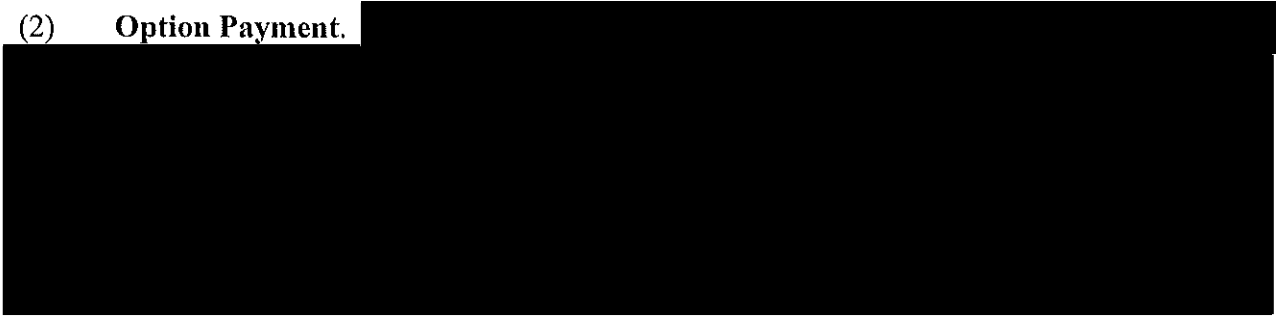

(3) **Payment for Lease and Easements.**

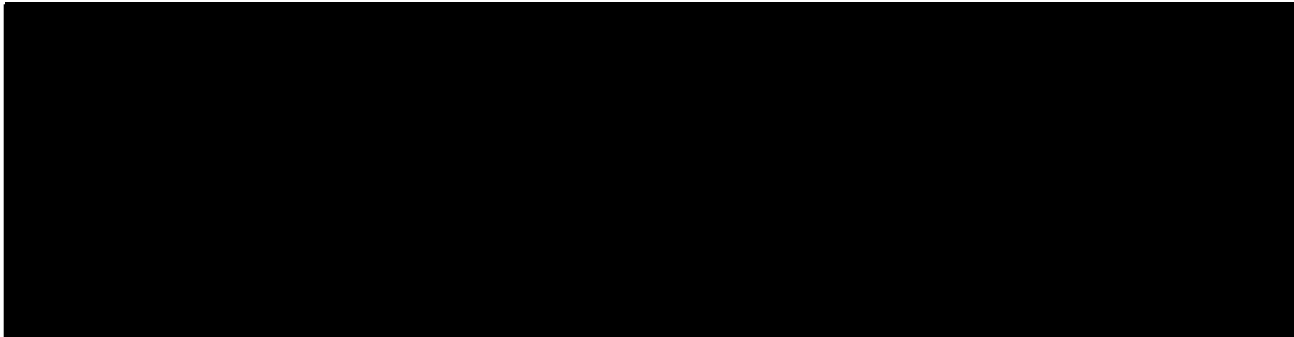
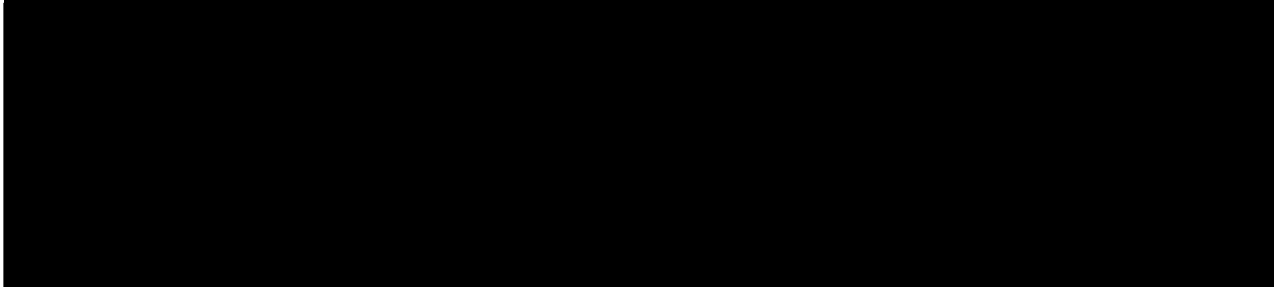

lcl

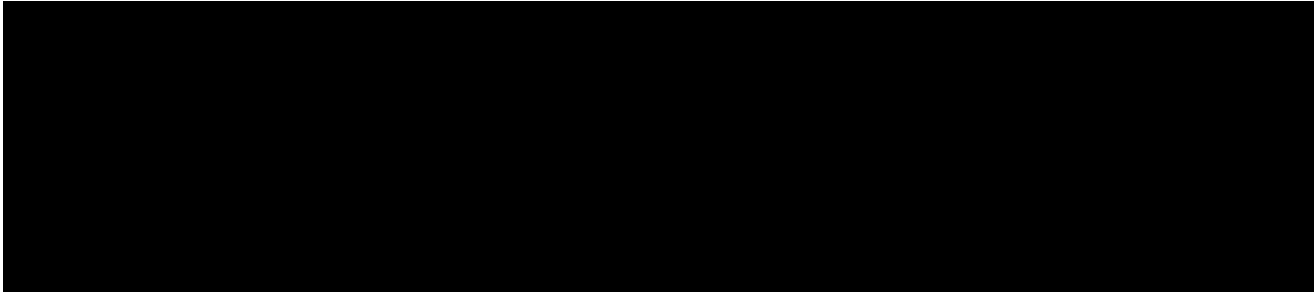

(4) Crop Compensation.

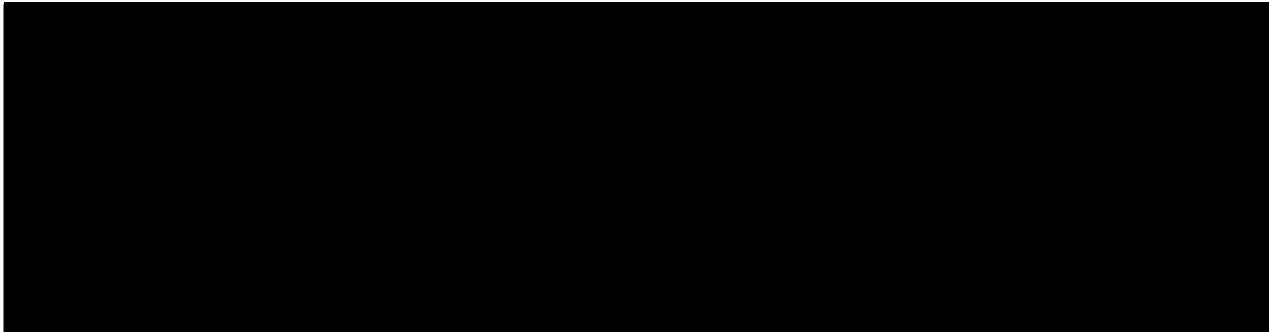
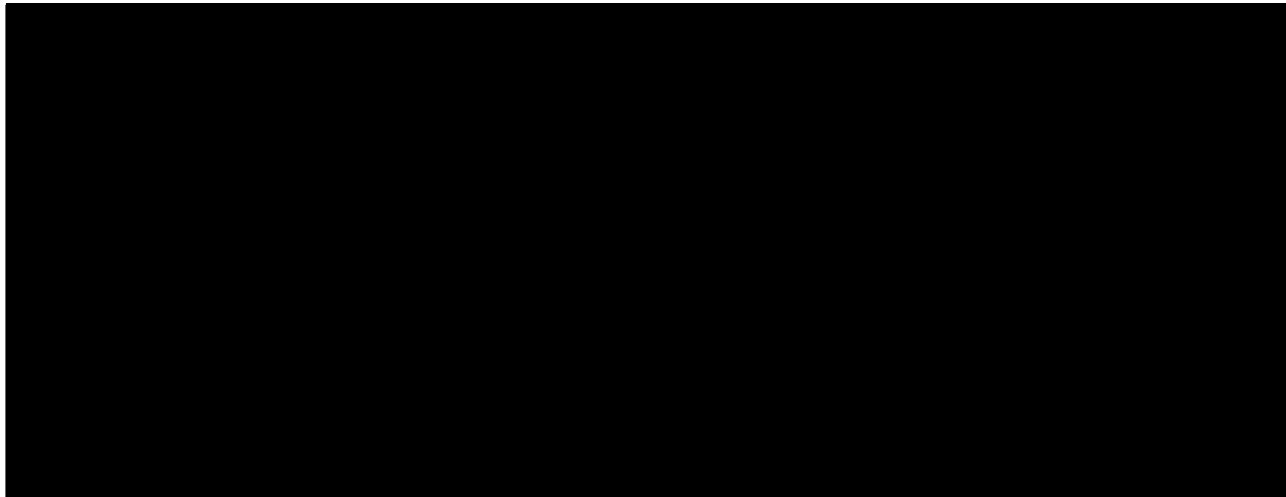

(5) Payment Allocation Schedule.



SOLAR LEASE AND EASEMENT AGREEMENT

- 18th August
1. **Parties.** This Solar Lease and Easement Agreement ("**Agreement**") is made and entered as of the 29th day of July, 2020 ("**Effective Date**"), by and between McMullin Anderson, LLC, a Kentucky limited liability company ("**Owner**") and Boulevard Associates, LLC, a Delaware limited liability company ("**Operator**"), which are sometimes individually referred to as a "**Party**" and collectively as the "**Parties**".
 2. **Project.** This Agreement relates to the solar-powered electrical power generation and transmission project known as the "Sebree Solar Energy Center" to be located in Henderson County, Kentucky ("**Project**"), which may be wholly or partially located on the Owner's property legally described on the attached **Exhibit A** to this Agreement ("**Owner's Property**"). Upon Operator's exercise of the Option (as defined below), the Project shall include (i) the Lease of Owner's Property described in Section 4, (ii) the Easements referenced in Section 5 that are located on the Owner's Property, and (iii) the Improvements referenced in Section 8 to be constructed on Owner's Property. The Lease, Easements and Improvements are sometimes collectively referred to as the "**Operator Property**".
 3. **Option.** Owner grants to Operator an exclusive option ("**Option**") to acquire the Lease and Easements referenced in Sections 4 and 5 in accordance with the following terms and conditions. Operator shall be entitled to acquire the Lease and the Easements in their entirety or in part, as Operator deems appropriate.
 - 3.1 **Option Term.** The period during which Operator may exercise the Option shall be for a term of five (5) years, commencing on the Effective Date ("**Option Term**").
 - 3.2 **Option Payment.** As consideration for the granting of the Option, Operator agrees to pay Owner the Option Payment set forth in **Exhibit D**.
 - 3.3 **Use of Owner's Property.** During the Option Term, Operator and its employees, agents and contractors shall have a right to enter upon the Owner's Property and the right of ingress and egress over and across the Owner's Property for the purposes of (i) surveying the Owner's Property; (ii) performing such other tests and studies as Operator may desire in connection with the Option, including, without limitation, environmental, avian and cultural resource assessments, and geotechnical, foundation and soil tests, provided that such activities do not unreasonably interfere with Owner's use of the Owner's Property; and (iii) installing, maintaining, operating, inspecting and removing one or more weather related instruments ("**Weather Instrument**") and fencing of said Weather Instrument and including the performance of all tests and studies associated therewith. Owner shall not permit any other individual or entity except Operator or its affiliates to install a Weather Instrument on Owner's Property.
 - 3.4 **Right to Grant Option.** Owner warrants and represents to Operator that (i) the statements in Section 9 concerning Owner's title to the Owner's Property are true and correct; (ii) Owner has the authority to grant this Option to Operator without the consent or approval of any other party; and (iii) there are no other existing options, rights of first refusal, contracts to

purchase, leases or mortgages that would prevent Operator from exercising its rights with respect to the Option.

3.5 **Exercise of Option.** Operator may exercise the Option by giving written notice to Owner ("**Option Notice**") at any time during the Option Term. Operator shall specify in the Option Notice the Commencement Date referenced in Section 6.1.1. On the Commencement Date, the Lease and Easements referenced in Sections 4 and 5 shall automatically become effective, and the Parties shall be subject to all of the terms and conditions of this Agreement with respect to such Lease and Easements and all rights and obligations relating thereto.

3.6 **Termination of Option.** If Operator fails to exercise the Option within the Option Term, the Option and the rights of Operator as the optionee shall automatically terminate.

4. **Lease.** Upon exercise of the Option by Operator, Owner leases to Operator, and Operator leases from Owner, Owner's Property for the Lease and Easement Term (defined in Section 6.1) in accordance with the terms and conditions of this Agreement ("**Lease**"), which Lease grants Operator and its agents, contractors, and employees the right to use the Owner's Property for the following permitted uses:

4.1 **Construction Right.** Operator leases Owner's Property for the purpose of constructing, operating, maintaining, repairing, replacing, and removing all or any part or component of the Improvements whether located on Owner's Property. Operator may exercise its right to use all or any part of the Owner's Property as and when Operator deems it necessary or advisable to do so to perform the activities for which this right is granted, including, without limitation, staging areas and parking for Operator's employees.

4.2 **Access Right.** Operator leases Owner's Property for unobstructed vehicular and pedestrian access and ingress to and egress from the Improvements, Owner's Property and any public roadways, and to construct, maintain, and utilize Roadway Improvements on the Owner's Property. Owner shall not permit others to obstruct or damage the roads or Roadway Improvements located on the Owner's Property or in any other way interfere with Operator's rights under this right. Operator shall repair any damage done to Roadway Improvements which result from use by Operator, its agents, servants or employees. Such roads shall be maintained in the condition necessary for use by Operator's equipment, and with regard to existing roads, shall be maintained in at least the condition that existed prior to Operator's use.

4.3 **Solar Panels Right.** Operator leases Owner's Property for Operator to construct, operate, replace, relocate, remove, and maintain Solar Panels and the appurtenant Collection Facilities, together with associated roads and parking areas on Owner's Property.

4.4 **Collection Facilities Right.** Operator leases Owner's Property for Operator to construct, operate, maintain, replace, relocate or remove Collection Facilities on and under the Owner's Property.

4.5 **Substation Right.** Operator leases Owner's Property for Operator to construct, operate, maintain, replace, relocate or remove one or more Substations on Owner's Property.

4.6 **Telecommunication Right.** Operator leases Owner's Property for Operator to construct, operate, maintain, replace, relocate or remove Telecommunication Facilities on and under the Owner's Property.

4.7 **Weather Instrument Right.** Operator leases Owner's Property in order to construct, operate, replace, relocate, remove, and maintain a Weather Instrument and the appurtenant Collection Facilities on Owner's Property.

4.8 **Battery Facilities Right.** Operator leases Owner's Property in order to construct, operate, replace, relocate, remove, and maintain one or more Battery Facilities on Owner's Property.

5. **Grant of Easements.** Upon the exercise of the Option by Operator, Owner grants to Operator, and Operator accepts from Owner, for the Lease and Easement Term referenced in Section 6.1, the following easements over and across the Owner's Property in accordance with the terms and conditions of this Agreement. The following easements are for the benefit of Operator and Operator's agents, contractors and employees and located on the Owner's Property and are collectively referred to as the "**Easements**".

5.1 **Sun Non-Obstruction Easement.** Owner grants Operator an irrevocable, exclusive easement for the right and privilege to use, maintain and capture the free and unobstructed sunlight over and across the Owner's Property. Owner shall not engage in any activity on Owner's Property or any other neighboring property owned by Owner that might interfere with the sunlight direction over any portion of Owner's Property; cause a decrease in the output or efficiency of any Solar Panel or Weather Instrument; or otherwise interfere with Operator's operation of the Project or exercise of any rights granted in this Agreement (collectively "**Interference**"). This grant of the easement expressly includes the right of Operator to enforce Operator's rights, including the physical removal of trees or structures (except existing trees and structures) causing Interference to the Project contemplated by Operator. Operator shall notify Owner before making any such removals.

5.2 **Effects Easement.** Owner grants to Operator an easement over Owner's Property for visual, view, light, flicker, noise, shadow, vibration, electromagnetic, electrical and radio frequency interference, and any other effects attributable to the Project located on the Owner's Property.

6. **Term.** The term of this Agreement ("**Term**") includes the Option Term referenced in Section 3.1, the Initial Lease and Easement Term as described in Section 6.1.1 and the Extended Lease and Easement Term as described in Section 6.1.2 (together, the Initial Lease and Easement Term and the Extended Lease and Easement Term, if applicable, is defined as the "**Lease and Easement Term**").

6.1 **Lease and Easement Term.**

6.1.1 **Initial Lease and Easement Term.** The initial term of the Lease and Easements shall commence on the date specified by Operator in the Option Notice ("**Commencement Date**"). The initial term of the Lease and Easements shall end thirty (30)

years after the Commencement Date (the "**Initial Lease and Easement Term**"), subject to the rights of renewal and termination as provided in this Agreement.

6.1.2 **Extended Lease and Easement Term.** Operator shall have the right to extend the Term of this Agreement for two (2) consecutive terms of five (5) years each in accordance with the terms and provisions of this Agreement (collectively "**Extended Lease and Easement Term**") by providing written notice to Owner of Operator's intent to extend the Term within one hundred eighty (180) days of the end of the existing Term. Each Extended Lease and Easement Term shall begin on the expiration date of the Initial Lease and Easement Term or previous Extended Lease and Easement Term, as the case may be. During the Extended Lease and Easement Term, Operator shall pay Owner the amounts set forth in **Exhibit D** as the consideration for the Lease and Easements.

6.1.3 **Delays During Lease and Easement Term.** At Operator's option, the Term may be extended for a period of time equal to the period of time during which operation of the Project is delayed or suspended because of the occurrence of a Regulatory Suspension or Force Majeure, which are defined as follows:

(i) "**Regulatory Suspension**" shall mean the enactment or application of any law, order, rule, or regulation of the Kentucky Public Service Commission, Federal Energy Regulatory Commission, or other local, state, or federal government authority having jurisdiction over the Project or Operator, or the failure of any such governmental authority to issue an approval or permit pursuant to any such law, order, rule, or regulation, which results in the delay, interruption, or suspension of the production, sale or transmission of electricity from the Solar Panels; and

(ii) "**Force Majeure**" shall mean causes beyond the reasonable control of and without the fault or negligence of the Party claiming Force Majeure, including but not limited to acts of God, labor unrest (including, but not limited to, slowdowns, picketing, boycotts or strikes), flood, earthquake, storm, fire, lightning, explosion, power failure or power surge, vandalism, theft, the cutting of power, transmission or other lines, wires or cables to the Project by persons other than Operator's employees or contractors, epidemic, war, revolution, riot, civil disturbance, sabotage, change in law or applicable regulation subsequent to the Commencement Date and action or inaction by any federal, state or local legislative, executive, administrative judicial agency or body which in any of the foregoing cases, by exercise of due foresight such Party could not reasonably have expected to avoid, and which, by the exercise of due diligence, it is unable to overcome.

The Parties shall be excused from performing their respective obligations under this Agreement and shall not be liable in damages or otherwise if and to the extent that they are unable to so perform or are prevented from performing by a Force Majeure, provided that: (i) the non-performing Party, as promptly as practicable after the occurrence of the Force Majeure, but in no event later than thirty (30) days thereafter, gives the other Party written notice describing the particulars of the occurrence; (ii) the suspension of performance is of no greater scope and of no longer duration than is reasonably required by the Force Majeure; (iii) the non-performing Party uses good faith and commercially reasonable efforts to remedy its inability to perform; and (iv) as soon as the non-performing Party is able to resume performance of its obligations excused as a

result of the occurrence, each Party shall give prompt written notification thereof to the other Party.

6.2 **Termination by Operator.** Provided Operator is not in default under any term of this Agreement, Operator, at its option, shall have the right to terminate this Agreement at any time during the Term of the Agreement, as to all or any part of the Operator Property. Termination shall be effective thirty (30) days after written notice of such termination to Owner. If Operator's notice is a full termination of the Operator Property, the Parties shall be relieved of all further duties and obligations under this Agreement, other than (i) the payment of any accrued and unpaid obligations owed by either Party as of the date of termination; (ii) the removal of the Improvements by Operator pursuant to Section 8.11; and (iii) any other obligations and liabilities that are expressly stated in this Agreement to survive such termination. Upon any such partial termination by Operator, the Parties shall be relieved of all further duties and obligations under this Agreement with respect to the portion thereof terminated by Operator, subject to the obligations and liabilities referenced in items (i) through (iii) above that shall continue to be applicable to the terminated portion of this Agreement. The Parties agree to execute an amendment to this Agreement evidencing such partial termination. If Operator elects to terminate the Agreement so that the term is terminated prior to the end of the 20th year of the Lease Term, then Operator shall pay to Owner One (1) year of Annual Installment Payments, due prior to the termination date of the Lease Term. The payment set forth above shall be referred to herein as the (the "Termination Payment"). Operator shall not be obligated to pay to Owner a Termination Payment if it terminates the Agreement due to a default under the applicable power purchase agreement for the purchase of electricity from the Solar Project.

7. **Payments.** If Operator exercises the Option referenced in Section 3, Operator agrees to pay Owner the amounts set forth in **Exhibit D** as consideration for the Lease, Easements and Operator's other rights and interests in the Owner's Property.

8. **Improvements.** Operator shall have the right, at its sole cost and expense, to construct, install, maintain, use, operate, repair, replace, relocate and remove all facilities, structures, equipment, machinery, wires, conduit, cables, poles, materials and property of every kind and character required for the construction and operation of portions of the Project on the Owner's Property, including, but not limited to, the Solar Panels, Collection Facilities, Substations, Telecommunication Facilities, Weather Instruments, Roadway Improvements and Battery Facilities referenced in Sections 8.1 through 8.7 (collectively, the "**Improvements**").

8.1 "**Solar Panels**" shall mean any photovoltaic energy system designed for the generation of electrical power from the collection of sunlight, including without limitation, the photovoltaic panels, foundations, support structures, braces and related equipment.

8.2 "**Collection Facilities**" shall mean all Improvements whose purpose is to deliver electrical power generated by the Solar Panels to an electrical power grid or other system, including without limitation transformers, overhead and underground electrical collection lines, telecommunication lines, splice boxes and interconnection facilities.

8.3 "**Substations**" shall mean electrical lines, meters, monitoring and control equipment, switches, transformers, all structures, equipment, enclosures, fencing, security devices, and other electrical and communications equipment necessary to condition and increase

the voltage of electricity generated by the Project to make it suitable for transmission on, and to deliver it to, Collection Facilities connected to an electric power grid or other system.

8.4 "**Telecommunication Facilities**" shall mean all Improvements whose purpose is to provide telecommunication services solely relating to the Project or any of Operator's solar powered projects, including telephone, closed-circuit television, microwave, internet, computer data and other telecommunication services.

8.5 "**Weather Instrument**" shall mean instruments used primarily to gather and transmit sunlight and meteorological data relating to the Project, and includes the instrument's foundations, guy wires, sunlight and meteorological data acquisition equipment, power source, and any required data and electrical transmission lines.

8.6 "**Roadway Improvements**" shall mean all improvements that may be necessary to construct, maintain and repair any new and existing roadways and other means of ingress and egress over, across and along the Owner's Property, including paving or surfacing of the roadways with asphalt, gravel or other roadway materials, installation of road signs and the construction and installation of culverts, bridges, drainage ditches, gates, cattle guards and similar structures and facilities.

8.7 "**Battery Facilities**" shall mean a type of equipment that can be given a new charge by passing an electric current through it designed for the storage of electrical power including without limitation, batteries and other devices for storage of electrical energy, foundations, support structures, braces and related equipment.

8.8 **Ownership of Improvements.** Except as otherwise provided in Section 11.7, all Improvements shall at all times remain the property of Operator, and Owner shall have no right, title or interest therein. All Improvements constructed or placed on the Owner's Property by Operator during the Term of this Agreement may be repaired, replaced, relocated, removed, added to or expanded upon by Operator at any time during the Term of this Agreement. Owner expressly waives any statutory lien or common law liens on the Improvements to which Owner might be entitled.

8.9 **Construction Liens.** Operator shall not permit any liens arising out of Operator's use of the Operator Property under this Agreement to be filed against the Owner's Property. Operator shall, within sixty (60) days after it receives notice of the lien, provide a bond or other security that Owner may reasonably request, or remove such lien from the Owner's Property in the manner provided by applicable law.

8.10 **Location of Improvements.** The acreage required from the Owner's Property for the Improvements for which the Lease and Easements are being granted cannot be determined until the completion of Operator's inspection, testing, study and surveying of the Owner's Property during the Option Term. Along with the Option Notice, Operator shall deliver to Owner a proposed plan of development showing the contemplated locations of the Improvements and a preliminary calculation of the acreage as determined by the area bounded by a perimeter fence required for the Project, which shall serve as the **Exhibit B** to this Agreement. During the final development and construction of the Project, such locations may need to be amended.

Following construction of the Project, Operator shall provide Owner an "as-built" survey of all Improvements on Owner's Property and the final calculation of the acreage as determined by the area bounded by a perimeter fence required for the Project, which shall serve as **Exhibit C** to this Agreement. Further, following construction, the Improvements may need to be relocated or rerouted by Operator, which Operator may perform, at any time during the Term of this Agreement, so long as the nature and extent of any such relocated or rerouted Improvements are not materially different and impose no materially greater burden on the Owner's Property than the original locations or routes, and so long as Operator takes commercially reasonable efforts to minimize disruption or inconvenience to Owner.

8.11 **Removal of Improvements**. Upon full or partial termination of any of the Lease Rights or Easements, Operator shall remove all Improvements and restore the area formerly occupied by the Improvements to substantially the same physical condition that existed immediately before the construction of the Improvements (the "**Removal Obligations**"). At Owner's request, all or any part of the Roadway Improvements may be left for use by Owner.

8.12 If a governmental authority does not require a performance bond or security for removal of the Improvements, then upon the earlier to occur of: (i) the termination of this Agreement; or (ii) on the twentieth (20th) anniversary of the commercial operations date of the Project, Operator shall obtain and deliver to Owner a bond in form and substance reasonably satisfactory to Owner securing Operator's Removal Obligations (the "Removal Bond"). The Removal Bond shall be equal to the estimated amount, if any (the "Net Removal Costs"), of removing the Improvements from Owner's Property. Operator shall not be required to deliver such Removal Bond to Owner if Operator has delivered such a bond in connection with the permitting of Owner's Property or any other portion of the Improvements for the Project. Once in place, Operator shall keep such bond, or a like replacement, in force throughout the remainder of the Term. The Net Removal Costs shall be determined by the Parties hereto acting in good faith. If the Parties cannot agree upon the Net Removal Costs within sixty (60) days of their first attempt to do so, then the Net Removal Costs shall be determined by an independent engineer mutually selected by the Parties. If the Parties cannot agree upon such independent engineer within the next thirty (30) days, then by an independent engineer appointed by a District Judge of Henderson County, Kentucky; and the decision of such an independent engineer (however selected) as to the Net Removal Costs shall be conclusive as between and binding upon, the Parties. If an independent engineer is selected, then the Parties hereto shall equally share all of the costs associated with the independent engineer's determination of the Net Removal Cost. If the Removal Bond is unavailable or an alternate form of security is more economical or desirable, then Operator may substitute an alternate form of security, such as a letter of credit, other form of bond, or guarantee reasonably acceptable to Owner that provides substantially equivalent security as the Removal Bond.

9. **Ownership and Title Matters**. Owner warrants and represents to Operator, both as of the Effective Date, and as of the Commencement Date as follows:

9.1 **Authority**. Owner represents and warrants that it is the holder of fee simple title and is the sole owner of the Owner's Property and has the unrestricted right and authority to sign this Agreement and to grant Operator the Lease and Easements and other rights granted in this

Agreement. When signed by both Parties, this Agreement constitutes a valid and binding agreement enforceable against Owner in accordance with its terms.

9.2 **Other Agreements.** The Owner's Property is not subject to any other agreements, options, rights of first refusal or other prior right of any party to purchase, lease or acquire easements in the Owner's Property, or create any prior claim or right that would preclude or interfere with Operator's rights and interests under this Agreement and the Lease and Easements.

9.3 **Minerals.** Except as disclosed by Owner to Operator at the time of the execution of this Agreement by Owner, Owner owns all of the oil, gas and other minerals, and all rights thereto as on or under the Owner's Property.

9.4 **Owner Mortgage.** Except as disclosed by Owner to Operator at the time of the execution of this Agreement by Owner, there are no mortgages encumbering the Owner's Property ("**Owner Mortgage**").

9.5 **Notice and Opportunity to Cure.** If there is an Owner Mortgage encumbering Owner's Property and Owner receives from the holder thereof any notice that payments are overdue, Owner shall notify Operator and each Operator Mortgagee (as defined at Section 13.1) by sending a copy of such overdue payment notice to Operator by the earlier of (i) five (5) days after receipt, or (ii) three (3) business days prior to the date by which a default under or in respect of such Owner Mortgage could occur. If Operator or any Operator Mortgagee determines that it would be in Operator's interest to make such payments to Owner Mortgagee on Owner's behalf, whether as a result of receiving such notice or otherwise, Operator shall have the right to make such payments and to credit the payments so made against the Annual Installment Payment next due under the Agreement.

9.6 **Subordination, Non-Disturbance & Attornment Agreement.** If there is an Owner Mortgage encumbering Owner's Property, Owner shall cooperate with Operator to obtain a Subordination, Non-Disturbance and Attornment Agreement ("**SNDA**") in the form prepared and provided by Operator, from each Owner Mortgagee, pursuant to which such Owner Mortgagee agrees, among other things, not to disturb Operator's possession and use of the Owner's Property. Owner shall not incur any loss in income, expense, obligation or liability with regard to the SNDA. Operator shall, at its sole cost and expense, record each such SNDA in the Office of the County Clerk in which Owner's Property is located. If Owner fails to deliver a SNDA from each Owner Mortgagee, Operator may, at its sole option, either (i) terminate this Agreement immediately upon written notice to Owner, or (ii) take such action as Operator deems reasonably necessary to effect the rights granted to Operator hereunder, and off-set all amounts expended in such efforts against the Annual Installment Payments and any other amounts due hereunder or in respect hereof.

10. **Representations and Warranties of Owner.** Owner hereby makes the following further representations and warranties both as of the Effective Date, and as of the Commencement Date:

10.1 **Physical Condition.** Owner has no knowledge of any existing physical conditions of the Owner's Property which would prevent, significantly restrict or make more

expensive Operator's development of the Owner's Property for the purposes specified in this Agreement, or which could, with the passage of time, or the giving of notice, constitute a violation of any currently applicable governmental law, ordinance, order, rule or regulation.

10.2 **Legal Restrictions.** Owner has no knowledge of any law, regulation, ordinance or order of any local, state or federal governmental authority which would prohibit or significantly restrict Operator's development of the Owner's Property pursuant to this Agreement. This Agreement does not violate any contract, agreement, instrument, judgment or order to which Owner is a party or which affects the Owner's Property. To the best of Owner's knowledge, the Owner's Property is currently in full and complete compliance with all governmental laws, ordinances, orders, rules and regulations applicable to the Owner's Property.

10.3 **No Litigation.** No litigation is pending and, to the best of Owner's knowledge, no litigation or administrative actions are proposed, threatened or anticipated with respect to any matter affecting the Owner's Property. If Owner learns of any litigation or administrative action proposed, threatened or instituted with respect to the Owner's Property, Owner shall give Operator notice within thirty (30) days thereof.

10.4 **Survival.** The representations and warranties set forth in this Section 10 shall survive the execution and delivery hereof.

11. **Use, Operation and Maintenance.**

11.1 **Exclusive Use by Operator.** Operator shall have the exclusive right (i) to use and possess the Owner Property in connection with the Project and other similar solar-powered electrical power generation projects; (ii) to investigate, inspect, survey, and conduct tests of the Owner's Property, including, but not limited to, meteorological, environmental, archeological and geotechnical tests and studies; (iii) to use and convert all of the sunlight resources on the Owner's Property; and (iv) to undertake such other activities on the Owner's Property that may be related to the Project, including, without limitation, the storage of Solar Panels, materials and equipment during the installation and construction of the Improvements; development and operation of communications systems; and site tours of the Project for visitors and other interested parties.

11.2 **No Required Installation or Operation.** Nothing in this Agreement shall be interpreted as imposing on Operator any obligation to install Solar Panels or other Improvements on the Owner's Property, or to operate the Project on the Owner's Property. Operator shall have the sole discretion to determine if and when any Solar Panels and other Improvements may be constructed on Owner's Property, and if and when to commence the operation of the Project on the Owner's Property.

11.3 **Permits and Approvals.** Operator shall be responsible, at its sole cost and expense, for obtaining any governmental permits and approvals necessary for the construction and operation of the Project and the construction and operation of the Improvements. Owner shall cooperate with Operator as necessary to obtain any governmental or utility approvals or permits, including, without limitation, signing any applications for such approvals, provided that

Owner shall not incur any loss in income, expense, obligation or liability with respect to Operator obtaining such permits or approvals.

11.4 **Compliance with Laws.** Operator shall comply in all material respects with valid laws applicable to the Owner's Property and the Operator Property. Operator shall have the right, in its sole discretion and at its sole expense, in Operator's name to contest the validity or applicability to the Owner's Property and the Operator Property of any law, ordinance, statute, order, regulation, property assessment or the like made by any governmental agency or entity. Operator shall control any such contest and Owner shall cooperate with Operator in every reasonable way in such contest, provided that Owner shall incur no expense, obligation or liability with regard to such contest.

11.5 **Care and Appearance.** Operator, in its exercise of the lease, easement and other rights granted hereunder shall, at all times, maintain the Owner's Property and the Improvements in a reasonably neat, clean and presentable condition. Operator shall not willfully or negligently damage or destroy the Owner's Property and shall keep the Owner's Property clean and free of debris created by Operator, its contractors, or others brought on to the Owner's Property by Operator. Operator shall not use the Owner's Property for storage, except for materials, construction equipment and vehicles directly associated with construction or maintenance of the Improvements on the Owner's Property or adjacent properties that are part of the Project.

11.6 **Fences and Gates.** At Owner's request, Operator shall repair or replace any fences, gates or cattle guards damaged or removed in connection with Operator's activities on the Owner's Property. Fences removed from the Owner's Property, if replaced, shall be re-built by Operator at its expense in mutually agreeable locations. All fence repair and construction shall be substantially similar to the construction of existing fences and cattle guards on Owner's Property. Any gates opened for access to Owner's Property by either Party shall be closed immediately after passing through so that livestock may not pass through. Once completed, all replacement fences, gates and cattle guards shall be owned and maintained by Owner. Upon abandonment or termination of the rights granted to Operator in this Agreement, any fences, gates and cattle guards installed by Operator shall remain and become the property of Owner. To minimize the need for temporary fencing, Owner will cooperate with Operator to avoid pasturing animals on or near the Improvements during periods of construction, maintenance or removal activity by Operator. Owner will discuss with Operator what temporary fencing is necessary during the periods of construction, maintenance or removal activity by Operator.

11.7 **Roadway Maintenance and Repairs.** Operator agrees to maintain and repair all Roadway Improvements located on the Operator Property; provided, however, Owner shall reimburse Operator for any costs and expenses incurred by Operator to repair any damage or perform any special maintenance of the Roadway Improvements caused by Owner or any person using the Roadway Improvements with Owner's permission, other than Operator.

12. **Taxes.**

12.1 **Owner's Taxes.** Owner covenants and agrees to pay prior to delinquency all real and personal property and other taxes, general and special assessments, and other charges of every description ("**Taxes**") levied or assessed against the Owner's Property and all

improvements thereon by governmental authorities, other than Operator's Taxes referenced in Section 12.2 (Taxes, excepting Operator's Taxes, are hereinafter referred to as "Owner's Taxes").

12.2 **Operator's Taxes.** [REDACTED]

12.3 **Failure to Pay.** In the event either Party fails to pay their share of Taxes prior to delinquency, the other Party shall have the right to pay such Taxes and any accrued penalties or interest, which payments shall increase or be offset against other Payments due under this Agreement.

12.4 **Operator's Right to Contest.** Operator may contest the legal validity or amount of any Operator's Taxes for which it is responsible under this Agreement, and may institute such proceedings as it considers necessary, provided that Operator shall bear all expenses in pursuing such contest or proceeding. With respect to any Taxes which may constitute a lien on the Owner's Property, Operator shall promptly pay such Taxes unless the proceeding in which it contests such Taxes shall operate to prevent or stay the collection of the Taxes so contested or unless Operator removes any such lien by bonding or otherwise. Owner agrees to render to Operator all reasonable assistance in contesting the validity or amount of any such Taxes, with the exception of Taxes levied by Owner, including joining in the signing of any reasonable protests or pleading which Operator may deem advisable to file; provided, however, that Operator shall reimburse Owner for its reasonable out-of-pocket expenses, including reasonable attorneys' fees incurred in connection with providing such assistance.

13. **Mortgage of Operator Property.**

13.1 **Right to Mortgage.** Operator may, upon written notice to Owner, but without requiring Owner's consent or approval, mortgage, collaterally assign, or otherwise encumber and grant security interests in all or any part of its interest in this Agreement and the Operator Property. These various security interests in all or a part of this Agreement and the Operator Property are collectively referred to as an "Operator Mortgage" and holder of such security interest, an "Operator Mortgagee". Any Operator Mortgagee shall use the Operator Property

only for the uses permitted under this Agreement. Whenever Operator has granted a security interest under this Section 13, it will give Owner notice of the Operator Mortgage (including the name and address of the Operator Mortgagee for notice purposes) to Owner within thirty (30) days; provided that failure to give this notice shall not constitute a default under this Agreement, but rather shall only have the effect of not binding Owner to provide such Operator Mortgage notice until the Operator and its address is given to Owner.

13.2 **Notice of Default and Opportunity to Cure.** As a precondition to exercising any rights or remedies related to any alleged default by Operator under this Agreement, Owner shall give written notice of the default to each Operator Mortgagee at the same time it delivers notice of default to Operator, specifying in detail the alleged event of default and the required remedy. Each Operator Mortgagee or its designee shall have the right, but not the obligation, to cure any default as Operator, and/or the right, but not the obligation, to remove any Improvements or other property owned by Operator or such Operator Mortgagee located on the Owner's Property to the same extent as Operator. The cure period for any Operator Mortgagee shall be the later of (i) the end of the Operator cure period under Section 18; (ii) thirty (30) days after such Operator Mortgagee's receipt of the default notice; or (iii) if applicable, the extended cure period provided for in Section 13.3. Failure by Owner to give an Operator Mortgagee notice of default shall not diminish Owner's rights against Operator, but shall preserve all rights of the Operator Mortgagee or its designee to cure any default and to remove any Improvements or other property of Operator or the Operator Mortgagee located on the Owner's Property.

13.3 **Extended Cure Period.** If any default by Operator under this Agreement cannot be cured without the Operator Mortgagee obtaining possession of all or part of the Operator Property, then any such default shall be deemed remedied if an Operator Mortgagee: (i) within sixty (60) days after receiving notice from Owner as set forth in Section 13.2, acquires possession of all or part of the Operator Property, or begins appropriate judicial or nonjudicial proceedings to obtain the same; (ii) diligently prosecutes any such proceedings to completion; and (iii) after gaining possession of all or part of the Operator Property performs all other obligations as and when the same are due in accordance with the terms of this Agreement. If an Operator Mortgagee is prohibited by any court or by operation of any bankruptcy or insolvency laws from commencing or prosecuting the proceedings described above, the sixty (60) day period specified above for commencing proceedings shall be extended for the period of such prohibition.

13.4 **Operator Mortgagee Liability.** Any Operator Mortgagee whose interest in the Operator Property is held solely for security purposes, shall have no obligation or liability under this Agreement unless and until the Operator Mortgagee succeeds to absolute title to the Operator Property and the rights of Operator under this Agreement. An Operator Mortgagee shall be liable to perform obligations under this Agreement only for and during the period it directly holds such absolute title.

13.5 **Certificates.** Owner shall execute any estoppel certificates (certifying as to truthful matters, including without limitation that no default then exists under this Agreement, if such be the case), consents to assignment and non-disturbance agreements as Operator or any Mortgagee may reasonably request from time to time. The Parties shall negotiate in good faith any amendment to this Agreement from time to time to include any provision that may be

reasonably requested by Operator or any Operator Mortgagee to implement the provisions contained in this Agreement or to preserve an Operator Mortgagee's security interest.

13.6 **Operator Mortgagee's Right to Enforce Mortgage and Assign.** Each Operator Mortgagee shall have the right, in its sole discretion: (i) to assign its Operator Mortgage; (ii) to enforce its lien and acquire title to all or any portion of the Operator Property by any lawful means; (iii) to take possession of and operate all or any portion of the Operator Property and to perform all obligations to be performed by Operator under this Agreement, or to cause a receiver to be appointed to do so; and (iv) to acquire all or any portion of the Operator Property by foreclosure or by an assignment in lieu of foreclosure and thereafter to assign or transfer all or any portion of the Operator rights under this Agreement to a third party in accordance with Section 14. Any Operator Mortgagee or other party who acquires Operator's interest in all or a portion of the Operator Property pursuant to foreclosure or assignment in lieu of foreclosure shall not be liable to perform the obligations imposed on Operator by this Agreement, which are incurred or accruing after such Operator Mortgagee or other party no longer has ownership or possession of the Operator Property.

13.7 **New Agreement.**

13.7.1 If the Operator Property is foreclosed upon or there is an assignment in lieu of foreclosure, or if this Agreement is rejected or disaffirmed pursuant to bankruptcy law or other law affecting creditor's rights and, within ninety (90) days after such event, Operator or any Operator Mortgagee or other purchaser at a foreclosure sale shall have arranged to the reasonable satisfaction of Owner to cure any material defaults under this Agreement, and for the payment of all Annual Installment Payments or other charges due and payable by Operator as of the date of such event, then Owner shall execute and deliver to Operator or such Operator Mortgagee or other purchaser at a foreclosure sale, or to a designee of one of these parties, as the case may be, a new agreement ("**New Agreement**") which (i) shall be for a term equal to the remainder of the Term of this Agreement before giving effect to such rejection or termination; (ii) shall contain the same covenants, agreements, terms, provisions and limitations as this Agreement (except for any requirements that have been fulfilled by Operator or any Operator Mortgagee or other purchaser at a foreclosure sale prior to rejection or termination of this Agreement); and (iii) shall include that portion of the Operator Property in which Operator or such other Operator Mortgagee or other purchaser at a foreclosure sale had an interest on the date of rejection or termination.

13.7.2 If more than one Operator Mortgagee makes a written request for a New Agreement pursuant to this provision, the New Agreement shall be delivered to the Operator Mortgagee requesting such New Agreement whose Operator Mortgage is prior in time, and the written request of any other Operator Mortgagee whose lien is subordinate shall be void and of no further force or effect. The provisions of this Section 13 shall survive the termination, rejection or disaffirmation of this Agreement and shall continue in full force and effect thereafter to the same extent as if this Section 13 were a separate and independent contract made by Owner, Operator and each Operator Mortgagee, and, from the effective date of such termination, rejection or disaffirmation of this Agreement to the date of execution and delivery of such New Agreement, such Operator Mortgagee or other purchaser at a foreclosure sale may use and enjoy the Operator Property without hindrance by Owner or any person claiming by, through or under

Owner; provided that all of the conditions for the New Agreement as set forth above are complied with.

13.8 **Operator Mortgagee's Consent to Amendment, Termination or Surrender.** Notwithstanding any provision of this Agreement to the contrary, the Parties agree that so long as any Operator Mortgage remains outstanding, this Agreement shall not be modified or amended, and Owner shall not accept a surrender, cancellation or release of all or any part of the Operator Property from Operator, prior to expiration of the Term of this Agreement, without the prior written consent of the Operator Mortgagee holding such Operator Mortgage. This provision is for the express benefit of and shall be enforceable by each Operator Mortgagee as if it were a party named in this Agreement.

14. **Assignment and Sublease.** Operator shall have the right, without Owner's consent, to sell, convey, lease, or assign all or any portion of this Agreement or the Operator Property, on either an exclusive or a non-exclusive basis, or to grant subleases, co-leases, easements, licenses or similar rights with respect to the Operator Property (collectively, "**Assignment**"), to one or more persons or entities (collectively "**Assignee**"). Each Assignee shall use the Operator Property only for the uses permitted under this Agreement. When Operator makes any Assignment under this Section 14, Operator shall give written notice to Owner of such Assignment (including the interest conveyed by the Assignment and address of the Assignee for notice purposes) to Owner; provided Operator's failure to give such notice shall not constitute a default under this Agreement, but rather shall only have the effect of not binding Owner with respect to such assignment or conveyance until such notice is given. Any Assignment by Operator shall release Operator from obligations subject thereof accruing after the date that liability for such obligations is assumed by the Assignee.

15. **Hazardous Materials.**

15.1 **Owner's Covenants Regarding Hazardous Materials.** Owner represents and warrants that, to the best of Owner's knowledge, the Owner's Property is not and has not been in violation of any federal, state or local environmental health or safety laws, statute, ordinance, rule, regulation or requirement ("**Environmental Laws**"), and Owner has not received any notice or other communication from any governmental authorities alleging that the Owner's Property is in violation of any Environmental Laws. "**Hazardous Materials**" shall mean any asbestos containing materials, petroleum, explosives, toxic materials, or substances regulated as hazardous wastes, hazardous materials, hazardous substances, or toxic substances under any federal, state, or local law or regulation. Owner warrants that Owner has done nothing to contaminate the Operator Property with Hazardous Materials or wastes.

15.2 **Operator's Covenants Regarding Hazardous Materials.** Operator shall, at Operator's sole cost and expense, promptly take removal or remedial action required by Environmental Law with regard to any material violation of any Environmental Law with regard to any Hazardous Materials brought onto the Owner's Property by Operator or its employees, agents, or contractors. Owner shall cooperate with Operator with regard to any scheduling or access to the Owner's Property in connection with any action required hereunder.

15.3 **Operator's Indemnity Regarding Hazardous Materials.** Operator shall indemnify, defend, protect and hold Owner harmless from any liability based on: (i) the release of Hazardous Materials in, on, under or about the Owner's Property caused by Operator or its employees, agents, or contractors, or (ii) the violation by Operator or its employees, agents, or contractors of any Environmental Law. The indemnity obligations set forth herein shall survive termination of this Agreement.

16. **Insurance and Indemnity.**

16.1 **Insurance.** At all times during which Operator is conducting any activities on the Property and at all times during the Term of this Agreement, Operator shall maintain in effect (1) commercial General Liability Insurance, including bodily injury and property damage coverage with minimum limits of \$1 Million Dollars per occurrence and \$2 Million Dollars aggregate and (2) Umbrella Liability Insurance with minimum limits of \$5 Million Dollars per occurrence and \$5 Million Dollars aggregate. Upon a written request by Owner, Operator shall name Owner as additional insured on such insurance policy and provide Owner with a certificate of such insurance.

16.2 **Indemnity by Operator.** Operator shall defend, indemnify, protect and hold Owner harmless from and against all liabilities, costs, expenses, obligations, losses, damages, claims, (collectively "**Claims**") resulting from the negligence, willful misconduct, or breach of this Agreement by Operator, its agents, contractors or employees, invitees, licensees and permittees; provided, however, that such Claims are not due to the sole negligence, willful misconduct, or breach by Owner, its agents, contractors or employees, invitees, licensees or permittees.

16.3 **Indemnity by Owner.** Owner shall defend, indemnify, protect, and hold Operator harmless from and against all Claims resulting from the negligence, willful misconduct, or breach of this Agreement by Owner, its agents, contractors or employees, invitees, licensees and permittees; provided, however, that such Claims are not due to the sole negligence, willful misconduct, or breach by Operator, its agents, contractors, employees, invitees, licensees, or permittees.

16.4 **Survival.** The obligations of the Parties under this Section 16 shall survive expiration or other termination of this Agreement.

17. **Confidentiality.** This Agreement includes confidential and proprietary information relating to Operator and the Project. Owner agrees not to provide copies of the Agreement or disclose the terms of the Agreement to any unauthorized person or entity. Operator authorizes Owner to provide copies of the Agreement and disclose the terms thereof to Owner's family ("family" shall be deemed to include all devisees or descendants of owner by will or intestacy), attorney, accountant, financial advisor and any existing or prospective mortgagee, lessee, or purchaser for the sole purpose of evaluating and advising Owner and for no other purpose, so long as such authorized parties agree in writing to become subject to the confidentiality provisions hereto and not to provide copies of the Agreement or disclose the terms thereof to any unauthorized person or entity. Any Owner and party shall return all material containing any confidential information to Operator immediately upon its request. Any party agrees to destroy

immediately upon request by Operator such analyses, compilation, studies or other documents, and any oral information will continue to be subject to the terms of this Agreement. Owner agrees that Operator will have no adequate remedy at law if any party violates any of the terms of this Agreement. In such event Operator will have the right, in addition to any other rights Operator may have, to obtain injunctive relief to restrain any breach or threatened breach by third party or specific enforcement of such terms plus reimbursement of attorneys' fees, court costs and all associated expenses. No party shall publish, file for public record, reproduce, or otherwise disseminate this document or any of the terms and provisions hereof to any party, other than the Parties set forth above without the prior written consent of Operator, which consent may be withheld for any reason and in Operator's sole discretion.

18. Default and Remedies.

18.1 Operator Payment Default. [REDACTED]

18.1.1 Collection of Payments. [REDACTED]

18.1.2 Terminate Agreement. [REDACTED]

18.2 Other Operator Default. [REDACTED]

[REDACTED]

18.3 **Owner Default.**

[REDACTED]

19. **Condemnation.**

19.1 **Complete Taking.** If, at any time, any authority having the power of eminent domain shall condemn all or substantially all of the Operator's Property, or all of the Improvements thereon, for any public use or otherwise, then the interests and obligations of Operator under this Agreement in or affecting the Operator's Property shall cease and terminate upon the earlier of (i) the date that the condemning authority takes physical possession of the Operator's Property or the Improvements thereon, (ii) the date that Operator is, in its sole judgment, no longer able or permitted to operate the Project on the Operator's Property in a commercially viable manner, or (iii) the date of the condemnation judgment. Operator shall continue to pay all amounts payable hereunder to Owner until the earlier of such dates, at which time the Parties shall be relieved of any and all further obligations and conditions to each other under this Agreement.

19.2 **Partial Taking.** If, at any time during the term of this Agreement, any authority having the power of eminent domain shall condemn one or more, but not all, of the Solar Panels, or any portion of the Improvements or the Operator's Property, then the interest and obligations of Operator under this Agreement as to those Solar Panels or any portion of the Improvements or the Operator's Property so taken shall cease and terminate upon the earlier of (i) the date that the condemning authority takes possession of such Solar Panels or any portion of the Improvements or the Operator's Property, (ii) the date that Operator is, in its reasonable judgment, no longer able or permitted to operate the Project on the Operator's Property, or any portion thereof, in a commercially viable manner, or (iii) the date of the condemnation judgment; and, unless this Agreement is terminated as hereinafter provided, this Agreement shall continue in full force and effect as to the remainder of the Solar Panels, Improvements and the Operator's Property. If the remainder of the Solar Panels or any other portion of the Improvements or the Operator's Property is or becomes insufficient or unsuitable for Operator's purposes hereunder, as determined by Operator in its sole discretion, then, subject to the rights of any Operator Mortgagee under Section 13, Operator shall have the right to terminate this Agreement as to the portion of the Operator's Property to which Operator continues to hold the rights, at which time the Parties shall be relieved of any further obligations and duties to each other under this Agreement.

19.3 **Apportionment, Distribution of Award.** On any taking, all sums awarded, including damages and interest, shall be paid as follows:

- (a) Any portion of the award by the court on account of any cost or loss that Operator may sustain in the removal and relocation of Operator's Improvements, to Operator;
- (b) Any portion of the award by the court for Operator's anticipated or lost revenues or profits, to Operator;
- (c) Any portion of the award by the court for Owner's lost revenues, to Owner;
- (d) All remaining amounts of the award, to Owner or Operator consistent with applicable Kentucky law.

20. **Notice.**

20.1 **Writing.** All notices given or permitted to be given hereunder shall be in writing.

20.2 **Delivery.** Notice is considered given either (i) when delivered in person to the recipient named below, (ii) upon receipt after deposit in the United States mail in a sealed envelope or container, postage and postal charges prepaid, return receipt requested or certified mail, addressed by name and address to the party or person intended, or (iii) twenty-four (24) hours from proper and timely delivery to an overnight courier service addressed by name and address to the party or person intended as follows:

Notice to Owner: McMullin Anderson, LLC
3288 Winterberry Circle
Marietta, GA 30062

[REDACTED]
[REDACTED]

Notice to Operator: Boulevard Associates, LLC
700 Universe Blvd
Juno Beach, FL 33408
Attn: Land Services Administration

[REDACTED]

20.3 **Change of Recipient or Address.** Either Party may, by notice given at any time or from time to time, require subsequent notices to be given to another individual person, whether a party or an officer or representative, or to a different address, or both. Notices given before actual receipt or notice of change shall not be invalidated by the change.

21. **Miscellaneous Provisions.**

21.1 **Successors and Assigns.** The terms and provisions of this Agreement shall run with the land and be binding on and inure to the benefit of the heirs, successors, assigns and personal representatives of the Parties. In accordance with this Agreement, Operator in its discretion may authorize other persons or entities to use the Operator Property for the purposes stated in this Agreement

21.2 **Memorandum.** Simultaneously with the execution of this Agreement, the Parties agree to execute and acknowledge a memorandum of this Agreement. Operator may record the executed memorandum in the public records of Henderson County, Kentucky.

21.3 **Entire Agreement.** This Agreement and the attached Exhibits shall constitute the entire agreement between the Parties and supersedes all other prior writings and understandings.

21.4 **Amendments.** This Agreement shall not be amended or modified in any way except by an instrument signed by the Parties and consented to by any Operator Mortgagee. The Parties hereto shall at all times hereafter execute any documents and do any further acts which may be necessary or desirable to carry out the purposes of this Agreement and to give full force and effect to each and all of the provisions hereof.

21.5 **Legal Matters.** This Agreement shall be governed by and interpreted in accordance with the then existing laws of the Commonwealth of Kentucky and the County where the Owner's Property is located shall be considered the proper forum or jurisdiction for any disputes arising in connection with this Agreement. The Parties agree to first attempt to settle any dispute arising out of or in connection with this Agreement by good-faith negotiation. If the Parties are unable to resolve amicably any dispute arising out of or in connection with this Agreement, each shall have all remedies available at law or in equity and as provided by this Agreement. **Each Party waives all right to trial by jury and specifically agrees that trial of**

suits or causes of action arising out of this Agreement shall be to the court of competent jurisdiction.

21.6 **Severability.** If any term or provision of this Agreement, or the application thereof to any person or circumstance shall, to any extent, be determined by judicial order or decision to be invalid or unenforceable, the remainder of this Agreement or the application of such term or provision to persons or circumstances other than those as to which it is held to be invalid, shall be enforced to the fullest extent permitted by law.

21.7 **Tax Credits.** If under applicable law Operator becomes ineligible for any currently existing tax credit, benefit or incentive for alternative energy expenditure established by any local, state or federal government, then, at Operator's option, the Parties shall negotiate in good faith to amend this Agreement or replace it with a different instrument so as to convert Operator's interest in the Operator Property to a substantially similar interest that makes Operator eligible for such tax credit, benefit or incentive. Such amendment or instrument shall not impair any of Owner's rights or increase the burdens or obligations of Owner under this Agreement.

21.8 **Approvals.** Whenever in this Agreement the approval or consent of either Party is required or contemplated, unless otherwise specified, such approval or consent shall not be unreasonably withheld or delayed.

21.9 **Authority.** The signatories hereto warrant that each has the authority to execute this Agreement on behalf of any entities which are Parties to this Agreement and that each such entity has executed this Agreement pursuant to its organizational documents or a resolution or consent of their Board of Directors or other governing body.

21.10 **Time of Essence.** Time is of the essence of each provision of this Agreement.

21.11 **Counterparts.** This Agreement may be executed in multiple counterparts, each of which shall be deemed an original, and all of which together shall constitute a single instrument.

[Signatures on Next page]

Owner:

McMullin Anderson LLC
a Kentucky limited liability company

By: 
James David Anderson, Managing Member

Operator:

Boulevard Associates, LLC
a Delaware limited liability company

By: _____
Matthew S. Handel, Vice President

Owner:

McMullin Anderson LLC
a Kentucky limited liability company

By: _____
James David Anderson, Managing Member

Operator:

Boulevard Associates, LLC
a Delaware limited liability company

By:  _____
Anthony Pedroni, Vice President

E HIBIT A

Legal Description of Owner's Property

Beginning at a stake on North side of Smith's Ferry Road; thence N 11 E 75 poles and 20 links to stake in North line of farm; thence with said line S 60 E 122 poles and 15 links to an ash in WM. Eblen's line; thence with said line S 4 W 1 pole and 19 links to small maple; thence N 86 W 116 poles to rock corner of Samuel Spencer; thence S 4 W 18 poles and 20 links to rock in Samuel Spencer's line and on North side of Smith's Ferry Road; thence N 75 W 2 poles and 13 links to the beginning, containing 21-12/100 acres.

Being the same property conveyed to Edgar McMullin, of the first part, by S.H. Spencer by deed dated January 6, 1932, of record in Deed Book 81, at page 621, Henderson County Court Clerk's office.

Beginning at a stake corner to Lot No. 1 on North side of Smith's Ferry Road; thence with line of said lot N. 11 E 75 poles and 20 links to stake in North line of farm and corner to first lot; thence N 60 W 82 poles and 6 links to a stake; thence S 23 W 99 poles to stake in the middle of Smith's Ferry Road; thence with said road S 77 E 10 poles and 9 links to bend in road; thence with road S 75 E 93 poles and 6 links to beginning, containing 49-77/100 acres, including 1-77/100 acres across the West and allotted James Sugg, and being the same land conveyed to B.W. McMullin by R.E. Sugg, et al. by deed dated January 7, 1891, and recorded in Deed Book 1, at page 590, in the County Clerk's office of Henderson County, Kentucky.

Beginning at a stake, two black oaks near McMullin's Chapel, and beginning corner in the deed; thence with Floyd and Lockett Road S 23 W 43 poles and 6 links to stake; thence S 67 E 39 poles and 8 links to stake in line of Lot #2; thence with line of said Lot N 23 E 38 poles and 5 links to corner of lot #2; thence N 60 W 39 poles and 16 links to beginning, containing 10 acres; and being the same land conveyed to B.W. McMullin by the following: Susan Denton, et al by deed dated March 28, 1897, and recorded in Deed Book 25, at page 197; L.A. Royster by deed dated November, 1897, recorded in Deed Book 38, at page 395; John W. Royster by deed dated November, 1899, and recorded in Deed Book 38, at page 401; Vinnie Algood, &c. by deed dated March 12, 1903, and recorded in Deed Book 38 at page 402; Marvin Royster by deed dated April 3, 1905, and recorded in Deed Book 41, at page 320; S.H. McMullin by deed dated January 22, 1908, and recorded in Deed Book 40, at page 422, and Foster C. Royster by deed dated January 12, 1909, and recorded in Deed Book 42, at page 183, all in the office of the County, Clerk of Henderson County, Kentucky.

LESS a lot of ground just south of said church and bounded as follows: Beginning at a corner post about 8 ft. South of SE corner of said church, running South 6 rods to a stake; thence W 12 rods to a stake in edge of Frog Island road; thence North with said road 6 rods to stake in edge of said road, thence east 12 rods to the beginning, containing 9/20 of an acre.

Beginning at a stake corner to Lot #3; thence with Floyd & Lockett road S 23 W 24 poles and 11 links to stake on Lockett & Floyd road; thence S 67 E 39 poles and 8 links to stake in line of lot #2; thence with said line N 23 E 24 poles and 11 links to stake corner to lot # 3; thence with line of said lot N 67 W 39 poles and 8 links to beginning, containing 6 acres; and being the land conveyed to B.W. McMullin by the following: W.B. Spencer by deed dated October 3, 1893, and

recorded in Deed Book 20, at page 559, and by W.B. and G.E. Spencer by deed dated January 27, 1897, and recorded in Deed Book 24, at page 179, all in the office of the County Clerk of Henderson County, Kentucky.

Beginning at a stake corner of Lot #4 of Floyd and Lockett Road; thence with said road S 23 W 13 poles and 14 links to stake; thence S 67 E 39 poles and 8 links to stake in line of Lot #2; thence with said line N 23 E 13 poles and 14 links to stake, corner to lot #4; thence with line of said Lot N 67 W 39 poles and 8 links to beginning, containing 3-1/3 acres and being the same lands conveyed to S.W. McMullin by the following: Eliza Armstrong, &c. by deed dated October 17, 1898, and recorded in Deed Book 38, at page 403, and by S.H. McMullin by deed dated December 26, 1907, and recorded in Deed Book 40, at page 225, all in the office of the County Clerk of Henderson County, Kentucky.

Beginning at a stake, corner to Lot #5 on Floyd and Lockett road; thence S 23 W 30 poles to junction of Floyd and Lockett and Smith's Ferry Road; thence with Smith's Ferry Road S 77 E 39 poles and 16 links to corner of Lot # 2; thence with line of said lot N 23 E 22 poles and 20 links to stake, corner to Lot #5; thence with line of said lot N 67 E 39 poles and 8 links to beginning, containing 6-1/2 acres, and being the same land conveyed to B.W. McMullin by S. H. McMullin by deed dated December 26, 1907, and recorded in Deed Book 40, at page 225, in the office of the County Clerk of Henderson County, Kentucky.

Tracts (2) to (6) inclusive were inherited by Edgar McMullin as shown by Affidavit of Descent of record in Deed Book 95, at page 284, Henderson County Court Clerks office.

A tract of land about one mile from town of Robards and bounded as follows: Beginning at a stone to Sam Spencer and Tom T. Royster; thence N 27-3/4 E 28.09 chains to a stake in the middle of a ditch, corner to Lot #2 small sycamore pointer; thence N 59 1/2 W 17.91 chains to stake in line of Lot # 3 23 links from S.H. McMullin line; thence S 27 3/4 W 28.09 chains to B.W. McMullin's line; thence S 59- 1/4 E 18 chains to the beginning, containing 50-36/100 acres.

Being the same land conveyed to the grantors by Thomas Sugg and wife by deed dated January 7, 1904, of record in Deed Book 34, at page 197, said Clerk's office.

Beginning at a stake in middle of a ditch, small sycamore pointer, and corner to Lot #1 (Sugg's) corner; thence N 58 - 3/4 W 18-14/100 chains to a stake in line of S.N. McMullin; thence N 27 - 3/4 E 15-18/100 chains to a stake corner to S.N. McMullin in Otey's line; thence S 66 - 1/2 E. 18 - 16/100 chains to a stake in middle of a ditch corner to T.T. Royster; thence S 27 - 3/4 W 17 - 36/100 chains to the beginning, containing 29 - 450/1000 acres, it being understood and agreed that said McMullin is to have an outlet 23 links wide and 28-9/100 chains long between the line of Thos. Sugg and that of S.N. McMullin, said outlet containing 650/1000 of an acres, containing in all 30-1/10 acres.

Being the same land conveyed to Edgar McMullin by C.N. Royster by deed dated August 28, 1900, of record in Deed Book 30, at page 330, in said Clerk's office.

A certain tract of land lying one mile South of Robards, Kentucky and bounded as follows: Beginning at a corner to Sugg; thence S 65 - 1/4 E 762 feet to a stake, corner to Thos. Sugg;

thence S. 27 – $\frac{3}{4}$ W 2857 feet to a stake, 10 feet from a stone; thence N 58-5/6 W. 763 feet to a stake; thence to the beginning about 2755 feet.

Containing 49.14 acres

Being the same property conveyed to Edger McMullin and B.W. McMullin by Emma J. Higginson, et al., by deed dated January 1, 1910, recorded in Deed Book 44, at page 41, said Clerk's office, and an undivided one-half interest therein inherited by Edgar McMullin from his father, B.W. McMullin, as shown by Affidavit of Descent of record in Deed Book 95, at page 284, said Clerk's office.

HOLDING PAGE FOR E HIBIT B

Preliminary Lease and Easement Improvement Plan and Acreage Calculation
To be Delivered with Option Notice

HOLDING PAGE FOR E HIBIT C

As Built Lease and Easement Improvements and Final Acreage Calculation

E HIBIT D

Lease and Easement Compensation

[REDACTED]

(2) **Payment for Lease and Easements.**

[REDACTED]

[REDACTED]

[REDACTED]

(3) **Crop Compensation.**

[REDACTED]

[REDACTED]

[REDACTED]

(4) **Timber Removal.** [REDACTED]

(5) **Payment Allocation Schedule.** [REDACTED]

Kentucky

SOLAR LEASE AND EASEMENT AGREEMENT

1. **Parties.** This Solar Lease and Easement Agreement ("**Agreement**") is made and entered as of the 2 day of December 2019 ("**Effective Date**"), by and between Rebecca A. Brown, Trustee of the Nunn Family Irrevocable Trust ("**Owner**") and Boulevard Associates, LLC, a Delaware limited liability company ("**Operator**"), which are sometimes individually referred to as a "**Party**" and collectively as the "**Parties**".

2. **Project.** This Agreement relates to the solar-powered electrical power generation and transmission project known as the "Sebree Solar Energy Center" to be located in Henderson County, Kentucky ("**Project**"), which may be wholly or partially located on the Owner's property legally described on the attached **Exhibit A** to this Agreement ("**Owner's Property**"). Upon Operator's exercise of the Option (as defined below), the Project shall include (i) the Lease of Owner's Property described in Section 4, (ii) the Easements referenced in Section 5 that are located on the Owner's Property, and (iii) the Improvements referenced in Section 8 to be constructed on Owner's Property. The Lease, Easements and Improvements are sometimes collectively referred to as the "**Operator Property**".

3. **Option.** Owner grants to Operator an exclusive option ("**Option**") to acquire the Lease and Easements referenced in Sections 4 and 5 in accordance with the following terms and conditions. Operator shall be entitled to acquire the Lease and the Easements in their entirety or in part, as Operator deems appropriate.

3.1 **Option Term.** The period during which Operator may exercise the Option shall be for a term of four (4) years commencing on the Effective Date ("**Option Term**").

3.2 **Option Payment.** As consideration for the granting of the Option, Operator agrees to pay Owner the Option Payment set forth in **Exhibit D**.

3.3 **Use of Owner's Property.** During the Option Term, Operator and its employees, agents and contractors shall have a right to enter upon the Owner's Property and the right of ingress and egress over and across the Owner's Property for the purposes of (i) surveying the Owner's Property; (ii) performing such other tests and studies as Operator may desire in connection with the Option, including, without limitation, environmental, avian and cultural resource assessments, and geotechnical, foundation and soil tests, provided that such activities do not unreasonably interfere with Owner's use of the Owner's Property; and (iii) installing, maintaining, operating, inspecting and removing one or more weather related instruments ("**Weather Instrument**") and fencing of said Weather Instrument and including the performance of all tests and studies associated therewith. Owner shall not permit any other individual or entity except Operator or its affiliates to install a Weather Instrument on Owner's Property.

3.4 **Right to Grant Option.** Owner warrants and represents to Operator that (i) the statements in Section 9 concerning Owner's title to the Owner's Property are true and correct; (ii) Owner has the authority to grant this Option to Operator without the consent or approval of any other party; and (iii) there are no other existing options, rights of first refusal, contracts to

purchase, leases or mortgages that would prevent Operator from exercising its rights with respect to the Option.

3.5 **Exercise of Option.** Operator may exercise the Option by giving written notice to Owner ("**Option Notice**") at any time during the Option Term. Operator shall specify in the Option Notice the Commencement Date referenced in Section 6.1.1, which date shall be no later than the expiration of the Option Term. On the Commencement Date, the Lease and Easements referenced in Sections 4 and 5 shall automatically become effective, and the Parties shall be subject to all of the terms and conditions of this Agreement with respect to such Lease and Easements and all rights and obligations relating thereto.

3.6 **Termination of Option.** If Operator fails to exercise the Option within the Option Term, the Option and the rights of Operator as the optionee shall automatically terminate.

4. **Lease.** Upon exercise of the Option by Operator, Owner leases to Operator, and Operator leases from Owner, Owner's Property for the Lease and Easement Term (defined in Section 6.1) in accordance with the terms and conditions of this Agreement ("**Lease**"), which Lease grants Operator and its agents, contractors, and employees the right to use the Owner's Property for the following permitted uses:

4.1 **Construction Right.** Operator leases Owner's Property for the purpose of constructing, operating, maintaining, repairing, replacing, and removing all or any part or component of the Improvements whether located on Owner's Property. Operator may exercise its right to use all or any part of the Owner's Property as and when Operator deems it necessary or advisable to do so to perform the activities for which this right is granted, including, without limitation, staging areas and parking for Operator's employees.

4.2 **Access Right.** Operator leases Owner's Property for unobstructed vehicular and pedestrian access and ingress to and egress from the Improvements, Owner's Property and any public roadways, and to construct, maintain, and utilize Roadway Improvements on the Owner's Property. Owner shall not permit others to obstruct or damage the roads or Roadway Improvements located on the Owner's Property or in any other way interfere with Operator's rights under this right. Operator shall repair any damage done to Roadway Improvements which result from use by Operator, its agents, servants or employees. Such roads shall be maintained in the condition necessary for use by Operator's equipment, and with regard to existing roads, shall be maintained in at least the condition that existed prior to Operator's use.

4.3 **Solar Panels Right.** Operator leases Owner's Property for Operator to construct, operate, replace, relocate, remove, and maintain Solar Panels and the appurtenant Collection Facilities, together with associated roads and parking areas on Owner's Property.

4.4 **Collection Facilities Right.** Operator leases Owner's Property for Operator to construct, operate, maintain, replace, relocate or remove Collection Facilities on and under the Owner's Property.

4.5 **Substation Right.** Operator leases Owner's Property for Operator to construct, operate, maintain, replace, relocate or remove one or more Substations on Owner's Property.

4.6 **Telecommunication Right.** Operator leases Owner's Property for Operator to construct, operate, maintain, replace, relocate or remove Telecommunication Facilities on and under the Owner's Property.

4.7 **Weather Instrument Right.** Operator leases Owner's Property in order to construct, operate, replace, relocate, remove, and maintain a Weather Instrument and the appurtenant Collection Facilities on Owner's Property.

4.8 **Battery Facilities Right.** Operator leases Owner's Property in order to construct, operate, replace, relocate, remove, and maintain one or more Battery Facilities on Owner's Property.

5. **Grant of Easements.** Upon the exercise of the Option by Operator, Owner grants to Operator, and Operator accepts from Owner, for the Lease and Easement Term referenced in Section 6.1, the following easements over and across the Owner's Property in accordance with the terms and conditions of this Agreement. The following easements are for the benefit of Operator and Operator's agents, contractors and employees and located on the Owner's Property and are collectively referred to as the "**Easements**".

5.1 **Sun Non-Obstruction Easement.** Owner grants Operator an irrevocable, exclusive easement for the right and privilege to use, maintain and capture the free and unobstructed sunlight over and across the Owner's Property. Owner shall not engage in any activity on Owner's Property or any other neighboring property owned by Owner that might interfere with the sunlight direction over any portion of Owner's Property; cause a decrease in the output or efficiency of any Solar Panel or Weather Instrument; or otherwise interfere with Operator's operation of the Project or exercise of any rights granted in this Agreement (collectively "**Interference**"). This grant of the easement expressly includes the right of Operator to enforce Operator's rights, including the physical removal of trees or structures (except existing trees and structures) causing Interference to the Project contemplated by Operator. Operator shall notify Owner before making any such removals.

5.2 **Effects Easement.** Owner grants to Operator an easement over Owner's Property for visual, view, light, flicker, noise, shadow, vibration, electromagnetic, electrical and radio frequency interference, and any other effects attributable to the Project located on the Owner's Property.

6. **Term.** The term of this Agreement ("**Term**") includes the Option Term referenced in Section 3.1, the Initial Lease and Easement Term as described in Section 6.1.1 and the Extended Lease and Easement Term as described in Section 6.1.2 (together, the Initial Lease and Easement Term and the Extended Lease and Easement Term, if applicable, is defined as the "**Lease and Easement Term**").

6.1 **Lease and Easement Term.**

6.1.1 **Initial Lease and Easement Term.** The initial term of the Lease and Easements shall commence on the date specified by Operator in the Option Notice ("**Commencement Date**"). The initial term of the Lease and Easements shall end thirty (30)

years after the Commencement Date (the "**Initial Lease and Easement Term**"), subject to the rights of renewal and termination as provided in this Agreement.

6.1.2 **Extended Lease and Easement Term.** Operator shall have the right to extend the Term of this Agreement for two (2) consecutive terms of five (5) years each in accordance with the terms and provisions of this Agreement (collectively "**Extended Lease and Easement Term**") by providing written notice to Owner of Operator's intent to extend the Term within one hundred eighty (180) days of the end of the existing Term. Each Extended Lease and Easement Term shall begin on the expiration date of the Initial Lease and Easement Term or previous Extended Lease and Easement Term, as the case may be. During the Extended Lease and Easement Term, Operator shall pay Owner the amounts set forth in **Exhibit D** as the consideration for the Lease and Easements.

6.1.3 **Delays During Lease and Easement Term.** At Operator's option, the Term may be extended for a period of time equal to the period of time during which operation of the Project is delayed or suspended because of the occurrence of a Regulatory Suspension or Force Majeure, which are defined as follows:

(i) "**Regulatory Suspension**" shall mean the enactment or application of any law, order, rule, or regulation of the Kentucky Public Service Commission, Federal Energy Regulatory Commission, or other local, state, or federal government authority having jurisdiction over the Project or Operator, or the failure of any such governmental authority to issue an approval or permit pursuant to any such law, order, rule, or regulation, which results in the delay, interruption, or suspension of the production, sale or transmission of electricity from the Solar Panels; and

(ii) "**Force Majeure**" shall mean causes beyond the reasonable control of and without the fault or negligence of the Party claiming Force Majeure, including but not limited to acts of God, labor unrest (including, but not limited to, slowdowns, picketing, boycotts or strikes), flood, earthquake, storm, fire, lightning, explosion, power failure or power surge, vandalism, theft, the cutting of power, transmission or other lines, wires or cables to the Project by persons other than Operator's employees or contractors, epidemic, war, revolution, riot, civil disturbance, sabotage, change in law or applicable regulation subsequent to the Commencement Date and action or inaction by any federal, state or local legislative, executive, administrative judicial agency or body which in any of the foregoing cases, by exercise of due foresight such Party could not reasonably have expected to avoid, and which, by the exercise of due diligence, it is unable to overcome.

The Parties shall be excused from performing their respective obligations under this Agreement and shall not be liable in damages or otherwise if and to the extent that they are unable to so perform or are prevented from performing by a Force Majeure, provided that: (i) the non-performing Party, as promptly as practicable after the occurrence of the Force Majeure, but in no event later than thirty (30) days thereafter, gives the other Party written notice describing the particulars of the occurrence; (ii) the suspension of performance is of no greater scope and of no longer duration than is reasonably required by the Force Majeure; (iii) the non-performing Party uses good faith and commercially reasonable efforts to remedy its inability to perform; and (iv) as soon as the non-performing Party is able to resume performance of its obligations excused as a

result of the occurrence, each Party shall give prompt written notification thereof to the other Party.

6.2 **Termination by Operator.** Provided Operator is not in default under any term of this Agreement, Operator, at its option, shall have the right to terminate this Agreement at any time during the Term of the Agreement, as to all or any part of the Operator Property. Termination shall be effective thirty (30) days after written notice of such termination to Owner. If Operator's notice is a full termination of the Operator Property, the Parties shall be relieved of all further duties and obligations under this Agreement, other than (i) the payment of any accrued and unpaid obligations owed by either Party as of the date of termination; (ii) the removal of the Improvements by Operator pursuant to Section 8.11; and (iii) any other obligations and liabilities that are expressly stated in this Agreement to survive such termination. Upon any such partial termination by Operator, the Parties shall be relieved of all further duties and obligations under this Agreement with respect to the portion thereof terminated by Operator, subject to the obligations and liabilities referenced in items (i) through (iii) above that shall continue to be applicable to the terminated portion of this Agreement. The Parties agree to execute an amendment to this Agreement evidencing such partial termination.

7. **Payments.** If Operator exercises the Option referenced in Section 3, Operator agrees to pay Owner the amounts set forth in **Exhibit D** as consideration for the Lease, Easements and Operator's other rights and interests in the Owner's Property.

8. **Improvements.** Operator shall have the right, at its sole cost and expense, to construct, install, maintain, use, operate, repair, replace, relocate and remove all facilities, structures, equipment, machinery, wires, conduit, cables, poles, materials and property of every kind and character required for the construction and operation of portions of the Project on the Owner's Property, including, but not limited to, the Solar Panels, Collection Facilities, Substations, Telecommunication Facilities, Weather Instruments, Roadway Improvements and Battery Facilities referenced in Sections 8.1 through 8.7 (collectively, the "**Improvements**").

8.1 "**Solar Panels**" shall mean any photovoltaic energy system designed for the generation of electrical power from the collection of sunlight, including without limitation, the photovoltaic panels, foundations, support structures, braces and related equipment.

8.2 "**Collection Facilities**" shall mean all Improvements whose purpose is to deliver electrical power generated by the Solar Panels to an electrical power grid or other system, including without limitation transformers, overhead and underground electrical collection lines, telecommunication lines, splice boxes and interconnection facilities.

8.3 "**Substations**" shall mean electrical lines, meters, monitoring and control equipment, switches, transformers, all structures, equipment, enclosures, fencing, security devices, and other electrical and communications equipment necessary to condition and increase the voltage of electricity generated by the Project to make it suitable for transmission on, and to deliver it to, Collection Facilities connected to an electric power grid or other system.

8.4 "**Telecommunication Facilities**" shall mean all Improvements whose purpose is to provide telecommunication services solely relating to the Project or any of Operator's solar

powered projects, including telephone, closed-circuit television, microwave, internet, computer data and other telecommunication services.

8.5 "**Weather Instrument**" shall mean instruments used primarily to gather and transmit sunlight and meteorological data relating to the Project, and includes the instrument's foundations, guy wires, sunlight and meteorological data acquisition equipment, power source, and any required data and electrical transmission lines.

8.6 "**Roadway Improvements**" shall mean all improvements that may be necessary to construct, maintain and repair any new and existing roadways and other means of ingress and egress over, across and along the Owner's Property, including paving or surfacing of the roadways with asphalt, gravel or other roadway materials, installation of road signs and the construction and installation of culverts, bridges, drainage ditches, gates, cattle guards and similar structures and facilities.

8.7 "**Battery Facilities**" shall mean a type of equipment that can be given a new charge by passing an electric current through it designed for the storage of electrical power including without limitation, batteries and other devices for storage of electrical energy, foundations, support structures, braces and related equipment.

8.8 "**Ownership of Improvements**." Except as otherwise provided in Section 11.7, all Improvements shall at all times remain the property of Operator, and Owner shall have no right, title or interest therein. All Improvements constructed or placed on the Owner's Property by Operator during the Term of this Agreement may be repaired, replaced, relocated, removed, added to or expanded upon by Operator at any time during the Term of this Agreement. Owner expressly waives any statutory lien or common law liens on the Improvements to which Owner might be entitled.

8.9 "**Construction Liens**." Operator shall not permit any liens arising out of Operator's use of the Operator Property under this Agreement to be filed against the Owner's Property. Operator shall, within sixty (60) days after it receives notice of the lien, provide a bond or other security that Owner may reasonably request, or remove such lien from the Owner's Property in the manner provided by applicable law.

8.10 "**Location of Improvements**." The acreage required from the Owner's Property for the Improvements for which the Lease and Easements are being granted cannot be determined until the completion of Operator's inspection, testing, study and surveying of the Owner's Property during the Option Term. Along with the Option Notice, Operator shall deliver to Owner a proposed plan of development showing the contemplated locations of the Improvements and a preliminary calculation of the acreage as determined by the area bounded by a perimeter fence required for the Project, which shall serve as the **Exhibit B** to this Agreement. During the final development and construction of the Project, such locations may need to be amended. Following construction of the Project, Operator shall provide Owner an "as-built" survey of all Improvements on Owner's Property and the final calculation of the acreage as determined by the area bounded by a perimeter fence required for the Project, which shall serve as **Exhibit C** to this Agreement. Further, following construction, the Improvements may need to be relocated or rerouted by Operator, which Operator may perform, at any time during the Term of this

Agreement, so long as the nature and extent of any such relocated or rerouted Improvements are not materially different and impose no materially greater burden on the Owner's Property than the original locations or routes, and so long as Operator takes commercially reasonable efforts to minimize disruption or inconvenience to Owner.

8.11 **Removal of Improvements.** Upon full or partial termination of any of the Lease Rights or Easements, Operator shall remove all Improvements and restore the area formerly occupied by the Improvements to substantially the same physical condition that existed immediately before the construction of the Improvements (the "**Removal Obligations**"). At Owner's request, all or any part of the Roadway Improvements may be left for use by Owner.

8.12 If a governmental authority does not require a performance bond or security for removal of the Improvements, then upon the earlier to occur of: (i) the termination of this Agreement; or (ii) on the twentieth (20th) anniversary of the commercial operations date of the Project, Operator shall obtain and deliver to Owner a bond in form and substance reasonably satisfactory to Owner securing Operator's Removal Obligations (the "Removal Bond"). The Removal Bond shall be equal to the estimated amount, if any (the "Net Removal Costs"), of removing the Improvements from Owner's Property. Operator shall not be required to deliver such Removal Bond to Owner if Operator has delivered such a bond in connection with the permitting of Owner's Property or any other portion of the Improvements for the Project. Once in place, Operator shall keep such bond, or a like replacement, in force throughout the remainder of the Term. The Net Removal Costs shall be determined by the Parties hereto acting in good faith. If the Parties cannot agree upon the Net Removal Costs within sixty (60) days of their first attempt to do so, then the Net Removal Costs shall be determined by an independent engineer mutually selected by the Parties. If the Parties cannot agree upon such independent engineer within the next thirty (30) days, then by an independent engineer appointed by a District Judge of Henderson County, Kentucky; and the decision of such an independent engineer (however selected) as to the Net Removal Costs shall be conclusive as between and binding upon, the Parties. If an independent engineer is selected, then the Parties hereto shall equally share all of the costs associated with the independent engineer's determination of the Net Removal Cost. If the Removal Bond is unavailable or an alternate form of security is more economical or desirable, then Operator may substitute an alternate form of security, such as a letter of credit, other form of bond, or guarantee reasonably acceptable to Owner that provides substantially equivalent security as the Removal Bond.

9. **Ownership and Title Matters.** Owner warrants and represents to Operator, both as of the Effective Date, and as of the Commencement Date as follows:

9.1 **Authority.** Owner represents and warrants that it is the holder of fee simple title and is the sole owner of the Owner's Property and has the unrestricted right and authority to sign this Agreement and to grant Operator the Lease and Easements and other rights granted in this Agreement. When signed by both Parties, this Agreement constitutes a valid and binding agreement enforceable against Owner in accordance with its terms.

9.2 **Other Agreements.** The Owner's Property is not subject to any other agreements, options, rights of first refusal or other prior right of any party to purchase, lease or acquire easements in the Owner's Property, or create any prior claim or right that would preclude

or interfere with Operator's rights and interests under this Agreement and the Lease and Easements.

9.3 **Minerals**. Intentionally omitted.

9.4 **Owner Mortgage**. Except as disclosed by Owner to Operator at the time of the execution of this Agreement by Owner, there are no mortgages encumbering the Owner's Property ("**Owner Mortgage**").

9.5 **Notice and Opportunity to Cure**. If there is an Owner Mortgage encumbering Owner's Property and Owner receives from the holder thereof any notice that payments are overdue, Owner shall notify Operator and each Operator Mortgagee (as defined at Section 13.1) by sending a copy of such overdue payment notice to Operator by the earlier of (i) five (5) days after receipt, or (ii) three (3) business days prior to the date by which a default under or in respect of such Owner Mortgage could occur. If Operator or any Operator Mortgagee determines that it would be in Operator's interest to make such payments to Owner Mortgagee on Owner's behalf, whether as a result of receiving such notice or otherwise, Operator shall have the right to make such payments and to credit the payments so made against the Annual Installment Payment next due under the Agreement.

9.6 **Subordination, Non-Disturbance & Attornment Agreement**. If there is an Owner Mortgage encumbering Owner's Property, Owner shall cooperate with Operator to obtain a Subordination, Non-Disturbance and Attornment Agreement ("**SNDA**") in the form prepared and provided by Operator, from each Owner Mortgagee, pursuant to which such Owner Mortgagee agrees, among other things, not to disturb Operator's possession and use of the Owner's Property. Owner shall not incur any loss in income, expense, obligation or liability with regard to the SNDA. Operator shall, at its sole cost and expense, record each such SNDA in the Office of the County Clerk in which Owner's Property is located. If Owner fails to deliver a SNDA from each Owner Mortgagee, Operator may, at its sole option, either (i) terminate this Agreement immediately upon written notice to Owner, or (ii) take such action as Operator deems reasonably necessary to effect the rights granted to Operator hereunder, and off-set all amounts expended in such efforts against the Annual Installment Payments and any other amounts due hereunder or in respect hereof.

10. **Representations and Warranties of Owner**. Owner hereby makes the following further representations and warranties both as of the Effective Date, and as of the Commencement Date:

10.1 **Physical Condition**. Owner has no knowledge of any existing physical conditions of the Owner's Property which would prevent, significantly restrict or make more expensive Operator's development of the Owner's Property for the purposes specified in this Agreement, or which could, with the passage of time, or the giving of notice, constitute a violation of any currently applicable governmental law, ordinance, order, rule or regulation.

10.2 **Legal Restrictions**. Owner has no knowledge of any law, regulation, ordinance or order of any local, state or federal governmental authority which would prohibit or significantly restrict Operator's development of the Owner's Property pursuant to this Agreement. This Agreement does not violate any contract, agreement, instrument, judgment or order to which Owner is a party or which affects the Owner's Property. To the best of Owner's

knowledge, the Owner's Property is currently in full and complete compliance with all governmental laws, ordinances, orders, rules and regulations applicable to the Owner's Property.

10.3 **No Litigation.** No litigation is pending and, to the best of Owner's knowledge, no litigation or administrative actions are proposed, threatened or anticipated with respect to any matter affecting the Owner's Property. If Owner learns of any litigation or administrative action proposed, threatened or instituted with respect to the Owner's Property, Owner shall give Operator notice within thirty (30) days thereof.

10.4 **Survival.** The representations and warranties set forth in this Section 10 shall survive the execution and delivery hereof.

11. **Use, Operation and Maintenance.**

11.1 **Exclusive Use by Operator.** Operator shall have the exclusive right (i) to use and possess the Owner Property in connection with the Project and other similar solar-powered electrical power generation projects; (ii) to investigate, inspect, survey, and conduct tests of the Owner's Property, including, but not limited to, meteorological, environmental, archeological and geotechnical tests and studies; (iii) to use and convert all of the sunlight resources on the Owner's Property; and (iv) to undertake such other activities on the Owner's Property that may be related to the Project, including, without limitation, the storage of Solar Panels, materials and equipment during the installation and construction of the Improvements; development and operation of communications systems; and site tours of the Project for visitors and other interested parties.

11.2 **No Required Installation or Operation.** Nothing in this Agreement shall be interpreted as imposing on Operator any obligation to install Solar Panels or other Improvements on the Owner's Property, or to operate the Project on the Owner's Property. Operator shall have the sole discretion to determine if and when any Solar Panels and other Improvements may be constructed on Owner's Property, and if and when to commence the operation of the Project on the Owner's Property.

11.3 **Permits and Approvals.** Operator shall be responsible, at its sole cost and expense, for obtaining any governmental permits and approvals necessary for the construction and operation of the Project and the construction and operation of the Improvements. Owner shall cooperate with Operator as necessary to obtain any governmental or utility approvals or permits, including, without limitation, signing any applications for such approvals, provided that Owner shall not incur any loss in income, expense, obligation or liability with respect to Operator obtaining such permits or approvals.

11.4 **Compliance with Laws.** Operator shall comply in all material respects with valid laws applicable to the Owner's Property and the Operator Property. Operator shall have the right, in its sole discretion and at its sole expense, in Operator's name to contest the validity or applicability to the Owner's Property and the Operator Property of any law, ordinance, statute, order, regulation, property assessment or the like made by any governmental agency or entity. Operator shall control any such contest and Owner shall cooperate with Operator in every

reasonable way in such contest, provided that Owner shall incur no expense, obligation or liability with regard to such contest.

11.5 **Care and Appearance.** Operator, in its exercise of the lease, easement and other rights granted hereunder shall, at all times, maintain the Owner's Property and the Improvements in a reasonably neat, clean and presentable condition. Operator shall not willfully or negligently damage or destroy the Owner's Property and shall keep the Owner's Property clean and free of debris created by Operator, its contractors, or others brought on to the Owner's Property by Operator. Operator shall not use the Owner's Property for storage, except for materials, construction equipment and vehicles directly associated with construction or maintenance of the Improvements on the Owner's Property or adjacent properties that are part of the Project.

11.6 **Fences and Gates.** At Owner's request, Operator shall repair or replace any fences, gates or cattle guards damaged or removed in connection with Operator's activities on the Owner's Property. Fences removed from the Owner's Property, if replaced, shall be re-built by Operator at its expense in mutually agreeable locations. All fence repair and construction shall be substantially similar to the construction of existing fences and cattle guards on Owner's Property. Any gates opened for access to Owner's Property by either Party shall be closed immediately after passing through so that livestock may not pass through. Once completed, all replacement fences, gates and cattle guards shall be owned and maintained by Owner. Upon abandonment or termination of the rights granted to Operator in this Agreement, any fences, gates and cattle guards installed by Operator shall remain and become the property of Owner. To minimize the need for temporary fencing, Owner will cooperate with Operator to avoid pasturing animals on or near the Improvements during periods of construction, maintenance or removal activity by Operator. Owner will discuss with Operator what temporary fencing is necessary during the periods of construction, maintenance or removal activity by Operator.

11.7 **Roadway Maintenance and Repairs.** Operator agrees to maintain and repair all Roadway Improvements located on the Operator Property; provided, however, Owner shall reimburse Operator for any costs and expenses incurred by Operator to repair any damage or perform any special maintenance of the Roadway Improvements caused by Owner or any person using the Roadway Improvements with Owner's permission, other than Operator.

12. **Taxes.**

12.1 **Owner's Taxes.** Owner covenants and agrees to pay prior to delinquency all real and personal property and other taxes, general and special assessments, and other charges of every description ("Taxes") levied or assessed against the Owner's Property and all improvements thereon by governmental authorities, other than Operator's Taxes referenced in Section 12.2 (Taxes, excepting Operator's Taxes, are hereinafter referred to as "Owner's Taxes").

12.2 **Operator's Taxes.**

[REDACTED]

[REDACTED]

12.3 **Failure to Pay.** In the event either Party fails to pay their share of Taxes prior to delinquency, the other Party shall have the right to pay such Taxes and any accrued penalties or interest, which payments shall increase or be offset against other Payments due under this Agreement.

12.4 **Operator's Right to Contest.** Operator may contest the legal validity or amount of any Operator's Taxes for which it is responsible under this Agreement, and may institute such proceedings as it considers necessary, provided that Operator shall bear all expenses in pursuing such contest or proceeding. With respect to any Taxes which may constitute a lien on the Owner's Property, Operator shall promptly pay such Taxes unless the proceeding in which it contests such Taxes shall operate to prevent or stay the collection of the Taxes so contested or unless Operator removes any such lien by bonding or otherwise. Owner agrees to render to Operator all reasonable assistance in contesting the validity or amount of any such Taxes, with the exception of Taxes levied by Owner, including joining in the signing of any reasonable protests or pleading which Operator may deem advisable to file; provided, however, that Operator shall reimburse Owner for its reasonable out-of-pocket expenses, including reasonable attorneys' fees incurred in connection with providing such assistance.

13. **Mortgage of Operator Property.**

13.1 **Right to Mortgage.** Operator may, upon written notice to Owner, but without requiring Owner's consent or approval, mortgage, collaterally assign, or otherwise encumber and grant security interests in all or any part of its interest in this Agreement and the Operator Property. These various security interests in all or a part of this Agreement and the Operator Property are collectively referred to as an "Operator Mortgage" and holder of such security interest, an "Operator Mortgagee". Any Operator Mortgagee shall use the Operator Property only for the uses permitted under this Agreement. Whenever Operator has granted a security interest under this Section 13, it will give Owner notice of the Operator Mortgage (including the name and address of the Operator Mortgagee for notice purposes) to Owner within thirty (30) days; provided that failure to give this notice shall not constitute a default under this Agreement, but rather shall only have the effect of not binding Owner to provide such Operator Mortgage notice until the Operator and its address is given to Owner.

13.2 **Notice of Default and Opportunity to Cure.** As a precondition to exercising any rights or remedies related to any alleged default by Operator under this Agreement, Owner

shall give written notice of the default to each Operator Mortgagee at the same time it delivers notice of default to Operator, specifying in detail the alleged event of default and the required remedy. Each Operator Mortgagee or its designee shall have the right, but not the obligation, to cure any default as Operator, and/or the right, but not the obligation, to remove any Improvements or other property owned by Operator or such Operator Mortgagee located on the Owner's Property to the same extent as Operator. The cure period for any Operator Mortgagee shall be the later of (i) the end of the Operator cure period under Section 18; (ii) thirty (30) days after such Operator Mortgagee's receipt of the default notice; or (iii) if applicable, the extended cure period provided for in Section 13.3. Failure by Owner to give an Operator Mortgagee notice of default shall not diminish Owner's rights against Operator, but shall preserve all rights of the Operator Mortgagee or its designee to cure any default and to remove any Improvements or other property of Operator or the Operator Mortgagee located on the Owner's Property.

13.3 **Extended Cure Period.** If any default by Operator under this Agreement cannot be cured without the Operator Mortgagee obtaining possession of all or part of the Operator Property, then any such default shall be deemed remedied if an Operator Mortgagee: (i) within sixty (60) days after receiving notice from Owner as set forth in Section 13.2, acquires possession of all or part of the Operator Property, or begins appropriate judicial or nonjudicial proceedings to obtain the same; (ii) diligently prosecutes any such proceedings to completion; and (iii) after gaining possession of all or part of the Operator Property performs all other obligations as and when the same are due in accordance with the terms of this Agreement. If an Operator Mortgagee is prohibited by any court or by operation of any bankruptcy or insolvency laws from commencing or prosecuting the proceedings described above, the sixty (60) day period specified above for commencing proceedings shall be extended for the period of such prohibition.

13.4 **Operator Mortgagee Liability.** Any Operator Mortgagee whose interest in the Operator Property is held solely for security purposes, shall have no obligation or liability under this Agreement unless and until the Operator Mortgagee succeeds to absolute title to the Operator Property and the rights of Operator under this Agreement. An Operator Mortgagee shall be liable to perform obligations under this Agreement only for and during the period it directly holds such absolute title.

13.5 **Certificates.** Owner shall execute any estoppel certificates (certifying as to truthful matters, including without limitation that no default then exists under this Agreement, if such be the case), consents to assignment and non-disturbance agreements as Operator or any Mortgagee may reasonably request from time to time. The Parties shall negotiate in good faith any amendment to this Agreement from time to time to include any provision that may be reasonably requested by Operator or any Operator Mortgagee to implement the provisions contained in this Agreement or to preserve an Operator Mortgagee's security interest.

13.6 **Operator Mortgagee's Right to Enforce Mortgage and Assign.** Each Operator Mortgagee shall have the right, in its sole discretion: (i) to assign its Operator Mortgage; (ii) to enforce its lien and acquire title to all or any portion of the Operator Property by any lawful means; (iii) to take possession of and operate all or any portion of the Operator Property and to perform all obligations to be performed by Operator under this Agreement, or to cause a receiver to be appointed to do so; and (iv) to acquire all or any portion of the Operator Property by

foreclosure or by an assignment in lieu of foreclosure and thereafter to assign or transfer all or any portion of the Operator rights under this Agreement to a third party in accordance with Section 14. Any Operator Mortgagee or other party who acquires Operator's interest in all or a portion of the Operator Property pursuant to foreclosure or assignment in lieu of foreclosure shall not be liable to perform the obligations imposed on Operator by this Agreement, which are incurred or accruing after such Operator Mortgagee or other party no longer has ownership or possession of the Operator Property.

13.7 **New Agreement.**

13.7.1 If the Operator Property is foreclosed upon or there is an assignment in lieu of foreclosure, or if this Agreement is rejected or disaffirmed pursuant to bankruptcy law or other law affecting creditor's rights and, within ninety (90) days after such event, Operator or any Operator Mortgagee or other purchaser at a foreclosure sale shall have arranged to the reasonable satisfaction of Owner to cure any material defaults under this Agreement, and for the payment of all Annual Installment Payments or other charges due and payable by Operator as of the date of such event, then Owner shall execute and deliver to Operator or such Operator Mortgagee or other purchaser at a foreclosure sale, or to a designee of one of these parties, as the case may be, a new agreement ("**New Agreement**") which (i) shall be for a term equal to the remainder of the Term of this Agreement before giving effect to such rejection or termination; (ii) shall contain the same covenants, agreements, terms, provisions and limitations as this Agreement (except for any requirements that have been fulfilled by Operator or any Operator Mortgagee or other purchaser at a foreclosure sale prior to rejection or termination of this Agreement); and (iii) shall include that portion of the Operator Property in which Operator or such other Operator Mortgagee or other purchaser at a foreclosure sale had an interest on the date of rejection or termination.

13.7.2 If more than one Operator Mortgagee makes a written request for a New Agreement pursuant to this provision, the New Agreement shall be delivered to the Operator Mortgagee requesting such New Agreement whose Operator Mortgage is prior in time, and the written request of any other Operator Mortgagee whose lien is subordinate shall be void and of no further force or effect. The provisions of this Section 13 shall survive the termination, rejection or disaffirmation of this Agreement and shall continue in full force and effect thereafter to the same extent as if this Section 13 were a separate and independent contract made by Owner, Operator and each Operator Mortgagee, and, from the effective date of such termination, rejection or disaffirmation of this Agreement to the date of execution and delivery of such New Agreement, such Operator Mortgagee or other purchaser at a foreclosure sale may use and enjoy the Operator Property without hindrance by Owner or any person claiming by, through or under Owner; provided that all of the conditions for the New Agreement as set forth above are complied with.

13.8 **Operator Mortgagee's Consent to Amendment, Termination or Surrender.** Notwithstanding any provision of this Agreement to the contrary, the Parties agree that so long as any Operator Mortgage remains outstanding, this Agreement shall not be modified or amended, and Owner shall not accept a surrender, cancellation or release of all or any part of the Operator Property from Operator, prior to expiration of the Term of this Agreement, without the prior written consent of the Operator Mortgagee holding such Operator Mortgage. This

provision is for the express benefit of and shall be enforceable by each Operator Mortgagee as if it were a party named in this Agreement.

14. **Assignment and Sublease.** Operator shall have the right, without Owner's consent, to sell, convey, lease, or assign all or any portion of this Agreement or the Operator Property, on either an exclusive or a non-exclusive basis, or to grant subeasements, co-easements, easements, licenses or similar rights with respect to the Operator Property (collectively, "**Assignment**"), to one or more persons or entities (collectively "**Assignee**"). Each Assignee shall use the Operator Property only for the uses permitted under this Agreement. When Operator makes any Assignment under this Section 14, Operator shall give written notice to Owner of such Assignment (including the interest conveyed by the Assignment and address of the Assignee for notice purposes) to Owner; provided Operator's failure to give such notice shall not constitute a default under this Agreement, but rather shall only have the effect of not binding Owner with respect to such assignment or conveyance until such notice is given. Any Assignment by Operator shall release Operator from obligations subject thereof accruing after the date that liability for such obligations is assumed by the Assignee.

15. **Hazardous Materials.**

15.1 **Owner's Covenants Regarding Hazardous Materials.** Owner represents and warrants that, to the best of Owner's knowledge, the Owner's Property is not and has not been in violation of any federal, state or local environmental health or safety laws, statute, ordinance, rule, regulation or requirement ("**Environmental Laws**"), and Owner has not received any notice or other communication from any governmental authorities alleging that the Owner's Property is in violation of any Environmental Laws. "**Hazardous Materials**" shall mean any asbestos containing materials, petroleum, explosives, toxic materials, or substances regulated as hazardous wastes, hazardous materials, hazardous substances, or toxic substances under any federal, state, or local law or regulation. Owner warrants that Owner has done nothing to contaminate the Operator Property with Hazardous Materials or wastes.

15.2 **Operator's Covenants Regarding Hazardous Materials.** Operator shall, at Operator's sole cost and expense, promptly take removal or remedial action required by Environmental Law with regard to any material violation of any Environmental Law with regard to any Hazardous Materials brought onto the Owner's Property by Operator or its employees, agents, or contractors. Owner shall cooperate with Operator with regard to any scheduling or access to the Owner's Property in connection with any action required hereunder.

15.3 **Operator's Indemnity Regarding Hazardous Materials.** Operator shall indemnify, defend, protect and hold Owner harmless from any liability based on: (i) the release of Hazardous Materials in, on, under or about the Owner's Property caused by Operator or its employees, agents, or contractors, or (ii) the violation by Operator or its employees, agents, or contractors of any Environmental Law. The indemnity obligations set forth herein shall survive termination of this Agreement.

16. **Insurance and Indemnity.**

16.1 **Insurance.** At all times during which Operator is conducting any activities on the Property and at all times during the Term of this Agreement, Operator shall maintain in effect (1) commercial General Liability Insurance, including bodily injury and property damage coverage with minimum limits of \$1 Million Dollars per occurrence and \$2 Million Dollars aggregate and (2) Umbrella Liability Insurance with minimum limits of \$5 Million Dollars per occurrence and \$5 Million Dollars aggregate. Operator shall name Owner as additional insured on such insurance policy and provide Owner with a certificate of such insurance.

16.2 **Indemnity by Operator.** Operator shall defend, indemnify, protect and hold Owner harmless from and against all liabilities, costs, expenses, obligations, losses, damages, claims, (collectively "**Claims**") resulting from the negligence, willful misconduct, or breach of this Agreement by Operator, its agents, contractors or employees, invitees, licensees and permittees; provided, however, that such Claims are not due to the sole negligence, willful misconduct, or breach by Owner, its agents, contractors or employees, invitees, licensees or permittees.

16.3 **Indemnity by Owner.** Owner shall defend, indemnify, protect, and hold Operator harmless from and against all Claims resulting from the negligence, willful misconduct, or breach of this Agreement by Owner, its agents, contractors or employees, invitees, licensees and permittees; provided, however, that such Claims are not due to the sole negligence, willful misconduct, or breach by Operator, its agents, contractors, employees, invitees, licensees, or permittees.

16.4 **Survival.** The obligations of the Parties under this Section 16 shall survive expiration or other termination of this Agreement.

17. **Confidentiality.** This Agreement includes confidential and proprietary information relating to Operator and the Project. Owner agrees not to provide copies of the Agreement or disclose the terms of the Agreement to any unauthorized person or entity. Operator authorizes Owner to provide copies of the Agreement and disclose the terms thereof to Owner's family ("family" shall be deemed to include all devisees or descendants of owner by will or intestacy), attorney, accountant, financial advisor and any existing or prospective mortgagee, lessee, or purchaser for the sole purpose of evaluating and advising Owner and for no other purpose, so long as such authorized parties agree in writing to become subject to the confidentiality provisions hereto and not to provide copies of the Agreement or disclose the terms thereof to any unauthorized person or entity. Any Owner and party shall return all material containing any confidential information to Operator immediately upon its request. Any party agrees to destroy immediately upon request by Operator such analyses, compilation, studies or other documents, and any oral information will continue to be subject to the terms of this Agreement. Owner agrees that Operator will have no adequate remedy at law if any party violates any of the terms of this Agreement. In such event Operator will have the right, in addition to any other rights Operator may have, to obtain injunctive relief to restrain any breach or threatened breach by third party or specific enforcement of such terms plus reimbursement of attorneys' fees, court costs and all associated expenses. No party shall publish, file for public record, reproduce, or otherwise disseminate this document or any of the terms and provisions hereof to any party, other than the Parties set forth above without the prior written consent of Operator, which consent may be withheld for any reason and in Operator's sole discretion.

18. Default and Remedies.

18.1 Operator Payment Default.

[Redacted text block]

18.1.1 Collection of Payments.

[Redacted text block]

18.1.2 Terminate Agreement.

[Redacted text block]

18.2 Other Operator Default.

[Redacted text block]

[REDACTED]

18.3 Owner Default.

[REDACTED]

19. Condemnation.

19.1 Complete Taking. If, at any time, any authority having the power of eminent domain shall condemn all or substantially all of the Operator's Property, or all of the Improvements thereon, for any public use or otherwise, then the interests and obligations of Operator under this Agreement in or affecting the Operator's Property shall cease and terminate upon the earlier of (i) the date that the condemning authority takes physical possession of the Operator's Property or the Improvements thereon, (ii) the date that Operator is, in its sole judgment, no longer able or permitted to operate the Project on the Operator's Property in a commercially viable manner, or (iii) the date of the condemnation judgment. Operator shall continue to pay all amounts payable hereunder to Owner until the earlier of such dates, at which time the Parties shall be relieved of any and all further obligations and conditions to each other under this Agreement.

19.2 Partial Taking. If, at any time during the term of this Agreement, any authority having the power of eminent domain shall condemn one or more, but not all, of the Solar Panels, or any portion of the Improvements or the Operator's Property, then the interest and obligations of Operator under this Agreement as to those Solar Panels or any portion of the Improvements or the Operator's Property so taken shall cease and terminate upon the earlier of (i) the date that the condemning authority takes possession of such Solar Panels or any portion of the Improvements or the Operator's Property, (ii) the date that Operator is, in its reasonable judgment, no longer able or permitted to operate the Project on the Operator's Property, or any portion thereof, in a commercially viable manner, or (iii) the date of the condemnation judgment; and, unless this Agreement is terminated as hereinafter provided, this Agreement shall continue in full force and effect as to the remainder of the Solar Panels, Improvements and the Operator's Property. If the

remainder of the Solar Panels or any other portion of the Improvements or the Operator's Property is or becomes insufficient or unsuitable for Operator's purposes hereunder, as determined by Operator in its sole discretion, then, subject to the rights of any Operator Mortgagee under Section 13, Operator shall have the right to terminate this Agreement as to the portion of the Operator's Property to which Operator continues to hold the rights, at which time the Parties shall be relieved of any further obligations and duties to each other under this Agreement.

19.3 **Apportionment, Distribution of Award.** On any taking, all sums awarded, including damages and interest, shall be paid as follows:

(a) Any portion of the award by the court on account of any cost or loss that Operator may sustain in the removal and relocation of Operator's Improvements, to Operator;

(b) Any portion of the award by the court for Operator's anticipated or lost revenues or profits, to Operator;

(c) Any portion of the award by the court for Owner's lost revenues, to Owner;

(d) All remaining amounts of the award, to Owner or Operator consistent with applicable Kentucky law.

20. **Notice.**

20.1 **Writing.** All notices given or permitted to be given hereunder shall be in writing.

20.2 **Delivery.** Notice is considered given either (i) when delivered in person to the recipient named below, (ii) upon receipt after deposit in the United States mail in a sealed envelope or container, postage and postal charges prepaid, return receipt requested or certified mail, addressed by name and address to the party or person intended, or (iii) twenty-four (24) hours from proper and timely delivery to an overnight courier service addressed by name and address to the party or person intended as follows:

Notice to Owner: Nunn Family Irrevocable Trust
7155 Highway 299
Robards, KY 42452

██
██

Notice to Operator: Boulevard Associates, LLC
700 Universe Blvd
Juno Beach, FL 33408
Attn: Land Services Administration

██

20.3 **Change of Recipient or Address.** Either Party may, by notice given at any time or from time to time, require subsequent notices to be given to another individual person,

whether a party or an officer or representative, or to a different address, or both. Notices given before actual receipt or notice of change shall not be invalidated by the change.

21. **Miscellaneous Provisions.**

21.1 **Successors and Assigns.** The terms and provisions of this Agreement shall run with the land and be binding on and inure to the benefit of the heirs, successors, assigns and personal representatives of the Parties. In accordance with this Agreement, Operator in its discretion may authorize other persons or entities to use the Operator Property for the purposes stated in this Agreement

21.2 **Memorandum.** Simultaneously with the execution of this Agreement, the Parties agree to execute and acknowledge a memorandum of this Agreement. Operator may record the executed memorandum in the public records of Henderson County, Kentucky.

21.3 **Entire Agreement.** This Agreement and the attached Exhibits shall constitute the entire agreement between the Parties and supersedes all other prior writings and understandings.

21.4 **Amendments.** This Agreement shall not be amended or modified in any way except by an instrument signed by the Parties and consented to by any Operator Mortgagee. The Parties hereto shall at all times hereafter execute any documents and do any further acts which may be necessary or desirable to carry out the purposes of this Agreement and to give full force and effect to each and all of the provisions hereof.

21.5 **Legal Matters.** This Agreement shall be governed by and interpreted in accordance with the then existing laws of the Commonwealth of Kentucky and the County where the Owner's Property is located shall be considered the proper forum or jurisdiction for any disputes arising in connection with this Agreement. The Parties agree to first attempt to settle any dispute arising out of or in connection with this Agreement by good-faith negotiation. If the Parties are unable to resolve amicably any dispute arising out of or in connection with this Agreement, each shall have all remedies available at law or in equity and as provided by this Agreement. **Each Party waives all right to trial by jury and specifically agrees that trial of suits or causes of action arising out of this Agreement shall be to the court of competent jurisdiction.**

21.6 **Severability.** If any term or provision of this Agreement, or the application thereof to any person or circumstance shall, to any extent, be determined by judicial order or decision to be invalid or unenforceable, the remainder of this Agreement or the application of such term or provision to persons or circumstances other than those as to which it is held to be invalid, shall be enforced to the fullest extent permitted by law.

21.7 **Tax Credits.** If under applicable law Operator becomes ineligible for any currently existing tax credit, benefit or incentive for alternative energy expenditure established by any local, state or federal government, then, at Operator's option, the Parties shall negotiate in good faith to amend this Agreement or replace it with a different instrument so as to convert Operator's interest in the Operator Property to a substantially similar interest that makes Operator eligible for such tax credit, benefit or incentive. Such amendment or instrument shall

not impair any of Owner's rights or increase the burdens or obligations of Owner under this Agreement.

21.8 **Approvals**. Whenever in this Agreement the approval or consent of either Party is required or contemplated, unless otherwise specified, such approval or consent shall not be unreasonably withheld or delayed.

21.9 **Authority**. The signatories hereto warrant that each has the authority to execute this Agreement on behalf of any entities which are Parties to this Agreement and that each such entity has executed this Agreement pursuant to its organizational documents or a resolution or consent of their Board of Directors or other governing body.

21.10 **Time of Essence**. Time is of the essence of each provision of this Agreement.

21.11 **Counterparts**. This Agreement may be executed in multiple counterparts, each of which shall be deemed an original, and all of which together shall constitute a single instrument.

[Signatures on Next Page]

Owner:

Nunn Family Irrevocable Trust

By: Rebecca A. Brown
Rebecca, A. Brown, Trustee

Operator:

Boulevard Associates, LLC
a Delaware limited liability company

By: [Signature]
Matthew S. Handel, Vice President

EXHIBIT A

Legal Description of Owner's Property

Parcel 1

Beginning at a stake 7 ft. from gate post in wire fence; thence with said fence S 72 ½ E. 56 poles and 17 links to a stake in the fence in J. W. Otey's line; thence N 19 ½ E. 60 poles to a stake in hedge fence; thence N. 4 ½ E. 9 poles and 8 links to a stake in Otey's line; thence N. 80 ¾ W. 62 poles and 13 links to a stake at a rail fence 60 poles and 10 links to the beginning, containing 24.46 acres.

And a passway easement of reasonable width over Tract V of that property described in Mortgage Book 344, Page 96 for purposes of ingress and egress from and to Tract II conveyed herein.

Parcel 2

Tract Five: Beginning at a stake at the West end of the hedge corner to George T. Crook; thence S. 82 E. 63 poles and 14 links to a stake; corner to Crook and Ed Otey; thence N 4 ½ E. 33 poles to a stone, corner to Fred Schaeffer in Ed. Otey's line at an angle to the Ed Otey road; thence with the South line of the road N. 87 W. 58 poles and 10 links to a stake corner to Lot #7; thence S. 12 ½ W. 28 poles to the beginning, containing 11.60 acres.

Parcel 3

Being 3.783 acres located on Kentucky Highway 1299 in Henderson County, Kentucky as shown by the plat of record in Deed Book 412, Page 491 in the Henderson County Clerk's Office.

Parcel 4

A certain lot or parcel located East of Ky. Hwy. 1299 and South of Ed Otey Road approximately 2 miles Northwest of the town of Robards, in Henderson County, Kentucky, and being more specifically described as follows:

To find the place of beginning, commence at an iron pin set in the East right-of-way line of Ky. Hwy. 1299, said iron pin being located 25 feet East of the centerline of the existing pavement of said Ky. Hwy. 1299, and being a corner to the Spencer Cemetery; thence with said Spencer Cemetery, South 75°23'59" East, a distance of 546.36 feet to an iron pin set at the base of a fence corner post; thence continuing with said Spencer Cemetery, South 7°08'08" West, a distance of 21.85 feet to an iron pin set at a corner to the Catherine Puryear & Elizabeth Nunn property recorded in Deed Book 61 Page 54 in the Henderson County Court Clerk's Office; thence with said Puryear & Nunn property, South 89°34'33" East, a distance of 608.12 feet to an iron pin set in the North line of said Puryear & Nunn property, being the South line of the Irvin Hunter, Jr., property recorded in Deed Book 411 Page 50 of which this description is a part, and being the point of beginning for this description; thence severing said Hunter property, North 10°10'24" East, a distance of 353.14 feet to the North line of said Hunter property, and being the South line of the Dennis & Judith Nunn property recorded in Deed Book 401 Page 324; thence with said Nunn property, South 73°41'29" East, a distance of 929.26 feet to a point in the West line of Tract 1 of the Hyde Brothers Agricultural Division, a plat of which is recorded in Plat Book 6 Page 29, said point being located South 18°2'57" West, 248.98 feet from an iron pin

found at a corner to said Tract 1; thence with said Tract 1, South 18°02'57" West, a distance of 98.32 feet to a point in said West line, said point being located North 18°02'57" East, 107.62 feet from an iron pin found at a corner to Tract 2 of said Division, and being a corner to said Puryear & Nunn property; thence with said Puryear & Nunn property, North 89°34'33" West, a distance of 923.80 feet to the point of beginning containing 206418 square feet or 4.7387 acres and being subject to all legal written and unwritten easements and rights of way. This description was prepared from a physical survey conducted under the direction of Dennis E. Branson, Ky. RLS 2532 on or about December 6, 1991. A plat of said tract is of record in Plat Book 6 at page 162 in the Henderson County Court Clerk's office.

Parcel 5

Beginning at a point in the center of the Frog Island Road, corner with Byron Phillips, runs N 58°-28' W 2347 feet to a stake, corner with Mrs. Hilary Denton; thence S 22°-50' W 82 feet to a stake and post, corner with Mrs. Hilary Denton; thence N 59°-56' W 241 feet to a stake corner with Mrs. Lila Chism in Mrs. Hilary Denton 's line; thence N 29°-38' E 3042 feet to a stake in Road, corner with Clarence Sheffer; thence with Road; S 59°-32' E 281 feet to a nail in road, corner with George Vogel and W.B. Algood; thence S 30°-40' W 1976 feet to a post and stake, corner with George Vogel ; thence S 58°-10' E 232 feet to a nail in the Frog Island Road, corner with George Vogel in John Pruitt's line; thence with said Road S 29°-33' W 969 feet to the place of beginning, containing 70.1 acres, subject to legal highways and road right-of-ways, as per survey made by W. W. Poole on November 3, 1995.

LESS the following two lots:

- 1) A 1 acre lot conveyed by Shirley E. Hurt and his wife, Walleen Hurt, to Larry Wayne Rideout and his wife, Claudia Bernice Rideout, by deed dated February 10, 1998, of record in Deed Book 474, Page 491, Henderson County Clerk's Office.
- 2) A 1 acre lot conveyed by Patricia Wiseman, unmarried, to Scott Wayne Rideout and his wife, Amanda L. Rideout, by deed dated November _____, 2005, of record in Deed Book 544, Page 927. Henderson County Clerk's Office.

Parcel 6

A certain tract or parcel located on the Northeast side of Kentucky Highway 1299, approximately two miles Northwest of the City of Robards, in Henderson County, Kentucky, and being more specifically described as follows:

Unless stated otherwise, any monument referred to herein as a "set iron pin" is a 5/8" diameter rebar, 18" in length set with an orange plastic cap stamped "PLS #2939". All bearings stated herein are referred to the 1983 NAD Kentucky South Zone coordinate system.

Beginning at a point located South 75°35'39" East, a distance of 30.33 feet from a P.K. Nailset at the Northwest corner of Tract 3 of the Mary Ann Sugg property described in Deed Book 549, page 1039, (of which this description is a part) at the Henderson County Court Clerk's Office, said point also being located in East right of way line of Kentucky Highway 1299 as described in Deed Book 159, page 543, to the Commonwealth of Kentucky, and in the southern line of the Elizabeth Powell property described in Deed Book 361, page 54; thence with the South line of said Powell property, South 75°35'39" East, a distance of 1924.78 feet to an iron pin set at the base of a fence corner post, said iron pin being located in the West line of the John Hyde

property described in Deed Book 581, page 130, (see also Tract 2 of the Hyde Brothers Agricultural Division, a plat of which is recorded in Plat Book 6, page 29); thence with the West line of said Hyde property, South 24°11'22" West, a distance of 185.76 feet to an iron pin set at the base of a fence corner post located at the Southwest corner of said Hyde property; thence with the South line of said Hyde property and the South line of the James Green property described in Deed Book 474, page 458, (see also Tract 3 of the Hyde Brothers Agricultural Division, a plat of which is recorded in Plat Book 6, page 29), South 81° 37' 56" East, a distance of 700.92 feet to an iron pin set in the South line of said Green property; thence severing Tract 2 of said Mary Ann Sugg property, South 25°29'46" West, a distance of 862.71 feet to a 30" oak tree with two blazes on the South side located at the Northwest corner of the Glen Royster property described in Deed Book 243, page 612; thence with the North line of said Royster property and the area dedicated as road right of way on the plat recorded in Plat Book 8, page 129 North 80°30'14" West, a distance of 1392.66 feet to an iron pin set in said Commonwealth of Kentucky right of way of Kentucky Highway 1299; thence with said right of way line the following six calls:

- 1) Thence along a curve to the left having a radius of 221.00 feet and being subtended by a chord of North 67°01'18" West, 107.62 feet, an arc distance of 108.71 feet along said curve to a point in said right of way line;
- 2) North 81°06'51" West, a distance of 796.80 feet to an iron pin set in said right of way line;
- 3) Thence along a curve to the right having a radius of 57.00 feet and being subtended by a chord of North 31°49'20" West, 86.42 feet, an arc distance of 98.08 feet along said curve to a point in said right of way line;
- 4) North 17°28'12" East, a distance of 233.85 feet to a point in said right if way line;
- 5) Thence along a curve to the left having a radius of 1844.00 feet and being subtended by a chord of North 11°43'52" West, 368.78 feet, an arc distance of 369.39 feet along said curve to an iron pin set in said right of way line;
- 6) North 05°59'32" East, a distance of 479.20 feet to the point of beginning and continuing 56.61 acres. This description was prepared from a physical survey conducted under the direction of Bruce K. Bailey, PLS #2939 of Bailey Surveys, Inc., on May 5, 2011, and which is of record in Plat Book 9, page 390A, Henderson County Clerk's Office.

Parcel 7

Tract 1: Beginning at a stake hickory and dogwood pointer in Oteys line, thence S 62 E 102 poles to a stake 1 pole and 3 links from a black oak corner with Wm. Eades, thence with Eades line N 30 ½ E. 169 ½ poles to a stake thence with Oteys line N. 59 37 W. 102 poles to a stake corner with lot No. 1 of the Marshall Smith division, thence with the line of said lot S 30 ½ W. 173 poles and 3 links to the beginning containing 108 acres more or less.

Less and Except: That property which was conveyed to Doris Keach and Margaret Keach, husband and wife, by deed from Urial Overfield and Lillian Overfield, husband and wife, dated April 7, 1951 which is recorded in Deed Book 160, Page 58 of the Henderson County Clerk's office and contains two acres, more or less, as described in said deed which is incorporated herein by reference.

Less and Except: That property which was conveyed by U.M. Overfield and Lillian Overfield, husband and wife, to the Commonwealth of Kentucky for the use and benefit of the Department

of Highways as described in a deed dated September 12, 1944 and contains 4.96 acres, as described in said deed, which description is incorporated herein by reference, and is recorded in Deed Book 119, Page 217 of the Henderson County Clerk's Office.

Less and Except: That property which was conveyed by Lillian Overfield, a widow, to the Commonwealth of Kentucky for the use and benefit of the Department of Highways as described in a deed dated September 21, 1959 of record in Deed Book 197, Page 280 of the Henderson County Clerk's Office, the description of such tract is contained in said deed and is incorporated herein by reference. The deed does not show the number of acres which were conveyed.

Tract 2: Beginning at a point on the West side of said U.S. Highway #41 as widened at the corner of the Urial Overfield farm; running thence with the Overfield line N 59-37 W 78.90 feet to a point, corner to Overfield and the parties of the first part; running thence with a continuation of the division line between said Overfield and parties of the first part land, N 30-30 E. 56.82 feet to a point on the West side of U.S. Highway #41; running thence in a Southeasterly direction with the Westerly line of said Highway as widened, 87.95 feet to the point of beginning, containing 0.05 acre.

Tract 3: A tract of land in Henderson County, Kentucky, approximately 10 miles south of the city of Henderson and ½ mile East of U.S. 41 and more particularly described as follows:

Beginning at a point in the Urial Overfield (now Austin Overfield) line and corner with T.L. Book; thence N 36°22' E a distance of 478.5 feet to the corner of Austin Overfield and William P.B. Slaughter; thence N 47°7' E a distance of 580.8 feet to the A. A. Watkins corner; thence S. 55°48' E a distance of 190.4 feet to the intersection of the West right of way line of the Pennyriple Parkway, which is 130 feet left of the station 3235+18 of the Pennyriple Parkway; thence S 6°33'30" E. a distance of 1018.0 feet; thence S 0°31'30" E a distance of 351.95 feet to the corner of H. J. Blackwell; thence N 54°54' W a distance of 1210.0 feet, more or less, to the point of beginning and containing 13.3 acres, more or less.

Parcel 8

A certain tract or parcel located approximately 1,500 feet East of Kentucky Highway 1299 and 1.5 miles Northwest of the City of Robards, in Henderson County, Kentucky and being more specifically described as follows:

Unless stated otherwise, any monument referred to herein as a "set iron pin" is a 1/2" diameter rebar, 18" in length set with an orange plastic cap stamped "PLS #2939". All bearings stated herein are referred to the 1983 NAD Kentucky South Zone coordinate system.

Beginning at a 30" oak tree found with two blazes on the south side, said oak tree being located at the Southeast corner of the Dennis Nunn property described in Deed Book 601 Page 142 at the Henderson County Court Clerk's Office, thence with the East line of said Nunn property, North 25°29'46" East a distance of 826.71 feet to an iron pin set in the south line of the James Green property described in Deed Book 474 Page 458; thence with the South line of said Green property, South 81°31'43" East, a distance of 1549.14 feet to an iron pin set in the West line of the Leo King Farm, LLC property described in Deed Book 610 Page 673; thence with the West line of said Leo King Farm, LLC property, South 04°40'12" East, a distance of 546.48 feet to an iron pin set at the Northwest corner of the Leo Mattingly, Jr. property described in Deed Book

608 Page 536; thence with the West line of said Mattingly property, South 13°54'39" West, a distance of 24.64 feet to a point located in the centerline of a large ditch; thence with the centerline of said large ditch and severing Tract 2 of the Mary Ann Sugg property described in Deed Book 549 Page 1039, of which this description is a part, the following eleven calls:

- 1) South 86°15'04" West, a distance of 77.92 feet to a point located in the centerline of said large ditch;
- 2) North 87°42'08" West, a distance of 135.23 feet to a point located in the centerline of said large ditch;
- 3) North 86°28'26" West, a distance of 74.62 feet to a point located in the centerline of said large ditch;
- 4) South 39°06'20" West, a distance of 153.33 feet to a point located in the centerline of said large ditch;
- 5) South 47°34'08" West, a distance of 122.36 feet to a point located in the centerline of said large ditch;
- 6) South 68°12'17" West, a distance of 180.38 feet to a point located in the centerline of said large ditch;
- 7) South 65°11'36" West, a distance of 144.66 feet to a point located in the centerline of said large ditch;
- 8) South 60°32'46" West, a distance of 319.67 feet to a point located in the centerline of said large ditch;
- 9) North 89°42'10" West, a distance of 180.80 feet to point located in the centerline of said large ditch;
- 10) North 85°48'58" West, a distance of 849.48 feet to a point located in the centerline of said large ditch;
- 11) South 71°19'53" West, a distance of 17.30 feet to a point located in the North line of Tract 1 of said Marry Ann Sugg property; thence continuing with the center line of said large ditch and severing said Tract 1, of which this description is a part, the following two (2) calls:
 - 1) South 71°19'53" West, a distance of 43.37 feet to a point located in the centerline of said large ditch;
 - 2) North 48°06'19" West, a distance of 42.63 feet to a point located in the East line of the James Riley property described in Deed Book 621 Page 491;

Thence with the East line of said Riley property the following two (2) calls:

- 1) North 26°14'19" East, a distance of 21.97 feet to an iron pin set at a bend in the East line of said Riley property;
- 2) North 27°59'58" East, a distance of 462.00 feet to the point of beginning and containing 43.18 acres.

This description was prepared from a physical survey conducted under the direction of Bruce K. Bailey, PLS #2939 of Bailey Surveys, Inc. on January 24, 2017.

This conveyance is subject to easements, restrictions, rights of way and mineral reservations of record.

See also the plat whereby said 43.18 acres has been consolidated with existing 56.61 acres of record in Plat Book 9, page 390A, making a total of 99.79 acres, more or less, by the Sugg & Nunn Subdivision and Consolidation plat, of record in Plat Book 10, page 186, Henderson County Clerk's Office.

Parcel 9

Tract 1: Beginning at a stake corner to lot No. 1 in the middle of Frog Island Road; thence S 80 E 153 poles to the stake corner to lot No. 1 in Thos. Suggs line; thence N 20 E 27 poles and 17 links to a stake corner to lot No. 3 in Suggs line; thence W 87-3/4 W 93 poles and 6 links to a stake corner to the Graveyard; thence with E end of the graveyard; thence South 18-1/2 W 7 poles and 16 links to corner of graveyard; thence North 71 W 33 poles and 23 links to a stake in middle of Frog Island road corner to the graveyard; thence S 13 W 12 poles and 4 links to the beginning, containing 13-50/100 acres.

Tract 2: A tract of land lying and being in Henderson County, Kentucky, in the neighborhood of McMullin's Chapel and bounded and described as follows:

Beginning at a stake in Enoch Royster's line corner to the dower; thence S. 14 W. 131 poles to a stake corner to dower in Patten's line; thence North 88-1/2 W. 28 poles and 4 links to a stake corner to lot #3 in Patten's line; thence N. 14 E 145 poles to a stake, corner to lot #3 in Enoch Royster's line; thence S. 58-1/4 E. 28 poles and 19 links to the beginning, containing 24 acres of land.

Tract 3: A tract of land being lot No. 2 in the division of the land of M.S. Spencer, bounded as follows: Beginning at a post 11 links from a 30" hickory corner to Mrs. E.N. Royster; thence with line of Mrs. E.N. Royster S 0-33 W 264 feet to a 36" sweet gum corner to Mrs. Royster; thence with line of Mrs. Royster N. 58-10 W. 561.3 feet to a stake in North line of a lane known as Spencer Lane and corner to Mrs. Nora Sugg; thence with line of Mrs. Nora Sugg S. 14-22 W 2149.7 feet to a post corner to G.S. Powell; thence with line of G.S. Powell S 87 25 E. 854 feet to a stake corner to Herman Sugg in line of G.S. Powell; thence with line of Herman Sugg N 3-19 E. 1295.3 feet to a post corner to Herman Sugg; thence N. 89-35 E 341.6 feet to post corner to Mrs. Nora Sugg in line of Herman Sugg; thence with line of Mrs. Nora Sugg and Mrs. E.N. Royster N. 9-22 E 498.6 feet and N 2-35 W. 284.1 feet to post corner to Mrs. E.N. Royster; thence with Mrs. Royster's line N 86-58 W. 318.5 feet to the point of beginning, containing an area of 36.5 acres, more or less. Spencer Lane as now located over and across the above tract is to remain open for outlet for 30 acre tract.

Less and Except: A tract of land conveyed to Samuel Lee Hunter, unmarried, in Deed Book 307, page 353 and more particularly described as follows:

A tract of land located 2.1 miles Northwest of Robards on West side of Kentucky Highway 1299 (Frog Island Road), and being more specifically described as follows: Beginning at a spike in center of Ky., 1299, said spike being at existing corner of Catholine Puryear farm, and being 90 feet North of a pipe culvert under Ky., 1299; thence leaving road N 80°22'20" W 70.40 feet to a steel post; thence N 22°02'45" E 121.50 feet to an iron pin; thence severing Puryear farm S 85°20'20" E 37.2 feet to center of said road, thence along center of road S 6°00' W 122.00 feet to point of beginning, containing 0.15 acres, less any legal road right-of-way.

Tract 4: Beginning at a black oak stump an original corner with E.N. Royster, running thence with Royster's line S. 89-1/2 E 6.14 chains to a stake on the West side of the road S. 39-1/2 E. 2 poles; thence S 2-1/2 W 1 pole and S 13-1/2 E. 2 poles; thence S 2-1/2 W 1 pole and S 13-1/2 5.83 poles to a stake; thence N 85-1/2 W 7.17 poles to a stake 8 poles West of a hickory corner with T.W. Spencer estate; thence S 8°57' E 8.05 to the beginning, containing 6 acres, more or less.

Less and Except: A 3.783 acre tract conveyed to Dennis Nunn in Deed Book 412, page 489 and as shown on Plat in Deed Book 412, page 491 in the Henderson County Court Clerk's Office.

Being the same property conveyed to Dennis E. Nunn by deed dated February 14th, 2019 of record in Deed Book 635, Page 898 in the Henderson County Clerk's Office.

HOLDING PAGE FOR EXHIBIT B

Preliminary Lease and Easement Improvement Plan and Acreage Calculation
To be Delivered with Option Notice

HOLDING PAGE FOR EXHIBIT C

As Built Lease and Easement Improvements and Final Acreage Calculation

EXHIBIT D

Lease and Easement Compensation

[REDACTED]

(2) Payment for Lease and Easements.

[REDACTED]

[REDACTED]

[REDACTED]

(3) Crop Compensation

[REDACTED]

[REDACTED]

(4) **Timber Removal.** [REDACTED]

(5) **Payment Allocation Schedule.** [REDACTED]

REAL ESTATE PURCHASE OPTION AGREEMENT

THIS REAL ESTATE PURCHASE OPTION AGREEMENT ("**Agreement**"), made and entered into as of the 11th day of January, 202__ by and between Mary Ann Sugg, a unmarried widow, whose address is 320 Chimney Hill Lane, Henderson, Kentucky 42450 ("**Seller**") and Sebree Solar, LLC, a Delaware limited liability company, whose address is 700 Universe Boulevard, Juno Beach, FL., 33408 ("**Purchaser**"), provides as follows:

THAT, FOR AND IN CONSIDERATION of the mutual covenants, promises, conditions, and undertakings set forth herein, the payment of the Option Fee (as hereafter defined), and other good and valuable consideration, the receipt and sufficiency of which the parties hereby acknowledge, Seller and Purchaser covenant and agree as follows:

1. **Grant of Option.** Seller hereby grants to Purchaser an exclusive right and option ("**Option**") to purchase from Seller, upon the terms and conditions hereafter set forth, that certain real property located in the County of Henderson ("**County**"), Commonwealth of Kentucky, and any structures, buildings, and other improvements thereon, together with existing access easements benefiting such real property, all of which is more particularly described on **Exhibit A** attached hereto and incorporated herein by reference together with Seller's right, title and interest, if any, in and to all streets, alleys and right-of-ways adjacent to the real property, any easement rights, air rights, subsurface development rights, water rights and other rights appurtenant to the real property, any minerals, including oil, gas and other hydrocarbon substances on the real property, all of which shall be referred to herein as the "**Property**".

2. **Duration of Option.** The term of the Option shall be four (4) years, commencing on the Effective Date ("**Option Term**").

3. **Option Fee.**



4. **Exercise of Option, Non-Exercise of Option.** Purchaser may elect to exercise the Option at any time during the Option Term by giving written notice of exercise to Seller. If the Option is exercised as provided herein, this Agreement shall become and constitute a binding contract for the purchase and sale of the Property on the terms and conditions set forth in this Agreement. Upon exercise of the Option by the Purchaser, closing on the purchase and sale of the Property hereunder ("**Settlement**") will occur on a date mutually agreed to by Purchaser and Seller, but no later than sixty (60) days after the date of such written notice of exercise ("**Settlement Date**"). Purchaser shall have the right to terminate the Agreement at any time during the Option Term in Purchaser's sole discretion for any reason by giving Seller written notice, and in such event Seller shall retain any Option Fee delivered by Purchaser as of the termination date, subject to the provisions of this Agreement under which Purchaser has the right to terminate the Agreement and have any Option Fee returned to Purchaser.

5. Purchase Price. [REDACTED]

6. Title.

A.

State of Title. Seller's title to the Property is, as of the Effective Date, and shall be, at the time of Settlement, marketable, fee simple, indefeasible, and fully insurable at standard rates by a reputable title insurance company selected by Purchaser ("**Title Insurer**"), subject only to those exceptions acceptable to Purchaser, in its sole discretion. Seller shall cause title to the Property to be conveyed to Purchaser by special warranty deed subject only to current taxes and assessments and matters approved by Purchaser in accordance with Section 6(B) (the "**Permitted Exceptions**"). At Settlement, Seller must satisfy all reasonable requirements imposed by the Title Insurer to issue its ALTA standard owner's policy of title insurance, insuring title to the Property in the name of the Purchaser with liability in the amount of the Purchase Price or such higher amount as may be specified by Purchaser (the "**Owner's Policy**"). The Owner's Policy shall list as exceptions to coverage only the foregoing taxes and assessments and the Permitted Exceptions.

B. Title Examination.

Within the Option Term, Purchaser, at its expense, may cause a Title Insurer to issue a title insurance commitment ("**Commitment**") to issue an Owner's Policy to Purchaser. At least thirty (30) days prior to the earlier of (a) the exercise of the Option or (b) the expiration of the Option Term, Purchaser shall advise Seller in writing ("**Title Objection Notice**") of those exceptions to title in the Commitment, which may include any unrecorded leases disclosed by the Seller in accordance with this Agreement, and those matters shown on the Survey contemplated by this Agreement that are unacceptable to Purchaser ("**Title Defects**"). Any exceptions to title insurance shown on the Commitment and matters shown on the Survey that are not contained in the Title Objection Notice shall be deemed Permitted Exceptions. Any title matters affecting the Property and arising after the Effective Date shall not be considered Permitted Exceptions without Purchaser's prior written consent in accordance with Section 6(C). Seller shall use its good faith efforts to cure all Title Defects promptly and at its expense. In the event that Seller is unable to cure any Title Defects (excluding any Monetary Liens) within the thirty (30) day period following the date of the Title Objection Notice or by the Settlement Date, whichever first occurs ("**Title Cure Period**") after good faith efforts to do so, Seller shall notify Purchaser in writing as to which Title Defects remain uncured on or before the end of the Title Cure Period and Purchaser shall have twenty (20) days following such notice to either: (i) elect to accept title to the Property subject to the uncured Title Defects, in which event such Title Defects shall be deemed Permitted Exceptions; (ii) terminate this Agreement by written notice thereof to Seller, whereupon this Agreement shall be terminated, the Option Fee shall be returned to Purchaser by Seller and both parties shall thereafter be released from all further obligations hereunder, except for those obligations specifically stated herein to survive termination of this Agreement; or (iii) elect to extend the Title Cure Period or Settlement Date, if the Option has been exercised, for a reasonable period of time designated by Purchaser (not to exceed thirty (30) days) and, if upon the expiration of such period Seller shall not have cured the Title Defects, Purchaser shall have the

options set forth in (i) or (ii) above. Notwithstanding the above, Seller shall be obligated to cure any Title Defects created by Seller and any judgment, lien or encumbrance that can be cured by the payment at Settlement of a liquidated amount ("**Monetary Liens**"). At Settlement, Seller shall provide Purchaser and Title Insurer with all affidavits in form reasonably acceptable to the Title Insurer to permit the Title Insurer to insure against adverse matters caused by Seller and first appearing in the Office of the Clerk of the County on a date subsequent to the effective date of the Commitment and prior to the recording of the deed required by the terms of this Agreement, and to permit Title Insurer to delete the standard exceptions, including parties in possession, mechanics' or materialmen's liens and unrecorded easements

C. Future Title Matters. Seller shall not, after the Effective Date, subject the Property, or consent, to any liens, encumbrances, covenants, conditions, restrictions, easements, or rights-of-way, or seek any zoning changes or take any other action that might affect or modify the status of title to the Property (other than curing or removing title exceptions as contemplated by Section 6(B)) without Purchaser's prior written consent. If Seller violates the provisions of the preceding sentence, Seller shall, prior to Settlement, and at its expense, effect the release of any such liens, encumbrances, covenants, conditions, restrictions, easements and rights-of-way, and take such steps as are necessary to return the zoning and title of the Property to the condition that existed as of the Effective Date or as agreed to by Purchaser.

7. Due Diligence.

A. Purchaser's Tests and Inspections. Purchaser shall have the right during the Option Term, to use all existing easements and roads providing access to the Property, including any easements described on **Exhibit A**, and to enter upon the Property and to perform, at its expense, boring tests and economic, engineering, topographic, environmental, survey and marketing tests or any other studies, tests and due diligence as Purchaser elects in its sole discretion. Said tests shall include but not be limited to the installation on the Property of any weather related instruments and fencing of said instruments reasonably required by Purchaser and access to said instruments. Purchaser shall not interfere with Seller's current operations on the Property while conducting any studies, tests and due diligence on the Property but in the event that Purchaser does interfere with Seller's current operations, Purchaser shall use all reasonable efforts to minimize any impact on Seller's operations. During the Option Term, Seller agrees to make available to Purchaser for inspection, and, at Settlement, to assign to Purchaser without cost, any and all architectural and engineering studies, surveys, and other related materials or information relating to the Property that are in, or come into, Seller's possession or control as more particularly set forth herein. Within the Option Term, Purchaser may elect, at its option and expense, to cause a survey of the Property ("**Survey**") to be prepared by a reputable surveyor, certifying the acreage of the Property and containing such other information as the Purchaser may direct. Provided Purchaser elects to cause a survey to be prepared, Purchaser may arrange for the preparation of the Survey during the Option Term or at any time prior to Settlement. Purchaser agrees to indemnify against and hold Seller harmless from any claims, damages, costs, or expenses arising from entry upon the Property by Purchaser, or any agents, contractors, or employees of Purchaser with the exception of: (i) any loss, liability, cost or expense to the extent arising from or related to acts of Seller or any tenants, (ii) any diminution in value of the Property arising from or related to matters discovered by Purchaser during its investigation of the Property, (iii) any latent defects in the

Property discovered by Purchaser, (iv) liability which results from the release of preexisting toxic or Hazardous Materials on or about the Property resulting from normal environmental testing procedures, and (v) liability which arises from the results or findings of such tests. The provisions of this Section shall survive the Settlement Date or earlier termination of this Agreement. If Settlement does not occur, Purchaser, at its own expense, shall repair any damage to the Property caused by Purchaser's tests and studies. In the event Purchaser does not exercise the Option, Purchaser shall provide to Seller a copy of the Survey it receives in accordance with this Agreement.

B. Delivery of Due Diligence Information. The following instruments and items of information shall be delivered by Seller to Purchaser within fifteen (15) days after the Effective Date to the extent these items are in the Seller's possession or control:

1. All reports covering underground soil and water conditions at the Property and in the possession of Seller or its agent.

2. Copies of any and all licenses, permits and inspection reports issued by governmental authorities with respect to the Property.

3. Copies of the most recent real estate tax bills as to the Property.

4. All current leases and royalty agreements for any portion of the Property.

5. All existing surveys for any portion of the Property.

6. All existing title policies for any portion of the Property.

7. All existing environmental reports for any portion of the Property.

8. Copies of well permits, statements of beneficial use and decrees relating to any ground water wells on or under the surface of the Property.

C. Access to Books and Records. Seller covenants and agrees that its shall give to Purchaser and to Purchaser's counsel, accountants and other representatives full access during normal business hours to the Property and to contracts and commitments of Seller relating to the Property, if any, and shall furnish to Purchaser all such information concerning the Property in the possession of Seller or their agents that Purchaser may reasonably request.

8. Settlement Deliveries.

A. Seller's Deliveries. At or before Settlement, Seller shall deliver to Escrow Agent all of the following documents and instruments, which shall have been executed by Seller:

1. A special warranty deed ("**Deed**"), in the form attached hereto as **Exhibit B** granting and conveying to Purchaser title to the Property in fee simple absolute, such Deed to be delivered in hand at Settlement;

2. A bill of sale and general assignment transferring and conveying all of Seller's right, title and interest in and to any personal property at the Property that Purchaser has agreed to accept and all of Seller's right, title and interest in and to all licenses, rights, permits and authorizations pertaining to the Property;

3. Such affidavits, certificates and forms as may be required by the Title Insurer, any lender, or state or local law;

4. A Certification of Non-Foreign Status pursuant to Section 1445 of the Internal Revenue Code ("**Section 1445**") that Seller is not a foreign person, foreign corporation, foreign partnership, foreign trust, or foreign estate (as those terms are defined in the Internal Revenue Code and related regulations), and applicable federal and state tax reporting certificates including, without limitation, any required state withholding or non-foreign status affidavit or certificate;

5. A solar easement encumbering lands owned by Seller within a half-mile radius of the Property, which restricts development or construction on such lands that would overshadow or otherwise block access of the sunlight to the solar collection facilities to be located on the Property;

6. All other documents and instruments referred to herein that are to be provided to Purchaser by Seller;

7. All documents reasonably required by the Escrow Agent, including, but not limited to, an executed settlement statement; and

B. Purchaser's Deliveries. At or before Settlement, Purchaser shall deliver to Escrow Agent all of the following:

1. The Survey (provided Purchaser elects to cause preparation of the Survey);

2. The Purchase Price subject to credits, prorations and adjustments as provided in this Agreement in cash or other immediately available funds;

3. All other documents and instruments referred to herein that are to be provided to Seller by Purchaser; and

4. All documents reasonably required by the Escrow Agent, including, but not limited to, an executed settlement statement.

9. **Settlement Costs: Prorated items and Adjustments.**

A. **Settlement Costs.** [Redacted]

B. **Prorations.** [Redacted]

C. Unless (i) Seller is not a “foreign person” as contemplated in Section 1445 and (ii) Seller executes at Settlement an affidavit in the form required by the Internal Revenue Service to exempt Purchaser from the withholding requirements under Section 1445, the delivery of the Purchase Price to Seller shall be subject to the satisfaction of the withholding requirements under Section 1445.

D. **Seller Crop Losses.** [Redacted]

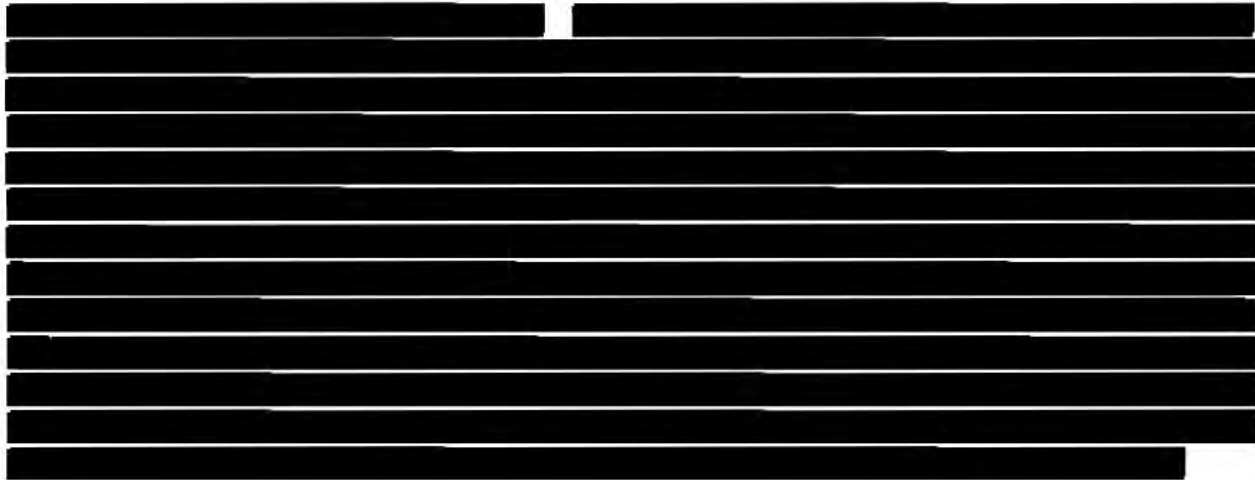

10. **Seller's Representations and Warranties.** To induce Purchaser to enter into this Agreement and to purchase the Property, Seller hereby makes the following representations and warranties as to the Property as of the date hereof (upon each of which Seller acknowledges and agrees that Purchaser is entitled to rely and has relied) each and all of which shall be true, correct and complete as of the Settlement Date:

A. **Authority.** Seller has the power and authority to enter into this Agreement and to consummate the transactions contemplated hereby. Seller, and any specific individual parties signing this Agreement on behalf of Seller represent and warrant that the parties signing this Agreement on behalf of the Seller have the full legal power, authority and right to execute and deliver this Agreement. Neither the entering into this Agreement nor the performance of any of Seller's obligations under this Agreement will violate the terms of any contract, agreement or instrument to which Seller is a party.

B. **Accuracy of Documents.** To the best of Seller's knowledge, all documents and papers delivered by Seller to Purchaser pursuant to this Agreement are true, correct and complete as of the dates thereof, and there have been no material changes from the information set forth in any of them.

C. **Special Assessment.** No portion of the Property is subject to or is affected by any special assessment for improvements completed prior to the date hereof, whether or not presently a lien thereon.

D. **Taxes.** No portion of the Property is subject to or affected by any outstanding or delinquent taxes or related financial liabilities.

E. **Litigation.** Seller has not been served (by means of formal, legal service of process as required by law) with any litigation, and no arbitration proceedings have been commenced, which do or will affect any aspect of the Property or Seller's ability to perform its obligations under this Agreement. In addition, within the last two (2) years, Seller has not been threatened with any litigation (or arbitration) by a third party which would affect any aspect of the Property or Seller's ability to perform its obligations under this Agreement.

F. Compliance. Seller has not received any notice of any presently uncured violation of any law, ordinance, rule or regulation (including, but not limited to, those relating to zoning, building, fire, environment, health and safety) of any governmental, quasi-governmental authority bearing on the construction, operation, ownership or use of the Property.

G. Condemnation Proceedings. Neither all nor any portion of the Property has been condemned or conveyed by deed in lieu of condemnation, nor is there now pending or, to the best of Seller's knowledge, threatened any condemnation or similar proceeding affecting the Property or any portion thereof. Seller has no knowledge that any such proceeding is contemplated. Seller has no knowledge of any change or proposed change in the route, grade or width of, or otherwise affecting, any street or road abutting the Property, which change might have a material adverse impact on the Property.

H. Condition of Property. To the best of Seller's knowledge, there are no areas within the Property which are subject to any statutes, rules, regulations, conservation easements (or like encumbrances) or ordinances that would adversely affect the Property or Purchaser's ownership and intended use thereof.

I. Subdivision. If the Property is not a separate tax lot under applicable laws, ordinances and regulations, and subdivision may be required for the conveyance of the Property to Purchaser. If required, the Property will, on or before the Settlement Date, be subdivided from the larger tract of land owned by Seller in order to convey the Property to Purchaser. Seller shall, on or before the Settlement Date, obtain all necessary governmental approvals for a Minor Subdivision Plat delineating the Property as a separate and legal lot of a minimum of 90 acres and maximum of 95 acres in a location and having the size and configuration designated by Purchaser upon the exercise of the Option, or as may be otherwise mutually agreed upon by Purchaser and Seller.

J. Zoning and Dedication. Purchaser intends to use the property to construct and operate a solar power plant. Seller shall cooperate fully with Purchaser and execute all documents required by Purchaser or governmental or quasi-governmental authority, if any, for the purpose of securing any land use change, re-zoning, zoning variance or special use, if necessary, in order for the Property to be used for Purchaser's intended purpose. Seller has not received any notice of any pending change in zoning from any governmental or quasi-governmental authority, which change would materially affect the present zoning of the Property. Seller has not made any commitment to any governmental or quasi-governmental authority having jurisdiction, or to any third party, to dedicate or grant any portion of the Property for roads, easements, rights of way, park lands or for any restrictions or to incur any other expense or obligation relating to the Property.

K. Flood Plain; Stormwater. To the best of Seller's knowledge, the Property is not the subject or location of any stormwater detention or surface drainage facilities serving any property other than the Property, and the Property is not located in a flood zone.

L. Property Use. Seller has no knowledge of any actual, pending or threatened designation of any portion of the Property, or the area in which the Property is located, as a historic

landmark or archeological district site or structure. Seller has no knowledge of any landfill or graveyard lying within the Property. Seller has not received any notice that any of the easements, covenants, conditions, restrictions or agreements to which the Property is subject interferes with or is breached by the use or operation of the Property as presently used.

M. Environmental Laws; Hazardous Materials.

1. The Property is not now, has not been during the period of Seller's ownership, and, to the best of Seller's knowledge, was not during any period prior to Seller's ownership:

(a) in violation of any past or present federal, state, or local statute, regulation, ordinance, administrative order, judicial order or any similar requirement having the force and effect of law, relating to the protection of human health or the environment (an "**Environmental Law**") including, but not limited to, any federal, state or local regulation relating to industrial hygiene or soil or ground water conditions; or

(b) used to generate, manufacture, store, refine, dispose of, or in any manner deal with, any flammable, explosive or radioactive material, hazardous waste, toxic substance or related material, oil, waste oil, or other petroleum based materials, or any other substance or material defined or designated as a hazardous or toxic substance, material or waste by any federal, state or local law or environmental statute, regulation or ordinance presently in effect or as amended or promulgated in the future (a "**Hazardous Material**");

2. Neither Seller nor, to Seller's knowledge, any prior owners or occupants of the Property have received any notice or advice from a governmental agency with regard to Hazardous Materials on, from or affecting the Property that could give rise to any liability under any Environmental Law, and, to Sellers' knowledge, there has been no investigation, notice of violation, request for information or claim of any kind asserted or threatened by any person, including any federal, state or local governmental agency, relating to the storage, disposal, discharge or release of any Hazardous Material in a manner that would give rise to any liability under any Environmental Law.

N. That as of the Effective Date, there are no leases or other agreements for occupancy in effect with respect to the Property other than agricultural leases which Seller has the right to terminate. Seller shall deliver exclusive possession of the Property to Purchaser at Settlement free and clear of all claims of tenants and others claiming possessory rights.

O. With the exception of this Agreement, no person or entity has a right of first refusal, option to purchase, or other right to purchase the Property pursuant to an agreement to which Seller is a party.

P. Seller has not filed for bankruptcy or other proceeding for the protection of debtors under state or federal law and that no similar involuntary proceeding has been filed or threatened against it.

Q. No part of the Property is subject to a special appraisal method that allows for the appraisal of the Property at less than its market value.

11. **Conditions Precedent.**

A. **Conditions for the Protection of Purchaser.** It shall be a condition precedent to Purchaser's obligation to purchase the Property and to perform its other obligations hereunder that each and every one of the conditions set forth under this Section 11(A) shall have been satisfied at or before Settlement, as hereafter provided, except for any such condition waived in writing by Purchaser, in whole or in part.

1. Between the Effective Date and the Settlement Date, the condition of the Property shall not have changed from the condition thereof as of the date of this Agreement, normal wear and tear excepted. Seller shall deliver vacant possession of the Property at Settlement. Prior to the Settlement Date, Seller shall remove all personal property, equipment and crops (whether or not harvestable for sale) from the Property.

2. Seller shall have delivered to Purchaser, on or before the Settlement Date, all of the documents and other information required of it pursuant to the provisions of this Agreement.

3. All of the covenants, representations, warranties, and agreements of Seller set forth in this Agreement shall be true, correct and complete as of the Effective Date and as of the Settlement Date. Notwithstanding that certain of Seller's representations and warranties may be limited to the extent of Seller's knowledge, the conditions precedent to Purchaser's obligation to consummate Settlement set forth in this Subparagraph shall not be so limited, and the satisfaction of such conditions shall depend upon the actual correctness on the Settlement Date of the matters stated in all such representations and warranties.

4. On or prior to the Settlement Date, Seller shall have performed, satisfied, or complied with all of the terms, provisions, covenants, conditions, and agreements of this Agreement.

5. Seller's title to the Property shall be as required by Section 6(B).

6. Seller [Purchaser] shall have created and subdivided the Property into a separate and legal lot of a minimum of 90 acres and maximum of 95 acres in a location and configuration designated by Purchaser upon the exercise of the Option, or as may be otherwise mutually agreed upon by Purchaser and Seller.

B. **Purchaser's Right to Extend Settlement Date.** In the event that any of the conditions of Settlement set forth in this Agreement is not satisfied as of the Settlement Date, Purchaser shall have the option to extend the time for Settlement by a period not in excess of thirty (30) days upon written notice to Seller to allow Seller additional time to fully satisfy any unsatisfied condition.

12. **Condemnation and Risk of Loss.**

A. **Condemnation.** In the event of condemnation or receipt of notice of condemnation of all of the Property, or any portion thereof, prior to the Settlement Date, Seller shall give written notice to Purchaser promptly after Seller receives such notice or otherwise learn of such condemnation or conveyance in lieu thereof. If all of the Property is, or is to be, condemned, this Agreement shall terminate immediately, and Seller shall immediately return the Option Fee to the Purchaser. If less than all of the Property is, or is to be, condemned or taken, Purchaser, at its option, may elect either (a) to terminate this Agreement effective upon written notice to Seller not later than thirty (30) days after receipt of notice from Seller and Seller shall immediately return amount of the Option Fee to the Purchaser minus the amount of the Initial Option Fee, which shall be retained by Seller, or (b) not to terminate this Agreement and proceed to Settlement. If Purchaser elects not to terminate this Agreement, Purchaser shall be entitled to receive, and Seller shall assign to Purchaser all of Seller's interest in, all of the condemnation proceeds and all interest thereon.

B. **Risk of Loss.** The risk of loss or damage to the Property prior to the Settlement, by casualty, act of God or any other event, shall be upon Seller.

13. **Covenants.**

A. **Condition of the Property.** Subject to the provisions of Section 12 hereof concerning condemnation, Seller, at Seller's expense, shall maintain the Property in at least as good condition as on the date hereof. Seller shall not diminish the quality or quantity of maintenance and upkeep services heretofore provided to the Property.

B. **Operation Until Settlement.** Between the Effective Date and the Settlement Date, Seller shall:

1. Not enter into any leases or other agreements for occupancy of the Property, or any part thereof, without Purchaser's prior written consent, which may be withheld in Purchaser's sole discretion.

2. Not transfer, convey, hypothecate, create a security interest in or lien upon, or otherwise dispose of any of the Property;

3. Comply with all federal, state and municipal laws, ordinances, and regulations relating to the Property;

4. Comply with all the terms, conditions and provisions of all agreements and other contractual arrangements referred to herein, or any other documents, agreements or instruments affecting the Property, make all payments required to be paid thereunder and suffer no default therein;

5. Promptly give written notice to Purchaser of the occurrence of any event materially affecting the Property, the Agreement, or the substance of the representations and warranties made hereunder; and

6. Operate and maintain the Property only in the ordinary course of business as currently conducted by Seller on the Property, if any; provided that the Seller shall not bring or store, or permit others to bring or store, any soil or fill material onto the Property that did not exist on the Property as of the Effective Date. Seller shall have the continued right to use the Property for this purpose between the Effective Date and the Settlement Date; provided that:

(a) Purchaser and its employees, representatives, and consultants shall have access to the Property after giving twenty-four (24) hour verbal or written notice to the Seller prior to entry and,

(b) Seller's use shall terminate upon the Settlement Date.

C. Other Acts or Omissions. Except as otherwise permitted herein, from the Effective Date until the Settlement Date, Seller shall not take any action or fail to take any action that would have a material adverse effect on the Property or Purchaser's ability to develop the Property after the Settlement Date, or that would cause any of the representations and warranties contained in Section 10 hereof to be untrue as of Settlement.

14. **Default.**

A. Purchaser's Rights. [Redacted]

B. Seller's Rights. [Redacted]

C. LIQUIDATED DAMAGES.

[REDACTED]

15. Brokers. Each party hereto represents to the other that there is no real estate broker involved in this transaction. Except as set forth in the foregoing sentence each party represents to the other that it has not made any agreement or taken any action which may cause any broker, agent or other person to become entitled to a brokerage or other fee or commission as a result of the transactions contemplated by this Agreement. Each party does hereby agree to indemnify and hold harmless the other from and against any and all costs, debts, damages, and claims, including, costs and reasonable attorneys' fees for pre-trial, trial or appellate matters in defending against any claims for brokerage commission or finder's fees arising through it relative to this transaction. The representations, warranties and agreements contained in this section shall survive the Settlement of this transaction.

16. Intentionally deleted.

17. General Provisions.

A. Completeness and Modification. This Agreement constitutes the entire agreement between the parties as to the transactions contemplated herein and supersedes all prior and contemporaneous discussions, understandings and agreements between the parties.

B. Assignments. Purchaser may not assign its rights hereunder without the prior written consent of Seller, which consent shall not unreasonably be withheld, delayed or conditioned; provided, however, that Purchaser, without the consent of Seller, may assign, in

whole or in part, its rights hereunder to any entity controlling, controlled by, or under common control with Purchaser.

C. Survival. All of Seller's representations, warranties, covenants, agreements and indemnifications made in, or pursuant to, this Agreement shall survive Settlement and delivery and recordation of the Deed.

D. Governing Law. This Agreement shall be governed by and interpreted in accordance with the laws of the Commonwealth of Kentucky. If the parties are unable to resolve amicably any dispute arising out of or in connection with this Agreement, they agree that such dispute shall be resolved in the circuit court located in the County. The parties agree that any rule of construction to the effect that ambiguities are to be resolved in favor of either party shall not be employed in the interpretation of this Agreement and is hereby waived. Notwithstanding anything to the contrary in this Agreement, neither party shall be entitled to recover punitive or exemplary damages, however arising, whether in contract, in tort, or otherwise, under or with respect to any action taken in connection with this Agreement.

E. Severability. If any term, covenant or condition of this Agreement, or the application thereof to any person or circumstance, shall to any extent be invalid or unenforceable, the remainder of this Agreement, or the application of such term, covenant or condition to other persons or circumstances, shall not be affected thereby, and each term, covenant or condition of this Agreement shall be valid and enforceable to the fullest extent permitted by law.

F. Costs. Regardless of whether Settlement occurs, each party shall be responsible for its own costs in connection with this Agreement and the transactions contemplated hereby, including, without limitation, fees of attorneys, engineers and accountants, except as otherwise expressly provided herein.

G. Notices. Any notice expressly provided for or permitted under this Agreement shall be in writing, shall be given either manually or by mail, overnight delivery service, such as UPS, FedEx, or Purolator, and shall be deemed sufficiently given when received by the party to be notified at its address set forth below, or three (3) business days after being mailed by registered or certified mail, postage prepaid, return receipt requested, or one (1) business day after being sent by such overnight delivery service, addressed to such party at such address, whichever shall first occur. Any party and any representative designated below, by notice to the other party, may change its address for receiving such notices.

If to Seller: Mary Ann Sugg
320 Chimney Hill Lane
Henderson, KY 42450

[REDACTED]
[REDACTED]

If to Purchaser: Sebree Solar, LLC
700 Universe Blvd.
Juno Beach, FL 33408

Attention: Land Services Administration
[REDACTED]

H. Incorporation by Reference. All of the Exhibits attached or referred to herein and all documents in the nature of such Exhibits are by this reference incorporated herein and made a part of this Agreement.

I. Interpretation. The section and paragraph headings used herein are for reference and convenience only and shall not enter into the interpretation hereof. Wherever used herein, the singular number shall include the plural and vice versa, and the use of any gender shall include all other genders, all as the context may require.

J. Business Days. If any action is required under the provisions of this Agreement to occur by a date that is a Saturday, Sunday or legal holiday, such date shall be extended to the first day thereafter that is not a Saturday, Sunday or legal holiday.

K. Waiver. No waiver or purported waiver by Purchaser of any contingency contained herein shall be valid against Purchaser unless it is in writing and signed by Purchaser.

L. Construction. The parties acknowledge that they and their counsel have reviewed this Agreement and that any rule of construction to the effect that any ambiguities are to be resolved against the drafting party shall not be employed in the interpretation of this Agreement or any exhibits or amendments hereto.

M. Memorandum of Option. Within ten (10) days of the Effective Date, Seller shall execute and deliver to Purchaser a Memorandum of this Agreement, which shall be recorded by Purchaser at the expense of Purchaser. In the event Seller fails to execute and deliver the Memorandum within ten (10) days of the Effective Date, Seller hereby authorizes the Purchaser to execute and record the Memorandum without the Seller's signature. In the event this Agreement is terminated by Purchaser or by Seller as a result of a default by Purchaser, in accordance with the terms of this Agreement and after written request by Seller, Purchaser shall execute a recordable document provided by Seller discharging the Memorandum of Option.

N. Confidentiality. Seller shall not disclose the fact or substance of this Agreement to any other persons or entities, other than Seller's counsel, tax advisor, or other consultants regarding this matter, unless and until Purchaser shall exercise its rights hereunder. Recordation of the Memorandum of Option contemplated under this Agreement shall not constitute a waiver of Purchaser's right to confidentiality.

O. Effective Date. The term "**Effective Date**" or such other similar term, shall be the last date on which a duplicate original of this Agreement has been executed by both Purchaser and Seller.

P. Time is of the Essence. The parties hereby agree that time is of the essence with respect to performance of each of the parties' obligations under this Agreement.

Q. Exclusivity of Option. Seller hereby agrees that the Option granted hereby shall be exclusive and agrees that, from and after the date of the Option and for so long thereafter as the Option is in force and effect, or until the Settlement Date occurs, whichever occurs later, Seller shall not offer any portion of the Property for sale to, accept any offer to purchase any portion of the Property from, nor enter into any contract to sell any portion of the Property with, nor enter into any lease, rental, or occupancy agreement affecting any portion of the Property with, nor enter into any agreement permitting any tenant to occupy any portion of the Property with, any person other than the Purchaser hereunder without in each instance first obtaining the prior written consent of the Purchaser.

R. Amendments. The terms of this Agreement may be waived, modified and amended only by and instrument in writing duly executed by Seller and Purchaser.

S. Counterparts. This Agreement may be executed in any number of counterparts and it shall be sufficient that the signature of each party appear on one or more such counterparts. All counterparts shall collectively constitute a single agreement. A facsimile or electronic signature to this Agreement or any amendment hereto shall be sufficient to prove the execution hereby by any person.

T. Waivers. No waiver of any breach of any covenant or provision herein contained shall be deemed a waiver of any preceding or succeeding breach thereof, or of any other covenant or provision herein contained. No extension of time for performance of any obligation or act shall be deemed an extension of time for performance of any other obligation or act except those of the waiving party, which shall be extended by a period of time equal to the period of the delay.

[Signatures on Next Page]

IN WITNESS WHEREOF, the parties have executed this Agreement on the day and year written below.

Seller:

Mary Ann Sugg
Mary Ann Sugg

Date Signed: 12/28/21

Purchaser:

Sebree Solar, LLC
A Delaware limited liability company

By: _____
Anthony Pedroni, Vice President

Date Signed: _____

IN WITNESS WHEREOF, the parties have executed this Agreement on the day and year written below.

Seller:



Mary Ann Sugg

Date Signed: 12/28/21

Purchaser:

Sebree Solar, LLC
A Delaware limited liability company

By: 

Anthony Pedroni, Vice President

Date Signed: _____

EXHIBIT A

Legal Description of Property

Parcel 1

TRACT 1:

A certain tract of land lying one mile west of Robards, Ky., and bounded as follows: Beginning at a stake in B. W. McMullins' line and running N 27-3/4 E 2770 feet to a stake, thence N 65-1/4 W 1205 feet to a stake north of branch, thence S 23-1/4 W 640 feet to margin of road; thence S 22 W 2,000 feet to corner of church lot; thence S 58-5/6 W 958 feet to the beginning, containing 65.61 acres, after deducting cemetery and church lot of 1.51 acres.

Parcel 2

TRACT 2:

The following property in Henderson County, Ky., viz: A tract or parcel of land being the south end of J. W. Oteys old home farm beginning at a large oak tree in the edge of the field, corner to the Curry land also corner to the north portion of this farm; thence W 138 poles and 13 links to a stake from which an oak bears S 82 E percimon bears S 70 E corner to N, part this farm in line thence with said line S 19 W 48 poles and 3 links to a stake corner to Higginson in J. S. McMullins line; thence S 86 E 40 poles and 20 links to a stake corner

to J. S. McMullins; thence S 24 W 28 poles to a stake corner to S. H. McMullins in J. S. McMullins line; thence S 66-1/2 E 124 poles and 12 links to a wild cherry tree in S. H. McMullins line; thence N 9.8.86 poles to a rock corner to Hattie Majors; thence N 7 W 33 poles and 3 links to the beginning, containing 78-60/100 acres.

LESS AND EXCEPT such portions of Parcel 1 Tract 1, and Parcel 2 Tract 2, if any, conveyed in deed recorded in Book 622, pages 903 through 907, inclusive, and described as follows:

A certain tract or parcel located approximately 1,500 feet east of Kentucky Highway 1299 and 1.5 miles northwest of the City of Robards, in Henderson County, Kentucky and being more specifically described as follows:

Unless stated otherwise, any monument referred to herein as a "set iron pin" is a 1/2" diameter rebar, 18" in length set with an orange plastic cap stamped "PLS #2939". All bearings stated herein are referred to the 1983 NAD Kentucky South Zone coordinate system.

Beginning at a 30" oak tree found with two blazes on the south side, said oak tree being located at the southeast corner of the Dennis Nunn property described in Deed Book 601 Page 142 at the Henderson County Court Clerk's Office, thence with the east line of said Nunn property, North 25 DEGREES 29 MINUTES 46 SECONDS East a distance of 862.71 feet to an iron pin set in the south line of the James Green property described in Deed Book 474 Page 458; thence with the south line of said Green property, South 81 DEGREES 31 MINUTES 43 SECONDS East, a distance of 1549.14 feet to an iron

pin set in the west line of the Leo King Farm, LLC property described in Deed Book 610 Page 673; thence with the west line of said Leo King Farm, LLC property, South 04 DEGREES 40 MINUTES 12 SECONDS East, a distance of 546.48 feet to an iron pin set at the northwest corner of the Leo Mattingly, Jr. property described in Deed Book 608 Page 536; thence with the west line of said Mattingly property, South 13 DEGREES 54 MINUTES 39 SECONDS West, a distance of 24.64 feet to a point located in the centerline of a large ditch; thence with the centerline of said large ditch and severing Tract 2 of the Mary Ann Sugg property described in Deed Book 549 Page 1039, of which this description is a part, the following eleven (11) calls:

- 1) South 86 DEGREES 15 MINUTES 04 SECONDS West, a distance of 77.92 feet to a point located in the centerline of said large ditch;
- 2) North 87 DEGREES 42 MINUTES 08 SECONDS West, a distance of 135.23 feet to a point located in the centerline of said large ditch;
- 3) North 86 DEGREES 28 MINUTES 26 SECONDS West, a distance of 74.62 feet to a point located in the centerline of said large ditch;
- 4) South 39 DEGREES 06 MINUTES 20 SECONDS West, a distance of 153.33 feet to a point located in the centerline of said large ditch;
- 5) South 47 DEGREES 34 MINUTES 08 SECONDS West, a distance of 122.36 feet to a point located in the centerline of said large ditch;
- 6) South 68 DEGREES 12 MINUTES 17 SECONDS West, a distance of 180.38 feet to a point located in the centerline of said large ditch;
- 7) South 65 DEGREES 11 MINUTES 36 SECONDS West, a distance of 144.66 feet to a point located in the centerline of said large ditch;
- 8) South 60 DEGREES 32 MINUTES 46 SECONDS West, a distance of 319.67 feet to a point located in the centerline of said large ditch;
- 9) North 89 DEGREES 42 MINUTES 10 SECONDS West, a distance of 180.80 feet to a point located in the centerline of said large ditch;
- 10) North 85 DEGREES 48 MINUTES 58 SECONDS West, a distance of 849.48 feet to a point located in the centerline of said large ditch;
- 11) South 71 DEGREES 19 MINUTES 53 SECONDS West, a distance of 17.30 feet to a point located in the north line of Tract 1 of

said Mary Ann Sugg property;

thence continuing with the center line of said large ditch and severing said Tract I, of which this description is a part, the following two (2) calls:

- 1) South 71 DEGREES 19 MINUTES 53 SECONDS West, a distance of 43.37 feet to a point located in the centerline of said large ditch;
- 2) North 48 DEGREES 06 MINUTES 19 SECONDS West, a distance of 42.63 feet to a point located in the east line of the James Riley property described in Deed Book 621 Page 491;

thence with the east line of said Riley property the following two (2) calls:

- 1) North 26 DEGREES 14 MINUTES 19 SECONDS East, a distance of 21.97 feet to an iron pin set at a bend in the east line of said Riley property;
- 2) North 27 DEGREES 59 MINUTES 58 SECONDS East, a distance of 462.00 feet to the point of beginning and containing 43.18 acres.

This description was prepared from a physical survey conducted under the direction of Bruce K. Bailey, PLS #2939 of Bailey Survycys, Inc. on January 24, 2017.

This conveyance is subject to easements, restrictions, rights of way and mineral reservations of record.

See also the plat whereby said 43.18 acres has been consolidated with existing 56.61 acres of record in Plat Book 9, page 390A, making a total of 99.79 acres, more or less, by the Sugg & Nunn Subdivision and Consolidation plat, of record in Plat Book 10, page 186, Henderson County Clerk's Office.

Being a portion of the same property conveyed to Kenneth W. Sugg by deed from Anita Sugg, unmarried widow, dated July 9, 2006, of record in Deed Book 549, page 1039, in the Henderson County Clerk's Office. Kenneth W. Sugg, aka Kenneth Wayne Sugg, died testate a resident of Henderson County, Kentucky, on March 12, 2007. By order of the Henderson District Court his Will was admitted to probate on May 19, 2007, in Case No. 07-P-00085, and filed of record in the aforesaid Clerk's Office in Will Book 35, page 737, with Mary Ann Sugg, the decedent's widow, appointed Executrix of the

Estate of Kenneth Wayne Sugg. Under Article IV of the aforesaid Will, Mary Ann Sugg was devised the subject property.

QLA ID: 8063

EXHIBIT B

Form of Special Warranty Deed

Mail Tax Bill in-care-of:

[Insert Name/Address of Grantee preferred contact for payment of taxes]

SPECIAL WARRANTY DEED

THIS SPECIAL WARRANTY DEED is made and entered into effective as of the ___ day of _____, 20__, by and between: (i) _____, a _____ limited liability company, whose address is _____ ("**Grantor**"), and (ii) _____, a _____ limited liability company, whose address is _____ ("**Grantee**").

W I T N E S S E T H:

That for and in consideration of the total sum of _____ (\$ _____), the receipt and sufficiency of which are hereby acknowledged, Grantor does hereby bargain, grant, sell and convey unto Grantee, in fee simple, with covenant of SPECIAL WARRANTY, certain real property, together with all improvements located thereon and all appurtenances thereunto belonging, situated in _____ County, Kentucky (the "**Property**"), more fully described on **Exhibit A**.

BEING the same property acquired by _____ by Deed dated _____, 20__, of record in Deed Book _____, Page _____, in the _____ County Clerk's office.

TO HAVE AND TO HOLD, in fee simple, all of the Property, together with all the rights, privileges, appurtenances and improvements thereunto belonging, unto Grantee, its successors and assigns, forever.

Grantor hereby specially covenants with Grantee, its successors and assigns, that Grantor will forever warrant and defend all of the Property so granted to Grantee, its successors and assigns, against every person lawfully claiming the same or any part thereof by, through or under Grantor, but not otherwise; and that the Property is free and clear of all taxes, liens and encumbrances, except (a) governmental laws, rules, regulations and restrictions affecting the Property, (b) the lien of current ad valorem taxes is not yet due and payable, and (c) all easements and restrictions of record.

As required by KRS 382.135, Grantor hereby certifies, and Grantee appears herein solely for the purpose of certifying, that the consideration stated above is correct.

IN TESTIMONY WHEREOF, witness the signatures of Grantor and Grantee effective as of the day, month and year first above written.

GRANTOR:

By: _____

Title: _____

COMMONWEALTH OF KENTUCKY)
COUNTY OF _____) SS
)

The foregoing instrument was acknowledged, subscribed and sworn to before me this _____ day of _____, 20__, by _____, acting in his/her capacity as _____ of _____, a _____ limited liability company, for and on behalf of said limited liability company.

My Commission expires: _____.

NOTARY PUBLIC

Notary ID #: _____

(SEAL)

GRANTEE:

By: _____

Title: _____

STATE OF _____)
) **SS**
COUNTY OF _____)

The foregoing instrument was acknowledged, subscribed and sworn to before me on _____, ____, 20__ by _____, by _____, acting in his/her capacity as _____ of _____, a _____ limited liability company, for and on behalf of said limited liability company, the Grantee.

[S E A L]

Notary Public, State of _____

My Commission Expires: _____

This instrument prepared by:

[Insert name, address and telephone number
of attorney; attorney must sign original]

ACCEPTANCE BY ESCROW AGENT

The undersigned Escrow Agent hereby acknowledges that on _____, [*insert year*] the undersigned received a fully executed duplicate original of the foregoing Real Estate Purchase Option Agreement between [*owner*], [*marital status or entity info*], as Seller and Boulevard Associates, LLC, a Delaware limited liability company, as Purchaser. Escrow Agent agrees to act as the Escrow Agent under this Agreement in accordance with the instructions provided therein, and to comply with these instructions. Escrow Agent has assigned Escrow Number _____ to the Property for that purpose.

By: _____
Name: _____
Title: _____
Date: _____

Kentucky

SOLAR LEASE AND EASEMENT AGREEMENT

1. **Parties.** This Solar Lease and Easement Agreement ("**Agreement**") is made and entered as of the 14 day of October, 2019 ("**Effective Date**"), by and between James M. Steinwachs, Sr. and Angie Steinwachs, husband and wife ("**Owner**") and Boulevard Associates, LLC, a Delaware limited liability company ("**Operator**"), which are sometimes individually referred to as a "**Party**" and collectively as the "**Parties**".

2. **Project.** This Agreement relates to the solar-powered electrical power generation and transmission project known as the "Sebree Energy Center" to be located in Henderson County, Kentucky ("**Project**"), which may be wholly or partially located on the Owner's property legally described on the attached **Exhibit A** to this Agreement ("**Owner's Property**"). Upon Operator's exercise of the Option (as defined below), the Project shall include (i) the Lease of Owner's Property described in Section 4, (ii) the Easements referenced in Section 5 that are located on the Owner's Property, and (iii) the Improvements referenced in Section 8 to be constructed on Owner's Property. The Lease, Easements and Improvements are sometimes collectively referred to as the "**Operator Property**".

3. **Option.** Owner grants to Operator an exclusive option ("**Option**") to acquire the Lease and Easements referenced in Sections 4 and 5 in accordance with the following terms and conditions. Operator shall be entitled to acquire the Lease and the Easements in their entirety or in part, as Operator deems appropriate.

3.1 **Option Term.** The period during which Operator may exercise the Option shall be for a term of five (5), commencing on the Effective Date ("**Option Term**").

3.2 **Option Payment.** As consideration for the granting of the Option, Operator agrees to pay Owner the Option Payment set forth in **Exhibit D**.

3.3 **Use of Owner's Property.** During the Option Term, Operator and its employees, agents and contractors shall have a right to enter upon the Owner's Property and the right of ingress and egress over and across the Owner's Property for the purposes of (i) surveying the Owner's Property; (ii) performing such other tests and studies as Operator may desire in connection with the Option, including, without limitation, environmental, avian and cultural resource assessments, and geotechnical, foundation and soil tests, provided that such activities do not unreasonably interfere with Owner's use of the Owner's Property; and (iii) installing, maintaining, operating, inspecting and removing one or more weather related instruments ("**Weather Instrument**") and fencing of said Weather Instrument and including the performance of all tests and studies associated therewith. Owner shall not permit any other individual or entity except Operator or its affiliates to install a Weather Instrument on Owner's Property.

3.4 **Right to Grant Option.** Owner warrants and represents to Operator that (i) the statements in Section 9 concerning Owner's title to the Owner's Property are true and correct; (ii) Owner has the authority to grant this Option to Operator without the consent or approval of any other party; and (iii) there are no other existing options, rights of first refusal, contracts to

purchase, leases or mortgages that would prevent Operator from exercising its rights with respect to the Option.

3.5 **Exercise of Option.** Operator may exercise the Option by giving written notice to Owner ("**Option Notice**") at any time during the Option Term. Operator shall specify in the Option Notice the Commencement Date referenced in Section 6.1.1. On the Commencement Date, the Lease and Easements referenced in Sections 4 and 5 shall automatically become effective, and the Parties shall be subject to all of the terms and conditions of this Agreement with respect to such Lease and Easements and all rights and obligations relating thereto.

3.6 **Termination of Option.** If Operator fails to exercise the Option within the Option Term, the Option and the rights of Operator as the optionee shall automatically terminate.

4. **Lease.** Upon exercise of the Option by Operator, Owner leases to Operator, and Operator leases from Owner, Owner's Property for the Lease and Easement Term (defined in Section 6.1) in accordance with the terms and conditions of this Agreement ("**Lease**"), which Lease grants Operator and its agents, contractors, and employees the right to use the Owner's Property for the following permitted uses:

4.1 **Construction Right.** Operator leases Owner's Property for the purpose of constructing, operating, maintaining, repairing, replacing, and removing all or any part or component of the Improvements whether located on Owner's Property. Operator may exercise its right to use all or any part of the Owner's Property as and when Operator deems it necessary or advisable to do so to perform the activities for which this right is granted, including, without limitation, staging areas and parking for Operator's employees.

4.2 **Access Right.** Operator leases Owner's Property for unobstructed vehicular and pedestrian access and ingress to and egress from the Improvements, Owner's Property and any public roadways, and to construct, maintain, and utilize Roadway Improvements on the Owner's Property. Owner shall not permit others to obstruct or damage the roads or Roadway Improvements located on the Owner's Property or in any other way interfere with Operator's rights under this right. Operator shall repair any damage done to Roadway Improvements which result from use by Operator, its agents, servants or employees. Such roads shall be maintained in the condition necessary for use by Operator's equipment, and with regard to existing roads, shall be maintained in at least the condition that existed prior to Operator's use.

4.3 **Solar Panels Right.** Operator leases Owner's Property for Operator to construct, operate, replace, relocate, remove, and maintain Solar Panels and the appurtenant Collection Facilities, together with associated roads and parking areas on Owner's Property.

4.4 **Collection Facilities Right.** Operator leases Owner's Property for Operator to construct, operate, maintain, replace, relocate or remove Collection Facilities on and under the Owner's Property.

4.5 **Substation Right.** Operator leases Owner's Property for Operator to construct, operate, maintain, replace, relocate or remove one or more Substations on Owner's Property.

4.6 **Telecommunication Right.** Operator leases Owner's Property for Operator to construct, operate, maintain, replace, relocate or remove Telecommunication Facilities on and under the Owner's Property.

4.7 **Weather Instrument Right.** Operator leases Owner's Property in order to construct, operate, replace, relocate, remove, and maintain a Weather Instrument and the appurtenant Collection Facilities on Owner's Property.

4.8 **Battery Facilities Right.** Operator leases Owner's Property in order to construct, operate, replace, relocate, remove, and maintain one or more Battery Facilities on Owner's Property.

5. **Grant of Easements.** Upon the exercise of the Option by Operator, Owner grants to Operator, and Operator accepts from Owner, for the Lease and Easement Term referenced in Section 6.1, the following easements over and across the Owner's Property in accordance with the terms and conditions of this Agreement. The following easements are for the benefit of Operator and Operator's agents, contractors and employees and located on the Owner's Property and are collectively referred to as the "**Easements**".

5.1 **Sun Non-Obstruction Easement.** Owner grants Operator an irrevocable, exclusive easement for the right and privilege to use, maintain and capture the free and unobstructed sunlight over and across the Owner's Property. Owner shall not engage in any activity on Owner's Property or any other neighboring property owned by Owner that might interfere with the sunlight direction over any portion of Owner's Property; cause a decrease in the output or efficiency of any Solar Panel or Weather Instrument; or otherwise interfere with Operator's operation of the Project or exercise of any rights granted in this Agreement (collectively "**Interference**"). This grant of the easement expressly includes the right of Operator to enforce Operator's rights, including the physical removal of trees or structures (except existing trees and structures) causing Interference to the Project contemplated by Operator. Operator shall notify Owner before making any such removals.

5.2 **Effects Easement.** Owner grants to Operator an easement over Owner's Property for visual, view, light, flicker, noise, shadow, vibration, electromagnetic, electrical and radio frequency interference, and any other effects attributable to the Project located on the Owner's Property.

6. **Term.** The term of this Agreement ("**Term**") includes the Option Term referenced in Section 3.1, the Initial Lease and Easement Term as described in Section 6.1.1 and the Extended Lease and Easement Term as described in Section 6.1.2 (together, the Initial Lease and Easement Term and the Extended Lease and Easement Term, if applicable, is defined as the "**Lease and Easement Term**").

6.1 **Lease and Easement Term.**

6.1.1 **Initial Lease and Easement Term.** The initial term of the Lease and Easements shall commence on the date specified by Operator in the Option Notice ("**Commencement Date**"). The initial term of the Lease and Easements shall end thirty (30)

years after the Commencement Date (the "**Initial Lease and Easement Term**"), subject to the rights of renewal and termination as provided in this Agreement.

6.1.2 **Extended Lease and Easement Term.** Operator shall have the right to extend the Term of this Agreement for two (2) consecutive terms of five (5) years each in accordance with the terms and provisions of this Agreement (collectively "**Extended Lease and Easement Term**") by providing written notice to Owner of Operator's intent to extend the Term within one hundred eighty (180) days of the end of the existing Term. Each Extended Lease and Easement Term shall begin on the expiration date of the Initial Lease and Easement Term or previous Extended Lease and Easement Term, as the case may be. During the Extended Lease and Easement Term, Operator shall pay Owner the amounts set forth in **Exhibit D** as the consideration for the Lease and Easements.

6.1.3 **Delays During Lease and Easement Term.** At Operator's option, the Term may be extended for a period of time equal to the period of time during which operation of the Project is delayed or suspended because of the occurrence of a Regulatory Suspension or Force Majeure, which are defined as follows:

(i) "**Regulatory Suspension**" shall mean the enactment or application of any law, order, rule, or regulation of the Kentucky Public Service Commission, Federal Energy Regulatory Commission, or other local, state, or federal government authority having jurisdiction over the Project or Operator, or the failure of any such governmental authority to issue an approval or permit pursuant to any such law, order, rule, or regulation, which results in the delay, interruption, or suspension of the production, sale or transmission of electricity from the Solar Panels; and

(ii) "**Force Majeure**" shall mean causes beyond the reasonable control of and without the fault or negligence of the Party claiming Force Majeure, including but not limited to acts of God, labor unrest (including, but not limited to, slowdowns, picketing, boycotts or strikes), flood, earthquake, storm, fire, lightning, explosion, power failure or power surge, vandalism, theft, the cutting of power, transmission or other lines, wires or cables to the Project by persons other than Operator's employees or contractors, epidemic, war, revolution, riot, civil disturbance, sabotage, change in law or applicable regulation subsequent to the Commencement Date and action or inaction by any federal, state or local legislative, executive, administrative judicial agency or body which in any of the foregoing cases, by exercise of due foresight such Party could not reasonably have expected to avoid, and which, by the exercise of due diligence, it is unable to overcome.

The Parties shall be excused from performing their respective obligations under this Agreement and shall not be liable in damages or otherwise if and to the extent that they are unable to so perform or are prevented from performing by a Force Majeure, provided that: (i) the non-performing Party, as promptly as practicable after the occurrence of the Force Majeure, but in no event later than thirty (30) days thereafter, gives the other Party written notice describing the particulars of the occurrence; (ii) the suspension of performance is of no greater scope and of no longer duration than is reasonably required by the Force Majeure; (iii) the non-performing Party uses good faith and commercially reasonable efforts to remedy its inability to perform; and (iv) as soon as the non-performing Party is able to resume performance of its obligations excused as a

result of the occurrence, each Party shall give prompt written notification thereof to the other Party.

6.2 **Termination by Operator.** Provided Operator is not in default under any term of this Agreement, Operator, at its option, shall have the right to terminate this Agreement at any time during the Term of the Agreement, as to all or any part of the Operator Property. Termination shall be effective thirty (30) days after written notice of such termination to Owner. If Operator's notice is a full termination of the Operator Property, the Parties shall be relieved of all further duties and obligations under this Agreement, other than (i) the payment of any accrued and unpaid obligations owed by either Party as of the date of termination; (ii) the removal of the Improvements by Operator pursuant to Section 8.11; and (iii) any other obligations and liabilities that are expressly stated in this Agreement to survive such termination. Upon any such partial termination by Operator, the Parties shall be relieved of all further duties and obligations under this Agreement with respect to the portion thereof terminated by Operator, subject to the obligations and liabilities referenced in items (i) through (iii) above that shall continue to be applicable to the terminated portion of this Agreement. The Parties agree to execute an amendment to this Agreement evidencing such partial termination.

7. **Payments.** If Operator exercises the Option referenced in Section 3, Operator agrees to pay Owner the amounts set forth in **Exhibit D** as consideration for the Lease, Easements and Operator's other rights and interests in the Owner's Property.

8. **Improvements.** Operator shall have the right, at its sole cost and expense, to construct, install, maintain, use, operate, repair, replace, relocate and remove all facilities, structures, equipment, machinery, wires, conduit, cables, poles, materials and property of every kind and character required for the construction and operation of portions of the Project on the Owner's Property, including, but not limited to, the Solar Panels, Collection Facilities, Substations, Telecommunication Facilities, Weather Instruments, Roadway Improvements and Battery Facilities referenced in Sections 8.1 through 8.7 (collectively, the "**Improvements**").

8.1 **"Solar Panels"** shall mean any photovoltaic energy system designed for the generation of electrical power from the collection of sunlight, including without limitation, the photovoltaic panels, foundations, support structures, braces and related equipment.

8.2 **"Collection Facilities"** shall mean all Improvements whose purpose is to deliver electrical power generated by the Solar Panels to an electrical power grid or other system, including without limitation transformers, overhead and underground electrical collection lines, telecommunication lines, splice boxes and interconnection facilities.

8.3 **"Substations"** shall mean electrical lines, meters, monitoring and control equipment, switches, transformers, all structures, equipment, enclosures, fencing, security devices, and other electrical and communications equipment necessary to condition and increase the voltage of electricity generated by the Project to make it suitable for transmission on, and to deliver it to, Collection Facilities connected to an electric power grid or other system.

8.4 **"Telecommunication Facilities"** shall mean all Improvements whose purpose is to provide telecommunication services solely relating to the Project or any of Operator's solar

powered projects, including telephone, closed-circuit television, microwave, internet, computer data and other telecommunication services.

8.5 "**Weather Instrument**" shall mean instruments used primarily to gather and transmit sunlight and meteorological data relating to the Project, and includes the instrument's foundations, guy wires, sunlight and meteorological data acquisition equipment, power source, and any required data and electrical transmission lines.

8.6 "**Roadway Improvements**" shall mean all improvements that may be necessary to construct, maintain and repair any new and existing roadways and other means of ingress and egress over, across and along the Owner's Property, including paving or surfacing of the roadways with asphalt, gravel or other roadway materials, installation of road signs and the construction and installation of culverts, bridges, drainage ditches, gates, cattle guards and similar structures and facilities.

8.7 "**Battery Facilities**" shall mean a type of equipment that can be given a new charge by passing an electric current through it designed for the storage of electrical power including without limitation, batteries and other devices for storage of electrical energy, foundations, support structures, braces and related equipment.

8.8 "**Ownership of Improvements**. Except as otherwise provided in Section 11.7, all Improvements shall at all times remain the property of Operator, and Owner shall have no right, title or interest therein. All Improvements constructed or placed on the Owner's Property by Operator during the Term of this Agreement may be repaired, replaced, relocated, removed, added to or expanded upon by Operator at any time during the Term of this Agreement. Owner expressly waives any statutory lien or common law liens on the Improvements to which Owner might be entitled.

8.9 "**Construction Liens**. Operator shall not permit any liens arising out of Operator's use of the Operator Property under this Agreement to be filed against the Owner's Property. Operator shall, within sixty (60) days after it receives notice of the lien, provide a bond or other security that Owner may reasonably request, or remove such lien from the Owner's Property in the manner provided by applicable law.

8.10 "**Location of Improvements**. The acreage required from the Owner's Property for the Improvements for which the Lease and Easements are being granted cannot be determined until the completion of Operator's inspection, testing, study and surveying of the Owner's Property during the Option Term. Along with the Option Notice, Operator shall deliver to Owner a proposed plan of development showing the contemplated locations of the Improvements and a preliminary calculation of the acreage as determined by the area bounded by a perimeter fence required for the Project, which shall serve as the **Exhibit B** to this Agreement. During the final development and construction of the Project, such locations may need to be amended. Following construction of the Project, Operator shall provide Owner an "as-built" survey of all Improvements on Owner's Property and the final calculation of the acreage as determined by the area bounded by a perimeter fence required for the Project, which shall serve as **Exhibit C** to this Agreement. Further, following construction, the Improvements may need to be relocated or rerouted by Operator, which Operator may perform, at any time during the Term of this

Agreement, so long as the nature and extent of any such relocated or rerouted Improvements are not materially different and impose no materially greater burden on the Owner's Property than the original locations or routes, and so long as Operator takes commercially reasonable efforts to minimize disruption or inconvenience to Owner.

8.11 **Removal of Improvements.** Upon full or partial termination of any of the Lease Rights or Easements, Operator shall remove all Improvements and restore the area formerly occupied by the Improvements to substantially the same physical condition that existed immediately before the construction of the Improvements (the "**Removal Obligations**"). At Owner's request, all or any part of the Roadway Improvements may be left for use by Owner.

9. **Ownership and Title Matters.** Owner warrants and represents to Operator, both as of the Effective Date, and as of the Commencement Date as follows:

9.1 **Authority.** Owner represents and warrants that it is the holder of fee simple title and is the sole owner of the Owner's Property and has the unrestricted right and authority to sign this Agreement and to grant Operator the Lease and Easements and other rights granted in this Agreement. When signed by both Parties, this Agreement constitutes a valid and binding agreement enforceable against Owner in accordance with its terms.

9.2 **Other Agreements.** The Owner's Property is not subject to any other agreements, options, rights of first refusal or other prior right of any party to purchase, lease or acquire easements in the Owner's Property, or create any prior claim or right that would preclude or interfere with Operator's rights and interests under this Agreement and the Lease and Easements.

9.3 **Minerals.** Except as disclosed by Owner to Operator at the time of the execution of this Agreement by Owner, Owner owns all of the oil, gas and other minerals, and all rights thereto as on or under the Owner's Property.

9.4 **Owner Mortgage.** Except as disclosed by Owner to Operator at the time of the execution of this Agreement by Owner, there are no mortgages encumbering the Owner's Property ("**Owner Mortgage**").

9.5 **Notice and Opportunity to Cure.** If there is an Owner Mortgage encumbering Owner's Property and Owner receives from the holder thereof any notice that payments are overdue, Owner shall notify Operator and each Operator Mortgagee (as defined at Section 13.1) by sending a copy of such overdue payment notice to Operator by the earlier of (i) five (5) days after receipt, or (ii) three (3) business days prior to the date by which a default under or in respect of such Owner Mortgage could occur. If Operator or any Operator Mortgagee determines that it would be in Operator's interest to make such payments to Owner Mortgagee on Owner's behalf, whether as a result of receiving such notice or otherwise, Operator shall have the right to make such payments and to credit the payments so made against the Annual Installment Payment next due under the Agreement.

9.6 **Subordination, Non-Disturbance & Attornment Agreement.** If there is an Owner Mortgage encumbering Owner's Property, Owner shall cooperate with Operator to obtain

a Subordination, Non-Disturbance and Attornment Agreement ("SNDA") in the form prepared and provided by Operator, from each Owner Mortgagee, pursuant to which such Owner Mortgagee agrees, among other things, not to disturb Operator's possession and use of the Owner's Property. Owner shall not incur any loss in income, expense, obligation or liability with regard to the SNDA. Operator shall, at its sole cost and expense, record each such SNDA in the Office of the County Clerk in which Owner's Property is located. If Owner fails to deliver a SNDA from each Owner Mortgagee, Operator may, at its sole option, either (i) terminate this Agreement immediately upon written notice to Owner, or (ii) take such action as Operator deems reasonably necessary to effect the rights granted to Operator hereunder, and off-set all amounts expended in such efforts against the Annual Installment Payments and any other amounts due hereunder or in respect hereof.

10. **Representations and Warranties of Owner.** Owner hereby makes the following further representations and warranties both as of the Effective Date, and as of the Commencement Date:

10.1 **Physical Condition.** Owner has no knowledge of any existing physical conditions of the Owner's Property which would prevent, significantly restrict or make more expensive Operator's development of the Owner's Property for the purposes specified in this Agreement, or which could, with the passage of time, or the giving of notice, constitute a violation of any currently applicable governmental law, ordinance, order, rule or regulation.

10.2 **Legal Restrictions.** Owner has no knowledge of any law, regulation, ordinance or order of any local, state or federal governmental authority which would prohibit or significantly restrict Operator's development of the Owner's Property pursuant to this Agreement. This Agreement does not violate any contract, agreement, instrument, judgment or order to which Owner is a party or which affects the Owner's Property. To the best of Owner's knowledge, the Owner's Property is currently in full and complete compliance with all governmental laws, ordinances, orders, rules and regulations applicable to the Owner's Property.

10.3 **No Litigation.** No litigation is pending and, to the best of Owner's knowledge, no litigation or administrative actions are proposed, threatened or anticipated with respect to any matter affecting the Owner's Property. If Owner learns of any litigation or administrative action proposed, threatened or instituted with respect to the Owner's Property, Owner shall give Operator notice within thirty (30) days thereof.

10.4 **Survival.** The representations and warranties set forth in this Section 10 shall survive the execution and delivery hereof.

11. **Use, Operation and Maintenance.**

11.1 **Exclusive Use by Operator.** Operator shall have the exclusive right (i) to use and possess the Owner Property in connection with the Project and other similar solar-powered electrical power generation projects; (ii) to investigate, inspect, survey, and conduct tests of the Owner's Property, including, but not limited to, meteorological, environmental, archeological and geotechnical tests and studies; (iii) to use and convert all of the sunlight resources on the Owner's Property; and (iv) to undertake such other activities on the Owner's Property that may be related to the Project, including, without limitation, the storage of Solar Panels, materials and

equipment during the installation and construction of the Improvements; development and operation of communications systems; and site tours of the Project for visitors and other interested parties.

11.2 **No Required Installation or Operation.** Nothing in this Agreement shall be interpreted as imposing on Operator any obligation to install Solar Panels or other Improvements on the Owner's Property, or to operate the Project on the Owner's Property. Operator shall have the sole discretion to determine if and when any Solar Panels and other Improvements may be constructed on Owner's Property, and if and when to commence the operation of the Project on the Owner's Property.

11.3 **Permits and Approvals.** Operator shall be responsible, at its sole cost and expense, for obtaining any governmental permits and approvals necessary for the construction and operation of the Project and the construction and operation of the Improvements. Owner shall cooperate with Operator as necessary to obtain any governmental or utility approvals or permits, including, without limitation, signing any applications for such approvals, provided that Owner shall not incur any loss in income, expense, obligation or liability with respect to Operator obtaining such permits or approvals.

11.4 **Compliance with Laws.** Operator shall comply in all material respects with valid laws applicable to the Owner's Property and the Operator Property. Operator shall have the right, in its sole discretion and at its sole expense, in Operator's name to contest the validity or applicability to the Owner's Property and the Operator Property of any law, ordinance, statute, order, regulation, property assessment or the like made by any governmental agency or entity. Operator shall control any such contest and Owner shall cooperate with Operator in every reasonable way in such contest, provided that Owner shall incur no expense, obligation or liability with regard to such contest.

11.5 **Care and Appearance.** Operator, in its exercise of the lease, easement and other rights granted hereunder shall, at all times, maintain the Owner's Property and the Improvements in a reasonably neat, clean and presentable condition. Operator shall not willfully or negligently damage or destroy the Owner's Property and shall keep the Owner's Property clean and free of debris created by Operator, its contractors, or others brought on to the Owner's Property by Operator. Operator shall not use the Owner's Property for storage, except for materials, construction equipment and vehicles directly associated with construction or maintenance of the Improvements on the Owner's Property or adjacent properties that are part of the Project.

11.6 **Fences and Gates.** At Owner's request, Operator shall repair or replace any fences, gates or cattle guards damaged or removed in connection with Operator's activities on the Owner's Property. Fences removed from the Owner's Property, if replaced, shall be re-built by Operator at its expense in mutually agreeable locations. All fence repair and construction shall be substantially similar to the construction of existing fences and cattle guards on Owner's Property. Any gates opened for access to Owner's Property by either Party shall be closed immediately after passing through so that livestock may not pass through. Once completed, all replacement fences, gates and cattle guards shall be owned and maintained by Owner. Upon abandonment or termination of the rights granted to Operator in this Agreement, any fences, gates and cattle guards installed by Operator shall remain and become the property of Owner.

To minimize the need for temporary fencing, Owner will cooperate with Operator to avoid pasturing animals on or near the Improvements during periods of construction, maintenance or removal activity by Operator. Owner will discuss with Operator what temporary fencing is necessary during the periods of construction, maintenance or removal activity by Operator.

11.7 **Roadway Maintenance and Repairs.** Operator agrees to maintain and repair all Roadway Improvements located on the Operator Property; provided, however, Owner shall reimburse Operator for any costs and expenses incurred by Operator to repair any damage or perform any special maintenance of the Roadway Improvements caused by Owner or any person using the Roadway Improvements with Owner's permission, other than Operator.

12. **Taxes.**

12.1 **Owner's Taxes.** Owner covenants and agrees to pay prior to delinquency all real and personal property and other taxes, general and special assessments, and other charges of every description ("Taxes") levied or assessed against the Owner's Property and all improvements thereon by governmental authorities, other than Operator's Taxes referenced in Section 12.2 (Taxes, excepting Operator's Taxes, are hereinafter referred to as "**Owner's Taxes**").

12.2 **Operator's Taxes.**



12.3 **Failure to Pay.** In the event either Party fails to pay their share of Taxes prior to delinquency, the other Party shall have the right to pay such Taxes and any accrued penalties or interest, which payments shall increase or be offset against other Payments due under this Agreement.

12.4 **Operator's Right to Contest.** Operator may contest the legal validity or amount of any Operator's Taxes for which it is responsible under this Agreement, and may institute such proceedings as it considers necessary, provided that Operator shall bear all expenses in pursuing such contest or proceeding. With respect to any Taxes which may constitute a lien on the Owner's Property, Operator shall promptly pay such Taxes unless the proceeding in which it

contests such Taxes shall operate to prevent or stay the collection of the Taxes so contested or unless Operator removes any such lien by bonding or otherwise. Owner agrees to render to Operator all reasonable assistance in contesting the validity or amount of any such Taxes, with the exception of Taxes levied by Owner, including joining in the signing of any reasonable protests or pleading which Operator may deem advisable to file; provided, however, that Operator shall reimburse Owner for its reasonable out-of-pocket expenses, including reasonable attorneys' fees incurred in connection with providing such assistance.

13. **Mortgage of Operator Property.**

13.1 **Right to Mortgage.** Operator may, upon written notice to Owner, but without requiring Owner's consent or approval, mortgage, collaterally assign, or otherwise encumber and grant security interests in all or any part of its interest in this Agreement and the Operator Property. These various security interests in all or a part of this Agreement and the Operator Property are collectively referred to as an "**Operator Mortgage**" and holder of such security interest, an "**Operator Mortgagee**". Any Operator Mortgagee shall use the Operator Property only for the uses permitted under this Agreement. Whenever Operator has granted a security interest under this Section 13, it will give Owner notice of the Operator Mortgage (including the name and address of the Operator Mortgagee for notice purposes) to Owner within thirty (30) days; provided that failure to give this notice shall not constitute a default under this Agreement, but rather shall only have the effect of not binding Owner to provide such Operator Mortgage notice until the Operator and its address is given to Owner.

13.2 **Notice of Default and Opportunity to Cure.** As a precondition to exercising any rights or remedies related to any alleged default by Operator under this Agreement, Owner shall give written notice of the default to each Operator Mortgagee at the same time it delivers notice of default to Operator, specifying in detail the alleged event of default and the required remedy. Each Operator Mortgagee or its designee shall have the right, but not the obligation, to cure any default as Operator, and/or the right, but not the obligation, to remove any Improvements or other property owned by Operator or such Operator Mortgagee located on the Owner's Property to the same extent as Operator. The cure period for any Operator Mortgagee shall be the later of (i) the end of the Operator cure period under Section 18; (ii) thirty (30) days after such Operator Mortgagee's receipt of the default notice; or (iii) if applicable, the extended cure period provided for in Section 13.3. Failure by Owner to give an Operator Mortgagee notice of default shall not diminish Owner's rights against Operator, but shall preserve all rights of the Operator Mortgagee or its designee to cure any default and to remove any Improvements or other property of Operator or the Operator Mortgagee located on the Owner's Property.

13.3 **Extended Cure Period.** If any default by Operator under this Agreement cannot be cured without the Operator Mortgagee obtaining possession of all or part of the Operator Property, then any such default shall be deemed remedied if an Operator Mortgagee: (i) within sixty (60) days after receiving notice from Owner as set forth in Section 13.2, acquires possession of all or part of the Operator Property, or begins appropriate judicial or nonjudicial proceedings to obtain the same; (ii) diligently prosecutes any such proceedings to completion; and (iii) after gaining possession of all or part of the Operator Property performs all other obligations as and when the same are due in accordance with the terms of this Agreement. If an Operator Mortgagee is prohibited by any court or by operation of any bankruptcy or insolvency

laws from commencing or prosecuting the proceedings described above, the sixty (60) day period specified above for commencing proceedings shall be extended for the period of such prohibition.

13.4 **Operator Mortgagee Liability.** Any Operator Mortgagee whose interest in the Operator Property is held solely for security purposes, shall have no obligation or liability under this Agreement unless and until the Operator Mortgagee succeeds to absolute title to the Operator Property and the rights of Operator under this Agreement. An Operator Mortgagee shall be liable to perform obligations under this Agreement only for and during the period it directly holds such absolute title.

13.5 **Certificates.** Owner shall execute any estoppel certificates (certifying as to truthful matters, including without limitation that no default then exists under this Agreement, if such be the case), consents to assignment and non-disturbance agreements as Operator or any Mortgagee may reasonably request from time to time. The Parties shall negotiate in good faith any amendment to this Agreement from time to time to include any provision that may be reasonably requested by Operator or any Operator Mortgagee to implement the provisions contained in this Agreement or to preserve an Operator Mortgagee's security interest.

13.6 **Operator Mortgagee's Right to Enforce Mortgage and Assign.** Each Operator Mortgagee shall have the right, in its sole discretion: (i) to assign its Operator Mortgage; (ii) to enforce its lien and acquire title to all or any portion of the Operator Property by any lawful means; (iii) to take possession of and operate all or any portion of the Operator Property and to perform all obligations to be performed by Operator under this Agreement, or to cause a receiver to be appointed to do so; and (iv) to acquire all or any portion of the Operator Property by foreclosure or by an assignment in lieu of foreclosure and thereafter to assign or transfer all or any portion of the Operator rights under this Agreement to a third party in accordance with Section 14. Any Operator Mortgagee or other party who acquires Operator's interest in all or a portion of the Operator Property pursuant to foreclosure or assignment in lieu of foreclosure shall not be liable to perform the obligations imposed on Operator by this Agreement, which are incurred or accruing after such Operator Mortgagee or other party no longer has ownership or possession of the Operator Property.

13.7 **New Agreement.**

13.7.1 If the Operator Property is foreclosed upon or there is an assignment in lieu of foreclosure, or if this Agreement is rejected or disaffirmed pursuant to bankruptcy law or other law affecting creditor's rights and, within ninety (90) days after such event, Operator or any Operator Mortgagee or other purchaser at a foreclosure sale shall have arranged to the reasonable satisfaction of Owner to cure any material defaults under this Agreement, and for the payment of all Annual Installment Payments or other charges due and payable by Operator as of the date of such event, then Owner shall execute and deliver to Operator or such Operator Mortgagee or other purchaser at a foreclosure sale, or to a designee of one of these parties, as the case may be, a new agreement ("**New Agreement**") which (i) shall be for a term equal to the remainder of the Term of this Agreement before giving effect to such rejection or termination; (ii) shall contain the same covenants, agreements, terms, provisions and limitations as this Agreement (except for any requirements that have been fulfilled by Operator or any Operator

Mortgagee or other purchaser at a foreclosure sale prior to rejection or termination of this Agreement); and (iii) shall include that portion of the Operator Property in which Operator or such other Operator Mortgagee or other purchaser at a foreclosure sale had an interest on the date of rejection or termination.

13.7.2 If more than one Operator Mortgagee makes a written request for a New Agreement pursuant to this provision, the New Agreement shall be delivered to the Operator Mortgagee requesting such New Agreement whose Operator Mortgage is prior in time, and the written request of any other Operator Mortgagee whose lien is subordinate shall be void and of no further force or effect. The provisions of this Section 13 shall survive the termination, rejection or disaffirmation of this Agreement and shall continue in full force and effect thereafter to the same extent as if this Section 13 were a separate and independent contract made by Owner, Operator and each Operator Mortgagee, and, from the effective date of such termination, rejection or disaffirmation of this Agreement to the date of execution and delivery of such New Agreement, such Operator Mortgagee or other purchaser at a foreclosure sale may use and enjoy the Operator Property without hindrance by Owner or any person claiming by, through or under Owner; provided that all of the conditions for the New Agreement as set forth above are complied with.

13.8 **Operator Mortgagee's Consent to Amendment, Termination or Surrender.** Notwithstanding any provision of this Agreement to the contrary, the Parties agree that so long as any Operator Mortgage remains outstanding, this Agreement shall not be modified or amended, and Owner shall not accept a surrender, cancellation or release of all or any part of the Operator Property from Operator, prior to expiration of the Term of this Agreement, without the prior written consent of the Operator Mortgagee holding such Operator Mortgage. This provision is for the express benefit of and shall be enforceable by each Operator Mortgagee as if it were a party named in this Agreement.

14. **Assignment and Sublease.** Operator shall have the right, without Owner's consent, to sell, convey, lease, or assign all or any portion of this Agreement or the Operator Property, on either an exclusive or a non-exclusive basis, or to grant subeasements, co-easements, easements, licenses or similar rights with respect to the Operator Property (collectively, "Assignment"), to one or more persons or entities (collectively "Assignee"). Each Assignee shall use the Operator Property only for the uses permitted under this Agreement. When Operator makes any Assignment under this Section 14, Operator shall give written notice to Owner of such Assignment (including the interest conveyed by the Assignment and address of the Assignee for notice purposes) to Owner; provided Operator's failure to give such notice shall not constitute a default under this Agreement, but rather shall only have the effect of not binding Owner with respect to such assignment or conveyance until such notice is given. Any Assignment by Operator shall release Operator from obligations subject thereof accruing after the date that liability for such obligations is assumed by the Assignee.

15. **Hazardous Materials.**

15.1 **Owner's Covenants Regarding Hazardous Materials.** Owner represents and warrants that, to the best of Owner's knowledge, the Owner's Property is not and has not been in violation of any federal, state or local environmental health or safety laws, statute, ordinance,

rule, regulation or requirement ("**Environmental Laws**"), and Owner has not received any notice or other communication from any governmental authorities alleging that the Owner's Property is in violation of any Environmental Laws. "**Hazardous Materials**" shall mean any asbestos containing materials, petroleum, explosives, toxic materials, or substances regulated as hazardous wastes, hazardous materials, hazardous substances, or toxic substances under any federal, state, or local law or regulation. Owner warrants that Owner has done nothing to contaminate the Operator Property with Hazardous Materials or wastes.

15.2 **Operator's Covenants Regarding Hazardous Materials.** Operator shall, at Operator's sole cost and expense, promptly take removal or remedial action required by Environmental Law with regard to any material violation of any Environmental Law with regard to any Hazardous Materials brought onto the Owner's Property by Operator or its employees, agents, or contractors. Owner shall cooperate with Operator with regard to any scheduling or access to the Owner's Property in connection with any action required hereunder.

15.3 **Operator's Indemnity Regarding Hazardous Materials.** Operator shall indemnify, defend, protect and hold Owner harmless from any liability based on: (i) the release of Hazardous Materials in, on, under or about the Owner's Property caused by Operator or its employees, agents, or contractors, or (ii) the violation by Operator or its employees, agents, or contractors of any Environmental Law. The indemnity obligations set forth herein shall survive termination of this Agreement.

16. **Insurance and Indemnity.**

16.1 **Insurance.** At all times during which Operator is conducting any activities on the Property and at all times during the Term of this Agreement, Operator shall maintain in effect (1) commercial General Liability Insurance, including bodily injury and property damage coverage with minimum limits of \$1 Million Dollars per occurrence and \$2 Million Dollars aggregate and (2) Umbrella Liability Insurance with minimum limits of \$5 Million Dollars per occurrence and \$5 Million Dollars aggregate. Upon a written request by Owner, Operator shall name Owner as additional insured on such insurance policy and provide Owner with a certificate of such insurance.

16.2 **Indemnity by Operator.** Operator shall defend, indemnify, protect and hold Owner harmless from and against all liabilities, costs, expenses, obligations, losses, damages, claims, (collectively "**Claims**") resulting from the negligence, willful misconduct, or breach of this Agreement by Operator, its agents, contractors or employees, invitees, licensees and permittees; provided, however, that such Claims are not due to the sole negligence, willful misconduct, or breach by Owner, its agents, contractors or employees, invitees, licensees or permittees.

16.3 **Indemnity by Owner.** Owner shall defend, indemnify, protect, and hold Operator harmless from and against all Claims resulting from the negligence, willful misconduct, or breach of this Agreement by Owner, its agents, contractors or employees, invitees, licensees and permittees; provided, however, that such Claims are not due to the sole negligence, willful misconduct, or breach by Operator, its agents, contractors, employees, invitees, licensees, or permittees.

16.4 **Survival.** The obligations of the Parties under this Section 16 shall survive expiration or other termination of this Agreement.

17. **Confidentiality.** This Agreement includes confidential and proprietary information relating to Operator and the Project. Owner agrees not to provide copies of the Agreement or disclose the terms of the Agreement to any unauthorized person or entity. Operator authorizes Owner to provide copies of the Agreement and disclose the terms thereof to Owner's family ("family" shall be deemed to include all devisees or descendants of owner by will or intestacy), attorney, accountant, financial advisor and any existing or prospective mortgagee, lessee, or purchaser for the sole purpose of evaluating and advising Owner and for no other purpose, so long as such authorized parties agree in writing to become subject to the confidentiality provisions hereto and not to provide copies of the Agreement or disclose the terms thereof to any unauthorized person or entity. Any Owner and party shall return all material containing any confidential information to Operator immediately upon its request. Any party agrees to destroy immediately upon request by Operator such analyses, compilation, studies or other documents, and any oral information will continue to be subject to the terms of this Agreement. Owner agrees that Operator will have no adequate remedy at law if any party violates any of the terms of this Agreement. In such event Operator will have the right, in addition to any other rights Operator may have, to obtain injunctive relief to restrain any breach or threatened breach by third party or specific enforcement of such terms plus reimbursement of attorneys' fees, court costs and all associated expenses. No party shall publish, file for public record, reproduce, or otherwise disseminate this document or any of the terms and provisions hereof to any party, other than the Parties set forth above without the prior written consent of Operator, which consent may be withheld for any reason and in Operator's sole discretion.

18. **Default and Remedies.**

18.1 **Operator Payment Default.**

18.1.1 **Collection of Payments.**

18.1.2 **Terminate Agreement.**

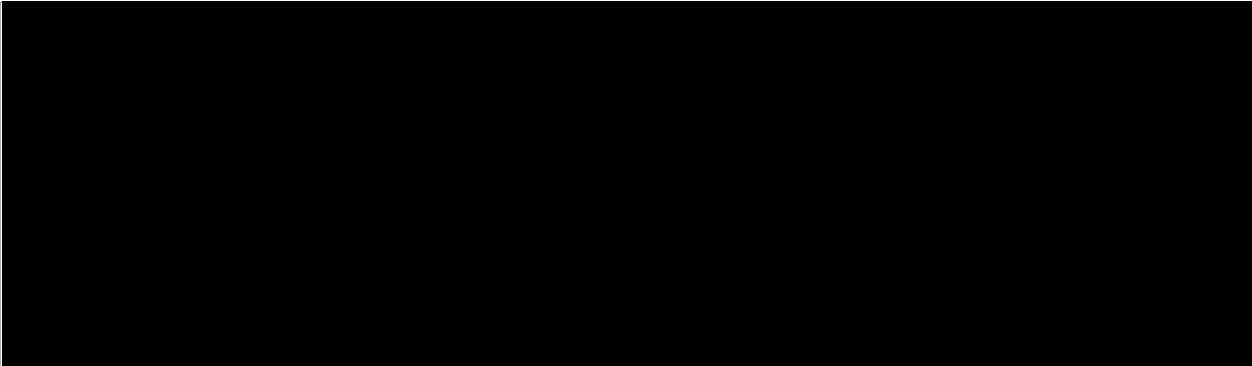

18.2 Other Operator Default

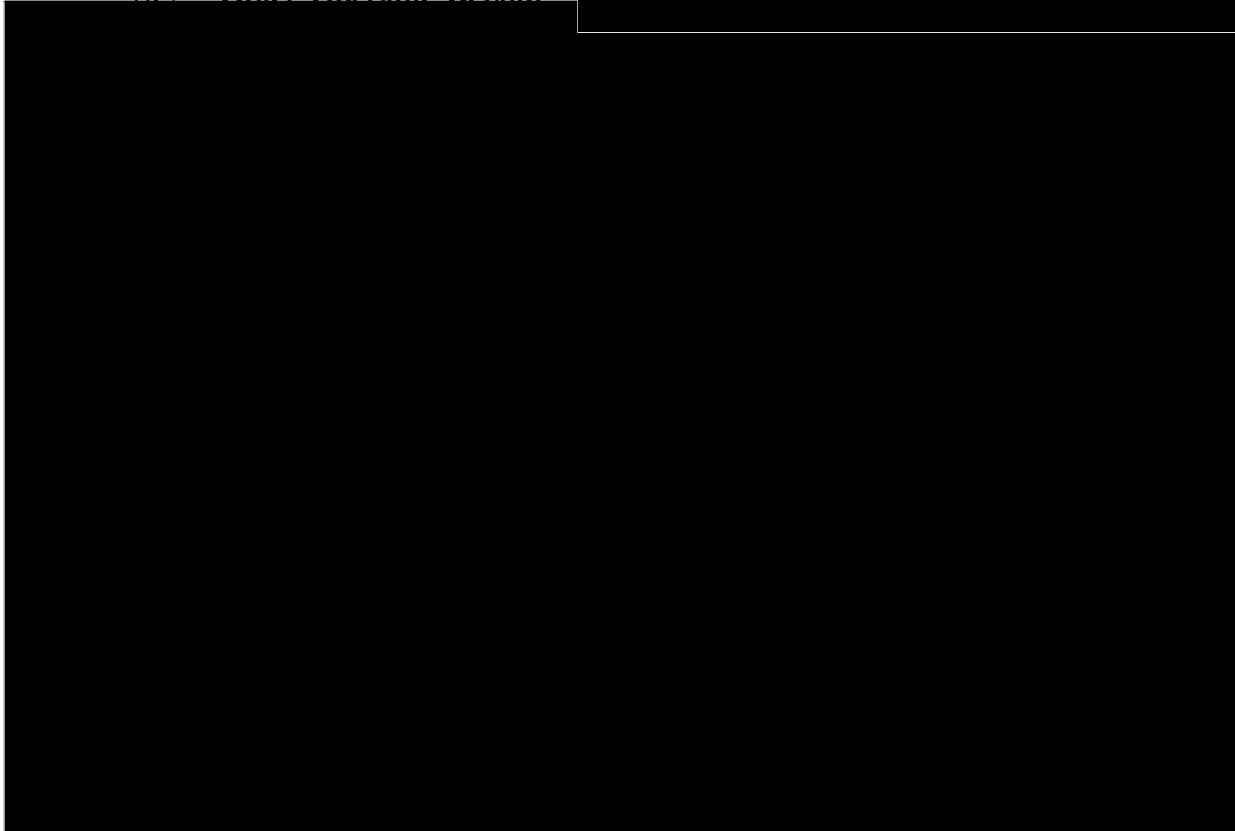
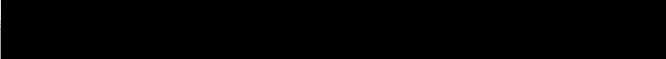

18.3 Owner Default.

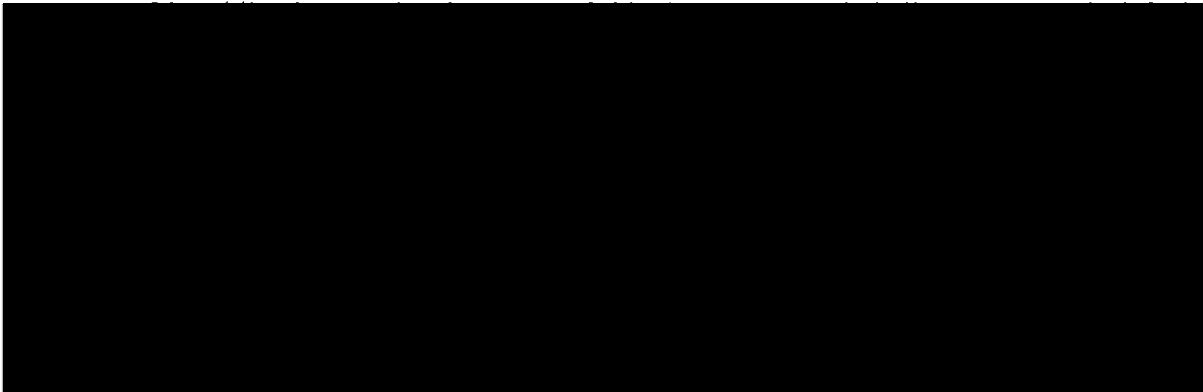
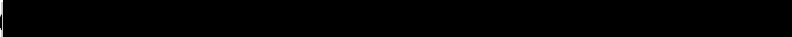

19. **Condemnation.**

19.1 **Complete Taking.** If, at any time, any authority having the power of eminent domain shall condemn all or substantially all of the Operator's Property, or all of the Improvements thereon, for any public use or otherwise, then the interests and obligations of Operator under this Agreement in or affecting the Operator's Property shall cease and terminate upon the earlier of (i) the date that the condemning authority takes physical possession of the Operator's Property or the Improvements thereon, (ii) the date that Operator is, in its sole judgment, no longer able or permitted to operate the Project on the Operator's Property in a commercially viable manner, or (iii) the date of the condemnation judgment. Operator shall continue to pay all amounts payable hereunder to Owner until the earlier of such dates, at which time the Parties shall be relieved of any and all further obligations and conditions to each other under this Agreement.

19.2 **Partial Taking.** If, at any time during the term of this Agreement, any authority having the power of eminent domain shall condemn one or more, but not all, of the Solar Panels, or any portion of the Improvements or the Operator's Property, then the interest and obligations of Operator under this Agreement as to those Solar Panels or any portion of the Improvements or the Operator's Property so taken shall cease and terminate upon the earlier of (i) the date that the condemning authority takes possession of such Solar Panels or any portion of the Improvements or the Operator's Property, (ii) the date that Operator is, in its reasonable judgment, no longer able or permitted to operate the Project on the Operator's Property, or any portion thereof, in a commercially viable manner, or (iii) the date of the condemnation judgment; and, unless this Agreement is terminated as hereinafter provided, this Agreement shall continue in full force and effect as to the remainder of the Solar Panels, Improvements and the Operator's Property. If the remainder of the Solar Panels or any other portion of the Improvements or the Operator's Property is or becomes insufficient or unsuitable for Operator's purposes hereunder, as determined by Operator in its sole discretion, then, subject to the rights of any Operator Mortgagee under Section 13, Operator shall have the right to terminate this Agreement as to the portion of the Operator's Property to which Operator continues to hold the rights, at which time the Parties shall be relieved of any further obligations and duties to each other under this Agreement.

19.3 **Apportionment, Distribution of Award.** On any taking, all sums awarded, including damages and interest, shall be paid as follows:

(a) Any portion of the award by the court on account of any cost or loss that Operator may sustain in the removal and relocation of Operator's Improvements, to Operator;

(b) Any portion of the award by the court for Operator's anticipated or lost revenues or profits, to Operator;

(c) Any portion of the award by the court for Owner's lost revenues, to Owner;

(d) All remaining amounts of the award, to Owner or Operator consistent with applicable Kentucky law.

20. **Notice.**

20.1 **Writing.** All notices given or permitted to be given hereunder shall be in writing.

20.2 **Delivery.** Notice is considered given either (i) when delivered in person to the recipient named below, (ii) upon receipt after deposit in the United States mail in a sealed envelope or container, postage and postal charges prepaid, return receipt requested or certified mail, addressed by name and address to the party or person intended, or (iii) twenty-four (24) hours from proper and timely delivery to an overnight courier service addressed by name and address to the party or person intended as follows:

Notice to Owner: James M. Steinwachs, Sr. and Angie Steinwachs
10029 Highway 416 W
Robards, KY 42452

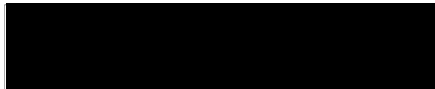

Notice to Operator: Boulevard Associates, LLC
700 Universe Blvd
Juno Beach, FL 33408



20.3 **Change of Recipient or Address.** Either Party may, by notice given at any time or from time to time, require subsequent notices to be given to another individual person, whether a party or an officer or representative, or to a different address, or both. Notices given before actual receipt or notice of change shall not be invalidated by the change.

21. **Miscellaneous Provisions.**

21.1 **Successors and Assigns.** The terms and provisions of this Agreement shall run with the land and be binding on and inure to the benefit of the heirs, successors, assigns and personal representatives of the Parties. In accordance with this Agreement, Operator in its discretion may authorize other persons or entities to use the Operator Property for the purposes stated in this Agreement

21.2 **Memorandum.** Simultaneously with the execution of this Agreement, the Parties agree to execute and acknowledge a memorandum of this Agreement. Operator may record the executed memorandum in the public records of Henderson County, Kentucky.

21.3 **Entire Agreement.** This Agreement and the attached Exhibits shall constitute the entire agreement between the Parties and supersedes all other prior writings and understandings.

21.4 **Amendments.** This Agreement shall not be amended or modified in any way except by an instrument signed by the Parties and consented to by any Operator Mortgagee. The Parties hereto shall at all times hereafter execute any documents and do any further acts which may be necessary or desirable to carry out the purposes of this Agreement and to give full force and effect to each and all of the provisions hereof.

21.5 **Legal Matters.** This Agreement shall be governed by and interpreted in accordance with the then existing laws of the Commonwealth of Kentucky and the County where the Owner's Property is located shall be considered the proper forum or jurisdiction for any disputes arising in connection with this Agreement. The Parties agree to first attempt to settle any dispute arising out of or in connection with this Agreement by good-faith negotiation. If the Parties are unable to resolve amicably any dispute arising out of or in connection with this Agreement, each shall have all remedies available at law or in equity and as provided by this Agreement. **Each Party waives all right to trial by jury and specifically agrees that trial of suits or causes of action arising out of this Agreement shall be to the court of competent jurisdiction.**

21.6 **Severability.** If any term or provision of this Agreement, or the application thereof to any person or circumstance shall, to any extent, be determined by judicial order or decision to be invalid or unenforceable, the remainder of this Agreement or the application of such term or provision to persons or circumstances other than those as to which it is held to be invalid, shall be enforced to the fullest extent permitted by law.

21.7 **Tax Credits.** If under applicable law Operator becomes ineligible for any currently existing tax credit, benefit or incentive for alternative energy expenditure established by any local, state or federal government, then, at Operator's option, the Parties shall negotiate in good faith to amend this Agreement or replace it with a different instrument so as to convert Operator's interest in the Operator Property to a substantially similar interest that makes Operator eligible for such tax credit, benefit or incentive. Such amendment or instrument shall not impair any of Owner's rights or increase the burdens or obligations of Owner under this Agreement.

21.8 **Approvals.** Whenever in this Agreement the approval or consent of either Party is required or contemplated, unless otherwise specified, such approval or consent shall not be unreasonably withheld or delayed.

21.9 **Authority.** The signatories hereto warrant that each has the authority to execute this Agreement on behalf of any entities which are Parties to this Agreement and that each such entity has executed this Agreement pursuant to its organizational documents or a resolution or consent of their Board of Directors or other governing body.

21.10 **Time of Essence.** Time is of the essence of each provision of this Agreement.

21.11 **Counterparts.** This Agreement may be executed in multiple counterparts, each of which shall be deemed an original, and all of which together shall constitute a single instrument.

[Signatures on Next Page]

Owner:

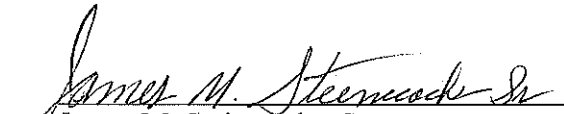
James M. Steinwachs, Sr.

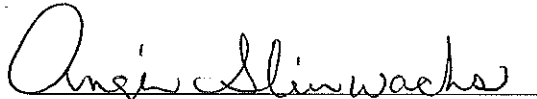
Angie Steinwachs

Operator:

Boulevard Associates, LLC
a Delaware limited liability company

By: 
Greg Schneck, Vice President

EXHIBIT A

Legal Description of Owner's Property

TRACT #1: Lot #4 - Beginning at a post oak and dogwood northwest corner of original survey and corner with McMullins; thence south 1 1/2 deg. west 95 poles 2 links to a stake in Denton line corner with Lot #3; thence south 86 1/2 deg. east 40 poles to a stake in corner with Lot #3 and in line of Lot #5; thence north 1 1/2 deg. east 95 poles 2 links to a stake corner with Lot #5 and in original line; thence north 88 1/4 deg. west 40 poles to the beginning, containing 23.77 acres, more or less.

ALSO

TRACT #2: Lot #5 - Beginning at a stake on north side of Roberts & Cairo Road, corner with Lot #1 running thence north 1 1/2 deg. east 120 poles and 11 links to a stake in original line; thence south 86 1/2 deg. east 28 poles to a stake; thence south 1 1/2 deg. west 101 poles to a stake in Roberts & Cairo Road, old corner with Lot #6; thence south 87 1/2 deg. west 12 poles 11 links to a stake in a ditch; thence south 16 1/2 deg. west 72 poles and 10 links to a stake on north side of road corner with Lot #2, the beginning, containing 25.24 acres, more or less.

ALSO

TRACT #3: Lot #6 - Beginning at a stake near a post oak in Roberts & Cairo Road corner with Roberts, running thence north 1 1/2 deg. east 104 poles and 11 links to a stake in the ditch line; thence north 86 1/2 deg. west 28 poles and 11 links to stake corner of Lot #1; thence north 1 1/2 deg. west 101 poles and 10 links to a stake on road; thence south 16 1/2 deg. west 72 poles and 10 links to a stake on road; thence south 87 1/2 deg. west 12 poles and 11 links to beginning, containing 25.24 acres.

AND ALSO

TRACT #4: 2 tracts of land adjoining making a total of about 20 acres, situated on the Robards-Cairo Road described as follows, to-wit:

A. Beginning at a stake near a black gum, corner with Denton, running thence south 88 1/2 deg, east 19 poles, 6 links to a stake corner to Lots 1-2; thence south 1 1/2 west 17 poles 21 links to a stake in the Robards-Cairo Road; thence north 78 1/4 east 20 poles 22 links to a stake on north side of road corner to Lot #5; thence north 1 1/2 deg, east 75 poles and 11 links to a stake, corner with Lot #4; thence north 88 1/2 west 40 poles to a stake in Denton line; thence with his line south 1 1/2 deg, west 88 poles, 9 links to beginning, containing 11 acres.

B. Adjoining the above described tract on the west of Canal Creek, and beginning at a stake, corner with U. S. Denton, running thence south 2 1/2 deg, west 54 poles and 11 links to a large black oak, original corner; thence south 1 1/2 deg, west 18 poles 14 links to a stake, 14 links south of east oak, corner to School House Inn; thence south 88 1/2 deg, west 17 poles and 10 links to a stake in road, running south 48 west 11 links from a black oak stump; thence north 78 1/4 east 2 poles and 2 links to a stake in road; thence south 1 1/2 deg, west 22 poles and 21 links to a stake corner with Lot #4; thence north 88 1/2 deg, west 12 poles and 10 links to the beginning, containing 8 acres.

LESS AND EXCEPT 10.614 acres retained by the grantor herein, as more fully described as Lot #1 of the Jackie Pryor Subdivision, pursuant to a subdivision plat dated May 4, 1993, approved May 13, 1993, filed of record in Plat Book 6, Page 214, Henderson County Court Clerk's Office.

ALSO LESS AND EXCEPT 1.152 acres shown as Lot 5 on the aforesaid plat and conveyed by Jackie Pryor to Darrell Wayne Smith and Joannae Smith, by deed dated March 27, 1987, of record in Deed Book 376, Page 180, Henderson County Court Clerk's Office.

CONTAINING after the said exceptions 90.054 acres, more or less.

HOLDING PAGE FOR EXHIBIT B

Preliminary Lease and Easement Improvement Plan and Acreage Calculation
To be Delivered with Option Notice

HOLDING PAGE FOR EXHIBIT C

As Built Lease and Easement Improvements and Final Acreage Calculation

EXHIBIT D

Lease and Easement Compensation

(1) **Option Payment.**



(2) **Payment for Lease and Easements.**

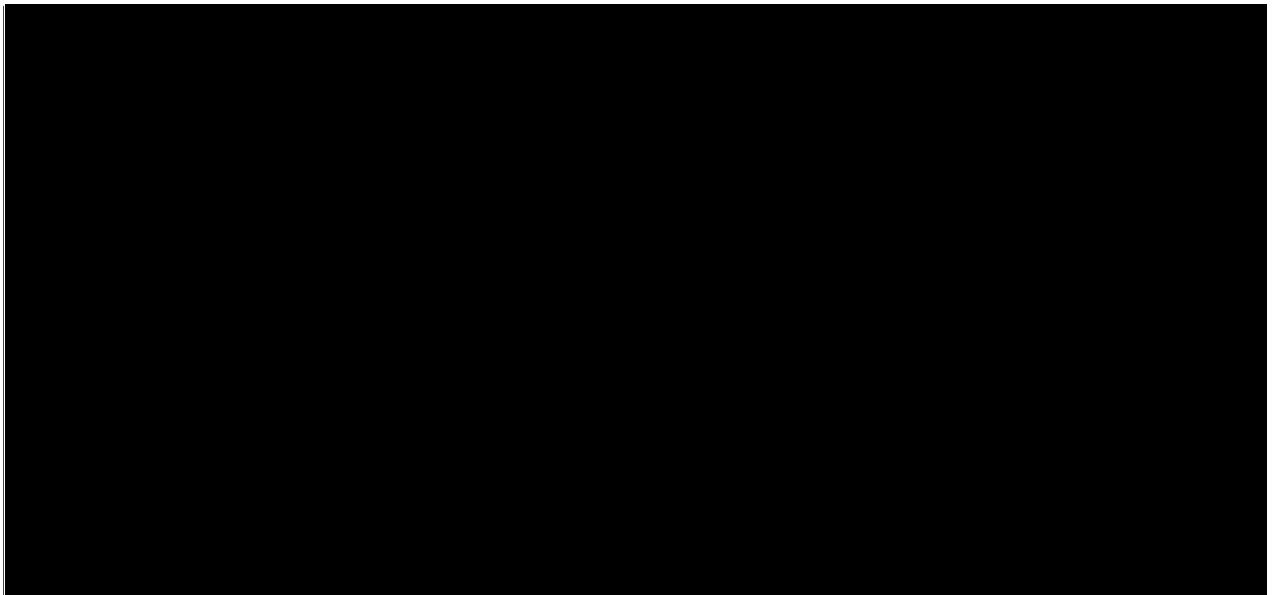
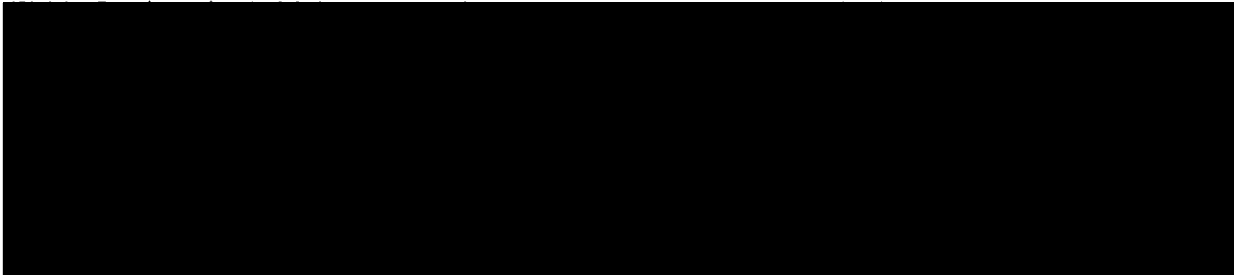

(3) **Crop Compensation.**

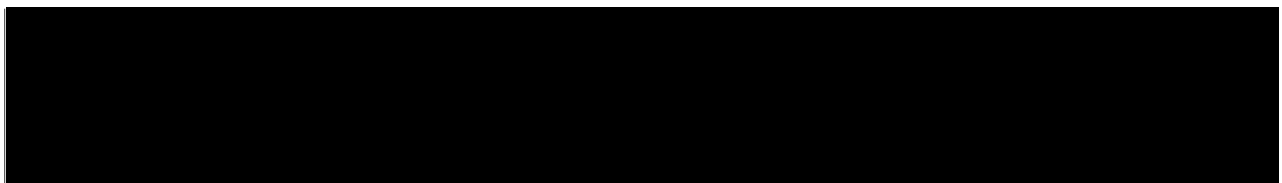

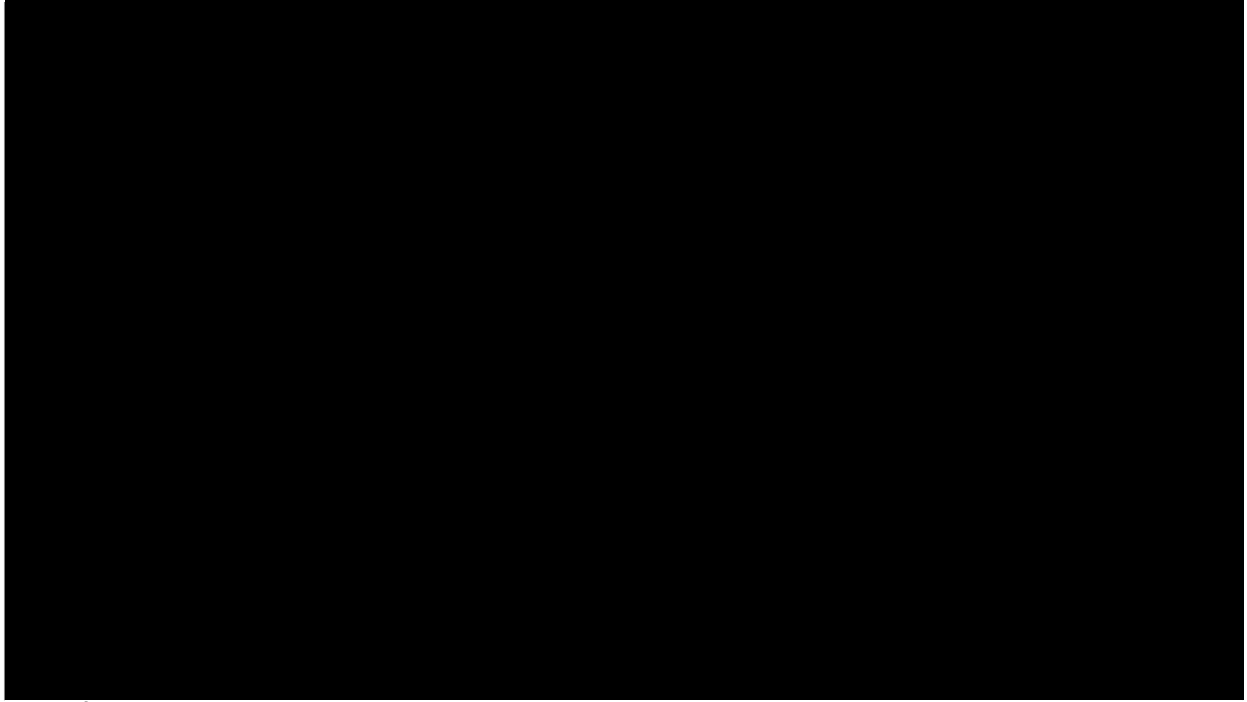

(4) Payment Allocation Schedule.

[Redacted]

[Redacted]

[Redacted]

Kentucky

SOLAR LEASE AND EASEMENT AGREEMENT

1. **Parties.** This Solar Lease and Easement Agreement ("**Agreement**") is made and entered as of the 20 day of December 2019 ("**Effective Date**"), by and between Milton E. Crowder and Diane G. Crowder, husband and wife ("**Owner**") and Boulevard Associates, LLC, a Delaware limited liability company ("**Operator**"), which are sometimes individually referred to as a "**Party**" and collectively as the "**Parties**".
2. **Project.** This Agreement relates to the solar-powered electrical power generation and transmission project known as the "Sebree Solar Energy Center" to be located in Henderson County, Kentucky ("**Project**"), which may be wholly or partially located on the Owner's property legally described on the attached **Exhibit A** to this Agreement ("**Owner's Property**"). Upon Operator's exercise of the Option (as defined below), the Project shall include (i) the Lease of Owner's Property described in Section 4, (ii) the Easements referenced in Section 5 that are located on the Owner's Property, and (iii) the Improvements referenced in Section 8 to be constructed on Owner's Property. The Lease, Easements and Improvements are sometimes collectively referred to as the "**Operator Property**".
3. **Option.** Owner grants to Operator an exclusive option ("**Option**") to acquire the Lease and Easements referenced in Sections 4 and 5 in accordance with the following terms and conditions. Operator shall be entitled to acquire the Lease and the Easements in their entirety or in part, as Operator deems appropriate.
 - 3.1 **Option Term.** The period during which Operator may exercise the Option shall be for a term of four (4) years, commencing on the Effective Date ("**Option Term**").
 - 3.2 **Option Payment.** As consideration for the granting of the Option, Operator agrees to pay Owner the Option Payment set forth in **Exhibit D**.
 - 3.3 **Use of Owner's Property.** During the Option Term, Operator and its employees, agents and contractors shall have a right to enter upon the Owner's Property and the right of ingress and egress over and across the Owner's Property for the purposes of (i) surveying the Owner's Property; (ii) performing such other tests and studies as Operator may desire in connection with the Option, including, without limitation, environmental, avian and cultural resource assessments, and geotechnical, foundation and soil tests, provided that such activities do not unreasonably interfere with Owner's use of the Owner's Property; and (iii) installing, maintaining, operating, inspecting and removing one or more weather related instruments ("**Weather Instrument**") and fencing of said Weather Instrument and including the performance of all tests and studies associated therewith. Owner shall not permit any other individual or entity except Operator or its affiliates to install a Weather Instrument on Owner's Property.
 - 3.4 **Right to Grant Option.** Owner warrants and represents to Operator that (i) the statements in Section 9 concerning Owner's title to the Owner's Property are true and correct; (ii) Owner has the authority to grant this Option to Operator without the consent or approval of any other party; and (iii) there are no other existing options, rights of first refusal, contracts to

purchase, leases or mortgages that would prevent Operator from exercising its rights with respect to the Option.

3.5 **Exercise of Option.** Operator may exercise the Option by giving written notice to Owner ("**Option Notice**") at any time during the Option Term. Operator shall specify in the Option Notice the Commencement Date referenced in Section 6.1.1. On the Commencement Date, the Lease and Easements referenced in Sections 4 and 5 shall automatically become effective, and the Parties shall be subject to all of the terms and conditions of this Agreement with respect to such Lease and Easements and all rights and obligations relating thereto.

3.6 **Termination of Option.** If Operator fails to exercise the Option within the Option Term, the Option and the rights of Operator as the optionee shall automatically terminate.

4. **Lease.** Upon exercise of the Option by Operator, Owner leases to Operator, and Operator leases from Owner, Owner's Property for the Lease and Easement Term (defined in Section 6.1) in accordance with the terms and conditions of this Agreement ("**Lease**"), which Lease grants Operator and its agents, contractors, and employees the right to use the Owner's Property for the following permitted uses:

4.1 **Construction Right.** Operator leases Owner's Property for the purpose of constructing, operating, maintaining, repairing, replacing, and removing all or any part or component of the Improvements whether located on Owner's Property. Operator may exercise its right to use all or any part of the Owner's Property as and when Operator deems it necessary or advisable to do so to perform the activities for which this right is granted, including, without limitation, staging areas and parking for Operator's employees. Any such areas being used temporarily by Operator shall be located immediately adjacent to the portion of the Property leased by Operator hereunder.

4.2 **Access Right.** Operator leases Owner's Property for unobstructed vehicular and pedestrian access and ingress to and egress from the Improvements, Owner's Property and any public roadways, and to construct, maintain, and utilize Roadway Improvements on the Owner's Property. Owner shall not permit others to obstruct or damage the roads or Roadway Improvements located on the Owner's Property or in any other way interfere with Operator's rights under this right. Operator shall repair any damage done to Roadway Improvements which result from use by Operator, its agents, servants or employees. Such roads shall be maintained in the condition necessary for use by Operator's equipment, and with regard to existing roads, shall be maintained in at least the condition that existed prior to Operator's use. Any roads inside of the fenced area of the project will be maintained by Operator at Operator's sole cost and expense.

4.3 **Solar Panels Right.** Operator leases Owner's Property for Operator to construct, operate, replace, relocate, remove, and maintain Solar Panels and the appurtenant Collection Facilities, together with associated roads and parking areas on Owner's Property.

4.4 **Collection Facilities Right.** Operator leases Owner's Property for Operator to construct, operate, maintain, replace, relocate or remove Collection Facilities on and under the Owner's Property.

4.5 **Substation Right.** Operator leases Owner's Property for Operator to construct, operate, maintain, replace, relocate or remove one or more Substations on Owner's Property.

4.6 **Telecommunication Right.** Operator leases Owner's Property for Operator to construct, operate, maintain, replace, relocate or remove Telecommunication Facilities on and under the Owner's Property.

4.7 **Weather Instrument Right.** Operator leases Owner's Property in order to construct, operate, replace, relocate, remove, and maintain a Weather Instrument and the appurtenant Collection Facilities on Owner's Property.

4.8 **Battery Facilities Right.** Operator leases Owner's Property in order to construct, operate, replace, relocate, remove, and maintain one or more Battery Facilities on Owner's Property.

5. **Grant of Easements.** Upon the exercise of the Option by Operator, Owner grants to Operator, and Operator accepts from Owner, for the Lease and Easement Term referenced in Section 6.1, the following easements over and across the Owner's Property in accordance with the terms and conditions of this Agreement. The following easements are for the benefit of Operator and Operator's agents, contractors and employees and located on the Owner's Property and are collectively referred to as the "**Easements**".

5.1 **Sun Non-Obstruction Easement.** Owner grants Operator an irrevocable, exclusive easement for the right and privilege to use, maintain and capture the free and unobstructed sunlight over and across the Owner's Property. Owner shall not engage in any activity on Owner's Property or any other neighboring property owned by Owner that might interfere with the sunlight direction over any portion of Owner's Property; cause a decrease in the output or efficiency of any Solar Panel or Weather Instrument; or otherwise interfere with Operator's operation of the Project or exercise of any rights granted in this Agreement (collectively "**Interference**"). This grant of the easement expressly includes the right of Operator to enforce Operator's rights, including the physical removal of trees or structures (except existing trees and structures) causing Interference to the Project contemplated by Operator. Operator shall notify Owner before making any such removals.

5.2 **Effects Easement.** Owner grants to Operator an easement over Owner's Property for visual, view, light, flicker, noise, shadow, vibration, electromagnetic, electrical and radio frequency interference, and any other effects attributable to the Project located on the Owner's Property.

6. **Term.** The term of this Agreement ("**Term**") includes the Option Term referenced in Section 3.1, the Initial Lease and Easement Term as described in Section 6.1.1 and the Extended Lease and Easement Term as described in Section 6.1.2 (together, the Initial Lease and Easement Term and the Extended Lease and Easement Term, if applicable, is defined as the "**Lease and Easement Term**").

6.1 **Lease and Easement Term.**

6.1.1 **Initial Lease and Easement Term.** The initial term of the Lease and Easements shall commence on the date specified by Operator in the Option Notice ("**Commencement Date**"). The initial term of the Lease and Easements shall end thirty (30) years after the Commencement Date (the "**Initial Lease and Easement Term**"), subject to the rights of renewal and termination as provided in this Agreement.

6.1.2 **Extended Lease and Easement Term.** Operator shall have the right to extend the Term of this Agreement for two (2) consecutive terms of five (5) years each in accordance with the terms and provisions of this Agreement (collectively "**Extended Lease and Easement Term**") by providing written notice to Owner of Operator's intent to extend the Term within one hundred eighty (180) days of the end of the existing Term. Each Extended Lease and Easement Term shall begin on the expiration date of the Initial Lease and Easement Term or previous Extended Lease and Easement Term, as the case may be. During the Extended Lease and Easement Term, Operator shall pay Owner the amounts set forth in **Exhibit D** as the consideration for the Lease and Easements.

6.1.3 **Delays During Lease and Easement Term.** At Operator's option, the Term may be extended for a period of time equal to the period of time during which operation of the Project is delayed or suspended because of the occurrence of a Regulatory Suspension or Force Majeure, which are defined as follows:

(i) "**Regulatory Suspension**" shall mean the enactment or application of any law, order, rule, or regulation of the Kentucky Public Service Commission, Federal Energy Regulatory Commission, or other local, state, or federal government authority having jurisdiction over the Project or Operator, or the failure of any such governmental authority to issue an approval or permit pursuant to any such law, order, rule, or regulation, which results in the delay, interruption, or suspension of the production, sale or transmission of electricity from the Solar Panels; and

(ii) "**Force Majeure**" shall mean causes beyond the reasonable control of and without the fault or negligence of the Party claiming Force Majeure, including but not limited to acts of God, labor unrest (including, but not limited to, slowdowns, picketing, boycotts or strikes), flood, earthquake, storm, fire, lightning, explosion, power failure or power surge, vandalism, theft, the cutting of power, transmission or other lines, wires or cables to the Project by persons other than Operator's employees or contractors, epidemic, war, revolution, riot, civil disturbance, sabotage, change in law or applicable regulation subsequent to the Commencement Date and action or inaction by any federal, state or local legislative, executive, administrative judicial agency or body which in any of the foregoing cases, by exercise of due foresight such Party could not reasonably have expected to avoid, and which, by the exercise of due diligence, it is unable to overcome.

The Parties shall be excused from performing their respective obligations under this Agreement and shall not be liable in damages or otherwise if and to the extent that they are unable to so perform or are prevented from performing by a Force Majeure, provided that: (i) the non-performing Party, as promptly as practicable after the occurrence of the Force Majeure, but in no event later than thirty (30) days thereafter, gives the other Party written notice describing the particulars of the occurrence; (ii) the suspension of performance is of no greater scope and of no

longer duration than is reasonably required by the Force Majeure; (iii) the non-performing Party uses good faith and commercially reasonable efforts to remedy its inability to perform; and (iv) as soon as the non-performing Party is able to resume performance of its obligations excused as a result of the occurrence, each Party shall give prompt written notification thereof to the other Party. Notwithstanding the foregoing, Operator shall pay Owner 50% of the Annual Installment Payments during any period of Force Majeure.

6.2 **Termination by Operator**. Provided Operator is not in default under any term of this Agreement, Operator, at its option, shall have the right to terminate this Agreement at any time during the Term of the Agreement, as to all or any part of the Operator Property. Termination shall be effective thirty (30) days after written notice of such termination to Owner. If Operator's notice is a full termination of the Operator Property, the Parties shall be relieved of all further duties and obligations under this Agreement, other than (i) the payment of any accrued and unpaid obligations owed by either Party as of the date of termination; (ii) the removal of the Improvements by Operator pursuant to Section 8.11; and (iii) any other obligations and liabilities that are expressly stated in this Agreement to survive such termination. Upon any such partial termination by Operator, the Parties shall be relieved of all further duties and obligations under this Agreement with respect to the portion thereof terminated by Operator, subject to the obligations and liabilities referenced in items (i) through (iii) above that shall continue to be applicable to the terminated portion of this Agreement. The Parties agree to execute an amendment to this Agreement evidencing such partial termination.

7. **Payments**. If Operator exercises the Option referenced in Section 3, Operator agrees to pay Owner the amounts set forth in **Exhibit D** as consideration for the Lease, Easements and Operator's other rights and interests in the Owner's Property.

8. **Improvements**. Operator shall have the right, at its sole cost and expense, to construct, install, maintain, use, operate, repair, replace, relocate and remove all facilities, structures, equipment, machinery, wires, conduit, cables, poles, materials and property of every kind and character required for the construction and operation of portions of the Project on the Owner's Property, including, but not limited to, the Solar Panels, Collection Facilities, Substations, Telecommunication Facilities, Weather Instruments, Roadway Improvements and Battery Facilities referenced in Sections 8.1 through 8.7 (collectively, the "**Improvements**").

8.1 **"Solar Panels"** shall mean any photovoltaic energy system designed for the generation of electrical power from the collection of sunlight, including without limitation, the photovoltaic panels, foundations, support structures, braces and related equipment.

8.2 **"Collection Facilities"** shall mean all Improvements whose purpose is to deliver electrical power generated by the Solar Panels to an electrical power grid or other system, including without limitation transformers, overhead and underground electrical collection lines, telecommunication lines, splice boxes and interconnection facilities.

8.3 **"Substations"** shall mean electrical lines, meters, monitoring and control equipment, switches, transformers, all structures, equipment, enclosures, fencing, security devices, and other electrical and communications equipment necessary to condition and increase

the voltage of electricity generated by the Project to make it suitable for transmission on, and to deliver it to, Collection Facilities connected to an electric power grid or other system.

8.4 "**Telecommunication Facilities**" shall mean all Improvements whose purpose is to provide telecommunication services solely relating to the Project or any of Operator's solar powered projects, including telephone, closed-circuit television, microwave, internet, computer data and other telecommunication services.

8.5 "**Weather Instrument**" shall mean instruments used primarily to gather and transmit sunlight and meteorological data relating to the Project, and includes the instrument's foundations, guy wires, sunlight and meteorological data acquisition equipment, power source, and any required data and electrical transmission lines.

8.6 "**Roadway Improvements**" shall mean all improvements that may be necessary to construct, maintain and repair any new and existing roadways and other means of ingress and egress over, across and along the Owner's Property, including paving or surfacing of the roadways with asphalt, gravel or other roadway materials, installation of road signs and the construction and installation of culverts, bridges, drainage ditches, gates, cattle guards and similar structures and facilities.

8.7 "**Battery Facilities**" shall mean a type of equipment that can be given a new charge by passing an electric current through it designed for the storage of electrical power including without limitation, batteries and other devices for storage of electrical energy, foundations, support structures, braces and related equipment.

8.8 **Ownership of Improvements.** Except as otherwise provided in Section 11.7, all Improvements shall at all times remain the property of Operator, and Owner shall have no right, title or interest therein. All Improvements constructed or placed on the Owner's Property by Operator during the Term of this Agreement may be repaired, replaced, relocated, removed, added to or expanded upon by Operator at any time during the Term of this Agreement. Owner expressly waives any statutory lien or common law liens on the Improvements to which Owner might be entitled.

8.9 **Construction Liens.** Operator shall not permit any liens arising out of Operator's use of the Operator Property under this Agreement to be filed against the Owner's Property. Operator shall, within sixty (60) days after it receives notice of the lien, provide a bond or other security that Owner may reasonably request, or remove such lien from the Owner's Property in the manner provided by applicable law.

8.10 **Location of Improvements.** The acreage required from the Owner's Property for the Improvements for which the Lease and Easements are being granted cannot be determined until the completion of Operator's inspection, testing, study and surveying of the Owner's Property during the Option Term. Along with the Option Notice, Operator shall deliver to Owner a proposed plan of development showing the contemplated locations of the Improvements and a preliminary calculation of the acreage as determined by the area bounded by a perimeter fence required for the Project, which shall serve as the **Exhibit B** to this Agreement. During the final development and construction of the Project, such locations may need to be amended.

Following construction of the Project, Operator shall provide Owner an "as-built" survey of all Improvements on Owner's Property and the final calculation of the acreage as determined by the area bounded by a perimeter fence required for the Project, which shall serve as **Exhibit C** to this Agreement. Further, following construction, the Improvements may need to be relocated or rerouted by Operator, which Operator may perform, at any time during the Term of this Agreement, so long as the nature and extent of any such relocated or rerouted Improvements are not materially different and impose no materially greater burden on the Owner's Property than the original locations or routes, and so long as Operator takes commercially reasonable efforts to minimize disruption or inconvenience to Owner.

8.11 Removal of Improvements. Upon full or partial termination of any of the Lease Rights or Easements, Operator shall, within one (1) year of such full or partial termination, remove all Improvements and restore the area formerly occupied by the Improvements to substantially the same physical condition that existed immediately before the construction of the Improvements (the "**Removal Obligations**"). At Owner's request, all or any part of the Roadway Improvements may be left for use by Owner. Annual Installments Payments shall continue to be made, on a prorated basis, until the Removal Obligations are substantially completed.

8.12 If a governmental authority does not require a performance bond or security for removal of the Improvements, then, Operator shall obtain and deliver to Owner a bond in form and substance reasonably satisfactory to Owner securing Operator's Removal Obligations (the "Removal Bond") prior to the date that the Project first delivers energy in commercial quantities onto the grid. The Removal Bond shall be equal to the estimated amount, if any (the "Net Removal Costs"), of removing the Improvements from Owner's Property less the salvage value of the Improvements. Operator shall not be required to deliver such Removal Bond to Owner if Operator has delivered such a bond in connection with the permitting of Owner's Property or any other portion of the Improvements for the Project. Once in place, Operator shall keep such bond, or a like replacement, in force throughout the remainder of the Term. The Net Removal Costs shall be determined by the Parties hereto acting in good faith. If the Parties cannot agree upon the Net Removal Costs within sixty (60) days of their first attempt to do so, then the Net Removal Costs shall be determined by an independent engineer mutually selected by the Parties. If the Parties cannot agree upon such independent engineer within the next thirty (30) days, then by an independent engineer appointed by a District Judge of Henderson County, Kentucky; and the decision of such an independent engineer (however selected) as to the Net Removal Costs shall be conclusive as between and binding upon, the Parties. If an independent engineer is selected, then the Parties hereto shall equally share all of the costs associated with the independent engineer's determination of the Net Removal Cost. If the Removal Bond is unavailable or an alternate form of security is more economical or desirable, then Operator may substitute an alternate form of security, such as a letter of credit, other form of bond, or guarantee reasonably acceptable to Owner that provides substantially equivalent security as the Removal Bond. Operator shall redetermine the amount of the Removal Security beginning immediately prior to the tenth (10th) year of the Lease and Easement Term and every five (5) years after the initial posting of the Removal Bond.

9. **Ownership and Title Matters.** Except as otherwise set forth herein, Owner warrants and represents to Operator, both as of the Effective Date, and as of the Commencement Date as follows:

9.1 **Authority.** Owner represents and warrants that it is the holder of fee simple title and is the sole owner of the Owner's Property and has the unrestricted right and authority to sign this Agreement and to grant Operator the Lease and Easements and other rights granted in this Agreement. When signed by both Parties, this Agreement constitutes a valid and binding agreement enforceable against Owner in accordance with its terms.

9.2 **Other Agreements.** The Owner's Property is not subject to any other agreements, options, rights of first refusal or other prior right of any party to purchase, lease or acquire easements in the Owner's Property, or create any prior claim or right that would preclude or interfere with Operator's rights and interests under this Agreement and the Lease and Easements.

9.3 **Minerals.** Except as disclosed by Owner to Operator at the time of the execution of this Agreement by Owner, Owner owns all of the oil, gas and other minerals, and all rights thereto as on or under the Owner's Property.

9.4 **Owner Mortgage.** Except as disclosed by Owner to Operator at the time of the execution of this Agreement by Owner, there are no mortgages encumbering the Owner's Property ("**Owner Mortgage**").

9.5 **Notice and Opportunity to Cure.** If there is an Owner Mortgage encumbering Owner's Property and Owner receives from the holder thereof any notice that payments are overdue, Owner shall notify Operator and each Operator Mortgagee (as defined at Section 13.1) by sending a copy of such overdue payment notice to Operator by the earlier of (i) five (5) days after receipt, or (ii) three (3) business days prior to the date by which a default under or in respect of such Owner Mortgage could occur. If Operator or any Operator Mortgagee determines that it would be in Operator's interest to make such payments to Owner Mortgagee on Owner's behalf, whether as a result of receiving such notice or otherwise, Operator shall have the right to make such payments and to credit the payments so made against the Annual Installment Payment next due under the Agreement.

9.6 **Subordination, Non-Disturbance & Attornment Agreement.** If there is an Owner Mortgage encumbering Owner's Property, Owner shall cooperate with Operator to obtain a Subordination, Non-Disturbance and Attornment Agreement ("**SNDA**") in the form prepared and provided by Operator, from each Owner Mortgagee, pursuant to which such Owner Mortgagee agrees, among other things, not to disturb Operator's possession and use of the Owner's Property. Owner shall not incur any loss in income, expense, obligation or liability with regard to the SNDA. Operator shall, at its sole cost and expense, record each such SNDA in the Office of the County Clerk in which Owner's Property is located. If Owner fails to deliver a SNDA from each Owner Mortgagee, Operator may, at its sole option, either (i) terminate this Agreement immediately upon written notice to Owner, or (ii) take such action as Operator deems reasonably necessary to effect the rights granted to Operator hereunder, and off-set all amounts

expended in such efforts against the Annual Installment Payments and any other amounts due hereunder or in respect hereof.

10. **Representations and Warranties of Owner.** Owner hereby makes the following further representations and warranties both as of the Effective Date, and as of the Commencement Date:

10.1 **Physical Condition.** Owner has no knowledge of any existing physical conditions except for Henderson County Zoning and land use ordinances and restrictions of the Owner's Property which would prevent, significantly restrict or make more expensive Operator's development of the Owner's Property for the purposes specified in this Agreement, or which could, with the passage of time, or the giving of notice, constitute a violation of any currently applicable governmental law, ordinance, order, rule or regulation.

10.2 **Legal Restrictions.** Owner has no knowledge of any law, regulation, ordinance or order of any local, state or federal governmental authority which would prohibit or significantly restrict Operator's development of the Owner's Property pursuant to this Agreement. This Agreement does not violate any contract, agreement, instrument, judgment or order to which Owner is a party or which affects the Owner's Property. To the best of Owner's knowledge, the Owner's Property is currently in full and complete compliance with all governmental laws, ordinances, orders, rules and regulations applicable to the Owner's Property.

10.3 **No Litigation.** No litigation is pending and, to the best of Owner's knowledge, no litigation or administrative actions are proposed, threatened or anticipated with respect to any matter affecting the Owner's Property. If Owner learns of any litigation or administrative action proposed, threatened or instituted with respect to the Owner's Property, Owner shall give Operator notice within thirty (30) days thereof.

10.4 **Survival.** The representations and warranties set forth in this Section 10 shall survive the execution and delivery hereof.

11. **Use, Operation and Maintenance.**

11.1 **Exclusive Use by Operator.** Operator shall have the exclusive right (i) to use and possess the Owner Property in connection with the Project and other similar solar-powered electrical power generation projects; (ii) to investigate, inspect, survey, and conduct tests of the Owner's Property, including, but not limited to, meteorological, environmental, archeological and geotechnical tests and studies; (iii) to use and convert all of the sunlight resources on the Owner's Property; and (iv) to undertake such other activities on the Owner's Property that may be related to the Project, including, without limitation, the storage of Solar Panels, materials and equipment during the installation and construction of the Improvements; development and operation of communications systems; and site tours of the Project for visitors and other interested parties.

11.2 **No Required Installation or Operation.** Nothing in this Agreement shall be interpreted as imposing on Operator any obligation to install Solar Panels or other Improvements on the Owner's Property, or to operate the Project on the Owner's Property. Operator shall have the sole discretion to determine if and when any Solar Panels and other Improvements may be

constructed on Owner's Property, and if and when to commence the operation of the Project on the Owner's Property.

11.3 **Permits and Approvals.** Operator shall be responsible, at its sole cost and expense, for obtaining any governmental permits and approvals necessary for the construction and operation of the Project and the construction and operation of the Improvements. Owner shall cooperate with Operator as necessary to obtain any governmental or utility approvals or permits, including, without limitation, signing any applications for such approvals, provided that Owner shall not incur any loss in income, expense, obligation or liability with respect to Operator obtaining such permits or approvals.

11.4 **Compliance with Laws.** Operator shall comply in all material respects with valid laws applicable to the Owner's Property and the Operator Property. Operator shall have the right, in its sole discretion and at its sole expense, in Operator's name to contest the validity or applicability to the Owner's Property and the Operator Property of any law, ordinance, statute, order, regulation, property assessment or the like made by any governmental agency or entity. Operator shall control any such contest and Owner shall cooperate with Operator in every reasonable way in such contest, provided that Owner shall incur no expense, obligation or liability with regard to such contest.

11.5 **Care and Appearance.** Operator, in its exercise of the lease, easement and other rights granted hereunder shall, at all times, maintain the Owner's Property and the Improvements in a reasonably neat, clean and presentable condition. Operator shall not willfully or negligently damage or destroy the Owner's Property and shall keep the Owner's Property clean and free of debris created by Operator, its contractors, or others brought on to the Owner's Property by Operator. Operator shall not use the Owner's Property for storage, except for materials, construction equipment and vehicles directly associated with construction or maintenance of the Improvements on the Owner's Property or adjacent properties that are part of the Project.

11.6 **Fences and Gates.** At Owner's request, Operator shall repair or replace any fences, gates or cattle guards damaged or removed in connection with Operator's activities on the Owner's Property. Fences removed from the Owner's Property, if replaced, shall be re-built by Operator at its expense in mutually agreeable locations. All fence repair and construction shall be substantially similar to the construction of existing fences and cattle guards on Owner's Property. Any gates opened for access to Owner's Property by either Party shall be closed immediately after passing through so that livestock may not pass through. Once completed, all replacement fences, gates and cattle guards shall be owned and maintained by Owner. Upon abandonment or termination of the rights granted to Operator in this Agreement, any fences, gates and cattle guards installed by Operator shall remain and become the property of Owner. To minimize the need for temporary fencing, Owner will cooperate with Operator to avoid pasturing animals on or near the Improvements during periods of construction, maintenance or removal activity by Operator. Owner will discuss with Operator what temporary fencing is necessary during the periods of construction, maintenance or removal activity by Operator.

11.7 **Roadway Maintenance and Repairs.** Operator agrees to maintain and repair all Roadway Improvements located on the Operator Property; provided, however, Owner shall reimburse Operator for any costs and expenses incurred by Operator to repair any damage or

perform any special maintenance of the Roadway Improvements caused by Owner or any person using the Roadway Improvements with Owner's permission, other than Operator.

12. **Taxes.**

12.1 **Owner's Taxes.** Owner covenants and agrees to pay prior to delinquency all real and personal property and other taxes, general and special assessments, and other charges of every description ("Taxes") levied or assessed against the Owner's Property and all improvements thereon by governmental authorities, other than Operator's Taxes referenced in Section 12.2 (Taxes, excepting Operator's Taxes, are hereinafter referred to as "**Owner's Taxes**").

12.2 **Operator's Taxes.**



12.3 **Failure to Pay.** In the event either Party fails to pay their share of Taxes prior to delinquency, the other Party shall have the right to pay such Taxes and any accrued penalties or interest, which payments shall increase or be offset against other Payments due under this Agreement.

12.4 **Operator's Right to Contest.** Operator may contest the legal validity or amount of any Operator's Taxes for which it is responsible under this Agreement, and may institute such proceedings as it considers necessary, provided that Operator shall bear all expenses in pursuing such contest or proceeding. With respect to any Taxes which may constitute a lien on the Owner's Property, Operator shall promptly pay such Taxes unless the proceeding in which it contests such Taxes shall operate to prevent or stay the collection of the Taxes so contested or unless Operator removes any such lien by bonding or otherwise. Owner agrees to render to Operator all reasonable assistance in contesting the validity or amount of any such Taxes, with the exception of Taxes levied by Owner, including joining in the signing of any reasonable protests or pleading which Operator may deem advisable to file; provided, however, that Operator shall reimburse Owner for its reasonable out-of-pocket expenses, including reasonable attorneys' fees incurred in connection with providing such assistance.

13. **Mortgage of Operator Property.**

13.1 **Right to Mortgage.** Operator may, upon written notice to Owner, but without requiring Owner's consent or approval, mortgage, collaterally assign, or otherwise encumber and grant security interests in all or any part of its interest in this Agreement and the Operator Property, but not in Owner's interest therein. These various security interests in all or a part of this Agreement and the Operator Property are collectively referred to as an "**Operator Mortgage**" and holder of such security interest, an "**Operator Mortgagee**". Any Operator Mortgagee shall use the Operator Property only for the uses permitted under this Agreement. Whenever Operator has granted a security interest under this Section 13, it will give Owner notice of the Operator Mortgage (including the name and address of the Operator Mortgagee for notice purposes) to Owner within thirty (30) days; provided that failure to give this notice shall not constitute a default under this Agreement, but rather shall only have the effect of not binding Owner to provide such Operator Mortgage notice until the Operator and its address is given to Owner.

13.2 **Notice of Default and Opportunity to Cure.** As a precondition to exercising any rights or remedies related to any alleged default by Operator under this Agreement, Owner shall give written notice of the default to each Operator Mortgagee at the same time it delivers notice of default to Operator, specifying in detail the alleged event of default and the required remedy. Each Operator Mortgagee or its designee shall have the right, but not the obligation, to cure any default as Operator, and/or the right, but not the obligation, to remove any Improvements or other property owned by Operator or such Operator Mortgagee located on the Owner's Property to the same extent as Operator. The cure period for any Operator Mortgagee shall be the later of (i) the end of the Operator cure period under Section 18; (ii) thirty (30) days after such Operator Mortgagee's receipt of the default notice; or (iii) if applicable, the extended cure period provided for in Section 13.3. Failure by Owner to give an Operator Mortgagee notice of default shall not diminish Owner's rights against Operator, but shall preserve all rights of the Operator Mortgagee or its designee to cure any default and to remove any Improvements or other property of Operator or the Operator Mortgagee located on the Owner's Property.

13.3 **Extended Cure Period.** If any default by Operator under this Agreement cannot be cured without the Operator Mortgagee obtaining possession of all or part of the Operator Property, then any such default shall be deemed remedied if an Operator Mortgagee: (i) within sixty (60) days after receiving notice from Owner as set forth in Section 13.2, acquires possession of all or part of the Operator Property, or begins appropriate judicial or nonjudicial proceedings to obtain the same; (ii) diligently prosecutes any such proceedings to completion; and (iii) after gaining possession of all or part of the Operator Property performs all other obligations as and when the same are due in accordance with the terms of this Agreement. If an Operator Mortgagee is prohibited by any court or by operation of any bankruptcy or insolvency laws from commencing or prosecuting the proceedings described above, the sixty (60) day period specified above for commencing proceedings shall be extended for the period of such prohibition.

13.4 **Operator Mortgagee Liability.** Any Operator Mortgagee whose interest in the Operator Property is held solely for security purposes, shall have no obligation or liability under this Agreement unless and until the Operator Mortgagee succeeds to absolute title to the

Operator Property and the rights of Operator under this Agreement. An Operator Mortgagee shall be liable to perform obligations under this Agreement only for and during the period it directly holds such absolute title.

13.5 **Certificates.** Owner shall execute any estoppel certificates (certifying as to truthful matters, including without limitation that no default then exists under this Agreement, if such be the case), consents to assignment and non-disturbance agreements as Operator or any Mortgagee may reasonably request from time to time. The Parties shall negotiate in good faith any amendment to this Agreement from time to time to include any provision that may be reasonably requested by Operator or any Operator Mortgagee to implement the provisions contained in this Agreement or to preserve an Operator Mortgagee's security interest.

13.6 **Operator Mortgagee's Right to Enforce Mortgage and Assign.** Each Operator Mortgagee shall have the right, in its sole discretion: (i) to assign its Operator Mortgage; (ii) to enforce its lien and acquire title to all or any portion of the Operator Property by any lawful means; (iii) to take possession of and operate all or any portion of the Operator Property and to perform all obligations to be performed by Operator under this Agreement, or to cause a receiver to be appointed to do so; and (iv) to acquire all or any portion of the Operator Property by foreclosure or by an assignment in lieu of foreclosure and thereafter to assign or transfer all or any portion of the Operator rights under this Agreement to a third party in accordance with Section 14. Any Operator Mortgagee or other party who acquires Operator's interest in all or a portion of the Operator Property pursuant to foreclosure or assignment in lieu of foreclosure shall not be liable to perform the obligations imposed on Operator by this Agreement, which are incurred or accruing after such Operator Mortgagee or other party no longer has ownership or possession of the Operator Property.

13.7 **New Agreement.**

13.7.1 If the Operator Property is foreclosed upon or there is an assignment in lieu of foreclosure, or if this Agreement is rejected or disaffirmed pursuant to bankruptcy law or other law affecting creditor's rights and, within ninety (90) days after such event, Operator or any Operator Mortgagee or other purchaser at a foreclosure sale shall have arranged to the reasonable satisfaction of Owner to cure any material defaults under this Agreement, and for the payment of all Annual Installment Payments or other charges due and payable by Operator as of the date of such event, then Owner shall execute and deliver to Operator or such Operator Mortgagee or other purchaser at a foreclosure sale, or to a designee of one of these parties, as the case may be, a new agreement ("**New Agreement**") which (i) shall be for a term equal to the remainder of the Term of this Agreement before giving effect to such rejection or termination; (ii) shall contain the same covenants, agreements, terms, provisions and limitations as this Agreement (except for any requirements that have been fulfilled by Operator or any Operator Mortgagee or other purchaser at a foreclosure sale prior to rejection or termination of this Agreement); and (iii) shall include that portion of the Operator Property in which Operator or such other Operator Mortgagee or other purchaser at a foreclosure sale had an interest on the date of rejection or termination.

13.7.2 If more than one Operator Mortgagee makes a written request for a New Agreement pursuant to this provision, the New Agreement shall be delivered to the Operator

Mortgagee requesting such New Agreement whose Operator Mortgage is prior in time, and the written request of any other Operator Mortgagee whose lien is subordinate shall be void and of no further force or effect. The provisions of this Section 13 shall survive the termination, rejection or disaffirmation of this Agreement and shall continue in full force and effect thereafter to the same extent as if this Section 13 were a separate and independent contract made by Owner, Operator and each Operator Mortgagee, and, from the effective date of such termination, rejection or disaffirmation of this Agreement to the date of execution and delivery of such New Agreement, such Operator Mortgagee or other purchaser at a foreclosure sale may use and enjoy the Operator Property without hindrance by Owner or any person claiming by, through or under Owner; provided that all of the conditions for the New Agreement as set forth above are complied with.

13.8 Operator Mortgagee's Consent to Amendment, Termination or Surrender. Notwithstanding any provision of this Agreement to the contrary, the Parties agree that so long as any Operator Mortgage remains outstanding, this Agreement shall not be modified or amended, and Owner shall not accept a surrender, cancellation or release of all or any part of the Operator Property from Operator, prior to expiration of the Term of this Agreement, without the prior written consent of the Operator Mortgagee holding such Operator Mortgage. This provision is for the express benefit of and shall be enforceable by each Operator Mortgagee as if it were a party named in this Agreement.

14. Assignment and Sublease. Operator shall have the right, without Owner's consent, to sell, convey, lease, or assign all or any portion of this Agreement or the Operator Property, on either an exclusive or a non-exclusive basis, or to grant subeasements, co-easements, easements, licenses or similar rights with respect to the Operator Property (collectively, "**Assignment**"), to one or more persons or entities (collectively "**Assignee**"). Each Assignee shall use the Operator Property only for the uses permitted under this Agreement. When Operator makes any Assignment under this Section 14, Operator shall give written notice to Owner of such Assignment (including the interest conveyed by the Assignment and address of the Assignee for notice purposes) to Owner; provided Operator's failure to give such notice shall not constitute a default under this Agreement, but rather shall only have the effect of not binding Owner with respect to such assignment or conveyance until such notice is given. Any Assignment by Operator shall release Operator from obligations subject thereof accruing after the date that liability for such obligations is assumed by the Assignee.

15. Hazardous Materials.

15.1 Owner's Covenants Regarding Hazardous Materials. Owner represents and warrants that, to the best of Owner's knowledge, the Owner's Property is not and has not been in violation of any federal, state or local environmental health or safety laws, statute, ordinance, rule, regulation or requirement ("**Environmental Laws**"), and Owner has not received any notice or other communication from any governmental authorities alleging that the Owner's Property is in violation of any Environmental Laws. "**Hazardous Materials**" shall mean any asbestos containing materials, petroleum, explosives, toxic materials, or substances regulated as hazardous wastes, hazardous materials, hazardous substances, or toxic substances under any

federal, state, or local law or regulation. Owner warrants that Owner has done nothing to contaminate the Operator Property with Hazardous Materials or wastes.

15.2 **Operator's Covenants Regarding Hazardous Materials.** Operator shall, at Operator's sole cost and expense, promptly take removal or remedial action required by Environmental Law with regard to any material violation of any Environmental Law with regard to any Hazardous Materials brought onto the Owner's Property by Operator or its employees, agents, or contractors. Owner shall cooperate with Operator with regard to any scheduling or access to the Owner's Property in connection with any action required hereunder.

15.3 **Operator's Indemnity Regarding Hazardous Materials.** Operator shall indemnify, defend, protect and hold Owner harmless from any liability based on: (i) the release of Hazardous Materials in, on, under or about the Owner's Property caused by Operator or its employees, agents, or contractors, or (ii) the violation by Operator or its employees, agents, or contractors of any Environmental Law. The indemnity obligations set forth herein shall survive termination of this Agreement.

16. **Insurance and Indemnity.**

16.1 **Insurance.** At all times during which Operator is conducting any activities on the Property and at all times during the Term of this Agreement, Operator shall maintain in effect (1) commercial General Liability Insurance, including bodily injury and property damage coverage with minimum limits of \$1 Million Dollars per occurrence and \$2 Million Dollars aggregate and (2) Umbrella Liability Insurance with minimum limits of \$5 Million Dollars per occurrence and \$5 Million Dollars aggregate. Operator shall name Owner as additional insured on such insurance policy and provide Owner with a certificate of such insurance.

16.2 **Indemnity by Operator.** Operator shall defend, indemnify, protect and hold Owner harmless from and against all liabilities, costs, expenses, obligations, losses, damages, claims, (collectively "**Claims**") resulting from the negligence, willful misconduct, or breach of this Agreement by Operator, its agents, contractors or employees, invitees, licensees and permittees; provided, however, that such Claims are not due to the sole negligence, willful misconduct, or breach by Owner, its agents, contractors or employees, invitees, licensees or permittees.

16.3 **Indemnity by Owner.** Owner shall defend, indemnify, protect, and hold Operator harmless from and against all Claims resulting from the negligence, willful misconduct, or breach of this Agreement by Owner, its agents, contractors or employees, invitees, licensees and permittees; provided, however, that such Claims are not due to the sole negligence, willful misconduct, or breach by Operator, its agents, contractors, employees, invitees, licensees, or permittees.

16.4 **Survival.** The obligations of the Parties under this Section 16 shall survive expiration or other termination of this Agreement.

17. **Confidentiality.** This Agreement includes confidential and proprietary information relating to Operator and the Project. Owner agrees not to provide copies of the Agreement or

disclose the terms of the Agreement to any unauthorized person or entity. Operator authorizes Owner to provide copies of the Agreement and disclose the terms thereof to Owner's family ("family" shall be deemed to include all devisees or descendants of owner by will or intestacy), attorney, accountant, financial advisor and any existing or prospective mortgagee, lessee, or purchaser for the sole purpose of evaluating and advising Owner and for no other purpose, so long as such authorized parties agree in writing to become subject to the confidentiality provisions hereto and not to provide copies of the Agreement or disclose the terms thereof to any unauthorized person or entity. Any Owner and party shall return all material containing any confidential information to Operator immediately upon its request. Any party agrees to destroy immediately upon request by Operator such analyses, compilation, studies or other documents, and any oral information will continue to be subject to the terms of this Agreement. Owner agrees that Operator will have no adequate remedy at law if any party violates any of the terms of this Agreement. In such event Operator will have the right, in addition to any other rights Operator may have, to obtain injunctive relief to restrain any breach or threatened breach by third party or specific enforcement of such terms plus reimbursement of attorneys' fees, court costs and all associated expenses. No party shall publish, file for public record, reproduce, or otherwise disseminate this document or any of the terms and provisions hereof to any party, other than the Parties set forth above without the prior written consent of Operator, which consent may be withheld for any reason and in Operator's sole discretion.

18. Default and Remedies.

18.1 Operator Payment Default.

[REDACTED]

18.1.1 Collection of Payments.

[REDACTED]

18.1.2 Terminate Agreement.

[REDACTED]

[Redacted text block]

18.2 Other Operator Default.

[Redacted text block]

18.3 Owner Default.

[Redacted text block]

19. Condemnation.

19.1 Complete Taking. If, at any time, any authority having the power of eminent domain shall condemn all or substantially all of the Operator's Property, or all of the Improvements thereon, for any public use or otherwise, then the interests and obligations of

Operator under this Agreement in or affecting the Operator's Property shall cease and terminate upon the earlier of (i) the date that the condemning authority takes physical possession of the Operator's Property or the Improvements thereon, (ii) the date that Operator is, in its sole judgment, no longer able or permitted to operate the Project on the Operator's Property in a commercially viable manner, or (iii) the date of the condemnation judgment. Operator shall continue to pay all amounts payable hereunder to Owner until the earlier of such dates, at which time the Parties shall be relieved of any and all further obligations and conditions to each other under this Agreement.

19.2 **Partial Taking.** If, at any time during the term of this Agreement, any authority having the power of eminent domain shall condemn one or more, but not all, of the Solar Panels, or any portion of the Improvements or the Operator's Property, then the interest and obligations of Operator under this Agreement as to those Solar Panels or any portion of the Improvements or the Operator's Property so taken shall cease and terminate upon the earlier of (i) the date that the condemning authority takes possession of such Solar Panels or any portion of the Improvements or the Operator's Property, (ii) the date that Operator is, in its reasonable judgment, no longer able or permitted to operate the Project on the Operator's Property, or any portion thereof, in a commercially viable manner, or (iii) the date of the condemnation judgment; and, unless this Agreement is terminated as hereinafter provided, this Agreement shall continue in full force and effect as to the remainder of the Solar Panels, Improvements and the Operator's Property. If the remainder of the Solar Panels or any other portion of the Improvements or the Operator's Property is or becomes insufficient or unsuitable for Operator's purposes hereunder, as determined by Operator in its sole discretion, then, subject to the rights of any Operator Mortgagee under Section 13, Operator shall have the right to terminate this Agreement as to the portion of the Operator's Property to which Operator continues to hold the rights, at which time the Parties shall be relieved of any further obligations and duties to each other under this Agreement.

19.3 **Apportionment, Distribution of Award.** On any taking, all sums awarded, including damages and interest, shall be paid as follows:

(a) Any portion of the award by the court on account of any cost or loss that Operator may sustain in the removal and relocation of Operator's Improvements, to Operator;

(b) Any portion of the award by the court for Operator's anticipated or lost revenues or profits, to Operator;

(c) Any portion of the award by the court for Owner's lost revenues, to Owner;

(d) All remaining amounts of the award, to Owner or Operator consistent with applicable Kentucky law.

20. **Notice.**

20.1 **Writing.** All notices given or permitted to be given hereunder shall be in writing.

20.2 **Delivery.** Notice is considered given either (i) when delivered in person to the recipient named below, (ii) upon receipt after deposit in the United States mail in a sealed envelope or container, postage and postal charges prepaid, return receipt requested or certified mail, addressed by name and address to the party or person intended, or (iii) twenty-four (24) hours from proper and timely delivery to an overnight courier service addressed by name and address to the party or person intended as follows:

Notice to Owner: Milton E. Crowder and Diane G. Crowder
8628 Highway 416 W
Robards, KY 42452



Notice to Operator: Boulevard Associates, LLC
700 Universe Blvd
Juno Beach, FL 33408
Attn: Land Services Administration

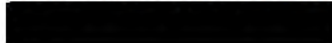

20.3 **Change of Recipient or Address.** Either Party may, by notice given at any time or from time to time, require subsequent notices to be given to another individual person, whether a party or an officer or representative, or to a different address, or both. Notices given before actual receipt or notice of change shall not be invalidated by the change.

21. **Miscellaneous Provisions.**

21.1 **Successors and Assigns.** The terms and provisions of this Agreement shall run with the land and be binding on and inure to the benefit of the heirs, successors, assigns and personal representatives of the Parties. In accordance with this Agreement, Operator in its discretion may authorize other persons or entities to use the Operator Property for the purposes stated in this Agreement

21.2 **Memorandum.** Simultaneously with the execution of this Agreement, the Parties agree to execute and acknowledge a memorandum of this Agreement. Operator may record the executed memorandum in the public records of Henderson County, Kentucky.

21.3 **Entire Agreement.** This Agreement and the attached Exhibits shall constitute the entire agreement between the Parties and supersedes all other prior writings and understandings.

21.4 **Amendments.** This Agreement shall not be amended or modified in any way except by an instrument signed by the Parties and consented to by any Operator Mortgagee. The Parties hereto shall at all times hereafter execute any documents and do any further acts which may be necessary or desirable to carry out the purposes of this Agreement and to give full force and effect to each and all of the provisions hereof.

21.5 **Legal Matters.** This Agreement shall be governed by and interpreted in accordance with the then existing laws of the Commonwealth of Kentucky and the County where

the Owner's Property is located shall be considered the proper forum or jurisdiction for any disputes arising in connection with this Agreement. The Parties agree to first attempt to settle any dispute arising out of or in connection with this Agreement by good-faith negotiation. If the Parties are unable to resolve amicably any dispute arising out of or in connection with this Agreement, each shall have all remedies available at law or in equity and as provided by this Agreement. **Each Party waives all right to trial by jury and specifically agrees that trial of suits or causes of action arising out of this Agreement shall be to the court of competent jurisdiction.**

21.6 **Severability.** If any term or provision of this Agreement, or the application thereof to any person or circumstance shall, to any extent, be determined by judicial order or decision to be invalid or unenforceable, the remainder of this Agreement or the application of such term or provision to persons or circumstances other than those as to which it is held to be invalid, shall be enforced to the fullest extent permitted by law.

21.7 **Tax Credits.** If under applicable law Operator becomes ineligible for any currently existing tax credit, benefit or incentive for alternative energy expenditure established by any local, state or federal government, then, at Operator's option, the Parties shall negotiate in good faith to amend this Agreement or replace it with a different instrument so as to convert Operator's interest in the Operator Property to a substantially similar interest that makes Operator eligible for such tax credit, benefit or incentive. Such amendment or instrument shall not impair any of Owner's rights or increase the burdens or obligations of Owner under this Agreement.

21.8 **Approvals.** Whenever in this Agreement the approval or consent of either Party is required or contemplated, unless otherwise specified, such approval or consent shall not be unreasonably withheld or delayed.

21.9 **Authority.** The signatories hereto warrant that each has the authority to execute this Agreement on behalf of any entities which are Parties to this Agreement and that each such entity has executed this Agreement pursuant to its organizational documents or a resolution or consent of their Board of Directors or other governing body.

21.10 **Time of Essence.** Time is of the essence of each provision of this Agreement.

21.11 **Counterparts.** This Agreement may be executed in multiple counterparts, each of which shall be deemed an original, and all of which together shall constitute a single instrument.

[Signatures on Next Page]

Owner:



Milton E. Crowder



Diane G. Crowder

Operator:

Boulevard Associates, LLC
a Delaware limited liability company

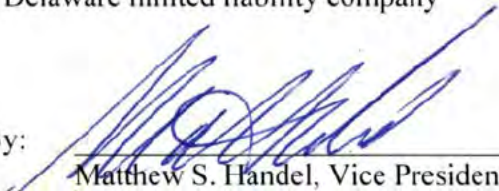
By: 

Matthew S. Handel, Vice President

EXHIBIT A

Legal Description of Owner's Property

The following described real property located in Henderson County, Kentucky, to- wit:

Beginning at a stake, corner to Sam Spencer in a few feet of a large maple tree, south 86° east 47 poles, 13 links to a stake, corner to Luther Eblen; thence north 4-3/4° east 43 poles to a stone, corner to Eblen; thence south 86° east 1 pole and 17 links to a stone; thence north 11-1/2° east 51 poles and 7 links to a stone, corner to Mrs. Wm. Eblen; thence north 87° west 33 poles to a corner in T.T. Royster's line; thence with his line south 18° west 95 poles, 16 links to the beginning, containing 21 acres, more or less but subject to legal highways.

Beginning at a stone, J.W. Otey's corner; thence running north 67-1/2° west 37 poles and 19 links to a maple stump, corner with Tom Spencer in Otey's line; thence south 27-1/2° west 179 poles and 3 links to a stone in the Royster line, corner with Tom Spencer; thence south 59-1/2° east 70 poles and 11 links to an elm in the Lithecum line, corner with Eblen; thence north 17-1/2° east 190 poles and 15 links to the beginning; containing 61.81 acres, more or less, but subject to legal highways.

Beginning at stone, corner to Samuel Spencer; thence south 88-1/2° east 117-3/4 poles to a stone in Felix Eakins' line; thence north 135 poles to a stone; thence north 88-1/2° west 117-3/4 poles to a stone; thence south with Samuel Spencer's line to the beginning, containing 100 acres, more or less, but subject to legal highways.

Beginning at a post oak stump in Lee Eakins line, corner to L.B. Eblen & W.G. Duncan & running thence with Duncan's line N. 1 W. 245 feet to a point in the middle of the Robards & Cairo Road and in L. B. Eblen's line; thence with the middle of said road S. 87-50 W. 411 feet, S. 71-10 W. 286 feet & S. 53-55 W. 126 feet to a point in middle of said road and in the T. T. Royster's line; thence with Royster's line S. 83-50 E. 616 feet to a post in said line; thence with Royster's and Lee Eakins line N. 89-45 E. 176 feet to the beginning, and containing 3.2 acres.

LESS AND EXCEPT the following tract sold by Mrs. W.D DeVasher and her husband to E. U. Weldon by deed recorded in Deed Book 109, at Page 119, Henderson County Court Clerk's Office, to- wit:

All that property located on the southeast corner of the intersection of the Robards and Tunnel Hill road and the Petersburg and Anthoston road known as Highway 283. Said parcel of land is bounded on the north by the Robards and Tunnel Hill road; on the east by the property of E.U. Weldon; on the south by the property of Lee Eakins and on the west by State Highway 283, or the Petersburg and Anthoston road, containing one acre, more or less. This is the eastern part of a lot of ground formerly owned by Rufus Eblen. Said State Highway 283 known as the Petersburg and Anthoston road cut said original lot in two, part thereof being located on the east side of said road and the other part on the west side and adjoining the lands of Mrs. W.D. DeVasher. There is only being conveyed by this deed the part that is located on the east side of said Highway 283. The part located on the west side and adjoining the land of Mrs. W.D. DeVasher is not included in this conveyance.

Being Tracts 1, 2, 3 and 6 in that certain deed from Charlotte Gregory Taylor, a Widow, to Arnold G. Taylor dated October 2, 1976, appearing of record in Deed Book 289, at Page 248, in the Henderson County Clerk's Office. Charlotte Gregory Taylor died on or about October __, 1984, thereby extinguishing her life estate in the above described property.

HOLDING PAGE FOR EXHIBIT B

Preliminary Lease and Easement Improvement Plan and Acreage Calculation
To be Delivered with Option Notice

HOLDING PAGE FOR EXHIBIT C

As Built Lease and Easement Improvements and Final Acreage Calculation

EXHIBIT D

Lease and Easement Compensation

[REDACTED]

[REDACTED]	[REDACTED]
[REDACTED]	[REDACTED]
[REDACTED]	[REDACTED]
[REDACTED]	[REDACTED]
[REDACTED]	[REDACTED]

[REDACTED]

(2) **Payment for Lease and Easements.**

[REDACTED]

[REDACTED]

[REDACTED]

[REDACTED]

(3) **Crop Compensation.**

[REDACTED]

[REDACTED]

(4) **Timber Removal.**

[REDACTED]

(5) **Payment Allocation Schedule.**

[REDACTED]

[REDACTED]

[REDACTED]

**SEBREE SOLAR II, LLC
CASE NO. 2022-00131
RESPONSE TO INFORMATION REQUEST**

SITING BOARD STAFF'S FIRST REQUEST FOR INFORMATION DATED 5/31/2023

REQUEST 2

RESPONSIBLE PARTY: Jason Andrews

Request 2. Detail any contracts by which Sebree Solar II has paid, has negotiated to pay, or any compensation paid to non-participating landowners, whether cash or-3- Case No. 2022-00131 otherwise, near the project. Include the terms of the agreements and which properties are involved in terms of distance to the project boundaries.

Response 2.

Sebree Solar II has not paid or negotiated to pay compensation to non-participating landowners near the project.

**SEBREE SOLAR II, LLC
CASE NO. 2022-00131
RESPONSE TO INFORMATION REQUEST**

SITING BOARD STAFF’S FIRST REQUEST FOR INFORMATION DATED 5/31/2023

REQUEST 3

RESPONSIBLE PARTY: Jason Andrews

Request 3. Provide a schedule for the project, starting from the receipt of the proposed certificate for construction to the completion of the project. Include the length of each construction phase.

Response 3.

<u>Milestone</u>	<u>Expected Completion Date</u>
Construction Certificate	October 2023
Interconnection Agreement Executed	Expected Mid-2024 based on past delays
All permits in hand – Solar Array	January 2025
Site Mobilization	January 2025
Civil Work Complete (7 months after mobilization)	July 2025
Mechanical Work Complete (15 months after mobilization)	March 2026
Commissioning Complete (3 months after Mechanical Work Complete)	June 2026
Commercial Operation Date	June 2026

**SEBREE SOLAR II, LLC
CASE NO. 2022-00131
RESPONSE TO INFORMATION REQUEST**

SITING BOARD STAFF'S FIRST REQUEST FOR INFORMATION DATED 5/31/2023

REQUEST 4

RESPONSIBLE PARTY: Jason Andrews

Request 4. Verify whether a power purchase agreement has been made. If so, provide.

Response 4.

Sebree Solar II has not entered into a power purchase agreement.

**SEBREE SOLAR II, LLC
CASE NO. 2022-00131
RESPONSE TO INFORMATION REQUEST**

SITING BOARD STAFF'S FIRST REQUEST FOR INFORMATION DATED 5/31/2023

REQUEST 5

RESPONSIBLE PARTY: Jason Andrews

Request 5. Provide the corporate structure of Next Era Energy Resources, LLC (Next Era).

Response 5.

NextEra Energy Resources, LLC, is a wholly owned indirect subsidiary of NextEra Energy, Inc.

**SEBREE SOLAR II, LLC
CASE NO. 2022-00131
RESPONSE TO INFORMATION REQUEST**

SITING BOARD STAFF'S FIRST REQUEST FOR INFORMATION DATED 5/31/2023

REQUEST 6

RESPONSIBLE PARTY: Jason Andrews

Request 6. List the membership interests in Sebree Solar II, LLC.

Response 6.

Sebree Solar II, LLC is a wholly owned indirect subsidiary of NextEra Energy Resources, LLC.

**SEBREE SOLAR II, LLC
CASE NO. 2022-00131
RESPONSE TO INFORMATION REQUEST**

**SITING BOARD STAFF'S FIRST REQUEST FOR INFORMATION DATED 5/31/2023
REQUEST 7**

RESPONSIBLE PARTY: Jason Andrews

Request 7. Refer to the Application, Exhibit 11 – Record of Environmental Violations. Provide the entities with an ownership interest in Sebree Solar II that were referenced in the response. Explain where the entities with that ownership interest in Sebree Solar II fit into the NextEra corporate structure.

Response 7. Sebree Solar II, LLC is a wholly owned indirect subsidiary of NextEra Energy Resources, LLC, which, in turn, is a wholly owned indirect subsidiary of NextEra Energy, Inc.

**SEBREE SOLAR II, LLC
CASE NO. 2022-00131
RESPONSE TO INFORMATION REQUEST**

SITING BOARD STAFF'S FIRST REQUEST FOR INFORMATION DATED 5/31/2023

REQUEST 8

RESPONSIBLE PARTY: Jason Andrews

Request 8. Provide the number of miles between the Sebree Solar II project and the project in Case No. 2021-00072, Electronic Application of Sebree Solar, LLC for a Certificate to Construct an Approximately 250-Megawatt Merchant Solar Electric Generating Facility and Approximately 4.5 Mile Nonregulated Transmission line in Henderson County, Kentucky, and Webster County, Kentucky Pursuant to KRS 278.700 and 807 KAR 5:100.

Response 8.

The Sebree Solar II project solar array is directly adjacent to the Sebree Solar project solar array and approximately 1.7 miles from the shared collector substation and northwestern terminus of the Sebree Solar Nonregulated Transmission Line associated with the Sebree Solar project.

**SEBREE SOLAR II, LLC
CASE NO. 2022-00131
RESPONSE TO INFORMATION REQUEST**

**SITING BOARD STAFF'S FIRST REQUEST FOR INFORMATION DATED 5/31/2023
REQUEST 9**

RESPONSIBLE PARTY: Jason Andrews

Request 9. Provide the number of miles between the Sebree Solar II project and the project in Case No. 2020-00242, Electronic Application of Unbridled Solar, LLC for a Certificate of Construction for an Approximately 160-Megawatt Merchant Electric Solar-4- Case No. 2022-00131 Generating Facility and Nonregulated Electric Transmission Line in Henderson and Webster Counties, Kentucky.

Response 9.

Based on review of the Unbridled Solar, LLC Preliminary Site Plans, dated February 2021, obtained from the Kentucky State Board of Electric Generation and Transmission case filings (https://psc.ky.gov/pscecf/2020-00242/kyunker%40mcbrayerfirm.com/02022021084811/Am_Exh_K_%28Preliminary_Site_Plan%29_.pdf), it appears that the northwestern portion of the Unbridled Solar project solar array is planned directly adjacent to the southeastern portion of the Sebree Solar II project solar array at the intersection of Spencer Thornberry Road and Route 416.

**SEBREE SOLAR II, LLC
CASE NO. 2022-00131
RESPONSE TO INFORMATION REQUEST**

SITING BOARD STAFF'S FIRST REQUEST FOR INFORMATION DATED 5/31/2023

REQUEST 10

RESPONSIBLE PARTY: Jason Andrews

Request 10. Provide the number of miles between the Sebree Solar II project and the project in Case No. 2020-00391, Electronic Application of Henderson County Solar LLC for a Certificate of Construction for an Approximately 50-Megawatt Merchant Electric Solar Generating Facility in Henderson County, Kentucky Pursuant to KRS 278.700 and 807 KAR 5:100.

Response 10.

Based on review of the Henderson County Solar, LLC Site Plans, dated June 18, 2021, obtained from the Kentucky State Board of Electric Generation and Transmission case filings (https://psc.ky.gov/pscecf/2020-00391/kristen%40gossamfordlaw.com/06252021093651/Volume_1_-_Tabs_1-13_Final.pdf), it appears that the southern portion of the Henderson County Solar project is planned approximately 4.4 miles northwest of the northern portion of the Sebree Solar II project.

**SEBREE SOLAR II, LLC
CASE NO. 2022-00131
RESPONSE TO INFORMATION REQUEST**

SITING BOARD STAFF'S FIRST REQUEST FOR INFORMATION DATED 5/31/2023

REQUEST 11

RESPONSIBLE PARTY: Jason Andrews

Request 11. Provide any overlaps in the projected construction schedules of the four projects in Henderson County, Kentucky.

Response 11.

Based on information from publicly available documents Sebree Solar II, LLC does not anticipate an overlap in construction with the three other projects in Henderson County, Kentucky. Listed below are the projected construction schedules of the additional projects in Henderson County, Kentucky. Sebree Solar II has attempted to contact the project developers to inquire about updated construction schedules. At the time of this Data Request, Sebree Solar II has not received any additional information to confirm updated construction schedules.

- Henderson County Solar project – According to [https://psc.ky.gov/pscecf/2020-00391/kristen%40gossamfordlaw.com/08272021113201/Final Responses to Data Requests.pdf](https://psc.ky.gov/pscecf/2020-00391/kristen%40gossamfordlaw.com/08272021113201/Final%20Responses%20to%20Data%20Requests.pdf), Henderson County Solar is scheduled to be in the final phase of construction with a October 31, 2023 COD. However, Sebree Solar II is not aware that construction has begun for this project and Sebree Solar II does not have additional information to confirm the updated construction schedule.

Siting Board Request 11

Page 2 of 2

- Unbridled Solar project – According to <https://nationalgridrenewables.com/unbridled/> Unbridled Solar has an anticipated COD of May 31, 2024 and should be under construction at this time. Sebree Solar II is not aware that the construction phase on Unbridled Solar has begun and Sebree Solar II does not have additional information to confirm the updated construction schedule.
- Sebree Solar project – Construction is anticipated to begin in late 2023 with an anticipated COD of year end 2025. Depending on when Unbridled Solar begins construction, there may be some construction overlap between Sebree Solar and Unbridled Solar. Unbridled Solar’s construction timeline is not known to Sebree Solar II at this time.
- Sebree Solar II project – Construction is anticipated to begin in early 2025 with an anticipated COD of mid 2026. Sebree Solar II does not anticipate any construction overlap with the three additional projects in Henderson County, Kentucky.

**SEBREE SOLAR II, LLC
CASE NO. 2022-00131
RESPONSE TO INFORMATION REQUEST**

SITING BOARD STAFF'S FIRST REQUEST FOR INFORMATION DATED 5/31/2023

REQUEST 12

RESPONSIBLE PARTY: Brian Bartels

Request 12. Describe the potential for cumulative effects on noise from construction activities of the four projects, and any steps to minimize these effects.

Response 12.

The Sebree Solar II project Sound Assessment, provided as an exhibit with the Site Assessment Report, considered both the Sebree Solar project and the Sebree Solar II project in the assessment of operational sound based on the assumption that both phases will be in operation concurrently. However, the Sound Assessment did not assess cumulative effects on noise from construction activities due to the assumption that the construction activities for the Sebree Solar and Sebree Solar II projects will not run concurrently.

Based on information publicly available, the Henderson County Solar project, which is mapped approximately 4.4 miles away from the Sebree Solar II project, is expected to be under construction from January 2023 through October 2023. Also based on publicly available information, the Unbridled Solar project, which is mapped adjacent to the southeastern portion of the Sebree Solar II project, is expected to be under construction from mid-year 2023 through May 2024. However, Sebree Solar II is not aware that construction has begun on either of these projects. With the uncertainty of the construction schedule of Henderson County Solar and Unbridled Solar, Sebree

Siting Board Request 12

Page 2 of 2

Solar II cannot determine the cumulative noise impacts from the projects. Sebree Solar II is not scheduled to overlap with any of the remaining projects in Henderson County. Sebree Solar II will continue to be aware of the Henderson County Solar and Unbridled Solar projects to understand updated construction schedules and associated timelines.

**SEBREE SOLAR II, LLC
CASE NO. 2022-00131
RESPONSE TO INFORMATION REQUEST**

SITING BOARD STAFF'S FIRST REQUEST FOR INFORMATION DATED 5/31/2023

REQUEST 13

RESPONSIBLE PARTY: Brian Bartels

Request 13. Describe the potential for cumulative effects on traffic and roadways from construction activities of the four projects, and any steps planned to minimize these effects.

Response 13.

The Traffic and Dust Study did not assess cumulative effects on construction activities between the Sebree Solar and Sebree Solar II projects due to the assumption that the construction activities for these projects will not run concurrently. Please see the response to Request No. 12 above for the approximate timelines of the two projects that are not affiliated with Sebree Solar II.

**SEBREE SOLAR II, LLC
CASE NO. 2022-00131
RESPONSE TO INFORMATION REQUEST**

SITING BOARD STAFF'S FIRST REQUEST FOR INFORMATION DATED 5/31/2023

REQUEST 14

RESPONSIBLE PARTY: **Andrew Lines**

Request 14. Describe the potential for cumulative effects on property values and land uses from the construction and operation of the four projects.

Response 14.

CohnReznick has prepared a Property Value Impact Study report, provided in the Application as Exhibit 12, Attachment A, Exhibit 1. In summary, the report includes the following conclusions: Based on a review of other academic studies noted within the Report, as well as interviews with assessors and market participants familiar with sales of property adjacent to solar farms, and the conclusions of the eleven solar farm studies CohnReznick conducted and summarized within the Report, CohnReznick concludes that there is no measurable and consistent evidence that solar farms are negatively impacting adjacent real estate property values. Given this conclusion, and CohnReznick's review of elements of the application of Sebree Solar II, LLC, CohnReznick does not expect there to be any negative impact to the real estate surrounding the applicant's Proposed Project.

**SEBREE SOLAR II, LLC
CASE NO. 2022-00131
RESPONSE TO INFORMATION REQUEST**

SITING BOARD STAFF'S FIRST REQUEST FOR INFORMATION DATED 5/31/2023

REQUEST 15

RESPONSIBLE PARTY: Jason Andrews

Request 15. Describe what steps have been taken, or will be taken, to communicate with the developers of Unbridled Solar, LLC and Henderson County Solar, LLC.

Response 15.

Sebree Solar II has taken the initial steps to open communication with the developers of both Unbridled Solar, LLC and Henderson County Solar, LLC. Phone messages and emails were sent to the perspective project website and directly to program managers to initiate communication. Sebree Solar II will establish and maintain communication with the developers from both projects to update them on project status and construction timelines.

Separately, Sebree Solar (first phase) has executed a crossing agreement with Unbridled Solar where the two transmission lines cross on land owned by Big Rivers Electric Corporation. This includes engineering drawings of how the two transmission lines will accommodate the other crossing the same land. Specific construction timelines were not included in this crossing agreement.

**SEBREE SOLAR II, LLC
CASE NO. 2022-00131
RESPONSE TO INFORMATION REQUEST**

SITING BOARD STAFF'S FIRST REQUEST FOR INFORMATION DATED 5/31/2023

REQUEST 16

RESPONSIBLE PARTY: Jason Andrews

Request 16. Refer to the Application, Exhibit 12, Site Assessment Report (SAR), Attachment 3. Provide if access to Cherry Hill Church will be impacted due to construction or operation of the Project. If yes, explain mitigation measures planned to alleviate impacts to Cherry Hill Church.

Response 16.

The Cherry Hill Church parcel is mapped adjacent to the Project Area. Several setbacks were applied to this parcel and the church building itself when developing the preliminary site plan, including a 100ft occupied structure setback from the building and a 25ft non-participating parcel setback from the parcel line. Based on the preliminary site plan, the closest Project infrastructure is a fence line of an array area, mapped approximately 110ft from the church building. Approximately 350 feet of visual screening/vegetative screening is also shown on the preliminary site plan to screen the church building from the Project infrastructure proposed to the south. Visual screening/vegetative screening is also shown to the west-northwest of the church parcel where Project infrastructure is proposed, approximately 400 feet from the church building. Construction and operation activities of the Project will not impact access to Cherry Hill Church.

**SEBREE SOLAR II, LLC
CASE NO. 2022-00131
RESPONSE TO INFORMATION REQUEST**

SITING BOARD STAFF'S FIRST REQUEST FOR INFORMATION DATED 5/31/2023

REQUEST 17

RESPONSIBLE PARTY: Jason Andrews

Request 17. Refer to the Application, Exhibit 12, SAR, Attachment 3. Provide if access to the Spencer Cemetery will be impacted due to construction or operation of the Project. If yes, explain mitigation measures planned to alleviate impacts to the Spencer Cemetery.

Response 17.

Spencer Cemetery was identified during the initial development of the Project constraints and a 100-foot setback was applied as an avoidance buffer to eliminate potential impacts to the cemetery. A preliminary access road is mapped to the southwest of the cemetery entrance, on the opposite side (west side) of Route 1299 for the Project. Construction and operation activities of the Project will not impact access to Spencer Cemetery.

**SEBREE SOLAR II, LLC
CASE NO. 2022-00131
RESPONSE TO INFORMATION REQUEST**

**SITING BOARD STAFF'S FIRST REQUEST FOR INFORMATION DATED 5/31/2023
REQUEST 18**

RESPONSIBLE PARTY: Joshua Crawford

Request 18. Refer to the Application, Exhibit 10, Attachment A, Secondary Economic Impacts, page 11. Explain if secondary impact is equivalent to induced impact in reference to the 58 jobs that will be created by the Project.

Response 18.

The secondary impact is the total estimated economic impact of the 58 jobs created as a result of the direct investment made as a part of the Sebree Solar II project. This is the same as the induced impact of the direct investment.

**SEBREE SOLAR II, LLC
CASE NO. 2022-00131
RESPONSE TO INFORMATION REQUEST**

SITING BOARD STAFF'S FIRST REQUEST FOR INFORMATION DATED 5/31/2023

REQUEST 19

RESPONSIBLE PARTY: Joshua Crawford

Request 19. Refer to the Application, Exhibit 10, Attachment A, Secondary Economic Impacts, page 11. Clarify whether the total 258 construction jobs created by the project are full-time equivalent jobs.

Response 19.

200 of the 258 jobs are construction jobs resulting from the construction phase and direct investment. The remaining 58 are those created because of that investment. In both case the jobs are full-time equivalent.

**SEBREE SOLAR II, LLC
CASE NO. 2022-00131
RESPONSE TO INFORMATION REQUEST**

**SITING BOARD STAFF'S FIRST REQUEST FOR INFORMATION DATED 5/31/2023
REQUEST 20**

RESPONSIBLE PARTY: Joshua Crawford

Request 20. Refer to the Application, Exhibit 10, Attachment A, Secondary Economic Impacts, page 11.

- a. Explain whether the employment of people who reside in counties other than Henderson County was considered in the economic impact analysis.
- b. If yes, provide a calculation of jobs created and the associated payroll for the project for the multi-county area.

Response 20.

The employment impact is measured based on the investment, not necessarily the county of residence from which the employee will come. In more rural, less integrated economies it is anticipated that some of the total employment will come from outside the county, but it is unknown exactly how much. The secondary economic impact is specific to Henderson County in its employment and economic impact.

**SEBREE SOLAR II, LLC
CASE NO. 2022-00131
RESPONSE TO INFORMATION REQUEST**

**SITING BOARD STAFF'S FIRST REQUEST FOR INFORMATION DATED 5/31/2023
REQUEST 21**

RESPONSIBLE PARTY: Joshua Crawford

Request 21. Refer to the Application, Exhibit 10, Attachment A, Local Tax Revenues, page 14.

- a. Explain if income tax or net profit tax were calculated for the project. If calculated, provide.
- b. If not calculated, explain the reasoning why the tax information was not calculated.

Response 21.a and 21.b.

Income and net-profit taxes were not calculated as a part of the economic impact. These taxes represented a relatively small and uncertain amount of money. This is especially true in the case of income taxes, which are currently being phased to zero as a result of action by the Kentucky General Assembly.

**SEBREE SOLAR II, LLC
CASE NO. 2022-00131
RESPONSE TO INFORMATION REQUEST**

**SITING BOARD STAFF'S FIRST REQUEST FOR INFORMATION DATED 5/31/2023
REQUEST 22**

RESPONSIBLE PARTY: Brian Bartels

Request 22. Refer to the Application, Exhibit 12, SAR, Attachment A, Exhibit 4, Noise Impact Assessment, pages 17-19. Provide updated maps for Figure 6-1, Figure 6-2, and Figure 6-3 with the Receptor ID numbers clearly visible and legible.

Response 22.

Due to scale, the Receptor IDs are not labeled on Figure 6-1 as it's an overview map to show that the northern portion of the Sebree Solar II project is depicted on Figure 6-2 and the southern portion of the Sebree Solar II project is depicted on Figure 6-3. See attached exhibit for the updated Figures 6-2 and 6-3 that show the Receptor ID labels at a larger font size than the original submittal.

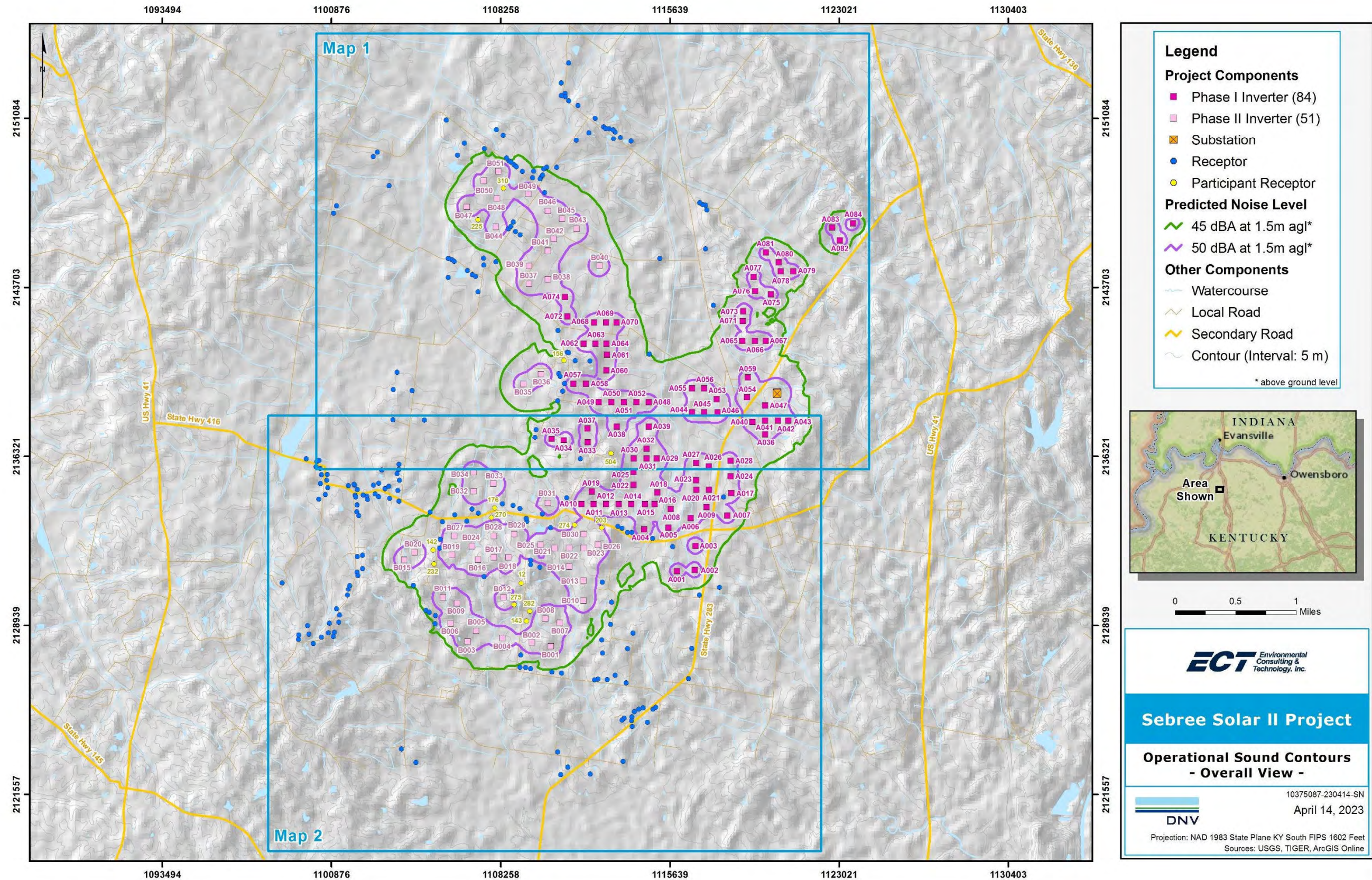

Figure 6-1 Modeled sound pressure levels within the Project area – Overall view

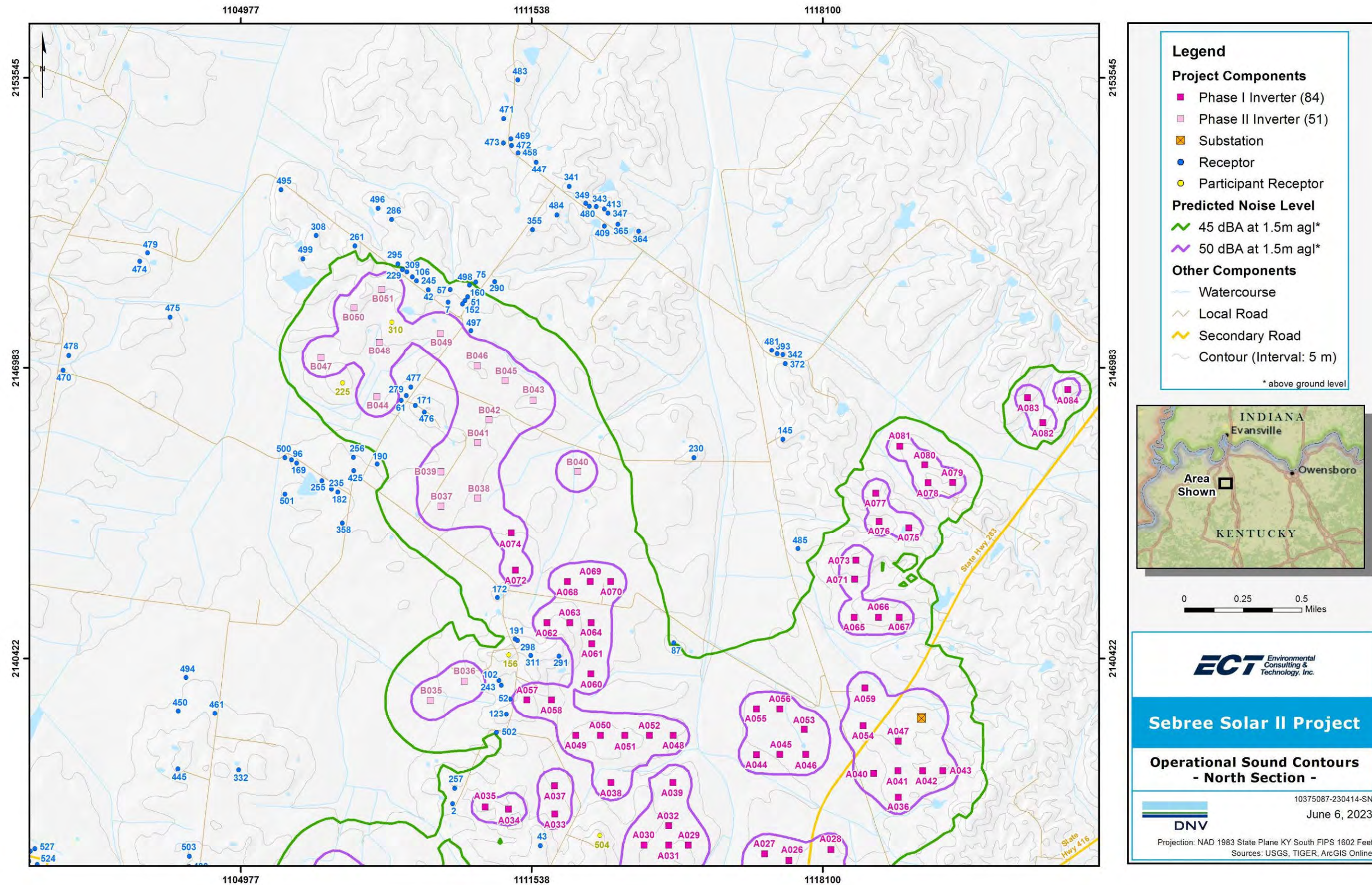

Figure 6-2 Modeled sound pressure levels within the Project area (1 of 2)

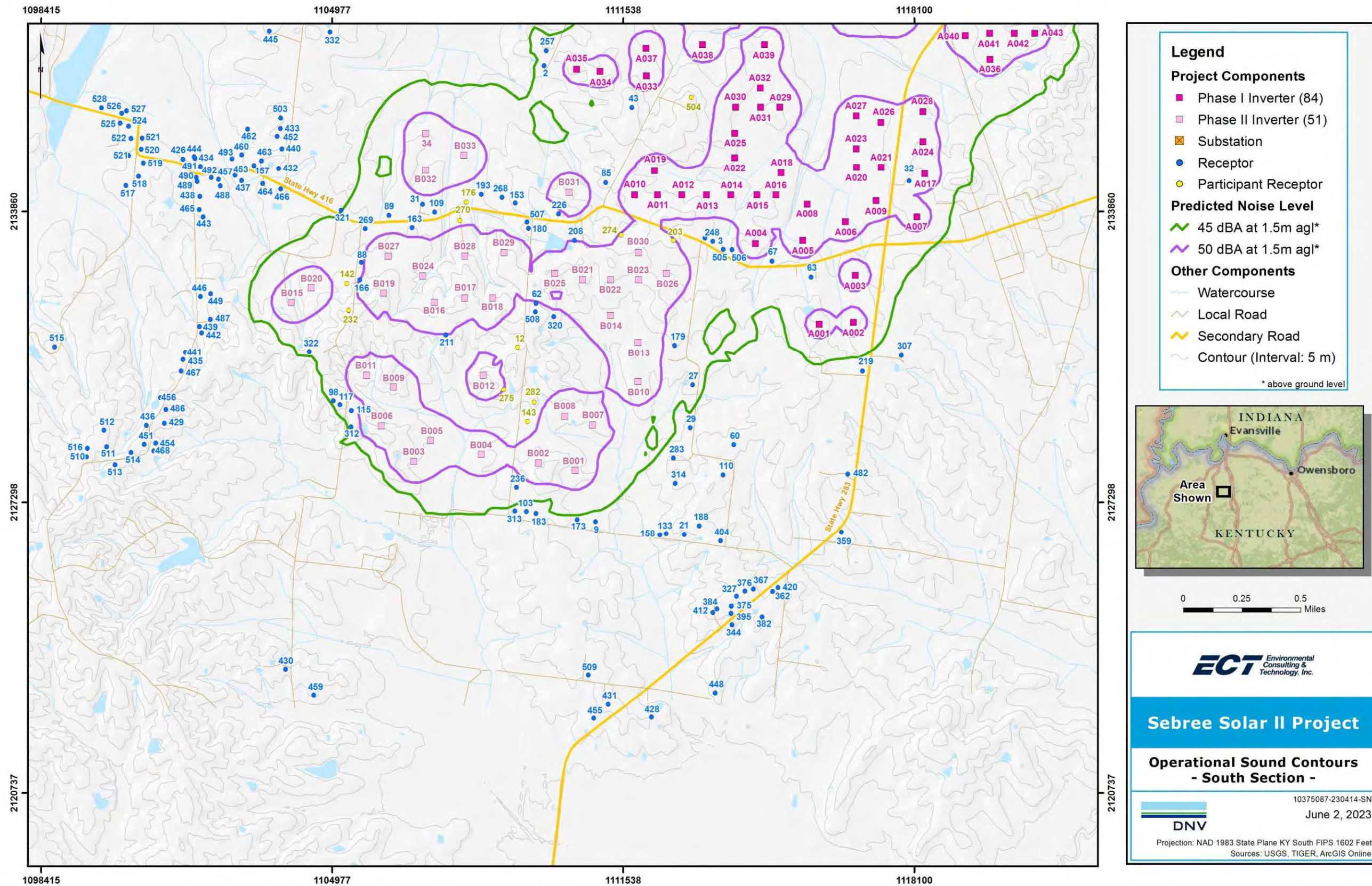

Figure 6-3 Modeled sound pressure levels within the Project area (2 of 2)

**SEBREE SOLAR II, LLC
CASE NO. 2022-00131
RESPONSE TO INFORMATION REQUEST**

**SITING BOARD STAFF'S FIRST REQUEST FOR INFORMATION DATED 5/31/2023
REQUEST 23**

RESPONSIBLE PARTY: Jason Andrews

Request 23. Refer to the Application, Exhibit 12, SAR, Attachment A, Exhibit 4, Noise Impact Assessment, page 13. DNV included a list of additional measures to mitigate noise from construction. Provide the noise mitigation measures Sebree Solar II will implement during construction.

Response 23.

Page 13 of the DNV Sound Assessment does not list additional measures. The additional measures are listed in Section 5.4, page 7 of the Noise Impact Assessment. Sebree Solar II plans on implementing the following noise mitigation measures for the Project as indicated in the SAR:

- Applicant will notify residents and businesses in the vicinity of the proposed Project about the start of construction, potential construction noises, and mitigation plans at least a month prior to commencing Project construction. These notifications will include contact information for receiving complaints.
- The Project anticipates that all construction and maintenance activities will generally occur from 8:00 AM to 6:00 PM Monday through Saturday and non-noise causing activities 6:00 AM to 10:00 PM, Monday through Sunday.

**SEBREE SOLAR II, LLC
CASE NO. 2022-00131
RESPONSE TO INFORMATION REQUEST**

SITING BOARD STAFF'S FIRST REQUEST FOR INFORMATION DATED 5/31/2023

REQUEST 24

RESPONSIBLE PARTY: Jason Andrews

Request 24. Detail any communications with members of the public, including neighboring landowners, regarding construction noise.

Response 24.

Sebree Solar II has not had any detailed communications with members of the public regarding construction noise. Sebree Solar II will communicate with members of the public, including neighboring landowners with notification of all residents and businesses in the vicinity of the proposed project about construction noise at least a month prior to commencing Project construction. These notifications will include contact information for members of the public to reach out to Sebree Solar II representatives.

**SEBREE SOLAR II, LLC
CASE NO. 2022-00131
RESPONSE TO INFORMATION REQUEST**

SITING BOARD STAFF'S FIRST REQUEST FOR INFORMATION DATED 5/31/2023

REQUEST 25

RESPONSIBLE PARTY: Brian Bartels

Request 25. Provide a chart with the expected noise level during pile driving at each noise receptor within 1,500 feet of the project boundaries.

Response 25.

The DNV Sound Assessment report, previously provided with the Sebree Solar II application, documents the expected noise level during pile driving activities in Appendix B for all participating receptors and for all non-participating receptors within one mile of the Project boundary. These tables are broken down as summarized below:

- Table 1 – Participating Residences and Distance to Closest Solar Panel (pp 25) – shows the distance to the closest solar panel and associated sound pressure level from pile driving during construction and installation of the panels.
- Table 2 – Non-Participating Residences Within One Mile and Distance to Closest Solar Panel (pp 26-30) – shows the distance to the closest solar panel and associated sound pressure level from pile driving during construction and installation of the panels.
- Table 3 – Participating Residences and Distance to Closest Inverter (pp 31) – shows the distance to the closest inverter and associated sound pressure level from pile driving during construction and installation of the inverters.

- Table 4 – Non-Participating Residences Within One Mile and Distance to Closest Inverter (pp 32-36) – shows the distance to the closest inverter and associated sound pressure level from pile driving during construction and installation of the inverters.
- Table 5 – Participating Residences and Distance to Substation Transformer (pp 37) – shows the distance to the substation transformer and associated sound pressure level from pile driving during construction and installation of the transformer.
- Table 6 – Non-Participating Residences Within One Mile and Distance to Substation Transformer (pp 37) – shows the distance to the substation transformer and associated sound pressure level from pile driving during construction and installation of the transformer.

**SEBREE SOLAR II, LLC
CASE NO. 2022-00131
RESPONSE TO INFORMATION REQUEST**

SITING BOARD STAFF'S FIRST REQUEST FOR INFORMATION DATED 5/31/2023

REQUEST 26

RESPONSIBLE PARTY: Jason Andrews

Request 26. Provide an Electrical One-Line diagram of the Project.

Response 26.

Please see attached for the Electrical One-Line diagram of the Project.

41 X TMEIC ESS-PSCS 3.71 MW / 4.05MVA Inverters 166.05MVA

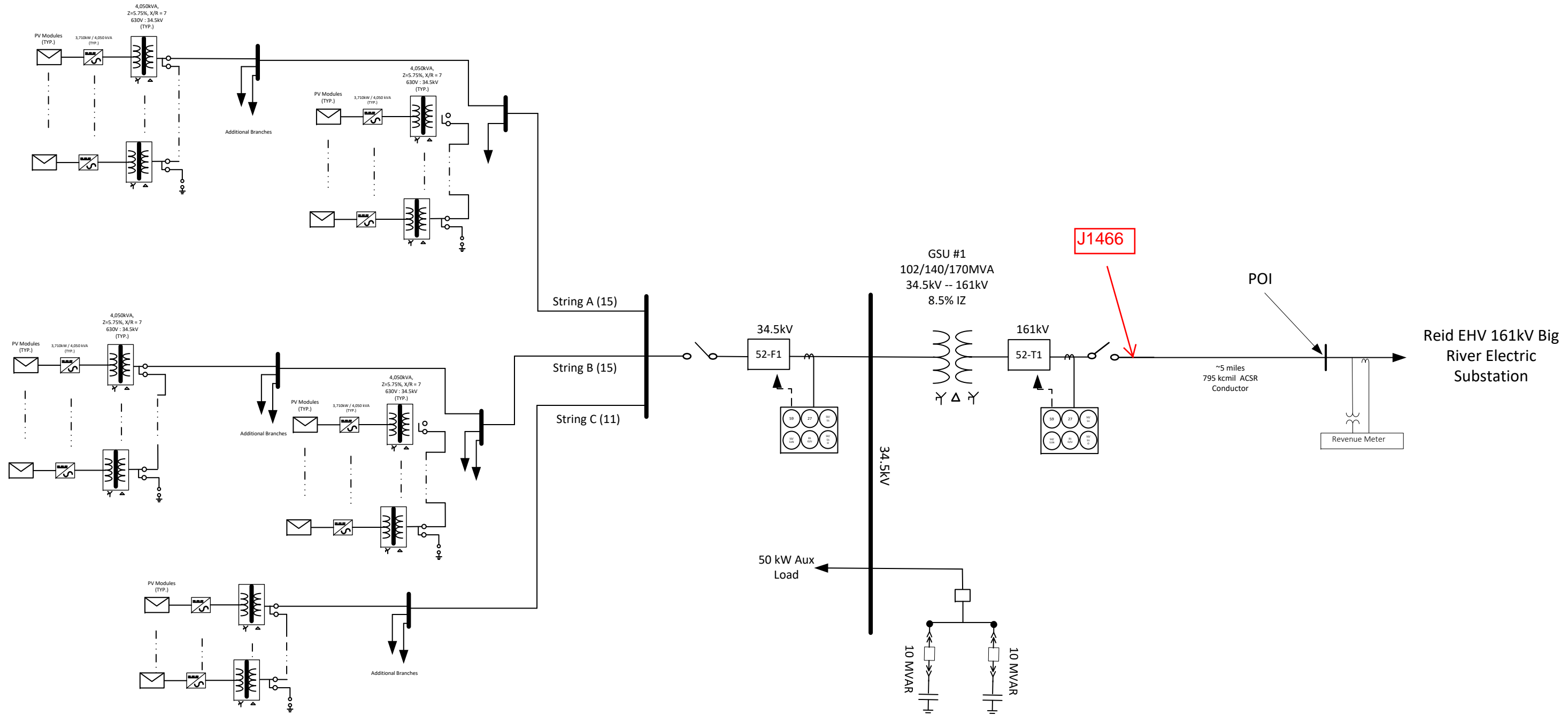

INDIVIDUAL GENERATOR DATA

Type of Generator: PV
 Manufacture & Model: TMEIC : NINJA4050
 Number of Gen Units: 41
 MVA Rating: 4.05MVA
 Rated Output (Pmax): 3.71MW
 Net Output: _____ MW
 Voltage Rating: : 0.630V
 Rated PF: 0.92

EQUIVALENT GENERATOR DATA

MVA Rating: 166.05MVA
 Rated Output (Pmax): 152.11 MW
 PF Regulation Range: +/- 0.92

**ISO Application
NOT FOR CONSTRUCTION**

	Seebree Solar II			
	Power: 150 MW Solar Interconnect Voltage: 161 kV			
DRAWN BY: C. W. Robinson	Size B	FSCM No N/A	DWG No. E1	REV 1
06/09/2020	SCALE: NONE		SHEET: 1 OF 1	

**SEBREE SOLAR II, LLC
CASE NO. 2022-00131
RESPONSE TO INFORMATION REQUEST**

**SITING BOARD STAFF'S FIRST REQUEST FOR INFORMATION DATED 5/31/2023
REQUEST 27**

RESPONSIBLE PARTY: Jason Andrews

Request 27. Provide information on the specifications, model number, and cutsheets of the photovoltaic (PV) cell/solar panels to be used.

Response 27.

The PV cell/solar panel modules to be purchased, including the specifications, are not yet finalized. Sebree Solar II will finalize this during the detailed engineering phase.

**SEBREE SOLAR II, LLC
CASE NO. 2022-00131
RESPONSE TO INFORMATION REQUEST**

SITING BOARD STAFF'S FIRST REQUEST FOR INFORMATION DATED 5/31/2023

REQUEST 28

RESPONSIBLE PARTY: Jason Andrews

Request 28. Provide information on where the PV cells/solar panels and the plant equipment are manufactured.

Response 28.

The PV cell/solar panel modules to be purchased, including the specifications, are not yet finalized. The sourcing of PV cells/solar panels will be decided just prior to the start of construction. Where it is practical and economic to do so, the Project will utilize components made in the United States.

**SEBREE SOLAR II, LLC
CASE NO. 2022-00131
RESPONSE TO INFORMATION REQUEST**

SITING BOARD STAFF'S FIRST REQUEST FOR INFORMATION DATED 5/31/2023

REQUEST 29

RESPONSIBLE PARTY: Jason Andrews

Request 29. Identify whether storage is being used and provide safety data sheets/cutsheets for any proposed energy storage system.

Response 29.

No large-scale energy storage is planned for the Project. Industry standard backup power batteries will be used in the control building.

**SEBREE SOLAR II, LLC
CASE NO. 2022-00131
RESPONSE TO INFORMATION REQUEST**

SITING BOARD STAFF'S FIRST REQUEST FOR INFORMATION DATED 5/31/2023

REQUEST 30

RESPONSIBLE PARTY: Jason Andrews

Request 30. Provide information on any fiber optic or communication network installed as a part of the project and any excavation that may be required for the installation.

Response 30.

Sebree Solar II plans to bury fiber optics throughout the site in trenches along with buried collection cables, where feasible. There will be a star network fiber configuration connecting each inverter to the control house in the substation for monitoring and control.

**SEBREE SOLAR II, LLC
CASE NO. 2022-00131
RESPONSE TO INFORMATION REQUEST**

SITING BOARD STAFF'S FIRST REQUEST FOR INFORMATION DATED 5/31/2023

REQUEST 31

RESPONSIBLE PARTY: Jason Andrews

Request 31. Provide information relating to Next Era's participation in the creation of the Henderson County Solar Ordinance.

Response 31.

NextEra Energy Resources representatives provided input to the draft Henderson County Solar Ordinance in 2019 prior to the final version being enacted. Comments from NextEra Energy Resources representatives included a request for flexibility in using existing vegetative buffers as an alternative to installing new vegetative buffers, and flexibility in the decommissioning surety bond or other form of bond acceptable to the County. These comments were considered and incorporated into the final ordinance as enacted in 2019.

**SEBREE SOLAR II, LLC
CASE NO. 2022-00131
RESPONSE TO INFORMATION REQUEST**

**SITING BOARD STAFF'S FIRST REQUEST FOR INFORMATION DATED 5/31/2023
REQUEST 32**

RESPONSIBLE PARTY: Jason Andrews

Request 32. Provide any setbacks or right of way that is required by Henderson County for the nonregulated transmission line.

Response 32.

Sebree Solar II has reviewed the latest Henderson County zoning ordinances and is unaware of any specific setbacks or right of way that is required by Henderson County for the nonregulated transmission line. Sebree Solar, LLC is conducting the planning and detailed engineering of the nonregulated transmission line and will ensure its construction is in accordance with all local and state regulations and guidelines.

**SEBREE SOLAR II, LLC
CASE NO. 2022-00131
RESPONSE TO INFORMATION REQUEST**

**SITING BOARD STAFF'S FIRST REQUEST FOR INFORMATION DATED 5/31/2023
REQUEST 33**

RESPONSIBLE PARTY: Jason Andrews

Request 33. Explain if any additional meetings with residents of Henderson County are planned.

Response 33.

Sebree Solar II recently held a landowner dinner on June 5, 2023 to provide project updates to participating landowners. Additionally, Sebree Solar II attended the June 6, 2023 Henderson County Planning Commission meeting, which was a public hearing, to request approval of Sebree Solar II Henderson County Site Plan approval. At this time, Sebree Solar II does not have any additional meetings scheduled with the residents of Henderson County.

**SEBREE SOLAR II, LLC
CASE NO. 2022-00131
RESPONSE TO INFORMATION REQUEST**

SITING BOARD STAFF'S FIRST REQUEST FOR INFORMATION DATED 5/31/2023

REQUEST 34

RESPONSIBLE PARTY: Jason Andrews

Request 34. Provide the planned time for construction to begin and end each day.

Explain how Sebree Solar II plans to mitigate arrivals and departures to minimize disruption to the area.

Response 34.

The Project anticipates that all construction and maintenance activities will generally occur from 8:00 AM to 6:00 PM, Monday through Saturday and non-noise causing activities from 6:00 AM through 10:00 PM, Monday through Sunday. The development of a Traffic Management Plan prior to construction will serve to minimize disruption to the area.

**SEBREE SOLAR II, LLC
CASE NO. 2022-00131
RESPONSE TO INFORMATION REQUEST**

SITING BOARD STAFF'S FIRST REQUEST FOR INFORMATION DATED 5/31/2023

REQUEST 35

RESPONSIBLE PARTY: Brian Bartels

Request 35. Provide when an Approved Jurisdictional Determination will be submitted to the United States Army Corps of Engineers.

Response 35.

Sebree Solar II anticipates submitting an Approved Jurisdictional Determination request to the USACE by August 2023.

**SEBREE SOLAR II, LLC
CASE NO. 2022-00131
RESPONSE TO INFORMATION REQUEST**

SITING BOARD STAFF'S FIRST REQUEST FOR INFORMATION DATED 5/31/2023

REQUEST 36

RESPONSIBLE PARTY: Brian Bartels

Request 36. Provide any communication with United States Fish and Wildlife regarding threatened and endangered species on the Project site.

Response 36.

Sebree Solar completed the following communications regarding potential threatened and endangered species (TES) for the Sebree I Project Area and a minimum 1-mile buffer. The Sebree II Project Area is located entirely within buffer areas reviewed for Sebree I.

- USFWS's Information for Planning and Consultation (IPaC) tool
- Letter to the USFWS requesting available information on known occurrence of sensitive species within the Project Area
- Henderson County distribution list of TES
- Letter to the Kentucky Office of Nature Preserves requesting information on known occurrence of State rate and endangered plant and animal species within the Project Area.
- Letter to the Kentucky Department of Fish and Wildlife Resources requesting available information on known occurrence of State rate and endangered plant and animal species within the Project Area.

Siting Board Request 36

Page 2 of 2

Sebree Solar II also conducted a desktop study to identify any potential bat habitat in the Project Area and evaluated these areas during the fieldwork conducted between 2020 and 2023. A 25-foot setback was implemented for potential bat habitat areas in the buildable area. Where possible, tree clearing activities will be limited to the USFWS tree clearing window from October 15 – March 31.

**SEBREE SOLAR II, LLC
CASE NO. 2022-00131
RESPONSE TO INFORMATION REQUEST**

SITING BOARD STAFF'S FIRST REQUEST FOR INFORMATION DATED 5/31/2023

REQUEST 37

RESPONSIBLE PARTY: Jason Andrews

Request 37. Refer to the Application, Exhibit 10, Attachment A, page 10. For each job type provided in the table, provide the number of each type of job that will be created.

Response 37.

Sebree Solar II anticipates approximately 200 construction jobs during the 18-to-24-month construction phase of the project. The jobs listed in the Application at Exhibit 10, Attachment A, page 10 will make up a large majority of the type of jobs, but the number of each type of job has yet to be determined. The Project has not secured an Engineering, Procurement, Construction (EPC) contract to be able to identify and specify the exact numbers to put against the type of job listed in Exhibit 10, Attachment A, page 10.

**SEBREE SOLAR II, LLC
CASE NO. 2022-00131
RESPONSE TO INFORMATION REQUEST**

**SITING BOARD STAFF'S FIRST REQUEST FOR INFORMATION DATED 5/31/2023
REQUEST 38**

RESPONSIBLE PARTY: Jason Andrews

Request 38. Refer to the Application, Exhibit 10, Attachment A, page 10. For each job type, provide whether the employment will include benefits such as health insurance.

Response 38.

Sebree Solar II has not yet secured an Engineering, Procurement, Construction (EPC) contract for the project at this time. It is the responsibility of the EPC contractor to determine benefits packages for their employees, and Sebree Solar II does not have this information.

**SEBREE SOLAR II, LLC
CASE NO. 2022-00131
RESPONSE TO INFORMATION REQUEST**

SITING BOARD STAFF'S FIRST REQUEST FOR INFORMATION DATED 5/31/2023

REQUEST 39

RESPONSIBLE PARTY: Joshua Crawford

Request 39. Refer to the Application, Exhibit 10, Attachment A, page 10. Explain if these are jobs that will be created solely for Sebree Solar II or if there will be an overlap with people employed in the Sebree Solar I project.

Response 39.

These jobs are specific to the Sebree II project and investment and do not overlap with the Sebree I jobs and investment.

**SEBREE SOLAR II, LLC
CASE NO. 2022-00131
RESPONSE TO INFORMATION REQUEST**

SITING BOARD STAFF'S FIRST REQUEST FOR INFORMATION DATED 5/31/2023

REQUEST 40

RESPONSIBLE PARTY: Jason Andrews

Request 40. Explain if Sebree Solar II and Sebree Solar I will share employees for the operational phases of the Projects.

Response 40.

Sebree Solar and Sebree Solar II have not determined the exact assignment of employees of the operational phases of the projects at this time. Collectively, early estimations predict the Projects will have a total of approximately six employees. Sebree Solar anticipates up to four personnel and Sebree Solar II estimates two personnel assigned.