

COMMONWEALTH OF KENTUCKY
BEFORE THE PUBLIC SERVICE COMMISSION

In the Matter of

Electronic Application of Bluegrass Water Utility)
Operating Company, LLC for Certificates of)
Convenience and Necessity for Projects at the)
Woodland Acres Site)

Case No. 2022-00015

Bluegrass Water’s Response to Staff’s First Request for Information

The Applicant, Bluegrass Water Utility Operating Company, LLC (“Bluegrass”) herewith submit its Response to the Commissions Staff’s First Request for Information. Signed, notarized verification for these Responses appears on the following pages. The undersigned counsel is responsible for any objection noted for a particular response.

Respectfully submitted,

/s/ Kathryn A. Eckert

Katherine K. Yunker
kyunker@mcbayerfirm.com
Kathryn A. Eckert
keckert@mcbayerfirm.com
MCBRAYER PLLC
201 East Main Street; Suite 900
Lexington, KY 40507-1310
859-231-8780
fax: 859-960-2917
Counsel for Bluegrass Water Utility Operating Company

Bluegrass Water Utility Operating Company, LLC

Verification

I, **Aaron Silas**, Regulatory Case Manager of Central States Water Resources, Inc., the manager of Applicant Bluegrass Operating Company, LLC being duly sworn, state that I prepared or supervised the preparation of the following responses to PSC's First Request for Information, and that the matters and things set forth in the responses are true and correct to the best of my knowledge, information and belief formed after reasonable inquiry.



Aaron Silas

STATE OF MISSOURI)
COUNTY OF St Louis)

Subscribed, sworn to, and acknowledged this 21st day of March, 2022, before me, a Notary Public in and before said County and State.

My Commission expires: 5/4/24

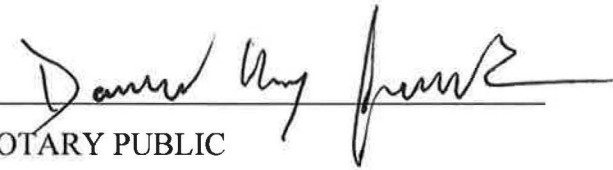
NOTARY PUBLIC

{seal}



Request

1. Refer to Application, page 4, paragraph 10.
 - a. Provide copies of all plans, specifications, drawings, manufacturer's information sheets pertaining to the moving bed biofilm reactor (MBBR) treatment system Bluegrass Water plans to install at the Woodland Acres facility.
 - b. Provide a detailed description of the MBBR treatment system Bluegrass Water plans to install and how it will be integrated into the current systems at the Woodland Acres facility.
-

Response

- a. Please see the Woodland Acres Plan Set attached hereto as KY2022-00015_BW_0001 to BW_0008.
- b. Please see the Woodland Acres Technical Specifications attached hereto as KY2022-00015_BW_0353 to KY2022-00015_BW_0359. A moving bed biofilm reactor (MBBR) system is one in which free floating media is added in a contained section of aeration treatment basin in order to provide exponentially increased surface area for the formation of biofilm while increasing the mechanical breakdown of wastewater solids through the movement of the media. This increased level of biofilm encourages more microorganism growth as well as a wider variety of microorganisms capable of breaking down pollutants and nutrients. MBBR treatment will be integrated into the current system by lower cages containing the media as well as improved diffusers into the existing aeration basic. This allows the MBBR system to be installed with no additional tankage at the facility. Additional blowers, aeration piping, and system controls will also be added to the system.

WOODLAND ACRES WWTF IN BULLITT COUNTY, KENTUCKY

PERMIT ISSUE: FEBRUARY 15, 2022
 BID ISSUE: _____, 2022
 CONSTRUCTION ISSUE: _____, 2022
 RECORD ISSUE: _____, 2022

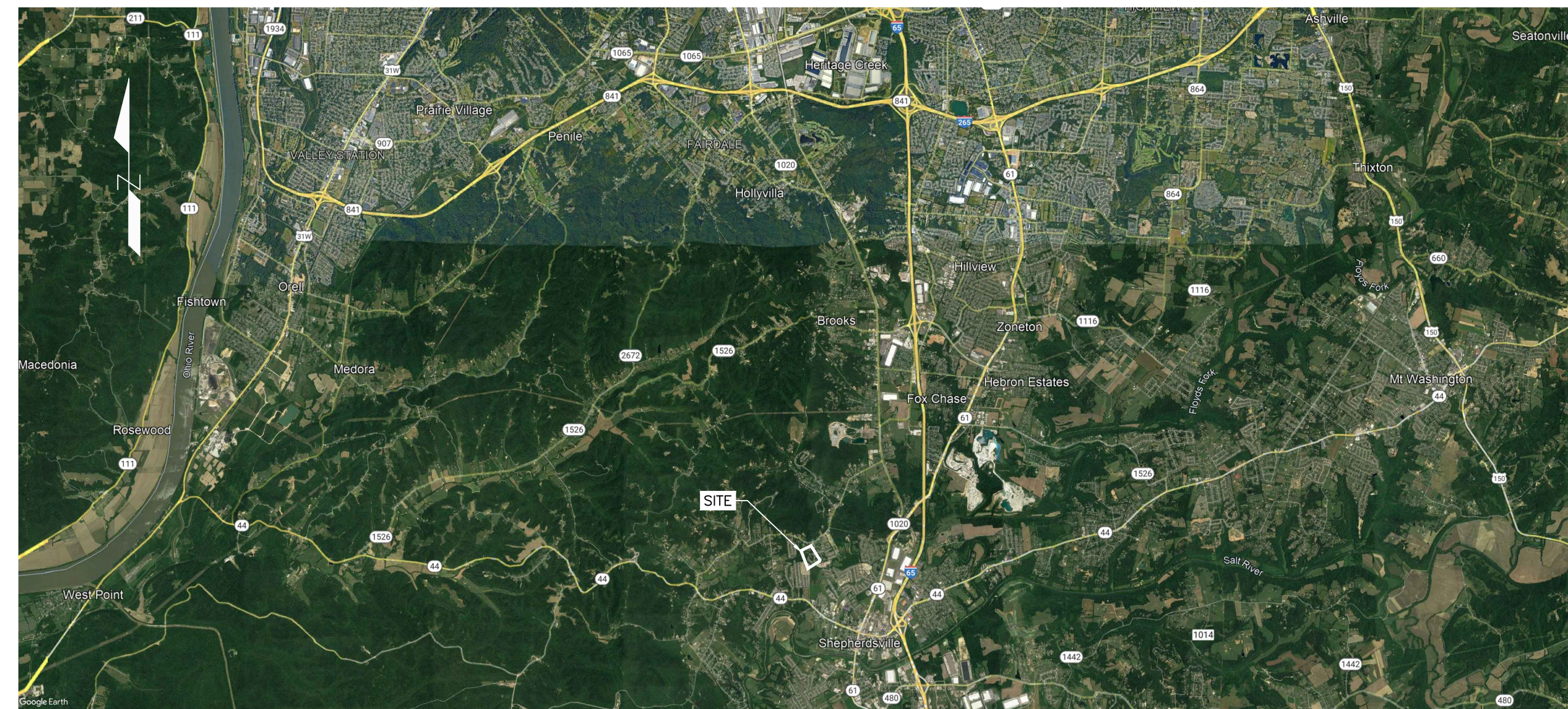

VICINITY MAP

DRAWING LIST

- C01 TITLE/COVER
- C02 NOTES
- C03 EXISTING CONDITIONS
- C04 PROPOSED SITE PLAN
- C05 CIVIL (& PROCESS) DETAILS
- P1 PROCESS FLOW DIAGRAM
- P2 WET WEATHER TANK PROCESS PLAN AND SECTIONS
- P3 IFAS DIFFUSER WELDMENT PROCESS PLAN AND SECTIONS



COVER SHEET
 WOODLAND ACRES WWTF IMPROVEMENTS
 HENLOCK DRIVE
 BULLITT, KENTUCKY



ENGINEERING CERTIFICATE OF
 AUTHORITY NO. 4804
 ENGINEERING LICENSE:
 BENJAMIN J. KUENZEL, PE33718



SEAL DATE: 2/15/2022
 DRAWN BY: KAR
 PROJ NUMBER: 542-19
 DATE: 2/15/2022
 DRAWING NO: C01

NO.	DATE	PERSON	REVISION
1	2/15/2022		PERMIT SET

ALL RIGHTS RESERVED. All 21 Design Group, Inc., plans, specifications and drawings are protected under copyright law and no part may be copied, reproduced, displayed publicly, used to create derivatives, distributed, stored in a retrieval system or transmitted in any form by any means without prior written permission of 21 Design Group, Inc.

General Notes and Construction Specifications

1. All water and sewer main construction shall be consistent with the local municipality requirements as well as all testing and disinfection requirements of Kentucky DEP.
2. The contractor shall obtain, erect, maintain and remove all signs, barricades, flagmen and other control devices as may be necessary for the purpose of regulating, warning or guiding traffic. Placement and maintenance of all traffic control devices shall be in accordance with the latest revision of the Manual on Uniform Traffic Control Devices.
3. Location of utilities shown on plans are approximate only, and are not necessarily complete. Contractor shall make his own investigations as to location of all existing underground structures, cables, utilities and pipe lines.
4. If existing utility lines of any nature are encountered which conflict in location with new construction, the contractor shall notify the engineer and owner so that the conflict may be resolved.
5. The contractor shall notify One Call at least 48 hours prior to construction so that each utility company can stake out any underground improvements that they may have which might interfere with the proposed construction.
6. The contractor shall be required to make arrangements for the proper bracing, shoring and other required protection of all roadways, structures, poles, cables and pipe lines, before construction begins. He shall be responsible for any damage to the streets or roadways and associated structures and shall make repairs as necessary to the satisfaction of the engineer and owner at his own expense.
7. The contractor shall be responsible for the protection of all private and public utilities even though they may not be shown on the plans. Any utility that is damaged during construction shall be repaired or replaced to the satisfaction of the engineer and owner by the contractor at his own expense.
8. The contractor shall examine the plans and specifications, visit the site of the work and inform himself/herself fully with the work involved, general and local conditions, all federal, state and local laws, ordinances, rules and regulations and all other pertinent items which may affect the cost and time of completion of this project before submitting a proposal.
9. All work and materials shall be in accordance with code requirements.
10. Prior to submitting his bid, the contractor shall call the attention of the engineer to any material or equipment he deems inadequate and to any item of work omitted on the plans.
11. Structures for valve vaults for water mains shall be in accordance with the improvement plans and the applicable municipality construction requirements. Where granular trench backfill is required around these structures, the cost shall be considered as incidental and shall be included in the contract unit price for the structure.
12. Frame and cover or grates for water main structures shall be as indicated within these improvement plans.
13. All final adjustments of casting will be accomplished by the use of precast concrete adjusting rings set in butyl rope joint sealant, mortar joints will not be allowed. Total height of adjusting rings used shall not exceed twelve (12") inches. cost for adjustment is considered incidental.
14. The contractor shall be responsible to place on grade and coordinate with other contractors all underground structure frames such as catch basins, inlets, manholes, hydrants, buffalo boxes, valves, etc. No additional compensation shall be paid and said adjustments shall be considered incidental to other items of construction.
15. The contractor shall restore any area disturbed to a condition equal to or better than its original use. This shall include finish grading, establishment of a vegetative cover (seeding or sod), general cleanup and pavement replacement.
16. All trenches caused by the construction of all utilities and the excavation around catch basins, manholes, inlets and other appurtenances which occur within the limits of existing or proposed pavements, sidewalks and curb and gutters or where the edge of the trench shall be within two (2') feet horizontally of said improvements shall be backfilled with compacted granular trench backfill or with approved suitable select material and properly compacted to 100% of maximum density as determined by the standard proctor dry density (ASTM d 698) compaction test. When granular material is required, the cost shall be considered incidental and shall be included in the contractors bid.
17. The depth of backfill shall be measured from the top of the pipe embedment to the finished subgrade or as noted on the plans.
18. The contractor shall be responsible for providing safe and healthful working

conditions throughout the construction of the proposed improvements.

19. The engineer will be given forty-eight (48) hours notice for any staking that is to be done. The cost of stakeout is the responsibility of the contractor.
20. The contractor shall inform the engineer and owner before work commences on each category of construction, i.e. water main, grading, pavement and drainage improvement. A twenty-four (24) hour notice shall be given for any item that requires final testing and inspection such as water mains or sanitary sewers.
21. The engineer will furnish the contractor with lines and grades necessary to the proper prosecution and control of the work. The contractor shall call the attention of the engineer to any errors or discrepancies which may be suspected in lines and grades which are established by the engineer, and shall not proceed with the work until any lines and grades which are believed to be in error have been verified or corrected by the engineer or his representative.
22. All survey monuments damaged or removed during construction of this project shall be replaced by the surveyor and said cost of replacement shall be paid by the contractor.
23. The contractor will have in his possession on the job site a copy of the plans and specifications during construction.
24. If approval for any items is required, the contractor shall contact the engineer for approval prior to ordering.
25. Any drain and/or field tile encountered by the contractor during the installation of the improvements shall be returned to original condition. This work to be considered incidental to the contract.
26. All road signs, street signs and traffic signs which need to be relocated or moved due to construction shall be taken down and stored by the contractor at his own expense, except those which are necessary for proper traffic control which shall be temporarily reset until completion of construction operations. After completion of the work, the contractor shall reset, at his expense, all said signs.
27. The contractor shall dispose of all excess excavation, unsuitable and unusable materials offsite and at an approved location in a manner that public or private property will not be damaged or endangered. This work is considered as incidental to the cost of the project. Contractor to follow any local, state, and federal guidelines for disposing of material off site.
28. No trench excavations will be permitted to remain open over any weekend, night, or any time site is left unattended.
29. Band-seal style couplings shall be used when joining sewer pipes of dissimilar materials.
30. As-built drawings shall be prepared by the contractor and submitted to the engineer as soon as the site improvements are completed. Any change in length, location or alignment shall be shown in red. As-builts will be performed by a licensed surveyor. It will include the tops and flowlines of all storm and sanitary structures.
31. The contractor is responsible for coordinating any required inspections with the engineer and city or state agency.
32. Special attention is drawn to the fact that the standard specifications requires the contractor to have a competent superintendent on the project site at all times, irrespective of the amount of work sublet. The superintendent shall be capable of reading and understanding the plans and municipality construction specifications, shall have full authority to execute orders to expedite the project, shall be responsible for scheduling and have control of all work as the agent of the contractor. Failure to comply with this provision will result in a suspension of work as provided in the contract documents.
33. The engineer and owner are not responsible for the construction means, methods, techniques, sequences or procedures, time of performance, programs or for any safety precautions used by the contractor. The contractor is solely responsible for execution of his work in accordance with the contract documents and specifications.
34. The utilities shown hereon were plotted from available information and do not necessarily reflect the actual existence, non-existence, size, type, or location of these or other utilities. The contractor shall be responsible for verifying the actual location of all utilities. All utilities shall be located in the field prior to any construction of improvements. These provisions shall in no way absolve any party from complying with the underground facility safety and damage prevention act.
35. All materials and methods of construction to meet the specifications submitted for the construction permit.
36. Construction should not commence until all permits have been received from all

governing agencies.

37. No land disturbance activities can be completed until all land disturbance permitting has been acquired. It is the responsibility of the contractor to verify permits are in place prior to activities. Contractor will be responsible for any fines that are incurred due activities completed prior to having necessary permitting in place.
38. All fill material shall be made of selected earth materials, free from broken masonry, rock, frozen earth, rubbish, organic material and debris.
39. Grading contractor shall keep existing roadways clean of mud and debris at all times. If the city or owner has to clean the roads it will be at the expense of the contractor.
40. All graded areas shall be protected from erosion by erosion control devices and/or seeding and mulching as required by all local and state agencies and permits.
41. No grade shall exceed a 3:1 slope except where noted.
42. Interim stormwater drainage control in the form of siltation control measures are required.
43. Adequate temporary off-street parking shall be provided for construction employees. Parking on non-surfaced areas shall be prohibited in order to eliminate the condition whereby mud from construction and employee vehicles is tracked onto the pavement causing hazardous roadway and driving conditions.
44. The contractor shall, at all times, contain mud and other spoils on the site. No vehicle, trailer or construction equipment is to deposit mud or any other material on public streets. Project will be stopped if streets are not cleaned immediately.
45. Public roadways shall be kept open to traffic during all phases of construction of improvements. No driving lanes shall be closed without prior written permission from the governing agency.
46. The contractor shall furnish, maintain, and remove traffic control devices for the purpose of regulating, warning, and directing traffic during construction in the public roadways. All flagmen, barricades, warning signs, etc. shall conform to the manual for uniform traffic control devices.
47. No investigation has been performed by the engineer regarding hazardous waste, underground conditions or utilities affecting the tract of land shown herein.
48. This plan is not a survey in any sort and shall not constitute a boundary survey.
49. Onsite utilities have been shown based on documents obtained from public entities.
50. See MEP/Arch. plans for site lighting and electrical design/layout.
51. Contractor shall comply with all OSHA requirements for safety and construction.
52. All utility trenches in paved areas shall be compacted to the requirements of the specific paving specification. Only granular material shall be used in utility trenches under paved areas.
53. All unsurfaced areas shall receive a minimum of 6" of topsoil. Contractor shall seed, fertilize, mulch, and maintain all disturbed areas until stabilization is provided meeting the technical specifications and/or direction of the Engineer.
54. The contractor is responsible for maintenance of sediment control bmps throughout the entire project.
55. All sewer laterals shall have a 2% minimum slope.
56. All storm sewer covers shall have the words "Storm Drain" cast in the top in letters three inches high. All sanitary sewer covers shall have "Sanitary Sewer" meeting same specification.
57. All frames, grates and covers shall be ductile iron, conforming to ASTM A48, Class 30 and shall be designed for heavy duty traffic.
58. Manhole steps shall be constructed of polypropylene conforming to ASTM D 4101 and shall meet current state and federal safety standards. Steps shall be Neenah R-1981-N or approved equal.
59. Pre-cast manholes shall be at least 48" diameter and conform with ASTM C478 and to design dimensions. All lift hole shall be thoroughly wetted and completed filled with mortar and smoothed. Structures shall be free of fractures or cracks.

All joints between pre-cast elements on manholes shall be made with an approved bitumastic material or an approved rubber gasket. Contractor shall submit shop drawings to engineer for approval prior to ordering.

60. All storm sewer 12" to 30" in diameter shall be Corrugated Polyethylene Pipe (CPP) or High Density Polypropylene (HDPP).
 - A. CPP pipe and fittings shall conform to ASTM F405 and F667 and shall have a circular cross-section and have a smooth wall interior.
 - B. End sections shall be polyethylene flared type with toe plates.
 - C. Joints shall be provided with neoprene or manufacturer's standard gaskets and meet ASTM F2881. Pipes up to shall be water tight according to D3212.
 - D. All CPP or HDPP shall be installed using embedment material meeting North Carolina Department of Transportation requirements.
 - E. Installation to conform to ASTM D2321 and pipe manufacturer's recommendations for backfill, bedding, installation, and minimum cover requirements.
 - F. Clean joints thoroughly, and coat bell, spigot and gasket with recommended lubricant before jointing.
61. Dual wall and triple wall polypropylene pipe (HDPP) shall conform to the requirements of AASHTO M330 "Standard Specification for Polypropylene Pipe, ASTM F2736 (Dual wall) for sizes 12" to 30" and ASTM F2764 (Triple wall) for sizes 30" to 60". All polypropylene pipe shall be installed according with ASTM F2321 "Standard Practice for Underground Installation of Thermoplastic Pipe for Sewers and Other Gravity-Flow Applications."



1351 Jefferson, Suite 301
 Washington, MO 63090
 Phone: 636-452-5227
 Email: mail@designgroup.net

GENERAL NOTES

**WOODLAND ACRES WWTF IMPROVEMENTS
 HENLOCK DRIVE
 BULLITT, KENTUCKY**

ENGINEERING CERTIFICATE OF AUTHORITY NO. 4804
 ENGINEERING LICENSE: BENJAMIN J. KUENZEL, PE33718



SEAL DATE: 2/15/2022
 DRAWN BY: KAR
 PROJ NUMBER: 542-19
 DATE: 2/15/2022
 DRAWING NO: C02

NO.	DATE	REVISION	PERMIT SET
1	2/15/2022		

ALL RIGHTS RESERVED. All "21 Design Group, Inc." plans, specifications and drawings are protected under copyright law and no part may be copied, reproduced, displayed publicly, used to create derivatives, distributed, stored in a retrieval system or transmitted in any form by any means without prior written permission of "21 Design Group, Inc."

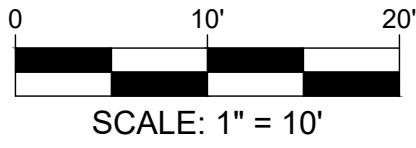
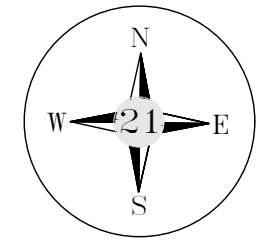

SCALE: 1" = 10'

DRAWING LEGEND

DESCRIPTION	EXISTING	PROPOSED
Easement	---	---
Setbacks	---	---
Property Lines	---	---
Aerial Electric	---	---
Tree Line	---	---
Sanitary Manhole	⊙	⊙
Utility Pole	⊙	⊙
Hydrant	⊙	⊙
Telephone Box	⊙	⊙
Water Valve	⊙	⊙
Gas Valve	⊙	⊙
Sign	⊙	⊙
Grated Inlet	⊙	⊙
Catch Basin	⊙	⊙
Grated Curb Inlet	⊙	⊙
Junction Box	⊙	⊙
Flared End Section	⊙	⊙

PAVEMENT LEGEND

Existing Asphalt	[Pattern]
Existing Concrete	[Pattern]
New Concrete	[Pattern]
New Standard Duty Asphalt	[Pattern]
New Heavy Duty Asphalt	[Pattern]
New Standard Duty Concrete	[Pattern]
New Heavy Duty Concrete	[Pattern]

EXISTING LOCATIONS

COORDINATE POINT	NORTHING	EASTING
A	3890560.078	4926587.826
B	3890443.631	4926683.201
C	3890601.547	4926597.586
D	3890624.040	4926685.018
E	3890570.981	4926699.030
F	3890565.973	4926681.210
G	3890562.510	4926669.432
H	3890547.729	4926611.579
I	3890588.232	4926604.322
J	3890591.286	4926615.844
K	3890580.050	4926619.087
L	3890576.998	4926607.565
M	3890593.217	4926621.655
N	3890604.362	4926668.478
O	3890605.512	4926673.510
P	3890598.482	4926675.520
Q	3890595.726	4926670.829
R	3890581.737	4926624.772
S	3890603.365	4926654.612
T	3890614.222	4926651.744
U	3890617.679	4926664.716
V	3890606.840	4926667.585

* NAD83 KENTUCKY STATE PLANES COORDINATES, SINGLE ZONE, US FOOT

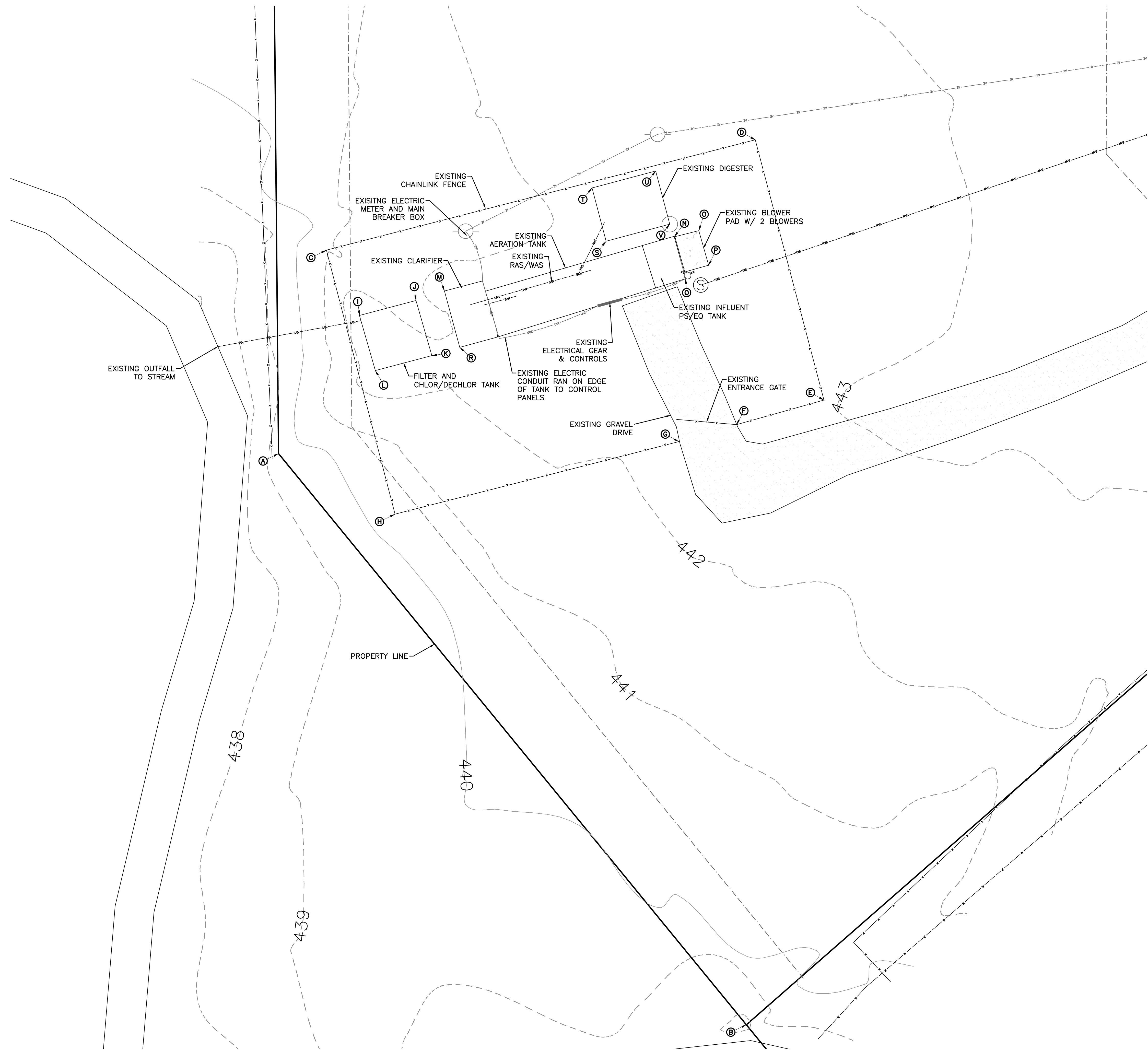

1351 Jefferson, Suite 301
Washington, MO 63090
mail@21designgroup.net
P: 636-452-5929

EXISTING CONDITIONS PLAN

WOODLAND ACRES WWTF IMPROVEMENTS
HEMLOCK DRIVE
BULLITT, KENTUCKY

ENGINEERING CERTIFICATE OF AUTHORITY NO. 4804
ENGINEERING LICENSE: BENJAMIN J. KUENZEL, PE33718



SEAL DATE	2/15/2022
DRAWN BY	KAR
PROJ NUMBER	542-19
DATE	2/15/2022
DRAWING NO.	C03

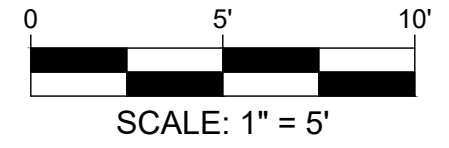
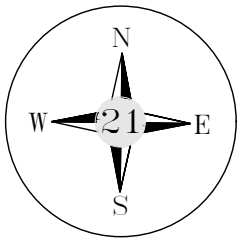

DRAWING LEGEND

Asphalt	
Concrete	
Easement	
Setbacks	
Property Lines	
Sanitary Sewer	
Gas Main	
Water Main	
Underground Telephone	
Aerial Electric	
Underground Electric	
Storm Sewer	
Contours	
Tree Line	
Sanitary Manhole	
Utility Pole	
Fire Hydrant	
Telephone Box	
Water Valve	
Gas Valve	
Sign	
Grated Inlet	
Catch Basin	
Grated Curb Inlet	
Junction Box	
Flared End Section	

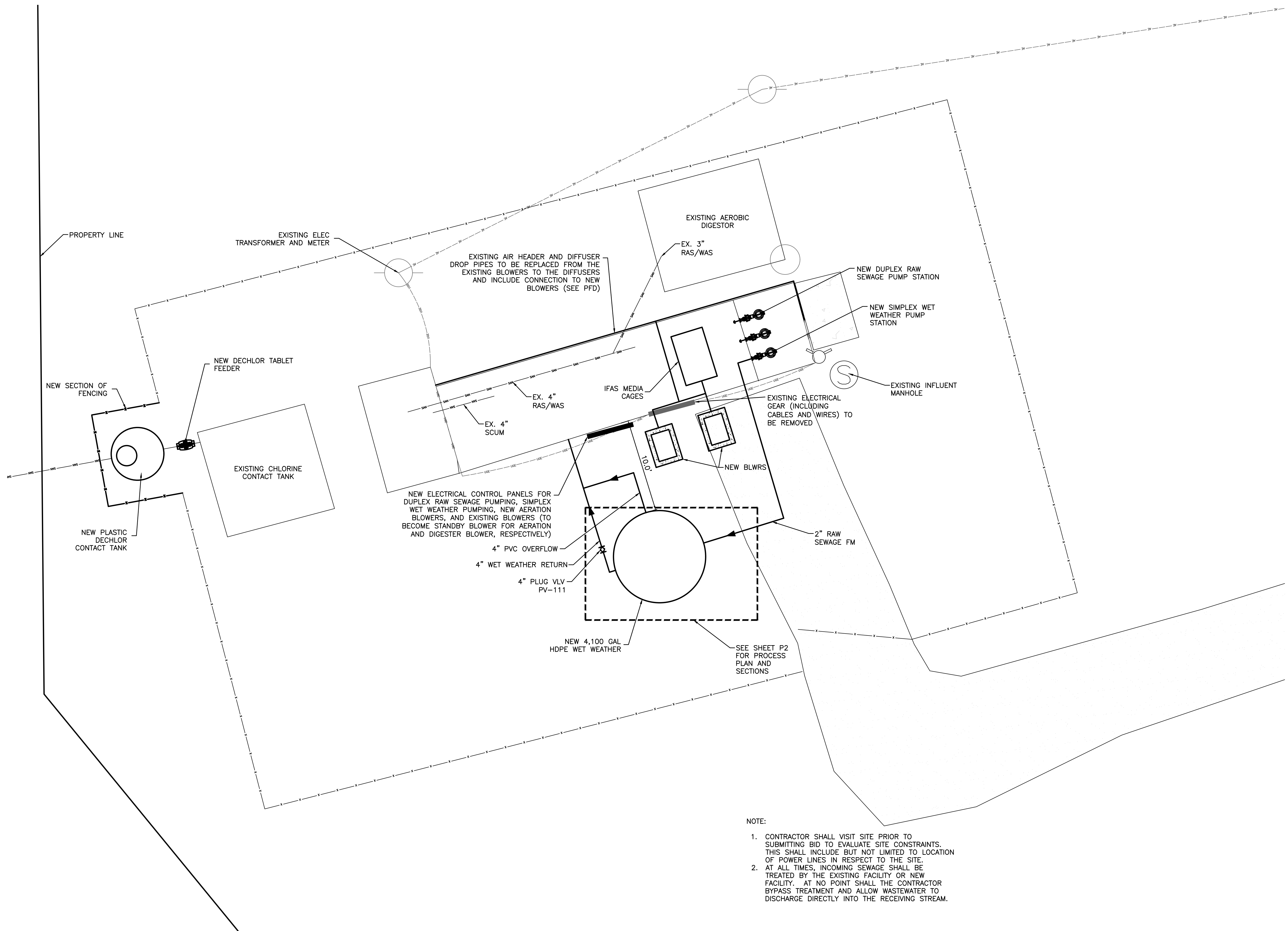

- NOTE:
1. CONTRACTOR SHALL VISIT SITE PRIOR TO SUBMITTING BID TO EVALUATE SITE CONSTRAINTS. THIS SHALL INCLUDE BUT NOT LIMITED TO LOCATION OF POWER LINES IN RESPECT TO THE SITE.
 2. AT ALL TIMES, INCOMING SEWAGE SHALL BE TREATED BY THE EXISTING FACILITY OR NEW FACILITY. AT NO POINT SHALL THE CONTRACTOR BYPASS TREATMENT AND ALLOW WASTEWATER TO DISCHARGE DIRECTLY INTO THE RECEIVING STREAM.

NO.	DATE	REVISION	PERMIT SET
1	2/15/2022		

21 DESIGN GROUP INC.
 1351 Jefferson, Suite 301
 Washington, MO 63090
 Phone: 636-452-5227
 Email: mail@21designgroup.net

SITE PLAN
 WOODLAND ACRES WWTF IMPROVEMENTS
 HENLOCK DRIVE
 BULLITT, KENTUCKY

ENGINEERING CERTIFICATE OF AUTHORITY NO. 4804
 ENGINEERING LICENSE: BENJAMIN J. KUENZEL, PE33718

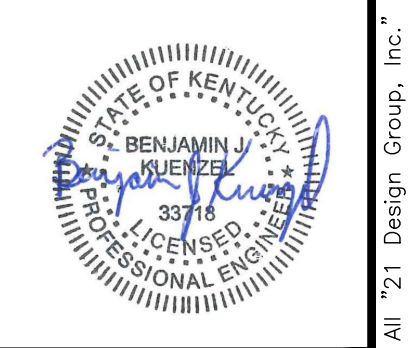

SEAL DATE	2/15/2022
DRAWN BY	KAR
PROJ NUMBER	542-19
DATE	2/15/2022
DRAWING NO.	C04

- NOTES:
1. PORTLAND CEMENT CONCRETE SHALL COMPLY WITH CURRENT DOT STANDARD SPECIFICATIONS FOR ROAD AND BRIDGE CONSTRUCTION. CONCRETE SHALL HAVE A 28-DAY COMPRESSIVE STRENGTH OF 4,000 PSI, AIR ENTRAINMENT OF 5 TO 7 PERCENT, AND SLUMP BETWEEN 1 TO 3 INCHES.
 2. SUBGRADE SHALL BE COMPACTED TO A DENSITY OF NO LESS THAN 95% OF STANDARD PROCTOR (PER ASTM D-698)
 3. SEE GEOTECHNICAL REPORT FOR PAVEMENT SPECIFICATION REQUIREMENTS.
 4. MAXIMUM JOINT SPACING SHALL BE 24 TIMES THE CONCRETE THICKNESS WITH SLABS BE NO GREATER THAN 2:1 LENGTH TO WIDTH.
 5. NON-REINFORCED CONCRETE PAVING. CONTRACTOR TO USE SMOOTH DOWELS AT CONSTRUCTION JOINTS.
 6. SEE GEOTECHNICAL REPORT FOR ALL COMPACTION, POURING, AND MATERIAL REQUIREMENTS. IF A CONFLICT EXISTS, THE GEOTECHNICAL REPORT GOVERNS.
 7. PROOF ROLL SUBGRADE DOUBLE TANDOM AXLE TRUCK PRIOR TO PLACING ROCK BASE MATERIAL.
 8. CONCRETE CURING SHALL BE PROVIDED PER ASTM C-309 OR MODOT SPECIFICATIONS, WHICHEVER IS GREATER.
 9. JOINT SEALER PER MODOT SPECIFICATIONS.
 10. WEATHER PROVISIONS SHALL COMPLY TO MODOT STANDARD CONSTRUCTION REQUIREMENTS.

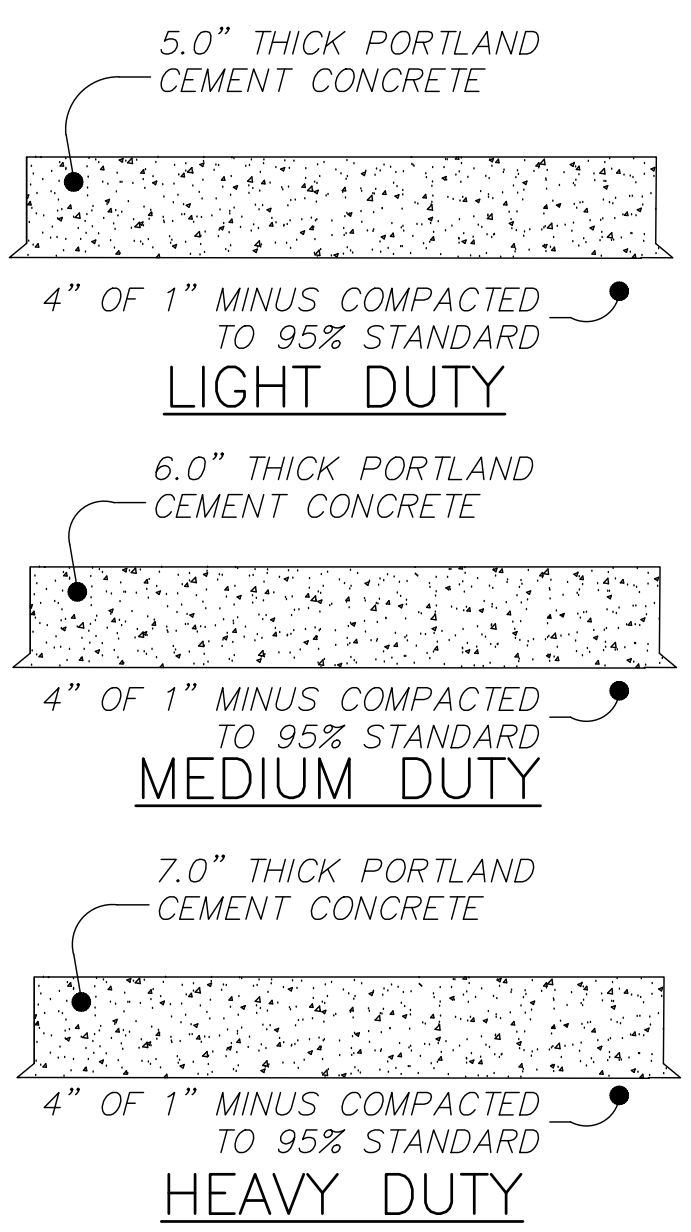

CONCRETE SECTION DETAILS
Not To Scale

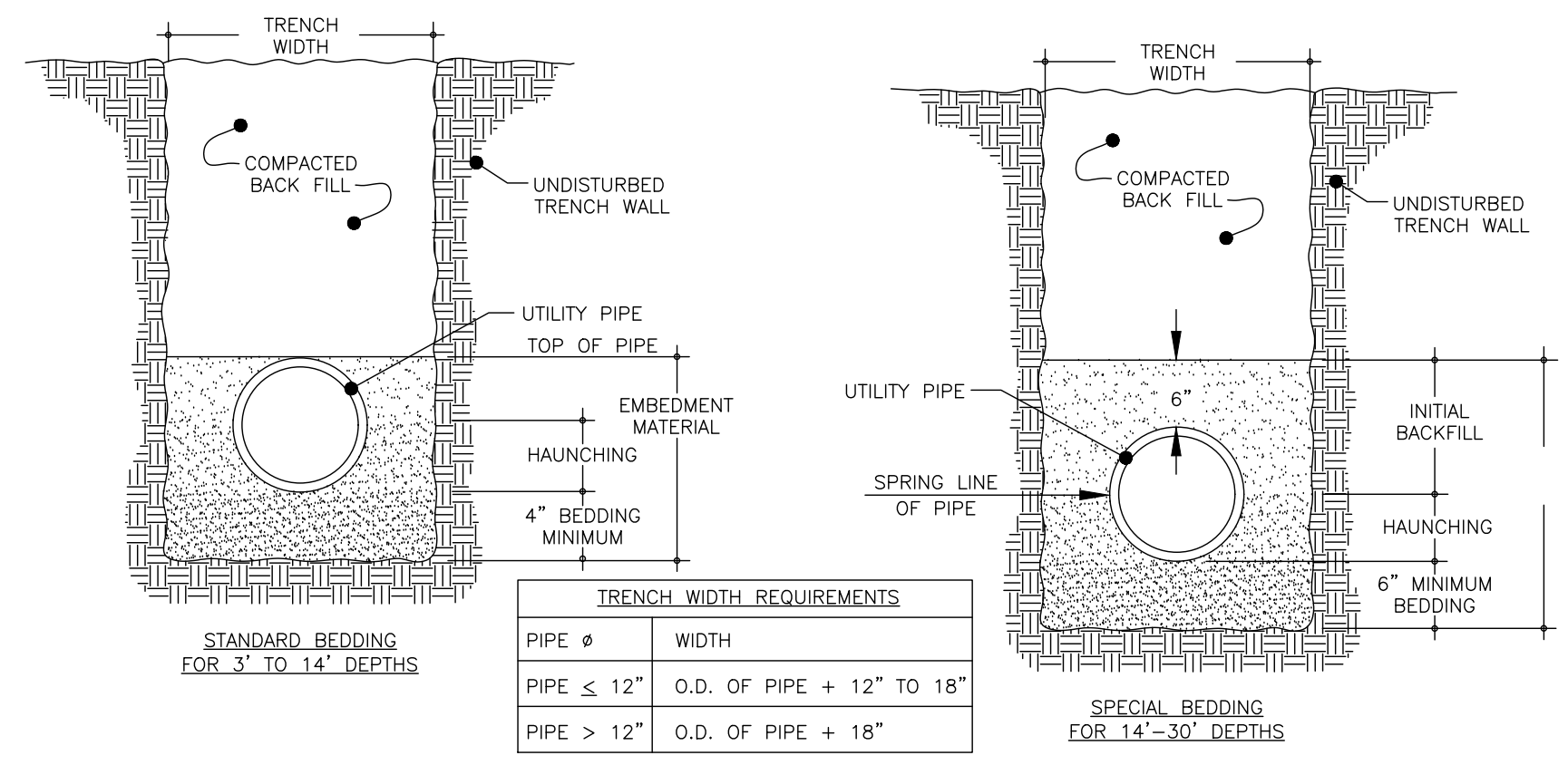

- NOTES:
1. EMBEDMENT MATERIAL MUST BE 1" MINUS GRANULAR BACKFILL.
 2. EMBEDMENT MATERIAL SHALL BE COMPACTED TO A MINIMUM 95% STANDARD PROCTOR DENSITY.
 3. STANDARD BEDDING SHALL BE UTILIZED FOR ALL CASES WHERE TRENCH BOTTOMS ARE UNSTABLE DUE TO SOIL TYPE OR MOISTURE CONDITIONS.
 4. TRENCH EXCAVATION SHALL CONFORM TO ALL OSHA CONSTRUCTION REQUIREMENTS.
 5. ANY TRENCHING UNDER PAVED AREAS SHALL BE BACKFILLED WITH 1" MINUS AND COMPACTED TO 95% STANDARD PROCTOR DENSITY.
 6. CONTRACTOR IS RESPONSIBLE FOR TRENCH SETTLEMENT.
 7. IN AREAS OF ROCK CUT, TRENCHES SHALL BE BACKFILLED WITH WELL GRADED GRANULAR MATERIAL TO 6" ABOVE THE TOP OF PIPE.
 8. ALL UTILITY INSTALLATION SHALL CONFORM TO THE PIPE MANUFACTURER.
 9. HAUNCHING SHALL BE WORKED AROUND THE PIPE BY HAND TO ELIMINATE ALL VOIDS.

UTILITY TRENCHING & BEDDING DETAIL
Not To Scale

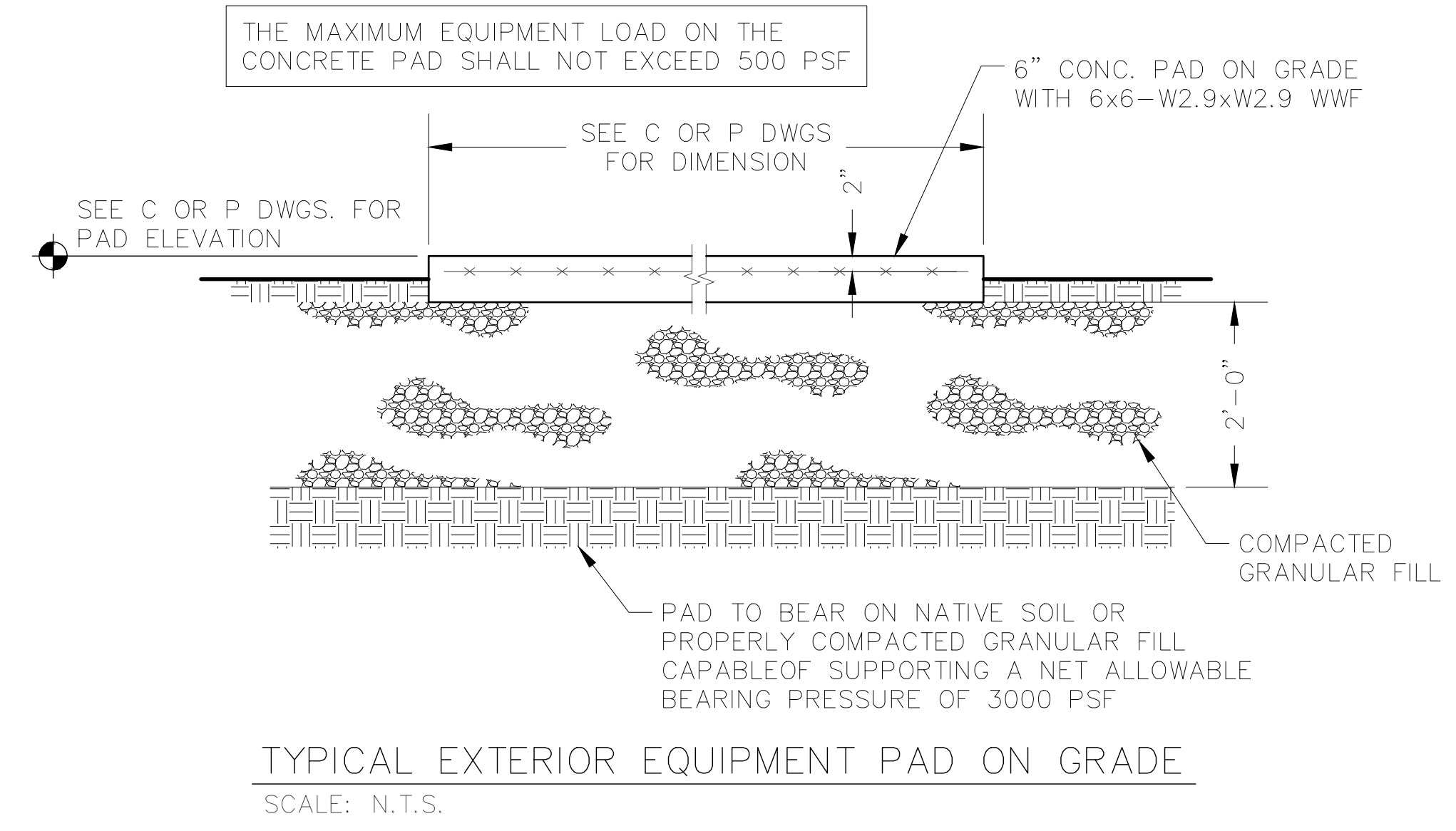

DATE	REVISION	PERMIT SET
2/15/2022		

21 DESIGN GROUP INC.
mail@21designgroup.net
1351 Jefferson, Suite 301
Washington, MO 63090
765-452-5927

DETAIL SHEET

WOODLAND ACRES WWTF IMPROVEMENTS
HEMLOCK DRIVE
BULLITT, KENTUCKY

ENGINEERING CERTIFICATE OF AUTHORITY NO. 4804
ENGINEERING LICENSE:
BENJAMIN J. KUENZEL, PE33718

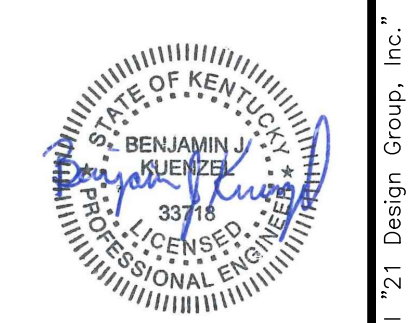

SEAL DATE	2/15/2022
DRAWN BY	KAR
PROJ NUMBER	542-19
DATE	2/15/2022
DRAWING NO.	C05

ALL RIGHTS RESERVED. All 21 Design Group, Inc., plans, specifications and drawings are protected under copyright law and no part may be copied, reproduced, displayed publicly, used to create derivatives, distributed, stored in a retrieval system or transmitted in any form by any means without prior written permission of 21 Design Group, Inc.

PLANT INFLUENT FLOW

Q_{ADF} = 25,000 GPD BOD = 225 MG/L
 Q_{PDF} = 75,000 GPD TSS = 225 MG/L
 Q_{PHF} = 100,000 GPD TKN = 40 MG/L

EFFLUENT PARAMETERS

BOD: 10 MG/L
 TSS: 30 MG/L
 NH₃-N: 4 MG/L IN WINTER
 10 MG/L IN SUMMER
 E-COLI-130 MPN/100 ML
 TOTAL RESIDUAL CHLORINE: 0.011 MG/L
 MIN. DO: 7.0 MG/L MIN.

DESIGN CRITERIA:

IFAS (CAGES)

NO. OF IFAS CAGES: 1
 DIMENSIONS: 4'x6'x10' (SWD)
 TOTAL CAGE VOLUME = 1,795 GALLONS
 INF. BOD = 225 MG/L, 47 LBS/DAY
 EFF. BOD TARGET = 68 MG/L, 14 LBS/DAY
 HRT @ ADF = 1.7 HRS
 MEDIA SURFACE RQD. = 937 M²
 MEDIA VOLUME RQD. (W/650 M²/M³ MEDIA) = 51 CF
 MEDIA VOLUME PROPOSED: 72 CF
 MEDIA FILL % = 30 %
 SCFM RQD. = 46 SCFM

WET-WEATHER STORAGE

NEW TANK VOLUME: 4,100 GAL
 NEW TANK HRT @ ADF: 3.94 HR
 TOTAL WET WEATHER VOLUME AT PLANT
 (INCLUDING EXISTING WET WEATHER TANK):
 10,832 GAL
 TOTAL WET WEATHER STORAGE RETENTION
 TIME AT ADF: 10.4 HR

WET WEATHER/INFLUENT PUMPS

P-111,112,113;
 MODEL: ZOELLER 841 GRINDER PUMP
 TDH: 30'
 GPM: 55 GPM

NEW BLOWERS

BLWR 231, 232,
 FUNCTION: EXTENDED AERATION, IFAS
 CAGES, RAS/WAS AIRLIFTS,
 POST-AERATION
 TOTAL SCFM RQD.: 118 SCFM
 SCFM/BLOWER: 59 SCFM
 DISCHARGE PRESSURE: 5.35 PSIG
 NO. OF BLOWERS: 1 EX. DEDICATED
 BLOWER, 2 NEW BLOWERS

CONTACT TANKS / POST-AERATION

VOLUME: 4,525 GAL
 HRT @ PHF: 65 MINUTES
 THE TANK WILL HAVE FOUR FLEXCAP
 DIFFUSERS USED FOR POST-AERATION TO
 MEET DO EFFLUENT MIN. OF 7 mg/L
 AIR FLOW RATE: 20 SCFM/1,000 CF
 SCFM PROVIDED: 12 SCFM

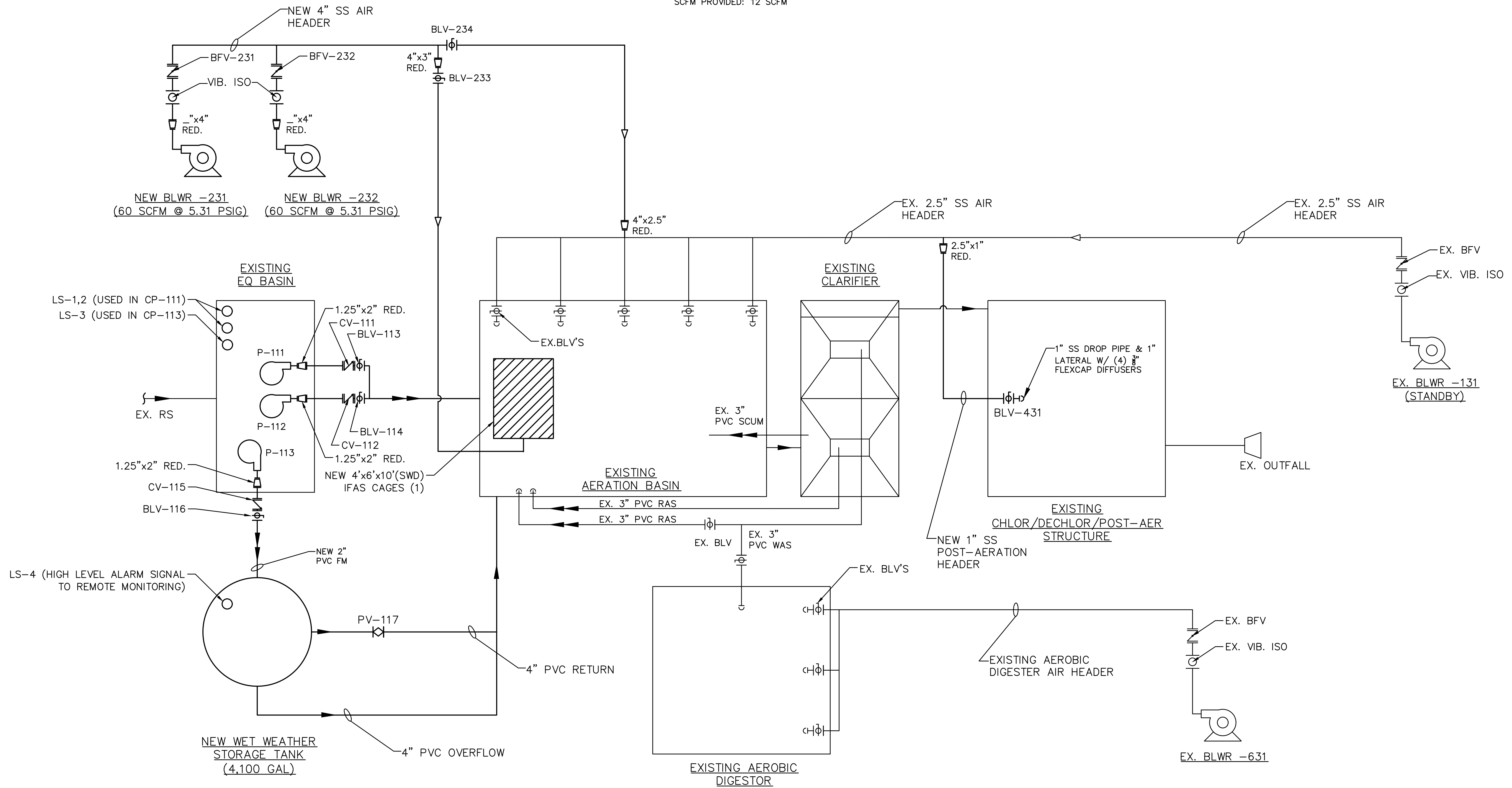

PROCESS FLOW DIAGRAM
 WOODLAND ACRES WWTF IMPROVEMENTS
 HEMLOCK DRIVE
 BULLITT, KENTUCKY

ENGINEERING CERTIFICATE OF AUTHORITY NO. 4804
 ENGINEERING LICENSE: BENJAMIN J. KUENZEL, PE33718

SEAL DATE: 2/15/2022
 DRAWN BY: KAR
 PROJ NUMBER: 0613-19
 DATE: 2/15/2022
 DRAWING NO: P1

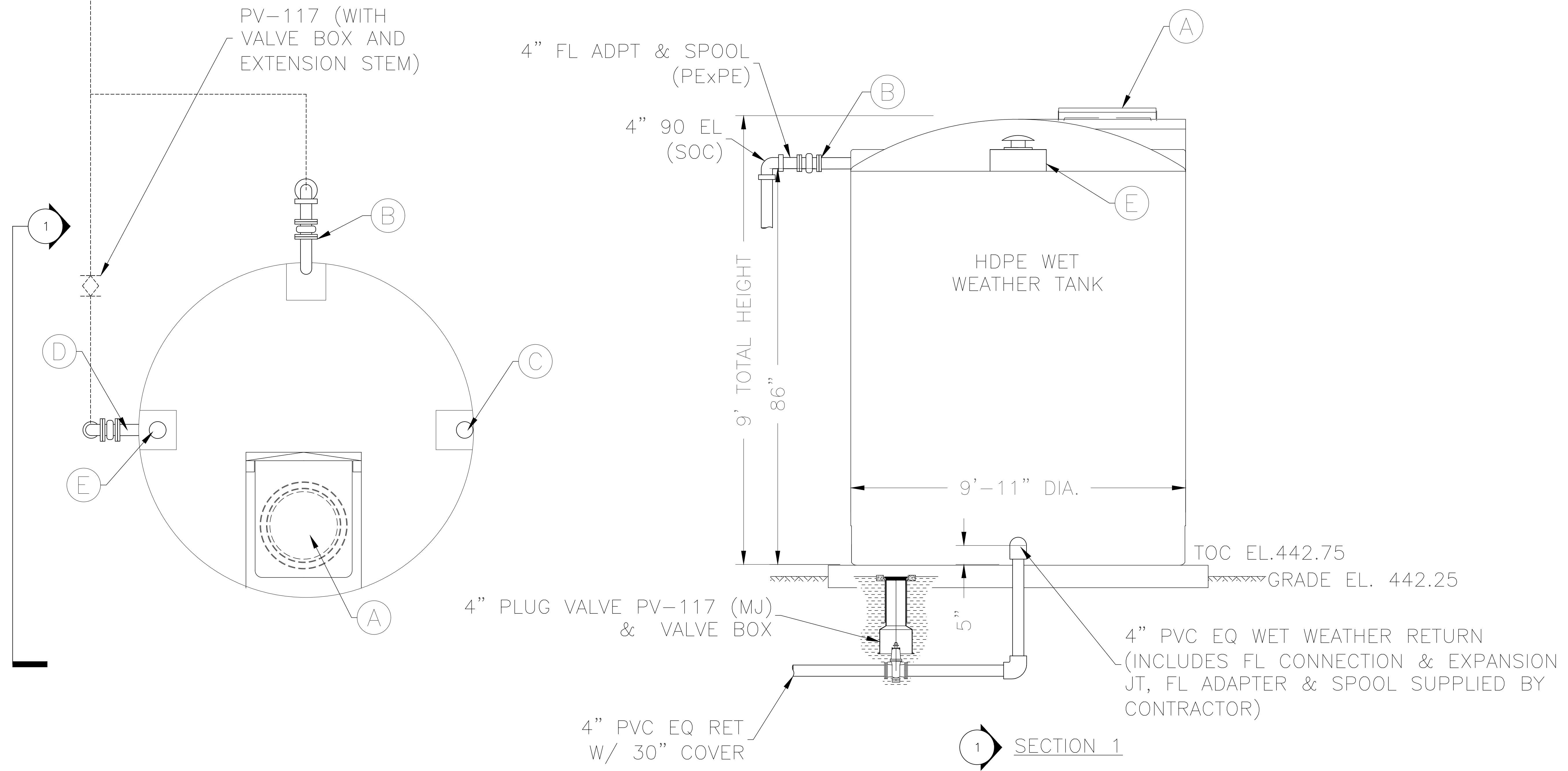

A	24" HINGED MANWAY COVER
B	4" PVC FL (FL EXP JT PROVIDED AND INSTALLED BY CONTRACTOR) OVERFLOW @ 86" AFF
C	2" PVC BULKHEAD FTG, FLANGE ADAPTER INFLUENT FM
D	4" PVC FL (EXP. JT. PROVIDED AND INSTALLED BY CONTRACTOR) & SIPHON DRAIN EQ. RETURN @ 5" AFF
E	6" POLYMUSHROOM VENT

DATE	PERSON	REVISION
2/15/2022 <td>KAR <td>PERMIT SET</td> </td>	KAR <td>PERMIT SET</td>	PERMIT SET

DESIGN GROUP INC.
 1351 Jefferson, Suite 301
 Washington, MO 63090
 Phone: 636-452-5227
 Email: info@designgroup.net

WET WEATHER TANK PROCESS PLAN AND SECTIONS
 WOODLAND ACRES WWTF IMPROVEMENTS
 HEMLOCK DRIVE
 BULLITT, KENTUCKY

ENGINEERING CERTIFICATE OF AUTHORITY NO. 4804
 ENGINEERING LICENSE: BENJAMIN J. KUENZEL, PE33718

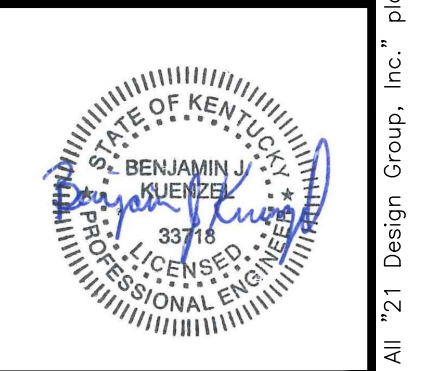

SEAL DATE	2/15/2022
DRAWN BY	KAR
PROJ NUMBER	542-19
DATE	2/15/2022
DRAWING NO.	P2

2022 WOODLAND ACRES WASTEWATER SYSTEM IMPROVEMENTS

Technical Specifications



Prepared For

Owner:

Central States Water Resources
1650 Des Peres Road, Suite 303
St. Louis, Missouri 63131

Prepared by:

21 Design Group
1351 Jefferson, Suite 301
Washington, MO 63090
636-432-2144

SECTION 000110
TABLE OF CONTENTS

SPECIFICATIONS

DIVISION 01 - GENERAL REQUIREMENTS -

- 01 10 00 - Summary
- 01 30 00 - Administrative Requirements
- 01 33 00 - Submittal Procedures
- 01 50 00 - Temporary Facilities and Controls
- 01 57 13 - Temporary Erosion and Sediment Control
- 01 64 00 - Owner Furnished Products
- 01 70 00 - Execution
- 01 78 00 - Closeout Submittals

DIVISION 02 - EXISTING CONDITIONS

- 02 41 00 - Demolition

DIVISION 03 - CONCRETE

- 03 05 10 - Leakage Testing of Hydraulic Structures
- 03 30 00 - Cast-in-Place Concrete

DIVISION 05 - METALS

- 05 50 00 - Metal Fabrications

DIVISION 09 - FINISHES

- 09 90 00 - Painting and Coating
- 09 90 10 - Painting Schedule

DIVISION 22 - PLUMBING (NOT USED)

DIVISION 26 - ELECTRICAL

- 26 05 10 - Common Motor Requirements
- 26 05 19 - Low-Voltage Electrical Power Conductors and Cables
- 26 05 33 - Raceway and Boxes for Electrical Systems
- 26 22 00 - Low-Voltage Transformers
- 26 24 16 - Panelboards
- 26 27 13 - Electricity Metering
- 26 27 26 - Wiring Devices
- 26 28 16 - Enclosed Switches and Circuit Breakers
- 26 29 13 - Enclosed Controllers
- 26 29 23 - Variable-Frequency Motor Controllers
- 26 36 00 - Transfer Switches
- 26 41 13 - Lighting Protection for Structures
- 26 56 19 - LED Exterior Lighting

DIVISION 31 - EARTHWORK

- 31 20 00 - Earth Moving
- 31 23 33 - Trenching and Backfilling

DIVISION 32 - EXTERIOR IMPROVEMENTS

- 32 15 40 - Crushed Stone Paving
- 32 31 13 - Steel Chain Link Fences and Gates

32 92 19 - Seeding

DIVISION 33 - UTILITIES

33 31 00 - Sanitary Sewer Systems

DIVISION 40 - PROCESS INTEGRATION

40 05 00 - General Piping Requirements

40 05 15 - Pressure Testing of Piping

40 05 20 - Miscellaneous Process Valves

40 05 24 - Valves, General

40 05 26 - IFAS Cages

40 05 62 - Plug Valves

40 05 63 - Ball Valves

40 05 66 - Butterfly Valves

40 05 67 - Check Valves for Specific Applications

40 07 11 - Miscellaneous Pipe Fittings and Accessories

40 07 22 - Flexible Pipe Couplings and Expansion Joints

40 07 62 - Wall Pipes, Seep Rings, and Penetrations

40 07 64 - Pipe Hangers and Supports

40 20 76 - Carbon & Stainless Steel Pipe

40 20 90 - PVC & CPVC (3 Inches and Smaller)

40 20 91 - PVC Pipe (4 Inch and Larger)

40 71 00 - Flow and Level Measurement

40 97 15 - Pressure Gauges

DIVISION 46 - WATER AND WASTEWATER EQUIPMENT

46 05 29 - Blowers and Blower Controls

46 51 03 - Air Diffusers

END OF SECTION

SECTION 011000

SUMMARY

PART 1 GENERAL

1.1 SUMMARY

- A. This section generally describes the project and includes work by others, work sequencing, Contractor's use of premises, Owner occupancy, maintenance and operation of existing facilities, special conditions, work restrictions, and utility connection fees.

1.2 LOCATION OF PROJECT SITE

- A. Woodland Acres: The project site is located at 57 Hemlock Drive Shepherdsville, Bullitt County, where shown on the drawings.

1.3 GENERAL DESCRIPTION OF WORK

- A. Woodland Acres: The work involves the addition of various treatment processes to supplement the existing treatment plant at Woodland Acres as shown and specified herein. The project will include: installation of blowers, blower control panels, and air process piping, installation of wet weather storage tank, installation of IFAS cages, design and installation of equipment pad(s), metals, access hatches, mechanical piping improvements, electrical improvements, earthwork and exterior improvements, utility improvements, process integration, process improvements, equipment supply coordination and installation, and miscellaneous improvements as shown and specified.

1.4 WORK SEQUENCE

- A. The outlined sequence of construction does not include all items necessary to complete the work but is intended to identify the sequence of critical events necessary to minimize disruption and to ensure compliance with regulatory requirements. It shall be understood by the Contractor that critical events identified are not all inclusive and that additional items of work not shown may be required. The sequence of construction is a precedence requirement and does not attempt to schedule the Contractor's work. It is intended only to indicate which activities must precede other activities in order to minimize interference and disruptions.
- B. The work sequence shall be determined by the Contractor and within ten (10) days after the "Notice to Proceed" is issued shall be:
 1. Submitted in writing to the Engineer for approval by the Engineer.
 2. The following suggested sequence of construction describes simplistically, the major events required to complete the work in the preferred order of completion. The order of events is designed to minimize disruption to the ongoing operation of the existing facilities.

1.5 CONTRACTOR'S USE OF PREMISES

- A. The Contractor's use of the project site shall be limited to its construction operations, including on-site storage of materials, on-site fabrication facilities, and field offices, as noted in the Contract Drawings.
- B. Contractor shall note the location of all utilities, such as sanitary sewer manholes, water meters and fire hydrants along the route of the work. Contractor shall maintain access to public utilities at all times. Fire hydrants that are inadvertently damaged during construction shall be reported immediately to the utility owner and fire department. The Contractor shall notify each owner and tenant of land or other property not less than five days prior to occupation of such land by the Contractor. Any agreement between the Contractor and the landowner or tenant involving the expenditure of money, materials, or equipment, and such agreement is made to complete the work on this contract, shall be in writing and acknowledged by the landowner/tenant with a copy provided to the Owner.

1.6 OWNER OCCUPANCY

- A. The Owner may utilize all or part of the existing facilities during the entire period of construction for the conduct of the Owner's normal operations. The Contractor shall cooperate with the Owner to minimize interference with the Contractor's operations and to facilitate the Owner's operations.

1.7 MAINTENANCE AND OPERATION OF EXISTING FACILITIES

- A. Work shall be scheduled and performed in such a manner as to result in the least possible disruption to the operation of the existing facilities and to the public's use of roadways, driveways, and utilities.

- B. Contractor shall perform a location investigation of existing underground utilities and facilities and shall have obtained all required permits and permissions. Contractor shall also deliver written notice to property occupants (private and public) of all planned disruption to roadways, driveways, and utilities seventy-two hours in advance of disruption.
- C. At no time shall the Contractor undertake to close off any pipelines, or open valves, or take any other action which would affect the operation of the existing system or facilities, except as specifically required by the Drawings and specifications, until authorization is granted by the Owner or Engineer and after proper notification.
- D. The facilities will be maintained in continuous operation by the Owner during the entire construction period of this contract. Work shall be scheduled and coordinated by the Contractor that such work will not impede the collection system or pump station operation or cause odor or other nuisance. In performing the work shown and specified, the Contractor shall plan and schedule his work to meet the operating requirements and all additional restrictions.
- E. Only the Owner can authorize the shutdown of any portions of the facility or system. The Contractor shall, under no circumstances, interfere with any existing component without the Owner's authorization in writing. Contractor shall notify the Owner at least 5 days in advance in writing. The Owner shall be responsible for removing facilities from operation.
- F. A planned shutdown may be cancelled by the Owner upon a 24-hour notification by the Owner/Engineer to the Contractor. Such cancellation shall be expected due to wet weather conditions or other conditions beyond the control of the Owner, Engineer or Contractor. All efforts shall be taken to check weather forecasts and the like prior to scheduling facility shutdowns. However, if a cancellation must occur, the Owner shall not be responsible for any additional costs associated with mobilization and demobilization.

1.8 SPECIAL PERMIT CONDITIONS AND WORK RESTRICTIONS

- A. Contractor shall research and report to Owner on any local jurisdiction's ordinance restricting the hours of operation for heavy construction equipment and schedule work in accordance with such ordinance. Contractor shall assume normal working hours on site may be 7 AM to 6 PM, Monday through Friday, and seek approval from Engineer or Owner for work outside of the normal working hours.

1.9 UTILITY CONNECTION FEES

- A. Contractor shall pay for utility connection fees and assessment fees including electric, water, gas, storm drain, and telephone.
- B. Submit contact information for each utility for which utility connections are desired and report to Owner or Engineer on communications with such utilities.

PART 2 PRODUCTS (NOT USED)

PART 3 EXECUTION (NOT USED)

END OF SECTION

PAGE INTENTIONALLY LEFT BLANK

**SECTION 013000 ADMINISTRATIVE
REQUIREMENTS**

PART 1 GENERAL

1.1 SUMMARY

- A. This section includes project management, project records, project meetings, photographic documentation, site safety, security, and environmental procedures.

1.2 PROJECT MANAGEMENT

- A. All work under the Contract shall be performed under the continuous supervision of competent personnel thoroughly experienced in the class of work specified. Prior to beginning the work, the Contractor shall give the Engineer, in writing, the name of the Contractor's official representative or superintendent for the project. The superintendent shall be capable of providing adequate supervision to the project and shall be responsible for receiving instructions, notices, and written orders from the Engineer. A change of the superintendent shall be reported to the Engineer in writing. Failure to provide adequate supervision to the project shall be grounds for the Engineer to require a change in supervision before allowing the work to proceed. The superintendent shall be responsible for reporting to the Engineer any inconsistencies, omissions, or lack of definite detail which is not covered on the plans or in the specification.
- B. File with the Engineer the names, phone numbers and addresses of two or more responsible persons in the Contractor's organization who are to be on call at all times. Contractor shall update the list within 24 hours of a change.
- C. The Contractor shall employ a Project Superintendent who will be responsible for continuous coordination among all phases of work. He shall serve as the Contractor's liaison with the Owner's Representative.
- D. The Project Superintendent shall have a minimum of three years of experience in the field and be acceptable to the Owner. He shall be maintained by the Contractor throughout the project and not be replaced without concurrence of the Owner.
- E. The Project Superintendent's responsibilities shall include, but not be limited to:
 - 1. Consult the contract drawings and specifications of all trades to verify and coordinate the location of the various building components and items to be installed by all Contractors. Review the daily work schedules of all Contractors for a minimum of interferences to the work of other Contractors. This work includes (but is not limited to) installation of sleeves in walls and/or foundations for electrical and mechanical pipes and damper or louver openings.
 - 2. Consult and cooperate with all Contractors and their installers for all work to determine space requirements and adequate clearances with respect to other equipment in the building. The Owner's Representative reserves the right to determine space priority in the event of interference between piping, conduit equipment, furnishings, etc., of various trades.
 - 3. Inspect, report to the Owner's representative and coordinate the removal, relocation and reconnection of any installed work which interferes with the work of other trades. All work so directed shall be at the expense of the installing Contractor.

1.3 PROJECT RECORDS

- A. During the performance of this contract, the Contractor shall maintain a suitable office at or near the site of the work which shall be the headquarters of a representative authorized to receive drawings, instructions, or other communication or articles. If a job costs less than \$100,000 the Contractor may use a workman's vehicle for the office at the site of the work and shall designate which workman's vehicle it will be.
- B. Copies of the drawings, specifications, approved shop drawings, change orders, and other contract documents shall be kept at the Contractor's office at the site of the work, and be made available for use at all times by Engineer and Owner.
- C. "As constructed" information shall be recorded on a separate set of Plans for submittal upon completion of the project. See Section 017800 for specifics on recording this information.

1.4 PRECONSTRUCTION CONFERENCE

- A. Prior to the start of work the Engineer, in cooperation with the various agencies, will establish the time and date, distribute agenda, and administer the preconstruction conference. Owner, Engineer, Contractor, major Subcontractor(s) and Governmental Agencies will attend.

1.5 PROGRESS MEETINGS

- A. Progress meetings will generally occur at the end of the month. The general job status will be discussed including progress of work, field observations, problems & decisions, shop submittal schedules and reviews, revision of construction schedule, corrective measures and project payments.

1.6 ELECTRONIC PROTOCOL

- A. This project will use electronic media for communications, submittal of shop drawings, pay requests, and other project related correspondence:

1.7 PHOTOGRAPHIC DOCUMENTATION

- A. Contractor shall be responsible for the production of pre-construction and construction photographs as provided herein.
 - 1. Pre-Construction Photographs: Photographs taken, in sufficient numbers and detail prior to the start of Work to show original construction site conditions.
 - 2. Progress Photographs: Photographs shall be taken throughout the duration of construction at regular intervals to document progress of the Work.
- B. Digital images shall be electronically transferred monthly and at the end of the project on computer disks in JPEG format. Each image shall be labeled with the date taken.
- C. Contractor shall provide electronic copies of photographs at the completion of the project before final payment is made.

1.8 OWNER PURCHASED EQUIPMENT AND MATERIAL

- A. Owner will be purchasing equipment and materials for the project which may affect the Work Sequence and Work Schedule. The following delivery schedule will be described elsewhere.
- B. Owner will be purchasing equipment and materials for the project which may affect the Work Sequence and Work Schedule. Refer to Section 016400 for the details and dates of arrival of the Owner's purchased equipment and materials for the project. Double handling may be required when equipment must be moved from a common carrier and placed in a temporary storage area.

1.9 AVAILABLE LAND

- A. Owner is providing for all land and access required for constructing the Work. If it is necessary or desirable that the Contractor use land outside of the Owner's acquired land, the Contractor shall obtain a written agreement with the landowner. The agreement between Contractor and property owner shall describe in detail such items as removal of fences, installation of temporary fences, limits of land to be occupied, and any costs associated with crop damage.

1.10 CONSTRUCTION PROGRESS SCHEDULE

- A. Develop an overall schedule and submit two copies within seven days of Notice to Proceed for review and approval to Owner's Representative a schedule of the work to be completed on the Project.
- B. Revise the schedule as requested by the Owner's Representative when:
 - 1. Work progress falls 10 percent behind scheduled progress.
 - 2. When time extensions are approved for changes and causes beyond Contractor's control.
 - 3. When Contractor feels a significant reorganization of activities becomes necessary because of field and material supply conditions in order to meet the contract completion date of the Project.
- C. Coordinate Work of various sections, space requirements for installation, and accessibility for construction by others.
- D. Work that disrupts utility service shall be shown on the Construction Schedule and specifically scheduled with the Owner. Schedule notification shall consist of a written notice defining the work to be accomplished, the normal function that will be interrupted, the duration of the interruption, and the mitigating effort to be performed by the Contractor to maintain the capacity to operate continuously. The written notice shall be submitted to the Owner fourteen days in advance of the proposed work and the Owner will respond to the Contractor in writing within 7 days of receipt of the notice regarding the acceptability of the proposed plan.
- E. At no time shall the Contractor close off any pipelines, or open valves, or take any other action which would affect the operation of the existing system or facilities, except as specifically required by the Drawings and specifications, until authorization is granted by the Owner or Engineer and after proper notification.

PART 2 PRODUCTS (NOT USED)

PART 3 EXECUTION (NOT USED)

END OF SECTION

THIS PAGE INTENTIONALLY LEFT BLANK.

SECTION 013300
SUBMITTAL PROCEDURES

PART 1 GENERAL

1.1 SUMMARY

- A. This section specifies the general requirements for the submittals of shop drawings, product data, and samples. Refer to Section 017800 for closeout submittal requirements.

1.2 GENERAL SUBMITTAL REQUIREMENTS

- A. All submittals shall be sent to Engineer at an email address to be provided to contractor during the pre-construction conference.
- B. All submittals, regardless of origin, shall be approved by Contractor before submitting to Engineer. The Contractor shall be responsible for timely submittals so that there will be no delay to the Work due to the absence of approved submittals.
- C. Upon receipt of a submittal, the Engineer will review and return the shop drawings within 14 calendar days. This review time will commence starting the next working day following receipt of the submittal.
- D. Contractor shall be solely responsible for the completeness of each submittal, including the identification of all deviations from the Contract Documents on each submittal and in the Contractor's letter of transmittal. Each submittal shall be complete in all aspects incorporating all information and data required to evaluate the products' compliance with the Contract Documents.
- E. Partial or incomplete submissions shall be returned to the Contractor without review. Time delays caused by rejection of submittals are not cause for extra charges to the Owner or time extensions.

1.3 ELECTRONIC SUBMITTALS

- A. Contractor may make electronic submittals which will be exchanged electronically through mutually agreeable software. Procore, ProjectWise, Submittal Exchange are acceptable, and others may be proposed by Contractor.
- B. Follow the submittal requirements below.
 - 1. Assemble complete submittal package into a single indexed file incorporating submittal requirements of a single specification section and transmittal form with links enabling navigation to each item.
 - 2. Use the same submittal and resubmittal numbering system.
 - 3. Identify the Project, Contractor, Subcontractor or supplier, pertinent Drawing sheet and detail number(s), and specification section number, as appropriate.
 - 4. Apply Contractor's standard certification stamp, signed or initialed certifying that review, approval, verification of Products required, field dimensions, adjacent construction Work, and coordination of information is in accordance with the requirements of the Work and Contract Documents. Submittals without this certification will be returned without review.

1.4 SHOP DRAWINGS

- A. Submit shop drawings in accordance with the Contract Documents and other technical sections in these Contract Documents requiring submittals.
- B. The use of contract drawing reproductions for shop drawings is subject to rejection.
- C. Shop drawings shall show applicable standards, such as ASTM number or Federal Specification, performance characteristics, the principal dimensions, weight, structural and operating features, space required, clearances, dimensions needed for installation and correlation with other equipment and materials, external connections, anchorages, supports required, type and/or brand of finish or shop coat, grease fittings, etc. depending on the subject of the Drawings.
- D. If the Contractor submits shop drawings of equipment by manufacturers other than those listed in the specifications, provide the following information with the submittal:
 - 1. The name and address of at least three companies or agencies that are currently using the equipment.
 - 2. The name and telephone number of at least one person at each of the above companies or agencies whom the Owner's Representative may contact.
 - 3. A description of the equipment that was installed at the above locations. The description shall be

in sufficient detail to allow the Owner's Representative to compare it with the equipment that is proposed to be installed in this project.

- E. For materials originating outside of the United States for which tests are required, provide recertification and retesting by an independent domestic testing laboratory.
- F. Provide a professional engineer's, architect, land surveyor, or landscape architect seal on appropriate drawings of items that are submitted for review where required by the Specifications. Each copy of a submittal requiring a Professional Seal shall bear an original seal with signature and date. Electronic seals are permitted provided they meet the State Board of Professional Licensing regulations.

1.5 PRODUCT DATA

- A. Product data may be in the form of manufacturer's catalog sheets, brochures, diagrams, schedules, performance charts, illustrations, and other standard descriptive data. Product data shall show applicable standards, such as ASTM number or Federal Specification.
- B. Where product data from a manufacturer is submitted, clearly mark each copy with indelible ink to identify pertinent materials, products or models proposed with all pertinent data, performance characteristics and capacities, dimensions, clearances, diagrams, controls, connections, anchorage, and supports. Present a sufficient level of detail for assessment of compliance with the contract documents.
- C. Manufacturer's standard schematic drawings may be used in the submittal, but shall be modified by deleting information which is not applicable to the project, and by providing additional information specific to the project.
- D. When warranties are required, a sample of the warranty for each product shall be submitted with the shop drawings or product data. The sample warranty shall be the same form that will be used for the actual warranty.
- E. When Buy American Provisions are required for the Project, Supplier/Manufacturer shall provide a Buy American Certification with submittals for materials and equipment covered by the Buy American Provisions. Contractor is responsible for confirming that any product purchased for the Project meets the Buy American Provisions.

1.6 SAMPLES

- A. Submit samples for review of the various materials, together with the finish, before purchasing, fabricating, applying, or installing such materials and finishes.
- B. Identify samples as to product, color, manufacturer, trade name, lot, style, model, etc., location of use, and contract document reference.
- C. Samples shall be of sufficient size or quantity to illustrate clearly the quality, type, range of color, finish or texture and shall be properly labeled to show complete project identification, the nature of the material, trade name of manufacturer and location of the Work where the material represented by the sample will be used.
- D. Acceptable samples will establish the standards by which the completed Work will be judged. Therefore, materials, finishes, and workmanship in the completed project shall be equal in every respect to that of the samples submitted and accepted.
- E. Samples of value may be returned to the Contractor for use in the project after review, analysis, comparison, and/or testing as may be required in the review process. One sample marked "resubmittal is not required" will be returned to the Contractor. Rejected samples will not be returned.
- F. Furnish one sample of the finally reviewed materials, colors, or textures to Engineer for final record. Such material samples shall carry on the back all identification as previously described. If the sample is paint, include manufacturer, mix and proportion, name of color, building, Contractor/Subcontractor, and surfaces to which it is to be applied.

1.7 CERTIFICATES OF COMPLIANCE

- A. Furnish a Certificate of Compliance for materials specified to a recognized standard or code prior to the use of any such materials in the work. The Engineer may permit the use of certain materials or assemblies prior to sampling and testing if accompanied by a Certificate of Compliance. The certificate shall be signed by the manufacturer of the material or the manufacturer of assembled materials and shall state that the materials involved comply in all respects with the requirements of the Specifications. A Certificate of Compliance shall be furnished with each lot of material delivered to the work and the lot so certified shall be clearly identified in the certificate.

- B. All materials used on the basis of a Certificate of Compliance may be sampled and tested at any time. The fact that material is used on the basis of a Certificate of Compliance shall not relieve the Contractor of responsibility for incorporating material in the Work which conforms to the requirements of the Contract Documents and any such material not conforming to such requirements will be subject to rejection whether in place or not.
- C. The Engineer reserves the right to refuse permission for use of material on the basis of a Certificate of Compliance.

1.8 ENGINEER'S REVIEW

- A. Engineer's review is only for general conformance with the design concept of the project and the information given in the Construction Documents. Neither the review nor any corrections or comment made on submittals during review relieves the Contractor from full compliance with the Contract Documents, including, but not limited to, the plans and specifications. *Engineer's* review of a specific item does not, nor shall it be construed to, include review of an assembly of which the item is a component. The Contractor is solely responsible for: all measurements, dimensions, quantities, materials, and proper fit up and interfacing of all components; all aspects of any fabrication process; the means, methods, techniques, sequences and procedures of construction; coordination of the work with that of all other trades; and performing all work in a safe and satisfactory manner.
- B. The returned submittal will indicate one of the following actions:
 - 1. Resubmittal not required - The review indicates that the submittal is in general conformance with the design concept and complies with the drawings and specifications. The Contractor may begin to implement the work method or incorporate the material or equipment covered by the submittal.
 - 2. Make corrections noted - The review indicates limited corrections are required as marked on the submittal. The Contractor may begin implementing the work method or incorporating the material and equipment covered by the submittal in accordance with the noted corrections. Where submittal information will be incorporated in O&M data, a corrected copy shall be provided.
 - 3. Revise & resubmit - The review reveals that the submittal is insufficient or contains incorrect data, or indicates that the material, equipment or work method is not in general conformance with the design concept or in compliance with the Drawings and Specifications. The Contractor shall not undertake work covered by such submittals until a new submittal is submitted.
 - 4. Rejected - The submittal was not accepted or reviewed.
- C. Engineer's review of submittals shall not relieve Contractor from responsibility for errors, omissions, deviations, or responsibility for compliance with the Contract Documents.

1.9 RESUBMITTALS

- A. Resubmittals shall be made within 30 days of the date of the review letter returning the material to be modified or corrected, unless within 14 days Contractor submits a request for an extension of the resubmittal time, listing the reasons the resubmittal cannot be completed within that time, and are approved by the Engineer.
- B. Contractor shall request an amendment to the Contract Documents, if the Contractor considers any correction indicated on the shop drawings to constitute a change to the Contract Documents.
- C. Resubmittals will be reviewed and returned in the same 14 day review period. It is considered reasonable that the Contractor shall make a complete and acceptable submittal by the second submission of a submittal item. Contractor shall verify that all exceptions previously noted by Engineer have been taken into account.
- D. Resubmittals shall have the original submittal number for that item followed by an alphabetic suffix. For example, if Submittal 33000-2 requires a resubmittal, the first resubmittal number will bear the designation "33000-2A" and the second resubmittal number will bear the designation "33000-2B".
- E. Resubmittals shall identify what revisions were made.
- F. The need for more than one resubmittal, or any other delay in obtaining Engineer's review of submittals, will not entitle Contractor to extensions of Contract Times unless the delay of the Work is the direct result of failure of Engineer to review and return any submittal to Contractor within the specified review period. Additionally, Contractor shall reimburse Owner for the charges of Engineer for review of the additional resubmissions. Monies due to the Contractor may be withheld to cover additional costs of any review beyond the second submittal.

1.10 SUBMITTALS FOR PROJECT CLOSEOUT

- A. When the following are specified in individual sections, submit them at project closeout, and according to Section 017800.
1. Project record documents
 2. Operation and maintenance data
 3. Warranties
 4. Bonds

PART 2 PRODUCTS (NOT USED)

PART 3 EXECUTION (NOT USED)

END OF SECTION

SECTION 015000
TEMPORARY FACILITIES AND CONTROLS

PART 1 GENERAL

1.1 SUMMARY

- A. This section Includes:
 - 1. Temporary Utilities: Water, sanitary facilities, electrical power, heating, lighting, ventilation.
 - 2. Temporary Controls: Site security, material storage, dust control, water control, noise control, safety, and fire danger.
 - 3. Construction Controls: Traffic Regulation, access roads and parking areas.
 - 4. Construction Facilities: Temporary field office, inspection hoist, and project sign.

1.2 ELECTRICAL POWER

- A. Provide for the purchase of power or provide portable power for the construction of the project where existing outlets are not available. Provide main service disconnect and overcurrent protection. Provide for the extension of utility lines to the point of usage. The cost of power shall be included in the appropriate bid items to which it is appurtenant and shall include full compensation for furnishing all labor, materials, tools, and equipment required to obtain and distribute power for construction purposes.
- B. Provide power outlets for construction operations, with branch wiring and distribution boxes. Provide flexible power cords as required for construction operations.
- C. Existing receptacles may be utilized during construction.

1.3 TEMPORARY BUILDING ENVIRONMENTAL CONTROLS

- A. HEATING
 - 1. Provide heating devices and heat as needed to maintain specified conditions for construction operations.
 - 2. Prior to operation of permanent equipment for temporary heating purposes, verify that installation is approved for operation, equipment is lubricated, and filters are in place. Provide and pay for operation, maintenance, and regular replacement of filters and worn or consumed parts.
- B. LIGHTING
 - 1. Provide and maintain lighting for construction operations to achieve a minimum lighting level of 2 watt/sq. ft.
 - 2. Provide branch wiring from power source to distribution boxes with lighting conductors, pigtails, and lamps as required.
 - 3. Maintain lighting and provide routine repairs.
 - 4. Permanent building lighting may be utilized during construction.
- C. VENTILATION
 - 1. Ventilate enclosed areas to assist cure of materials, to dissipate humidity, and to prevent accumulation of dust, fumes, vapors, or gases.

1.4 CONSTRUCTION WATER

- A. The Contractor shall make his own arrangements for developing water sources and supply labor and equipment to collect, load, transport, and apply water as necessary for compaction of materials, concrete construction operations; testing; dust control; and other construction use.
- B. Obtain water from private sources. Payment for costs connected with utilization of the source shall be made by the Contractor. Water shall be clean and free from objectionable deleterious amounts of acids, alkalines, salts, or organic materials.
- C. Include the cost of construction water in the appropriate bid item to which it is appurtenant. The cost shall include full compensation for furnishing all labor, materials, tools, and equipment and doing all the work necessary to develop a sufficient water supply and furnishing the necessary equipment for applying the water as described in these specifications.
- D. Coordinate the use of water for any construction related purpose with the water utility and Engineer. Provide 24 hour notice prior to withdrawing water from any source.

1.5 SANITARY FACILITIES

- A. Contractor shall provide and maintain adequate fixed or portable chemical sanitary toilet facilities on the job site, and conform to local health codes which govern in the project area. Toilets at construction job sites shall conform to the requirements of Part 1926 of the OSHA Standards for Construction.
- B. The Contractor shall maintain the sanitary facilities in a satisfactory and sanitary condition at all times and shall enforce their use. He shall rigorously prohibit the committing of nuisances on the site of the Work, on the lands of the Owner, or an adjacent property.
- C. Contractor's use of Owner's facilities will not be allowed.

1.6 CONSTRUCTION SITE SECURITY

- A. Provide barriers to prevent unauthorized entry to construction areas, to protect adjacent properties from damage from construction operations, and to serve as warnings for dangerous areas and excavations.
- B. Provide security and facilities to protect Work, and Owner's operations from unauthorized entry, vandalism, or theft. The Owner is not responsible for the security of the site or structures.
- C. Protect non-owned vehicular traffic, stored materials, site, and structures from damage.
- D. Provide a security fence around construction site or storage area; equip with vehicular gates with locks. Provide keys to Owner and Engineer. If gates are chained, allow Contractor and Owner padlocks to be linked together so either party can unlock the gate.
- E. Provide security lighting.

1.7 MATERIAL STORAGE

- A. Storing and Protecting Materials
 - 1. Store and protect products in accordance with manufacturer's instructions, with seals and labels intact and legible. Store sensitive products in weather-tight, climate-controlled enclosures.
 - 2. For exterior storage of fabricated products, place on sloped supports, above ground.
 - 3. Cover products subject to deterioration with impervious sheet covering. Provide ventilation to avoid condensation.
 - 4. Store loose granular materials on solid surfaces in a well-drained area. Prevent mixing with foreign matter.
- B. Storage Areas
 - 1. Generally, storage areas shall be provided within the designated staging area. The staging area is general and does not indicate limits of construction. Responsibility for protection and safekeeping of equipment and materials at or near the sites will be solely that of the Contractor and no claim shall be made against the Owner by reasons of any act of an employee or trespasser. Should an occasion arise necessitating access to an area occupied by stored equipment and/or materials, the Contractor shall immediately move them. No equipment or materials shall be placed upon the Owner's property until it is acceptable to the Owner
 - 2. Provide off-site storage and protection when site does not permit on-site storage or protection.
 - 3. Arrange storage of products to permit access for inspection. Periodically inspect to assure products are undamaged and are maintained under specified conditions.
 - 4. Upon completion of the Contract, the Contractor shall remove from the storage areas all of their equipment, temporary fencing, surplus materials, rubbish, and restore the areas.

1.8 DUST CONTROL

- A. Perform dust control operations to prevent construction operations from producing dust in amounts harmful to persons or causing a nuisance to persons living nearby or occupying buildings in the vicinity of the work. Use water or dust preventative to control dust. May be tied to SWPPP requirements.

1.9 WATER CONTROL

- A. Work to be performed may require draining, pumping, dewatering, and certain cleaning operations necessary to complete the work as specified and as indicated on the drawings. It is the intent of these specifications that such draining, pumping, dewatering, and cleaning operations shall be the obligation of the Contractor
- B. Make provisions for maintaining proper drainage of the work area. Preserve and maintain natural drainage patterns. Remedy situations which could cause excessive erosion including the use of drainage checks or water bars on slopes subject to erosion.

1.10 NOISE CONTROL

- A. Maintain equipment, particularly muffling systems on internal combustion engines, so that acceptable noise levels are not exceeded. If on-site generators are used, locate it in area where the sound will be least offensive.
- B. Provide sound barriers as shown on the drawings.

1.11 SAFETY

- A. The Contractor shall alone be responsible for the safety, efficiency, and adequacy of the plant, appliances and methods, and for any damage which may result from their failure or their improper construction, maintenance or operation.
- B. Contractor shall have a man available 24 hours a day who can be contacted at any time in case of an emergency caused by the construction operations. Name, address, and telephone number of this person shall be filed with the Owner.
- C. All open trenches and other excavations shall be provided with suitable barriers, signs, and lights to the extent that adequate protection is provided to the public against accident by reason of such open construction. All open trenches shall be backfilled or must be barricaded, at the end of each working day.
- D. All barricades, signs, warning lights and other protective devices shall be installed and maintained in conformance with applicable statutory requirements, and, where within highway right-of-way, as required by the authority having jurisdiction.
- E. Materials or equipment in or alongside public streets, roads and highways shall be so placed that the work at all times shall be so conducted as to cause the minimum obstruction and inconvenience to the traveling public. These obstructions shall be provided with barricades, signs, warning lights and other protective devices.
- F. Safety Data Sheets (SDS) shall be provided to the Owner for all materials stored/used during construction of the project.

1.12 FIRE DANGER

- A. Minimize fire danger in the vicinity of and adjacent to the construction site. Provide labor and equipment to protect the surrounding private property from fire damage resulting from construction operations.
- B. All fire hydrants and water control valves shall be kept free from obstruction and available for use at all times.

1.13 INSPECTION AIDS

- A. Contractor shall provide power driven equipment for hoisting Owner's representative for inspection purposes.

1.14 TRAFFIC REGULATION

- A. Contractor shall maintain traffic and protect the public from all damage to persons and property within the contract limits, in accordance with all applicable state, local, and city regulations. The Contractor shall conduct its operations so as to maintain and protect access for vehicular and pedestrian traffic to and from all properties and business establishments adjoining or adjacent to those streets affected by its operations, and to subject the public to a minimum of delay and inconvenience. Suitable signs, barricades, railing, etc. shall be erected and the work outlined by adequate lighting at night. Danger lights shall be provided as required. Watchmen and flagmen shall be provided as may be necessary for the protection of traffic.
- B. The Contractor shall notify the owner or occupant (if not owner-occupied) of the closure of the driveways to be closed more than one eight-hour work day, at least three working days prior to the closure. The Contractor shall minimize the inconvenience and minimize the time period that the driveways will be closed. The Contractor shall fully explain to the owner/occupant how long the work will take and when closure is to start.

1.15 PROJECT SIGN

- A. A project sign is not required for this project.

PART 2 PRODUCTS (NOT USED)

PART 3 EXECUTION (NOT USED)

END OF SECTION

THIS PAGE INTENTIONALLY LEFT BLANK

SECTION 015713
TEMPORARY EROSION AND SEDIMENT CONTROL

PART 1 GENERAL

1.1 SUMMARY

- A. Stormwater Pollution Prevention Plan (SWPPP)
- B. Erosion Control Measures
- C. Velocity and Flow Control Measures
- D. Sediment Control Measures
- E. Application/Installation of Measures
- F. Removal/Replacement of Measures

1.2 DESCRIPTION OF WORK

- A. Furnish all materials; install, construct, maintain, and remove specified erosion control devices; at locations specified in the contract documents, or where specified by the Engineer.
- B. Complete the required construction work on this project, while minimizing soil erosion and controlling water pollution. Maintain these features as specified, from initial construction stages to final completion of the project.

1.3 SUBMITTALS

- A. Comply with Section 013300.
- B. Upon request, provide copies of all records and documentation related to compliance with the SWPPP.

1.4 SCHEDULING AND CONFLICTS

- A. Comply with the following:
 - 1. Implement erosion and sediment control measures at the appropriate time(s).
 - 2. Coordinate construction to minimize damage to erosion and sediment control devices.

1.5 SPECIAL REQUIREMENTS

- A. Protection of Property: Prevent accumulation of soil, sediment, or debris from project site onto adjoining public or private property. Remove any accumulation of soil or debris immediately and take remedial actions for prevention.
- B. Permit Compliance: When applicable, conduct all operations in compliance with the SWPPP. Labor, equipment, or materials not included as a bid item, but necessary to prevent stormwater contamination from construction related sources, are considered incidental. Incidental work related to compliance with the permit may include, but is not limited to: hazardous materials protection, fuel containment, waste disposal, and providing employee sanitary facilities.

- C. Project Staging: Replacing erosion and sediment control practices that are damaged or removed by the contractor in a manner that is inconsistent with the current project staging or SWPPP is the Contractor's responsibility and will be at the Contractor's expense.

PART 2 PRODUCTS – NOT USED

PART 3 EXECUTION

3.1 SWPPP PREPARATION

- A. Prepare a SWPPP according to the requirements of the State.
- B. Have the SWPPP prepared by an individual experienced in erosion and sediment control.
- C. Ensure that controls utilized in the SWPPP conform to the type and quantity of erosion and sediment controls required.
- D. Submit the completed SWPPP to the Engineer for review and approval prior to filing.
- E. Upon approval of the Engineer, submit and pay fee as appropriate.

3.2 SWPPP MANAGEMENT

- A. Update the SWPPP according to the requirements of the State.
- B. Revise the SWPPP and implement changes, as necessary, to prevent sediment or hazardous materials from being transported off the site.
- C. Submit all SWPPP revisions to the Engineer for review and approval.
- D. Perform and maintain records of erosion and sediment control site inspections, unless otherwise specified in the contract documents.
- E. Retain all records on-site.
- F. Provide all records and documentation to the Engineer upon completion of the project.

3.3 EROSION AND SEDIMENT CONTROL INSPECTION

- A. Perform inspections following rainfall events in excess of ½ inch.
- B. Notify the Engineer immediately of situations requiring attention beyond that provided for in the contract documents.
- C. Provide copies of the inspection reports to the Engineer.

END OF SECTION

**SECTION 016400
OWNER-FURNISHED PRODUCTS**

PART 1 GENERAL

1.1 SUMMARY

- A. This section generally describes the logistical aspects of equipment and materials that will be furnished by the Owner for each project.

1.2 OWNER FURNISHED EQUIPMENT AND MATERIALS

- A. The Contractor shall include in his Contract price or prices all costs in connection with handling, storing, protecting, and installing materials, supplies, or equipment furnished by the Owner and shall make good all losses and breakage due to carelessness or negligence while same are in his possession. The obligations of the Contractor under this section shall not extend to defective materials or equipment supplied by the Owner, and the Owner will reimburse the Contractor for Contractor's cost, for work in relation to defective material supplied by the Owner.
- B. All 2022 Kentucky Projects: Equipment and material furnished by Owner and in current inventory will be:
1. Pumps (with appurtenances) and pump control panels with pump VFDs; see Plans and Section 333216
 2. Flow Meters (see Plans and Section 407100)
 3. Blowers, blower enclosures if applicable, blower control panels with blower VFDs, check valve, and pressure relief valve shipped loose for contractor installation. (see Plans and Section 460529)
 4. Owner to supply all air process piping downstream from air headers i.e., drop pipes, laterals, and diffusers for IFAS, IFAS cages and media.
 5. Remote monitoring equipment (see Plans)
- C. A copy of the approved shop drawings and installation requirements for the Owner furnished equipment will be made available to the Contractor during bidding process.
- D. A copy of the specifications, purchase order and manufacturer's information for Owner furnished equipment will be made available to the Contractor during the bidding process.

1.3 DELIVERY OF EQUIPMENT

- A. The Owner will provide furnished equipment to the project site. The Contractor shall provide a crane and labor to unload the Owner furnished equipment.

1.4 CONTRACTOR'S RESPONSIBILITIES

- A. Contractor shall review specifications, manufacturer's information, approved shop drawings and installation requirements for the Owner furnished equipment.
- B. Contractor shall carefully examine each shipment of Owner furnished equipment or material upon arrival. Defective items shall be brought to the attention of the Engineer. Upon inspection and acceptance by the Contractor, the Contractor shall assume custody, and provide insurance for and be responsible for the Owner furnished equipment and materials from the point of delivery on. The Owner furnished equipment and materials shall be properly handled to prevent damage. The Owner will not accept title to the equipment until the project is substantially complete.
- C. Damaged or misplaced Owner furnished items shall be replaced by the Contractor. Replacements shall conform to the original equipment specifications.
- D. Contractor to install all equipment and materials, Owner furnished and otherwise.

1.5 OWNER-FURNISHED TECHNICAL ASSISTANCE

- A. Field service representatives from manufacturers will be provided for Owner furnished equipment will be provided in accordance with the purchase orders, specifications, and agreements with the Owner

furnished equipment suppliers. Contractor will be responsible for coordinating with manufacturer's representative for providing necessary services.

- B. The Owner-furnished equipment manufacturers will provide technical services at no cost to the Contractor, as detailed in the agreements between Owner and the manufacturers.
- C. If the Contractor requires additional time from manufacturer representatives for installation supervision or assistance, installation review, instrumentation calibration, or other field services beyond what is detailed in the agreements between the Owner and the manufacturers, the Contractor shall include these costs in their bid. No additional charges by manufacturers will be paid by Owner for manufacturer's services.

PART 2 PRODUCTS (NOT USED)

PART 3 EXECUTION (NOT USED)

END OF SECTION

SECTION 017000

EXECUTION

PART 1 GENERAL

1.1 SUMMARY

- A. This section includes lands and rights-of-way, underground utility locations, construction layout and staking, methods of operation, salvage of materials and equipment, and cutting and patching.

1.2 MOBILIZATION AND NOTIFICATIONS

- A. Contractor shall notify Engineer and Owner seven working days in advance of startup of construction operations, addition of work crews, or major increase in work force.

1.3 UNDERGROUND UTILITY LOCATIONS

- A. Utility locations are generally not shown on the Drawings. If shown, the locations of the utilities depicted on the Contract Drawings are not to be considered exact. The approximate utility locations, where shown, were derived from data obtained from generalized large-scale utility company supplied drawings or from prior facility construction drawings. The actual location of existing utilities is the sole responsibility of the Contractor. Those shown on the plans are given to call particular attention to areas of special concern.
- B. The Contractor shall make his own investigations including exploratory excavations as needed to determine the locations and type of existing utilities to be encountered. Any work associated with crossing or paralleling a particular utility shall be subsidiary to the work as stipulated in General Conditions.
- C. The utilities anticipated to be affected, if any, by this Project are indicated on the Contract drawings. The utilities shown are not intended to be a complete or an all-inclusive. Other utilities may exist in the Project area and may not be shown. The Contractor shall be responsible for contacting all affected utilities; municipalities, local, County, State, and Federal entities whether or not they are shown or listed.
- D. The Contractor shall coordinate all work which parallels, crosses, or is in the vicinity of a given utility with the Owner of that particular utility. The Contractor shall notify all utilities and underground service agencies in advance of work scheduled or envisioned and arrange to have their respective services located. Upon exposing a utility or underground service, the respective service agency shall be contacted by the Contractor, such that an inspection of the service can be made by the utility (if desired) prior to backfilling. The Contractor shall obtain acceptance, in writing, from the utility regarding the preservation of their respective service during construction.
- E. Should any facility, either underground or overhead, be unexpectedly encountered or damaged during construction, the Contractor shall immediately notify a representative of the company involved and take such steps as necessary for protection of the general public and his own personnel.

1.4 CONSTRUCTION LAYOUT AND STAKING

- A. All work under this Contract shall be constructed in accordance with the lines and grades shown on the Contract Drawings or as directed by the Engineer. Elevation of existing ground, structures and appurtenances are believed to be reasonably correct, but are not guaranteed to be absolute and therefore are presented only as an approximation. Any error or apparent discrepancy in the data shown or omissions of data required for accurately accomplishing the stakeout survey shall be referred immediately to the Engineer for interpretation or correction.

- B. The Owner will establish reference points for construction, which in the judgment of the Engineer are necessary to enable the Contractor to proceed with the Work. The reference points shall be basic horizontal and vertical control points in the project area. Preserve these points and transfer from them distances and elevations necessary for the execution of the structural and piping work. These points shall be used as datum for work under this contract.
- C. The Contractor will furnish construction staking to execute the work as described below. The Contractor shall provide an experienced instrument man, competent assistants, and such instruments, tools, stakes, and other materials required to complete the survey, layout, and measurement work.
- D. The Contractor shall be responsible to preserve benchmarks, reference points, stakes, property pins, and all other survey location items. In case of destruction by the Contractor or resulting from his negligence, he shall be held liable for any expense and damage and shall be responsible for any mistakes that may be caused by the unnecessary loss or disturbance of such benchmarks, reference points and stakes.

1.5 LAYOUT MODIFICATIONS

- A. Should the Contractor desire a revision in the designated alignment or location he shall make said request to the Owner's Representative. The decision of the Owner's Representative is final.
- B. Alignment changes may be proposed and staked by Contractor for review in field by the Owner's Representative and/or Owner. Contractor may propose differences or deviations of the work to avoid disturbances, surface obstructions, easement changes. Reroutes may be authorized by the Owner or Owner's Representative based on staked field conditions. Alignment changes agreed upon by Owner or Owner's representative shall be recorded by the Contractor on the Record Drawings. Field Orders will be issued by the Owner's Representative to document significant changes in alignment.
- C. Adjustment for actual quantities installed for the pipeline and appurtenances, if different from the drawings, will be paid for in accordance with Contract Documents.

1.6 OWNER'S CONSTRUCTION REPRESENTATIVE AT PROJECT SITE

- A. The Owner may appoint or employ a person(s) to work as the Construction Representative on the project. The Owner's Representative shall represent the Owner as specifically set forth in the Contract, and shall observe the work performed under this Contract to the end that such work is performed in substantial accordance with the drawings and specifications. Such observation shall in no way remove any obligations on the part of the Contractor to provide all required supervision and quality control necessary to perform the work in accordance with the Contract.
- B. If the Owner's Representative observes departures from the drawings and specifications, the Owner's Representative will call them to the attention of the Contractor, who shall promptly correct the unsatisfactory conditions. If the Contractor believes there has been no departure from the drawings and specifications, the Contractor may make written appeal.
- C. The presence or absence of the Owner's Representative, or the failure of the Owner's Representative to detect faulty work shall in no way relieve the Contractor from his obligation to perform the work strictly in accordance with the drawings and specifications.
- D. The Owner's Representative shall have no authority to permit any deviation from the drawings and specifications, except on written Change Order or Field Order as applicable. The Contractor will be liable for any deviation, except on such written order.

1.7 METHODS OF OPERATION

- A. The Contractor shall inform the Owner in advance concerning his plans for carrying on

each part of the work, but the Contractor alone shall be responsible for the safety, adequacy, and efficiency of his plant, equipment, and methods.

- B. Any method of work suggested by the Owner or Engineer, but not specified, shall be used at the risk and responsibility of the Contractor; and the Engineer and Owner will assume no responsibility therefor.
- C. Review by the Owner or Engineer of any plan or method of work proposed by the Contractor shall not relieve the Contractor of any responsibility therefor, and such review shall not be considered as an assumption of any risk or liability by the Owner or Engineer, or any officer, agent, or employee thereof. The Contractor shall have no claim because of the failure or inefficiency of any plan or method so reviewed.
- D. The Owner and the Engineer will not be responsible for any act or omission of the Contractor, or any subcontractor, or any of their agents or employees, or any other persons performing any of the work. The Owner and Engineer will not be responsible for any failure of the Contractor or his subcontractors or any other persons to perform the work in accordance with the requirements of the Contract Documents.

1.8 UNFAVORABLE CONSTRUCTION CONDITIONS

- A. During unfavorable weather, wet ground, or other unsuitable construction conditions, Contractor shall confine his operations to work which will not be affected adversely by such conditions. No work shall be constructed under conditions that would adversely affect the quality, unless the Contractor takes special precautions to perform the work in a proper and satisfactory manner.

1.9 OBSTRUCTIONS

- A. Any street signs, traffic signs, posts, mailboxes, guard fence, standards, yard lights or other similar obstructions shall be removed, properly stored and reset or salvaged to the Owner as directed by the Engineer.
- B. Trees and shrubs that are encountered in the vicinity of the proposed facilities shall be removed only if deemed necessary by the Engineer.
- C. Existing fences (including chain link fences) interfering with the construction operations shall be maintained by the Contractor until completion of the work affected thereby, unless written permission is obtained from the owner to leave an interfering fence dismantled for any agreed period of time. On completion of the work the Contractor shall restore all fences to their original or to a better condition and to their original location or as shown on the plans
- D. All property pins, section corners or other monuments moved and/or destroyed by the Contractor's operations shall be replaced and reset. Replacement and resetting shall be done by a professional Engineer or Surveyor paid by the Contractor at no additional cost to the Owner.

PART 2 PRODUCTS (NOT USED)

PART 3 EXECUTION (NOT USED)

END OF SECTION

THIS PAGE INTENTIONALLY LEFT BLANK

SECTION 017800
CLOSEOUT SUBMITTALS

PART 1 GENERAL

1.1 SUMMARY

- A. This section includes closeout submittals, operation and maintenance data, warranties, spare parts and maintenance materials, and project records.

1.2 SUBMITTALS

- A. Submit written certification that Contract Documents have been reviewed, Work has been inspected, and that Work is complete in accordance with Contract Documents and ready for Engineer's review. A partial list of such items appears below, but it shall be the Contractor's responsibility to submit any other items which are required in the Contract Documents:
1. Written test results of project components, where required.
 2. Performance affidavits for equipment, where required.
 3. Certificates of inspection and acceptance by local governing agencies having jurisdiction.
 4. Keys, padlocks, and other items not considered spare parts or maintenance materials.
 5. Clearances of all property owners for work requiring site restoration caused by Contractor's operations.
- B. Provide final submittals to Engineer that are required by governing or other authorities.
- C. Submit final Application for Payment identifying total adjusted quantities, and final change order if required.

1.3 OPERATION AND MAINTENANCE DATA

- A. Submit data bound in 8-1/2 x 11-inch text pages, three ring binders with metal hinges.
- B. Prepare binder cover with printed title "OPERATION AND MAINTENANCE INSTRUCTIONS", title of project, and subject matter of binder when multiple binders are required.
- C. Internally subdivide the binder contents with permanent page dividers, logically organized as described below; with tab titling clearly printed under reinforced laminated plastic tabs.
- D. Contents: Prepare a Table of Contents for each volume, with each Product or system description identified, typed on white paper, in three parts as follows:
1. Section 1: Directory, listing names, addresses, and telephone numbers of Engineer, Contractor, Subcontractors, and major equipment suppliers.
 2. Section 2: Operation and maintenance instructions, arranged by specification section. For each category, identify names, addresses, and telephone numbers of Subcontractors, suppliers and manufacturers. Identify the following:
 - a. Significant design criteria.
 - b. List of equipment.
 - c. Parts list for each component.
 - d. Operating instructions.
 - e. Maintenance instructions for equipment and systems.
 - f. Maintenance instructions for finishes, including recommended cleaning methods and materials, and special precautions identifying detrimental agents.
 3. Section 3: Project documents and certificates, including the following:
 - a. Air and water balance reports.
 - b. Certificates.

- c. Photocopies of warranties and bonds.
- E. Submit 1 draft copy of completed volumes 30 days prior to final inspection. This copy will be reviewed and returned after final inspection, with Engineer comments. Revise content of all document sets as required prior to final submission.
- F. Submit the required number of sets of revised final volumes within 30 days after receipt of Engineer's comments.

1.4 SPARE PARTS AND MAINTENANCE MATERIALS

- A. Provide products, spare parts, maintenance, and extra materials in quantities specified in individual specification sections.
- B. Deliver to Project site and place in location as directed; obtain receipt prior to final payment.
- C. Contractor shall furnish an inventory listing of all spare parts for each piece of equipment using the form included at the end of this section, or similar form.

1.5 WARRANTIES

- A. Provide notarized copies of all warranties.
- B. Execute and assemble transferable warranty documents from Subcontractors, suppliers, and manufacturers.
- C. Provide Table of Contents and assemble in three ring binder similar to O&M manuals.
- D. Submit prior to final Application for Payment.
- E. For items of Work delayed beyond date of Substantial Completion, provide updated submittal within 10 days after acceptance, listing date of acceptance as start of warranty period.

1.6 PROJECT RECORDS

- A. Specifications: Contractor shall legibly mark and record at each Product section description of actual Products installed, including the following:
 - 1. Manufacturer's name and product model and number.
 - 2. Product substitutions or alternates utilized.
 - 3. Changes made by Addenda and modifications.
- B. Drawings: Contractor shall legibly mark each item to record actual construction including:
 - 1. Measured depths of foundations in relation to finish floor datum.
 - 2. Measured horizontal and vertical locations of underground utilities and appurtenances, referenced to permanent surface improvements.
 - 3. Measured locations of internal utilities and appurtenances concealed in construction, referenced to visible and accessible features of the Work.
 - 4. Field changes of dimension and detail.
 - 5. Details not on original Contract drawings

PART 2 PRODUCTS (NOT USED)

PART 3 EXECUTION (NOT USED)

END OF SECTION

SECTION 024100

DEMOLITION

PART 1 GENERAL

1.1 SUMMARY

- A. The removal and or reuse, salvage and disposal of materials and equipment necessary for the work to be performed as shown on the Drawings and as specified herein.
- B. Existing buildings, structures, boxes, pipes, pavements, curbs, and other items are to be removed, altered, salvaged, and disposed of as specified herein or indicated in the drawings.
- C. Equipment, material, and piping, except as specified to be salvaged for the Owner, or removed by others, within the limits of the demolition, excavations, and backfills, will become the property of the Contractor and shall be removed from the project site. The salvage value of this equipment, materials, and piping shall be reflected in the contract price.
- D. Electrical downstream of the electric meter to be replaced. Above ground conduit, cables, wires, and supports to be removed, altered, salvaged, and disposed of as specified herein or indicated in the drawings.

1.2 PROCEDURES

- A. Procedures to be used for the removal of all types of materials shall provide for careful removal and disposition of materials specified to be salvaged, protection of property which is to remain undisturbed, coordination with other work in progress, and timely disconnection of utility services. Existing property which is damaged by the Contractor's operations shall be repaired or replaced in kind by the Contractor at no additional cost to the Owner.
- B. Existing Utilities: The Contractor shall notify the Owner and other proper authorities concerned not less than seven days before starting work in any area. He shall furnish all necessary information as to the nature and extent of the work and shall obtain their cooperation and instructions in locating and protecting all underground pipes, cables, and other utilities. All utility line locations shown on the Drawings are approximate.
- C. Perform the work in a manner that will not damage parts of the structure not intended to be removed or to be salvaged for the Owner. If, in the opinion of the Owner's Representative, the method of demolition used may endanger or damage parts of the structure or affect the satisfactory operation of the facilities, promptly change the method when so notified by the Owner's Representative.
- D. Explosives: The use of explosives will not be permitted.

1.3 SUBMITTALS

- A. Submit shop drawings in accordance with the Section 013300.
- B. Shop Drawings: Indicate demolition and removal sequence and location of salvageable items. Include proposed method of demolition and provisions for erosion, dust, and noise control.
- C. Project Record Documents: Accurately record actual locations of capped utilities and subsurface obstructions. Indicate what fill materials were used in backfilling. Information is to be recorded in drawing form.
- D. Salvaged Material Data: Submit description of all salvaged materials, inspection data, and parts lists.

PART 2 PRODUCTS

2.1 MATERIALS

- A. Materials noted to be removed and not relocated, salvaged, or reused in the project shall be removed from the construction site and disposed of by the Contractor. Salvaged materials shall be delivered to an area designated by the Engineer or Owner.
- B. Do not reuse material salvaged from demolition work on this project, except as specifically shown or specified.

PART 3 EXECUTION

3.1 GENERAL

- A. During removal operations all persons and property shall be protected from injury or damage. The work shall proceed in a manner that will minimize the generation and spread of dust, flying particles and objectionable odors.

3.2 PROTECTION

- A. Before beginning any cutting or demolition work, the Contractor shall carefully survey the existing structures and examine the Drawings and specifications to determine the extent of the proposed construction activities. The Contractor shall take all necessary precautions to insure against damage to existing work to remain in place, to be reused, or to remain the property of the Owner, and any damage to such work shall be repaired or replaced as approved by the Engineer at no additional cost to the Owner. Repairing shall mean the restoration of a surface or item to a condition as near as practicable to match the existing adjoining surfaces unless otherwise noted, detailed, or specified. When repairing involves painting, special coatings, vinyl fabric, or other applied finish, refinish the entire surface plane (i.e., wall or ceiling), unless complete refinishing of the entire space is scheduled or specified. Repairing includes cleaning of soiled surfaces.
- B. Erect, and maintain temporary barriers and security devices, including warning signs and lights, and similar measures, for protection of the public, Owner, Contractor's employees, and existing improvements to remain. Method and materials of the partitions including adequate bracing shall be submitted to the Engineer for review.
- C. Provide temporary weather protection, where required.
- D. Mark location of utilities.

3.3 DISPOSITION BY CLASSIFICATION

- A. Disposition of materials and equipment shall be indicated on the plans by the following designations:
 - 1. Reinstall: Material or equipment to be reinstalled into the work shall be carefully removed from the existing location, shall be cleaned, and otherwise readied for reuse, and shall be protected from damage. Such items shall be reinstalled in accordance with applicable sections of these specifications covering new items of similar categories.
 - 2. Salvage: Materials and equipment to be salvaged shall be carefully removed, cleaned and delivered to a location on Owner's premises as designated by the Engineer or Owner. Final list of items to be salvaged is subject to the Owner's review.
 - 3. Remove: Materials and equipment to be removed shall be considered scrap and shall be disposed of by the Contractor. Removed concrete shall be disposed of off-site unless otherwise directed by the Owner or his representative. Final list of items to be scrapped is subject to the Owner's review.
 - 4. Abandon: Materials and equipment to be abandoned in place shall be properly taken out of service according to the methods identified in the project specifications.

3.4 CLEAN-UP

- A. Debris and rubbish: Remove debris and rubbish from the site daily.

- B. Debris Control: Remove and transport debris in a manner as to prevent spillage on streets or adjacent areas.
- C. Regulations: Local regulations regarding hauling and disposal apply.

3.5 REMOVALS - GENERAL

- A. All mechanical and electrical materials indicated to be salvaged shall be removed prior to initiating the scrapping/removal of the existing structure or facility.
- B. All removed structural steel, supports, grating, etc. shall be scrapped unless otherwise noted on the Drawings.
- C. Structures, Walls, and Partitions: Structure and finish shall be removed to the minimum required to remove and install piping. The Contractor shall limit the size of openings for removal. At locations where pipes are removed and not reinstalled, the openings or holes shall be completely filled in to match the surrounding area. At locations where pipes are removed and reinstalled, the openings or holes shall be filled in as shown on the Drawings or specified.
- D. Remove all reinforcement, anchor bolts, and other protruding elements that can cause a safety hazard.
- E. All sanitary sewer lines to be abandoned in place shall be pressure filled with flowable concrete fill as specified in the section entitled "Cast in Place Concrete" unless otherwise shown.
- F. Exposed pipes to be abandoned may be plugged at the ends in lieu of being completely removed.
- G. Underground structures to be abandoned in place shall be filled with concrete or flowable concrete fill to a depth not less than the crown elevation of the uppermost connecting sewer line. The remaining volume of the structures shall be filled with flowable concrete fill or granular fill compacted 90% standard Proctor density.

3.6 REMOVALS - ASBESTOS PIPE

- A. Removal procedures shall be in accordance with current federal and state regulations. Testing of material may be required unless the material has been classified.

END OF SECTION

THIS PAGE INTENTIONALLY LEFT BLANK.

SECTION 030510
LEAKAGE TESTING OF HYDRAULIC STRUCTURES

PART 1 GENERAL

1.1 SUMMARY

- A. This section describes the method of testing concrete and pre-cast concrete hydraulic structures for leakage.

1.2 RELATED WORK SPECIFIED ELSEWHERE

- A. Precast Concrete Utility Structures: 330516.

PART 2 PRODUCTS

2.1 PROVIDE WATER, PIPING, AND EQUIPMENT TO TEST CONCRETE STRUCTURES FOR LEAKAGE.

PART 3 EXECUTION

3.1 GENERAL

- A. Hydrostatically test any reinforced concrete basin which will contain water to determine that it is free of detectable leaks. Do not start leak testing or cleaning of surfaces until cast-in-place concrete has achieved its full 28-day compressive strength and joint sealants have set and cured a minimum of 14 days. Basins to be tested shall be in their final condition with all structural supporting members (slabs, beams, etc.) in place and at their full 28-day compressive strength.
- B. Prior to testing, thoroughly clean exposed surfaces, removing surface laitance and loose matter from walls and slabs. Remove wash water and debris from the structures by means other than washing through plant piping. Replace crystalline waterproofing if damaged by cleaning operations.
- C. Conduct testing before backfill is placed against walls and after concrete has attained the specified compressive strength, the concrete has cured, and joint sealants have set and cured a minimum of 14 days.

3.2 LEAKAGE TEST PROCEDURE

- A. Fill hydraulic structures to be subjected to leakage tests with water to the maximum operating liquid level line. Filling shall not exceed 3 feet of water depth per 24-hour period. Filling shall be at a uniform rate over a 24-hour period with continuous monitoring. For structures with adjacent bays, fill all bays simultaneously. Empty adjacent bays alternately. Repair any running leaks which appear during filling before continuing.
- B. Seed the floor slab of each hydraulic structure with one bag of cement per 1,000-square-foot surface area. Seeding shall take place after the test filling has reached 18 inches in depth. Detect leaks in construction and expansion joints with the aid of a diver. Stir cementitious deposits on the floor. Observe cement deposits flowing toward leaks and repair where the defect is located.
- C. After the structure has been kept full for 48 hours, it will be assumed for the purposes of the test that the absorption of moisture by the concrete in the structure is complete. Close all valves and gates to the structure and measure the change in water surface each day for a five-day period.
- D. During the test period, examine exposed portions of the structure, and mark visible leaks or damp spots. Repair visible leaks or damp spots after dewatering. If the drop in water surface in a 24-hour period exceeds 1/10 of 1% of the normal volume of liquid contained in the structure, the leakage shall be considered excessive. Crystalline waterproofing shall be assumed to be fully effective within three days after filling the structure. Repair leaks and damp spots that still exist three days after filling.
- E. If the leakage is excessive, drain the structure, repair leaks and damp spots, and refill the structure and again test for leakage. Continue this process until leaks have been repaired.
- F. Inspect the manholes of the underdrain system for evidence of leaks in floor slabs. If leaking is indicated, locate and repair.
- G. Repair visible leaks and damp spots whether leakage exceeds the allowable leakage or not. Repair leaks and damp spots with the same procedure that would otherwise be used to repair leakage in the event that the leakage test fails.
- H. Repairs and additional filling and testing (including the cost of water) shall be made by the Contractor at no additional cost to the Owner.

3.3 REPAIR METHODS

- A. Methods for repairing concrete not passing the leakage test and that for repairs of leaks and damp spots shall be as described in Section 033000.

END OF SECTION

SECTION 033000
CAST-IN-PLACE CONCRETE

PART 1 GENERAL

1.1 RELATED DOCUMENTS

- A. Drawings and general provisions of the Contract Documents, including Division 01 Specification Sections, apply to this Section.

1.2 SUMMARY

- A. Section includes cast-in-place concrete, including formwork, reinforcement, concrete materials, mixture design, placement procedures, and finishes, for the following:
 - 1. Footings.
 - 2. Foundation walls.
 - 3. Slabs-on-grade.
 - 4. Suspended slabs.
 - 5. Concrete toppings.
 - 6. Building frame members.
 - 7. Building and basin walls.

1.3 DEFINITIONS

- A. Cementitious Materials: Portland cement alone or in combination with one or more of the following: blended hydraulic cement, fly ash and other pozzolans, ground granulated blast-furnace slag, and silica fume; subject to compliance with requirements.

1.4 ACTION SUBMITTALS

- A. Product Data: For each type of product indicated.
- B. Design Mixtures: For each concrete mixture. The proposed mix designs shall be submitted by the contractor for review to the engineer of record. Mix design is the responsibility of the Contractor subject to the limitations of the Specifications. Review processing of this submission will be required only as evidence that the mix has been designed by qualified persons and that the minimum requirements of the Specifications have been met. Such review will in no way alter the responsibility of the Contractor to furnish concrete meeting the requirements of the Specifications relative to all criteria listed in the specification. Concrete mix design quantities and test results shall be submitted for review and shall be accepted before concrete work is started. Reports covering the source, quality, and proportions of the concrete materials used in the design mix should include the following information:
- C. Submit alternate design mixtures when characteristics of materials, Project conditions, weather, test results, or other circumstances warrant adjustments.
- D. Steel Reinforcement Shop Drawings: Placing drawings that detail fabrication, bending, and placement. Include bar sizes, lengths, material, grade, bar schedules, stirrup spacing, bent bar diagrams, bar arrangement, splices and laps, mechanical connections, tie spacing, hoop spacing, and supports for concrete reinforcement.
- E. Formwork Shop Drawings: Prepared by or under the supervision of a qualified professional engineer detailing fabrication, assembly, and support of formwork.
 - 1. Shoring and Reshoring: Indicate proposed schedule and sequence of stripping formwork, shoring removal, and reshoring installation and removal.
- F. Construction Joint Layout: Indicate proposed construction joints required to construct the structure.
 - 1. Location of construction joints is subject to approval of the Engineer.

1.5 INFORMATIONAL SUBMITTALS

- A. Submit shop drawings and samples in accordance with Section 013300.

- B. Material Certificates: For each of the following, signed by manufacturers:
 - 1. Cementitious materials.
 - 2. Admixtures.
 - 3. Form materials and form-release agents.
 - 4. Steel reinforcement and accessories.
 - 5. Fiber reinforcement.
 - 6. Waterstops.
 - 7. Curing compounds.
 - 8. Floor and slab treatments.
 - 9. Bonding agents.
 - 10. Adhesives.
 - 11. Vapor retarders.
 - 12. Semirigid joint filler.
 - 13. Joint-filler strips.
 - 14. Repair materials.
- C. Material Test Reports: For the following, from a qualified testing agency, indicating compliance with requirements:
 - 1. Aggregates. Provide certificates that aggregate comply with ASTM C 33. State weathering region limits of coarse aggregates: severe, moderate, or negligible. State basis of determining that alkali reactivity potential is negligible. Identify certifications and tests to actual materials to be used in the work. Provide additional tests and certifications for each change in material source. Provide an alternate materials source of aggregate if tests indicate that aggregates are reactive or possess severe weathering potential. Submit gradation analysis for fine and course aggregate with concrete mix designs. If deleterious substances are present, state the amount.
- D. Floor surface flatness and levelness measurements indicating compliance with specified tolerances.
- E. Field quality-control reports.
- F. Minutes of preinstallation conference.

1.6 QUALITY ASSURANCE

- A. Installer Qualifications: A qualified installer who employs on Project personnel qualified as ACI-certified Flatwork Technician and Finisher and a supervisor who is an ACI-certified Concrete Flatwork Technician.
- B. Manufacturer Qualifications: A firm experienced in manufacturing ready-mixed concrete products and that complies with ASTM C 1602 requirements for production facilities and equipment.
 - 1. Manufacturer certified according to NRMCA's "Certification of Ready Mixed Concrete Production Facilities."
- C. Testing Agency Qualifications: An independent agency, qualified according to ASTM C 1077 and ASTM E 329 for testing indicated.
 - 1. Personnel conducting field tests shall be qualified as ACI Concrete Field Testing Technician, Grade 1, according to ACI CP-1 or an equivalent certification program.

2. Personnel performing laboratory tests shall be ACI-certified Concrete Strength Testing Technician and Concrete Laboratory Testing Technician - Grade I. Testing Agency laboratory supervisor shall be an ACI-certified Concrete Laboratory Testing Technician - Grade II.
- D. Source Limitations: Obtain each type or class of cementitious material of the same brand from the same manufacturer's plant, obtain aggregate from single source, and obtain admixtures from single source from single manufacturer.
- E. Welding Qualifications: Qualify procedures and personnel according to AWS D1.4, "Structural Welding Code - Reinforcing Steel."
- F. ACI Publications: Comply with the following unless modified by requirements in the Contract Documents:
 1. ACI 301, "Specifications for Structural Concrete," Sections 1 through 5 and Section 7, "Lightweight Concrete."
 2. ACI 117, "Specifications for Tolerances for Concrete Construction and Materials."
 3. ACI 318, "Building Code requirements for Structural Concrete"
 4. ACI 350, "Code Requirements for Environmental Engineering Concrete Structures"
- G. Concrete Testing Service: Engage a qualified independent testing agency to perform material evaluation tests and to design concrete mixtures.
- H. Evaluation and Acceptance of Concrete
 1. Evaluation and acceptance of the compressive strength of concrete shall be according to the requirements of ACI 318, Chapter 5 "Concrete Quality, Mixing, and Placing", and as specified herein.
 2. If any concrete fails to meet these requirements, immediate corrective action shall be taken to increase the compressive strength for all subsequent batches of the type of concrete affected.
 3. All concrete which fails to meet ACI requirements and these specifications, is subject to removal and replacement at the cost of the Contractor.
- I. In the event tests on control specimens of concrete fall below the specified requirements, the Engineer may permit check tests for strengths to be made by means of typical cores drilled from the related part of the structure in accordance with ASTM C 42 and C 39. All costs associated with the failure to meet the specification requirements, including this type of testing and removal and replacement shall be borne by the Contractor.

1.7 DELIVERY, STORAGE, AND HANDLING

- A. Steel Reinforcement: Deliver, store, and handle steel reinforcement to prevent bending and damage.
- B. Waterstops: Store waterstops under cover to protect from moisture, sunlight, dirt, oil, and other contaminants.

PART 2 PRODUCTS

2.1 FORM-FACING MATERIALS

- A. Smooth-Formed Finished Concrete: Form-facing panels that will provide continuous, true, and smooth concrete surfaces. Furnish in largest practicable sizes to minimize number of joints.
 1. Plywood, metal, or other approved panel materials.
 2. Exterior-grade plywood panels, suitable for concrete forms, complying with DOC PS 1, and as follows:
 - a. High-density overlay, Class 1 or better.
 - b. Medium-density overlay, Class 1 or better; mill-release agent treated and edge sealed.
 - c. Structural 1, B-B or better; mill oiled and edge sealed.
 - d. B-B (Concrete Form), Class 1 or better; mill oiled and edge sealed.
- B. Rough-Formed Finished Concrete: Plywood, lumber, metal, or another approved material. Provide lumber dressed on at least two edges and one side for tight fit.
- C. Forms for Cylindrical Columns, Pedestals, and Supports: Metal, glass-fiber-reinforced plastic, paper, or fiber tubes that will produce surfaces with gradual or abrupt irregularities not exceeding specified formwork surface class. Provide units with sufficient wall thickness to resist plastic concrete loads without detrimental deformation.
- D. Pan-Type Forms: Glass-fiber-reinforced plastic or formed steel, stiffened to resist plastic concrete loads without detrimental deformation.
- E. Void Forms: Biodegradable paper surface, treated for moisture resistance, structurally sufficient to

support weight of plastic concrete and other superimposed loads.

- F. Chamfer Strips: Wood, metal, PVC, or rubber strips, 3/4 by 3/4 inch, minimum.
- G. Rustication Strips: Wood, metal, PVC, or rubber strips, kerfed for ease of form removal.
- H. Form-Release Agent: Commercially formulated form-release agent that will not bond with, stain, or adversely affect concrete surfaces and will not impair subsequent treatments of concrete surfaces.
 - 1. Formulate form-release agent with rust inhibitor for steel form-facing materials.
- I. Form Ties: Factory-fabricated, removable or snap-off metal or glass-fiber-reinforced plastic form ties designed to resist lateral pressure of fresh concrete on forms and to prevent spalling of concrete on removal.
 - 1. Furnish units that will leave no corrodible metal closer than 1 inch to the plane of exposed concrete surface.
 - 2. Furnish ties that, when removed, will leave holes no larger than 1 inch in diameter in concrete surface.
 - 3. Furnish ties with integral water-barrier plates to walls indicated to receive dampproofing or waterproofing.
 - 4. Form ties for liquid retaining walls and walls below grade shall be provided with water stop washers located on the permanently embedded portions of the ties at the approximate center of the wall.
 - 5. Bolts and rods that are to be completely withdrawn shall be coated with a nonstaining bond breaker.
 - 6. The Contractor shall be responsible for the water tightness of the form ties and any repairs needed.

2.2 STEEL REINFORCEMENT

- A. Recycled Content of Steel Product may be utilized at proportions approved by Engineer.
- B. Reinforcing Bars: ASTM A 615, Grade 60, deformed.
- C. Low-Alloy-Steel Reinforcing Bars: ASTM A 706, deformed.
- D. Steel Bar Mats: ASTM A 184, fabricated from ASTM A 615, Grade 60, deformed bars, assembled with clips.
- E. Plain-Steel Wire: ASTM A 82.
- F. Deformed-Steel Wire: ASTM A 496.
- G. Plain-Steel Welded Wire Reinforcement: ASTM A 185, plain, fabricated from as-drawn steel wire into flat sheets.
- H. Deformed-Steel Welded Wire Reinforcement: ASTM A 497, flat sheet.

2.3 REINFORCEMENT ACCESSORIES

- A. Joint Dowel Bars: ASTM A 615, Grade 60, plain-steel bars, cut true to length with ends square and free of burrs.
- B. Epoxy-Coated Joint Dowel Bars: ASTM A 615, Grade 60, plain-steel bars, ASTM A 775 epoxy coated.
- C. Epoxy Repair Coating: Liquid, two-part, epoxy repair coating; compatible with epoxy coating on reinforcement and complying with ASTM A 775.
- D. Zinc Repair Material: ASTM A 780, zinc-based solder, paint containing zinc dust, or sprayed zinc.
- E. Bar Supports: Bolsters, chairs, spacers, and other devices for spacing, supporting, and fastening reinforcing bars and welded wire reinforcement in place. Manufacture bar supports from steel wire, plastic, or precast concrete according to CRSI's "Manual of Standard Practice," of greater compressive strength than concrete and as follows:
 - 1. For concrete surfaces exposed to view where legs of wire bar supports contact forms, use CRSI Class 1 plastic-protected steel wire or CRSI Class 2 stainless-steel bar supports.
- F. Bar Couplers: Reinforcing steel bar splicing couplers shall be a mechanical type as manufactured by Dayton Barsplice Inc., or equal. Use couplers which develop 125% of the specified yield strength of the reinforcing bars. Make field demonstrations and sample splicing prior to splicing bars being included into the work.

2.4 CONCRETE MATERIALS

- A. Cementitious Material: Use the following cementitious materials, of the same type, brand, and source,

throughout Project:

1. Portland Cement: ASTM C 150, Type I; gray.
 - a. Fly Ash: ASTM C 618, Class F.
 - b. Ground Granulated Blast-Furnace Slag: ASTM C 989, Grade 100 or 120.
 - c. The Portland cement shall contain not more than 0.60% alkalis. The term "alkalis" referred to herein is defined as the sum of the percentage of sodium oxide and 0.658 times the percentage of potassium oxide ($\text{Na}_2\text{O} + 0.658 \text{K}_2\text{O}$). These oxides shall be determined in accordance with ASTM C 114.
 - d. The Portland cement shall contain not more than 8% tricalcium aluminate.
 - e. A single brand of cement shall be used throughout the Work, and prior to its use, the brand shall be acceptable to the Engineer.
 - f. The cement shall be suitably protected from exposure to moisture until used. Cement that has become lumpy shall not be used. Sacked cement shall be stored in such a manner so as to permit access for inspection and sampling.
 - g. Certified mill test reports for each shipment of cement to be used shall be submitted to the Engineer if requested regarding compliance with these Specifications.
 - h. Fly ash shall have a carbon content of less than 4% as measured by the loss on ignition. 75% of the fly ash shall have a fineness of 45 microns or less.

- B. Silica Fume: ASTM C 1240, amorphous silica.
- C. Normal-Weight Aggregates: ASTM C 33, Class 3S; coarse aggregate or better, graded. Provide aggregates from a single source.
 - 1. Maximum Coarse-Aggregate Size: 1 inch nominal.
 - 2. Fine Aggregate: Free of materials with deleterious reactivity to alkali in cement.
 - 3. Coarse aggregates shall consist of well-graded, clean, hard, durable gravel, crushed gravel, crushed rock or a combination thereof. Coarse aggregates shall not contain any materials that are reactive with the alkalis in the cement when exposed to moisture. Where aggregate reactivity has not been established or tested, low-alkali cement shall be used.
 - 4. Fine aggregates shall be natural sand or a combination of natural and manufactured sand that are hard and durable.
 - 5. Combined aggregates shall be well graded from coarse to fine sizes, and shall be uniformly graded between screen sizes to produce a concrete that has optimum workability and consolidation characteristics. Where a trial batch is required for a mix design, the final combined aggregate gradations will be established during the trial batch process
 - 6. When tested in accordance with "Potential Reactivity of Aggregates (Chemical Method)" (ASTM C 289), the ratio of silica released to reduction in alkalinity shall not exceed 1.0.
 - 7. When tested in accordance with "Organic Impurities in Sands for Concrete" (ASTM C 40), the fine aggregate shall produce a color in the supernatant liquid no darker than the reference standard color solution.
 - 8. When tested in accordance with "Resistance to Abrasion of Small size Coarse Aggregate by Use of the Los Angeles Machine (ASTM C 131), the coarse aggregate shall show a loss not exceeding 42% after 500 revolutions, or 10.5% after 100 revolutions.
 - 9. When tested in accordance with "Soundness of Aggregates by Use of Sodium Sulfate or Magnesium Sulfate" (ASTM C 88), the loss resulting after five cycles shall not exceed 15% for fine or coarse aggregate when using sodium sulfate.
- D. Lightweight Aggregate: ASTM C 330, 1-inch; nominal maximum aggregate size.
- E. Water: ASTM C 1602.

2.5 ADMIXTURES

- A. Air-Entraining Admixture: ASTM C 260.
- B. Concrete used for liquid containing or retaining structures such as tanks, basins or other liquid retaining or holding structures shall include a crystalline waterproofing admixture such as that manufactured by Xypex Chemical Corp. Such admixture is to be provided for all elements of such liquid containing or retaining structures including top slabs and beams for closed tanks or basins. Equal admixtures from any other manufacturer are acceptable. Mix designs containing flyash shall use Xypex Admix C-500 or equal. Mix design without fly ash shall use Xypex Admix C-1000 or equal. Follow all manufacturer recommendations including dosage rates.
- C. Chemical Admixtures: Provide admixtures certified by manufacturer to be compatible with other admixtures and that will not contribute water-soluble chloride ions exceeding those permitted in hardened concrete. Do not use calcium chloride or admixtures containing calcium chloride.
 - 1. Water-Reducing Admixture: ASTM C 494, Type A.
 - 2. Retarding Admixture: Use where the air temperature at the time of placement is expected to be consistently over 80° F. ASTM C 494, Type B.
 - 3. Water-Reducing and Retarding Admixture: ASTM C 494, Type D.
 - 4. High-Range, Water-Reducing Admixture: ASTM C 494, Type F. High-Range, Water-Reducing and Retarding Admixture: ASTM C 494, Type G.
 - a. If the high range water reducing agent is added to the concrete at the batch plant, it shall be second generation type, W.R. Grace & Co. Daracem 100; BASF Pozzoloth 430R, or equal. High range water reducer shall be added to the concrete after all other ingredients have been mixed and initial slump has been verified.
 - b. If the high range water reducer is added to the concrete at the job site, it shall be used in conjunction with a low range water reducer and shall be BASF Pozzoloth 400N and Pozzoloth MBL82, W.R. Grace & Co. WRDA 19 and WRDA 79, or equal. Concrete shall have a slump of 3 inches ± 1/2 inch prior to adding the high range water reducing admixture at the job site. The high range water reducing admixture shall be accurately measured and pressure injected into the mixer as a single dose by an experienced

technician. A standby system shall be provided and tested prior to each day's operation of the job site system.

- c. Concrete shall be mixed at mixing speed for a minimum of 30 mixer revolutions after the addition of the high range water reducer.
5. Plasticizing and Retarding Admixture: ASTM C 1017, Type II.

- D. Set-Accelerating Corrosion-Inhibiting Admixture: Use where the air temperature at the time of placement is expected to be consistently under 40° F. Commercially formulated, anodic inhibitor or mixed cathodic and anodic inhibitor; capable of forming a protective barrier and minimizing chloride reactions with steel reinforcement in concrete and complying with ASTM C 494, Type C.
 - 1. Products: Subject to compliance with requirements, available products that may be incorporated into the Work include, but are not limited to, the following:
 - a. Axim Italcementi Group, Inc.; CATEXOL CN-CI.
 - b. BASF Construction Chemicals - Building Systems; Rheocrete CNI.
 - c. Euclid Chemical Company (The), an RPM company; ARRMATECT.
 - d. Grace Construction Products, W. R. Grace & Co.; DCI.
 - e. Sika Corporation; Sika CNI.

- E. Non-Set-Accelerating Corrosion-Inhibiting Admixture: Commercially formulated, non-set-accelerating, anodic inhibitor or mixed cathodic and anodic inhibitor; capable of forming a protective barrier and minimizing chloride reactions with steel reinforcement in concrete.
 - 1. Products: Subject to compliance with requirements, available products that may be incorporated into the Work include, but are not limited to, the following:
 - a. BASF Construction Chemicals - Building Systems; Rheocrete 222+.
 - b. Cortec Corporation; MCI-2000.
 - c. Grace Construction Products, W. R. Grace & Co.; DCI-S.
 - d. Sika Corporation; FerroGard 901.

- G. Color Pigment: ASTM C 979, synthetic mineral-oxide pigments or colored water-reducing admixtures; color stable, nonfading, and resistant to lime and other alkalis.
 - 1. Manufacturers: Subject to compliance with requirements, available manufacturers offering products that may be incorporated into the Work include, but are not limited to, the following:
 - a. ChemMasters.
 - b. Davis Colors.
 - c. Dayton Superior Corporation.
 - d. Hoover Color Corporation.
 - e. Lambert Corporation.
 - f. QC Construction Products.
 - g. Rockwood Pigments NA, Inc.
 - h. Scofield, L. M. Company.
 - i. Solomon Colors, Inc.
 - 2. Color: As indicated by manufacturer's designation.

2.6 FIBER REINFORCEMENT

- A. Carbon-Steel Fiber: ASTM A 820, deformed, minimum of *1.5 inches* long, and aspect ratio of *35 to 40*.
 - 1. Products: Subject to compliance with requirements, available products that may be incorporated into the Work include, but are not limited to, the following:
 - a. Fiber: Type 1, Cold-Drawn Wire:
 - 1) Bekaert; Dramix.
 - 2) Fibercon International, Inc.; Fibercon Drawn Wire.
 - 3) Nycon, Inc.; Nycon SF Type I.
 - 4) Propex Concrete Systems Corp.; Novocon 1050.
 - 5) Sika Corporation; Sika Fiber SH.
 - b. Fiber: Type 2, Cut Sheet:
 - 1) Bekaert; Wiremix.
 - 2) Fibercon International, Inc.; Fibercon Cut Sheet.
 - 3) Nycon, Inc.; Nycon SF Type II.

- B. Synthetic Micro-Fiber: Monofilament polypropylene micro-fibers engineered and designed for use in concrete, complying with ASTM C 1116, Type III, 1/2 to 1-1/2 inches long.
1. Products: Subject to compliance with requirements, available products that may be incorporated into the Work include, but are not limited to, the following:
 - a. Monofilament Micro-Fibers:
 - 1) Axim Italcementi Group, Inc.; Fibrasol II P.
 - 2) Euclid Chemical Company (The), an RPM company; Fiberstrand 100.
 - 3) FORTA Corporation; FORTA Econo-Mono.
 - 4) Grace Construction Products, W. R. Grace & Co.; Grace MicroFiber.
 - 5) Metalcrete Industries; Polystrand 1000.
 - 6) Nycon, Inc.; ProConM.
 - 7) Propex Concrete Systems Corp.; Fibermesh 150.
 - 8) Sika Corporation; Sika Fiber PPM.
 - b. Fibrillated Micro-Fibers:
 - 1) Axim Italcementi Group, Inc.; Fibrasol F.
 - 2) Euclid Chemical Company (The), an RPM company; Fiberstrand F.
 - 3) FORTA Corporation; FORTA Econo-Net.
 - 4) Grace Construction Products, W. R. Grace & Co.; Grace Fibers.
 - 5) Nycon, Inc.; ProConF.
 - 6) Propex Concrete Systems Corp.; Fibermesh 300.
 - 7) Sika Corporation; Sika Fiber PPF.
- C. Synthetic Macro-Fiber: Polyolefin macro-fibers engineered and designed for use in concrete, complying with ASTM C 1116, Type III, 1 to 2-1/4 inches long.
1. Products: Subject to compliance with requirements, available products that may be incorporated into the Work include, but are not limited to, the following:
 - a. 3M; Scotchcast Polyolefin Fibers 1".
 - b. Euclid Chemical Company (The), an RPM company; Tuf-Strand SF.
 - c. FORTA Corporation; FORTA FERRO.
 - d. Grace Construction Products, W. R. Grace & Co.; Strux 90/40.
 - e. Nycon, Inc.; XL.
 - f. Propex Concrete Systems Corp.; Fibermesh 650.
 - g. Sika Corporation; Sika Fiber MS.

2.7 WATERSTOPS

- A. Flexible Rubber Waterstops: CE CRD-C 513, with factory-installed metal eyelets, for embedding in concrete to prevent passage of fluids through joints. Factory fabricate corners, intersections, and directional changes.
1. Manufacturers: Subject to compliance with requirements, available manufacturers offering products that may be incorporated into the Work include, but are not limited to, the following:
 - a. Greenstreak.
 - b. Williams Products, Inc.
 2. Profile: Flat, dumbbell with center bulb.
 3. Dimensions: 4 inches by 3/16 inch thick, nontapered.
- B. Flexible PVC Waterstops: CE CRD-C 572, [with factory-installed metal eyelets,] for embedding in concrete to prevent passage of fluids through joints. Factory fabricate corners, intersections, and directional changes.
1. Manufacturers: Subject to compliance with requirements, available manufacturers offering products that may be incorporated into the Work include, but are not limited to, the following:
 - a. BoMetals, Inc.
 - b. Greenstreak.
 - c. Paul Murphy Plastics Company.
 - d. Vinylex Corp.
 2. Profile: Flat, dumbbell with center bulb.
 3. Dimensions: 4 inches by 3/16 inch thick; nontapered.
- C. Self-Expanding Butyl Strip Waterstops: Manufactured rectangular or trapezoidal strip, butyl rubber with sodium bentonite or other hydrophilic polymers, for adhesive bonding to concrete, 3/4 by 1 inch.
1. Products: Subject to compliance with requirements, available products that may be

incorporated into the Work include, but are not limited to, the following:

- a. Carlisle Coatings & Waterproofing, Inc.; MiraSTOP.
 - b. CETCO; Volclay Waterstop-RX.
 - c. Concrete Sealants Inc.; Conseal CS-231.
 - d. Greenstreak; Swellstop.
 - e. Henry Company, Sealants Division; Hydro-Flex.
 - f. JP Specialties, Inc.; Earth Shield Type 20.
- D. Self-Expanding Rubber Strip Waterstops: Manufactured rectangular or trapezoidal strip, bentonite-free hydrophilic polymer modified chloroprene rubber, for adhesive bonding to concrete, 3/8 by 3/4 inch.

1. Products: Subject to compliance with requirements, available products that may be incorporated into the Work include, but are not limited to, the following:
 - a. Adeka Ultra Seal/OCM, Inc.; Adeka Ultra Seal.
 - b. Greenstreak; Hydrotite.
 - c. Vinylex Corp.; Swellseal.

2.9 CURING MATERIALS

- A. Evaporation Retarder: Waterborne, monomolecular film forming, manufactured for application to fresh concrete.
 1. Products: Subject to compliance with requirements, available products that may be incorporated into the Work include, but are not limited to, the following:
 - a. Axim Italcementi Group, Inc.; CATEXOL CimFilm.
 - b. BASF Construction Chemicals - Building Systems; Confilm.
 - c. ChemMasters; SprayFilm.
 - d. Conspec by Dayton Superior; Aquafilm.
 - e. Dayton Superior Corporation; Sure Film (J-74).
 - f. Edoco by Dayton Superior; BurkeFilm.
 - g. Euclid Chemical Company (The), an RPM company; Eucobar.
 - h. Kaufman Products, Inc.; Vapor-Aid.
 - i. Lambert Corporation; LAMBCO Skin.
 - j. L&M Construction Chemicals, Inc.; E-CON.
 - k. Meadows, W. R., Inc.; EVAPRE.
 - l. Metalcrete Industries; Waterhold.
 - m. Nox-Crete Products Group; MONOFILM.
 - n. Sika Corporation; SikaFilm.
 - o. SpecChem, LLC; Spec Film.
 - p. Symons by Dayton Superior; Finishing Aid.
 - q. TK Products, Division of Sierra Corporation; TK-2120 TRI-FILM.
 - r. Unitex; PRO-FILM.
 - s. Vexcon Chemicals, Inc.; Certi-Vex Envio Set.
- B. Absorptive Cover: AASHTO M 182, Class 2, burlap cloth made from jute or kenaf, weighing approximately 9 oz. / sq. yd. when dry.
- C. Moisture-Retaining Cover: ASTM C 171, polyethylene film or white burlap-polyethylene sheet.
- D. Water: Potable.
- E. Clear, Waterborne, Membrane-Forming Curing Compound: ASTM C 309, Type 1, Class B, nondissipating
 1. Products: Subject to compliance with requirements, available products that may be incorporated into the Work include, but are not limited to, the following:
 - a. Anti-Hydro International, Inc.; AH Clear Cure WB.
 - b. BASF Construction Chemicals - Building Systems; Kure-N-Seal WB.
 - c. ChemMasters; Safe-Cure & Seal 20.
 - d. Conspec by Dayton Superior; Cure and Seal WB.
 - e. Cresset Chemical Company; Crete-Trete 309-VOC Cure & Seal.
 - f. Dayton Superior Corporation; Safe Cure and Seal (J-18).
 - g. Edoco by Dayton Superior; Spartan Cote WB II.
 - h. Euclid Chemical Company (The), an RPM company; Aqua Cure VOX; Clearseal WB 150.
 - i. Kaufman Products, Inc.; Cure & Seal 309 Emulsion.
 - j. Lambert Corporation; Glazecote Sealer-20.
 - k. L&M Construction Chemicals, Inc.; Dress & Seal WB.
 - l. Meadows, W. R., Inc.; Vocomp-20.
 - m. Metalcrete Industries; Metcure.
 - n. Nox-Crete Products Group; Cure & Seal 150E.
 - o. Symons by Dayton Superior; Cure & Seal 18 Percent E.
 - p. TK Products, Division of Sierra Corporation; TK-2519 WB.
 - q. Vexcon Chemicals, Inc.; Starseal 309.

- F. Clear, Solvent-Borne, Membrane-Forming Curing and Sealing Compound: ASTM C 1315, Type 1, Class A.
1. Products: Subject to compliance with requirements, available products that may be incorporated into the Work include, but are not limited to, the following:
 - a. BASF Construction Chemicals - Building Systems; Kure-N-Seal 25 LV.
 - b. ChemMasters; Spray-Cure & Seal Plus.
 - c. Conspec by Dayton Superior; Sealcure 1315.
 - d. Dayton Superior Corporation; Day-Chem Cure and Seal (J-22UV).
 - e. Edoco by Dayton Superior; Cureseal 1315.
 - f. Euclid Chemical Company (The), an RPM company; Super Diamond Clear; LusterSeal 300.
 - g. Kaufman Products, Inc.; Sure Cure 25.
 - h. Lambert Corporation; UV Super Seal.
 - i. L&M Construction Chemicals, Inc.; Lumiseal Plus.
 - j. Meadows, W. R., Inc.; CS-309/30.
 - k. Metalcrete Industries; Seal N Kure 30.
 - l. Right Pointe; Right Sheen 30.
 - m. Vexcon Chemicals, Inc.; Certi-Vex AC 1315.
 2. VOC Content: Curing and sealing compounds shall have a VOC content of 200 g/L or less when calculated according to 40 CFR 59, Subpart D (EPA Method 24).

2.10 SEALANT

- A. The joint sealant shall be a two-part, gray, nonstaining, nonsagging, polyurethane sealant, which cures at ambient temperature to a firm, flexible, resilient, tear-resistant rubber.
- B. Technical Requirements:

1. Consistency	Gun grade
2. Tack free time	72 hours maximum
3. Pot life	1 to 3 hours
4. Hardness	30 Shore A, +/-5
5. Elongation	50%
6. Tensile strength, ASTM D 412	200 psi
7. Peel strength on concrete	No loss of bond with 50% +/- movement
8. Temperature service range	-40 F to +150 F

- C. Backing Rod: Backing rod shall be an extruded closed-cell polyethulene foam road. The rod shall be 1/4 inch larger in diameter than the joint wideth. Where possible, provide full-length sections for the joint; minimize splices. Apply backup rod and bond breaker tape in expansion joints.
- D. Bond breaker tape shall be an adhesive-backed glazed butyl or polyethylene tape, which will adhere to the premolded joint material or concrete surface The tape shall be the same width as teh joint. The tape shall be compatible with the sealant.
- E. Expansion Joint Filler: Extruded closed-cell polyethalene foam equal in thickness to joint. Provide foam with tear off strip where joint to receive sealant.
- F. Pre-molded joint Filler: Joint filler shall be preformed, non-extruded type constructed of closed-cell neoprene conforming to ASTM D 1752. Type 1, as manufactured by W.R. Grace Company of Cambridge, Massachusetts; W. R. Meadows, Inc., Elgin, Illinois; or equal.

2.11 RELATED MATERIALS

- A. Expansion and Isolation-Joint-Filler Strips: ASTM D 1751, asphalt-saturated cellulosic fiber.
- B. Semirigid Joint Filler: Two-component, semirigid, 100 percent solids, epoxy resin with a Type A shore durometer hardness of 80 per ASTM D 2240.
- C. Bonding Agent: ASTM C 1059, Type II, non-redispersible, acrylic emulsion or styrene butadiene.
- D. Epoxy Bonding Adhesive: ASTM C 881, two-component epoxy resin, capable of humid curing and bonding to damp surfaces, of class suitable for application temperature and of grade to suit requirements, and as follows:

1. Types I and II, non-load bearing, for bonding hardened or freshly mixed concrete to hardened concrete.
- E. Reglets: Fabricate reglets of not less than 0.022 inch thick, galvanized-steel sheet. Temporarily fill or cover face opening of reglet to prevent intrusion of concrete or debris.
- F. Dovetail Anchor Slots: Hot-dip galvanized-steel sheet, not less than 0.034 inch thick, with bent tab anchors. Temporarily fill or cover face opening of slots to prevent intrusion of concrete or debris.
- G. Nonepoxy bonding agent shall be Larsen Weldcrete, Euclid Euco Weld, or equal.
- H. Nonshrink grout shall conform to ASTM C 1107 and shall be BASF Masterflow 713, Sika SikaGrout 212, or equal.

2.12 REPAIR MATERIALS

- A. Repair Underlayment: Cement-based, polymer-modified, self-leveling product that can be applied in thicknesses from 1/8 inch and that can be feathered at edges to match adjacent floor elevations.
 1. Cement Binder: ASTM C 150, portland cement or hydraulic or blended hydraulic cement as defined in ASTM C 219.
 2. Primer: Product of underlayment manufacturer recommended for substrate, conditions, and application.
 3. Aggregate: Well-graded, washed gravel, 1/8 to 1/4 inch or coarse sand as recommended by underlayment manufacturer.
 4. Compressive Strength: Not less than 4100 psi at 28 days when tested according to ASTM C 109.
- B. Repair Overlayment: Cement-based, polymer-modified, self-leveling product that can be applied in thicknesses from 1/4 inch (and that can be filled in over a scarified surface to match adjacent floor elevations).
 1. Cement Binder: ASTM C 150, portland cement or hydraulic or blended hydraulic cement as defined in ASTM C 219.
 2. Primer: Product of topping manufacturer recommended for substrate, conditions, and application.
 3. Aggregate: Well-graded, washed gravel, 1/8 to 1/4 inch or coarse sand as recommended by topping manufacturer.
 4. Compressive Strength: Not less than 5000 psi at 28 days when tested according to ASTM C 109.

2.13 CONCRETE MIXTURES, GENERAL

- A. Prepare design mixtures for each type and strength of concrete, proportioned on the basis of laboratory trial mixture or field test data, or both, according to ACI 301.
 1. Use a qualified independent testing agency for preparing and reporting proposed mixture designs based on laboratory trial mixtures.
- B. Cementitious Materials: Use fly ash, pozzolan, ground granulated blast-furnace slag, and silica fume as needed to reduce the total amount of portland cement, which would otherwise be used, by not less than 40 percent:
 1. Fly Ash: 25 percent.
 2. Combined Fly Ash and Pozzolan: 25 percent.
 3. Ground Granulated Blast-Furnace Slag: 50 percent.
 4. Combined Fly Ash or Pozzolan and Ground Granulated Blast-Furnace Slag: 50 percent portland cement minimum, with fly ash or pozzolan not exceeding 25 percent.
 5. Silica Fume: 10 percent.
 6. Combined Fly Ash, Pozzolans, and Silica Fume: 35 percent with fly ash or pozzolans not exceeding 25 percent and silica fume not exceeding 10 percent.
 7. Combined Fly Ash or Pozzolans, Ground Granulated Blast-Furnace Slag, and Silica Fume: 50 percent with fly ash or pozzolans not exceeding 25 percent and silica fume not exceeding 10 percent.
- C. Limit water-soluble, chloride-ion content in hardened concrete to 0.06 percent by weight of cement.
- D. Admixtures: Use admixtures according to manufacturer's written instructions.
 1. Use water-reducing admixture in concrete, as required, for placement and workability.
 2. Use water-reducing and retarding admixture when required by high temperatures, low humidity, or other adverse placement conditions.

3. Use water-reducing admixture in pumped concrete, concrete for heavy-use industrial slabs and parking structure slabs, concrete required to be watertight, and concrete with a water-cementitious materials ratio below 0.50.
 4. Use corrosion-inhibiting admixture in concrete mixtures where indicated.
- E. Color Pigment: Add color pigment to concrete mixture according to manufacturer's written instructions and to result in hardened concrete color consistent with approved mockup.
- F. Controlled Low Strength Material (Flowable Fill): Flowable fill shall be manufactured at plants that have qualified as an approved source in accordance with the Standard Operating Procedure for Ready-Mix Concrete
1. The Contractor shall submit mix design for flowable fill to the Engineer for approval. The following table lists the suggested mix design for flowable fill:

COMPONENT	QUANTITY
CEMENT TYPE 1	75-150 LB/YD3
FLY ASH	150-600 LB/YD3
WATER	MIX DESIGN SHALL PRODUCE A CONSISTENCY THAT WILL RESULT IN A FLOWABLE, SELF-LEVELING PRODUCT AT THE TIME OF PLACEMENT.
AIR	5%-15%
UNIT WEIGHT	100-125 LB/FT3

2.14 CONCRETE MIXTURES FOR BUILDING ELEMENTS

- A. Footings, Foundation Walls: Proportion normal-weight concrete mixture as follows:
1. Minimum Compressive Strength: 4500 psi at 28 days.
 2. Maximum Water-Cementitious Materials Ratio: 0.5
 3. Slump Limit: 5 inches for concrete with verified slump of 2 to 4 inches before adding high-range water-reducing admixture or plasticizing admixture.
 4. Air Content: 6 percent, plus or minus 1.5 percent at point of delivery for 1-inch nominal maximum aggregate size.
- B. Slabs-on-Grade: Proportion normal-weight concrete mixture as follows:

1. Minimum Compressive Strength: 4500 psi at 28 days.
 2. Minimum Cementitious Materials Content: 470 lb/cu. yd.
 3. Slump Limit: 5 inches, plus or minus 1 inch.
 4. Air Content: 6 percent, plus or minus 1.5 percent at point of delivery for 1-inch nominal maximum aggregate size.
 5. Air Content: Do not allow air content of trowel-finished floors to exceed 3 percent.
 6. Steel-Fiber Reinforcement: Add to concrete mixture, according to manufacturer's written instructions, at a rate of 50 lb/cu. yd.
- C. Suspended Slabs: Proportion normal-weight concrete mixture as follows:
1. Minimum Compressive Strength: 5000 psi at 28 days.
 2. Minimum Cementitious Materials Content: 470 lb/cu. yd.
 3. Slump Limit: 4 inches, plus or minus 1 inch.
 4. Air Content: 6 percent, plus or minus 1.5 percent at point of delivery for 1-inch nominal maximum aggregate size.
 5. Air Content: Do not allow air content of trowel-finished floors to exceed 3 percent.
 6. Steel-Fiber Reinforcement: Add to concrete mixture, according to manufacturer's written instructions, at a rate of 50 lb/cu. yd.
 7. Synthetic Micro-Fiber: Uniformly disperse in concrete mixture at manufacturer's recommended rate, but not less than 1.0 lb/cu. yd.

8. Synthetic Macro-Fiber: Uniformly disperse in concrete mixture at manufacturer's recommended rate, but not less than 4.0 lb/cu. yd.

2.15 FABRICATING REINFORCEMENT

- A. Fabricate steel reinforcement according to CRSI's "Manual of Standard Practice."

2.16 CONCRETE MIXING

- A. Ready-Mixed Concrete: Measure, batch, mix, and deliver concrete according to ASTM C 94/C 94M and furnish batch ticket information.
 1. When air temperature is between 85 and 90 deg F, reduce mixing and delivery time from 1-1/2 hours to 75 minutes; when air temperature is above 90 deg F, reduce mixing and delivery time to 60 minutes.
- B. Project-Site Mixing: Measure, batch, and mix concrete materials and concrete according to ASTM C 1602. Mix concrete materials in appropriate drum-type batch machine mixer.
 1. For mixer capacity of 1 cu. yd. or smaller, continue mixing at least 1-1/2 minutes, but not more than 5 minutes after ingredients are in mixer, before any part of batch is released.
 2. For mixer capacity larger than 1 cu. yd., increase mixing time by 15 seconds for each additional 1 cu. yd.
 3. Provide batch ticket for each batch discharged and used in the Work, indicating Project identification name and number, date, mixture type, mixture time, quantity, and amount of water added. Record approximate location of final deposit in structure.

PART 3 EXECUTION

3.1 FORMWORK

- A. Design, erect, shore, brace, and maintain formwork, according to ACI 301, to support vertical, lateral, static, and dynamic loads, and construction loads that might be applied, until structure can support such loads.
- B. Construct formwork so concrete members and structures are of size, shape, alignment, elevation, and position indicated, within tolerance limits of ACI 117.
- C. Limit concrete surface irregularities, designated by ACI 347 as abrupt or gradual, as follows:
 1. Class A, 1/8 inch for smooth-formed finished surfaces.
 2. Class B, 1/4 inch for rough-formed finished surfaces.
- D. Construct forms tight enough to prevent loss of concrete mortar.
- E. Fabricate forms for easy removal without hammering or prying against concrete surfaces. Provide crush or wrecking plates where stripping may damage cast concrete surfaces. Provide top forms for inclined surfaces steeper than 1.5 horizontal to 1 vertical.
 1. Install keyways, reglets, recesses, and the like, for easy removal.
 2. Do not use rust-stained steel form-facing material.
- F. Set edge forms, bulkheads, and intermediate screed strips for slabs to achieve required elevations and slopes in finished concrete surfaces. Provide and secure units to support screed strips; use strike-off templates or compacting-type screeds.
- G. Provide temporary openings for cleanouts and inspection ports where interior area of formwork is inaccessible. Close openings with panels tightly fitted to forms and securely braced to prevent loss of concrete mortar. Locate temporary openings in forms at inconspicuous locations.
- H. Chamfer exterior corners and edges of permanently exposed concrete.
- I. Form openings, chases, offsets, sinkages, keyways, reglets, blocking, screeds, and bulkheads required in the Work. Determine sizes and locations from trades providing such items.
- J. Clean forms and adjacent surfaces to receive concrete. Remove chips, wood, sawdust, dirt, and other debris just before placing concrete.
- K. Retighten forms and bracing before placing concrete, as required, to prevent mortar leaks and maintain proper alignment.
- L. Coat contact surfaces of forms with form-release agent, according to manufacturer's written instructions, before placing reinforcement.

3.2 EMBEDDED ITEMS

- A. Place and secure anchorage devices and other embedded items required for adjoining work that is attached to or supported by cast-in-place concrete. Use setting drawings, templates, diagrams, instructions, and directions furnished with items to be embedded.
 - 1. Install anchor rods, accurately located, to elevations required and complying with tolerances in Section 7.5 of AISC's "Code of Standard Practice for Steel Buildings and Bridges."
 - 2. Install reglets to receive waterproofing and to receive through-wall flashings in outer face of concrete frame at exterior walls, where flashing is shown at lintels, shelf angles, and other conditions.
 - 3. Install dovetail anchor slots in concrete structures as indicated.

3.3 REMOVING AND REUSING FORMS

- A. General: Formwork for sides of beams, walls, columns, and similar parts of the Work that does not support weight of concrete may be removed after cumulatively curing at not less than 50 deg F for 24 hours after placing concrete. Concrete has to be hard enough to not be damaged by form-removal operations and curing and protection operations need to be maintained.
 - 1. Leave formwork for beam soffits, joists, slabs, and other structural elements that supports weight of concrete in place until concrete has achieved its 28-day design compressive strength.
 - 2. Remove forms only if shores have been arranged to permit removal of forms without loosening or disturbing shores.
- B. Clean and repair surfaces of forms to be reused in the Work. Split, frayed, delaminated, or otherwise damaged form-facing material will not be acceptable for exposed surfaces. Apply new form-release agent.
- C. When forms are reused, clean surfaces, remove fins and laitance, and tighten to close joints. Align and secure joints to avoid offsets. Do not use patched forms for exposed concrete surfaces unless approved by Engineer.

3.4 SHORES AND RESHORES

- A. Comply with ACI 318 and ACI 301 for design, installation, and removal of shoring and reshoring.
 - 1. Do not remove shoring or reshoring until measurement of slab tolerances is complete.

- B. Plan sequence of removal of shores and reshore to avoid damage to concrete. Locate and provide adequate reshoring to support construction without excessive stress or deflection.

3.5 STEEL REINFORCEMENT

- A. General: Bar bending details and placing drawings shall conform to the "Manual of Standard Practice for Detailing Reinforced Concrete Structures" ACI 315 and with CRSI's "Manual of Standard Practice" for placing reinforcement.
- B. Clean reinforcement of loose rust and mill scale, earth, ice, and other foreign materials that would reduce bond to concrete.
- C. Accurately position, support, and secure reinforcement against displacement. Locate and support reinforcement with bar supports to maintain minimum concrete cover. Do not tack weld crossing reinforcing bars.
- D. Set wire ties with ends directed into concrete, not toward exposed concrete surfaces.
- E. Install welded wire reinforcement in longest practicable lengths on bar supports spaced to minimize sagging. Lap edges and ends of adjoining sheets at least one mesh spacing. Offset laps of adjoining sheet widths to prevent continuous laps in either direction. Lace overlaps with wire.
- F. Steel in walls, unless otherwise shown, shall be continuous through the length of the various members.
- G. Wire mesh reinforcements in slabs shall be continuous, shall have joints lapped at least one full square + 2", and shall be supported as specified.
- H. Welding of reinforcing bars is prohibited unless noted otherwise. When welding is approved, welding shall be in accordance with AWS D1.4 "Welding Reinforcing Steel".
- I. Provide corner bars of the same size and spacing as adjacent reinforcing.
- J. Openings in walls or structural slabs shall be reinforced with minimum 2-#5 bars on all sides or as indicated in details. Extend reinforcing minimum 24" beyond the opening or as indicated.
- K. All reinforcing bars are to be made continuous or lapped minimum 48 bar diameters or as indicated on drawings.
- L. Dowel Bar Substitution: Contractor has the option to replace any or all dowels indicated on the drawings with a dowel bar substitution. Dowel bar substitution shall be of a size to match size of dowels indicated for strength. Inserts shall be secured to the forms in a manner recommended by the manufacturer. Bolts shall be provided with wire fabricated type to provide bolt clearance.
- M. Epoxy Adhesive Set Dowel Bars:
 - 1. Install in accordance with adhesive manufacture recommendations.
 - 2. Drill hole 1/8" larger than the bar outer diameter to a depth 1/2" deeper than the minimum design embedment.
 - 3. Clean the hole completely with brush and air blast removing all debris.
 - 4. Fill hole half full with properly mixed adhesive.
 - 5. Insert the bar while rotating it two full revolutions to completely distribute epoxy throughout the annular space.
 - 6. Agitate the bars to remove all air voids to full depth embedment penetration.

3.6 JOINTS

- A. General: Construct joints true to line with faces perpendicular to surface plane of concrete.
- B. Construction Joints: Install so strength and appearance of concrete are not impaired, at locations indicated or as approved by Engineer.
 - 1. Place joints perpendicular to main reinforcement. Continue reinforcement across construction joints unless otherwise indicated. Do not continue reinforcement through sides of strip placements of floors and slabs.

2. Form keyed joints as indicated. Embed keys at least 1 1/2 inches into concrete.
 3. Locate joints for beams, slabs, joists, and girders in the middle third of spans. Offset joints in girders a minimum distance of twice the beam width from a beam-girder intersection.
 4. Locate horizontal joints in walls and columns at underside of floors, slabs, beams, and girders and at the top of footings or floor slabs.
 5. Space vertical joints in walls as indicated. Locate joints beside piers integral with walls, near corners, and in concealed locations where possible.
 6. Use a bonding agent at locations where fresh concrete is placed against hardened or partially hardened concrete surfaces.
 7. Use epoxy-bonding adhesive at locations where fresh concrete is placed against hardened or partially hardened concrete surfaces.
- C. Contraction Joints in Slabs-on-Grade: Form weakened-plane contraction joints, sectioning concrete into areas as indicated. Construct contraction joints for a depth equal to at least one-fourth of concrete thickness as follows:
1. Grooved Joints: Form contraction joints after initial floating by grooving and finishing each edge of joint to a radius of 1/8 inch. Repeat grooving of contraction joints after applying surface finishes. Eliminate groover tool marks on concrete surfaces.
 2. Sawed Joints: Form contraction joints with power saws equipped with shatterproof abrasive or diamond-rimmed blades. Cut 1/8 inch wide joints into concrete when cutting action will not tear, abrade, or otherwise damage surface and before concrete develops random contraction cracks.
- D. Isolation Joints in Slabs-on-Grade: After removing formwork, install joint-filler strips at slab junctions with vertical surfaces, such as column pedestals, foundation walls, grade beams, and other locations, as indicated.

1. Extend joint-filler strips full width and depth of joint, terminating flush with finished concrete surface unless otherwise indicated.
 2. Terminate full-width joint-filler strips not less than 1/2 inch or more than 1 inch below finished concrete surface where joint sealants, specified in Division 07 Section "Joint Sealants," are indicated.
 3. Install joint-filler strips in lengths as long as practicable. Where more than one length is required, lace or clip sections together.
- E. Doweled Joints: Install dowel bars and support assemblies at joints where indicated. Lubricate or asphalt coat one-half of dowel length to prevent concrete bonding to one side of joint.

3.7 WATERSTOPS

- A. Flexible Waterstops: Install in construction joints and at other joints indicated to form a continuous diaphragm. Install in longest lengths practicable. Support and protect exposed waterstops during progress of the Work. Field fabricate joints in waterstops according to manufacturer's written instructions.
- B. To properly secure waterstops in wall joints before concrete is placed, drill holes in waterstops approximately 1 inch from each edge or between the outermost ribs at each edge and center the waterstop in the joint. Tie both edges of the waterstop and fasten to reinforcing steel with black annealed steel tie wire as specified for tying reinforcing steel and secure in place so that the waterstop will be perpendicular to the joint and remain in the required position during concrete placement. The spacing of the waterstop ties shall match the spacing of the adjacent reinforcing, but need not be spaced closer than 12 inches on center.
- C. Self-Expanding Strip Waterstops: Install in construction joints and at other locations indicated, according to manufacturer's written instructions, adhesive bonding, mechanically fastening, and firmly pressing into place. Install in longest lengths practicable.
- D. Horizontal PVC waterstops in slabs shall have the edge of the waterstop lifted while placing concrete below the waterstop. Then the waterstop shall be manually forced against and into the placed concrete and covered with fresh concrete, to ensure adequate encasement of the waterstop in concrete.
- E. Waterstops shall be installed so that half of the width will be embedded on each side of the joint. Care shall be exercised to ensure that the waterstop is completely embedded in void-free concrete.

3.8 INSTALLATION OF JOINT SEALANTS

- A. Immediately before installing the joint sealant, clean the joint cavity by sandblasting or power wire brushing. Install bond breaker tape per manufacturer's instructions.
- B. After the joints have been prepared as described above, apply the joint sealant. Apply the primer, if required, and joint sealant only with the equipment and methods recommended by the joint sealant manufacturer.
- C. Application criteria for the sealant materials, such as temperature and moisture requirements and primer cure time, shall be in accordance with the recommendations of the sealant manufacturer.
- D. Apply masking tape along the edges of the exposed surface of the exposed joints. Trowel the joints smooth with a tuck pointing tool wiped with a solvent recommended by the sealant manufacturer.
- E. After the sealant has been applied, remove the masking tape and any sealant spillage.
- F. Installation of Premolded Joint Filler: Install in joint accurately as shown. Attach to concrete with a bonding agent recommended by the joint sealant and joint filler manufacturer for compatibility.

3.9 CONCRETE PLACEMENT

- A. Before placing concrete, verify that installation of formwork, reinforcement, and embedded items is complete and that required inspections have been performed.
- B. Do not add water to concrete during delivery, at Project site, or during placement unless such quantity of water is intentionally withheld for later addition at project site. Such addition, in no case should result in altering of the specified water to cementitious material ratio. Indicate the amount of mixing water that is withheld for later addition at the project site on the batch tickets. Provide such batch tickets to the concrete inspector for review and record.
- C. Before test sampling and placing concrete, water may be added at Project site, subject to limitations of ACI 301.

1. Do not add water to concrete after adding high-range water-reducing admixtures to mixture.
- D. Deposit concrete continuously in one layer or in horizontal layers of such thickness that no new concrete will be placed on concrete that has hardened enough to cause seams or planes of weakness. If a section cannot be placed continuously, provide construction joints as indicated. Deposit concrete to avoid segregation.
1. Deposit concrete in horizontal layers of depth to not exceed formwork design pressures and in a manner to avoid inclined construction joints.
 2. Consolidate placed concrete with mechanical vibrating equipment according to ACI 301.
 3. Do not use vibrators to transport concrete inside forms. Insert and withdraw vibrators vertically at uniformly spaced locations to rapidly penetrate placed layer and at least 6 inches into preceding layer. Do not insert vibrators into lower layers of concrete that have begun to lose plasticity. At each insertion, limit duration of vibration to time necessary to consolidate concrete and complete embedment of reinforcement and other embedded items without causing mixture constituents to segregate.
- E. Deposit and consolidate concrete for floors and slabs in a continuous operation, within limits of construction joints, until placement of a panel or section is complete.
1. Consolidate concrete during placement operations so concrete is thoroughly worked around reinforcement and other embedded items and into corners.
 2. Maintain reinforcement in position on chairs during concrete placement.
 3. Screed slab surfaces with a straightedge and strike off to correct elevations.
 4. Slope surfaces uniformly to drains where required.
 5. Begin initial floating using bull floats or darbies to form a uniform and open-textured surface plane, before excess bleedwater appears on the surface. Do not further disturb slab surfaces before starting finishing operations.
- F. Placement in Wall Forms: Concrete shall not be dropped through reinforcement steel or into any deep form, whether reinforcement is present or not, causing separation of the coarse aggregate from the mortar on account of repeatedly hitting rods or the sides of the form as it falls, nor shall concrete be placed in any form in such a manner as to leave accumulation of mortar on the form surfaces above the placed concrete. In such cases, some means such as the use of hoppers and, if necessary, vertical ducts of canvas, rubber, or metal shall be used for placing concrete in the forms in a manner that it may reach the place of final deposit without separation. In no case shall the free fall of concrete exceed 4 feet before the ends of ducts, chutes, or buggies. Concrete shall be uniformly distributed during the process of depositing and in no case after depositing shall any portion be displaced in the forms more than 6 feet in horizontal direction. Concrete in forms shall be deposited in uniform horizontal layers not deeper than 2 feet; and care shall be taken to avoid inclined layers or inclined construction joints except where such are required for sloping members. Each layer shall be placed while the previous layer is still soft. The rate of placing concrete in forms shall not exceed 5 feet of vertical rise per hour.
- G. Conveyor Belts and Chutes: All ends of chutes, hopper gates, and all other points of concrete discharge throughout the Contractor's conveying, hoisting and placing system shall be so designed and arranged that concrete passing from them will not fall separated into whatever receptacle immediately receives it. Conveyor belts, if used, shall be of a type acceptable to the Engineer. Chutes longer than 50 feet will not be permitted. Minimum slopes of chutes shall be such that concrete of the specified consistency will readily flow in them. If a conveyor belt is used, it shall be wiped clean by a device operated in such a manner that none of the mortar adhering to the belt will be wasted. All conveyor belts and chutes shall be covered. Sufficient illumination shall be provided in the interior of all forms so that the concrete at the places of deposit is visible from the deck or runway.
- H. Placement in Slabs: Concrete placed in sloping slabs shall proceed uniformly from the bottom of the slab to the top, for the full width of the pour. As the work progresses, the concrete shall be vibrated and carefully worked around the slab reinforcement, and the surface of the slab shall be screeded in an upslope direction
- I. Temperature of Concrete: Concrete temperature shall conform to the applicable requirements of ACI 305R - Hot Weather Concreting, and ACI 306R - Cold Weather Concreting, unless otherwise modified herein. The temperature of concrete when it is being placed shall be not more than 90° F. Concrete ingredients shall not be heated to a temperature higher than that necessary to keep the temperature of the mixed concrete, as placed, from falling below the specified minimum temperature. If concrete is placed when the weather is such that the temperature of the concrete would exceed 90° F, the Contractor shall employ effective means, such as precooling of aggregates and mixing water using ice

or placing at night, as necessary to maintain the temperature of the concrete, as it is placed, below 90° F. The Contractor shall be entitled to no additional compensation on the account of the foregoing requirements. See subsections 3.4 and 3.5 for additional requirements.

- J. Concrete shall be handled from the mixer to the place of final deposit as rapidly as practicable by methods, which will prevent segregation or loss of ingredients and in a manner that the required quality of the concrete is maintained. No concrete shall be placed more than 1½ hours after mixing of that particular batch has commenced.
- K. Pumping Equipment: Pumping equipment and procedures, if used, shall conform to the recommendations contained in the report of ACI Committee 304 on Placing Concrete by Pumping Methods, ACI 304.2R. The specified slump shall be measured at the point of discharge. The loss of slump in pumping shall not exceed 1 inch with or without a superplastizer. The slump loss shall be determined by tests made at each end of the pumping system. If tests indicate a loss greater than 1 inch, the contractor shall modify the pumping system as required to reduce the slump loss.
- L. The order of placing concrete in all parts of the work shall be acceptable to the Engineer. In order to minimize the effects of shrinkage, placement shall be scheduled so that one end of each unit is free, except at corner closures. The placing of units shall be done by placing alternate units in a manner such that each unit placed shall have cured at least 7 days before the contiguous unit or units are placed, except that the corner sections of vertical walls shall not be placed until the 2 adjacent wall panels have cured at least 14 days.
- M. The surface of the concrete shall be level whenever a run of concrete is stopped. To insure a level, straight joint on the exposed surface of walls, a wood strip at least ¾ inch thick shall be tacked to the forms on these surfaces. The concrete shall be carried about 1/2 of an inch above the underside of the strip. About one hour after the concrete is placed, the strip shall be removed and any irregularities in the edge formed by the strip shall be leveled with a trowel and all laitance shall be removed.
- N. As concrete is placed in the forms or in excavations, it shall be thoroughly settled and compacted, throughout the entire depth of the layer which is being consolidated, into a dense, homogeneous mass, filling all corners and angles, thoroughly embedding the reinforcement, eliminating rock pockets, and bringing only a slight excess of water to the exposed surface of concrete during placement. Vibrators shall be high-speed power vibrators (8,000 to 10,000 rpm) of an immersion type in sufficient number and with (at least one) standby units as required.
- O. Care shall be used in placing concrete around waterstops. The concrete shall be carefully worked by rodding and vibrating to make sure that all air and rock pockets have been eliminated. Where waterstops are placed horizontally, the concrete shall be worked under the waterstops by hand, making sure that all air and rock pockets have been eliminated. Concrete surrounding the waterstops shall be given additional vibration, over and above that used for adjacent concrete placement to assure complete embedment of the waterstops in the concrete.
- P. Concrete in walls shall be internally vibrated and at the same time stirred, or worked with suitable appliances, tamping bars, shovels, or forked tools until it completely fills the forms or excavations and closes snugly against all surfaces, eliminating all air or stone pockets which may cause honeycombing, pitting or planes of weakness. Subsequent layers of concrete shall not be placed until the layers previously placed have been worked thoroughly as specified. Vibrators shall be provided in sufficient numbers, with standby units as required, to accomplish the results herein specified within 15 minutes after concrete of the prescribed consistence is placed in the forms. The vibrating head shall be kept from contact with the surfaces of the forms. Overvibrating and use of vibrators to transport concrete within forms shall not be allowed. Vibrators shall be inserted and withdrawn at many points, approximately 18 inches apart. At each insertion, the duration shall be sufficient to consolidate the concrete, but not sufficient to cause segregation, generally from 5 to 15 sec. duration.
- Q. Backfill placed against walls and grade beams shall be done evenly on both sides. Do not place backfill against walls until the concrete has attained a compressive strength equal to the specified 28-day compressive strength. Backfill against basement foundation walls shall not be placed until ground level floor and lower level slabs that brace this wall are in place and cured unless the wall is properly braced with temporary bracing. All bracing, if used, shall be responsibility of the contractor. Submit all calculations and details to the structural engineer for record. Backfill placed directly adjacent to basement and retaining walls shall be compacted clean free draining granular material. For a minimum of 2'-6" from face of wall. Provide a 1'-6" deep cap of compacted approved impervious cohesive material at top of granular backfill. All backfill shall be compacted using hand operated equipment; no heavy equipment shall be allowed within 5'-0" of any wall.
- R. No aluminum of any type shall be allowed in concrete work unless coated to prevent

aluminum-concrete reaction.

- S. Cross reference structural and Engineerural drawings for inserts, anchor bolts, notches, ledges, lugs, etc. required on beams. Width and depth of beams given are overall out-to-out dimensions of concrete.
- T. All field bending of reinforcing shall be done cold. Heating of bars will not be permitted.
- U. Maximum O.D. of embedded conduit shall be no larger than 1/3 slab thickness. No conduit shall be placed above the welded wire fabric in slabs- on-grade or concrete fill placed onto composite metal deck. Do not place pipes, ducts, reglets or chases in structural concrete or composite floor systems without approval of the structural engineer through the Engineer.
- V. Provide vertical construction joints in concrete walls that have their outside surface exposed to view at a maximum uniform spacing not to exceed 30'-0". Coordinate joint locations with Engineerural drawings. Do not cast unexposed walls or grade beams in lengths over 60'-0". Wait 48 hours between adjacent pours. Provide waterstops at all vertical construction joints in walls.
- W. Construction joints in floors shall be located within the middle third of spans of slabs, beams, and girders. Joints in girders shall be offset a minimum distance of two times the width of intersecting beams. Provide waterstops at all construction joints in basin top and bottom concrete slab and beam framing.
- X. No footing shall be placed onto or against sub-grades containing free water, frost, or ice.
- Y. Cold-Weather Placement: Comply with ACI 306.1 and as follows. Protect concrete work from physical damage or reduced strength that could be caused by frost, freezing actions, or low temperatures.
 - 1. When average high and low temperature is expected to fall below 40 deg F for three successive days, maintain delivered concrete mixture temperature within the temperature range required by ACI 301.
 - 2. Do not use frozen materials or materials containing ice or snow. Do not place concrete on frozen subgrade or on subgrade containing frozen materials.
 - 3. Do not use calcium chloride, salt, or other materials containing antifreeze agents or chemical accelerators unless otherwise specified and approved in mixture designs.
- Z. Hot-Weather Placement: Comply with ACI 301 and as follows:
 - 1. Maintain concrete temperature below 90 deg F at time of placement. Chilled mixing water or chopped ice may be used to control temperature, provided water equivalent of ice is calculated to total amount of mixing water. Using liquid nitrogen to cool concrete is Contractor's option.
 - 2. Fog-spray forms, steel reinforcement, and subgrade just before placing concrete. Keep subgrade uniformly moist without standing water, soft spots, or dry areas.

3.10 CONCRETE SLAB ON GRADE CONSTRUCTION

- A. All unacceptable fill and top soil shall be removed from below all proposed slabs-on-grade and the exposed natural soil shall be proof rolled and the compaction verified by a qualified independent soils testing firm prior to placing fill. Areas exhibiting weakness shall be removed and replaced by acceptable compacted fill.
- B. A minimum 4" of compacted granular fill shall be placed under all slabs-on-grade. All fill required to attain final sub-grade for slabs and walls shall be an acceptable material placed and compacted as directed by the project soils consultant report recommendations.
- C. A vapor barrier with minimum 10 mil thickness shall be placed under all interior slab-on-grade or below granular fill for floors to receive floor covering as indicated on Engineerural drawings. Lap and seal all edges. No vapor barrier required for slab on grades without floor coverings unless noted otherwise.
- D. Pitch slabs to drains and provide depressions, where shown on the process or structural or Engineerural drawings, without reducing the thickness of slab indicated. See details for additional reinforcing for slabs on grade depressions greater than 1".
- E. Provide slab-on-grade construction joints around each column, against grade beams, interior walls, and between columns and walls. Provide slab joints to form areas not to exceed 15' in length in each direction. See typical details. Submit detailed drawings showing locations of all construction joints.

3.11 FINISHING FORMED SURFACES

- A. Rough-Formed Finish: As-cast concrete texture imparted by form-facing material with tie holes and defects repaired and patched. Remove fins and other projections that exceed specified limits on formed-surface irregularities.
 - 1. Apply to concrete surfaces not exposed to public view

- B. Smooth-Formed Finish: As-cast concrete texture imparted by form-facing material, arranged in an orderly and symmetrical manner with a minimum of seams. Repair and patch tie holes and defects. Remove fins and other projections that exceed specified limits on formed-surface irregularities.
 - 1. Apply to concrete surfaces exposed to public view.
- C. Rubbed Finish: Apply the following to smooth-formed finished as-cast concrete for basin and tank walls that are exposed to view and where indicated:
 - 1. Smooth-Rubbed Finish: Not later than one day after form removal, moisten concrete surfaces and rub with carborundum brick or another abrasive until producing a uniform color and texture. Do not apply cement grout other than that created by the rubbing process.
 - 2. Grout-Cleaned Finish: Wet concrete surfaces and apply grout of a consistency of thick paint to coat surfaces and fill small holes. Mix one part portland cement to one and one-half parts fine sand with a 1:1 mixture of bonding admixture and water. Add white portland cement in amounts determined by trial patches so color of dry grout will match adjacent surfaces. Scrub grout into voids and remove excess grout. When grout whitens, rub surface with clean burlap and keep surface damp by fog spray for at least 36 hours.
 - 3. Cork-Floated Finish: Wet concrete surfaces and apply a stiff grout. Mix one part portland cement and one part fine sand with a 1:1 mixture of bonding agent and water. Add white portland cement in amounts determined by trial patches so color of dry grout will match adjacent surfaces. Compress grout into voids by grinding surface. In a swirling motion, finish surface with a cork float.
- D. Related Unformed Surfaces: At tops of walls, horizontal offsets, and similar unformed surfaces adjacent to formed surfaces, strike off smooth and finish with a texture matching adjacent formed surfaces. Continue final surface treatment of formed surfaces uniformly across adjacent unformed surfaces unless otherwise indicated.

3.12 FINISHING FLOORS AND SLABS

- A. General: Comply with ACI 302.1R recommendations for screeding, restraighening, and finishing operations for concrete surfaces. Do not wet concrete surfaces.
- B. Scratch Finish: While still plastic, texture concrete surface that has been screeded and bull-floated or darbied. Use stiff brushes, brooms, or rakes to produce a profile amplitude of 1/4 inch in one direction.
 - 1. Apply scratch finish to surfaces indicated.
- C. Float Finish: Consolidate surface with power-driven floats or by hand floating if area is small or inaccessible to power driven floats. Restraighten, cut down high spots, and fill low spots. Repeat float passes and restraighening until surface is left with a uniform, smooth, granular texture.
 - 1. Apply float finish to surfaces indicated.
- D. Trowel Finish: After applying float finish, apply first troweling and consolidate concrete by hand or power-driven trowel. Continue troweling passes and restraighten until surface is free of trowel marks and uniform in texture and appearance. Grind smooth any surface defects that would telegraph through applied coatings or floor coverings.
 - 1. Apply a trowel finish to surfaces indicated.
 - 2. Finish surfaces to the following tolerances, according to ASTM E 1155, for a randomly trafficked floor surface:
 - a. Specified overall values of flatness, F(F) 25; and of levelness, F(L) 20; with minimum local values of flatness, F(F) 17; and of levelness, F(L) 15.
 - b. Specified overall values of flatness, F(F) 35; and of levelness, F(L) 25; with minimum local values of flatness, F(F) 24; and of levelness, F(L) 17; for slabs-on-grade.
 - c. Specified overall values of flatness, F(F) 30; and of levelness, F(L) 20; with minimum local values of flatness, F(F) 24; and of levelness, F(L) 15; for suspended slabs.
 - d. Specified overall values of flatness, F(F) 45; and of levelness, F(L) 35; with minimum local values of flatness, F(F) 30; and of levelness, F(L) 24.
 - 3. Finish and measure surface so gap at any point between concrete surface and an unlevelled, freestanding, 10 ft. long straightedge resting on two high spots and placed anywhere on the surface does not exceed 1/4 inch.
- E. Broom Finish: Apply a broom finish to exterior concrete platforms, steps, ramps, and elsewhere as indicated.
 - 1. Immediately after float finishing, slightly roughen trafficked surface by brooming with fiber-bristle broom perpendicular to main traffic route. Coordinate required final finish with Engineer before application.

3.13 MISCELLANEOUS CONCRETE ITEMS

- A. Filling In: Fill in holes and openings left in concrete structures after work of other trades is in place unless otherwise indicated. Mix, place, and cure concrete, as specified, to blend with in-place construction. Provide other miscellaneous concrete filling indicated or required to complete the Work.
- B. Curbs: Provide monolithic finish to interior curbs by stripping forms while concrete is still green and by steel-troweling surfaces to a hard, dense finish with corners, intersections, and terminations slightly rounded.
- C. Equipment Bases and Foundations: Provide machine and equipment bases and foundations as shown on Drawings. Set anchor bolts for machines and equipment at correct elevations, complying with diagrams or templates from manufacturer furnishing machines and equipment.
- D. Steel Pan Stairs: Provide concrete fill for steel pan stair treads, landings, and associated items. Cast-in inserts and accessories as shown on Drawings. Screed, tamp, and trowel finish concrete surfaces.

3.14 CONCRETE PROTECTING AND CURING

- A. General: Protect freshly placed concrete from premature drying and excessive cold or hot temperatures. Comply with ACI 306.1 for cold-weather protection and ACI 301 for hot-weather protection during curing.
- B. Evaporation Retarder: Apply evaporation retarder to unformed concrete surfaces if hot, dry, or windy conditions cause moisture loss approaching 0.2 lb/sq. ft. x h before and during finishing operations. Apply according to manufacturer's written instructions after placing, screeding, and bull floating or darbying concrete, but before float finishing.
- C. Formed Surfaces: Cure formed concrete surfaces, including underside of beams, supported slabs, and other similar surfaces. If forms remain during curing period, moist cure after loosening forms. If removing forms before end of curing period, continue curing for the remainder of the curing period.
- D. Unformed Surfaces: Begin curing immediately after finishing concrete. Cure unformed surfaces, including floors and slabs, concrete floor toppings, and other surfaces.
- E. All concrete in liquid containing structures shall be water cured.
- F. Cure concrete according to ACI 308.1, by one or a combination of the following methods:
 - 1. Moisture Curing: Keep surfaces continuously moist for not less than seven days with the following materials:
 - a. Water.
 - b. Continuous water-fog spray.
 - c. Absorptive cover, water saturated, and kept continuously wet. Cover concrete surfaces and edges with 12-inch lap over adjacent absorptive covers.
 - 2. Moisture-Retaining-Cover Curing: Cover concrete surfaces with moisture-retaining cover for curing concrete, placed in widest practicable width, with sides and ends lapped at least 12 inches, and sealed by waterproof tape or adhesive. Cure for not less than seven days. Immediately repair any holes or tears during curing period using cover material and waterproof tape.
 - a. Moisture cure or use moisture-retaining covers to cure concrete surfaces to receive floor coverings.
 - b. Moisture cure or use moisture-retaining covers to cure concrete surfaces to receive penetrating liquid floor treatments.
 - c. Cure concrete surfaces to receive floor coverings with either a moisture-retaining cover or a curing compound that the manufacturer certifies will not interfere with bonding of floor covering used on Project.

3. Curing Compound: Apply uniformly in continuous operation by power spray or roller according to manufacturer's written instructions. Recoat areas subjected to heavy rainfall within three hours after initial application. Maintain continuity of coating and repair damage during curing period.
 - a. Removal: After curing period has elapsed, remove curing compound without damaging concrete surfaces by method recommended by curing compound manufacturer **<<None - N/A; or unless manufacturer certifies curing compound will not interfere with bonding of floor covering used on Project>>**.
4. Curing and Sealing Compound: Apply uniformly to floors and slabs indicated in a continuous operation by power spray or roller according to manufacturer's written instructions. Recoat areas subjected to heavy rainfall within three hours after initial application. Repeat process 24 hours later and apply a second coat. Maintain continuity of coating and repair damage during curing period.

3.15 LIQUID FLOOR TREATMENTS

- A. Penetrating Liquid Floor Treatment: Prepare, apply, and finish penetrating liquid floor treatment according to manufacturer's written instructions.
 1. Remove curing compounds, sealers, oil, dirt, laitance, and other contaminants and complete surface repairs.
 2. Do not apply to concrete that is less than **<<three; seven; 14; or 28>>** days' old.
 3. Apply liquid until surface is saturated, scrubbing into surface until a gel forms; rewet; and repeat brooming or scrubbing. Rinse with water; remove excess material until surface is dry. Apply a second coat in a similar manner if surface is rough or porous.
- B. Polished Concrete Floor Treatment: Apply polished concrete finish system to cured and prepared slabs to match accepted mockup.
 1. Machine grind floor surfaces to receive polished finishes level and smooth **<<None - N/A; or and to depth required to reveal aggregate to match approved mockup>>**.
 2. Apply penetrating liquid floor treatment for polished concrete in polishing sequence and according to manufacturer's written instructions, allowing recommended drying time between successive coats.
 3. Continue polishing with progressively finer grit diamond polishing pads to gloss level to match approved mockup.
 4. Control and dispose of waste products produced by grinding and polishing operations.
 5. Neutralize and clean polished floor surfaces.

- C. Sealing Coat: Uniformly apply a continuous sealing coat of curing and sealing compound to hardened concrete by power spray or roller according to manufacturer's written instructions.
- D. When called for in Finish Schedule or on plans, apply first coat of clear concrete floor sealer after final troweling. Surface is damp, but not wet, and can no longer be marred by workman spray sealer at rate of 300 sq. ft. per gallon. After all trades have completed work, mop-clean floor with TSP solution to remove oil, grease, and dirt, rinse, allow to dry, then cover with second spray coat of sealer at rate of 400 sq. ft. per gallon. Do not allow puddles to occur in either coat.

3.16 JOINT FILLING

- A. Prepare, clean, and install joint filler according to manufacturer's written instructions.
 - 1. Defer joint filling until concrete has aged at least ~~<<one; or six>>~~ month(s). Do not fill joints until construction traffic has permanently ceased.
- B. Remove dirt, debris, saw cuttings, curing compounds, and sealers from joints; leave contact faces of joint clean and dry.
- C. Install semirigid joint filler full depth in saw-cut joints and at least 2 inches deep in formed joints. Overfill joint and trim joint filler flush with top of joint after hardening.

3.17 CONCRETE SURFACE REPAIRS

- A. Defective Concrete: Repair and patch defective areas when approved by Engineer. Remove and replace concrete that cannot be repaired and patched to Engineer's approval.
- B. Patching Mortar: Mix dry-pack patching mortar, consisting of one part portland cement to two and one-half parts fine aggregate passing a No. 16 sieve, using only enough water for handling and placing.
- C. Repairing Formed Surfaces: Surface defects include color and texture irregularities, cracks, spalls, air bubbles, honeycombs, rock pockets, fins and other projections on the surface, and stains and other discolorations that cannot be removed by cleaning.
 - 1. Immediately after form removal, cut out honeycombs, rock pockets, and voids more than 1/2 inch in any dimension to solid concrete. Limit cut depth to 3/4 inch. Make edges of cuts perpendicular to concrete surface. Clean, dampen with water, and brush-coat holes and voids with bonding agent. Fill and compact with patching mortar before bonding agent has dried. Fill form-tie voids with patching mortar or cone plugs secured in place with bonding agent.
 - 2. Repair defects on surfaces exposed to view by blending white portland cement and standard portland cement so that, when dry, patching mortar will match surrounding color. Patch a test area at inconspicuous locations to verify mixture and color match before proceeding with patching. Compact mortar in place and strike off slightly higher than surrounding surface.
 - 3. Repair defects on concealed formed surfaces that affect concrete's durability and structural performance as determined by Engineer.
- D. Repairing Unformed Surfaces: Test unformed surfaces, such as floors and slabs, for finish and verify surface tolerances specified for each surface. Correct low and high areas. Test surfaces sloped to drain for trueness of slope and smoothness; use a sloped template.
 - 1. Repair finished surfaces containing defects. Surface defects include spalls, popouts, honeycombs, rock pockets, crazing and cracks in excess of 0.01 inch wide or that penetrate to reinforcement or completely through unreinforced sections regardless of width, and other objectionable conditions.
 - 2. After concrete has cured at least 14 days, correct high areas by grinding.
 - 3. Correct localized low areas during or immediately after completing surface finishing operations by cutting out low areas and replacing with patching mortar. Finish repaired areas to blend into adjacent concrete.
 - 4. Correct other low areas scheduled to receive floor coverings with a repair underlayment. Prepare, mix, and apply repair underlayment and primer according to manufacturer's written instructions to produce a smooth, uniform, plane, and level surface. Feather edges to match adjacent floor elevations.
 - 5. Correct other low areas scheduled to remain exposed with a repair topping. Cut out low areas to ensure a minimum repair topping depth of 1/4 inch to match adjacent floor elevations. Prepare, mix, and apply repair topping and primer according to manufacturer's written instructions to produce a smooth, uniform, plane, and level surface.
 - 6. Repair defective areas, except random cracks and single holes 1 inch or less in diameter, by cutting out and replacing with fresh concrete. Remove defective areas with clean, square cuts

and expose steel reinforcement with at least a 3/4-inch clearance all around. Dampen concrete surfaces in contact with patching concrete and apply bonding agent. Mix patching concrete of same materials and mixture as original concrete except without coarse aggregate. Place, compact, and finish to blend with adjacent finished concrete. Cure in same manner as adjacent concrete.

7. Repair random cracks and single holes 1 inch or less in diameter with patching mortar. Groove top of cracks and cut out holes to sound concrete and clean off dust, dirt, and loose particles. Dampen cleaned concrete surfaces and apply bonding agent. Place patching mortar before bonding agent has dried. Compact patching mortar and finish to match adjacent concrete. Keep patched area continuously moist for at least 72 hours.
- E. Perform structural repairs of concrete, subject to Engineer's approval, using epoxy adhesive and patching mortar.
- F. Repair materials and installation not specified above may be used, subject to Engineer's approval.
- G. Repair of concrete not passing leakage test: After the structure has been tested for leaks, repair leaking concrete cracks by cutting out a square edged and uniformly aligned joint 3/8 inch wide by 3/4 inch deep, preparing exposed surfaces of the joint, priming the joint, and apply low viscosity polyurethane joint sealant in accordance with Manufacturer. The Contractor may submit alternate methods of crack repair for review by the Engineer.

3.18 FIELD QUALITY CONTROL

- A. Testing and Inspecting: Owner will engage a special inspector and qualified testing and inspecting agency to perform field tests and inspections and prepare test reports.
- B. Testing and Inspecting: Engage a qualified testing and inspecting agency to perform tests and inspections and to submit reports.
- C. Inspections:
 - 1. Steel reinforcement placement.
 - 2. Steel reinforcement welding.
 - 3. Headed bolts and studs.
 - 4. Verification of use of required design mixture.
 - 5. Concrete placement, including conveying and depositing.
 - 6. Curing procedures and maintenance of curing temperature.
 - 7. Verification of concrete strength before removal of shores and forms from beams and slabs.
- D. Concrete Tests: Testing of composite samples of fresh concrete obtained according to ASTM C 172 shall be performed according to the following requirements:
 - 1. Testing Frequency: Obtain one composite sample for each day's pour of each concrete mixture exceeding 5 cu. yd., but less than 25 cu. yd., plus one set for each additional 50 cu. yd. or fraction thereof.
 - 2. Testing Frequency: Obtain at least one composite sample for each 100 cu. yd. or fraction thereof of each concrete mixture placed each day.
 - a. When frequency of testing will provide fewer than five compressive-strength tests for each concrete mixture, testing shall be conducted from at least five randomly selected batches or from each batch if fewer than five are used.
 - 3. Slump: ASTM C 143; one test at point of placement for each composite sample, but not less than one test for each day's pour of each concrete mixture. Perform additional tests when concrete consistency appears to change.
 - 4. Air Content: ASTM C 231, pressure method, for normal-weight concrete; one test for each composite sample, but not less than one test for each day's pour of each concrete mixture.
 - 5. Concrete Temperature: ASTM C 1064; one test hourly when air temperature is 40 deg F and below and when 80 deg F and above, and one test for each composite sample.
 - 6. Unit Weight: ASTM C 138, fresh unit weight of structural lightweight concrete; one test for each composite sample, but not less than one test for each day's pour of each concrete mixture.
 - 7. Compression Test Specimens: ASTM C 31.
 - a. Cast and laboratory cure two sets of two and one set of one standard cylinder specimens for each composite sample.
 - b. Cast and field cure two sets of two standard cylinder specimens for each composite sample.
 - 8. Compressive-Strength Tests: ASTM C 39; test one set of two laboratory-cured specimens at 7 days and one set of two specimens at 28 days. Hold one set of one specimen for future testing if the two tests mentioned above do not meet strength requirements.
 - a. Test one set of two field-cured specimens at 7 days and one set of two specimens at 28 days.
 - b. A compressive-strength test shall be the average compressive strength from a set of two specimens obtained from same composite sample and tested at age indicated.
 - 9. When strength of field-cured cylinders is less than 85 percent of companion laboratory-cured cylinders, Contractor shall evaluate operations and provide corrective procedures for protecting and curing in-place concrete.
 - 10. Strength of each concrete mixture will be satisfactory if every average of any three consecutive compressive-strength tests equals or exceeds specified compressive strength and no compressive-strength test value falls below specified compressive strength by more than 500 psi.
 - 11. Test results shall be reported in writing to Engineer, concrete manufacturer, and Contractor within 48 hours of testing. Reports of compressive-strength tests shall contain Project identification name and number, date of concrete placement, name of concrete testing and inspecting agency, location of concrete batch in Work, design compressive strength at 28 days, concrete mixture proportions and materials, compressive breaking strength, and type of break for both 7- and 28-day tests.
 - 12. Nondestructive Testing: Impact hammer, sonoscope, or other nondestructive device may be permitted by Engineer but will not be used as sole basis for approval or rejection of concrete.
 - 13. Additional Tests: Testing and inspecting agency shall make additional tests of concrete when test

results indicate that slump, air entrainment, compressive strengths, or other requirements have not been met, as directed by Engineer. Testing and inspecting agency may conduct tests to

- determine adequacy of concrete by cored cylinders complying with ASTM C 42 or by other methods as directed by Engineer.
14. Additional testing and inspecting, at Contractor's expense, will be performed to determine compliance of replaced or additional work with specified requirements.
 15. Correct deficiencies in the Work that test reports and inspections indicate do not comply with the Contract Documents.
- E. Measure floor and slab flatness and levelness according to ASTM E 1155 within 24 hours of finishing.
 - F. Water-Soluble Chloride Ion: Water-soluble chloride ion testing shall be performed in accordance with ASTM C 1218.
 - G. Drying Shrinkage Test
 - H. Concrete shrinkage tests shall be performed once for each 1,000 cubic yards of concrete with controlled shrinkage that is placed and shall be made on concrete from a batch of concrete from which concrete compression test cylinders are made. Shrinkage testing shall be in accordance with ASTM C 157.
 - I. A drying shrinkage test shall be conducted on the preliminary trial batch with the maximum water-cementitious materials ratio used to qualify each proposed concrete mix design using the concrete materials, including admixtures, which are proposed for the project. Three test specimens shall be prepared for each test. Specimens shall be fabricated, cured, dried, and measured in accordance with ASTM C 157.
 - J. Drying shrinkage for each specimen shall be computed as the difference between the base length at (0) zero days drying age and the length after drying at each test age. Results of the shrinkage test shall be reported to the nearest 0.001%. If drying shrinkage of any specimen deviates from the average for that test age by more than 0.004%, the results for that specimen shall be disregarded.
 - K. The average drying shrinkage of each set of test specimens cast in the laboratory from a trial batch as measured at the 21 days drying age shall not exceed 0.035% for concrete to be used in liquid-containing structures and 0.045% for concrete to be used in other structures. Drying shrinkage tests will not be required for isolated footings, pipe blocking, pipe encasement, and duct banks.
 - L. At the Contractor's option, a shrinkage-reducing admixture may be used to comply with the maximum shrinkage requirements. Shrinkage reducing admixture shall be Grace Construction Products Eclipse; or Degussa Tetraguard AS20, or equal, at a rate of 1 gallon per cubic yard. All concrete admixtures shall be from one manufacturer and shall be compatible. Admixture content, batching method, and time of introduction to mix shall comply with these specifications and with manufacturer's recommendations.

3.19 PROTECTION OF LIQUID FLOOR TREATMENTS

- A. Protect liquid floor treatment from damage and wear during the remainder of construction period. Use protective methods and materials, including temporary covering, recommended in writing by liquid floor treatments installer.

END OF SECTION

SECTION 055000
METAL FABRICATIONS

PART 1 GENERAL

1.1 RELATED DOCUMENTS

- A. Drawings and general provisions of the Contract, including General and Supplementary Conditions and Division 01 Specification Sections, apply to this Section.

1.2 SUMMARY

- A. Section Includes:
 - 1. Steel framing and supports for mechanical and electrical equipment.
 - 2. Steel framing and supports for applications where framing and supports are not specified in other Sections.
 - 3. Steel girders for supporting wood frame construction.
 - 4. Steel pipe columns for supporting wood frame construction.

5. Prefabricated building columns.
 6. Shelf angles.
 7. Metal ladders.
 8. Ladder safety cages.
 9. Alternating tread devices.
 10. Metal ships' ladders and pipe crossovers.
 11. Metal floor plate and supports.
 12. Miscellaneous steel trim including steel angle corner guards and steel edgings.
 13. Metal bollards.
 14. Pipe guards.
 15. Abrasive metal nosings.
 16. Cast-iron wheel guards.
 17. Metal downspout boots.
 18. Loose bearing and leveling plates for applications where they are not specified in other Sections.
- B. Products furnished, but not installed, under this Section:
1. Loose steel lintels.
 2. Anchor bolts, steel pipe sleeves, slotted-channel inserts, and wedge-type inserts indicated to be cast into concrete or built into unit masonry.
 3. Steel weld plates and angles for casting into concrete for applications where they are not specified in other Sections.
- C. Related Sections:
1. Section 033000 "Cast-in-Place Concrete" for installing anchor bolts, steel pipe sleeves, slotted-channel inserts, wedge-type inserts, and other items cast into concrete.
 2. Section 051200 "Structural Steel Framing."
 3. Section 055100 "Metal Stairs, Handrails and Railings."
 4. Section 055300 "Metal Gratings, Cover Plates and Access Hatches."

1.3 PERFORMANCE REQUIREMENTS

- A. Delegated Design: Design steel members including comprehensive engineering analysis by a qualified professional engineer licensed in the state where the project is located, using performance requirements and design criteria indicated on the drawings and in accordance with the building code.
- B. Structural Performance of Aluminum Ladders: Aluminum ladders including landings shall withstand the effects of loads and stresses within limits and under conditions specified in ANSI A14.3.
- C. Structural Performance of Alternating Tread Devices: Alternating tread devices shall withstand the effects of loads and stresses within limits and under conditions specified in ICC's International Building Code.
- D. Thermal Movements: Allow for thermal movements from ambient and surface temperature changes acting on exterior metal fabrications by preventing buckling, opening of joints, overstressing of components, failure of connections, and other detrimental effects.
1. Temperature Change: 120 deg F, ambient; 180 deg F, material surfaces.

1.4 ACTION SUBMITTALS

- A. Product Data: For the following:
1. Nonslip aggregates and nonslip-aggregate surface finishes.
 2. Prefabricated building columns.
 3. Metal nosings and treads.
 4. Paint products.
 5. Grout.
- B. Shop Drawings: Show fabrication and installation details for metal fabrications.
1. Include plans, elevations, sections, and details of metal fabrications and their connections. Show anchorage and accessory items.
- C. Delegated-Design Submittal: For installed products indicated to comply with performance requirements and design criteria, including analysis data signed and sealed by the qualified professional engineer responsible for their preparation.

1.5 INFORMATIONAL SUBMITTALS

- A. Qualification Data: For qualified professional engineer.
- B. Mill Certificates: Signed by manufacturers of stainless-steel certifying that products furnished comply with requirements.
- C. Welding certificates.
- D. Paint Compatibility Certificates: From manufacturers of topcoats applied over shop primers certifying that shop primers are compatible with topcoats.

1.6 QUALITY ASSURANCE

- A. Welding Qualifications: Qualify procedures and personnel according to AWS D1.1/D1.1M, "Structural Welding Code - Steel."
- B. Welding Qualifications: Qualify procedures and personnel according to the following:
 1. AWS D1.1/D1.1M, "Structural Welding Code - Steel."
 2. AWS D1.2/D1.2M, "Structural Welding Code - Aluminum."
 3. AWS D1.6, "Structural Welding Code - Stainless Steel."

1.7 PROJECT CONDITIONS

- A. Field Measurements: Verify actual locations of walls and other construction contiguous with metal fabrications by field measurements before fabrication.

1.8 COORDINATION

- A. Coordinate selection of shop primers with topcoats to be applied over them. Comply with paint and coating manufacturers' written recommendations to ensure that shop primers and topcoats are compatible with one another.
- B. Coordinate installation of anchorages and steel weld plates and angles for casting into concrete. Furnish setting drawings, templates, and directions for installing anchorages, including sleeves, concrete inserts, anchor bolts, and items with integral anchors, that are to be embedded in concrete or masonry. Deliver such items to Project site in time for installation.

PART 2 PRODUCTS

2.1 METALS, GENERAL

- A. Metal Surfaces, General: Provide materials with smooth, flat surfaces unless otherwise indicated. For metal fabrications exposed to view in the completed Work, provide materials without seam marks, roller marks, rolled trade names, or blemishes.

2.2 FERROUS METALS

- A. Recycled Content of Steel Products: Postconsumer recycled content plus one-half of preconsumer recycled content not less than 25 percent.
- B. Steel Plates, Shapes, and Bars: ASTM A 36.
- C. Stainless-Steel Sheet, Strip, and Plate: ASTM A 240 or ASTM A 666, Type 304.
- D. Stainless-Steel Bars and Shapes: ASTM A 276, Type 304.
- E. Rolled-Steel Floor Plate: ASTM A 786, rolled from plate complying with ASTM A 36 or ASTM A 283, Grade C or D.
- F. Rolled-Stainless-Steel Floor Plate: ASTM A 793.
- G. Abrasive-Surface Floor Plate: Steel plate with abrasive granules rolled into surface.
 1. Products: Subject to compliance with requirements, available products that may be incorporated into the Work include, but are not limited to, the following:
 - a. IKG Industries, a division of Harsco Corporation; Mebac.
 - b. SlipNOT Metal Safety Flooring, a W. S. Molnar company; SlipNOT.
- H. Steel Tubing: ASTM A 500, cold-formed steel tubing.
- I. Steel Pipe: ASTM A 53, standard weight (Schedule 40) unless otherwise indicated.
- J. Slotted Channel Framing: Cold-formed metal box channels (struts) complying with MFMA-4.
 1. Size of Channels: 1-5/8 by 1-5/8 inches unless indicated otherwise.
 2. Material: Galvanized steel, ASTM A 653, commercial steel, Type B with G90 coating; 0.108-inch nominal thickness.
 3. Material: Cold-rolled steel, ASTM A 1008, commercial steel, Type B; 0.0966-inch minimum thickness; unfinished.

K. Cast Iron: Either gray iron, ASTM A 48, or malleable iron, ASTM A 47, unless otherwise indicated.

2.3 NONFERROUS METALS

A. Aluminum Plate and Sheet: ASTM B 209, Alloy 6061-T6.

B. Aluminum Extrusions: ASTM B 221, Alloy 6063-T6.

C. Aluminum-Alloy Rolled Tread Plate: ASTM B 632, Alloy 6061-T6.

D. Aluminum Castings: ASTM B 26/B 26M, Alloy 443.0-F.

E. Bronze Plate, Sheet, Strip, and Bars: ASTM B 36, Alloy UNS No. C28000 (muntz metal, 60 percent copper).

F. Bronze Extrusions: ASTM B 455, Alloy UNS No. C38500 (extruded architectural bronze).

G. Bronze Castings: ASTM B 584, Alloy UNS No. C83600 (leaded red brass) or No. C84400 (leaded semired brass).

H. Nickel Silver Extrusions: ASTM B 151, Alloy UNS No. C74500.

I. Nickel Silver Castings: ASTM B 584, Alloy UNS No. C97600 (20 percent leaded nickel bronze).

2.4 FASTENERS

A. General: Unless otherwise indicated, provide Type 304 stainless-steel fasteners for exterior use and zinc-plated fasteners with coating complying with ASTM B 633 or ASTM F 1941, Class Fe/Zn 5, at exterior walls. Select fasteners for type, grade, and class required.

1. Provide stainless-steel fasteners for fastening aluminum.
2. Provide stainless-steel fasteners for fastening stainless steel.
3. Provide stainless-steel fasteners for fastening nickel silver.
4. Provide bronze fasteners for fastening bronze.

B. Steel Bolts and Nuts: Regular hexagon-head bolts, ASTM A 307, Grade A; with hex nuts, ASTM A 563; and, where indicated, flat washers.

C. Steel Bolts and Nuts: Regular hexagon-head bolts, ASTM A 325, Type 3; with hex nuts, ASTM A 563, Grade C3; and, where indicated, flat washers.

D. Stainless-Steel Bolts and Nuts: Regular hexagon-head annealed stainless-steel bolts, ASTM F 593; with hex nuts, ASTM F 594; and, where indicated, flat washers; Alloy Group 1.

E. Anchor Bolts: ASTM F 1554, Grade 36, of dimensions indicated; with nuts, ASTM A 563; and, where indicated, flat washers.

1. Hot-dip galvanize or provide mechanically deposited, zinc coating where item being fastened is indicated to be galvanized.

F. Eyebolts: ASTM A 489.

G. Machine Screws: ASME B18.6.3.

H. Lag Screws: ASME B18.2.1.

I. Wood Screws: Flat head, ASME B18.6.1.

J. Plain Washers: Round, ASME B18.22.1.

K. Lock Washers: Helical, spring type, ASME B18.21.1.

L. Anchors, General: Anchors capable of sustaining, without failure, a load equal to six times the load imposed when installed in unit masonry and four times the load imposed when installed in concrete, as determined by testing according to ASTM E 488, conducted by a qualified independent testing agency.

M. Cast-in-Place Anchors in Concrete: Either threaded type or wedge type unless otherwise indicated; galvanized ferrous castings, either ASTM A 47 malleable iron or ASTM A 27 cast steel. Provide bolts, washers, and shims as needed, all hot-dip galvanized per ASTM F 2329.

N. Post-Installed Anchors: Torque-controlled expansion anchors or chemical anchors.

1. Material for Interior Locations: Carbon-steel components zinc plated to comply with ASTM B 633 or ASTM F 1941, Class Fe/Zn 5, unless otherwise indicated.
2. Material for Exterior Locations and Where Stainless Steel is Indicated: Alloy Group 1 stainless-steel bolts, ASTM F 593, and nuts, ASTM F 594.

O. Slotted-Channel Inserts: Cold-formed, hot-dip galvanized-steel box channels (struts) complying with MFMA-4, 1-5/8 by 7/8 inches by length indicated with anchor straps or studs not less than 3 inches long at not more than 8 inches o.c. Provide with temporary filler and tee-head bolts, complete with

washers and nuts, all zinc-plated to comply with ASTM B 633, Class Fe/Zn 5, as needed for fastening to inserts.

2.5 MISCELLANEOUS MATERIALS

- A. Welding Rods and Bare Electrodes: Select according to AWS specifications for metal alloy welded.
- B. Low-Emitting Materials: Paints and coatings shall comply with the testing and product requirements of the California Department of Health Services' "Standard Practice for the Testing of Volatile Organic Emissions from Various Sources Using Small-Scale Environmental Chambers."
- C. Shop Primers: Provide primers that comply with Section 099000.
- D. Universal Shop Primer: Fast-curing, lead- and chromate-free, universal modified-alkyd primer complying with MPI#79 and compatible with topcoat.
 - 1. Use primer containing pigments that make it easily distinguishable from zinc-rich primer.
- E. Epoxy Zinc-Rich Primer: Complying with MPI#20 and compatible with topcoat.

- F. Galvanizing Repair Paint: High-zinc-dust-content paint complying with SSPC-Paint 20 and compatible with paints specified to be used over it.
- G. Bituminous Paint: Cold-applied asphalt emulsion complying with ASTM D 1187.
- H. Nonshrink, Metallic Grout: Factory-packaged, ferrous-aggregate grout complying with ASTM C 1107, specifically recommended by manufacturer for heavy-duty loading applications.
- I. Nonshrink, Nonmetallic Grout: Factory-packaged, nonstaining, noncorrosive, nongaseous grout complying with ASTM C 1107. Provide grout specifically recommended by manufacturer for interior and exterior applications.
- J. Concrete: Comply with requirements in Section 033000 "Cast-in-Place Concrete" for normal-weight, air-entrained, concrete with a minimum 28-day compressive strength of 3000 psi.

2.6 FABRICATION, GENERAL

- A. Shop Assembly: Preassemble items in the shop to greatest extent possible. Disassemble units only as necessary for shipping and handling limitations. Use connections that maintain structural value of joined pieces. Clearly mark units for reassembly and coordinated installation.
- B. Cut, drill, and punch metals cleanly and accurately. Remove burrs and ease edges to a radius of approximately 1/32 inch unless otherwise indicated. Remove sharp or rough areas on exposed surfaces.
- C. Form bent-metal corners to smallest radius possible without causing grain separation or otherwise impairing work.
- D. Form exposed work with accurate angles and surfaces and straight edges.
- E. Weld corners and seams continuously to comply with the following:
 - 1. Use materials and methods that minimize distortion and develop strength and corrosion resistance of base metals.
 - 2. Obtain fusion without undercut or overlap.
 - 3. Remove welding flux immediately.
 - 4. At exposed connections, finish exposed welds and surfaces smooth and blended so no roughness shows after finishing.
- F. Form exposed connections with hairline joints, flush and smooth, using concealed fasteners or welds where possible. Where exposed fasteners are required, use Phillips flat-head (countersunk) fasteners unless otherwise indicated. Locate joints where least conspicuous.
- G. Fabricate seams and other connections that will be exposed to weather in a manner to exclude water. Provide weep holes where water may accumulate.
- H. Cut, reinforce, drill, and tap metal fabrications as indicated to receive finish hardware, screws, and similar items.
- I. Provide for anchorage of type indicated; coordinate with supporting structure. Space anchoring devices to secure metal fabrications rigidly in place and to support indicated loads.
 - 1. Where units are indicated to be cast into concrete or built into masonry, equip with integrally welded steel strap anchors, 1/8 by 1-1/2 inches, with a minimum 6 inch embedment and 2 inch hook, not less than 8 inches from ends and corners of units and 24 inches o.c., unless otherwise indicated.

2.7 MISCELLANEOUS FRAMING AND SUPPORTS

- A. General: Provide steel framing and supports not specified in other Sections as needed to complete the Work.
- B. Fabricate units from steel shapes, plates, and bars of welded construction unless otherwise indicated. Fabricate to sizes, shapes, and profiles indicated and as necessary to receive adjacent construction.
 - 1. Fabricate units from slotted channel framing where indicated.
 - 2. Furnish inserts for units installed after concrete is placed.
- C. Fabricate steel pipe columns for supports from steel pipe with steel baseplates and top plates as required. Drill or punch baseplates and top plates for anchor and connection bolts and weld to pipe with fillet welds all around. Make welds the same size as pipe wall thickness unless otherwise indicated.
 - 1. Unless otherwise indicated, fabricate from Schedule 40 steel pipe.
 - 2. Unless otherwise indicated, provide 1/2 inch baseplates with four 5/8 inch anchor bolts and 1/4 inch top plates.

- D. Galvanize miscellaneous framing and supports where indicated.
- E. Prime miscellaneous framing and supports as indicated in Section 099000.

2.8 SHELF ANGLES

- A. Fabricate shelf angles from steel angles of sizes indicated and for attachment to concrete framing. Provide horizontally slotted holes to receive 3/4 inch bolts, spaced not more than 6 inches from ends and 24 inches o.c., unless otherwise indicated.
 - 1. Provide mitered and welded units at corners.
 - 2. Provide open joints in shelf angles at expansion and control joints. Make open joint approximately 2 inches larger than expansion or control joint.
- B. For cavity walls, provide vertical channel brackets to support angles from backup masonry and concrete.
- C. Galvanize shelf angles located in exterior walls.
- D. Prime shelf angles located in exterior walls as specified in Section 099000.
- E. Furnish wedge-type concrete inserts, complete with fasteners, to attach shelf angles to cast-in-place concrete.

2.9 METAL LADDERS

- A. General:
 - 1. Comply with ANSI A14.3 unless otherwise indicated.
 - 2. For elevator pit ladders, comply with ASME A17.1.
- B. Vertical Ladders: Fabricate ladders as shown in the drawings. Ladders shall be aluminum unless indicated otherwise in the drawings. The distance between rungs, cleats, and steps shall not exceed 12 inches and shall be uniform throughout the length of the ladder. The minimum clear length of rungs or cleats shall be 16 inches.
- C. Inclined Aluminum Ladders with built in handrail: Ladders shall be aluminum construction: Alloy 6063-T5, mill finish. Clear width of stair treads shall be 16-inches unless otherwise indicated.

Provide 1-1/2-inch diameter handrails. Provide 6-inch by 2-inch by 1/8-inch minimum channel stringers. Provide minimum 4-1/8-inch by 1/4-inch minimum rung able to withstand a 1,000-pound load. Provide minimum 3/16-inch thick aluminum wall and floor brackets. Provide 1-1/2-inch aluminum handrails. Manufacturer: O'Keefe's, Inc., Model 523-10 or equal.

D. Steel Ladders:

1. Space siderails 16 inches apart unless otherwise indicated.
2. Space siderails of elevator pit ladders 12 inches apart.
3. Siderails: Continuous, 3/8-by-2-1/2-inch steel flat bars, with eased edges.
4. Rungs: 1-inch diameter steel bars.
5. Fit rungs in centerline of siderails; plug-weld and grind smooth on outer rail faces.
6. Provide nonslip surfaces on top of each rung, either by coating rung with aluminum-oxide granules set in epoxy-resin adhesive or by using a type of manufactured rung filled with aluminum-oxide grout.
7. Provide nonslip surfaces on top of each rung by coating with abrasive material metallically bonded to rung.
 - a. Products: Subject to compliance with requirements, available products that may be incorporated into the Work include, but are not limited to, the following:
 - 1) IKG Industries, a division of Harsco Corporation; Mebac.
 - 2) SlipNOT Metal Safety Flooring, a W. S. Molnar company; SlipNOT.
8. Provide platforms as indicated fabricated from welded or pressure-locked steel bar grating, supported by steel angles. Limit openings in gratings to no more than 1/2 inch in least dimension.
9. Support each ladder at top and bottom and not more than 60 inches o.c. with welded or bolted steel brackets.
10. Galvanize exterior ladders, including brackets and fasteners.
11. Prime exterior ladders, including brackets and fasteners, with zinc-rich primer.; or primer specified in Section 099000.

E. Aluminum Ladders:

1. Manufacturers: Subject to compliance with requirements, available manufacturers offering products that may be incorporated into the Work include, but are not limited to, the following:
 - a. ACL Industries, Inc.
 - b. Alco-Lite Industrial Products.
 - c. Halliday Products.
 - d. O'Keefe's Inc.
 - e. Precision Ladders, LLC.
 - f. Royalite Manufacturing, Inc.
 - g. Thompson Fabricating, LLC.
2. Space siderails 16 inches apart unless otherwise indicated.
3. Siderails: Continuous extruded-aluminum channels or tubes, not less than 2 1/2 inches deep, 3/4 inch wide, and 1/8 inch thick.
4. Rungs: Extruded-aluminum tubes, not less than 3/4 inch deep and not less than 1/8 inch thick, with ribbed tread surfaces.
5. Fit rungs in centerline of siderails; fasten by welding or with stainless-steel fasteners or brackets and aluminum rivets.
6. Provide platforms as indicated fabricated from pressure-locked aluminum bar grating or extruded-aluminum plank grating, supported by extruded-aluminum framing. Limit openings in gratings to no more than 1/2 inch in least dimension.

7. Support each ladder at top and bottom and not more than 60 inches o.c. with welded or bolted aluminum brackets.
8. Provide minimum 72 inch high, hinged security door with padlock hasp at foot of ladder to prevent unauthorized ladder use.

2.10 ALTERNATING TREAD DEVICES

- A. Alternating Tread Devices: Fabricate alternating tread devices to comply with ICC's International Building Code. Fabricate of open-type construction with channel or plate stringers and pipe and tube railings unless otherwise indicated. Provide brackets and fittings for installation.
 1. Manufacturers: Subject to compliance with requirements, available manufacturers offering products that may be incorporated into the Work include, but are not limited to, the following:
 2. Basis-of-Design Product: Subject to compliance with requirements, provide product by one of the

following:

- a. Lapeyre Stair Inc.
 - b. Schmidt Structural Products; a subsidiary of Penco Products, Inc.
3. Fabricate from aluminum and assemble by welding or with stainless-steel fasteners.

2.11 METAL SHIPS' LADDERS AND PIPE CROSSOVERS

- A. Provide metal ships' ladders and pipe crossovers where indicated. Fabricate of open-type construction with channel or plate stringers and pipe and tube railings unless otherwise indicated. Provide brackets and fittings for installation.
1. Fabricate ships' ladders and pipe crossovers, including railings from aluminum.
 2. Fabricate treads and platforms from pressure-locked aluminum bar grating, extruded-aluminum plank grating, rolled-aluminum-alloy tread plate or abrasive-surface floor plate. Limit openings in gratings to no more than 1/2 inch in least dimension.
 3. Comply with applicable railing requirements in Section 055100 "Metal Stairs, Handrails and Railings."

2.12 METAL FLOOR PLATE

- A. Fabricate from rolled-steel floor or rolled-aluminum-alloy tread, as indicated:
1. Thickness: 1/8 inch or as indicated.
- B. Provide grating sections where indicated fabricated from <<welded or pressure-locked steel bar grating or pressure-locked aluminum bar grating as indicated. Limit openings in gratings to no more than 1/2 inch in least dimension.
- C. Provide steel or aluminum angle supports as indicated.
- D. Include steel or aluminum angle stiffeners, and fixed and removable sections as indicated.
- E. Provide flush steel or aluminum bar drop handles for lifting removable sections, one at each end of each section.

2.13 MISCELLANEOUS STEEL TRIM

- A. Unless otherwise indicated, fabricate units from steel shapes, plates, and bars of profiles shown with continuously welded joints and smooth exposed edges. Miter corners and use concealed field splices where possible.
- B. Provide cutouts, fittings, and anchorages as needed to coordinate assembly and installation with other work.
1. Provide with integrally welded steel strap anchors for embedding in concrete or masonry construction.
- C. Galvanize exterior miscellaneous steel trim.
- D. Prime exterior miscellaneous steel trim with zinc-rich primer as specified in Section 099000.

2.14 METAL BOLLARDS

- A. Fabricate metal bollards from Schedule 40 steel pipe.
1. Cap bollards with 1/4 inch thick steel plate.
 2. Where bollards are indicated to receive controls for door operators, provide necessary cutouts for controls and holes for wire.
 3. Where bollards are indicated to receive light fixtures, provide necessary cutouts for fixtures and holes for wire.
- B. Fabricate bollards with 3/8 inch thick steel baseplates for bolting to concrete slab. Drill baseplates at all four corners for 3/4 inch anchor bolts.
1. Where bollards are to be anchored to sloping concrete slabs, angle baseplates for plumb alignment of bollards.
- C. Fabricate sleeves for bollard anchorage from steel pipe with 1/4 inch thick steel plate welded to bottom of sleeve. Make sleeves not less than 8 inches deep and 3/4 inch larger than OD of bollard.

- D. Fabricate internal sleeves for removable bollards from Schedule 40 steel pipe or 1/4 inch wall-thickness steel tubing with an OD approximately 1/16 inch less than ID of bollards. Match drill sleeve and bollard for 3/4 inch steel machine bolt.
- E. Prime bollards with zinc-rich primer as specified in Section 099000.

2.15 LOOSE BEARING AND LEVELING PLATES

- A. Provide loose bearing and leveling plates for steel items bearing on masonry or concrete construction. Drill plates to receive anchor bolts and for grouting.
- B. Galvanize plates.
- C. Prime plates with zinc-rich primer as specified in Section 099000.

2.16 STEEL WELD PLATES AND ANGLES

- A. Provide steel weld plates and angles not specified in other Sections, for items supported from concrete construction as needed to complete the Work. Provide each unit with no fewer than two integrally welded steel strap anchors for embedding in concrete.

2.17 FINISHES, GENERAL

- A. Comply with NAAMM's "Metal Finishes Manual for Architectural and Metal Products" for recommendations for applying and designating finishes.
- B. Finish metal fabrications after assembly.
- C. Finish exposed surfaces to remove tool and die marks and stretch lines, and to blend into surrounding surface.

2.18 STEEL AND IRON FINISHES

- A. Galvanizing: Hot-dip galvanize items as indicated to comply with ASTM A 153 for steel and iron hardware and with ASTM A 123 for other steel and iron products.
 - 1. Do not quench or apply post galvanizing treatments that might interfere with paint adhesion.
- B. Shop prime iron and steel items not indicated to be galvanized unless they are to be embedded in concrete, sprayed-on fireproofing, or masonry, or unless otherwise indicated.
 - 1. Shop prime with primers specified in Section 099000 unless zinc-rich primer is indicated.
- C. Preparation for Shop Priming: Prepare surfaces to comply with SSPC-SP 6/NACE No. 3, "Commercial Blast Cleaning" or SSPC-SP 3, "Power Tool Cleaning".
- D. Shop Priming: Apply shop primer to comply with SSPC-PA 1, "Paint Application Specification No. 1: Shop, Field, and Maintenance Painting of Steel," for shop painting.
 - 1. Stripe paint corners, crevices, bolts, welds, and sharp edges.

2.19 ALUMINUM FINISHES

- A. Finish designations prefixed by AA comply with the system established by the Aluminum Association for designating aluminum finishes.
- B. As-Fabricated Finish: AA-M10 (Mechanical Finish: as fabricated, unspecified).
- C. Class I, Clear Anodic Finish: AA-M12C22A41 (Mechanical Finish: non-specular as fabricated; Chemical Finish: etched, medium matte; Anodic Coating: Architectural Class I, clear coating 0.018 mm or thicker) complying with AAMA 611.

PART 3 EXECUTION

3.1 INSTALLATION, GENERAL

- A. Cutting, Fitting, and Placement: Perform cutting, drilling, and fitting required for installing metal fabrications. Set metal fabrications accurately in location, alignment, and elevation; with edges and surfaces level, plumb, true, and free of rack; and measured from established lines and levels.
- B. Fit exposed connections accurately together to form hairline joints. Weld connections that are not to be left as exposed joints but cannot be shop welded because of shipping size limitations. Do not weld, cut, or abrade surfaces of exterior units that have been hot-dip galvanized after fabrication and are for bolted or screwed field connections.
- C. Field Welding: Comply with the following requirements:
 - 1. Use materials and methods that minimize distortion and develop strength and corrosion resistance of base metals.
 - 2. Obtain fusion without undercut or overlap.
 - 3. Remove welding flux immediately.
 - 4. At exposed connections, finish exposed welds and surfaces smooth and blended so no roughness shows after finishing and contour of welded surface matches that of adjacent surface.
- D. Fastening to In-Place Construction: Provide anchorage devices and fasteners where metal fabrications are required to be fastened to in-place construction. Provide threaded fasteners for use with concrete and masonry inserts, toggle bolts, through bolts, lag screws, wood screws, and other connectors.
- E. Provide temporary bracing or anchors in formwork for items that are to be built into concrete, masonry, or similar construction.
- F. Corrosion Protection: Coat concealed surfaces of aluminum that will come into contact with grout, concrete, masonry, wood, or dissimilar metals with the following:
 - 1. Cast Aluminum: Heavy coat of bituminous paint.
 - 2. Extruded Aluminum: Two coats of clear lacquer.

3.2 INSTALLING MISCELLANEOUS FRAMING AND SUPPORTS

- A. General: Install framing and supports to comply with requirements of items being supported, including manufacturers' written instructions and requirements indicated on Shop Drawings.
- B. Anchor supports for operable partitions securely to and rigidly brace from building structure.
- C. Support steel girders on solid grouted masonry, concrete, or steel pipe columns. Secure girders with anchor bolts embedded in grouted masonry or concrete or with bolts through top plates of pipe columns.
 - 1. Where grout space under bearing plates is indicated for girders supported on concrete or masonry, install as specified in "Installing Bearing and Leveling Plates" Article.
- D. Install pipe columns on concrete footings with grouted baseplates. Position and grout column baseplates as specified in "Installing Bearing and Leveling Plates" Article.
 - 1. Grout baseplates of columns supporting steel girders after girders are installed and leveled.

3.3 INSTALLING METAL BOLLARDS

- A. Fill metal-capped bollards solidly with concrete and allow concrete to cure seven days before installing.
 - 1. Do not fill removable bollards with concrete.
- B. Anchor bollards to existing construction with expansion anchors; anchor bolts; or through bolts. Provide four 3/4 inch bolts at each bollard unless otherwise indicated.
 - 1. Embed anchor bolts at least 4 inches in concrete.
- C. Anchor bollards in concrete as indicated.

3.4 INSTALLING BEARING AND LEVELING PLATES

- A. Clean concrete and masonry bearing surfaces of bond-reducing materials, and roughen to improve bond to surfaces. Clean bottom surface of plates.
- B. Set bearing and leveling plates on wedges, shims, or leveling nuts. After bearing members have been positioned and plumbed, tighten anchor bolts. Do not remove wedges or shims but, if protruding, cut off flush with edge of bearing plate before packing with grout.
 - 1. Use nonshrink grout, either metallic or nonmetallic, in concealed locations where not exposed to moisture; use nonshrink, nonmetallic grout in exposed locations unless otherwise indicated.
 - 2. Pack grout solidly between bearing surfaces and plates to ensure that no voids remain.

3.5 INSTALLING LADDERS

- A. Mount ladders so that no permanent obstruction is within 7 inches of the ladder's centerline.

3.6 ADJUSTING AND CLEANING

- A. Touchup Painting: Immediately after erection, clean field welds, bolted connections, and abraded areas. Paint uncoated and abraded areas with the same material as used for shop painting to comply with SSPC-PA 1 for touching up shop-painted surfaces.
 - 1. Apply by brush or spray to provide a minimum 2.0 mil dry film thickness.
- B. Touchup Painting: Cleaning and touchup painting of field welds, bolted connections, and abraded areas of shop paint are specified in Section 099000.
- C. Galvanized Surfaces: Clean field welds, bolted connections, and abraded areas and repair galvanizing to comply with ASTM A 780.

END OF SECTION

SECTION 099000
PAINTING AND COATING

PART 1 - GENERAL

1.1 DESCRIPTION

- A. This section includes materials and application of painting and coating systems for the following surfaces:
- B. Exposed, submerged, and buried metal.
- C. PVC
- D. ~~Masonry~~
- E. Concrete (in contact with aluminum)
- F. Wood
- G. ~~Drywall~~
- H. ~~It does not include coating steel water tanks and reservoirs.~~

1.2 REFERENCES

- A. ASTM D 16 - Terminology Relating to Paint, Varnish, Lacquer, and Related Products.
- B. ASTM D 4263 - Indicating Moisture in Concrete by the Plastic Sheet Method.
- C. ASTM F 1869 - Measuring Moisture Vapor Emission Rate of Concrete Subfloor Using Anhydrous Calcium Chloride.
- D. AWWA D 102 - Painting Steel Water Storage Tanks
- E. International Concrete Repair Institute (ICRI) Guideline No. 310.2-1997 (formerly 03732) - Selecting and Specifying Concrete Surface Preparation for Sealers, Coatings, and Polymer Overlays.
- F. NACE SP0188 - Standard Recommended Practice, Discontinuity (Holiday) Testing of Protective Coatings.
- G. NAPF 500-03-04 Abrasive Blast Cleaning.
- H. SSPC-SP 1 - Solvent Cleaning.
- I. SSPC-SP 3 - Powertool Cleaning
- J. SSPC-SP 5/NACE 1 - White Metal Blast Cleaning.
- K. SSPC-SP 6/NACE 3 - Commercial Blast Cleaning.
- L. SSPC-SP 10/NACE 2 - Near-White Metal Blast Cleaning.
- M. SSPC-SP 13/NACE 6 - Surface Preparation of Concrete.
- N. SSPC-SP 16 - Brush-Off Blast Cleaning of Coated and Uncoated Galvanized Steel, Stainless Steels, and Non-Ferrous Metals
- O. SSPC-TU 11 - Inspection of Fluorescent Coating Systems

1.3 SUBMITTALS

- A. Submit shop drawings in accordance with the Contract Documents and Section 013300.
- B. Submit manufacturer's data sheets showing the following information, including surface preparation products such as block fillers and galvanized metal primers:
 - 1. Percent solids by volume.
 - 2. Minimum and maximum recommended dry-film thickness per coat for prime, intermediate, and finish coats.
 - 3. Recommended surface preparation.
 - 4. Recommended thinners.
 - 5. Statement verifying that the specified prime coat is recommended by the manufacturer for use with the specified intermediate and finish coats.
 - 6. Application instructions including recommended equipment and temperature limitations.
 - 7. Curing requirements and instructions.
- C. Submit color swatches or charts.

- D. Submit certifications from the manufacturer of field coatings that shop prime coat materials to be applied by others is compatible with field coats.
- E. Submit manufacturer's certification that coatings comply with specified requirements and are suitable for intended application.
- F. Submit material safety data sheets for each coating.
- G. Submit certificate identifying the type and gradation of abrasives used for surface preparation.
- H. Warranty: Submit manufacturer's standard warranty, or special warranty if set forth in the contract documents.

1.4 QUALITY ASSURANCE

- A. Manufacturer's Qualifications:
 - 1. Specialize in manufacture of coatings with a proven successful experience.
 - 2. Able to demonstrate successful performance on comparable projects.
 - 3. Single Source Responsibility: Coatings and coating application reducers and additives shall be products of a single manufacturer.
- B. Applicator's Qualifications:
 - 1. Experienced in application of specified coatings on projects of similar size and complexity to this Work.
 - 2. Applicator's Personnel: Employ persons trained for application of specified coatings.
 - 3. Applicator's Quality Assurance: Upon request, submit list of a minimum of 5 completed projects of similar size and complexity to this Work. Include for each project:
 - a. Project name and location.
 - b. Name of owner.
 - c. Name of contractor.
 - d. Name of engineer.
 - e. Name of coating manufacturer.
 - f. Approximate area of coatings applied.
 - g. Date of completion.
- C. Provide field primers and undercoat paint produced by the same manufacturer as the intermediate and finish coats. All field coatings shall be by the same manufacturer.

1.5 DELIVERY, STORAGE, AND HANDLING

- A. Delivery: Deliver materials to site in manufacturer's original, unopened containers and packaging, with labels clearly identifying:
 - 1. Coating or material name.
 - 2. Manufacturer.
 - 3. Color name and number.
 - 4. Batch or lot number.
 - 5. Date of manufacture.
 - 6. Mixing and thinning instructions.
- B. Storage:
 - 1. Store materials in a clean dry area and within temperature range in accordance with manufacturer's instructions in the area designated by owner's representative.
 - 2. Keep containers sealed until ready for use.
 - 3. Do not use materials beyond manufacturer's shelf-life limits.
- C. Handling: Protect materials during handling and application to prevent damage or contamination
 - 1. Avoid danger of fire: Deposit cleaning rags and waste materials in metal containers having tight covers or remove from building each night. Provide fire extinguishers of type recommended by coating manufacturer in areas of storage and where finishing is occurring. Allow no smoking or open containers of solvents. Store solvents in safety cans.
 - 2. Upon project completion, remaining material will become property of Owner. Seal material as required for storage, marked as to contents and shelf life, and store where required by Owner.
 - 3. Protect floor and walls of storage area from splatter and disfiguration.
 - 4. Prepare multiple-component coatings using all of the contents of the container for each component as packaged by the paint manufacturer. Do not use partial batches. Do not use

multiple-component coatings that have been mixed beyond their pot life. Provide small quantity kits for touch-up painting and for painting other small areas. Mix only the components specified and furnished by the paint manufacturer. Do not intermix additional components for reasons of color or otherwise, even within the same generic type of coating.

1.6 WORK SCHEDULE

Two weeks prior to the beginning of any coating work, establish with the Owner and Engineer a mutually agreeable schedule for the work. The schedule shall allow for all inspections required.

1.7 REGULATORY REQUIREMENTS

Conform to applicable code for flame and smoke rating requirements for products and finishes.

PART 2 - MATERIALS

2.1 MANUFACTURERS

- A. Tnemec Company Inc.
- B. The Sherwin Williams Company
- C. Induron
- D. Diamond Vogel
- E. ENGINEER Approved Equal

2.2 PAINT SYSTEMS SCHEDULE

Paint Systems Schedule is located at the end of this section. Painting products are listed on the System Schedule.

2.3 PAINT FINISH SCHEDULE

The Paint Finish Schedule at the end of this section or located on the drawings indicates which surfaces are to be painted. If there is a doubt as to whether a surface is to be painted, assume it is until instructed otherwise by the Engineer.

2.4 COLORS

Paint colors will be selected from the manufacturer's standard color charts by the Owner and Engineer.

2.5 TOUCH-UP PAINT

Furnish a minimum of one gallon of each coating, in each color used, for the Owners use in future touch-up and minor repair work. Furnish the coatings in unbroken containers clearly labeled with the manufacturer's name, product number, product number, color, date of manufacture and coating system identification.

2.6 GALVANIZED METAL TOUCH-UP

Touch-up galvanized metals with Sherwin Williams Zinc Clad "Cold Galvanizing Compound", or equal, 3 mils DFT minimum, unless shown otherwise in another specification section. Provide SSPC-SP1 surface preparation.

2.7 ABRASIVES AND SURFACE PROFILE

Abrasives and surface profile shall be as recommended by the paint manufacturer for the paint material being coated and the application. Provide information for Engineer review.

PART 3 - EXECUTION

3.1 ENVIRONMENTAL REQUIREMENTS

- A. Weather:
 - 1. Air and Surface Temperatures: Prepare surfaces and apply and cure coatings within air and surface temperature range in accordance with manufacturer's instructions.
 - 2. Surface Temperature: Minimum of 5 degrees F (3 degrees C) above dew point.
 - 3. Relative Humidity: Prepare surfaces and apply and cure coatings within relative humidity range in accordance with manufacturer's instructions.
 - 4. Precipitation: Do not prepare surfaces or apply coatings in rain, snow, fog, or mist.
 - 5. Wind: Do not spray coatings if wind velocity is above manufacturer's limit.

- B. Ventilation: Provide ventilation during coating evaporation stage in confined or enclosed areas in accordance with AWWA D 102.
- C. Dust and Contaminants:
 1. Schedule coating work to avoid excessive dust and airborne contaminants.
 2. Protect work areas from excessive dust and airborne contaminants during coating application and curing
 3. Protect working parts of mechanical and electrical equipment from damage during surface preparation and painting process. Mask openings in motors to prevent paint and other materials from entering the motors.
- D. Maintain interior temperature and relative humidity of space, as recommended by coating manufacturer, 24 hours before applying and until coating is cured.
- E. Do not paint when temperature of metal to be painted is above 120°F.
- F. Do not apply alkyd, inorganic zinc, silicone aluminum, or silicone acrylic paints if air or surface temperature is below 40°F or expected to be below 40°F within 24 hours.

3.2 PROTECTION OF SURFACES NOT SCHEDULED TO BE COATED

- A. Protect surrounding areas and surfaces not scheduled to be coated from damage during surface preparation and application of coatings.
- B. Immediately remove coatings that fall on surrounding areas and surfaces not scheduled to be coated

3.3 SURFACE PREPARATION OF STEEL

- A. Prepare steel surfaces in accordance with paint manufacturer's instructions.
- B. Fabrication Defects:
 1. Correct steel and fabrication defects revealed by surface preparation.
 2. Remove weld spatter and slag.
 3. Round sharp edges and corners of welds to a smooth contour.
 4. Smooth weld undercuts and recesses.
 5. Grind down porous welds to pinhole-free metal.
 6. Remove weld flux from surface.
- C. Ensure surfaces are dry.
- D. Immersion or Below Grade Surfaces: Remove visible oil, grease, dirt, dust, mill scale, rust, paint, oxides, corrosion products, and other foreign matter in accordance with SSPC-SP 10/NACE 2. Create a surface profile as required by the coating manufacturer.
- E. Exterior Exposed or Interior Exposed Surfaces: Remove visible oil, grease, dirt, dust, mill scale, rust, paint, oxides, corrosion products, and other foreign matter in accordance with SSPC-SP 6/NACE 3. Create a surface profile mils as required by the coating manufacturer.
- F. Abrasive Blast-Cleaned Surfaces: Coat abrasive blast-cleaned surfaces with primer before visible rust forms on surface. Do not leave blast-cleaned surfaces uncoated for more than 8 hours. Do not touch blasted surface with bare hands. Do not abrasive blast or prepare more surface area in one day than can be coated in one day; prepare surfaces and apply coatings the same day.
- G. For carbon steel surfaces, after abrasive blast cleaning, verify the surface profile by measuring with an impressioner tape acceptable to the Owner's Representative. Perform a minimum of one test per 100 square feet of surface area. Testing shall be witnessed by the Owner's Representative. The impressioner tape used in the test shall be permanently marked with the date, time, and locations where the test was made. Test results shall be promptly presented to the Owner's Representative.
- H. Shop Primer: Shop primed steel shall receive a field sweep blast prior to the application of subsequent coats. Prepare shop primer to receive field coat in accordance with manufacturer's instructions. Removal all unknown shop primers and re-prime in accordance with this specification.

3.4 SURFACE PREPARATION OF GALVANIZED STEEL AND NONFERROUS METAL

- A. Prepare galvanized steel and nonferrous metal surfaces in accordance with SSPC-SP 16 and the coating manufacturer's instructions.
- B. Test galvanized surfaces for chromate treatments and remove as required by SSPC-SP 16, or other Engineer approved method.

- C. Ensure surfaces are dry.

3.5 SURFACE PREPARATION OF DUCTILE OR CAST IRON

- A. Prepare ductile or cast iron surfaces in accordance with NAPF 500-03-04 Abrasive Blast Cleaning with the exception that ALL rust and mold coating be removed. Only tightly adhered annealing oxide may remain.
- B. Bituminous coated pipe shall NOT be allowed if field painting is required.
- C. Ensure surfaces are clean, dry, and free of oil, grease, dirt, dust, and other contaminants.
- D. Painting contractor shall install a 360 degree bead of caulk. Prior to painting, in the void between mating flange faces and in the void between any pipe and the thread-on flange. The bead caulk shall prevent exterior water from penetrating into the described void and leaving rust streaks.
- E. Caulk shall be a paintable, high grade flexible polysulfide joint sealant as manufactured by Polyspec or equal

3.6 SURFACE PREPARATION OF PVC

- A. Prepare PVC surfaces in accordance with manufacturer's instructions.
- B. Ensure surfaces are clean, dry, and free of oil, grease, dirt, dust, and other contaminants.
- C. Scarify PVC surfaces.

3.7 SURFACE PREPARATION OF CONCRETE

- A. Interior, Wet Substrate:
 - 1. Prepare concrete surfaces in accordance with manufacturer's instructions, SSPC-SP 13/NACE 6, and ICRI 310.2.
 - 2. Allow concrete to cure for a minimum of 28 days.
 - 3. Test concrete for moisture in accordance with ASTM D 4263 and, if necessary, F 1869.
 - 4. Abrasive blast surface to remove laitance and solid contaminants and to provide clean, sound substrate with uniform anchor profile.
 - 5. Verify that the pH of the cleaned concrete surfaces to be coated is within the range of to 8 to 11. Application of coating materials outside this range will not be permitted without written approval from the Engineer.
 - 6. Fill holes, pits, voids, and cracks with manufacturer approved surfacer.
 - 7. Ensure surfaces are clean, dry, and free of oil, grease, chalk, form release agents, and other contaminants.
- B. Exterior and Interior Dry:
 - 1. Prepare concrete surfaces in accordance with manufacturer's instructions, SSPC-SP 13/NACE 6, and ICRI 310.2.
 - 2. Allow concrete to cure for a minimum of 28 days.
 - 3. Test concrete for moisture in accordance with ASTM D 4263 and, if necessary, F 1869.
 - 4. Level concrete protrusions and mortar spatter.
 - 5. Verify that the pH of the cleaned concrete surfaces to be coated is within the range of to 8 to 11. Application of coating materials outside this range will not be permitted without written approval from the Engineer.
 - 6. Fill hairline cracks less than 1/64 inch (0.4 mm) in accordance with manufacturer's instructions.
 - 7. Prepare cracks wider than 1/64 inch (0.4 mm), moving cracks, gaps, and expansion joints in accordance with manufacturer's instructions.
 - 8. Ensure surfaces are clean, dry, and free of oil, grease, chalk, form release agents, and other contaminants.

3.8 SURFACE PREPARATION OF CONCRETE FLOORS

- A. Prepare concrete surfaces in accordance with manufacturer's instructions, SSPC-SP 13/NACE 6, and ICRI 310.2.
- B. Ensure surfaces are clean, dry, and free of oil, grease, dirt, dust, and other contaminants.
- C. Allow concrete to cure for a minimum of 28 days before coating.
- D. Test concrete for moisture in accordance with ASTM D 4263 and, if necessary, F 1869.

- E. Verify that the pH of the cleaned concrete surfaces to be coated is within the range of 8 to 11. Application of coating materials outside this range will not be permitted without written approval from the Engineer.

3.9 SURFACE PREPARATION OF POROUS CONCRETE MASONRY UNITS

- A. Prepare porous concrete masonry unit surfaces in accordance with manufacturer's instructions and SSPC-SP 13/NACE 6.
- B. Ensure surfaces are clean, dry, and free of oil, grease, dirt, dust, and other contaminants.
- C. Allow mortar to cure for a minimum of 28 days before coating.
- D. Level protrusions and mortar spatter.

3.10 SURFACE PREPARATION OF GYPSUM BOARD

- A. Prepare gypsum board surfaces in accordance with manufacturer's instructions.
- B. Ensure surfaces are clean, dry, and free of oil, grease, dirt, dust, and other contaminants.
- C. Sand joint compound smooth and feather edge.
- D. Avoid heavy sanding of adjacent gypsum board surfaces, which will raise nap of paper covering.
- E. Do not apply putty, patching pencils, caulking, or masking tape to drywall surfaces to be painted.
- F. Lightly scuff-sand tape joints after priming to remove raised paper nap. Do not sand through primer.

3.11 SURFACE PREPARATION OF WOOD

- A. Prepare wood surfaces in accordance with manufacturer's instructions.
- B. Ensure surfaces are clean, dry, and free of oil, grease, dirt, dust, surface deposits of sap or pitch, and other contaminants.
- C. Seal knots and pitch pockets.
- D. Sand rough spots with the grain.
- E. Fill cracks and holes with approved materials after primer is dry. Sand flush with surface when filler is hard.
- F. Lightly sand between coats.

3.12 PROCEDURES FOR ITEMS HAVING SHOP-APPLIED PRIME COATS

- A. After application of primer to surfaces, allow coating to cure for a minimum of two hours before handling to minimize damage.
- B. When loading for shipment to the project site, use spacers and other protective devices to separate items to prevent damaging the shop-primed surfaces during transit and unloading. If wood spacers are used, remove wood splinters and particles from the shop-primed surfaces after separation. Use padded chains or ribbon binders to secure the loaded items and minimize damage to the shop-primed surfaces.
- C. Cover shop-primed items 100% with protective coverings or tarpaulins to prevent deposition of road salts, fuel residue, and other contaminants in transit.
- D. Handle shop-primed items with care during unloading, installation, and erection operations to minimize damage. Do not place or store shop-primed items on the ground or on top of other work unless ground or work is covered with a protective covering or tarpaulin. Place shop-primed items above the ground upon platforms, skids, or other supports.

3.13 FIELD TOUCH-UP OF SHOP-APPLIED PRIME COATS

- A. Remove oil and grease surface contaminants on metal surfaces in accordance with SSPC SP-1. Use clean rags wetted with a degreasing solution, rinse with clean water, and wipe dry.
- B. Remove dust, dirt, salts, moisture, chalking primers, or other surface contaminants that will affect the adhesion or durability of the coating system. Use a high-pressure water blaster or scrub surfaces with a broom or brush wetted with a solution of trisodium phosphate, detergent, and water. Rinse scrubbed surfaces with clean water.
- C. Remove loose or peeling primer and other surface contaminants not easily removed by the previous cleaning methods in accordance with SSPC SP-7. Take care that remaining primers are not damaged

by the blast cleaning operation. Remaining primers shall be firmly bonded to the steel surfaces with blast cleaned edges feathered.

- D. Remove rust, scaling, or primer damaged by welding or during shipment, storage, and erection in accordance with SSPC SP-10. Take care that remaining primers are not damaged by the blast cleaning operation. Areas smaller than 1 square inch may be prepared per SSPC SP-11. Remaining primers shall be firmly bonded to the steel surfaces with cleaned edges feathered.
- E. Use repair procedures on damaged primer that protects adjacent primer. Blast cleaning may require the use of lower air pressure, smaller nozzles, and abrasive particle sizes, short blast nozzle distance from surface, shielding, and/or masking.
- F. After abrasive blast cleaning of damaged and defective areas, remove dust, blast particles, and other debris by dusting, sweeping, and vacuuming; then apply the specified touch-up coating.
- G. Surfaces that are shop primed shall receive a field touch-up of the same primer used in the original prime coat.
- H. Review other Specification Sections in which primers are shop applied to assure compatibility of the total coating system. On request, furnish information on characteristics of intermediate and finish coating materials to assure compatibility with primers. Notify the Owners Representative of anticipated problems using the materials specified over substrates primed by others.

3.14 PROCEDURES FOR THE APPLICATION OF COATINGS

- A. Apply coatings in accordance with manufacturer's instructions.
- B. Mix and thin coatings, including multi-component materials, in accordance with manufacturer's instructions. Only full kits shall be mixed, unless properly measured using graduated measuring devices. Only mix coatings in areas designated for that purpose by the Owner's Representative.
- C. Keep containers closed when not in use to avoid contamination.
- D. Do not use mixed coatings beyond pot life limits.
- E. Use application equipment, tools, pressure settings, and techniques in accordance with manufacturer's instructions.
- F. Uniformly apply coatings at spreading rate required to achieve specified DFT.
- G. Apply coatings to be free of film characteristics or defects that would adversely affect performance or appearance of coating systems.
- H. Stripe paint with brush critical locations on steel such as welds, corners, and edges using specified primer. Apply an additional stripe coat of the intermediate coating material in immersion areas.
- I. Roll or backroll the first coat of epoxy or block filler applied to concrete or interior block substrates to work the material into the substrate

3.15 SURFACES NOT TO BE COATED

- A. Do not paint the following surfaces unless otherwise noted in the drawings or in other specification sections. Protect during the painting of adjacent areas:
- B. Prefinished items not to be painted include, but are not limited to, the following factory-finished components, unless noted otherwise:
 - 1. Toilet enclosures
 - 2. Acoustic materials
 - 3. Architectural woodwork and casework
 - 4. Shop finished water treatment process, mechanical, and electrical equipment
 - 5. Light fixtures
 - 6. Switchgear
 - 7. Distribution cabinets
 - 8. Metal Building Wall and Roof Panels
 - 9. FRP Pipe Supports, Hangers, and grating
 - 10. Laboratory Cabinets
- C. Finished metal surfaces not to be painted include, but are not limited to, the following, unless noted otherwise:
 - 1. Aluminum

2. Stainless steel and stainless steel piping, except for color coding
 3. Chromium plated
 4. Copper pipe, except for color coding
 5. Submerged brass and copper.
- D. Interior and exterior galvanized metal surfaces shall not be painted, unless noted otherwise in the paint schedule or on the plans.
- E. Operating parts not to be painted include moving parts of operating equipment, such as the following:
1. Valve and damper operators
 2. Linkage
 3. Sensing devices
 4. Motor and fan shafts
- F. Labels
1. Do not paint over Underwriters Laboratories, Factory Mutual or other code-required labels or equipment name, identification, performance rating, or nomenclature plates.
- G. Concrete and masonry surfaces unless noted to be painted on Paint Finish Schedule.
- H. Shop primed steel joists if not exposed to view upon completion of construction.
- I. Miscellaneous Items
1. Fencing
 2. Concrete reinforcement steel
 3. Buried piping unless specifically noted otherwise
 4. Exposed electrical conduit.
 5. Glass
 6. Roofing
 7. Metal letters
 8. Grease fittings
- J. Remove, mask, or otherwise protect hardware, lighting fixtures, switchplates, aluminum surfaces, machined surfaces, couplings, shafts, bearings, nameplates on machinery, and other surfaces not intended to be painted. Provide drop cloths to prevent paint materials from falling on or marring adjacent surfaces. Protect working parts of mechanical and electrical equipment from damage during surface preparation and painting process. Mask openings in motors to prevent paint and other materials from entering the motors.

3.16 SURFACES TO BE COATED

- A. Coat surfaces with the specific coating systems as described below:
1. Coat mechanical equipment, such as pumps, as described in the various mechanical equipment specifications. Color of finish coat shall match the color of the connecting piping.
 2. Coat aboveground and exposed piping or piping in vaults and structures as described in the various piping specifications.
 3. Coat valves as described in the various valve specifications. Aboveground valves, or valves in vaults and structures, shall match the color of the connecting piping.
 4. Coat aluminum surfaces in contact with concrete per System No. 11.
 5. Coat aboveground structural steel or structural steel located in vaults and structures as described in Section 05120.
 6. Field applied epoxy coatings for patching and touch-up of fusion-bonded epoxy lining and coatings shall meet the requirements of Specification Section 09961.

3.17 FIELD QUALITY CONTROL

- A. Required Inspections and Documentation:
1. Verify coatings and other materials are as specified.
 2. Verify environmental conditions are as specified.
 3. Verify surface preparation and application are as specified.
 4. Verify DFT of each coat and total DFT of each coating system are as specified using wet film and dry film gauges. DFT's shall be measured in accordance with SSPC-PA2.
 5. Coating Defects: Check coatings for film characteristics or defects that would adversely affect performance or appearance of coating systems.

- a. Check for holidays on interior steel immersion surfaces using holiday detector in accordance with NACE SP0188 or SSPC TU-11 using a safe blue light inspection lamps if OAP technology is used.
6. Report:
 - a. Prepare inspection reports daily.
 - b. Submit written reports describing inspections made and actions taken to correct nonconforming work.
 - c. Report nonconforming work not corrected.
 - d. Submit copies of report to Engineer and Contractor.
7. Perform tests in the presence of the Owner's Representative when available. The Owner's Representative may perform independent testing of coating systems, including wet film, dry film, holiday, surface profile, or testing of paint products as deemed necessary.
8. Manufacturer's Field Services: Manufacturer's representative shall provide technical assistance and guidance for surface preparation and application of coating systems

3.18 REPAIR OF IMPROPERLY COATED SURFACES

If the item has an improper finish color or insufficient film thickness, clean and topcoat the surface with the specified paint material to obtain the specified color and coverage. Sandblast or mechanically abrade visible areas of chipped, peeled, or abraded paint, feathering the edges. Then prime and finish coat in accordance with the specifications. Work shall be free of runs, bridges, shiners, laps, or other imperfections.

3.19 CLEANING

- A. During the progress of the work, remove discarded materials, rubbish, cans, and rags at the end of each day's work.
- B. Thoroughly clean brushes and other application equipment at the end of each period of use and when changing to another paint or color.
- C. Upon completion of painting work, remove masking tape, tarps, and other protective materials. Clean glass and paint spattered surfaces. Remove spattered paint by washing and scaping. Use care not to scratch or damage finished surfaces.
- D. All glass that is scratched or damaged by the painter's work or while cleaning off the paint from the glass shall be replaced.
- E. Collect waste material which may constitute a fire hazard, place in closed metal containers, and remove daily from site.

END OF SECTION

PAGE INTENTIONALLY LEFT BLANK

**SECTION 099000.10
PAINT SYSTEM SCHEDULE**

**PART 1 SCHEDULE 1
TNEMEC PAINTS**

No	Description	Surface preparation	Prime Coat		Intermediate Coat		Final Coat		NOTES
			Series	Min. DFT	Series	Min. DFT	Series	Min. DFT	
1	Exterior Metal - Architectural	SSPC SP3	10	2.0 to 4.0	1029	2.0 to 3.0	1029	2.0 to 3.0	
2	Exterior Metal - Corrosive	SSPC SP6, SEE NOTE 3	90-97	2.0 to 4.0	N69	3.5 to 4.5	73	2.0 to 3.0	Applies to all exterior metal in vicinity of wastewater plant unless indicated as galvanized. Painting existing package plant is not required on this project unless coating is damaged
3	Exterior Galv. Metal	SSPC SP1 & brush-blast	27	3.5 to 4.5	N69	3.5 to 4.5	73	2.0 to 3.0	Where indicated
4	Exterior Concrete	14 day cure & clean and dry	156	4.0 to 8.0	---	---	156	4.0 to 8.0	
5	Exterior Buried Concrete	14 day cure & clean and dry	46-413	8.0 to 12.0	---	---	46-413	8.0 to 12.0	
6	Exterior Masonry	28 day cure & clean and dry	156	60 to 80 ft ² /gal	---	---	156	80 to 100 ft ² /gal	
7	Exterior Wood	Sand & no residues	10	2.5 to 3.5	1029	2.0 to 3.0	1029	2.0 to 3.0	
8	Exterior Pipe and Equipment	SSPC SP6, See Note 2 for DIP	N69	3.0 to 5.0	N69	4.0 to 6.0	73	4.0 to 6.0	Applies to all non-stainless, non-galvanized exterior pipe and equipment

9	Exterior PVC and FRP	Lightly Abrade	27	2.0 to 3.0	---	---	73	2.0 to 3.0	Applies where PVC or FRP exposed to sun
10	Buried Metal	SSPC-SP6, See Note 3	46H-413	16.0 to 20.0	---	---	---	---	
11	Aluminum in Contact with Concrete	SSPC-SP6	46H-413	16.0 to 20.0	---	---	---	---	
12	Submerged Metal - Potable	SSPC-SP10	N140	3.0 to 5.0	N140	4.0 to 6.0	N140	4.0 to 6.0	
13	Submerged Metal - Nonpotable	SSPC-SP10	N69	3.0 to 5.0	N69	4.0 to 6.0	N69	4.0 to 6.0	Contractor shall provide touch-up coat to cages
14	Submerged Concrete - Potable	28 day cure & brush blast	N140	4.0 to 6.0	N140	4.0 to 6.0	N140	4.0 to 6.0	
15	Submerged Concrete - Nonpotable	28 day cure & brush blast	N69	4.0 to 6.0	N69	4.0 to 6.0	N69	4.0 to 6.0	
16	Metal High Temp	SSPC-SP10	39	0.7 to 1.5	39	0.7 to 1.5	39	0.7 to 1.5	Applies to all non-stainless pipe and equipment within 50' of blower discharge
17	Interior Metal - Architectural	SSPC-SP3	10	2.0 to 4.0	1029	2.0 to 3.0	1029	2.0 to 3.0	
18	Interior Metal - Corrosive	SSPC-SP6	N69	2.0 to 3.0	N69	3.0 to 5.0	N69	3.0 to 5.0	
19	Interior Galv. Metal	SSPC-SP6	27	4.0 to 6.0	---	---	73	2.0 to 3.0	
20	Interior Concrete - Architectural	28 day cure & clean and dry	104	60 to 80 ft ² /g al	---	---	104	80 to 100 ft ² /g al	
21	Interior Concrete - Corrosive	28 day cure & brush blast	104	60 to 80 ft ² /g al	---	---	104	80 to 100 ft ² /g al	
22	Concrete Floor Painted	28 day cure & brush blast	201	6.0 to 8.0	280	8.0 to 10.0	280	8.0 to 10.0	
23	Concrete Floor Clear Sealer	28 day cure & brush blast	201	10.0 to 12.0	---	---	---	---	

24	Interior-Masonry-- Archi	28-day- cure	130	60- to- 80- ft ² /g al	1029	2.0 to 3.0	1029	2.0- to- 3.0	
25	Interior-Masonry-- Corrosive	28-day- cure	104	60- to- 80- ft ² /g al	---	---	104	80 to 100- ft ² /g al	
26	Interior Wood	sand & no- residues	36	2.0- to- 3.0	1029	2.0 to 3.0	1029	2.0- to- 3.0	
27	Interior Gypsum Drywall	See Spec. 09260	151	1.0- to- 2.0	113	2.0 to 3.0	113	2.0- to- 3.0	
28	Bound- Absorption- Panels	No- residues	23	1.5- to- 3.0	23	1.5 to 3.0	---	---	
29	Interior Pipe- and- Equipment, See note 1	SSPC- SP6, See Note 2 for DIP	27	3.0- to- 5.0	N69	4.0 to 6.0	N69	4.0- to- 6.0	
30	Interior PVC- and FRP	Lightly- Abrade	27	2.0- to- 3.0	---	---	N69	2.0- to- 3.0	
31	Electrical Conduit Runs, Metallic Tubing	SSPC SP6	37H	2.0 to 3.5	Match	Wall	Match	Wall	
32	Cotton/Canvas on Pipe- Insulation	---	1029	1.5- to- 2.0	---	---	1029	1.5- to- 2.0	
33	Submerged Metal - Zinc Primer	SSPC- SP10	91- H2O	2.5- to- 3.5	N140	4.0 to 6.0	N140	4.0- to- 6.0	
34	Metal- Corrosive-- Zinc Primer	SSPC-SP6	91- H2O	2.5- to- 3.5	N69	3.0 to 5.0	N69	3.0- to- 5.0	
35	Interior Gypsum Drywall-- Epoxy		151- 1051	.07 to 1.5	113	4.0 to 5.0	113	4.0- to- 5.0	
36	Exterior Metal- Architectural, Epoxy	SSPC-SP6	27	4.0- to- 6.0	---	---	73	2.0- to- 3.0	
37	Interior Metal- Architectural, Epoxy	SSPC-SP6	27	4.0- to- 6.0	---	---	73	2.0- to- 3.0	

Notes: All paint systems shown with crosshatching are not anticipated to be required on this project.

1. Unless otherwise specified.
2. Surface prep shall be in compliance with Tnemec Technical Bulletin No. 07-52. If surface profile is less than 1.5 mils then brush-off blast clean, if surface profile is more than 1.5 mils then hand or power tool clean.
3. SSPC SP10 for immersion service.

4. Coating systems from other suppliers, including Sherwin Williams and other suppliers approved in Section 099000 will be accepted. This schedule outlines specific systems acceptable if Tnemec is selected.

END OF SECTION

SECTION 260510

COMMON MOTOR REQUIREMENTS

PART 1 GENERAL

1.1 SUMMARY

- A. Drawings and general provisions of the Contract, including General and Supplementary Conditions and Division 01 Specification Sections, apply to this Section.

1.2 COORDINATION

- A. Coordinate features of motors, installed units, and accessory devices to be compatible with the following:
 - 1. Motor controllers.
 - 2. Torque, speed, and horsepower requirements of the load.
 - 3. Ratings and characteristics of supply circuit and required control sequence.
 - 4. Ambient and environmental conditions of installation location.

1.3 WARRANTY

- A. Special Warranty: Manufacturer's standard form in which manufacturer agrees to repair or replace components of motors that fail in materials or workmanship within specified warranty period.
 - 1. Failures include, but are not limited to, the following:
 - a. Motor winding failure.
 - 2. Warranty Period: Five years from date of Substantial Completion.

PART 2 PRODUCTS

2.1 GENERAL MOTOR REQUIREMENTS

- A. Comply with requirements in this Section except when stricter requirements are specified in plumbing equipment schedules or Sections.
- B. Comply with NEMA MG 1 unless otherwise indicated.
- C. Comply with IEEE 841 for severe-duty motors.

2.2 MOTOR CHARACTERISTICS

- A. Duty: Continuous duty at ambient temperature of 40 deg C and at altitude of 3300 feet above sea level.
- B. Capacity and Torque Characteristics: Sufficient to start, accelerate, and operate connected loads at designated speeds, at installed altitude and environment, with indicated operating sequence, and without exceeding nameplate ratings or considering service factor.

2.3 POLYPHASE MOTORS

- A. Description: NEMA MG 1, Design B, medium induction motor.
- B. Manufacturers:
 - 1. US Motor
 - 2. General Electric Company
 - 3. Westinghouse

- 4. Approved Equal.
- C. Efficiency: Premium efficient, as defined in NEMA MG 1.
- D. Service Factor: 1.15.
- E. Windings: Copper magnet wire with moisture-resistant insulation varnish, designed and tested to resist transient spikes, high frequencies, and short time rise pulses produced by pulse-width modulated inverters.
- F. Multispeed Motors: Separate winding for each speed.
- G. Rotor: Random-wound, squirrel cage.
- H. Bearings: Regreasable, shielded, antifriction ball bearings suitable for radial and thrust loading.
- I. Temperature Rise: Class B.
- J. Insulation: Class F.
- K. Peak Voltage Rating of stator wiring to be a minimum of 2,200 volts.
- L. Code Letter Designation:
 - 1. Motors 15 HP and Larger: NEMA starting Code F or Code G.
 - 2. Motors Smaller than 15 HP: Manufacturer's standard starting characteristic.
- M. Enclosure Material: Cast iron frame and end bells.
- N. Thermal Protection: Comply with NEMA MG 1.
- O. Severe-Duty Motors: Comply with IEEE 841, with 1.15 minimum service factor.
- P. Provide shaft grounding (diverter) ring on drive end of all vertical motors.
- Q. Provide shaft grounding (diverter) ring on drive end and insulated bearing on the non-drive end of all motors 25 hp and larger controlled by variable-frequency motor controllers.

2.4 SINGLE-PHASE MOTORS

- A. Motors larger than 1/20 hp shall be one of the following, to suit starting torque and requirements of specific motor application:
 - 1. Permanent-split capacitor.
 - 2. Split phase.
 - 3. Capacitor start, inductor run.
 - 4. Capacitor start, capacitor run.
- B. Multispeed Motors: Variable-torque, permanent-split-capacitor type.
- C. Bearings: Prelubricated, antifriction ball bearings or sleeve bearings suitable for radial and thrust loading.
- D. Motors 1/20 HP and Smaller: Shaded-pole type.
- E. Thermal Protection: Internal protection to automatically open power supply circuit to motor when winding temperature exceeds a safe value calibrated to temperature rating of motor insulation. Thermal-protection device shall automatically reset when motor temperature returns to normal range.

PART 3 EXECUTION (NOT APPLICABLE)

END OF SECTION

SECTION 260519

LOW-VOLTAGE ELECTRICAL POWER CONDUCTORS AND CABLES

PART 1 GENERAL

1.1 RELATED DOCUMENTS

- A. Drawings and general provisions of the Contract and Division 01 Specification Sections apply to this Section.

1.2 DEFINITIONS

- A. VFC: Variable frequency controller.

1.3 ACTION SUBMITTALS

- A. Product Data: For each type of product.

1.4 INFORMATIONAL SUBMITTALS

- A. Qualification Data: For testing agency.
- B. Field quality-control reports.

1.5 QUALITY ASSURANCE

- A. Testing Agency Qualifications: Member company of NETA or an NRTL.
 - 1. Testing Agency's Field Supervisor: Certified by NETA to supervise on-site testing.

PART 2 PRODUCTS

2.1 CONDUCTORS AND CABLES

- A. Manufacturers: Subject to compliance with requirements, provide products by one of the following:
 - 1. [Alcan Products Corporation; Alcan Cable Division](#).
 - 2. [Alpha Wire](#).
 - 3. [Belden Inc](#).
 - 4. [Encore Wire Corporation](#).
 - 5. [General Cable Technologies Corporation](#).
 - 6. [Southwire Incorporated](#).
- B. Aluminum and Copper Conductors: Comply with NEMA WC 70/ICEA S-95-658.
- C. Conductor Insulation: Comply with NEMA WC 70/ICEA S-95-658 for Type THHN-2-THWN-2 and Type XHHW-2.
- D. Multiconductor Cable: Comply with NEMA WC 70/ICEA S-95-658 for metal-clad cable, Type MC with ground wire.

2.2 CONNECTORS AND SPLICES

- A. Manufacturers: Subject to compliance with requirements, provide products by one of the following:
 - 1. [AFC Cable Systems, Inc](#).
 - 2. [Hubbell Power Systems, Inc](#).
 - 3. [O-Z/Gedney](#); a brand of the EGS Electrical Group.
 - 4. [3M](#); Electrical Markets Division.
 - 5. [Tyco Electronics](#).
- B. Description: Factory-fabricated connectors and splices of size, ampacity rating, material, type, and class for application and service indicated.

2.3 SYSTEM DESCRIPTION

- A. Electrical Components, Devices, and Accessories: Listed and labeled as defined in NFPA 70, by a qualified testing agency, and marked for intended location and application.
- B. Comply with NFPA 70.

PART 3 EXECUTION

3.1 CONDUCTOR MATERIAL APPLICATIONS

- A. Feeders: Copper for feeders smaller than No. 4 AWG; copper or aluminum for feeders No. 4 AWG and larger. Solid for No. 10 AWG and smaller; stranded for No. 8 AWG and larger.
- B. Branch Circuits: Copper. Solid for No. 10 AWG and smaller; stranded for No. 8 AWG and larger.

3.2 CONDUCTOR INSULATION AND MULTICONDUCTOR CABLE APPLICATIONS AND WIRING METHODS

- A. Service Entrance: Type THHN-2-THWN-2, single conductors in raceway Type SE or Type USE multiconductor cable.
- B. Exposed Feeders: Type THHN-2-THWN-2, single conductors in raceway Metal-clad cable, Type MC.
- C. Feeders Concealed in Ceilings, Walls, Partitions, and Crawlspace: Type THHN-2-THWN-2, single conductors in raceway Metal-clad cable, Type MC.
- D. Feeders Concealed in Concrete, below Slabs-on-Grade, and Underground: Type THHN-2-THWN-2, single conductors in raceway.
- E. Feeders Installed below Raised Flooring: Type THHN-2-THWN-2, single conductors in raceway Metal-clad cable, Type MC.
- F. Feeders in Cable Tray: Type THHN-2-THWN-2, single conductors in raceway Type XHHW-2, single conductors larger than No. 1/0 AWG Metal-clad cable, Type MC.
- G. Exposed Branch Circuits, Including in Crawlspace: Type THHN-2-THWN-2, single conductors in raceway Metal-clad cable, Type MC.
- H. Branch Circuits Concealed in Ceilings, Walls, and Partitions: Type THHN-2-THWN-2, single conductors in raceway Metal-clad cable, Type MC.
- I. Branch Circuits Concealed in Concrete, below Slabs-on-Grade, and Underground: Type THHN-2-THWN-2, single conductors in raceway.
- J. Branch Circuits Installed below Raised Flooring: Type THHN-2-THWN-2, single conductors in raceway Metal-clad cable, Type MC.
- K. Branch Circuits in Cable Tray: Type THHN-2-THWN-2, single conductors in raceway Metal-clad cable, Type MC.
- L. Cord Drops and Portable Appliance Connections: Type SO, hard service cord with stainless-steel, wire-mesh, strain relief device at terminations to suit application.

3.3 INSTALLATION OF CONDUCTORS AND CABLES

- A. Conceal cables in finished walls, ceilings, and floors unless otherwise indicated.
- B. Complete raceway installation between conductor and cable termination points according to Division 26 Section "Raceways and Boxes for Electrical Systems" prior to pulling conductors and cables.
- C. Use manufacturer-approved pulling compound or lubricant where necessary; compound used must not deteriorate conductor or insulation. Do not exceed manufacturer's recommended maximum pulling tensions and sidewall pressure values.
- D. Use pulling means, including fish tape, cable, rope, and basket-weave wire/cable grips, that will not damage cables or raceway.

- E. Install exposed cables parallel and perpendicular to surfaces of exposed structural members, and follow surface contours where possible.
- F. Support cables according to Division 26 Section "Hangers and Supports for Electrical Systems."
- G. Complete cable tray systems installation according to Division 26 Section "Cable Trays for Electrical Systems" prior to installing conductors and cables.

3.4 CONNECTIONS

- A. Tighten electrical connectors and terminals according to manufacturer's published torque-tightening values. If manufacturer's torque values are not indicated, use those specified in UL 486A-486B.
- B. Make splices, terminations, and taps that are compatible with conductor material and that possess equivalent or better mechanical strength and insulation ratings than unspliced conductors.
 - 1. Use oxide inhibitor in each splice, termination, and tap for aluminum conductors.
- C. Wiring at Outlets: Install conductor at each outlet, with at least 12 inches of slack.

3.5 IDENTIFICATION

- A. Identify and color-code conductors and cables according to Division 26 Section "Identification for Electrical Systems."
- B. Identify each spare conductor at each end with identity number and location of other end of conductor, and identify as spare conductor.

3.6 SLEEVE AND SLEEVE-SEAL INSTALLATION FOR ELECTRICAL PENETRATIONS

- A. Install sleeves and sleeve seals at penetrations of exterior floor and wall assemblies. Comply with requirements in Division 26 Section "Sleeves and Sleeve Seals for Electrical Raceways and Cabling."

3.7 FIRESTOPPING

- A. Apply firestopping to electrical penetrations of fire-rated floor and wall assemblies to restore original fire-resistance rating of assembly according to Division 07 Section "Penetration Firestopping."

3.8 FIELD QUALITY CONTROL

- A. Testing Agency: Engage a qualified testing agency to perform tests and inspections.
- B. Manufacturer's Field Service: Engage a factory-authorized service representative to test and inspect components, assemblies, and equipment installations, including connections.
- C. Perform the following tests and inspections[[with the assistance of a factory-authorized service representative]]:
 - 1. After installing conductors and cables and before electrical circuitry has been energized, test service entrance and feeder conductors [[and] [conductors feeding the following critical equipment and services]] for compliance with requirements.
 - a. <<Insert, in separate subparagraphs, critical equipment and services to be tested>>.
 - 2. Perform each visual and mechanical inspection and electrical test stated in NETA Acceptance Testing Specification. Certify compliance with test parameters.
 - 3. Infrared Scanning: After Substantial Completion, but not more than 60 days after Final Acceptance, perform an infrared scan of each splice in conductors No. 3 AWG and larger. Remove box and equipment covers so splices are accessible to portable scanner. Correct deficiencies determined during the scan.
 - a. Follow-up Infrared Scanning: Perform an additional follow-up infrared scan of each splice 11 months after date of Substantial Completion.

b. Instrument: Use an infrared scanning device designed to measure temperature or to detect significant deviations from normal values. Provide calibration record for device.

c. Record of Infrared Scanning: Prepare a certified report that identifies splices checked and that describes scanning results. Include notation of deficiencies detected, remedial action taken, and observations after remedial action.

D. Test and Inspection Reports: Prepare a written report to record the following:

1. Procedures used.
2. Results that comply with requirements.
3. Results that do not comply with requirements and corrective action taken to achieve compliance with requirements.

E. Cables will be considered defective if they do not pass tests and inspections.

END OF SECTION

SECTION 260533
RACEWAY AND BOXES FOR ELECTRICAL SYSTEMS

PART 1 GENERAL

1.1 SUMMARY

- A. Drawings and general provisions of the Contract, including General and Supplementary Conditions and Division 01 Specification Sections, apply to this Section.

1.2 DEFINITIONS

- A. ARC: Aluminum rigid conduit.
- B. GRC: Galvanized rigid steel conduit.
- C. IMC: Intermediate metal conduit.

1.3 ACTION SUBMITTALS

- A. Product Data: For surface raceways, wireways and fittings, floor boxes, hinged-cover enclosures, and cabinets.
- B. LEED Submittals:
 - 1. Product Data for Credit IEQ 4.1: For solvent cements and adhesive primers, documentation including printed statement of VOC content.
- C. Shop Drawings: For custom enclosures and cabinets. Include plans, elevations, sections, and attachment details.
- D. Samples: For and wireways, nonmetallic wireways, surface raceways and for each color and texture specified.

1.4 INFORMATIONAL SUBMITTALS

- A. Coordination Drawings: Conduit routing plans, drawn to scale, on which the following items are shown and coordinated with each other, based on input from installers of the items involved:
 - 1. Structural members in the paths of conduit groups with common supports.
 - 2. HVAC and plumbing items and architectural features in the paths of conduit groups with common supports.
- B. Qualification Data: For professional engineer.
- C. Seismic Qualification Certificates: For enclosures, cabinets, and conduit racks and their mounting provisions, including those for internal components, from manufacturer.
 - 1. Basis for Certification: Indicate whether withstand certification is based on actual test of assembled components or on calculation.
 - 2. Dimensioned Outline Drawings of Equipment Unit: Identify center of gravity and locate and describe mounting and anchorage provisions.
 - 3. Detailed description of equipment anchorage devices on which the certification is based and their installation requirements.
 - 4. Detailed description of conduit support devices and interconnections on which the certification is based and their installation requirements.
- D. Source quality-control test reports.

PART 2 PRODUCTS

2.1 METAL CONDUITS, TUBING, AND FITTINGS

- A. Manufacturers: Subject to compliance with requirements, provide products by one of the following:
 - 1. AFC Cable Systems, Inc.

2. Allied Tube & Conduit.
 3. Anamet Electrical, Inc.
 4. Electri-Flex Company.
 5. O-Z/Gedney.
 6. Wheatland Tube Company.
- B. Listing and Labeling: Metal conduits, tubing, and fittings shall be listed and labeled as defined in NFPA 70, by a qualified testing agency, and marked for intended location and application.
- C. GRC: Comply with ANSI C80.1 and UL 6.
- D. ARC: Comply with ANSI C80.5 and UL 6A.
- E. IMC: Comply with ANSI C80.6 and UL 1242.
- F. PVC-Coated Steel Conduit: PVC-coated rigid steel conduit.
1. Comply with NEMA RN 1.
 2. Coating Thickness: 0.040 inch, minimum.
- G. EMT: Comply with ANSI C80.3 and UL 797.
- H. FMC: Comply with UL 1; zinc-coated steel.
- I. LFMC: Flexible steel conduit with PVC jacket and complying with UL 360.
- J. Fittings for Metal Conduit: Comply with NEMA FB 1 and UL 514B.
1. Conduit Fittings for Hazardous (Classified) Locations: Comply with UL 886 and NFPA 70.
 2. Fittings for EMT:
 - a. Material: Steel.
 - b. Type: Setscrew or compression.
 3. Expansion Fittings: PVC or steel to match conduit type, complying with UL 651, rated for environmental conditions where installed, and including flexible external bonding jumper.
 4. Coating for Fittings for PVC-Coated Conduit: Minimum thickness of 0.040 inch, with overlapping sleeves protecting threaded joints
- K. Joint Compound for IMC, GRC, or ARC: Approved, as defined in NFPA 70, by authorities having jurisdiction for use in conduit assemblies, and compounded for use to lubricate and protect threaded conduit joints from corrosion and to enhance their conductivity.

2.2 NONMETALLIC CONDUITS, TUBING, AND FITTINGS

- A. Manufacturers: Subject to compliance with requirements, provide products by one of the following:
1. AFC Cable Systems, Inc.
 2. Anamet Electrical, Inc.
 3. Arnco Corporation.
 4. CANTEX Inc.
 5. CertainTeed Corporation.
 6. Condux International, Inc.
 7. Electri-Flex Company.
 8. Lamson & Sessions; Carlon Electrical Products.
 9. RACO; Hubbell.
 10. Thomas & Betts Corporation.

- B. Listing and Labeling: Nonmetallic conduits, tubing, and fittings shall be listed and labeled as defined in NFPA 70, by a qualified testing agency, and marked for intended location and application
- C. ENT: Comply with NEMA TC 13 and UL 1653.
- D. RNC: Type EPC-40-PVC, complying with NEMA TC 2 and UL 651 unless otherwise indicated.
- E. LFNC: Comply with UL 1660.
- F. Rigid HDPE: Comply with UL 651A.
- G. Continuous HDPE: Comply with UL 651B.
- H. Coilable HDPE: Preassembled with conductors or cables, and complying with ASTM D 3485.
- I. RTRC: Comply with UL 1684A and NEMA TC 14.
- J. Fittings for ENT and RNC: Comply with NEMA TC 3; match to conduit or tubing type and material.
- K. Fittings for LFNC: Comply with UL 514B.
- L. Solvent cements and adhesive primers shall have a VOC content of 510 and 550 g/L or less, respectively, when calculated according to 40 CFR 59, Subpart D (EPA Method 24).

2.3 METAL WIREWAYS AND AUXILIARY GUTTERS

- A. Manufacturers: Subject to compliance with requirements, provide products by one of the following:
 - 1. Cooper B-Line, Inc.
 - 2. Hoffman.
 - 3. Square D.
- B. Description: Sheet metal, complying with UL 870 and NEMA 250 unless otherwise indicated, and sized according to NFPA 70.
 - 1. Metal wireways installed outdoors shall be listed and labeled as defined in NFPA 70, by a qualified testing agency, and marked for intended location and application.
- C. Fittings and Accessories: Include covers, couplings, offsets, elbows, expansion joints, adapters, hold-down straps, end caps, and other fittings to match and mate with wireways as required for complete system.
- D. Wireway Covers: As indicated.
- E. Finish: Manufacturer's standard enamel finish.

2.4 NONMETALLIC WIREWAYS AND AUXILIARY GUTTERS

- A. Manufacturers: Subject to compliance with requirements, provide products by one of the following:
 - 1. Hoffman.
 - 2. Lamson & Sessions; Carlon Electrical Products.
- B. Listing and Labeling: Nonmetallic wireways and auxiliary gutters shall be listed and labeled as defined in NFPA 70, by a qualified testing agency, and marked for intended location and application.
- C. Description: Fiberglass polyester, extruded and fabricated to size and shape indicated, with no holes or knockouts. Cover is gasketed with oil-resistant gasket material and fastened with captive screws treated for corrosion resistance. Connections are flanged, with stainless-steel screws and oil-resistant gaskets.
- D. Description: PVC plastic, extruded and fabricated to size and shape indicated, with snap-on cover and mechanically coupled connections with plastic fasteners.

- E. Fittings and Accessories: Couplings, offsets, elbows, expansion joints, adapters, hold-down straps, end caps, and other fittings shall match and mate with wireways as required for complete system.
- F. Solvent cements and adhesive primers shall have a VOC content of 510 and 550 g/L or less, respectively, when calculated according to 40 CFR 59, Subpart D (EPA Method 24).

2.5 SURFACE RACEWAYS

- A. Listing and Labeling: Surface raceways and tele-power poles shall be listed and labeled as defined in NFPA 70, by a qualified testing agency, and marked for intended location and application.
- B. Surface Metal Raceways: Galvanized steel with snap-on covers complying with UL 5. Manufacturer's standard enamel finish in color selected by Architect.
 - 1. Manufacturers: Subject to compliance with requirements, provide products by one of the following:
 - a. Wiremold / Legrand.
- C. Surface Nonmetallic Raceways: Two- or three-piece construction, complying with UL 5A, and manufactured of rigid PVC with texture and color selected by Architect from manufacturer's standard colors. Product shall comply with UL 94 V-0 requirements for self-extinguishing characteristics.
 - 1. Manufacturers: Subject to compliance with requirements, provide products by one of the following:
 - a. Hubbell Incorporated.
 - b. Panduit Corp.
 - c. Wiremold / Legrand.
- D. Tele-Power Poles:
 - 1. Manufacturers: Subject to compliance with requirements, provide products by one of the following:
 - a. Mono-Systems, Inc.
 - b. Panduit Corp.
 - c. Wiremold / Legrand.
 - 2. Material: Galvanized steel with ivory baked-enamel finish Aluminum with clear anodized finish]].
 - 3. Fittings and Accessories: Dividers, end caps, covers, cutouts, wiring harnesses, devices, mounting materials, and other fittings shall match and mate with tele-power pole as required for complete system.

2.6 BOXES, ENCLOSURES, AND CABINETS

- A. Manufacturers: Subject to compliance with requirements, provide products by one of the following:
 - 1. Cooper Technologies Company; Cooper Crouse-Hinds.
 - 2. EGS/Appleton Electric.
 - 3. Erickson Electrical Equipment Company.
 - 4. Hoffman.
 - 5. Hubbell Incorporated.
 - 6. O-Z/Gedney.
 - 7. RACO; Hubbell.

8. Robroy Industries.
 9. Spring City Electrical Manufacturing Company.
 10. Thomas & Betts Corporation.
 11. Wiremold / Legrand.
- B. General Requirements for Boxes, Enclosures, and Cabinets: Boxes, enclosures, and cabinets installed in wet locations shall be listed for use in wet locations.
 - C. Sheet Metal Outlet and Device Boxes: Comply with NEMA OS 1 and UL 514A.
 - D. Cast-Metal Outlet and Device Boxes: Comply with NEMA FB 1, ferrous alloy, Type FD, with gasketed cover.
 - E. Nonmetallic Outlet and Device Boxes: Comply with NEMA OS 2 and UL 514C.
 - F. Metal Floor Boxes:
 1. Material: Cast metal or sheet metal.
 2. Type: Fully adjustable.
 3. Shape: Rectangular.
 4. Listing and Labeling: Metal floor boxes shall be listed and labeled as defined in NFPA 70, by a qualified testing agency, and marked for intended location and application.
 - G. Nonmetallic Floor Boxes: Nonadjustable, round.
 1. Listing and Labeling: Nonmetallic floor boxes shall be listed and labeled as defined in NFPA 70, by a qualified testing agency, and marked for intended location and application.
 - H. Luminaire Outlet Boxes: Nonadjustable, designed for attachment of luminaire weighing 50 lb. Outlet boxes designed for attachment of luminaires weighing more than 50 lb shall be listed and marked for the maximum allowable weight.
 - I. Paddle Fan Outlet Boxes: Nonadjustable, designed for attachment of paddle fan weighing 70 lb.
 1. Listing and Labeling: Paddle fan outlet boxes shall be listed and labeled as defined in NFPA 70, by a qualified testing agency, and marked for intended location and application.
 - J. Small Sheet Metal Pull and Junction Boxes: NEMA OS 1.
 - K. Cast-Metal Access, Pull, and Junction Boxes: Comply with NEMA FB 1, cast aluminum with gasketed cover.
 - L. Box extensions used to accommodate new building finishes shall be of same material as recessed box.
 - M. Device Box Dimensions: 4 inches square by 2-1/8 inches deep.
 - N. Gangable boxes [[are allowed] [are prohibited]].
 - O. Hinged-Cover Enclosures: Comply with UL 50 and NEMA 250, Type 1 with continuous-hinge cover with flush latch unless otherwise indicated.
 1. Metal Enclosures: Steel, finished inside and out with manufacturer's standard enamel.
 2. Nonmetallic Enclosures: Plastic.
 3. Interior Panels: Steel; all sides finished with manufacturer's standard enamel.
 - P. Cabinets:
 1. NEMA 250, Type 1 galvanized-steel box with removable interior panel and removable front, finished inside and out with manufacturer's standard enamel.
 2. Hinged door in front cover with flush latch and concealed hinge.
 3. Key latch to match panelboards.
 4. Metal barriers to separate wiring of different systems and voltage.

5. Accessory feet where required for freestanding equipment.
6. Nonmetallic cabinets shall be listed and labeled as defined in NFPA 70, by a qualified testing agency, and marked for intended location and application.

2.7 HANDHOLES AND BOXES FOR EXTERIOR UNDERGROUND WIRING

- A. General Requirements for Handholes and Boxes:
 1. Boxes and handholes for use in underground systems shall be designed and identified as defined in NFPA 70, for intended location and application.
 2. Boxes installed in wet areas shall be listed and labeled as defined in NFPA 70, by a qualified testing agency, and marked for intended location and application.
- B. Polymer-Concrete Handholes and Boxes with Polymer-Concrete Cover: Molded of sand and aggregate, bound together with polymer resin, and reinforced with steel or fiberglass or a combination of the two.
 1. Manufacturers: Subject to compliance with requirements, provide products by one of the following:
 - a. Armorcast Products Company.
 - b. Carson Industries LLC.
 2. Standard: Comply with SCTE 77.
 3. Configuration: Designed for flush burial with [[open] [closed] [integral closed]] bottom unless otherwise indicated.
 4. Cover: Weatherproof, secured by tamper-resistant locking devices and having structural load rating consistent with enclosure and handhole location.
 5. Cover Finish: Nonskid finish shall have a minimum coefficient of friction of 0.50.
 6. Cover Legend: Molded lettering, "ELECTRIC."
 7. Conduit Entrance Provisions: Conduit-terminating fittings shall mate with entering ducts for secure, fixed installation in enclosure wall.
 8. Handholes 12 Inches Wide by 24 Inches Long and Larger: Have inserts for cable racks and pulling-in irons installed before concrete is poured.
- C. Fiberglass Handholes and Boxes: Molded of fiberglass-reinforced polyester resin, with frame and covers of polymer concrete.
 1. Manufacturers: Subject to compliance with requirements, provide products by one of the following:
 - a. Armorcast Products Company.
 - b. Carson Industries LLC.
 - c. Nordic Fiberglass, Inc.
 - d. Oldcastle Precast, Inc; Christy Concrete Products
 - e. Synertech Moulded Products, Inc.
 2. Standard: Comply with SCTE 77.
 3. Color of Frame and Cover: Gray.
 4. Configuration: Designed for flush burial unless otherwise indicated.
 5. Cover: Weatherproof, secured by tamper-resistant locking devices and having structural load rating consistent with enclosure and handhole location.
 6. Cover Finish: Nonskid finish shall have a minimum coefficient of friction of 0.50.
 7. Cover Legend: Molded lettering, "ELECTRIC."

8. Conduit Entrance Provisions: Conduit-terminating fittings shall mate with entering ducts for secure, fixed installation in enclosure wall.
9. Handholes 12 Inches Wide by 24 Inches Long and Larger: Have inserts for cable racks and pulling-in irons installed before concrete is poured.

2.8 SOURCE QUALITY CONTROL FOR UNDERGROUND ENCLOSURES

- A. Handhole and Pull-Box Prototype Test: Test prototypes of handholes and boxes for compliance with SCTE 77. Strength tests shall be for specified tier ratings of products supplied.
 1. Tests of materials shall be performed by an independent testing agency.
 2. Strength tests of complete boxes and covers shall be by either an independent testing agency or manufacturer. A qualified registered professional engineer shall certify tests by manufacturer.
 3. Testing machine pressure gages shall have current calibration certification complying with ISO 9000 and ISO 10012, and traceable to NIST standards.

PART 3 EXECUTION

3.1 RACEWAY APPLICATION

- A. Outdoors: Apply raceway products as specified below, unless otherwise indicated:
 1. Exposed Conduit: Rigid steel conduit.
 2. Concealed Conduit, Aboveground: EMT.
 3. Underground Conduit: RNC, Type EPC-40-PVC, direct buried.
 4. Connection to Vibrating Equipment (Including Transformers and Hydraulic, Pneumatic, Electric Solenoid, or Motor-Driven Equipment): LFMC.
 5. Boxes and Enclosures, Aboveground: NEMA 250, Type 3R.
- B. Indoors: Apply raceway products as specified below unless otherwise indicated:
 1. Exposed, Not Subject to Physical Damage: EMT.
 2. Exposed, Not Subject to Severe Physical Damage: EMT.
 3. Exposed and Subject to Severe Physical Damage: Rigid steel conduit. Raceway locations include the following:
 - a. Loading dock.
 - b. Corridors used for traffic of mechanized carts, forklifts, and pallet-handling units.
 - c. Mechanical rooms.
 - d. Gymnasiums.
 4. Concealed in Ceilings and Interior Walls and Partitions: EMT.
 5. Connection to Vibrating Equipment (Including Transformers and Hydraulic, Pneumatic, Electric Solenoid, or Motor-Driven Equipment): FMC, except use LFMC in damp or wet locations.
 6. Damp or Wet Locations: Rigid steel conduit.
 7. Boxes and Enclosures: NEMA 250, Type 1, except use NEMA 250, Type 4, nonmetallic in damp or wet locations.
- C. Minimum Raceway Size: [[1/2-inch] [3/4-inch]] trade size.
- D. Raceway Fittings: Compatible with raceways and suitable for use and location.
 1. Rigid and Intermediate Steel Conduit: Use threaded rigid steel conduit fittings, unless otherwise indicated.

2. PVC Externally Coated, Rigid Steel Conduits: Use only fittings listed for use with this type of conduit. Patch and seal all joints, nicks, and scrapes in PVC coating after installing conduits and fittings. Use sealant recommended by fitting manufacturer and apply in thickness and number of coats recommended by manufacturer.
 3. EMT: Comply with NEMA FB 2.10.
 4. Flexible Conduit: Use only fittings listed for use with flexible conduit. Comply with NEMA FB 2.20.
- E. Install nonferrous conduit or tubing for circuits operating above 60 Hz. Where aluminum raceways are installed for such circuits and pass through concrete, install in nonmetallic sleeve.
 - F. Do not install aluminum conduits, boxes, or fittings in contact with concrete or earth.
 - G. Install surface raceways only where indicated on Drawings.
 - H. Do not install nonmetallic conduit where ambient temperature exceeds 120 deg F.

3.2 INSTALLATION

- A. Comply with NECA 1 and NECA 101 for installation requirements except where requirements on Drawings or in this article are stricter. Comply with NECA 102 for aluminum conduits. Comply with NFPA 70 limitations for types of raceways allowed in specific occupancies and number of floors.
- B. Keep raceways at least 6 inches away from parallel runs of flues and steam or hot-water pipes. Install horizontal raceway runs above water and steam piping.
- C. Complete raceway installation before starting conductor installation.
- D. Complete with requirements in Division 26 Section "Hangers and Supports for Electrical Systems" for hangers and supports.
- E. Arrange stub-ups so curved portions of bends are not visible above the finished slab.
- F. Install no more than the equivalent of three 90-degree bends in any conduit run except for control wiring conduits, for which fewer bends are allowed. Support within 12 inches of changes in direction.
- G. Conceal conduit and EMT within finished walls, ceilings, and floors unless otherwise indicated. Install conduits parallel or perpendicular to building lines.
- H. Support conduit within 12 inches of enclosures to which attached.
- I. Raceways Embedded in Slabs:
 1. Run conduit larger than 1-inch trade size, parallel or at right angles to main reinforcement. Where at right angles to reinforcement, place conduit close to slab support. Secure raceways to reinforcement at maximum 10-foot intervals
 2. Arrange raceways to cross building expansion joints at right angles with expansion fittings.
 3. Arrange raceways to keep a minimum of concrete cover in all directions.
 4. Do not embed threadless fittings in concrete unless specifically approved by Architect for each specific location.
 5. Change from ENT to RNC, Type EPC-40-PVC, rigid steel conduit, or IMC before rising above the floor.
- J. Stub-ups to Above Recessed Ceilings:
 1. Use EMT, IMC, or RMC for raceways.
 2. Use a conduit bushing or insulated fitting to terminate stub-ups not terminated in hubs or in an enclosure.
- K. Threaded Conduit Joints, Exposed to Wet, Damp, Corrosive, or Outdoor Conditions: Apply listed compound to threads of raceway and fittings before making up joints. Follow compound manufacturer's written instructions.

- L. Coat field-cut threads on PVC-coated raceway with a corrosion-preventing conductive compound prior to assembly.
- M. Raceway Terminations at Locations Subject to Moisture or Vibration: Use insulating bushings to protect conductors, including conductors smaller than No. 4 AWG.
- N. Terminate threaded conduits into threaded hubs or with locknuts on inside and outside of boxes or cabinets. Install bushings on conduits up to 1-1/4-inch trade size and insulated throat metal bushings on 1-1/2-inch trade size and larger conduits terminated with locknuts. Install insulated throat metal grounding bushings on service conduits.
- O. Install raceways square to the enclosure and terminate at enclosures with locknuts. Install locknuts hand tight plus 1/4 turn more.
- P. Do not rely on locknuts to penetrate nonconductive coatings on enclosures. Remove coatings in the locknut area prior to assembling conduit to enclosure to assure a continuous ground path.
- Q. Cut conduit perpendicular to the length. For conduits 2-inch trade size and larger, use roll cutter or a guide to make cut straight and perpendicular to the length.
- R. Install pull wires in empty raceways. Use polypropylene or monofilament plastic line with not less than 200-lb tensile strength. Leave at least 12 inches of slack at each end of pull wire. Cap underground raceways designated as spare above grade alongside raceways in use.
- S. Surface Raceways:
 1. Install surface raceway with a minimum 2-inch radius control at bend points.
 2. Secure surface raceway with screws or other anchor-type devices at intervals not exceeding 48 inches and with no less than two supports per straight raceway section. Support surface raceway according to manufacturer's written instructions. Tape and glue are not acceptable support methods.
- T. Install raceway sealing fittings at accessible locations according to NFPA 70 and fill them with listed sealing compound. For concealed raceways, install each fitting in a flush steel box with a blank cover plate having a finish similar to that of adjacent plates or surfaces. Install raceway sealing fittings according to NFPA 70.
- U. Install devices to seal raceway interiors at accessible locations. Locate seals so no fittings or boxes are between the seal and the following changes of environments. Seal the interior of all raceways at the following points:
 1. Where conduits pass from warm to cold locations, such as boundaries of refrigerated spaces.
 2. Where an underground service raceway enters a building or structure.
 3. Where otherwise required by NFPA 70.
- V. Comply with manufacturer's written instructions for solvent welding RNC and fittings.
- W. Expansion-Joint Fittings:
 1. Install in each run of aboveground RNC that is located where environmental temperature change may exceed 30 deg F and that has straight-run length that exceeds 25 feet. Install in each run of aboveground RMC[[and EMT]] conduit that is located where environmental temperature change may exceed 100 deg F and that has straight-run length that exceeds 100 feet.
 2. Install type and quantity of fittings that accommodate temperature change listed for each of the following locations:
 - a. Outdoor Locations Not Exposed to Direct Sunlight: 125 deg F temperature change.
 - b. Outdoor Locations Exposed to Direct Sunlight: 155 deg F temperature change.
 - c. Indoor Spaces: Connected with the Outdoors without Physical Separation: 125 deg F temperature change.
 - d. Attics: 135 deg F temperature change.

3. Install fitting(s) that provide expansion and contraction for at least 0.00041 inch per foot of length of straight run per deg F of temperature change for PVC conduits. Install fitting(s) that provide expansion and contraction for at least 0.00078 inch per foot of length of straight run per deg F of temperature change for metal conduits.
 4. Install expansion fittings at all locations where conduits cross building or structure expansion joints.
 5. Install each expansion-joint fitting with position, mounting, and piston setting selected according to manufacturer's written instructions for conditions at specific location at time of installation. Install conduit supports to allow for expansion movement.
- X. Flexible Conduit Connections: Use maximum of 72 inches of flexible conduit for lighting fixtures, equipment subject to vibration, noise transmission, or movement; and for transformers and motors.
1. Use LFMC in damp or wet locations subject to severe physical damage.
 2. Use LFMC or LFNC in damp or wet locations not subject to severe physical damage.
- Y. Mount boxes at heights indicated on Drawings. If mounting heights of boxes are not individually indicated, give priority to ADA requirements. Install boxes with height measured to [[center] [top] [bottom]] of box unless otherwise indicated.
- Z. Recessed Boxes in Masonry Walls: Saw-cut opening for box in center of cell of masonry block, and install box flush with surface of wall. Prepare block surfaces to provide a flat surface for a raintight connection between box and cover plate or supported equipment and box.
- AA. Horizontally separate boxes mounted on opposite sides of walls so they are not in the same vertical channel.
- BB. Locate boxes so that cover or plate will not span different building finishes.
- CC. Support boxes of three gangs or more from more than one side by spanning two framing members or mounting on brackets specifically designed for the purpose.
- DD. Fasten junction and pull boxes to or support from building structure. Do not support boxes by conduits.
- EE. Set metal floor boxes level and flush with finished floor surface.
- FF. Set nonmetallic floor boxes level. Trim after installation to fit flush with finished floor surface.

3.3 INSTALLATION OF UNDERGROUND CONDUIT

- A. Direct-Buried Conduit:
1. Excavate trench bottom to provide firm and uniform support for conduit. Prepare trench bottom as specified in Division 31 Section "Earth Moving" for pipe less than 6 inches in nominal diameter.
 2. Install backfill as specified in Division 31 Section "Earth Moving."
 3. After installing conduit, backfill and compact. Start at tie-in point, and work toward end of conduit run, leaving conduit at end of run free to move with expansion and contraction as temperature changes during this process. Firmly hand tamp backfill around conduit to provide maximum supporting strength. After placing controlled backfill to within 12 inches of finished grade, make final conduit connection at end of run and complete backfilling with normal compaction as specified in Division 31 Section "Earth Moving."
 4. Install manufactured duct elbows for stub-ups at poles and equipment and at building entrances through the floor, unless otherwise indicated. Encase elbows for stub-up ducts throughout the length of the elbow.
 5. Install manufactured rigid steel conduit elbows for stub-ups at poles and equipment and at building entrances through the floor.

- a. Couple steel conduits to ducts with adapters designed for this purpose, and encase coupling with 3 inches of concrete for a minimum of 12 inches on each side of the coupling.
 - b. For stub-ups at equipment mounted on outdoor concrete bases and where conduits penetrate building foundations, extend steel conduit horizontally a minimum of 60 inches from edge of foundation or equipment base. Install insulated grounding bushings on terminations at equipment.
6. Warning Planks: Bury warning planks approximately 12 inches above direct-buried conduits but a minimum of 6 inches below grade. Align planks along centerline of conduit.
 7. Underground Warning Tape: Comply with requirements in Division 26 Section "Identification for Electrical Systems."

3.4 INSTALLATION OF UNDERGROUND HANDHOLES AND BOXES

- A. Install handholes and boxes level and plumb and with orientation and depth coordinated with connecting conduits to minimize bends and deflections required for proper entrances.
- B. Unless otherwise indicated, support units on a level bed of crushed stone or gravel, graded from 1/2-inch sieve to No. 4 sieve and compacted to same density as adjacent undisturbed earth.
- C. Elevation: In paved areas, set so cover surface will be flush with finished grade. Set covers of other enclosures 1 inch above finished grade.
- D. Install hand holes and boxes with bottom below the frost line.
- E. Install removable hardware, including pulling eyes, cable stanchions, cable arms, and insulators, as required for installation and support of cables and conductors and as indicated. Select arm lengths to be long enough to provide spare space for future cables, but short enough to preserve adequate working clearances in the enclosure.
- F. Field-cut openings for conduits according to enclosure manufacturer's written instructions. Cut wall of enclosure with a tool designed for material to be cut. Size holes for terminating fittings to be used, and seal around penetrations after fittings are installed.

3.5 SLEEVE AND SLEEVE-SEAL INSTALLATION FOR ELECTRICAL PENETRATIONS

- A. Install sleeves and sleeve seals at penetrations of exterior floor and wall assemblies. Comply with requirements in Division 26 Section "Sleeves and Sleeve Seals for Electrical Raceways and Cabling."

3.6 FIRESTOPPING

- A. Install firestopping at penetrations of fire-rated floor and wall assemblies. Comply with requirements in Division 07 Section "Penetration Firestopping."

3.7 PROTECTION

- A. Protect coatings, finishes, and cabinets from damage and deterioration.
 1. Repair damage to galvanized finishes with zinc-rich paint recommended by manufacturer.
 2. Repair damage to PVC or paint finishes with matching touchup coating recommended by manufacturer.

END OF SECTION

This Page Intentionally Left Blank

SECTION 262200
LOW-VOLTAGE TRANSFORMERS

PART 1 GENERAL

1.1 SUMMARY

- A. Drawings and general provisions of the Contract and Division 1 Specification Sections apply to this Section.

1.2 ACTION SUBMITTALS

- A. Product Data: Include rated nameplate data, capacities, weights, dimensions, minimum clearances, installed devices and features, and performance for each type and size of transformer indicated.
- B. Shop Drawings: Detail equipment assemblies and indicate dimensions, weights, loads, required clearances, method of field assembly, components, and location and size of each field connection.
1. Wiring Diagrams: Power, signal, and control wiring.

1.3 INFORMATIONAL SUBMITTALS

- A. Manufacturer Seismic Qualification Certification: Submit certification that transformers, accessories, and components will withstand seismic forces defined in Division 26 Section "Vibration and Seismic Controls for Electrical Systems." Include the following:
1. Basis for Certification: Indicate whether withstand certification is based on actual test of assembled components or on calculation.
- a. The term "withstand" means "the unit will remain in place without separation of any parts from the device when subjected to the seismic forces specified."
- b. The term "withstand" means "the unit will remain in place without separation of any parts from the device when subjected to the seismic forces specified and the unit will be fully operational after the seismic event."
2. Dimensioned Outline Drawings of Equipment Unit: identify center of gravity, locate, and describe mounting and anchorage provisions.
3. Detailed description of equipment anchorage devices on which the certification is based and their installation requirements.
- B. Qualification Data: For testing agency.
- C. Source quality-control test reports.
- D. Field quality-control test reports.

1.4 CLOSEOUT SUBMITTALS

- A. Operation and Maintenance Data: For transformers to include in emergency, operation, and maintenance manuals.

1.5 QUALITY ASSURANCE

- A. Testing Agency Qualifications: An agency, with the experience and capability to conduct the testing indicated, that is a member company of the InterNational Electrical Testing Association or is a nationally recognized testing laboratory (NRTL) as defined by OSHA in 29 CFR 1910.7, and that is acceptable to authorities having jurisdiction.
1. Testing Agency's Field Supervisor: Person currently certified by the InterNational Electrical Testing Association or the National Institute for Certification in Engineering Technologies to supervise on-site testing specified in Part 3.
- B. Testing Agency Qualifications: An independent agency, with the experience and capability to conduct the testing indicated, that is a nationally recognized testing laboratory (NRTL) as defined by OSHA in 29 CFR 1910.7.

- C. Source Limitations: Obtain each transformer type through one source from a single manufacturer.
- D. Electrical Components, Devices, and Accessories: Listed and labeled as defined in NFPA 70, Article 100, by a testing agency acceptable to authorities having jurisdiction, and marked for intended use.
- E. Comply with IEEE C57.12.91, "Test Code for Dry-Type Distribution and Power Transformers."

1.6 DELIVERY, STORAGE, AND HANDLING

- A. Temporary Heating: Apply temporary heat according to manufacturer's written instructions within the enclosure of each ventilated-type unit, throughout periods during which equipment is not energized and when transformer is not in a space that is continuously under normal control of temperature and humidity.

1.7 COORDINATION

- A. Coordinate size and location of concrete bases with actual transformer provided. Cast anchor-bolt inserts into bases. Concrete, reinforcement, and formwork requirements are specified in Division 03.
- B. Coordinate installation of wall-mounting and structure-hanging supports with actual transformer provided.

PART 2 PRODUCTS

2.1 MANUFACTURERS

- A. Manufacturers: Subject to compliance with requirements, provide products by one of the following:
 1. Acme Electric Corporation.
 2. Eaton Electrical Sector; Eaton Corporation; Cutler-Hammer Products.
 3. Siemens Energy & Automation, Inc.
 4. Sola/Hevi-Duty.
 5. Square D Co./Groupe Schneider NA; Schneider Electric.

2.2 GENERAL TRANSFORMER REQUIREMENTS

- A. Description: Factory-assembled and -tested, air-cooled units for 60-Hz service.
- B. Cores: Grain-oriented, non-aging silicon steel.
- C. Coils: Continuous windings without splices except for taps.
 1. Internal Coil Connections: Brazed or pressure type.
 2. Coil Material: Aluminum.

2.3 DISTRIBUTION TRANSFORMERS

- A. Comply with NEMA ST 20, and list and label as complying with UL 1561.
- B. Provide transformers that are constructed to withstand seismic forces specified in Division 26 Section "Vibration and Seismic Controls for Electrical Systems."
- C. Cores: One leg per phase.
- D. Enclosure: Ventilated, NEMA 250, Type 2.
 1. Core and coil shall be encapsulated within resin compound, sealing out moisture and air.
- E. Enclosure: Ventilated, NEMA 250, Type 3R.
 1. Core and coil shall be encapsulated within resin compound, sealing out moisture and air.
- F. Transformer Enclosure Finish: Comply with NEMA 250.
 1. Finish Color: Gray.

- G. Taps for Transformers Smaller Than 3 kVA: One 5 percent tap above normal full capacity.
- H. Taps for Transformers 7.5 to 24 kVA: One 5 percent tap above and one 5 percent tap below normal full capacity.
- I. Taps for Transformers 25 kVA and Larger: Two 2.5 percent taps above and two 2.5 percent taps below normal full capacity.
- J. Insulation Class: 220 deg C, UL-component-recognized insulation system with a maximum of 150 deg C rise above 40 deg C ambient temperature.
- K. Energy Efficiency for Transformers Rated 15 kVA and Larger:
 - 1. Complying with NEMA TP 1, Class 1 efficiency levels.
 - 2. Tested according to NEMA TP 2.
- L. K-Factor Rating: Transformers indicated to be K-factor rated shall comply with UL 1561 requirements for nonsinusoidal load current-handling capability to the degree defined by designated K-factor.
 - 1. Unit shall not overheat when carrying full-load current with harmonic distortion corresponding to designated K-factor.
 - 2. Indicate value of K-factor on transformer nameplate.
- M. Electrostatic Shielding: Each winding shall have an independent, single, full-width copper electrostatic shield arranged to minimize interwinding capacitance.
 - 1. Arrange coil leads and terminal strips to minimize capacitive coupling between input and output terminals.
 - 2. Include special terminal for grounding the shield.
 - 3. Shield Effectiveness:
 - a. Capacitance between Primary and Secondary Windings: Not to exceed 33 picofarads over a frequency range of 20 Hz to 1 MHz.
 - b. Common-Mode Noise Attenuation: Minimum of minus 120 dBA at 0.5 to 1.5 kHz; minimum of minus 65 dBA at 1.5 to 100 kHz.
 - c. Normal-Mode Noise Attenuation: Minimum of minus 52 dBA at 1.5 to 10 kHz.
- N. Wall Brackets: Manufacturer's standard brackets.
- O. Fungus Proofing: Permanent fungicidal treatment for coil and core.
- P. Low-Sound-Level Requirements: Minimum of 3 dBA less than NEMA ST 20 standard sound levels when factory tested according to IEEE C57.12.91.
- Q. Low-Sound-Level Requirements: Maximum sound levels, when factory tested according to IEEE C57.12.91, as follows:
 - 1. 9 kVA and Less: 40 dBA.
 - 2. 30 to 50 kVA: 45 dBA.
 - 3. 51 to 150 kVA: 50 dBA.
 - 4. 151 to 300 kVA: 55 dBA.
 - 5. 301 to 500 kVA: 60 dBA.
 - 6. 501 to 750 kVA: 62 dBA.
 - 7. 751 to 1000 kVA: 64 dBA.

2.4 BUCK-BOOST TRANSFORMERS

- A. Description: Self-cooled, two-winding dry type, rated for continuous duty and with wiring terminals suitable for connection as autotransformer. Transformers shall comply with NEMA ST 1 and shall be listed and labeled as complying with UL 506 or UL 1561.

B. Enclosure: Ventilated, NEMA 250, Type 2.

1. Finish Color: Gray.

2.5 IDENTIFICATION DEVICES

A. Nameplates: Engraved, laminated-plastic or metal nameplate for each [[distribution] [buck-boost]] transformer, mounted with corrosion-resistant screws. Nameplates and label products are specified in Division 26 Section "Identification for Electrical Systems."

2.6 SOURCE QUALITY CONTROL

A. Test and inspect transformers according to IEEE C57.12.91.

B. Factory Sound-Level Tests: Conduct sound-level tests on equipment for this Project.

PART 3 EXECUTION

3.1 EXAMINATION

A. Examine conditions for compliance with enclosure- and ambient-temperature requirements for each transformer.

B. Verify that field measurements are as needed to maintain working clearances required by NFPA 70 and manufacturer's written instructions.

C. Examine walls, floors, roofs, and concrete bases for suitable mounting conditions where transformers will be installed.

D. Verify that ground connections are in place and requirements in Division 26 Section "Grounding and Bonding for Electrical Systems" have been met. Maximum ground resistance shall be 5 ohms at location of transformer.

E. Proceed with installation only after unsatisfactory conditions have been corrected.

3.2 INSTALLATION

A. Install wall-mounting transformers level and plumb with wall brackets fabricated by transformer manufacturer.

1. Brace wall-mounting transformers as specified in Division 26 Section "Vibration and Seismic Controls for Electrical Systems."

B. Construct concrete bases and anchor floor-mounting transformers according to manufacturer's written instructions and requirements in Division 26 Section "Vibration and Seismic Controls for Electrical Systems."

3.3 CONNECTIONS

A. Ground equipment according to Division 26 Section "Grounding and Bonding for Electrical Systems."

B. Connect wiring according to Division 26 Section "Low-Voltage Electrical Power Conductors and Cables."

3.4 FIELD QUALITY CONTROL

A. Testing Agency: Engage a qualified testing agency to perform tests and inspections and prepare test reports.

B. Manufacturer's Field Service: Engage a factory-authorized service representative to inspect, test, and adjust components, assemblies, and equipment installations, including connections. Report results in writing.

C. Perform tests and inspections and prepare test reports.

1. Manufacturer's Field Service: Engage a factory-authorized service representative to inspect components, assemblies, and equipment installations, including connections, and to assist in testing.

D. Tests and Inspections:

1. Perform each visual and mechanical inspection and electrical test stated in NETA Acceptance Testing Specification. Certify compliance with test parameters.
- E. Remove and replace units that do not pass tests or inspections and retest as specified above.
- F. Infrared Scanning: Two months after Substantial Completion, perform an infrared scan of transformer connections.
1. Use an infrared-scanning device designed to measure temperature or detect significant deviations from normal values. Provide documentation of device calibration.
 2. Perform 2 follow-up infrared scans of transformers, one at 4 months and the other at 11 months after Substantial Completion.
 3. Prepare a certified report identifying transformer checked and describing results of scanning. Include notation of deficiencies detected, remedial action taken, and scanning observations after remedial action.
- G. Test Labeling: On completion of satisfactory testing of each unit, attach a dated and signed "Satisfactory Test" label to tested component.

3.5 ADJUSTING

- A. Record transformer secondary voltage at each unit for at least 48 hours of typical occupancy period. Adjust transformer taps to provide optimum voltage conditions at secondary terminals. Optimum is defined as not exceeding nameplate voltage plus 10 percent and not being lower than nameplate voltage minus 3 percent at maximum load conditions. Submit recording and tap settings as test results.
- B. Connect buck-boost transformers to provide nameplate voltage of equipment being served, plus or minus 5 percent, at secondary terminals.
- C. Output Settings Report: Prepare a written report recording output voltages and tap settings.

3.6 CLEANING

- A. Vacuum dirt and debris; do not use compressed air to assist in cleaning.

END OF SECTION

This Page Intentionally Left Blank

SECTION 262416

PANELBOARDS

PART 1 GENERAL

1.1 RELATED DOCUMENTS

- A. Drawings and general provisions of the Contract and Division 01 Specification Sections apply to this Section.

1.2 DEFINITIONS

- A. SPD: Surge Protective Device.
- B. SVR: Suppressed voltage rating.

1.3 ACTION SUBMITTALS

- A. Product Data: For each type of panelboard, switching and overcurrent protective device, transient voltage suppression device, accessory, and component indicated. Include dimensions and manufacturers' technical data on features, performance, electrical characteristics, ratings, and finishes.
- B. Shop Drawings: For each panelboard and related equipment.
 - 1. Include dimensioned plans, elevations, sections, and details. Show tabulations of installed devices, equipment features, and ratings.
 - 2. Detail enclosure types and details for types other than NEMA 250, Type 1.
 - 3. Detail bus configuration, current, and voltage ratings.
 - 4. Short-circuit current rating of panelboards and overcurrent protective devices.
 - 5. Include evidence of NRTL listing for series rating of installed devices.
 - 6. Detail features, characteristics, ratings, and factory settings of individual overcurrent protective devices and auxiliary components.
 - 7. Include wiring diagrams for power, signal, and control wiring.
 - 8. Include time-current coordination curves for each type and rating of overcurrent protective device included in panelboards. Submit on translucent log-log graft paper; include selectable ranges for each type of overcurrent protective device.

1.4 INFORMATIONAL SUBMITTALS

- A. Qualification Data: For qualified testing agency.
- B. Seismic Qualification Certificates: Submit certification that panelboards, overcurrent protective devices, accessories, and components will withstand seismic forces defined in Section 260548.16 "Seismic Controls for Electrical Systems." Include the following:
 - 1. Basis for Certification: Indicate whether withstand certification is based on actual test of assembled components or on calculation.
 - 2. Dimensioned Outline Drawings of Equipment Unit: Identify center of gravity and locate and describe mounting and anchorage provisions.
 - 3. Detailed description of equipment anchorage devices on which the certification is based and their installation requirements.
- C. Field Quality-Control Reports:
 - 1. Test procedures used.
 - 2. Test results that comply with requirements.
 - 3. Results of failed tests and corrective action taken to achieve test results that comply with requirements.

- D. Panelboard Schedules: For installation in panelboards. Submit final versions after load balancing.

1.5 CLOSEOUT SUBMITTALS

- A. Operation and Maintenance Data: For panelboards and components to include in emergency, operation, and maintenance manuals. In addition to items specified in Section 017823 "Operation and Maintenance Data," include the following:
 - 1. Manufacturer's written instructions for testing and adjusting overcurrent protective devices.
 - 2. Time-current curves, including selectable ranges for each type of overcurrent protective device that allows adjustments.

1.6 MAINTENANCE MATERIAL SUBMITTALS

- 1. Furnish extra materials that match products installed and that are packaged with protective covering for storage and identified with labels describing contents.
 - a. Keys: Two spares for each type of panelboard cabinet lock.
 - b. Circuit Breakers Including GFCI and Ground Fault Equipment Protection (GFEP) Types: Two spares for each panelboard.
 - c. Fuses for Fused Switches: Equal to 10 percent of quantity installed for each size and type, but no fewer than three of each size and type.
 - d. Fuses for Fused Power-Circuit Devices: Equal to 10 percent of quantity installed for each size and type, but no fewer than three of each size and type.
 - e. <Insert extra materials>.

1.7 QUALITY ASSURANCE

- A. Testing Agency Qualifications: Member company of NETA or an NRTL.
 - 1. Testing Agency's Field Supervisor: Currently certified by NETA to supervise on-site testing.
- B. Source Limitations: Obtain panelboards, overcurrent protective devices, components, and accessories from single source from single manufacturer.
- C. Product Selection for Restricted Space: Drawings indicate maximum dimensions for panelboards including clearances between panelboards and adjacent surfaces and other items. Comply with indicated maximum dimensions.
- D. Electrical Components, Devices, and Accessories: Listed and labeled as defined in NFPA 70, by a qualified testing agency, and marked for intended location and application.
- E. Comply with NEMA PB 1.
- F. Comply with NFPA 70.

1.8 DELIVERY, STORAGE, AND HANDLING

- A. Remove loose packing and flammable materials from inside panelboards; install temporary electric heating (250 W per panelboard) to prevent condensation.
- B. Handle and prepare panelboards for installation according to NEMA PB 1.

1.9 PROJECT CONDITIONS

- A. Environmental Limitations:
 - 1. Do not deliver or install panelboards until spaces are enclosed and weathertight, wet work in spaces is complete and dry, work above panelboards is complete, and temporary HVAC system is operating and maintaining ambient temperature and humidity conditions at occupancy levels during the remainder of the construction period.
 - 2. Rate equipment for continuous operation under the following conditions unless otherwise indicated:
 - a. Ambient Temperature: Not exceeding minus 22 deg F to plus 104 deg F.

- b. Altitude: Not exceeding 6600 feet.
- B. Service Conditions: NEMA PB 1, usual service conditions, as follows:
 - 1. Ambient temperatures within limits specified.
 - 2. Altitude not exceeding 6600 feet.
- C. Interruption of Existing Electric Service: Do not interrupt electric service to facilities occupied by Owner or others unless permitted under the following conditions and then only after arranging to provide temporary electric service according to requirements indicated:
 - 1. Notify Engineer no fewer than two days in advance of proposed interruption of electric service.
 - 2. Do not proceed with interruption of electric service without Owner's written permission.
 - 3. Comply with NFPA 70E.

1.10 COORDINATION

- A. Coordinate layout and installation of panelboards and components with other construction that penetrates walls or is supported by them, including electrical and other types of equipment, raceways, piping, encumbrances to workspace clearance requirements, and adjacent surfaces. Maintain required workspace clearances and required clearances for equipment access doors and panels.
- B. Coordinate sizes and locations of concrete bases with actual equipment provided. Cast anchor-bolt inserts into bases. Concrete, reinforcement, and formwork requirements are specified in Division 03.

1.11 WARRANTY

- A. Special Warranty: Manufacturer's standard form in which manufacturer agrees to repair or replace transient voltage suppression devices that fail in materials or workmanship within specified warranty period.
 - 1. Warranty Period: Five years from date of Substantial Completion.

PART 2 PRODUCTS

2.1 GENERAL REQUIREMENTS FOR PANELBOARDS

- A. Fabricate and test panelboards according to IEEE 344 to withstand seismic forces defined in Section 260548.16 "Seismic Controls for Electrical Systems."
- B. Enclosures: Flush- and surface-mounted cabinets.
 - 1. Rated for environmental conditions at installed location.
 - a. Indoor Dry and Clean Locations: NEMA 250, Type 1.
 - b. Outdoor Locations: NEMA 250, Type 3R.
 - c. Wash-Down Areas: NEMA 250, Type 4X, stainless steel.
 - d. Other Wet or Damp Indoor Locations: NEMA 250, Type 4.
 - e. Indoor Locations Subject to Dust, Falling Dirt, and Dripping Noncorrosive Liquids: NEMA 250, Type 5 or Type 12.
 - 2. Front: Secured to box with concealed trim clamps. For surface-mounted fronts, match box dimensions; for flush-mounted fronts, overlap box.
 - 3. Hinged Front Cover: Entire front trim hinged to box and with standard door within hinged trim cover.
 - 4. Skirt for Surface-Mounted Panelboards: Same gage and finish as panelboard front with flanges for attachment to panelboard, wall, and ceiling or floor.
 - 5. Gutter Extension and Barrier: Same gage and finish as panelboard enclosure; integral with enclosure body. Arrange to isolate individual panel sections.

6. Finishes:
 - a. Panels and Trim: Steel, factory finished immediately after cleaning and pretreating with manufacturer's standard two-coat, baked-on finish consisting of prime coat and thermosetting topcoat.
 - b. Back Boxes: Same finish as panels and trim.
 - c. Fungus Proofing: Permanent fungicidal treatment for overcurrent protective devices and other components.
7. Directory Card: Inside panelboard door, mounted in metal frame with transparent protective cover.
- C. Incoming Mains Location: Top and bottom.
- D. Phase, Neutral, and Ground Buses:
 1. Material: Tin-plated aluminum or Hard-drawn copper, 98 percent conductivity.
 2. Equipment Ground Bus: Adequate for feeder and branch-circuit equipment grounding conductors; bonded to box.
 3. Isolated Ground Bus: Adequate for branch-circuit isolated ground conductors; insulated from box.
 4. Extra-Capacity Neutral Bus: Neutral bus rated 200 percent of phase bus and UL listed as suitable for nonlinear loads.
 5. Split Bus: Vertical buses divided into individual vertical sections.
- E. Conductor Connectors: Suitable for use with conductor material and sizes.
 1. Material: Tin-plated aluminum or Hard-drawn copper, 98 percent conductivity.
 2. Main and Neutral Lugs: Mechanical type.
 3. Ground Lugs and Bus-Configured Terminators: Mechanical type.
 4. Feed-Through Lugs: Mechanical type, suitable for use with conductor material. Locate at opposite end of bus from incoming lugs or main device.
 5. Subfeed (Double) Lugs: Mechanical type suitable for use with conductor material. Locate at same end of bus as incoming lugs or main device.
 6. Gutter-Tap Lugs: Mechanical type suitable for use with conductor material. Locate at same end of bus as incoming lugs or main device.
 7. Extra-Capacity Neutral Lugs: Rated 200 percent of phase lugs mounted on extra-capacity neutral bus.
- F. Service Equipment Label: NRTL labeled for use as service equipment for panelboards or load centers with one or more main service disconnecting and overcurrent protective devices.
- G. Future Devices: Mounting brackets, bus connections, filler plates, and necessary appurtenances required for future installation of devices.
- H. Panelboard Short-Circuit Current Rating: Rated for series-connected system with integral or remote upstream overcurrent protective devices and labeled by an NRTL. Include size and type of allowable upstream and branch devices, listed and labeled for series-connected short-circuit rating by an NRTL.
- I. Panelboard Short-Circuit Current Rating: Fully rated to interrupt symmetrical short-circuit current available at terminals.

2.2 PERFORMANCE REQUIREMENTS

- A. Seismic Performance: Panelboards shall withstand the effects of earthquake motions determined according to SEI/ASCE 7.

1. The term "withstand" means "the unit will remain in place without separation of any parts from the device when subjected to the seismic forces specified[[and the unit will be fully operational after the seismic event]]."
- B. Surge Suppression: Factory installed as an integral part of indicated panelboards, complying with UL 1449 SPD Type 1.

2.3 DISTRIBUTION PANELBOARDS

- A. Manufacturers: Subject to compliance with requirements, provide products by one of the following:
 1. Eaton Electrical Inc.; Cutler-Hammer Business Unit.
 2. Siemens Energy & Automation, Inc.
 3. Square D; a brand of Schneider Electric.
- B. Panelboards: NEMA PB 1, power and feeder distribution type.
- C. Doors: Secured with vault-type latch with tumbler lock; keyed alike.
 1. For doors more than 36 inches high, provide two latches, keyed alike.
- D. Mains: As Indicated
- E. Branch Overcurrent Protective Devices for Circuit-Breaker Frame Sizes 125 A and Smaller: Bolt-on circuit breakers.
- F. Branch Overcurrent Protective Devices for Circuit-Breaker Frame Sizes Larger Than 125 A: Bolt-on circuit breakers; plug-in circuit breakers where individual positive-locking device requires mechanical release for removal.
- G. Branch Overcurrent Protective Devices: Fused switches.
- H. Contactors in Main Bus: NEMA ICS 2, Class A, electrically or mechanically held, general-purpose controller, with same short-circuit interrupting rating as panelboard.
 1. Internal Control-Power Source: Control-power transformer, with fused primary and secondary terminals, connected to main bus ahead of contactor connection.
 2. External Control-Power Source: 120-V branch circuit.

2.4 LIGHTING AND APPLIANCE BRANCH-CIRCUIT PANELBOARDS

- A. Manufacturers: Subject to compliance with requirements, provide products by one of the following:
 1. Eaton Electrical Inc.; Cutler-Hammer Business Unit.
 2. Siemens Energy & Automation, Inc.
 3. Square D; a brand of Schneider Electric.
- B. Panelboards: NEMA PB 1, lighting and appliance branch-circuit type.
- C. Mains: As indicated.
- D. Branch Overcurrent Protective Devices: Bolt-on circuit breakers, replaceable without disturbing adjacent units.
- E. Contactors in Main Bus: NEMA ICS 2, Class A, electrically or mechanically held, general-purpose controller, with same short-circuit interrupting rating as panelboard.
 1. Internal Control-Power Source: Control-power transformer, with fused primary and secondary terminals, connected to main bus ahead of contactor connection.
 2. External Control-Power Source: 120-V branch circuit.
- F. Doors: Concealed hinges; secured with flush latch with tumbler lock; keyed alike.
- G. Column-Type Panelboards: Narrow gutter extension, with cover, to overhead junction box equipped with ground and neutral terminal buses.

2.5 ELECTRONIC-GRADE PANELBOARDS

- A. Manufacturers: Subject to compliance with requirements, provide products by one of the following:
 - 1. Current Technology; a subsidiary of Danahar Corporation.
 - 2. Eaton Electrical Inc.; Cutler-Hammer Business Unit.
 - 3. Liebert Corporation.
 - 4. Siemens Energy & Automation, Inc.
 - 5. Square D; a brand of Schneider Electric.
- B. Panelboards: NEMA PB 1; with factory-installed, integral SPD; labeled by an NRTL for compliance with UL 67 after installing SPD.
- C. Doors: Secured with vault-type latch with tumbler lock; keyed alike.
- D. Main Overcurrent Protective Devices: Bolt-on thermal-magnetic circuit breakers.
- E. Branch Overcurrent Protective Devices: Bolt-on thermal-magnetic circuit breakers.
- F. Buses:
 - 1. Copper phase and neutral buses; 200 percent capacity neutral bus and lugs.
 - 2. Copper equipment and isolated ground buses.

2.6 DISCONNECTING AND OVERCURRENT PROTECTIVE DEVICES

- A. Manufacturers: Subject to compliance with requirements, provide products by one of the following:
 - 1. Eaton Electrical Inc.; Cutler-Hammer Business Unit.
 - 2. Siemens Energy & Automation, Inc.
 - 3. Square D; a brand of Schneider Electric.
- B. Molded-Case Circuit Breaker (MCCB): Comply with UL 489, with interrupting capacity to meet available fault currents.
 - 1. Thermal-Magnetic Circuit Breakers: Inverse time-current element for low-level overloads, and instantaneous magnetic trip element for short circuits. Adjustable magnetic trip setting for circuit-breaker frame sizes 250 A and larger.
 - 2. Adjustable Instantaneous-Trip Circuit Breakers: Magnetic trip element with front-mounted, field-adjustable trip setting.
 - 3. Electronic trip circuit breakers with rms sensing; field-replaceable rating plug or field-replaceable electronic trip; and the following field-adjustable settings:
 - a. Instantaneous trip.
 - b. Long- and short-time pickup levels.
 - c. Long- and short-time time adjustments.
 - d. Ground-fault pickup level, time delay, and I²t response.
 - 4. Current-Limiting Circuit Breakers: Frame sizes 400 A and smaller; let-through ratings less than NEMA FU 1, RK-5.
 - 5. GFCI Circuit Breakers: Single- and two-pole configurations with Class A ground-fault protection (6-mA trip).
 - 6. Ground-Fault Equipment Protection (GFEP) Circuit Breakers: Class B ground-fault protection (30-mA trip).
 - 7. Arc-Fault Circuit Interrupter (AFCI) Circuit Breakers: Comply with UL 1699; 120/240-V, single-pole configuration.

8. Molded-Case Circuit-Breaker (MCCB) Features and Accessories:
 - a. Standard frame sizes, trip ratings, and number of poles.
 - b. Lugs: Mechanical style, suitable for number, size, trip ratings, and conductor materials.
 - c. Application Listing: Appropriate for application; Type SWD for switching fluorescent lighting loads; Type HID for feeding fluorescent and high-intensity discharge (HID) lighting circuits.
 - d. Ground-Fault Protection: Integrally mounted relay and trip unit with adjustable pickup and time-delay settings, push-to-test feature, and ground-fault indicator.
 - e. Communication Capability: Circuit-breaker-mounted communication module with functions and features compatible with power monitoring and control system specified in Division 26 Section "Electrical Power Monitoring and Control."
 - f. Shunt Trip: 120-V trip coil energized from separate circuit, set to trip at 55 percent of rated voltage.
 - g. Undervoltage Trip: Set to operate at 35 to 75 percent of rated voltage with field-adjustable 0.1- to 0.6-second time delay.
 - h. Auxiliary Contacts: One SPDT switch with "a" and "b" contacts; "a" contacts mimic circuit-breaker contacts and "b" contacts operate in reverse of circuit-breaker contacts.
 - i. Alarm Switch: Single-pole, normally open contact that actuates only when circuit breaker trips.
 - j. Key Interlock Kit: Externally mounted to prohibit circuit-breaker operation; key shall be removable only when circuit breaker is in off position.
 - k. Zone-Selective Interlocking: Integral with electronic trip unit; for interlocking ground-fault protection function with other upstream or downstream devices.
 - l. Multipole units enclosed in a single housing or factory assembled to operate as a single unit.
 - m. Handle Padlocking Device: Fixed attachment for locking circuit breaker handle in off position.
 - n. Handle Clamp: Loose attachment for holding circuit breaker handle in on position.
- C. Fused Switch: NEMA KS 1, Type HD; clips to accommodate specified fuses; lockable handle.
 1. Fuses, and Spare-Fuse Cabinet: Comply with requirements specified in Division 26 Section "Fuses."
 2. Fused Switch Features and Accessories: Standard ampere ratings and number of poles.
 3. Auxiliary Contacts: One normally open and normally closed contact(s) that operate with switch handle operation.

2.7 PANELBOARD SUPPRESSORS

- A. Manufacturers: Subject to compliance with requirements, provide products by one of the following:
 1. Current Technology; a subsidiary of Danahar Corporation.
 2. Eaton Electrical Inc.; Cutler-Hammer Business Unit.
 3. Liebert Corporation.
 4. Siemens Energy & Automation, Inc.
 5. Square D; a brand of Schneider Electric.
 6. Or approved equal.
- B. Surge Protection Device: IEEE C62.41-compliant, integrally mounted, solid-state, parallel-connected, non-modular type, with sine-wave tracking suppression and filtering modules,

UL 1449, second edition, short-circuit current rating matching or exceeding the panelboard short-circuit rating, and with the following features and accessories:

1. Accessories:
 - a. LED indicator lights for power and protection status.
 - b. Audible alarm, with silencing switch, to indicate when protection has failed.
 - c. One set of dry contacts rated at 5 A and 250-V ac, for remote monitoring of protection status.

2.8 ACCESSORY COMPONENTS AND FEATURES

- A. Accessory Set: Include tools and miscellaneous items required for overcurrent protective device test, inspection, maintenance, and operation.
- B. Portable Test Set: For testing functions of solid-state trip devices without removing from panelboard. Include relay and meter test plugs suitable for testing panelboard meters and switchboard class relays.

PART 3 EXECUTION

3.1 EXAMINATION

- A. Receive, inspect, handle, and store panelboards according to NEMA PB 1.1.
- B. Examine panelboards before installation. Reject panelboards that are damaged or rusted or have been subjected to water saturation.
- C. Examine elements and surfaces to receive panelboards for compliance with installation tolerances and other conditions affecting performance of the Work.
- D. Proceed with installation only after unsatisfactory conditions have been corrected.

3.2 INSTALLATION

- A. Install panelboards and accessories according to NEMA PB 1.1.
- B. Equipment Mounting: Install panelboards on concrete bases, 4-inch nominal thickness. Comply with requirements for concrete base specified in Division 03 Section "Cast-in-Place Concrete."
 1. Install dowel rods to connect concrete base to concrete floor. Unless otherwise indicated, install dowel rods on 18-inch centers around full perimeter of base.
 2. For panelboards, install epoxy-coated anchor bolts that extend through concrete base and anchor into structural concrete floor.
 3. Place and secure anchorage devices. Use setting drawings, templates, diagrams, instructions, and directions furnished with items to be embedded.
 4. Install anchor bolts to elevations required for proper attachment to panelboards.
 5. Attach panelboard to the vertical finished or structural surface behind the panelboard.
- C. Temporary Lifting Provisions: Remove temporary lifting eyes, channels, and brackets and temporary blocking of moving parts from panelboards.
- D. Comply with mounting and anchoring requirements specified in Division 26 Section "Vibration and Seismic Controls for Electrical Systems."
- E. Mount top of trim 72 inches above finished floor unless otherwise indicated.
- F. Mount panelboard cabinet plumb and rigid without distortion of box. Mount recessed panelboards with fronts uniformly flush with wall finish and mating with back box.
- G. Install overcurrent protective devices and controllers not already factory installed.
 1. Set field-adjustable, circuit-breaker trip ranges.
- H. Install filler plates in unused spaces.

- I. Stub four 1-inch empty conduits from panelboard into accessible ceiling space or space designated to be ceiling space in the future. Stub four 1-inch empty conduits into raised floor space or below slab not on grade.
- J. Arrange conductors in gutters into groups and bundle and wrap with wire ties after completing load balancing.
- K. Comply with NECA 1.

3.3 IDENTIFICATION

- A. Identify field-installed conductors, interconnecting wiring, and components; provide warning signs complying with Section 260553 "Identification for Electrical Systems."
- B. Create a directory to indicate installed circuit loads after balancing panelboard loads; incorporate Owner's final room designations. Obtain approval before installing. Use a computer or typewriter to create directory; handwritten directories are not acceptable.
- C. Panelboard Nameplates: Label each panelboard with a nameplate complying with requirements for identification specified in Section 260553 "Identification for Electrical Systems."
- D. Device Nameplates: Label each branch circuit device in distribution panelboards with a nameplate complying with requirements for identification specified in Section 260553 "Identification for Electrical Systems."

3.4 FIELD QUALITY CONTROL

- A. Testing Agency: Engage a qualified testing agency to perform tests and inspections.
- B. Manufacturer's Field Service: Engage a factory-authorized service representative to inspect, test, and adjust components, assemblies, and equipment installations, including connections.
- C. Perform tests and inspections.
 - 1. Manufacturer's Field Service: Engage a factory-authorized service representative to inspect components, assemblies, and equipment installations, including connections, and to assist in testing.
- D. Acceptance Testing Preparation:
 - 1. Test insulation resistance for each panelboard bus, component, connecting supply, feeder, and control circuit.
 - 2. Test continuity of each circuit.
- E. Tests and Inspections:
 - 1. Perform each visual and mechanical inspection and electrical test stated in NETA Acceptance Testing Specification. Certify compliance with test parameters.
 - 2. Correct malfunctioning units on-site, where possible, and retest to demonstrate compliance; otherwise, replace with new units and retest.
 - 3. Perform the following infrared scan tests and inspections and prepare reports:
 - a. Initial Infrared Scanning: After Substantial Completion, but not more than 60 days after Final Acceptance, perform an infrared scan of each panelboard. Remove front panels so joints and connections are accessible to portable scanner.
 - b. Follow-up Infrared Scanning: Perform an additional follow-up infrared scan of each panelboard 11 months after date of Substantial Completion.
 - c. Instruments and Equipment:
 - (1) Use an infrared scanning device designed to measure temperature or to detect significant deviations from normal values. Provide calibration record for device.
- F. Panelboards will be considered defective if they do not pass tests and inspections.

- G. Prepare test and inspection reports, including a certified report that identifies panelboards included and that describes scanning results. Include notation of deficiencies detected, remedial action taken, and observations after remedial action.

3.5 ADJUSTING

- A. Adjust moving parts and operable component to function smoothly, and lubricate as recommended by manufacturer.
- B. Set field-adjustable circuit-breaker trip ranges as indicated or as specified in Section 260573 "Overcurrent Protective Device Coordination Study."
- C. Load Balancing: After Substantial Completion, but not more than 60 days after Final Acceptance, measure load balancing and make circuit changes.
 - 1. Measure as directed during period of normal system loading.
 - 2. Perform load-balancing circuit changes outside normal occupancy/working schedule of the facility and at time directed. Avoid disrupting critical 24-hour services such as fax machines and on-line data processing, computing, transmitting, and receiving equipment.
 - 3. After circuit changes, recheck loads during normal load period. Record all load readings before and after changes and submit test records.
 - 4. Tolerance: Difference exceeding 20 percent between phase loads, within a panelboard, is not acceptable. Rebalance and recheck as necessary to meet this minimum requirement.

3.6 PROTECTION

- A. Temporary Heating: Apply temporary heat to maintain temperature according to manufacturer's written instructions.

END OF SECTION

SECTION 262713
ELECTRICITY METERING

PART 1 GENERAL

1.1 RELATED DOCUMENTS

- A. Drawings and general provisions of the Contract and Division 01 Specification Sections, apply to this Section.

1.2 DEFINITIONS

- A. KY Pulse: Term used by the metering industry to describe a method of measuring consumption of electricity that is based on a relay opening and closing in response to the rotation of the disk in the meter.

1.3 ACTION SUBMITTALS

- A. Product Data: For each type of product indicated.
- B. Shop Drawings: For electricity-metering equipment.
 - 1. Dimensioned plans and sections or elevation layouts.
 - 2. Wiring Diagrams: For power, signal, and control wiring. Identify terminals and wiring designations and color-codes to facilitate installation, operation, and maintenance. Indicate recommended types, wire sizes, and circuiting arrangements for field-installed wiring, and show circuit protection features.

1.4 INFORMATIONAL SUBMITTALS

- A. Field quality-control reports.

1.5 QUALITY ASSURANCE

- A. Electrical Components, Devices, and Accessories: Listed and labeled as defined in NFPA 70, by a qualified testing agency, and marked for intended location and application.

1.6 DELIVERY, STORAGE, AND HANDLING

- A. Receive, store, and handle modular meter center according to NECA 400.

1.7 COORDINATION

- A. Electrical Service Connections: Coordinate with utility companies and components they furnish as follows:
 - 1. Comply with requirements of utilities providing electrical power services.
 - 2. Coordinate installation and connection of utilities and services, including provision for electricity-metering components.

PART 2 PRODUCTS

2.1 EQUIPMENT FOR ELECTRICITY METERING BY UTILITY COMPANY

- A. Meters will be furnished by utility company.
- B. Current-Transformer Cabinets: Comply with requirements of electrical-power utility company.
- C. Meter Sockets: Comply with requirements of electrical-power utility company.
- D. Meter Sockets: Steady-state and short-circuit current ratings shall meet indicated circuit ratings.

PART 3 EXECUTION

3.1 INSTALLATION

- A. Comply with equipment installation requirements in NECA 1.
- B. Install meters furnished by utility company. Install raceways and equipment according to utility company's written requirements. Provide empty conduits for metering leads and extend grounding connections as required by utility company.

- C. Electrical Contractor is responsible for getting new electrical service connected to the new building.
- D. Electrical Contractor is responsible for contacting the Electrical Utility and getting all requirements for new electrical service to building and/or site.
- E. Electrical Contractor is to comply with all electrical utility regulations and provide all conduit, trenching/backfill and connections as required by electrical utility.

3.2 IDENTIFICATION

- A. Comply with requirements for identification specified in Section 260553 "Identification for Electrical Systems."
 - 1. Series Combination Warning Label: Self-adhesive type, with text as required by NFPA 70.
 - 2. Equipment Identification Labels: Adhesive film labels with clear protective overlay. For residential meters, provide an additional card holder suitable for printed, weather-resistant card with occupant's name.

3.3 FIELD QUALITY CONTROL

- A. Perform tests and inspections.
 - 1. Manufacturer's Field Service: Engage a factory-authorized service representative to inspect components, assemblies, and equipment installations, including connections, and to assist in testing.
- B. Tests and Inspections:
 - 1. Connect a load of known kilowatt rating, 1.5 kW minimum, to a circuit supplied by metered feeder.
 - 2. Turn off circuits supplied by metered feeder and secure them in off condition.
 - 3. Run test load continuously for eight hours minimum, or longer, to obtain a measurable meter indication. Use test-load placement and setting that ensures continuous, safe operation.
 - 4. Check and record meter reading at end of test period and compare with actual electricity used, based on test-load rating, duration of test, and sample measurements of supply voltage at test-load connection. Record test results.
- C. Electricity metering will be considered defective if it does not pass tests and inspections.

END OF SECTION

SECTION 262726
WIRING DEVICES

PART 1 GENERAL

1.1 RELATED DOCUMENTS

- A. Drawings and general provisions of the Contract, including General and Supplementary Conditions and Division 01 Specification Sections, apply to this Section.

1.2 DEFINITIONS

- A. EMI: Electromagnetic interference.
- B. GFCI: Ground-fault circuit interrupter.
- C. Pigtail: Short lead used to connect a device to a branch-circuit conductor.
- D. RFI: Radio-frequency interference.
- E. TVSS: Transient voltage surge suppressor.
- F. UTP: Unshielded twisted pair.

1.3 ADMINISTRATIVE REQUIREMENTS

- A. Coordination:
 - 1. Receptacles for Owner-Furnished Equipment: Match plug configurations.
 - 2. Cord and Plug Sets: Match equipment requirements.

1.4 ACTION SUBMITTALS

- A. Product Data: For each type of product indicated.
- B. Shop Drawings: List of legends and description of materials and process used for pre-marking wall plates.

1.5 INFORMATIONAL SUBMITTALS

- A. Field quality-control test reports.

1.6 CLOSEOUT SUBMITTALS

- A. Operation and Maintenance Data: For wiring devices to include in all manufacturers' packing label warnings and instruction manuals that include labeling conditions.

1.7 MAINTENANCE MATERIAL SUBMITTALS

- A. Furnish extra materials described in subparagraphs below that match products installed and that are packaged with protective covering for storage and identified with labels describing contents.
 - 1. Service/Power Poles: One for every 10, but no less than one.
 - 2. Floor Service Outlet Assemblies: One for every 10, but no less than one.
 - 3. Poke-Through, Fire-Rated Closure Plugs: One for every five floor service outlets installed, but no fewer than two.
 - 4. TVSS Receptacles: One for every 10 of each type installed, but no fewer than two of each type.

PART 2 PRODUCTS

2.1 MANUFACTURERS

- A. Manufacturers' Names: Shortened versions (shown in parentheses) of the following manufacturers' names are used in other Part 2 articles:
 - 1. Cooper Wiring Devices; a division of Cooper Industries, Inc. (Cooper).
 - 2. Hubbell Incorporated; Wiring Device-Kellems (Hubbell).
 - 3. Leviton Mfg. Company Inc. (Leviton).
 - 4. Pass & Seymour/Legrand (Pass & Seymour).
- B. Source Limitations: Obtain each type of wiring device and associated wall plate from single source from single manufacturer.

2.2 GENERAL WIRING-DEVICE REQUIREMENTS

- A. Wiring Devices, Components, and Accessories: Listed and labeled as defined in NFPA 70, by a qualified testing agency, and marked for intended location and application.
- B. Comply with NFPA 70.
- C. Devices that are manufactured for use with modular plug-in connectors may be substituted under the following conditions:
 - 1. Connectors shall comply with UL 2459 and shall be made with stranding building wire.
 - 2. Devices shall comply with the requirements in this Section.

2.3 STRAIGHT BLADE RECEPTACLES

- A. Convenience Receptacles, 125 V, 20 A: Comply with NEMA WD 1, NEMA WD 6 Configuration 5-20R, UL 498, and FS W-C-596.
 - 1. Products: Subject to compliance with requirements, provide one of the following:
 - a. Cooper; 5351 (single), CR5352 (duplex).
 - b. Hubbell; HBL5351 (single), HBL5352 (duplex).
 - c. Leviton; 5891 (single), 5352 (duplex).
 - d. Pass & Seymour; 5361 (single), 5362 (duplex).
- B. Hospital-Grade, Duplex Convenience Receptacles, 125 V, 20 A: Comply with NEMA WD 1, NEMA WD 6 Configuration 5-20R, UL 498 Supplement sd, and FS W-C-596.
 - 1. Products: Subject to compliance with requirements, provide one of the following:
 - a. Cooper; 8310 (single), 8300 (duplex).
 - b. Hubbell; HBL8310 (single), HBL8300 (duplex).
 - c. Leviton; 8310 (single), 8300 (duplex).
 - d. Pass & Seymour; 8301 (single), 8300H (duplex).
 - 2. Description: Single-piece, rivetless, nickel-plated, all-brass grounding system. Nickel-plated, brass mounting strap.
- C. Isolated-Ground, Duplex Convenience Receptacles, 125 V, 20 A: Comply with NEMA WD 1, NEMA WD 6 Configuration 5-20R, UL 498, and FS W-C-596.
 - 1. Products: Subject to compliance with requirements, provide one of the following:
 - a. Hubbell; IG5362.
 - b. Leviton; 5362-IG.
 - c. Pass & Seymour; IG5362.
 - 2. Description: Straight blade; equipment grounding contacts shall be connected only to the green grounding screw terminal of the device and with inherent electrical isolation from mounting strap. Isolation shall be integral to receptacle construction and not dependent on removable parts.
- D. Tamper-Resistant Convenience Receptacles, 125 V, 20 A: Comply with NEMA WD 1, NEMA WD 6 Configuration 5-20R, UL 498 Supplement sd, and FS W-C-596.
 - 1. Products: Subject to compliance with requirements, provide one of the following:
 - a. Cooper; TR8300.
 - b. Hubbell; HBL8300SGA.
 - c. Leviton; 8300-SGG.
 - d. Pass & Seymour; TR63H.

2. Description: Labeled to comply with NFPA 70, "Health Care Facilities" Article, "Pediatric Locations" Section.

2.4 GFCI RECEPTACLES

- A. General Description:
 1. Straight blade, feed-through type.
 2. Comply with NEMA WD 1, NEMA WD 6, UL 498, UL 943 Class A, and FS W-C-596.
 3. Include indicator light that shows when the GFCI has malfunctioned and no longer provides proper GFCI protection.
- B. Duplex GFCI Convenience Receptacles, 125 V, 20 A:
 1. Products: Subject to compliance with requirements, provide one of the following:
 - a. Cooper; VGF20.
 - b. Pass & Seymour; 2095.
- C. Hospital-Grade, Duplex GFCI Convenience Receptacles, 125 V, 20 A: Comply with NEMA WD 1, NEMA WD 6 Configuration 5-20R, UL 498 Supplement sd, and FS W-C-596.
 1. Products: Subject to compliance with requirements, provide one of the following:
 - a. Cooper; VGFH20.
 - b. Hubbell; HFR8300HL.
 - c. Leviton; 7899-HG.
 - d. Pass & Seymour; 2095HG.

2.5 TVSS RECEPTACLES

- A. General Description: Comply with NEMA WD 1, NEMA WD 6, UL 498, and UL 1449, with integral TVSS in line to ground, line to neutral, and neutral to ground.
 1. TVSS Components: Multiple metal-oxide varistors; with a nominal clamp-level rating of 400 volts and minimum single transient pulse energy dissipation of 240 J, according to IEEE C62.41.2 and IEEE C62.45.
 2. Active TVSS Indication: Visual and audible, with light visible in face of device to indicate device is "active" or "no longer in service."
- B. Duplex TVSS Convenience Receptacles:
 1. Products: Subject to compliance with requirements, provide one of the following:
 - a. Cooper; 5362BLS.
 - b. Hubbell; HBL5362SA.
 - c. Leviton; 5380.
 2. Description: Straight blade, 125 V, 20 A; NEMA WD 6 Configuration 5-20R.
- C. Isolated-Ground, Duplex Convenience Receptacles:
 1. Products: Subject to compliance with requirements, provide one of the following:
 - a. Cooper; IG5362BLS.
 - b. Hubbell; IG5362SA.
 - c. Leviton; 5380-IG.
 2. Description:
 - a. Straight blade, 125 V, 20 A; NEMA WD 6 Configuration 5-20R.

- b. Equipment grounding contacts shall be connected only to the green grounding screw terminal of the device and with inherent electrical isolation from mounting strap. Isolation shall be integral to receptacle construction and not dependent on removable parts.
- D. Hospital-Grade, Duplex Convenience Receptacles: Comply with UL 498 Supplement sd.
 - 1. Products: Subject to compliance with requirements, provide one of the following:
 - a. Cooper; 8300BLS.
 - b. Hubbell; HBL8362SA.
 - c. Leviton; 8380.
 - 2. Description:
 - a. Straight blade, 125 V, 20 A; NEMA WD 6 Configuration 5-20R.
 - b. Electrical Components, Devices, and Accessories: Listed and labeled as defined in NFPA 70, by a qualified testing agency, and marked for intended location and application.
 - c. Comply with NFPA 70.
- E. Isolated-Ground, Hospital-Grade, Duplex Convenience Receptacles:
 - 1. Products: Subject to compliance with requirements, provide one of the following:
 - a. Cooper; IG8300HGBLS.
 - b. Hubbell; IG8362SA.
 - c. Leviton; 8380-IG.
 - 2. Description:
 - a. Straight blade, 125 V, 20 A; NEMA WD 6 Configuration 5-20R.
 - b. Comply with UL 498 Supplement sd.
 - c. Equipment grounding contacts shall be connected only to the green grounding screw terminal of the device and with inherent electrical isolation from mounting strap. Isolation shall be integral to receptacle construction and not dependent on removable parts.

2.6 HAZARDOUS (CLASSIFIED) LOCATION RECEPTACLES

- A. Wiring Devices for Hazardous (Classified) Locations: Comply with NEMA FB 11 and UL 1010.
 - 1. Manufacturers: Subject to compliance with requirements, provide products by one of the following:
 - a. Cooper Crouse-Hinds.
 - b. EGS/Appleton Electric.
 - c. Killark; a division of Hubbell Inc.

2.7 TWIST-LOCKING RECEPTACLES

- A. Single Convenience Receptacles, 125 V, 20 A: Comply with NEMA WD 1, NEMA WD 6 Configuration L5-20R, and UL 498.
 - 1. Products: Subject to compliance with requirements, provide one of the following:
 - a. Cooper; CWL520R.
 - b. Hubbell; HBL2310.
 - c. Leviton; 2310.
 - d. Pass & Seymour; L520-R.
- B. Isolated-Ground, Single Convenience Receptacles, 125 V, 20 A:
 - 1. Products: Subject to compliance with requirements, provide one of the following:

- a. Hubbell; IG2310.
 - b. Leviton; 2310-IG.
2. Description:
- a. Comply with NEMA WD 1, NEMA WD 6 Configuration L5-20R, and UL 498.
 - b. Equipment grounding contacts shall be connected only to the green grounding screw terminal of the device and with inherent electrical isolation from mounting strap. Isolation shall be integral to receptacle construction and not dependent on removable parts.

2.8 PENDANT CORD-CONNECTOR DEVICES

A. Description:

1. Matching, locking-type plug and receptacle body connector.
2. NEMA WD 6 Configurations L5-20P and L5-20R, heavy-duty grade, and FS W-C-596.
3. Body: Nylon, with screw-open, cable-gripping jaws and provision for attaching external cable grip.
4. External Cable Grip: Woven wire-mesh type made of high-strength galvanized-steel wire strand, matched to cable diameter, and with attachment provision designed for corresponding connector.

2.9 CORD AND PLUG SETS

A. Description:

1. Match voltage and current ratings and number of conductors to requirements of equipment being connected.
2. Cord: Rubber-insulated, stranded-copper conductors, with Type SOW-A jacket; with green-insulated grounding conductor and ampacity of at least 130 percent of the equipment rating.
3. Plug: Nylon body and integral cable-clamping jaws. Match cord and receptacle type for connection.

2.10 TOGGLE SWITCHES

A. Comply with NEMA WD 1, UL 20, and FS W-S-896.

B. Switches, 120/277 V, 20 A:

1. Products: Subject to compliance with requirements, provide one of the following:
 - a. Single Pole:
 - (1) Cooper; AH1221.
 - (2) Hubbell; HBL1221.
 - (3) Leviton; 1221-2.
 - (4) Pass & Seymour; CSB20AC1.
 - b. Two Pole:
 - (1) Cooper; AH1222.
 - (2) Hubbell; HBL1222.
 - (3) Leviton; 1222-2.
 - (4) Pass & Seymour; CSB20AC2.
 - c. Three Way:
 - (1) Cooper; AH1223.
 - (2) Hubbell; HBL1223.
 - (3) Leviton; 1223-2.

- (4) Pass & Seymour; CSB20AC3.
- d. Four Way:
 - (1) Cooper; AH1224.
 - (2) Hubbell; HBL1224.
 - (3) Leviton; 1224-2.
 - (4) Pass & Seymour; CSB20AC4.
- C. Pilot-Light Switches, 20 A:
 - 1. Products: Subject to compliance with requirements, provide one of the following:
 - a. Cooper; AH1221PL for 120 and 277 V.
 - b. Hubbell; HBL1201PL for 120 and 277 V.
 - c. Leviton; 1221-LH1.
 - d. Pass & Seymour; PS20AC1RPL for 120 V, PS20AC1RPL7 for 277 V.
 - 2. Description: Single pole, with neon-lighted handle, illuminated when switch is "off."
- D. Key-Operated Switches, 120/277 V, 20 A:
 - 1. Products: Subject to compliance with requirements, provide one of the following:
 - a. Cooper; AH1221L.
 - b. Hubbell; HBL1221L.
 - c. Leviton; 1221-2L.
 - d. Pass & Seymour; PS20AC1-L.
 - 2. Description: Single pole, with factory-supplied key in lieu of switch handle.
- E. Single-Pole, Double-Throw, Momentary-Contact, Center-off Switches: 120/277 V, 20 A; for use with mechanically held lighting contactors.
 - 1. Products: Subject to compliance with requirements, provide one of the following:
 - a. Cooper; 1995.
 - b. Hubbell; HBL1557.
 - c. Leviton; 1257.
 - d. Pass & Seymour; 1251.
- F. Key-Operated, Single-Pole, Double-Throw, Momentary-Contact, Center-off Switches: 120/277 V, 20 A; for use with mechanically held lighting contactors, with factory-supplied key in lieu of switch handle.
 - 1. Products: Subject to compliance with requirements, provide one of the following:
 - a. Cooper; 1995L.
 - b. Hubbell; HBL1557L.
 - c. Leviton; 1257L.
 - d. Pass & Seymour; 1251L.

2.11 WALL-BOX DIMMERS

- A. Dimmer Switches: Modular, full-wave, solid-state units with integral, quiet on-off switches, with audible frequency and EMI/RFI suppression filters.
- B. Control: Continuously adjustable slider; with single-pole or three-way switching. Comply with UL 1472.

- C. Incandescent Lamp Dimmers: 120 V; control shall follow square-law dimming curve. On-off switch positions shall bypass dimmer module.
 - 1. 600 W; dimmers shall require no derating when ganged with other devices.
- D. Fluorescent Lamp Dimmer Switches: Modular; compatible with dimmer ballasts; trim potentiometer to adjust low-end dimming; dimmer-ballast combination capable of consistent dimming with low end not greater than 20 percent of full brightness.

2.12 WALL PLATES

- A. Single and combination types to match corresponding wiring devices.
 - 1. Plate-Securing Screws: Metal with head color to match plate finish.
 - 2. Material for Finished Spaces: 0.035-inch- thick, satin-finished stainless steel.
 - 3. Material for Unfinished Spaces: Galvanized steel.
 - 4. Material for Damp Locations: Cast aluminum with spring-loaded lift cover, and listed and labeled for use in "wet locations."
- B. Wet-Location, Weatherproof Cover Plates: NEMA 250, complying with type 3R weather-resistant, die-cast aluminum or thermoplastic with lockable cover.

2.13 FLOOR SERVICE FITTINGS

- A. Type: Modular, flush-type, dual-service units suitable for wiring method used.
- B. Compartments: Barrier separates power from voice and data communication cabling.
- C. Service Plate: Round, solid brass with satin finish.
- D. Power Receptacle: NEMA WD 6 configuration 5-20R, gray finish, unless otherwise indicated.
- E. Voice and Data Communication Outlet: Blank cover with bushed cable opening with two modular, keyed, color-coded, RJ-45 Category 5e jacks for UTP cable.

2.14 POKE-THROUGH ASSEMBLIES

- A. Manufacturers: Subject to compliance with requirements, provide products by one of the following:
 - 1. Hubbell Incorporated; Wiring Device-Kellems.
 - 2. Pass & Seymour/Legrand.
 - 3. Square D/Schneider Electric.
 - 4. Thomas & Betts Corporation.
 - 5. Wiremold/Legrand.
- B. Description:
 - 1. Factory-fabricated and -wired assembly of below-floor junction box with multichanneled, through-floor raceway/firestop unit and detachable matching floor service outlet assembly.
 - 2. Comply with UL 514 scrub water exclusion requirements.
 - 3. Service Outlet Assembly: Pedestal type with services indicated or Flush type with two simplex receptacles and space for two RJ-45 jacks.
 - 4. Size: Selected to fit nominal 3-inch cored holes in floor and matched to floor thickness.
 - 5. Fire Rating: Unit is listed and labeled for fire rating of floor-ceiling assembly.
 - 6. Closure Plug: Arranged to close unused 3-inch cored openings and reestablish fire rating of floor.
 - 7. Wiring Raceways and Compartments: For a minimum of four No. 12 AWG conductors and a minimum of two, 4-pair, Category 5e voice and data communication cables.

2.15 PREFABRICATED MULTIOUTLET ASSEMBLIES

- A. Manufacturers: Subject to compliance with requirements, provide products by one of the following:
 - 1. Hubbell Incorporated; Wiring Device-Kellems.
 - 2. Wiremold/Legrand.
- B. Description:
 - 1. Two-piece surface metal raceway, with factory-wired multioutlet harness.
 - 2. Components shall be products from single manufacturer designed for use as a complete, matching assembly of raceways and receptacles.
- C. Raceway Material: Metal, with manufacturer's standard finish or PVC.
- D. Multioutlet Harness:
 - 1. Receptacles: 15-A, 125-V, NEMA WD 6 Configuration 5-15R receptacles complying with NEMA WD 1, UL 498, and FS W-C-596.
 - 2. Receptacle Spacing: 6 inches, 9 inches, or 12 inches.
 - 3. Wiring: No. 12 AWG solid, Type THHN copper, single circuit or two circuit, connecting alternating receptacles.

2.16 SERVICE POLES

- A. Description:
 - 1. Factory-assembled and -wired units to extend power and voice and data communication from distribution wiring concealed in ceiling to devices or outlets in pole near floor.
 - 2. Poles: Nominal 2.5-inch square cross section, with height adequate to extend from floor to at least 6 inches above ceiling, and with separate channels for power wiring and voice and data communication cabling.
 - 3. Mounting: Ceiling trim flange with concealed bracing arranged for positive connection to ceiling supports; with pole foot and carpet pad attachment.
 - 4. Finishes: Manufacturer's standard painted finish and trim combination.
 - 5. Wiring: Sized for minimum of five No. 12 AWG power and ground conductors and a minimum of four, 4-pair, Category 3 or 5 voice and data communication cables.
 - 6. Power Receptacles: Two duplex, 20-A, heavy-duty, NEMA WD 6 configuration 5-20R units.
 - 7. Voice and Data Communication Outlets: Blank insert with bushed cable opening with two RJ-45 Category 5e jacks.

2.17 FINISHES

- A. Device Color:
 - 1. Wiring Devices Connected to Normal Power System: Gray or White, unless otherwise indicated or required by NFPA 70 or device listing.
 - 2. Wiring Devices Connected to Emergency Power System: Red.
 - 3. TVSS Devices: Blue.
 - 4. Isolated-Ground Receptacles: As specified above, with orange triangle on face.
- B. Wall Plate Color: For plastic covers, match device color.

PART 3 EXECUTION

3.1 INSTALLATION

- A. Comply with NECA 1, including the mounting heights listed in that standard, unless otherwise noted.

B. Coordination with Other Trades:

1. Take steps to insure that devices and their boxes are protected. Do not place wall finish materials over device boxes and do not cut holes for boxes with routers that are guided by riding against outside of the boxes.
2. Keep outlet boxes free of plaster, drywall joint compound, mortar, cement, concrete, dust, paint, and other material that may contaminate the raceway system, conductors, and cables.
3. Install device boxes in brick or block walls so that the cover plate does not cross a joint unless the joint is troweled flush with the face of the wall.
4. Install wiring devices after all wall preparation, including painting, is complete.

C. Conductors:

1. Do not strip insulation from conductors until just before they are spliced or terminated on devices.
2. Strip insulation evenly around the conductor using tools designed for the purpose. Avoid scoring or nicking of solid wire or cutting strands from stranded wire.
3. The length of free conductors at outlets for devices shall meet provisions of NFPA 70, Article 300, without pigtails.
4. Existing Conductors:
 - a. Cut back and pigtail, or replace all damaged conductors.
 - b. Straighten conductors that remain and remove corrosion and foreign matter.
 - c. Pigtailling existing conductors is permitted provided the outlet box is large enough.

D. Device Installation:

1. Replace all devices that have been in temporary use during construction or that show signs that they were installed before building finishing operations were complete.
2. Keep each wiring device in its package or otherwise protected until it is time to connect conductors.
3. Do not remove surface protection, such as plastic film and smudge covers, until the last possible moment.
4. Connect devices to branch circuits using pigtails that are not less than 6 inches in length.
5. When there is a choice, use side wiring with binding-head screw terminals. Wrap solid conductor tightly clockwise, 2/3 to 3/4 of the way around terminal screw.
6. Use a torque screwdriver when a torque is recommended or required by the manufacturer.
7. When conductors larger than No. 12 AWG are installed on 15- or 20-A circuits, splice No. 12 AWG pigtails for device connections.
8. Tighten unused terminal screws on the device.
9. When mounting into metal boxes, remove the fiber or plastic washers used to hold device mounting screws in yokes, allowing metal-to-metal contact.

E. Receptacle Orientation:

1. Install ground pin of vertically mounted receptacles up, and on horizontally mounted receptacles to the right.
2. Install hospital-grade receptacles in patient-care areas with the ground pin or neutral blade at the top.
3. Mount bottom of receptacles at 16" in commercial/office environment. Mount bottom of receptacles at 24" in industrial (water plant, wastewater plant, pump stations, etc.). Mount counter top receptacles at 4" above counter top.

- F. Device Plates: Do not use oversized or extra-deep plates. Repair wall finishes and remount outlet boxes when standard device plates do not fit flush or do not cover rough wall opening.
- G. Dimmers:
 1. Install dimmers within terms of their listing.
 2. Verify that dimmers used for fan speed control are listed for that application.
 3. Install unshared neutral conductors on line and load side of dimmers according to manufacturers' device listing conditions in the written instructions.
- H. Lighting Switch Height: Mount top of switch at 48" above finished floor.
- I. Arrangement of Devices: Unless otherwise indicated, mount flush, with long dimension vertical and with grounding terminal of receptacles on top. Group adjacent switches under single, multigang wall plates.
- J. Adjust locations of floor service outlets and service poles to suit arrangement of partitions and furnishings.

3.2 IDENTIFICATION

- A. Comply with Division 26 Section "Identification for Electrical Systems."
- B. Identify each receptacle with panelboard identification and circuit number. Use hot, stamped or engraved machine printing with black-filled lettering on face of plate, and durable wire markers or tags inside outlet boxes.

3.3 FIELD QUALITY CONTROL

- A. Perform the following tests and inspections[[with the assistance of a factory-authorized service representative]]:
 1. In healthcare facilities, prepare reports that comply with recommendations in NFPA 99.
 2. Test Instruments: Use instruments that comply with UL 1436.
 3. Test Instrument for Convenience Receptacles: Digital wiring analyzer with digital readout or illuminated LED indicators of measurement.
- B. Tests for Convenience Receptacles:
 1. Line Voltage: Acceptable range is 105 to 132 V.
 2. Percent Voltage Drop under 15-A Load: A value of 6 percent or higher is not acceptable.
 3. Ground Impedance: Values of up to 2 ohms are acceptable.
 4. GFCI Trip: Test for tripping values specified in UL 1436 and UL 943.
 5. Using the test plug, verify that the device and its outlet box are securely mounted.
 6. The tests shall be diagnostic, indicating damaged conductors, high resistance at the circuit breaker, poor connections, inadequate fault current path, defective devices, or similar problems. Correct circuit conditions, remove malfunctioning units and replace with new ones, and retest as specified above.
- C. Test straight blade convenience outlets in patient-care areas and hospital-grade convenience outlets for the retention force of the grounding blade according to NFPA 99. Retention force shall be not less than 4 oz.
- D. Wiring device will be considered defective if it does not pass tests and inspections.
- E. Prepare test and inspection reports.

END OF SECTION

SECTION 262816
ENCLOSED SWITCHES AND CIRCUIT BREAKERS

PART 1 GENERAL

1.1 RELATED DOCUMENTS

- A. Drawings and general provisions of the Contract and Division 01 Specification Sections apply to this Section.

1.2 DEFINITIONS

- A. NC: Normally closed.
- B. NO: Normally open.
- C. SPDT: Single pole, double throw.

1.3 PERFORMANCE REQUIREMENTS

- A. Seismic Performance: Enclosed switches and circuit breakers shall withstand the effects of earthquake motions determined according to ASCE/SEI 7.
 - 1. The term "withstand" means "the unit will remain in place without separation of any parts from the device when subjected to the seismic forces specified."

1.4 ACTION SUBMITTALS

- A. Product Data: For each type of enclosed switch, circuit breaker, accessory, and component indicated. Include dimensioned elevations, sections, weights, and manufacturers' technical data on features, performance, electrical characteristics, ratings, accessories, and finishes.
 - 1. Enclosure types and details for types other than NEMA 250, Type 1.
 - 2. Current and voltage ratings.
 - 3. Short-circuit current ratings (interrupting and withstand, as appropriate).
 - 4. Include evidence of NRTL listing for series rating of installed devices.
 - 5. Detail features, characteristics, ratings, and factory settings of individual overcurrent protective devices, accessories, and auxiliary components.
 - 6. Include time-current coordination curves (average melt) for each type and rating of overcurrent protective device; include selectable ranges for each type of overcurrent protective device.
- B. Shop Drawings: For enclosed switches and circuit breakers. Include plans, elevations, sections, details, and attachments to other work.
 - 1. Wiring Diagrams: For power, signal, and control wiring.

1.5 INFORMATIONAL SUBMITTALS

- A. Qualification Data: For qualified testing agency.
- B. Seismic Qualification Certificates: For enclosed switches and circuit breakers, accessories, and components, from manufacturer.
 - 1. Basis for Certification: Indicate whether withstand certification is based on actual test of assembled components or on calculation.
 - 2. Dimensioned Outline Drawings of Equipment Unit: Identify center of gravity and locate and describe mounting and anchorage provisions.
 - 3. Detailed description of equipment anchorage devices on which the certification is based and their installation requirements.
- C. Field quality-control reports.
 - 1. Test procedures used.

2. Test results that comply with requirements.
3. Results of failed tests and corrective action taken to achieve test results that comply with requirements.

D. Manufacturer's field service report.

1.6 CLOSEOUT SUBMITTALS

- A. Operation and Maintenance Data: For enclosed switches and circuit breakers to include in emergency, operation, and maintenance manuals. In addition to items specified in Division 01 Section "Operation and Maintenance Data," include the following:
1. Manufacturer's written instructions for testing and adjusting enclosed switches and circuit breakers.
 2. Time-current coordination curves (average melt) for each type and rating of overcurrent protective device; include selectable ranges for each type of overcurrent protective device.

1.7 MAINTENANCE MATERIAL SUBMITTALS

- A. Furnish extra materials that match products installed and that are packaged with protective covering for storage and identified with labels describing contents.
1. Fuses: Equal to 10 percent of quantity installed for each size and type, but no fewer than three of each size and type.
 2. Fuse Pullers: Two for each size and type.

1.8 QUALITY ASSURANCE

- A. Testing Agency Qualifications: Member company of NETA or an NRTL.
1. Testing Agency's Field Supervisor: Currently certified by NETA to supervise on-site testing.
- B. Source Limitations: Obtain enclosed switches and circuit breakers, overcurrent protective devices, components, and accessories, within same product category, from single source from single manufacturer.
- C. Product Selection for Restricted Space: Drawings indicate maximum dimensions for enclosed switches and circuit breakers, including clearances between enclosures, and adjacent surfaces and other items. Comply with indicated maximum dimensions.
- D. Electrical Components, Devices, and Accessories: Listed and labeled as defined in NFPA 70, by a qualified testing agency, and marked for intended location and application.
- E. Comply with NFPA 70.

1.9 PROJECT CONDITIONS

- A. Environmental Limitations: Rate equipment for continuous operation under the following conditions unless otherwise indicated:
1. Ambient Temperature: Not less than minus 22 deg F and not exceeding 104 deg F.
 2. Altitude: Not exceeding 6600 feet.
- B. Interruption of Existing Electric Service: Do not interrupt electric service to facilities occupied by Owner or others unless permitted under the following conditions and then only after arranging to provide temporary electric service according to requirements indicated:
1. Notify Engineer no fewer than seven days in advance of proposed interruption of electric service.
 2. Indicate method of providing temporary electric service.
 3. Do not proceed with interruption of electric service without Owner's written permission.
 4. Comply with NFPA 70E.

1.10 COORDINATION

- A. Coordinate layout and installation of switches, circuit breakers, and components with equipment served and adjacent surfaces. Maintain required workspace clearances and required clearances for equipment access doors and panels.

PART 2 PRODUCTS

2.1 FUSIBLE SWITCHES

- A. Manufacturers: Subject to compliance with requirements, provide products by one of the following:
 - 1. Eaton Electrical Inc.; Cutler-Hammer Business Unit.
 - 2. Siemens Energy & Automation, Inc.
 - 3. Square D; a brand of Schneider Electric.
- B. Type HD, Heavy Duty, Single Throw, 240 or 600-V ac, 1200 A and Smaller: UL 98 and NEMA KS 1, horsepower rated, with clips or bolt pads to accommodate indicated fuses, lockable handle with capability to accept three padlocks, and interlocked with cover in closed position.
- C. Type HD, Heavy Duty, Six Pole, Single Throw, 240 or 600-V ac, 200 A and Smaller: UL 98 and NEMA KS 1, horsepower rated, with clips or bolt pads to accommodate indicated fuses, lockable handle with capability to accept three padlocks, and interlocked with cover in closed position.
- D. Type HD, Heavy Duty, Double Throw, 240 or 600-V ac, 1200 A and Smaller: UL 98 and NEMA KS 1, horsepower rated, with clips or bolt pads to accommodate indicated fuses, lockable handle with capability to accept three padlocks, and interlocked with cover in closed position.
- E. Accessories:
 - 1. Equipment Ground Kit: Internally mounted and labeled for copper and aluminum ground conductors.
 - 2. Neutral Kit: Internally mounted; insulated, capable of being grounded and bonded; labeled for copper and aluminum neutral conductors.
 - 3. Isolated Ground Kit: Internally mounted; insulated, capable of being grounded and bonded; labeled for copper and aluminum neutral conductors.
 - 4. Class R Fuse Kit: Provides rejection of other fuse types when Class R fuses are specified.
 - 5. Auxiliary Contact Kit: Two NO/NC (Form "C") auxiliary contact(s), arranged to activate before switchblades open.
 - 6. Hookstick Handle: Allows use of a hookstick to operate the handle.
 - 7. Lugs: Mechanical type, suitable for number, size, and conductor material.
 - 8. Service-Rated Switches: Labeled for use as service equipment.
 - 9. Accessory Control Power Voltage: Remote mounted and powered; As indicated.

2.2 NONFUSIBLE SWITCHES

- A. Manufacturers: Subject to compliance with requirements, provide products by one of the following:
 - 1. Eaton Electrical Inc.; Cutler-Hammer Business Unit.
 - 2. Siemens Energy & Automation, Inc.
 - 3. Square D; a brand of Schneider Electric.
- B. Type HD, Heavy Duty, Single Throw, 240 or 600-V ac, 1200 A and Smaller: UL 98 and NEMA KS 1, horsepower rated, lockable handle with capability to accept three padlocks, and interlocked with cover in closed position.

- C. Type HD, Heavy Duty, Six Pole, Single Throw, 240 or 600-V ac, 200 A and Smaller: UL 98 and NEMA KS 1, horsepower rated, lockable handle with capability to accept three padlocks, and interlocked with cover in closed position.
- D. Type HD, Heavy Duty, Double Throw, 240 or 600-V ac, 1200 A and Smaller: UL 98 and NEMA KS 1, horsepower rated, lockable handle with capability to accept three padlocks, and interlocked with cover in closed position.
- E. Accessories:
 - 1. Equipment Ground Kit: Internally mounted and labeled for copper and aluminum ground conductors.
 - 2. Neutral Kit: Internally mounted; insulated, capable of being grounded and bonded; labeled for copper and aluminum neutral conductors.
 - 3. Isolated Ground Kit: Internally mounted; insulated, capable of being grounded and bonded; labeled for copper and aluminum neutral conductors.
 - 4. Auxiliary Contact Kit: Two NO/NC (Form "C") auxiliary contact(s), arranged to activate before switchblades open.
 - 5. Hookstick Handle: Allows use of a hookstick to operate the handle.
 - 6. Lugs: Mechanical type, suitable for number, size, and conductor material.
 - 7. Accessory Control Power Voltage: Remote mounted and powered; As indicated.

2.3 RECEPTACLE SWITCHES

- A. Manufacturers: Subject to compliance with requirements, provide products by one of the following:
 - 1. Eaton Electrical Inc.; Cutler-Hammer Business Unit.
 - 2. Siemens Energy & Automation, Inc.
 - 3. Square D; a brand of Schneider Electric.
- B. Type HD, Heavy-Duty, Single-Throw Fusible Switch: 240 or 600-V ac, ampacity as indicated; UL 98 and NEMA KS 1; horsepower rated, with clips or bolt pads to accommodate indicated fuses; lockable handle with capability to accept three padlocks; interlocked with cover in closed position.
- C. Type HD, Heavy-Duty, Single-Throw Nonfusible Switch: 240 or 600-V ac, ampacity as indicated; UL 98 and NEMA KS 1; horsepower rated, lockable handle with capability to accept three padlocks; interlocked with cover in closed position.
- D. Interlocking Linkage: Provided between the receptacle and switch mechanism to prevent inserting or removing plug while switch is in the on position, inserting any plug other than specified, and turning switch on if an incorrect plug is inserted or correct plug has not been fully inserted into the receptacle.
- E. Receptacle: Polarized, three-phase, four-wire receptacle (fourth wire connected to enclosure ground lug).

2.4 SHUNT TRIP SWITCHES

- A. Manufacturers: Subject to compliance with requirements, provide products by one of the following:
 - 1. Cooper Bussmann, Inc.
 - 2. Ferraz Shawmut, Inc.
 - 3. Littelfuse, Inc.
- B. General Requirements: Comply with ASME A17.1, UL 50, and UL 98, with 200-kA interrupting and short-circuit current rating when fitted with Class J fuses.

- C. Switches: Three-pole, horsepower rated, with integral shunt trip mechanism and Class J fuse block; lockable handle with capability to accept three padlocks; interlocked with cover in closed position.
- D. Control Circuit: 120-V ac; obtained from integral control power transformer, with primary and secondary fuses, with a control power transformer of enough capacity to operate shunt trip, connected pilot, and indicating and control devices.
- E. Accessories:
 - 1. Oiltight key switch for key-to-test function.
 - 2. Oiltight red ON pilot light.
 - 3. Isolated neutral lug; 100 percent rating.
 - 4. Mechanically interlocked auxiliary contacts that change state when switch is opened and closed.
 - 5. Form C alarm contacts that change state when switch is tripped.
 - 6. Three-pole, double-throw, fire-safety and alarm relay; [[120-V ac] [24-V dc]] coil voltage.
 - 7. Three-pole, double-throw, fire-alarm voltage monitoring relay complying with NFPA 72.

2.5 MOLDED-CASE CIRCUIT BREAKERS

- A. Manufacturers: Subject to compliance with requirements, provide products by one of the following:
 - 1. Eaton Electrical Inc.; Cutler-Hammer Business Unit.
 - 2. Siemens Energy & Automation, Inc.
 - 3. Square D; a brand of Schneider Electric.
- B. General Requirements: Comply with UL 489, NEMA AB 1, and NEMA AB 3, with interrupting capacity to comply with available fault currents.
- C. Thermal-Magnetic Circuit Breakers: Inverse time-current element for low-level overloads and instantaneous magnetic trip element for short circuits. Adjustable magnetic trip setting for circuit-breaker frame sizes 250 A and larger.
- D. Adjustable, Instantaneous-Trip Circuit Breakers: Magnetic trip element with front-mounted, field-adjustable trip setting.
- E. Electronic Trip Circuit Breakers: Field-replaceable rating plug, rms sensing, with the following field-adjustable settings:
 - 1. Instantaneous trip.
 - 2. Long- and short-time pickup levels.
 - 3. Long- and short-time time adjustments.
 - 4. Ground-fault pickup level, time delay, and I²t response.
- F. Current-Limiting Circuit Breakers: Frame sizes 400 A and smaller, and let-through ratings less than NEMA FU 1, RK-5.
- G. Integrally Fused Circuit Breakers: Thermal-magnetic trip element with integral limiter-style fuse listed for use with circuit breaker and trip activation on fuse opening or on opening of fuse compartment door.
- H. Ground-Fault, Circuit-Interrupter (GFCI) Circuit Breakers: Single- and two-pole configurations with Class A ground-fault protection (6-mA trip).
- I. Ground-Fault, Equipment-Protection (GFEP) Circuit Breakers: With Class B ground-fault protection (30-mA trip).
- J. Features and Accessories:

1. Standard frame sizes, trip ratings, and number of poles.
2. Lugs: Mechanical type, suitable for number, size, trip ratings, and conductor material.
3. Application Listing: Appropriate for application; Type SWD for switching fluorescent lighting loads; Type HID for feeding fluorescent and high-intensity discharge lighting circuits.
4. Ground-Fault Protection: Comply with UL 1053; integrally mounted, self-powered type with mechanical ground-fault indicator; relay with adjustable pickup and time-delay settings, push-to-test feature, internal memory, and shunt trip unit; and three-phase, zero-sequence current transformer/sensor.
5. Communication Capability: Circuit-breaker-mounted communication module with functions and features compatible with power monitoring and control system, specified in Division 26 Section "Electrical Power Monitoring and Control."
6. Shunt Trip: Trip coil energized from separate circuit, with coil-clearing contact.
7. Undervoltage Trip: Set to operate at 35 to 75 percent of rated voltage without intentional time delay.
8. Auxiliary Contacts: Two SPDT switches with "a" and "b" contacts; "a" contacts mimic circuit-breaker contacts, "b" contacts operate in reverse of circuit-breaker contacts.
9. Alarm Switch: One [[NO] [NC]] contact that operates only when circuit breaker has tripped.
10. Key Interlock Kit: Externally mounted to prohibit circuit-breaker operation; key shall be removable only when circuit breaker is in off position.
11. Zone-Selective Interlocking: Integral with [[electronic] [ground-fault]] trip unit; for interlocking ground-fault protection function.
12. Electrical Operator: Provide remote control for on, off, and reset operations.
13. Accessory Control Power Voltage: Integrally mounted, self-powered.

2.6 MOLDED-CASE SWITCHES

- A. Manufacturers: Subject to compliance with requirements, provide products by one of the following:
 1. Eaton Electrical Inc.; Cutler-Hammer Business Unit.
 2. Siemens Energy & Automation, Inc.
 3. Square D; a brand of Schneider Electric.
- B. General Requirements: MCCB with fixed, high-set instantaneous trip only, and short-circuit withstand rating equal to equivalent breaker frame size interrupting rating.
- C. Features and Accessories:
 1. Standard frame sizes and number of poles.
 2. Lugs: Mechanical type, suitable for number, size, trip ratings, and conductor material.
 3. Ground-Fault Protection: Comply with UL 1053; remote-mounted and powered type with mechanical ground-fault indicator; relay with adjustable pickup and time-delay settings, push-to-test feature, internal memory, and shunt trip unit; and three-phase, zero-sequence current transformer/sensor.
 4. Shunt Trip: Trip coil energized from separate circuit, with coil-clearing contact.
 5. Undervoltage Trip: Set to operate at 35 to 75 percent of rated voltage without intentional time delay.
 6. Auxiliary Contacts: Two SPDT switches with "a" and "b" contacts; "a" contacts mimic switch contacts, "b" contacts operate in reverse of switch contacts.
 7. Alarm Switch: One NC contact that operates only when switch has tripped.

8. Key Interlock Kit: Externally mounted to prohibit switch operation; key shall be removable only when switch is in off position.
9. Zone-Selective Interlocking: Integral with ground-fault shunt trip unit; for interlocking ground-fault protection function.
10. Electrical Operator: Provide remote control for on, off, and reset operations.
11. Accessory Control Power Voltage: Integrally mounted, self-powered.

2.7 ENCLOSURES

- A. Enclosed Switches and Circuit Breakers: NEMA AB 1, NEMA KS 1, NEMA 250, and UL 50, to comply with environmental conditions at installed location.
 1. Indoor, Dry and Clean Locations: NEMA 250, Type 1.
 2. Outdoor Locations: NEMA 250, Type 3R.
 3. Wash-Down Areas: NEMA 250, Type 4X, stainless steel.
 4. Other Wet or Damp, Indoor Locations: NEMA 250, Type 4.
 5. Indoor Locations Subject to Dust, Falling Dirt, and Dripping Noncorrosive Liquids: NEMA 250, Type 12.
 6. Hazardous Areas Indicated on Drawings: NEMA 250, Type 7 or Type 9.

PART 3 EXECUTION

3.1 EXAMINATION

- A. Examine elements and surfaces to receive enclosed switches and circuit breakers for compliance with installation tolerances and other conditions affecting performance of the Work.
- B. Proceed with installation only after unsatisfactory conditions have been corrected.

3.2 INSTALLATION

- A. Install individual wall-mounted switches and circuit breakers with tops at uniform height unless otherwise indicated.
- B. Comply with mounting and anchoring requirements specified in Division 26 Section "Vibration and Seismic Controls for Electrical Systems."
- C. Temporary Lifting Provisions: Remove temporary lifting eyes, channels, and brackets and temporary blocking of moving parts from enclosures and components.
- D. Install fuses in fusible devices.
- E. Comply with NECA 1.

3.3 IDENTIFICATION

- A. Comply with requirements in Division 26 Section "Identification for Electrical Systems."
 1. Identify field-installed conductors, interconnecting wiring, and components; provide warning signs.
 2. Label each enclosure with engraved metal or laminated-plastic nameplate.

3.4 FIELD QUALITY CONTROL

- A. Testing Agency: Engage a qualified testing agency to perform tests and inspections.
- B. Manufacturer's Field Service: Engage a factory-authorized service representative to inspect, test, and adjust components, assemblies, and equipment installations, including connections.
- C. Perform tests and inspections.
 1. Manufacturer's Field Service: Engage a factory-authorized service representative to inspect components, assemblies, and equipment installations, including connections, and to assist in testing.

- D. Acceptance Testing Preparation:
 - 1. Test insulation resistance for each enclosed switch and circuit breaker, component, connecting supply, feeder, and control circuit.
 - 2. Test continuity of each circuit.
- E. Tests and Inspections:
 - 1. Perform each visual and mechanical inspection and electrical test stated in NETA Acceptance Testing Specification. Certify compliance with test parameters.
 - 2. Correct malfunctioning units on-site, where possible, and retest to demonstrate compliance; otherwise, replace with new units and retest.
 - 3. Perform the following infrared scan tests and inspections and prepare reports:
 - a. Initial Infrared Scanning: After Substantial Completion, but not more than 60 days after Final Acceptance, perform an infrared scan of each enclosed switch and circuit breaker. Remove front panels so joints and connections are accessible to portable scanner.
 - b. Follow-up Infrared Scanning: Perform an additional follow-up infrared scan of each enclosed switch and circuit breaker 11 months after date of Substantial Completion.
 - c. Instruments and Equipment: Use an infrared scanning device designed to measure temperature or to detect significant deviations from normal values. Provide calibration record for device.
 - 4. Test and adjust controls, remote monitoring, and safeties. Replace damaged and malfunctioning controls and equipment.
- F. Enclosed switches and circuit breakers will be considered defective if they do not pass tests and inspections.
- G. Prepare test and inspection reports, including a certified report that identifies enclosed switches and circuit breakers and that describes scanning results. Include notation of deficiencies detected, remedial action taken, and observations after remedial action.

3.5 ADJUSTING

- A. Adjust moving parts and operable components to function smoothly, and lubricate as recommended by manufacturer.
- B. Set field-adjustable circuit-breaker trip ranges.

END OF SECTION

SECTION 262913
ENCLOSED CONTROLLERS

PART 1 GENERAL

1.1 SUMMARY

- A. Drawings and general provisions of the Contract, including General and Supplementary Conditions and Division 01 Specification Sections, apply to this Section.

1.2 DEFINITIONS

- A. CPT: Control power transformer.
- B. MCCB: Molded-case circuit breaker.
- C. MCP: Motor circuit protector.
- D. N.C.: Normally closed.
- E. N.O.: Normally open.
- F. OCPD: Overcurrent protective device.
- G. SCR: Silicon-controlled rectifier.

1.3 PERFORMANCE REQUIREMENTS

- A. Seismic Performance: Enclosed controllers shall withstand the effects of earthquake motions determined according to ASCE/SEI 7.
 - 1. The term "withstand" means "the unit will remain in place without separation of any parts from the device when subjected to the seismic forces specified."

1.4 ACTION SUBMITTALS

- A. Product Data: For each type of enclosed controller. Include manufacturer's technical data on features, performance, electrical characteristics, ratings, and enclosure types and finishes.
- B. Shop Drawings: For each enclosed controller. Include dimensioned plans, elevations, sections, details, and required clearances and service spaces around controller enclosures.
 - 1. Show tabulations of the following:
 - a. Each installed unit's type and details.
 - b. Factory-installed devices.
 - c. Nameplate legends.
 - d. Short-circuit current rating of integrated unit.
 - e. Listed and labeled for integrated short-circuit current (withstand) rating of OCPDs in combination controllers by an NRTL acceptable to authorities having jurisdiction.
 - f. Features, characteristics, ratings, and factory settings of individual OCPDs in combination controllers.
 - 2. Wiring Diagrams: For power, signal, and control wiring.

1.5 INFORMATIONAL SUBMITTALS

- A. Qualification Data: For qualified testing agency.
- B. Seismic Qualification Certificates: For enclosed controllers, accessories, and components, from manufacturer.
 - 1. Basis for Certification: Indicate whether withstand certification is based on actual test of assembled components or on calculation.
 - 2. Dimensioned Outline Drawings of Equipment Unit: Identify center of gravity and locate and describe mounting and anchorage provisions.
 - 3. Detailed description of equipment anchorage devices on which the certification is based and their installation requirements.
- C. Field quality-control reports.

- D. Load-Current and Overload-Relay Heater List: Compile after motors have been installed, and arrange to demonstrate that selection of heaters suits actual motor nameplate full-load currents.
- E. Load-Current and List of Settings of Adjustable Overload Relays: Compile after motors have been installed, and arrange to demonstrate that switch settings for motor running overload protection suit actual motors to be protected.

1.6 CLOSEOUT SUBMITTALS

- A. Operation and Maintenance Data: For enclosed controllers to include in emergency, operation, and maintenance manuals. In addition to items specified in Division 01 Section "Operation and Maintenance Data," include the following:
 - 1. Routine maintenance requirements for enclosed controllers and installed components.
 - 2. Manufacturer's written instructions for testing and adjusting circuit breaker and MCP trip settings.
 - 3. Manufacturer's written instructions for setting field-adjustable overload relays.
 - 4. Manufacturer's written instructions for testing, adjusting, and reprogramming reduced-voltage solid-state controllers.

1.7 MATERIALS MAINTENANCE SUBMITTALS

- A. Furnish extra materials that match products installed and that are packaged with protective covering for storage and identified with labels describing contents.
 - 1. Fuses for Fused Switches: Equal to 10 percent of quantity installed for each size and type, but no fewer than three of each size and type.
 - 2. Control Power Fuses: Equal to 10 percent of quantity installed for each size and type, but no fewer than two of each size and type.
 - 3. Indicating Lights: Two of each type and color installed.
 - 4. Auxiliary Contacts: Furnish one spare for each size and type of magnetic controller installed.
 - 5. Power Contacts: Furnish three spares for each size and type of magnetic contactor installed.

1.8 QUALITY ASSURANCE

- A. Testing Agency Qualifications: Member company of NETA or an NRTL.
 - 1. Testing Agency's Field Supervisor: Currently certified by NETA to supervise on-site testing.
- B. Electrical Components, Devices, and Accessories: Listed and labeled as defined in NFPA 70, by a qualified testing agency, and marked for intended location and application.
- C. Comply with NFPA 70.
- D. IEEE Compliance: Fabricate and test enclosed controllers according to IEEE 344 to withstand seismic forces defined in Division 26 Section "Vibration and Seismic Controls for Electrical Systems."

1.9 DELIVERY, STORAGE, AND HANDLING

- A. Store enclosed controllers indoors in clean, dry space with uniform temperature to prevent condensation. Protect enclosed controllers from exposure to dirt, fumes, water, corrosive substances, and physical damage.
- B. If stored in areas subject to weather, cover enclosed controllers to protect them from weather, dirt, dust, corrosive substances, and physical damage. Remove loose packing and flammable materials from inside controllers; install temporary electric heating, with at least 250 W per controller.

1.10 PROJECT CONDITIONS

- A. Environmental Limitations: Rate equipment for continuous operation under the following conditions unless otherwise indicated:

1. Ambient Temperature: Not less than minus 22 deg F and not exceeding 104 deg F.
2. Altitude: Not exceeding 6600 feet.
- B. Interruption of Existing Electrical Systems: Do not interrupt electrical systems in facilities occupied by Owner or others unless permitted under the following conditions and then only after arranging to provide temporary electrical service according to requirements indicated:
 1. Notify Engineer no fewer than two days in advance of proposed interruption of electrical systems.
 2. Indicate method of providing temporary utilities.
 3. Do not proceed with interruption of electrical systems without Owner's written permission.
 4. Comply with NFPA 70E.

1.11 COORDINATION

- A. Coordinate layout and installation of enclosed controllers with other construction including conduit, piping, equipment, and adjacent surfaces. Maintain required workspace clearances and required clearances for equipment access doors and panels.
- B. Coordinate sizes and locations of concrete bases with actual equipment provided. Cast anchor-bolt inserts into bases. Concrete, reinforcement, and formwork requirements are specified in Division 03.
- C. Coordinate installation of roof curbs, equipment supports, and roof penetrations.

PART 2 PRODUCTS

2.1 FULL-VOLTAGE CONTROLLERS

- A. General Requirements for Full-Voltage Controllers: Comply with NEMA ICS 2, general purpose, Class A.
- B. Motor-Starting Switches: "Quick-make, quick-break" toggle or push-button action; marked to show whether unit is off or on.
 1. Manufacturers: Subject to compliance with requirements, provide products by one of the following:
 - a. Eaton Electrical Inc.; Cutler-Hammer Business Unit.
 - b. Rockwell Automation, Inc.; Allen-Bradley brand.
 - c. Siemens Energy & Automation, Inc.
 - d. Square D; a brand of Schneider Electric.
 2. Configuration: As indicated.
 3. Surface mounting.
 4. Red pilot light.
- C. Fractional Horsepower Manual Controllers: "Quick-make, quick-break" toggle or push-button action; marked to show whether unit is off, on, or tripped.
 1. Manufacturers: Subject to compliance with requirements, provide products by one of the following:
 - a. Eaton Electrical Inc.; Cutler-Hammer Business Unit.
 - b. Rockwell Automation, Inc.; Allen-Bradley brand.
 - c. Siemens Energy & Automation, Inc.
 - d. Square D; a brand of Schneider Electric.
 2. Configuration: As indicated.

3. Overload Relays: Inverse-time-current characteristics; NEMA ICS 2, Class 10 tripping characteristics; heaters matched to nameplate full-load current of actual protected motor; external reset push button; bimetallic type.
 4. Surface mounting.
 5. Red pilot light.
- D. Integral Horsepower Manual Controllers: "Quick-make, quick-break" toggle or push-button action; marked to show whether unit is off, on, or tripped.
1. Manufacturers: Subject to compliance with requirements, provide products by one of the following:
 - a. Eaton Electrical Inc.; Cutler-Hammer Business Unit.
 - b. Rockwell Automation, Inc.; Allen-Bradley brand.
 - c. Siemens Energy & Automation, Inc.
 - d. Square D; a brand of Schneider Electric.
 2. Configuration: As indicated.
 3. Overload Relays: Inverse-time-current characteristics; NEMA ICS 2, Class 10 tripping characteristics; heaters and sensors in each phase, matched to nameplate full-load current of actual protected motor and having appropriate adjustment for duty cycle; external reset push button; bimetallic type.
 4. Surface mounting.
 5. Red pilot light.
 6. N.O. and N.C. auxiliary contact.
- E. Magnetic Controllers: Full voltage, across the line, electrically held.
1. Manufacturers: Subject to compliance with requirements, provide products by one of the following:
 - a. Eaton Electrical Inc.; Cutler-Hammer Business Unit.
 - b. Rockwell Automation, Inc.; Allen-Bradley brand.
 - c. Siemens Energy & Automation, Inc.
 - d. Square D; a brand of Schneider Electric.
 2. Configuration: As indicated.
 3. Contactor Coils: Pressure-encapsulated type with coil transient suppressors.
 - a. Operating Voltage: Depending on contactor NEMA size and line-voltage rating, manufacturer's standard matching control power or line voltage.
 4. Power Contacts: Totally enclosed, double-break, silver-cadmium oxide; assembled to allow inspection and replacement without disturbing line or load wiring.
 5. Control Circuits: 120-V ac; obtained from integral CPT, with primary and secondary fuses, with CPT of sufficient capacity to operate integral devices and remotely located pilot, indicating, and control devices.
 - a. CPT Spare Capacity: 100 VA.
 6. Bimetallic Overload Relays:
 - a. Inverse-time-current characteristic.
 - b. Class 10, Class 20 or Class 30 tripping characteristic.
 - c. Heaters in each phase matched to nameplate full-load current of actual protected motor and with appropriate adjustment for duty cycle.

- d. Ambient compensated.
 - e. Automatic resetting.
7. Solid-State Overload Relay:
- a. Switch or dial selectable for motor running overload protection.
 - b. Sensors in each phase.
 - c. Class 10, Class 20, Class 10/20 tripping characteristic selected to protect motor against voltage and current unbalance and single phasing.
 - d. Class II ground-fault protection, with start and run delays to prevent nuisance trip on starting.
 - e. Analog communication module.
8. N.C. and N.O., isolated overload alarm contact.
9. External overload reset push button.
- F. Combination Magnetic Controller: Factory-assembled combination of magnetic controller, OCPD, and disconnecting means.
1. Manufacturers: Subject to compliance with requirements, provide products by one of the following:
- a. Eaton Electrical Inc.; Cutler-Hammer Business Unit.
 - b. Rockwell Automation, Inc.; Allen-Bradley brand.
 - c. Siemens Energy & Automation, Inc.
 - d. Square D; a brand of Schneider Electric.
2. Fusible Disconnecting Means:
- a. NEMA KS 1, heavy-duty, horsepower-rated, fusible switch with clips or bolt pads to accommodate indicated fuses.
 - b. Lockable Handle: Accepts three padlocks and interlocks with cover in closed position.
3. Auxiliary Contacts: N.O./N.C., arranged to activate before switch blades open.
4. Nonfusible Disconnecting Means:
- a. NEMA KS 1, heavy-duty, horsepower-rated, nonfusible switch.
 - b. Lockable Handle: Accepts three padlocks and interlocks with cover in closed position.
 - c. Auxiliary Contacts: N.O./N.C., arranged to activate before switch blades open.
5. MCP Disconnecting Means:
- a. UL 489, NEMA AB 1, and NEMA AB 3, with interrupting capacity to comply with available fault currents, instantaneous-only circuit breaker with front-mounted, field-adjustable, short-circuit trip coordinated with motor locked-rotor amperes.
 - b. Lockable Handle: Accepts three padlocks and interlocks with cover in closed position.
 - c. Auxiliary contacts "a" and "b" arranged to activate with MCP handle.
 - d. N.C. and N.O. alarm contact that operates only when MCP has tripped.
 - e. Current-limiting+ module to increase controller short-circuit current (withstand) rating to 100 kA.
6. MCCB Disconnecting Means:
- a. UL 489, NEMA AB 1, and NEMA AB 3, with interrupting capacity to comply with available fault currents; thermal-magnetic MCCB, with inverse time-current element for low-level overloads and instantaneous magnetic trip element for short circuits.

- b. Front-mounted, adjustable magnetic trip setting for circuit-breaker frame sizes 250 A and larger.
- c. Lockable Handle: Accepts three padlocks and interlocks with cover in closed position.
- d. Auxiliary contacts "a" and "b" arranged to activate with MCCB handle.
- e. N.C. and N.O. alarm contact that operates only when MCCB has tripped.

2.2 REDUCED-VOLTAGE MAGNETIC CONTROLLERS

- A. General Requirements for Reduced-Voltage Magnetic Controllers: Comply with NEMA ICS 2, general purpose, Class A; closed-transition; adjustable time delay on transition.
- B. Reduced-Voltage Magnetic Controllers: Reduced voltage, electrically held.
 - 1. Manufacturers: Subject to compliance with requirements, provide products by one of the following:
 - a. Eaton Electrical Inc.; Cutler-Hammer Business Unit.
 - b. Rockwell Automation, Inc.; Allen-Bradley brand.
 - c. Siemens Energy & Automation, Inc.
 - d. Square D; a brand of Schneider Electric.
 - 2. Configuration:
 - a. Wye-Delta Controller: Four contactors, with a three-phase starting resistor/reactor bank.
 - b. Part-Winding Controller: Separate START and RUN contactors, field-selectable for 1/2- or 2/3-winding start mode, with either six- or nine-lead motors; with separate overload relays for starting and running sequences.
 - c. Autotransformer Reduced-Voltage Controller: Medium-duty service, with integral overtemperature protection; taps for starting at 50, 65, and 80 percent of line voltage; two START and one RUN contactors.
 - 3. Contactor Coils: Pressure-encapsulated type with coil transient suppressors.
 - a. Operating Voltage: Depending on contactor NEMA size and line-voltage rating, manufacturer's standard matching control power or line voltage.
 - 4. Power Contacts: Totally enclosed, double-break, silver-cadmium oxide; assembled to allow inspection and replacement without disturbing line or load wiring.
 - 5. Control Circuits: 120-V ac; obtained from integral CPT, with primary and secondary fuses, with CPT of sufficient capacity to operate integral devices and remotely located pilot, indicating, and control devices.
 - a. CPT Spare Capacity: 100 VA.
 - 6. Melting Alloy Overload Relays:
 - a. Inverse-time-current characteristic.
 - b. Class 10, Class 20, or Class 30 tripping characteristic.
 - c. Heaters in each phase matched to nameplate full-load current of actual protected motor and with appropriate adjustment for duty cycle.
 - 7. Bimetallic Overload Relays:
 - a. Inverse-time-current characteristic.
 - b. Class 10, Class 20, or Class 30 tripping characteristic.
 - c. Heaters in each phase matched to nameplate full-load current of actual protected motor and with appropriate adjustment for duty cycle.
 - d. Ambient compensated.

- e. Automatic resetting.
- 8. Solid-State Overload Relay:
 - a. Switch or dial selectable for motor running overload protection.
 - b. Sensors in each phase.
 - c. Class 10, Class 20, or Class 10/20 selectable tripping characteristic selected to protect motor against voltage and current unbalance and single phasing.
 - d. Class II ground-fault protection, with start and run delays to prevent nuisance trip on starting.
 - e. Analog communication module.
- 9. N.C. and N.O., isolated overload alarm contact.
- 10. External overload reset push button.
- C. Combination Reduced-Voltage Magnetic Controller: Factory-assembled combination of reduced-voltage magnetic controller, OCPD, and disconnecting means.
 - 1. Manufacturers: Subject to compliance with requirements, provide products by one of the following:
 - a. Eaton Electrical Inc.; Cutler-Hammer Business Unit.
 - b. Rockwell Automation, Inc.; Allen-Bradley brand.
 - c. Siemens Energy & Automation, Inc.
 - d. Square D; a brand of Schneider Electric.
 - 2. Fusible Disconnecting Means:
 - a. NEMA KS 1, heavy-duty, horsepower-rated, fusible switch with clips or bolt pads to accommodate indicated fuses.
 - b. Lockable Handle: Accepts three padlocks and interlocks with cover in closed position.
 - c. Auxiliary Contacts: N.O./N.C., arranged to activate before switch blades open.
 - 3. Nonfusible Disconnecting Means:
 - a. NEMA KS 1, heavy-duty, horsepower-rated, nonfusible switch.
 - b. Lockable Handle: Accepts three padlocks and interlocks with cover in closed position.
 - c. Auxiliary Contacts: N.O./N.C., arranged to activate before switch blades open.
 - 4. MCP Disconnecting Means:
 - a. UL 489, NEMA AB 1, and NEMA AB 3, with interrupting capacity to comply with available fault currents, instantaneous-only circuit breaker with front-mounted, field-adjustable, short-circuit trip coordinated with motor locked-rotor amperes.
 - b. Lockable Handle: Accepts three padlocks and interlocks with cover in closed position.
 - c. Auxiliary contacts "a" and "b" arranged to activate with MCP handle.
 - d. N.C. and N.O. alarm contact that operates only when MCP has tripped.
 - e. Current-limiting module to increase controller short-circuit current (withstand) rating to 100 kA.
 - 5. MCCB Disconnecting Means:
 - a. UL 489, NEMA AB 1, and NEMA AB 3, with interrupting capacity to comply with available fault currents; thermal-magnetic MCCB, with inverse time-current element for low-level overloads and instantaneous magnetic trip element for short circuits.
 - b. Front-mounted, adjustable magnetic trip setting for circuit-breaker frame sizes 250 A and larger.

- c. Lockable Handle: Accepts three padlocks and interlocks with cover in closed position.
- d. Auxiliary contacts "a" and "b" arranged to activate with MCCB handle.
- e. N.C. and N.O. alarm contact that operates only when MCCB has tripped.

2.3 REDUCED-VOLTAGE SOLID-STATE CONTROLLERS

- A. General Requirements for Reduced-Voltage Solid-State Controllers: Comply with UL 508.
- B. Reduced-Voltage Solid-State Controllers: An integrated unit with power SCRs, heat sink, microprocessor logic board, door-mounted digital display and keypad, bypass contactor, and overload relay; suitable for use with NEMA MG 1, Design B, polyphase, medium induction motors.
 - 1. Manufacturers: Subject to compliance with requirements, provide products by one of the following:
 - a. Eaton Electrical Inc.; Cutler-Hammer Business Unit.
 - b. Rockwell Automation, Inc.; Allen-Bradley brand.
 - c. Siemens Energy & Automation, Inc.
 - d. Square D; a brand of Schneider Electric.
 - 2. Configuration: Standard duty; nonreversible or reversible.
 - 3. Starting Mode: Voltage ramping, Current limit, Torque control, or Torque control with voltage boost, as indicated, and starting mode shall be field selectable.
 - 4. Stopping Mode: Coast to stop, Adjustable torque deceleration, or Adjustable braking, and stopping mode shall be field selectable.
 - 5. Shorting (Bypass) Contactor: Operates automatically when full voltage is applied to motor, and bypasses the SCRs. Solid-state controller protective features shall remain active when the shorting contactor is in the bypass mode.
 - 6. Shorting and Input Isolation Contactor Coils: Pressure-encapsulated type; manufacturer's standard operating voltage, matching control power or line voltage, depending on contactor size and line-voltage rating. Provide coil transient suppressors.
 - 7. Logic Board: Identical for all ampere ratings and voltage classes, with environmental protective coating.
 - 8. Control Circuits: 120-V ac; obtained from integral CPT, with primary and secondary fuses, with CPT of sufficient capacity to operate integral devices and remotely located pilot, indicating, and control devices.
 - a. CPT Spare Capacity: 100 VA.
 - 9. Adjustable acceleration-rate control using voltage or current ramp, and adjustable starting torque control with up to 400 percent current limitation for 20 seconds.
 - 10. SCR bridge shall consist of at least two SCRs per phase, providing stable and smooth acceleration with external feedback from the motor or driven equipment.
 - 11. Keypad, front accessible; for programming the controller parameters, functions, and features; shall be manufacturer's standard and include not less than the following functions:
 - a. Adjusting motor full-load amperes, as a percentage of the controller's rating.
 - b. Adjusting current limitation on starting, as a percentage of the motor full-load current rating.
 - c. Adjusting linear acceleration and deceleration ramps, in seconds.
 - d. Initial torque, as a percentage of the nominal motor torque.
 - e. Adjusting torque limit, as a percentage of the nominal motor torque.
 - f. Adjusting maximum start time, in seconds.

- g. Adjusting voltage boost, as a percentage of the nominal supply voltage.
 - h. Selecting stopping mode, and adjusting parameters.
 - i. Selecting motor thermal overload protection class between 5 and 30.
 - j. Activating and de-activating protection modes.
 - k. Selecting or activating communication modes.
12. Digital display, front accessible; for showing motor, controller, and fault status; shall be manufacturer's standard and include not less than the following:
- a. Controller Condition: Ready, starting, running, stopping.
 - b. Motor Condition: Amperes, voltage, power factor, power, and thermal state.
 - c. Fault Conditions: Controller thermal fault, motor overload alarm and trip, motor underload, overcurrent, shorted SCRs, line or phase loss, phase reversal, and line frequency over or under normal.
13. Controller Diagnostics and Protection:
- a. Microprocessor-based thermal protection system for monitoring SCR and motor thermal characteristics, and providing controller overtemperature and motor-overload alarm and trip; settings selectable via the keypad.
 - b. Protection from line-side reverse phasing; line-side and motor-side phase loss; motor jam, stall, and underload conditions; and line frequency over or under normal.
 - c. Input isolation contactor that opens when the controller diagnostics detect a faulted solid-state component or when the motor is stopped.
 - d. Shunt trip that opens the disconnecting means when the controller diagnostics detect a faulted solid-state component.
14. Remote Output Features:
- a. All outputs prewired to terminal blocks.
 - b. Form C status contacts that change state when controller is running.
 - c. Form C alarm contacts that change state when a fault condition occurs.
15. Optional Features:
- a. Analog output for field-selectable assignment of motor operating characteristics; 0 to 10-V dc or 4 to 20-mA dc, as indicated.
 - b. Additional field-assignable Form C contacts, as indicated, for alarm outputs.
 - c. Surge suppressors in solid-state power circuits providing three-phase protection against damage from supply voltage surges 10 percent or more above nominal line voltage.
 - d. Full-voltage bypass contactor operating manually, with NORMAL/BYPASS selector switch. Power contacts shall be totally enclosed, double break, and silver-cadmium oxide; and Melting Alloy Overload Relays:
 - (1) Inverse-time-current characteristic.
 - (2) Class 10, Class 20, or Class 30 tripping characteristic.
 - (3) Heaters in each phase matched to nameplate full-load current of actual protected motor and with appropriate adjustment for duty cycle.
 - f. Bimetallic Overload Relays:
 - (1) Inverse-time-current characteristic.
 - (2) Class 10, Class 20, or Class 30 tripping characteristic.
 - (3) Heaters in each phase matched to nameplate full-load current of actual protected motor and with appropriate adjustment for duty cycle.

- (4) Ambient compensated.
 - (5) Automatic resetting.
 - g. Solid-State Overload Relay:
 - (1) Switch or dial selectable for motor running overload protection.
 - (2) Sensors in each phase.
 - (3) Class 10, Class 20, or Class 10/20 selectable tripping characteristic selected to Class II ground-fault protection, with start and run delays to prevent nuisance trip on starting.
 - (5) Analog communication module.
 - h. N.C. and N.O., isolated overload alarm contact.
 - i. External overload reset push button.
- C. Combination Reduced-Voltage Solid-State Controller: Factory-assembled combination of reduced-voltage solid-state controller, OCPD, and disconnecting means.
1. Manufacturers: Subject to compliance with requirements, provide products by one of the following:
 - a. Eaton Electrical Inc.; Cutler-Hammer Business Unit.
 - b. Rockwell Automation, Inc.; Allen-Bradley brand.
 - c. Siemens Energy & Automation, Inc.
 - d. Square D; a brand of Schneider Electric.
 2. Fusible Disconnecting Means:
 - a. NEMA KS 1, heavy-duty, horsepower-rated, fusible switch with clips or bolt pads to accommodate indicated fuses.
 - b. Lockable Handle: Accepts three padlocks and interlocks with cover in closed position.
 - c. Auxiliary Contacts: N.O./N.C., arranged to activate before switch blades open.
 3. MCP Disconnecting Means:
 - a. UL 489, NEMA AB 1, and NEMA AB 3, with interrupting capacity to comply with available fault currents, instantaneous-only circuit breaker with front-mounted, field-adjustable, short-circuit trip coordinated with motor locked-rotor amperes.
 - b. Lockable Handle: Accepts three padlocks and interlocks with cover in closed position.
 - c. Auxiliary contacts "a" and "b" arranged to activate with MCP handle.
 - d. N.C. and N.O. alarm contact that operates only when MCP has tripped.
 - e. Current-limiting module to increase controller short-circuit current (withstand) rating to 100 kA.
 4. MCCB Disconnecting Means:
 - a. UL 489, NEMA AB 1, and NEMA AB 3, with interrupting capacity to comply with available fault currents; thermal-magnetic MCCB, with inverse time-current element for low-level overloads and instantaneous magnetic trip element for short circuits.
 - b. Front-mounted, adjustable magnetic trip setting for circuit-breaker frame sizes 250 A and larger.
 - c. Lockable Handle: Accepts three padlocks and interlocks with cover in closed position.
 - d. Auxiliary contacts "a" and "b" arranged to activate with MCCB handle.
 - e. N.C. and N.O. alarm contact that operates only when MCCB has tripped.

5. Molded-Case Switch Disconnecting Means:
 - a. UL 489, NEMA AB 1, and NEMA AB 3, with in-line fuse block for Class J or L power fuses (depending on ampere rating), providing an interrupting capacity to comply with available fault currents; MCCB with fixed, high-set instantaneous trip only.
 - b. Lockable Handle: Accepts three padlocks and interlocks with cover in closed position.
 - c. Auxiliary contacts "a" and "b" arranged to activate with molded-case switch handle.
 - d. N.C. and N.O. alarm contact that operates only when molded-case switch has tripped.

2.4 MULTISPEED MAGNETIC CONTROLLERS

- A. General Requirements for Multispeed Magnetic Controllers: Comply with NEMA ICS 2, general purpose, Class A.
- B. Multispeed Magnetic Controllers: Two speed, full voltage, across the line, electrically held.
 1. Manufacturers: Subject to compliance with requirements, provide products by one of the following:
 - a. Eaton Electrical Inc.; Cutler-Hammer Business Unit.
 - b. Rockwell Automation, Inc.; Allen-Bradley brand.
 - c. Siemens Energy & Automation, Inc.
 - d. Square D; a brand of Schneider Electric.
 2. Configuration: Nonreversing; consequent pole.
 3. Contactor Coils: Pressure-encapsulated type with coil transient suppressors.
 - a. Operating Voltage: Depending on contactor NEMA size and line-voltage rating, manufacturer's standard matching control power or line voltage.
 4. Power Contacts: Totally enclosed, double break, silver-cadmium oxide; assembled to allow inspection and replacement without disturbing line or load wiring.
 5. Control Circuits: 120-V ac; obtained from integral CPT, with primary and secondary fuses, with CPT of sufficient capacity to operate integral devices and remotely located pilot, indicating, and control devices.
 - a. CPT Spare Capacity: 100 VA.
 6. Compelling relays shall ensure that motor will start only at low speed.
 7. Accelerating timer relays shall ensure properly timed acceleration through speeds lower than that selected.
 8. Decelerating timer relays shall ensure automatically timed deceleration through each speed.
 9. Antiplugging timer relays shall ensure a time delay when transferring from FORWARD to REVERSE and back.
 10. Melting Alloy Overload Relays:
 - a. Inverse-time-current characteristic.
 - b. Class 10, Class 20 or Class 30 tripping characteristic.
 - c. Heaters in each phase matched to nameplate full-load current of actual protected motor and with appropriate adjustment for duty cycle.
 11. Bimetallic Overload Relays:
 - a. Inverse-time-current characteristic.
 - b. Class 10, Class 20 or Class 30 tripping characteristic.
 - c. Heaters in each phase matched to nameplate full-load current of actual protected motor and with appropriate adjustment for duty cycle.

- d. Ambient compensated.
 - e. Automatic resetting.
12. Solid-State Overload Relay:
- a. Switch or dial selectable for motor running overload protection.
 - b. Sensors in each phase.
 - c. Class 10, Class 20, Class 10/20 selectable tripping characteristic selected to protect motor against voltage and current unbalance and single phasing.
 - d. Class II ground-fault protection, with start and run delays to prevent nuisance trip on starting.
 - e. Analog communication module.
13. N.C. and N.O., isolated overload alarm contact.
14. External overload reset push button.
- C. Combination Multispeed Magnetic Controller: Factory-assembled combination of reduced-voltage magnetic controller, OCPD, and disconnecting means.
1. Manufacturers: Subject to compliance with requirements, provide products by one of the following:
- a. Eaton Electrical Inc.; Cutler-Hammer Business Unit.
 - b. General Electric Company; GE Consumer & Industrial - Electrical Distribution.
 - c. Rockwell Automation, Inc.; Allen-Bradley brand.
 - d. Siemens Energy & Automation, Inc.
 - e. Square D; a brand of Schneider Electric.
2. Fusible Disconnecting Means:
- a. NEMA KS 1, heavy-duty, horsepower-rated, fusible switch with clips or bolt pads to accommodate indicated fuses.
 - b. Lockable Handle: Accepts three padlocks and interlocks with cover in closed position.
 - c. Auxiliary Contacts: N.O./N.C., arranged to activate before switch blades open.
3. Nonfusible Disconnecting Means:
- a. NEMA KS 1, heavy-duty, horsepower-rated, nonfusible switch.
 - b. Auxiliary Contacts: N.O./N.C., arranged to activate before switch blades open.
4. MCP Disconnecting Means:
- a. UL 489, NEMA AB 1, and NEMA AB 3, with interrupting capacity to comply with available fault currents, instantaneous-only circuit breaker with front-mounted, field-adjustable, short-circuit trip coordinated with motor locked-rotor amperes.
 - b. Lockable Handle: Accepts three padlocks and interlocks with cover in closed position.
 - c. Auxiliary contacts "a" and "b" arranged to activate with MCP handle.
 - d. N.C. and N.O. alarm contact that operates only when MCP has tripped.
 - e. Current-limiting module to increase controller short-circuit current (withstand) rating to 100 kA.
5. MCCB Disconnecting Means:
- a. UL 489, NEMA AB 1, and NEMA AB 3, with interrupting capacity to comply with available fault currents; thermal-magnetic MCCB, with inverse time-current element for low-level overloads and instantaneous magnetic trip element for short circuits.

- b. Front-mounted, adjustable magnetic trip setting for circuit-breaker frame sizes 250 A and larger.
- c. Lockable Handle: Accepts three padlocks and interlocks with cover in closed position.
- d. Auxiliary contacts "a" and "b" arranged to activate with MCCB handle.
- e. N.C. and N.O. alarm contact that operates only when MCCB has tripped.

2.5 ENCLOSURES

- A. Enclosed Controllers: NEMA ICS 6, to comply with environmental conditions at installed location.
 - 1. Dry and Clean Indoor Locations: Type 1.
 - 2. Outdoor Locations: Type 3R.
 - 3. Wash-Down Areas: Type 4X, stainless steel.
 - 4. Other Wet or Damp Indoor Locations: Type 4.
 - 5. Indoor Locations Subject to Dust, Falling Dirt, and Dripping Noncorrosive Liquids: Type 12.
 - 6. Hazardous Areas Indicated on Drawings: Type 7 or Type 9.

2.6 ACCESSORIES

- A. General Requirements for Control Circuit and Pilot Devices: NEMA ICS 5; factory installed in controller enclosure cover unless otherwise indicated.
 - 1. Push Buttons, Pilot Lights, and Selector Switches: Heavy-duty, oiltight type.
 - a. Push Buttons: Shielded types; momentary as indicated.
 - b. Pilot Lights: LED types; colors as indicated.
 - c. Selector Switches: Rotary type.
 - 2. Elapsed Time Meters: Heavy duty with digital readout in hours; resettable.
 - 3. Meters: Panel type, 2-1/2-inch minimum size with 90- or 120-degree scale and plus or minus two percent accuracy. Where indicated, provide selector switches with an off position.
- B. Reversible N.C./N.O. auxiliary contact(s).
- C. Control Relays: Auxiliary and adjustable solid-state time-delay relays.
- D. Phase-Failure, Phase-Reversal, and Undervoltage and Overvoltage Relays: Solid-state sensing circuit with isolated output contacts for hard-wired connections. Provide adjustable undervoltage, overvoltage, and time-delay settings.
- E. Breather and drain assemblies, to maintain interior pressure and release condensation in Type 4 or Type 4X enclosures (as indicated) installed outdoors or in unconditioned interior spaces subject to humidity and temperature swings.
- F. Space heaters, with N.C. auxiliary contacts, to mitigate condensation in Type 3R, Type 4X, or Type 12 enclosures (as indicated) installed outdoors or in unconditioned interior spaces subject to humidity and temperature swings.
- G. Sun shields installed on fronts, sides, and tops of enclosures installed outdoors and subject to direct and extended sun exposure.
- H. Cover gaskets for Type 1 enclosures.
- I. Terminals for connecting power factor correction capacitors to the load side of overload relays.
- J. Spare control wiring terminal blocks, quantity as indicated; wired.

PART 3 EXECUTION

3.1 EXAMINATION

- A. Examine areas and surfaces to receive enclosed controllers, for compliance with requirements and other conditions affecting performance of the Work.

- B. Examine enclosed controllers before installation. Reject enclosed controllers that are wet, moisture damaged, or mold damaged.
- C. Proceed with installation only after unsatisfactory conditions have been corrected.

3.2 INSTALLATION

- A. Wall-Mounted Controllers: Install enclosed controllers on walls with tops at uniform height unless otherwise indicated, and by bolting units to wall or mounting on lightweight structural-steel channels bolted to wall. For controllers not at walls, provide freestanding racks complying with Division 26 Section "Hangers and Supports for Electrical Systems."
- B. Floor-Mounted Controllers: Install enclosed controllers on 4-inch nominal-thickness concrete base. Comply with requirements for concrete base specified in Division 03 Section "Cast-in-Place Concrete."
 - 1. Install dowel rods to connect concrete base to concrete floor. Unless otherwise indicated, install dowel rods on 18-inch centers around the full perimeter of concrete base.
 - 2. For supported equipment, install epoxy-coated anchor bolts that extend through concrete base and anchor into structural concrete floor.
 - 3. Place and secure anchorage devices. Use setting drawings, templates, diagrams, instructions, and directions furnished with items to be embedded.
 - 4. Install anchor bolts to elevations required for proper attachment to supported equipment.
- C. Seismic Bracing: Comply with requirements specified in Division 26 Section "Vibration and Seismic Controls for Electrical Systems."
- D. Temporary Lifting Provisions: Remove temporary lifting eyes, channels, and brackets and temporary blocking of moving parts from enclosures and components.
- E. Install fuses in each fusible-switch enclosed controller.
- F. Install fuses in control circuits if not factory installed. Comply with requirements in Division 26 Section "Fuses."
- G. Install heaters in thermal overload relays. Select heaters based on actual nameplate full-load amperes after motors have been installed.
- H. Install, connect, and fuse thermal-protector monitoring relays furnished with motor-driven equipment.
- I. Install power factor correction capacitors. Connect to the load side of overload relays. If connected to the load side of overload relays, adjust overload heater sizes to accommodate the reduced motor full-load currents.
- J. Comply with NECA 1.

3.3 IDENTIFICATION

- A. Identify enclosed controllers, components, and control wiring. Comply with requirements for identification specified in Division 26 Section "Identification for Electrical Systems."
 - 1. Identify field-installed conductors, interconnecting wiring, and components; provide warning signs.
 - 2. Label each enclosure with engraved nameplate.
 - 3. Label each enclosure-mounted control and pilot device.

3.4 CONTROL WIRING INSTALLATION

- A. Install wiring between enclosed controllers, remote devices and facility's central control system. Comply with requirements in Division 26 Section "Control-Voltage Electrical Power Cables."
- B. Bundle, train, and support wiring in enclosures.
- C. Connect selector switches and other automatic-control selection devices where applicable.

1. Connect selector switches to bypass only those manual- and automatic-control devices that have no safety functions when switch is in manual-control position.
2. Connect selector switches with enclosed-controller circuit in both manual and automatic positions for safety-type control devices such as low- and high-pressure cutouts, high-temperature cutouts, and motor overload protectors.

3.5 FIELD QUALITY CONTROL

- A. Testing Agency: Engage a qualified testing agency to perform tests and inspections.
- B. Manufacturer's Field Service: Engage a factory-authorized service representative to inspect, test, and adjust components, assemblies, and equipment installations, including connections.
- C. Perform tests and inspections.
 1. Manufacturer's Field Service: Engage a factory-authorized service representative to inspect components, assemblies, and equipment installations, including connections, and to assist in testing.
- D. Acceptance Testing Preparation:
 1. Test insulation resistance for each enclosed controller, component, connecting supply, feeder, and control circuit.
 2. Test continuity of each circuit.
- E. Tests and Inspections:
 1. Inspect controllers, wiring, components, connections, and equipment installation. Test and adjust controllers, components, and equipment.
 2. Test insulation resistance for each enclosed-controller element, component, connecting motor supply, feeder, and control circuits.
 3. Test continuity of each circuit.
 4. Verify that voltages at controller locations are within plus or minus 10 percent of motor nameplate rated voltages. If outside this range for any motor, notify Engineer before starting the motor(s).
 5. Test each motor for proper phase rotation.
 6. Perform each electrical test and visual and mechanical inspection stated in NETA Acceptance Testing Specification. Certify compliance with test parameters.
 7. Correct malfunctioning units on-site, where possible, and retest to demonstrate compliance; otherwise, replace with new units and retest.
 8. Perform the following infrared (thermographic) scan tests and inspections and prepare reports:
 - a. Initial Infrared Scanning: After Substantial Completion, but not more than 60 days after Final Acceptance, perform an infrared scan of each multi-pole enclosed controller. Remove front panels so joints and connections are accessible to portable scanner.
 - b. Follow-up Infrared Scanning: Perform an additional follow-up infrared scan of each multi-pole enclosed controller 11 months after date of Substantial Completion.
 - c. Instruments and Equipment: Use an infrared scanning device designed to measure temperature or to detect significant deviations from normal values. Provide calibration record for device.
 9. Test and adjust controls, remote monitoring, and safeties. Replace damaged and malfunctioning controls and equipment.
- F. Enclosed controllers will be considered defective if they do not pass tests and inspections.

- G. Prepare test and inspection reports including a certified report that identifies enclosed controllers and that describes scanning results. Include notation of deficiencies detected, remedial action taken and observations after remedial action.

3.6 ADJUSTING

- A. Set field-adjustable switches, auxiliary relays, time-delay relays, timers, and overload-relay pickup and trip ranges.
- B. Adjust overload-relay heaters or settings if power factor correction capacitors are connected to the load side of the overload relays.
- C. Adjust the trip settings of MCPs and thermal-magnetic circuit breakers with adjustable instantaneous trip elements. Initially adjust to six times the motor nameplate full-load ampere ratings and attempt to start motors several times, allowing for motor cooldown between starts. If tripping occurs on motor inrush, adjust settings in increments until motors start without tripping. Do not exceed eight times the motor full-load amperes (or 11 times for NEMA Premium Efficient motors). Where these maximum settings do not allow starting of a motor, notify Engineer before increasing settings.
- D. Set the taps on reduced-voltage autotransformer controllers at 50, 65 or 80 percent.
- E. Set field-adjustable switches and program microprocessors for required start and stop sequences in reduced-voltage solid-state controllers.
- F. Set field-adjustable circuit-breaker trip ranges.

3.7 PROTECTION

- A. Temporary Heating: Apply temporary heat to maintain temperature according to manufacturer's written instructions until enclosed controllers are ready to be energized and placed into service.
- B. Replace controllers whose interiors have been exposed to water or other liquids prior to Substantial Completion.

3.8 DEMONSTRATION

- A. Engage a factory-authorized service representative to train Owner's maintenance personnel to adjust, operate, and maintain enclosed controllers.

END OF SECTION

SECTION 262923

VARIABLE-FREQUENCY MOTOR CONTROLLERS

PART 1 GENERAL

1.1 SUMMARY

- A. Drawings and general provisions of the Contract, including General and Supplementary Conditions and Division 01 Specification Sections, apply to this Section.

1.2 DEFINITIONS

- A. BAS: Building automation system.
- B. CE: Conformite Europeene (European Compliance).
- C. CPT: Control power transformer.
- D. EMI: Electromagnetic interference.
- E. LED: Light-emitting diode.
- F. NC: Normally closed.
- G. NO: Normally open.
- H. OCPD: Overcurrent protective device.
- I. PID: Control action, proportional plus integral plus derivative.
- J. RFI: Radio-frequency interference.
- K. VFC: Variable-frequency motor controller.

1.3 ACTION SUBMITTALS

- A. Product Data: For each type and rating of VFC indicated.
 - 1. Include dimensions and finishes for VFCs.
 - 2. Include rated capacities, operating characteristics, electrical characteristics, and furnished specialties and accessories.
- B. Shop Drawings: For each VFC indicated.
 - 1. Include mounting and attachment details.
 - 2. Include details of equipment assemblies. Indicate dimensions, weights, loads, required clearances, method of field assembly, components, and location and size of each field connection.
 - 3. Include diagrams for power, signal, and control wiring.
 - 4. Include Harmonic analysis for IEEE519 Compliance: Harmonic analysis for specific project including total harmonic voltage distortion and total harmonic current distortion (TDD). VFC manufacturer shall provide calculations, specific to this installation, showing total harmonic voltage distortion is less than 5%. Analysis shall indicate any requirement for any input or output line filtering in addition to the required 5% line reactors specified. VFC manufacturer shall provide any additional filtering and/or devices to meet IEEE519 requirements.

1.4 INFORMATIONAL SUBMITTALS

- A. Coordination Drawings: Floor plans, drawn to scale, showing dimensioned layout on which the following items are shown and coordinated with each other, using input from installers of the items involved:
 - 1. Required working clearances and required area above and around VFCs.
 - 2. Show VFC layout and relationships between electrical components and adjacent structural and mechanical elements.
 - 3. Show support locations, type of support, and weight on each support.
 - 4. Indicate field measurements.
- B. Qualification Data: For manufacturer and testing agency.
- C. Seismic Qualification Certificates: For each VFC, accessories, and components, from manufacturer.

1. Certificate of compliance.
 2. Dimensioned Outline Drawings of Equipment Unit: Identify center of gravity and locate and describe mounting and anchorage provisions.
 3. Detailed description of equipment anchorage devices on which the certification is based, and their installation requirements.
- D. Product Certificates: For each VFC from manufacturer.
- E. Harmonic Analysis Report: Provide Project-specific calculations and manufacturer's statement of compliance with IEEE 519.
- F. Source quality-control reports.
- G. Field quality-control reports.
- H. Sample Warranty: For special warranty.

1.5 CLOSEOUT SUBMITTALS

- A. Operation and Maintenance Data: For VFCs to include in emergency, operation, and maintenance manuals.
1. In addition to items specified in Division 01 Section "Operation and Maintenance Data," include the following:
 - a. Manufacturer's written instructions for testing and adjusting thermal-magnetic circuit breaker and MCP trip settings.
 - b. Manufacturer's written instructions for setting field-adjustable overload relays.
 - c. Manufacturer's written instructions for testing, adjusting, and reprogramming microprocessor control modules.
 - d. Manufacturer's written instructions for setting field-adjustable timers, controls, and status and alarm points.
 - e. Load-Current and Overload-Relay Heater List: Compile after motors have been installed, and arrange to demonstrate that selection of heaters suits actual motor nameplate, full-load currents.
 - f. Load-Current and List of Settings of Adjustable Overload Relays: Compile after motors have been installed, and arrange to demonstrate that switch settings for motor-running overload protection suit actual motors to be protected.

1.6 MAINTENANCE MATERIAL SUBMITTALS

- A. Furnish extra materials described below that match products installed and that are packaged with protective covering for storage and identified with labels describing contents.
1. Power Fuses: Equal to 10 percent of quantity installed for each size and type, but no fewer than three of each size and type.
 2. Control Power Fuses: Equal to 10 percent of quantity installed for each size and type, but no fewer than two of each size and type.
 3. Indicating Lights: Two of each type and color installed.
 4. Auxiliary Contacts: Furnish one spare(s) for each size and type of magnetic controller installed.
 5. Power Contacts: Furnish three spares for each size and type of magnetic contactor installed.

1.7 QUALITY ASSURANCE

- A. Testing Agency Qualifications: Member company of NETA or an NRTL.
1. Testing Agency's Field Supervisor: Currently certified by NETA to supervise on-site testing.
- B. Source Limitations: Obtain VFCs of a single type through one source from a single manufacturer.

- C. Electrical Components, Devices, and Accessories: Listed and labeled as defined in NFPA 70, Article 100, by a testing agency acceptable to authorities having jurisdiction, and marked for intended use..
- D. Product Selection for Restricted Space: Drawings indicate maximum dimensions for VFCs, minimum clearances between VFCs, and adjacent surfaces and other items. Comply with indicated maximum dimensions and clearances.

1.8 DELIVERY, STORAGE, AND HANDLING

- A. If stored in space that is not permanently enclosed and air conditioned, remove loose packing and flammable materials from inside controllers and install temporary electric heating, with at least 250 W per controller.
- B. Product Selection for Restricted Space: Drawings indicate maximum dimensions for VFCs, including clearances between VFCs, and adjacent surfaces and other items.

1.9 WARRANTY

- A. Special Warranty: Manufacturer agrees to repair or replace VFCs that fail in materials or workmanship within specified warranty period.
 - 1. Warranty Period: Two years from date of Substantial Completion.

1.10 COORDINATION

- A. Coordinate layout and installation of VFCs with other construction including conduit, piping, equipment, and adjacent surfaces. Maintain required workspace clearances and required clearances for equipment access doors and panels.
- B. Coordinate size and location of concrete bases. Cast anchor-bolt inserts into bases.
- C. Coordinate features of VFCs, installed units, and accessory devices with pilot devices and control circuits to which they connect.

PART 2 PRODUCTS

2.1 MANUFACTURERS

- A. Manufacturers: Subject to compliance with requirements, provide products by one of the following:
 - 1. ABB Power Distribution, Inc.; ABB Control, Inc., Subsidiary (Model ACH 550).
 - 2. Eaton Electrical Sector; Eaton Corporation; Cutler-Hammer Business Unit (smaller than 100 HP - Model DG1, 100 HP and larger – Model CPX9000).
 - 3. Rockwell Automation, Inc; Allen-Bradley Brand (Model 700).

2.2 SYSTEM DESCRIPTION

- A. General Requirements for VFCs:
 - 1. VFCs and Accessories: Listed and labeled as defined in NFPA 70, by a qualified testing agency, and marked for intended location and application.
 - 2. Comply with NEMA ICS 7, NEMA ICS 61800-2, and [[UL 508A] [UL 508C]].
- B. VFC Description: Variable-frequency motor controller, consisting of power converter that employs pulse-width-modulated inverter, factory built and tested in an enclosure, with integral disconnecting means and overcurrent and overload protection; listed and labeled by an NRTL as a complete unit; arranged to provide self-protection, protection, and variable-speed control of one or more three-phase induction motors by adjusting output voltage and frequency.
 - 1. Units suitable for operation of NEMA MG 1, Design A and Design B motors, as defined by NEMA MG 1, Section IV, Part 30, "Application Considerations for Constant Speed Motors Used on a Sinusoidal Bus with Harmonic Content and General Purpose Motors Used with Adjustable-Voltage or Adjustable-Frequency Controls or Both."

2. Units suitable for operation of inverter-duty motors as defined by NEMA MG 1, Section IV, Part 31, "Definite-Purpose Inverter-Fed Polyphase Motors."
 3. Listed and labeled for integrated short-circuit current (withstand) rating by an NRTL acceptable to authorities having jurisdiction.
- C. Design and Rating: Match load type, such as fans, blowers, and pumps; and type of connection used between motor and load such as direct or through a power-transmission connection.
1. Units serving motors smaller than 100 HP shall be 6-pulse or 18-pulse type VFC.
 2. Units serving motors 100 HP and larger shall be 18-pulse VFC.
- D. Output Rating: Three phase; 10 to 60 Hz, with voltage proportional to frequency throughout voltage range.
- E. Unit Operating Requirements:
1. Input AC Voltage Tolerance: Plus 10 and minus 15 percent of VFC input voltage rating.
 2. Input AC Voltage Unbalance: Not exceeding 5 percent.
 3. Input Frequency Tolerance: Plus or minus 3 percent of VFC frequency rating.
 4. Minimum Efficiency: 96 percent at 60 Hz, full load.
 5. Minimum Displacement Primary-Side Power Factor: 96 percent under any load or speed condition.
 6. Minimum Short-Circuit Current (Withstand) Rating: 10 kA.
 7. Ambient Temperature Rating: Not less than 32 deg F and not exceeding 104 deg F.
 8. Humidity Rating: Less than 95 percent (noncondensing).
 9. Altitude Rating: Not exceeding 3300 feet.
 10. Vibration Withstand: Comply with NEMA ICS 61800-2.
 11. Overload Capability: 1.1 times the base load current for 60 seconds; minimum of 1.8 times the base load current for three seconds.
 12. Starting Torque: Minimum 100 percent of rated torque from 3 to 60 Hz.
 13. Speed Regulation: Plus or minus 10 percent.
 14. Output Carrier Frequency: Selectable; 0.5 to 15 kHz.
 15. Stop Modes: Programmable; includes fast, free-wheel, and dc injection braking.
- F. Inverter Logic: Microprocessor based, 16 or 32 bit, isolated from all power circuits.
- G. Isolated Control Interface: Allows VFCs to follow remote-control signal over a minimum 40:1 speed range.
1. Signal: Pneumatic.
- H. Internal Adjustability Capabilities:
1. Minimum Speed: 5 to 25 percent of maximum rpm.
 2. Maximum Speed: 80 to 100 percent of maximum rpm.
 3. Acceleration: 0.1 to 999.9 seconds.
 4. Deceleration: 0.1 to 999.9 seconds.
 5. Current Limit: 30 to minimum of 150 percent of maximum rating.
- I. Self-Protection and Reliability Features:
1. Surge Suppression: Factory installed as an integral part of the VFC, complying with UL 1449 SPD, Type 1 or Type 2.

2. Surge Suppression: Field-mounted surge suppressors complying with Division 26 Section "Surge Protection for Low-Voltage Electrical Power Circuits," UL 1449 SPD, Type 2.
 3. Loss of Input Signal Protection: Selectable response strategy, including speed default to a percent of the most recent speed, a preset speed, or stop; with alarm.
 4. Under- and overvoltage trips.
 5. Inverter overcurrent trips.
 6. VFC and Motor-Overload/Overtemperature Protection: Microprocessor-based thermal protection system for monitoring VFCs and motor thermal characteristics, and for providing VFC overtemperature and motor-overload alarm and trip; settings selectable via the keypad.
 7. Critical frequency rejection, with three selectable, adjustable deadbands.
 8. Instantaneous line-to-line and line-to-ground overcurrent trips.
 9. Loss-of-phase protection.
 10. Reverse-phase protection.
 11. Short-circuit protection.
 12. Motor overtemperature fault.
- J. Automatic Reset/Restart: Attempt three restarts after drive fault or on return of power after an interruption and before shutting down for manual reset or fault correction. Bidirectional autospeed search shall be capable of starting into rotating loads spinning in either direction and returning motor to set speed in proper direction, without damage to controller, motor, or load.
- K. Power-Interruption Protection: To prevent motor from re-energizing after a power interruption until motor has stopped, unless "Bidirectional Autospeed Search" feature is available and engaged.
- L. Bidirectional Autospeed Search: Capable of starting VFC into rotating loads spinning in either direction and returning motor to set speed in proper direction, without causing damage to drive, motor, or load
- M. Torque Boost: Automatically varies starting and continuous torque to at least 1.5 times the minimum torque to ensure high-starting torque and increased torque at slow speeds.
- N. Motor Temperature Compensation at Slow Speeds: Adjustable current fall-back based on output frequency for temperature protection of self-cooled, fan-ventilated motors at slow speeds.
- O. Input Line Conditioning: Integral 5 percent impedance line reactors to reduce the harmonics to the power line and protection from AC line transients. Impedance may be accomplished with dual (positive and negative DC bus) reactors or AC line reactors. AC line reactors are required if only one DC reactor utilized. Additional conditioning or filtering as determined by THD/TDD analysis performed by VFC manufacturer.
- P. VFC Output Filtering: As determined by THD/TDD analysis performed by VFC manufacturer. dV/dt output filter comprised of three-phase load reactor and resistor/capacitor clipping circuit shall be provide for all VFCs serving submersible motors.
- Q. Integral Disconnecting Means: NEMA KS 1, fusible switch with pad-lockable, door-mounted handle mechanism.
1. Disconnect Rating: Not less than 115 percent of VFC input current rating.
 2. Disconnect Rating: Not less than 115 percent of NFPA 70 motor full-load current rating or VFC input current rating, whichever is larger.
 3. Auxiliary Contacts: NO or NC, arranged to activate before switch blades open.
 4. Auxiliary contacts "a" and "b" arranged to activate with circuit-breaker handle.
 5. NC alarm contact that operates only when circuit breaker has tripped.

2.3 PERFORMANCE REQUIREMENTS

- A. Seismic Performance: VFCs shall withstand the effects of earthquake motions determined according to ASCE/SEI 7. The designated VFCs shall be tested and certified by an NRTL as meeting the ICC-ES AC 156 test procedure requirements
1. The term "withstand" means "the unit will remain in place without separation of any parts when subjected to the seismic forces specified[[and the unit will be fully operational after the seismic event]]."

2.4 CONTROLS AND INDICATION

- A. Status Lights: Door-mounted LED indicators displaying the following conditions:
1. Power on.
 2. Run.
 3. Overvoltage.
 4. Line fault.
 5. Overcurrent.
 6. External fault.
- B. Panel-Mounted Operator Station: Manufacturer's standard front-accessible, sealed keypad and plain-English-language digital display; allows complete programming, program copying, operating, monitoring, and diagnostic capability.
1. Keypad: In addition to required programming and control keys, include keys for HAND, OFF, and AUTO modes.
 2. Security Access: Provide electronic security access to controls through identification and password with at least three levels of access: View only; view and operate; and view, operate, and service.
 - a. Control Authority: Supports at least four conditions: Off, local manual control at VFC, local automatic control at VFC, and automatic control through a remote source.
- C. Historical Logging Information and Displays:
1. Real-time clock with current time and date.
 2. Running log of total power versus time.
 3. Total run time.
 4. Fault log, maintaining last four faults with time and date stamp for each.
- D. Indicating Devices: Digital display mounted flush in VFC door and connected to display VFC parameters including, but not limited to:
1. Output frequency (Hz).
 2. Motor speed (rpm).
 3. Motor status (running, stop, fault).
 4. Motor current (amperes).
 5. Motor torque (percent).
 6. Fault or alarming status (code).
 7. PID feedback signal (percent).
 8. DC-link voltage (V dc).
 9. Set point frequency (Hz).
 10. Motor output voltage (V ac).
- E. Control Signal Interfaces:
1. Electric Input Signal Interface:
 - a. A minimum of two programmable analog inputs: Operator-selectable "x"- to "y"-mA dc.
 - b. A minimum of six multifunction programmable digital inputs.
 2. Pneumatic Input Signal Interface: 3 to 15 psig.

3. Remote Signal Inputs: Capability to accept any of the following speed-setting input signals from the BAS or other control systems:
 - a. 0- to 10-V dc.
 - b. 4- to 20-mA dc.
 - c. Potentiometer using up/down digital inputs.
 - d. Fixed frequencies using digital inputs.
4. Output Signal Interface: A minimum of one programmable analog output signal (operator-selectable "x"- to "y"-mA dc), which can be configured for any of the following:
 - a. Output frequency (Hz).
 - b. Output current (load).
 - c. DC-link voltage (V dc).
 - d. Motor torque (percent).
 - e. Motor speed (rpm).
 - f. Set point frequency (Hz).
5. Remote Indication Interface: A minimum of two programmable dry-circuit relay outputs (120-V ac, 1 A) for remote indication of the following:
 - a. Motor running.
 - b. Set point speed reached.
 - c. Fault and warning indication (overtemperature or overcurrent).
 - d. PID high- or low-speed limits reached.
- F. PID Control Interface: Provides closed-loop set point, differential feedback control in response to dual feedback signals. Allows for closed-loop control of fans and pumps for pressure, flow, or temperature regulation.
 1. Number of Loops: One.
- G. BAS Interface: Factory-installed hardware and software shall interface with BAS to monitor, control, display, and record data for use in processing reports. VFC settings shall be retained within VFC's nonvolatile memory.
 1. Hardwired Points:
 - a. Monitoring: On-off status.
 - b. Control: On-off operation.
 2. Communication Interface: Comply with ASHRAE 135. Communication shall interface with BAS to remotely control and monitor lighting from a BAS operator workstation. Control features and monitoring points displayed locally at lighting panel shall be available through the BAS.

2.5 LINE CONDITIONING AND FILTERING

- A. Input Line Conditioning: Based on the manufacturer's harmonic analysis study and report, provide input filtering, as required, to limit total demand (harmonic current) distortion and total harmonic voltage demand at the defined point of common coupling to meet IEEE 519 recommendations.
- B. Output Line Conditioning: Provide dV/dt output filter comprised of three-phase load reactor and resistor/capacitor clipping circuit for VFC's with lead lengths of longer than 60 feet.
- C. Provide factory installed RFI filters for electrical noise reduction to prevent interference with sensitive electrical equipment or wireless devices.

2.6 FEATURES

- A. Communication Port: RS-232 port, USB 2.0 port, or equivalent connection capable of connecting a printer and a notebook computer to be used with an external system within a multidrop LAN configuration. Interface shall allow all parameter settings of VFC to be programmed via BMX control. Provide and install communications equipment for VFC to retain these settings within the nonvolatile memory. Coordinate with controls contractor but must provide communications for Ethernet IP and ModBus or other to match SCADA system.

2.7 ENCLOSURES

- A. VFC Enclosures: NEMA 250, to comply with environmental conditions at installed location.
 - 1. Dry and Clean Indoor Locations: Type 1.
 - 2. Outdoor Locations: Type 3R.
 - 3. [[Kitchen] [Wash-Down]] Areas: Type 4X, stainless steel.
 - 4. Other Wet or Damp Indoor Locations: Type 4.
 - 5. Indoor Locations Subject to Dust, Falling Dirt, and Dripping Noncorrosive Liquids: Type 12.
- B. Plenum Rating: UL 1995; NRTL certification label on enclosure, clearly identifying VFC as "Plenum Rated."

2.8 ACCESSORIES

- A. General Requirements for Control-Circuit and Pilot Devices: NEMA ICS 5; factory installed in VFC enclosure cover unless otherwise indicated.
 - 1. Push Buttons: Covered.
 - 2. Pilot Lights: Push to test.
 - 3. Selector Switches: **Rotary** type.
 - 4. Stop and Lockout Push-Button Station: Momentary-break, push-button station with a factory-applied hasp arranged so padlock can be used to lock push button in depressed position with control circuit open.
- B. Control Relays: Auxiliary and adjustable solid-state time-delay relays.
- C. Phase-Failure, Phase-Reversal, and Undervoltage and Overvoltage Relays: Solid-state sensing circuit with isolated output contacts for hard-wired connections. Provide adjustable undervoltage, overvoltage, and time-delay settings.
- D. Supplemental Digital Meters:
- E. Breather and drain assemblies, to maintain interior pressure and release condensation in NEMA 250, Type 4, Type 4X or Type 12 enclosures (as indicated) installed outdoors or in unconditioned interior spaces subject to humidity and temperature swings.
- F. Space heaters, with NC auxiliary contacts, to mitigate condensation in NEMA 250, Type 3R, Type 4X, or Type 12 enclosures (as indicated) installed outdoors or in unconditioned interior spaces subject to humidity and temperature swings.
- G. Cooling Fan and Exhaust System: For NEMA 250, Type 1 or Type 12; UL 508 component recognized: Supply fan, with composite or stainless-steel intake and exhaust grills and filters; 120-V ac; obtained from integral CPT.
- H. Sun shields installed on fronts, sides, and tops of enclosures installed outdoors and subject to direct and extended sun exposure.
- I. Spare control-wiring terminal blocks; unwired.

2.9 SOURCE QUALITY CONTROL

- A. Testing: Test and inspect VFCs according to requirements in NEMA ICS 61800-2.
 - 1. Test each VFC while connected to its specified motor or a motor that is comparable to that for which the VFC is rated.
 - 2. Verification of Performance: Rate VFCs according to operation of functions and features specified.
- B. VFCs will be considered defective if they do not pass tests and inspections.
- C. Prepare test and inspection reports.

PART 3 EXECUTION

3.1 EXAMINATION

- A. Examine areas, surfaces, and substrates to receive VFCs, with Installer present, for compliance with requirements for installation tolerances, and other conditions affecting performance of the Work.
- B. Examine VFC before installation. Reject VFCs that are wet, moisture damaged, or mold damaged.
- C. Examine roughing-in for conduit systems to verify actual locations of conduit connections before VFC installation.
- D. Prepare written report, endorsed by Installer, listing conditions detrimental to performance of the Work.
- E. Proceed with installation only after unsatisfactory conditions have been corrected.

3.2 INSTALLATION

- A. Wall-Mounting Controllers: Install with tops at uniform height and with disconnect operating handles not higher than 79 inches above finished floor, unless otherwise indicated, and by bolting units to wall or mounting on lightweight structural-steel channels bolted to wall. For controllers not on walls, provide freestanding racks complying with Division 26 Section "Hangers and Supports for Electrical Systems."
- B. Floor-Mounting Controllers: Install VFCs on 4-inch nominal thickness concrete base. Comply with requirements for concrete base specified in Division 03.
 - 1. Install dowel rods to connect concrete base to concrete floor. Unless otherwise indicated, install dowel rods on 18-inch centers around the full perimeter of concrete base.
 - 2. For supported equipment, install epoxy-coated anchor bolts that extend through concrete base and anchor into structural concrete floor.
 - 3. Place and secure anchorage devices. Use setting drawings, templates, diagrams, instructions, and directions furnished with items to be embedded.
 - 4. Install anchor bolts to elevations required for proper attachment to supported equipment.
- C. Seismic Bracing: Comply with requirements specified in Division 26 Section "Seismic Controls for Electrical Systems."
- D. Temporary Lifting Provisions: Remove temporary lifting eyes, channels, and brackets and temporary blocking of moving parts from enclosures and components.
- E. Install fuses in each fusible-switch VFC.
- F. Install fuses in control circuits if not factory installed. Comply with requirements in Division 26 Section "Fuses."
- G. Install heaters in thermal-overload relays. Select heaters based on actual nameplate full-load amperes after motors are installed.
- H. Install, connect, and fuse thermal-protector monitoring relays furnished with motor-driven equipment.
- I. Comply with NECA 1.

3.3 CONTROL WIRING INSTALLATION

- A. Install wiring between VFCs and remote devices and facility's central-control system. Comply with requirements in Division 26 Section "Control-Voltage Electrical Power Cables."
- B. Bundle, train, and support wiring in enclosures.
- C. Connect hand-off-automatic switch and other automatic-control devices where applicable.

1. Connect selector switches with control circuit in both hand and automatic positions for safety-type control devices such as low- and high-pressure cutouts, high-temperature cutouts, and motor overload protectors.

3.4 IDENTIFICATION

- A. Identify VFCs, components, and control wiring. Comply with requirements for identification specified in Section 260553 "Identification for Electrical Systems."
 1. Identify field-installed conductors, interconnecting wiring, and components; provide warning signs.
 2. Label each VFC with engraved nameplate.
 3. Label each enclosure-mounted control and pilot device.
- B. Operating Instructions: Frame printed operating instructions for VFCs, including control sequences and emergency procedures. Fabricate frame of finished metal, and cover instructions with clear acrylic plastic. Mount on front of VFC units.

3.5 FIELD QUALITY CONTROL

- A. Testing Agency: Engage a qualified testing agency to perform tests and inspections.
- B. Manufacturer's Field Service: Engage a factory-authorized service representative to test and inspect components, assemblies, and equipment installations, including connections.
- C. Perform tests and inspections with the assistance of a factory-authorized service representative.
- D. Acceptance Testing Preparation:
 1. Test insulation resistance for each VFC element, bus, component, connecting supply, feeder, and control circuit.
 2. Test continuity of each circuit.
- E. Tests and Inspections:
 1. Inspect VFC, wiring, components, connections, and equipment installation. Test and adjust controllers, components, and equipment.
 2. Test insulation resistance for each VFC element, component, connecting motor supply, feeder, and control circuits.
 3. Test continuity of each circuit.
 4. Verify that voltages at VFC locations are within 10 percent of motor nameplate rated voltages. If outside this range for any motor, notify Architect before starting the motor(s).
 5. Test each motor for proper phase rotation.
 6. Perform each electrical test and visual and mechanical inspection, except optional tests, stated in NETA ATS. Certify compliance with test parameters.
 7. Correct malfunctioning units on-site, where possible, and retest to demonstrated compliance; otherwise, replace with new units and retest.
 8. Test and adjust controls, remote monitoring, and safeties. Replace damaged and malfunctioning controls and equipment.
- F. VFCs will be considered defective if they do not pass tests and inspections.
- G. Prepare test and inspection reports, including a certified report that identifies the VFC and describes scanning results. Include notation of deficiencies detected, remedial action taken, and observations made after remedial action.

3.6 STARTUP SERVICE

- A. Engage a factory-authorized service representative to perform startup service.
 1. Complete installation and startup checks according to manufacturer's written instructions.

3.7 ADJUSTING

- A. Program microprocessors for required operational sequences, status indications, alarms, event recording, and display features. Clear events memory after final acceptance testing and prior to Substantial Completion.
- B. Set field-adjustable switches, auxiliary relays, time-delay relays, timers, and overload-relay pickup and trip ranges.
- C. Adjust the trip settings of instantaneous-only circuit breakers and thermal-magnetic circuit breakers with adjustable, instantaneous trip elements. Initially adjust to 6 times the motor nameplate full-load amperes and attempt to start motors several times, allowing for motor cool-down between starts. If tripping occurs on motor inrush, adjust settings in increments until motors start without tripping. Do not exceed 8 times the motor full-load amperes (or 11 times for NEMA Premium Efficient motors if required). Where these maximum settings do not allow starting of a motor, notify Engineer or Owner before increasing settings.
- D. Set the taps on reduced-voltage autotransformer controllers, if applicable.
- E. Set field-adjustable circuit-breaker trip ranges.
- F. Set field-adjustable pressure switches.

3.8 PROTECTION

- A. Temporary Heating: Apply temporary heat to maintain temperature according to manufacturer's written instructions until controllers are ready to be energized and placed into service.
- B. Replace VFCs whose interiors have been exposed to water or other liquids prior to Substantial Completion.

3.9 DEMONSTRATION

- A. Engage a factory-authorized service representative to train Owner's maintenance personnel to adjust, operate, reprogram, and maintain VFCs.

END OF SECTION

This Page Intentionally Left Blank

SECTION 263600
TRANSFER SWITCHES

PART 1 GENERAL

1.1 RELATED DOCUMENTS

- A. Drawings and general provisions of the Contract and Division 01 Specification Sections apply to this Section.

1.2 ACTION SUBMITTALS

- A. Product Data: For each type of product indicated. Include rated capacities, weights, operating characteristics, furnished specialties, and accessories.
- B. Shop Drawings: Dimensioned plans, elevations, sections, and details showing minimum clearances, conductor entry provisions, gutter space, installed features and devices, and material lists for each switch specified.
 - 1. Single-Line Diagram: Show connections between transfer switch, bypass/isolation switch, power sources, and load; and show interlocking provisions for each combined transfer switch and bypass/isolation switch.

1.3 INFORMATIONAL SUBMITTALS

- A. Qualification Data: For manufacturer.
- B. Manufacturer Seismic Qualification Certification: Submit certification that transfer switches accessories, and components will withstand seismic forces defined in Division 26 Section "Vibration and Seismic Controls for Electrical Systems." Include the following:
 - 1. Basis for Certification: Indicate whether withstand certification is based on actual test of assembled components or on calculation.
 - a. The term "withstand" means "the unit will remain in place without separation of any parts from the device when subjected to the seismic forces specified."
 - b. The term "withstand" means "the unit will remain in place without separation of any parts from the device when subjected to the seismic forces specified and the unit will be fully operational after the seismic event."
 - 2. Dimensioned Outline Drawings of Equipment Unit: Identify center of gravity and locate and describe mounting and anchorage provisions.
 - 3. Detailed description of equipment anchorage devices on which the certification is based and their installation requirements.
- C. Field quality-control test reports.

1.4 CLOSEOUT SUBMITTALS

- A. Operation and Maintenance Data: For each type of product to include in emergency, operation, and maintenance manuals. In addition to items specified in Division 01 Section "Operation and Maintenance Data," include the following:
 - 1. Features and operating sequences, both automatic and manual.
 - 2. List of all factory settings of relays; provide relay-setting and calibration instructions, including software, where applicable.

1.5 QUALITY ASSURANCE

- A. Manufacturer Qualifications: Maintain a service center capable of providing training, parts, and emergency maintenance repairs within a response period of less than eight hours from time of notification.
- B. Testing Agency Qualifications: An independent agency, with the experience and capability to conduct the testing indicated, that is a member company of the InterNational Electrical Testing

Association or is a nationally recognized testing laboratory (NRTL) as defined by OSHA in 29 CFR 1910.7, and that is acceptable to authorities having jurisdiction.

1. Testing Agency's Field Supervisor: Person currently certified by the InterNational Electrical Testing Association or the National Institute for Certification in Engineering Technologies to supervise on-site testing specified in Part 3.
- C. Source Limitations: Obtain all transfer switches through one source from a single manufacturer.
- D. Electrical Components, Devices, and Accessories: Listed and labeled as defined in NFPA 70, Article 100, by a testing agency acceptable to authorities having jurisdiction, and marked for intended use.
- E. Comply with NEMA ICS 1.
- F. Comply with NFPA 70.
- G. Comply with NFPA 99.
- H. Comply with NFPA 110.
- I. Comply with UL 1008 unless requirements of these Specifications are stricter.

1.6 FIELD CONDITIONS

- A. Interruption of Existing Electrical Service: Do not interrupt electrical service to facilities occupied by Owner or others unless permitted under the following conditions and then only after arranging to provide temporary electrical service:
 1. Notify Engineer no fewer than two days in advance of proposed interruption of electrical service.
 2. Do not proceed with interruption of electrical service without Owner's written permission.

1.7 COORDINATION

- A. Coordinate size and location of concrete bases. Cast anchor-bolt inserts into bases. Concrete, reinforcement, and formwork requirements are specified in Division 03 Section "Cast-in-Place Concrete."

PART 2 PRODUCTS

2.1 MANUFACTURED UNITS

- A. Manufacturers: Subject to compliance with requirements, provide products by one of the following:
 1. Contactor Transfer Switches:
 - a. Emerson; ASCO Power Technologies, LP.
 - b. GE Zenith Controls.
 - c. Kohler Power Systems; Generator Division.
 - d. Onan/Cummins Power Generation; Industrial Business Group.
 - e. Russelectric, Inc.

2.2 GENERAL TRANSFER-SWITCH PRODUCT REQUIREMENTS

- A. Indicated Current Ratings: Apply as defined in UL 1008 for continuous loading and total system transfer, including tungsten filament lamp loads not exceeding 30 percent of switch ampere rating, unless otherwise indicated.
 1. Where transfer switch includes internal fault-current protection, rating of switch and trip unit combination shall exceed indicated fault-current value at installation location.
- B. Solid-State Controls: Repetitive accuracy of all settings shall be plus or minus 2 percent or better over an operating temperature range of minus 20 to plus 70 deg C.
- C. Resistance to Damage by Voltage Transients: Components shall meet or exceed voltage-surge withstand capability requirements when tested according to IEEE C62.41. Components shall meet or exceed voltage-impulse withstand test of NEMA ICS 1.

- D. Electrical Operation: Accomplish by a nonfused, momentarily energized solenoid or electric-motor-operated mechanism, mechanically and electrically interlocked in both directions.
- E. Switch Characteristics: Designed for continuous-duty repetitive transfer of full-rated current between active power sources.
 - 1. Limitation: Switches using molded-case switches or circuit breakers or insulated-case circuit-breaker components are not acceptable.
 - 2. Switch Action: Double throw; mechanically held in both directions.
 - 3. Contacts: Silver composition or silver alloy for load-current switching. Conventional automatic transfer-switch units, rated 225 A and higher, shall have separate arcing contacts.
- F. Neutral Switching. Where four-pole switches are indicated, provide neutral pole switched simultaneously with phase poles.
- G. Neutral Terminal: Solid and fully rated, unless otherwise indicated.
- H. Oversize Neutral: Ampacity and switch rating of neutral path through units indicated for oversize neutral shall be double the nominal rating of circuit in which switch is installed.
- I. Heater: Equip switches exposed to outdoor temperatures and humidity, and other units indicated, with an internal heater. Provide thermostat within enclosure to control heater.
- J. Battery Charger: For generator starting batteries.
 - 1. Float type rated 2 A.
 - 2. Ammeter to display charging current.
 - 3. Fused ac inputs and dc outputs.
- K. Annunciation, Control, and Programming Interface Components: Devices at transfer switches for communicating with remote programming devices, annunciators, or annunciator and control panels shall have communication capability matched with remote device.
- L. Factory Wiring: Train and bundle factory wiring and label, consistent with Shop Drawings, either by color-code or by numbered or lettered wire and cable tape markers at terminations. Color-coding and wire and cable tape markers are specified in Division 26 Section "Identification for Electrical Systems."
 - 1. Designated Terminals: Pressure type, suitable for types and sizes of field wiring indicated.
 - 2. Power-Terminal Arrangement and Field-Wiring Space: Suitable for top, side, or bottom entrance of feeder conductors as indicated.
 - 3. Control Wiring: Equipped with lugs suitable for connection to terminal strips.
- M. Enclosures: General-purpose NEMA 250, Type 1, Type 3R or Type 12 (as indicated), complying with NEMA ICS 6 and UL 508, unless otherwise indicated.

2.3 AUTOMATIC TRANSFER SWITCHES

- A. Comply with Level 1 equipment according to NFPA 110.
- B. Switching Arrangement: Double-throw type, incapable of pauses or intermediate position stops during normal functioning, unless otherwise indicated.
- C. Manual Switch Operation: Under load, with door closed and with either or both sources energized. Transfer time is same as for electrical operation. Control circuit automatically disconnects from electrical operator during manual operation.
- D. Manual Switch Operation: Unloaded. Control circuit automatically disconnects from electrical operator during manual operation.
- E. Signal-Before-Transfer Contacts: A set of normally open/normally closed dry contacts operates in advance of retransfer to normal source. Interval is adjustable from 1 to 30 seconds.
- F. Digital Communication Interface: Matched to capability of remote annunciator or annunciator and control panel.
- G. Transfer Switches Based on Molded-Case-Switch Components: Comply with NEMA AB 1, UL 489, and UL 869A.

- H. Automatic Closed-Transition Transfer Switches: Include the following functions and characteristics:
1. Fully automatic make-before-break operation.
 2. Load transfer without interruption, through momentary interconnection of both power sources not exceeding 100 ms.
 3. Initiation of No-Interruption Transfer: Controlled by in-phase monitor and sensors confirming both sources are present and acceptable.
 - a. Initiation occurs without active control of generator.
 - b. Controls ensure that closed-transition load transfer closure occurs only when the 2 sources are within plus or minus 5 electrical degrees maximum, and plus or minus 5 percent maximum voltage difference.
 4. Failure of power source serving load initiates automatic break-before-make transfer.
- I. In-Phase Monitor: Factory-wired, internal relay controls transfer so it occurs only when the two sources are synchronized in phase. Relay compares phase relationship and frequency difference between normal and emergency sources and initiates transfer when both sources are within 15 electrical degrees, and only if transfer can be completed within 60 electrical degrees. Transfer is initiated only if both sources are within 2 Hz of nominal frequency and 70 percent or more of nominal voltage.
- J. Motor Disconnect and Timing Relay: Controls designate starters so they disconnect motors before transfer and reconnect them selectively at an adjustable time interval after transfer. Control connection to motor starters is through wiring external to automatic transfer switch. Time delay for reconnecting individual motor loads is adjustable between 1 and 60 seconds, and settings are as indicated. Relay contacts handling motor-control circuit inrush and seal currents are rated for actual currents to be encountered.
- K. Programmed Neutral Switch Position: Switch operator has a programmed neutral position arranged to provide a midpoint between the two working switch positions, with an intentional, time-controlled pause at midpoint during transfer. Pause is adjustable from 0.5 to 30 seconds minimum and factory set for 0.5 second, unless otherwise indicated. Time delay occurs for both transfer directions. Pause is disabled unless both sources are live.
- L. Automatic Transfer-Switch Features:
1. Undervoltage Sensing for Each Phase of Normal Source: Sense low phase-to-ground voltage on each phase. Pickup voltage shall be adjustable from 85 to 100 percent of nominal, and dropout voltage is adjustable from 75 to 98 percent of pickup value. Factory set for pickup at 90 percent and dropout at 85 percent.
 2. Adjustable Time Delay: For override of normal-source voltage sensing to delay transfer and engine start signals. Adjustable from zero to six seconds, and factory set for one second.
 3. Voltage/Frequency Lockout Relay: Prevent premature transfer to generator. Pickup voltage shall be adjustable from 85 to 100 percent of nominal. Factory set for pickup at 90 percent. Pickup frequency shall be adjustable from 90 to 100 percent of nominal. Factory set for pickup at 95 percent.
 4. Time Delay for Retransfer to Normal Source: Adjustable from 0 to 30 minutes, and factory set for 10 minutes to automatically defeat delay on loss of voltage or sustained undervoltage of emergency source, provided normal supply has been restored.
 5. Test Switch: Simulate normal-source failure.
 6. Switch-Position Pilot Lights: Indicate source to which load is connected.
 7. Source-Available Indicating Lights: Supervise sources via transfer-switch normal- and emergency-source sensing circuits.
 - a. Normal Power Supervision: Green light with nameplate engraved "Normal Source Available."

- b. Emergency Power Supervision: Red light with nameplate engraved "Emergency Source Available."
- 8. Unassigned Auxiliary Contacts: Two normally open, single-pole, double-throw contacts for each switch position, rated 10 A at 240-V ac.
- 9. Transfer Override Switch: Overrides automatic retransfer control so automatic transfer switch will remain connected to emergency power source regardless of condition of normal source. Pilot light indicates override status.
- 10. Engine Starting Contacts: One isolated and normally closed, and one isolated and normally open; rated 10 A at 32-V dc minimum.
- 11. Engine Shutdown Contacts: Instantaneous; shall initiate shutdown sequence at remote engine-generator controls after retransfer of load to normal source.
- 12. Engine Shutdown Contacts: Time delay adjustable from zero to five minutes, and factory set for five minutes. Contacts shall initiate shutdown at remote engine-generator controls after retransfer of load to normal source.
- 13. Engine-Generator Exerciser: Solid-state, programmable-time switch starts engine generator and transfers load to it from normal source for a preset time, then retransfers and shuts down engine after a preset cool-down period. Initiates exercise cycle at preset intervals adjustable from 7 to 30 days. Running periods are adjustable from 10 to 30 minutes. Factory settings are for 7-day exercise cycle, 20-minute running period, and 5-minute cool-down period. Exerciser features include the following:
 - a. Exerciser Transfer Selector Switch: Permits selection of exercise with and without load transfer.
 - b. Push-button programming control with digital display of settings.
 - c. Integral battery operation of time switch when normal control power is not available.

2.4 BYPASS/ISOLATION SWITCHES

- A. Comply with requirements for Level 1 equipment according to NFPA 110.
- B. Description: Manual type, arranged to select and connect either source of power directly to load, isolating transfer switch from load and from both power sources. Include the following features for each combined automatic transfer switch and bypass/isolation switch:
 - 1. Means to lock bypass/isolation switch in the position that isolates transfer switch with an arrangement that permits complete electrical testing of transfer switch while isolated. While isolated, interlocks prevent transfer-switch operation, except for testing or maintenance.
 - 2. Drawout Arrangement for Transfer Switch: Provide physical separation from live parts and accessibility for testing and maintenance operations.
 - 3. Bypass/Isolation Switch Current, Voltage, Closing, and Short-Circuit Withstand Ratings: Equal to or greater than those of associated automatic transfer switch, and with same phase arrangement and number of poles.
 - 4. Contact temperatures of bypass/isolation switches shall not exceed those of automatic transfer-switch contacts when they are carrying rated load.
 - 5. Operability: Constructed so load bypass and transfer-switch isolation can be performed by 1 person in no more than 2 operations in 15 seconds or less.
 - 6. Legend: Manufacturer's standard legend for control labels and instruction signs shall describe operating instructions.
 - 7. Maintainability: Fabricate to allow convenient removal of major components from front without removing other parts or main power conductors.
- C. Interconnection of Bypass/Isolation Switches with Automatic Transfer Switches: Factory-installed copper bus bars; plated at connection points and braced for the indicated available short-circuit current.

2.5 NONAUTOMATIC TRANSFER SWITCHES

- A. Operation: Electrically actuated by push buttons designated "Normal Source" and "Alternate Source." Switch shall be capable of transferring load in either direction with either or both sources energized.
- B. Operation: Electrically actuated by push buttons designated "Normal Source" and "Alternate Source." In addition, removable manual handle provides quick-make, quick-break manual-switching action. Switch shall be capable of electrically or manually transferring load in either direction with either or both sources energized. Control circuit disconnects from electrical operator during manual operation.
- C. Double-Throw Switching Arrangement: Incapable of pauses or intermediate position stops during switching sequence.
- D. Nonautomatic Transfer-Switch Accessories:
 - 1. Pilot Lights: Indicate source to which load is connected.
 - 2. Source-Available Indicating Lights: Supervise sources via transfer-switch normal- and alternate-source sensing circuits.
 - a. Normal Power Supervision: Green light with nameplate engraved "Normal Source Available."
 - b. Emergency Power Supervision: Red light with nameplate engraved "Alternate Source Available."
 - 3. Unassigned Auxiliary Contacts: One set of normally closed contacts for each switch position, rated 10 A at 240-V ac.

2.6 REMOTE ANNUNCIATOR SYSTEM

- A. Functional Description: Remote annunciator panel shall annunciate conditions for indicated transfer switches. Annunciation shall include the following:
 - 1. Sources available, as defined by actual pickup and dropout settings of transfer-switch controls.
 - 2. Switch position.
 - 3. Switch in test mode.
 - 4. Failure of communication link.
- B. Annunciator Panel: LED-lamp type with audible signal and silencing switch.
 - 1. Indicating Lights: Grouped for each transfer switch monitored.
 - 2. Label each group, indicating transfer switch it monitors, location of switch, and identity of load it serves.
 - 3. Mounting: Flush, modular, steel cabinet, unless otherwise indicated.
 - 4. Lamp Test: Push-to-test or lamp-test switch on front panel.

2.7 REMOTE ANNUNCIATOR AND CONTROL SYSTEM

- A. Functional Description: Include the following functions for indicated transfer switches:
 - 1. Indication of sources available, as defined by actual pickup and dropout settings of transfer-switch controls.
 - 2. Indication of switch position.
 - 3. Indication of switch in test mode.
 - 4. Indication of failure of digital communication link.
 - 5. Key-switch or user-code access to control functions of panel.
 - 6. Control of switch-test initiation.
 - 7. Control of switch operation in either direction.
 - 8. Control of time-delay bypass for transfer to normal source.
- B. Malfunction of annunciator, annunciation and control panel, or communication link shall not affect functions of automatic transfer switch. In the event of failure of communication link, automatic transfer switch automatically reverts to stand-alone, self-contained operation. Automatic transfer-

switch sensing, controlling, or operating function shall not depend on remote panel for proper operation.

- C. Remote Annunciation and Control Panel: Solid-state components. Include the following features:
 - 1. Controls and indicating lights grouped together for each transfer switch.
 - 2. Label each indicating light control group. Indicate transfer switch it controls, location of switch, and load it serves.
 - 3. Digital Communication Capability: Matched to that of transfer switches supervised.
 - 4. Mounting: Flush, modular, steel cabinet, unless otherwise indicated.

2.8 SOURCE QUALITY CONTROL

- A. Factory test and inspect components, assembled switches, and associated equipment. Ensure proper operation. Check transfer time and voltage, frequency, and time-delay settings for compliance with specified requirements. Perform dielectric strength test complying with NEMA ICS 1.

PART 3 EXECUTION

3.1 INSTALLATION

- A. Design each fastener and support to carry load indicated by seismic requirements and according to seismic-restraint details. See Division 26 Section "Seismic Controls for Electrical Systems."
- B. Floor-Mounting Switch: Anchor to floor by bolting.
 - 1. Concrete Bases: 4 inches high, reinforced, with chamfered edges. Extend base no more than 4 inches in all directions beyond the maximum dimensions of switch, unless otherwise indicated or unless required for seismic support. Construct concrete bases according to Division 26 Section "Hangers and Supports for Electrical Systems."
- C. Annunciator and Control Panel Mounting: Flush in wall, unless otherwise indicated.
- D. Identify components according to Division 26 Section "Identification for Electrical Systems."
- E. Set field-adjustable intervals and delays, relays, and engine exerciser clock.

3.2 CONNECTIONS

- A. Wiring to Remote Components: Match type and number of cables and conductors to control and communication requirements of transfer switches as recommended by manufacturer. Increase raceway sizes at no additional cost to Owner if necessary to accommodate required wiring.
- B. Ground equipment according to Division 26 Section "Grounding and Bonding for Electrical Systems."
- C. Connect wiring according to Division 26 Section "Low-Voltage Electrical Power Conductors and Cables."

3.3 FIELD QUALITY CONTROL

- A. Testing Agency: Engage a qualified independent testing and inspecting agency to perform tests and inspections and prepare test reports.
- B. Manufacturer's Field Service: Engage a factory-authorized service representative to inspect, test, and adjust components, assemblies, and equipment installations, including connections.
- C. Perform the following tests and inspections:
 - 1. After installing equipment and after electrical circuitry has been energized, test for compliance with requirements.
 - 2. Perform each visual and mechanical inspection and electrical test stated in NETA Acceptance Testing Specification. Certify compliance with test parameters.
 - 3. Measure insulation resistance phase-to-phase and phase-to-ground with insulation-resistance tester. Include external annunciation and control circuits. Use test voltages and procedure recommended by manufacturer. Comply with manufacturer's specified minimum resistance.

- a. Check for electrical continuity of circuits and for short circuits.
 - b. Inspect for physical damage, proper installation and connection, and integrity of barriers, covers, and safety features.
 - c. Verify that manual transfer warnings are properly placed.
 - d. Perform manual transfer operation.
4. After energizing circuits, demonstrate interlocking sequence and operational function for each switch at least three times.
- a. Simulate power failures of normal source to automatic transfer switches and of emergency source with normal source available.
 - b. Simulate loss of phase-to-ground voltage for each phase of normal source.
 - c. Verify time-delay settings.
 - d. Verify pickup and dropout voltages by data readout or inspection of control settings.
 - e. Test bypass/isolation unit functional modes and related automatic transfer-switch operations.
 - f. Perform contact-resistance test across main contacts and correct values exceeding 500 microhms and values for 1 pole deviating by more than 50 percent from other poles.
 - g. Verify proper sequence and correct timing of automatic engine starting, transfer time delay, retransfer time delay on restoration of normal power, and engine cool-down and shutdown.
5. Ground-Fault Tests: Coordinate with testing of ground-fault protective devices for power delivery from both sources.
- a. Verify grounding connections and locations and ratings of sensors.
- D. Testing Agency's Tests and Inspections:
1. After installing equipment and after electrical circuitry has been energized, test for compliance with requirements.
 2. Perform each visual and mechanical inspection and electrical test stated in NETA Acceptance Testing Specification. Certify compliance with test parameters.
 3. Measure insulation resistance phase-to-phase and phase-to-ground with insulation-resistance tester. Include external annunciation and control circuits. Use test voltages and procedure recommended by manufacturer. Comply with manufacturer's specified minimum resistance.
 - a. Check for electrical continuity of circuits and for short circuits.
 - b. Inspect for physical damage, proper installation and connection, and integrity of barriers, covers, and safety features.
 - c. Verify that manual transfer warnings are properly placed.
 - d. Perform manual transfer operation.
 4. After energizing circuits, demonstrate interlocking sequence and operational function for each switch at least three times.
 - a. Simulate power failures of normal source to automatic transfer switches and of emergency source with normal source available.
 - b. Simulate loss of phase-to-ground voltage for each phase of normal source.
 - c. Verify time-delay settings.
 - d. Verify pickup and dropout voltages by data readout or inspection of control settings.
 - e. Test bypass/isolation unit functional modes and related automatic transfer-switch operations.

- f. Perform contact-resistance test across main contacts and correct values exceeding 500 microhms and values for 1 pole deviating by more than 50 percent from other poles.
 - g. Verify proper sequence and correct timing of automatic engine starting, transfer time delay, retransfer time delay on restoration of normal power, and engine cool-down and shutdown.
 - 5. Ground-Fault Tests: Coordinate with testing of ground-fault protective devices for power delivery from both sources.
 - a. Verify grounding connections and locations and ratings of sensors.
- E. Coordinate tests with tests of generator and run them concurrently.
- F. Report results of tests and inspections in writing. Record adjustable relay settings and measured insulation and contact resistances and time delays. Attach a label or tag to each tested component indicating satisfactory completion of tests.
- G. Remove and replace malfunctioning units and retest as specified above.
- H. Prepare test and inspection reports.
- I. Infrared Scanning: After Substantial Completion, but not more than 60 days after Final Acceptance, perform an infrared scan of each switch. Remove all access panels so joints and connections are accessible to portable scanner.
 - 1. Follow-up Infrared Scanning: Perform an additional follow-up infrared scan of each switch 11 months after date of Substantial Completion.
 - 2. Instrument: Use an infrared scanning device designed to measure temperature or to detect significant deviations from normal values. Provide calibration record for device.
 - 3. Record of Infrared Scanning: Prepare a certified report that identifies switches checked and that describes scanning results. Include notation of deficiencies detected, remedial action taken, and observations after remedial action.

3.4 DEMONSTRATION

- A. Engage a factory-authorized service representative to train Owner's maintenance personnel to adjust, operate, and maintain transfer switches and related equipment as specified below. Refer to Division 01 Section "Demonstration and Training."
- B. Coordinate this training with that for generator equipment.

END OF SECTION

THIS PAGE INTENTIONALLY LEFT BLANK

SECTION 264113
LIGHTNING PROTECTION FOR STRUCTURES

PART 1 GENERAL

1.1 RELATED DOCUMENTS

- A. Drawings and general provisions of the Contract and Division 01 Specification Sections apply to this Section.

1.2 ACTION SUBMITTALS

- A. Product Data: For each type of product indicated.
- B. Shop Drawings: For air terminals and mounting accessories.
 - 1. Layout of the lightning protection system, along with details of the components to be used in the installation.
 - 2. Include indications for use of raceway, data on how concealment requirements will be met, and calculations required by NFPA 780 for bonding of grounded and isolated metal bodies.

1.3 INFORMATIONAL SUBMITTALS

- A. Qualification Data: For qualified Installer and manufacturer. Include data on listing or certification by UL.
- B. Certification, signed by Contractor, that roof adhesive is approved by manufacturer of roofing material.
- C. Field quality-control reports.
- D. Comply with recommendations in NFPA 780, Annex D, "Inspection and Maintenance of Lightning Protection Systems," for maintenance of the lightning protection system.
- E. Other Informational Submittals: Plans showing dimensioned as-built locations of grounding features, including the following:
 - 1. Ground rods.
 - 2. Ground loop conductor.

1.4 QUALITY ASSURANCE

- A. Installer Qualifications: Certified by UL, trained and approved for installation of units required for this Project.
- B. System Certificate:
 - 1. UL Master Label.
 - 2. UL Master Label Recertification.
- C. Electrical Components, Devices, and Accessories: Listed and labeled as defined in NFPA 780, "Definitions" Article.

1.5 COORDINATION

- A. Coordinate installation of lightning protection with installation of other building systems and components, including electrical wiring, supporting structures and building materials, metal bodies requiring bonding to lightning protection components, and building finishes.
- B. Coordinate installation of air terminals attached to roof systems with roofing manufacturer and Installer.
- C. Flashings of through-roof assemblies shall comply with roofing manufacturers' specifications.

PART 2 PRODUCTS

2.1 LIGHTNING PROTECTION SYSTEM COMPONENTS

- A. Comply with UL 96 and NFPA 780.

- B. Roof-Mounted Air Terminals: NFPA 780, Class I, aluminum or copper, unless otherwise indicated.
 - 1. Manufacturers: Subject to compliance with requirements, provide products by one of the following:
 - a. [Preferred Lightning Protection](#).
 - b. [Robbins Lightning, Inc.](#)
 - 2. Air Terminals More than 24 Inches Long: With brace attached to the terminal at not less than half the height of the terminal.
 - 3. Single-Membrane, Roof-Mounted Air Terminals: Designed specifically for single-membrane roof system materials. Comply with requirements in roofing Sections.
- C. Main and Bonding Conductors: Copper or Aluminum.
- D. Ground Loop Conductor: The same size and type as the main conductor except tinned.
- E. Ground Rods: Copper-clad steel; 3/4 inch in diameter by 10 feet long.
- F. Heavy-Duty, Stack-Mounted, Lightning Protection Components: Stainless steel, Solid copper, Monel metal or Lead sheathed.

PART 3 EXECUTION

3.1 INSTALLATION

- A. Install lightning protection components and systems according to UL 96A and NFPA 780.
- B. Install conductors with direct paths from air terminals to ground connections. Avoid sharp bends.
- C. Conceal the following conductors:
 - 1. System conductors.
 - 2. Down conductors.
 - 3. Interior conductors.
 - 4. Conductors within normal view of exterior locations at grade within 200 feet of building.
- D. Cable Connections: Use crimped or bolted connections for all conductor splices and connections between conductors and other components. Use exothermic-welded connections in underground portions of the system.
- E. Cable Connections: Use exothermic-welded connections for all conductor splices and connections between conductors and other components.
 - 1. Exception: In single-ply membrane roofing, exothermic-welded connections may be used only below the roof level.
- F. Air Terminals on Single-Ply Membrane Roofing: Comply with roofing membrane and adhesive manufacturer's written instructions.
- G. Bond extremities of vertical metal bodies exceeding 60 feet in length to lightning protection components.
- H. Ground Loop: Install ground-level, potential equalization conductor and extend around the perimeter of area or item indicated.
 - 1. Bury ground ring not less than 24 inches from building foundation.
 - 2. Bond ground terminals to the ground loop.
 - 3. Bond grounded building systems to the ground loop conductor within 12 feet of grade level.
- I. Bond lightning protection components with intermediate-level interconnection loop conductors to grounded metal bodies of building at 60-foot intervals.

3.2 SLEEVE AND SLEEVE-SEAL INSTALLATION FOR ELECTRICAL PENETRATIONS

- A. Install sleeves and sleeve seals at penetrations of exterior floor and wall assemblies. Comply with requirements in Division 26 Section "Sleeves and Sleeve Seals for Electrical Raceways and Cabling."

3.3 CORROSION PROTECTION

- A. Do not combine materials that can form an electrolytic couple that will accelerate corrosion in the presence of moisture unless moisture is permanently excluded from junction of such materials.
- B. Use conductors with protective coatings where conditions cause deterioration or corrosion of conductors.

3.4 FIELD QUALITY CONTROL

- A. Notify Architect at least 48 hours in advance of inspection before concealing lightning protection components.
- B. UL Inspection: Meet requirements to obtain a UL Master Label for system.
- C. LPI System Inspection: Meet requirements to obtain an LPI System Certificate.

END OF SECTION

THIS PAGE INTENTIONALLY LEFT BLANK

SECTION 265619
LED EXTERIOR LIGHTING

PART 1 GENERAL

1.1 RELATED DOCUMENTS

- A. Drawings and general provisions of the Contract and Division 01 Specification Sections apply to this Section.

1.2 DEFINITIONS

- A. CCT: Correlated color temperature.
- B. CRI: Color rendering index.
- C. Fixture: See "Luminaire."
- D. IP: International Protection or Ingress Protection Rating.
- E. Lumen: Measured output of lamp and luminaire, or both.
- F. Luminaire: Complete lighting unit, including lamp, reflector, and housing.

1.3 ACTION SUBMITTALS

- A. Product Data: For each type of luminaire.

1.4 INFORMATIONAL SUBMITTALS

- A. Coordination Drawings: Plans, drawn to scale, on which the following items are shown and coordinated with each other, using input from installers of the items involved:
 - 1. Luminaire.
 - 2. Photoelectric relay.
- B. Product Certificates: For each type of the following:
 - 1. Luminaire.
 - 2. Photoelectric relay.
- C. Sample warranty.

1.5 CLOSEOUT SUBMITTALS

- A. Operation and Maintenance Data:
 - 1. Provide a list of all lamp types used on Project. Use ANSI and manufacturers' codes.
 - 2. Provide a list of all photoelectric relay types used on Project; use manufacturers' codes.

1.6 FIELD CONDITIONS

- A. Verify existing and proposed utility structures prior to the start of work associated with luminaire installation.
- B. Mark locations of exterior luminaires for approval by Architect prior to the start of luminaire installation.

1.7 DELIVERY, STORAGE, AND HANDLING

- A. Package aluminum poles for shipping according to ASTM B 660.
- B. Store poles on decay-resistant-treated skids at least 12 inches above grade and vegetation. Support poles to prevent distortion and arrange to provide free air circulation.
- C. Retain factory-applied pole wrappings on metal poles until right before pole installation. For poles with nonmetallic finishes, handle with web fabric straps.

1.8 WARRANTY

- A. Special Warranty: Manufacturer's standard form in which manufacturer agrees to repair or replace products that fail in materials or workmanship; that corrode; or that fade, stain, perforate, erode, or chalk due to effects of weather or solar radiation within specified warranty period. Manufacturer may exclude lightning damage, hail damage, vandalism, abuse, or unauthorized repairs or alterations from special warranty coverage.
 - 1. Warranty Period for Luminaires: Five years from date of Substantial Completion.
 - 2. Warranty Period for Metal Corrosion: Five years from date of Substantial Completion.

3. Warranty Period for Color Retention: Five years from date of Substantial Completion.
4. Warranty Period for Poles: Repair or replace lighting poles and standards that fail in finish, materials, and workmanship within manufacturer's standard warranty period, but not less than three years from date of Substantial Completion.

PART 2 PRODUCTS

2.1 LUMINAIRE REQUIREMENTS

- A. Electrical Components, Devices, and Accessories: Listed and labeled as defined in NFPA 70, by a qualified testing agency, and marked for intended location and application.
- B. NRTL Compliance: Luminaires shall be listed and labeled for indicated class and division of hazard by an NRTL.
- C. FM Global Compliance: Luminaires for hazardous locations shall be listed and labeled for indicated class and division of hazard by FM Global.
- D. UL Compliance: Comply with UL 1598 and listed for wet location.
- E. Lamp base complying with ANSI C81.61.
- F. CRI of 80. CCT of 4100 K.
- G. L70 minimum lamp life of 35,000 hours.
- H. Nominal Operating Voltage: 120 V ac.
- I. Lamp Rating: Lamp marked for outdoor use and in enclosed locations.
- J. Source Limitations: Obtain luminaires from single source from a single manufacturer.
- K. Source Limitations: For luminaires, obtain each color, grade, finish, type, and variety of luminaire from single source with resources to provide products of consistent quality in appearance and physical properties.

2.2 LUMINAIRE TYPES

- A. Refer to Drawings.

2.3 MATERIALS

- A. Metal Parts: Free of burrs and sharp corners and edges.
- B. Sheet Metal Components: Corrosion-resistant aluminum or Stainless steel. Form and support to prevent warping and sagging.
- C. Doors, Frames, and Other Internal Access: Smooth operating, free of light leakage under operating conditions, and designed to permit relamping without use of tools. Designed to prevent doors, frames, lenses, diffusers, and other components from falling accidentally during relamping and when secured in operating position. Doors shall be removable for cleaning or replacing lenses.
- D. Diffusers and Globes:
 1. Acrylic Diffusers: 100 percent virgin acrylic plastic, with high resistance to yellowing and other changes due to aging, exposure to heat, and UV radiation.
 2. Glass: Annealed crystal glass unless otherwise indicated.
 3. Lens Thickness: At least 0.125 inch minimum unless otherwise indicated.
- E. Lens and Refractor Gaskets: Use heat- and aging-resistant resilient gaskets to seal and cushion lenses and refractors in luminaire doors.
- F. Reflecting surfaces shall have minimum reflectance as follows unless otherwise indicated:
 1. White Surfaces: 85 percent.
 2. Specular Surfaces: 83 percent.
 3. Diffusing Specular Surfaces: 75 percent.
- G. Housings:

1. Rigidly formed, weather- and light-tight enclosure that will not warp, sag, or deform in use.
2. Provide filter/breather for enclosed luminaires.

2.4 FINISHES

- A. Variations in Finishes: Noticeable variations in same piece are unacceptable. Variations in appearance of adjoining components are acceptable if they are within the range of approved Samples and are assembled or installed to minimize contrast.
- B. Luminaire Finish: Manufacturer's standard paint applied to factory-assembled and -tested luminaire before shipping. Where indicated, match finish process and color of pole or support materials.
- C. Factory-Applied Finish for Aluminum Luminaires: Comply with NAAMM's "Metal Finishes Manual for Architectural and Metal Products" for recommendations for applying and designating finishes.
 1. Finish designations prefixed by AA comply with the system established by the Aluminum Association for designating aluminum finishes.
 2. Natural Satin Finish: Provide fine, directional, medium satin polish (AA-M32); buff complying with AA-M20 requirements; and seal aluminum surfaces with clear, hard-coat wax.
 3. Class I, Clear-Anodic Finish: AA-M32C22A41 (Mechanical Finish: Medium satin; Chemical Finish: Etched, medium matte; Anodic Coating: Architectural Class I, clear coating 0.018 mm or thicker) complying with AAMA 611.
 4. Class I, Color-Anodic Finish: AA-M32C22A42/A44 (Mechanical Finish: Medium satin; Chemical Finish: Etched, medium matte; Anodic Coating: Architectural Class I, integrally colored or electrolytically deposited color coating 0.018 mm or thicker), complying with AAMA 611.
 - a. Color: Bronze.

2.5 GENERAL REQUIREMENTS FOR POLES AND SUPPORT COMPONENTS

- A. Structural Characteristics: Comply with AASHTO LTS-4-M.
 1. Wind-Load Strength of Poles: Adequate at indicated heights above grade without failure, permanent deflection, or whipping in steady winds of speed indicated in "Structural Analysis Criteria for Pole Selection" Article.
 2. Strength Analysis: For each pole, multiply the actual equivalent projected area of luminaires and brackets by a factor of 1.1 to obtain the equivalent projected area to be used in pole selection strength analysis.
- B. Luminaire Attachment Provisions: Comply with luminaire manufacturers' mounting requirements. Use stainless-steel fasteners and mounting bolts unless otherwise indicated.
- C. Mountings, Fasteners, and Appurtenances: Corrosion-resistant items compatible with support components.
 1. Materials: Shall not cause galvanic action at contact points.
 2. Anchor Bolts, Leveling Nuts, Bolt Caps, and Washers: Hot-dip galvanized after fabrication unless otherwise indicated.
 3. Anchor-Bolt Template: Plywood or steel.
- D. Handhole: Oval-shaped, with minimum clear opening of 2-1/2 by 5 inches, with cover secured by stainless-steel captive screws. Provide on all, except wood poles.
- E. Concrete Pole Foundations: Cast in place, with anchor bolts to match pole-base flange. Concrete, reinforcement, and formwork are specified in Division 03 Section "Cast-in-Place Concrete."

2.6 STEEL POLES

- A. Poles: Comply with ASTM A 500, Grade B, carbon steel with a minimum yield of 46,000 psig; one-piece construction up to 40 feet in height with access handhole in pole wall.
 1. Shape: As scheduled.

2. Mounting Provisions: Butt flange for bolted mounting on foundation or breakaway support.
- B. Steel Mast Arms: Single-arm, Truss or Davit type, continuously welded to pole attachment plate. Material and finish same as pole.
- C. Brackets for Luminaires: Detachable, cantilever, without underbrace.
 1. Adapter fitting welded to pole, allowing the bracket to be bolted to the pole mounted adapter, then bolted together with stainless-steel bolts.
 2. Cross Section: Tapered oval, with straight tubular end section to accommodate luminaire.
 3. Match pole material and finish.
- D. Pole-Top Tenons: Fabricated to support luminaire or luminaires and brackets indicated, and securely fastened to pole top.
- E. Steps: Fixed steel, with nonslip treads, positioned for 15-inch vertical spacing, alternating on opposite sides of pole; first step at elevation 10 feet above finished grade.
- F. Intermediate Handhole and Cable Support: Weathertight, 3-by-5-inch handhole located at midpoint of pole with cover for access to internal welded attachment lug for electric cable support grip.
- G. Grounding and Bonding Lugs: Welded 1/2-inch threaded lug, complying with requirements in Division 26 Section "Grounding and Bonding for Electrical Systems," listed for attaching grounding and bonding conductors of type and size listed in that Section, and accessible through handhole.
- H. Cable Support Grip: Wire-mesh type with rotating attachment eye, sized for diameter of cable and rated for a minimum load equal to weight of supported cable times a 5.0 safety factor.
- I. Platform for Lamp and Ballast Servicing: Factory fabricated of steel with finish matching that of pole.
- J. Prime-Coat Finish: Manufacturer's standard prime-coat finish ready for field painting.
- K. Galvanized Finish: After fabrication, hot-dip galvanize complying with ASTM A 123/A 123M.
- L. Factory-Painted Finish: Comply with NAAMM's "Metal Finishes Manual for Architectural and Metal Products" for recommendations for applying and designating finishes.
 1. Surface Preparation: Clean surfaces to comply with SSPC-SP 1, "Solvent Cleaning," to remove dirt, oil, grease, and other contaminants that could impair paint bond. Grind welds and polish surfaces to a smooth, even finish. Remove mill scale and rust, if present, from uncoated steel, complying with SSPC-SP 5/NACE No. 1, "White Metal Blast Cleaning," or with SSPC-SP 8, "Pickling."
 2. Interior Surfaces of Pole: One coat of bituminous paint, or otherwise treat for equal corrosion protection.
 3. Exterior Surfaces: Manufacturer's standard finish consisting of one or more coats of primer and two finish coats of high-gloss, high-build polyurethane enamel.

2.7 ALUMINUM POLES

- A. Poles: Seamless, extruded structural tube complying with ASTM B 429/B 429M, Alloy 6063-T6 with access handhole in pole wall.
- B. Poles: ASTM B 209 (ASTM B 209M), 5052-H34 marine sheet alloy with access handhole in pole wall.
 1. Shape: As Scheduled.
 2. Mounting Provisions: Butt flange for bolted mounting on foundation or breakaway support.
- C. Pole-Top Tenons: Fabricated to support luminaire or luminaires and brackets indicated, and securely fastened to pole top.

- D. Grounding and Bonding Lugs: Welded 1/2-inch threaded lug, complying with requirements in Division 26 Section "Grounding and Bonding for Electrical Systems," listed for attaching grounding and bonding conductors of type and size listed in that Section, and accessible through handhole.
- E. Brackets for Luminaires: Detachable, with pole and adapter fittings of cast aluminum. Adapter fitting welded to pole and bracket, then bolted together with stainless-steel bolts.
 - 1. Tapered oval cross section, with straight tubular end section to accommodate luminaire.
 - 2. Finish: Same as luminaire.
- F. Prime-Coat Finish: Manufacturer's standard prime-coat finish ready for field painting.
- G. Aluminum Finish: Comply with NAAMM's "Metal Finishes Manual for Architectural and Metal Products" for recommendations for applying and designating finishes.
 - 1. Finish designations prefixed by AA comply with the system established by the Aluminum Association for designating aluminum finishes.
 - 2. Natural Satin Finish: Provide fine, directional, medium satin polish (AA-M32); buff complying with AA-M20; and seal aluminum surfaces with clear, hard-coat wax.
 - 3. Class I, Clear Anodic Finish: AA-M32C22A41 (Mechanical Finish: medium satin; Chemical Finish: etched, medium matte; Anodic Coating: Architectural Class I, clear coating 0.018 mm or thicker) complying with AAMA 611.
 - 4. Class I, Color Anodic Finish: AA-M32C22A42/A44 (Mechanical Finish: medium satin; Chemical Finish: etched, medium matte; Anodic Coating: Architectural Class I, integrally colored or electrolytically deposited color coating 0.018 mm or thicker) complying with AAMA 611.

PART 3 EXECUTION

3.1 GENERAL INSTALLATION REQUIREMENTS

- A. Comply with NECA 1.
- B. Use fastening methods and materials selected to resist seismic forces defined for the application and approved by manufacturer.
- C. Install lamps in each luminaire.
- D. Fasten luminaire to structural support.
- E. Supports:
 - 1. Sized and rated for luminaire weight.
 - 2. Able to maintain luminaire position after cleaning and re-lamping.
 - 3. Support luminaires without causing deflection of finished surface.
 - 4. Luminaire-mounting devices shall be capable of supporting a horizontal force of 100 percent of luminaire weight and a vertical force of 400 percent of luminaire weight.
- F. Wall-Mounted Luminaire Support:
 - 1. Attached to a minimum 1/8 inch backing plate attached to wall structural members.
- G. Wiring Method: Install cables in raceways. Conceal raceways and cables.
- H. Install luminaires level, plumb, and square with finished grade unless otherwise indicated.
- I. Coordinate layout and installation of luminaires with other construction.
- J. Adjust luminaires that require field adjustment or aiming. Include adjustment of photoelectric device to prevent false operation of relay by artificial light sources, favoring a north orientation.
- K. Comply with requirements in Section 260519 "Low-Voltage Electrical Power Conductors and Cables" and 260533 "Raceways and Boxes for Electrical Systems" for wiring connections and wiring methods.

3.2 POLE INSTALLATION

- A. Alignment: Align pole foundations and poles for optimum directional alignment of luminaires and their mounting provisions on the pole.
- B. Concrete Pole Foundations: Set anchor bolts according to anchor-bolt templates furnished by pole manufacturer. Concrete materials, installation, and finishing requirements are specified in Division 03.
- C. Foundation-Mounted Poles: Mount pole with leveling nuts, and tighten top nuts to torque level recommended by pole manufacturer.
 - 1. Use anchor bolts and nuts selected to resist seismic forces defined for the application and approved by manufacturer.
 - 2. Grout void between pole base and foundation. Use nonshrink or expanding concrete grout firmly packed to fill space.
 - 3. Install base covers unless otherwise indicated.
 - 4. Use a short piece of 1/2-inch- diameter pipe to make a drain hole through grout. Arrange to drain condensation from interior of pole.
- D. Raise and set poles using web fabric slings (not chain or cable).

3.3 CORROSION PREVENTION

- A. Aluminum: Do not use in contact with earth or concrete. When in direct contact with a dissimilar metal, protect aluminum by insulating fittings or treatment.
- B. Steel Conduits: Comply with Section 260533 "Raceways and Boxes for Electrical Systems." In concrete foundations, wrap conduit with 0.010-inch-thick, pipe-wrapping plastic tape applied with a 50 percent overlap.

3.4 FIELD QUALITY CONTROL

- A. Inspect each installed luminaire for damage. Replace damaged luminaires and components.
- B. Perform the following tests and inspections:
 - 1. Operational Test: After installing luminaires, switches, and accessories, and after electrical circuitry has been energized, test units to confirm proper operation.
 - 2. Verify operation of photoelectric controls.
- C. Luminaire will be considered defective if it does not pass tests and inspections.
- D. Prepare a written report of tests, inspections, observations, and verifications indicating and interpreting results. If adjustments are made to lighting system, retest to demonstrate compliance with standards.

END OF SECTION

SECTION 312000
EARTH MOVING

PART 1 GENERAL

1.1 SUMMARY

- A. Provide all operations necessary to complete site clearing; stockpiling; dewatering; excavations; embankments and backfilling; subgrade preparation; aggregate base; placement of topsoil; and finish grading.
- B. Construct and maintain all temporary drainage swales, berms and diversions; furnish, operate, and maintain all necessary pumping and other equipment for dewatering. After above items serve their purpose, remove them and restore site.
- C. Excavation will be unclassified, and the term "excavation" shall include all material encountered without regard to its physical properties, characteristics or composition.

1.2 LIMITS OF THE WORK

- A. Earthwork shall not extend beyond the areas of excavation, embankment or other construction shown on the drawings.
- B. Contractor shall install construction fencing or other visible barrier around trees and other areas that need to be protected from the earthwork prior moving equipment into that area.
- C. Excavations for new construction shall not undercut existing footings, foundations, or surfacing.
- D. Blasting with any type of explosive will not be permitted, unless shown otherwise in these Specifications.

1.3 SAFETY AND PROTECTION

- A. Shoring, sheeting, and bracing shall be provided as required to protect the work and workmen from damage or injury by caving or sloughing.
- B. Laws and ordinances regulating health and safety measures shall be practiced.

- A. Submit shop drawings in accordance with Section 013300.
- B. None required unless material gradations are requested by Owner's Representative.
- C. Material Gradations.
- D. Standard Proctor Curves for Site and Borrow Materials.
- E. Test results for all proposed imported materials. Test results shall include the Unified Soil Classification System designation, the Liquid Limit (LL), and the Plasticity Index (PI) for each material.
- F. The Contractor shall provide a minimum three gallon sample of each proposed material.

1.4 COMPACTION TESTING

- A. Sample backfill materials for the density testing shall be taken according to ASTM D75.
- B. Determine the density of soil in place by the sand cone method ASTM D 1556; rubber-balloon method ASTM D2167; or nuclear method ASTM D 2922.
- C. Compaction is the calculated ratio of the in-place (dry) density to the laboratory maximum (dry) density expressed as a percentage.
- D. Determine laboratory moisture-density relations of soils according to the ASTM test method identified in the specific subsection.
- E. If the Owner is responsible for compaction testing, the Contractor shall pay the costs of any retesting of work not conforming to specifications.
- F. The following table identifies the compaction required based on the location of the soil.

LOCATION	COMPACTION DENSITY
Under paved areas, sidewalks and piping	90% of ASTM D 1557 or 95% of ASTM D698
Unpaved areas	85% of ASTM D698
Inside of structures under foundations, under equipment support pads, under slabs-on-grade and scarified existing subgrade under fill material	90% of ASTM D1557 or 95% of ASTM D698
Outside structures next to walls, piers, columns and any other structure exterior members	90% of ASTM D1557 or 85% of ASTM D698
Outside structures under equipment support foundations *	95% of ASTM D1557 or 100% of ASTM D698
Granular fill under base slabs and building floor slabs on grade	75% relative density per ASTM D4253 and ASTM D4254
Structural fill for over excavations	90% of ASTM D1557 or 95% of ASTM D698
*Granular fill or flowable fill may be substituted	

1.5 FREQUENCY OF TESTING

- A. Tests of the fill materials and embankments will be made at the following approximate rates or as deemed necessary by the Owner's Representative.
 - 1. One field density test for each 300 square yards of subgrade prior to placing fill.
 - 2. One field density test for each 100 cubic yards of fill placed or each layer of fill for each work area, whichever is greater.
 - 3. One moisture-density curve for each type material used, as indicated by sieve analysis and plasticity index.
 - 4. Field density and moisture test may be determined by current ASTM sand cone, or nuclear methods.

1.6 COMPACTION METHODS

- A. Obtain compaction of backfill and embankment by mechanical means. Jetting or flooding is not permitted. Compact each layer with mechanical tampers. Do not place backfill at hydraulic structures until hydraulic testing has been completed. Do not place backfill against cantilevered walls until design strength of concrete has been reached. Do not place backfill against walls supported at the top by floor

slabs until design strength has been reached.

- B. Use light vibratory or hand tamping equipment adjacent to the wall. Take particular care compacting around pipe spools. Do not use heavy compaction equipment within a horizontal distance from the wall equal to the height of the wall.

PART 2 PRODUCTS

2.1 EXCAVATED MATERIALS

- A. Topsoil obtained by stripping and suitable for finish grading where arable soil is required shall be stockpiled for future use.
- B. Material from the excavation is considered to be an acceptable backfill material provided it is free of vegetal matter, roots, debris, frozen matter, and stones larger than 3 inches in the greatest dimension.
- C. Moisture content is to be maintained at a level sufficient to obtain the specified compaction.

2.2 IMPERMEABLE MATERIAL FOR BACKFILL AND EMBANKMENTS

- A. Impermeable material for backfill and embankments shall be materials classified as CL, CL/CH, CH, or MH as defined by the Unified Soil Classification System. This material shall be free of organic matter, roots, debris, and particles larger than 1 inch in greatest dimension. Submit documentation that material meets this criteria.

2.3 STRUCTURAL FILL

- A. Material for Low Volume Change Structural Fill below structures shall be materials classified as CL, CL/CH, or CH, as defined by the United Soil Classification System. Material shall have a Liquid Limit of less than 45 and a Plasticity Index of less than 20. This material shall be free of organic matter, roots, debris, and particles larger than 1 inch in greatest dimension. Submit documentation that material meets this criteria. Most on-site material can be used as low volume change structural fill.
- B. Material for other Structural Fill below structures shall be materials classified as CL, CL/CH, or CH, as defined by the United Soil Classification System. Material shall have a Liquid Limit of less than 60, and a Plasticity Limit of less than 30. Submit documentation that material meets this criteria. Most on-site material can be used as low volume change structural fill.

2.4 AGGREGATE BASE MATERIAL

- A. Aggregates for granular bases shall be meet Kentucky DOT specifications.
- B. Aggregates for granular base shall meet the following gradation:

Sieve Size	Percent Passing by Weight
1 1/2 inch	100
1 inch	95-100
1/2 inch	25-65
3/8 inch	5-55
No. 4	0-10

2.5 WATER FOR COMPACTION

- A. Water shall be clean and free of acid, alkali, or organic materials and shall have a pH of 7.0 to 9.0, a maximum chloride concentration of 500 mg/l. Provide temporary tanker trucks, equipment and materials to convey water from the source to the point of use.

PART 3 EXECUTION

3.1 SITE CLEARING

- A. See Section 311000.

3.2 STOCKPILING OF TOPSOIL

- A. Topsoil shall be removed to a depth of one foot. The depth of topsoil may vary throughout the project. Topsoil shall be stockpiled for use in finishing operations.
- B. Protect the stockpile with erosion and sediment controls to prevent loss of material leaving the site.

3.3 OPEN EXCAVATIONS AND STOCKPILES

- A. Provide diversion ditches and dams upstream of disturbed areas to minimize water from entering excavated areas. Construct and maintain all temporary drainage swales, berms and diversions until permanent erosion and sediment controls are established.
- B. Provide erosion and sediment BMPs to controls for non-vegetated surfaces.
- C. When storing excess excavated material, do not obstruct surface drainage or existing waterways with the stockpiles.
- D. See Section 015713 and comply with the SWPPP.

3.4 DEWATERING

- A. Furnish, operate, and maintain all necessary pumping and other equipment for dewatering at all times during construction to remove and dispose of all water from any source from all excavations.
- B. Use methods which will ensure dry excavations and preserve the final lines and grades of the excavation. Methods used may include well points, sump pumps, suitable rock or gravel drains, temporary pipelines, or other acceptable means. Dewater so that floor or footing concrete will not be placed in water. Do not allow water to rise against walls or above footings and slabs.
- C. Dispose of water in a manner that will not damage adjacent property or be a menace to public health. Provide a copy of written permission from the owner of property over which water will pass, become a nuisance, or become impounded. Water may be discharged into the public road ditches located adjacent to the project site.
- D. Excavations that may entrap snow and subject the subgrade soils to a change in the moisture content shall not be left open during winter construction shut-down periods. Any snow that does become entrapped in excavations shall be removed within twenty-four hours.

3.5 GENERAL EXCAVATION

- A. Perform all material conditioning and excavations required. Excavation includes the removal and selected disposal of all excess or unsuitable materials of whatever nature.
- B. Excavate to full depth and width required to accommodate the lines and grades shown on the Drawings. Remove all materials which become blown or washed into excavations.
- C. Contractor shall select sloping or near-vertical trench and structure excavation slopes as he finds compatible with the soil conditions. The Contractor shall select any shoring which he deems appropriate and compatible with the soil conditions. These selections shall be exercised as a portion of the Contractor's responsibility for safety of site operations. The Contractor is responsible for conforming to OSHA requirements as may be applicable during structural excavating, trench excavations, site work, and in other areas of the work.
- D. Excavated material which meets required specifications may be used in embankments or backfill when approved and accepted.
- E. Remove from the site unsuitable materials such as large rocks, excessive organic materials and excess excavation material.

3.6 ROCK EXCAVATION

- A. All rock excavation shall be under one classification, which shall include solid ledge rock in its natural location that requires systematic quarrying, drilling and/or blasting for its removal and also boulders that exceed 1/2 cubic yard in volume.
- B. When rock is encountered, strip free of earth.
- C. The use of explosives shall be limited to the magnitude and location of the charge that will not cause damage to adjacent existing construction and utilities through shock vibrations or other stress loadings.
 - 1. Provide adequate blanket protection to ensure that there will not be fragments of rock or other debris flying through the air when discharging explosives.
 - 2. Contractor to employ personnel certified by appropriate regulatory authority to execute blasting operations if the Owner or local jurisdiction requires such certification.
 - 3. Explosive permits shall be obtained from appropriate local and state authorities.
 - 4. Where explosives and blasting are used, comply with all laws and ordinances of municipal, state and Federal agencies relating to the use of explosives.
 - a. Use qualified personnel for blasting and take proper precautions to protect persons, property

- or the work from damage or injury from blast or explosion.
- b. Conduct preblast survey in the company of the Owner's Representative to aid in determining any damage caused by blasting.
- c. Any damage to existing construction or other features caused by blasting operations to be repaired and paid for by Contractor.

3.7 EMBANKMENTS

- A. Place all embankments to lines and grades shown. Areas to be covered with topsoil shall be underfilled so the finished lines conform after topsoil placement. Protect and maintain embankments during the course of construction. Replace all materials lost due to storm damage until permanent stabilization. Use materials obtained during excavation or imported materials. Do not use brush, sod, or other unsuitable materials in embankments.
- B. No embankment shall be constructed on frozen material, nor shall organic material be used for embankment.
- C. When an embankment is to be placed against a hillside or existing embankment whose slopes are steeper than 4:1; the existing slope shall be continuously benched in approximately 24 inches rises as the new fill is brought up on lifts as specified below. The material bladed out, the bottom of the area cut into, and the embankment material being placed shall be compacted to the required density.
- D. In fill sections, place material in loose lifts not exceeding 8 inches; brought to within 2% to +4% of optimum moisture content. Bring up each lift uniformly over the entire area being filled and compact each lift to its required density.
- E. Maintain the proper moisture content in the uppermost layer. If placing of materials is interrupted and the material dries, bring to proper moisture content before resuming by sprinkling, cultivating, and rolling to the required compaction. Do not place or roll material during rainfall of sufficient intensity to materially increase the moisture content. If any material placed in embankment acquires a greater moisture content than is suitable for compaction, allow to dry or remove. If removed, recondition the new surface before placing new material. Repair any irregularities caused by erosion by excavating, cultivating, filling, and compacting.

3.8 STRUCTURAL EXCAVATION

- A. Structural excavation is the removal of all materials of whatever nature to approved structural subgrade and as necessary for construction of structures and foundations. Approved structural subgrade is that material which has been observed by the Engineer and upon which structural foundations or other materials may be placed. Locate limits of excavation for structures with formed vertical surfaces at least 5 feet from the extreme outside of the structure to the toe of the cut slope or at a 1:1 slope as detailed on the drawings, whichever is greater.
- B. Design excavations in the proximity of adjacent structures so as to protect the structures from damage or undermining. Design and install shoring if necessary. Side slopes of excavation shall be only as steep as is safe for material to stand. Avoid unnecessary disturbance of adjacent ground.
- C. Subgrade Preparation
 1. Remove all existing "fill", loose natural clays, sand, and compressible materials under proposed structures. Provide a relatively smooth subgrade.
 2. The exposed bottoms of excavations shall consist of undisturbed native material.
 3. Where excavation is inadvertently carried beyond the design elevation or approved structural subgrade, adjust the construction as directed to meet the structural requirements. Over excavations shall be backfilled with graded structural fill compacted to the required density, or adjust the construction as required to meet the structural requirements as approved by the Owner's Representative.

3.9 BACKFILL AROUND STRUCTURES

- A. Place backfill in 6-inch uniform loose lifts and compact to the required density. Larger lifts may be utilized if it is demonstrated to the Owner's Representative that satisfactory results can be obtained.
- B. Use a minimum of 1 foot impermeable backfill for the top layer to prevent surface water from infiltrating next to walls.

3.10 SUBGRADE PREPARATION FOR DRIVE AREAS

- A. Roads, drives and pads shall be graded to grades designated in Drawings.
- B. Soil shall be free of organic material, trash and debris, and rocks larger than three inches in any dimension, and shall not be frozen while construction is in progress.

- C. The subgrade shall be plowed or diced to a depth of 8 inches and the loosened material compacted to the required cross-section elevation.
- D. Subgrade shall be compacted to minimum of 95% of ASTM D698.
- E. Compacted subgrade must support the weight of vehicles and equipment without producing ruts in the surface. Owner's Representative may require Contractor to demonstrate subgrade adequacy by requiring Contractor to move fully loaded equipment across compacted subgrade.
- F. Should rock be encountered, it shall be removed to a depth of one foot below the top of the subgrade and fill material placed and compacted as provided above.

3.11 PROTECTION

- A. Subgrade shall be repaired from action of the elements or others. Any settlement or erosion that occurs prior to placing the aggregate base shall be repaired to the specific line, grade and cross-section. Any subgrade that has become unacceptable shall be reworked as necessary to restore the subgrade to shape, tolerance, density, and moisture content range for such density, immediately prior to the placing of the aggregate base.
- B. The Contractor shall protect all existing improvements from damage resulting from his subgrade operation. Any improvement damaged shall be repaired or replaced by the Contractor at his own expense.

3.12 PLACEMENT OF TOPSOIL

- A. All areas where topsoil is to be placed shall be scarified to a depth of 6" minimum by means of discing, harrowing or culti-packing.
- B. Topsoil shall be spread evenly to a depth of at least 6-inches, smooth and true to the lines and grades as indicated on the Plans, and ready to receive seed and fertilizer. Seedbed areas shall be free of trash, debris and rocks over 2" in size.

3.13 DISPOSAL OF MATERIAL

- A. Excess earth material shall be transported to onsite storage area by Contractor. The Contractor shall not dispose of any excavated material until there is sufficient material to complete all necessary project embankments and fill areas.
- B. Material not suitable for embankment, fill or backfill shall be disposed of off-site at a location determined by the Owner's Representative. Transportation of such material and any disposal fees shall be provided by the Contractor.
- C. Material in excess of requirements for embankment, fill or backfill shall be disposed of on-site or at locations determined by Owner's Representative. Transportation of such material and any disposal fees shall be provided by the Contractor.

3.14 FINISH GRADING

- A. Upon completion of the work, clean the entire site area affected of trash and debris, and grade the surface smooth to drain so that no depressions, vehicle tracks, or ridges are left which could accumulate rainwater.

END OF SECTION

SECTION 312333
TRENCHING AND BACKFILLING

PART 1 GENERAL

1.1 SUMMARY

- A. This section includes materials and installation for trench excavation, backfilling, and compacting.
- B. Sheeting, shoring, bracing, and protection of adjacent property, trees, and structures.
- C. Preparation of subgrades, bedding for pipe, backfilling, and disposal of excess excavation.

1.2 SUBMITTALS

- A. Submit shop drawings in accordance with the Section 013300.
- B. All specified bedding and backfill material, except earth excavated material.
- C. Moisture-Density test for each backfill material.
- D. Sheeting, shoring and bracing design calculations by a registered professional engineer licensed in the State.

1.3 DEFINITIONS

- A. Pipe Embedment Zone - The full width of trench from both below and above the bottom of the pipe or conduit to a horizontal level above the top of the pipe as defined by the embedment class or as shown on the details.
- B. Trench Zone - The portion of the trench from the pipe embedment zone to finished grade in unpaved areas, and to the bottom of the drive zone in drive areas.
- C. Pipe Cover - The distance from the top of the finished grade of the trench to the top of the waterline pipe.
- D. Aggregate Pipe Base - A layer of material below the pipe embedment zone to stabilize the bottom of the trench and provide uniform bearing of the pipe and pipe embedment.
- E. Class A Excavated Material
 - 1. Hard shale, sandstone, limestone, granite or similar materials which is encountered in monolithic ledges greater than 8" in thickness and which, in the opinion of the Owner's Representative, require jackhammering, use of a special headache ball or hydrohammer for removal. A toothed bucket is not considered as special "ripping" equipment.
 - 2. Two or more ledges with inter-lying strata of earth, clay, or gravel not more than eight (8) inches in thickness in each strata will be classified as a solid monolithic formation from the top of the top ledge to the bottom of the bottom ledge. Boulders that are encountered within glacial till or other soil and are not a portion of a continuous monolithic formation shall not be considered
- F. Unclassified Excavated Material - All earth or other materials that do not meet the requirements of Class A excavated material.

1.4 COMPACTION TESTING

- A. An independent geotechnical firm hired by General Contractor will test perform material testing and field compaction testing.
- B. Material testing for each backfill material shall be two moisture density tests or two relative density tests according to the appropriate ASTM specification.
- C. Minimum testing frequency for in-place field shall be:
 - 1. One test for every 200 cubic yards of backfill for site backfill with a minimum of one test for every full shift of compaction operation on mass earthwork.
 - 2. One test at intervals of 500 feet along the trench.
 - 3. One in-place field density test whenever there is a suspicion of a change in backfill material, quality of moisture or effectiveness of compaction.
- D. Sample backfill materials for the density testing shall be taken according to ASTM D75.
- E. Determine the density of soil in place by the sand cone method ASTM D 1556, rubber-balloon method ASTM D2167; or nuclear method ASTM D 2922.
- F. Compaction is the calculated ratio of the in-place (dry) density to the laboratory maximum (dry) density expressed as a percentage.

- G. Determine laboratory moisture-density relations of soils according to the ASTM test method identified in the specific subsection.
- H. If the Owner is responsible for compaction testing, the Contractor shall pay the costs of any retesting of work not conforming to specifications.
- I. The following table identifies the compaction required based on the location of the trench.
 - 1. LOCATION/COMPACTION DENSITY
 - a. Under paved areas, sidewalks, and pipe crossings: 95% of ASTM D698
 - b. Under foundations and equipment support pads: 95% of ASTM D698
 - c. Unpaved areas: 85% of ASTM D698
 - d. Granular backfill: 75% relative density per ASTM D4253 and ASTM D4254

PART 2 PRODUCTS

2.1 PIPE EMBEDMENT MATERIAL

- A. Native earth material which is fine, loose material, free from stones 1-inch and larger, hard frozen clods, and other material that may cause damage to the pipe, organic matter and debris that will deteriorate and cause voids.
- B. Rigid Pipe - Bedding Classes A, B, C or crushed rock, as described in ASTM C12.
- C. Ductile Iron Pipe - Type 1 through Type 5 laying conditions, as described in ASTM A746.
- D. PVC and other Flexible Pipe - Classes I, II, III, as described in ASTM D2321.
- E. Composite Pipe - Same as Flexible Pipe except as described in ASTM D2680.

2.2 GRANULAR BACKFILL MATERIAL

- A. Granular material shall meet the following gradation:
 - 1. Sieve Size 1 inch, Percent Passing By Weight: 100%
 - 2. Sieve Size 3/4 inch, Percent Passing By Weight: 85-100%
 - 3. Sieve Size 3/8 inch, Percent Passing By Weight: 50-80%
 - 4. Sieve Size No. 4, Percent Passing By Weight: 35-60%
 - 5. Sieve Size No. 40, Percent Passing By Weight: 15-30%
 - 6. Sieve Size No. 200, Percent Passing By Weight: 5-10%
- B. The granular material shall not contain clay lumps or organic matter. The fraction passing the No. 4 sieve shall have liquid limits no greater than 25 and a plasticity index no greater than 5. The material shall meet the quality requirements of ASTM C33.

2.3 AGGREGATE PIPE BASE MATERIAL

- A. The aggregate base material shall consist of crushed rock or gravel; free from dust, clay and trash; be hard, durable, non-friable and meet the gradation as defined in ASTM C33 for No. 76 coarse aggregate or the following gradation:
 - 1. Sieve Size 3/4 inch; Percent Passing By Weight: 100%
 - 2. Sieve Size No. 4; Percent Passing By Weight: 0-35%
 - 3. Sieve Size No. 8; Percent Passing By Weight: 0-17%
 - 4. Sieve Size No. 200; Percent Passing By Weight: 0-10%
- B. Other gradations may be utilized provided all the material passes the 3/4 sieve and it can be demonstrated that they provide adequate base support for the pipe.
- C. The aggregate material shall meet the quality requirements of ASTM C33.

PART 3 EXECUTION

3.1 PREPARATION

- A. Verify that survey bench marks and intended elevations for the Work are as shown on drawings.
- B. Identify required lines, levels, contours, and datum.
- C. Identify by visible markings all plant life, trees, lawns, fences and other features that are to be protected.
- D. Protect bench marks from excavation equipment and vehicular traffic.
- E. Existing underground installations such as water mains, gas mains, sewers, telephone lines, power lines, and buried structures in the vicinity of the work to be done hereunder are indicated on the

drawings only to the extent such information has been made available to or discovered by the Engineer in preparing the drawings. There is no guarantee as to the accuracy or completeness of such information, and all responsibility for the accuracy and completeness thereof is expressly disclaimed. Generally, service connections are not indicated on the drawings.

- F. The Contractor shall be solely responsible for locating all existing underground installations, including service connections in advance of excavating or trenching by contacting the owners thereof and prospecting. The Contractor shall use his own information and shall not rely upon any information shown on the drawings concerning existing underground installations.
- G. Where utilities are parallel to or cross the construction but do not conflict with the permanent work to be constructed, follow the procedures given below or as indicated in the drawings. Notify the utility owner 48 hours in advance of the crossing construction and coordinate the construction schedule with the utility owner's requirements.
- H. Determine the true location and depth of utilities and service connections which may be affected by or affect the work. Determine the type, material, and condition of these utilities. In order to provide sufficient lead time to resolve unforeseen conflicts, order materials and take appropriate measures to ensure that there is no delay in

3.2 SHEETING, SHORING, AND BRACING OF TRENCHES

- A. Sheeting and bracing, or trench boxes shall be provided where necessary to conform to 29CFR1926 Subpart P-Excavations, OSHA requirements.
- B. Where it is necessary to drive sheeting below the centerline of the pipe, it shall be driven to a depth of at least 2 feet below the flow line of the pipe, or as directed by the geotechnical engineer.

3.3 TRENCH WIDTHS

- A. Trench widths shall be as shown in the drawings.
- B. The width of the trench shall be ample to allow the pipe to be laid and jointed properly and to allow the bedding and haunching to be placed and compacted to adequately support the pipe. The trench sides shall be kept as nearly vertical as possible. When wider trenches are specified, appropriate bedding class and pipe strength shall be used.
- C. In unsupported, unstable soil the size and stiffness of the pipe, stiffness of the embedment and in-situ soil and depth of cover shall be considered in determining the minimum trench width necessary to adequately support the pipe
- D. Ledge rock, boulders, and large stones shall be removed to provide a minimum clearance of 4-inches below and on each side of the pipe.
- E. Trench width at the top of the trench will not be limited except where width of excavation would undercut adjacent structures and footings. In such case, width of trench shall be a minimum clearance of the trench wall to outside pipe being a minimum of 4-inches, and that there is at least 24-inch clearance between the top edge of the trench and the structure or footing.

3.4 MINIMUM PIPE COVER

- A. Pipeline Location: Non-Paved Areas, Cover - 42 inches
- B. Pipeline Location: Paved Areas, Cover - 42 inches
- C. Pipeline Location: Under ditches and minor drainage courses, Cover - 4 feet
- D. Pipeline Location: Under rivers and streams, Cover - 4 feet
- E. Pipeline Location: State Highway, Cover - 6 feet

3.5 TRENCH EXCAVATION

- A. Perform all excavation regardless of type, nature or condition of the material encountered to accomplish the construction. Excavate the trench to the lines and grades shown on the drawings with allowance for pipe thickness and for pipe base or special bedding.
- B. Care shall be taken not to over-excavate. If the trench is excavated below the required grade, refill any part of the trench excavated below the grade with native material and compact to a density equal to the rest of the trench bottom.
- C. Length of open trench to be no more than amount of pipe installed in one working day. Backfilling of the open trench to grade to be no more than 40-feet behind the installed pipe.
- D. Blasting will not be permitted unless approved by Owner and appropriate jurisdictions.

- E. After the required excavation has been completed, the Owner's Representative will inspect the exposed subgrade to determine the need for any additional excavation. It is the intent that additional excavation be conducted in all areas within the influence of the pipeline where unacceptable materials exist in the exposed subgrade. Over excavation shall include the removal of all such unacceptable material that exists directly beneath the pipeline to a width 24-inches greater than the pipe outside diameter and to the depth required. Refill the trench to subgrade of pipe base with native material. Place the foundation stabilization material over the full width of the trench and compact in layers not exceeding 6 inches deep compacted to 95 percent relative compaction and carried to the required grade.

3.6 LOCATION OF EXCAVATED MATERIAL

- A. During trench excavation, place the excavated material only within the working area. Do not obstruct any roadways or streets. Conform to federal, state, and local codes governing the safe loading of trenches with excavated material.
- B. Excavated material not used as backfill shall be disposed of off-site.

3.7 DEWATERING

- A. Provide and maintain means and devices to remove and dispose of all water entering the trench excavation during the time the trench is being prepared for the pipe laying, during the laying of the pipe, and until the backfill has been completed.
- B. Water entering the excavation or other parts of the work shall be removed until all the work has been completed. No sanitary sewer shall be used for the disposal of trench water, unless specifically approved by the engineer, and then only if the trench water does not ultimately arrive at existing pumping or wastewater treatment facilities
- C. Dispose of the water in a manner to prevent damage to adjacent property. Do not drain trench water through the pipeline under construction. Do not allow groundwater to rise around the pipe until jointing compound has set hard.

3.8 INSTALLING BURIED PIPING

- A. Grade the bottom of the trench to the line and grade to which the pipe is to be laid, with allowance for pipe thickness. Remove hard spots that would prevent a uniform thickness of bedding. Place the specified thickness of pipe base material over the full width of trench. Grade the top of the pipe base ahead of the pipe laying to provide firm, continuous, uniform support along the full length of pipe, and compact to the relative compaction specified herein. Before laying each section of the pipe, check the grade and correct any irregularities.
- B. Excavate bell holes at each joint to permit proper assembly and inspection of the entire joint. Fill the area excavated for the joints with the bedding material specified or indicated in the drawings for use in the pipe zone.
- C. Inspect each pipe and fitting before lowering the buried pipe or fitting into the trench. Inspect the interior and exterior protective coatings. Patch damaged areas in the field with material recommended by the protective coating manufacturer. Clean ends of pipe thoroughly. Remove foreign matter and dirt from inside of pipe and keep clean during and after installation.
- D. Handle pipe in such a manner as to avoid damage to the pipe. Do not drop or dump pipe into trenches under any circumstances.
- E. Lay the pipe at the proper elevation and grade and properly attach to the adjacent pipe according to the type of joint.
- F. When the pipe laying is not in progress, including the noon hours, close the open ends of pipe. Do not allow trench water, animals, or foreign material to enter the pipe.
- G. Keep the trench dry until the pipe has been installed and jointed to the other pipe.

3.9 TRENCH BACKFILLING

- A. Backfill according to the details for the particular type of pipe, and per the following:
 - 1. Place the specified thickness of pipe base material over the full width of trench. Grade the top of the pipe base ahead of the pipe laying to provide firm, uniform support along the full length of pipe. Organic matter or clay material which may fall in an open trench during construction shall be removed. The Contractor shall limit the amount of native material which may fall on top of the completed pipe base until the pipe is installed.
 - 2. Backfill shall be of a suitable material removed from excavation except where other material is specified. Debris, frozen material, large clods or stones, organic matter, or other unstable

materials shall not be used for final backfill within 2 feet (0.6 m) of the top of the pipe. Do not bury waste material.

3. After pipe has been bedded, backfill simultaneously on both sides of the pipe, keeping the level of backfill the same on each side. Carefully place the material around the pipe so that the pipe barrel is completely supported and that no voids or uncompacted areas are left beneath the pipe. Do not permit free fall of the material until at least 2 feet of cover is provided over the top of the pipe. Use particular care in placing material on the underside of the pipe to prevent lateral movement during subsequent backfilling.
4. Compact material placed within 12 inches of the outer surface of the pipe by hand tamping only.
5. Continue to place the backfill material in the trench until it reaches the finished grad according to the following criteria:
 - a. Backfilling under Paved Areas: Plus or minus 1/2 inch from required elevations.
 - b. General Backfilling: Plus 3 inches from required elevations.

3.10 BACKFILL COMPACTION METHODS

- A. Compact by using mechanical compaction or hand tamping. Do not use high impact hammer-type equipment except where the pipe manufacturer warrants in writing that such use will not damage the pipe. Jetting will not be allowed.
- B. Do not use any axle-driven or tractor-drawn compaction equipment within 5 feet of walls and structures.
- C. When existing pipe is encountered during excavation, care shall be taken to support pipe sufficiently so pipe remains in service and to ensure safety of workers. During backfilling place bedding material in and around the existing pipe and compact to specifications above.

3.11 PLACEMENT OF SAND-CEMENT SLURRY BACKFILL

- A. Place sand-cement slurry backfill in a uniform manner that will prevent voids in or segregation of the material. Remove foreign material that falls into the excavation or trench. Do not commence backfilling over or place any material over the slurry cement backfill until at least four hours after placing the sand-cement slurry.

3.12 PLACEMENT OF CLSM (CONTROLLED LOW-STRENGTH MATERIAL)

- A. Provide batching equipment to obtain the proper weights of soil, cement, water, and admixtures. Measuring devices shall be sensitive to a 2% variation above or below the actual weights required. Volumetric batching may be used, provided the same accuracy required for weight batching is maintained.
- B. Design and operate the mixers used for mixing the CLSM so that the CLSM as discharged from the mixer is uniform in composition and consistency throughout each batch.
- C. Place the CLSM such that it flows easily into all openings between the pipe and the excavated trench. In some cases, such as trenches on a slope, a stiffer mix may be required to prevent it from flowing down the trench. In this case, use vibration to ensure that the CLSM completely fills all spaces.
- D. Lay the pipe on the soil pads and place the CLSM bedding as shown in the drawings. Place bedding under pipe from one side and vibrate so that it flows under the pipe until it appears on the other side. Then add CLSM to both sides of the pipe and vibrate until it completely fills the space between the pipe and the excavated trench bottom. This operation shall follow as closely behind pipelaying operations as possible. Place CLSM in such a way as to prevent uplift or buckling of the pipe. Deposit CLSM as nearly as practicable in its final position. Do not disturb the pipe trench or cause foreign material to become mixed with the cement slurry.
- E. Do not place backfill above the pipe until the CLSM has reached the initial set. Place and maintain a 6-inch cover of moist backfill cover until additional backfill is placed. If the ambient temperature is 50°F or less, place an additional 6-inch cover of backfill over the 6-inch moist backfill cover prior to the end of the working day.
- F. Whenever freezing temperatures are imminent, maintain the CLSM at a temperature of not less than 50°F for 24 hours after placement. The temperature of the mix shall be 50°F or greater at the time of placement. Monitor the temperature by placing a thermometer in the CLSM immediately after sampling at the placement site. When freezing weather appears imminent, make ready at the placement site materials that may be required for protection of the CLSM. Delay placement of CLSM until adequate provisions for protection against weather are made. Do not place CLSM bedding in pipe trenches when the trench bottom or walls are frozen or contain frozen material. Backfill placed as cover over the CLSM is prohibited from containing any frozen material.

3.13 INSTALLING IMPERVIOUS BARRIERS

- A. Construct impervious barriers in the pipe and trench zones at 300-foot intervals on slopes exceeding 30% and within 50-feet of vertical points of inflection on slopes exceeding 30%. Construct concrete barriers such that the bottom of the collar extends at least 3 inches into the pipe base, at least 3 inches into each side of the walls of the trench, and at least 3 inches above the top of the pipe zone.
- B. Install ABS dams by digging a slot approximately 3 inches deep into the pipe base, located approximately 3 feet from the nearest pipe bell. Key the dam into the groove such that the neck of the adapter connection pipe faces upstream. Center the dam into position and insert the edges into the side walls of the trench. Slide a Fernco adapter over the pipe to be installed. Move the pipe through the dam opening and assemble the pipe joint. Slip the Fernco adapter over the ABS barrier's neck and tighten the adapter's bands. Backfill both sides of the dam such that there are no voids around the pipe.

3.14 PROTECTING UNDERGROUND UTILITIES

- A. Underground utilities are to be protected in place and remain in service, unless otherwise specified on the Plans or in the specifications. Compact bedding material under and around the utility so that no voids are left. Flowable fill may be an acceptable method of bedding and backfill.
 - 1. Where indicated in the drawings or as determined by the Owner's Representative, support utilities by a reinforced concrete beam or support wall as shown on the utility support details in the drawings. The primary purpose of the beam is to prevent settlement of the existing utility line during and after construction. The Contractor is responsible for the protection of the utility during construction and shall incorporate the beam as part of the protection.
- B. Abandoned utility lines may be cut to facilitate installation of the new Works. All open ends are to be plugged. The cut utility line shall be removed from the site.
 - 1. Storm drains and sewers are to be plugged with an 8-inch wall of brick and mortar.
 - 2. Waterlines are to be capped with a cast-iron cap or a 3-foot-long concrete plug.
- C. Sewer services, water services, and other utility service lines are not shown on the Drawings. Interference with these services may occur. If such situations arise, the Contractor shall move the conflicting utilities (such as water service leads, sewer service lines, gas lines, etc.) or adjust the pipeline vertical and/or horizontal alignment to maintain required vertical and/or horizontal separations. All proposed modifications to the pipeline alignment shall be presented to the Owner's Representative for review and all changes made shall conform to the recommendations of the Owner's Representative.
- D. If the utility must be removed to facilitate construction of the new Works, the utility will be reconstructed with new materials and placed back into service. During this period, Contractor shall provide temporary service for the disconnected utility.
- E. Disruption of water service to residential and/or places of business as a result of the Contractor's operations shall be limited to a maximum of 8 (eight) hours. In the event that disruption of a particular service will be longer than 8 hours, the Contractor shall provide temporary potable water service which meets the Department of Health requirements for potable water to the affected residence or place of business for drinking purposes. In the event that disruption of a particular service will be longer than 24 hours, the Contractor shall provide temporary potable water service which meets the entire domestic water demands of the affected residence or place of business. The Contractor shall at all times maintain on site, the materials required for providing temporary water services.
- F. Waterlines whose thrust is in the direction of the new excavation, may be affected by the construction. Protect thrust blocks in place or shore to resist the thrust by a means approved by the water utility. If the thrust blocks are exposed or rendered to be ineffective in the opinion of the Owner's Representative, reconstruct them to bear against firm unexcavated soil.

END OF SECTION

SECTION 321540
CRUSHED STONE PAVING

PART 1 - GENERAL

1.1 SUMMARY

- A. Section Includes: Provision of aggregate base course material consisting as a mixture of coarse and fine graded aggregate that is free of vegetation and other deleterious matter. Work consists of placing one or more lifts of aggregates, and specified additives, on prepared subgrade, and geogrid, or geotextile, as specified, using conventional equipment and methods for mixing, placement, and compaction of aggregates onto subgrade.

1.2 RELATED DOCUMENTS

- A. Drawings and general provisions of the Contract, including General and Supplementary Conditions and Division 01 Specification Sections, apply to this Section.
 - 1. Section 013300 "Submittal Procedures".
 - 2. Section 311000 "Site Clearing" for site stripping, grubbing, stripping and stockpiling topsoil, and removal of above- and below-grade improvements and utilities.
 - 3. Section 312000 "Earth Moving" for subgrade preparation and subgrade testing.

1.3 UNIT PRICES

- A. Rock Measurement: Volume of rock actually removed, measured in original position, but not to exceed the following. Unit prices for rock excavation include replacement with approved materials.
 - 1. 6 inches outside of minimum required dimensions of Crushed Stone Paving against grade.

1.4 DEFINITIONS

- A. Backfill: Soil material or controlled low-strength material used to fill an excavation.
- B. Borrow Soil: Satisfactory soil imported from off-site for use as fill or backfill.
- C. Drainage Course: Aggregate layer supporting the slab-on-grade that also minimizes upward capillary flow of pore water.
- D. Engineered Fill: Fill material allowing the required compaction density. Can be same material used for crushed stone paving.
- E. Excavation: Removal of material encountered above subgrade elevations and to lines and dimensions indicated.
 - 1. Authorized Additional Excavation: Excavation below subgrade elevations or beyond indicated lines and dimensions as directed by Engineer. Authorized additional excavation and replacement material will be paid for according to Contract provisions for changes in the Work.
 - 2. Bulk Excavation: Excavation more than 10 feet in width and more than 30 feet in length.
 - 3. Unauthorized Excavation: Excavation below subgrade elevations or beyond indicated lines and dimensions without direction by Engineer. Unauthorized excavation, as well as remedial work directed by Engineer, shall be without additional compensation.
- F. Fill: Soil materials used to raise existing grades.
- G. Rock: Rock material in beds, ledges, unstratified masses, conglomerate deposits, and boulders of rock material that exceed 1 cu. yd. for bulk excavation that cannot be removed by rock excavating equipment equivalent to the following in size and performance ratings, without systematic drilling, ram hammering, ripping, or blasting, when permitted:
 - 1. Bulk Excavation: Late-model, track-mounted loader; rated at not less than 230-hp flywheel power and developing a minimum of 47,992-lbf breakout force with a general-purpose bare bucket; measured according to SAE J-732.
- H. Rock: Rock material in beds, ledges, unstratified masses, conglomerate deposits, and boulders of rock material 3/4 cu. yd. or more in volume that exceed a standard penetration resistance of 100 blows/2 inches or when tested by a geotechnical testing agency, according to ASTM D 1586.
- I. Subbase Course: Aggregate layer placed between the subgrade and base course for pavement.
- J. Subgrade: Uppermost surface of an excavation or the top surface of a fill or backfill immediately below subbase, drainage fill, drainage course, or topsoil materials.

1.5 SUBMITTALS

- A. Submit shop drawings in accordance with the Section 013300.
- B. Product Data: For each type of the following manufactured products required:
 - 1. Geotextiles.
- C. Samples for Verification: For the following products, in sizes indicated below:
 - 1. Geotextile: 12 by 12 inches.

1.6 INFORMATIONAL SUBMITTALS

- A. Material Test Reports: For each aggregate material proposed for paving as follows
 - 1. Classification according to ASTM C 33.
 - 2. Sieve gradation according to KYTC.
- B. Geotechnical Testing Agency Qualifications: Qualified according to ASTM E 329 and ASTM D 3740 for testing indicated.

1.7 PROJECT CONDITIONS

- A. Traffic: Minimize interference with adjoining roads, streets, walks, and other adjacent occupied or used facilities during paving operations.
 - 1. Do not close or obstruct streets, walks, or other adjacent occupied or used facilities without permission from Owner and authorities having jurisdiction.
 - 2. Provide alternate routes around closed or obstructed traffic ways if required by Owner or authorities having jurisdiction.
- B. Utility Locator Service: Notify utility locator service for area where Project is located before beginning paving operations.

PART 2 - PRODUCTS

2.2 GEOTEXTILES

- A. Subsurface Drainage Geotextile: Refer to Section 310519 "Geotextiles":
 - 1. Survivability: Class 1; AASHTO M 288.
 - 2. Grab Tensile Strength: 157 lbf; ASTM D 4632.
 - 3. Sewn Seam Strength: 142 lbf; ASTM D 4632.
 - 4. Tear Strength: 56 lbf; ASTM D 4533.
 - 5. Puncture Strength: 56 lbf; ASTM D 4833.
 - 6. Apparent Opening Size: No. 40 sieve, maximum; ASTM D 4751.
 - 7. Permittivity: 0.5 per second, minimum; ASTM D 4491.
 - 8. UV Stability: 50 percent after 500 hours' exposure; ASTM D 4355.
- B. Separation Geotextile: Refer to Section 310519 "Geotextiles":
 - 1. Survivability: Class 2; AASHTO M 288.
 - 2. Grab Tensile Strength: 247 lbf; ASTM D 4632.
 - 3. Sewn Seam Strength: 222 lbf; ASTM D 4632.
 - 4. Tear Strength: 90 lbf; ASTM D 4533.
 - 5. Puncture Strength: 90 lbf; ASTM D 4833.
 - 6. Apparent Opening Size: No. 60 sieve, maximum; ASTM D 4751.
 - 7. Permittivity: 0.02 per second, minimum; ASTM D 4491.
 - 8. UV Stability: 50 percent after 500 hours' exposure; ASTM D 4355.

PART 3 - EXECUTION

3.1 PREPARATION

- A. Protect structures, utilities, sidewalks, pavements, and other facilities from damage caused by settlement, lateral movement, undermining, washout, and other hazards created by Crushed Stone Paving operations.
- B. Protect and maintain erosion and sedimentation controls during paving operations.
- C. Protect subgrades and foundation soils from freezing temperatures and frost. Remove temporary protection before placing subsequent materials.
- D. Subgrade to be excavated and compacted per Section 312000 "Earth Moving".
- E. Place Geotextile as required under crushed stone paving per manufacturers recommendations.
- F. Do not place crushed aggregate or geotextiles on excessively wet, frozen, rutted subgrade or any surface not in compliance with compaction density requirements in Section 312000 "Earth Moving".
- G. Aggregate to be uniformly mixed to form a homogeneous mixture of particles.

3.2 EXCAVATION, GENERAL

- A. Unclassified Excavation: Excavate to subgrade elevations regardless of the character of surface and subsurface conditions encountered. Unclassified excavated materials may include rock, soil materials, and obstructions. No changes in the Contract Sum or the Contract Time will be authorized for rock excavation or removal of obstructions.
 - 1. If excavated materials intended for fill and backfill include unsatisfactory soil materials and rock, replace with satisfactory soil materials.
 - 2. Remove rock to lines and grades indicated to permit installation of permanent construction without exceeding the following dimensions:
 - a. 24 inches outside of edge of paving.
- B. Classified Excavation: Excavate to subgrade elevations. Material to be excavated will be classified as earth and rock. Do not excavate rock until it has been classified and cross sectioned by Engineer. The Contract Sum will be adjusted for rock excavation according to unit prices included in the Contract

Documents. Changes in the Contract Time may be authorized for rock excavation.

1. Rock excavation includes removal and disposal of rock. Remove rock to lines and subgrade elevations indicated to permit installation of permanent construction without exceeding the following dimensions:
 - a. 24 inches or outside of edge of paving.

3.3 SUBGRADE INSPECTION

- A. Notify Engineer when excavations have reached required subgrade.
- B. If Engineer determines that unsatisfactory soil is present, continue excavation and replace with compacted backfill or engineered fill material as directed.
- C. Proof-roll subgrade below pavements with a pneumatic-tire and loaded 10-wheel, tandem-axle dump truck weighing not less than 15 tons to identify soft pockets and areas of excess yielding. Do not proof-roll wet or saturated subgrades.
 1. Completely proof-roll subgrade in one direction, repeating proof-rolling in direction perpendicular to first direction>>. Limit vehicle speed to 3 mph.
 2. Excavate soft spots, unsatisfactory soils, and areas of excessive pumping or rutting, as determined by Engineer, and replace with compacted backfill or engineered fill as directed.
- D. Authorized additional excavation and replacement material will be paid for according to Contract provisions for changes in the Work.
- E. Reconstruct subgrades damaged by freezing temperatures, frost, rain, accumulated water, or construction activities, as directed by Engineer, without additional compensation.

3.4 SOIL MOISTURE CONTROL

- A. Uniformly moisten subgrade and each subsequent fill or backfill layer before compaction to within 2 percent of optimum moisture content.

3.5 COMPACTION OF SOIL BACKFILLS AND FILLS

- A. Layers of Crushed Stone Aggregate is to be placed in uniform layer thickness via a mechanical spreader such that no compacted layer exceeds 6 inches.
- B. Maximum thickness of one compacted layer is 6 inches. Minimum layer thickness of one compacted layer is 3 inches.
- C. Compacted aggregate surfacing is to be at 98 percent standard proctor at +/- 2 percent optimum moisture per ASTM D 698; or density as determined by MT 230 and per MDT 301>>.

3.6 FIELD QUALITY CONTROL

- A. Special Inspections: Contractor shall engage a qualified special inspector to perform the following special inspections:
 1. Determine prior to placement of fill that site has been prepared in compliance with requirements.
 2. Determine that fill material and maximum lift thickness comply with requirements.
 3. Determine, at the required frequency, that in-place density of compacted fill complies with requirements.
- B. Testing Agency: Contractor shall engage a qualified geotechnical engineering testing agency to perform tests and inspections.
- C. Allow testing agency to inspect and test subgrades and each fill or backfill layer. Proceed with subsequent earth moving only after test results for previously completed work comply with requirements.
- D. Testing agency will test compaction of soils in place according to ASTM D 1556, ASTM D 2167, ASTM D 2922, and ASTM D 2937, as applicable. Tests will be performed at the following locations and frequencies:
 1. Paved Areas: At subgrade and at each compacted fill and backfill layer, at least one test for every 1000 sq. ft. or less of paved area but in no case fewer than three tests.
- E. When testing agency reports that subgrades, fills, or backfills have not achieved degree of compaction specified, scarify and moisten or aerate, or remove and replace soil materials to depth required; re-compact and retest until specified compaction is obtained.
- F. Final compacted surface is to be constructed to elevations on Drawings within 0.04 feet (1/2 inch). Ensure surface smoothness is within 0.04 feet (1/2 inch) in 10 feet. Test for smoothness with 10 foot long straightedge.

- G. Ensure an average compacted thickness within 0.02 feet (1/4 inch) of that detailed on drawing. Engineer will confirm average Project thickness at 1000 sq. ft. intervals. Contractor to correct any thickness deficiencies by removing material, scarifying to a depth of 3 inches and adding material resulting in a minimum 3 inch compacted lift.
- H. Contractor to ensure uniform compaction of all crushed stone surfacing.

END OF SECTION

THIS PAGE INTENTIONALLY LEFT BLANK

SECTION 323113
STEEL CHAIN LINK FENCES AND GATES

PART 1 GENERAL

1.1 SUMMARY

- A. This section includes materials and installation of galvanized or PVC-coated steel chain link fence and gates top and bottom tension wires and anticlimb extension arms with barbed wire.

1.2 PERFORMANCE REQUIREMENTS

- A. Delegated Design: Design chain-link fences and gates, including comprehensive engineering analysis by a qualified professional engineer, using performance requirements and design criteria indicated.
- B. Structural Performance: Chain-link fence and gate framework shall withstand the effects of gravity loads and the following loads and stresses.
 - 1. Minimum Post Size: Determine according to ASTM F 1043 for framework up to 12 feet high, and post spacing not to exceed 10 feet.
 - 2. Minimum Post Size and Maximum Spacing: Determine according to CLFMI WLG 2445, based on mesh size and pattern specified and on the following:
 - a. Wind Speed, V3s: 90 mph
 - b. Exposure Category: B
- C. Lightning Protection System: Maximum grounding-resistance value of 25 ohms under normal dry conditions.

1.3 SUBMITTALS

- A. Submit shop drawings in accordance with Section 013300.
- B. Submit product data for each type of product indicated. Include construction details, material descriptions, dimensions and profiles, and finishes.
- C. Shop Drawings: Include plans, elevations, sections, details, and attachments to other work. Show accessories, hardware, gate operation, and operational clearances.
- D. For chain-link fences and gate framework indicated to comply with performance requirements and design criteria, including analysis data signed and sealed by the qualified professional engineer responsible for their preparation licensed in the state where the project is located.

1.4 PROJECT CONDITIONS

- A. Field Measurements: Verify layout information for chain-link fences and gates shown on Drawings in relation to property survey and existing structures. Verify dimensions by field measurements.

1.5 WARRANTY

- A. Special Warranty: Manufacturer's standard form in which manufacturer or Installer agrees to repair or replace components of chain-link fences and gates that fail in materials or workmanship within specified warranty period.
 - 1. Failures include, but are not limited to, the following:
 - a. Faulty operation of gate.
 - b. Deterioration of metals, metal finishes, and other materials beyond normal weathering.
 - 2. Warranty Period: Five years from date of Substantial Completion.

PART 2 PRODUCTS

2.1 CHAIN LINK FABRIC

- A. General: Provide fabric in one-piece heights measured between top and bottom of outer edge of selvage knuckle or twist. Comply with CLFMI Product Manual and with requirements indicated below:
 - 1. Fabric Height: As indicated on Drawings
 - 2. Steel Wire Fabric: Wire diameter of 0.192 inch.
 - a. Mesh Size: 2 inches.
 - b. Zinc-Coated Fabric: ASTM A 392, Type II, Class 1, 1.2 oz./sq. ft. with zinc coating applied before weaving.
 - c. Polymer-Coated Fabric: ASTM F 668, Class <1; over zinc coated steel wire.
 - 1) Color: As selected by Owner from manufacturer's full range>>.
 - d. Coat selvage ends of fabric that is metallic coated before the weaving process with manufacturer's standard clear protective coating.

2.2 FENCE FRAMING

- A. Post and Rails: Comply with ASTM F 1043 for framing, including rails, braces, and line; terminal; and corner posts. Provide members with minimum dimensions and wall thickness according to ASTM F 1043 or ASTM F 1083 based on the following:
1. Fence Height: As indicated on Drawings
 2. Horizontal Framework Members: Intermediate rails complying with ASTM F 1043.
 3. Metallic coating for steel framing: Type A, consisting of not less than minimum 2.0-oz./sq. ft. average zinc coating per ASTM A 123/A 123M or 4.0-oz./sq. ft. zinc coating per ASTM A 653/A 653M.

4. Polymer coating over metallic coating: Match chain-link fabric, complying with ASTM F 934.

2.3 TENSION WIRE

- A. Metallic-Coated Steel Wire: 0.177 inch diameter, marcelled tension wire complying with ASTM A 817 and ASTM A 824, with the following metallic coating:
 1. Type II, zinc coated (galvanized) by hot-dip or electrolytic process, with the coating weight matching the chain-link fabric coating weight.
- B. Polymer-Coated Steel Wire: 0.177 inch diameter, tension wire complying with ASTM F 1664 to match the coating of the chain-link fabric. Color of wire to match chain-link fabric unless otherwise noted.

2.4 SWING GATES

- A. General: Comply with ASTM F 900 for gate posts and single swing gate types. Gate leaf width as noted on the plans.
- B. Pipe and Tubing:
 1. Zinc-Coated Steel: Comply with ASTM F 1043 and ASTM F 1083; protective coating and finish to match fence framing.
- C. Frame Corner Construction: Welded or assembled with corner fittings.
- D. Extended Gate Posts and Frame Members: Extend gate posts and frame end members above top of chain-link fabric at both ends of gate frame as indicated to attach barbed wire or tape assemblies.
- E. Hardware:
 1. Hinges: 180 degree inward swing.
 2. Latches permitting operation from both sides of gate with provision for padlocking accessible from both sides of gate.
 3. Padlock and Chain: Owner furnished.
 4. Lock: Owner furnished.
- F. Pipe and Tubing:
 1. Zinc-Coated Steel: Comply with ASTM F 1043 and ASTM F 1083; protective coating and finish to match fence framing.
- G. Frame Corner Construction: Welded or assembled with corner fittings.
- H. Extended Gate Posts and Frame Members: Extend gate posts and frame end members above top of chain-link fabric at both ends of gate frame as indicated to attach barbed wire or tape assemblies.
- I. Overhead Track Assembly: Manufacturer's standard track, with overhead framing supports, bracing, and accessories, engineered to support size, weight, width, operation, and design of gate and roller assemblies.
- J. Hardware:
 1. Latches permitting operation from both sides of gate with provision for padlocking accessible from both sides of gate.
 2. Padlock and Chain: Owner furnished.
 3. Lock: Owner furnished.
 4. Hangers, roller assemblies, and stops fabricated from galvanized steel.

2.5 FITTINGS

- A. General: Comply with ASTM F 626.
- B. Post Caps: Provide for each post.
 1. Provide line post caps with loop to receive tension wire or top rail.
- C. Rail and Brace Ends: For each gate, corner, pull, and end post.
- D. Rail Fittings: Provide the following:
 1. Top Rail Sleeves: Pressed-steel or round-steel tubing not less than 6 inches long.
 2. Rail Clamps: Line and corner boulevard clamps for connecting intermediate and bottom rails in the fence line-to-line posts.
- E. Tension and Brace Bands: As required by the manufacturer.
- F. Tension Bars: Steel, length not less than 2 inches shorter than full height of chain-link fabric. Provide one bar for each gate and end post, and two for each corner and pull post, unless fabric is integrally woven into post.

- G. Truss Rod Assemblies: Steel, hot-dip galvanized after threading rod and turnbuckle or other means of adjustment.
- H. Barbed Wire Arms: Pressed steel or cast iron, with clips, slots, or other means for attaching strands of barbed wire, and means for attaching to posts; for each post unless otherwise indicated, and as follows:
 - 1. Provide line posts with arms that accommodate top rail or tension wire.
 - 2. Provide corner arms at fence corner posts, unless extended posts are indicated.
 - 3. Type I, single slanted arm.
- I. Tie Wires, Clips, and Fasteners: According to ASTM F 626.
 - 1. Standard Round Wire Ties: For attaching chain-link fabric to posts, rails, and frames. Hot-Dip Galvanized Steel: 0.106 inch diameter wire; galvanized coating thickness matching coating thickness of chain-link fence fabric.
- J. Finish: Metallic Coating for Pressed Steel or Cast Iron: Not less than 1.2 oz. /sq. ft. zinc.

2.6 PRIVACY SLATS

- A. Material: PVC, UV-light stabilized, not less than 0.006 inch thick; attached to not less than 0.0475 inch diameter, twisted galvanized wire; hedge-type lattice; sized to fit mesh specified for direction indicated.
- B. Material: Polyethylene tubular slats, not less than 0.023 inch thick, manufactured for chain-link fences from virgin polyethylene containing UV inhibitor, sized to fit mesh specified for direction indicated; with vandal-resistant fasteners and locks strips.
- C. Material: Fiber-glass-reinforced plastic, UV-light stabilized, not less than 0.06 inch thick, sized to fit mesh specified for direction indicated; with vandal-resistant fasteners and lock strips.
- D. Material: Aluminum, not less than 0.01 inch thick, sized to fit mesh specified for direction indicated.
- E. Material: Redwood, 5/16 inch thick, sized to fit mesh specified for direction indicated.
- F. Color: As selected by Owner from manufacturer's full range.

2.7 BARBED WIRE

- A. Steel Barbed Wire: Comply with ASTM A 121, for two-strand barbed wire, 0.099 inch diameter line wire with 0.080 inch diameter, four-point round barbs spaced not more than 5 inches o.c.
 - 1. Zinc Coating: Type Z, Class 3.

2.8 BARBED TAPE

- A. Wire-Reinforced Tape: ASTM F 1910; with four-point, needle-sharp barbs permanently cold clenched around a core wire.
 - 1. Core Wire: High-tensile-strength, zinc-coated steel or stainless steel.
- B. Tie Wires: Stainless steel, 0.065 inch in diameter.
- C. Fabrication: Continuous coils of barbed tape as defined in ASTM F 1379 for the following characteristics:
 - 1. Configuration: Single coil.
 - 2. Style: Helical pattern.
 - 3. Coil Diameter(s): 18 inches.
 - 4. Coil Loop Spacing(s): 12 inches or Manufacturer's standard.
 - 5. Barb Length Classification: Long, 1.2 inch barb.
 - 6. Barb Spacing: 4 inches o.c.
 - 7. Barb Set: Manufacturer's standard.

2.9 GROUT AND ANCHORING CEMENT

- A. Nonshrink, Nonmetallic Grout: Premixed, factory-packaged, nonstaining, noncorrosive, nongaseous grout complying with ASTM C 1107. Provide grout, recommended in writing by manufacturer, for exterior applications.
- B. Erosion-Resistant Anchoring Cement: Factory-packaged, nonshrink, nonstaining, hydraulic-controlled expansion cement formulation for mixing with potable water at Project site to create pourable anchoring, patching, and grouting compound. Provide formulation that is resistant to erosion from water exposure without needing protection by a sealer or waterproof coating and that is recommended in writing by manufacturer, for exterior applications.

2.10 FENCE GROUNDING

- A. Conductors: Bare, solid wire for No. 6 AWG and smaller; stranded wire for No. 4 AWG and larger.
 - 1. Material above Finished Grade: Copper
 - 2. Material on or below Finished Grade: Copper
 - 3. Bonding Jumpers: Braided copper tape, 1 inch wide, woven of No. 30 AWG bare copper wire, terminated with copper ferrules.
- B. Connectors and Grounding Rods: Comply with UL 467.
 - 1. Grounding Rods: Copper-clad steel, 5/8 by 96 inches.

PART 3 EXECUTION

3.1 EXAMINATION

- A. Examine areas and conditions, with Installer present, for compliance with requirements for site clearing, earthwork, pavement work, and other conditions affecting performance of the Work.
 - 1. Do not begin installation before final grading is completed unless otherwise permitted by Engineer.
- B. Proceed with installation only after unsatisfactory conditions have been corrected.

3.2 PREPARATION

- A. Stake locations of fence lines, gates, and terminal posts. Do not exceed intervals of 500 feet or line of sight between stakes. Indicate locations of utilities, lawn sprinkler system, underground structures, benchmarks, and property monuments.

3.3 INSTALLATION, GENERAL

- A. Install chain-link fencing to comply with ASTM F 567 and more stringent requirements indicated and as indicated in the Drawings.

3.4 CHAIN LINK FENCE INSTALLATION

- A. Post Excavation: Drill or hand-excavate holes for posts to diameters and spacings indicated, in firm, undisturbed soil.
- B. Post Setting: Set posts in concrete at indicated spacing into firm, undisturbed soil.
 - 1. Verify that posts are set plumb, aligned, and at correct height and spacing, and hold in position during setting with concrete or mechanical devices.
 - 2. Concrete Fill: Place concrete around posts to dimensions indicated and vibrate or tamp for consolidation. Protect aboveground portion of posts from concrete splatter.
 - a. Exposed Concrete: Extend 2 inches above grade; shape and smooth to shed water.
 - b. Concealed Concrete: Top 2 inches below grade as indicated on Drawings to allow covering with surface material.
 - c. Posts Set into Concrete in Sleeves: Use steel pipe sleeves preset and anchored into concrete for installing posts. After posts have been inserted into sleeves, fill annular space between post and sleeve with non-shrink, nonmetallic grout or anchoring cement, mixed and placed to comply with anchoring material manufacturer's written instructions, and finished sloped to drain water away from post.
 - d. Posts Set into Voids in Concrete: Form or core drill holes not less than 5 inches deep and 3/4 inch between post and concrete with non-shrink, nonmetallic grout or anchoring cement, mixed and placed to comply with anchoring material manufacturer's written instructions, and finished sloped to drain water away from post.
- 3. Mechanically Driven Posts: Drive into soil to depth of 30 inches.

Protect post top to prevent distortion.

- C. Terminal Posts: Locate terminal end, corner, and gate posts per ASTM F 567 and terminal pull posts at changes in horizontal or vertical alignment of 15 degrees or more unless indicated otherwise on Drawings.
- D. Line Posts: Space line posts uniformly at 8 feet o.c.
- E. Post Bracing and Intermediate Rails: Install according to ASTM F 567, maintaining plumb position and alignment of fencing. Diagonally brace terminal posts to adjacent line posts with truss rods and turnbuckles. Install braces at end and gate posts and at both sides of corner and pull posts.
 - 1. Locate horizontal braces at mid-height of fabric 72 inches or higher, on fences with top rail and at two-third fabric height on fences without top rail. Install so posts are plumb when diagonal rod is under proper tension.
- F. Tension Wire: Install according to ASTM F 567, maintaining plumb position and alignment of fencing. Pull wire taut, without sags. Fasten fabric to tension wire with 0.120 inch diameter hog rings of same material and finish as fabric wire, spaced a maximum of 24 inches o.c. Install tension wire in locations indicated before stretching fabric. Provide horizontal tension wire at the following locations:
 - 1. Extended along top and bottom of fence fabric. Install top tension wire through post cap loops. Install bottom tension wire within 6 inches of bottom of fabric and tie to each post with not less than same diameter and type of wire.
 - 2. Extended along top of barbed wire arms; or extended posts and top of fence fabric for supporting barbed tape.
 - 3. As indicated on Drawings.
- G. Top Rail: Install according to ASTM F 567, maintaining plumb position and alignment of fencing. Run rail continuously through line post caps, bending to radius for curved runs and terminating into rail end attached to posts or post caps fabricated to receive rail at terminal posts. Provide expansion couplings as recommended in writing by fencing manufacturer.
- H. Intermediate and Bottom Rails: Install and secure to posts with fittings.
- I. Chain-Link Fabric: Apply fabric to outside of enclosing framework. Leave 1 inch between finish grade or surface and bottom selvage unless otherwise indicated. Pull fabric taut and tie to posts, rails, and tension wires. Anchor to framework so fabric remains under tension after pulling force is released.
- J. Tension or Stretcher Bars: Thread through fabric and secure to end, corner, pull, and gate posts with tension bands spaced not more than 15 inches o.c.
- K. Tie Wires: Use wire of proper length to firmly secure fabric to line posts and rails. Attach wire at one end to chain-link fabric, wrap wire around post a minimum of 180 degrees, and attach other end to chain-link fabric per ASTM F 626. Bend ends of wire to minimize hazard to individuals and clothing.
 - 1. Maximum Spacing: Tie fabric to line posts at 12 inches o.c. and to braces at 24 inches o.c.
- L. Fasteners: Install nuts for tension bands and carriage bolts on the side of the fence opposite the fabric side.
- M. Privacy Slats: Install slats in direction indicated, securely locked in place. Install slats vertically.
- N. Barbed Wire: Install barbed wire uniformly spaced angled toward security side of fence as indicated on Drawings. Pull wire taut, install securely to extension arms, and secure to end post or terminal arms.
- O. Barbed Tape: Comply with ASTM F 1911. Install barbed tape uniformly in configurations indicated and fasten securely to prevent movement or displacement.

3.5 GATE INSTALLATION

- A. Install gates according to manufacturer's written instructions, level, plumb, and secure for full opening without interference. Attach fabric as for fencing. Attach hardware using tamper-resistant or concealed means. Install ground-set items in concrete for anchorage. Adjust hardware for smooth operation and lubricate where necessary.

3.6 GROUNDING AND BONDING

- A. Fence Grounding: Install at maximum intervals of 1500 feet except as follows:
 - 1. Fences within 100 Feet of Buildings, Structures, Walkways, and Roadways: Ground at maximum intervals of 750 feet.
 - a. Gates and Other Fence Openings: Ground fence on each side of opening.
 - 1) Bond metal gates to gate posts.

- 2) Bond across openings, with and without gates, except openings indicated as intentional fence discontinuities. Use No. 2 AWG wire and bury it at least 18 inches below finished grade.
- B. Protection at Crossings of Overhead Electrical Power Lines: Ground fence at location of crossing and at a maximum distance of 150 feet on each side of crossing.
- C. Fences Enclosing Electrical Power Distribution Equipment: Ground as required by IEEE C2 unless otherwise indicated.
- D. Grounding Method: At each grounding location, drive a grounding rod vertically until the top is 6 inches below finished grade. Connect rod to fence with No. 6 AWG conductor. Connect conductor to each fence component at the grounding location, including the following:
 1. Make grounding connections to each barbed wire strand with wire-to-wire connectors designed for this purpose.
 2. Make grounding connections to each barbed tape coil with connectors designed for this purpose.
- E. Bonding Method for Gates: Connect bonding jumper between gate post and gate frame.
- F. Connections: Make connections to minimize possibility of galvanic action or electrolysis. Select connectors, connection hardware, conductors, and connection methods so metals in direct contact will be galvanically compatible.
 1. Use electroplated or hot-tin-coated materials to ensure high conductivity and to make contact points closer in order of galvanic series.
 2. Make connections with clean, bare metal at points of contact.
 3. Make aluminum-to-steel connections with stainless-steel separators and mechanical clamps.
 4. Make aluminum-to-galvanized-steel connections with tin-plated copper jumpers and mechanical clamps.
 5. Coat and seal connections having dissimilar metals with inert material to prevent future penetration of moisture to contact surfaces.
- G. Bonding to Lightning Protection System: If fence terminates at lightning-protected building or structure, ground the fence and bond the fence grounding conductor to lightning protection down conductor or lightning protection grounding conductor complying with NFPA 780.

3.7 ADJUSTING

- A. Gates: Adjust gates to operate smoothly, easily, and quietly, free of binding, warp, excessive deflection, distortion, nonalignment, misplacement, disruption, or malfunction, throughout entire operational range. Confirm that latches and locks engage accurately and securely without forcing or binding.
- B. Automatic Gate Operator: Energize circuits to electrical equipment and devices. Adjust operators, controls, safety devices, alarms and limit switches.
 1. Hydraulic Operator: Purge operating system, adjust pressure and fluid levels, and check for leaks.
 2. Operational Test: After electrical circuitry has been energized, start units to confirm proper motor rotation and unit operation.
 3. Test and adjust controls, alarms and safeties. Replace damaged and malfunctioning controls and equipment.
- C. Lubricate hardware, gate operators and other moving parts.

3.8 DEMONSTRATION

- A. Engage a factory-authorized service representative to train Owner's personnel to adjust, operate, and maintain chain-link fences and gates.

END OF SECTION

SECTION 329219

SEEDING

PART 1 GENERAL

1.1 SUMMARY

- A. This section governs the furnishing of all labor, equipment, tools and materials, and the performance of all work for final seeding of lawns and non-maintained vegetation areas, disturbed by construction operations, and removal of rocks, debris and other foreign matter not suitable for a seed bed.
- B. Refer to SWPPP and Land Disturbance permit for temporary seeding and other erosion control products usage in conjunction with seeding and mulching.
- C. Alternative forms of seeding and mulching, such as hydro seeding and hydro mulching, may be submitted for review.

1.2 SUBMITTALS

- A. Submit shop drawings in accordance with Section 013300.
- B. Provide a mechanically printed seed mixture tag showing percentage of seed mix, year of production, net weight, germination rate, purity, date of packaging, and location of origin.
- C. Hydro mulch material, rolled erosion control product (RECP), and other manufactured products.
- D. Fertilizer: certification of analysis from a certified fertilizer dealer, and straw to be inspected in the field prior to application.
- E. Topsoil analysis by a qualified soil-testing laboratory stating percentages of organic matter; gradation of sand, silt, and clay content; cation exchange capacity; deleterious material; pH; and mineral and plant-nutrient content.
- F. Certified soil fertility report providing nutrient and mineral analysis as a basis for fertilizer requirement.
- G. Certification of composted organics analysis with U.S. Compost Council's Seal of Testing Assurance and recommended rates of application.

PART 2 PRODUCTS

2.1 MULCH

- A. Oat, rye or wheat straw, that are reasonably free from weeds, foreign matter detrimental to plant life, and in dry condition. Supply straw mulch per SUDAS.
- B. Hydromulch shall consist of fiber mulch. Fiber mulch shall be derived from wood chips or recycled paper products. The mulch shall be free of chemicals and growth inhibitors. Mulch shall contain a green dye to assist in metering a uniform application. Supply mulch for hydraulic seeding per SUDAS.
- C. Tackifier (soil binder) shall be a physllium based, organic compound derived from natural plant sources. Binder shall consist of an active hydrophilic colloid, which will hydrate with water and, upon drying after application, will tack hydrospray mix to soil surface. Binder shall be nontoxic and contain no growth or germination inhibitors. Supply tackifier per SUDAS.
- D. Sticking Agent and Inoculant for Legumes per SUDAS.

2.2 MANUFACTURED BMP PRODUCTS

- A. Rolled Erosion Control Product (RECP) may be used for temporary erosion control to hold seed until the newly seeded area is stabilized. The RECP shall be 100% agricultural straw stitched with degradable thread to a single UV accelerated photodegradable polypropylene netting, similar to North American Green S-75 on embankments and DS-75 in lawn areas.

- B. Other forms of RECP may be proposed, such as Bonded Fiber Matrix (BFM) and Turf Reinforcement Mat (TRM).

2.3 FERTILIZER

- A. A commercial granular fertilizer, grade 13-13-13 total nitrogen (N), available phosphoric acid (P205), and soluble potash (K20), delivered in sealed bags and bearing the manufacturer's "Guaranteed Statement of Analysis." Apply at rate determined by soil fertility analysis submittal.

2.4 GRASS SEED

- A. Deliver to site in original containers showing analysis of seed mixture, percentage of pure live seed (% germination and % purity), year of production, net weight, date of packaging, and location of origin.
- B. Seed mix per SUDAS Seed Mixtures.

2.5 TOPSOIL

- A. Topsoil furnished by the CONTRACTOR shall consist of a natural friable surface soil without admixtures of undesirable subsoil, refuse, or foreign materials. It shall be reasonably free from roots, hard clay, and coarse gravel, stones larger than one inch in any dimension, noxious weeds, grass, brush, sticks, stubble or other material which would be detrimental to the proper development of vegetative growth.
- B. Topsoil shall contain not less than 3%, or more than 15% organic matter, by weight as determined by loss-on-ignition of oven-dried samples in accordance with ASTM T-6. Organic material shall be decomposed and free of wood.
- C. Topsoil consists of loam, sandy loam, silt loam, silty clay loam, or clay loam humus-bearing soils adapted to sustain plant life, and ensure this topsoil is in a pH range of 6.0 to 8.0.

Soil Classification	Minimum	Maximum
Clay	5%	30%
Silt	10%	70%
Sand & Gravel	10%	70%
Organic Matter	3%	20%
pH	6.1	7.8

- 1. Topsoil shall conform to the following gradation.

Sieve Size	Percentage Passing
1 inch	100%
1/2 inch	95%-97%
No. 4	40%-60%
No. 10	40%-60%
No. 200	10%-30%

PART 3 EXECUTION

3.1 TEMPORARY SEEDING

- A. Provide temporary seeding in areas prone to erosion and sediment transport.
- B. Install RECP in areas that are steeper than 6 (horiz): 1 (vert) according to manufacturer's recommended method.
- C. Temporary Seed Mix: Apply the following temporary grass seed mix at the specified rate per acre.
 - 1.

- a. Spring Planting

Location	Species	Pounds per Acre
Established Lawns	Oat or Rye	60
Non-Lawn Areas	Oat, Rye or Red Clover	60

- b. Fall Planting

Location	Species	Pounds per Acre
Established Lawns	Winter Wheat/Rye	60
Non-Lawn Areas	Winter Wheat/Winter Rye	60

2. Fertilizing
 - a. Apply fertilizer at a rate of 150 pounds per acre.
3. Reseeding
 - a. Reseed areas within 30 days of initial seeding where no stand of grass has occurred.

3.2 FINAL SEEDING

A. GENERAL

1. Planting Season: August 15 - November 1 and April 1 - June 1.
2. Mulched on the same day.
3. Proceed with planting only when existing and forecasted weather conditions permit. Do not sow immediately following rain, when ground is too dry, or during windy periods.
4. Areas to be seeded as a dormant seeding must be protected from erosion over winter by mulching.

B. SURFACE PREPARATION

1. Scarify subsoil to a depth of 6 inches by means of blading, chisel plowing, discing, rock picking, harrowing or any other operation necessary to return the ground surface as nearly as practical to its original condition. Remove foreign materials, plants, roots, stones one inch and larger, and debris from the disturbed area. Add suitable material to areas that settled excessively. Spread six inches of topsoil over the area. Rake until the surface is smooth and level with the surrounding ground.
2. Topsoil: see 2.05.
3. Seedbed preparation, seed preparation, seed application, and seed mulching per SUDAS.

3.3 FERTILIZING

- A. Apply fertilizer at a rate of 300 pounds per acre. Work the fertilizer into the topsoil.
- B. Apply after smooth raking of topsoil and prior to roller compaction.
- C. Mix thoroughly into topsoil.
- D. lightly water to aid the dissipation of fertilizer.
- E. If seeding with the drilling method, include a fertilizer attachment on the drill which allows the placement of fertilizer in a band on or near the drill row.
- F. If seeding by means of a hydraulic seeder, include the required amount of fertilizer to be mixed with the seed, cellulose fiber mulch and water and applied in the seeding operation.

3.4 PERMANENT SEEDING

- A. Apply seed evenly in two intersecting directions using mechanical power drills or seeders.
- B. Roll seeded area with cultipacker type roller at right angle to slopes not exceeding 112 lbs.
- C. Apply the following permanent grass seed mix at the specified rate.

Species	PLS Pounds/Acre
Western Wheatgrass (Rodan or Rosana)	2
Slender Wheatgrass (Revenue or Primar)	1
Green Needlegrass (Lodorm)	2
Blue Grama (northern seed source)	2
Sideoats Grama (Killdeer)	8
Switchgrass (Dakota)	3
Little Bluestem (Blaze or Camper)	5
Total	23

*PLS-Pure Live Seed (% germination times % purity)

1. For sandier sites, add 2 lb PLS per acre Prane Sandreed, and 3 lb PLS per acre Sand Bluestem.
2. For low wet areas and drainage ways, add 4 lb PLS per acre Big Bluestem.
3. Apply the selected seed mix per SUDAS.

D. Grass Seed Mix:

Species	% of Mix	PLS per Acre
K31 Fescue	80	340
Perennial Rye	20	60
Total	100	300

3.5 SEEDING BY DRILLING

- A. The specified seed or seed mixture shall be drilled in uniformly using a grass drill equipped with individually mounted adjustable spring loaded, double-disk furrow openers fitted with depth control bands and packer wheels.
- B. The depth of control bands shall be of a size to provide final planting of not more than the optimum depth.
- C. Packer wheels shall have adjustable spring tension and be mounted individually on each furrow opener or be mounted independently with a press wheel situated to follow directly behind each opener

3.6 MULCHING

- A. Immediately following seeding and compacting, apply mulch to a thickness of not less than 1/8 inches (approximately 2 tons per acre). Approximately ten (10) percent of the soil surface shall be visible through the mulch blanket prior to mulch tiller (punching) operation. Maintain clearance from shrubs and trees.
- B. The mulching material shall be punched into the soil so that it is partially covered. The punching operation shall be performed longitudinally with a mulch tiller consisting of a series of dull, flat disks with notched or cutout edges. The disks shall be approximately 20 inches in diameter and 1/4-inch thick, shall be spaced approximately 8-inches apart, and shall be fitted with scrapers. The working width of the tiller shall not exceed six (6) feet per member, but may be operated in gangs of not over 3 members each (18 feet total width).
- C. Care shall be exercised to obtain a reasonably even distribution of mulch partially incorporated into the soil. It may be necessary to use weights or hydraulic pressure to insure that the mulch is punched into the soil adequately.
- D. On slopes too steep for disking, the mulching shall be "patted" with forks as it is placed on the slopes. Soil from the top of slope areas shall be placed by hand methods on the mulching material to reduce loss due to wind. Non-friable soil should be placed over the upper 1/3 of slopes and should average approximately one cubic foot of soil to each 25 square feet of area.
- E. When mulch is applied with a straw blower, it may be necessary to remove cutting knives to prevent cutting mulch too short.
- F. The Contractor shall arrange his work so that the mulch can be placed and punched immediately after each slope area is seeded. Mulching operations shall not lag behind seeding operations more than 24 hours during clear weather. When rain is threatening, the Contractor shall make every effort to mulch areas the same day as seeded. Mulch shall be replaced before seeds germinate when re-mulching wind or rain damaged areas.
- G. Apply potable water with a fine spray immediately after each area has been mulched

3.7 HYDROSEEDING

- A. Contractor may propose hydroseeding upon approval of the Engineer and Owner. Contractor shall submit a hydroseeding plan and product data.
- B. The hydrospray shall be applied in the form of a slurry consisting of cellulose fiber, seed, stabilizer additives, tackifier, commercial fertilizer, and water. When hydraulically sprayed on the soil surface, the mix shall form a blotter-like ground cover impregnated uniformly with seed and fertilizer and shall allow moisture to percolate to the underlying soil.

- C. Prior to hydroseeding, the site shall be measured and staked to identify the areas to be sprayed by each truckload of mix.
- D. Hydraulic equipment used for the application of the slurry shall be a 1500-gallon capacity agitator-mixer. This equipment shall have a built-in agitation system and operating capacity sufficient to agitate, suspend and homogeneously mix a slurry containing not less than 40 pounds of fiber mulch, plus a combined total of 15 pounds of fertilizer solids for each 100 gallons of water or per the submitted soil fertility analysis, whichever is less.
- E. The slurry distribution hose lines shall be large enough to prevent stoppage and shall be equipped with a set of hydraulic spray nozzles which will provide a continuous non-fluctuating discharge. Slurry tank shall be mounted on a traveling unit.
- F. Seeding rate to be hydroseeded shall be increased by 50 percent,
- G. Hydroseed Slurry Mix

PRODUCT	APPLICATION RATE (pound per acre)
Seed Mix	150% of grass seeding rate
Fiber Mulch	2000
Slow-Release Fertilizer: Up to this amount per soil fertility test.	
20-10-5	200
0-18-0 Single Super-Phosphate	150
Agricultural Gypsum	500
Soil Sulfur	100
Soil Binder	100

3.8 HYDROMULCHING

- A. Hydromulching application shall be similar to hydroseeding as far as equipment and procedures.
- B. Hydromulch slurry mix shall be as follows:
 - 1. Fiber Mulch: 200 lbs/acre.
 - 2. Soil Binder: 50 lbs/acre. Mix soil binder at the rate of 30 pounds of concentrate mixed with 1,500 gallons of water.

3.9 MAINTENANCE

- A. Reseed damaged grass areas showing root growth failure, deterioration, bare or thin spots and eroded areas.
- B. Contractor shall be responsible for controlling the growth of weeds in areas disturbed during construction until all seeding work has been completed.
- C. The Contractor shall re-landscape and properly reseed all areas damaged by their operations. Trenches which have settled within the warranty period, and which were previously seeded, shall be reshaped and reseeded by the Contractor at the Contractor's expense.

END OF SECTION

THIS PAGE INTENTIONALLY LEFT BLANK.

SECTION 333100
SANITARY SEWER SYSTEMS

PART 1 GENERAL

1.1 SUMMARY

- A. The Contractor shall furnish all material, tools, equipment, and labor necessary for material handling, cutting, installation and jointing of various types and sizes of pipe at the locations shown on the Drawings, or as detailed and in conformance with the specifications.

1.2 COORDINATION OF WORK

- A. All work shall be fully coordinated with other work and shop drawings must be checked with each of the various trades. Conflicts in the sequence of the work shall be coordinated through consultation with the Engineer.

1.3 APPLICABLE STANDARDS

- A. Specifications of the following listed standards will be referred to hereinafter by standards abbreviation and specification number which shall include the latest revision thereof.
 1. ANSI, American National Standards Institute.
 2. ASTM, American Society for Testing and Materials.
 3. AWWA, American Water Works Association.
 4. AASHTO American Association of State Highway Transportation Officials.

1.4 QUALITY ASSURANCE

- A. Items submitted for approval in accordance with requirements shown on the Drawings and details shall be of the manufacturer indicated, or an approved equal, in compliance with materials, operations, physical assembly and performance as specified herein.
- B. In addition to the correction period set forth in General Conditions, the manufacturer's standard warranties shall be provided.

1.5 SUBMITTALS

- A. Pipe and Fittings: Certification of compliance, shop drawings.
- B. Precast Concrete Structures & Appurtenances: Shop drawings, certification of compliance.
- C. Coating and lining systems, non-shrink grout, polyethylene corrosion protection: Manufacturer's data and specification sheets and certification of compliance.
- D. Construction Sequence

1.6 PRODUCT DELIVERY, STORAGE AND HANDLING

- A. Store materials to prevent physical damage.
- B. Protect materials during transportation and installation to avoid physical damage.
- C. Pipe, fittings, and accessories shall be handled in a manner to insure installation of the material in an undamaged and structurally sound condition.
- D. Particular care shall be taken to not harm pipe bell and spigot ends. Handling equipment and procedures shall be in accordance with the approved manufacturer's recommendation for proper handling of his products. Improper handling of pipe that results in damage to pipe will be grounds for rejection of the pipe for installation.

1.7 CONNECT TO EXISTING LINES

- A. Work shall be so scheduled and timed as to cause the least possible interference with the operation of the existing system.
- B. Adequate facilities for disposal of fluids which may be released during the connecting operations shall be available.
- C. Contractor shall provide the necessary pumps and temporary piping and associated accessories as required for pumping of wastewater around areas of construction so as to not impede the collection and treatment of the wastewater.
- D. Sewage and water contaminated with sewage shall be conveyed to sanitary sewers.

1.8 BYPASS PUMPING

- A. Where flow control is required to perform a specified repair, replacement, or connection to an existing sewer pipe or manhole, plugging or blocking shall be used wherever possible.
- B. If plugging or blocking is not feasible or at the Contractor's discretion, Contractor shall provide the necessary pumps and temporary piping and associated accessories as required for pumping of wastewater around areas of construction so as to not impede the collection and treatment of the wastewater. Backup pumping capability will be required.
- C. The design, installation, and operation of the temporary pumping system shall be the Contractor's responsibility. The temporary pumping system shall comply with the requirements of all codes and regulatory agencies having jurisdiction. Contractor shall be responsible for any spillage of raw sewage that results in civil or criminal charges from any local, state, or federal agency and will bear all costs for these charges and any restoration required.
- D. It is essential to the operation of the existing sewerage system that there be no interruption in the flow of sewage throughout the duration of the Project. Contractor shall provide, maintain, and operate all temporary facilities such as plugs, pumping equipment (both primary and backup units as required), conduits, all necessary power or fuel source, and all other labor and equipment necessary to handle the sewage by-pass flow.
- E. Contractor shall provide all necessary means to safely convey the sewage past the work area. Contractor shall not stop or impede the sewer flows under any circumstances.
- F. Contractor shall maintain sewage flow around the work area in a manner that will not cause surcharging of sewers, damage to sewers, and that will protect public and private property from damage and flooding.
- G. Contractor shall protect water resources, wetlands, and other natural resources.
- H. Contractor shall insure that the flow diversion pumping system is properly operated and maintained and shall provide responsible personnel to oversee the diversion pumping system at all times.
- I. Work shall be so scheduled and timed as to cause the least possible interference with the operation of the existing sewer collection and treatment system.
- J. Sewage and water contaminated with sewage shall be conveyed to sanitary sewers.
- K. Bypass pumping shall be considered subsidiary to all other bid items.

1.9 WRAP OF BEDDING MATERIAL WITH GEOTEXTILE FABRIC

- A. A layer of medium weight non-woven geotextile fabric shall be placed between the pipe zone backfill and the intermediate zone backfill to reduce fines migration into the pipe zone. Filter fabric shall be laid-out and overlapped according to the manufacturer's recommendations.

1.10 WARRANTY

- A. Full warranty against defects in materials and workmanship for one year after FINAL ACCEPTANCE, including all parts, labor, and expenses.

PART 2 PRODUCTS

2.1 PVC (POLYVINYL CHLORIDE) SEWER PIPE

- A. SDR 35 PVC sewer pipe shall conform to ASTM D3034. SCH. 40 and SCH 80 PVC Pipe (Class 12454-B) shall conform to ASTM D1784 and D1785. All pipe joints shall be rubber gasketed bell and spigot. Pipe shall be made from PVC plastic having a cell classification of 12454-B, 12454-C, or 13343-C having a minimum tensile modulus of 500,000 psi, as defined in ASTM D1784. Nominal laying length shall be 13 feet for 8" through 18" and 19 1/2 feet for 21-inch through 27-inch sizes.
- B. PVC pipe joints shall be bell and spigot design conforming to the requirements of ASTM D3212.
- C. Gaskets shall meet the requirements of ASTM F477. Solvent weld or non-gasket friction joints are not acceptable.
- D. PVC fittings shall be manufactured from the same material as the pipe and meet the requirements of ASTM D3034 for 4" through 15" and ASTM F679 - PS46 for 18" through 27". Fittings shall be so designed so that deflection under load is equal to or less than that of the connecting PVC pipe.

2.2 DUCTILE IRON PIPE

- A. Ductile iron pipe, where indicated on the Drawings or required, shall be as specified herein.
- B. All ductile iron pipe shall be push on or mechanical joint and shall conform to the requirements of ANSI/AWWA C151/A21.51. The wall thickness and outside diameter of the pipe shall conform to Tables 51.4 and 51.5 of AWWA C151. All ductile iron pipe shall be Class 51, except as noted otherwise.
- C. Fittings for use with the ductile iron pipe specified herein, shall be ductile iron. Cast ductile iron fittings shall be pressure rated for at least 250 psi. All fittings with mechanical joints and push on joints shall conform to AWWA/ANSI C110/A21.10 and ANSI/AWWA C111/A21.11, except that Buna-N gaskets shall be used for the joint. The fitting manufacturer shall furnish the proper gaskets, nuts, bolts, glands, for each type of joint. Compact fittings are not acceptable. All fittings shall be American made with uniform flange/gland thickness.
- D. The interior of all ductile iron pipe and fittings shall be lined with polyethylene or coated with Protecto 401 Ceramic Epoxy or Coropipe II WasteLiner as manufactured by Madison Chemical Industries, Inc.
- E. All ductile iron pipe and fittings shall be checked for dry film thickness (DFT) in accordance with the SSPCA-PA2. Each pipe and fitting shall be marked with the date of application of the lining system and with its numerical sequence of application on that date. The pipe supplier shall furnish a certificate stating that the lining applicator has complied with all specification requirements relative to the material, its application and inspection.
- F. Surface preparation, number of coats, application of the lining material and field touch-up shall be in strict accordance with the lining material manufacturer's recommendations. During the installation of the pipe, the lining manufacturer shall provide the services of a field engineer to instruct and demonstrate to the Contractor's personnel the procedure for the field touch-up of the lining where field cuts and taps were required.
- G. Holiday inspection shall be conducted using test equipment described in AWWA C 210, Section 5.3.3.1. In accordance with the coating manufacturer's recommendation, holiday testing may be conducted any time after the coating has reached sufficient cure.
- H. Polyethylene: Inside coatings of all ductile iron pipe and fittings shall be of virgin polyethylene with nominal thickness of 40 mils (35 mils minimum) complying with ANSI/ASTM D 1248.
 - 1. The polyethylene shall be bonded to the interior of the pipe by heat. All surfaces to be lined shall be blast cleaned comparable to the requirements of SSPC-SP6 or NACE no. 3.
 - 2. All pipe and fittings shall be lined with a minimum dry film thickness of 40 mils, except for the gasket groove and spigot end up to 6-inches back from the end of the spigot which shall be lined with 10 mils of the material.
 - 3. The coating thickness on sealing areas in the bell socket interior and on the spigot end of the pipe exterior shall be 8 mils nominal with a maximum of 10 mils. Thicker coatings in these areas are acceptable if it is demonstrated that joint dimensions are within allowable tolerances after coating.
 - 4. Repairs and touchup shall be performed in accordance with the manufacturer's recommended repair and touchup procedures. All field cut ends shall be repaired, sealed and fully cured prior to installation.
 - 5. Polyethylene Lining Testing - Factory tests. All ductile iron pipe and fittings with polyethylene linings shall be subjected to a 10,000-volt spark test prior to shipment. This test shall be utilized to seek any pinholes in the lining after the lining has cooled. Any pipe section or fitting that fails the non-destructive test shall be rejected.
- I. Epoxy Coating: Inside coatings of all ductile iron pipe and fittings shall be an amine cured novalac epoxy containing at least 20% by volume of ceramic quartz pigment. The coating shall be Protecto 401 Ceramic Epoxy as manufactured by the Protecto Division of Vulcan Painters, Inc. The coating shall be a nominal 40 mils DFT thickness, with a minimum of 30 mils DFT thickness.
 - 1. The epoxy coating shall be installed and tested in strict accordance with AWWA C 116/ANSI A21.16 and as supplemented in these specifications.

- J. Polyurethane Coating: Inside coatings of all ductile iron pipe and fittings shall receive a two-component polyurethane coating system. The lining material shall consist of a ceramic modified polyisocyanate resin and polyol resin mixed in a 1:1 ratio at the time of application. The material shall be Corropipe II WasteLiner(CM) as manufactured by the Madison Chemical Industries, Inc. The lining material shall be an ASTM D 16 Type V system. The coating shall be a minimum of 40 mils DFT thickness.
1. All surfaces to be coated or lined shall be cleaned to a near white metal finish (SSPC-SP 10) as applied to ductile iron pipe and fittings. All surfaces shall be completely dry, free of moisture, dust, grease or any other deleterious substances at the time the coating or lining is applied.
 2. The coating thickness on the sealing areas in the bell socket interior and on the spigot end of the pipe exterior shall be 8 mils DFT nominal with a maximum of 10 mils DFT. Thicker coatings in these areas are acceptable if it is demonstrated that joint dimensions are within allowable tolerances after coating.
 3. Field joints, repair and touch up material shall be GP II (E) Touch-Up as manufactured by Madison Chemical Industries, Inc. This work shall be performed in strict accordance with the manufacturer's recommended procedures. All field cut ends and touch ups shall be repaired, sealed and properly cured prior to installation.
- K. Exterior Coating: An asphaltic coating shall be applied to the exterior of all ductile iron pipe and fittings intended for buried service and shall conform to ANSI/AWWA C151/A21.51. The exterior of all piping in the wet well shall be coated as specified in the Painting Section. All ductile iron pipe and fittings intended for interior use and for use above grade shall receive a prime coat of universal primer as specified in the Painting Section.
- L. An asphaltic coating shall be applied to the exterior of all ductile iron pipe and fittings intended for buried service and shall conform to ANSI/AWWA C151/A21.51.
- M. Corrosion Protection:
1. The exterior of all buried ductile iron piping shall be protected from corrosion by a seamless linear low-density polyethylene (LLDPE) tube conforming to ANSI/AWWA C105/A21.5 with a minimum thickness of 8 mils.
 2. The tube shall have markings placed at two-foot intervals and include the manufacturer's name and/or trade mark, the year of manufacture, the standard designation ANSI/AWWA C105/A21.5, the minimum film thickness and material type, the application range of pipe nominal diameters for the film, and a warning notice: "Warning - Corrosion Protection - Repair any Damage."
 3. Corrosion protection supplied in 48-inch wide flat sheets shall be used to cover irregular shaped valves, fittings and appurtenances not protected by the tube form of polyethylene wrap.
 4. Securing tape shall be 2-inch wide by ten (10) mil thickness and supplied by the pipe manufacturers.

2.3 GEOTEXTILE FABRIC

- A. Geotextile wrap of bedding material shall be with filter fabric US 205NW or equivalent and meet the following specifications:
1. Apparent Opening Size (AOS): #80 U.S. Standard Sieve Size per ASTM D4751.
 2. Grab Tensile/Elongation: 205 lbs/50% per ASTM D4632.
 3. Puncture Strength: 130 lb minimum, average roll value per ASTM D4833.

2.4 MANHOLES, CONCRETE ADDITIVES FOR MANHOLES, MANHOLE COATINGS AND NON-SHRINK GROUT FOR MANHOLES

- A. Precast reinforced concrete manholes, concrete additives for manholes, manhole coatings and non-shrink grout for Sanitary Sewer Systems shall be as specified in Section 330516.

2.5 EXPANSION PIPE PLUG

- A. Expansion pipe plugs 4" - 18" diameter shall be Hand-Tite Pipe Plug as manufactured by R.C. Graham Co.

2.6 TRACER WIRE

- A. All gravity sewer pipes and new sections of laterals shall be installed with tracer wire to facilitate future location of the pipe.

- B. Locator wire shall be #12 gauge solid copper wire with PE-45 insulation as manufactured by Kris-Tech Wire Company or an approved equal. Alternative manufacturer wire must be specified as locator or tracer wire and shall not be conductor wire for other purposes.
- C. Locator wire shall be installed in such a manner to keep slices to an absolute minimum.
- D. All connections or splices shall be made with a Splice Kit equal to 3M-DBR-Part Number – 054007-09964 or approved equal.
- E. Wire shall be taped as shown on the Construction Plan details.
- F. Wire shall be installed along all lines and outside manhole structures, lampholes, and cleanouts as shown on the Construction Plan details and shall have enough slack to extend to 48" above ground.
- G. Contractor must prove continuity of locator wire after installation is complete. Owner's Representative must be present during continuity testing.
- H. Locator wire installation, including signal loss, shall be warranted for one year.

PART 3 EXECUTION

3.1 TRENCHING, BACKFILLING AND COMPACTING

- A. Trenching and backfilling shall be in accordance with applicable requirements of Section 312333.

3.2 GENERAL PIPE INSTALLATION

- A. Pipe shall be protected during handling against impact shocks and free fall and the pipe interior shall be free of extraneous material.
- B. Pipe Handling: Pipe, manholes and appurtenances shall be handled in a manner to insure installation of the material in an undamaged and structurally sound condition. Particular care shall be taken to not harm pipe coatings. Handling equipment and procedures shall be in accordance with the approved manufacturer's recommendation for proper handling of its products. Improper handling of pipe that results in damage to pipe or coatings will be grounds for rejection of the pipe for installation. The Engineer will be the final judge as to the acceptability of any material on the project. Cutting of pipe is discouraged. The Contractor is urged to plan his job to minimize the necessity for cutting. Prior to installation each pipe shall be inspected for defects and cracks. All defective, unsound or damaged pipe shall be rejected. The interior of all pipes and fittings shall be thoroughly cleaned and kept clean thereafter. All joints surfaces shall be kept absolutely clean during the jointing process. Pipelines and runs intended to be straight shall be laid straight and to grade. Grade changes and alignment deflections shall be made as shown on the drawings.
- C. Laying Pipe: Pipe shall not be laid in wet trench. At times when the laying of the pipe is not in progress, the open ends of the pipe shall be closed in such a manner that water due to rainfall or infiltration cannot enter. All joints shall be completed. Except where necessary for making connections with other lines, closures, or as authorized by the Engineer, pipe shall be laid with the bells facing upstream.
- D. Aligning Pipe: Tangent runs intended to be straight shall be laid straight. Horizontal and vertical deflections shall be by angular divergence of the axis of adjacent pipe at the joint in accordance with manufacturer's recommendations. Shorter lengths of pipe may be used to increase the number of available joints.

3.3 PIPE INSTALLATION

- A. Bedding Pipe: Pipe shall be placed in bedding material as specified in Section 312333 TRENCHING AND BACKFILLING.
- B. Laying Pipe: Lay pipe upgrade starting at the low point and with spigot end of pipe pointing downstream with bell holes excavated as required. Inspect each length and reject damaged or defective lengths. All pipe shall be laid with ends abutting and true to line and grade and shall be fitted and matched so that when laid together they will form a smooth and uniform invert. As the work progresses, the interior of the pipe shall be cleared of all superfluous materials.

- C. Pipe jointing shall be accomplished as follows:
 - 1. All surfaces of the portions of the pipe to be joined shall be clean and dry. Lubricants and primers shall be used as recommended by the pipe manufacturer. The joints shall then be placed, fitted, joined and adjusted so as to obtain a water tight joint. Where possible the proper seating of the gasketed joints shall be visually inspected prior to placement of the next section of pipe. Pipe or piped joints found to be defective shall be removed from the trench, marked as defective and returned to the manufacturer.
- D. The downstream end of new line extensions shall be plugged in a positive manner by use of inflatable plugs or other means acceptable to the Engineer until construction, cleaning, and testing is completed and the new construction is accepted by the Engineer.
- E. Service (Wye) Connections. Install fittings for service connections in all types of pipe at locations and in the manner designated by the manufacturer and approved by the Engineer.
- F. Riser Pipes shall be constructed of approved sewer pipe and fittings as specified herein and as detailed on the Drawings. Each riser pipe shall be plugged with an Engineer approved plugging device.
- G. House service lines shall be constructed of approved sewer pipe and fittings as specified herein and as detailed on the Drawings. Connections between new and old work shall be made by means of suitable adapters approved by the Engineer.
- H. Sewer lines and stubs indicated on the Drawings to be plugged for future connection, shall be plugged with an Engineer approved plugging device. The plugging device shall be corrosion resistant, designed for long term burial and prevent infiltration for the duration of its use. It shall allow easy removal for future connection with no damage to the existing line or stub. The plug shall be as manufactured by Hand-Tite, Inc. or approved equal.

3.4 SEPARATION OF WATER MAINS AND SEWERS

- A. Gravity Sanitary Sewers. When potable water pipes and gravity sanitary sewers are laid parallel to each other, the horizontal distance between them shall be not less than 10 ft (3.0 m). The distance shall be measured from edge to edge. The laying of water pipes and sanitary sewers shall be in separate trenches with undisturbed earth between them. When a water pipe and a sanitary sewer cross and the sewer is 2 ft (0.6 m) or more (clear space) below the water pipe, no special requirements or limitations are provided herein. At all other crossings, the sanitary sewer is to be constructed of one of the following materials (or approved equal) and pressure tested to assure water tightness.
 - 1. Ductile iron pipe conforming to ASTM A536 or ANSI/AWWA C151/A21.51 with minimum thickness class 50, and gasketed, push-on, or mechanical joints in conformance with ANSI/AWWA C110/A21.10 or ANSI/AWWA C111/A21.11.
 - 2. PVC pipe conforming to ASTM D3034 with minimum wall thickness of SDR41, ASTM F679, ASTM F789, or ASTM F794, with gasketed push-on joints in conformance with ASTM D3212.
 - 3. Reinforced concrete pipe conforming to ASTM C76 with gasketed joints in conformance with ASTM C361 or ASTM C443.
- B. Joints in the sewer pipe shall be located as far as practical from the intersected water main.
- C. Where a water main is laid across or through an area where there is an existing sanitary sewer, which is not constructed of one of the above specified materials and is 2 ft (0.6m) or less below the water pipe, the existing sewer shall be encased in concrete with a minimum of 6 in (15 cm) thickness for a 10 ft (3.0 m) distance on each side of the crossing or the crossed section of sewer replaced to meet the above specified construction requirements.
- D. Pressure Sewer Lines. When force mains run parallel to water lines, the separation distance shall be as far as practical, but at least a 10 ft (3.0m) horizontal separation shall be maintained. There shall be at least a 2 ft (0.6 m) vertical separation at crossings with the water main crossing above the sewer force main.

3.5 MANHOLES - GENERAL

- A. Excavation and backfill around manholes shall be in accordance with the applicable paragraphs in Section 312333 TRENCHING AND BACKFILLING. Install manholes on an 8-inch layer of gravel bedding used for sewer pipe bedding. Bedding shall extend a minimum of 6-inches beyond the outer edge of the base

- B. Handle with care to avoid damage to joint ends of each section. Damaged sections may be subject to rejection at the discretion of the Engineer. All manhole construction shall be watertight. The invert, walls and steps shall be cleaned of excess grout and laitance.
- C. Floors of the manholes shall be shaped and smoothed so that flow channels will be formed such that the manhole will be self-cleaning and free of areas where solids may be deposited. The floors shall have a slope of one (1) inch per foot on areas outside of the flow channels.
- D. Connection to existing sewer mains shall be done in an approved manner. Cutting into existing sewer shall be done in such a manner as to prevent damage to sewer not being removed. New invert channel(s) shall be constructed as required and in accordance with the requirements herein and as shown on the Drawings.
- E. Precast manholes with T-lock liner shall be spark tested in strict accordance with the manufacturers recommended test procedures by a certified technician and witnessed by the Owner's representative.

3.6 MANHOLES - PRECAST CONCRETE

- A. Manholes, wetwell and valve vault shall be constructed of precast reinforced manhole sections, concentric or eccentric reducer cone section and flat tops as detailed.
- B. All precast structures shall be set plumb and level on a 8-inch thick (minimum) layer of compacted $\frac{3}{4}$ " gravel.
- C. All section joints shall be set and sealed with an approved joint sealant.

3.7 MANHOLE CASTINGS

- A. All castings and frames shall be placed in the positions indicated on the Drawings.
- B. Manhole Castings shall be set on a full mortar bed or sealed with a troweled-on butyl rubber mastic sealant, Press-Seal Gasket Corporation "Trowelable EZ-Stik #3". In situations where the exterior walls of the manhole will be exposed to weather or where bolt down covers are required, the manhole casting shall be bolted to the precast cone section or flat slab top using $\frac{3}{4}$ " diameter stainless steel threaded rod, nuts and washers epoxy anchored into the concrete.
- C. Castings and frames shall be set true to line and to correct elevations.

3.8 CONNECTION TO MANHOLES.

- A. Connections to new manholes shall utilize flexible connections. Flexible connections allow for limited differential settlement to occur between the pipe and manhole. The uniform compaction of the bedding material under the pipe and up to the spring line or top of the pipe as detailed is essential to the control of this differential settlement. Resilient connectors shall be used with all flexible connections. A flexible preformed mastic sealant shall be installed around the bottom half of the exterior pipe surface between the resilient connector and the invert. This flexible sealant shall be installed to separate the pipe from the invert to maintain the flexibility of the pipe/manhole connection. Pipes installed with flexible connections shall not have concrete encasement at the outside of the manhole.
- B. Connection to Existing Structures shall be done in such a manner as to prevent damage to existing structures. Hole for installation of pipe shall be approximately 4 inches larger in diameter than the outside diameter of the pipe to be installed. Annular space around the pipe or resilient connector, as required, shall be filled solid with non-shrink grout. New invert channels shall be constructed as required and shall conform with the requirements herein. For installing a new manhole on an existing pipe, a clamp-on resilient connector shall be installed on the pipe prior to grouting into the manhole wall.

3.9 NON-SHRINK GROUT

- A. All mixing, surface preparation, handling, placing, consolidation, curing and other means of execution for prepackaged grouts shall be done in strict accordance with the instructions and recommendations of the manufacturer.
- B. Grout shall be placed in such a manner, for the consistency necessary for each application, so as to assure that the space to be grouted is completely filled.

C. The finish of the grout surface shall match that of the adjacent concrete.

3.10 CLEANING AND TESTING

A. General:

1. After all installations are complete, including all backfill and compaction, all piping and appurtenances shall be cleaned of foreign materials. Flushing of foreign materials from a newly completed section of interceptor sewer into section already in service will not be allowed. If ductile iron pipe is utilized the Contractor shall take care not to damage the internal linings. If lining is damaged during either installation or cleaning it shall be repaired in strict accordance with and approved by the pipe manufacturer's technical field service personnel.
2. Contractor shall furnish all labor, tools, potable water, and equipment necessary to perform leakage and deflection tests as specified herein. The methods and equipment used to make the test shall be mutually determined by the Engineer and Contractor before any testing is started. For the purpose of testing, a section of the line shall be considered as the length of line between manholes. Any section that fails the test shall be repaired and retested by the Contractor until the leakage and/or deflection limits is within the allowable limits. Water used for exfiltration testing shall not be allowed to be disposed of through the completed sewer line. The Contractor shall provide the required pumps to dispose of test water to the nearest storm sewer or waterway.
3. If inspection or test shows defects, such defective work or material shall be replaced and inspection and tests repeated. Repairs to piping and appurtenances shall be made with new material at no additional cost to the Owner.
4. All visible leaks shall be repaired.

B. Gravity Lines:

1. Lines shall be checked for alignment by lamping and visual inspection and deflection by mandrel testing. The pipe between manholes shall not be more than 1/4 of the pipe diameter out of alignment.
2. Deflection limits for flexible sewer pipe shall not exceed five (5) percent of the nominal diameter of the pipe. Deflection limits shall be verified by passing a mandrel through the section of sewer line not less than 30 days after completion of the installation.
3. Perform deflection test using a properly sized mandrel without mechanical pulling devices.
4. Under no circumstances shall the mandrel test be performed prior to the completion of all compaction operations required for surface preparation, regardless of the time of completion of the pipe installation.
5. The sewer mandrel shall be fabricated with a diameter not less than 95 percent of base or average diameter of the pipe as determined by the ASTM standard to which the pipe is manufactured. The mandrel shall be certified by an independent testing laboratory. The current certification shall be submitted and approved by the Engineer prior to using the mandrel.
6. The Contractor shall provide video verification of the sewer main on all lines 30 days after substantial completion.
7. Air Test:
 - a. In addition to the visual inspection, the Contractor shall perform a low pressure air test on all pipe installed.
 - b. Testing methods for PVC pipe shall conform to the applicable requirements of ASTM F1417.
 - c. Testing methods for concrete pipe shall conform to the applicable requirements of ASTM C 924.
 - d. Testing methods for vitrified clay pipe shall conform to the applicable requirements of ASTM C828.
 - e. For making the low pressure air tests, the Contractor shall use equipment specifically designed and manufactured for the purpose of testing sewer pipelines using low pressure air. The equipment shall be provided with an air regulator valve or pressure relief valve set so that the internal air pressure in the pipeline cannot exceed 9 psig. All air used shall pass through a single control panel.

- f. Pneumatic plugs shall have a sealing length equal to or greater than the diameter of the pipe to be tested. Pneumatic plugs shall resist internal test pressures without requiring external bracing or blocking.
 - g. The Contractor shall be extremely cautious when testing with low pressure air. It is extremely important that the various plugs be installed in such a way as to prevent blowouts. Inasmuch as a force of 250 lbf (112N) is exerted on an 8-inch (230 mm) plug by an internal pipe pressure of 5 psi (34 kPa), it should be realized that sudden expulsion of a poorly installed plug or of a plug that is partially deflated before the pipe pressure is release can be dangerous.
 - h. NO ONE shall be allowed in the manholes during testing.
 - i. The section of pipe between successive manholes shall be sealed with suitable plugs. Do not overpressure the line. Do not exceed 9.0 psig. One of the plugs shall have an orifice through which to pass air into the section of pipe being tested. The air supply source (air compressor) shall have a 9 psig pressure relief valve. The air supply line shall have a positive on-off valve and suitable means for readily disconnecting it at the control panel. A second orifice in the plug shall be used for constantly reading the internal pressure of the pipe. This orifice shall be continuously connected to a pressure gauge having a range of from 0 to 10 psi. The gauge shall have minimum divisions of 0.10 psi and shall have an accuracy of ± 0.04 psi.
 - j. The line under test shall be slowly pressurized to approximately 4 psi. Regulate the air supply so that the pressure is maintained between 3.5 and 4.0 psig for at least 2 minutes. The air temperature should stabilize in equilibrium with the temperature of the pipe walls. Disconnect the air supply and decrease the pressure to exactly 3.5 psi before starting the test.
 - k. Determine the time required for the pressure to drop from 3.5 psi to 2.5 psi, and compare this interval to the required time to decide if the rate of air loss is within the allowable. Tables 1 and 2 show the minimum holding times for PVC pipe listed by diameter. If the pressure drops 1.0 psig before the appropriate time shown in Table 1 has elapsed, the air loss rate shall be considered excessive and the pipe section has failed the test. For testing of long sections or sections of larger diameter pipes, or both, a timed-pressure drop of 0.5 psig shall be used in lieu of the 1.0 psig drop as shown in Table 2.
 - l. Upon completion of the test, open the bleeder valve and allow all air to escape. Plugs should not be removed until air pressure in the test section has been reduced to atmospheric pressure.
8. An infiltration/exfiltration test may be performed with prior approval by the Engineer.
- a. Infiltration Test: An infiltration test shall be performed when the crown of the sewer line is below the ground water table. The amount of water leaking into the sewer shall be measured by the use of appropriately sized weirs designed specifically for this purpose and approved by the Engineer. The allowable leakage shall not be more than 50 gallons per day, per mile of pipe, per inch nominal diameter. The section of pipe to be tested shall be pumped dry before the start of the test.
 - b. Exfiltration Test: In areas where the crown of the pipe is above the ground water level, an exfiltration test shall be performed. The section of sewer to be tested shall be filled with water so that the water table in the upstream manhole is at least 4 feet above the flowline or 2 feet above the top of the pipe, whichever is greater. The amount of water added during the test period to maintain the water level shall be measured and it shall not exceed a rate of 50 gallons per day, per mile of pipe, per inch of nominal diameter. PVC joints shall be repaired by removal and replacement of the pipe section or pipe joint as directed by the Engineer. D.I.P. joints found to be defective shall be repaired by disassembly of the pipe joint, replacement of the joint and or pipe gasket and reassembly of pipe section utilizing a ductile iron mechanical joint long sleeve with internal pipe filler. Bell clamps will not be an acceptable method of joint repair.
- C. Manholes:
- 1. Manholes structure shall be either vacuum or hydrostatically tested. Vacuum or hydrostatic testing is recommended prior to backfilling, where feasible, to assist in locating leaks. The final test and acceptance shall be based only on a test after the manhole is backfilled and the cast manhole ring is in place. Existing manholes where new connections are made will not be required

- to be vacuum or hydrostatically tested. These manholes shall be visually inspected for water tightness with any leakage noted and corrected prior to manhole acceptance.
2. Vacuum Test - A vacuum test shall be performed on all new manholes. Plug all manhole entrances and exits other than the manhole top access using suitably sized and rated pneumatic or mechanical pipeline plugs. Follow manufacturer's recommendations and warnings for proper and safe installation of such plugs, taking care to securely brace the plugs and the pipe. Attach the vacuum test device to the cast manhole ring and draw a vacuum to 10" of mercury. With the valve at the vacuum line connection closed and the vacuum pump off, measure the time required for the vacuum to drop to 9" of mercury. The manhole passes the test if the time is greater than 60 seconds for a 48" diameter manhole, 75 seconds for a 60" diameter manhole, and 90 seconds for a 72" diameter manhole. If the manhole fails the test, the Contractor shall locate the leak and make proper repairs with non-shrink grout. The manhole shall be retested until acceptable test results are obtained.
 3. Hydrostatic Test - Manholes may be tested using internal or external hydrostatic pressure with prior approval by the Engineer. External hydrostatic testing shall only be used where the groundwater level is at least 4 feet above the invert of the manhole. In all other cases, the internal hydrostatic test procedures must be followed. Sewers connected to the manhole shall be adequately plugged. For the internal hydrostatic test, the manhole shall be filled with water to the top or to a maximum depth of 25-feet above the invert. Water gain or loss shall not exceed 1.14 gallons per day per vertical foot of manhole for either external or internal hydrostatic testing. Infiltration and exfiltration shall be determined after 24 hours of hydrostatic testing by determining the gain or loss of water in the manhole. Contractor shall be responsible for retrieving any plugs or material accidentally washed down a sewer.

3.11 CORROSION PROTECTION

- A. Protective coating for D.I. pipe shall be provided by the use of 8 mil polyethylene loose fitting tubing. The wrapping shall be bunched up at each end to provide for overlap to adjoining pipe by 1 foot. The wrapping on the adjacent pipe is pulled over the bell and secured with three circumferential turns of polyethylene adhesive tape. The resulting loose wrap on the barrel of the pipe shall be pulled snugly around the barrel and taped at 3 foot intervals. The Contractor shall use care in backfilling as to avoid tearing and shall repair all holes in the wrapping.
- B. Polyethylene encasement materials and installation shall be in accordance with ANSI/AWWA C105/A21.5.

3.12 BYPASS PUMPING

- A. Where plugging is used, the Contractor shall monitor upstream manholes for excessive surcharge conditions. The Contractor shall take immediate action and utilize all means necessary to quickly alleviate the surcharge conditions.
- B. Contractor is responsible for locating any existing utilities in the area Contractor selects to locate the diversion pipelines. The diversion pipelines shall be located to minimize any disturbance to existing utilities, traffic, and the Contractor shall obtain approval of the pipeline locations from the Owner and Engineer prior to installation.
- C. Plugging or blocking of sewage flows shall incorporate primary and secondary plugging devices. Plugging devices shall be braced and/or designed such that they are capable of retaining the maximum head that could be produced at the plug location during maximum surcharging of the sewer system. When plugging or blocking is no longer needed for performance and acceptance of work, the plugs or blocks shall be removed in a manner that permits the sewage flow to slowly return to normal, to prevent surcharging or causing other major disturbances downstream.
- D. When working inside manholes, Contractor shall exercise caution and comply with OSHA requirements when working in the presence of sewer gases, combustible oxygen-deficient atmospheres, and confined spaces.
- E. Contractor shall protect the discharge lines from damage in the areas of backhoe operations. Damaged, leaking or defective discharge lines shall be immediately replaced.
- F. Contractor shall confine the discharge pipelines to the limits of Work as defined by the contract documents during bypassing operations.

END OF SECTION

**SECTION 400500 GENERAL
PIPING REQUIREMENTS**

PART 1 GENERAL

1.1 DESCRIPTION

- A. This section describes the general requirements for selecting piping materials; selecting the associated bolts, nuts, and gaskets for flanges for the various piping services in the project; and miscellaneous piping items.

1.2 SUBMITTALS

- A. Submit shop drawings in accordance with Section 013300.
- B. Provide data sheets for each type of piping and submit affidavits of compliance with referenced standards (e.g. AWWA, ANSI, ASTM, etc.).
- C. Submit verification of NSF 61 Certification for pipe and fittings.
- D. Submit affidavit of compliance with referenced standards (e.g., AWWA, ANSI, ASTM, etc.).
- E. Submit certified copies of mill test reports for bolts and nuts, including coatings if specified. Provide recertification by an independent domestic testing laboratory for materials originating outside of the United States.
- F. Submit manufacturer's data sheet for gaskets supplied showing dimensions and bolting recommendations.
- G. Submit manufacturer's data sheet for flange insulating kits.
- H. Submit manufacturer's data sheet for insulating unions, showing recommended installation procedures.

1.3 DEFINITIONS OF BURIED AND EXPOSED PIPING

- A. Buried piping is piping buried in the soil, commencing at the wall or beneath the slab of a structure. Where a coating is specified, provide the coating up to the structure wall. Piping encased in concrete is considered to be buried. Do not coat encased pipe.
- B. Exposed piping is piping in any of the following conditions or locations:
 - 1. Above ground.
 - 2. Inside buildings, vaults, or other structures.
 - 3. In underground concrete trenches or galleries.

1.4 INTENT OF DRAWINGS AND SPECIFICATIONS

- A. Except in details, piping is indicated diagrammatically. Sizes and locations are indicated on the Drawings. Not every offset and fitting, or structural difficulty that may be encountered has been indicated on the Drawings.
- B. Perform minor modifications to piping alignment where necessary to avoid structural, mechanical, or other type of obstructions that cannot be removed or changed.
 - 1. Modifications are intended to be of minor scope, not involving a change in the design concept or a change to the Contract Price or Contract Time.

PART 2 PRODUCTS

2.1 MATERIALS SELECTION AND ALTERNATIVE MATERIALS

- A. The drawings list the material and specification for each piping service in the project. The same pipe material shall be used for all pipe sizes in all locations for the given piping service. Do not intermix piping materials unless shown on the Drawings. Stainless steel pipe may be used as an alternate to ductile iron pipe in "exposed piping" locations.

2.2 THREAD FORMING FOR STAINLESS STEEL BOLTS

- A. Form threads by means of rolling, not cutting or grinding.

2.3 BOLTS AND NUTS FOR FLANGES FOR PVC, STAINLESS STEEL, STEEL, AND DUCTILE IRON PIPING

- A. Bolts and nuts for all buried flanges and all flanges located indoors; outdoors; above ground; and in vaults and structures shall be Type 304 stainless steel conforming to ASTM A193, Grade B8 Class 2, for bolts and ASTM A194, Grade 8, for nuts unless indicated otherwise. Fit shall be Class 2A and

2B per ASME B1.1 when connecting cast iron valves having body bolt holes.

- B. Bolts and nuts used in flange insulation kits shall conform to the same requirements as described in the paragraph contained herein; or ASTM A193 (Grade B7). Nuts shall conform to ASTM A194 (Grade 2H).
- C. Form threads for stainless steel bolts by means of rolling, not cutting or grinding.
- D. Provide washers for each nut and bolt head. Washers shall be of the same material as the nuts.

2.4 LUBRICANT FOR STAINLESS STEEL BOLTS AND NUTS

- A. Lubricant shall be chloride free and shall be RAMCO TG-50, Anti-Seize by RAMCO, Specialty Lubricants Corporation Huskyä Lube O'Seal, or equal.

2.5 GASKETS FOR FLANGES FOR DUCTILE IRON PIPING AND FITTINGS IN WATER SERVICE

- A. Gaskets shall be full face, 1/8-inch thick, cloth-inserted rubber, with a Shore "A" hardness of 75 to 85. Gaskets shall be suitable for a water pressure of 200 psi at a temperature of 180°F. Gaskets shall have "nominal" pipe size inside diameters not the inside diameters per ASME B16.21. Products: Garlock Style 19 or equal.

2.6 GASKETS FOR FLANGES FOR DUCTILE IRON AND STAINLESS STEEL PIPING AND FITTINGS IN AIR SERVICE

- A. Gaskets shall be full face, 1/8-inch thick, cloth-inserted rubber, with a Shore "A" hardness of 60. Gaskets shall be suitable for air pressure of 150 psi at a temperature of 300°F. Gaskets shall have "nominal" pipe size inside diameters not the inside diameters per ASME B16.21. Products: Garlock Style 8314 or equal.

2.7 GASKETS FOR FLANGES FOR STEEL AND DUCTILE-IRON PIPING AND FITTINGS IN RAW SEWAGE, SLUDGE, AND SCUM SERVICE

- A. Gaskets shall be full face, 1/8-inch thick, Buna-N having a hardness of 55 to 65 durometer. Gaskets shall be suitable for a water pressure of 200 psi at a temperature of 250°F. Gaskets shall have "nominal" pipe size inside diameters not the inside diameters per ASME B16.21. Provide Garlock Style 9122 or equal.

2.8 GASKETS FOR FLANGES FOR PVC AND CPVC PIPING

- A. Gaskets for flanged joints shall be full faced, 1/8-inch thick, having a hardness of 50 to 70 durometer. Gasket material for other than sodium hypochlorite service shall be EPR. Gasket material for sodium hypochlorite service shall be Viton ETP.

2.9 FLANGE INSULATION KITS

- A. Flange insulation kits shall consist of insulating gasket, an insulating stud sleeve for each bolt, insulating washers for each bolt, and a steel washer between each insulating washer and the nut. The sleeves shall be one piece, integral with the insulating washer. Gaskets shall be full face. Provide double sleeve and washer sets for each bolt.
- B. Gasket material shall be phenolic, 1/8-inch thick. The flange insulating gasket shall be full diameter of the flange with a nitrile O-ring on each side of the gasket. Dielectric strength shall not be less than 500 volts per mil and a compressive strength of not less than 24,000-psi.
- C. Insulating flange bolt sleeves shall be high-density polyethylene or spiral-wrapped mylar. Dielectric strength shall not be less than 1,200 volts per mil.
- D. Insulating flange bolt washers shall be high-strength phenolic a minimum thickness of 1/8-inch. Dielectric strength shall not be less than 500 volts per mil and a compressive strength of not less than 25,000-psi.
- E. Steel flange bolt washers for placement over the insulating washers shall be a minimum thickness of 1/8-inch and be cadmium plated.
- F. Flange insulation kits shall be as manufactured by Central Plastics Company, Advance Product Systems, or equal.

2.10 INSULATING UNIONS

- A. Insulating unions shall consist of a molded nylon sealing sleeve mounted in a three-piece malleable-iron (ASTM A47 or A197) body. Ends shall be threaded (ASME B1.20.1) when connecting to steel piping and copper solder joint when connecting to copper piping. Minimum working pressure shall be 150-psi. Unions shall be as manufactured by Central Plastics Company, Capital Insulation, or equal.

PART 3 EXECUTION

3.1 INSTALLING PIPE SPOOLS IN CONCRETE

- A. Install pipes in walls and slabs before placing concrete. See Section 400762.

3.2 RAISED FACE AND FLAT FACE FLANGES

- A. Use a flat-faced carbon steel, or alloy flange when mating with a flat-faced cast or ductile iron flanges.
- B. High pressure rated flanges as required to mate with equipment when equipment flange is of high pressure rating than required for piping.
- C. Where a raised face flange connects to a flat-faced flange, remove the raised face of the flange.

3.3 INSTALLING ABOVEGROUND OR EXPOSED PIPING

- A. Set piping plumb and at the horizontal and vertical location shown on the Drawings. Provide pipe hangers and supports to maintain alignment, as detailed in the drawings and as specified in Section 400764.
- B. Install pipe without springing, forcing, or stressing the pipe or any adjacent connecting valves or equipment.
- C. Pipe penetrations through walls, slabs, and floors shall be as detailed on the Drawings or as allowed for alternate configurations as specified herein.
- D. Install pipe spools in walls and slabs before placing concrete.
- E. Inspection for Defects: Before installation, inspect pipe and appurtenances for defects and, when applicable, tap the pipe with a light hammer to detect cracks. Reject defective, damaged, or unsound pipe and appurtenances.
- F. Cutting: Cut pipe, when necessary, in a neat and workmanlike manner without damage to the pipe, interior lining, and exterior coating. Perform cutting with an approved mechanical cutter, using a wheel cutter when applicable and practicable.
- G. Cut pipe ends square, ream pipe and tube ends to full pipe diameter, remove burrs.
- H. Beveling: Grind smooth and bevel cut ends and rough edges using methods recommended by the manufacturer and approved by Engineer.
- I. Bolt holes of flanges shall straddle the horizontal and vertical centerlines of the pipe. Clean flanges by wire brushing before installing flanged fittings. Lubricate bolts and tighten nuts uniformly and progressively. If flanges leak under pressure testing, loosen or remove the nuts and bolts, reset or replace the gasket, reinstall or retighten the bolts and nuts, and retest the joints. Joints shall be watertight.
- J. Provide a flange insulation kit at all flanges between dissimilar metals whether shown on the Drawings or not.
- K. Install access fittings to permit disinfection of water system.

3.4 INSTALLING FLANGED PIPING

- A. Set pipe with the flange bolt holes straddling the pipe horizontal and vertical centerline. Install pipe without springing, forcing, or stressing the pipe or any adjacent connecting valves or equipment. Before bolting up, align flange faces to the design plane within 1/16 inch per foot measured across any diameter. Align flange bolt holes within 1/8-inch maximum offset.
- B. Inspection for Defects: Before installation, inspect pipe and appurtenances for defects and, when applicable, tap the pipe with a light hammer to detect cracks. Reject defective, damaged, or unsound pipe and appurtenances.
- C. Inspect each gasket to verify that it is the correct size, material, and type for the specified service and that it is clean and undamaged. Examine bolts or studs, nuts, and washers for defects such as burrs or cracks and rust and replace as needed.
- D. Clean flanges by wire brushing before installing flanged fittings. Clean flange bolts and nuts by wire brushing, lubricate carbon steel bolts with oil and graphite, and tighten nuts uniformly and progressively.
- E. Bolt lengths shall extend completely through their nuts. Any that fail to do so shall be considered acceptably engaged if the lack of complete engagement is not more than one thread.
- F. Do not use more than one gasket between contact faces in assembling a flanged joint.
- G. Tighten the bolts to the manufacturer's specifications, using the recommended cross bolt pattern in

multiple steps of increasing torque, until the final torque requirements are achieved. Do not over torque.

- H. If flanges leak under pressure testing, loosen or remove the nuts and bolts, reset or replace the gasket, reinstall or retighten the bolts and nuts, and retest the joints. Joints shall be watertight.
- I. Install access fittings to permit disinfection of water system.

3.5 INSTALLING BLIND FLANGES

- A. At outlets not indicated to be connected to valves or to other pipes and to complete the installed pipeline hydrostatic test, provide blind flanges with bolts, nuts, and gaskets.
- B. Coat the inside face of blind flanges per Section 099000, System No. 12.

3.6 INSTALLING GROOVED-END PIPING

- A. Install grooved-end pipe and fittings in accordance with the coupling manufacturer's recommendations and the following.
- B. Clean loose scale, rust, oil, grease, and dirt from the pipe or fitting groove before installing coupling. Apply the coupling manufacturer's gasket lubricant to the gasket exterior including lips, pipe ends, and housing interiors.
- C. Fasten coupling alternately and evenly until coupling halves are seated. Use torques as recommended by the coupling manufacturer.
- D. Provide separate hangers and supports at both sides of flexible joints; see Section 400764.

3.7 INSTALLATION OF STAINLESS STEEL BOLTS AND NUTS

- A. Prior to assembly, coat threaded portions of stainless steel bolts and nuts with lubricant.

3.8 INSTALLATION OF SCHEDULE 80 PVC PIPING

- A. Cut pipe ends square and remove all burrs, chips, and filings before joining pipe or fittings. Bevel solvent welded pipe ends as recommended by the pipe manufacturer.
- B. Wipe away loose dirt and moisture from the ID and OD of the pipe end and the ID of the fitting before applying solvent cement. Do not apply solvent cement to wet surfaces.
- C. Make up solvent welded joints per ASTM D2855.
- D. Allow at least eight (8) hours of drying time before moving solvent welded joints or subjecting the joints to an internal or external loads or pressures.
- E. Tighten bolts on PVC flanges by tightening the nuts diametrically opposite each other using a torque wrench. Complete tightening shall be accomplished in stages.
- F. Cut threaded ends to the dimensions of ASME B1.20.1. Ends shall be square cut. Follow the pipe manufacturer's recommendations regarding pipe hold-down methods, saw cutting blade size, and saw cutting speed. Pipe or tubing cutters shall be specifically designed for use on PVC pipe.
- G. If a hold-down vise is used when the pipe is cut, insert a rubber sheet between the vise jaws and the pipe to protect from scratching the pipe.
- H. Thread cutting dies shall be clean and sharp and shall not be used to cut materials other than plastic.
- I. Apply Teflon thread compound or Teflon tape lubricant to threads before screwing on the fitting.
- J. Provide unions on exposed piping 3-inches and smaller as follows:
 - 1. Provide a union 6 to 12-inches downstream of valves.
 - 2. Upstream and downstream of equipment which may need to be removed for maintenance.
 - 3. Where shown in the Drawings.

END OF SECTION

SECTION 400515
PRESSURE TESTING OF PIPING

PART 1 GENERAL

1.1 DESCRIPTION

- A. This section specifies the cleaning and hydrostatic, pneumatic, and leakage testing of pressure piping for pumping stations, wastewater treatment plants; general water piping systems; and raw sewage force mains.

1.2 RELATED WORK SPECIFIED ELSEWHERE

- A. General Piping Requirements: 400500.
- B. Valves, General: 400524.

1.3 SUBMITTALS

- A. Submit shop drawings in accordance with Section 013300.
- B. Submit test bulkhead locations and design calculations, pipe attachment details, and methods to prevent excessive pipe wall stresses.
- C. Submit six copies of the test records to the Owner's Representative upon completion of the testing.

1.4 TEST PRESSURES

- A. Test pressures for the various services and types of piping are shown in:
 - 1. Subsection on "Test Pressure and Test Fluids" in Part 3.

1.5 TESTING RECORDS

- A. Provide records of each piping installation during the testing. These records shall include:
 - 1. Date and times of test.
 - 2. Identification of pipeline, or pipeline section tested or retested.
 - 3. Identification of pipeline material.
 - 4. Identification of pipe specification.
 - 5. Test fluid.
 - 6. Test pressure at low point in process, pipeline, or pipeline section.
 - 7. Remarks: Leaks identified (type and location), types of repairs, or corrections made.
 - 8. Certification by Contractor that the leakage rate measured conformed to the specifications.

PART 2 PRODUCTS

2.1 VENTS AND DRAINS FOR ABOVEGROUND PIPING

- A. Install vents on the high points of aboveground piping, whether shown in the drawings or not. Install drains on low points of aboveground piping, whether shown in the drawings or not. Provide a valve at each vent or drain point. Valves shall be 3/4 inch for piping 3 inches and larger and 1/2 inch for piping smaller than 3 inches.
 - 1. Valves shall be as specified in Section 400563 and suited for the application unless otherwise shown in the drawings.

2.2 MANUAL AIR-RELEASE VALVES FOR BURIED PIPING

- A. Provide temporary manual air-release valves at test bulkheads for pipeline test. Construct the pipe outlet in the same manner as for a permanent air valve and after use, seal with a blind flange, pipe cap, or plug and coat the same as the adjacent pipe.

2.3 TEST BULKHEADS

- A. Design and fabricate test bulkheads per Section VIII of the ASME Boiler and Pressure Vessel Code. Materials shall comply with Part UCS of said code. Design pressure shall be at least 2.0 times the specified test pressure for the section of pipe containing the bulkhead. Limit stresses to 70 percent of yield strength of the bulkhead material at the bulkhead design pressure. Include air-release and water drainage connections.

2.4 TESTING FLUID

- A. Testing fluid shall be water unless a pneumatic test is shown in the following subsections.
- B. For lubricating oil; hydraulic oil; fuel oil; and gasoline piping, use potable water for

hydrostatic testing and flushing.

- C. For potable water pipelines, obtain and use only potable water for hydrostatic testing.
- D. Submit request for use of water from waterlines of water utility 48 hours in advance.
- E. The Contractor may obtain the water from the water utility water utility's *rate of charges*.

2.5 TESTING EQUIPMENT

- A. Provide calibrated pressure gauges, pipes, bulkheads, pumps, compressors, and meters to perform the hydrostatic and pneumatic testing.

PART 3 EXECUTION

3.1 TESTING PREPARATION

- A. Pipes shall be in place, backfilled, and anchored before commencing pressure testing.
- B. Conduct pressure tests on exposed and aboveground piping after the piping has been installed and attached to the pipe supports, hangers, anchors, expansion joints, valves, and meters.
- C. For buried piping, the pipe may be partially backfilled, and the joints left exposed for inspection during an initial leakage test. Perform the final pressure test, however, after completely backfilling and compacting the trench.
- D. Provide any temporary piping needed to carry the test fluid to the piping that is to be tested. After the test has been completed and demonstrated to comply with the specifications, disconnect and remove temporary piping. Do not remove exposed vent and drain valves at the high and low points in the tested piping; remove any temporary buried valves and cap the associated outlets. Plug taps or connections to the existing piping from which the test fluid was obtained.
- E. Provide temporary drain lines needed to carry testing fluid away from the pipe being tested. Remove such temporary drain lines after completing the pressure testing. Pipes may remain full after testing.
- F. Prior to starting the test, the Contractor shall notify the Owner's Representative.

3.2 CLEANING

- A. Before conducting hydrostatic tests, flush pipes with water to remove dirt and debris. For pneumatic tests, blow air through the pipes. Maintain a flushing velocity of at least 3 fps for water testing and at least 2,000 fpm for pneumatic testing. Flush pipes for time period as given by the formula: $T=(2L)/3$, in which "T" is flushing time (seconds) and "L" is pipe length (feet).
- B. For pipelines 24 inches or larger in diameter, acceptable alternatives to flushing are use of high-pressure water jet, sweeping, or scrubbing. Water, sediment, dirt, and foreign material accumulated during this cleaning operation shall be discharged, vacuumed, or otherwise removed from the pipe.

3.3 TESTING AND DISINFECTION SEQUENCE FOR POTABLE WATER PIPING

- A. Perform required disinfection after hydrostatic testing, except when pipeline being tested is connected to a potable waterline.
- B. Locate and install test bulkheads, valves, connections to existing pipelines, and other appurtenances in a manner to provide an air gap separation between existing potable water pipelines and the pipeline being tested. Disinfect water and pipeline being tested before hydrostatic testing when connected to a potable waterline.

3.4 LENGTH OF TEST SECTION FOR BURIED PIPING

- A. The maximum length of test section for buried pipe of 12 inches or smaller in diameter is 1 mile; for buried pipe larger than 12 inches, 1 mile. Provide intermediate test bulkheads where the pipeline length exceeds these limits.

3.5 INITIAL PIPELINE FILLING FOR HYDROSTATIC TESTING

- A. Maximum rate of filling shall not cause water velocity in pipeline to exceed 1 fps. Filling may be facilitated by removing automatic air valves and releasing air manually.

3.6 TESTING NEW PIPE WHICH CONNECTS TO EXISTING PIPE

- A. Prior to testing new pipelines which are to be connected to existing pipelines, isolate the new line from the existing line by means of test bulkheads, pipe caps, spectacle flanges, or blind flanges. After successfully testing the new line, remove test bulkheads, caps, or flanges and connect to the existing piping.

3.7 HYDROSTATIC TESTING OF ABOVEGROUND OR EXPOSED PIPING

- A. Open vents at high points of the piping system to purge air while filling the pipe with water. Venting during system filling may also be provided by temporarily loosening flanges.
- B. Subject the piping system to the test pressure indicated. Maintain the test pressure for a minimum of two hours. Examine joints, fittings, valves, and connections for leaks. The piping system shall show zero leakage or weeping. Correct leaks and retest until zero leakage is obtained.
- C. Where the test pressure is not indicated, test each pressure piping system at 150 percent of the operating pressure indicated, but not less than 25 psi test pressure. The required test period is two hours. Observe each test section for leakage at end of test period. Test fails if leakage observed or pressure drop exceeds 5 percent of test pressure.
- D. Test hot and cold water piping systems subject to the Uniform Plumbing Code per Section 609 latest edition of the code. Piping subject to this testing requirement is listed below.

3.8 HYDROSTATIC TESTING OF BURIED PIPING

- A. Where any section of the piping contains concrete thrust blocks or encasement, do not perform the pressure test until at least 10 days after placing the concrete. When testing mortar-lined or PVC piping, fill the pipe to be tested with water and allow it to soak for at least 48 hours to absorb water before conducting the pressure test.
- B. Apply and maintain the test pressure by means of a positive displacement hydraulic force pump.
- C. Maintain the test pressure for the following duration by restoring it whenever it falls an amount of 5 psi:
 - 1. Pipe Diameter 18 inches and Less: 2 hours.
 - 2. Pipe Diameter 20 to 36 inches: 8 hours.
 - 3. Pipe Diameter Greater than 36 inches: 24 hours.
- D. After the test pressure is reached, use a meter to measure the additional water added to maintain the pressure. This amount of water is the loss due to leakage in the piping system. The allowable leakage volume is defined by the formula: $L=(HND \times \text{Square Root}[P])/C$. Where L=Allowable leakage (gallons), H=Specified test period (hours), N=Number of rubber-gasketed joints in the pipe tested (use zero for welded or flanged pipe), D=Diameter of the pipe (inches), P=Specified test pressure (psig), and C=7,400.
- E. After the test pressure is reached, use a meter to measure the additional water added to maintain the pressure. This amount of water is the loss due to leakage in the piping system. The allowable leakage volume is defined by the formula: $L=(HSD \times \text{Square Root}[P])/C$. Where L=Allowable leakage (gallons), H=Specified test period (hours), S=length of pipe tested (feet), D=Diameter of the pipe (inches), P=Specified test pressure (psig), and C=148,000.
- F. Test piping subject to the Uniform Fire Code requirements per NFPA 24. Test such piping hydrostatically at not less than 200-psi pressure for two hours or at 50 psi in excess of the maximum static pressure when the maximum static pressure is in excess of 150 psi. The amount of leakage in piping shall be measured at the specified test pressure by pumping from a calibrated container. The amount of leakage at the joints shall not exceed 2 quarts per hour per 100 gaskets or joints irrespective of pipe diameter. The piping subject to this testing requirement is listed below shown in the drawings.
- G. The allowable leakage for buried piping having threaded, brazed, or welded (including solvent welded) joints shall be zero.
- H. Repair and retest any pipes showing leakage rates greater than that allowed in the above criteria.

3.9 PNEUMATIC TESTING

- A. Perform pneumatic testing using dry air or nitrogen. Perform tests only after the piping has been completely installed including supports, hangers, and anchors. Protect test personnel and Owner's operating personnel. Secure piping to be tested to prevent the pipe from moving and to prevent damage to adjacent piping and equipment. Remove or isolate from the piping any appurtenant instruments or devices that could be damaged by the test prior to applying the test.
- B. Apply an initial pneumatic leakage test of 25 psig to the piping system prior to final leak testing. Examine for leakage, detected by soap bubbles, at joints and connections. After correcting visible leaks, gradually increase the pressure in the system to not more than one-half of the test pressure. Then increase the pressure in steps of approximately one-tenth of the test pressure until the required test pressure has been reached. Continuously maintain the pneumatic test pressure for a minimum time of four hours and for such additional time as may be necessary to conduct a soap bubble

examination for leakage. The piping system shall show no leakage. Correct any visible leakage and retest.

- C. Test piping systems subject to the Uniform Plumbing Code per Section **1214** of the **latest** edition of the code. Piping subject to this testing requirement is **listed below**.

3.10 REPETITION OF TEST

- A. If the actual leakage exceeds the allowable, locate and correct the faulty work and repeat the test. Restore the work and all damage resulting from the leak and its repair. Eliminate visible leakage.

3.11 BULKHEAD AND TEST FACILITY REMOVAL

- A. After a satisfactory test, remove the testing fluid, remove test bulkheads and other test facilities, and restore the pipe coatings.

3.12 TEST PRESSURE AND TEST FLUIDS

- A. Testing and design **pressures (psig)** for different types of process piping shall be as **listed below**.
 - 1. Force Main:
 - a. 50 psig test pressure. (Design operating pressure <19-31 psig w/out surge)
 - 2. Gravity Sewer, Gravity Process Lines:
 - a. Low Pressure Air (See Section 333100).
 - 3. Process Air:
 - a. 8 psig test pressure. (Design operating pressures 4 – 6.5 psig)

END OF SECTION

SECTION 400520
MISCELLANEOUS PROCESS VALVES

PART 1 - GENERAL

1.1 DESCRIPTION

- A. This section includes materials, testing, and installation of process valves including hose bibbs; globe; angle; needle; diaphragm; pinch; solenoid; pet cocks; mud valves; vacuum breakers; deluge valves; flap valves; balancing valves; gauge valves; instrument valve manifolds; and telescoping valves.

1.2 RELATED WORK SPECIFIED ELSEWHERE

- A. Painting and Coating: 099000 (and Paint System Schedule 09900.10)
- B. General Piping Requirements: 400500.
- C. Pressure Testing of Piping: 400515.
- D. Valves, General: 400524.
- E. Air-Release and Vacuum-Relief Valves: 400560.
- F. Plug Valves: 400562.
- G. Ball Valves: 400563.
- H. Check Valves for Specific Applications: 400565.
- I. Butterfly Valves: 400566.

1.3 SUBMITTALS

- A. Submit shop drawings in accordance with Section 013300.
- B. Submit manufacturer's catalog data and detailed construction sheets showing all valve parts. Describe each part by material of construction, specification (such as AISI, ASTM, SAE, or CDA), and grade or type. Identify each valve by tag number to which the catalog data and detail sheets pertain.
- C. Show valve dimensions including laying lengths. Show port sizes. Show dimensions and orientation of valve actuators, as installed on the valves.
- D. Show location of internal stops for gear actuators. State differential pressure and fluid velocity used to size actuators. For worm-gear actuators, state the radius of the gear sector in contact with the worm and state the handwheel diameter.
- E. Show valve linings and coatings. Submit manufacturer's catalog data and descriptive literature.
- F. Submit certification from manufacturer that valves are NSF 61 listed.
- G. Provide additional O&M data per Section 017823.

1.4 WARRANTY

- A. Full warranty against defects in materials and workmanship for one year after final acceptance, including all parts, labor, and expenses.

PART 2 - PRODUCTS

2.1 GENERAL

- A. Valves and the required actuators are identified by tag numbers on the drawings and in the Valve Schedule. See the Valve Schedule Section of Valves, General 400524.
- B. Valves shall be installed complete with flange gaskets, nuts and bolts, operating handwheels or levers, chainwheels, extension stems, floor stands, gear actuators, operating nuts, chains, and wrenches required for operation.
- C. Valves shall have the name of the manufacturer and the size of the valve cast or molded onto the valve body or bonnet or shown on a permanently attached plate.
- D. Bronze or brass material requirements:
 - 1. Any bronze or brass components in contact with water throughout the treatment process shall be made "Lead-Free" as defined in the "Reduction of Lead in Drinking Water Act." Lead-Free shall contain no more than twenty-five hundredth of one percent (0.25 percent or less) total lead contained by weight. The manufacturer shall certify that the bronze meets the "Lead-Free"

requirements.

2. For buried locations, valves with mechanical joint ends may be substituted for the flanged ends specified provided the mechanical joint ends are compatible with the pipe ends.

2.2 VALVE ACTUATORS/OPERATORS

- A. Provide operator types in accordance with the Valve Schedule.
- B. Valves shall open by turning counterclockwise
- C. Valve Boxes: Furnish valve boxes for all buried valves.

2.3 BOLTS AND NUTS FOR FLANGED AND MECHANICAL JOINT VALVES

- A. Bolts and nuts for flanged valves shall be as described in Section 400500.
- B. Buried Service Bolts (for valve installation) shall be fluorocarbon coated cor-ten steel t-bolts and nuts equal to NSS cor-blue or approved equal low allow corrosion-resistant high-strength steel in accordance with ANSI/AWWA C111/A21.11.

2.4 GASKETS FOR FLANGES

- A. Gaskets for flanged end valves shall be as described in Section 400500.

2.5 LINING AND COATING

- A. Coat the exterior of metal valves located above ground or in vaults and structures the same as the adjacent piping. If the adjacent piping is not coated, then coat valves per Section 099000. Apply the specified prime coat at the place of manufacture. Apply intermediate and finish coats at the place of manufacturer or in the field. Finish coat shall match the color of the adjacent piping. Coat handwheels the same as the valves. Do not coat bronze, brass, or stainless steel valves.
- B. Coat the exterior of buried metal valves at the place of manufacture per Section 099000, System No. 10.
- C. Coat the exterior of submerged metal valves, stem guides, extension stems, and bonnets at the place of manufacture per Section 099000, System No. 12. Do not coat bronze, brass, or stainless steel valves.
- D. Line the interior metal parts of metal valves 4 inches and larger, excluding seating areas and bronze and stainless steel pieces, per Section 099000, System No. 12. Apply lining at the place of manufacture. Alternatively, line and coat valves with fusion-bonded epoxy per Section 099761.
- F. Alternatively, apply a fusion-bonded lining suitable for potable water in compliance with AWWA C550.
- G. Coat floor stands per Section 099000.
- H. Measure the thickness of the valve interior linings per Section 099000. Repair areas having insufficient film thickness per Section 099000.

2.6 PACKING, O-RINGS, AND GASKETS

- A. Unless otherwise stated in the detailed valve specifications, packing, O-rings, and gaskets shall be one of the following non-asbestos materials:
 1. Teflon.
 2. Kevlar aramid fiber.
 3. Acrylic or aramid fiber bound by nitrile. Products: Garlock "Bluegard," Klinger "Klingersil C4400," or equal.
 4. Buna-N (nitrile).
 5. EPDM.

2.7 RUBBER SEATS

- A. Rubber seats shall be made of a rubber compound that is resistant to free chlorine and monochloramine concentrations up to 10 mg/l in the fluid conveyed.

2.8 VALVE END CONNECTIONS

- A. Valve end connections for exposed valves shall be flanged unless shown otherwise. The Contractor shall verify the compatibility of valve ends, including class and drilling of flanges with the connecting pipe.
- B. Buried valve end connections shall be mechanical joint or a push-on unless shown otherwise in the Drawings or in the Valve Schedule.

2.9 VALVES

- A. Globe Valves, Angle Valves, Hose Valves, Hose Bibbs, and Fire Hydrants:
1. Bronze Globe Valves 2 Inches and Smaller:
 - a. Globe valves, 2 inches and smaller, shall be all bronze (ASTM B62 or ASTM B584, Alloy C83600) with screwed ends, union bonnet, inside screw, rising stem, and composition or PTFE disc.
 - b. Valves shall have a pressure rating of at least 300 psi at a temperature of 150 degrees F.
 - c. Stem shall be bronze: ASTM B371 (Alloy C69400), ASTM B99 (Alloy C65100), or ASTM B584 (Alloy C87600).
 - d. Valves shall be Crane No. 7TF, Walworth Figure 3095, Stockham B-22T, or equal.
 - 1) Bronze Angle Hose Valves:
 - (a) Angle-type hose valves of sizes 1-1/2 inches and 2-1/2 inches shall be brass or bronze (ASTM B62 or ASTM B584, Alloy C83600) body with rising or nonrising stem, composition disc, and bronze or malleable iron handwheel. Stem shall be bronze, ASTM B62, ASTM B584 (Alloy C83600), or ASTM B198 (Alloy C87600).
 - (b) Valves shall have a cold-water service pressure rating of at least 150 psi.
 - (c) Provide cap and chain with valve.
 - (d) Threads on the valve outlet shall be American National Standard fire hose coupling screw thread.
 - (e) Valves shall be Nibco T-301-HC, Powell Figure 151 with Figure 527 nipple adapter, Crane 17TF with hose nipple adapter, or equal.
 - 2) Bronze Angle Hose Valves (1-1/2-inch and 2-1/2-inch) with Quick Connect Coupling Adapters (for Nonpotable Water Service):
 - (a) Angle-type hose valves of sizes 1-1/2 and 2-1/2 inches shall have brass or bronze (ASTM B62 or B584, Alloy C83600) body with rising or nonrising stem, composition disc, and bronze or malleable iron hand wheel. Stem shall be bronze, ASTM B62, ASTM B585 (Alloy C83600), or ASTM B198 (Alloy C87600).
 - (b) Valve shall have cold-water service pressure rating of at least 150 psi.
 - (c) Threads on valve outlet shall be American National Standard fire hose coupling screw thread (ASME B1.20.7).
 - (d) Provide atmospheric vacuum breaker conforming to ASSE Standard 1011 and IAPMO code and approved by the local health department.
 - (e) Provide with quick connect female adapter to fit the quick connect male adapter on rubber water hose per specification section 221118.
 - (f) Products: Nibco T-301-HC, Powell Figure 151, Crane 17TF, or equal.
 - 3) Bronze Hose Bibbs:
 - (a) Hose bibbs of size 1/2 inch, 3/4 inch, and 1 inch shall be all bronze (ASTM B62 or ASTM B584, Alloy C83600) with rising or nonrising stem, composition disc, bronze or malleable iron handwheel, and bronze stem (ASTM B99, Alloy C65100; ASTM B371, Alloy C69400; or ASTM B584, Alloy C87600). Packing shall be Teflon or graphite.
 - (b) Valves shall have a pressure rating of at least 125 psi for cold-water service.
 - (c) Threads on valve outlet shall be American National Standard fire hose coupling screw thread (ASME B1.20.7).
 - (d) Provide atmospheric vacuum breaker conforming to ASSE Standard 1011 and IAPMO code and approved by the local health department.
 - (e) Valves shall be Jenkins Figure 112, 113, or 372, Nibco Figure T-113-HC, Powell Figure 503H, or equal.
 - 4) Bronze Hose Bibbs 1-inch with Quick Connect Coupling Adapters (for Nonpotable Water Service):
 - (a) Hose bibbs of sizes 1-inch shall be all bronze (ASTM B62 or ASTM B584, Alloy C83600) with rising or non-rising stem, composition disc, bronze or malleable iron hand wheel, and bronze stem (ASTM B99, Alloy C65100; ASTM B371, Alloy C69400; or ASTM B584, Alloy C87600). Packing shall be Teflon or graphite.
 - (b) Valve shall have a pressure rating of at least 125 psi for cold-water service.
 - (c) Threads on valve outlet shall be American National Standard fire hose coupling screw thread (ASME B1.20.7).
 - (d) Provide atmospheric vacuum breaker conforming to ASSE Standard 1011 and

- IAPMO code and approved by the local health department.
- (e) Provide with quick connect female coupling to fit the quick connect male adapter on the rubber water hose per specification section 221118.
 - (f) Products: Jenkins Figure 112, 113, or 372; Nibco Figure T-113-HC; Powell Figure 503H; or equal.
- 5) Hose Valves (3/4 Inch) with Quick Connect Coupling Adapters (for Nonpotable Water Service):
 - (a) Brass body, pressure rating of at least 125 psi cold water, 3/4-inch NPT female inlet, 3/4-inch male hose thread outlet, lock shield bonnet, and removable handle.
 - (b) Provide atmospheric vacuum breaker conforming to ASSE Standard 1011 and IAPMO code and approved by the local health department.
 - (c) Provide with quick connect female adapter to fit the quick connect male adapter on the rubber water hose per Section 221118.
 - (d) Products: Acorn 8126 surface pipe mounted valve with bent nose without flange; Acorn 8121 mount through wall valve with bent nose with flange; Acorn 8131 pipe and pedestal mounted valve located above 6 inches, straight nose; Acorn 8136 pedestal mounted valve located lower than 6 inches, inverted nose; or equal.
 - 6) Bronze Needle Valves 3/4 Inch and Smaller:
 - (a) Needle valves shall be all bronze (ASTM B61, ASTM B62, or ASTM B584, Alloy C83600) with screwed ends, screwed bonnet, and rising stem.
 - (b) Valves shall have a pressure rating of at least 400 psi at a temperature of 150 degrees F.
 - (c) Stem shall be bronze: ASTM B98 (Alloy C65100), ASTM B150 (Alloy C64200), ASTM B584 (Alloy C87600), or ASTM B371 (Alloy C69400).
 - (d) Valves shall be Stockham B-64, Crane No. 88, or equal.
 - 7) Stainless Steel Globe Valves 2 Inches and Smaller:
 - (a) Globe valves 2 inches and smaller shall have bodies, stems, packing nuts, glands, bonnets, union bonnet rings, discs, and disc nuts made of Type 316 stainless steel (ASTM A351, Grade CF8M; or ASTM A276). Packing shall be Teflon.
 - (b) Provide screwed ends (ASME B1.20.1), rising stem, and malleable iron or aluminum handwheel.
 - (c) Valves shall have a pressure rating of at least 150 psig at a temperature of 200 degrees F.
 - (d) Valves shall be Jenkins Figure 1308, Crane/Alloyco Figure 40, or equal.
 - 8) Brass Angle Valves for Use in Fire Protection Service:
 - (a) Valves for use at fire hose racks shall be nominal 1-1/2-inch size, with female NPT inlet and outlet. Valves shall be UL listed and FM rated for fire protection service.
 - (b) Valve shall be constructed of brass with an iron handwheel, painted red.
 - (c) Valve shall be rated for at least 300-psi working pressure.
 - (d) Valves shall be Potter-Roemer Fig. 4070, Allenco Fig. 171, or equal.
 - 9) Bronze Angle Valves 2 Inches and Smaller:
 - (a) Angle valves, 2 inches and smaller, shall be all bronze (ASTM B62 or ASTM B584, Alloy C83600) with screwed ends, union or screwed bonnet, inside screw, rising stem, and bronze disc.
 - (b) Valves shall have a pressure rating of at least 200 psi.
 - (c) Stem shall be bronze: ASTM B371 (Alloy C69400 or C69700).
 - (d) Valves shall be Stockham B-222T, Lunkenheimer Figure 2141, or equal.
 - 10) Wet Barrel Fire Hydrants (AWWA C503):
 - (a) See Section 331219.
 - 11) Dry Barrel Fire Hydrants (AWWA C502):
 - (a) See Section 331219.
 - 12) Angle Fire Hydrants (Wharf Head Valves--AWWA C503):
 - (a) See Section 331219.
2. Diaphragm Valves:
 - a. Cast-Iron Diaphragm Valves 3/4 Inch Through 8 Inches:
 - 1) Diaphragm valves, sizes 3/4 inch through 8 inches, shall be of the weir type complying with MSS SP-83, Category B, with cast-iron (ASTM A48, Class 30, or ASTM A126, Class B) body bonnet and lining suited for application. Diaphragm shall be suited for the application.

- 2) O-rings shall be Teflon. Body-bonnet joint bolting stem, bushing, and travel stop shall be Type 304 stainless steel (ASTM A193, Grade B8).
- 3) Valve shall be manual handwheel operated with rising indicator stem or rising handwheel.
- 4) Valves shall have a minimum pressure rating of 100 psi at a temperature of 120 degrees F.
- 5) Ends shall be flanged, Class 125, ASME B16.1.
- 6) Valves shall be ITT Dia-Flo, Saunders Weir Type, or equal.
- 7) Cast-Iron Diaphragm Valves With Extension Stems:
 - (a) Diaphragm valves, sizes 3/4 inch through 8 inches, shall be of the weir type complying with MSS SP-83, Category B, with cast-iron (ASTM A48, Class 30, or ASTM A126, Class B) body bonnet, and lining suited for application. Diaphragm shall be suited for the application.
 - (b) O-rings shall be Teflon. Body-bonnet joint bolting stem, bushing, and travel stop shall be Type 304 stainless steel (ASTM A193, Grade B8).
 - (c) Valves shall have 2-inch-square operating nut with extension stem actuator.
 - (d) Valves shall have a minimum pressure rating of 100 psi at a temperature of 120 degrees F.
 - (e) Ends shall be flanged, Class 125, ASME B16.1.
 - (f) Valves shall be ITT Dia-Flo, Saunders Weir Type, or equal.
- 8) PVC Diaphragm Valves 1/2 Inch Through 4 Inches:
 - (a) Diaphragm valves, sizes 1/2 inch through 4 inches, shall be of the weir type with PVC bodies and PVC or polypropylene bonnets. PVC shall comply with ASTM D1784, Cell Classification 12454. Polypropylene shall comply with ASTM D4101. Body wall thickness shall conform to Schedule 80 per ASTM D1785.
 - (b) Valve diaphragms shall be EPDM; Viton; or PTFE. Provide elastomer backing for PTFE diaphragms.
 - (c) O-rings shall be EPDM or Viton. Body-bonnet bolting shall be Type 304 stainless steel (ASTM B193, Grade B8) or Hastelloy C (ASTM F468, Grade N10276).
 - (d) Provide polypropylene manual handwheel actuator with rising indicator stem.
 - (e) Minimum pressure rating shall be 150 psi at a temperature of 73 degrees F and 135 psi at a temperature of 110 degrees F.
 - (f) Ends for valves 2 inches and smaller shall be true union with socket weld connections. Ends for valves larger than 2 inches shall be flanged, Class 125, ASME B16.1.
 - (g) Products: Spears Manufacturing Company, ITT Dia-Flo, or equal.
- 9) PVC Diaphragm Valves 1/2 Inch Through 4 Inches in Sodium Hypochlorite Service:
 - (a) Diaphragm valves, sizes 1/2 inch through 4 inches, shall be of the weir type with PVC bodies and PVC or polypropylene bonnets. PVC shall comply with ASTM D1784, Cell Classification 12454. Polypropylene shall comply with ASTM D4101. Body wall thickness shall conform to Schedule 80 per ASTM D1785.
 - (b) Valve diaphragms shall be PTFE coated. Provide Buna-N elastomer backing for diaphragms.
 - (c) O-rings shall be Viton. Body-bonnet bolting shall be Hastelloy C (ASTM F468, Grade N10276).
 - (d) Provide polypropylene manual handwheel actuator with rising indicator stem.
 - (e) Minimum pressure rating shall be 150 psi at a temperature of 73 degrees F and 135 psi at a temperature of 110 degrees F.
 - (f) Ends for valves 2 inches and smaller shall be true union with socket weld connections. Ends for valves larger than 2 inches shall be flanged, Class 125, ASME B16.1.
 - (g) Products: Spears Manufacturing Company or ITT Dia-Flo or equal.
- 10) CPVC Diaphragm Valves 1/2 Inch Through 4 Inches:
 - (a) Diaphragm valves, sizes 1/2 inch through 4 inches, shall be of the weir type with CPVC bodies and CPVC or polypropylene bonnets. CPVC shall comply with ASTM D1784, Cell Classification 23447 or 23547B. Polypropylene shall comply with ASTM D4101. Body wall thickness shall conform to Schedule 80 per ASTM F441.
 - (b) Valve diaphragms shall be EPDM; Viton; or PTFE. Provide elastomer

- backing for PTFE diaphragms.
- (c) O-rings shall be EPDM or Viton.
- (d) Body-bonnet bolting shall be Type 304 stainless steel (ASTM B193, Grade B8) or Hastelloy C (ASTM F468, Grade N10276).
- (e) Provide polypropylene manual handwheel actuator with rising indicator stem. Minimum pressure rating shall be 150 psi at a temperature of 73 degrees F and 110 psi at a temperature of 140 degrees F.
- (f) Ends for valves 2 inches and smaller shall be true union with socket weld connections. Ends for valves larger than 2 inches shall be flanged, Class 125, ASME B16.1.
- (g) Products: Spears Manufacturing Company, ITT Dia-Flo, or equal.
- 11) CPVC Diaphragm Valves 1/2 Inch Through 4 Inches in Sodium Hypochlorite Service:
 - (a) Diaphragm valves, sizes 1/2 inch through 4 inches, shall be of the weir type with PVC bodies and PVC or polypropylene bonnets. PVC shall comply with ASTM D1784, Cell Classification 12454. Polypropylene shall comply with ASTM D4101. Body wall thickness shall conform to Schedule 80 per ASTM D1785.
 - (b) Valve diaphragms shall be PTFE coated. Provide Buna-N elastomer backing for PTFE diaphragms.
 - (c) O-rings shall be Viton.
 - (d) Body-bonnet bolting shall be Hastelloy C (ASTM F468, Grade N10276).
 - (e) Provide polypropylene manual handwheel actuator with rising indicator stem.
 - (f) Minimum pressure rating shall be 150 psi at a temperature of 73 degrees F and 135 psi at a temperature of 110 degrees F.
 - (g) Ends for valves 2 inches and smaller shall be true union with socket weld connections. Ends for valves larger than 2 inches shall be flanged, Class 125, ASME B16.1.
 - (h) Products: Spears Manufacturing Company, ITT Dia-Flo, or equal.
- 3. Pinch Valves:
 - a. Pinch Valves 1 Inch Through 8 Inches:
 - 1) Pinch valves of sizes 1 inch through 8 inches shall have cast-iron (ASTM A48, Class 30) bodies with totally enclosed actuators and full port design. Sleeves shall be neoprene, Buna-N, or Hypalon. Stems shall be stainless steel or galvanized steel.
 - 2) Ends shall be flanged, ASME B16.1, Class 125.
 - 3) Valves shall be handwheel operated with upper and lower pinch bars.
 - 4) Valves installed on the end of a pipe shall be provided with a Type 304 stainless steel retaining ring to hold the sleeve end in place.
 - 5) Positive Opening Tabs:
 - (a) Ensure that sleeve will not collapse under less than 2 psig internal pressure.
 - (b) Stainless steel with stainless steel fasteners attached to top and bottom pinch bars.
 - (c) Attached to nylon reinforced external band around full circumference of sleeve.
 - (d) Band width: Full width of pinch bars.
 - (1) Valves shall be Red Valve Series 75, Flexible Valve Corporation Series 2100, Galligher "SIGMA," or equal.
 - 6) Pinch Valves 1 Inch Through 8 Inches With Extension Stems:
 - (a) Pinch valves of sizes 1 inch through 8 inches shall have cast-iron (ASTM A48, Class 30) bodies with totally enclosed actuators and full port design. Sleeves shall be neoprene, Buna-N, or Hypalon. Stems shall be stainless steel or galvanized steel.
 - (b) Ends shall be flanged, ASME B16.1, Class 125.
 - (c) Valves shall have 2-inch-square AWWA operating nuts with extension stem actuators. Valves shall have upper and lower pinch bars.
 - (d) Valves installed on the end of a pipe shall be provided with a Type 304 stainless steel retaining ring to hold the sleeve end in place.
 - (e) Positive Opening Tabs:
 - (1) Ensure that sleeve will not collapse under less than 2 psig internal pressure.
 - (2) Stainless steel with stainless steel fasteners attached to top and bottom pinch bars.
 - (3) Attached to nylon reinforced external band around full circumference of

sleeve.

(4) Band width: Full width of pinch bars.

(5) Valves shall be Red Valve Series 75, Galligher "SIGMA," or equal.

4. Solenoid Valves:

a. Design and construct solenoid valves such that they can be used in both horizontal and vertical piping. Provide strainers on solenoid valve supply.

1) Metallic Solenoid Valves 1-1/2 Inches and Smaller:

- (a) Solenoid valves of sizes 1/4 inch through 1-1/2 inches for water and air service shall have forged brass (Alloy C23000) or bronze (ASTM B62) bodies with Teflon main seats. Internal plunger, core tube, plunger spring, and cage assembly shall be stainless steel (Types 302, 304, or 305).
- (b) Solenoid enclosures shall be NEMA 1 or NEMA 4; except where explosion-proof is noted in the drawings.
- (c) Valve actuators shall be 120-volt a-c.
- (d) Seals shall be Teflon.
- (e) Valves shall have a maximum operating pressure and a maximum differential pressure of 125 psi.
- (f) Solenoid valves shall be energized to *open*.
- (g) Valves shall be ASCO "Redhat" 8210 Series or Parker Hannifin "Skinner" Model equal.

2) Plastic Solenoid Valves 1/4 Inch Through 1 Inch:

- (a) Solenoid valves of sizes 1/4 inch through 1 inch for water and chemical services shall have CPVC bodies with EPDM seals. Valve bodies shall be of the true union design with threaded end connections with the coil assembly contained in a molded polyester housing. Plunger or core tube shall be Teflon or polypropylene.
- (b) Solenoid enclosures shall be NEMA 4X.
- (c) Valve actuators shall be 120 volts a-c.
- (d) Valves shall have a minimum operating pressure of 120 psi and a maximum differential pressure of 25 psi on either side of the valve, with the valve in the closed position.
- (e) Solenoid valves shall be energized to open.
- (f) Products: Hayward or equal.

3) Pilot-Operated Solenoid Valves 1/2 Inch Through 2 Inches:

- (a) Pilot-operated solenoid valves of sizes 1/2 inch through 2 inches for water and chemical services shall have PVC; CPVC; PVDF (Kynar); or polypropylene bodies with Viton or EPDM seals.
- (b) Valve bodies shall be of a design in which threaded NPT connections are molded into the valve body. The coil assembly shall be contained in a molded housing of the same material as the valve body or of molded polyester. Plunger or core tube shall be Teflon or polypropylene.
- (c) When the valve is pressurized and the coil is energized, the coil shall create an electromagnetic field in the top section of the core tube. The resulting electromagnetic force shall pull the core and pilot seat upward, opening the pilot valve. The liquid above the diaphragm shall then vent through the open orifice of the pilot valve to the downstream piping. The inlet pressure under the diaphragm shall lift the diaphragm and open the main valve orifice. When the coil is de-energized, the pilot solenoid spring shall push the core and pilot seat downward, closing the pilot valve. Pressure above the diaphragm shall rise to the inlet pressure level, forcing the diaphragm downward against the main valve seat, sealing the valve.
- (d) Solenoid enclosures shall be NEMA 4X.
- (e) Actuators shall be 120 volts a-c.
- (f) Valve shall sustain a minimum backpressure of 70 psi on the downstream side of the valve, with the valve in the closed position. Minimum inlet pressure rating shall be 140 psi at a temperature of 75 degrees F.
- (g) Solenoid valves shall be energized to open.
- (h) Products: Plast-O-Matic Series PS or equal.

4) Three-Way Metallic Solenoid Valves 1/2 Inch and Smaller:

- (a) Solenoid valves of sizes 1/8 inch through 1/2 inch for water service shall have

8. Deluge Valves:
 - a. Deluge Valves, 2 Inches:
 - 1) Deluge valves shall be nominal 2-inch size, with a 2-inch NPT inlet connection, at least a 1-1/2-inch NPT discharge connection, and NPT trim connections.
 - 2) Valves shall be rated for at least 175-psi working pressure, and be UL listed and FM approved for fire protection service.
 - 3) The valve body and cover shall be constructed of ductile iron. The valve clapper, seat, and clamp ring shall be constructed of bronze.
 - 4) Provide valves with all trim necessary for electric actuation as indicated in the drawings.
 - 5) Valves shall be Viking Model E-1, Gem Model B Flooding, or equal.

9. Flap Valves:
 - a. Flap Valves (Cast-Iron):
 - 1) Flap valves shall have cast-iron body (ASTM A48 or A126) with bronze (ASTM B62) hinge pin, flap ring, and seat.
 - 2) Ends shall be flanged, spigot end, or hub to match the connecting pipe.
 - 3) Products: Clow F-3012, F-3014, F-3016; Waterous Flap Valves; Waterman Industries; or equal.
 - b. Flap Valves (Non-Metallic):
 - 1) Flap valves or gates shall have a reinforced copolymer or stainless steel body with a flap made of non-metallic material resistant to ultraviolet light.
 - 2) Body of the valve shall not be less than 1/4 inch thick for valve sizes 12-inch diameter and smaller, and 1/2 inch thick for larger valve sizes.
 - 3) Cover (flap) shall be held in place with a clamp bar and Type 316 stainless steel threaded fastener no smaller than 5/16 inch diameter.
 - 4) Hinge shall be suitably reinforced with encapsulated fabric to prevent any water from contacting the fabric.
 - 5) Weight shall be molded into the non-metallic flap material to aid in proper quick closure and to prevent material distortion.
 - 6) Hinge and flap assembly shall be readily replaceable while the gate is in service.
 - 7) Flap gates shall open when there is a differential pressure across the flap of 0.2-feet or less and be designed to meet seating pressures listed in the Valve Schedule.
 - 8) With the flap gate submerged, the head loss shall not exceed 0.3-feet at all exit velocities for gates 60-inches or smaller.
 - 9) Allowable leakage through the flap gate, due to seating load, shall not exceed 0.2 gallons per minute per foot of wetted perimeter.
 - 10) Ends shall be flanged and capable of mounting to a Class 125/150 bolt pattern flanged pipe. Provide gasket between flap gate and connecting pipe.
 - (a) Flap valve materials shall be compatible with a pH range of 7.0 to 9.0 and a maximum chlorine concentration of 4.0 mg/L and a maximum fluoride concentration of 1.0 mg/L.
 - (b) Products: Plasti-Fab, Hydro Gate, Whipps, Inc, or equal.

10. Balancing Valves, Gauge Valves, and Valve Manifolds:
 - a. Balancing Valve:
 - 1) Construct valves of bronze.
 - 2) Valves shall have a machined orifice flow restriction, internal O-rings, a rated working pressure of at least 300 psi, flow setting indicating pointer and calibrated nameplate, and a pressure readout valve port on each side of the orifice.
 - 3) Equip pressure ports with integral check valves.
 - 4) Connections shall be NPT.
 - 5) Valves shall be Bell & Gosset Circuit Setter, Illinois Series 6000, or equal.
 - 6) Gauge Valve:
 - (a) Gauge valves shall be a combination isolation and vent valve with a minimum pressure rating of 3,000 psi at 200 degrees F.
 - (b) Isolation valve shall have interchangeable hard or soft seat.
 - (c) Body, bonnet, and stem shall be Type 316 stainless steel. Packing shall be Teflon or Buna-N.
 - (d) Valves shall have screwed ends and nonblowout stems.

- (e) Valves shall be AGCO M9 gauge valve or equal.
 - 7) 1/2-Inch Stainless Steel Two-Valve Manifolds:
 - (a) Provide manifold body block with separate block valve and calibration or bleed valve.
 - (b) Provide three ports: inlet (process), outlet (instrument), and calibration or bleed port.
 - (c) Minimum pressure rating shall be 6,000 psi at a temperature of 100 degrees F.
 - (d) Valve body, stem, side rings, disc rings, bonnet, valve handles, and packing nut shall be Type 316 stainless steel (ASTM A276, A351, or A479). Upper and lower packing shall be Teflon or UHMWPE.
 - (e) Provide hardened Type 316 stainless steel ball tips on manifold stems.
 - (f) Provide vee stem with replaceable Teflon, PFA; or Delrin seat on manifold stems.
 - (g) End connections shall be 1/2-inch female NPT per ASME B1.20.1.
 - (h) Provide Type 316 stainless steel pipe mounting bracket assembly consisting of bracket, U-bolts, cap screws, nuts, and lock washers.
 - (i) Product: Whitey Series M2 or equal.
 - 8) 1/2-Inch Stainless Steel Three-Valve Manifolds:
 - (a) Provide manifold body block with separate block valves and equalizer valve.
 - (b) Provide four main ports: two valve-size inlet (process) and two valve-size outlet (instrument) ports. Provide two 1/4-inch body connections with hex key pipe plugs for bleed service.
 - (c) Minimum pressure rating shall be 750 psi at a temperature of 100 degrees F.
 - (d) Valve body, stem, side rings, disc rings, bonnet, valve handles, and packing nut shall be Type 316 stainless steel (ASTM A276, A351, or A479). Upper and lower packing shall be Teflon or UHMWPE.
 - (e) Provide hardened Type 316 stainless steel ball tips on manifold stems.
 - (f) Provide vee stem with replaceable Teflon PFA or Delrin seat on manifold stems.
 - (g) Provide two 1/4-inch purge connections with hex key plugs.
 - (h) End connections shall be ***1/2-inch female NPT per ASME B1.20.1; or of the nut-and-ferrule type for connection to tubing>>***.
 - (i) Provide Type 316 stainless steel pipe mounting bracket assembly consisting of bracket, U-bolts, cap screws, nuts, and lock washers.
 - (j) Product: Whitey Series M3 or equal.
 - 9) 1/2-Inch Stainless Steel Five-Valve Manifolds:
11. Telescoping Valves 12 Inches and Smaller:
- a. Fabricate plain; flared; V-notch; or U-notch telescoping valve tube from Type 304 stainless steel with a minimum wall thickness of 1/8 inch.
 - b. Provide Type 304 stainless steel lifting strap, companion flange, stem, fasteners, and hardware.
 - c. Provide Buna-N or neoprene gasket for watertight seal around the sliding tube.
 - d. Valve travel shall be as shown in the drawings.
 - e. Provide nonrising stem with offset handwheel actuator
 - f. Provide Type 304 stainless steel anchor bolts for actuator pedestal.
 - g. Manufacturers: Waterman Industries, Inc., Coldwell-Wilcox Company, or equal.

PART 3 - EXECUTION

3.1 JOINTS

- A. Bolt holes of flanged valves shall straddle the horizontal and vertical centerlines of the pipe run to which the valves are attached. Clean flanges by wire brushing before installing flanged valves. Clean flange bolts and nuts by wire brushing, lubricate threads with oil and graphite, and tighten nuts uniformly and progressively. If flanges leak under pressure testing, loosen or remove the nuts and bolts, reseal or replace the gasket, reinstall or retighten the bolts and nuts, and retest the joints. Joints shall be watertight.
- B. Clean threaded joints by wire brushing or swabbing. Apply Teflon joint compound or Teflon tape to pipe threads before installing threaded valves. Joints shall be watertight.
- C. Install lug-type valves with separate hex head machine bolts at each bolt hole and each flange (two bolts per valve bolt hole).
- D. Install grooved-end couplings for valves in accordance with Section 400500.

3.2 INSTALLING EXPOSED VALVES

- A. Install in accordance with manufacturer's instructions.
- B. Unless otherwise indicated in the drawings, install valves in horizontal runs of pipe having centerline elevations 4 feet 6 inches or less above the floor with their operating stems vertical. Install valves in horizontal runs of pipe having centerline elevations between 4 feet 6 inches and 6 feet 9 inches above the floor with their operating stems horizontal.
- C. Install valves on vertical runs of pipe that are next to walls with their stems horizontal, away from the wall. Valves on vertical runs of pipe that are not located next to walls shall be installed with their stems horizontal, oriented to facilitate valve operation.

3.3 INSTALLING BURIED VALVES

- A. Connect the valve, coat the flanges, or apply tape wrapping or polyethylene encasement, and place and compact the backfill to the height of the valve stem.
- B. Place block pads under the extension pipe to maintain the valve box vertical during backfilling and repaving and to prevent the extension pipe from contacting the valve bonnet.
- C. Mount the upper slip pipe of the extension in midposition and secure with backfill around the extension pipe. Pour the concrete ring allowing a depression so the valve box cap will be flush with the pavement surface.
- D. Install debris cap as close as possible under the cast-iron cover without interfering with the cover operation. Trim flexible skirt to provide a smooth contact with the interior or the extension pipe.

3.4 FIELD COATING BURIED VALVES

- A. Coat flanges of buried valves and the flanges of the adjacent piping, and the bolts and nuts of flanges and mechanical joints, per Section 099000, System No. 10.
- B. Wrap buried metal valves 6 inches and larger with polyethylene sheet.
- C. Wrap buried metal valves 6 inches and larger in two layers of polyethylene conforming to AWWA C105, 8 mils in thickness each. Pass the two sheets of polyethylene under the valve and the coated flanges or joints with the connecting pipe and draw the sheets around the valve body, the valve bonnet, and the connecting pipe. Secure the sheets with plastic adhesive tape about the valve stem below the operating nut and about the barrel of the connecting pipe to prevent the entrance of soil. Fold overlaps twice and tape. Backfill the valve with care to avoid damaging the polyethylene.

3.5 MOUNTING GEAR ACTUATORS

- A. The valve manufacturer shall select and mount the gear actuator and accessories on each valve and stroke the valve from fully open to fully closed prior to shipment.

3.6 VALVE FIELD TESTING

- A. Operate manual valves through three full cycles of opening and closing. Valves shall operate from full open to full close without sticking or binding. Do not backfill buried valves until after verifying that valves operate from full open to full closed. If valves stick or bind, or do not operate from full open to full closed, repair or replace the valve and repeat the tests.
- B. Gear actuators shall operate valves from full open to full close through three cycles without binding or sticking. The pull required to operate handwheel- or chainwheel-operated valves shall not exceed 80 pounds. The torque required to operate valves having 2-inch AWWA nuts shall not exceed 150 ft-lbs.

If actuators stick or bind or if pulling forces and torques exceed the values stated previously, repair or replace the actuators and repeat the tests. Operators shall be fully lubricated in accordance with the manufacturer's recommendations prior to operating.

- C. After flap valve/gate installation, exercise each valve from the closed position to fully open position and back to the closed position at least twice and verify if valve is properly seated.

END OF SECTION

**SECTION 400524
VALVES, GENERAL**

PART 1 GENERAL

1.1 WORK INCLUDED

- A. The Contractor shall provide all tools, supplies, materials, equipment, and labor necessary for furnishing, epoxy coating, installing, adjusting, and testing of all valves and appurtenant work, complete and operable, in accordance with the requirements of the Contract Documents. Where buried valves are shown, the Contractor shall furnish and install valve boxes to grade, with covers, extensions, and position indicators.
- B. The provisions of this Section shall apply to all valves and valve operators specified in the various Sections of these Specifications except where otherwise specified in the Contract Documents. Valves and operators in particular locations may require a combination of units, sensors, limit switches, and controls specified in other sections of these Specifications.

1.2 CONTRACTOR SUBMITTALS

- A. Shop Drawing. Shop drawings of all valves and operators including associated wiring diagrams and electrical data, shall be furnished as specified in Section entitled "Shop Drawings, Project Data and Samples".
- B. Valve Labeling. The Contractor shall submit a schedule of valves to be labeled indicating in each case the valve location and the proposed wording for the label.

1.3 QUALITY ASSURANCE

- A. Valve Testing. Unless otherwise specified, each valve body shall be tested under a test pressure equal to twice its design water-working pressure.
- B. Bronze Parts. Unless otherwise specified, all interior bronze parts of valves shall conform to the requirements of ASTM B 62, or, where not subject to dezincification, to ASTM B 584.

PART 2 PRODUCTS

2.1 VALVES

- A. General: The Contractor shall furnish all valves, gates, valve-operating units, stem extensions, and other accessories as shown or specified. All valves and gates shall be new and of current manufacture.
- B. Shut-off valves mounted higher than 6-feet above working level shall be provided with chain operators. All valves shall have a minimum design pressure rating of 150 psi and capable of a test pressure of 300 psi. For service applications with pressures in excess of 150 psi, valves shall have a minimum pressure rating in excess of the service application working pressure.
- C. Cast iron parts of valves shall meet the requirements of ASTM A 126. Flanged ends shall be flat-faced and have bolt circle and bolt patterns conforming to ANSI/ASME B16.1, Class 125, unless otherwise specified hereinafter.
- D. All castings shall be clean and sound, without defects of any kind and no plugging, welding or repairing of defects will be permitted. All bolt heads and nuts shall be hexagonal conforming to ANSI B18.2. Gaskets shall be full face and made of natural or synthetic elastomers in conformance with ANSI B16.21 suitable for the service characteristics, especially chemical compatibility, and temperature. Nonferrous alloys of various types shall be used for parts of valves as specified. Where no definite specification is given, the material shall be the recognized acceptable standard for that particular application.
- E. All buried valves shall be provided with cast-iron valve boxes unless otherwise indicated. The boxes shall be asphalt varnished, or enameled cast iron, adjustable to grade, and installed perpendicularly, centered around, and covering the upper portions of the valve or valve operator, or the pipe. The top of each valve box shall be placed flush with finish grade unless otherwise indicated on the Drawings. Valve boxes shall be as specified elsewhere in this section.
- F. All buried valves and other valves located below the concrete operating deck or level, specified or noted to be key operated, shall have an operator to finish grade or deck level, a 2-inch square AWWA operating nut, and cover or box and cover, as may be required.
- G. Protective Coating: Except where otherwise specified, ferrous surface except stainless steel in the interior passages of all valves 4-inch and larger, as well as the exterior surfaces of all submerged valves, shall receive a fusion-bonded epoxy coating in accordance with AWWA C550. Flange faces of valves shall not be epoxy coated. The Contractor, through the valve manufacturer, shall certify in writing that such coating has been applied and tested in the

- manufacturing plant prior to shipment, in accordance with these Specifications.
- H. Valve Operators: Where shown, certain valves shall be furnished with operators, provided by the valve or gate manufacturer. All operators of a given type shall be furnished by the same manufacturer. All valve operators, regardless of type, shall be installed, adjusted, and tested by the valve manufacturer at the manufacturing plant.
 - I. All operators, unless otherwise specified, shall turn counterclockwise to open. Operators shall have the open direction clearly and permanently marked. All valve operators, manual, motor and pneumatic, shall be provided with the valve by the valve manufacturer. The Contractor, through the valve manufacturer, shall be solely responsible for the selection of the proper operator to meet the operating conditions specified herein. Field calibration and testing of the operators and valves to ensure a proper installation and an operating system shall be the responsibility of the Contractor.
 - J. Unless otherwise specified, all manual operators shall have levers or handwheels. Where buried, the valves shall have extensions with square nuts or floor stands. Tee wrenches for buried valves and hydrants shall be provided at a rate of one (1) per five (5) valves/hydrants. Valves mounted higher than 7'6" above floor or operating level shall have chain operators. Unless otherwise shown or specified, valves of sizes 4-inch and larger shall have gear-assisted operators.
 - K. Operation of valves shall be designed so that the effort required to operate the handwheel, lever or chain shall not exceed 40 pounds applied at the extremity of the wheel or lever. The handwheels on valves 14 inches and smaller shall not be less than 8 inches in diameter, and on valves larger than 14 inches, the handwheel shall not be less than 12 inches in diameter.
 - L. Chainwheel operator shall be fabricated of malleable iron and pocketed type chainwheels with chain guards and guides. Chainwheel operators shall be marked with an arrow and the word "open" indicating direction to open. The operators shall have galvanized smooth welded link type chain. Chain that is crimped or has links with exposed ends shall not be acceptable.
 - M. Floor Stands: Floor stands shall be cast iron, non-rising stem type with lockable hand wheel operator, valve position indicator and steel extension stem. Hand wheel shall be lockable in the full closed position. The floor stand shall be furnished with an armored padlock and six keys. Lock shall be as manufactured by Master, Schlage or equal. Floor stand shall be standard pattern type as manufactured by Clow Corporation, or equal.
 - N. Valve Labeling: A label shall be provided on all shut-off valves. The label shall be of 1/16-inch plastic or stainless steel, minimum 2 inches by 4 inches in size, and shall be permanently attached to the valve or on the wall adjacent to the valve or as indicated by the Engineer.
 - O. Position Indicators: All shut-off valves, 6-inch and larger, shall have operators with position indicators. Where buried, these valves shall be provided with valve boxes and covers containing position indicators, and valve extensions, as required. The valve indicator shall be hermetically sealed for installation inside a cast iron valve box and shall show valve disc position, direction of rotation and number of turns from fully opened to full closed. Position indicator, complete, shall be Diviner Ground Level Position Indicator as manufactured by Henry Pratt Company, GPI-S Series as manufactured by DynaTorque, Inc, or Valve Position Indicator as manufactured by Trumbull Industries, Inc.
 - P. Extension Stems: Extension stems and stem guides shall be furnished and installed where specified, indicated on the drawings, or otherwise required for proper valve operation. Extension stems shall be of solid steel and shall be not smaller in diameter than the stem of the valve actuator shaft. Extension stems shall be connected to the valve actuator by means of a Lovejoy "Type D" single universal joint with grease-filled protective rubber boot and S.S. fasteners. All stem connections shall be pinned.
 - Q. At least two stem guides shall be furnished with each valve requiring stem guides. Stem guides shall be of cast iron construction, bronze bushed and adjustable in two directions. Stem guide spacing shall not exceed 100 times the stem diameter or 10 feet, whichever is smaller. The top stem guide shall be designed to carry the weight of the extension stem. The extension stem shall have a collar; the collar shall be pinned to the stem and shall bear against the stem thrust guide.
 - R. Extension stems shall be provided for all buried valves when the valve actuator is greater than 4 feet below finished grade and/or as required for position indicators. Each extension stem for a buried valve shall extend to within 6 inches of the ground surface, shall be provided with spacers which will center the stem in the valve box, and shall be equipped with a wrench nut.

2.2 WOODLAND ACRES VALVE SCHEDULE

VALVE SCHEDULE					
<u>Valve Number</u>	<u>Valve Type</u>	<u>Size (in)</u>	<u>Location</u>	<u>Operator</u>	<u>JOINT TYPE</u>
BFV-231	304SS Butterfly, Wafer	4"	BLWR 231 ISO	LO	WAFER
BFV-232	304SS Butterfly, Wafer	4"	BLWR 232 ISO	LO	WAFER
BLV-234	304SS Ball, Full Port	4"	SS Air Header to Aeration Basin	LO	NPT
BLV-233	304SS Ball, Full Port	3"	Air Header to MBBR Cages	LO	NPT
CV-111	PVC Ball Check	2"	P-111	NA	NPT
CV-112	PVC Ball Check	2"	P-112	NA	NPT
BLV-113	304SS Ball, Full Port	2"	P-111 ISO	LO	NPT
BLV-114	304SS Ball, Full Port	2"	P-112 ISO	LO	NPT
CV-115	PVC Ball Check	2"	P-113	NA	NPT
BLV-116	304SS Ball, Full Port	2"	P 113 ISO	LO	NPT
PV-117	DI Metal Plug	4"	PVC return from storage tank	Vlv. Box, Ext. Stem	MJ

2.3 VALVE BOXES

- A. Each valve buried to a depth of 4 feet or less shall be provided with a slide type valve box. Valve boxes shall be cast iron, extension sleeve type, suitable for the depth of cover required by the drawings. Not more than one extension will be allowed with each slide type valve box. Valve boxes shall be not less than 5 inches in inside diameter, shall have a minimum thickness at any point of 3/16 inch, and shall be provided with suitable cast iron bases and covers.
- B. Each valve buried to a depth greater than 4 feet shall be provided with a valve box consisting of a cast iron cover and a 6-inch cast iron pipe section. The cover shall be a Clay & Bailey "No. 2193" or Tyler "Series 6890-A" or equal. The pipe shaft shall be sized to extend from the valve to 5 inches inside the valve box cover. Covers shall have cast thereon designation of the service for which the valve is used.
- C. All parts of valve boxes, bases, and covers shall be shop coated by dipping in asphalt varnish.
- D. Top sections and covers for valve boxes which are to be provided with position indicators shall be designed for proper installation of the position indicator and accessories.
- E. Valves and valve boxes shall be set plumb. Each valve box shall be placed directly over the valve it serves, with the top of the box brought flush with the finished grade. After being placed in proper position, earth shall be filled in around each valve box and thoroughly tamped on each side of the box.
- F. The covers shall be marked "WATER", "SEWER", "GAS", depending on service.

PART 3 EXECUTION

3.1 VALVE INSTALLATION

- A. General: All valves, operating units, stem extensions, valve boxes, and accessories shall be installed in accordance with the manufacturer's written instructions and as shown and specified. All gates shall be adequately braced to prevent warpage and bending under the intended use. Valves shall be firmly supported to avoid undue stresses on the pipe.
- B. Access: All valves shall be installed to provide easy access for operation, removal, and maintenance and to avoid conflicts between valve operators and structural members or handrails.
- C. Valve Accessories: Where combinations of valves, sensors, switches, and controls are specified, it shall be the responsibility of the Contractor to properly assemble and install these various items so that all systems are compatible and operating properly. The relationship between interrelated items shall be clearly noted on shop drawing submittals.

END OF SECTION

PAGE INTENTIONALLY LEFT BLANK.

SECTION 400526

IFAS CAGES

PART 1 GENERAL

1.1 RELATED DOCUMENTS

- A. Drawings and general provisions of the Contract, including General and Supplementary Conditions and technical specification sections, apply to this section.

1.2 SUMMARY

- A. The contractor shall furnish all labor and tools, to perform all work and services necessary for the installation of Owner Furnished Integrated Fixed Film Activated Sludge (IFAS) Equipment, complete and ready for operation in accordance with the provisions of the contract documents.
- B. The owner shall furnish all materials necessary for the installation, including the cages, diffusers (from top of drop pipe down), blowers and blower controls, and media.
- C. Related Sections include the following:
 - a. Blowers and Blower Controls – 460529
 - b. Air Diffusers – 465103

PART 2 PRODUCTS

2.1 SCOPE OF SUPPLY

- A. The Owner shall supply all process equipment and design necessary to achieve the performance standards including:
 - i. Air supply blowers
 - ii. High surface area media
 - iii. Coarse bubble aeration grid
 - iv. IFAS media retaining cages
 - v. Blower control panel
 - vi. Shop drawings and process engineering design
- B. Other non-process related equipment will NOT be provided by the Owner, items include but are not limited to:
 - i. Electrical infrastructure and equipment wiring
 - ii. Piping, valves, pipe supports, piping appurtenances

2.2 AERATION GRID

- A. Included in the scope of supply for the aeration grid are the following: Midwest Water Operations will fabricate and supply the aeration grid which includes all submerged diffuser piping, diffusers, and drop pipes. **Contractor shall be responsible for providing the pipe supports to allow the top of the diffuser to be set at no more than 9-inches from the floor elevation.**
- B. Midwest Water Operations shall provide the services of a field representative to advise on field installation. The services of the field representative shall include at least one (1) day, exclusive of travel time, and one (1) travel trip during the time that the equipment is being installed. The Contractor shall notify the Midwest Water Operations a minimum of ten (10) working days prior to the time that the field services are desired.

2.3 HIGH SURFACE AREA MEDIA

- A. High surface area media shall be manufactured by Raschig or equal and furnished by the Owner for installation by Contractor.

2.4 CAGES

- A. The cages shall be furnished by Owner furnished for installation by Contractor and supplied through Midwest Water Operations.

2.5 AIR SUPPLY BLOWERS

- A. The air supply blowers and blower control panels shall be manufactured by HAC Group, furnished by the Owner, and installed by Contractor.
- B. The control panel will be mounted outside, and it shall be enclosed in an outdoor rated NEMA weatherproof enclosure.
- C. The panel shall be delivered completely assembled, pre-wired, tested, and ready for installation.
- D. The control panel shall have sufficiently sized variable frequency drives for the blowers along with starters for the blower enclosure fans. The enclosure fans shall have a 15 min off delay after the blower is switched off to allow for enclosure cooling.
- E. The control panel shall include a 7-day timer switch that will automatically switch the duty and standby blowers.
- F. The integrated temperature controllers shall be able to accept a type-K thermocouple input and have a digital readout with buttons necessary to adjust the minimum temperature setting.

PART 3 EXECUTION

3.1 INSTALLATION

- A. The IFAS system shall be constructed to the lines and grades as shown on the Drawings.
- B. Installation of the IFAS reactor components shall be in accordance with the Engineer's specifications.
- C. Connect all electrical components in accordance with the requirements provided by manufacturer in submittals.
- D. Owner shall provide the services of a field representative to advise on field installation. The services of the field representative shall include at least one (1) day, exclusive of travel time, and one (1) travel trip during the time that the equipment is being installed. The Contractor shall notify the manufacturer a minimum of ten (10) working days prior to the time that the field services are desired.

3.2 CONTRACTOR RESPONSIBILITIES

- A. The contractor shall furnish all labor and tools, to perform all work and services necessary for and incidental to the installation of a complete system, complete and ready for operation in accordance with the provisions of the contract documents.

- B. Products relevant to this section will be Owner furnished for installation by Contractor unless otherwise stated previously.
- C. The contractor is responsible for the rehabilitation of the existing tanks or other related work if shown on the drawings.
- D. Contractor is responsible for any hardware that is not explicitly stated as provided in this spec, including but not limited to bolts, gaskets, seals, anchors etc.
- E. Contractor shall provide power necessary to operate the IFAS system as shown on Electrical Riser Diagram.

3.3 WARRANTY

- A. The Contractor shall provide a one (1) year warranty to warranty the labor and installation of the IFAS equipment.

END OF SECTION

SECTION 400562

PLUG VALVES

PART 1 - GENERAL

1.1 DESCRIPTION

- A. This section includes materials, testing, and installation of plug valves and accessories.

1.2 RELATED WORK SPECIFIED ELSEWHERE

- A. Painting and Coating: 099000.
- B. General Piping Requirements: 400500.
- C. Pressure Testing of Piping: 400515.
- D. Valves, General: 400524.

1.3 SUBMITTALS

- A. Submit shop drawings in accordance with Section 013300.
- B. Submit manufacturer's catalog data and detailed construction sheets showing all valve parts. Describe each part by material of construction, specification (such as AISI, ASTM, SAE, or CDA), and grade or type. Identify each valve by tag number to which the catalog data and detail sheets pertain.
- C. Show valve dimensions including laying lengths. Show port sizes. Show dimensions and orientation of valve actuators, as installed on the valves.
- D. Show location of internal stops for gear actuators. State differential pressure and fluid velocity used to size actuators. For worm-gear actuators, state the radius of the gear sector in contact with the worm and state the handwheel diameter.
- E. Show valve linings and coatings. Submit manufacturer's catalog data and descriptive literature.
- F. For eccentric plug valves, show the clear diameter or size of the port. Show the actual area of the port as a percentage of the area as calculated for the nominal valve size.
- G. Submit certification from manufacturer that valves are NSF 61 listed.
- H. Provide additional O&M data per Section 017823.

1.4 PROOF OF DESIGN TEST FOR ECCENTRIC PLUG VALVES

- A. The Contractor shall require the valve manufacturer to furnish six certified copies of reports covering the design tests for the eccentric plug valves as described in AWWA C517 and the following. One prototype valve of each size and class of a manufacturer's design shall be tested for leakage at the specified design pressure and hydrostatically tested with twice the specified design pressure. The hydrostatic test shall be performed with the plug in the open position. The leakage test shall be performed with the plug in the closed position. The duration of each test shall be 10 minutes minimum. During the leakage test, there shall be no indication of leakage past the valve plug. Valves specified to have bi-directional seats shall be leak tight in both directions. In the case of flanged valves, the valve body shall be bolted to a flanged test head.
- B. No part of the valve or plug shall be permanently deformed by the hydrostatic test. During the hydrostatic test, there shall be no leakage through the metal, the end joints, or the shaft seal.
- C. It is the intent that the valve manufacturer provides evidence of the adequacy of each type offered to perform under design pressures within the applicable rating for a sufficient number of test cycles simulating a full service life. The adequacy is to be proven by tests, made on one or more valves selected to represent each basic type of seat design of a size within each applicable group, in a pressure class or classes equal to or greater than that specified. The test cycle requirements are as follows:
 - 1. Size Group 3 to 20 inches: 10,000 cycles with a minimum differential pressure of 150 psig.
 - 2. Size Group 24 to 42 inches: 5,000 cycles with a minimum differential pressure of 150 psig.
 - 3. Every test cycle shall consist of applying the specified differential pressure to the plug in the closed position, then opening the plug (which will relieve the pressure) to the wide-open position and then closing the plug.

4. The valve shall be leak tight under the specified pressure differential upon completion of the cycle test without having to stop during the test to repair the valve, modify or reinforce the seat, or install shims or wedges around the seat.
5. The plug shall not be rotated past the center position to jam the plug onto the seat during the hydrostatic test, the leakage test, or the cycle test.

1.5 WARRANTY

- A. Full warranty against defects in materials and workmanship for one year after FINAL ACCEPTANCE, including all parts, labor, and expenses.

PART 2 - PRODUCTS

2.1 GENERAL

- A. Valves and the required actuators are identified by tag numbers and in the Valve Schedule. See the Valve Schedule Section 400521.
- B. Valves shall be installed complete with flange gaskets, nuts and bolts, operating handwheels or levers, chainwheels, extension stems, floor stands, gear actuators, operating nuts, chains, and wrenches required for operation.
- C. Valves shall have the name of the manufacturer and the size of the valve cast or molded onto the valve body or bonnet or shown on a permanently attached plate.
- D. Bronze or brass material requirements:
- E. Any bronze or brass components in contact with water throughout the treatment process shall be made "Lead-Free" as defined in the "Reduction of Lead in Drinking Water Act." Lead-Free shall contain no more than twenty-five hundredth of one percent (0.25 percent or less) total lead contained by weight. The manufacturer shall certify that the bronze meets the "Lead-Free" requirements.
- F. For buried locations, valves with mechanical joint ends may be substituted for the flanged ends specified provided the mechanical joint ends are compatible with the pipe ends.

2.2 VALVE ACTUATORS/OPERATORS

- A. Provide operator types in accordance with the Valve Schedule.
- B. Valves shall open by turning counterclockwise.
- C. Valve Boxes: Furnish valve boxes for all buried valves.

2.3 BOLTS AND NUTS FOR FLANGED AND MECHANICAL JOINT VALVES

- A. Bolts and nuts for flanged valves shall be as described in Section 400500.
- B. Buried Service Bolts (for valve installation) shall be fluorocarbon coated cor-ten steel t-bolts and nuts equal to NSS cor-blue or approved equal low allow corrosion-resistant high-strength steel in accordance with ANSI/AWWA C111/A21.11.

2.4 GASKETS FOR FLANGES

- A. Gaskets for flanged end valves shall be as described in Section 400500.

2.5 LINING AND COATING

- A. Coat the exterior of metal valves located above ground or in vaults and structures the same as the adjacent piping. If the adjacent piping is not coated, then coat valves per Section 099000. Apply the specified prime coat at the place of manufacture. Apply intermediate and finish coats at the place of manufacturer or in the field. Finish coat shall match the color of the adjacent piping. Coat handwheels the same as the valves. Do not coat bronze, brass, or stainless steel valves.
- B. Coat the exterior of buried metal valves at the place of manufacture per Section 099000, System No. 10.
- C. Coat the exterior of submerged metal valves, stem guides, extension stems, and bonnets at the place of manufacture per Section 099000, System No. 12.
- D. Line the interior metal parts of metal valves 4 inches and larger, excluding seating areas and bronze and stainless steel pieces, per Section 099000, System No. 12. Apply lining at the place of manufacture.
- E. Coat floor stands per Section 099000, System No. 10.
- F. Measure the thickness of the valve interior linings per Section 099000. Repair areas having insufficient

film thickness per Section 099000.

2.6 PACKING, O-RINGS, AND GASKETS

- A. Unless otherwise stated in the detailed valve specifications, packing, O-rings, and gaskets shall be one of the following nonasbestos materials:
 - 1. Teflon.
 - 2. Kevlar aramid fiber.
 - 3. Acrylic or aramid fiber bound by nitrile. Products: Garlock "Bluegard," Klinger "Klingersil C4400," or equal.
 - 4. Buna-N (nitrile).
 - 5. EPDM

2.7 RUBBER SEATS

- A. Rubber seats shall be made of a rubber compound that is resistant to free chlorine and monochloramine concentrations up to 10 mg/l in the fluid conveyed.

2.8 VALVE END CONNECTIONS

- A. Valve end connections for exposed valves shall be flanged unless shown otherwise. The Contractor shall verify the compatibility of valve ends, including class and drilling of flanges with the connecting pipe.
- B. Buried valve end connections shall be mechanical joint or a push-on unless shown otherwise in the Drawings or in the Valve Schedule.

2.9 VALVES

- A. Plug Valves:
 - B. Plug and Seating Design for Eccentric Plug Valves
 - 1. Eccentric plug valves shall comply with AWWA C517 and the following.
 - 2. Provide a rectangular or circular plug design, with an associated rectangular or round seat. Provide bidirectional seating design. The valve shall seat with the rated pressure both upstream and downstream of the closed plug. Provide geared actuators sized for bidirectional operation.
 - a. For eccentric plug valves, the metallic portion of the plug shall be one-piece design and shall be without external reinforcing ribs which result in there being a space between the rib and the main body of the plug through which water can pass.
 - b. Valves shall be repackable without any disassembly of valve or actuator. The valve shall be capable of being repacked while under the design pressure in the open position.
 - c. Nowhere in the valve or actuators shall the valve shaft be exposed to iron on iron contact.
 - d. Sleeve bearings shall be stainless steel in valve sizes 20 inches and smaller and bronze or stainless steel in valve sizes 24 inches and larger.
 - e. Provide enclosed worm-gear actuators for valves 6 inches and larger.
 - f. Rubber compounds shall have less than 2 percent volume increase when tested in accordance with ASTM D471 after being immersed in distilled water at a temperature of 71.4 to 75.4 degrees F for 70 hours.
 - g. Lubricated Plug Valves:
 - 1) Plug coating shall be Teflon or nylon, permanently bonded to the plug. Body, gland, and cover capscrews and bolts and nuts shall be Type 316 stainless steel or high-strength alloy steel (ASTM A193, Grade B7). Provide operating and sealant extensions for buried valves.
 - h. Eccentric Plug Valves 3 Inches and Smaller (to be used in wastewater / sewer applications in lieu of cast iron unless shown or specified otherwise):
 - 1) Eccentric plug valves, 1/2 inch through 3 inches, shall be nonlubricated type.
 - 2) Minimum pressure rating shall be 175 psi.
 - 3) Bodies shall be made of cast iron per ASTM A126, Class B.
 - 4) Ends shall be threaded or flanged (ASME B16.1, Class 125).
 - 5) Plug shall be cast iron (ASTM A126, Class B) with Buna-N or neoprene facing.
 - 6) Design plugs to seat over a pressure range of 25 psi to the valve design pressure rating.
 - 7) Body capscrews and bolts and nuts shall be Type 316 stainless steel.
 - 8) Packing shall be nitrile butadiene-filled Teflon. Provide 100 percent port area.
 - 9) Valves shall be DeZurik PEF, Val-Matic "Cam-Centric," or equal.

- i. Eccentric Plug Valves 4 Inches Through 12 Inches (to be used in wastewater / sewer applications in lieu of cast iron unless shown or specified otherwise):
 - 1) Eccentric plug valves, 4 inches through 12 inches, shall be non-lubricated type.
 - 2) Minimum pressure rating shall be 175 psi.
 - 3) Bodies shall be cast iron per ASTM A126, Class B.
 - 4) Ends shall be flanged, Class 125 per ASME B16.1 for exposed valves.
 - 5) Ends shall be mechanical joint per ANSI A21.11 and AWWA C111 for buried valves.
 - 6) Plugs shall be cast iron (ASTM A126, Class B), or ductile iron (ASTM A536, Grade 65-45-12) with Buna-N or neoprene facing, 70 Type A durometer hardness per ASTM D2240.
 - 7) Design plugs to seat over a pressure range of 25 psi to the valve design pressure rating.
 - 8) Valve body seats shall be Type 304 or 316 stainless steel or have a raised welded-in overlay at least 1/8-inch thick of not less than 90 percent nickel, minimum Brinell hardness of 200.
 - 9) Body capscrews and bolts and nuts shall be Type 316 stainless steel.
 - 10) Shaft bearing bushings shall be permanently lubricated TFE or Delrin sleeve type stainless steel or bronze. Top and bottom thrust bearing shall be provided.
 - 11) The shaft seal shall be per AWWA specification C504-80, Section 3.7 and be of either bronze cartridge type double O-rings with lower grit seal O-ring, V-type packing, or pull down packing.
 - 12) Provide 100 percent port area.
 - 13) Valves shall be DeZurik PEF, Val-Matic Series 5800 or equal.
- j. Cast-Iron Lubricated Plug Valves 2-Inch Through 6 Inches, Class 125:
 - 1) Lubricated plug valves of sizes 2-inch through 6 inches shall have cast iron (ASTM A126, Class B) bodies and plugs.
 - 2) Valves shall be of the short pattern with bolted cover (two-bolt type) and resilient packing. Plugs shall be of the tapered design.
 - 3) Valve ends shall be flanged, Class 125, ASME B16.1. Face-to-face dimensions shall conform to ASME B16.10, Class 125, gate valves.
 - 4) Valve shall have a minimum pressure rating of 175-psi CWP.
 - 5) Valves shall be lubricated with the manufacturer's recommended lubricant for the service.
 - 6) Valve shall be Nordstrom Figure 143, Christensens 9AS40114, Kerotest Figure 2201 or P33 or equal.

PART 3 - EXECUTION

3.1 JOINTS

- A. Bolt holes of flanged valves shall straddle the horizontal and vertical centerlines of the pipe run to which the valves are attached. Clean flanges by wire brushing before installing flanged valves. Clean flange bolts and nuts by wire brushing, lubricate threads with oil and graphite, and tighten nuts uniformly and progressively. If flanges leak under pressure testing, loosen or remove the nuts and bolts, reseal or replace the gasket, reinstall or retighten the bolts and nuts, and retest the joints. Joints shall be watertight.
- B. Clean threaded joints by wire brushing or swabbing. Apply Teflon joint compound or Teflon tape to pipe threads before installing threaded valves. Joints shall be watertight.
- C. Install lug-type valves with separate hex head machine bolts at each bolt hole and each flange (two bolts per valve bolt hole).
- D. Install grooved-end couplings for valves in accordance with Section 400500.

3.2 INSTALLING EXPOSED VALVES

- A. Unless otherwise indicated in the drawings, install valves in horizontal runs of pipe having centerline elevations 4 feet 6 inches or less above the floor with their operating stems vertical. Install valves in horizontal runs of pipe having centerline elevations between 4 feet 6 inches and 6 feet 9 inches above the floor with their operating stems horizontal.
- B. Install valves on vertical runs of pipe that are next to walls with their stems horizontal, away from the wall. Valves on vertical runs of pipe that are not located next to walls shall be installed with their stems

horizontal, oriented to facilitate valve operation.

3.3 INSTALLING BURIED VALVES

- A. Connect the valve, coat the flanges, or apply tape wrapping or polyethylene encasement, and place and compact the backfill to the height of the valve stem.
- B. Place block pads under the extension pipe to maintain the valve box vertical during backfilling and repaving and to prevent the extension pipe from contacting the valve bonnet.
- C. Mount the upper slip pipe of the extension in midposition and secure with backfill around the extension pipe. Pour the concrete ring allowing a depression so the valve box cap will be flush with the pavement surface.

3.4 FIELD COATING BURIED VALVES

- A. Coat flanges of buried valves and the flanges of the adjacent piping, and the bolts and nuts of flanges and mechanical joints, per Section 099000, System No. 10.
- B. Wrap buried metal valves 6 inches and larger with polyethylene sheet per Section 400713.
- C. Wrap buried metal valves 6 inches and larger in two layers of polyethylene conforming to AWWA C105, 8 mils in thickness each. Pass the two sheets of polyethylene under the valve and the coated flanges or joints with the connecting pipe and draw the sheets around the valve body, the valve bonnet, and the connecting pipe. Secure the sheets with plastic adhesive tape about the valve stem below the operating nut and about the barrel of the connecting pipe to prevent the entrance of soil. Fold overlaps twice and tape. Backfill the valve with care to avoid damaging the polyethylene.

3.5 INSTALLING ECCENTRIC PLUG VALVES

- A. Install such that the rotation of the plug is about a horizontal axis.
- B. Install such that the plug stores in the top when the valve is open.
- C. Orient the valve such that the seat is opposite the high-pressure side.

3.6 MOUNTING GEAR ACTUATORS

- A. The valve manufacturer shall select and mount the gear actuator and accessories on each valve and stroke the valve from fully open to fully closed prior to shipment.

3.7 VALVE LEAKAGE TESTING

- A. Test valves for leakage at the same time that the connecting pipelines are tested. See Section 400515 for pressure testing requirements. Protect or isolate any parts of valves, actuators, or control and instrumentation systems whose pressure rating is less than the pressure test. Valves shall show zero leakage. Repair or replace any leaking valves and retest.

3.8 VALVE FIELD TESTING

- A. Operate manual valves through three full cycles of opening and closing. Valves shall operate from full open to full close without sticking or binding. Do not backfill buried valves until after verifying that valves operate from full open to full closed. If valves stick or bind, or do not operate from full open to full closed, repair or replace the valve and repeat the tests.
- B. Gear actuators shall operate valves from full open to full close through three cycles without binding or sticking. The pull required to operate handwheel- or chainwheel-operated valves shall not exceed 80 pounds. The torque required to operate valves having 2-inch AWWA nuts shall not exceed 150 ft-lbs. If actuators stick or bind or if pulling forces and torques exceed the values stated previously, repair or replace the actuators and repeat the tests. Operators shall be fully lubricated in accordance with the manufacturer's recommendations prior to operating.

END OF SECTION

THIS PAGE INTENTIONALLY LEFT BLANK.

SECTION 400563

BALL VALVES

PART 1 - GENERAL

1.1 DESCRIPTION

- A. This section includes:
 - 1. Materials, testing, and installation of general ball valves and accessories.
 - 2. Materials, testing, and installation of AWWA C507 rubber-seated and metal-seated ball valves size range 6 through 48 inches.

1.2 RELATED WORK SPECIFIED ELSEWHERE

- A. Painting and Coating: 099000.
- B. General Piping Requirements: 400500.
- C. Pressure Testing of Piping: 400515.
- D. Valves, General: 400524.

1.3 SUBMITTALS

- A. Submit shop drawings in accordance with Section 013300.
- B. Submit manufacturer's catalog data and detailed construction sheets showing all valve parts. Describe each part by material of construction, specification (such as AISI, ASTM, SAE, or CDA), and grade or type. Identify each valve by tag number to which the catalog data and detail sheets pertain.
- C. Show valve dimensions including laying lengths. Show port sizes. Show dimensions and orientation of valve actuators, as installed on the valves.
- D. Show location of internal stops for gear actuators. State differential pressure and fluid velocity used to size actuators. For worm-gear actuators, state the radius of the gear sector in contact with the worm and state the handwheel diameter.
- E. Show valve linings and coatings. Submit manufacturer's catalog data and descriptive literature.
- F. Submit certification from manufacturer that valves are NSF 61 listed.

1.4 MANUFACTURER'S SERVICES

- A. Provide equipment manufacturer's services at the job site for the minimum man-days listed below, travel time excluded.
 - 1. Two eight hour days to check the installation, supervise startup, supervise testing and adjustments of air operated valves, and instruct the Owner's personnel in the operation and maintenance of the equipment.
 - 2. Any additional trips required by the Contractor before or after final startup and training shall not be charged to the Owner.

1.5 WARRANTY

- A. Full warranty against defects in materials and workmanship for one year after FINAL ACCEPTANCE, including all parts, labor, and expenses.

PART 2 - PRODUCTS

2.1 GENERAL

- A. Valves and the required actuators are identified by tag numbers on the drawings and in the Valve Schedule. See the Valve Schedule Section 400521.
- B. Valves shall be installed complete with flange gaskets, nuts and bolts, operating handwheels or levers, chainwheels, extension stems, floor stands, gear actuators, operating nuts, chains, and wrenches required for operation.
- C. Valves shall have the name of the manufacturer and the size of the valve cast or molded onto the valve body or bonnet or shown on a permanently attached plate.
- D. Bronze or brass material requirements:

1. Any bronze or brass components in contact with potable water shall be made "Lead-Free" as defined in the "Reduction of Lead in Drinking Water Act." Lead-Free shall contain no more than twenty-five hundredth of one percent (0.25 percent or less) total lead contained by weight. The manufacturer shall certify that the bronze meets the "Lead-Free" requirements.
2. For buried locations, valves with mechanical joint ends may be substituted for the flanged ends specified provided the mechanical joint ends are compatible with the pipe ends.

2.2 VALVE ACTUATORS/OPERATORS

- A. Provide operator types in accordance with the Valve Schedule.
- B. Provide a ball shaft support bearing on the cover for AWWA C507 ball valves.
- C. For AWWA C507 ball valves, design the link and lever torque unit such that during the first 50 percent of the closing stroke, the flow area is reduced by approximately 80 percent to 93 percent. The remaining flow area shall be gradually reduced to a complete shutoff throughout the last 50 percent of the closing stroke.
- D. Materials of the valve actuating mechanism subject to rubbing shall be of different hardness. The valve actuating mechanism shall be capable of being inspected, lubricated, removed, and repaired without removing the valve from the connecting piping.
- E. Valves shall open by turning counterclockwise.
- F. Valve Boxes: Furnish valve boxes for all buried valves.

2.3 BOLTS AND NUTS FOR FLANGED AND MECHANICAL JOINT VALVES

- A. Bolts and nuts for flanged valves shall be as described in the detailed piping specifications in Section 400500.
- B. Buried Service Bolts (for valve installation) shall be fluorocarbon coated cor-ten steel t-bolts and nuts equal to NSS cor-blue or approved equal low alloy corrosion-resistant high-strength steel in accordance with ANSI/AWWA C111/A21.11.

2.4 GASKETS FOR FLANGES

- A. Gaskets for flanged end valves shall be as described in the detailed piping specifications in Section 400500.

2.5 LINING AND COATING

- A. Coat the exterior of metal valves located above ground or in vaults and structures the same as the adjacent piping. If the adjacent piping is not coated, then coat valves per Section 099000, System No. 10. Apply the specified prime, intermediate, and finish coat at the place of manufacture. Apply intermediate and finish coats at the place of manufacturer or in the field. Finish coat shall match the color of the adjacent piping. Coat handwheels the same as the valves. Do not coat bronze, brass, or stainless steel valves.
- B. Coat the exterior of buried metal valves at the place of manufacture per Section 099000, System No. 10.
- C. Coat the exterior of submerged metal valves, stem guides, extension stems, and bonnets at the place of manufacture per Section 099000, System No. 12.
- D. Line the interior metal parts of metal valves 4 inches and larger, excluding seating areas and bronze and stainless steel pieces, per Section 099000, System No. 12. Apply lining at the place of manufacture. Interior lining shall meet the requirements of NSF 61.
- E. Coat floor stands per Section 099000, System No. 10.
- F. Measure the thickness of the valve interior linings per Section 099000. Repair areas having insufficient film thickness per Section 099000.

2.6 PACKING, O-RINGS, AND GASKETS

- A. Unless otherwise stated in the detailed valve specifications, packing, O-rings, and gaskets shall be one of the following nonasbestos materials:
 1. Teflon.
 2. Kevlar aramid fiber.
 3. Acrylic or aramid fiber bound by nitrile. Products: Garlock "Bluegard," Klinger "Klingersil C4400," or equal.
 4. Buna-N (nitrile).

5. EPDM.

2.7 RUBBER SEATS

- A. Rubber seats shall be made of a rubber compound that is resistant to free chlorine and monochloramine concentrations up to 10 mg/l in the fluid conveyed.

2.8 VALVE END CONNECTIONS

- A. Valve end connections for exposed valves shall be flanged unless shown otherwise or noted otherwise. The Contractor shall verify the compatibility of valve ends, including class and drilling of flanges with the connecting pipe.
- B. Buried valve end connections shall be mechanical joint or a push-on unless shown otherwise in the Drawings or in the Valve Schedule.

2.9 VALVES

- A. Ball Valves (Air and Water Service):

1. Full Port Threaded Bronze Ball Valves 2 Inches and Smaller for Water, etc. Service:
 - a. Ball valves, 2 inches and smaller, for air or water service shall have a pressure rating of at least 600 psi WOG at a temperature of 100 degrees F.
 - b. Provide full port ball and body design.
 - c. Valves shall comply with MSS SP-110.
 - d. Provide bronze (ASTM B62 or ASTM B584, Alloy C83600 or C84400) body and plug ball retainer. Ball and stem shall be Type 316 stainless steel.
 - e. Valves shall have threaded ends (ASME B1.20.1), nonblowout stems, reinforced Teflon seats, and have plastic-coated lever actuators.
 - f. Provide locking lever handle.
 - g. Provide stem extensions when valves are installed in insulated piping. Stem extensions shall be of a length sufficient to bring the bottom of the operating handle above the outside of the insulation.
 - h. Valves shall be Stockham T-285 Series, Apollo 77C-140 Series, or equal.
2. Flanged Bronze Ball Valves, Class 150, 4 Inches and Smaller for Water, etc. service:
 - a. Ball valves 4 inches and smaller shall have a minimum pressure rating of 200 psi at a temperature of 150 degrees F.
 - b. Valve body shall be aluminum bronze (ASTM B148, Alloy C95400) or bronze (ASTM B62 or ASTM B584, Alloy C83600).
 - c. Ball and stem shall be Type 316 stainless steel or bronze (ASTM B21, Alloy C48500).
 - d. Seat and seals shall be Teflon.
 - e. Ends shall be flanged, flat faced ASME B16.5, Class 150.
 - f. Valves shall be Neles-Jamesbury Style 5150, McCanna Series S151-BR, or equal.
3. Bronze Ball Valve Curb Stops, 2 Inches and Smaller, for Water, etc. Service:
 - a. Ball valve curb stops shall be bronze (ASTM B62 or ASTM B584, Alloy C83600) with male inlet iron pipe threads and female outlet iron pipe threads and shall conform to AWWA C800.
 - b. Minimum pressure rating shall be 300 psi.
 - c. Stops shall be Ford Ball Valve Curb Stop B81-777 with straight lever handle or equal.
4. Bronze Ball/Corporation Stops, 2 Inches and Smaller, for Water, etc. Service:
 - a. Corporation stops shall be bronze (ASTM B62 or ASTM B584, Alloy C83600) with male inlet iron pipe threads and female outlet iron pipe threads and shall conform to AWWA C800.
 - b. Minimum pressure rating shall be 300 psi.
 - c. Stops shall be Ford Ballcorp Type FB 1700, James Jones J-1931, or equal. Stops shall have an outlet fitting to adapt from iron pipe thread to copper tubing.
5. True Union PVC Ball Valves 4 Inches and Smaller for Wastewater, etc. Service:
 - a. Thermoplastic ball valves, 4 inches and smaller, for wastewater, water and chemical service shall be rated at a pressure of 150 psi at a temperature of 105 degrees F.
 - b. Body, ball, and stem shall be PVC conforming to ASTM D1784, Type 1, Grade 1. Seats shall be Teflon.
 - c. O-ring seals shall be Viton. O-rings used in chemical service shall be verified for chemical compatibility by manufacturer.
 - d. Valve ends shall be of the true union design. Ends shall be socket welded except where threaded or flanged-end valves are specifically shown in the drawings.

- e. Valves shall have handle for manual operation unless otherwise shown.
 - f. Provide stem extensions when valves are installed in insulated piping. Stem extensions shall be of a length sufficient to bring the bottom of the operating handle above the outside of the insulation.
 - g. Valves shall be as manufactured by Spears Manufacturing 2000 Series, Plast-O-Matic, Hayward or equal.
6. True Union CPVC Ball Valves 4 Inches and Smaller for Wastewater, etc. Service:
- a. CPVC ball valves, 4 inches and smaller, for wastewater, water and chemical service shall be rated at a pressure of 150 psi at a temperature of 105 degrees F and rated at a pressure of 100 psi at a temperature of 150 degrees F.
 - b. Body, ball, and stem shall be CPVC conforming to ASTM D1784, Type 4, Grade 1. Seats shall be Teflon.
 - c. O-ring seals shall be Viton.
 - d. Valve ends shall be of the true-union design. Ends shall be socket welded except where threaded or flanged-end valves are specifically shown in the drawings.
 - e. Valves shall have handle for manual operation unless otherwise shown.
 - f. Provide stem extensions when valves are installed in insulated piping. Stem extensions shall be of a length sufficient to bring the bottom of the operating handle above the outside of the insulation.
 - g. Valves shall be as manufactured by Spears Manufacturing 2000 Series, Plast-O-Matic, Hayward, or equal.
7. True Union CPVC Ball Valves 4 Inches and Smaller with Vented Ball for Sodium Hypochlorite, etc. Service:
- a. Vented CPVC ball valves, 4 inches and smaller, for chemical service shall be rated at a pressure of 150 psi at a temperature of 105 degrees F and rated at a pressure of 85 psi at a temperature of 140 degrees F.
 - b. Provide machined vent hole, deburred, in the ball to allow gases to vent.
 - c. Body, ball, and stem shall be CPVC conforming to ASTM D1784, Type 4, Grade 1. Seats shall be Teflon.
 - d. O-ring seals shall be Viton.
 - e. Valve ends shall be of the true-union design. Ends shall be socket welded except where threaded or flanged-end valves are specifically shown in the drawings.
 - f. Valves shall have handle for manual operation.
 - g. Provide stem extensions when valves are installed in insulated piping. Stem extensions shall be of a length sufficient to bring the bottom of the operating handle above the outside of the insulation.
 - h. Valves shall be by Spears Manufacturing, Plast-O-Matic, Hayward or Equal.
8. Full Port Threaded Stainless Steel Ball Valves 3 Inches and Smaller for Process Air Service
- a. Stainless steel ball valves, 3 inches and smaller, for air and water service shall be rated at a minimum pressure of 1,000 psi WOG at a temperature of 100 degrees F.
 - b. Valve body, ball, and stem shall be Type 304 stainless steel, ASTM A276 or A351. Seat and seals shall be reinforced RPTFE.
 - c. Valves shall have lever actuators, plastic coated. Provide locking lever handle.
 - d. Provide stem extensions when valves are installed in insulated piping. Stem extensions shall be of a length sufficient to bring the bottom of the operating handle above the outside of the insulation.
 - e. Valves shall have threaded ends (ASME B1.20.1) and nonblowout stems.
 - f. Valves shall be Apollo 76F-100-A Series, or equal.
9. Full Port Flanged Stainless Steel Ball Valves ½ inch to 12 inches, Class 150 for Process Air Service:
- a. Stainless steel ball valves 1/2 inch through 12 inches shall have flanged ends, ASME B16.5, Class 150.
 - b. Pressure rating shall be at least 250 psi at a temperature of 100 degrees F.
 - c. Bodies shall be Type 304 stainless steel (ASTM A351, Type CF8M). Ball, stem, and compression ring shall be Type 304 or 316 stainless steel. Bonnet bolting shall be ASTM A193, Grade B8M.
 - d. Seats and seals shall be RPTFE.
 - e. Valves shall be Apollo Series 87A-200-Series, or equal.
10. Regular or Full Port, Threaded End, Carbon Steel Ball Valves 2 Inches and Smaller for LPG,

Natural Gas, and Fuel Oil Service (UL Listed):

- a. Carbon steel ball valves 2 inches and smaller shall be rated at a minimum pressure of 2,000-psi WOG for sizes 1 inch and smaller; 1,500-psi WOG for sizes 1-1/4 inches through 2 inches; 1,000-psi WOG for sizes 2-1/2 inches through 3 inches; and 250 psi UL listed for LPG, natural gas, and fuel oil service in all sizes.
 - b. Provide regular or full port design.
 - c. Valve body and retainer shall be carbon steel, ASTM A216, Grade WCB; ASTM A105; or ASTM A108. Ball, gland nut, and stem shall be carbon steel (ASTM A108) or stainless steel (ASTM A479), with chrome-plated ball. Seat, packing, and seals shall be PTFE or reinforced PTFE.
 - d. Valves shall have lever handle, plastic coated.
 - e. Valve shall have threaded ends (ASME B1.20.1). Provide nonblowout stems.
 - f. Provide adjustable packing gland. Provide double union end connections.
 - g. Products: Apollo 489-100 Series, or equal.
11. Forged, Flanged, Carbon Steel Ball Valves 2 Inches Through 24 Inches, Class 150, for High Temperature Hot Water Service:
- a. Valves shall be of the trunnion-mounted ball design, with three-piece body, full bore, double block and bleed, and with anti-static device.
 - b. Design and construction shall comply with API-6D and NACE MR-01-75. The seal design shall utilize the differential between the sealing diameter of the seat insert or ball contact and the outer diameter of the seat. When the fluid differential pressure is insufficient to cause the valve to seal, seat springs shall cause it to seal.
 - c. Provide a secondary metal-to-metal seal after a fire. When the primary soft seals are destroyed by fire, the fire-safe seals shall energize the seat assembly to seal. The fire-safe seal design shall comply with API 607 and API 6FA.
 - d. Provide a stem sealant injection fitting. Provide seat sealant injection fittings on valves 6 inches and larger.
 - e. Provide integral enclosed worm-gear actuator with handwheel for valves 6 inches and larger. Provide lever actuator for valves smaller than 6 inches.
 - f. Valves shall be Class 150 per ASME B16.5, with raised face flanges.
 - g. Design conditions shall be:
 - (1) Fluid: Water.
 - (2) Fluid Temperature Range: 60 degrees F to 400 degrees F.
 - (3) Pressure: 100 psi (maximum).
 - (4) Materials of construction shall be as follows:
 - (5) Body: Carbon steel; ASTM A105.
 - (6) Ball: Carbon steel with 0.003-inch electroless nickel plating; ASTM A105.
 - (7) Stem: Stainless steel; ASTM A182, Grade F316.
 - (8) Seats and inserts: Stainless steel plus nylon; ASTM A182, Grade F316.
 - (9) Seals: Viton/graphite.
 - (10) Body stud bolts and nuts: Alloy steel; ASTM A193, Grade B7M and A194, Grade 2HM.
 - (11) Worm-gear housing: Ductile iron; ASTM A395 or A536.
 - (12) Valves shall be GWC Valve International, Inc., Model FF or equal.
12. Flanged Carbon Steel Ball Valves 4 Inches and Smaller, Class 150 for Miscellaneous Applications:
- a. Carbon steel ball valves 1/2 inch through 4 inches shall have flanged ends, ASME B16.5, Class 150.
 - b. Valve shall have a pressure rating of at least 285 psi at a temperature of 100 degrees F.
 - c. Bodies shall be steel, ASTM A216, Grade WCB. Ball, stem, and compression ring shall be Type 316 stainless steel. Body studs and nuts shall comply with ASTM A193, Grade B7, and ASTM A194, Grade 2H, respectively. Seat and seals shall be Teflon.
 - d. Valves shall be Jamesbury Type 5150, McCanna Series 51F1-CS, or equal.
13. Flanged Ductile-Iron Ball Valves 4 Inches and Smaller, Class 125 for Miscellaneous Applications:
- a. Ball valves 4 inches and smaller shall be rated at a pressure of 200 psi at a temperature of 300 degrees F.
 - b. Valve body shall be ductile iron (ASTM A395 or A536). Ball, stem, and compression ring shall be Type 316 stainless steel. Seat and seals shall be Teflon.
 - c. Provide seats both upstream and downstream of the ball.

- d. Ends shall be flanged, ASME B16.1, Class 125.
 - e. Valves shall be Neles-Jamesbury Style 5150, McCanna Series S151, Worcester Series 51, or equal.
14. Flanged Ball Valves for Chlorine Gas Service:
- a. Ball valves for chlorine gas service shall have carbon steel (ASTM A216, Grade WCB) bodies with Hastelloy (ASTM A494, Alloy CW-12MW) ball and stem. Stem seals and body seals shall be Teflon.
 - b. Minimum operating pressure shall be 200 psi.
 - c. Valve seats shall incorporate a relief system per Chlorine Institute Pamphlet No. 6 such that in the event of pressure buildup in the valve body, chlorine will vent toward the upstream side of the valve.
 - d. Prepare valves for chlorine service as recommended by the Chlorine Institute Pamphlet No. 6.
 - e. Valve ends shall be flanged, Class 150, per ASME B16.5.
 - f. Valves shall have a plastic-coated lever operator.
 - g. Valves shall be Neles-Jamesbury Type 530SC (1/2 inch through 1 inch), 5300C (1-1/2 inches and larger); McCanna Model F; ITT Cam-Tite CLV; or equal.
15. Regular Port, Threaded End, Carbon Steel Ball Valves 2 Inches and Smaller for Anhydrous Ammonia Service (UL Listed):
- a. Carbon steel ball valves 2 inches and smaller shall be rated at a minimum pressure of 800-psi WOG and be UL listed for anhydrous ammonia service.
 - b. Valve body and retainer shall be carbon steel, ASTM A181; ASTM A216, Grade WCB; ASTM A105; or ASTM A108. Ball, stem nut, and stem shall be carbon steel (ASTM A108) or stainless steel (ASTM A479), with chrome-plated ball. Seat, packing, and seals shall be PTFE or reinforced PTFE. Body bolts shall conform to ASTM A449 or ASTM A193, Grade B7. Nuts for body bolts shall conform to ASTM A194, Grade 2H.
 - c. Provide nonblowout stems.
 - d. Valves shall have lever handle, plastic coated.
 - e. Valve shall have threaded ends (ASME B1.20.1).
 - f. Products: Neles-Jamesbury Type 2000 or equal.
16. Class 150 Flanged Carbon Steel Ball Valves 8 Inches and Smaller for Anhydrous Ammonia Service (UL Listed):
- a. Ball valves 1/2 inch through 8 inches shall have carbon steel (ASTM A216, Grade WCB) bodies, carbon steel ball and stem, and be UL listed for anhydrous ammonia service. Provide chrome or electroless nickel plating on ball. Stem seals and body seals shall be PTFE.
 - b. Body pressure rating and valve end flanges shall be Class 150 per ASME B16.5.
 - c. Provide plastic-coated lever actuator for valves smaller than 6 inches; provide geared actuator for valves 6 inches and larger.
 - d. Products: Neles-Jamesbury Type 5150 or equal.
17. Polyethylene Ball Valves for Natural Gas Service:
- a. Polyethylene ball valve used for gas service shall be made from medium density polyethylene resin conforming to ASTM D1248, Type II, Class B, Category 5, Grade P24.
 - b. Valve shall comply with ASME B16.40.
 - c. The valve shall have standard stub ends suitable for heat fusion welding.
 - d. The valve shall have seals and seats molded from Nitrile (Buna-N) material and shall be compatible with gas service.
 - e. Valve shall be Nordstrom Polyvalve, Kerotest Polyball, or equal.
18. Ball Valves (AWWA C507) for Water service:
- a. Valves shall be flanged, conforming to AWWA C507 and the following.
 - b. Valves shall be operable and hydrodynamically stable for fluid velocities up to 35 fps, fluid temperatures of 33 degrees F to 125 degrees F, and environmental temperature range of 35 degrees F to 125 degrees F.
 - c. The ball position shall be partially to fully open under the above criteria. Valve shaft, key, actuator, and complete assembly shall not fail at the specified maximum fluid velocity. Valve ball shall not change position under any line velocity scenario, including maximum velocity.
 - d. Flanged ends shall be flat-faced Class 125, ASME B16.1 or ASME B16.42 for Class 150 or Class 250, ASME B16.1 or ASME B16.42 for Classes 250 and 300 valves.
 - e. Metal-Seated Ball Valves:

- (1) Body: The valve body shall consist of two end pieces and two center body half pieces. Each end piece shall be bolted to the two adjoining center pieces. The two center pieces shall be longitudinally split and shall have machined surfaces for mating with each other. The center body pieces shall contain the ball assembly with the associated shaft stuffing box and packing. The body shall have integrally cast, bronze bushed trunnions. It shall provide rigid means for supporting the torque unit without the necessity of additional supports. Provide two pipe connections, one for an air vent and the other for drain. The end pieces shall contain the flanges for connecting to the adjacent piping. The port openings on the end pieces shall be a true 100 percent full circular opening equal to the nominal size of the valve.
 - (2) Ball: The ball shall have integrally cast, bronze bushed trunnions. An extension of one trunnion (the operating shaft) shall pass through a sealing device (O-ring retainer) and connect to the valve operating mechanism. The operating shaft shall be chrome plated where it passes through the sealing device. The sealing device shall be capable of being removed and having its seals replaced with the line under full pressure, without removing the valve from the line. Design the ball shaft so that the factor of safety for all combined stresses shall be at least five to one. Maximum torsional deflection shall not exceed 1/6 degree per foot of unsupported length using a seat coefficient of friction of 0.5 and a bearing coefficient of friction of 0.3.
 - (3) Bearings: Provide sleeve-type bearings fitted within both the ball and body trunnions. Bearing loading shall not exceed 900 psi at 150-psi differential pressure, 1,500 psi at 250-psi differential pressure, or 1,900 psi at 300-psi differential pressure. Bearings shall be Teflon-lined with fiberglass backing or bronze and of dissimilar hardnesses to prevent galling.
 - (4) Seats: Provide valves with a fixed body seat and a rotating ball seat. The ball seat shall be connected to the ball by means of a stainless steel mounting ring which is securely attached and pinned into position. Do not use seat designs in which the seat is threaded directly onto the ball. Seats shall be metal; no resilient seating surfaces are acceptable. Install metal seating surfaces on a two-degree offset axis to prevent wedging of the seats. Maximum seat bearing pressure shall be 1,000 psi. Seats shall be rigidly attached to the body and ball. Ball seats shall be adjustable to allow sealing in one direction without removing the valve from the adjacent piping.
 - (5) Manufacturers: Apco/Willamette Valve Inc., List 26; Pratt MSBV; or equal.
- f. Rubber-Seated Ball Valves:
- (1) Body: The valve body shall have integral support legs or pads and shall consist of two body end pieces and a center body piece through-bolted and O-ring sealed against leakage.
 - (2) Ball: The valve ball shall be taper-pinned to an upper and lower fitted shaft that is turned, ground, and polished to a 32-microninch or smoother finish per ASME B46.1.
 - (3) Bearings and Seals: The center section shall be fitted with sleeve-type bearings contained in the body hubs. Bearings shall be self-lubricating, with minimum wall thickness of 1/4 inch. Material shall be Teflon-lined with fiberglass backing. Bearing surfaces shall be isolated from flow by O-ring seals. The ball assembly shall be supported by a two-way thrust bearing assembly consisting of a Type 304 stainless steel stud and a bronze thrust collar (ASTM B505, Alloy C93200) in a grease-packed cavity.
 - (4) Seats: Valve seats shall be of a synthetic rubber compound that is resistant to free chlorine and monochloramine concentrations up to 10 mg/l in the fluid conveyed. Seats shall be retained in the valve body by mechanical means without retaining rings, segments, screws, or hardware of any kind in the flow stream. Seats shall seal a full 360 degrees without interruption and shall mate with a spherical Type 316 stainless steel seating surface on the ball. Valve seats shall be field adjustable around the full 360-degree circumference and replaceable without dismantling the operator, ball, or shaft. Where line size permits, seats shall also be capable of being replaced or adjusted without removing the valve from the line.
 - (5) Valves shall be single-seated to allow closure in one direction.
 - (6) Manufacturer: Henry Pratt Co. or equal.
 - (7) Leakage: The allowable leakage through the seat shall be as described in AWWA C507.
 - (8) Materials of Construction.

- a. Materials of construction for Class 150 valves shall be as follows:
 - Valve body: Cast iron (ASTM A126, Class B or ASTM A48, Class 35) or Ductile iron (ASTM A536, Grade 65 45-12).
 - Ball or rotor: Cast iron (ASTM A48, Class 35-minimum) or Ductile iron (ASTM A536, Grade 65 45-12).
 - Ball shaft: Alloy steel (ASTM A564, UNS S17400, Condition H1150).
 - Shaft and taper pins: Stainless steel (ASTM A276, Type 304 or 316) or Monel (ASTM B164, Alloy N04400).
 - Body bolts, studs, and nuts: Stainless steel (Type 304 per ASTM B193, Grade B8 and ASTM A194, Grade 8).
 - Capscrews (internal and external) and lockwashers: Stainless steel (AISI Type 316).
 - Seats (rubber): Buna-N.
 - Ball seats (metal): Stainless steel (ASTM A276, Type 304).
 - Body seats (metal): Monel (UNS N04400).
- b. Materials for construction for Classes 250 and 300 valves shall be as follows:
 - Valve body, ball or rotor: Steel (ASTM A216, Grade WCB) or Ductile iron (ASTM A536, Grade 65 45-12).
 - Ball shaft: Alloy steel (ASTM A564, UNS S17400, Condition H1150).
 - Shaft and taper pins: Stainless steel (ASTM A276, Type 304 or 316) or Monel (ASTM B164, Alloy N04400).
 - Body bolts, studs, and nuts: Stainless steel (Type 304 per ASTM A193, Grade B8 and A194, Grade 8).
 - Capscrews (internal and external) and lockwashers: Stainless steel (AISI Type 316).
 - Seats (rubber): Buna-N.
 - Ball seats (metal): Stainless steel (ASTM A276, Type 304).
 - Body seats (metal): Monel (UNS N04400).

PART 3 - EXECUTION

3.1 SHIPMENT AND STORAGE

- A. Provide flanged openings with metal closures at least 3/16-inch thick, with elastomer gaskets and at least four full-diameter bolts. Install closures at the place of valve manufacture prior to shipping. For studed openings, use all the nuts needed for the intended service to secure closures.
- B. Provide threaded openings with steel caps or solid-shank steel plugs. Do not use nonmetallic (such as plastic) plugs or caps. Install caps or plugs at the place of valve manufacture prior to shipping.
- C. Inspect valves on receipt for damage in shipment and conformance with quantity and description on the shipping notice and order. Unload valves carefully to the ground without dropping. Use forklifts or slings under skids. Do not lift valves with slings or chain around operating shaft, actuator, or through waterway. Lift valves with eyebolts or rods through flange holes or chain hooks at ends of valve parts.
- D. Protect the valve and actuators from weather and the accumulation of dirt, rocks, and debris. Do not expose rubber seats to sunlight or ozone for more than 30 days. Also, see the manufacturer's specific storage instructions.
- E. Make sure flange faces, joint sealing surfaces, body seats, and disc seats are clean. Check the bolting attaching the actuator to the valve for loosening in transit and handling. If loose, tighten firmly. Open and close the valve to make sure it operates properly and that stops or limit switches are correctly set so that the valve seats fully. Close valve before installing.
- F. If the valves and associated power actuators are stored or installed outside or in areas subject to temperatures below 40 degrees F or are exposed to the weather prior to permanent installation, provide the manufacturer's recommended procedures for extended storage. Provide temporary covers over actuator electrical components. Provide temporary conduits, wiring, and electrical supply to space heaters. Exercise each actuator from its fully open to fully closed position at least once every seven days. Inspect electrical contacts before start-up.

3.2 JOINTS

- A. Bolt holes of flanged valves shall straddle the horizontal and vertical centerlines of the pipe run to which the valves are attached. Clean flanges by wire brushing before installing flanged valves. Clean

flange bolts and nuts by wire brushing, lubricate threads with oil and graphite, and tighten nuts uniformly and progressively. If flanges leak under pressure testing, loosen or remove the nuts and bolts, reseal or replace the gasket, reinstall or retighten the bolts and nuts, and retest the joints. Joints shall be watertight.

- B. Clean threaded joints by wire brushing or swabbing. Apply Teflon joint compound or Teflon tape to pipe threads before installing threaded valves. Joints shall be watertight.
- C. Install lug-type valves with separate hex head machine bolts at each bolt hole and each flange (two bolts per valve bolt hole).

3.3 INSTALLING EXPOSED VALVES

- A. Unless otherwise indicated in the drawings, install valves in horizontal runs of pipe having centerline elevations 4 feet 6 inches or less above the floor with their operating stems vertical. Install valves in horizontal runs of pipe having centerline elevations between 4 feet 6 inches and 6 feet 9 inches above the floor with their operating stems horizontal.
- B. Install valves on vertical runs of pipe that are next to walls with their stems horizontal, away from the wall. Valves on vertical runs of pipe that are not located next to walls shall be installed with their stems horizontal, oriented to facilitate valve operation.
- C. Install valves such that the balls rotate about a horizontal axis.
- D. Handle valves carefully when positioning, avoiding contact or impact with other equipment, vault walls, or trench walls.
- E. Clean valve interiors and adjacent piping of foreign material prior to making up valve to pipe joint connection. Prepare pipe ends and install valves in accordance with the pipe manufacturer's instructions for the joint used. Do not deflect pipe-valve joint. Do not use a valve as a jack to pull pipe into alignment. The installation procedure shall not result in bending of the valve/pipe connection with pipe loading.
- F. Support body support legs or pads on a concrete pad without being anchored to such support. Install such that the valve is not subject to any loads due to thermal expansion of the pipe or support any piping loads on the body.
- G. Provide a separate support beneath the actuator extending beyond the valve body, so that no eccentric loads are imposed on the connecting piping.
- H. Prior to assembly, coat threaded portions of stainless steel bolts and nuts with lubricant.

3.4 INSTALLING BURIED VALVES

- A. Connect the valve, coat the flanges, apply tape wrapping or polyethylene encasement, and place and compact the backfill to the height of the valve stem.
- B. Place block pads under the extension pipe to maintain the valve box vertical during backfilling and repaving and to prevent the extension pipe from contacting the valve bonnet.
- C. Mount the upper slip pipe of the extension in midposition and secure with backfill around the extension pipe. Pour the concrete ring allowing a depression so the valve box cap will be flush with the pavement surface.
- D. In streets without concrete curbs and in open areas, install the valve box as for a paved area with concrete curb except include a marker post. Cut the marker post from 4-inch by 4-inch dense structural grade Douglas fir No. 2 or Southern Pine No. 2 surfaced on four sides to a length of 5 feet. Chamfer the top. Set the post in concrete, 2 feet into the ground, away from traffic, and to the side of the pipeline. Coat with a seal and finish coat of white alkyd exterior paint. On the side facing the valve, letter in black the word "VALVE" and the distance in feet from the marker post to the valve box cap.
- E. Install debris cap as close as possible under the cast-iron cover without interfering with the cover operation. Trim flexible skirt to provide a smooth contact with the interior or the extension pipe. Install Owner-furnished locks.

3.5 FIELD COATING BURIED VALVES

- A. Coat flanges of buried valves and the flanges of the adjacent piping, and the bolts and nuts of flanges and mechanical joints, per Section 099000, System No. 10.
- B. Wrap buried metal valves 6 inches and larger with polyethylene sheet per Section 400713.
- C. Wrap buried metal valves 6 inches and larger in two layers of polyethylene conforming to AWWA C105, 8 mils in thickness each. Pass the two sheets of polyethylene under the valve and the coated flanges or joints with the connecting pipe and draw the sheets around the valve body, the valve

bonnet, and the connecting pipe. Secure the sheets with plastic adhesive tape about the valve stem below the operating nut and about the barrel of the connecting pipe to prevent the entrance of soil. Fold overlaps twice and tape. Backfill the valve with care to avoid damaging the polyethylene.

3.6 MOUNTING GEAR ACTUATORS

- A. The valve manufacturer shall select and mount the gear actuator and accessories on each valve and stroke the valve from fully open to fully closed prior to shipment.

3.7 VALVE LEAKAGE TESTING

- A. Test valves for leakage at the same time that the connecting pipelines are tested. See Section 400515 for pressure testing requirements. Protect or isolate any parts of valves, actuators, or control and instrumentation systems whose pressure rating is less than the pressure test. Valves shall show zero leakage. Repair or replace any leaking valves and retest.

3.8 VALVE FIELD TESTING

- A. Actuators shall be fully lubricated in accordance with the manufacturer's recommendations prior to operating.
- B. Operate manual valves through three full cycles of opening and closing. Valves shall operate from full open to full close without sticking or binding. Do not backfill buried valves until after verifying that valves operate from full open to full closed. If valves stick or bind, or do not operate from full open to full closed, repair or replace the valve and repeat the tests.
- C. Gear actuators shall operate valves from full open to full close through three cycles without binding or sticking. The pull required to operate handwheel- or chainwheel-operated valves shall not exceed 80 pounds. The torque required to operate valves having 2-inch AWWA nuts shall not exceed 150 ft-lbs. If actuators stick or bind or if pulling forces and torques exceed the values stated previously, repair or replace the actuators and repeat the tests. Operators shall be fully lubricated in accordance with the manufacturer's recommendations prior to operating.

END OF SECTION

SECTION 400566
BUTTERFLY VALVES

PART 1 - GENERAL

1.1 SUMMARY

- A. This section includes materials, testing, and installation of butterfly valves and accessories in process air, water and wastewater applications.

1.2 RELATED WORK SPECIFIED ELSEWHERE

- A. Painting and Coating: 099000.
- B. General Piping Requirements: 400500.
- C. Pressure Testing of Piping: 400515.
- D. Valves, General: 400524.

1.3 SUBMITTALS

- A. Submit shop drawings in accordance with Section 013300.
- B. Submit manufacturer's catalog data and detailed construction sheets showing all valve parts. Describe each part by material of construction, specification (such as AISI, ASTM, SAE, or CDA), and grade or type. Identify each valve by tag number to which the catalog data and detail sheets pertain.
- C. Show valve dimensions including laying lengths. Show port sizes. Show dimensions and orientation of valve actuators, as installed on the valves.
- D. Show location of internal stops for gear actuators. State differential pressure and fluid velocity used to size actuators. For worm-gear actuators, state the radius of the gear sector in contact with the worm and state the handwheel diameter.
- E. Show valve linings and coatings. Submit manufacturer's catalog data and descriptive literature.
- F. Show the clear diameter or size of the port. Show the actual area of the port as a percentage of the area as calculated for the nominal valve size.

1.4 WARRANTY

- A. Full warranty against defects in materials and workmanship for one year after FINAL ACCEPTANCE including all parts, labor, and expenses.

PART 2 - PRODUCTS

2.1 GENERAL

- A. Valves and the required actuators are identified by tag numbers on the drawings and in the Valve Schedule. See the Valve Schedule in Valves, General Section 400524.
- B. Valves shall be installed complete with flange gaskets, nuts and bolts, operating handwheels or levers, chainwheels, extension stems, floor stands, gear actuators, operating nuts, chains, and wrenches required for operation.
- C. Valves shall have the name of the manufacturer and the size of the valve cast or molded onto the valve body or bonnet or shown on a permanently attached plate. Valves shall open by turning counterclockwise.
- D. Bolts, nuts and gaskets for flanged valves shall be as described in Section 400500.
- E. Lining and coating shall be as described in Section 099000.
- F. Packing, O-Rings and gaskets shall be Teflon, Kevlar aramid fiber, acrylic or aramid fiber, Buna-N or EPDM.
- G. Valve end connections for exposed valves shall be wafer or flanged, as indicated in Valve Schedule. Contractor shall verify compatibility of valve ends, including class and drilling flanges with the connecting pipe.
- H. Buried valve end connections shall be mechanical joint of push on joint unless otherwise shown in the drawings or in the Valve Schedule.

2.2 VALVES

A. BUTTERFLY VALVES FOR PROCESS AIR SERVICE (MSS SP-67).

1. Comply with MSS SP-67.
2. Materials:
 - a. Valve Bodies:
 - i. Wafer body: Cast iron ASTM A126, Class B.
 - ii. Lug Body: Ductile iron, ASTM A395.
 - b. Valve Shaft or Stem:
 - i. Stainless steel, ASTM A276, Type 316
 - c. Valve Disc:
 - i. Ductile iron, ASTM A395, nickel plated, or
 - ii. Aluminum Bronze, ASTM B148 Alloy 954
 - d. Valve Seat:
 - i. Water and air below 180 Deg F
 1. Buna-N
 - ii. Water and air 180 to 250 Deg F
 1. EPDM
 - iii. Valve seat shall be a full body seat isolating stem and body from flow.
3. Design Requirements:
 - a. Exposed and submerged valves 3 IN through 20 IN.
 - i. Body type: Wafer
 - ii. Working pressure: Rated for 150 psi.
 - iii. Equip with fully taped anchor lugs drilled per ASME B16.5.

B. BUTTERFLY VALVES FOR WATER AND WASTEWATER APPLICATIONS:

4. Comply with AWWA C504.
5. Materials:
 - a. Acceptable Materials for Valve Bodies:
 - i. Cast iron ASTM A126, Class B.
 - ii. Cast iron ASTM A48, Class 40
 - iii. Ductile iron ASTM A536, Grade 65-45-12
 - iv. Alloy Cast Iron ASTM A436, Type 1 and Type 2
 - v. Alloy Cast Iron ASTM A439, Type D2.
 - b. Valve Shaft or Stem:
 - i. Stainless steel, 18-8, Type 304
 - c. Acceptable Materials for Valve Disc:
 - i. ASTM A436, Type 1 alloy cast iron.
 - ii. ASTM A536, Grade 65-45-12 ductile iron
 - iii. Bronze in accordance with AWWA C504
 - iv. Aluminum Bronze, ASTM B148 Alloy 954
 - d. Valve Seat:
 - i. Water below 180 Deg F
 1. Buna-N
 - ii. Valve seat shall be a full body seat isolating stem and body from flow.
6. Design Requirements:
 - a. Exposed and submerged valves 3 IN through 20 IN.
 - i. Body type: Short body flanged or wafer, as indicated
 - ii. Working pressure: Rated for 150 psi (Class 150B per AWWA).

2.3 ACCESSORIES

- A. Refer to Valve Schedule for type of actuators. Furnish actuator integral with valve.

PART 3 EXECUTION

3.1 JOINTS

- A. Bolt holes of flanged valves shall straddle the horizontal and vertical centerlines of the pipe run to which the valves are attached. Clean flanges by wire brushing before installing flanged valves. Clean bolts and nuts by wire brushing, lubricate threads with oil and graphite, and tighten bolts uniformly and progressively. If flanges leak under pressure testing, loosen or remove the nuts and bolts, reseal or replace the gasket, reinstall or retighten the bolts and nuts, and retest the joints. Joints shall be watertight.
- B. Clean threaded joints with wire brush and by swabbing. Apply Teflon joint compound or Teflon tape to the pipe threads before installing threaded valves. Joints shall be watertight.
- C. Install lug type valves with separate hex head machine bolts at each bolt hole and each flange (two bolts per valve bolt hole).
- D. Install grooved end couplings for valves in accordance with grooved coupling supplier recommendations.

3.2 INSTALLING EXPOSED VALVES

- A. Unless otherwise indicated in the drawings, install valves in horizontal runs of pipe having centerline elevations 4 feet 6 inches or less above the floor with their operating stems vertical. Install valves in horizontal runs of pipe having centerline elevations between 4 feet 6 inches and 6 feet 9 inches above the floor with their operating stems horizontal.
- B. Install valves on vertical runs of pipe that are next to walls with their stems horizontal, away from the wall. Valves on vertical runs of pipe that are not located next to walls shall be installed with their stems horizontal, oriented to facilitate valve operation.
- C. Valve operator locations have been shown arbitrarily on the Drawings. Contractor shall verify the location of the operator to comply with above requirements, and to allow access for installation, operation, and maintenance.

3.3 INSTALLING BURIED VALVES

- A. Connect the valve, coat the retainer glands, install the tape wrapping or polyethylene encasement, and place and compact the backfill to the height of the valve stem.
- B. Place block pads under the extension pipe to maintain the valve box vertical during backfilling and repaving and to prevent the extension pipe from contacting the valve bonnet.
- C. Mount the upper slip pipe of the extension in midposition and secure with backfill around the extension pipe. Pour the concrete ring allowing a depression so the valve box cap will be flush with the pavement surface.

3.4 FIELD COATING BURIED VALVES

- A. Coat flanges of buried valves and the retaining hardware of the adjacent piping, and the bolts and nuts of retaining hardware and mechanical joints, per Section 099000.
- B. Wrap buried metal valves 6 inches and larger with polyethylene sheet.
- C. Wrap buried metal valves 6 inches and larger in two layers of polyethylene conforming to AWWA C105, 8 mils in thickness each. Pass the two sheets of polyethylene under the valve and the coated flanges or joints with the connecting pipe and draw the sheets around the valve body, the valve bonnet, and the connecting pipe. Secure the sheets with plastic adhesive tape about the valve stem below the operating nut and about the barrel of the connecting pipe to prevent the entrance of soil. Fold overlaps twice and tape. Backfill the valve with care to avoid damaging the polyethylene.

3.5 MOUNTING GEAR ACTUATORS

- A. The valve manufacturer shall select and mount the gear actuator and accessories on each valve and stroke the valve from fully open to fully closed prior to shipment.

3.6 VALVE FIELD TESTING

- A. Operate manual valves through three full cycles of opening and closing. Valves shall operate from full open to full close without sticking or binding. Do not backfill buried valves until after verifying that

valves operate from full open to full closed. If valves stick or bind, or do not operate from full open to full closed, repair or replace the valve and repeat the tests.

- B. Gear actuators shall operate valves from full open to full close through three cycles without binding or sticking. The pull required to operate handwheel- or chainwheel-operated valves shall not exceed 80 pounds. The torque required to operate valves having 2-inch AWWA nuts shall not exceed 150 ft-lbs. If actuators stick or bind or if pulling forces and torques exceed the values stated previously, repair or replace the actuators and repeat the tests. Operators shall be fully lubricated in accordance with the manufacturer's recommendations prior to operating.

END OF SECTION

SECTION 400567
CHECK VALVES FOR SPECIFIC APPLICATIONS

PART 1 - GENERAL

1.1 SUMMARY

- A. This section includes materials, testing, and installation of check valves and accessories in process air applications.

1.2 RELATED WORK SPECIFIED ELSEWHERE

- A. Painting and Coating: 099000.
- B. General Piping Requirements: 400500.
- C. Pressure Testing of Piping: 400515.
- D. Valve Schedule: 400521.

1.3 SUBMITTALS

- A. Submit shop drawings in accordance with Section 013300.
- B. Submit manufacturer's catalog data and detailed construction sheets showing all valve parts. Describe each part by material of construction, specification (such as AISI, ASTM, SAE, or CDA), and grade or type. Identify each valve by tag number to which the catalog data and detail sheets pertain.
- C. Show valve dimensions including laying lengths. Show port sizes. Show dimensions and orientation of valve appurtenances, as installed on the valves.
- D. Show valve linings and coatings. Submit manufacturer's catalog data and descriptive literature.
- E. Show the clear diameter or size of the port. Show the actual area of the port as a percentage of the area as calculated for the nominal valve size.
- F. Provide additional O&M data per Section 017823.

1.4 WARRANTY

- A. Full warranty against defects in materials and workmanship for one year after FINAL ACCEPTANCE including all parts, labor, and expenses.

PART 2 - PRODUCTS

2.1 GENERAL

- A. Valves are identified by tag numbers on the drawings and in the Valve Schedule. See the Valve Schedule Section 400521.
- B. Bolts, nuts and gaskets for flanged valves shall be as described in Section 400500.
- C. Lining and coating shall be as described in Section 099000.
- D. Valve end connections for exposed valves shall be flanged unless shown otherwise. Contractor shall verify compatibility of valve ends, including class and drilling flanges with the connecting pipe.

2.2 VALVES

- A. CHECK VALVES FOR STRAINER FEED PUMP STATIONS (NOT USED)
 - 1. Supply rubber flapper type check valve for raw sewage applications. Check valve shall be Swing-Flex by Val Matic, APCO CRF series, or equal.
 - 2. Standards and Approvals: Valves shall be designed, manufactured, tested and certified to ANSI/AWWA C508 standard.
 - 3. Connections shall be flanges with drilling to ANSI B16.1, Class 125.
 - 4. Materials: The valve body and cover shall be constructed of ASTM A536 Grade 65-45-12 ductile iron or ASTM A126 Class B Gray Iron for 30" and larger valves.
 - 5. Pressure rating: Valve shall withstand up to 250 psi of operating pressure.
 - 6. Options: Coating shall be applied to interior and exterior with an NSF/ANSI 61 approved fusion bonded epoxy coating.

B. CHECK VALVES FOR RAW SEWAGE PUMPING APPLICATIONS (NOT USED)

7. Supply rubber flapper type check valve for raw sewage applications. Check valve shall be Swing-Flex by Val Matic, APCO CRF series, or equal.
8. Standards and Approvals: Valves shall be designed, manufactured, tested and certified to ANSI/AWWA C508 standard.
9. Connections shall be flanges with drilling to ANSI B16.1, Class 125.
10. Materials: The valve body and cover shall be constructed of ASTM A536 Grade 65-45-12 ductile iron or ASTM A126 Class B Gray Iron for 30" and larger valves.
11. Pressure rating: Valve shall withstand up to 250 psi of operating pressure.
12. Options: Coating shall be applied to interior and exterior with an NSF/ANSI 61 approved fusion bonded epoxy coating.

C. CHECK VALVE FOR DUCKBILL CHECK APPLICATIONS, WHERE SHOWN (NOT USED)

1. Supply duckbill check valve by Red Valve or Onyx to meet specific application requirements. In line or flanged valve types will be accepted.

D. CHECK VALVES FOR PROCESS AIR APPLICATIONS

1. Note: Blower supplier will supply check valve with each blower supplied, shipped loose (along with pressure relief valves) for installation by Contractor. No additional process air check valves required for Contractor supply.
2. Supply double disk type wafer body check valves for process air applications. Check valve shall be Dual-Disc Check Valve by Val Matic, Double Door Check Valve by APCO, Duo-Chek Style G or H by Crane or Equal.
3. Standards and Approvals: ASME pressure class 125.
4. Connections shall be wafer body, retained wafer or retainerless wafer.
5. Materials: The valve body shall be carbon steel (with factory applied coating).
6. Seal: EPDM.
7. Coating shall be applied to interior and exterior per Specification Section 099000.

PART 3 EXECUTION

3.1 INSTALLING EXPOSED VALVES

- A. Install check valves in the orientation shown in the drawings with provisions to allow for access as required.

END OF SECTION

SECTION 400711
MISCELLANEOUS PIPE FITTINGS AND ACCESSORIES

PART 1 GENERAL

1.1 DESCRIPTION

- A. This section includes materials and installation of miscellaneous piping specialties, such as chemical diffusers; chemical solution tubes; backflow preventers; and PVC calibration columns. Note that all materials referenced in this section are being supplied and installed under the separate sections referenced below.

1.2 RELATED WORK SPECIFIED ELSEWHERE

- A. Painting and Coating: 099000.
- B. Domestic Water Piping Specialties: 221119 (includes RPZ Backflow preventer)
- C. General Piping Requirements: 400500.
- D. Piping Schedule: 400501.
- E. Corporation Stops and Service Saddles: 402713.
- F. Pressure Testing of Piping: 400515.
- G. Liquid Chemical Feed Systems: 433300. (Includes chemical solution tubes; PVC calibration column; no chemical diffuser is required for this project)

1.3 SUBMITTALS

- A. Submit shop drawings in accordance with Section 013300. (Not applicable for this project)
- B. Submit manufacturer's catalog data and descriptive literature showing dimensions and materials of construction by ASTM reference and grade. Show coatings.
- C. Submit certification from manufacturer that fittings are NSF 61 listed.
- D. Provide additional O&M data per Section 017823.

1.4 WARRANTY

- A. Full warranty against defects in materials and workmanship for one year following FINAL ACCEPTANCE, including all parts, labor, and expenses.

PART 2 PRODUCTS

2.1 FLANGE INSULATION KITS (NOT USED)

- A. See Section 400500.

2.2 INSULATING UNIONS (NOT USED)

- A. See Section 400500.

2.3 CHEMICAL DIFFUSERS (NOT USED)

- A. Diffuser configuration shall provide multiple feed points along a cross section within the basin. Materials of construction shall be compatible with chemical solution and be capable of withstanding the working pressure of the system and the hydrostatic pressure of the basin. Manufacturer to design orifices in quantity and diameter to obtain optimum chemical transfer for the application.
- B. Connection to Diffuser: Connecting pipe shall be "hard" pipe compatible with chemical solution used and capable of withstanding the working pressure of the system. Connection of the connecting pipe to the chemical diffuser shall allow for disassembly.
- C. Provide means to support or anchor the diffuser in the basin for the diffuser orientations shown in the Drawings. Anchors and supports shall be compatible with the chemical solution used.
- D. Chemical diffuser shall be by SAF-T-Flow, Hydro Instruments, or equal.

2.4 LONG BODY BURIED PIPE COUPLINGS (NOT USED)

- A. Buried long body pipe couplers, as shown in the Contract Documents, shall be of the gasketed, sleeve-type design with a diameter to properly fit the pipe. Each coupling shall consist of one (1) steel middle ring, two (2) steel followers, two (2) rubber compound wedge section gaskets and sufficient track-head bolts to properly compress the gaskets. Buried long body couplers shall be Dresser- Model

40, or Engineer approved equivalent.

- B. The coupling gaskets shall be composed of a crude or synthetic rubber base compound with other products to produce a material that will not deteriorate from age, heat, or exposure to air under normal storage conditions. It shall also possess the quality of resilience and ability to resist cold flow of the material so that the joint will remain sealed and tight indefinitely when subjected to shock, vibration, pulsation, and temperature or other adjustments of the pipeline.

2.5 BACKFLOW PREVENTERS (SUPPLY RPZ BACKFLOW PREVENTER UNDER REQUIREMENTS OF SECTION 221119)

- A. Reduced Pressure Backflow Preventers, 2-Inch and Smaller
 - 1. The reduced pressure backflow preventer shall consist of two independently operating, spring loaded, "Y" pattern check valves and one hydraulically dependent differential relief valve. The device shall automatically reduce the pressure in the "zone" between the check valves to at least 5-psi lower than the inlet pressure. Should the differential between the upstream and the zone of the unit drop to 2-psi, the differential relief valve shall open and maintain the proper differential.
 - 2. Reduced pressure backflow preventer assemblies shall be Febco Model 825YA, or Engineer approved equivalent.
- B. Vertical Reduced Pressure Type Backflow Preventer, 2 1/2-inch and Larger
 - 1. The reduced pressure backflow preventer shall consist of two independently operating, spring loaded, "Y" pattern check valves and one hydraulically dependent differential relief valve. The device shall automatically reduce the pressure in the "zone" between the check valves to at least 5-psi lower than the inlet pressure. Should the differential between the upstream and the zone of the unit drop to 2-psi, the differential relief valve shall open and maintain the proper differential.
 - 2. Vertical backflow preventer shall be Febco Model 880V - N Shape, or Engineer approved equivalent.
- C. Reduced Pressure Backflow Preventer, 2 1/2-inch and Larger
 - 1. Reduced pressure backflow preventer assemblies shall consist of two independent "Y" configured check valves and one differential relief valve. By design, the assembly shall automatically reduce the pressure in the zone between the check valves by 5-psi. Should the differential between the zone and upstream pressure drop to 2-psi, the differential relief valve will open, maintaining proper zone differential.
 - 2. All internal metal parts included in the check assemblies shall be of Series 300 stainless steel, and shall not contain any dissimilar metals, Elastomeric seat discs on the checks and relief valve must be reversible and seat rings shall be B-61 bronze. The check assembly shall be center stem guided at the seat ring and at the cover by replaceable non-corrosive bushings. Relief valve spring is to be Series 300 stainless steel.
 - 3. Valve bodies and cover shall be manufactured of ductile iron ASTM A536, Grade 65-45-2, Ductile Iron bodies shall be flanged, ASME B16.1, Class 125.
 - 4. Reduced pressure backflow preventer assemblies shall include flange, full port resilient wedge shut-off valves and four ball valve test cocks, considered integral to the assembly. Assemblies must be factory assembled and backflow tested.
 - 5. The assembly shall be constructed so all internal parts, including seat rings, can be serviced from the top or side or removed while assembly is in line. The assembly shall be rated 175-psi working pressure.
 - 6. Provide a bronze air gap drain to catch atmospheric discharge from the device. The drain must be of such design as to allow mounting directly to the reduced pressure backflow preventer.
 - 7. The assembly shall meet or exceed requirements of ASSE Standard 1013, AWWA Standard C511, and the USC Foundation for Cross Connection Control and Hydraulic Research.
 - 8. Reduced pressure backflow preventer assemblies shall be Febco Model 825YD, or Engineer approved equivalent.

2.6 METALLIC QUICK-CONNECT COUPLINGS (NOT USED)

- A. **Type 1:** Quick-connect couplings larger than 1 inch shall be female coupler, ASME B16.1, Class 125, flange type with locking handles. Provide dust plug and security chain with each coupling. Bodies and locking handles shall be **Type 316 stainless steel**. Gasket shall be **Buna-N**. Couplings shall be Ever-Tite Model FLB, Parker-Hannifin Model 400-DL, or equal.
- B. **Type 2:** Quick-connect couplings shall be male adapter/ASME B16.1 Class 125 flange. Bodies shall be **Type 316 stainless steel**. Provide quick-connect plug or cap for each coupling. Couplings shall

be Ever-Tite Model FLA, CIVACON Model 633-LAS, or equal.

- C. **Type 3:** Quick-connectors 1 inch and smaller shall be Type 316 stainless steel, female body by male stem. Quick-connector shall have a ring of Type 316 stainless steel locking balls and Buna-N O-ring. Quick-connectors shall not have internal ball or poppet valve. Quick-connectors shall be Swagelok QF series, Aeroquip FD45 series, or equal.
- D. **Type 4:** Female couplers shall be 90-degree elbow type with internal spring check valve. Pressure of 0.75 psi shall open valve for full flow. Provide dust plug and security chain with each coupler. Bodies shall be Type 316 stainless steel. Gasket shall be Buna-N. Couplers shall be CIVACON 633-G, Evertite, Parker Fluid Connector, or equal.

2.7 "Y" STRAINERS (NOT USED)

- A. "Y" Strainers (2-Inch and Smaller Diameter)
 - 1. "Y" strainers shall be either bronze body or PVC body. Body type shall be bronze if adjacent pipe material is copper tube or galvanized steel. Body type shall be PVC if adjacent pipe material is PVC.
 - 2. Strainer size shall match size of adjacent piping or shall be as shown on the Drawings.
 - 3. The strainer shall contain a removable cap to allow the filter screen to be removed without removing the strainer from the pipeline. The filter screen shall be Type 316 stainless steel or PVC with 1/32-inch or 20 mesh openings.
 - 4. Minimum working pressure of strainers shall be 150-psi.
 - 5. Strainers shall have threaded end connections.
 - 6. Provide one spare screen with each "Y"-strainer. Pack screens in a box with manufacturer's name, address, and telephone number.
- B. "Y" Strainers (Greater than 2-Inch Diameter)
 - 1. "Y" strainers shall be stainless steel body.
 - 2. The strainer shall contain a removable cap to allow the filter screen to be removed without removing the strainer from the pipeline. The filter screen shall be Type 316 stainless steel with 80 mesh openings.
 - 3. Minimum working pressure of strainers shall be 150-psi.
 - 4. Strainers shall have flanged end connections, or as indicated on the Drawings.
 - 5. Provide one spare screen with each "Y" strainer. Pack screens in a box with manufacturer's name and local representative's name, address, and telephone number.
 - 6. Strainers shall be by Eaton Corporation, or Engineer approved equivalent.

2.8 CAST-IRON WYE STRAINERS 4 THROUGH 10 INCHES (NOT USED)

- A. Strainers 4 inches through 10 inches shall have cast-iron body and cover (ASTM A126, Class B), with minimum pressure rating of 175 psi, wye pattern. Screen shall be stainless steel (ASTM A240 or A666, Type 304), with a perforated screen area that is minimum three times the area of the pipe to which the strainer is attached.
- B. Provide a blowoff connection with isolation ball valve and plug or cap on strainer cover.
- C. Ends shall be flanged, conforming to ASME B16.1, Class 125; flanges shall be flatfaced.
- D. The strainer, except for stainless steel parts, shall be fusion-bonded epoxy lined and coated per Section 099761.
- E. Strainers shall be Watts Regulator 77F Series, Mueller Steam Specialty Model 758, Red-White Valve Corp., or equal.
- F. Calibration cylinder and fittings shall be made of inert clear PVC pipe conforming to ASTM D1785, Schedule 80 and equipped with flanged connection to pump manifold and end cap fitted with vacuum breaker and ball valve for air venting. Calibration cylinders shall have calibration marks with at least 12 inches (305 mm) of clear observable length permanently marked in gallons and liters and fractions thereof, to allow reading of the fluid contents with an accuracy of 1 percent. Provide at least 10 calibration lines, with a minimum of one line every 100-ml.

PART 3 EXECUTION

3.1 INSTALLATION OF SERVICE SADDLES (NOT USED)

- A. Install service saddles and long body couplings with the gasket seated on the pipe so that zero leakage is obtained. Tighten bolts to the torque requirements recommended by the manufacturer.

3.2 PAINTING AND COATING OF SERVICE SADDLES (NOT USED)

- A. Coat service saddles located above ground or in vaults and structures the same as the piping to which they are attached. Color of finish coat shall match the color of the pipe to which the service saddle is connected. Do not coat stainless steel strap.
- B. Coat buried saddles and corporation stops with three (3) wraps of AWWA C209 tape.

3.3 BACKFLOW INSTALLATION (SEE REQUIREMENTS OF 221119)

- A. Install backflow assemblies at the locations shown on the drawings, and per the manufacturer's recommendations.
- B. Provide Schedule 80 PVC piping from air gap drain outlet on RPBP devices to six (6) inches above floor.
- C. Coordinate location of RPBP devices with other trades so that water discharge will not damage nearby equipment.

3.4 LINING AND COATING BACKFLOW PREVENTERS (SEE REQUIREMENTS OF 221119)

- A. Coat backflow preventers located above ground or in vaults and structures per Section 099000, System 29. Apply the specified prime coat at the place of manufacture. Apply intermediate and finish coats at the place of manufacture or at the jobsite. Finish coat shall match the color of the adjacent piping. Coat handwheels the same as the valves. Do not coat bronze or brass valves. Line the interior metal parts of metal valves, excluding seating areas and bronze and stainless steel pieces, per Section 099000. Apply lining at the place of manufacture. Alternately, apply a fusion-bonded coating suitable for potable water in compliance with AWWA C550.
-

3.5 INSTALLING QUICK-CONNECT COUPLINGS (NOT USED)

- A. Attach to piping per the relevant piping specification.

3.6 INSTALLING CALIBRATION COLUMNS (SEE REQUIREMENTS OF 433300)

- A. Connect calibration columns to the piping by means of a tee connection.

END OF SECTION

SECTION 400722

FLEXIBLE PIPE COUPLINGS AND EXPANSION JOINTS

PART 1 GENERAL

1.1 DESCRIPTION

- A. This section includes materials and installation of:
 - 1. flexible gasketed sleeve-type compression pipe couplings for steel; and ductile-iron pipe
 - 2. thermal expansion compensators and expansion joints 4 inches in diameter and smaller for steel, PVC; CPVC; and copper pipe.
 - 3. flexible expansion joints; expansion loops; or restrained flange adapters and couplings for connecting different pipe materials.

1.2 RELATED WORK SPECIFIED ELSEWHERE

- A. Painting and Coating: 099000.
- B. General Piping Requirements: 400500.
- C. Piping Schedule: 400501.
- D. Pressure Testing of Piping: 400515.
- E. Wall Pipes, Seep Rings, and Penetrations: 400762.
- F. Pipe Hangers and Supports: 400764.

1.3 SUBMITTALS

- A. Submit shop drawings in accordance with Section 013300
- B. Submit manufacturer's catalog data on flexible pipe couplings, thermal expansion compensators; restrained flange adapters; expansion loops; and expansion joints. Show manufacturer's model or figure number for each type of coupling or joint for each type of pipe material for which couplings and joints are used. Show coatings.
- C. Submit manufacturer's recommended torques to which the coupling bolts shall be tightened for the flexible gasketed sleeve-type compression pipe couplings.
- D. Show materials of construction by ASTM reference and grade. Show dimensions.
- E. Show number, size, and material of construction of tie rods and lugs for each thrust harness on the project.

1.4 WARRANTY

- A. Full warranty against defects in materials and workmanship for one year after FINAL ACCEPTANCE, including all parts, labor, and expenses.

PART 2 PRODUCTS

2.1 COUPLING SYSTEM DESIGN AND COMPONENT UNIT RESPONSIBILITY

- A. The coupling manufacturer shall furnish the gaskets, bolts, nuts, glands, end rings, and hardware for pipe couplings of all types and shall design these components as an integral system. Design the gaskets for the coupling and appropriately size to provide a watertight seal at the design pressure and temperature. Ship gaskets, bolts, nuts, glands, end rings, and hardware for pipe couplings with the pipe coupling and clearly label indicating the origin of the material, including place and date of manufacture. Package the manufacturer's printed installation instructions with each pipe coupling.

2.2 STEEL FLEXIBLE PIPE COUPLINGS

- A. Steel couplings shall have center sleeves and end rings made of carbon; Steel couplings shall have center sleeves and end rings made of Type 304 stainless; or Steel couplings shall have center sleeves and end rings made of Type 316 stainless steel conforming to AWWA C219, Section 4. Minimum center sleeve length shall be 5 inches for pipe sizes 3/4 inch through 4-1/2 inches, 7 inches for pipe sizes 5 inches through 24 inches, and 10 inches for pipe sizes larger than 24 inches.
- B. Sleeve bolts in exposed service shall be carbon, Type 304 stainless; or Type 316 stainless steel per AWWA C219, Section 4. Sleeve bolts in buried or submerged service shall be Type 304 stainless; or Type 316 stainless steel per AWWA C219, Section 4.
- C. Steel end rings shall be cast, forged, or hot rolled in one piece. Do not use rings fabricated from two or

more shapes.

- D. Wall thickness of sleeve shall be at least that specified for the size of pipe in which the coupling is to be used.

2.3 DUCTILE-IRON FLEXIBLE PIPE COUPLINGS

- A. Couplings shall have center sleeves and end rings made of ductile iron conforming to AWWA C219, Section 4.
- B. Sleeve bolts in exposed service shall be carbon; Type 304 stainless; or Type 316 stainless steel per AWWA C219, Section 4. Sleeve bolts in buried or submerged service shall be Type 304 stainless or Type 316 stainless steel per AWWA C219, Section 4.

2.4 JOINT HARNESESSES

- A. Tie bolts or studs shall be as shown in the following table. Bolt or stud material shall conform to ASTM A193, Grade B7. Nuts shall conform to ASTM A194, Grade 2H. Lug material shall conform to ASTM A36, ASTM A283, Grade B, C, or D, or ASTM A285, Grade C. Lug dimensions for steel pipe shall be as shown in AWWA Manual M11 (2004 edition), Figure 13-20, using the number and size of lugs as tabulated below.
- B. Lugs for steel pipe shall be Type P for pipes 6 through 10 inches and Type RR for pipes 12 inches and larger.; or Lug or ear dimensions for ductile-iron pipe shall be as shown in the drawings.
- C. Manufactured lugs shall incorporate a three-hole design that utilizes two flange bolts to hold each lug in place for each tie-rod. Lug shall be A36 steel or 316 stainless steel. Manufactured lugs shall be Romac Series 490, or equal.
- D. Select number and size of bolts based on the test pressure shown in Section 4005010. Stagger bolts equally around pipe circumference. Where odd number is tabulated, place odd bolt at top. For test pressures less than or equal to 150 psi, use the 150-psi design in the table above. For test pressures between 150 and 300 psi, use the 300-psi design in the table above.
- E. Provide washer for each nut. Washer material shall be the same as the nuts. Minimum washer thickness shall be 1/8 inch.

2.5 FLEXIBLE PIPE COUPLINGS FOR PLAIN-END STEEL PIPE

- A. Couplings shall be steel, Dresser Style 38, Smith-Blair Type 411, Baker Series 200, or equal.

2.6 FLEXIBLE PIPE COUPLINGS FOR PLAIN-END DUCTILE-IRON PIPE

- A. Couplings for pipe 12 inches and smaller shall be cast iron, Dresser Style 253 or 253 long sleeve, Smith-Blair Type 441, Baker Series 228, or equal.
- B. Couplings for pipe larger than 12 inches shall be cast iron or steel, Dresser Style 38 or 153, Smith-Blair Style 411, Baker Series 228, or equal.

2.7 TRANSITION COUPLINGS

- A. Couplings for connecting different pipes having different outside diameters shall be steel: Dresser Style 62 or 162, Smith-Blair Series 413, Baker Series 212 or 220, or equal.
- B. Couplings shall have an internal full circumference ring pipe stop at the midpoint of the coupling. Inside diameter of coupling pipe stop shall equal inside diameter of smaller diameter pipe.

2.8 FLANGED COUPLING ADAPTERS FOR STEEL PIPE

- A. Adapters for steel pipe shall be steel: Dresser Style 128, Smith-Blair Type 913, or equal. Flange ends shall match the flange of the connecting pipe; see detail piping specifications.

2.9 FLANGED COUPLING ADAPTERS FOR CAST- AND DUCTILE-IRON PIPE

- A. Adapters for cast- and ductile-iron pipe 12 inches and smaller shall be cast iron: Dresser Style 127, Smith-Blair Series 912, or equal.
- B. Adapters for cast- and ductile-iron pipe larger than 12 inches shall be steel: Dresser Style 128, Smith-Blair Type 913, or equal.
- C. Flange ends shall match the flange of the connecting pipe.

2.10 RESTRAINED FLANGE ADAPTER FOR DUCTILE IRON PIPE

- A. Restrained flange adapter shall be made of ductile iron conforming to ASTM A536.
- B. Flange bolt circle of the adapter shall be compatible with Class 125 flanges per AWWA C115.

FLEXIBLE PIPE COUPLINGS AND EXPANSION JOINTS

- C. Restraint for the flange adapter shall consist of a plurality of individually actuated gripping wedges.
- D. Restrained flange adapter shall be Series 2100 Megaflange as produced by EBAA Iron, Inc., or approved equal.
- E. Restrained flange adapters shall only be used specifically where shown on the Contract Documents or with written approval from the Engineer for additional locations.

2.11 DISMANTLING JOINTS

- A. The dismantling joint shall consist of a flanged steel spigot piece, a flanged sleeve, a center ring welded onto the sleeve, and a follower ring containing a gasket through which the spigot piece slides into the sleeve. The joint shall accommodate up to 2 inches of longitudinal movement. The longitudinal adjustability shall be provided by a telescopic action of a flanged spigot and associated sleeve, which inserts into the spigot. A system of tie bolts or rods shall connect the center ring of the sleeve or the end flange on the sleeve to the end flange on the spigot piece. Provide washers and nuts on the tie bolts on both sides of the center ring or sleeve and flange and the spigot end flange to allow for adjustment of the extension length for the sleeve.
- B. The minimum design pressure shall be the same as the adjacent piping. Design stresses shall not exceed 40% of the yield strength of the materials. Minimum factory test pressure shall be 150% of the design pressure.
- C. The gasket shall be compressed by a separate bolting and gland system, independent of the tie bolts. Gasket shall be isoprene, Buna-N or EPDM.
- D. Fabrication, assembly, and erection shall comply with Section 400513.
- E. Dismantling joints shall have a spigot piece made of steel conforming to ASTM A36, A53 (Type E or S), or A283, Grade C having a minimum yield strength of 30,000 psi and a flange adapter and follower ring made of ductile iron conforming to ASTM A536, Grade 65-45-12.
- F. Sleeve and follower ring bolts shall have a minimum yield strength of 105,000 psi, a minimum tensile strength of 125,000 psi, and shall conform to ASTM A193, Grade B7.
- G. Steel flanges [, center ring,] and gasket follower rings shall be cast, forged, or hot rolled in one piece. Do not use flanges or rings fabricated from two or more shapes. Flanges shall conform to ANSI Classes 125 and 150.
- H. Wall thickness of spigot piece and sleeve shall be at least that specified for the size of pipe in which the coupling is to be used.
- I. Flanges: See Section 40051300.
- J. Manufacturers: Romac Industries Style DJ400 or equal.

2.12 SEGMENTED RESTRAINED SLEEVE COUPLINGS AND FLANGED ADAPTER COUPLINGS FOR CARBON AND STAINLESS STEEL PIPE

- A. The coupling shall be of the split or segmented sleeve type with a double arch cross-section, which closes around plain steel pipe ends. The design pressure and wall thickness of the body shall be at least that specified for the size of pipe on which the coupling is to be used. Provide welded steel restraint rings on the pipe ends for end restraint. As the coupling closes, it shall confine an elastomeric

gasket on each pipe end to create a radial seal. The axial seal shall be affected at the closure plates as bolts pull the coupling snug round the pipe. Provide shoulders on each end of the couplings. Flanged adapter couplings shall incorporate a flange on one end (instead of an end ring and shoulder) to match the flange on the connecting pipe or valve. Products: Victaulic "Depend-O-Lok" Model F x F Type 2 for sleeve couplings or Victaulic "Depend-O-Lok" Model F x F flanged adapter coupling for flanged adapter couplings.

- B. Carbon steel piping includes steel pipe lined with cement mortar, polyurethane or epoxy.
- C. Body, flange, and closure plates for couplings used with carbon steel pipe in exposed service shall be carbon steel per ASTM A36, Type 304 or 304L stainless steel per ASTM A240 or A 666; or Type 316 or 316L stainless steel per ASTM A240 or A666.
- D. Body, flange, and closure plates for couplings used with carbon steel pipe in buried service shall be. Type 304 or 304L stainless steel per ASTM A240 or A666; or Type 316 or 316L stainless steel per ASTM A240 or A666.
- E. End restraint rings for couplings used with carbon steel pipe shall be carbon steel per ASTM A108, Grade 1020; Type 304 or 304L stainless steel per ASTM A276; or Type 316 or 316L stainless steel per ASTM A276. Provide end restraint rings on each of the connecting pipes. The end rings shall be welded to the pipe ends using a welding procedure complying with the ASME Pressure Vessel Code, Section IX. Weld the end restraint rings to the pipe before applying the lining and coating (if any is specified) to the pipe. The welded end restraint rings shall have at least the pressure rating of the pipe to which the coupling is attached.
- F. Fasteners for couplings used with carbon steel pipe in exposed service shall be Type 304 stainless steel per ASTM A276, F593, or F738 with stainless steel nuts per ASTM F594 or F836; carbon steel per ASTM A325, with carbon steel nuts and washers per ASTM A563; or Type 316 stainless steel per ASTM A276, F593, or F738 with stainless steel nuts per ASTM F594 or F836
- G. Fasteners for couplings used with carbon steel pipe in buried service shall be Type 304 stainless steel per ASTM A276, F593, or F738 with stainless steel nuts per ASTM F594 or F836; or Type 316 stainless steel per ASTM A276, F593, or F738 with stainless steel nuts per ASTM F594 or F836.
- H. Coupling body, flange, and closure plates for couplings used with stainless steel pipe shall be Type 304 or 304L stainless steel per ASTM A240 or A666; or Type 316 or 316L stainless steel per ASTM A240 or A666.
- I. End restraint rings for couplings used with stainless steel pipe shall be Type 304 or 304L stainless steel per ASTM A276; or Type 316 or 316L stainless steel per ASTM A276. Provide end restraint rings on each of the connecting pipes. The end rings shall be welded to the pipe ends using a welding procedure complying with the ASME Pressure Vessel Code, Section IX. The welded end restraint rings shall have at least the pressure rating of the pipe to which the coupling is attached.
- J. Fasteners for couplings used with stainless steel pipe shall be Type 304 stainless steel per ASTM A276, F593, or F738 with stainless steel nuts per ASTM F594 or F836; or Type 316 stainless steel per ASTM A276, F593, or F738 with stainless steel nuts per ASTM F594 or F836.
- K. Gaskets shall be isoprene, Buna-N; or EPDM conforming to ASTM D2000 for water and sewage service and having a temperature range of -20°F to +180°F.
- L. Provide joint sealant between the pipe ends for piping 24 inches and larger after the sleeve coupling is installed: Sikaflex 2C with Sikaflex 429 primer.

2.13 TYPE 1 EXPANSION JOINTS: FOR COPPER PIPE

- A. Expansion joints for copper pipe shall be all bronze: Metraflex Model HPMF expansion compensator, Hyspan Model 8509 or 8510 expansion compensator, or equal. Expansion compensators shall have antitorque devices to protect the bellows. Minimum working pressure shall be 175 psig.

2.14 TYPE 2 EXPANSION JOINTS: FOR STEEL PIPE 4 INCHES AND SMALLER

- A. Expansion joints for steel pipe 4 inches and smaller shall be carbon steel: Hyspan Model 8503 or 8504 expansion compensators, Metraflex Model HP expansion compensator, or equal. Expansion compensators shall have antitorque devices to protect the bellows. Minimum working pressure shall be 150 psi.

2.15 TYPE 3 EXPANSION JOINTS: TEFLON BELLOWS TYPE

- A. Expansion joints shall be Teflon bellows type having three convolutions, ductile-iron flanges, Monel reinforcing ring, and a Teflon facing on the flanges. Minimum working pressure shall be 110 psi. Provide thrust harnesses. Flanges shall be Class 125, ASME B16.1. Products: Peabody-Dore Style E-1608-B, Resistoflex No. R6905, or equal.

2.16 TYPE 4 EXPANSION JOINTS: SPHERICAL EXPANSION JOINTS

- A. Spherical design expansion joints shall be chlorobutyl with polyester fiber reinforcing and be provided with steel retaining rings and Type 304 stainless steel gusset plates and control rods. Expansion joints shall have flat-face flanges integral with the body to match 125/150-pound flanges. Expansion joints for hot water service shall be rated at a minimum of 150 psig at 212°F.

Joint Size	Flange to Flange Length (inches)	Minimum Pressure Rating (150°) (psi)
4-8	6	225
10-12	8	225
14-20	10-12	125

- B. Expansion joints shall be manufactured by Metraflex Metrasphere, Proco Series 240, or equal.

2.17 TYPE 5 EXPANSION JOINTS: SINGLE; DOUBLE; OR TRIPLE ARCH RUBBER TYPE (24 INCHES AND SMALLER)

- A. Expansion joints shall be rubber, single; double; or triple arch type, with integral flat-face ANSI Class 125/150 flanges.
 1. Cover Elastomer: Butyl; Neoprene; or Chlorobutyl.
 2. Tube Elastomer: Butyl; Neoprene; Chlorobutyl; Teflon®; Hypalon®; or Nitrile.
 3. Arch Type: Open or Filled.
 4. Fluid: Potable water; Raw water; Raw sewage; or sludge.
 5. Fluid Temperature Range: 40°F to 105°F.
 6. Ambient Temperature Range: 30° F to 120°F.
- B. Minimum working pressure shall be 150 psi for joints 12 inches and smaller, 120 psi for 14- and 16-inch joints, 110 psi for 18- and 20-inch joints, and 100 psi for 24-inch joints. Provide steel thrust plates, retaining rings, and control rods. Products: Proco Style 220, General Rubber Style 1075, or equal.

2.18 TYPE 6 EXPANSION JOINTS: FLEXIBLE EXPANSION JOINTS

- A. Each flexible expansion joint shall consist of two ball joints and two or three expansion sleeves. Each expansion sleeve shall allow an expansion capability of at least 4 inches. Material of construction shall be ductile iron conforming to the material requirements of AWWA C153. Minimum deflection shall be 15 degrees in both vertical and horizontal planes. Minimum pressure rating of the flexible coupling joint assembly shall be 350 psi. Provide stop collars on the sleeves to restrain the lateral travel. Provide synthetic rubber gaskets in sleeves and balls. Ends of assembly shall be flanged or mechanical joint to match the connecting piping.
- B. Coat exposed, buried and submerged assemblies per Section 099000. Color of finish coat shall match the connecting piping or be the same as the connecting piping.
- C. Flexible expansion joints shall be EBAA Iron, Inc., "Flex-Tend"; Romac Industries "FlexiJoint"; or equal.

2.19 TYPE 7: ELASTOMERIC COUPLING

- A. Provide elastomeric couplings suitable for the pipe types and sizes to be connected. Elastomeric coupling shall consist of an elastomeric plastic sleeve and Type 304 or 305 stainless steel pipe clamps. Provide a minimum of two clamps for pipes up to 15 inches in outer diameter. Provide a minimum of four clamps on a sleeve 10 inches long for pipes larger in diameter than 15 inches.

2.20 TYPE 8 COUPLINGS: FOR CONNECTING VITRIFIED CLAY PIPE TO PLASTIC OR DUCTILE-IRON PIPE

- A. Couplings shall consist of a styrene butadiene (SBR) or neoprene rubber body with stainless steel bands, housings, and clamps. The clamping device for couplings 10 inches and larger shall be cold-rolled steel or stainless steel. Products: Calder Couplings for pipes 3 through 8 inches and

Ceramicweld Coupling for pipes 10 through 42 inches.

2.21 TYPE 9: EXPANSION LOOPS FOR COMPRESSED AIR PIPING

- A. Expansion loops shall consist of two flexible sections of Type 300 stainless steel hose and braid, two 90-degree elbows, and one 180-degree return with drain valve. Fittings shall be Schedule 40 carbon steel with male NPT connections. Expansion loops shall provide a minimum of 1-1/2 inches of axial movement in all directions and shall have a minimum pressure rating of 455 psi at 70°F. Install pipe guides within four pipe diameters of each side of the loop, as recommended by the expansion loop supplier. Manufacturers: Flexicraft, Metraflex, or equal.

2.22 TYPE 10: FLEXIBLE HOSE CONNECTORS 3 INCHES AND SMALLER

- A. Flexible hose connectors 3 inches and smaller shall be of the corrugated metal hose type with an external braid. Connectors shall have a minimum pressure rating of 300 psi at a temperature of 150°F. Corrugation tubing material shall be Type 316 stainless steel with Type 316 or 321 stainless steel braid material. End connections shall be ground joint female union with ANSI/ASME B1.20.1 NPT threads; Class 150 flat-faced flanges. Length shall be 12-24 inches unless otherwise indicated. Flexible connectors shall be American BOA, Flexonics, Metraflex, or equal.

2.23 TYPE 11: FLEXIBLE ELASTOMERIC INTERNAL JOINT

- A. Rubber Joint Liner: EPDM.
- B. Bands, Shims, and Setscrews:
 - 1. Stainless steel bands, spacers, shims, and setscrews for securing rubber membrane across piping joints shall be Type 316 per ASTM A240.
 - 2. Welding: Perform welding with coated electrode 316L, AWS Class A5.4, AC-DC-16, with tensile strength of 70,000 psi.
- C. Liquid Joint Lubrication:
 - 1. Liquid joint lubricant to assist in installation of the rubber joint seal and bands shall be a nontoxic vegetable-based lubricating gel.
 - 2. Required Properties:
 - a. Shall not deteriorate or decompose while in storage for a minimum of two years.
 - b. Shall have a soft pasty consistency suitable for use intended from 0°F to 120°F.
 - c. Shall not have any deteriorating effect on natural or synthetic rubber gaskets.
 - d. Shall not impart taste or odor to water.
 - e. Shall have no objectionable odor.
 - f. Shall be nontoxic and does not support the growth of bacteria.
 - g. pH: 9.6 minimum and 11 maximum (pH meter).
 - h. Method of Test: ASTM D562.
 - i. Shall not contain any petroleum-based oils or grease.
 - j. Shall not contain any materials considered toxic.
- D. Filling Materials for Gaps Between Joints: The filling material shall be an injected elastomeric joint filler.
- E. Epoxy:
 - 1. Coating Appearance: Smooth, white, thixotropic liquid.
 - 2. Gel Appearance: Smooth, white mastic of stiff consistency.
 - 3. Service Temperature Range: 50°F to 200°F.
- F. Thread Sealing Compound:
 - 1. Thread sealing compound shall be a nontoxic paste type with Teflon.
 - 2. Teflon Components Required Properties--Physical Data:
 - a. Flash Point: 410°F closed cup.
 - b. Specific Gravity: 1.4 to 1.42.
 - c. Viscosity: 200,000 to 275,000 centipoises.
 - d. Temperature Range: -50°F to 500°F.
 - e. Pressure Application: Maximum 10,000 psi.
- G. Products: EPDM rubber material shall be AMEX-10/WEKO-SEAL from Miller Pipeline Corporation, telephone 317-293-0278; HY-FLEX from Lineal Industries, telephone 1-877-787-9461; or equal.

Description	Method	Result
Flexural strength	ASTM D790	6,000 psi
Flexural modulus	ASTM D790	550,000 psi
Compressive strength, yield	ASTM D695	4,275 psi
Tensile strength	ASTM D638	3,700 psi
Tensile ultimate elongation	ASTM D638	1.4%
Hardness, Shore D	ASTM D2583	85
Hardness, Pencil	ASTM D3363	6H
Impact, IZOD	ASTM D256	0.19 ft-lb/inch of notch
Temperature resistance	Steel, unprimed	250°F
Temperature resistance	Concrete	250°F
Solids content	-----	100%
Solvents present	-----	None

2.24 TYPE 12 EXPANSION JOINTS: METAL BELLOWS PUMP CONNECTION JOINTS 1-1/2 THROUGH 24 INCHES

- A. Provide multiple bellows, annular, flanged expansion joint constructed from single or multiple metal laminations. Provide flow liner. Provide thrust restraining rod system. Minimum pressure rating shall be 275 psi at a temperature of 200°F. Flanges shall be Class 150 per ASME B16.5. Provide fixed, flat-face flanges. Materials of construction shall be as follows:

Item	Material	Specification
Bellows or flow liner>>	Stainless steel	ASTM A240 or A666, Type 304 or 321
Flanges	Steel	ASTM A285, Grade C

- B. Products: Hyspan Model 5501 R or Keflex Type 151-TR or equal.

2.25 PIPE ALIGNMENT GUIDES FOR EXPANSION JOINTS AND EXPANSION COMPENSATORS (TYPES 1, 2, AND 3)

- A. For copper pipes, use Hyspan Series 9500 Copper Tube Alignment Guides, Metraflex Style I, B-Line, Anvil International, or equal.
- B. For bellows-type expansion joints and expansion loops in steel, PVC, and CPVC pipe, use Hyspan Series 9500 Pipe Alignment Guide, Metraflex Style I, B-Line, Anvil International, or equal.

2.26 BOLTS AND NUTS FOR FLANGES

- A. See Section 400500.

2.27 THREADED CAPS FOR PROTECTION OF NUTS AND BOLT THREADS

- A. See Section 400500.

PART 3 EXECUTION

3.1 INSTALLATION OF FLEXIBLE PIPE COUPLINGS, SEGMENTED SLEEVE COUPLINGS, AND EXPANSION JOINTS

- A. Clean oil, scale, rust, and dirt from pipe ends. Clean gaskets in flexible pipe couplings before installing.
- B. Install expansion joints per manufacturer's recommendations, so that 50% of total travel is available for expansion and 50% is available for contraction.
- C. Lubricate bolt threads with graphite and oil prior to installation.
- D. Install threaded nut and bolt thread protection caps after completing the bolt, nut, and gasket installation. Install on exposed; buried; and submerged flexible pipe couplings, transition couplings, flanged coupling adapters, dismantling joints, and segmented restrained sleeve couplings.

3.2 INSTALLATION OF TYPE 11 FLEXIBLE ELASTOMERIC INTERNAL JOINT

- A. Store the membranes in a cool, dry environment away from direct sunlight. Do not remove the rubber joint seals from the plastic bags prior to use. Store seals in a cool, dry environment and do not remove from their plastic bags until required for use. Do not allow them to remain in direct sunlight.
- B. Surface Preparation of Joint Area: Prepare the area of pipe either side of the joint where the actual lip seals make contact with the pipe to a finish that will allow the lip seals to bed consistently and so provide a permanent seal.
- C. Surface Lubrication: Immediately prior to fitting the seal, clean the area with a dry brush and coat with lubricant that is a nontoxic vegetable soap compatible with the composition of the flexible joint seal. Apply the lubricant using a paintbrush over the ground area. Do not pick up dust deposits from the unground surface into the lubricant and therefore onto the ground surface.
- D. Positioning the Seal: Prior to placing the seal, coat the area of pipe which will be covered with the seal with an epoxy coating and allow to partially set up prior to seal installation. Check the seal for damage. Check that the test unit is tight before fitting the seal in place. Place the flexible joint seal in position bridging the joint gap, guided by the marks. Position the seal accurately on the ground areas. The test unit in the seal should be located at either 9 o'clock or 3 o'clock position. Position the seal parallel to the joint gap.
- E. Positioning Retaining Bands: Place two stainless steel radiused shims, 6 inches long and 3/64-inch-thick, underneath the wedge area in the grooves, to provide a bridge that will transmit the radial load evenly to the flexible joint seal, as the bands are expanded. Then place the stainless steel bands in the grooves provided in the seal. Temporarily lock both bands in position.
- F. Expanding the Seal into Position: Use the hydraulic expanding device to apply a set pressure to the retaining bands of the flexible joint seal.
 - 1. When positioning the expander in line with the retaining band, ensure that the band remains in the groove of the flexible joint seal and does not become moved or dislodged. Ensure the expander is positioned correctly on the band.
 - 2. The expander is expanded which radially transmits a load against the retaining band and flexible joint seal. Hold this pressure for at least two minutes. The range of pressure registered on the expander shall be 4,000 psi minimum and 5,000 psi maximum.
 - 3. A space is provided at bottom dead center position of the expander that exposes the grooved-end cleats of the retaining band. Fit a radiused locking wedge piece between the exposed gap of the expanded band ends. Select a size of wedge having a slight interference fit between the band ends, and tap the wedge (leading edge first) into position, locking in the compression of the flexible joint seal. The radius of the wedge shall equal the radius of the pipe.
 - 4. Release the hydraulic pressure from the expander and repeat the procedure on the second retaining band of the seal.
 - 5. Repeat this entire operation (i.e., re-expanded) not before 30 minutes have elapsed after the first expansion. This allows for any seal relaxation that may take place and usually a slightly larger wedge can be fitted. The load forces transmitted by the expander have been determined from test data and should not be altered by changing the pressure used to activate the expander.
- G. Testing the Seal, Test 1: Apply two individual pressure tests to the seal before closing the pipeline. Apply the first test after each section has been completed and not before 30 minutes have elapsed after the final fitting of the seal. Apply a pressure of 10 psig. Because of the excessive ballooning to the center membrane of the seal (that will occur at this higher pressure), lock a restraining device called a "test band" in its expanding position during testing. If the pressure test indicates leakage, determine the cause and repeat from Step E.
- H. Testing the Seal, Test 2: In the second test, introduce 5 psig through the valve in the flexible joint seal. Sustain this pressure while applying a soap and water test to the outer edge and entire body of the seal. Inspect for leakage. If pressure test indicates leakage, determine the cause and repeat from Step E.
- I. Testing Valve Assembly: After the final test of 5 psig, seal the test valve of the flexible joint seal with a countersunk hex head completion plug using a nontoxic thread-sealing compound on the threads. Remove installation hardware, test band, and pressure gauges from the pipe.

3.3 PAINTING AND COATING

- A. Coat buried flexible pipe couplings (including joint harness assemblies), transition couplings,

segmented sleeve couplings, and flanged coupling adapters per Section 099000. Coat buried bolt threads, tie bolt threads, and nuts per Section 099000. Then wrap the buried couplings with polyethylene wrap.

- B. Coat flexible pipe couplings (including joint harness assemblies), transition couplings, segmented sleeve couplings, and flanged coupling adapters located indoors, in vaults and structures, and above ground with the same coating system as specified for the adjacent pipe. If the adjacent pipe is not coated, coat couplings per Section 099000. Apply prime coat at factory.
- C. Line carbon steel and iron flexible pipe couplings and segmented sleeve couplings per Section 099000.
- D. Alternatively, line and coat carbon steel and iron flexible pipe couplings and segmented sleeve couplings with fusion-bonded epoxy.
- E. Wrap Types 7 and 8 couplings with polyethylene.
- F. Coat couplings, expansion joints; expansion compensators; and alignment guides located above ground or in vaults and structures [with the same coating system as specified for the adjacent pipe. If the adjacent pipe is not coated, coat couplings per Section 099000. Color shall match the color of the connecting pipe.

3.4 HYDROSTATIC TESTING

- A. Hydrostatically test flexible pipe couplings, expansion joints, segmented sleeve couplings, and expansion compensators in place with the pipe being tested. Test in accordance with Section 400515.

3.5 PIPE HANGERS AND SUPPORTS FOR EXPANSION JOINTS AND EXPANSION COMPENSATORS (TYPES 1, 2, AND 3)

- A. At each expansion compensator or bellows-type expansion joint located on horizontal piping runs, provide a pipe alignment guide within four pipe diameters of each end of the expansion joint or compensator. Provide a second pipe alignment guide within 14 pipe diameters of each end of the expansion joint or compensator.
- B. Mount pipe alignment guides on wall brackets or steel channels as manufactured by Anvil International, B-Line, or equal.

END OF SECTION

THIS PAGE INTENTIONALLY LEFT BLANK.

SECTION 400762
WALL PIPES, SEEP RINGS, AND PENETRATIONS

PART 1 GENERAL

1.1 DESCRIPTION

- A. This section includes materials, installation, and testing of steel, cast-iron, and ductile-iron wall pipes and sleeves (including wall collars and seepage rings) and penetrations.

1.2 RELATED WORK SPECIFIED ELSEWHERE

- A. Painting and Coating: 099000.
- B. Precast Concrete Utility Structures: 330516.
- C. General Piping Requirements: 400500.

1.3 SUBMITTALS

- A. Submit shop drawings in accordance with Section 013300.
- B. Submit detail drawings for fabricated steel or cast-iron wall and floor pipes and sleeves, wall flanges, seep rings, and sealing materials. Show dimensions and wall thicknesses.
- C. Show flange sizes and the appropriate ANSI or AWWA flange dimensional standard where flanged end wall pipes or penetrations are used.
- D. Show grooved-end dimensions and AWWA grooved-end dimensional standard where grooved-end wall pipes or penetrations are used.
- E. List coating systems to be applied, manufacturer, and dry thickness of coatings. Call out coatings where coatings are to be applied.
- F. List materials of construction, with ASTM material reference and grade.
- G. Submit manufacturer's instructions for installing rubber annular hydrostatic sealing devices.
- H. Submit six copies of the results of the leakage test for cast-iron sleeves having shrink-fit steel collars or collar halves bottomed in a groove and steel sleeves having welded steel collars.

1.4 WARRANTY

- A. Full warranty against defects in materials and workmanship for one year after FINAL ACCEPTANCE; including all parts, labor, and expenses.

PART 2 PRODUCTS

2.1 GENERAL

- A. Use cast-iron, ductile-iron, or fabricated steel wall sleeves when containing rubber annular hydrostatic sealing devices through which piping passes.
- B. Use only cast-iron or ductile-iron wall pipes when connecting to cast-iron and ductile-iron pipe. Use only fabricated steel or stainless steel wall pipes when connecting to steel or stainless steel pipe, respectively.
- C. Cast-iron flanges shall conform to ASME B16.1, Class 125 or 250, to match the flange on the connecting pipe.
- D. Steel flanges shall conform to AWWA C207, Class D. Class 300 steel flanges 48 inches and smaller shall conform to AWWA C207, Class F. Class 300 flanges larger than 48 inches shall conform to the dimensions of ASME B16.1 Class 250 flanges. Flanges shall be flat face. Flanges shall match the flange on the connecting pipe.
- E. See Section 400500 for flange bolts and gaskets.

2.2 CAST-IRON OR DUCTILE-IRON WALL PIPES AND SLEEVES

- A. Provide cast- or ductile-iron wall pipes with ends as shown in the drawings for connection to adjacent cast-iron and ductile-iron pipe or for containing pipes where they pass through concrete walls, ceilings, and floor slabs. Provide seepage ring on wall pipes and sleeves passing through concrete walls and slabs that are to be watertight. Locate collars such that the collar is at the center of the wall or floor slab, unless otherwise shown in the drawings.
- B. Wall pipes and sleeves shall be of the following types:
 - 1. Pipe or sleeve with integrally cast seep ring.

2. Pipe or sleeve with shrink-fit steel collar attached.
 3. Pipe or sleeve with steel collar halves bottomed in a groove provided in the pipe or sleeve.
 4. Pipe or sleeve with ductile iron collar welded continuously around pipe (360 degrees) on both sides of collar. Welding shall be done in pipe manufacturer's shop by a qualified welder.
- C. Minimum wall thickness for pipes and sleeves having integrally cast seep rings shall be as follows:
1. Pipe or Sleeve Size 3 inches: Minimum Wall Thickness 0.48 inches.
 2. Pipe or Sleeve Size 4 inches: Minimum Wall Thickness 0.52 inches.
 3. Pipe or Sleeve Size 6 inches: Minimum Wall Thickness 0.55 inches.
 4. Pipe or Sleeve Size 8 inches: Minimum Wall Thickness 0.60 inches.
 5. Pipe or Sleeve Size 10 inches: Minimum Wall Thickness 0.68 inches.
 6. Pipe or Sleeve Size 12 inches: Minimum Wall Thickness 0.75 inches.
 7. Pipe or Sleeve Size 14 inches: Minimum Wall Thickness 0.66 inches.
 8. Pipe or Sleeve Size 16 inches: Minimum Wall Thickness 0.70 inches.
 9. Pipe or Sleeve Size 18 inches: Minimum Wall Thickness 0.75 inches.
 10. Pipe or Sleeve Size 20 inches: Minimum Wall Thickness 0.80 inches.
 11. Pipe or Sleeve Size 24 inches: Minimum Wall Thickness 0.89 inches.
- D. Minimum wall thickness of pipes or sleeves having shrink-fit collars shall be special Class 52. Cut shrink-fit collars from a 1/4-inch-thick steel ring. Attach the collar to a cast-iron or ductile-iron pipe or sleeve by heating the steel collar and allowing it to shrink over the pipe at the necessary location. Provide an epoxy bond (Keysite 740 or 742 or Scotchkote 302) between the pipe and collar. Sandblast the area of the pipe to be epoxy coated per SSPC SP-10.
- E. Wall pipes or sleeves having steel collar halves bottomed in a groove shall be ductile iron Special Class 54 minimum unless otherwise shown. Wall flanges shall consist of 1/4-inch-thick steel seep ring halves for pipes through 24-inch and 3/8-inch-thick halves for pipe 30 inches and larger, bottomed in a groove provided on the pipe. The pipe groove shall be machine cut to a depth of 1/16 to 5/64 inch to provide a press fit for the seep ring. Seep ring halves shall be welded together after fit into groove but shall not be welded to pipe. Seep rings shall be sealed completely around the pipe with silicon sealant manufactured by Dow-Corning No. 790, General Electric Silpruf, or equal.
- F. The material used in cast- or ductile-iron wall flanges, wall sleeves, and wall penetrations shall conform to ASTM A395, A436, A536, A48 (Class 35), or A126 (Class B).
- G. Pressure test at least one of each size of cast-iron pipes or sleeves having shrink-fit steel collars or collar halves installed in a groove in the pipe at the place of fabrication to demonstrate watertightness of the seal between the collar and the sleeve. The test shall be at a pressure of 20 psig for four hours' duration and shall show zero leakage.

2.3 FABRICATED STEEL WALL PIPES AND SLEEVES

- A. Provide fabricated steel wall pipes and sleeves with ends as shown in the drawings for connection to adjacent steel pipes, or for containing pipes, where they pass through concrete walls. Provide seepage ring or wall flange on wall pipes and sleeves passing through concrete walls and slabs that are to be watertight. Wall thickness shall be the same as the pipe wall thickness when connecting to steel pipe. Minimum wall thickness for sleeves containing pipes shall be standard weight per ASME B36.10 for sleeves 72 inches and smaller and 1/2 inch for sleeves greater than 72 inches through 96 inches.
- B. Wall flanges shall be in the form of a steel wall collar welded to the steel sleeve or penetration. Cut welded wall collars from a 1/4-inch steel ring. Attach the collar to a steel wall pipe or sleeve with full circle, 3/16-inch fillet welds. Welding procedures shall be in accordance with ASME B31.3, Chapter V.
- C. Steel pipe used in fabricating wall sleeves containing pipes shall comply with ASTM A53 (Type E or S), Grade B; ASTM A135, Grade B; ASTM A139, Grade B; or API 5L or 5LX. Wall pipes connecting to steel pipe shall be of the same material as the connecting pipe. Wall collar material shall comply with ASTM A36, A105, A181, or A182.
- D. Stainless steel pipe used in fabricating wall pipes shall be of the same material as the connecting pipe. Wall collar material shall comply with ASTM A240.
- E. Pressure test at least one of each size of fabricated steel wall sleeve or penetration and collar assemblies at the place of fabrication to demonstrate watertightness of the seal between the collar and the sleeve. The test shall be at a pressure of 20 psig for four hours' duration and shall show zero leakage.

2.4 RUBBER ANNULAR HYDROSTATIC SEALING DEVICES

- A. Rubber annular hydrostatic sealing devices shall be of the modular mechanical type, utilizing

interlocking synthetic rubber links shaped to continuously fill the annular space between the pipe sleeve and the passing pipe. Assemble links to form a continuous rubber belt around the pipe, with a pressure plate under each bolthead and nut.

- B. Materials of construction shall be as follows:
 - 1. Pressure plate: Delrin plastic; carbon steel; Type 304 stainless steel; Type 316 stainless steel; or Reinforced nylon polymer.
 - 2. Bolts and nuts for links: Type 303 or 316 stainless steel; or Zinc phosphated carbon steel.
 - 3. Sealing element: EPDM or Nitrile rubber.
- C. The size of the wall sleeve needed to accommodate the passing pipe shall be as recommended by the rubber annular seal manufacturer.
- D. Provide centering blocks in 25 percent of the sealing elements on pipelines larger than 12 inches in diameter.
- E. The rubber annular hydrostatic sealing devices shall be Link Seal as manufactured by Thunderline Corporation; Innerlynx as manufactured by Advance Products & Systems, Inc.; or equal.

2.5 BOLTS, NUTS, AND GASKETS FOR FLANGED-END WALL PIPES

- A. See Section 400500.

2.6 POLYETHYLENE FOAM FILLER FOR PIPE PENETRATIONS

- A. Packing foam shall be an extruded closed-cell polyethylene foam rod, such as Minicel backer rod, manufactured by Industrial Systems Department, Plastic Products Group of Hercules, Inc., Middletown, Delaware; Ethafoam, as manufactured by Dow Chemical Company, Midland, Michigan; or equal. The rod shall be 1/2 inch larger in diameter than the annular space.

2.7 POLYURETHANE SEALANT FOR PIPE PENETRATIONS

- A. Sealant shall be multipart, polyurethane sealant, to cure at ambient temperature, for continuous immersion in water. Install as recommended by the manufacturer. Products: SIKA Sikaflex 2C or equal.

2.8 PAINTING AND COATING

- A. Line and coat sleeves and pipes except stainless steel with fusion-bonded epoxy per Section 099000 or Engineer approved fusion bonded epoxy coating system.
- B. Coat penetrations and sleeves exposed, above ground, or in vaults and structures in accordance with Section 099000 or Engineer approved fusion-bonded epoxy coating system.
- C. Coat submerged sleeves and penetrations per Section 099000, System No. 12 or Engineer approved fusion bonded epoxy coating system.
- D. Coat buried sleeves and penetrations per Section 099000, System No. 10 or Engineer approved fusion bonded epoxy coating system.
- E. Do not coat stainless steel sleeves and penetrations.

PART 3 EXECUTION

3.1 LOCATION OF PIPES AND SLEEVES

- A. Provide a wall or floor pipe where shown in the drawings and wherever piping passes through walls or floors of tanks or channels in which the water surface is above the pipe penetration.
- B. Provide a floor sleeve where shown in the drawings and wherever plastic pipe, steel, or stainless steel pipe 3 inches and smaller or stainless steel or copper tubing passes through a floor or slab. Provide a rubber annular sealing device in the annular space between the sleeve and the passing pipe or tubing.
- C. Provide wall sleeves where shown in the drawings and wherever plastic, steel or stainless steel pipe 3 inches and smaller, or stainless steel or copper tubing passes through a wall. Provide a single rubber annular seal when the wall is 8 inches thick or less. Provide two rubber annular seals (one at each end of the sleeve) when the wall is more than 8 inches thick. Pack the annular space with polyethylene foam filler and fill the ends of the penetration with 2 inches of elastomeric sealant on both sides of the structure.
- D. Where wall sleeves are installed in which water or soil is on one or both sides of the channel or wall, provide two rubber annular seals (one at each end of the sleeve).
- E. Where pipes pass through walls or slabs and no sleeves or wall or floor pipe with seep ring is provided, pack the annular space with polyethylene foam filler and fill the ends of the penetration with

2 inches of elastomeric sealant on both sides of the structure.

3.2 INSTALLATION IN EXISTING CONCRETE WALLS AND SLABS

- A. Core drill holes 1 to 2 inches larger in diameter than the outside diameter of the wall flange or collar. Install wall pipe and collar assembly axially aligned with the piping to which it will be connected or will contain. Pack the void space between the sleeve and concrete with polyethylene foam filler and fill the ends of the penetration with 2 inches of elastomeric sealant on both sides of the structure.

3.3 INSTALLATION IN NEW CONCRETE WALLS AND SLABS

- A. Install wall pipes and sleeves in walls before placing concrete. Do not allow any portion of the pipe or sleeve to touch any of the reinforcing steel. Install wall pipe or sleeve and collar assembly axially aligned with the piping to which it will be attached or will contain. Provide supports to prevent the pipe or sleeve from displacing or deforming while the concrete is being poured and is curing.

3.4 INSTALLATION IN DRY FLOORS AND SLABS

- A. Install pipe sleeves and spools in concrete floors and slabs which do not have water over them such that the sleeve or pipe extends from the bottom of the floor or slab to an elevation sufficient to make pipe and fitting connections; unless shown otherwise in the drawings.

3.5 INSTALLATION OF WALL PIPES HAVING FLANGED END CONNECTIONS

- A. Check alignment before grouting in place or pouring concrete. Realign if the sleeve is not properly aligned.
- B. Install flanged end wall sleeves or penetrations with bolt holes of the end flanges straddling the horizontal and vertical centerlines of the sleeve.

3.6 QUALIFICATIONS OF WELDERS

- A. Welder qualifications shall be in accordance with AWS D1.1.

3.7 INSTALLATION OF RUBBER ANNULAR HYDROSTATIC SEALING DEVICES

- A. Install in accordance with the manufacturer's instructions.

3.8 FIELD TESTING

- A. Check each wall penetration for leakage at the time the hydraulic structure is tested for leakage; see Section 033000. Penetrations shall show zero leakage.

END OF SECTION

SECTION 400764
PIPE HANGERS AND SUPPORTS

PART 1 GENERAL

1.1 DESCRIPTION

- A. This section includes materials and installation of pipe hangers and supports including accessory items, such as anchor bolts and screws; pipe spiders; neoprene isolation pads; cable trays for hoses; and drip guards.

1.2 RELATED WORK SPECIFIED ELSEWHERE

- A. Painting and Coating: 099000.
- B. Flexible Pipe Couplings and Expansion Joints: 400722.
- C. Wall Pipes, Seep Rings, and Penetrations: 400762.

1.3 SUBMITTALS

- A. Submit shop drawings in accordance with the Section 013300.
- B. Provide line drawings of each piping system to the scale shown in the drawings, locating each support or hanger. Identify each type of hanger or support by the manufacturer's catalog number or figure.
- C. Provide installation drawings and manufacturer's catalog information on each type of hanger and support used. Clearly indicate the actual pipe outside diameter (not just nominal pipe size) that is used for the hangers and supports.
- D. Submit layout drawings for the drip guards, showing dimensions and thicknesses. Show design of seam or joint where field connections will be made between sections and pieces of drip guards. Submit a certificate listing the type of resin to be used, describing the manufacturer's brand name or designation, composition, and characteristics.

1.4 WARRANTY

- A. Full warranty against defects in materials and workmanship for one year after FINAL ACCEPTANCE, including all parts, labor, and expenses.

PART 2 - PRODUCTS

2.1 DESIGN CRITERIA.

- A. Pipe supports, anchors, and expansion joints have been indicated on the Drawings in certain locations, but no attempt has been made to indicate every pipe support, anchor, and expansion joint. The Contractor shall design anchors, pipe supports, expansion joints, and flexible couplings not already shown on the Drawings, in accordance with the requirements specified herein. Additional pipe supports may be required adjacent to expansion joints, couplings, valves, meters, and equipment. Contractor shall not delete or relocate supports, expansion joints, or couplings shown in the Drawings without the Engineer's approval.
- B. Absence of pipe supports and details on the Drawings shall not relieve the Contractor of responsibility of providing them throughout the plant.
- C. The Contractor's design shall include pipe supports, bracing, and anchorage adjacent to expansion joints, couplings, valves, in-line devices, equipment, wyes and tees, or changes in direction as required for dismantling piping, removing valves or other in-line devices, disconnecting piping from equipment, and pipe support, in addition to supports in accordance with the maximum spacing specified herein.
- D. Pipe support and hanger components shall withstand hydrostatic loads, up-lift forces, dead loads imposed by the weight of the pipes, fittings, and valves (all filled with water), plus valve actuators and any insulation, and internal test pressures, and shall have a minimum safety factor of five based on material ultimate strength.
- E. All piping shall be rigidly supported so there is no visible movement or visible sagging between supports. The system shall comply with specified code requirements.
- F. Provide anchors to resist thrust due to temperature changes, changes in diameter or direction, or dead-ends. Anchors shall be located as specified to force expansion and contraction to occur at expansion joints, loops, or elbows, and as needed to prevent excessive bending stresses and opening of mechanical couplings. Anchorage for temperature changes shall be centered between elbows and mechanical joints used as expansion joints. Anchorage for bellow type expansion joints may be

located adjacent to the joint.

- G. When expansion joints are required, pipe guides shall be provided adjacent to bellows type expansion joints. Guides will not be required where mechanical couplings are permitted as expansion joints. Guides shall be located on both sides of expansion joints, except where anchors are adjacent to the joint. Unless otherwise indicated on the Drawings, one guide shall be within four pipe diameters from the joint and a second guide within 14 pipe diameters from the first joint. Pipe supports shall allow adequate movement; pipe guides shall not be used for support. Pipe guides shall be provided at locations as recommended by the manufacturer.
- H. Pipe supports for insulated cold piping systems shall be sized for the outside diameter of the insulated pipe, and an insulation protection shield shall be installed between the support and the insulation. Rigid insulation inserts shall be installed between the pipe and the insulation shields for piping larger than 2-inches or when needed to prevent crushing of the insulation. Inserts shall be of the same thickness as the adjacent insulation and shall be vapor sealed.
- I. When supports for the FRP piping systems are in contact with less than 180-degrees of the pipe surface or when the width of the support is less than one-third the nominal pipe diameter (4-inches minimum), and FRP saddle, shaped to the outside diameter of the pipe, shall be bonded to at least the bottom 120-degrees of the pipe.
- J. Supply design criteria to the precast concrete manufacturer for any piping supported from the precast members.
- K. Hanger and Support Systems.
 - 1. Pipe hangers and supports shall be as manufactured by Anvil, Unistrut, B-Line, Superstrut, or equal.
 - 2. Pipe hangers and supports shall comply with MSS SP-58 for the standard types referenced in the drawings. Construct special hangers and supports if detailed in the drawings. Type numbers for standard hangers and supports shall be in accordance with MSS SP-58 as listed below:
 - a. Type 1: Adjustable steel clevis.
 - 1) Manufacturer and Model: Anvil Fig. 590 or 260 or approved equal.
 - b. Type 3: Steel double-bolt pipe clamp.
 - 1) Manufacturer and Model: Anvil Fig. 295A or 295H or approved equal.
 - c. Type 4: Steel pipe clamp (pipes smaller than 3 inches).
 - 1) Manufacturer and Model: Anvil Fig. 212 or approved equal.
 - d. Type 4: Steel pipe clamp (pipes 3 inches and larger).
 - 1) Manufacturer and Model: Anvil Fig. 216 or approved equal.
 - e. Type 5: Pipe hanger support plate.
 - 1) Manufacturer and Model: Anvil Fig. 49 or approved equal.
 - f. Type 6: Adjustable swivel pipe ring.
 - 1) Manufacturer and Model: Anvil Superstrut 714, Anvil Fig. 104, or approved equal.
 - g. Type 7: Adjustable steel band hanger.
 - 1) Manufacturer and Model: Anvil Fig. 69 or approved equal.
 - h. Type 8: Trapeze Beam.
 - 1) Manufacturer and Model: Anvil Fig. 45 or approved equal.
 - i. Type 9: Adjustable band hanger.
 - 1) Manufacturer and Model: Anvil Fig. 97 or approved equal.
 - j. Type 10: Adjustable swivel ring band hanger.
 - 1) Manufacturer and Model: Anvil Fig. 70 or approved equal.
 - k. Type 11: Split pipe ring with adjustable turnbuckle.
 - 1) Manufacturer and Model: Anvil Fig. 108 or approved equal.
 - l. Type 13: Steel turnbuckle.
 - 1) Manufacturer and Model: Anvil Fig. 230 or approved equal.
 - m. Type 14: Steel clevis.
 - 1) Manufacturer and Model: Anvil Fig. 299 or approved equal.
 - n. Type 15: Swivel turnbuckle.
 - 1) Manufacturer and Model: Anvil Fig. 114 or approved equal.
 - o. Type 16: Malleable iron socket.
 - 1) Manufacturer and Model: Anvil Fig. 110R or approved equal.
 - p. Type 17: Steel weldless eye nut.
 - 1) Manufacturer and Model: Anvil Fig 290 or approved equal.
 - q. Type 18: Steel or malleable iron concrete insert.

- 1) Manufacturer and Model: Anvil Fig. 281, Superstrut 452 or approved equal.
- r. Type 19: Top beam C-clamp.
 - 1) Manufacturer and Model: Anvil Fig. 92 or approved equal.
- s. Type 20: Side I-beam or channel clamp.
 - 1) Manufacturer and Model: Anvil Fig. 14 or 217 or approved equal.
- t. Type 21: Center I-beam clamp.
 - 1) Manufacturer and Model: Anvil Figure 134 or approved equal.
- u. Type 22: Welded attachment type.
 - 1) Manufacturer and Model: Anvil Fig. 66 or approved equal.
- v. Type 23: C-clamp.
 - 1) Manufacturer and Model: Anvil Fig. 86 or approved equal.
- w. Type 24: U-bolt.
 - 1) Manufacturer and Model: Anvil Fig. 137 or approved equal.
- x. Type 26: Clip.
 - 1) Manufacturer and Model: Anvil Fig. 262 or approved equal.
- y. Type 28: Steel I-beam clamp with eye nut.
 - 1) Manufacturer and Model: Anvil Fig. 228 or approved equal.
- z. Type 29: Steel wide flange.
 - 1) Manufacturer and Model: Anvil Fig. 228 clamp with eye nut aa.
- Type 30: Malleable iron beam clamp with extension piece.
 - 1) Manufacturer and Model: Superstrut CM-754 or approved equal. ab.
- Type 31: Light welded steel bracket.
 - 1) Manufacturer and Model: Anvil Fig. 194 or approved equal.
- ac. Type 32: Medium welded steel bracket.
 - 1) Manufacturer and Model: Anvil Fig. 195 or approved equal. ad.
- Type 33: Heavy welded steel bracket.
 - 1) Manufacturer and Model: Anvil Fig. 199 or approved equal. ae.
- Type 34: Side beam bracket.
 - 1) Manufacturer and Model: Anvil Fig. 202 or approved equal.
- af. Type 36: Pipe saddle support.
 - 1) Manufacturer and Model: Anvil Fig. 258 or approved equal. ag.
- Type 37: Pipe stanchion saddle.
 - 1) Manufacturer and Model: Anvil Fig. 259 or approved equal. ah.
- Type 38: Adjustable pipe saddle support.
 - 1) Manufacturer and Model: Anvil Fig. 265 or approved equal.
- ai. Type 39: Steel pipe covering.
 - 1) Manufacturer and Model: Anvil Fig. 160, 161, 162, 163, 164, or 165; Superstrut A 789; or approved equal.
- aj. Type 40: Insulation protection shield.
 - 1) Manufacturer and Model: Anvil Fig. 167 or approved equal. ak.
- Type 41: Single pipe roll.
 - 1) Manufacturer and Model: Anvil Fig. 171 or approved equal.
- al. Type 43: Adjustable roller hanger with swivel.
 - 1) Manufacturer and Model: Anvil Fig. 181 or approved equal. am.
- Type 44: Pipe roll, complete.
 - 1) Manufacturer and Model: Anvil Fig. 271 or approved equal. an.
- Type 45: Lateral Brace Clamp.
 - 1) Manufacturer and Model: Anvil Fig. 775 or approved equal.
- 3. Hangers, rods, clamps, protective shields, metal framing, support components, and hanger accessories shall be hot-dipped galvanized per ASTM A153; or plain carbon steel (ASTM A36, A575, or A576) unless noted otherwise.
- 4. Hangers, rods, clamps, protective shields, metal framing, support components, and hanger accessories in treatment process, pumping, and chemical storage/feed areas and rooms shall be stainless steel or FRP.
- 5. Submerged hangers, rods, clamps, protective shields, metal framing, support components, and hanger accessories in wet wells, tanks, channels or tank covers shall be Type 316 stainless steel.

- L. Offset Pipe Clamp.
1. Anvil Figure 103 or equal. Material shall be **carbon steel; Type 304 stainless steel; or Type 316 stainless steel.**
- M. Miscellaneous Pipe Supports and Hangers.
1. Pipe Anchor Chair: Anvil Figure 198 or equal.
 2. One Hole Clamp: Anvil Figure 126 or equal.
 3. Roller Chair: Anvil Figure 175 or equal.
- N. Steel Channel Framing System.
1. Steel channel frames shall be 1-5/8 inches wide by 1-5/8 or 3-1/4 inches high by 12-gauge metal thickness, unless otherwise shown in the drawings. Material shall conform to ASTM A36, A570 (Grade 33 minimum), or A653 unless stainless steel is indicated in the drawings. Stainless steel shall be Type 304. One side of the channel shall have a continuous open slot with inturned clamping ridges. Maximum allowable stress under any combination of applied uniformly distributed loads and concentrated loads shall not exceed those recommended in the AISC or AISI. Deflection shall not exceed 1/240 of span. Use multiple back-to-back channels to achieve these criteria if single channels are not sufficient. Products: Unistrut P1000 or P5000 Series, B-Line B11 or B22 Series, or equal.
 2. Steel channels shall be hot-dipped galvanized per ASTM A153; plain; coated with 20 mils of white PVC per ASTM D1784; or coated with Engineer approved fusion-bonded epoxy system.
 3. Nuts shall be machined and case hardened. Provide rectangular nuts with the ends shaped to permit a quarter turn crosswise in the framing channel. Provide two serrated grooves in the nut to engage the inturned edges of the channel.
 4. Pipe clamps (including attachment screws and nuts) shall be Unistrut P1100 or P2000 Series, B-Line B2000 Series, or equal. Material shall be Type 304 stainless steel.
 5. Hanger rods for trapezes shall be hot dipped galvanized carbon steel (ASTM A36, A575, or A576) unless stainless steel is indicated in the drawings. Stainless steel hanger rod material shall comply with ASTM A276, Type 304.
 6. Accessory fittings and brackets shall be the same material as the channel or trapeze. Provide coating on carbon steel fittings and brackets as specified for the channels and frames.
 - a. Flat Plate Fittings: Unistrut P1065, P1066, P1925; Superstrut AB-206, AB-207; or equal.
 - b. Post Bases: Unistrut P2072A, Superstrut AP-232, or equal.
 - c. 90-Degree Brackets: Unistrut P1326, P1346; Superstrut AB-203; or equal.
 - d. Rounded-End Flat Plate Fittings: Unistrut P2325, Superstrut X-240, or equal.
 7. Parallel pipe clamps shall be Unistrut P1563 through P1573, Superstrut AB-719, or equal. Material shall be hot-dipped galvanized carbon steel, coated as specified for channels and frames unless stainless steel is indicated in the drawings. Stainless steel clamp material shall comply with ASTM A276, Type 304.
- O. FRP Channel Framing System.
1. FRP pipe hangers and supports shall be Aickinstruct, Inc., or equal.
 2. Material properties shall be as follows:
 - a. Longitudinal Direction:
 - 1) Ultimate Tensile (psi): 35,000 minimum.
 - 2) Ultimate Compressive (psi): 35,000 minimum.
 - 3) Ultimate Flexural (psi): 35,000 minimum.
 - 4) Tensile Modulus (psi): 3.0×10^6 minimum.
 - 5) Flexural Modulus (psi): 2.0×10^6 minimum.
 - 6) Ultimate Shear Strength (psi): 6,000 minimum.
 - 7) Izod Impact (ASTM D256) Ft-lb/inch notch: 30 minimum.
 - b. Transverse Direction:
 - 1) Ultimate Tensile (psi): 10,000 minimum.
 - 2) Ultimate Compressive (psi): 20,000 minimum.
 - 3) Ultimate Flexural (psi): 14,000 minimum.
 - 4) Tensile Modulus (psi): 1.0×10^6 minimum.
 - 5) Compressive Modulus (psi): 1.4×10^6 minimum.
 - 6) Flexural Modulus (psi): 1.0×10^6 minimum.
 - 7) Ultimate Shear Strength (psi): 5,500 minimum.
 - 8) Ultimate Bearing Stress (psi): 35,000 minimum.
 - 9) Izod Impact (ASTM D256) Ft-lb notch: 5 minimum.

- c. Hardness:
 - 1) Barcol Test: 50 minimum.
- 3. Glass fiber reinforced composites and plastic products shall have a flame spread rating of 25 or less when tested per ASTM E84.
- 4. Channel framing shall be 1-5/8 inches deep by 1-5/8 inches wide and shall be made using vinylester resin equal to Derakane 411, Ashland Hetron 922, or Reichhold Dion 9800. It shall have a nexus polyester surfacing veil over 100% of the surface which, along with a filler system, will protect against degradation from ultraviolet light. Channel shall be supplied with integral notches 1 inch on center. Notches shall be located on the interior flange to prevent slippage of pipe clamps and fittings after installation. In place of notched channel, unnotched channel may be used if the vertical channel sections supporting the horizontal piping are provided with stop lock hardware at each pipe clamp to prevent slippage. Channel framing shall be Aickinstrut G.R.P. Type V 200 series or equal.
- 5. Channel framing connections shall be made with vinylester glass fiber composite nuts, bolts, all threaded rods, channel fittings, bases, and hanger assemblies. Nuts, bolts, and rods shall be Aickinstrut 4200 series, Strut Tech PVCG, or equal. Channel fittings shall be Aickinstrut 2800 style or equal.
- 6. Load-bearing pipe clamps and nonload-bearing pipe straps shall be nonmetallic and nonconductive and shall be made by the injection molding process using polyurethane base resin. Pipe clamps and straps shall be Aickinstrut 3100 series or equal.
- 7. Clevis hangers shall be made with vinylester glass fiber and be Aickinstrut 1500 series or equal.
- 8. Hanger rods for trapezes shall be hot dipped galvanized carbon steel (ASTM A36, A575, or A576) unless stainless steel is indicated in the drawings. Stainless steel hanger rod material shall comply with ASTM A276, Type 304.
- P. Pipe Spiders.
 - 1. Superstrut S-794 or equal.
- Q. Waffle Isolation Pads.
 - 1. Mason Type "W"; Machinery Installation Systems "Unisorb" Type S, SB, F, or FB; or equal. Provide minimum 1/4-inch thickness.
- R. Neoprene Isolating Sleeves for Metal Pipe 6 Inches and Smaller.
 - 1. Unistrut P2600, B-Line "Vibrocushion," or equal.
- S. Cable Trays for Support of Chemical Hoses.
 - 1. Provide PVC-coated aluminum, 3-inch loading depth ladder-type cable trays with 6-inch rung spacing. Width shall be 12 inches unless otherwise shown in the drawings. Cable tray shall have a capacity of 56 pounds per foot at 12-foot spacing with a 1.73-inch-capacity deflection. Side members shall have outward flanges. Design loading with a safety factor of 1.5 per NEMA VE-1. Conform to NEMA Class 12A.
 - 2. Cable tray shall be P-W Western, Inc., No. 06-4D03-0012-12; T. J. Cope, Inc., No. 3338-12-SL-12-06; or equal.
 - 3. Provide aluminum support brackets, hold-down clamps (P-W Western, Inc., No. 9988-1B23-01; T. J. Cope, Inc., No. 9018; or equal), and cable clamps (P-W Western, Inc., No. 9996-1911-21; T. J. Cope, Inc., No. SCC-400; or equal) for support of cable trays.
- T. Drip Guards.
 - 1. Drip guards shall be minimum 1/4 inch thick, PVC or FRP. Color shall be white.
 - 2. PVC shall conform to ASTM D1784, Cell Classification 12454-B and ASTM D1927, Type I.
 - 3. Seams or joints between sections and pieces shall be leak free. Design joints so that liquid can flow across the joint and not form ponds.
 - 4. FRP drip guards shall include a corrosion-resistant layer on the side of the drip guard exposed to piping. The exposed corrosion-resistant layer shall be resin rich, shall consist of Type C glass monofilament surfacing mat or Nexus organic fiber, and shall be a minimum of 20 mils thick. Glass content in the corrosion-resistant layer shall not exceed 23% by weight. The structural layer shall be composed of chopped strand mat having a minimum glass content of 30% by weight. The overall glass content of the finished laminate shall be at least 30% by weight. Provide resin throughout the laminate. Determine glass content per ASTM D2584. Resin shall be Derakane 411, Reichhold Dion 9800, Ashland Hetron 922, or equal. Construction shall comply with ASTM D2563, Level II. Hardness shall be at least 90% of the resin manufacturer's recommended Barcol hardness, with a minimum Barcol hardness of 30, with the resin fully cured. Maximum strain in the laminate shall be 0.001 inch/inch. Maximum

air bubble size in the laminate shall be 1/16 inch. Maximum frequency of air bubbles shall be 10 per square inch of laminate. Construction shall comply with NBS Voluntary Product Standard PS 15-69.

5. Provide nylon washers (minimum 1/8 inch thick) on both sides of holes where pipe hangers penetrate the drip guard. Provide Type 316 stainless steel nuts to connect the drip guards to pipe hangers and supports.

U. Anchor Bolts, Screws, and inserts.

1. Anchor bolts and screws for attaching pipe supports and hangers to walls, floors, ceilings, and roof beams shall be hot-dipped galvanized steel, ASTM A307 or Type 316 stainless steel, ASTM A276 or F593. Nuts shall be galvanized steel, ASTM A563 or Type 316 stainless steel, ASTM A194, Grade 8M or ASTM F594, Type 316 stainless steel.
2. Concrete inserts or anchor bolts shall be used to support piping from new cast-in-place concrete. Adhesive anchors shall be used to fasten supports to existing concrete and masonry.
3. Inserts:
 - a. Reference building structural concrete drawings for concrete inserts. When not provided as part of the building concrete structure, provide inserts for suspending hangers from reinforced concrete slabs and side of reinforced concrete beams. It shall be the Contractor's responsibility to accurately locate and attach inserts to concrete forms.
 - b. Where inserts are omitted, drill through concrete slab from below and provide thru-bolt with recessed square steel plate and nut recessed into and grouted flush with slab. X-ray locate existing reinforcement before drilling.

PART 3 - EXECUTION

3.1 PIPE HANGER AND WALL SUPPORT SPACING

- A. Install pipe hangers and wall supports on horizontal and vertical runs at the spacing shown or detailed in the drawings. Provide hanger rods (for horizontal runs) and wall supports of the sizes shown or detailed in the drawings. If no spacing or rod sizes are given in the drawings or in the specifications for a particular piping system, use the following:
- B. Pipe Hanger and Wall Support Spacing for Steel and Ductile-Iron Pipe:
 1. Pipe Size (inches): 3/8 and smaller.
 - a. Support/Hanger Max Spacing (feet): 4
 - b. Minimum Rod Size (inches): 3/8
 2. Pipe Size (inches): 1/2 through 1.
 - 1) Support/Hanger Max Spacing (feet): 6
 - 2) Minimum Rod Size (inches): 3/8
 3. Pipe Size (inches): 1-1/4 through 2.
 - 1) Support/Hanger Max Spacing (feet): 8
 - 2) Minimum Rod Size (inches): 3/8
 4. Pipe Size (inches): 2-1/2 and 3.
 - 1) Support/Hanger Max Spacing (feet): 10.
 - 2) Minimum Rod Size (inches): 1/2
 5. Pipe Size (inches): 3-1/2 and 4.
 - 1) Support/Hanger Max Spacing (feet): 10
 - 2) Minimum Rod Size (inches): 5/8
 6. Pipe Size (inches): 6.
 - 1) Support/Hanger Max Spacing (feet): 12
 - 2) Minimum Rod Size (inches): 3/4
 7. Pipe Size (inches): 8.
 - 1) Support/Hanger Max Spacing (feet): 12
 - 2) Minimum Rod Size (inches): 7/8
 8. Pipe Size (inches): 10 and 12.
 - 1) Support/Hanger Max Spacing (feet): 14
 - 2) Minimum Rod Size (inches): 7/8
 9. Pipe Size (inches): 14 and 16.
 - 1) Support/Hanger Max Spacing (feet): 16
 - 2) Minimum Rod Size (inches): 1
 10. Pipe Size (inches): 18.
 - 1) Support/Hanger Max Spacing (feet): 15

- 2) Minimum Rod Size (inches): 1
- l. Pipe Size (inches): 20 through 24.
 - 1) Support/Hanger Max Spacing (feet): 9
 - 2) Minimum Rod Size (inches): 1-1/4
- m. Pipe Size (inches): 30.
 - 1) Support/Hanger Max Spacing (feet): 7
 - 2) Minimum Rod Size (inches): 1-1/4
- 2. Pipe Hanger or Wall Support Spacing for PVC and CPVC Pipe:
 - a. Pipe Size (inches): 3/4.
 - 1) Support/Hanger Max Spacing (feet): 4
 - 2) Minimum Rod Size (inches): 3/8
 - b. Pipe Size (inches): 1.
 - 1) Support/Hanger Max Spacing (feet): 4
 - 2) Minimum Rod Size (inches): 3/8
 - c. Pipe Size (inches): 1-1/4.
 - 1) Support/Hanger Max Spacing (feet): 4-1/2
 - 2) Minimum Rod Size (inches): 3/8
 - d. Pipe Size (inches): 1-1/2.
 - 1) Support/Hanger Max Spacing (feet): 5
 - 2) Minimum Rod Size (inches): 3/8
 - e. Pipe Size (inches): 2.
 - 1) Support/Hanger Max Spacing (feet): 5
 - 2) Minimum Rod Size (inches): 3/8
 - f. Pipe Size (inches): 2-1/2.
 - 1) Support/Hanger Max Spacing (feet): 5
 - 2) Minimum Rod Size (inches): 1/2
 - g. Pipe Size (inches): 3.
 - 1) Support/Hanger Max Spacing (feet): 6
 - 2) Minimum Rod Size (inches): 1/2
 - h. Pipe Size (inches): 4.
 - 1) Support/Hanger Max Spacing (feet): 6
 - 2) Minimum Rod Size (inches): 5/8
 - i. Pipe Size (inches): 6.
 - 1) Support/Hanger Max Spacing (feet): 7
 - 2) Minimum Rod Size (inches): 3/4
 - j. Pipe Size (inches): 8.
 - 1) Support/Hanger Max Spacing (feet): 7
 - 2) Minimum Rod Size (inches): 7/8
 - k. Pipe Size (inches): 10.
 - 1) Support/Hanger Max Spacing (feet): 8
 - 2) Minimum Rod Size (inches): 7/8
 - l. Pipe Size (inches): 12.
 - 1) Support/Hanger Max Spacing (feet): 8
 - 2) Minimum Rod Size (inches): 7/8
- 3. Pipe Hanger or Wall Support Spacing for Copper Tubing and Pipe:
 - a. Pipe Size (inches): 1 and smaller.
 - 1) Support/Hanger Max Spacing (feet): 4
 - 2) Minimum Rod Size (inches): 3/8
 - b. Pipe Size (inches): 1-1/4 through 2.
 - 1) Support/Hanger Max Spacing (feet): 6
 - 2) Minimum Rod Size (inches): 3/8
 - c. Pipe Size (inches): 2-1/2 through 3.
 - 1) Support/Hanger Max Spacing (feet): 8
 - 2) Minimum Rod Size (inches): 1/2
- 4. For piping services not described, provide hangers and supports per MSS SP-58 and SP-69.
- 5. Provide bracing for piping 8 inches and smaller that is installed on hangers or trapezes per MSS SP-127, except provide lateral bracing at maximum 10-foot center-to-center spacings. Provide sway bracing for hangers for piping larger than 8 inches as detailed in the drawings.

C. Pipe Support Spacing for Supports on Top of Slabs or Grade

1. Install pipe supports on horizontal runs at the spacing shown or detailed in the drawings. Provide supports of the type shown or detailed in the drawings. If no spacings are given in the drawings or in the specifications for a particular piping system, use the following:
2. Pipe Support Spacing for Steel and Ductile-Iron Pipe:
 - a. Pipe Size (inches): 3/8 and smaller.
 - 1) Support/Hanger Max Spacing (feet): 4.
 - b. Pipe Size (inches): 1/2 through 1.
 - 1) Support/Hanger Max Spacing (feet): 6.
 - c. Pipe Size (inches): 1-1/4 through 2.
 - 1) Support/Hanger Max Spacing (feet): 8.
 - d. Pipe Size (inches): 2-1/2 and 3.
 - 1) Support/Hanger Max Spacing (feet): 10.
 - e. Pipe Size (inches): 3-1/2 and 4.
 - 1) Support/Hanger Max Spacing (feet): 10.
 - f. Pipe Size (inches): 6.
 - 1) Support/Hanger Max Spacing (feet): 12.
 - g. Pipe Size (inches): 8.
 - 1) Support/Hanger Max Spacing (feet): 12.
 - h. Pipe Size (inches): 10 and 12.
 - 1) Support/Hanger Max Spacing (feet): 14.
 - i. Pipe Size (inches): 14 and 16.
 - 1) Support/Hanger Max Spacing (feet): 16.
 - j. Pipe Size (inches): 18.
 - 1) Support/Hanger Max Spacing (feet): 16.
 - k. Pipe Size (inches): 20 through 24.
 - 1) Support/Hanger Max Spacing (feet): 18.
 - l. Pipe Size (inches): 30.
 - 1) Support/Hanger Max Spacing (feet): 18.
 - m. Pipe Size (inches): 36.
 - 1) Support/Hanger Max Spacing (feet): 12.
3. Pipe support spacing for other pipe materials shall be the same as described above in paragraph entitled "Pipe Hanger and Wall Support Spacing."

D. Installing Pipe Hangers and Supports

1. Pipe hangers, brackets, and supports shall be furnished complete with all necessary inserts, anchor bolts, bolts, nuts, washers, and other accessories.
2. All piping shall be supported in a manner which will prevent undue stress on any valve, meter, fitting, or piece of equipment. In addition, pipe supports shall be provided at changes in direction or elevation, adjacent to flexible couplings, and where otherwise shown in the Drawings. Pipe supports and hangers shall not be installed in equipment access areas.
3. Provide separate hangers or supports at each valve. Provide one hanger or support around each end of the valve body or on the adjacent connecting pipe within one pipe diameter of the valve end. Provide additional hangers or supports to relieve eccentric loadings imposed by offset valve actuators.
4. Provide separate hangers or supports at each pipe elbow, tee, or fitting. Provide separate hangers or supports on both sides of each non-rigid joint or flexible pipe coupling.
5. Where horizontal piping is arranged with two or more parallel pipe runs, trapeze hangers may be used in lieu of individual hangers. Trapeze assembly shall consist of structure attachments as previously specified with rod size dependent upon total weight supported. Spacing of assemblies shall be determined by the minimum pipe size included in the group supported. Trapeze horizontal assemblies shall be structural angle or channel section of sufficient size to prevent measurable sag between rods. All pipe runs shall be attached to the horizontal with intermediate pipe guides and U-bolts or one-hole clamps. Pre-engineered support equipment may be used when selected and installed in accordance with the manufacturer's recommendations.
6. Adjust pipe hangers per MSS SP-89, paragraph 10.6.
7. Install leveling bolts beneath support baseplates. Provide 3/4 to 1-inch thick non-shrink, non-staining grout pad beneath each base.
8. Install piping without springing, forcing, or stressing the pipe or any connecting valves, pumps, and other equipment to which the pipe is connected.

9. Do not support piping from other piping.
- E. Installing Steel and FRP Channel Frames
1. Use 1-5/8-inch-high channel frames unless 3-1/4-inch is needed to provide clearance from walls. Use multiple back-to-back channels if additional clearance is needed.
 2. Seal the ends of cut FRP channel frames with the channel manufacturer's sealant or resin.
- F. Installing Neoprene Isolating Pads or Sleeves
1. Install a sleeve around each metal pipe 6 inches and smaller at the point of bearing or contact with the pipe hanger or support.
 2. Install isolating pad between each metal pipe larger than 6" at the point of bearing or contact with the pipe hanger or support.
- G. Installing Cable Trays for Chemical Hoses
1. Provide cable tray supports at 8-foot centers, maximum. Locate a support within 2 feet of each fitting extremity. Provide one support under each of the three side rails for horizontal tees. Allow for thermal expansion based on 50 degrees F temperature variation.
 2. Attach chemical hoses to rungs of cable tray at 6-foot intervals using cable clamps.
- H. Painting and Coating
1. Grind welds of fabricated steel pipe supports smooth, prepare surface by sandblasting, and apply coating system.
 2. Exposed pipe hangers and supports are to be provide with hot dip galvanized coating. For areas where the pipe supports are cut, welded, or any other case where the integrity of the galvanized coating is affected due to erection on site, touch up and repair the affected area per Section 099000.
 3. Paint exposed pipe hangers and supports to match the color of the adjacent wall using System per Section 099000. If the adjacent wall is not painted, paint the hangers and supports to match color code of the largest pipe on the support.
 4. Submerged pipe hangers are to be provided as 316 Stainless Steel. No coating required.
 5. Coat submerged pipe hangers and supports per Section 099000.
 6. If the ferrous metal pipe hangers and supports are not galvanized or Stainless Steel, the pipe supports shall be coated per Section 099000.

END OF SECTION

THIS PAGE INTENTIONALLY LEFT BLANK.

SECTION 402076

CARBON AND STAINLESS STEEL PIPE

PART 1 GENERAL

1.1 DESCRIPTION

- A. This section includes materials and installation of carbon steel pipe and fittings 26 inches and smaller conforming to ASTM A53 and stainless steel pipe and fittings 30 inches in diameter and smaller conforming to ASTM A312. Seller shall supply piping having a maximum design pressure appropriate for the intended application.

1.2 SUBMITTALS

- A. Submit shop drawings in accordance with the General Conditions and Section 013300
- B. Submit materials list showing material of pipe and fittings with ASTM reference and grade. Submit manufacturer's certificate of compliance with referenced standards. Show piping service
- C. Manufacturer's catalog data marked to indicate materials being furnished.
- D. Weight and support requirements.
- E. Certificate of compliance, signed by the Manufacturer, stating that the equipment offered is in full compliance with the specifications.
- F. Welder certification documents.
- G. Pickling and passivating procedure.
- H. For piping 6-inches and larger, submit detailed piping layout drawings showing location and dimensions of pipe, fittings, taps, and outlets in full detail, location of pipe hangers and supports, large-scale details of all special castings, and locations and types of restraint to prevent joints from pulling apart. Include laying lengths of flanges, gaskets, valves, meters, inline pumps, and other equipment determining piping dimensions. FIELD VERIFY DIMENSIONS PRIOR TO PREPARTION OF LAYOUT DRAWINGS. DO NOT FABRICATE PIPE UNTIL SUBMITTAL HAS BEEN RETURNED STAMPED "RESUBMITTAL IS NOT REQUIRED" OR "MAKE CORRECTIONS NOTED." Label or number each fitting or piece of pipe and provide the following information for each item:
 - 1. Material of construction, with ASTM reference and grade.
 - 2. Wall thickness of stainless steel cylinder.
 - 3. Manufacturer's certificate of compliance with referenced pipe standards.
 - 4. Show weld sizes and dimensions of grooved-end collars, flanges, reinforcing collars, wrapper plates, and crotch plates.

1.3 QUALITY ASSURANCE

- A. Welder Qualifications
 - 1. Piping systems welding shall be by welders qualified and certified under provisions of AWS to weld austenitic chromium-nickel stainless steel and carbon steel pipe and tubing meeting requirements of ASME Section VIII, Division 1 and ANSI B31.3.
 - 2. Welders shall be certified by an independent, acceptable testing agency not more than 12 months prior to commencing work.
 - 3. Perform certification with machines and electrodes similar to those used in the work.
 - 4. Certify welders at no additional cost to the Owner.

1.4 WARRANTY

- A. Full warranty against defects in materials and workmanship for two (2) years after final acceptance by the Owner, including all parts, labor, and expenses.
- B. Owner, Owner's Representative, and Contractor shall conduct a 23-month warranty inspection of the pipe to ensure that it is free from defects, pitting, and corrosion. All defective areas shall be repaired according to manufacturer's recommendations or replaced.

PART 2 PRODUCTS

2.1 STAINLESS STEEL PIPE

- A. Pipe shall conform to ASTM A312, Grade TP 316L.
- B. Seller shall determine pipe sizes and wall thicknesses applicable to the application it will be used and

shall conform to ASME B36.19.

2.2 CARBON STEEL PIPE

- A. Pipe shall conform to ASTM A53, Type F, Grade A.
- B. Seller shall determine pipe sizes and wall thicknesses applicable to the application it will be used and shall conform to ASME B36.10.

2.3 FITTINGS

- A. Fittings 3 inches and smaller shall be socket welded, conforming to ASME B16.9 and ASME B16.11. Seller shall determine fitting class applicable to the application it will be used.
 - 1. Material for socket welded fittings shall conform to ASTM A403, Class WP316L or ASTM A182, Grade F316L.
- B. Fittings for aboveground or exposed pipe larger than 3 inches through 24 inches shall be *butt-welded*, conforming to ASTM A403, Class WP, same material and wall thickness as the pipe, conforming to ASME B16.9. Elbows shall be long radius unless indicated otherwise on the Drawings.
- C. Fittings for pipe larger than 24 inches shall conform to ASME B16.9. Material shall be the same as the pipe.

2.4 PICKLING, PASSIVATING, AND FINAL CLEANING

- A. After fabrication, mechanically clean/descale the welded surface, to remove all thick visible oxide scale with wire brushes and/or non-metallic devices. Brushes shall be stainless steel and used only on stainless steel.
- B. After descaling is completed, all pipe and fittings shall be immersed in a pickling solution to remove all weld heat tinted layers from the surface of the stainless steel, ensure removal of all free iron, weld scale, and other impurities and to insure the establishment of a passive surface prior to passivation. Pickling solution shall be a nitric-hydrofluoric bath at the proper temperature and length of time per ASTM A380. Perform a complete neutralizing operation by immersion in a trisodium phosphate rinse followed by a clean water rinse.
 - 1. Chemical clean shall completely remove the surface contamination but will not significantly affect the stainless steel itself.
 - 2. After final cleaning, wet surfaces with water and inspect for rust spots after 24-hours. Reclean if there is any evidence of rusting.
 - 3. Contractor may submit alternate pickling and passivating procedure other than the full immersion bath for review by the Engineer. Alternate pickling and passivating procedure shall be in accordance with ASTM A380. Submittal of alternate procedure does not ensure approval.
- C. After descaling and pickling, the stainless steel piping/fabrication shall be fully passivated to enhance the corrosion resistance of the stainless steel, through forming a chemically inactive surface when exposed to air or oxidizing agent. Passivation shall be completed per ASTM A380, and A967.

2.5 QUALITY CONTROL

- A. Include the "Hydrostatic Test" and "Flattening Test" requirements described in ASTM A999. A nondestructive electric test per ASTM A999 may be substituted for the hydrostatic test.

2.6 EXTERIOR AESTHETIC FINISH

- A. Where shown in the Drawings, or Piping Schedule, exterior finish for piping 12 inches and larger shall be equivalent to a No. 4 per ASTM A480. As an alternative, provide a bright electropolished finish per ASTM B912. The electropolished surface shall pass the test for visual defects per ASTM B912, paragraph 5.1.

2.7 UNIONS

- A. Unions shall WOG forged stainless steel, class determined by seller and appropriate for the application it is used, with dimensions conforming to MSS SP-83. Ends shall be socket-welded type.
 - 1. Material shall conform to ASTM A182, Grade F316L for socket-welded type unions.

2.8 JOINTS

- A. Joints for pipes 3 inches and smaller shall be socket welded, same material as specified for fittings, class determined by seller and appropriate for the application it is used, conforming to ASME B16.11.

- B. Joints for buried or submerged pipe larger than 3 inches shall be butt-welded. Joints for aboveground or exposed pipe larger than 3 inches shall be butt-welded.
- D. Where piping connects to wall pipes, meters, valves, or other equipment, the pipe ends shall match the ends of the wall pipes, meters, valves, or equipment, unless indicated otherwise.

2.9 OUTLETS AND NOZZLES

- A. Outlets of size 3 inches and smaller in piping 4 inches and larger shall be of the Thredolet type, per MSS SP-97, Figure 13-23. Outlets class shall be selected by the seller and appropriate for the application it is used, conforming to ASTM A182, Grade F316L or ASTM A403, Grade WP316L.
- B. For outlets 3-inches and smaller in piping smaller than 4-inches, use a tee with threaded outlet.
- C. For outlets larger than 3-inches, use a tee with a flanged outlet. Side outlets are not considered equivalent to fabricated tees and shall not be used without written permission.

2.10 THREAD LUBRICANT

- A. Use Teflon thread lubricating compound or Teflon tape.

2.11 FLANGES

- A. Provide weld-neck flanges (conforming to ASME B16.5) for piping 3 inches and smaller to connect to flanged valves, fittings, or equipment. Provide weld-neck or Van Stone flanges (per ASTM F2015) for piping larger than 3 inches. Flanges shall be Class 150 per ASME B16.5. Flanges shall match the connecting flanges on the adjacent fitting, valve, or piece of equipment. Flanges shall be flat face.
- B. Material for weld-neck flanges shall conform to ASTM A182, Grade F316L
- C. Material for Van Stone flanges shall be as follows
 1. Exposed Applications: Carbon steel; ASTM A216, Grade WGA or WGB; Stainless steel; ASTM A351, Grade CF8; or Stainless steel; ASTM A351, Grade CF8M.
 2. Submerged or Buried Applications: Stainless steel; ASTM A351, Grade CF8M

2.12 BOLTS AND NUTS FOR FLANGES

- A. Bolts and nuts for Class 125 or 150 flanges located indoors; outdoors above ground; and in vaults and structures shall be carbon steel, ASTM A307, Grade B, hot-dipped galvanized per ASTM F2329.
- B. Bolts and nuts for all buried flanges and all flanges located indoors; outdoors; above ground; and in vaults and structures shall be Type 316 stainless steel conforming to ASTM A193, Grade B8M Class 2, for bolts, and ASTM A194, Grade 8M, for nuts unless indicated otherwise. Fit shall be Class 2A and 2B per ASME B1.1 when connecting cast iron valves having body bolt holes.
- C. Hex head machine bolts for use with lugged valves shall comply with ASTM A193, Grade B7.
- D. Bolts for ASME B16.5 and B16.47 Class 300 flanges located indoors; outdoors; above ground; and in vaults and structures shall conform to ASTM A193, Grade B7, with nuts conforming to ASTM A194, Grade 2H.
- E. Bolts and nuts for buried or submerged Class 300 flanges and Class 300 flanges located outdoors above ground or in vaults and structures shall be Type 316 stainless steel conforming to ASTM A193, Grade B8M, Class 2, for bolts and ASTM A194, Grade 8M, for nuts.
- F. Bolts for piping in sodium hypochlorite service shall be titanium, per ASTM F467, Grade Ti1, Ti2, or Ti7. Nuts shall conform to ASTM F467, same material as the bolts.
- G. Bolts and nuts used in flange insulation kits shall conform to the same requirements as described in the paragraph contained herein; or ASTM A193 (Grade B7). Nuts shall conform to ASTM A194 (Grade 2H).
- H. Form threads for stainless steel bolts by means of rolling, not cutting or grinding.
- I. Provide washers for each nut and bolt head. Washers shall be of the same material as the nuts.

2.13 LUBRICANT FOR STAINLESS STEEL BOLTS AND NUTS

- A. Lubricant shall be chloride free and shall be RAMCO TG-50, Anti-Seize by RAMCO, Specialty Lubricants Corporation Huskyä Lube O'Seal, or equal.

2.14 GASKETS FOR FLANGES

- A. Gaskets shall be suitable for a maximum pressure of 300 psi and a maximum temperature of 500 degrees F. Gaskets for raw digester gas and methane gas service shall be one of the following materials:

1. Teflon envelope type, full face, 1/8-inch insert, with compressed nonasbestos filler. Provide free-flow design in which the Teflon is machined or milled between leaves to provide a space for the filler.
2. PTFE with inert filler, 1/8-inch thick. Product: Garlock "Gylon."
3. Viton B, 1/8-inch thick.

2.15 WYE STRAINERS

- A. Strainers 2 inches and smaller shall be stainless steel, wye pattern, with minimum pressure rating of 300-psi WOG. Material shall conform to ASTM A351 or A743, Grade CF8M. Screen shall be 20 mesh and same material as the strainer. Provide pet cock of the same material as the strainer body in the blowoff connection. Ends shall be threaded conforming to ASME B1.20.1. Provide one spare screen for each strainer. Strainers shall be Sarco Type 316, Muessco No. 861, or equal.

2.16 PROTECTIVE END CAPS

- A. Provide protective end caps on each piece of pipe or fabricated section, completely sealing the piece from contamination during shipment and storage. Provide the same type of seals on each fitting, or ship and store fittings in sealed boxes or containers.

2.17 SHOP FABRICATION

- A. General
 1. Shop fabricate 4-inch and larger stainless steel and carbon steel pipe and fittings in sections as large as practical.
 2. Pipe and fitting joints in shop fabrication shall be weld joints. Ends of shop fabrications shall have flanges or plain ends. Plain ends shall be prepared for field installed couplings.
- B. Shop Welding
 1. Shop welding procedures for stainless steel pipe shall meet requirements of ANSI/AWS D10.4.
 2. All process gas piping is welded in accordance with ASME B31.3 for normal gas service.
 3. Prepare edges by machine shaping or cutting. Bevel ends of pipe and fittings with wall thickness of 3/16-inch and larger. Bevel ends of stainless steel pipe to meet requirements of ANSI/AWS D10.4. Separate abutting pipe ends before welding, and completely fuse inside walls of pipe without overlapping. Welding shall be continuous around the joint and shall be completed without interruption. Welds shall be single "V" butt type, of sound weld metal thoroughly fused into the ends of pipe and into bottom of "V". Welds shall be free from cold spots, pin holes, oxide inclusions, burrs, snags, rough projections or other defects.
 4. Use an inert shielding gas welding method. Do not use oxygen fuel welding. Purge the interior of the pipe with inert gas prior to root pass.
 5. Welded butt joints (both longitudinal and circumferential) shall comply with ANSI/AWS D10.4. Do not use backing rings. Provide full penetration and smooth internal diameters for the root bead of welds. Grind the inside weld of socket welds flush with pipe internal diameter. Welds shall be of smooth finish. Use anti-spatter compounds specifically formulated or designed for use with stainless steel. Do not allow heat tint to form in the heat-affected zone or remove heat tint completely from the heat-affected zone of the finished weld. The maximum depth of grinding or abrasive blasting to remove defects shall not exceed 10-percent of the wall thickness. Do not perform abrasive blasting with steel shot, grit, or sand.
 6. No iron or steel surfaces shall come into contact with the stainless steel. This includes placing on steel tables, racks, pipe supports, etc. Do not use carbon steel wire brushes or grinders.
 7. Welding electrodes shall comply with AWS A5.4. Bare wire shall comply with AWS A5.9. Use electrodes as follows:
 - a. Type 304 Pipe Material: E 308 Welding Electrode Material.
 - b. Type 304L Pipe Material: E 347 Welding Electrode Material.
 - c. Type 316 Pipe Material: E 316 Welding Electrode Material.
 - d. Type 316L Pipe Material: E 318 Welding Electrode Material.

PART 3 EXECUTION

3.1 SHIPPING, STORAGE, AND HANDLING

- A. When loading piping for shipment to the project site, use spacers and other protective devices to separate pipes to prevent damaging the surfaces during transit and unloading. If wood spacers are used, remove wood splinters and particles from the pipe surfaces after separation. Use padded chains or ribbon binders to secure the loaded pipe and minimize damage.

- B. Cover piping 100% with protective coverings or tarpaulins to prevent deposition of road salts, fuel residue, and other contaminants in transit.
- C. Provide stulls, braces, and supports during shipping and storage such that out-of-roundness or deflection does not exceed 0.5% of the pipe diameter.
- D. Handle piping with care during unloading, installation, and erection operations to minimize damage. Do not place or store pipe on the ground or on top of other work unless ground or work is covered with a protective covering or tarpaulin. Place pipe above the ground upon platforms, skids, or other supports.
- E. Store piping at the site on pallets to prevent direct contact with ground or floor. Cover pipe during storage with protective coverings or tarpaulins to prevent deposition of rainwater, salt air, dirt, dust, and other contaminants.
- F. Do not allow stainless steel piping to contact carbon steel surfaces during storage, handling, or installation and erection at the site.
- G. Piping supplier during manufacturing, fabrication and handling stages, and the Contractor during handling and installation steps, shall use extreme care to avoid contact of any ferrous materials with the stainless steel piping. Pipe storage and fabrication racks shall be non-ferrous, stainless steel, or rubber lined. Nylon slings or straps shall be used for handling stainless steel piping. Slings or straps used for stainless steel piping shall not be used with any other materials. Contact with ferrous items may cause rusting or iron particles embedded in the piping walls. After installation, the Contractor shall wash and rinse all foreign matter from the piping surface. If rusting of embedded iron occurs, the Contractor shall pickle the affected surface with Oakite Deoxidizer SS, or equal, scrub with stainless steel brushes and rinse clean.

3.2 SHOP TESTING OF FABRICATED OR WELDED COMPONENTS

- A. After completion of fabrication and welding in the shop, test each component according to the referenced standards. Test fabricated fittings per ASME B31.3. Test the same in fittings which have not been previously shop hydrostatically tested by the dye penetrant method as described in ASME Boiler and Pressure Vessel Code Section VIII, Appendix B. In lieu of the dye penetrant method of testing, completed fittings may be hydrostatically tested. Use a hydrostatic pressure of 150-percent of the design pressure.
 - 1. Perform tests of production welds in fabricated piping in accordance with ASME B31.3.

3.3 FIELD WELD JOINTS FOR STAINLESS STEEL PIPE AND FITTINGS

- A. General
 - 1. Do not field weld pipe or fittings, unless field welding is approved in writing by the Engineer.
 - a. Welding in field shall be performed only when requested on shop drawings and accepted by Owner and Owner's Representative in writing as specified in this Section.
 - b. Field welding of pipe or fittings will only be considered by the Engineer if:
 - Contractor submits documentation of welder's certification to perform welding and documentation of welder's experience in welding the style of pipe; and Contractor can demonstrate that pipe can be welded to meet requirements of reference standards.
 - If field welding is not approved by the Engineer, provide clamp type coupling joints or flange joints, as specified in this Section and the appropriate piping material Section, at no additional cost to the Owner.
- B. Field Weld Joints for Stainless Steel Pipe and Fittings if Field Weld Joints are Allowed:
 - 1. Welding procedures for stainless steel pipe and fittings shall meet requirements of ANSI/AWS 10.4.
 - 2. Separate abutting pipe ends before welding, and completely fuse inside walls of pipe without overlapping. Welding shall be continuous around the joint and shall be completed without interruption. Welds shall be single "V" butt type, of sound weld metal thoroughly fused into the ends of pipe and into bottom of "V". Welds shall be free from cold spots, pin-holes, oxide inclusions, burrs, snags, rough projections, or other defects.
 - 3. Protect and finish stainless steel weld joints as follows:
 - a. Wire brush outside weld area. Remove weld splatter. Brushes shall be stainless steel and used only on stainless steel.
 - b. Remove surface oxidation by brushing or grinding and brushing.
 - c. Pickle the weld and heat-affected zone with field applied paste. Follow manufacturer's recommendations.

3.3 INSTALLING FLANGED PIPING

- C. Set pipe with the flange bolt holes straddling the pipe horizontal and vertical centerline. Install pipe without springing, forcing, or stressing the pipe or any adjacent connecting valves or equipment. Before bolting up, align flange faces to the design plane within 1/16 inch per foot measured across any diameter. Align flange bolt holes within 1/8-inch maximum offset.
- D. Inspection for Defects: Before installation, inspect pipe and appurtenances for defects and, when applicable, tap the pipe with a light hammer to detect cracks. Reject defective, damaged, or unsound pipe and appurtenances.
- E. Inspect each gasket to verify that it is the correct size, material, and type for the specified service and that it is clean and undamaged. Examine bolts or studs, nuts, and washers for defects such as burrs or cracks and rust and replace as needed.
- F. Clean flanges by wire brushing before installing flanged fittings. Clean flange bolts and nuts by wire brushing, lubricate carbon steel bolts with oil and graphite, and tighten nuts uniformly and progressively.
- G. Bolt lengths shall extend completely through their nuts. Any that fail to do so shall be considered acceptably engaged if the lack of complete engagement is not more than one thread.
- H. Do not use more than one gasket between contact faces in assembling a flanged joint.
- I. Tighten the bolts to the manufacturer's specifications, using the recommended cross bolt pattern in multiple steps of increasing torque, until the final torque requirements are achieved. Do not over torque.
- J. If flanges leak under pressure testing, loosen or remove the nuts and bolts, reset or replace the gasket, reinstall or retighten the bolts and nuts, and retest the joints. Joints shall be gas tight.
- K. Install threaded nut and bolt thread protection caps after completing the bolt, nut, and gasket installation. Install on exposed, buried, and submerged piping.

3.4 INSTALLATION OF STAINLESS STEEL BOLTS AND NUTS

- A. Prior to assembly, coat threaded portions of stainless steel bolts and nuts with lubricant.

3.5 INSTALLING SUBMERGERED, ABOVEGROUND, OR EXPOSED PIPING

- A. Set piping plumb and at the horizontal and vertical location shown on the Drawings. Provide pipe hangers and supports to maintain alignment, as determined by the seller based on the application.
- B. Install pipe without springing, forcing, or stressing the pipe or any adjacent connecting valves or equipment. Pipe penetrations through walls, slabs, and floors shall be as detailed on the Drawings or as allowed for alternate configurations as specified herein.
- C. Install pipe spools in walls and slabs before placing concrete.
- D. Inspection for Defects: Before installation, inspect pipe and appurtenances for defects and, when applicable, tap the pipe with a light hammer to detect cracks. Reject defective, damaged, or unsound pipe and appurtenances.
- E. Cutting: Cut pipe, when necessary, in a neat and workmanlike manner without damage to the pipe, interior lining, and exterior coating. Perform cutting with an approved mechanical cutter, using a wheel cutter when applicable and practicable.
- F. Cut pipe ends square, ream pipe and tube ends to full pipe diameter, remove burrs.
- G. Beveling: Grind smooth and bevel cut ends and rough edges using methods recommended by the manufacturer and approved by Engineer.
- H. Bolt holes of flanges shall straddle the horizontal and vertical centerlines of the pipe. Clean flanges by wire brushing before installing flanged fittings. Lubricate bolts and tighten nuts uniformly and progressively. If flanges leak under pressure testing, loosen or remove the nuts and bolts, reset or replace the gasket, reinstall or retighten the bolts and nuts, and retest the joints. Joints shall be watertight.
- I. Provide a flange insulation kit at all flanges between dissimilar metals whether shown on the Drawings or not.

3.6 FIELD INSTALLATION OF AUXILIARIES

- A. Mount field-installed auxiliary equipment, piping, conduit, instruments, coolers, seal pots, control panels, consoles, and so forth separately from the machine and driver unless such equipment is manufactured or fabricated as an integral part of the machine. These items shall not interfere with

removal of the machine or driver or with access to the machinery for normal operation and maintenance.

- B. Locate auxiliary support piping, conduit, instrumentation, and so forth, for a single drop area on the machinery baseplate or soleplate. Do not install piping, conduit, and other support systems at multiple locations on the base.
- C. Make openings for branch connections in piping of NPS 1 inch or smaller by drilling the run pipe. Do not perform torch cutting of any opening smaller than NPS 1 inch in diameter.
- D. Use process-compatible pipe joint compounds for threaded connections. Do not use PTFE tape pipe sealant or antiseize lubricants to make up any threaded connections in lubricating oil, seal fluid, buffer gas, or utility connections to any machine.
- E. Threaded connections shall have two to five exposed pipe threads after making up the joint.

3.7 STRAY ELECTRICAL CURRENTS

- A. Stray currents from welding can cause damage to seals, bearings, and other machinery components. Stray electrical currents can also magnetize machinery components that can later generate damaging currents. Conform to the following requirements for field welds around machinery.
- B. Attach welding ground cables adjacent to the place where the weld is being made. Attach the welding clamps onto the pipe near the weld and ground the welding machine properly. Do not use spring-type alligator clamps.
- C. Do not attach ground leads to any part of the machinery, auxiliary systems, or supports for any reason.
- D. Should it be necessary to attach piping to the machinery for the purpose of field welding, isolate the machinery from the pipe flange by using a full-circle 1/8-inch-thick composition gasket. Then install insulated bolts or studs. Then perform a continuity check to prove the electrical isolation of the machine from the piping.
- E. Measure and record machinery magnetic flux density readings before and after welding. If residual magnetism is in excess of 1 millitesla (10 gauss), degaussing shall be required.

3.8 INSTALLATION VERIFICATION

- A. Prior to checking final piping alignment to the machinery, the piping system shall be complete as follows.
- B. Complete pipe pressure testing and drying out of the system and remove hydrotest blind flanges.
- C. Install and adjust permanent supports and hangers.
- D. Remove temporary supports and hangers.
- E. All the system piping components and machinery shall be at the same ambient temperature within a range of 18 degrees F before starting final piping alignment checks.
- F. Verify that the machine inlet and outlet piping is properly constructed. This inspection shall include verification of gasket material, gasket size, and the material, size, and length of flange bolts, studs, and nuts.
- G. Inspect the machine to verify that it is still removable. This means that sufficient flanged, threaded, and grooved-end piping connections exist to completely remove the machinery from the mounting plate for maintenance without requiring the cutting or welding of pipe or tubing.

3.9 FLANGE AND PIPING ALIGNMENT REQUIREMENTS

- A. Do not spring flanges of connecting piping into position.
- B. Line up pipe flange bolt holes with machinery nozzle bolt holes within 1/16 inch maximum offset from the center of the bolt hole to permit insertion of bolts without applying any external force to the piping.
- C. The machine and piping flange faces shall be parallel to less than 0.001 inch per inch of pipe flange outer diameter up to a maximum of 0.030 inch. For piping flange outer diameters smaller than 10 inches, the flanges shall be parallel to 0.010 inch or less. For raised face flanges, feeler gauge readings shall be taken at the raise face.
- D. Flange face separation shall be within the gasket spacing plus or minus 1/16 inch. Use only one gasket per flanged connection.

3.10 PIPING ALIGNMENT

- A. The objective of the following requirements is to verify that strains imposed by the piping on the machinery are minimized. Less strain imposed on the machine casing results in less distortion of running clearances and better machine performance and reliability.
- B. Separately work machinery inlet and outlet piping systems into position to bring the piping flanges into alignment with the matching machinery flanges. Do not move machinery to achieve piping alignment. Do not use electrical heating stress relieving to achieve piping alignment.
- C. Remove temporary supports for piping alignment (such as chain falls and wedges) during final alignment readings and piping bolt-up. Support piping by permanent fixed and spring supports and hangers. Piping shall not be binding on pipe guides or restraints.
- D. Measure pipe strain while all piping connections are being made to the machine. This includes lubricating oil piping, bearing cooling water piping, seal water piping, auxiliary piping such as steam, air, and flushing medium, as well as process piping and electrical conduits.
- E. For pieces of machinery with common piping such as pairs of pumps, monitor both shaft alignments during pipe installation and connection operations. Additionally, all of the machinery shall be bolted up at the same time with indicator readings taken on each shaft simultaneously.

3.11 PIPE STRAIN MEASUREMENT

- A. Install an alignment bracket on the coupling hub or shaft of the machine being checked for pipe strain.
- B. Mount indicators on the coupling hub to measure vertical and horizontal movement on the machine as the flange bolts are being tightened.
- C. Bolt-up of the piping flanges to the machinery flanges shall proceed with the largest flanges first. Complete bolt-up in a continuous effort without disturbing the location of the dial indicators.
- D. Use torque wrenches to tighten flange bolts. Initial tightening of the flange bolts shall be snug (10 percent of the total torque). Tighten flange bolts to 30 percent of final torque. Then tighten the flange bolts to 100 percent of final torque. Piping bolt torque values shall be specified by the machinery manufacturer taking into account whether bolt threads are lubricated or nonlubricated.

3.12 MISCELLANEOUS REQUIREMENTS

- A. After final piping connection, final shaft alignment shall be verified and all machinery shall be hand rotated to ensure that neither binding nor case distortion has occurred during piping installation.

3.13 PAINTING AND COATING

- A. Coat exposed carbon steel pipe and fittings per Section 099000, System No. 18.
- B. Do not coat stainless steel pipe and fittings.

END OF SECTION

SECTION 402090
PVC & CPVC PIPE (3 INCHES AND SMALLER)

PART 1 GENERAL

1.1 DESCRIPTION

- A. This section includes:
 - 1. Materials, installation, and testing of PVC pipe and fittings of size 3 inches and smaller for use in process piping having a maximum design pressure of 150 psi and having a maximum design temperature of 105 degrees F.
 - 2. Materials, installation, and testing of chlorinated polyvinyl chloride (CPVC) pipe and fittings of size 3 inches and smaller for use in process piping having a maximum design pressure of 150 psi at a maximum operating temperature of 105 degrees F and a maximum design pressure of 100 psi at a temperature of 140 degrees F.

1.2 RELATED WORK SPECIFIED ELSEWHERE

- A. Painting and Coating: 099000.
- B. Trenching and Backfilling: 312333.
- C. General Piping Requirements: 400500.
- D. Pressure Testing of Piping: 400515.
- E. Wall Pipes, Seep Rings, and Penetrations: 400762.
- F. Pipe Hangers and Supports: 400764.
- G. Equipment, Piping, and Valve Identification: 400775.
- H. PVC Pipe (4 Inches and Larger): 402091.

1.3 SUBMITTALS

- A. Submit shop drawings in accordance with Section 013300.
- B. Submit materials list showing materials of pipe and fittings with ASTM reference and grade. Submit manufacturer's certification of compliance with referenced standards, e.g., ASTM D1784, D1785 (PVC), F441 (CPVC), F439 (CPVC), and D2467 (PVC). Show wall thickness of pipe and fittings. Show fitting dimensions.
- C. Submit data sheets for solvent cement and demonstrating compliance with ASTM D2564, F493 (CPVC), and F656.
- D. Submit certification from manufacturer that all pipes and fittings are NSF approved for conveying potable water.

1.4 WARRANTY

- A. Full warranty against defects in materials and workmanship for one year after FINAL ACCEPTANCE, including all parts, labor, and expenses.

PART 2 PRODUCTS

2.1 PIPE

- A. PVC Pipe shall be Schedule 80, Type I, Grade 1 (Class 12454-B), conforming to ASTM D1784 and D1785.
- B. CPVC Pipe shall be Schedule 80, Type IV, Grade 1 (Class 23477-B), conforming to ASTM D1784 and F441.

2.2 PVC PIPE COLORING AND MARKING FOR RECLAIMED WATER; OR IRRIGATION>> SERVICE

- A. PVC pipe shall be purple (Pantone 522) and shall be marked on both sides of the pipe with the wording "CAUTION: RECLAIMED or IRRIGATION WATER--DO NOT DRINK." The lettering shall be minimum 1-inch-high black letters and shall be repeated at intervals not exceeding 36-inches. The purple coloring shall be achieved by adding pigment to the PVC material as the pipe is being manufactured.

2.3 FITTINGS

- A. PVC Fittings shall be Schedule 80 and shall conform to ASTM D2464 for threaded fittings and ASTM D2467 for socket-type fittings.

- B. CPVC Fittings shall be Schedule 80 and shall conform to ASTM F437 for threaded fittings and ASTM F439 for socket-type fittings.

2.4 FLANGES

- A. PVC and CPVC flanges shall be of the one-piece solid socket design and shall be made of the same material as the pipe. Pressure rating shall be at least 150 psi at a temperature of 73 degrees F. Minimum burst pressure shall be 500 psi. Flanges shall match the dimensions of ASME B16.5, Class 150, steel flanges for outside diameter, bolt circle, and bolt holes. Do not use Van Stone flanges.

2.5 UNIONS

- A. PVC Unions shall have socket-type ends, Viton O-rings, and shall be Schedule 80. Material shall be Type I, Grade 1 PVC, per ASTM D1784.
- B. CPVC Unions shall have socket-type ends, Viton O-rings, and shall be Schedule 80. Material shall be Type IV, Grade 1 CPVC, per ASTM D1784.
- C. Union connections to other metal piping materials shall comply with MSS SP-107. The fitting end for connection to CPVC pipe shall be a female socket. Provide wrought or cast copper tailpieces for connection to copper piping and tubing. Provide Type 316 stainless steel tailpieces for connection to steel piping.

2.6 JOINTS

- A. Pipe and fitting joints shall be socket welded except where threaded and flanged joints are required to connect to valves and equipment.

2.7 SOLVENT CEMENT (IN OTHER THAN PAA OR SODIUM HYPOCHLORITE SERVICE)

- A. PVC Solvent cement for socket joints shall comply with ASTM D2564 and F656.
- B. CPVC Solvent cement for socket joints shall comply with ASTM F493. Use the type of solvent cement as recommended in ASTM F493, Appendix X2.

2.8 SOLVENT CEMENT IN SODIUM HYPOCHLORITE SERVICE

- A. Solvent cement shall be free of silica. Products: IPS "Weld-On" PVC or CPVC 724 or Oatey "Lo V.O.C. PVC or CPVC Heavy Duty Gray."

2.9 GASKETS FOR FLANGES

- A. See Section 400500.

2.10 BOLTS AND NUTS FOR FLANGES

- A. See Section 400500.

2.11 LUBRICANT FOR STAINLESS STEEL BOLTS AND NUTS

- A. See Section 400500.

2.12 WYE STRAINERS

- A. PVC and CPVC wye strainers shall be manufactured of the same material as the pipe, with 30-mesh screens and Viton seals. Connecting ends shall be the socket type, solvent welded. Provide one spare screen for each strainer.

PART 3 EXECUTION

3.1 GENERAL

- A. Do not install PVC or CPVC pipe when the temperature is below 40°F or above 90°F. Store loose pipes on racks with a maximum support spacing of 3 feet. Provide shades for pipe stored outdoors or installed outdoors until the pipe is filled with water.
- B. Store fittings indoors in their original cartons.
- C. Store solvent cement indoors or, if outdoors, shade from direct sunlight exposure. Do not use solvent cements that have exceeded the shelf life marked on the storage container.
- D. Before installation, check pipe and fittings for cuts, scratches, gouges, buckling, kinking, or splitting on pipe ends. Remove any pipe section containing defects by cutting out the damaged section of pipe.
- E. Do not drag PVC or CPVC pipe over the ground, drop it onto the ground, or drop objects on it.

3.2 SOLVENT-WELDED JOINTS

- A. Prior to solvent welding, remove fittings and couplings from their cartons and expose them to the air at the same temperature conditions as the pipe for at least one hour.

- B. Cut pipe ends square and remove all burrs, chips, and filings before joining pipe or fittings. Bevel solvent-welded pipe ends as recommended by the pipe manufacturer.
- C. Wipe away loose dirt and moisture from the inside and outside of the pipe end and the inside of the fitting before applying solvent cement. Clean the surfaces of both pipes and fittings that are to be solvent welded with a clean cloth moistened with acetone or methylethyl ketone. Do not apply solvent cement to wet surfaces.
- D. The pipe and fitting socket shall have an interference fit. Perform a dry fit test at each joint before applying solvent cement. The pipe shall enter the fitting socket between one-third and two-thirds of the full socket depth when assembled by hand.
- E. Make up solvent-welded joints per ASTM D2855 (PVC) or F493 Appendix X1 (CPVC). Application of cement to both surfaces to be joined and assembly of these surfaces shall produce a continuous bond between them with visual evidence of cement at least flush with the outer end of the fitting bore around the entire joint perimeter.
- F. Allow at least eight hours of drying time before moving solvent-welded joints or subjecting the joints to any internal or external loads or pressures.
- G. Acceptance criteria for solvent-welded joints shall be as follows:
 - 1. Unfilled Areas in Joint: None permitted.
 - 2. Unbonded Areas in Joint: None permitted.
 - 3. Protrusion of Material into Pipe Bore, Percent of Pipe Wall Thickness: Cement, 50 Percent.

3.3 FLANGED JOINTS

- A. Lubricate carbon steel bolt threads with graphite and oil before installation.
- B. Tighten bolts on PVC and CPVC flanges by tightening the nuts diametrically opposite each other using a torque wrench. Complete tightening shall be accomplished in stages and the final torque values shall be as follows:
 - 1. Pipe Size of 1/2 to 1-1/2 Inches: 10 to 15 foot-pounds Final Torque.
 - 2. Pipe Size of 2 to 3 Inches: 20 to 30 foot-pounds Final Torque.

3.4 INSTALLATION OF STAINLESS STEEL BOLTS AND NUTS

- A. See Section 400500.

3.5 THREADED JOINTS

- A. Cut threaded ends on PVC or CPVC to the dimensions of ASME B1.20.1. Ends shall be square cut. Follow the pipe manufacturer's recommendations regarding pipe hold-down methods, saw cutting blade size, and saw cutting speed.
- B. Pipe or tubing cutters shall be specifically designed for use on PVC or CPVC pipe. Use cutters manufactured by Reed Manufacturing Company, Ridge Tool Company, or equal.
- C. If a hold-down vise is used when the pipe is cut, insert a rubber sheet between the vise jaws and the pipe to avoid scratching the pipe.
- D. Thread cutting dies shall be clean and sharp and shall not be used to cut materials other than plastic.
- E. Apply Teflon® thread compound or Teflon® tape lubricant to threads before screwing on the fitting.

3.6 INSTALLING UNIONS

- A. Provide unions on exposed piping 3 inches and smaller as follows:
 - B. At every change in direction (horizontal and vertical).
 - C. Six to twelve inches downstream of valves.
 - D. Every 40 feet in straight pipe runs.
 - E. Where shown in the drawings.

3.7 INSTALLING BURIED PIPE

- A. Install in accordance with Section 312333 and as follows.
 - B. Trench bottom shall be continuous, smooth, and free of rocks. See the details in the drawings for trench dimensions, pipe bedding, and backfill.
 - C. After the pipe has been solvent-welded and the joints have set, snake the pipe in the trench per the pipe manufacturer's recommendations in order to allow for thermal expansion and contraction of the pipe.

- D. Do not backfill the pipe trench until the solvent-welded joints have set. Support the pipe uniformly and continuously over its entire length on firm, stable soil. Do not use blocking to change pipe grade or to support pipe in the trench.
- E. Install buried PVC and CPVC pipe in accordance with ASTM D2774 and the pipe manufacturer's recommendations. Backfill materials in the pipe zone shall be imported sand per Section 312333.

3.8 INSTALLING ABOVEGROUND OR EXPOSED PIPING

- A. See Section 400500.
- B. Fill empty piping with water and provide temporary shading or other means to keep the surface temperature of the pipe below 100 degrees F.

3.9 PAINTING AND COATING

- A. Coat interior piping per Section 099000, System No. 30.
- B. Coat exterior piping per Section 099000, System No. 9.

3.10 HYDROSTATIC TESTING

- A. Perform hydrostatic testing for leakage in accordance with Section 400515.

END OF SECTION

SECTION 402091
PVC PIPE (4 INCHES AND LARGER)

PART 1 GENERAL

1.1 DESCRIPTION

- A. This section includes materials, installation, and testing of PVC pipe and fittings of size 4 inches and larger for use in aboveground or otherwise exposed process piping having a maximum design pressure of 50 psi and a maximum design temperature of 105 degrees F.

1.2 RELATED WORK SPECIFIED ELSEWHERE

- A. Painting and Coating: 099000.
- B. Trenching and Backfilling: 312333.
- C. General Piping Requirements: 400500.
- D. Pressure Testing of Piping: 400515.
- E. Wall Pipes, Seep Rings, and Penetrations: 400762.
- F. PVC & CPVC Pipe and Fittings, 3 Inches and Smaller: 402090.

1.3 SUBMITTALS

- A. Submit shop drawings in accordance with Section 013300.
- B. Submit materials list showing materials of pipe and fittings with ASTM reference and grade. Submit manufacturer's certification of compliance with referenced standards, e.g., ASTM D1784, D1785, D2467, and ASME B31.3. Show wall thickness of pipe and fittings. Show fitting dimensions.
- C. Submit data sheets for solvent cement and demonstrating compliance with ASTM D2564 and F656.
- D. Submit piping layout drawings showing location and dimensions of pipe and fittings. Include laying lengths of valves, meters, in-line pumps, and other equipment determining piping dimensions. Label or number each fitting or piece of pipe. Show location and detail of every pipe hanger and pipe support.
- E. Submit manufacturer's recommended torques for tightening bolts on flanged connections.
- F. Submit manufacturer's recommended method of installing solvent welded and hot gas welded joints. Submit bonding procedure specification (BPS) developed in accordance with ASME B31.3 (2006 edition), Chapter VII, Part 9, paragraph A328.2.
- G. Submit the names of employees to be utilized on the project who have been qualified per the BPS to make solvent-welded joints and hot gas welded joints. Submit the results of the BPS qualification tests per ASME B31.3, Chapter VII, Part 9, paragraphs A328.2.4 and A328.2.5 for each such employee.
- H. If any fabricated branch connections or tees are used, submit design calculations, service experience records, and performance test records per ASME B31.3, Chapter VII, Part 2, paragraph A304.7.2.
- I. Submit certification from manufacturer that all pipes and fittings are NSF approved for conveying potable water.

1.4 MANUFACTURER'S SERVICE

- A. Provide pipe manufacturer's services at the jobsite for the following minimum labor days, travel time excluded:
- B. One labor day to instruct the Contractor's personnel in the preparation and execution of solvent-welded and hot gas welded joints for the sizes of pipes to be installed in the project.
- C. One person to observe and advise during the assembly and installation of every pipe joint assembly in the project, including hot gas welding for repairing joints. The manufacturer's representative shall be qualified to make both solvent-welded joints and hot gas welded joints per the BPS.

1.5 WARRANTY

- A. Full warranty against defects in materials and workmanship for one year after FINAL ACCEPTANCE, including all parts, labor, and expenses.

PART 2 PRODUCTS

2.1 PIPE

- A. Pipe shall be Schedule 40 or 80, as shown, Type I, Grade 1 (Class 12454-B), conforming to ASTM D1784 and D1785.

- B. Diffuser piping supplied by others will utilize other piping standards.

2.2 FITTINGS

- A. Fittings shall be socket type, Schedule 40 or 80, as shown, and shall conform to ASTM D2467.
- B. Fabricated branch connections or tees may be used only where the type or size of fitting is not described in ASTM D2467. Joints and seams in fabricated fittings shall be in accordance with ASME B31.3 (2006 edition), Chapter VII, Part 9, paragraph A328.5.4. The design and fabrication of such branch connection and tees shall be in accordance with ASME B31.3, Chapter VII, paragraphs A304.3 and A328.5.2. Minimum wall thickness shall be equivalent to that of Schedule 80 pipe.

2.3 FLANGES

- A. PVC flanges shall be of the one-piece solid socket design and shall be made of the same material as the pipe. Pressure rating shall be at least 150 psi at a temperature of 73 degrees F. Minimum burst pressure shall be 500 psi. Flanges shall match the dimensions of ASME B16.5, Class 150 steel flanges for outside diameter, bolt circle, and bolt holes.

2.4 JOINTS

- A. Pipe and fitting joints shall be socket welded except where flanged joints are required to connect to valves and equipment.

2.5 SOLVENT CEMENT

- A. Solvent cement for socket joints shall comply with ASTM D2564 and F656.

2.6 GASKETS FOR FLANGES

- A. See Section 400500.

2.7 BOLTS AND NUTS FOR FLANGES

- A. See Section 400500.

2.8 LUBRICANT FOR STAINLESS STEEL BOLTS AND NUTS

- A. See Section 400500.

PART 3 EXECUTION

3.1 GENERAL

- A. Do not install PVC pipe when the temperature is below 40 degrees F or above 90 degrees F. Store loose pipes on racks with a maximum support spacing of 3 feet. Provide shades for pipe stored outdoors or installed outdoors until the pipe is filled with water.
- B. Store fittings indoors in their original cartons.
- C. Store solvent cement indoors or, if outdoors, shade from direct sunlight exposure. Do not use solvent cements that have exceeded the shelf life marked on the storage container.
- D. Before installation, check pipe and fittings for cuts, scratches, gouges, buckling, kinking, or splitting on pipe ends. Remove any pipe section containing defects by cutting out the damaged section of pipe.
- E. Do not drag PVC pipe over the ground, drop it onto the ground, or drop objects on it.

3.2 SOLVENT-WELDED AND HOT GAS WELDED JOINTS

- A. Bonding requirements shall be in accordance with ASME B31.3 (2006 edition), Chapter VII, Part 9. Bonding shall include both solvent welding or cementing and hot gas welding.
- B. Prior to solvent welding, remove fittings and couplings from their cartons and expose them to the air at the same temperature conditions as the pipe for at least one hour.
- C. Cut pipe ends square and remove burrs, chips, and filings before joining pipe or fittings. Bevel pipe ends as recommended by the pipe manufacturer in the BPS.
- D. Wipe away loose dirt and moisture from the inside and outside diameters of the pipe end and the inside diameter of the fitting before applying solvent cement. Clean the surfaces of both pipes and fittings that are to be solvent welded with a clean cloth moistened with acetone or methyl ethyl ketone. Do not apply solvent cement to wet surfaces.
- E. The pipe and fitting socket shall have an interference fit. Perform a dry fit test at each joint before applying solvent cement. The pipe shall enter the fitting socket between one-third and two-thirds of the full socket depth when assembled by hand.
- F. Make field solvent-welded and hot gas welded joints only in the presence of the pipe manufacturer's

representative who shall instruct and advise the Contractor's personnel in the assembly of the joints. Joint bonding shall be done in accordance with a BPS established by the pipe manufacturer. Qualification of the BPS shall be in accordance with ASME B31.3, Chapter VII, Part 9, paragraphs A328.2 through A328.5. Each person who will perform bonding shall be qualified in executing the BPS per paragraph A328.2.5.

- G. Make up solvent-welded joints per ASTM D2855 and the BPS. Application of cement to both surfaces to be joined and assembly of these surfaces shall produce a continuous bond between them with visual evidence of cement at least flush with the outer end of the fitting bore around the entire joint perimeter.
- H. Allow at least eight hours of drying time before moving solvent welded joints or subjecting the joints to any internal or external loads or pressures.
- I. After completion of the solvent-welded joints, subject the piping system to a hydrostatic test pressure of 75 psi per Section 400515. Solvent-welded joints that show minor weeping at isolated points around the circumference of the joint may be repaired by the hot gas welding method. There shall be no more than one point of weeping for every 12 inches of circumference of the pipe. Remove solvent-welded joints that show excessive leakage and assemble new joints.
- J. The hot gas welding method shall produce a continuous seal at the fillet formed by the junction of the fitting socket entrance and the pipe. Use a hot gas welding procedure per the BPS and the following to melt a plastic filler rod and the surfaces of the pipe in the fillet area. Force the softened rod into the softened fillet. Provide the hot gas weld around the entire circumference of the solvent-welded joint.
- K. Terminate a hot gas weld by lapping the bead on top of itself for a distance of 3/8 inch to 1/2 inch. Do not terminate a hot gas weld by overlapping the bead side by side.
- L. Provide three weld passes on each hot gas welded joint. Deposit the first bead at the bottom of the fillet. Deposit the second and third beads on each side of the first bead. Stagger the starting point for each bead and allow each weld pass to cool before proceeding with the next pass.
- M. Upon completion of each hot gas welded bead, check that the filler rod has completely fused into the base pipe. If the filler rod can be removed or pulled back from the base material, then reject the entire hot gas weld. Reject any hot gas welds showing brown or black discoloration.
- N. Upon completion of the hot gas welded joints, subject the piping system to a test pressure of 75 psi per Section 400515. Cut out, remove, and replace any joints that are leaking. No rework of leaking hot gas welded joints will be permitted.
- O. Acceptance criteria for solvent-welded and hot gas welded joints shall be as follows:
 - 1. Kind of Imperfection: Cracks.
 - a. Hot Gas Welded Joints: None permitted.
 - b. Solvent Cemented Joints: Not applicable.
 - 2. Kind of Imperfection: Unfilled areas in joint.
 - a. Hot Gas Welded Joints: None permitted.
 - b. Solvent Cemented Joints: None permitted.
 - 3. Kind of Imperfection: Unbonded areas in joint.
 - a. Hot Gas Welded Joints: Not applicable.
 - b. Solvent Cemented Joints: None permitted.
 - 4. Kind of Imperfection: Inclusions of charred material.
 - a. Hot Gas Welded Joints: None permitted.
 - b. Solvent Cemented Joints: Not applicable.
 - 5. Kind of Imperfection: Unfused filler material inclusions.
 - a. Hot Gas Welded Joints: None permitted.
 - b. Solvent Cemented Joints: Not applicable.
 - 6. Kind of Imperfection: Protrusion of material into pipe bore, percent of pipe wall thickness.
 - a. Hot Gas Welded Joints: Not applicable.
 - b. Solvent Cemented Joints: Cement, 50 percent.

3.3 FLANGED JOINTS

- A. Lubricate bolt threads with graphite and oil before installation.
- B. Tighten bolts on PVC flanges by tightening the nuts diametrically opposite each other using a torque wrench. Complete tightening shall be accomplished in stages and the final torque values shall be as follows:
 - 1. Pipe Size of 4 inches: 20 to 30 foot-pounds Final Torque.

2. Pipe Size of 6 to 8 inches: 33 to 50 foot-pounds Final Torque.

3.4 INSTALLATION OF STAINLESS STEEL BOLTS AND NUTS

A. See Section 400500.

3.5 INSTALLING ABOVEGROUND AND EXPOSED PIPING

A. See Section 400500.

B. Fill empty piping with water, provide temporary shading, or other means to keep the surface temperature of the pipe below 100 degrees F.

3.6 PAINTING AND COATING

A. Coat interior piping per Section 099000, System No. 30

B. Coat exterior piping per Section 099000, System No. 9

3.7 FINAL HYDROSTATIC TESTING

A. Perform final hydrostatic testing for leakage in accordance with Section 400515 after all joints have been tested and defective joints have been repaired or replaced.

END OF SECTION

SECTION 407100

FLOW AND LEVEL MEASUREMENT

PART 1 GENERAL

1.1 SUMMARY

- A. This section describes requirements for the following flow metering devices:
 - 1. Electronic-type flow meters:
 - a. Magnetic flow meters, inline-type **(Not Applicable)**
 - 2. Mechanical-type flow meters:
 - a. Positive displacement meters (5/8-inch to 2-inch).
 - 3. Open channel flow meters: **(Not Applicable)**
 - a. Flow metering weirs.
 - b. Flumes.
 - 4. Other devices:
 - a. Level Elements
 - b. Flow switches.

1.2 SUBMITTALS

- A. General: Submit shop drawings in accordance with the submittal procedures of the General Requirements.
- B. Product Data:
 - 1. Submit manufacturer's descriptive literature and product specifications for each product.
 - 2. Materials of construction shall describe any applicable material specifications (e.g., AISI, ASTM, CDA, SAE) as well as grade or type.
 - 3. Use equipment tag numbering to correlate each product with the relevant product data.
- C. Shop Drawings:
 - 1. Indicate typical layout including dimensions and minimum laying lengths of unimpeded flow.
 - 2. Submit detail drawings of the flow meter
 - 3. If Contract Documents were marked for dimension verification by Contractor, submit drawings showing field measured dimensions.
 - 4. Submit detail drawings of specialty accessory components not included in manufacturer's product data.

1.3 WARRANTY

- A. Full warranty against defects in materials and workmanship for two years including all parts, labor, and expenses.

PART 2 PRODUCTS

2.1 MATERIALS OF CONSTRUCTION

- A. All materials of construction for components that will contact potable water or will contact water indented to become potable must conform to NSF/ANSI Standard 61.
- B. Unless specified otherwise in this Section, meters with bronze main cases shall utilize bronze or 18-8 stainless steel case bolts (capscrews)

2.2 ELECTRONIC-TYPE FLOW METERS:

- A. Magnetic flow meters, inline-type. **(Not Applicable)**
 - 1. Manufacturers: Rosemount, Badger or equal.
 - 2. The magnetic flow meter shall be an obstructionless pipeline-mounted instrument to magnetically measure the flow of fluid.
 - 3. The output signal shall not be affected by changes in fluid viscosity or density and shall have zero-point stability and auto zeroing functions.
 - 4. The magnetic flow meter shall have a drip- and splash-proof sensor, capable of withstanding temporary submersion of up to 30 feet of water for 48 hours.
 - 5. The magnetic flow meter shall have an integral terminal box with watertight cable seals.

6. Interconnecting cables.
 - a. Provide stainless steel grounding rings and grounding straps per manufacturer's requirements.
7. Materials of Construction
 - a. Flangeless Meters: The flow tube shall be flangeless wafer construction with cast aluminum enclosure. Provide bolting kit.
 - b. Flanged Meters: The flow tube shall be Type 304 stainless steel with carbon steel flanges.
8. Indicator/Totalizer
 - a. The indicator/totalizer shall accept the process flow signal from the magnetic flow meter and convert its electrical output signals directly proportional to the instantaneous metered flow rate. The housing shall be suitable for field mounting.
9. Transmitter
 - a. The transmitter shall be microprocessor based with flow rate indicator in engineering units, forward, reversed, and net flow totalizer, all in user-selectable engineering units. The display shall also be capable of indicating alarm status and velocity of fluid. The transmitter shall be mounted on Unistrut near the flow meter. The transmitter shall output a 4-20 mA signal to the Mission Monitoring panel, and a 4-20 mA signal directly to the Peroxyacetic Acid Pump P-461.
10. Interconnecting Cable
 - a. The interconnecting cable between the sensor and the transmitter shall be furnished by the magnetic flow meter manufacturer.
11. The overall system's performance shall be as follows:
 - a. Accuracy: 0.5% of flow rate with minimum fluid velocity of 1 fps.
 - b. Repeatability: $\pm 0.1\%$ of flow rate.
 - c. The accuracy of each meter shall be verified by calibration in a flow laboratory traceable to the U.S. National Institute of Standards and Technology.
 - d. Adjustable full-scale range.
 - e. Outputs: Bidirectional, isolated 4- to 20-mA d-c and either 24-volt d-c scaled pulse, or 0- to 10-KHz frequency.
 - f. Power Consumption: 20 watts maximum.
 - g. Temperature Limits, Ambient: -20°F to $+140^{\circ}\text{F}$.
 - h. The flow meter shall have a positive zero return (PZR) input controlled by an external dry contact.
 - i. The meter shall have empty pipe detection.
 - j. A common alarm discrete output (a dry contact or a transistor switch) shall be provided for remote indication of fault conditions.

2.3 MECHANICAL-TYPE FLOW METERS:

- A. Positive displacement meters (5/8-inch to 2-inch) shall be used to monitor potable water consumption and used in addition to utility supplied meter.
 1. Meters shall be positive displacement type, oscillating piston, with sealed register and magnetic drive.
 2. Meters shall conform, except as otherwise specified herein, to the requirements of AWWA C700.
 3. Manufacturers: Sensus, Badger, or equal.
 4. Meters shall register not less than 98.0% or more than 101.5% of actual flow at any flow rate within the normal flow limits specified below:

Meter Size (inches)	Normal Flow Limit (gpm)	Max. Pressure Drop (psi)
5/8 x 3/4	1 to 20	11.0
3/4	2 to 30	11.5
1	3 to 50	11.5
1 1/2	5 to 100	12.0
2	8 to 160	12.5

5. Pressure drop through meters, when operated within specified normal flow limits, shall not exceed the -specified values above.
6. Registers shall be magnetically coupled to the meter and shall be hermetically sealed.
7. Register shall be a six-digit direct-reading totalizer type, calibrated in U.S. gallons.
8. Housing shall be bronze.

9. Disc shall be plastic or hard rubber.
10. Disc spindle, thrust roller insert, and magnet spindle shall be Type 316 stainless steel.
11. End Connections shall be threaded, NPSM, ASME B1.20.1.
12. The pressure rating shall be 150 psi, unless otherwise indicated on Bid Documents.
13. Meter flow accuracy shall be \pm over the flow ranges of meter.

2.4 OPEN CHANNEL FLOW METERS:

A. UltraSonic Level Sensor and Transmitter (**Not Applicable**)

1. Acceptable Manufacturer:
 - a. Eastech
 - b. Milltronics
 - c. Endress + Hauser
 - d. Magnetrol
2. Materials:
 - a. Sensor wetted parts: PVC, polypropylene, KYNAR or polyvinylidene fluoride (PVDF)
3. Design and fabrication:
 - a. Sensor:
 - 1) Emits Ultrasonic sound.
 - 2) Detects return echo reflected from surface and converts it to electrical energy proportional to level
 - b. Temperature compensated
 - c. Capable of being configured to ignore false targets.
 - d. Operating temperature: -4 to 140 Degrees Fahrenheit
 - e. Humidity: 95 percent non-condensing.
 - f. Transmitter:
 - 1) Capable of producing output signal proportional to level of 4-20 mA DC into 500-ohm load.
 - 2) Power Supply: 120 Vac (+/-10 percent), 60 Hz.
 - 3) Inaccuracy: 0.25 percent of range or 0.24 IN, whichever is greater.
 - 4) Resolution: 0.1 percent of span or 0.08 IN, whichever is greater.
 - 5) Display: Four-digit LED or LCD scalable to engineering units with selectable decimal point.
 - 6) Temperature: -5 to 122 Deg F.
 - 7) Humidity: 95 percent noncondensing.
 - 8) Memory: EEPROM (non-volatile).
 - 9) Keypad programmer.

2.5 PRESSURE TRANSMITTER LEVEL ELEMENTS:

A. Pressure Transmitters:

1. Acceptable Manufacturers:
 - a. Rosemount, Model 3051
 - b. Foxboro, I/A series.
 - c. Honeywell 100e.
2. Materials:
 - a. Process flanges and adapters: (316 Stainless Steel)
 - b. Housing: (Aluminum)
 - c. Vent/Drain Valve: (316 Stainless Steel)
 - d. Fill Fluid:
 - 1) Utilize manufacturer's standard fill for other applications.
 - (a) Ensure fill is suitable for application temperatures.

3. Design and Fabrication:
 - a. Smart Transmitters utilizing microprocessor based electronics.
 - b. Output: 4-20 mA DC proportional to pressure.
 - c. Nonvolatile memory.
 - d. Power Supply: 24 Vdc.
 - e. Adjustable zero and span.
 - f. Temperature limits: -20 to 180 Degrees Fahrenheit
 - 1) -4 to 175 Degrees Fahrenheit for LCD indicators.
 - g. Overpressure Limits: Withstand 150 percent of stated maximum service pressure without damage.
 - h. Humidity Limits: 0 to 100 Percent Relative Humidity
 - i. Damping: Adjustable between 0 and 32 Seconds.
 - j. Inaccuracy (includes effects of linearity, repeatability, and hysteresis): +/-0.10 percent of calibrated span for 15:1 rangeability.

2.6 OTHER FLOW DEVICES

A. Level Elements

1. Submersible Transmitter Level Element **(Not Applicable)**

a. Float switches.

- LS-1-Pump Stop for Duplex Raw Sewage Pumping System, to be provided by pump supplier.
- LS-2-Lead Pump Start for Duplex Raw Sewage Pumping System, to be provided by pump supplier.
- LS-3-Lag Pump Start for Duplex Raw Sewage Pumping System, to be provided by pump supplier.
- LS-4-Pump Stop Simplex Wet Weather Pumping System, to be provided by pump supplier
- LS-5-Lead Pump Start for Simplex Wet Weather Pumping System, to be provided by pump supplier.
- LS-6-High Level Alarm for Wet Weather Tank, to be provided by Contractor and to be powered directly through the Remote Monitoring System.

PART 3 – EXECUTION

3.1 ERECTION, INSTALLATION, AND APPLICATION

- A. Install, erect, apply, or otherwise place products in accordance with manufacturers printed instructions, GLUMRB Recommended Standards for Water Works and Wastewater Facilities, relevant AWWA standards, and applicable standards promulgated by local jurisdictional authority.
- B. Install plumb, level, and square as shown on Drawing, free from warp or twist while maintaining dimensional tolerances and alignment with surrounding construction or adjacent surfaces.
- C. Install observing minimum laying lengths of unimpeded upstream and downstream flow, using tube elements or radial vane elements if necessary to provide accurate metering operation.
- D. Provide the necessary couplings and fittings to complete meter connections to any piping, tubing, valves, and curb stops.
 1. For each flow meter installed in flanged or grooved piping, provide a replacement spool the same length of the meter, with gaskets, made of the same material as the adjoining piping.
 2. For positive displacement fittings shall be bronze: Ford, James Jones, Mueller, or equal.
- E. Magnetic flow meters shall be provided with ground to adjacent pipe. Locate to ensure full pipe at all times.

3.2 FLOW AND LEVEL MEASUREMENT SCHEDULE

A.

Herrington Haven	
<u>Product</u>	<u>Location</u>
Floats	LS-1, LS-2, & LS-3 LS-4, LS-5, & LS-6

END OF SECTION

PAGE INTENTIONALLY LEFT BLANK

SECTION 460529
BLOWERS AND BLOWER CONTROLS

PART 1 GENERAL

1.1 SECTION INCLUDES

- A. Installation of Owner Furnished Blowers for aeration air supply and Blower Controls.
- B. Woodland Acres: The Blower and Blower Control systems shall include Blowers BLWR-231 & BLWR-232. Control panel shall include VFDs, cooling fans, circuit protection, ON/OFF switches, and run lights. These items shall be supplied by HAC Group.
- C. Each blower shall be supplied with a check valve and a pressure relief valve, shipped loose for installation by Contractor. Note that the plans do not show the check valve or relief valve, but each of these shall be installed by Contractor, and spatial provisions were made in Plans to accommodate the addition of these items.
- G. The Contractor will be directly responsible for providing and installing all items not listed above for complete blower and blower control systems, including but not limited to the blower equipment pads, downstream process air vibration isolators, isolation valves, piping and appurtenances, communications conduit and cables routed to Remote Monitoring controls, site work, electrical distribution, etc. Installation shall include the Contractor directly performing startup and commissioning of the blowers and blower controls and coordinating remotely with the Blower and Blower Controls supplier (HAC Group) and Engineer.

1.2 REFERENCE STANDARDS

- A. ABMA STD 9 - Load Ratings and Fatigue Life for Ball Bearings; 1990 (Reapproved 2008).
- B. ABMA STD 11 - Load Ratings and Fatigue Life for Roller Bearings; 1990 (Reapproved 2008).
- C. ANSI/AGMA 6011 - Specifications for High Speed Helical Gear Units; 2014.
- D. ASHRAE Std 52.2 - Method of Testing General Ventilation Air-Cleaning Devices for Removal Efficiency by Particle Size; 2012.
- E. ASME B16.1 - Gray Iron Pipe Flanges and Flanged Fittings; 2010.
- F. ASME B40.100 - Pressure Gauges and Gauge Attachments; 2013.
- G. NEMA ICS 1 - Industrial Control and Systems: General Requirements; 2005 (R2008).
- H. NEMA MG 1 - Motors and Generators; 2011.

PART 2 PRODUCTS

2.1 GENERAL

- A. Products relevant to this section will be Owner furnished for installation by Contractor.

PART 3 EXECUTION

3.1 INSTALLATION

- A. All equipment shall be installed in accordance with acceptable procedures submitted with the shop drawings, manufacturer's instructions and installation manual and as indicated on the Drawings and specified herein, unless otherwise accepted by the Engineer.
- B. Install equipment in accordance with manufacturer's instructions.
- C. Provide the services of manufacturer's technical representative to supervise installation, adjustment, demonstration, testing, and startup.
- D. Anchor blower/motor bases to foundations per supplier recommendations.

3.2 FIELD QUALITY CONTROL - PRIOR TO STARTUP

- A. After air distribution and diffusion systems have been installed, Contractor shall demonstrate of proper operation of each blower at specified operating conditions

3.3 ELECTRICAL/CONTROL SYSTEMS.

- A. Electrical equipment shall be of the type and quality set forth herein and in accordance with Division 26. Items of equipment installed inside the control panel shall be arranged as shown on the drawings and as specified.
- B. All work shall be performed and all materials shall be in accordance with the National Electrical Code, the National Electrical Safety Code, and applicable local regulations and ordinances. Where required by applicable codes, materials and equipment shall be listed by Underwriters' Laboratories or other testing organization acceptable to the governing authority.

3.4 START UP SERVICE

- A. The Owner-supplier agreement DOES NOT require blower system supplier to provide the services of a factory-trained representative to perform initial start-up of the blowers and blower controls and to instruct the Owner's operating personnel in the operation and maintenance of the equipment provided by them. Contractor shall coordinate with Engineer and manufacturer remotely during installation, startup and commissioning as required.

END OF SECTION

SECTION 465103
AIR DIFFUSERS

PART 1 GENERAL

1.1 SECTION INCLUDES

- A. Installation of Owner Furnished air diffuser, air distribution, and diffusion system for:
 - 1. Pre-Aeration. (NOT USED)
 - 2. IFAS Cages
- B. Air diffusers, in basin drop pipe, in basin air header, and in basin laterals.
- C. In basin air distribution piping and diffuser supports and accessories.
- D. The Contractor will be directly responsible for providing and installing all items not listed above for air diffuser systems, including but not limited to the diffuser pipe supports (to result in top of diffusers being set no more than 9-inches above floor slab), piping between the blowers and drop pipes, the isolation valves upstream of the drop pipes, the tank improvements and accessories, earthwork, etc. Installation shall include the Contractor directly performing startup and coordinating with Engineer, diffuser and aerator supplier, and blower and blower controls supplier to discuss the requirements for installation, startup and commissioning.

PART 2 PRODUCTS

2.1 GENERAL

- A. Products relevant to this section will be Owner furnished for installation by Contractor. Information on the products being Owner Furnished will be provided in Appendices.

PART 3 EXECUTION

3.1 INSTALLATION

- A. Install in accordance with Engineer approved procedures, approved shop drawings, diffuser supplier's written instructions, and as indicated on the Drawings.

3.2 FIELD QUALITY CONTROL - PRIOR TO STARTUP

- A. Piping System: Test with air at minimum of two times normal design pressure; apply pressure and hold for at least 60 minutes without leakage.
- B. In-Tank Diffusers: Test by filling tank with water to depth of approximately two feet (600 mm) above top of diffusers, and:
 - 1. Apply air at design pressure.
 - 2. Inspect diffusers for proper operation and uniformity of diffusion.
 - 3. Adjust diffusers as required for uniform diffusion.
- D. Replace diffusers that cannot be sufficiently adjusted.

END OF SECTION

PAGE INTENTIONALLY LEFT BLANK

PAGE INTENTIONALLY LEFT BLANK

Request

2. Refer to Application, page 4, paragraph 10. Provide copies of all documentation reviewed or generated relating to the decision to construct the MBBR treatment system
-

Response

Please see the engineering memorandum attached hereto as KY2022-00015_BW_0353 to KY2022-00015_BW_0359; please see also the response to 1 PSC 07.

Woodland Acres – Woodland Acres WWTP KY0096100

Kentucky

Engineering Memorandum

Date: September 11, 2020

Introduction

The Woodland Acres wastewater treatment facility is located in Shepherdsville, Kentucky approximately 17 miles south of Louisville, Kentucky. This facility services 121 parcels. The system operates under Kentucky DEP Permit number KY0096100 and Agency ID number 479.

Wastewater Treatment Facility Existing Conditions

The plant is authorized to discharge up to 25,000 gallons per day (gpd) by the KDEP per the operating permit.

A summary of the existing permit limits are described below:

- BOD5 – 10/15 mg/L (Monthly average/Maximum Weekly Average)
- TSS – 30/45 mg/L
- NH3-N – 4/6 mg/L in Summer
- NH3-N – 10/15 mg/L in Winter
- E-Coli – 130/240 mpn/100 ml
- Total Residual Chlorine – 0.011/0.019 mg/L
- Dissolved Oxygen – 7.0 mg/L minimum

The subdivision has 121 parcels and little additional buildout would seem possible. Based off of the number of possible connections and assuming 250 gpd of flow per customer, 30,000 gpd of average daily flow would be expected when the available lots are fully occupied.

A review was performed of EPA's Echo compliance website which lists violations of wastewater treatment plants across the country. The Woodland Acres wastewater treatment plant has exceeded permit limitations several times in recent months and years for E-Coli, BOD, and Ammonia.



The existing facility includes an extended aeration package plant including a mechanically cleaned bar rack screen, a single aeration basin, equalization basin with two influent pumps (one portable), aerobic digestion, rapid sand filter, and a chlorine contact tank. Dechlorination is utilized downstream of disinfection.

The packaged plant has aged and shows significant signs of wear and corrosion. The blowers and diffusers are in need of replacement, and one of the two RAS lines has broken off into the aeration basin. The basin appears to have been modified over time with changes to original structural components. The basin does not include handrail needed to protect operators or visitors from falling into the package plant.

Functionally, the system also has some limitations:

- The entire community is challenged by high ground water levels. The site visit was conducted during a moderate storm event that resulted in significant stormwater challenges in the streets and wastewater flow challenges at the plant. During the visit the blowers had been turned off to inventory solids, and both influent pumps were continuously pumping at what appeared to be a rate higher than the plant was capable of processing. When the blowers were turned on briefly, the noise was significant and the discharge pressure was likely excessive.
- According to operators, the all gravity collection system results in significant I&I, impacting system performance.
- The blower discharge pressure may be excessively high..
- The operator believes it is necessary to turn off aeration during wet weather events to minimize the loss of solids and to retain a healthy biomass.
- The tertiary treatment basin (rapid sand filter, contact tank and dechlorination tank) is highly corroded.
- There is no ideal place for chlorine tablet addition or dechlorination tablet addition.
- There is no flow monitoring at this time.
- The facility includes significant amounts of exposed wiring.

The fencing around most of the site is generally in relatively good condition, and there is significance footprint available for the addition of improvements.

Currently no remote monitoring is in place at the site. This makes it difficult for the operators to know when the facility is failing. Operational monitoring should be completed to monitor the quality of effluent, which should then be compared to the operating permit.

Wastewater Treatment Facility Recommended Improvements

- The condition of the tank calls for taking the facility off line for structural repair, at a minimum to include the addition of access bridge improvements, safety handrail, welding repairs, and the addition of a new RAS line from one of the hopper bottomed clarifiers to the front end of the plant. Because of this, it makes sense to take advantage of the down time to upgrade the

system to an MBBR treatment system to simplify operations and improve performance during wet weather events. The conversion from extended aeration activated sludge to MBBR will include the addition of baffle walls, new diffusers, new blowers, media, and media retention sieves.

- The smaller footprint MBBR will allow a fraction of the existing tank to be used for digestion. The new system will generate significantly less sludge than the existing extended aeration system as well, so sludge handling needs will significantly decrease.
- The 10' foot deep clarifier is adequate for a fixed film type system, and will function much better in this application than with the existing activated sludge system.
- The effluent from the three stage MBBR will be evenly distributed into and through the clarifier, and the level control in the clarifier will be maintained with the addition of a weir trough and weir.
- A flow meter will be installed in the clarifier effluent piping, in route to the contact tank.
- Peroxyacetic acid will be introduced directly into the contact tank in lieu of attempting to install chlorination and dechlorination tablet feeders in the limited hydraulic profile. The PAA chemical requires less contact time, and will more consistently achieve the necessary disinfection objectives.
- Alum will be introduced into the clarifier to improve settleability when required to consistently achieve solids reduction and in turn, BOD effluent limit compliance.
- The existing chlorine contact tank will be equipped with diffusers to help in meeting the dissolved oxygen effluent limit.
- Three blowers will replace the existing two blowers. One will serve the aeration tank needs, air lift needs, and post-aeration needs; one will serve the digester needs; and one will serve as standby for both applications.

Wastewater Collection System Understanding

While no mapping was provided, the collection system consists of only gravity collection.

According to the operator, the collection system consists of 8" and 10" gravity sewers, and the high groundwater table results in significant peak flow events at the facility. Wastewater enters the wastewater treatment plant through a gravity sewer.

Wastewater Collection System Recommended Improvements

- The system should be evaluated to create mapping and develop GIS shapefiles for future maintenance. System mapping at the fingertips of the operators will enhance the level of service and timing of responses to emergency and customer issues.
- Perform smoke testing, perform video inspection at selected locations, evaluate systems and create GIS based maintenance priority list.

REVISED CAPITAL ESTIMATE - NOV. 5, 2021

NARUC - Wastewater - Woodland Acres (25,000 GPD)

Item	NARUC Category	EXPENSES	FIXED ASSETS	TOTAL
Blowers and Blower Control Rplcmnt. for New System (3, 7.5 HP)	Sewer - Treatment and Disposal	\$0	\$55,000	\$55,000
Installation of Blowers	Sewer - Treatment and Disposal	\$0	\$19,300	\$19,300
Blower Pad	Sewer - Treatment and Disposal	\$0	\$1,500	\$1,500
Blower Discharge Header Piping, Valves, Etc. (Installed)	Sewer - Treatment and Disposal	\$0	\$10,000	\$10,000
Package Plant Diffusers & Diffuser Piping Replacement	Sewer - Treatment and Disposal	\$0	\$8,500	\$8,500
Cages w/Diffusers (36) and MBBR Media (11 Cubic Meters)(3, 4'x6'x11')	Sewer - Treatment and Disposal	\$0	\$0	\$0
Cage Materials (w/Shipping, Tax)	Sewer - Treatment and Disposal	\$0	\$12,000	\$12,000
Cage Fabrication	Sewer - Treatment and Disposal	\$0	\$27,500	\$27,500
Painting for Carbon Steel	Sewer - Treatment and Disposal	\$0	\$4,100	\$4,100
Media	Sewer - Treatment and Disposal	\$0	\$13,300	\$13,300
Diffusers & Diffuser Piping	Sewer - Treatment and Disposal	\$0	\$11,000	\$11,000
Installation of Cages	Sewer - Treatment and Disposal	\$0	\$30,600	\$30,600
PAA Equipment	Sewer - Treatment and Disposal	\$0	\$12,000	\$12,000
PAA Pad Addition	Sewer - Treatment and Disposal	\$0	\$1,250	\$1,250
PAA Equipment Installation	Sewer - Treatment and Disposal	\$0	\$4,000	\$4,000
Wet Weather Tank	Sewer - Treatment and Disposal	\$0	\$15,200	\$15,200
Wet Weather Valves, Grinder FM Piping, Return Piping	Sewer - Treatment and Disposal	\$0	\$15,000	\$15,000
Wet Weathe Tank Pad	Sewer - Treatment and Disposal	\$0	\$1,500	\$1,500
Wet Weather Diffusers Installed	Sewer - Treatment and Disposal	\$0	\$6,000	\$6,000
Wet Weather Tank Pad	Sewer - Treatment and Disposal	\$0	\$1,250	\$1,250
Wet Weather Blower and Blower Pad	Sewer - Treatment and Disposal	\$0	\$10,000	\$10,000
Wet Weatehr Air Piping Addition	Sewer - Treatment and Disposal	\$0	\$3,000	\$3,000
Wet Weather Grinder Pump and Conrol Panel Replacment	Sewer - Treatment and Disposal	\$0	\$5,000	\$5,000
Add/Upgrade Mission Monitoring System	Sewer - Treatment and Disposal	\$0	\$7,000	\$7,000
Electrical Wiring Improvements for Safety for Package Plant	Sewer - General Plant	\$0	\$10,000	\$10,000
Electrical Distribution for New Ext. Aer. / MBBR Blowers	Sewer - General Plant	\$0	\$20,000	\$20,000
Electrical Distribution for PAA, Wet Weather, and Grinder Pump	Sewer - General Plant	\$0	\$20,000	\$20,000
Gravel Access Road Improvements (185 ft Gravel)	Sewer - General Plant	\$0	\$5,000	\$5,000
Fence Replacement (Minor)	Sewer - General Plant	\$0	\$2,000	\$2,000
TOTAL		\$0	\$331,000	\$331,000

APPENDIX



Blowers, EQ Basin, and Electrical Cables



**Electrical Boxes and
Electrical Cabling**

Civil Engineering
Surveying & Mapping
Potable Water
Wastewater Treatment

21 DESIGN

Civil Site Design
Construction Support
Transportation
Wastewater Collection



**EQ Basin, Portable Pump Discharge,
Digester, Miscellaneous Electrical Cables**



**Clarifier Performance During Wet Weather
(and No Aeration in Aeration Tank)**

Civil Engineering
Surveying & Mapping
Potable Water
Wastewater Treatment

21 DESIGN

Civil Site Design
Construction Support
Transportation
Wastewater Collection



Chlor/Dechlor Structure

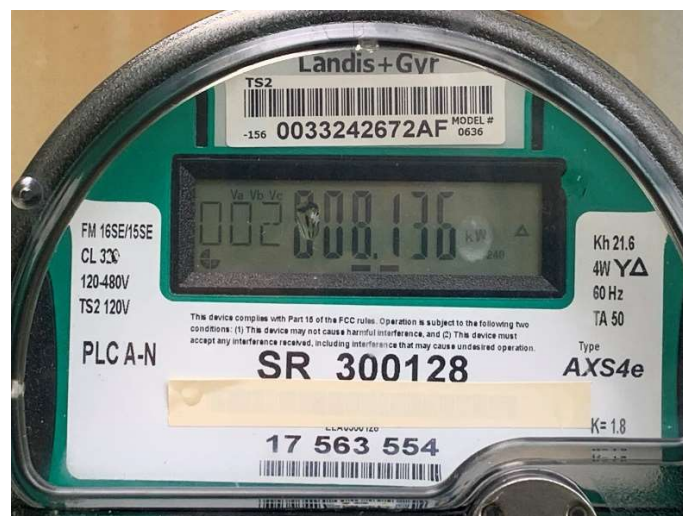

WWTP Electrical Meter

Request

3. Refer to Application, page 4, paragraph 11. Explain how Bluegrass Water estimated the cost of constructing the MBBR system, and provide copies of all documents used to determine the estimated cost of constructing the MBBR system.
-

Response

Bluegrass Water engaged 21 Design Group, Inc. (21 Design) to prepare a capital estimate updated from that which was provided in Ky. PSC Case No. 2020-00290 for the Woodland Acres site. 21 Design prepared the estimated costs for the project subcategories (including MBBR) in its Woodland Acres CPCN Application, focusing on those requiring certificate approval from the Commission. The full estimate is found attached hereto as KY2022-00015_BW_0360.

21 Design is a professional engineering firm that has designed and assisted in construction administration on more Central States Water Resources (CSWR) projects than any other engineering firm and has extensive experience preparing construction estimates generally. This experience includes providing Preliminary Opinions of Probable Construction costs on dozens of design-bid-build project, where 21 Design provided planning, preliminary engineering, final design, bidding and construction administration engineering services; and also assisting with direct design-build/turnkey projects by providing project management, including the development of project budgets and construction cost estimates at various portions of each project. Based on its experience in a wide range of project stages from inception through operations, 21 Design routinely witnesses bidding and construction activities and uses information captured to estimate future project costs.

21 Design also works with its sister company, Midwest Water Operations (Midwest Water), to estimate costs of construction. Midwest Water has provided extensive operational assistance on CSWR projects, including establishing construction budgets, along with construction services for a significant portion of the improvements performed for CSWR facilities to date. This experience allows Midwest Water to assist with estimating future project costs.

At the time it prepared the estimates, 21 Design had considerable information regarding the Woodland Acres projects on which to base estimates. Because the projects have been designed, unknown costs have been considerably reduced along with risk. The primary risk that remains for these projects is the impact of the permit review process on final costs. The current estimates include the use of recent equipment budgetary proposals, material quantity takeoffs and pricing from recent projects, and experience from the professionals at both 21 Design and Midwest Water. 21 Design estimates in this stage of design typically have accuracy within 10-15% of final project costs.

CPCN Filing Capital Estimate - Woodland Acres

Construction Project	NARUC Category	Estimate	Subtotal
KPDES Permit Compliance Upgrades			
<u>MBBR Treatment System</u>	Sewer - Treatment and Disposal		\$ 204,300
Blowers and Controls for New MBBR Assemblies (3 each)		\$ 74,300	
Blower Pad		\$ 1,500	
Blower Discharge Header Piping, Valves, Appurtenances		\$ 10,000	
MBBR Assemblies Complete (3 each)		\$ 98,500	
Electrical Distribution for MBBR Treatment System		\$ 20,000	
<u>Peracetic Acid Disinfection System</u>	Sewer - Treatment and Disposal		\$ 22,250
PAA Equipment and Pad		\$ 17,250	
Electrical Distribution for PAA Disinfection System		\$ 5,000	
<u>Wet Weather Overflow Prevention System</u>	Sewer - Treatment and Disposal		\$ 70,700
Wet Weather Tank and Pad		\$ 16,700	
Wet Weather Valves, Grinder FM Piping, Return Piping		\$ 15,000	
Wet Weather Diffusers		\$ 6,000	
Wet Weather Blower and Blower Pad		\$ 10,000	
Wet Weather Air Piping		\$ 3,000	
Wet Weather Grinder Pump and Control Panel		\$ 5,000	
Electrical Distribution for Wet Weather Overflow Prevention System		\$ 15,000	
<u>All Weather Gravel Access Road for All Three New Systems</u>	Sewer - General Plant	\$ 5,000	\$ 5,000
TOTAL Capital Estimate for CPCN Filing		\$ 302,250	\$ 302,250

Request

4. Refer to Application, pages 4, paragraph 10. State what current measures the Woodland Acres facility uses to remove nutrients and lower ammonia levels.
-

Response

The Woodland Acres facility currently relies on conventional aeration treatment to remove nutrients, including lowering ammonia levels. Through this process, blowers pump air through diffusers into a basin where wastewater and aerated sludge are mixed by the air flow causing increased biological activity to metabolize the waste. This process produces less variety and density of microorganism life in the aeration basin when compared to an MBBR, and as a result is less effective at breaking down ammonia and other nutrients. This causes the facility to regularly fail to adequately reduce ammonia levels. As indicated in the effluent exceedances report (EPA ECHO) attached hereto as KY2022-00015_BW_0361 to KY2022-00015_BW_0363 and the response to 1 PSC 06, the facility has failed to meet ammonia limits on many occasions in the last twelve months and is not expected to comply with permitted limits without improvements.

Effluent Limit Exceedances Report

WOODLAND ACRES, SHEPHERDSVILLE, KY, 40165

Facility Information

NPDES (National Pollutant Discharge Elimination System) ID: KY0091600

FRS (Facility Registry Service) ID: 110033639784

Other NPDES (National Pollutant Discharge Elimination System) IDs associated with this FRS (Facility Registry Service) ID: None

TRI (Toxics Release Inventory) ID(s): None

Major/Non-Major Indicator: Non-Major

Facility Type: NON-POTW

Latitude/Longitude: 38.008333/-85.729722

4-Digit SIC (Standard Industrial Classification) Code: 6515 - OPER OF RES

MOBILE HOME SITES

6-Digit NAICS (North American Industry Classification System) Code: --

Permit Information

Permit Status: Effective

Permit Issuance: STATE OF KENTUCKY

Original Issue Date: 10/14/1988

Last Issue Date: 07/30/2021

Permit Effective Date: 10/01/2021

Permit Expiration Date: 09/30/2026

DMR Signer: --

Approved Pretreatment Program: N/A

Combined Sewer Overflow (CSO) Outfall: N/A

Receiving Watershed Information

State Water Body Name (ICIS (Integrated Compliance Information System)): MUD RUN CRK, UT TO MUD RUN CREEK

WBD (Watershed Boundary Dataset) Subwatershed Name / 12-Digit WBD (Watershed Boundary Dataset) HUC (Hydrologic Unit Code) (FRS Derived): Bullitt Lick Creek-Salt River (051401021103)

Listed for Impairment (ATTAINS (Assessment, Total Maximum Daily Load (TMDL) Tracking and Implementation System)): No

Impairment Class (ATTAINS (Assessment, Total Maximum Daily Load (TMDL) Tracking and Implementation System)): Not provided.

Enforcement Information

Last Formal Enforcement Action: 10/06/2021

Civil Enforcement Case Number: KY-DOW-21-3-0030

DOJ/Court Docket Number: --

Court Docket Number: --

Type Description: State Administrative Order of Consent

Related Reports

- [View DMR Pollutant Loading Report](#)
- [View Detailed Facility Report](#)
- [View Effluent Charts](#)

Report Options

Adjust Date Range: Apr. 2021 → Mar. 2022

Display records identified as potential outliers or data errors



Total Exceedance Counts

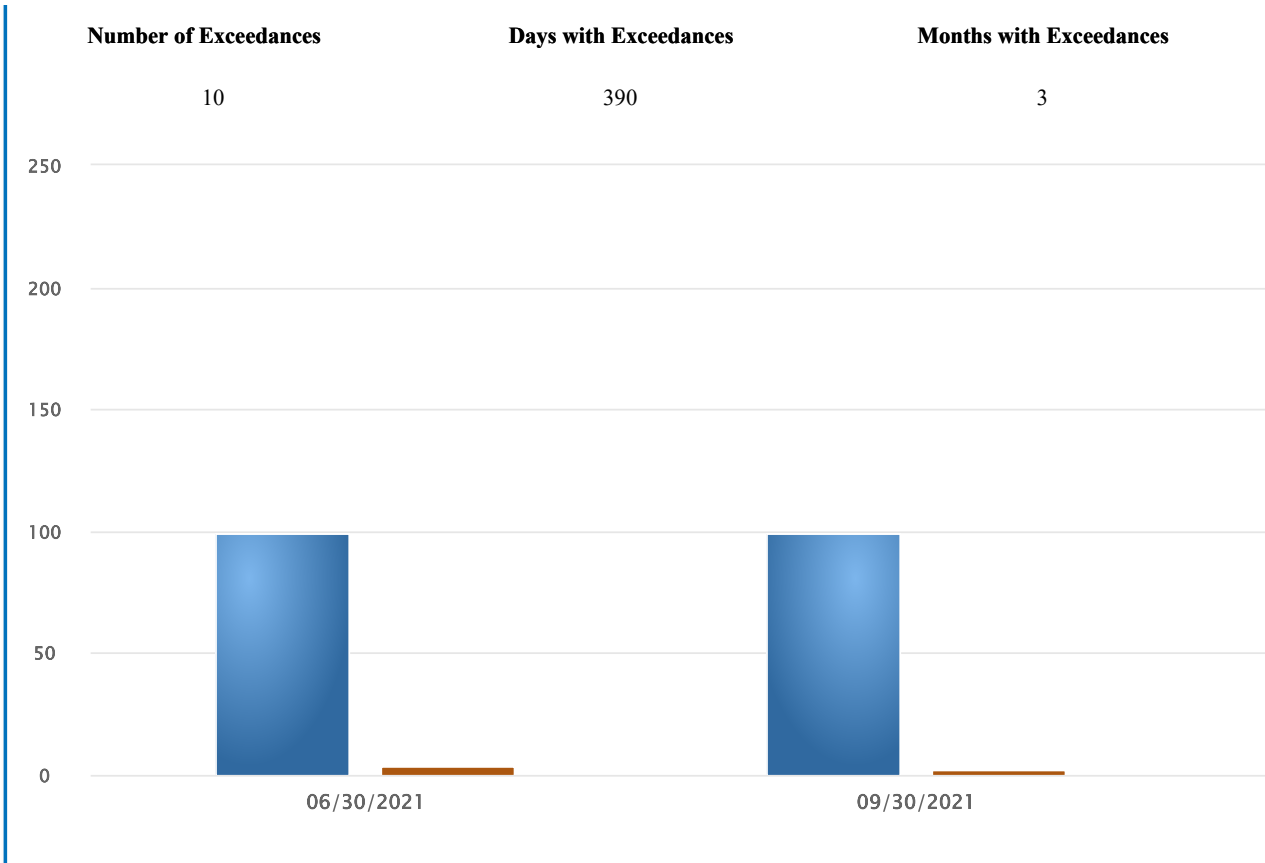

Exceedance Counts by Pollutant

Parameter Code	Description	Limit Type	Contains Potential Outliers?	Number of Exceedances	Days with Exceedances
00530	Solids, total suspended	MO AVG		1	92
00530	Solids, total suspended	MX WK AV		1	7
00610	Nitrogen, ammonia total (as N)	DAILY MX		2	2
00610	Nitrogen, ammonia total (as N)	MO AVG		3	183
00610	Nitrogen, ammonia total (as N)	MX WK AV		1	7
80082	BOD, carbonaceous, 05 day, 20 C	MO AVG		1	92
80082	BOD, carbonaceous, 05 day, 20 C	MX WK AV		1	7

Exceedance Details

Date	Outfall	Parameter	Average Daily Flow (MGD)	Limit Type	DMR Value	Limit Value	Percent Exceedance	Load over Limit (lb/period)	Load over Limit (lb-eq/period)
06/30/2021	001	00610 - Nitrogen, ammonia total (as N)	--	MO AVG	11.10 mg/L	<= 4 mg/L	178	--	--
06/30/2021	001	00610 - Nitrogen, ammonia total (as N)	--	MX WK AV	1.81 kg/d	<= 0.566893 kg/d	220	--	--
06/30/2021	001	00610 - Nitrogen, ammonia total (as N)	0.0430	MO AVG	1.81 kg/d	<= 0.376417 kg/d	382	288	0.3201
06/30/2021	001	00610 - Nitrogen, ammonia total (as N)	--	DAILY MX	11.10 mg/L	<= 6 mg/L	85	--	--
09/30/2021	001	00530 - Solids, total suspended	--	MX WK AV	91 mg/L	<= 45 mg/L	102	--	--
09/30/2021	001	00530 - Solids, total suspended	--	MO AVG	91 mg/L	<= 30 mg/L	203	--	--
12/31/2021	001	00610 - Nitrogen, ammonia total (as N)	--	DAILY MX	16.50 mg/L	<= 15 mg/L	10	--	--
12/31/2021	001	00610 - Nitrogen, ammonia total (as N)	0.1116	MO AVG	16.50 mg/L	<= 10 mg/L	65	557	0.6182
12/31/2021	001	80082 - BOD, carbonaceous, 05 day, 20 C	--	MX WK AV	16 mg/L	<= 15 mg/L	7	--	--
12/31/2021	001	80082 - BOD, carbonaceous, 05 day, 20 C	0.1116	MO AVG	16 mg/L	<= 10 mg/L	60	514	--

Request

5. Refer to Application, page 4, paragraph 10. State permitted limits of nutrient and ammonia levels.
-

Response

A summary of the existing permit limits are described below:

BOD5 – 10/15 mg/L (Monthly average/Maximum Weekly Average)
TSS – 30/45 mg/L
NH3-N – 4/6 mg/L in Summer
NH3-N – 10/15 mg/L in Winter
E-Coli – 130/240 mpn/100 ml
Total Residual Chlorine – 0.011/0.019 mg/L
Dissolved Oxygen – 7.0 mg/L minimum

Request

6. Refer to Application, page 4, paragraph 10. Provide all documents reflecting testing of nutrient and ammonia levels, and explain why Bluegrass Water contends that the levels need to be reduced.
-

Response

Please see the effluent exceedances report (EPA ECHO) attached to the response to 1 PSC 04 as KY2022-00015_BW_0361 to KY2022-00015_BW_0363. Bluegrass ran the effluent exceedance report from the Federal Enforcement and Compliance History Online system (ECHO), which showed that the Woodland Acres facility exceeded limits for ammonia 6 times in the last 12 months, for a total of 192 days out of compliance; exceeded BOD limits 2 times in the last 12 months, for a total of 99 days out of compliance; and exceeded TSS limits 2 times in the last 12 months, for a total of 99 days out of compliance.

This data is from federally mandated Discharge Monitoring Report (DMR) testing, which is the primary tool that environmental regulators used to evaluate facility compliance. This record demonstrates that currently the Woodland Acres facility cannot consistently meet limits (even following operational improvements and triage repairs by Bluegrass), and therefore will require further improvements to be in compliance with permitted limits.

Request

7. Refer to Application, page 4, paragraph 10. State expected reductions in nutrient and ammonia levels upon installation of MBBR system.
-

Response

Please see the estimate of expected reductions in nutrient and ammonia levels attached hereto as KY2022-00015_BW_0368 and the design summary calculations attached hereto as KY2022-00015_BW_0364 to KY2022-00015_BW_0367. The MBBR improvements will provide a second form of biology within the system that grows as a fixed film on a moving bed of media. This supplemental biology will allow the mass of activated sludge maintained in the system to be reduced. By reducing the activated sludge mass stored, the system will carry a lower sludge blanket in the clarifiers, and wet weather conditions will not be as likely to result in the loss of suspended growth solids over the effluent weir in the clarifier.

Without this supplemental media, when wet weather results in the loss of solids the ammonia-reducing organisms typically are the first organisms lost in the system. The new MBBR biology will be directly useful in the reduction of ammonia and will indirectly allow the activated sludge nitrifying organisms to be maintained in the system.

Regarding nutrient removal, the improvement in solids retention within the system will also improve upon the overall levels of phosphorus reduction. Every pound of biological solids retained in the system stores in it approximately 1% phosphorus. By improving solids reduction performance at the Woodland Acres site, Bluegrass will also be improving upon phosphorus removal performance.

MBBR Design Criteria
Woodland Acres
February 9, 2022

Plant Influent Characteristics

1	Annual Average Daily Flow	25,000	gpd
2	Maximum Monthly Average Daily Flow	25,000	gpd
3	Peak Daily Flow	75,000	gpd
4	Peak Hourly Flow (w/out Equalization)	100,000	gpd
5	Influent BOD	225	mg/L
6	Influent BOD	46.9	lbs/day
7	Influent TSS	225	mg/L
8	Influent TSS	46.9	lbs/day
9	Influent NH3-N	35	mg/L
10	Influent NH3-N	7.3	lbs/day
11	Influent TKN	40	mg/L
12	Influent TKN	8.3	lbs/day
13	Influent pH	7	
14	Water Temperature	12	deg-C

Roughing MBBR Influent Characteristics

15	Annual Average Daily Flow	25,000	gpd
16	Maximum Monthly Average Daily Flow	25,000	gpd
17	Peak Daily Flow (w/Equalization)	75,000	gpd
18	Peak Hourly Flow (w/Equalization)	100,000	gpd
19	Influent BOD	225	mg/L
20	Influent BOD	46.9	lbs/day
21	Influent TSS	225	mg/L
22	Influent NH3-N	35	mg/L
23	Influent TKN	40	mg/L
24	Design Influent TKN	40	mg/L
25	Influent pH	7	
26	MBBR Effluent Water Temperature	10	deg-C

Roughing IFAS Media Sizing Summary

27	No. of Tanks Cages Proposed	1	
28	Length of Each	6.0	ft
29	Width of Each	4.0	ft
30	Side Water Depth of Each	10.0	ft
31	Tank Height of Each	12.0	ft
32	Volume of Each	1,795	gallons
33	Volume Total	1,795	gallons
34	Hydraulic Retention Time at Annual Average Flow	1.72	hours
35	Hydraulic Retention Time at Maximum Monthly Average Flow	1.72	hours
36	Hydraulic Retention Time at Peak Hourly Flow	0.43	hours
37	Total Media Surface Area Requirement	937	m ²
38	Total Media Surface Area Proposed	1,325	m ²

MBBR Design Criteria
Woodland Acres
February 9, 2022

<u>IFAS Aeration</u>		<u>Stage 1</u>	
39	Target Fixed Film BOD Effluent (70% Removal)	68	mg/L
40	AOR (lbs/day)	49	lbs/day
41	Assumed Diffuser Subm. at AWL (ft.)	9.25	ft
42	Elevation (ft.)	442	ft
43	Alpha	0.70	
44	Beta	0.9	
45	Target DO Residual (MBBR Process) (mg/L)	3.0	mg/L
46	SOR (lbs/day)	118	lbs/day
47	Target Diffuser Efficiency/ft. Submergence	1.1	%
48	Airflow Required for MBBR Aeration (scfm)	46	scfm
49	Airflow per 1,000 scfm	191	scfm/1,000 cf
50	No. of Blowers	3	1 Exist/2 New
51	Type of Blower	PD	
52	Discharge Pressure	5.31	psig
<u>Extended Aeration</u>			
53	Target BOD Effluent	5	mg/L
54	Target NH3-N Effluent	3	mg/L
55	AOR (lbs/day)	43	lbs/day
56	Assumed Diffuser Subm. at AWL (ft.)	9.25	ft
57	Elevation (ft.)	442	ft
58	Alpha	0.70	
59	Beta	0.9	
60	Target DO Residual (Ex. Aeration Process) (mg/L)	2.00	mg/L
61	SOR (lbs/day)	87	lbs/day
62	Target Diffuser Efficiency/ft. Submergence	1.10	%
63	Airflow Required for Extended Aeration (scfm)	41	scfm
64	No. of Blowers	3	(Shared)
65	Type of Blower	PD	
66	Discharge Pressure	5.31	psig

MBBR Design Criteria

Woodland Acres

February 9, 2022

Blower Requirement Summary

67	<u>NEW BLWR'S-231, 232</u>		
68	Airflow Required for IFAS Aeration (scfm)	46	scfm
69	Airflow Required for Extended Aeration (scfm)	41	scfm
70	Airflow Required for RAS/WAS Airlifts (scfm)	14	scfm
71	Airflow Required for Post-Aeration (scfm)	12	scfm
72	Total SCFM Required	118	scfm
73	No. of Operating Blowers	2	
74	SCFM Required per Blower	59	scfm
75	No. of Existing Blowers Dedicated for Backup/Standby	1	
76	Assumed Overall Efficiency	0.62	
77	Estimated BHP Required (Total):	4.3	bhp
78	NPHP (Total)	5	bhp
79	No. Blowers	2	
80	Type of Blower	PD	
81	Discharge Pressure	5.31	psig

Existing Tank Sizing Summary

82	<u>Extended Aeration Zone</u>		
83	Tank Length	30.0	ft
84	Tank Width	9.0	ft
85	Side Water Depth	10.0	ft
86	Zone Volume	20,196	gal
87	HRT at Average Daily Flow	19.39	hr
88	HRT at Peak Hourly Flow	4.85	hr
89	<u>Wet Weather Storage Basin</u>		
90	Tank Length	10.0	ft
91	Tank Width	9.0	ft
92	Side Water Depth	10.0	ft
93	Zone Volume	6,732	gal
94	HRT at Average Daily Flow	6.46	hr
95	<u>Existing Post-Aeration/Contact Tank</u>		
96	No. of Contact Tanks	1	
97	Contact Tank Length	11	ft
98	Contact Tank Width	11	ft
99	Contact Tank Depth	5	ft
100	Contact Tank Volume	4,525	gallons
101	Contact Tank Hydraulic Retention Time at PHF	65	minutes
102	Airflow Required for CCT	20	scfm/1,000 cf
103	Total SCFM Required	12	scfm

MBBR Design Criteria
Woodland Acres
February 9, 2022

<u>New Wet Weather Storage Basin</u>			
104	Tank Diameter	9.92	ft
105	Tank Depth	7.17	ft
106	Volume of New Tank	4,100	gallons
107	Hydraulic Retention Time of New Tank at ADF	3.94	hr
108	Total Equalization Volume	10,832	gallons
109	Total Wet Weather Storage Retention Time at ADF	10.40	hr
<u>Effluent Parameters</u>			
110	Effluent SBOD (Design Target)	5	mg/L
111	Effluent SBOD (Design Target)	1.0	lbs/day
112	Effluent BOD	10.0	mg/L
113	Effluent NH3-N	3.0	mg/L
114	Effluent NH3-N	0.6	lbs/day
115	Effluent TSS	30	mg/L
116	Effluent TSS	6.3	lbs/day
117	E. Coli	130/240	mpn/100 mL

Woodland Acres
 IFAS / MBBR Calculations for Supplemental Media

Raw Sewage Influent

Maximum Monthly Average Daily Flow	25,000	gpd
Peak Daily Flow	75,000	gpd
BOD	225	mg/L
TSS	225	mg/L
NH3-N	40	mg/L
TKN	40	mg/L
Temperature	10	deg-C
Surface Area - BOD Removal	937	m ²
Surface Area - Nitrification	0	m ²
Total Media Surface Area	937	m ²

MBBR Stage 1

Targetting 70% BOD Reduction

BOD ₇ Kinetic Rates per AnoxKaldness to Meet Effluent Objectives at 15-deg. C	25.00	g BOD / m ² / day
Conservative Reduction in Targetted Rate	23.75	g BOD / m ² / day
BOD ₅ Kinetic Rates per AnoxKaldness to Meet Effluent Objectives at 15-deg. C	20.30	g BOD / m ² / day
Temperature Coefficient	1.05	
BOD ₅ Kinetic Rates per AnoxKaldness to Meet Effluent Objectives at 20-deg. C	25.91	g BOD / m ² / day
BOD ₅ Kinetic Rates per to Meet Effluent Objectives at 10-deg C	15.90	g BOD / m ² / day
BOD Reduction		
MBBR Influent BOD	225	mg/L
MBBR Target Effluent SBOD	68	mg/L
BOD Removal Performance	158	mg/L
MBBR Influent BOD	47	lbs/day
MBBR Target Effluent SBOD	14	lbs/day
BOD Removal Required	33	lbs/day
BOD Removal Required	14,896	g BOD / day
Media Surface Area Rqd. (based on above Kinetic Rate Rqd)	937	m ²
Media Volume Required (based on 650 m ² / m ³ effective surface area based on Jaegger Media)	1.4	m ³
Media Volume Required (based on 650 m ² / m ³ effective surface area per Jaegger)	51	ft ³
Effluent TSS		
Sludge Yield (lbs. TSS / lb. BOD Removed)	0.4	#sTSS / #BOD Rem.
Effluent TSS from MBBR Stage 1 Effluent	288	mg/L
Effluent TKN		
Nutrient Uptake through Assimilation (% of BOD Removed)	0.04	#sTKN / #BOD Rem.
Effluent TKN from MBBR Stage 1 Effluent	34	mg/L

Request

8. Refer to Application, page 4, paragraph 10. Describe any alternatives to installation of the MBBR system for reducing nutrient and ammonia levels.
-

Response

The proposed improvements for the Woodland Acres site are necessary because the wastewater treatment facility is not currently capable of consistently complying with permitted limits and carries a likely risk of causing damage to the environment. The installation of the MBBR system is intended to enhance the facility's ability to remove nutrients and lower ammonia levels. MBBRs dramatically improve aeration treatment by providing significantly more surface area for biofilm to form on, thereby enhancing the amount of biological treatment that can occur. This project, working in concert with the other identified projects, will allow the Woodland Acres facility to consistently comply with permitted limits.

Alternatives to MBBR installation were considered for biological treatment for compliance with ammonia limits and reduction in BOD and TSS, and MBBR was determined to be the most economically sound treatment option that would provide adequate biological treatment. One alternative considered for this component was a more conventional IFAS fixed film attached growth system. This option was rejected because it would be more costly than an MBBR, and is more operationally complex, which makes it prone to treatment failure. In addition to being inherently more expensive, this option would also require additional tankage repairs, further increasing the cost of the IFAS option over an MBBR.

Another option Bluegrass considered instead of the MBBR installation was installation of additional conventional aeration tankage. However, this would be costly and less efficient than attached growth biological treatment and would require more blowers and other aeration equipment. This would lead to more up-front costs result in greater operational expense through power consumption at the facility. Therefore, Bluegrass concluded an MBBR is the most economical biological treatment method practical for the facility to achieve compliance with limits while minimizing rate impact. Please see also the response to 1 PSC 27 for a discussion of overall alternatives for the three Woodland Acres projects proposed in this application.

Request

9. Refer to Application, page 4, paragraph 10. Provide estimated costs of any alternatives described in Bluegrass Water's response to Request No. 8 above.
-

Response

Please see the response to 1 PSC 08 and 1 PSC 27.

Request

10. Refer to Application, page 4-5, paragraph 12.
 - a. Provide copies of all plans, specifications, drawings, and manufacturer's information sheets pertaining to the peracetic acid disinfection system Bluegrass Water plans to install at the Woodland Acres facility.
 - b. Provide a detailed description of the peracetic acid disinfection system Bluegrass Water plans to install and how it will be integrated into the current systems at the Woodland Acres facility
-

Response

- a. Please see the Woodland Acres Plan Set attached in response to 1 PSC 01(a).
- b. The peracetic acid disinfection system will allow the Woodland Acres facility to consistently meet permitted limits for E.coli while eliminating the possibility of exceeding total residual chlorine limits, both of which have regularly been exceeded by the facility in the last several years. The disinfection capabilities of the system are similar to the existing chlorine disinfection system, which is no longer functioning optimally and will require repair or replacement even if Bluegrass chose to continue to use chlorine disinfection. However, the peracetic acid system will not require dichlorination, which will result in a drop in chemical costs over time. Because the system does not utilize chlorine, there is no possibility of exceeding total residual chlorine limits following the changeover to peracetic acid. The new system will be able to use the existing chlorine contact chamber with additional drops for post aeration run from the blowers running the rest of the facility.

Request

11. Refer to Application, page 4, paragraph 10. Provide copies of all documentation reviewed or generated relating to the decision to construct the peracetic acid disinfection system.
-

Response

Please see the engineering memorandum attached to the response to 1 PSC 02.

Request

12. Refer to Application, page 4, paragraph 11. Explain how Bluegrass Water estimated the cost of constructing the peracetic acid disinfection system, and provide copies of all documents used to determine the estimated cost of constructing the peracetic acid disinfection system.
-

Response

Please see the response to 1 PSC 03, which is the same for the peracetic acid disinfection system.

Request

13. Refer to Application, pages 4–5, paragraph 12. State what current measures the Woodland Acres facility uses to disinfect and to lower chlorine levels.
-

Response

The Woodland Acres facility currently utilizes sodium hypochlorite for disinfection and sodium bisulfite for dichlorination. The sodium hypochlorite is utilized to kill bacteria in the effluent allowing for compliance with E.coli limits while (after enough contact time for disinfection) the sodium bisulfite is added to remove chlorine following the disinfection in order to meet total residual chlorine limits. The Woodland Acres system has historically struggled with compliance with both E.coli and total residual chlorine limits, indicating operational issues and issues with the existing disinfection system; necessitating the proposed equipment replacement and conversion to peracetic acid disinfection.

Request

14. Refer to Application, pages 4–5, paragraph 12. State permitted limits of *E.coli* and other pathogens and chlorine levels.
-

Response

Please see the response to 1 PSC 05.

Request

15. Refer to Application, pages 4–5, paragraph 12. Provide all documents reflecting testing of *E.coli* and other pathogens and chlorine levels, and explain why Bluegrass Water contends that the levels need to be reduced.
-

Response

Please see the attachment included with the response to 1 PSC 04. The levels need to be reduced to comply with permit limits. To summarize federal testing data, the Woodland Acres facility has 4 *E.coli* and 2 Total residual chlorine violations in the last 3 years for a total of 275 days of noncompliance with respect to the failures of the existing disinfection system. The proposed system will prevent these violations from recurring.

Request

16. Refer to Application, pages 4–5, paragraph 12. State expected reductions in *E.coli* and other pathogens and chlorine levels upon installation of peracetic acid disinfection system.
-

Response

The advantage of utilizing peracetic acid for disinfection is that it achieves similar disinfection rates as chlorine but without utilizing chlorine. Since no chlorine is used, there is no possibility of exceeding total residual chlorine limits following the change to peracetic acid. The Woodland Acres system is expected to consistently meet limits for *E.coli* as well.

Request

17. Refer to Application, pages 4–5, paragraph 12. Describe any alternatives to installation of the peracetic acid disinfection system for reducing *E.coli* and other pathogens and chlorine levels.
-

Response

The proposed improvements are required because the Woodland Acres facility is not currently capable of consistently complying with permitted limits and therefore causes damage to the environment. The installation of a peracetic acid disinfection system is intended to improve the facility's disinfection system and eliminate residual chlorine in the facility's effluent. The facility has regularly struggled to meet *E.coli* limits and will require an improved disinfection system to be in consistent compliance. Peracetic acid disinfection is a more environmentally friendly form of disinfection compared to the existing chlorine system.

For this specific project, peracetic acid disinfection was determined to be the most economically sound treatment option that would provide disinfection. One alternative considered for this aspect of the project was replacing the existing chlorine disinfection system; however, the peracetic acid was determined to be similar in cost but more environmentally friendly, and will improve effluent quality with post aeration. Another option considered would be to install an ultraviolet disinfection system. Ultraviolet disinfection systems are significantly more expensive than peracetic acid or chlorine disinfection. As a result, the peracetic acid system is the most economical disinfection method practical for the facility to achieve compliance with limits while minimizing rate impact.

Please see also the response to 1 PSC 27 for a discussion of overall alternatives for the three Woodland Acres projects proposed in this application.

Request

18. Refer to Application, pages 4–5, paragraph 12. Provide estimated costs of any alternatives described in Bluegrass Water’s response to Request No. 17 above.
-

Response

Please see the response to 1 PSC 17 and 1 PSC 27.

Request

19. Refer to Application, page 5, paragraphs 14-15.
 - a. Provide copies of all plans, specifications, drawings, manufacturer's information sheets pertaining to the moving bed biofilm reactor (MBBR) treatment system Bluegrass Water plans to install at the Woodland Acres facility.
 - b. Provide a detailed description of the wet weather overflow prevention measures Bluegrass Water plans to install and how they will be integrated into the current systems at the Woodland Acres facility.
-

Response

- a. Please see the Woodland Acres Plan Set attached in response to 1 PSC 01(a).
- b. Please see the Woodland Acres Technical Specifications attached in response to 1 PSC 01(b). The proposed wet weather overflow prevention system will allow some flow to be diverted into an HDPE storage tank during high flow periods. This will prevent the Woodland Acres facility from being overwhelmed during high flows and allow the retained flow to be dosed out over time following the wet weather event. Excessive flows during wet weather can compromise treatment by washing out the activated sludge from the plant, immediately leading to exceedances of solids limits, and in the following days leaving the plant with inadequate biological activity to sustain proper treatment process. By dosing out the stored flow the Woodland Acres facility can be maintained at a flow rate that it can effectively treat preventing this interruption in treatment. The new HDPE tank will sit south of the existing tanks as shown in the plan drawings on sheet 4 of the Plan Set.

Request

20. Refer to Application, page 5, paragraphs 14–15. Provide copies of all documentation reviewed or generated relating to the decision to construct the wet weather overflow prevention measures.
-

Response

Please see the engineering memorandum attached to the response to 1 PSC 02.

Request

21. Refer to Application, pages 5–6, paragraph 16. Explain how Bluegrass Water estimated the cost of constructing the wet weather overflow prevention measures, and provide copies of all documents used to determine the estimated cost of constructing the wet weather overflow prevention measures.
-

Response

Please see the response to 1 PSC 03, which is the same for the wet weather overflow prevention measures.

Request

22. Refer to Application, page 5, paragraphs 14–15. State what current measures the Woodland Acres facility uses to handle wet weather overflow prevention measures.
-

Response

There are no current processes in place to handle wet weather overflows, causing the Woodland Acres facility to regularly surge during high flow periods.

Request

23. Refer to Application, pages 5, paragraphs 14–15. Describe any alternatives to installation of wet weather overflow prevention measures for remedying the risks and problems listed in Bluegrass Water’s response to Request No. 16 above.
-

Response

The proposed improvements are required because the Woodland Acres facility is not currently capable of consistently complying with permitted limits and therefore causes damage to the environment. The installation of a wet weather overflow prevention measures is intended to improve the facility’s ability to handle surge flows that have caused washouts at the facility in the past and led to sanitary sewage overflows. Flows to the facility increase significantly during rain events, overwhelming the facility in ways that can compromise effective treatment, wash out solids, and even cause overflows. To stop this sort of event from overwhelming the facility, the new wet weather storage will allow some of the flow to be diverted into a holding tank which can be dosed out over time at a rate which the plant can handle. This system will also remain useful in the future even if Bluegrass is eventually able to connect to the City of Shepherdsville as holding tankage for a new lift station.

Bluegrass considered several alternatives to the wet weather overflow prevention system. The problem with high flow periods is straight forward; a tank is the only practical way address the issues caused for treatment, but alternatives in the type of tank installed were considered to reduce rate impact. A more traditional concrete or steel tank would significantly increase the cost of this project, so Bluegrass designed the system to work instead with a polyethylene tank with UV protection in place to ensure longevity. This significantly reduces the rate impact of the project.

Please see also the response to 1 PSC 27 for a discussion of overall alternatives for the three Woodland Acres projects proposed in this application.

Request

24. Refer to Application, page 5, paragraphs 14–15. Provide estimated cost of any alternatives described in Bluegrass Water’s response to Request No. 23 above.
-

Response

Specific cost estimates for a steel or concrete tank were not assembled because it is very clear that the polyethylene tank will be dramatically less expensive. Bluegrass’s understanding is that a steel or concrete tank would cost several times the total price of the polyethylene tank project and were not worth itemizing at the expense of additional engineering costs.

Request

25. Refer to Application, page 5, paragraphs 14–15. Explain “permitted limits” with regards to wet weather overflow.

Response

The design flow of the Woodland Acres facility is 25,000 GPD, which is regularly exceeded during periods of high flow. While this is not something that would likely result in enforcement action from the Department of Water, these high flow periods "wash out" the plant, thus eliminating much of the beneficial biology that is needed for the treatment process. As a result, the treatment process is compromised and can become inadequate to meet permitted limits during and after wet weather events. A wet weather overflow tank would allow the flow rate to be controlled during high flow periods, with some water being stored, and prevent the "wash out" events from occurring, protecting the treatment process.

Request

26. Refer to the Application, pages 6-8, paragraph 19.
- a. Confirm that Bluegrass Water's proposed improvements will not impact operational costs (i.e.: electricity, sludge removal, maintenance, chemicals, etc.).
 - b. If Bluegrass Water's response to Request 26.a is no, provide Bluegrass Water's estimates of the operational costs impacts identified. Include documentation and detailed calculations to support the identified cost impacts.
 - c. State whether the projects are expected to affect the useful lives of the Woodland Acres wastewater treatment plant (WWTP) or collection system, and if so, describe the extent to which they are expected to affect the useful lives.
 - d. Provide the estimated Depreciation expense for each proposed asset that will be added to Bluegrass Water's plant in service. Include documentation and detailed calculations to support calculated depreciation expense impacts.
-

Response

- a. Bluegrass expects an increase in electricity expenses due to the increased usage necessary to achieve enough treatment to meet limits. Bluegrass is unsure of the exact quantitative impact on costs that this increased usage will cause.
- b. Please see the response to 1 PSC 26(a) above.
- c. The projects are designed to replace the aeration equipment, disinfection equipment, and add a new wet weather surge tank. As this equipment will essentially be new, the useful lives of those assets will be extended. Please see the Depreciation Schedule attached hereto as KY2022-00015_BW_0369 for a summary of the estimated useful life of these assets.
- d. Please see the attachment produced in response to 1 PSC 26(c) above.

Bluegrass Water UOC

Woodland Acres WWTP CPCN application

March 2022

Project	Asset	Cost	Est. Useful life	*Depreciation %	Annual Depreciation Expense
MBBR	Blowers and controls for MBBRs	74,300.00	20	3.3%	2,451.90
MBBR	Blower Pad	1,500.00	30	3.3%	49.50
MBBR	Blower discharge header piping, calves, appurtenances	10,000.00	20	3.3%	330.00
MBBR	MBBR assemblies (complete)	98,500.00	20	3.3%	3,250.50
MBBR	Electrical distribution for MBBR	20,000.00	30	3.3%	660.00
Peracetic Acid Disinfection	Peracetic acid equipment and pad	17,250.00	20	3.3%	569.25
Peracetic Acid Disinfection	Electrical distribution for PAA	5,000.00	30	3.3%	165.00
Wet Weather Overflow Prevention	Wet Weather Tank and Pad	16,700.00	30	3.3%	551.10
Wet Weather Overflow Prevention	Wet Weather Valves, Grinder piping, return piping	15,000.00	30	3.3%	495.00
Wet Weather Overflow Prevention	Wet Weather Diffusers	6,000.00	20	3.3%	198.00
Wet Weather Overflow Prevention	Wet Weather Blower and Pad	10,000.00	20	3.3%	330.00
Wet Weather Overflow Prevention	Wet Weather air piping	3,000.00	30	3.3%	99.00
Wet Weather Overflow Prevention	Wet Weather Grinder pump and control	5,000.00	10	3.3%	165.00
Wet Weather Overflow Prevention	Electrical distribution for WWOP	15,000.00	30	3.3%	495.00
		297,250.00			9,809.25

** Depreciation rate is based on value estimated in KY PSC Case Bluegrass Water - 2020-00290*

Request

27. Describe and provide a copy of any cost benefit analysis performed by Bluegrass Water with respect to each of the proposed projects.

Response

As discussed in the alternatives analysis and compliance issues in previous questions, these improvements must be implemented to achieve compliance with environmental regulation and permitted limits. Alternatives were considered at both the level of analysis of all of the combined projects and for each project component to ensure that we could achieve compliance for the lowest possible cost with the lowest possible rate impact.

Alternatives for the three Woodland Acres projects (MBBR, Peroxyacetic Acid disinfection, and Wet Weather Storage) have been considered to ensure the option that is most cost-effective and that will cause the smallest rate impact is selected. Two major alternatives to the proposed projects were identified. The first practical option considered was connecting to the City of Shepherdsville (City) wastewater treatment system. After communicating with the City, the City concluded that to connect to its system Bluegrass would need to construct a large lift station and several existing sewer mains would need to be replaced with larger mains. The estimated costs of these upgrades would exceed \$1,000,000, and the ongoing cost of City waste treatment and maintaining conveyance systems to move wastewater to the City would be greater than the costs of operating Bluegrass's own facility. Bluegrass rejected this option because it would result in a much greater rate impact to customers than the proposed combined projects.

The second alternative would be total plant replacement, as the Woodland Acres plant's tanks are in poor condition making basic rehabilitation and expansion of the plant not practical. The cost to replace the facility would likely be between \$800,000 and \$1,200,000. This would offer a long-term solution for current compliance issues, but at a cost between 3 and 4 times the cost of the proposed combined projects.

Request

28. Provide a copy of any engineering reports or analyses prepared by or on behalf of Bluegrass Water assessing the condition of the Woodland Acres WWTP or collection system or discussing any improvements or repairs recommended for the Woodland Acres WWTP or collection system.
-

Response

Please see the plans and specifications attached to the response to 1 PSC 01; please also see the engineering memorandum attached to the response to 1 PSC 02.

Request

29. Provide any correspondence between Bluegrass Water and any third party engineering firm regarding the condition of or discussing any improvements or repairs recommended for the Woodland Acres WWTP or collection system.
-

Response

Please see the email attached hereto as KY2022-00015_BW_0370; please see also the attachments provided in response to 1 PSC 01, 02, 03, and 07.

From: jeremey@21designgroup.net
To: [Jake Freeman](#); [Enrique Chavez, Jr.](#); [ben kuenzel](#)
Subject: Woodland Acres, KY
Date: Friday, September 17, 2021 9:15:53 AM

Jake and Enrique: After the discussion on Woodland Acres, I wanted to throw out a thought to consider.

When I was there, the I&I looked BAD there. Sounds like they turn off air during wet weather to keep solids from passing. The MBBR cages will be better situation when we reduce MLSS concentrations, so I like that plan in short term for that reason.

One potential additional improvement that could be made now might be to add an equalization tank sized for relocation of the cages. The future MBBR tanks would only need to be about 5-6 hours of HRT at the average daily flow (25,000 gpd), or say 6,000 gallons total, +/- . That is also a very helpful target in volume for an equalization tank to significantly reduce the burden on the existing clarifiers.

They actually have 2 sets of raw sewage pumps used there (one is just discharging into hose and portable in nature). If we use one set of pumps to pump to equalization when needed (and the other set to pump into the package plant directly), it would be simple to set up new equalization tank. If a new EQ tank overflows, we could direct it to disinfection. Whether it overflows or not, we could return contents of EQ tank to influent wet well after the rain events. The EQ tank could sit on grade (so excavation and dewatering of groundwater wouldn't be a problem).

The major benefit this offers is that if the existing steel tank fails, we would have tanks in place for relocating the cages to get treatment running again quickly. (We may need to quickly install a new pump station if the tank fails still though, so installing a fiberglass wet well sized to replace the influent pumps if needed would be an additional potential improvement).

Just a couple of thoughts to consider.

Jeremey Lay
21 Design Group, Inc.
1351 Jefferson St., Suite 301
Washington, MO 63090
jeremey@21Designgroup.net
636-222-7341

Request

30. Identify the contractor or contractors that will complete the work on each project, if any, and explain the process by which Bluegrass Water identified and retained the contractors. If Bluegrass Water has not retained a contractor but intends to do so, explain the process by which Bluegrass Water will identify and retain a contractor.
-

Response

No contractor has been awarded this work to date. A bid package will be assembled with all work once approved by the Commission, and the winning bidder will be selected based on all relevant considerations including cost, qualifications, and responsiveness to bid specifications.

Request

31. Provide copies of any Agreed Orders Bluegrass Water has entered into with the Energy and Environment Cabinet (EEC) for the Woodland Acres facility and any applicable Corrective Action Plan for the Woodland Acres facility.
-

Response

Please see the Agreed Order attached hereto as KY2022-00015_BW_0371 to KY2022-00015_BW_0389 and the Corrective Action Plan attached hereto as KY2022-00015_BW_0390 to KY2022-00015_BW_0391.

Filed 10/6/2021 OAH

COMMONWEALTH OF KENTUCKY
ENERGY AND ENVIRONMENT CABINET
DIVISION OF ENFORCEMENT
CASE NO. DOW 21-3-0030

IN RE: Woodland Acres Utilities, LLC
Woodland Acres WWTP
57 Hemlock Drive
Shepherdsville, KY 40165
AI No. 479
Activity ID No. ERF20210001

AGREED ORDER

WHEREAS, the parties to this Agreed Order, the Energy and Environment Cabinet (hereinafter "Cabinet") and Bluegrass Water Utility Operating Company, LLC (hereinafter "BWUOC") state:

STATEMENTS OF FACT

1. The Cabinet is charged with the statutory duty of enforcing KRS Chapter 224 and the regulations promulgated pursuant thereto.
2. BWUOC is an active Kentucky Limited Liability Company in good standing that owns and operates utilities and whose principal address according to the Kentucky Secretary of State, is 1650 Des Peres Road, Suite 303, St. Louis, Missouri 63131.
3. Woodland Acres Wastewater Treatment Plant (hereinafter "Woodland Acres WWTP" or "facility"), is located at 57 Hemlock Drive, Shepherdsville, Kentucky 40165. The facility has a design capacity of 0.025 million gallons per day and discharges to an unnamed tributary to Mud Run.
4. Woodland Acres WWTP is currently owned and operated by Woodland Acres Utilities, LLC. The facility's discharges are permitted under Kentucky Pollutant Discharge

Elimination Systems (hereinafter "KPDES") permit number KY0091600, issued by the Cabinet's Division of Water (hereinafter "DOW"). The facility's KPDES permit expires on March 31, 2021.

5. Woodland Acres Utilities, LLC, is an inactive for-profit Kentucky corporation in bad standing, according to the Kentucky Secretary of State.

6. BWUOC has indicated to the Cabinet that it plans to acquire Woodland Acres WWTP, provided it receives from the Kentucky Public Service Commission ("Commission") all approvals required to make the acquisition. If the Commission approves the acquisition, BWUOC plans to assume ownership and operation of Woodland Acres WWTP on or around March 1, 2021.

7. BWUOC has contracted with a third-party firm to produce an engineering memorandum detailing the status of and repairs needed at Woodland Acres WWTP (Exhibit A). This report was submitted to the Cabinet on or about January 26, 2021.

8. If it receives all required Commission approvals, BWUOC has indicated to the Cabinet that it plans to make substantial repairs and/or upgrades to the facility to address the deficiencies noted in Exhibit A.

NOW THEREFORE, in the interest of providing corrective actions to Woodland Acres WWTP, the parties hereby consent to the entry of this Agreed Order and agree as follows:

REMEDIAL MEASURES

9. BWUOC shall notify the Cabinet in writing that it has assumed ownership and operation of Woodland Acres WWTP within fifteen (15) days of acquiring the facility.

10. Within fifteen (15) days of assuming ownership and operation of the facility, BWUOC shall submit a "Change in Ownership Certification" to the Cabinet.

11. At all times, commencing with assuming ownership of the facility, BWUOC shall provide for proper operation and maintenance of the facility in accordance with 401 KAR 5:065

Section 2(1).

12. Within thirty (30) days of execution of this Agreed Order, BWUOC shall submit to the Cabinet for review and acceptance, a written Corrective Action Plan (hereinafter "CAP") to bring the facility into compliance with its KPDES permit and correct the deficiencies noted in Exhibit A. The CAP shall include, but not be limited to, an identification of actions BWUOC shall implement to ensure compliance that includes; proper operation and maintenance to its sewage treatment system, collection system, and disinfection unit. The CAP shall also include a list of all actions necessary to ensure the completion of upgrades to its facility including a list of completion dates for each action. Include in the CAP a final compliance date for completion of all remedial measures listed;

- A. Upon review of the CAP, the Cabinet may, in whole or in part, (1) accept or (2) decline and provide comments to BWUOC identifying the deficiencies. Upon receipt of Cabinet comments, BWUOC shall have ninety (90) days to revise and resubmit the CAP for review and acceptance. Upon resubmittal, the Cabinet may, in whole or in part, (1) accept or (2) disapprove and provide comments to BWUOC identifying the deficiencies. Upon such resubmittal, if the CAP is disapproved, the Cabinet may deem BWUOC to be out of compliance with this Agreed Order for failure to timely submit the CAP. The parties to this Agreed Order may also agree in writing to further extend the period in which BWUOC and the Cabinet accept a revised and resubmitted CAP.
- B. BWUOC may request an amendment of the accepted CAP by writing the Director of the Division of Enforcement at 300 Sower Blvd., Frankfort,

Kentucky 40601 and stating the reasons for the request. If granted, the amended CAP shall not affect any provision of this Agreed Order unless expressly provided in the amended CAP. This does not require an amendment request pursuant to paragraph 20 of this Agreed Order.

C. Upon Cabinet acceptance of all or any part of the CAP, the amended CAP or any accepted part thereof (provided that the accepted part is not dependent upon implementation of any part not yet accepted), shall be deemed incorporated into this Agreed Order as an enforceable requirement of this Agreed Order. This does not require an amendment request pursuant to paragraph 20 of this Agreed Order.

13. So long as BWUOC is in compliance with the terms and conditions of this Agreed Order, the Cabinet's Division of Enforcement agrees to hold any formal enforcement action for numeric permit parameter violations for the KPDES permit described in paragraph 4, in abeyance. Should BWUOC fail to comply with the terms and conditions of this Agreed Order, the Cabinet may seek formal enforcement action that would have otherwise been held in abeyance.

14. By the final compliance date in the accepted CAP, BWUOC shall be in full compliance with its KPDES permit.

15. All submittals required by the terms of this Agreed Order shall be submitted to: Division of Enforcement, Attention: Director, 300 Sower Blvd., Frankfort, Kentucky, 40601.

MISCELLANEOUS PROVISIONS

16. This Agreed Order shall be of no force and effect unless BWUOC assumes ownership and operations of Woodland Acres WWTP.

17. This Agreed Order addresses only the items described above. Other than the matters agreed to by entry of this Agreed Order, nothing contained herein shall be construed to waive or to limit any remedy or cause of action by the Cabinet based on statutes or regulations under its jurisdiction and BWUOC reserves its defenses thereto. The Cabinet expressly reserves its right at any time to issue administrative orders and to take any other action it deems necessary that is not inconsistent with this Agreed Order, including the right to order all necessary remedial measures, assess penalties for violations, or recover all response costs incurred, and BWUOC reserves its defenses thereto.

18. This Agreed Order shall not prevent the Cabinet from issuing, reissuing, renewing, modifying, revoking, suspending, denying, terminating, or reopening any permit to BWUOC. BWUOC reserves its defenses thereto, except that BWUOC shall not use this Agreed Order as a defense.

19. BWUOC waives its right to any hearing on the matters admitted herein. However, failure by BWUOC to comply strictly with any or all of the terms of this Agreed Order shall be grounds for the Cabinet to seek enforcement of this Agreed Order in Franklin Circuit Court and to pursue any other appropriate administrative or judicial action under KRS Chapter 224 and the regulations promulgated pursuant thereto.

20. The Agreed Order may not be amended except by a written order of the Cabinet's Secretary or a designee thereof. BWUOC may request an amendment by writing the Director of the Division of Enforcement at 300 Sower Blvd., Frankfort, Kentucky 40601, and stating the reasons for the request. If granted, the amended Agreed Order shall not affect any provision of this Agreed Order unless expressly provided in the amended Agreed Order.

21. The Cabinet does not, by its consent to the entry of this Agreed Order, warrant or aver in any manner that BWUOC's complete compliance with this Agreed Order will result in compliance with the provisions of KRS Chapter 224 and the regulations promulgated pursuant thereto. Notwithstanding the Cabinet's review and approval of any plans formulated pursuant to this Agreed Order, BWUOC shall remain solely responsible for compliance with the terms of KRS Chapter 224 and the regulations promulgated thereto, this Agreed Order, and any permit and compliance schedule requirements.

22. BWUOC shall give notice of this Agreed Order to any purchaser, lessee or successor in interest prior to the transfer of ownership and/or operation of any part of the facility occurring prior to termination of this Agreed Order, shall notify the Cabinet that such notice has been given, and shall follow all statutory requirements for a transfer.

23. This Agreed Order applies specifically and exclusively to the unique facilities referenced herein and is inapplicable to any other facility.

24. Compliance with this Agreed Order is not conditional on the receipt of any federal, state, or local funds.

25. This Agreed Order shall be of no force and effect unless and until it is entered by the Secretary or a designee thereof as evidenced by his or her signature thereon. If this Agreed Order contains any date by which BWUOC is to take any action or cease any activity, and the Secretary enters the Agreed Order after that date, then BWUOC is nonetheless obligated to have taken the action or ceased the activity by the date contained in this Agreed Order.

TERMINATION

26. This Agreed Order shall terminate upon BWUOC's completion of all requirements described in this Agreed Order. BWUOC may submit written notice to the Cabinet when it believes

all requirements have been performed. The Cabinet shall notify BWUOC in writing whether it concurs that all requirements of this Agreed Order have been completed. The Cabinet reserves its right to enforce this Agreed Order, and BWUOC reserves its right to file a petition for hearing pursuant to KRS 224.10-420(2) contesting the Cabinet's determination.

CASE NO. DOW 21-3-0030

AGREED TO BY:

Josiah Cox (Aug 10, 2021 11:19 CDT)

Josiah Cox, President
Bluegrass Water Utility Operating Company, LLC

Aug 10, 2021

Date

CASE NO. DOW 21-3-0030

APPROVAL RECOMMENDED BY:



Michael B. Kroeger, Director (Assistant)
Division of Enforcement

9/9/2021

Date

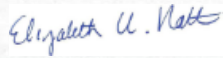

Elizabeth U. Natter, Executive Director
Office of General Counsel

10/6/2021

Date

ORDER

Wherefore, the foregoing Agreed Order is entered as the final Order of the Energy and Environment Cabinet this 6th day of October, 2021.

ENERGY AND ENVIRONMENT CABINET



John S. Lyons, Deputy Secretary
Authorized Designee, Rebecca W. Goodman,
Secretary Energy & Environment Cabinet

CERTIFICATE OF SERVICE

I hereby certify that a true and accurate copy of the foregoing **AGREED ORDER** was mailed, postage prepaid, to the following this 6th day of October, 2021.

Bluegrass Water Utility Operating Company, LLC
Attn: Jacob Freeman
1650 Des Peres Road, Suite 303
St. Louis, MO 63131

And ~~mailed, messenger to~~: Electronically mailed to:

Michael B. Kroeger, Director
Division of Enforcement
300 Sower Blvd.
Frankfort, Kentucky 40601

Elizabeth U. Natter, Executive Director
Office of General Counsel
Energy and Environment Cabinet
300 Sower Blvd.
Frankfort, Kentucky 40601



DOCKET COORDINATOR

Distribution:
DOW-email
S&H
DBG

Exhibit A

Civil Engineering
Surveying & Mapping
Potable Water
Wastewater Treatment



Civil Site Design
Construction Support
Transportation
Wastewater Collection

Woodland Acres – Woodland Acres WWTP KY0096100

Kentucky

Engineering Memorandum

Date: September 11, 2020

Introduction

The Woodland Acres wastewater treatment facility is located in Shepherdsville, Kentucky approximately 17 miles south of Louisville, Kentucky. This facility services 121 parcels. The system operates under Kentucky DEP Permit number KY0096100 and Agency ID number 479.

Wastewater Treatment Facility Existing Conditions

The plant is authorized to discharge up to 25,000 gallons per day (gpd) by the KDEP per the operating permit.

A summary of the existing permit limits are described below:

- BOD5 – 10/15 mg/L (Monthly average/Maximum Weekly Average)
- TSS – 30/45 mg/L
- NH3-N – 4/6 mg/L in Summer
- NH3-N – 10/15 mg/L in Winter
- E-Coli – 130/240 mpn/100 ml
- Total Residual Chlorine – 0.011/0.019 mg/L
- Dissolved Oxygen – 7.0 mg/L minimum

The subdivision has 121 parcels and little additional buildout would seem possible. Based off of the number of possible connections and assuming 250 gpd of flow per customer, 30,000 gpd of average daily flow would be expected when the available lots are fully occupied.

A review was performed of EPA's Echo compliance website which lists violations of wastewater treatment plants across the country. The Woodland Acres wastewater treatment plant has exceeded permit limitations several times in recent months and years for E-Coli, BOD, and Ammonia.

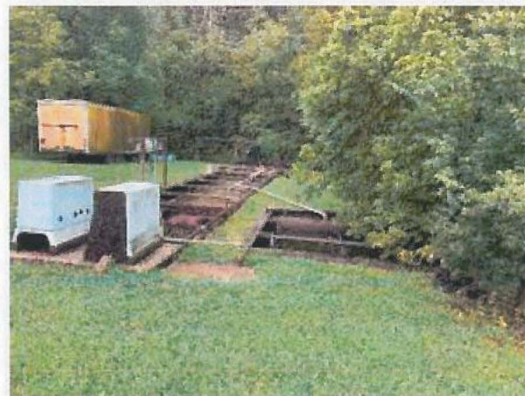

1351 Jefferson St., Suite 301
Washington, MO 63090

CONFIDENTIAL TO CSWR

636-432-5029

Civil Engineering
Surveying & Mapping
Potable Water
Wastewater Treatment



Civil Site Design
Construction Support
Transportation
Wastewater Collection

The existing facility includes an extended aeration package plant including a mechanically cleaned bar rack screen, a single aeration basin, equalization basin with two influent pumps (one portable), aerobic digestion, rapid sand filter, and a chlorine contact tank. Dechlorination is utilized downstream of disinfection.

The packaged plant has aged and shows significant signs of wear and corrosion. The blowers and diffusers are in need of replacement, and one of the two RAS lines has broken off into the aeration basin. The basin appears to have been modified over time with changes to original structural components. The basin does not include handrail needed to protect operators or visitors from falling into the package plant.

Functionally, the system also has some limitations:

- The entire community is challenged by high ground water levels. The site visit was conducted during a moderate storm event that resulted in significant stormwater challenges in the streets and wastewater flow challenges at the plant. During the visit the blowers had been turned off to inventory solids, and both influent pumps were continuously pumping at what appeared to be a rate higher than the plant was capable of processing. When the blowers were turned on briefly, the noise was significant and the discharge pressure was likely excessive.
- According to operators, the all gravity collection system results in significant I&I, impacting system performance.
- The blower discharge pressure may be excessively high..
- The operator believes it is necessary to turn off aeration during wet weather events to minimize the loss of solids and to retain a healthy biomass.
- The tertiary treatment basin (rapid sand filter, contact tank and dechlorination tank) is highly corroded.
- There is no ideal place for chlorine tablet addition or dechlorination tablet addition.
- There is no flow monitoring at this time.
- The facility includes significant amounts of exposed wiring.

The fencing around most of the site is generally in relatively good condition, and there is significance footprint available for the addition of improvements.

Currently no remote monitoring is in place at the site. This makes it difficult for the operators to know when the facility is failing. Operational monitoring should be completed to monitor the quality of effluent, which should then be compared to the operating permit.

Wastewater Treatment Facility Recommended Improvements

- The condition of the tank calls for taking the facility off line for structural repair, at a minimum to include the addition of access bridge improvements, safety handrail, welding repairs, and the addition of a new RAS line from one of the hopper bottomed clarifiers to the front end of the plant. Because of this, it makes sense to take advantage of the down time to upgrade the

1351 Jefferson St., Suite 301
Washington, MO 63090

CONFIDENTIAL TO CSWR

636-432-5029

Civil Engineering
Surveying & Mapping
Potable Water
Wastewater Treatment

21 DESIGN

Civil Site Design
Construction Support
Transportation
Wastewater Collection

system to an MBBR treatment system to simplify operations and improve performance during wet weather events. The conversion from extended aeration activated sludge to MBBR will include the addition of baffle walls, new diffusers, new blowers, media, and media retention sieves.

- The smaller footprint MBBR will allow a fraction of the existing tank to be used for digestion. The new system will generate significantly less sludge than the existing extended aeration system as well, so sludge handling needs will significantly decrease.
- The 10' foot deep clarifier is adequate for a fixed film type system, and will function much better in this application than with the existing activated sludge system.
- The effluent from the three stage MBBR will be evenly distributed into and through the clarifier, and the level control in the clarifier will be maintained with the addition of a weir trough and weir.
- A flow meter will be installed in the clarifier effluent piping, in route to the contact tank.
- Peroxyacetic acid will be introduced directly into the contact tank in lieu of attempting to install chlorination and dechlorination tablet feeders in the limited hydraulic profile. The PAA chemical requires less contact time, and will more consistently achieve the necessary disinfection objectives.
- Alum will be introduced into the clarifier to improve settleability when required to consistently achieve solids reduction and in turn, BOD effluent limit compliance.
- The existing chlorine contact tank will be equipped with diffusers to help in meeting the dissolved oxygen effluent limit.
- Three blowers will replace the existing two blowers. One will serve the aeration tank needs, air lift needs, and post-aeration needs; one will serve the digester needs; and one will serve as standby for both applications.

Wastewater Collection System Understanding

While no mapping was provided, the collection system consists of only gravity collection.

According to the operator, the collection system consists of 8" and 10" gravity sewers, and the high groundwater table results in significant peak flow events at the facility. Wastewater enters the wastewater treatment plant through a gravity sewer.

Wastewater Collection System Recommended Improvements

- The system should be evaluated to create mapping and develop GIS shapefiles for future maintenance. System mapping at the fingertips of the operators will enhance the level of service and timing of responses to emergency and customer issues.
- Perform smoke testing, perform video inspection at selected locations, evaluate systems and create GIS based maintenance priority list.

1351 Jefferson St., Suite 301
Washington, MO 63090

CONFIDENTIAL TO CSWR

636-432-5029

Civil Engineering
Surveying & Mapping
Potable Water
Wastewater Treatment



Civil Site Design
Construction Support
Transportation
Wastewater Collection

APPENDIX



Blowers, EQ Basin, and Electrical Cables



Electrical Boxes and
Electrical Cabling

1351 Jefferson St., Suite 301
Washington, MO 63090

CONFIDENTIAL TO CSWR

636-432-5029

Civil Engineering
Surveying & Mapping
Potable Water
Wastewater Treatment

21 DESIGN

Civil Site Design
Construction Support
Transportation
Wastewater Collection



**EQ Basin, Portable Pump Discharge,
Digester, Miscellaneous Electrical Cables**



**Clarifier Performance During Wet Weather
(and No Aeration in Aeration Tank)**

1351 Jefferson St., Suite 301
Washington, MO 63090

CONFIDENTIAL TO CSWR

636-432-5029

Civil Engineering
Surveying & Mapping
Potable Water
Wastewater Treatment



Civil Site Design
Construction Support
Transportation
Wastewater Collection



Chlor/Dechlor Structure



WWTP Electrical Meter

1351 Jefferson St., Suite 301
Washington, MO 63090

CONFIDENTIAL TO CSWR

636-432-5029

DOW 21-3-0030 - Woodland Acres AO

Final Audit Report

2021-08-10

Created:	2021-08-09
By:	Mandy Keubler (mkeubler@cswrgroup.com)
Status:	Signed
Transaction ID:	CBJCHBCAABAA341sUeBgv9Zo22gFKtqDBsCuVD7dvOqg

"DOW 21-3-0030 - Woodland Acres AO" History

-  Document created by Mandy Keubler (mkeubler@cswrgroup.com)
2021-08-09 - 9:19:16 PM GMT- IP address: 71.10.211.134
-  Document emailed to Josiah Cox (jcox@cswrgroup.com) for signature
2021-08-09 - 9:19:44 PM GMT
-  Email viewed by Josiah Cox (jcox@cswrgroup.com)
2021-08-10 - 4:19:15 PM GMT- IP address: 12.127.143.250
-  Document e-signed by Josiah Cox (jcox@cswrgroup.com)
Signature Date: 2021-08-10 - 4:19:25 PM GMT - Time Source: server- IP address: 12.127.143.250
-  Agreement completed.
2021-08-10 - 4:19:25 PM GMT



October 20, 2021

Nicholas Fields
Kentucky Department of Environmental Protection
Division of Enforcement
300 Sower Blvd., 3rd Floor
Frankfort, KY 40601

Bluegrass Water Utility Operating Company, LLC
Woodland Acres WWTP
KYPDES Permit No. KY0091600
Agency No. 479

Corrective Action Plan

In light of the Woodland Acres WWTP's failure to meet permitted limits, Bluegrass Water submits the following corrective action plan.

BWUOC has recently purchased this treatment plant. With the change of ownership, operational modifications have been implemented and are ongoing. Due to the poor maintenance of the facility by the previous ownership, the current plant is not capable of consistently meeting limits.

1. Causes of Effluent Violations

- Ammonia
- Total Suspended Solids (TSS)
- Carbonaceous Biological Oxygen Demand (CBOD)
- E. Coli

A review was performed of EPA's Echo compliance website which lists violations. The Woodland Crossing WWTF has been in "Significant noncompliance" for all of the last 12 quarters with numerous effluent exceedances as well as notices for improper maintenance and operations of the facility. The package plant portion of the facility has not been maintained by the previous ownership and is severely rusted and structurally unsound. Several electrical safety concerns exist, the return activated sludge piping has fallen in the basin, and other piping within the plant is constructed of PVC which can degrade in sunlight. The raw sewage pumps and the blowers are reaching the end of their useful lives and are not likely producing the pumping rate or air supply rate they were designed to produce.

In light of the poor maintenance of these portions of the plant, it is also probable that the diffusers in the aeration plant are in poor condition and not properly aerating the wastewater being treated. This compromises the treatment process and can result in exceedances in any of the above limits. Previous ownership allowed the plant to fall into such a state of disrepair that it is realistic to expect that the package plant would need to be totally replaced to consistently meet limits using the current process. This is especially evident in the condition of the tankage itself that would require either massive patching or replacement.

In addition to the self-inflicted maintenance challenges, the average daily flow is at the plant's rated capacity, and the peak flows caused by high inflow and infiltration likely exceed the rated capacity of clarifier and disinfection unit processes. There is a need to add equalization to reduce the peak flow to these unit processes and the reduce the solids

loading rate to the clarifier.

2. System Evaluation and Corrective Actions

The existing system will need to be replaced in the coming years. In an effort to make progress toward this goal as a part of the short term, the improvements will be phased.

A flow meter and Mission Monitoring system has already been installed and is being utilized to remotely monitor the facility. The flow meter will be calibrated.

The first phase of improvements will include the addition of equalization tanks that can ultimately be used to replace the package plant aeration tankage. Initially, the new equalization tanks will perform primary treatment on excess wet weather flows and reduce the hydraulic burden on the clarifier and contact tank. The first phase of improvements will also include the addition of moving bed biological reactor media installed in cages and positioned on the floor of the aeration tanks. The new MBBR cages will be sized to convert the existing system from an activated sludge system into an MBBR system to reduce the solids loading challenge on the currently hydraulically overloaded clarifier. In the future, the cages of MBBR media can be relocated into the new equalization tanks and serve as the primary biological treatment process.

The first phase of improvements will also include the addition of a peroxyacetic acid (PAA) storage and feed system to improve disinfection performance and the addition of an aluminum sulfate storage and feed system to help in meeting total suspended solids limits. A manual transfer switch will be added to allow for the use of a remote generator.

The existing stand-alone aerobic digester will remain in service.

In the future, a second phase of improvements will include a clarifier system, a new contact tank, and the relocation of the new chemical feed facilities to serve in the new treatment scheme. It is also anticipated that a new influent pump station and equalization facility will be required at that time.

3. Project Milestones

- a. Continue monitoring performance of facility (June 30, 2023)
- b. Install temporary wet weather equalization tank (November 30, 2021)
- c. Calibrate flow meter and Mission monitoring system (November 30, 2021)
- d. Submit construction permit application for major modifications (January 15, 2022)
- e. Procure equipment (May 15, 2022)
- f. Receive construction permit (August 30, 2022)
- g. Complete construction (June 30, 2023)

Sincerely,



ENRIQUE CHAVEZ JR.
Utility Project Manager

(314) 380-8043
(314) 437-5714
(314) 736-4743
echavez@cswrgroup.com
1650 Des Peres Rd., Suite 303
Des Peres, MO 63131
centralstateswaterresources.com

Request

32. Provide all reports Bluegrass Water has made to the EEC, if any, regarding its efforts to bring the Woodland Acres facility within compliance and any correspondence received regarding the same from EEC.
-

Response

Please see the documents attached in response to 1 PSC 31.

Request

33. Provide any citations or notices of violations received by Bluegrass Water from the EEC or the Environmental Protection Agency for violations at the Woodland Acres facility.
-

Response

No notices of violation have been issued to Bluegrass due to the Agreed Order (attached in response to 1 PSC 31).

Request

34. Provide any correspondence Bluegrass Water has received from the EEC's Division of Compliance or Division of Water regarding the Woodland Acres facility.
-

Response

Please see the documents attached in response to 1 PSC 31.

Request

35. Provide a copy of the current discharge permit for the Woodland Acres WWTP.

Response

Please see the current discharge permit attached hereto as KY2022-00015_BW_0392 to
KY2022-00015_BW_0422.

ANDY BESHEAR
GOVERNOR



REBECCA W. GOODMAN
SECRETARY

ENERGY AND ENVIRONMENT CABINET
DEPARTMENT FOR ENVIRONMENTAL PROTECTION

ANTHONY R. HATTON
COMMISSIONER

300 SOWER BOULEVARD
FRANKFORT, KENTUCKY 40601

July 30, 2021

Mr. Michael Dick
Bluegrass Water Utility Operating Company
1650 Des Peres Road, Suite 303
Des Peres, MO 63131

Re: KPDES Final Permit Issuance
KPDES No.: KY0091600
Woodland Acres
AI ID: 479
Bullitt County, Kentucky

Dear Mr. Dick:

Enclosed is the Kentucky Pollutant Discharge Elimination System (KPDES) permit for the above-referenced facility. This action constitutes a final permit issuance under 401 KAR 5:075, pursuant to KRS 224.16-050.

This permit will become effective on the date indicated in the attached permit provided that no request for adjudication is granted. All provisions of the permit will be effective and enforceable in accordance with 401 KAR 5:075.

Any demand for a hearing on the permit shall be filed in accordance with the procedures specified in KRS 224.10-420, 224.10-440, 224.10-470 and any regulations promulgated thereto. Any person aggrieved by the issuance of a permit final decision may demand a hearing, pursuant to KRS 224.10-420(2), within thirty (30) days from the date of the issuance of this letter. Two (2) copies of request for hearing should be submitted in writing to the Energy and Environment Cabinet, Office of Administrative Hearings, 211 Sower Boulevard, Frankfort, Kentucky 40601 and the Commonwealth of Kentucky, Energy and Environment Cabinet, Division of Water, 300 Sower Boulevard, Frankfort, Kentucky 40601. For your record keeping purposes, it is recommended that these requests be sent by certified mail. The written request must conform to the appropriate statutes referenced above.

If you have any questions regarding the KPDES decision, please contact the Surface Water Permits Branch by phone at (502) 564-3410 or via email at SWPBSupport@ky.gov. Further information on procedures and legal matters pertaining to the hearing request may be obtained by contacting the Office of Administrative Hearings at (502) 564-7312.

Sincerely,

A handwritten signature in black ink that reads "Jason M. Hurt".

Jason M. Hurt, P.E.
Manager, Surface Water Permits Branch
Division of Water

JMH: asw
Enclosure



KPDES



**KENTUCKY POLLUTANT
DISCHARGE ELIMINATION
SYSTEM**

PERMIT

**AUTHORIZATION TO DISCHARGE UNDER THE
KENTUCKY POLLUTANT DISCHARGE ELIMINATION SYSTEM**

PERMIT NO.: KY0091600

AGENCY INTEREST NO.: 479

Pursuant to Authority in KRS 224,

Bluegrass Water Utility Operating Company
1650 Des Peres Road, Suite 303
Des Peres, MO 63131

is authorized to discharge from a facility located at

Woodland Acres WWTP
Lot 57 Hemlock Drive
Shepherdsville, Bullitt County, Kentucky

to receiving waters named

Unnamed Tributary to Mud Run Creek

in accordance with effluent limitations, monitoring requirements and other conditions set forth in this permit.

This permit shall become effective on October 1, 2021.

This permit and the authorization to discharge shall expire at midnight, September 30, 2026.

Date Signed: July 30, 2021

A handwritten signature in black ink, appearing to read "Carey M. Johnson".

**Carey M. Johnson, Director
Division of Water**

**DEPARTMENT FOR ENVIRONMENTAL PROTECTION
Division of Water, 300 Sower Blvd, Frankfort, Kentucky 40601**

Printed on Recycled Paper

KY2022-00015_BW_0393

THIS KPDES PERMIT CONSISTS OF THE FOLLOWING SECTIONS:

1. EFFLUENT LIMITATIONS AND MONITORING REQUIREMENTS.....4

1.1. Compliance Monitoring Locations (Outfalls) 4

1.2. Effluent Limitations and Monitoring Requirements 4

1.3. Standard Effluent Requirements 5

2. STANDARD CONDITIONS.....7

2.1. Duty to Comply 7

2.2. Duty to Reapply..... 7

2.3. Need to Halt or Reduce Activity Not a Defense..... 7

2.4. Duty to Mitigate 7

2.5. Proper Operation and Maintenance..... 7

2.6. Permit Actions..... 7

2.7. Property Rights 7

2.8. Duty to Provide Information 7

2.9. Inspection and Entry 8

2.10. Monitoring and Records 8

2.11. Signatory Requirement 9

2.12. Reporting Requirements..... 9

2.13. Bypass 10

2.14. Upset 11

3. OTHER CONDITIONS14

3.1. Schedule of Compliance..... 14

3.2. Other Permits..... 14

3.3. Continuation of Expiring Permit..... 14

3.4. Antidegradation 14

3.5. Reopener Clause 14

3.6. Connection to Regional Sewer System 14

3.7. Certified Operators 14

3.8. Outfall Signage 14

4. MONITORING AND REPORTING REQUIREMENTS16

4.1. KPDES Outfalls..... 16

4.2. Sufficiently Sensitive Analytical Methods 16

4.3. Certified Laboratory Requirements 16

4.4. Submission of DMRs 16

SECTION 1

EFFLUENT LIMITATIONS AND MONITORING REQUIREMENTS

1. EFFLUENT LIMITATIONS AND MONITORING REQUIREMENTS

1.1. Compliance Monitoring Locations (Outfalls)

The following table lists the outfalls authorized by this permit, the latitude and longitude of each and the DOW assigned KPDES outfall number:

TABLE 1.					
Outfall No.	Outfall Type	Latitude (N)	Longitude (W)	Receiving Water	Description of Outfall
001	External	38.007913°	85.731103°	Unnamed Tributary to Mud Run Creek	Domestic Wastewater

1.2. Effluent Limitations and Monitoring Requirements

Beginning on the effective date and lasting through the term of this permit, discharges from Outfall 001 shall comply with the following effluent limitations:

TABLE 2.									
EFFLUENT LIMITATIONS								MONITORING REQUIREMENTS	
Effluent Characteristic	Units	Loadings (lbs/day)		Concentrations				Frequency	Sample Type
		Monthly Average	Maximum Weekly Average	Minimum	Monthly Average	Maximum Weekly Average	Maximum		
Flow	MGD	Report	Report ¹	N/A	N/A	N/A	N/A	1/Quarter	Instantaneous
pH	SU	N/A	N/A	6.0	N/A	N/A	9.0	1/Quarter	Grab
CBOD ₅ ²	mg/l	N/A	N/A	N/A	10	15	N/A	1/Quarter	Composite ³
Total Suspended Solids	mg/l	N/A	N/A	N/A	30	45	N/A	1/Quarter	Composite ³
Nitrogen, Ammonia total [as N]									
May 1 – October 31	mg/l	N/A	N/A	N/A	4.0	6.0 ¹	N/A	1/Quarter	Grab
November 1 – April 30	mg/l	N/A	N/A	N/A	10.0	15.0 ¹	N/A	1/Quarter	Grab
Dissolved Oxygen	mg/l	N/A	N/A	7.0	N/A	N/A	N/A	1/Quarter	Grab
E. coli ⁴	#/100 ml	N/A	N/A	N/A	130 ⁵	240 ⁶	N/A	1/Quarter	Grab
Total Residual Chlorine	mg/l	N/A	N/A	N/A	0.011	0.019 ¹	N/A	1/Quarter	Grab

¹Daily Maximum

²CBOD₅ – Carbonaceous Biochemical Oxygen Demand, 5-day

³A sample composed of four or more equal or flow-proportional aliquots collected over a period of no less than eight and no more than twenty-four hours and aggregated so that the aggregate sample reflects the average water quality of the effluent during the compositing or sample period

TABLE 2.

EFFLUENT LIMITATIONS								MONITORING REQUIREMENTS	
Effluent Characteristic	Units	Loadings (lbs/day)		Concentrations				Frequency	Sample Type
		Monthly Average	Maximum Weekly Average	Minimum	Monthly Average	Maximum Weekly Average	Maximum		
⁴ E. coli – <i>Escherichia coli</i> Bacteria									
⁵ Thirty (30) day Geometric Mean									
⁶ Seven (7) day Geometric Mean									

1.3. Standard Effluent Requirements

The discharges to Waters of the Commonwealth shall not produce floating solids, visible foam or a visible sheen on the surface of the receiving waters.

SECTION 2

STANDARD CONDITIONS

2. STANDARD CONDITIONS

The following conditions apply to all KPDES permits.

2.1. Duty to Comply

The permittee must comply with all conditions of this permit. Any permit noncompliance constitutes a violation of KRS Chapter 224 and is grounds for enforcement action; for permit termination, revocation and reissuance, or modification; or denial of a permit renewal application. Any person who violates applicable statutes or who fails to perform any duty imposed, or who violates any determination, permit, administrative regulation, or order of the Cabinet promulgated pursuant thereto shall be liable for a civil penalty as provided at KRS 224.99.010.

2.2. Duty to Reapply

If the permittee wishes to continue an activity regulated by this permit after the expiration date of this permit, the permittee must apply for a new permit.

2.3. Need to Halt or Reduce Activity Not a Defense

It shall not be a defense for a permittee in an enforcement action that it would have been necessary to halt or reduce the permitted activity in order to maintain compliance with the conditions of this permit.

2.4. Duty to Mitigate

The permittee shall take all reasonable steps to minimize or prevent any discharge or sludge use or disposal in violation of this permit which has a reasonable likelihood of adversely affecting human health or the environment.

2.5. Proper Operation and Maintenance

The permittee shall at all times properly operate and maintain all facilities and systems of treatment and control (and related appurtenances) which are installed or used by the permittee to achieve compliance with the conditions of this permit. Proper operation and maintenance also includes adequate laboratory controls and appropriate quality assurance procedures. This provision requires the operation of back-up or auxiliary facilities or similar systems which are installed by a permittee only when the operation is necessary to achieve compliance with the conditions of the permit.

2.6. Permit Actions

This permit may be modified, revoked and reissued, or terminated for cause. The filing of a request by the permittee for a permit modification, revocation and reissuance, or termination, or a notification of planned changes or anticipated noncompliance does not stay any permit condition.

2.7. Property Rights

This permit does not convey any property rights of any sort, or any exclusive privilege.

2.8. Duty to Provide Information

The permittee shall furnish to the Director, within a reasonable time, any information which the Director may request to determine whether cause exists for modifying, revoking and reissuing, or terminating this permit or to determine compliance with this permit. The permittee shall also furnish to the Director upon request, copies of records required to be kept by this permit.

2.9. Inspection and Entry

The permittee shall allow the Director, or an authorized representative (including an authorized contractor acting as a representative of the Administrator), upon presentation of credentials and other documents as may be required by law, to:

- (1) Enter upon the permittee's premises where a regulated facility or activity is located or conducted, or where records must be kept under the conditions of this permit;
- (2) Have access to and copy, at reasonable times, any records that must be kept under the conditions of this permit;
- (3) Inspect at reasonable times any facilities, equipment (including monitoring and control equipment), practices, or operations regulated or required under this permit; and
- (4) Sample or monitor at reasonable times, for the purposes of assuring permit compliance or as otherwise authorized by the Clean Water Act, any substances or parameters at any location.

2.10. Monitoring and Records

- (1) Samples and measurements taken for the purpose of monitoring shall be representative of the monitored activity.
- (2) Except for records of monitoring information required by this permit related to the permittee's sewage sludge use and disposal activities, which shall be retained for a period of at least five (5) years (or longer as required by 401 KAR 5:065, Section 2(10) [40 CFR 503]), the permittee shall retain records of all monitoring information, including all calibration and maintenance records and all original strip chart recordings for continuous monitoring instrumentation, copies of all reports required by this permit, and records of all data used to complete the application for this permit, for a period of at least three (3) years from the date of the sample, measurement, report or application. This period may be extended by request of the Director at any time.
- (3) Records of monitoring information shall include:
 - a) The date, exact place, and time of sampling or measurements;
 - b) The individual(s) who performed the sampling or measurements;
 - c) The date(s) analyses were performed;
 - d) The individual(s) who performed the analyses;
 - e) The analytical techniques or methods used; and
 - f) The results of such analyses.
- (4) Monitoring must be conducted according to test procedures approved under 401 KAR 5:065, Section 2(8) [40 CFR 136] unless another method is required under 401 KAR 5:065, Section 2(9) or (10) [40 CFR subchapters N or O].
- (5) KRS 224.99-010 provides that any person who knowingly violates KRS 224.70-110 or other enumerated statutes, or who knowingly renders inaccurate any monitoring device or method required to be maintained under this permit shall be guilty of a Class D felony and, upon conviction, shall be punished by a fine of not more than \$25,000, or by imprisonment for not less than one (1) year and not more than five (5) years, or by both fine and imprisonment for each separate violation. Each day upon which a violation occurs shall constitute a separate violation.

2.11. Signatory Requirement

(1) All applications, reports, or information submitted to the Director shall be signed and certified pursuant to 401 KAR 5:060, Section 4 [40 CFR 122.22].

(2) KRS 224.99-010 provides that any person who knowingly provides false information in any document filed or required to be maintained under KRS Chapter 224 shall be guilty of a Class D felony and upon conviction thereof, shall be punished by a fine not to exceed twenty-five thousand dollars (\$25,000), or by imprisonment, or by fine and imprisonment, for each separate violation. Each day upon which a violation occurs shall constitute a separate violation.

2.12. Reporting Requirements**2.12.1. Planned Changes**

The permittee shall give notice to the Director as soon as possible of any planned physical alterations or additions to the permitted facility. Notice is required only when:

(1) The alteration or addition to a permitted facility may meet one (1) of the criteria for determining whether a facility is a new source in KRS 224.16-050 [40 CFR 122.29(b)]; or

(2) The alteration or addition could significantly change the nature or increase the quantity of pollutants discharged. This notification applies to pollutants which are subject neither to effluent limitations in the permit, nor to notification requirements under KRS 224.16-050 [40 CFR 122.42(a)(1)].

(3) The alteration or addition results in a significant change in the permittee's sludge use or disposal practices, and such alteration, addition, or change may justify the application of permit conditions that are different from or absent in the existing permit, including notification of additional use or disposal sites not reported during the permit application process or not reported pursuant to an approved land application plan.

2.12.2. Anticipated Noncompliance

The permittee shall give advance notice to the Director of any planned changes in the permitted facility or activity which may result in noncompliance with permit requirements.

2.12.3. Transfers

This permit is not transferable to any person except after notice to the Director. The Director may require modification or revocation and reissuance of the permit to change the name of the permittee and incorporate such other requirements as may be necessary under KRS 224 [CWA; see 40 CFR 122.61; in some cases, modification or revocation and reissuance is mandatory].

2.12.4. Monitoring Reports

Monitoring results shall be reported at the intervals specified elsewhere in this permit.

(1) Monitoring results must be reported on a Discharge Monitoring Report (DMR) or forms provided or specified by the Director for reporting results of monitoring of sludge use or disposal practices.

(2) If the permittee monitors any pollutant more frequently than required by the permit using test procedures approved under 401 KAR 5:065, Section 2(8) [40 CFR 136], or another method required for an industry-specific waste stream under 401 KAR 5:065, Section 2(9) or (10) [40 CFR subchapters N or O], the results of such monitoring shall be included in the calculation and reporting of the data submitted in the DMR or sludge reporting form specified by the Director.

(3) Calculations for all limitations which require averaging of measurements shall utilize an arithmetic mean unless otherwise specified by the Director in the permit.

2.12.5. Compliance Schedules

Reports of compliance or noncompliance with, or any progress reports on, interim and final requirements contained in any compliance schedule of this permit shall be submitted no later than fourteen (14) days following each schedule date.

2.12.6. Twenty-four-Hour Reporting

(1) The permittee shall report any noncompliance which may endanger health or the environment. Any information shall be provided orally within twenty-four (24) hours from the time the permittee becomes aware of the circumstances. A written submission shall also be provided within 5 days of the time the permittee becomes aware of the circumstances. The written submission shall contain a description of the noncompliance and its cause; the period of noncompliance, including exact dates and times, and if the noncompliance has not been corrected, the anticipated time it is expected to continue; and steps taken or planned to reduce, eliminate, and prevent reoccurrence of the noncompliance.

(2) The following shall be included as information which must be reported within twenty-four (24) hours under this paragraph.

- a) Any unanticipated bypass which exceeds any effluent limitation in the permit. (See §122.41(g))
- b) Any upset which exceeds any effluent limitation in the permit.
- c) Violation of a maximum daily discharge limitation for any of the pollutants listed by the Director in the permit to be reported within twenty-four (24) hours.

(3) The Director may waive the written report on a case-by-case basis under 40 CFR 122.41 (l), if the oral report has been received within twenty-four (24) hours.

2.12.7. Other Noncompliance

The permittee shall report all instances of noncompliance not reported under Sections 2.12.1, 2.12.4, 2.12.5 and 2.12.6, at the time monitoring reports are submitted. The reports shall contain the information listed in Section 2.12.6.

2.12.8. Other Information

Where the permittee becomes aware that it failed to submit any relevant facts in a permit application, or submitted incorrect information in a permit application or in any report to the Director, it shall promptly submit such facts or information.

2.13. Bypass

2.13.1. Definitions

(1) Bypass means the intentional diversion of waste streams from any portion of a treatment facility.

(2) Severe property damage means substantial physical damage to property, damage to the treatment facilities which causes them to become inoperable, or substantial and permanent loss of natural resources which can reasonably be expected to occur in the absence of a bypass. Severe property damage does not mean economic loss caused by delays in production.

2.13.2. Bypass Not Exceeding Limitations

The permittee may allow any bypass to occur which does not cause effluent limitations to be exceeded, but only if it also is for essential maintenance to assure efficient operation. These bypasses are not subject to the provisions of Section 2.13.3 and 2.13.4.

2.13.3. Notice

(1) Anticipated bypass. If the permittee knows in advance of the need for a bypass, it shall submit prior notice, if possible at least ten (10) days before the date of the bypass.

(2) Unanticipated bypass. The permittee shall submit notice of an unanticipated bypass as required in Section 2.12.6.

2.13.4. Prohibition of Bypass

(1) Bypass is prohibited, and the Director may take enforcement action against a permittee for bypass, unless:

- a) Bypass was unavoidable to prevent loss of life, personal injury, or severe property damage;
- b) There were no feasible alternatives to the bypass, such as the use of auxiliary treatment facilities, retention of untreated wastes, or maintenance during normal periods of equipment downtime. This condition is not satisfied if adequate back-up equipment should have been installed in the exercise of reasonable engineering judgment to prevent a bypass which occurred during normal periods of equipment downtime or preventive maintenance; and
- c) The permittee submitted notices as required under Section 2.13.3.

(2) The Director may approve an anticipated bypass, after considering its adverse effects, if the Director determines that it will meet the three (3) conditions listed above in Section 2.13.4.

2.14. Upset**2.14.1. Definition**

Upset means an exceptional incident in which there is unintentional and temporary noncompliance with technology-based permit effluent limitations because of factors beyond the reasonable control of the permittee. An upset does not include noncompliance to the extent caused by operational error, improperly designed treatment facilities, inadequate treatment facilities, lack of preventive maintenance, or careless or improper operation.

2.14.2. Effect of an Upset

An upset constitutes an affirmative defense to an action brought for noncompliance with such technology-based permit effluent limitations if the requirements of Section 2.14.3 are met. No determination made during administrative review of claims that noncompliance was caused by upset, and before an action for noncompliance, is final administrative action subject to judicial review.

2.14.3. Conditions Necessary for a Demonstration of Upset

A permittee who wishes to establish the affirmative defense of upset shall demonstrate, through properly signed, contemporaneous operating logs, or other relevant evidence that:

- (1) An upset occurred and that the permittee can identify the cause(s) of the upset;
- (2) The permitted facility was at the time being properly operated; and
- (3) The permittee submitted notice of the upset as required in Section 2.12.6; and

(4) The permittee complied with any remedial measures required under Section 2.4.

2.14.4. Burden of Proof

In any enforcement proceeding the permittee seeking to establish the occurrence of an upset has the burden of proof.

SECTION 3

OTHER CONDITIONS

3. OTHER CONDITIONS

3.1. Schedule of Compliance

The permittee shall attain compliance with all requirements of this permit on the effective date of this permit unless otherwise stated.

3.2. Other Permits

This permit has been issued under the provisions of KRS Chapter 224 and regulations promulgated pursuant thereto. Issuance of this permit does not relieve the permittee from the responsibility of obtaining any other permits or licenses required by this Cabinet and other state, federal, and local agencies.

3.3. Continuation of Expiring Permit

This permit shall be continued in effect and enforceable after the expiration date of the permit provided the permittee submits a timely and complete application in accordance with 401 KAR 5:060, Section 2(4).

3.4. Antidegradation

For those discharges subject to the provisions of 401 KAR 10:030, Section 1(3)(b)5, the permittee shall install, operate, and maintain wastewater treatment facilities consistent with those identified in the Socioeconomic Demonstration and Alternatives Analysis (SDAA) submitted with the KPDES permit application.

3.5. Reopener Clause

This permit shall be modified, or alternatively revoked and reissued, to comply with any applicable effluent standard or limitation issued or approved in accordance with 401 KAR 5:050 through 5:080, if the effluent standard or limitation so issued or approved:

- (1) Contains different conditions or is otherwise more stringent than any effluent limitation in the permit; or
- (2) Controls any pollutant not limited in the permit.

The permit as modified or reissued under this paragraph shall also contain any other requirements of KRS Chapter 224 when applicable.

3.6. Connection to Regional Sewer System

This WWTP is temporary and in no way supersedes the need of a regional sewer system. The permittee shall eliminate the discharge and WWTP plant by connection to a regional sewer system when it becomes available as defined in 401 KAR 5:002.

3.7. Certified Operators

The wastewater treatment plant shall be under the primary responsibility of a Class I Wastewater Treatment Plant Certified Operator or higher.

3.8. Outfall Signage

This KPDES permit establishes monitoring points, effluent limitations, and other conditions to address discharges from the permitted facility. In an effort to better document and clarify these locations, the permittee should place and maintain a permanent marker at each of the monitoring locations.

SECTION 4

MONITORING AND REPORTING REQUIREMENTS

4. MONITORING AND REPORTING REQUIREMENTS

4.1. KPDES Outfalls

Discharge samples and measurements shall be collected at the compliance point for each KPDES Outfall identified in this permit. Each sample shall be representative of the volume and nature of the monitored discharge.

4.2. Sufficiently Sensitive Analytical Methods

Analytical methods utilized to demonstrate compliance with the effluent limitations established in this permit shall be sufficiently sensitive to detect pollutant levels at or below the required effluent limit, i.e. the Method Minimum Level shall be at or below the effluent limit. In the instance where an EPA-approved method does not exist that has a Method Minimum Level at or below the established effluent limitation, the permittee shall:

- (1) Use the method specified in the permit; or
- (2) The EPA-approved method with an ML that is nearest to the established effluent limit.

It is the responsibility of the permittee to demonstrate compliance with permit parameter limitations by utilization of sufficiently sensitive analytical methods.

4.3. Certified Laboratory Requirements

All laboratory analyses and tests required to demonstrate compliance with the conditions of this permit shall be performed by a laboratory holding the appropriate general or field-only certification issued by the Cabinet pursuant to 401 KAR 5:320.

4.4. Submission of DMRs

The completed DMR for each monitoring period must be entered into the DOW approved electronic system no later than midnight on the 28th day of the month following the monitoring period for which monitoring results were obtained.

For more information regarding electronic submittal of DMRs, please visit the Division's website at: <https://eec.ky.gov/Environmental-Protection/Water/SubmitReport/Pages/NetDMR.aspx> or contact the DMR Coordinator at (502) 564-3410.

KPDES



**KENTUCKY POLLUTANT
DISCHARGE ELIMINATION
SYSTEM**

FACT SHEET

KPDES No.: KY0091600

AI No.: 479

Woodland Acres WWTP

Lot 57 Hemlock Drive

Shepherdsville, Bullitt County, Kentucky

Date: July 30, 2021

Public Notice Information

Public Notice Start Date: May 20, 2021

Comment Due Date: June 19, 2021

General information concerning the public notice process may be obtained on the Division of Water's Public Notice Webpage at the following address:

<https://eec.ky.gov/Environmental-Protection/Water/Pages/Water-Public-Notices-and-Hearings.aspx>.

Public Notice Comments

Comments must be received by the Division of Water no later than 4:30 PM on the closing date of the comment period. Comments may be submitted by e-mail at: DOWPublicNotice@ky.gov or written comments may be submitted to the Division of Water at 300 Sower Blvd, Frankfort, Kentucky 40601.

Reference Documents

A copy of this proposed fact sheet, proposed permit, the application, other supporting material and the current status of the application may be obtained from the Department for Environmental Protection's Pending Approvals Search Webpage:

http://dep.gateway.ky.gov/eSearch/Search_Pending_Approvals.aspx?Program=Wastewater&NumDaysDoc=30.

Open Records

Copies of publicly-available documents supporting this fact sheet and proposed permit may also be obtained from the Department for Environmental Protection Central Office. Information regarding these materials may be obtained from the Open Records Coordinator at (502) 782-6849 or by e-mail at EEC.KORA@ky.gov.

**DEPARTMENT FOR ENVIRONMENTAL PROTECTION
Division of Water, 300 Sower Blvd, Frankfort, Kentucky 40601**

Printed on Recycled Paper

KY2022-00015_BW_0409

THIS KPDES FACT SHEET CONSISTS OF THE FOLLOWING SECTIONS:

1. FACILITY SYNOPSIS.....4

1.1. Name and Address of Applicant.....4

1.2. Facility Location.....4

1.3. Description of Applicant’s Operation4

1.4. Wastewaters Collected and Treatment4

1.5. Permitting Action4

2. RECEIVING / INTAKE WATERS.....6

2.1. Receiving Waters.....6

2.2. Intake Waters – Nearest Downstream Intake.....6

3. OUTFALL 0018

3.1. Outfall Description8

3.2. Reported Values8

3.3. Effluent Limitations and Monitoring Requirements9

3.4. Pertinent Factors.....10

3.5. Justification of Requirements.....10

4. OTHER CONDITIONS.....13

4.1. Schedule of Compliance.....13

4.2. Antidegradation13

4.3. Standard Conditions.....13

4.4. Sufficiently Sensitive Analytical Methods13

4.5. Certified Laboratory13

4.6. Connection to Regional Sewer System.....13

4.7. Certified Operators13

4.8. Location Map.....14

SECTION 1

FACILITY SYNOPSIS

1. FACILITY SYNOPSIS

1.1. Name and Address of Applicant

Bluegrass Water Utility Operating Company
 1650 Des Peres Road, Suite 303
 Des Peres, MO 63131

1.2. Facility Location

Woodland Acres WWTP
 Lot 57 Hemlock Drive
 Shepherdsville, Bullitt County, Kentucky

1.3. Description of Applicant’s Operation

The applicant operates a domestic wastewater treatment plant serving a mobile home park consisting of 121 mobile homes.

1.4. Wastewaters Collected and Treatment

The following table lists the actual average flow reported, the facility’s approved long-term average design treatment capacity, the wastewater types collected, and the treatment type for each outfall:

TABLE 1.				
Outfall No.	Avg. Flow (MGD)	Design Capacity (MGD)	Wastewater Types Collected	Treatment Type
001	0.0125	0.025	100% Domestic Wastewater	Equalization, Aeration, Settling, Aerobic Digestion, Rapid Sand Filter, Chlorination/Dechlorination

1.5. Permitting Action

This is a reissuance of a minor KPDES permit for an existing domestic wastewater treatment plant [SIC Code 4952].

SECTION 2

RECEIVING/INTAKE WATERS

2. RECEIVING / INTAKE WATERS

2.1. Receiving Waters

All surface waters of the Commonwealth have been assigned stream use designations consisting of one or more of the following designations: Warmwater Aquatic Habitat (WAH), Primary Contact Recreation (PCR), Secondary Contact Recreation (SCR), Domestic Water Supply (DWS), Coldwater Aquatic Habitat (CAH) or Outstanding State Resource Water (OSRW)[401 KAR 10:026].

All surface waters of the Commonwealth are assigned one of the following antidegradation categories: Outstanding National Resource Water (ONRW), Exceptional Water (EW), Impaired Water (IW) or High Quality Water (HQ)[401 KAR 10:030].

Surface waters categorized as an IW are listed for non-support of uses in Kentucky’s most recently approved *Integrated Report to Congress on the Condition of Water Resources in Kentucky*. The 305 (b) List identifies stream segments that do not support their use designation. However, Outstanding State Resource Waters, Exceptional Waters, and waters found only as mercury or methylmercury impaired for fish consumption shall not be categorized as impaired *for antidegradation purposes*[401 KAR 10:030].

The following table lists the stream use classifications and antidegradation category associated with this permit.

TABLE 2.				
Receiving Water Name	Use Designation	Antidegradation Category	7Q10 Low Flow (cfs)	Harmonic Mean Flow (cfs)
Unnamed Tributary of Mud Run Creek	WAH, PCR, SCR, DWS	HQ	0.0	0.0

2.2. Intake Waters – Nearest Downstream Intake

TABLE 3.						
Intake Water Name	Public Water Supply Name	Latitude (N) Decimal Degrees	Longitude (W) Decimal Degrees	Miles Downstream	7Q10 Low Flow (cfs)	Harmonic Mean Flow (cfs)
Ohio River	Evansville Water Utility, IN	37.957651°	87.574393°	185	12,900	60,900

SECTION 3

OUTFALL 001

3. OUTFALL 001

3.1. Outfall Description

The following table lists the outfall type, location, and description:

TABLE 4.				
Outfall Type	Latitude (N)	Longitude (W)	Receiving Water	Description of Outfall
External	38.007913°	85.731103°	Unnamed Tributary to Mud Run Creek	Domestic Wastewater

3.2. Reported Values

The following table summarizes the reported values for Outfall 001:

TABLE 5.							
Reported Parameters	Units	EFFLUENT					
		Loadings (lbs/day)		Concentrations			
		Monthly Average	Maximum Weekly Average	Minimum	Monthly Average	Maximum Weekly Average	Maximum
Flow	MGD	0.0125	0.0125 ¹	N/A	N/A	N/A	N/A
pH	SU	N/A	N/A	6.19	N/A	N/A	8.20
CBOD ₅ ²	mg/l	12	12	N/A	15	15	N/A
Total Suspended Solids	mg/l	16	16	N/A	15	15	N/A
Nitrogen, Ammonia total [as N]							
May 1 – October 31	mg/l	11.2	11.2	N/A	11.2	11.2 ¹	N/A
November 1 – April 30	mg/l	2.14	2.14	N/A	6.60	6.60 ¹	N/A
Dissolved Oxygen	mg/l	N/A	N/A	7.0	N/A	N/A	N/A
E. coli ³	#/100 ml	N/A	N/A	N/A	1375 ⁴	1375 ⁵	N/A
Total Residual Chlorine	mg/l	N/A	N/A	N/A	0.1460	0.1460 ¹	N/A
¹ Daily Maximum							
² CBOD ₅ – Carbonaceous Biochemical Oxygen Demand, 5-day							
³ E. coli – <i>Escherichia coli</i> Bacteria							
⁴ Thirty (30) day Geometric Mean							
⁵ Seven (7) day Geometric Mean							

The above values are based upon 5-year DMR averages from 1/1/2016 to 3/31/2021.

3.3. Effluent Limitations and Monitoring Requirements

The following table summarizes the effluent limitations and monitoring requirements for Outfall 001:

TABLE 6.									
EFFLUENT LIMITATIONS								MONITORING REQUIREMENTS	
Effluent Characteristic	Units	Loadings (lbs/day)		Concentrations				Frequency	Sample Type
		Monthly Average	Maximum Weekly Average	Minimum	Monthly Average	Maximum Weekly Average	Maximum		
Flow	MGD	Report	Report ¹	N/A	N/A	N/A	N/A	1/Quarter	Instantaneous
pH	SU	N/A	N/A	6.0	N/A	N/A	9.0	1/Quarter	Grab
CBOD ₅ ²	mg/l	N/A	N/A	N/A	10	15	N/A	1/Quarter	Composite ³
Total Suspended Solids	mg/l	N/A	N/A	N/A	30	45	N/A	1/Quarter	Composite ³
Nitrogen, Ammonia total [as N]									
May 1 – October 31	mg/l	N/A	N/A	N/A	4.0	6.0 ¹	N/A	1/Quarter	Grab
November 1 – April 30	mg/l	N/A	N/A	N/A	10.0	15.0 ¹	N/A	1/Quarter	Grab
Dissolved Oxygen	mg/l	N/A	N/A	7.0	N/A	N/A	N/A	1/Quarter	Grab
E. coli ⁴	#/100 ml	N/A	N/A	N/A	130 ⁵	240 ⁶	N/A	1/Quarter	Grab
Total Residual Chlorine	mg/l	N/A	N/A	N/A	0.011	0.019 ¹	N/A	1/Quarter	Grab
¹ Daily Maximum									
² CBOD ₅ – Carbonaceous Biochemical Oxygen Demand, 5-day									
³ A sample composed of four or more equal or flow-proportional aliquots collected over a period of no less than eight and no more than twenty-four hours and aggregated so that the aggregate sample reflects the average water quality of the effluent during the compositing or sample period									
⁴ E. coli – <i>Escherichia coli</i> Bacteria									
⁵ Thirty (30) day Geometric Mean									
⁶ Seven (7) day Geometric Mean									

3.4. Pertinent Factors

The effluent limitations for this outfall were developed in accordance with DOW’s General Procedures for Limitations Development located on DOW’s webpage at: <https://eec.ky.gov/Environmental-Protection/Forms%20Library/General%20Procedures%20for%20Limitations%20Development.pdf>.

3.4.1. Secondary Treatment Standards

Discharges of biochemically degradable wastes are subject to technology-based effluent limitations (TBELs) known as the Secondary Treatment Standards. Both state and federal regulations establish the requirements for secondary treatment. State regulations for secondary treatment only apply to non-POTWs [401 KAR 5:045].

TABLE 7.		
State Defined Secondary Treatment Standards		
Pollutant or Pollutant Characteristic	30-day average	7-day average
BOD ₅ (mg/l)	30	45
TSS (mg/l)	30	45

3.5. Justification of Requirements

Chapters 5 and 10 of Title 401 of the Kentucky Administrative Regulations (KARs), cited in the following, have been duly promulgated pursuant to the requirements of Chapter 224 of the Kentucky Revised Statutes.

At a minimum, all permits shall contain technology-based effluent limitations (TBELs) [401 KAR 5:065, Section 2(4) – 40 CFR 122.44(a)]. When necessary to achieve water quality standards, all permits shall contain water quality-based effluent limitations (WQBELs) [401 KAR 5:065, Section 2(4) – 40 CFR 122.44(d)]. Any WQBELs included in this permit are based upon the Kentucky Water Quality Standards (KYWQS) [401 KAR 10:031].

3.5.1. Flow

The monitoring requirements for this parameter are consistent with the KPDES permit program requirements for establishing effluent limitations, standards, and permit conditions [401 KAR 5:065, Section 2(4) – 40 CFR 122.44(i)(1)(ii)] and requirements for recording and reporting of monitoring results [401 KAR 5:050, Section 4 – 40 CFR 122.48].

3.5.2. CBOD₅

The limitations for this parameter are consistent with the secondary treatment standards for biochemically degradable wastes as defined in state regulations [401 KAR 5:045, Section 3]. DOW found that it was necessary to impose WQBELs for this parameter in order to achieve water quality standards. [401 KAR 5:065, Section 2(4) – 40 CFR 122.44(d)]. These effluent limitations are also consistent with Kentucky’s Water Quality Standards [401 KAR 10:031, Section 4(1)(e) & (i) respectively]. The EPA’s River and Stream Water Quality Model (QUAL 2E/K) was used to develop these limitations.

3.5.3. Total Suspended Solids

The limitations for this parameter are consistent with the secondary treatment standards for biochemically degradable wastes as defined in state regulations [401 KAR 5:045, Section 3]. These effluent limitations are also consistent with Kentucky’s Water Quality Standards [401 KAR 10:031, Section 4(1)(g)].

3.5.4. Ammonia and Dissolved Oxygen

The limitations for these parameters are WQBELs developed using the EPA's River and Stream Water Quality Model (QUAL 2E/K) [401 KAR 10:031, Section 4(1)(e) & (i)].

3.5.5. E. coli

The limitations for this parameter are consistent with Kentucky's Water Quality Standards [401 KAR 10:031, Section 7].

3.5.6. pH

The limitations for this parameter are consistent with Kentucky's Water Quality Standards [401 KAR 10:031, Section 4(1)(b) and Section 7].

3.5.7. Total Residual Chlorine

The limitations for this parameter are consistent with Kentucky's Water Quality Standards [401 KAR 10:031, Section 4(1)(k)].

SECTION 4

OTHER CONDITIONS

4. OTHER CONDITIONS

4.1. Schedule of Compliance

The permittee is required to comply with all effluent limitations by the effective date of the permit unless a compliance schedule is included with the permit. A schedule of compliance, if included with this permit, is consistent with the regulatory provisions for establishing a schedule of compliance [401 KAR 5:050, Section 3--40 CFR 122.47].

4.2. Antidegradation

The conditions of Kentucky's Antidegradation Policy have been satisfied [401 KAR 10:029, Section 1]. This permitting action is a reissuance of a KPDES permit that does not authorize an expanded discharge.

4.3. Standard Conditions

The conditions listed in the Standard Conditions Section of the permit are consistent with the conditions applicable to all permits [401 KAR 5:065, Section 2(1) – 40 CFR 122.41].

4.4. Sufficiently Sensitive Analytical Methods

Analytical methods utilized to demonstrate compliance with the effluent limitations established in this permit shall be sufficiently sensitive to detect pollutant levels at or below the required effluent limit [401 KAR 5:065, Section 2(4) – 40 CFR 122.44(i)].

4.5. Certified Laboratory

All environmental analysis is to be performed by a certified laboratory is consistent with the certified wastewater laboratory requirements [401 KAR 5:320, Section 1].

4.6. Connection to Regional Sewer System

In accordance with 401 KAR 5:005, Section 4 if a sewer system served by a regional facility becomes available, the WWTP shall be abandoned and the influent flow shall be diverted to the regional facility.

4.7. Certified Operators

Wastewater treatment plants and wastewater collection systems that accept wastewaters containing domestic sewage are to be operated by a certified operator [401 KAR 5:010].

4.8. Location Map

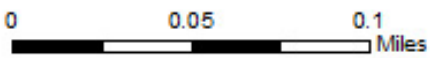

Legend

— 24K NHD Blueline Streams

Request

36. State when Bluegrass Water anticipates beginning each project identified in the Application and when it anticipates completing each project and placing it in service.
-

Response

The schedule for the Woodland Acres projects is highly dependent on when CPCN approval is received. With long lead times and current labor shortages in the market, the amount of time the project will take also largely hinges on when and if the project is approved. It is likely that following all approvals the projects will be completed within eighteen months.