

**CRALEY** **Fibre**™

Connecting YOUR community



## CRALEY Fibre™ Quick Install Guide

- The following slides are a 'Quick Installation Guide' for the CRALEY Fibre™ solution
- Images used throughout these slides are for illustration purposes only, and are not to scale or accurate representations of the actual product
- For further, more detailed information on your specific project, please refer to the specific Instructions for Use information in your full study pack

### **IMPORTANT**

Any works carried out on public water networks must be undertaken by fully qualified and authorised water engineers. You must always observe the correct processes and procedures and ensure that the disinfection process is carried out strictly in accordance to the guidelines.



**Connecting YOUR community**

- **The first stage of any CRALEY Fiber™ Installation is the Enabling Works**
  - The enabling works process provides sufficient access to the underground pipeline for the purposes of carrying out the install process
  - Generally, this will entail
    - a) Selecting a suitable existing vault to install the CRALEY Fibre™ fittings
    - b) Modifying an existing vault
    - c) or Constructing a new vault
  - The slides 4 - 12 provide an overview of the vault requirements and vault styles

# General Vault Clearances

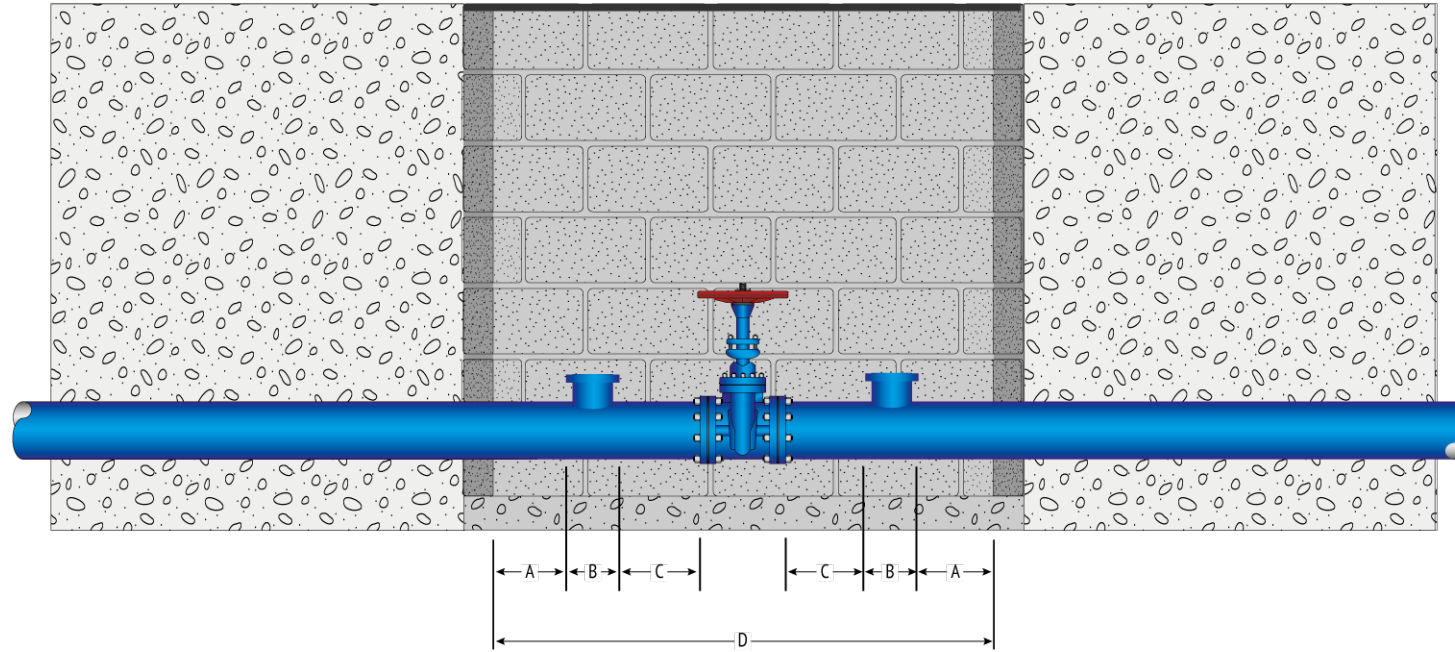

	M-Series	T-Series (Angled Entry)	T-Series (Vertical Entry)
A	150mm (6")	300mm (12")	200mm (8")
B	M-Series Boss or Saddle	T-Series AE Flange or Saddle Dimension	T-Series VE Flange or Saddle Dimension
C	150mm (6")	300mm (12")	200mm (8")
D	Minimum 1,200mm (48"), Width 600mm (24")	Minimum of 1,500mm (60") for a Type C and 900mm (36") for a Type A, Width 600mm (24")	

# CRALEY Fibre™ Vault Options – In-line

## General Entry/Exit points (no valves)

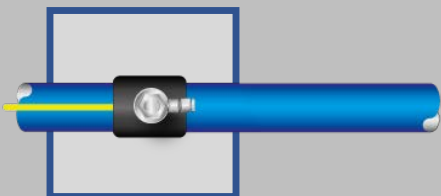

Type A

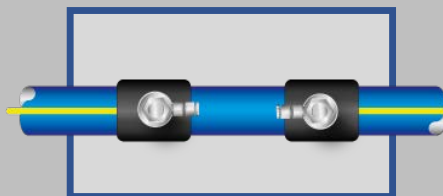

Type B

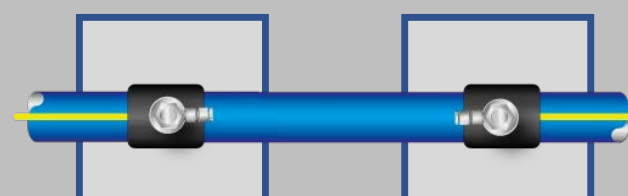

2 x Type A

## Valve by-pass vaults

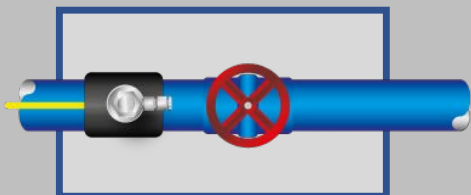

Type C

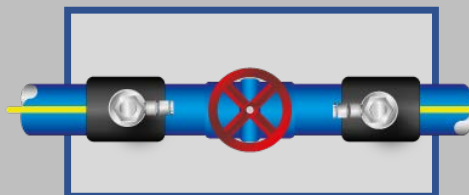

Type D

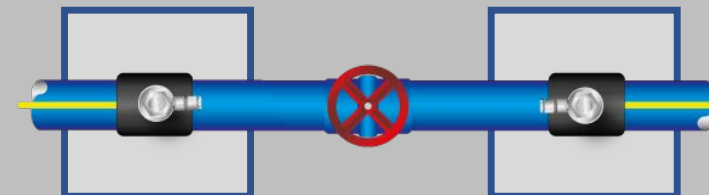

2 x Type A

# CRALEY Fibre™ Vault Options - Bends

## Swept Bends

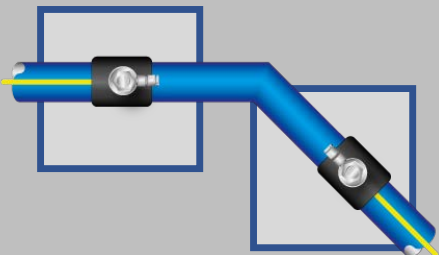

2 x Type A

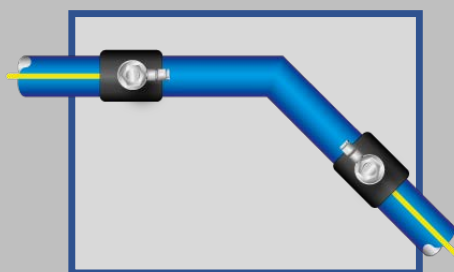

Type E

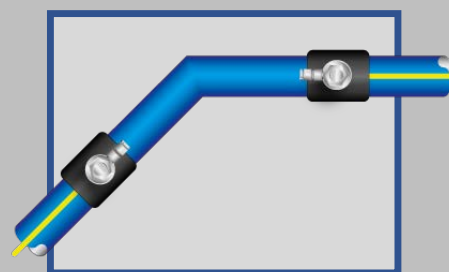

Type E

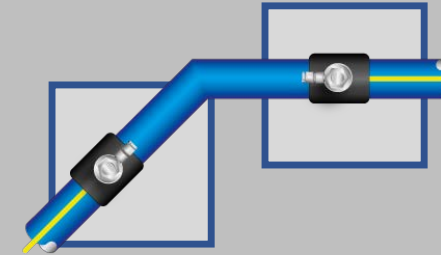

2 x Type A

## 90° Bends

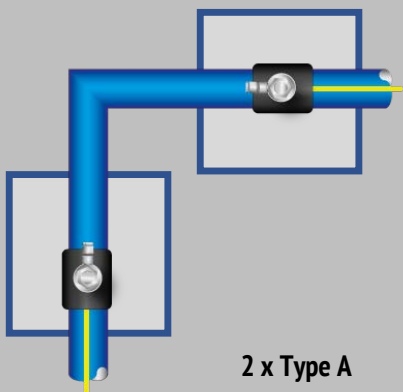

2 x Type A

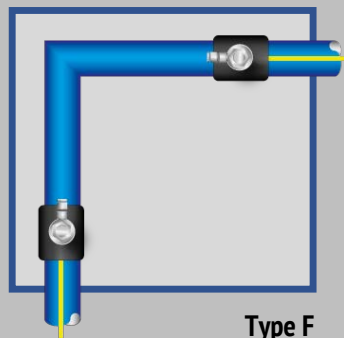

Type F

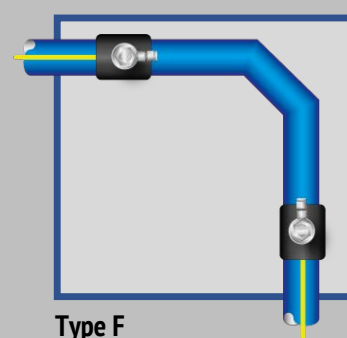

Type F

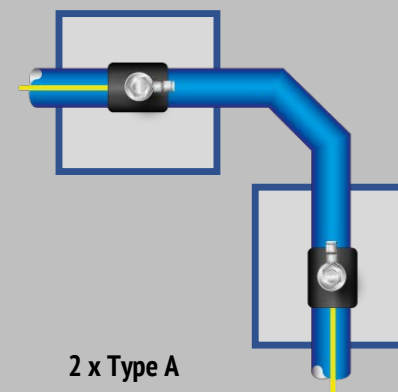

2 x Type A

## Vault Type A

Vault 'Type A' is used to contain either a single CRALEY Fibre™ entry or exit fitting.

Measurements provided are the minimum required clearances to ensure sufficient working space within the vault.

Minimum Dimensions			
	M-Series	T-Series (Angled Entry)	T-Series (Vertical Entry)
A	150mm (6")	200mm (8")	200mm (8")
B	Selected product overall dimension		
C	150mm (6")	200mm (8")	200mm (8")
D	300mm (12")	800mm (32")	800mm (32")
E	50mm (2")	100mm (4")	100mm (4")

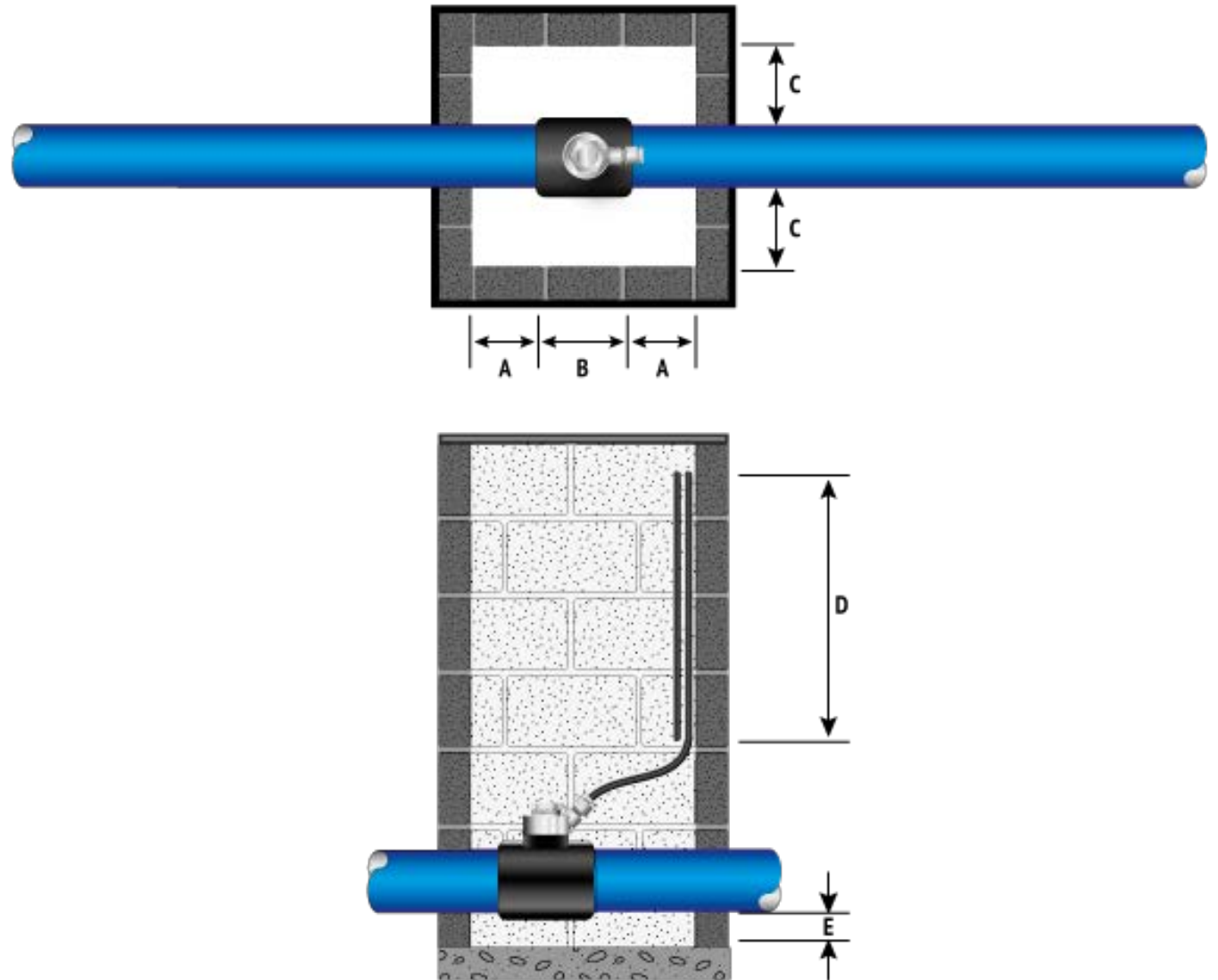

# Vault Type B

Vault 'Type B' is used to contain a two CRALEY Fibre™ entry/exit fittings

Measurements provided are the minimum required clearances to ensure sufficient working space within the vault.

Minimum Dimensions			
	M-Series	T-Series (Angled Entry)	T-Series (Vertical Entry)
A	150mm (6")	200mm (8")	200mm (8")
B	Selected product overall dimension		
C	100mm (4")	300mm (12")	200mm (8")
D	150mm (6")	200mm (8")	200mm (8")
E	300mm (12")	800mm (32")	800mm (32")
F	50mm (2")	100mm (4")	100mm (4")

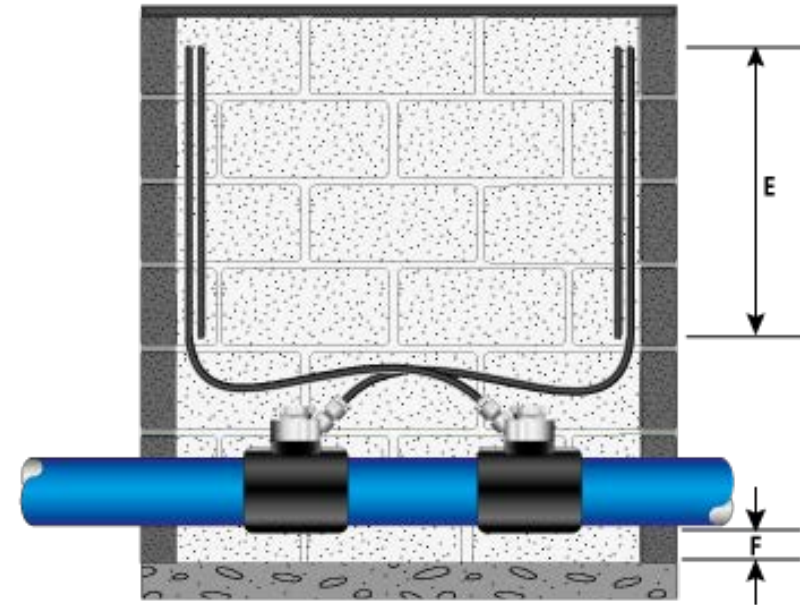
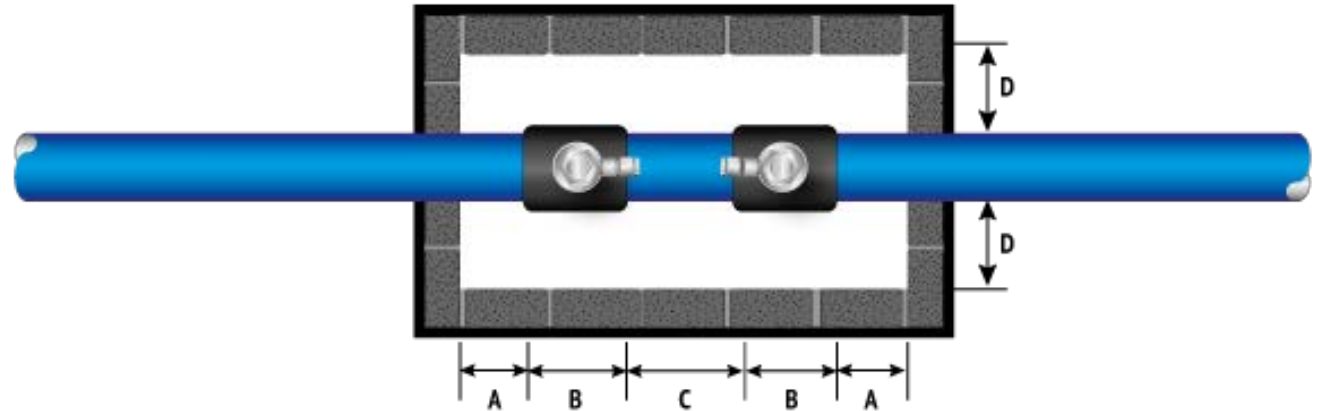



# Vault Type C

Vault 'Type C' is used to contain a single CRALEY Fibre™ entry/exit fitting and a valve or similar.

Measurements provided are the minimum required clearances to ensure sufficient working space within the vault.

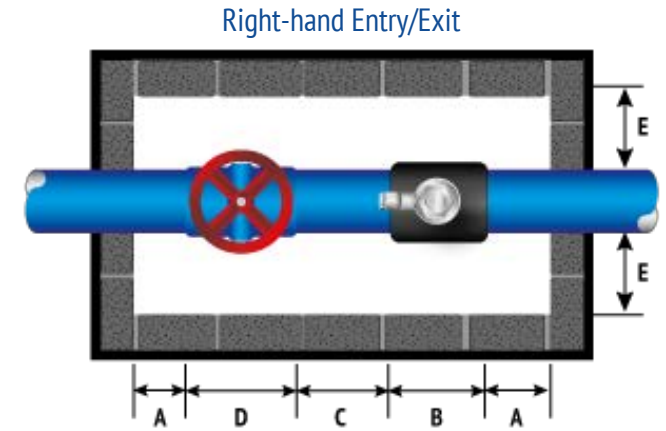
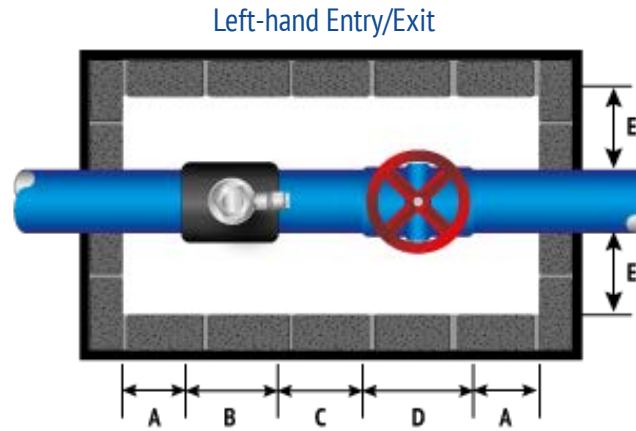

Minimum Dimensions			
	M-Series	T-Series (Angled Entry)	T-Series (Vertical Entry)
A	150mm (6")	200mm (8")	200mm (8")
B	Selected product overall dimension		
C	100mm (4")	300mm (12")	200mm (8")
D	Overall valve dimension		
E	150mm (6")	200mm (8")	200mm (8")
F	300mm (12")	800mm (32")	800mm (32")
G	50mm (2")	100mm (4")	100mm (4")

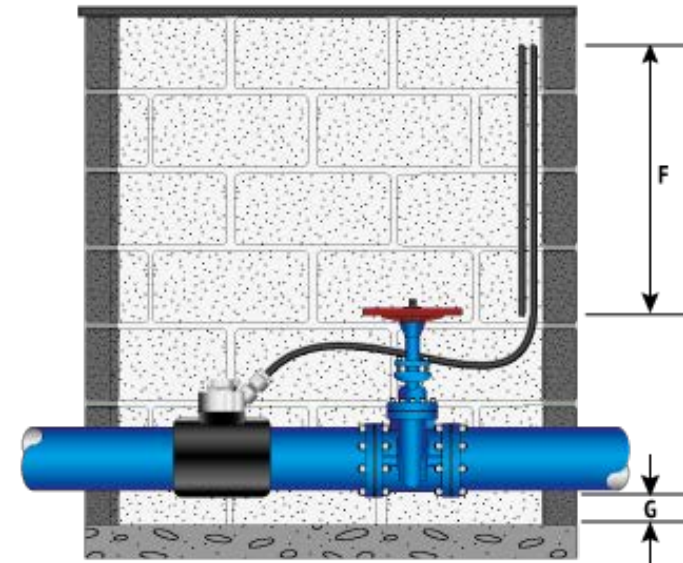

# Vault Type D

Vault 'Type D' is used to contain a two CRALEY Fibre™ entry/exit fittings and a valve or similar.

Measurements provided are the minimum required clearances to ensure sufficient working space within the vault.

Minimum Dimensions			
	M-Series	T-Series (Angled Entry)	T-Series (Vertical Entry)
A	150mm (6")	200mm (8")	200mm (8")
B	Selected product overall dimension		
C	100mm (4")	300mm (12")	200mm (8")
D	Overall valve dimension		
E	150mm (6")	200mm (8")	200mm (8")
F	300mm (12")	800mm (32")	800mm (32")
G	50mm (2")	100mm (4")	100mm (4")

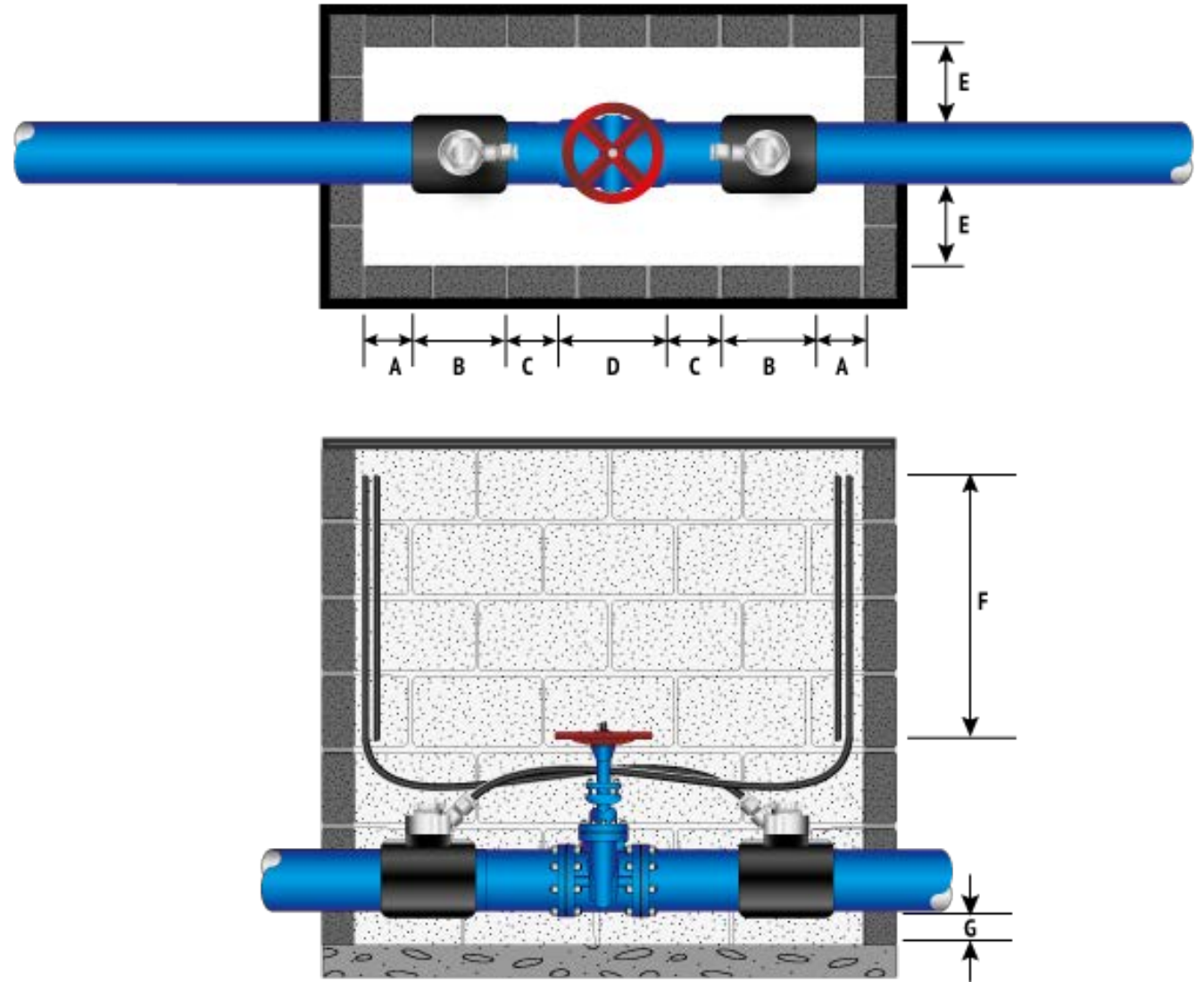

# Vault Type E

Vault 'Type E' is used to navigate swept bends on certain installations. The vault is designed to contain 1 entry and 1 exit fitting.

Measurements provided are the minimum required clearances to ensure sufficient working space within the vault.

Right-hand Swept Bend

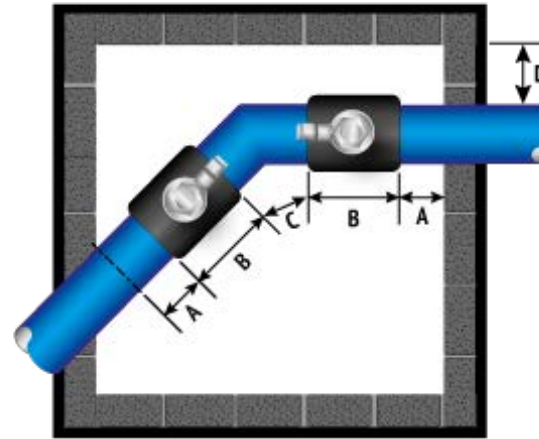

Left-hand Swept Bend

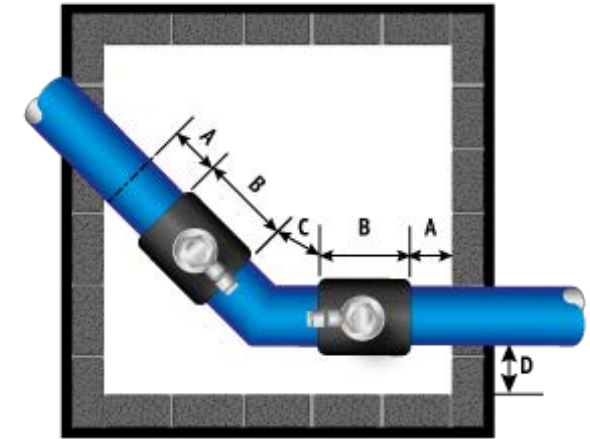

Minimum Dimensions			
	M-Series	T-Series (Angled Entry)	T-Series (Vertical Entry)
A	150mm (6")	200mm (8")	200mm (8")
B	Selected product overall dimension		
C	100mm (4")	300mm (12")	200mm (8")
D	150mm (6")	200mm (8")	200mm (8")
E	300mm (12")	800mm (32")	800mm (32")
F	50mm (2")	100mm (4")	100mm (4")

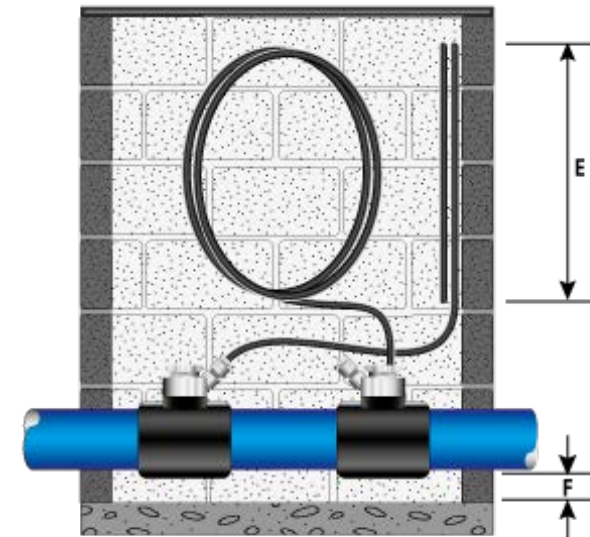

# Vault Type F

Vault 'Type F' is used to navigate sharp right-angled bends on certain installations. The vault is designed to contain 1 entry and 1 exit fitting.

Measurements provided are the minimum required clearances to ensure sufficient working space within the vault.

Minimum Dimensions			
	M-Series	T-Series (Angled Entry)	T-Series (Vertical Entry)
A	150mm (6")	200mm (8")	200mm (8")
B	Selected product overall dimension		
C	100mm (4")	300mm (12")	200mm (8")
D	100mm (6")	200mm (8")	200mm (8")
E	300mm (12")	800mm (32")	800mm (32")
F	50mm (2")	100mm (4")	100mm (4")

Left-Hand Sharp Bend

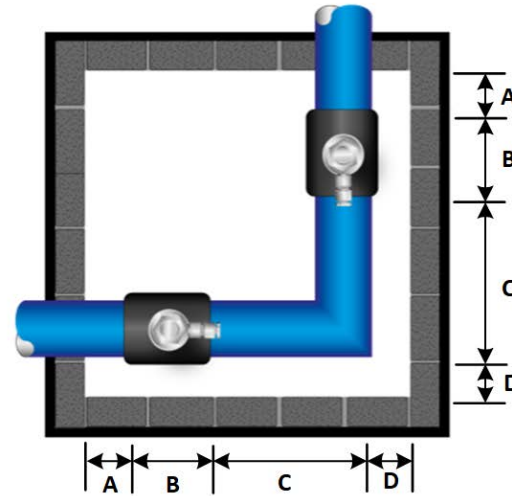

Right-Hand Sharp Bend

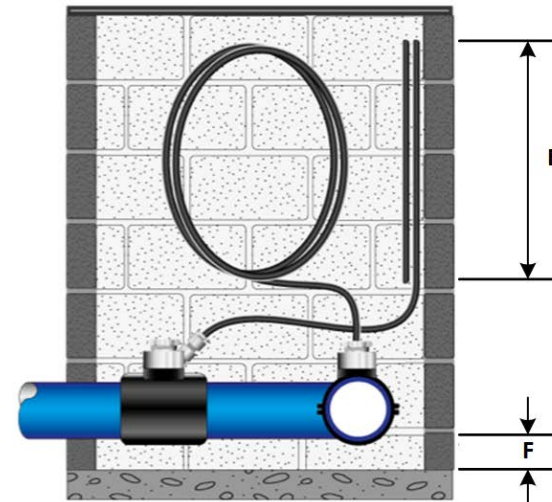
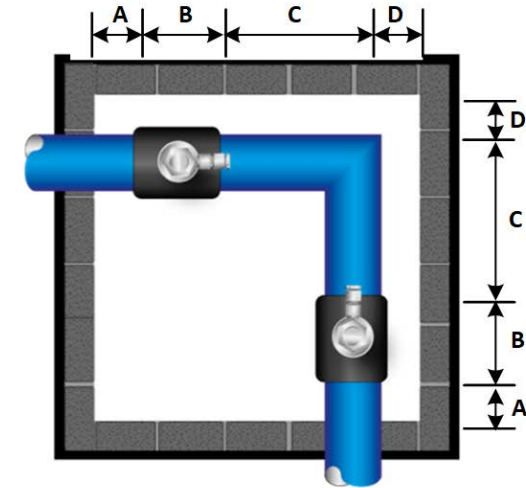

## Fit an appropriate thread or flange port interface

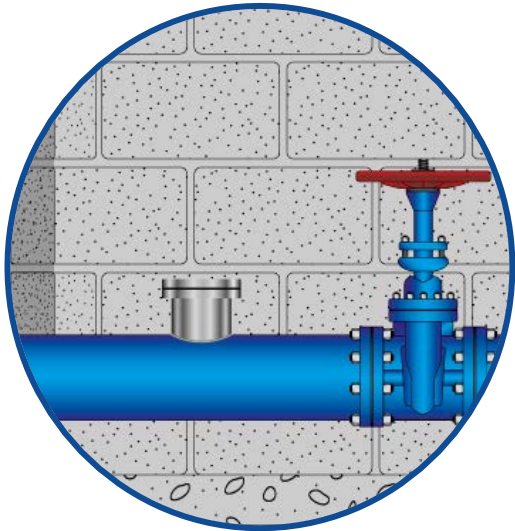

- Ensure that the interface port is installed within the vault in accordance with the vault clearance data
- Fit an appropriate boss or saddle to accept the CRALEY Fibre™ fittings
  - This can be either a threaded fitting (BSP or NPT) or a flange fitting
  - Threaded fittings normally come in the form of a pipe saddle, whereas boss fittings are normally welded to the pipeline
  - In either case, you must make sure that the boss or saddle is fully compatible with the CRALEY Fibre™ fitting

Note: The preferred interface for T-Series fitting is a flange-based fitting

## On-site Preparation

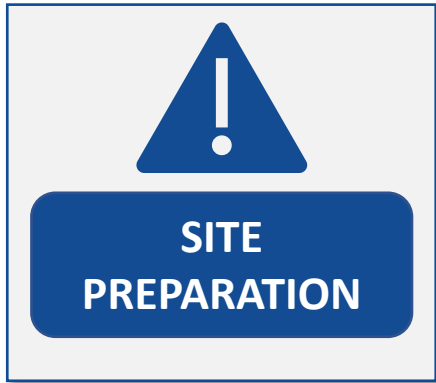

- Before the install process begins, prepare all equipment in readiness
  - Ensure sufficient Messenger Pipe™ length is available
  - Check you have the necessary install fittings and final fittings
  - Ensure all adaptor interfaces match the install fittings and final fittings
  - Check the water velocity and pressure
  - Select the appropriate parachute to match the pipe size, the water velocity and the pressure according to the selection table
  - Disinfect all tools, fittings and parachutes in a chlorination bath (1000ppm)
    - These items should be submerged in a chlorine solution for 20 minutes
    - Use a hand-held spray bottle to supplement the chlorination during the install
  - Have water pumps available to pump out the vaults if necessary



## De-pressurising the pipeline

- Stop the water flow and depressurise the pipeline
- Close the nearest up-stream valve to End A
- Once the pipeline is depressurised, close the nearest valve to End B

Turn off the nearest up-stream valve to End A to de-pressurise the pipe

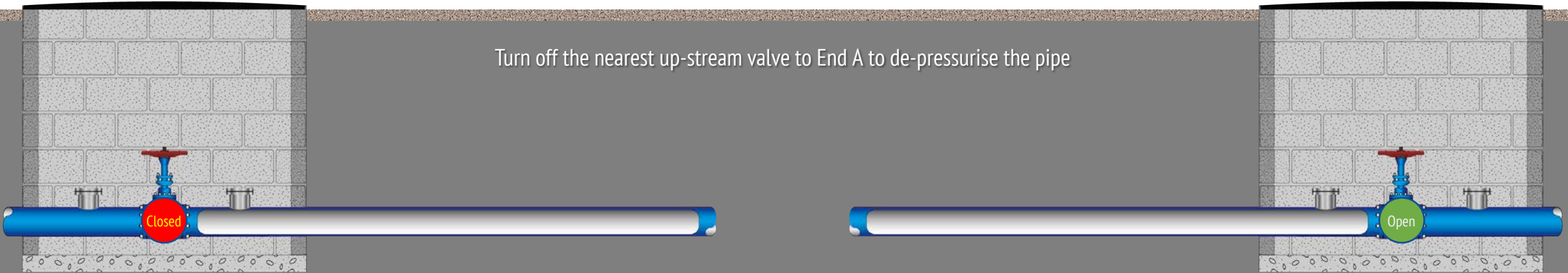

End A : Sealed

End B : Sealed

## Inserting the Parachute

- Ensure that the valves are closed at both End A and End B
- Remove the sealing plate from the interface port at End A
- Feed the draw-line through the Draw-line Insertion fitting
- Attach the parachute to the draw-line in accordance with the instructions
- Fit the Draw-line Insertion fitting to the interface port
- Fit the Draw-line Extraction Fitting to End B

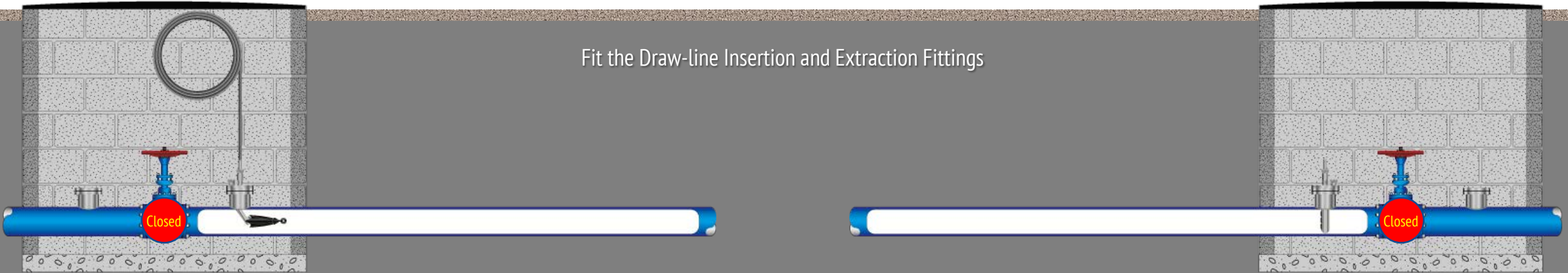

End A : Draw-line Insertion Fitting

End B : Draw-line Extraction Fitting



## Draw-line Insertion

- Turn on the valve at End A and End B
- Hold the parachute in place, either manually or using the launch tube until the water in the pipeline has reached normal operating conditions. i.e. no turbulence or air
- Once you have achieved laminar flow, release the parachute
- The parachute will now transit along the pipeline; the transit speed will depend on the water velocity
- During the installation process ensure that the disinfection chamber is kept topped-up with chlorination solution
- Catch the parachute at End B using the chosen method

Draw-line Insertion using the water flow to transit the parachute from End A to End B

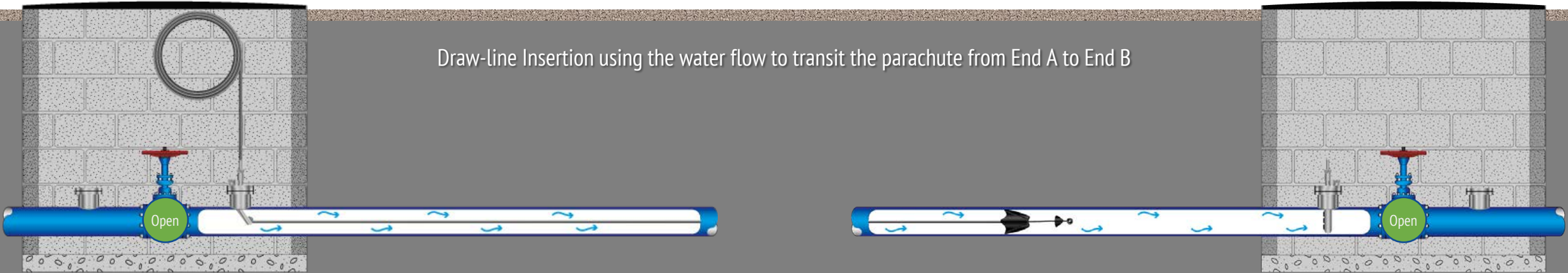

End A : Draw-line Insertion Fitting

End B - Draw-line Extraction Fitting

## Draw-line Extraction

- Ensure that the valves are closed at both End A and End B
- Remove the installation fitting from End B
- Remove the parachute from the pipeline and detach it from the draw-line

Remove the install fitting at End B to remove the parachute and draw-line from the pipe

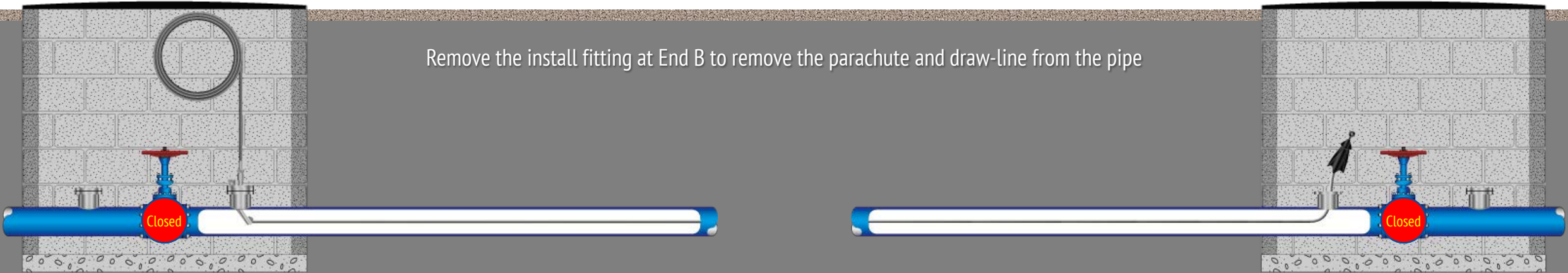

End A : Draw-line Insertion Fitting

End B : Fitting Removed

## Messenger Pipe™ Insertion

- At End B, feed the Messenger Pipe through the appropriate Installation Fitting and attach the Messenger Pipe™ to the draw-line using a cable sock or similar
- Attach the installation fitting. You should now have a Draw-line installation fitting at End A and a Messenger Pipe™ installation fitting at End B
- Turn on the valves at End A feed the Messenger Pipe
- Commence pulling the draw-line at End B until the Messenger Pipe arrives
- Turn-off the valve at End A and open the valve at End B to depressurise the pipeline
- Remove the installation fittings at End A and End B

Draw-line Insertion using the water flow to transit the parachute from End A to End B

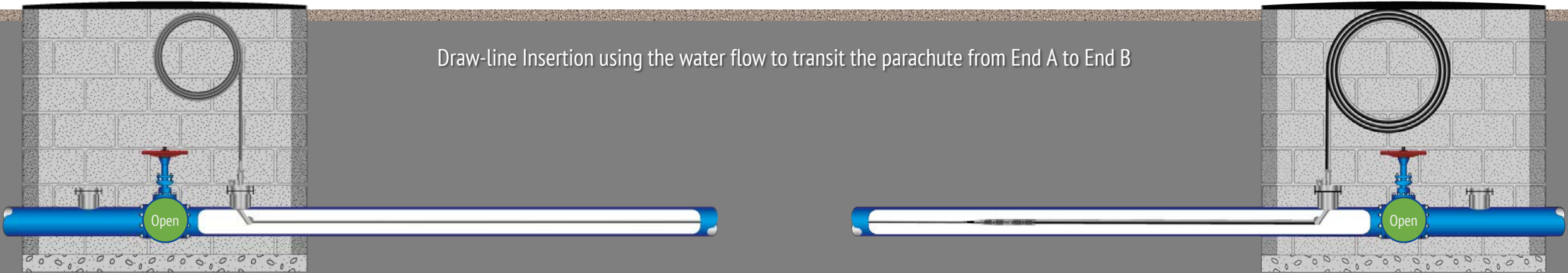

End A : Draw-line Insertion Fitting

End B - Draw-line Extraction Fitting

## Final Fittings

- Fit the appropriate CRALEY Fibre™ Final Fitting at End A and End B, being careful to follow the instructions included with each fitting
- Before tightening the sealing mechanism, pull the Messenger Pipe tight, and then re-insert approximately 150-200mm (6" – 8") back into the pipe to allow for the effects of temperature changes on the Messenger Pipe™
- Leave sufficient 'tails' of Messenger Pipe™ at each end of the link, coiled neatly; suggested tail length of between 5 and 10m (15 and 30ft)
- If the fibre cable is not being fitted immediately, fit a Messenger Pipe™ push-on end-cap to prevent dust and moisture from entering the Messenger Pipe™ internal bore

Messenger Pipe™ now fully inserted between End A and End B and the Final Fittings are in place

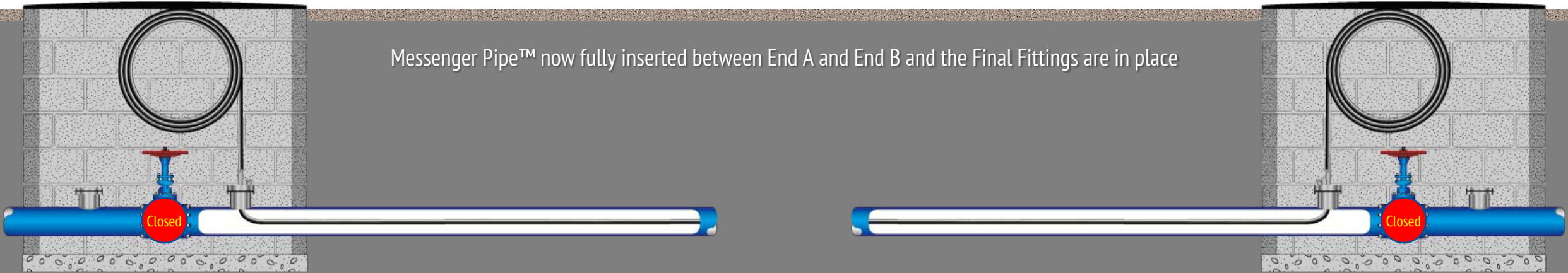

End A : Final Fitting

End B – Final Fitting



# CRALEY Fibre™ Installation Complete

- Open the valves at End A and End B
- The pipeline is now fully operational
- Ensure that the Messenger Pipe™ tails are neatly coiled and fixed to the sides of the vault
- Fit a 'Caution' label on each of the final fittings and fill in the contact details



Pipeline is now fully operational

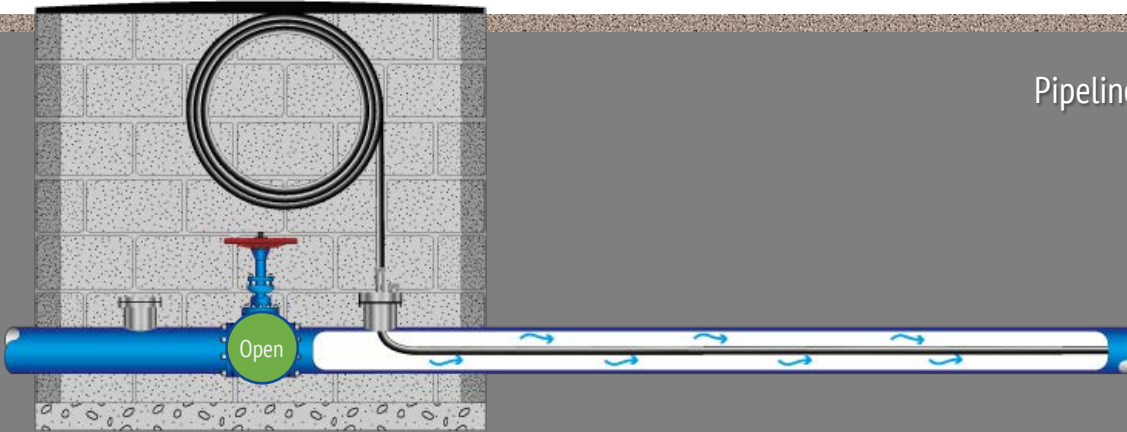

End A : Final Fitting

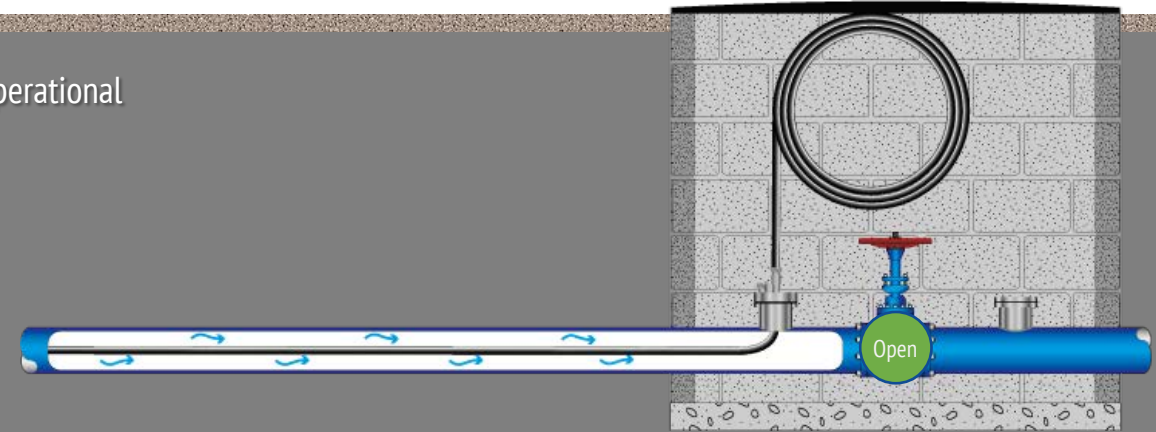

End B - Final Fitting

## Fibre Blowing

- The fibre blowing operation can take place whilst the pipeline is in full operational mode
- Remove the Messenger Pipe™ end caps (if fitted)
- Insert a steel ball or blowing shuttle, 80% of the internal diameter of the Messenger Pipe™, at either End A or End B
- At the opposite end fit a 'catching net' to safely catch the ball as it exits the pipe to prevent potential injury
- Introduce compressed air to the Messenger Pipe™ to 'blow' the ball/shuttle through the Messenger Pipe™ to the other end
- Then blow a 'cleaning sponge' through in the same way; repeat this 2 or 3 times to ensure that the internal bore is free from dust and moisture
- Once the following steps have been completed, the fibre mini-cable can be inserted using standard blowing techniques
- Carry out the required terminations and splicing



A steel ball is used to 'prove' the integrity of the internal bore

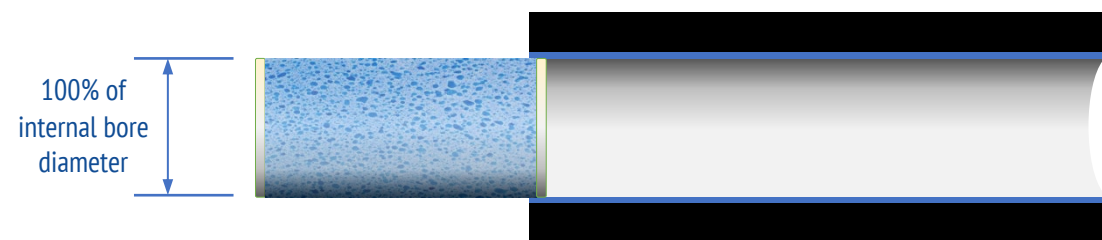

A sponge is used to remove dust residue and moisture from the internal bore

# CRALEY™

Making your network smarter



**Telephone:** +44 1252 962 111

**Fax:** +44 1252 962 123

**Email:** [office@craley.com](mailto:office@craley.com)

**Web:** [www.craley.com](http://www.craley.com)

**Address:** Abbey House, 282 Farnborough Road, Farnborough,  
Hampshire. GU14 7NA. United Kingdom