

CRALEYTM

Making your network smarter



P-200601-MADI

**CRALEY FibreTM Full Study
Lexington Road Links**

December 2020

Contents		
1. Introduction	3	
2. Approvals	3	
3. Project Overview Maps	4	
3.1 . MD-LEXRD-FO-001	4	
3.2 . MD-LEXRD-002.	5	
3.3 . MD-LEXRD-DO-003	6	
3.4 . MD-LEXRD-DO-004	7	
3.5 . MD-LEXRD-DO-005	8	
3.6 . MD-LEXRD-DO-006	9	
3.7 . MD-LEXRD-DO-007	10	
3.8 . MD-LEXRD-DO-008	11	
3.9 . MD-LEXRD-DO-009	12	
3.10 MD-LEXRD-DO-009	13	
4. Project Links - Detailed	14	
5. Bill of Materials	47	
6. Minimum Product Standards	47	
6.1 . Fittings	47	
6.2 . Messenger Pipe™.	47	
6.3 . Fibre Cables	47	
7. Materials in Contact	48	
7.1 . Overview	48	
7.2 . Long-term Water Contact Materials	48	
7.3 . Short-term Water Contact Materials	48	
8. Disinfection Process	49	
8.1 . Overview	49	
8.2 . Chlorine Based Disinfection	49	
8.3 . Chlorine Solution Preparation.	49	
8.4 . Disinfection Procedures	49	
8.5 . Residual Chlorine Introduced into a Water Pipe	49	
8.6 . Health and Safety Aspects	49	
8.7 . Disinfection Contact Timing	49	
9. Chamber Dimensioning	50	
9.1 . General Chamber Guidelines	50	
9.2 . Chamber Types – Overview	50	
9.3 . Chamber Types – Details	50	
9.4 . Options for Splice Box Location	54	
10. Pipeline Preparation	55	
10.1 Port Dimensions	55	
10.2 Standard Port Interface	55	
10.3 Example Port Options	55	
11. Installation Techniques	56	
11.1 Overview	56	
11.2 Live Installation	56	
11.3 Semi-Live Installation	56	
11.4 De-pressurised Installation.	57	
11.5 Messenger Pipe™ Water Block Fittings.	57	
12. Proposed Madison County Install Technique	57	
13. Installation Equipment Required	60	
13.1 Overview	60	
13.2 General Installation Kit	60	
13.3 . Project Specific Installation Fittings	60	
13.4 . Project Specific Installation Accessories	60	
13.5 . Items to be sourced in the local market	60	
13.6 . Optional equipment which would be useful	60	
13.7 Endoscope Specification	60	
13.8 . Overview of Installation Fittings and Accessories	60	
14. Messenger Pipe™ Impact on the Hydraulic Regime	61	
14.1 Overview	61	
14.2 Madison County Lex Road Analysis.	61	
15. Messenger Pipe™ Handling	62	
15.1 Storage	62	
15.2 Lifting.	62	
15.3 Unwinding the Messenger Pipe™	62	
15.4 Rewinding the Messenger Pipe™	63	
15.5 Messenger Pipe™ Minimum Bend Radius.	63	
15.6 Use of Messenger Pipe™ Rollers	63	
16. Fibre Blowing	64	
16.1 Fibre Blowing Overview	64	
16.2 Messenger Pipe Fill Ratio (MPFR)	65	
17. Training and Supervision Services Overview	65	
18. Health & Safety	66	
18.1 Overview	66	
18.2 Risk Assessment	66	
18.3 Traffic Management & Pedestrian Safety	66	
18.4 Personal Protective Equipment (PPE).	66	
19. PR1000 Chlorine Tablets Health & Safety Data	67	
20. RACI - Roles & Responsibilities Matrix	68	
21. Indicative Schedule of Works	69	
21.1 Gantt Chart with team size assumptions	69	
22. Pricing	70	
22.1 Fittings	70	
22.2 Installation Kit & Installation Accessories	70	
22.3 CRALEY Fibre™ Professional Oversight & Training Services	71	
22.4 Pricing Summary	71	
22.5 Payment Schedule	71	
1st Stage Payment with order	71	
22.6 Pricing Notes:	71	

1. Introduction

CRALEY Fibre™ is a 'pipe-in-a-pipe' solution in which a special purpose, small-bore 'Messenger Pipe' is inserted into existing water pipelines or similar for the purposes of installing ultra-fast fibre optic communication cables.

Once the CRALEY Fibre™ solution has been installed, it is possible to install a fibre-optic communications cable within the 'Messenger Pipe', which is designed to fully isolate the cable from the water, ensuring that the cable never comes into contact with the water.

Whilst CRALEY Fibre™ is designed specifically for water, it is perfectly suitable for use with other fluids, including distillates and gas.

This simple but effective solution overcomes the difficulties associated with more conventional FTTx delivery solutions: specifically the problems relating to digging up roads and driveways to the building, costs of excavation and time to install the fibre.

This Report

Following the information provided by Madison County personnel after completing the survey documentation, this report details the proposed engineering design for the deployment of a CRALEY Fibre™ solution within the Lexington Road water network.

It is understood that the customer desires to deploy a fibre optic network to include as much capacity as possible to use the fibre both for in-house communication (SCADA applications and others) and third parties (FTTx and others) as the main goals.

This final report, based on information learned and identified from the remote assisted on-site survey and data gathering including preparation, compilation, review & editing, and final issue, includes:

- Lengths, distances, elevations, curves, elevation changes of pipeline
- External environmental challenges that might cause issues
- Chambers, valves, access points and other elements
- Pipeline characteristics
- Hydraulic regimes and conditions
- Potential permitting requirements
- Preparation works to be done
- Final Fittings and Messenger Pipe™ selection and design
- Optical Cable selection
- Installation Technique selection
- Installation Kit selection and design
- Customised Scope of Works & Installation Schedule/Plan
- Post-installation works to be done
- Health and Safety Documentation & Procedures
- RAMS (Risk Assessment & Method Statement) Documents
- Indicative Scope of Works & Installation Schedule/Plan
- Project Responsibilities
- CRALEY services

2. Approvals

All CRALEY Fibre™ products and materials have undergone rigorous testing by various certification bodies around the globe, including international certification bodies such as NSF and WRAS.

The products, processes and procedures utilised in a CRALEY Fibre™ installation have been fully approved and certified for use in potable water networks and installations have been carried out around the globe since 2008.

In addition to the international approvals and certification, the CRALEY Fibre™ solution has been approved by many local authorities and regional countries.

Approval Mark



Details

NSF/ANSI Standard 61 (NSF-61) is a set of national standards that relates to water treatment and establishes stringent requirements for the control of equipment that comes in contact with either potable water or products that support the production of potable water. The tests vary from a basic cold water test using water at different pH levels, to the more challenging chemical certification. In all cases the equipment is tested before and after exposure to a given fluid to determine whether anything has been leached out or extracted from the equipment. NSF-61 was developed by the National Sanitation Foundation (NSF), a global independent public health and environmental organization, and the American National Standards Institute (ANSI), which oversees the consensus for developing standards for manufacturing and procedures in the USA.

NSF/ANSI 372: Is an American National Standard that establishes a standardised methodology for the determination and verification of product compliance to minimise lead contaminants. NSF/ANSI 372 is consistent with the United States Safe Drinking Water Act (SDWA) and its lead-free plumbing requirements, as well as the requirements of individual U.S. states such as California.



A Water Regulations Advisory Scheme, or WRAS approval, is an easy way to demonstrate that a material or water fitting is of a suitable quality and standard.

Any water fitting, which when installed, will carry or receive water from the public mains water supply in the UK, must comply with the Water Supply (Water Fittings) Regulations or Scottish Bye-laws.

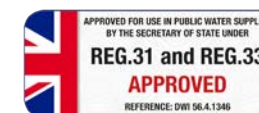

Regulation 31 of The Water Supply (Water Quality) Regulations 2016 (as amended) implements Article 10 of the Council of the European Union Drinking Water Directive (DWD) in England and Wales for all chemicals and construction products used by water undertakers, from the source of the water, up to the point of delivery to the consumer's building. It sets out how approvals can be given to such construction products and materials that do not prejudice water quality and consumer safety.

Regulation 33 covers the same aspects as above, but specifically for Scotland and Northern Ireland.

Regulation 31/33 ensures that water suppliers, when producing and distributing drinking water, only use products and substances to that do not cause any detrimental effects on the safety or quality of the drinking water.

3. Project Overview Maps

3.1 MD-LEXRD-FO-001



Drawing Reference: MD-LEXRD-FO-001			Commercial in Confidence			Drawn	Date	Name	Position	 ENGINEERING
Rev. No.	Date	Revision Details	Checked	Approved	Scale	Drawing Name				
01	18/11/2020	Final Drawing			As Shown	Madison County- Lexington Road Project Project Deployment Overview				

3.2 MD-LEXRD-002

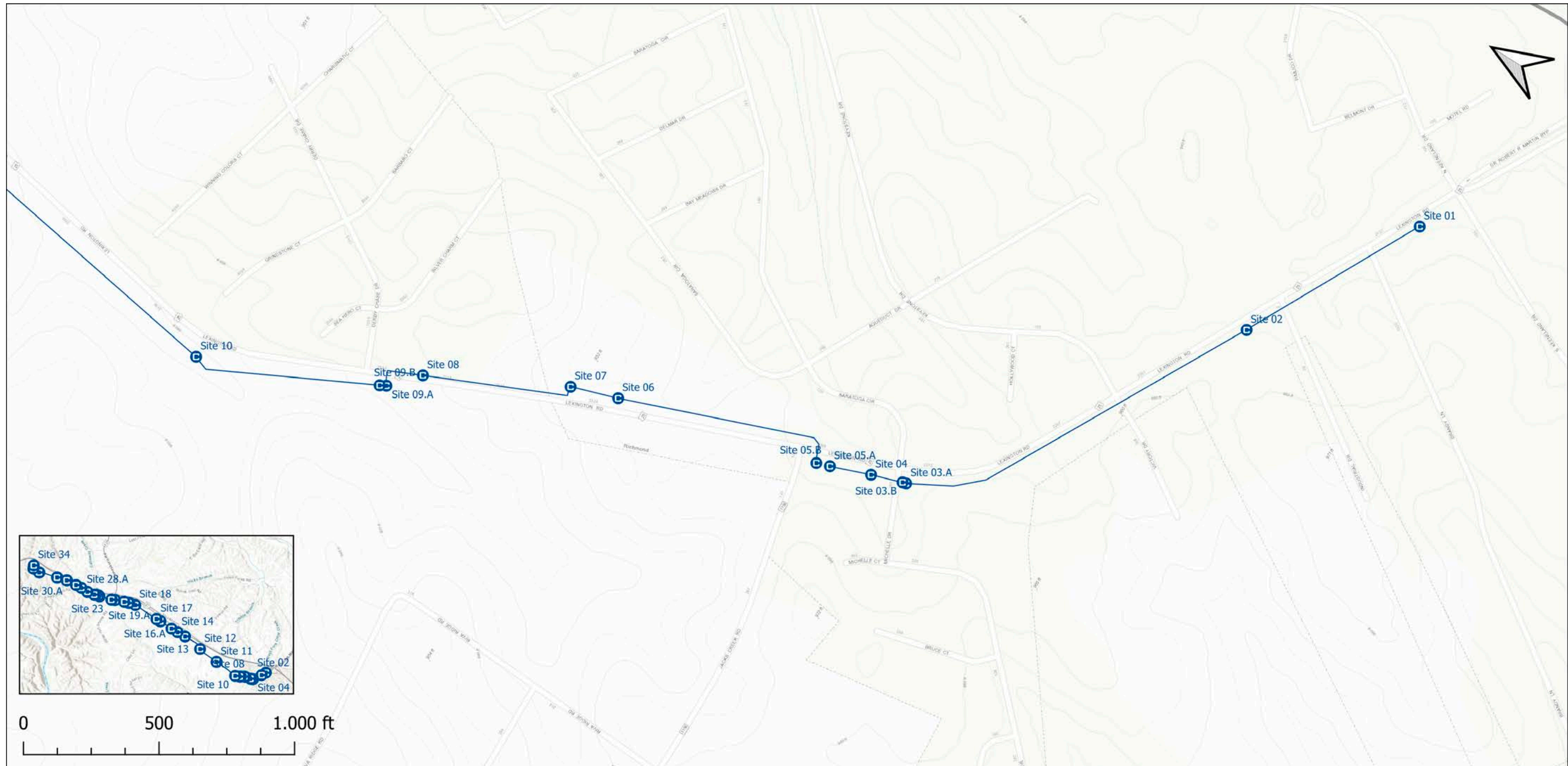

Drawing Reference: MD-LEXRD-DO-001			Commercial in Confidence			Date	Name	Position	 ENGINEERING
Rev. No.	Date	Revision Details	Drawn	18/11/2020	Joan Vilaseca i Vila	CD			
01	18/11/2020	Final Drawing	Checked						
			Approved				Scale	Drawing Name	
				As Shown	Madison County- Lexington Road Project Project Links Overview 01				

3.3 MD-LEXRD-DO-003

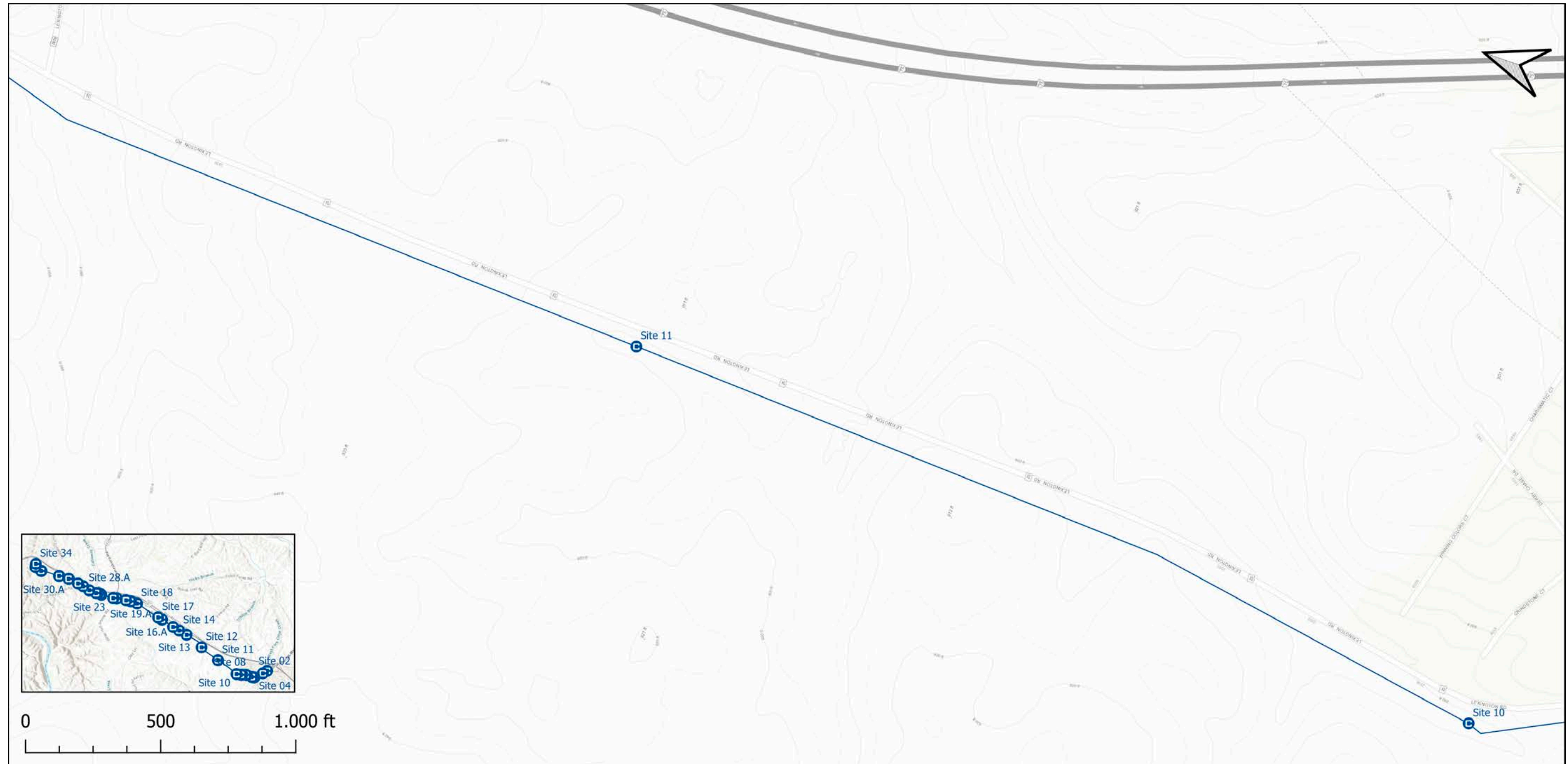

Drawing Reference: MD-LEXRD-DO-002			Commercial in Confidence			Drawn	Date	Name	Position	 ENGINEERING
Rev. No.	Date	Revision Details	Checked	18/11/2020	Joan Vilaseca i Vila	CD				
01	18/11/2020	Final Drawing	Approved							
			Scale	Drawing Name						
			As Shown	Madison County- Lexington Road Project Project Links Overview 02						

3.4 MD-LEXRD-DO-004

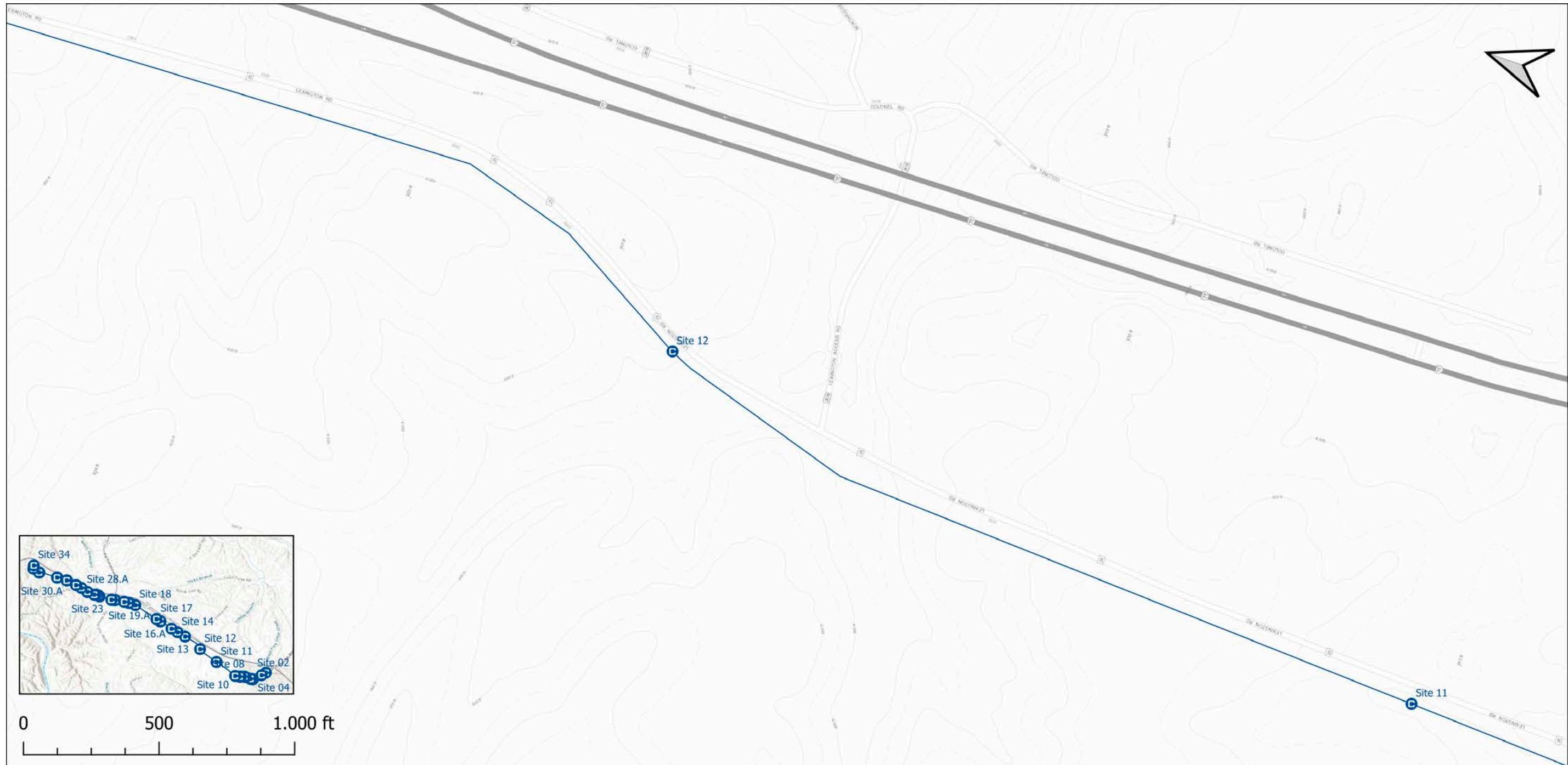

Drawing Reference: MD-LEXRD-DO-003			Commercial in Confidence			Drawn	18/11/2020	Name	Joan Vilaseca i Vila	Position	CD	 Making your network smarter
Rev. No.	Date	Revision Details	Checked		Approved							
01	18/11/2020	Final Drawing	Scale	As Shown	Drawing Name	Madison County- Lexington Road Project Project Links Overview 03						
											ENGINEERING	

3.5 MD-LEXRD-DO-005

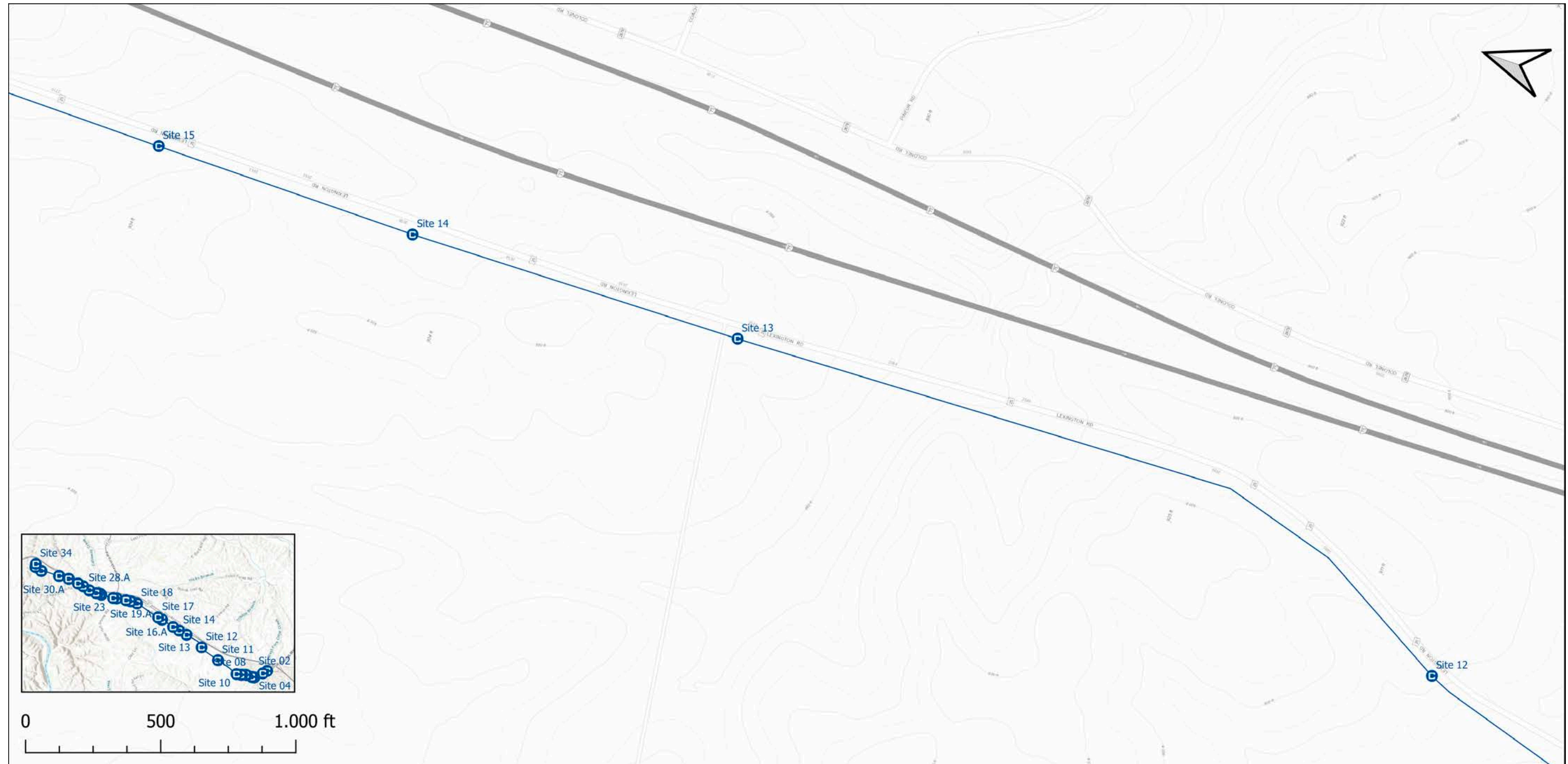

Drawing Reference: MD-LEXRD-DO-004			Commercial in Confidence			Drawn	Date	Name	Position	 ENGINEERING
Rev. No.	Date	Revision Details	Checked	18/11/2020	Joan Vilaseca i Vila	CD				
01	18/11/2020	Final Drawing	Approved							
			Scale	Drawing Name						
			As Shown	Madison County- Lexington Road Project Project Links Overview 04						

3.6 MD-LEXRD-DO-006

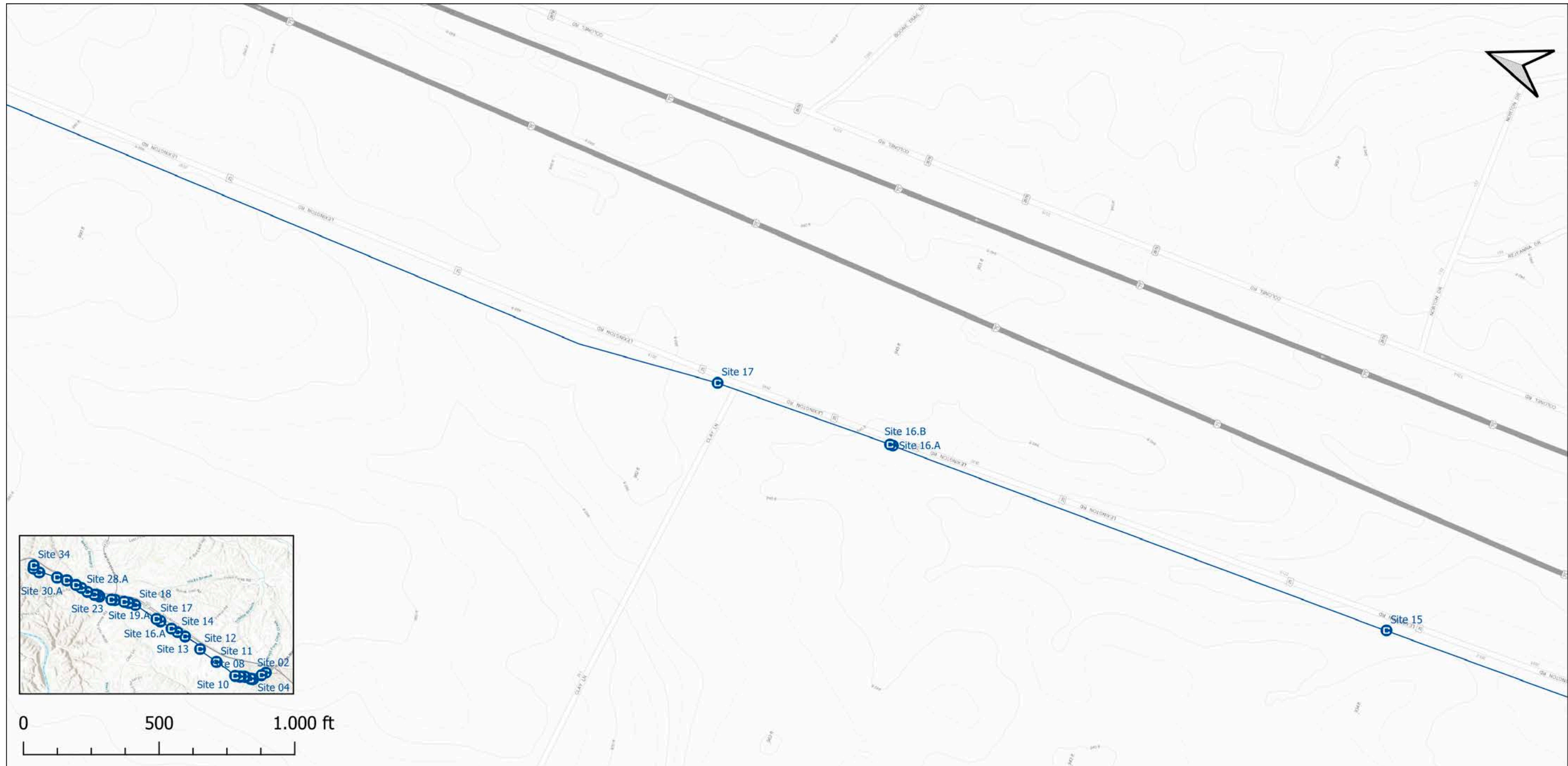

Drawing Reference: MD-LEXRD-DO-005			Commercial in Confidence			Drawn	18/11/2020	Name	Joan Vilaseca i Vila	Position	CD	 Making your network smarter
Rev. No.	Date	Revision Details	Checked		Approved							
01	18/11/2020	Final Drawing	Scale	As Shown	Drawing Name	Madison County- Lexington Road Project Project Links Overview 05						
											ENGINEERING	

3.7 MD-LEXRD-DO-007

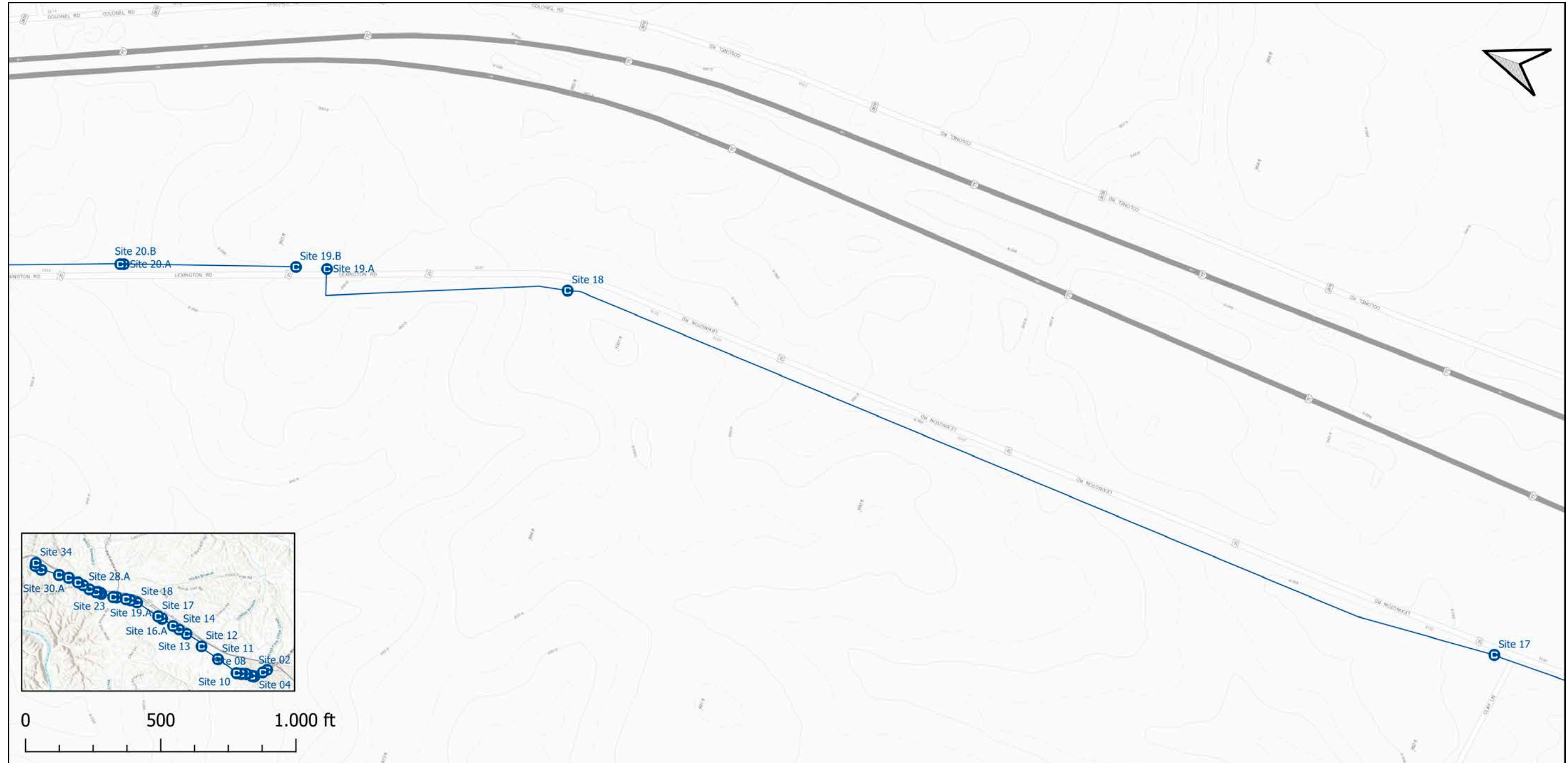

Drawing Reference: MD-LEXRD-DO-006			Commercial in Confidence			Drawn	Date	Name	Position	 Making your network smarter	
Rev. No.	Date	Revision Details	Checked	18/11/2020	Joan Vilaseca i Vila	CD					
01	18/11/2020	Final Drawing	Approved								
			Scale	Drawing Name							
			As Shown	Madison County- Lexington Road Project Project Links Overview 06							
										ENGINEERING	

3.8 MD-LEXRD-DO-008

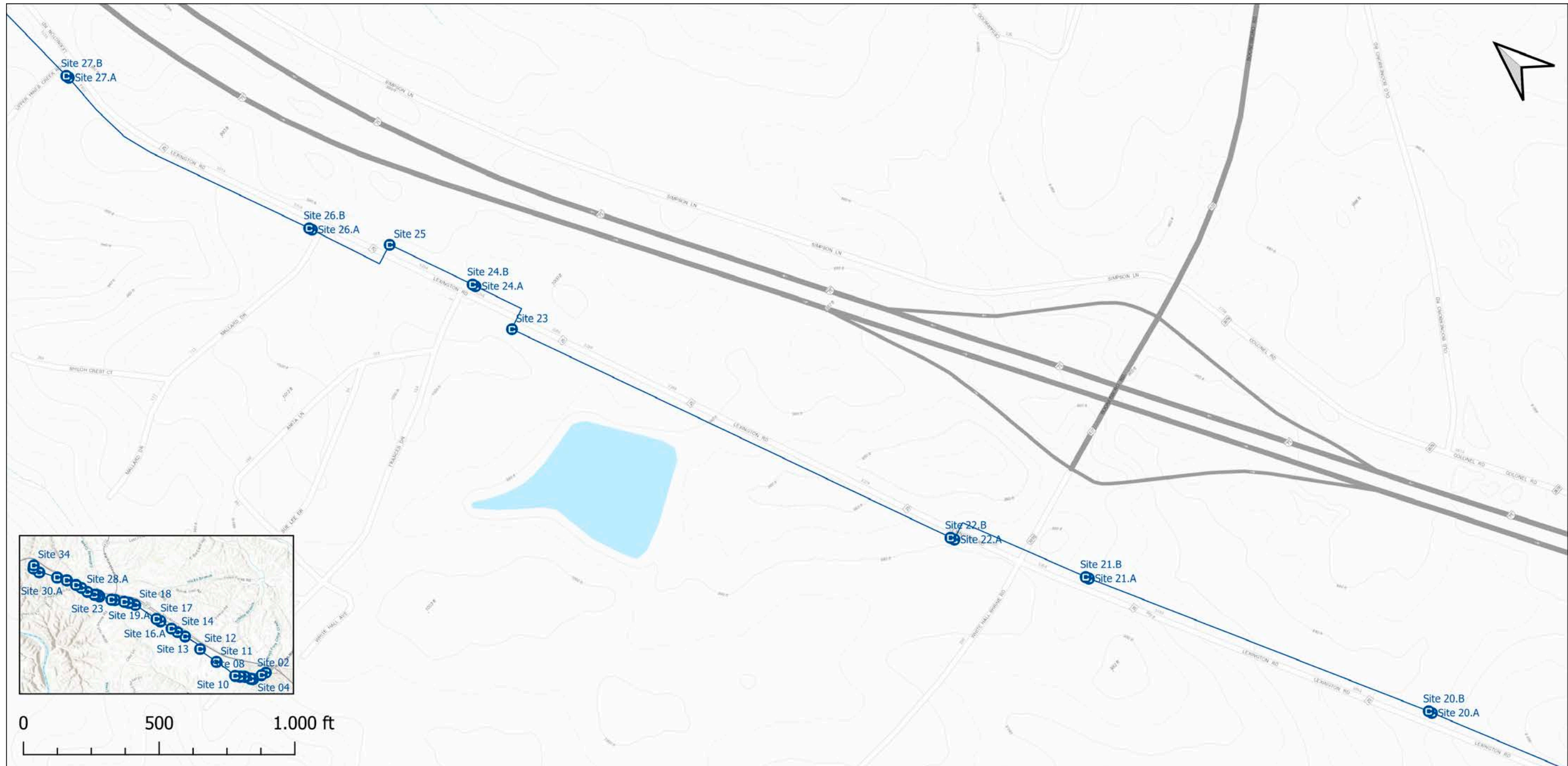

Drawing Reference: MD-LEXRD-DO-007			Commercial in Confidence			Drawn	18/11/2020	Name	Joan Vilaseca i Vila	Position	CD	 Making your network smarter
Rev. No.	Date	Revision Details	Checked		Approved							
01	18/11/2020	Final Drawing	Scale	As Shown	Drawing Name	Madison County- Lexington Road Project Project Links Overview 07						
											ENGINEERING	

3.9 MD-LEXRD-DO-009

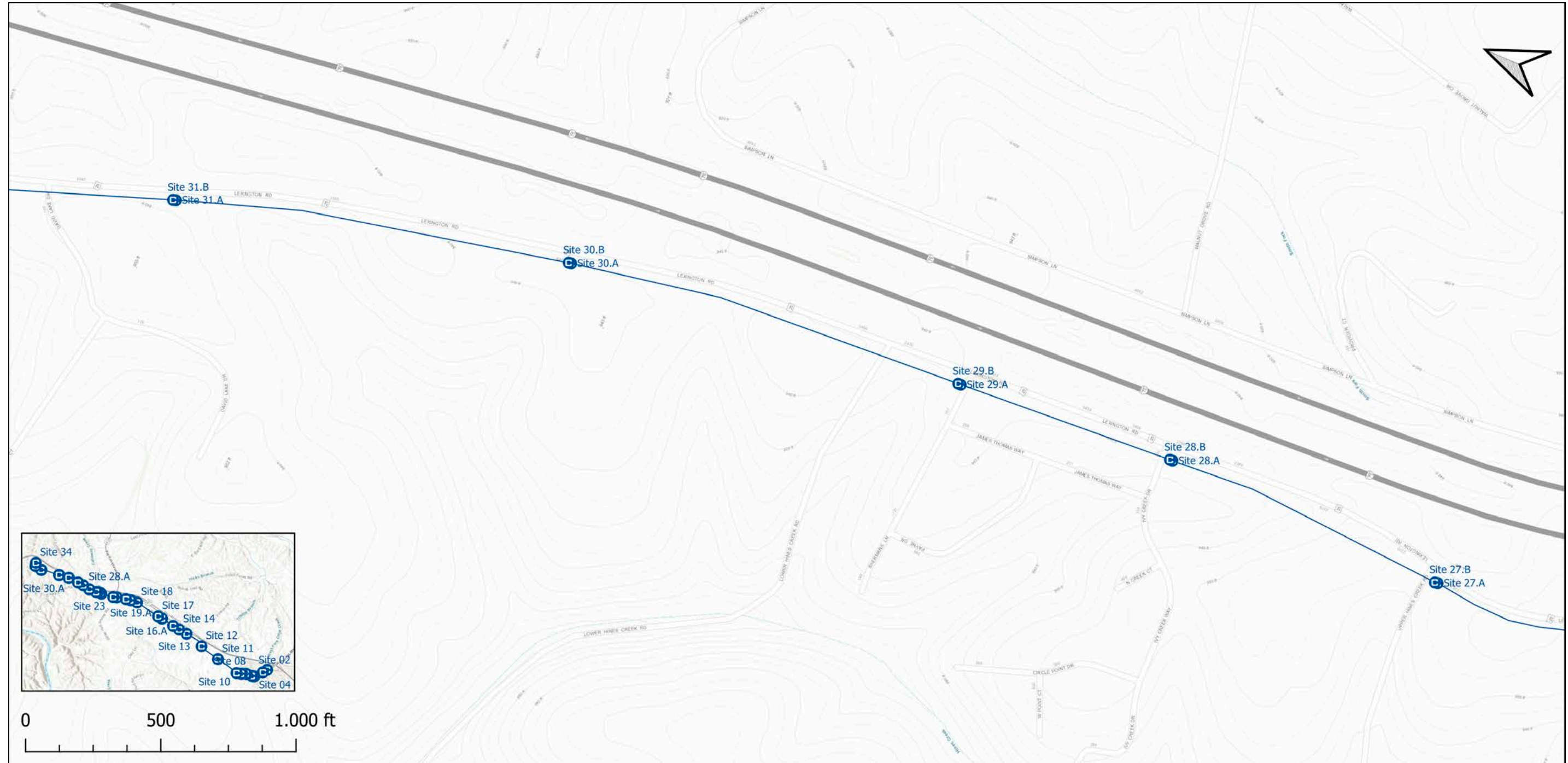

Drawing Reference: MD-LEXRD-DO-008			Commercial in Confidence			Drawn	Date	Name	Position	 Making your network smarter
Rev. No.	Date	Revision Details	Checked	18/11/2020	Joan Vilaseca i Vila	CD				
01	18/11/2020	Final Drawing	Approved							
			Scale	Drawing Name			ENGINEERING			
			As Shown	Madison County- Lexington Road Project Project Links Overview 08						

3.10 MD-LEXRD-DO-009

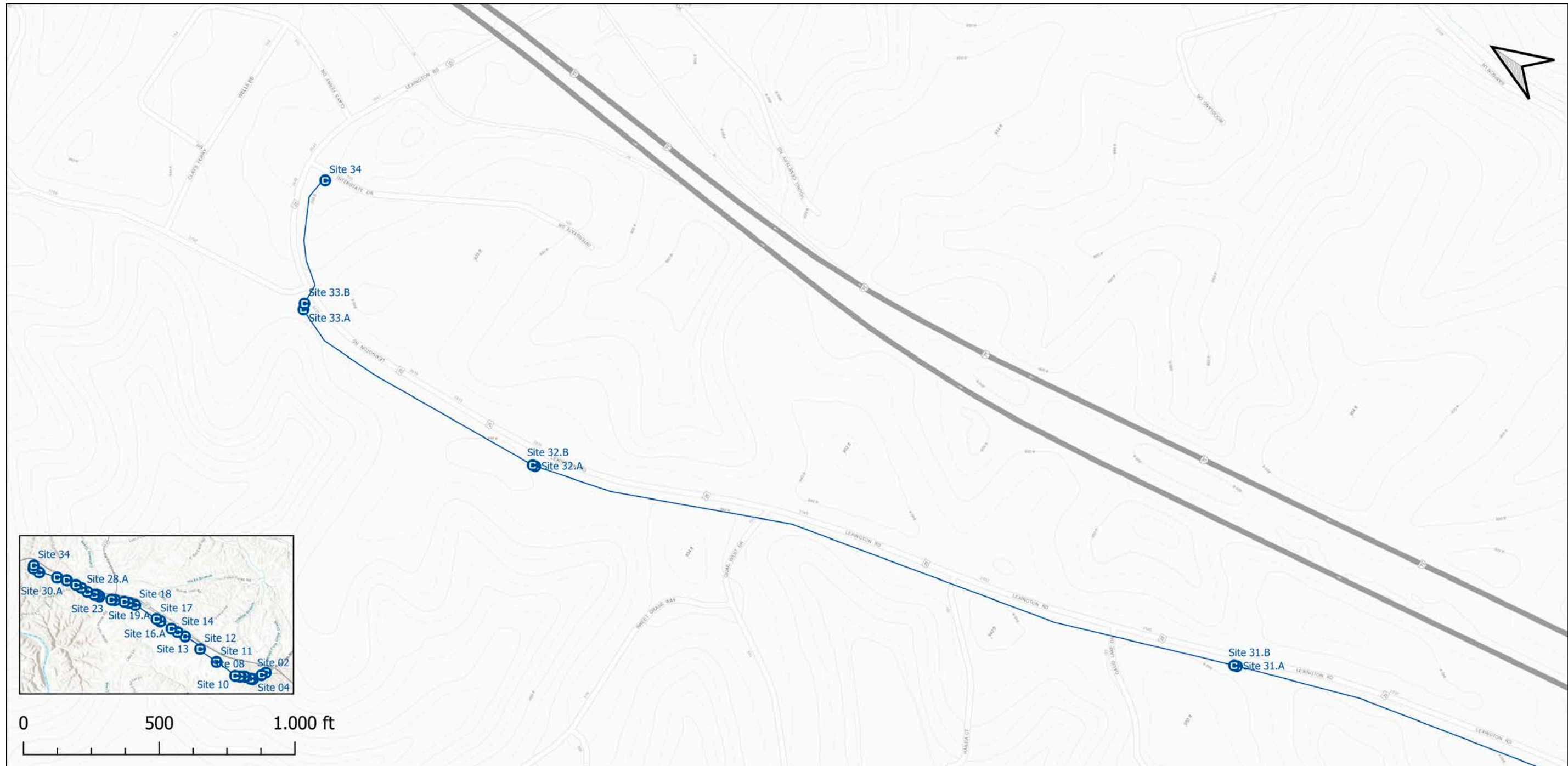

Drawing Reference: MD-LEXRD-DO-009			Commercial in Confidence			Date	Name	Position	 Making your network smarter
Rev. No.	Date	Revision Details	Drawn	18/11/2020	Joan Vilaseca i Vila	CD			
01	18/11/2020	Final Drawing	Checked						
			Approved					ENGINEERING	
			Scale	Drawing Name					
			As Shown	Madison County- Lexington Road Project Project Links Overview 09					

4. Project Links - Detailed

Link 01 - Key Data

End A (Site #)	End B (Site #)	Length (ft)	Cumulative Bends (°)	Pipe Material	Pipe Diameter (Inches)	Operating Pressure (psi)	Volume (Gall./Day)	Flow Velocity (ft/s)	Flow Generation	Flow Direction
01	02	743	0	PVC	12	63	678,633	1.34	Pumped	West

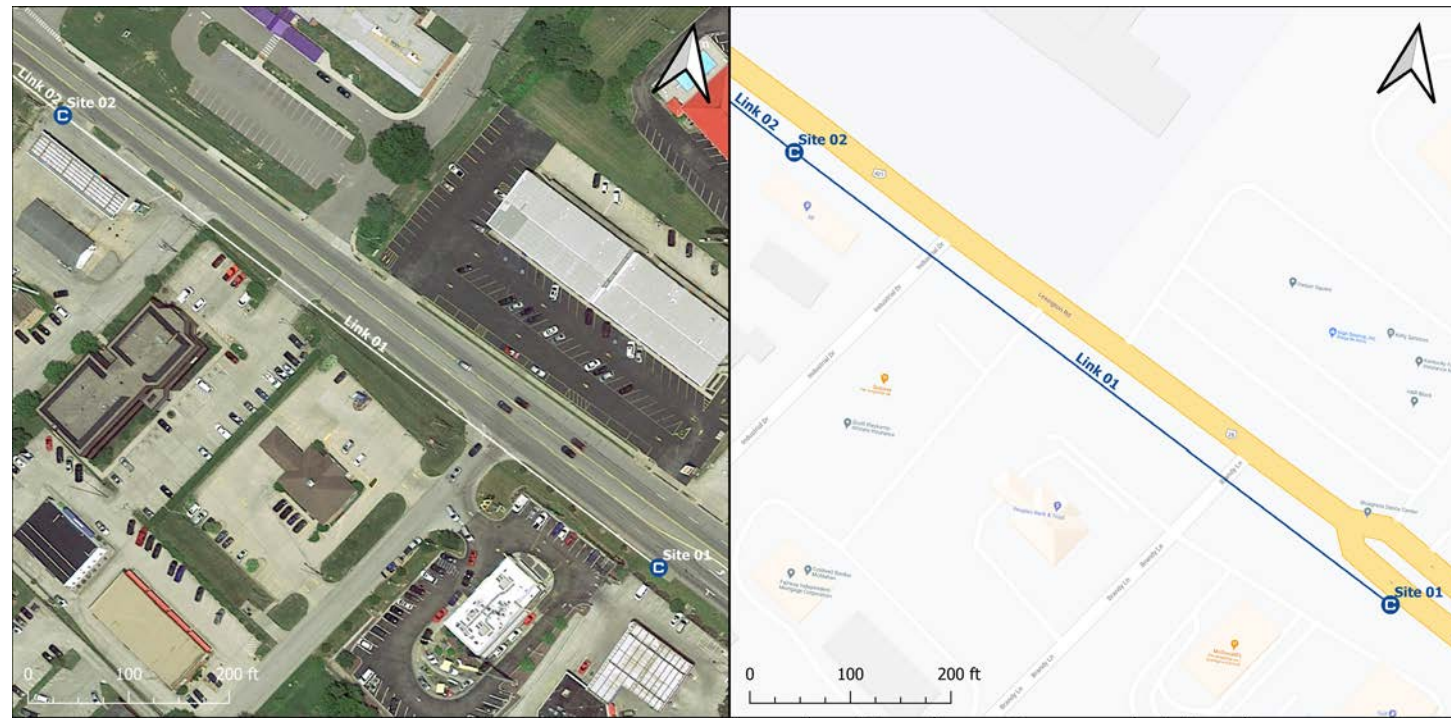

Drawing Reference: MD-LEXRD-SL-001		Commercial in Confidence		Date	Name	Position	CRALEY Making your network smarter
Rev. No.	Date	Revision Details		Drawn	Checked	Approved	
01	18/11/2020	Final Drawing		Scale	Drawing Name		ENGINEERING
				As Shown	Madison County - Lexington Road Project Link 01 - Detail		

Site 01 - 2121 Lex Rd - Object ID 469

Latitude (°)	Longitude (°)	Element	Site Access Permit	HASL (ft)	Chamber Type	Chamber Dimensions (X/Y/Z)	Chamber Status	Overall Site Setup	Additional Duct Length (ft)
37.776281	-84.3199	None	Free	923	A	36/36/48	New	1x Single	-

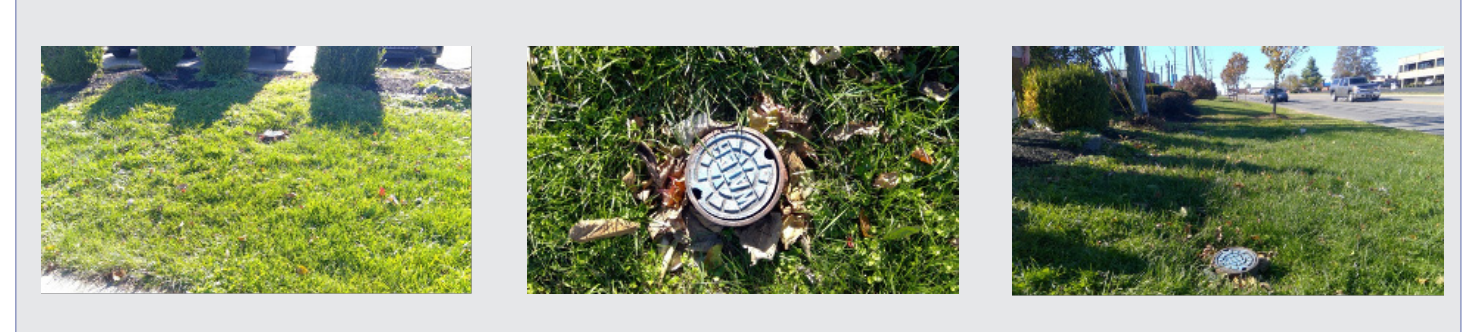

Site 02 - 2121 Lex Rd - Object ID 469

Latitude (°)	Longitude (°)	Element	Site Access Permit	HASL (ft)	Chamber Type	Chamber Dimensions (X/Y/Z)	Chamber Status	Overall Site Setup	Additional Duct Length (ft)
37.77721	-84.32219	Stop Valve	Free	946	C	36/72/48	New	1x Double	-





Product and Installation Requirements	Information
CRALEY Fibre™ Stainless Steel 4" T-Series Vertical Entry Flange Final Fitting	2 units
CRALEY Fibre™ 24/14 Armoured Messenger Pipe	854 ft
CRALEY Fibre™ 288 Fibre Cable - 288-strand	854 ft
CRALEY Fibre™ Installation Technique	De-pressurised
CRALEY Fibre™ Installation Parachute - based on reported internal condition & pipe diameter	250mm

Installation Fitting Components Required:	Upper Part	Lower Part
Draw-line Installation Fitting	Type A	Type A
Magnetic Grab & Net Capture Fitting	Type B	Type C
Messenger Pipe™ Installation Fitting	Type C	Type F

Observations/Notes
1. See section "13.3 Project Specific Installation Fittings" on page 60 for an explanation of the installation fitting components
2. See section "9.1 General Chamber Guidelines" on page 50 for information on chamber types
3. See page 57 for more information on parachute sizing
4. All images provided by Madison County
5. Where images have not been provided, a general image representing the location has been generated

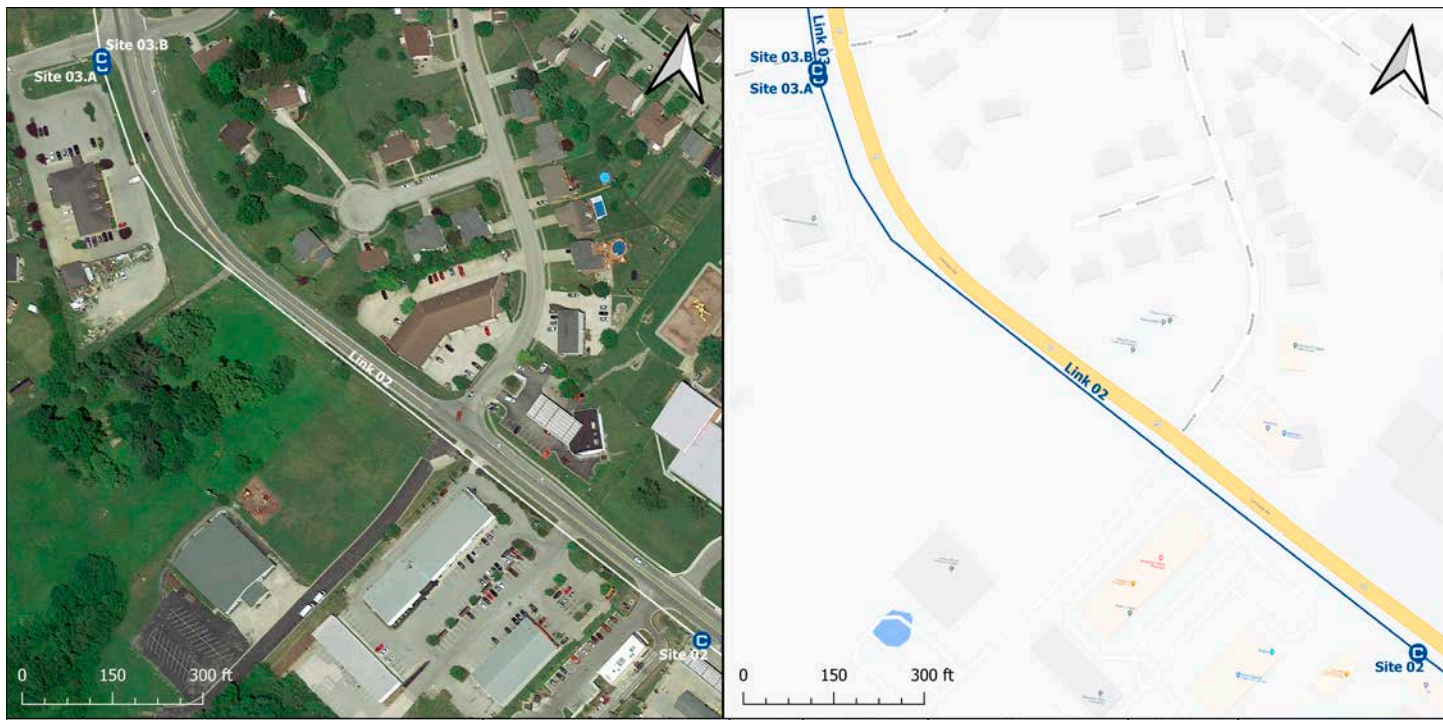
Link 02 - Key Data										
End A (Site #)	End B (Site #)	Length (ft)	Cumulative Bends (°)	Pipe Material	Pipe Diameter (Inches)	Operating Pressure (psi)	Volume (Gall./Day)	Flow Velocity (ft/s)	Flow Generation	Flow Direction
02	03.A	1,405	47	PVC	12	63	678,633	1.34	Pumped	West



Drawing Reference: MD-LEXRD-SL-002		Commercial in Confidence		Date	Name	Position	 ENGINEERING
Rev. No.	Date	Revision Details		Drawn	Checked	Approved	
01	18/11/2020	Final Drawing		Scale	Drawing Name		
				As Shown	Madison County- Lexington Road Project Link 02- Detail		

Site 02 - 297 Michelle Dr - Object ID 215									
Latitude (°)	Longitude (°)	Element	Site Access Permit	HASL (ft)	Chamber Type	Chamber Dimensions (X/Y/Z)	Chamber Status	Overall Site Setup	Additional Duct Length (ft)
37.77721	-84.32219	Stop Valve	Free	946	C	36/72/48	New	1x Double	-



Site 03.A - 297 Michelle Dr - Object ID 215									
Latitude (°)	Longitude (°)	Element	Site Access Permit	HASL (ft)	Chamber Type	Chamber Dimensions (X/Y/Z)	Chamber Status	Overall Site Setup	Additional Duct Length (ft)
37.7793	-84.32615	Stop Valve	Free	938	A	36/36/48	New	2x Single	8



Product and Installation Requirements	Information
CRALEY Fibre™ Stainless Steel 4" T-Series Vertical Entry Flange Final Fitting	2 units
CRALEY Fibre™ 24/14 Armoured Messenger Pipe	1,591 ft
CRALEY Fibre™ 288 Fibre Cable - 288-strand	1,591 ft
CRALEY Fibre™ Installation Technique	De-pressurised
CRALEY Fibre™ Installation Parachute - based on reported internal diameter	250mm

Installation Fitting Components Required:	Upper Part	Lower Part
Draw-line Installation Fitting	Type A	Type A
Magnetic Grab & Net Capture Fitting	Type B	Type C
Messenger Pipe™ Installation Fitting	Type C	Type F

Observations/Notes
1. See section "13.3 Project Specific Installation Fittings" on page 60 for an explanation of the installation fitting components
2. See section "9.1 General Chamber Guidelines" on page 50 for information on chamber types
3. See page 57 for more information on parachute sizing
4. All images provided by Madison County
5. Where images have not been provided, a general image representing the location has been generated

Link 03 - Key Data

End A (Site #)	End B (Site #)	Length (ft)	Cumulative Bends (°)	Pipe Material	Pipe Diameter (Inches)	Operating Pressure (psi)	Volume (Gall./Day)	Flow Velocity (ft/s)	Flow Generation	Flow Direction
03.B	04	119	0	PVC	12	63	678,633	1.34	Pumped	NW



Drawing Reference: MD-LEXRD-SL-003		Commercial in Confidence		Date	Name	Position	CRALEY Making your network smarter
Rev. No.	Date	Revision Details		Drawn	Checked	Approved	
01	18/11/2020	Final Drawing		Scale	Drawing Name		ENGINEERING
				As Shown	Madison County - Lexington Road Project Link 03 - Detail		

Site 03.B - 297 Michelle Dr - Object ID 474

Latitude (°)	Longitude (°)	Element	Site Access Permit	HASL (ft)	Chamber Type	Chamber Dimensions (X/Y/Z)	Chamber Status	Overall Site Setup	Additional Duct Length (ft)
37.779336	-84.32616	Stop Valve	Free	938	A	36/36/48	New	2x Single	8

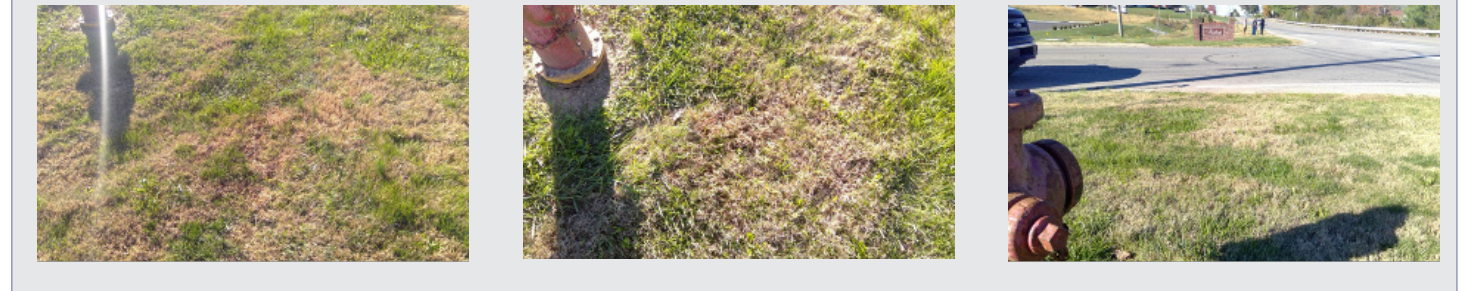

Site 04 - 296 Michelle Dr - Object ID 476

Latitude (°)	Longitude (°)	Element	Site Access Permit	HASL (ft)	Chamber Type	Chamber Dimensions (X/Y/Z)	Chamber Status	Overall Site Setup	Additional Duct Length (ft)
37.77965	-84.32626	Stop Valve	Free	927	C	36/72/48	New	1x Double	-



Product and Installation Requirements	Information
CRALEY Fibre™ Stainless Steel 4" T-Series Vertical Entry Flange Final Fitting	2 units
CRALEY Fibre™ 24/14 Armoured Messenger Pipe	167 ft
CRALEY Fibre™ 288 Fibre Cable - 288-strand	167 ft
CRALEY Fibre™ Installation Technique	De-pressurised
CRALEY Fibre™ Installation Parachute - based on reported internal condition & pipe diameter	250mm

Installation Fitting Components Required:	Upper Part	Lower Part
Draw-line Installation Fitting	Type A	Type A
Magnetic Grab & Net Capture Fitting	Type B	Type C
Messenger Pipe™ Installation Fitting	Type C	Type F

Observations/Notes

1. See section "13.3 Project Specific Installation Fittings" on page 60 for an explanation of the installation fitting components
2. See section "9.1 General Chamber Guidelines" on page 50 for information on chamber types
3. See page 57 for more information on parachute sizing
4. All images provided by Madison County
5. Where images have not been provided, a general image representing the location has been generated

Link 04 - Key Data

End A (Site #)	End B (Site #)	Length (ft)	Cumulative Bends (°)	Pipe Material	Pipe Diameter (Inches)	Operating Pressure (psi)	Volume (Gall./Day)	Flow Velocity (ft/s)	Flow Generation	Flow Direction
04	05.A	157	0	PVC	12	63	678,633	1.34	Pumped	NW

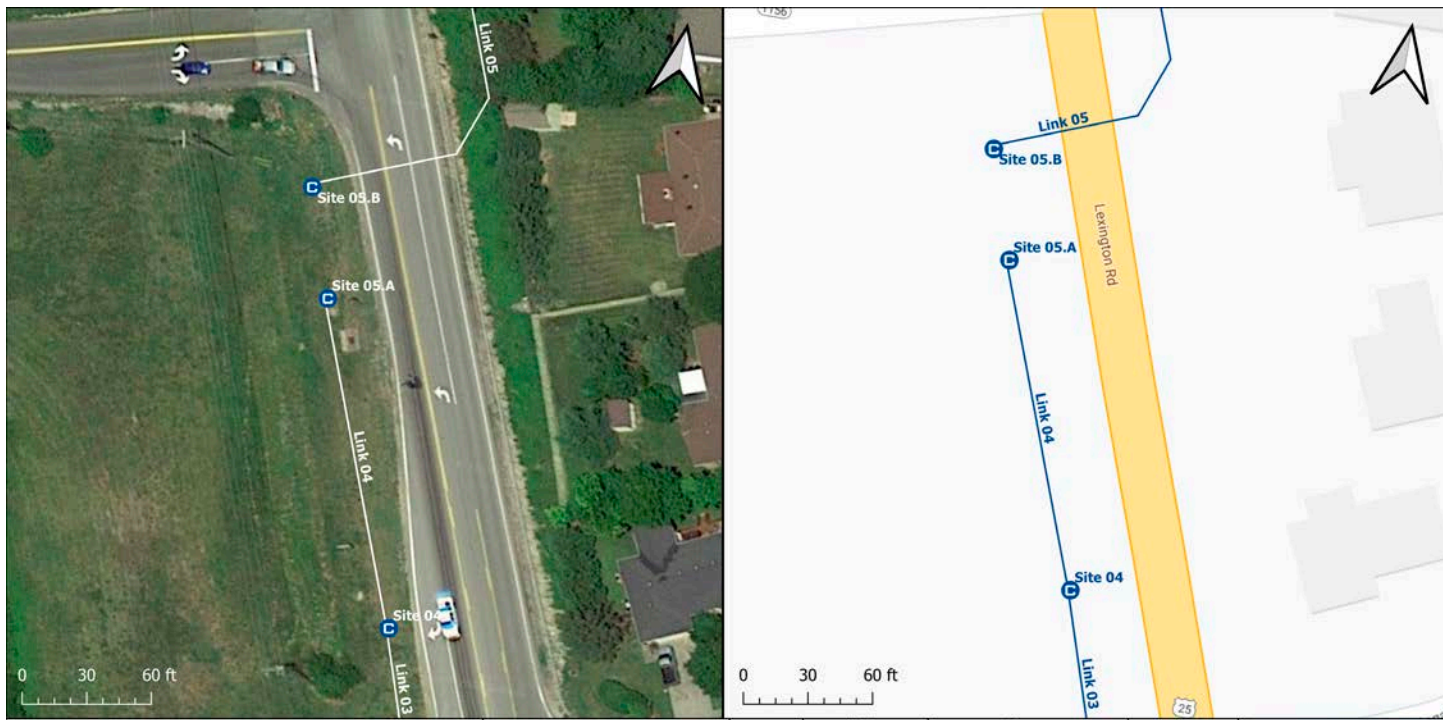

Drawing Reference: MD-LEXRD-SL-004		Commercial in Confidence		Date	Name	Position	 ENGINEERING
Rev. No.	Date	Revision Details		Drawn	Checked	Approved	
01	18/11/2020	Final Drawing		Scale	Drawing Name		
				As Shown	Madison County- Lexington Road Project Link 04- Detail		

Site 04 - 296 Michelle Dr - Object ID 476

Latitude (°)	Longitude (°)	Element	Site Access Permit	HASL (ft)	Chamber Type	Chamber Dimensions (X/Y/Z)	Chamber Status	Overall Site Setup	Additional Duct Length (ft)
37.77965	-84.32626	Stop Valve	Free	927	C	36/72/48	New	1x Double	-



Site 05.A - Lex Rd and Jacks Creek Rd - Object ID 2570

Latitude (°)	Longitude (°)	Element	Site Access Permit	HASL (ft)	Chamber Type	Chamber Dimensions (X/Y/Z)	Chamber Status	Overall Site Setup	Additional Duct Length (ft)
37.78001	-84.32649	Stop Valve	Free	915	A	36/36/48	New	2x Single	8



Product and Installation Requirements	Information
CRALEY Fibre™ Stainless Steel 4" T-Series Vertical Entry Flange Final Fitting	2 units
CRALEY Fibre™ 24/14 Armoured Messenger Pipe	209 ft
CRALEY Fibre™ 288 Fibre Cable - 288-strand	209 ft
CRALEY Fibre™ Installation Technique	De-pressurised
CRALEY Fibre™ Installation Parachute - based on reported internal condition & pipe diameter	250mm

Installation Fitting Components Required:	Upper Part	Lower Part
Draw-line Installation Fitting	Type A	Type A
Magnetic Grab & Net Capture Fitting	Type B	Type C
Messenger Pipe™ Installation Fitting	Type C	Type F

Observations/Notes
1. See section "13.3 Project Specific Installation Fittings" on page 60 for an explanation of the installation fitting components
2. See section "9.1 General Chamber Guidelines" on page 50 for information on chamber types
3. See page 57 for more information on parachute sizing
4. All images provided by Madison County
5. Where images have not been provided, a general image representing the location has been generated

Link 05 - Key Data

End A (Site #)	End B (Site #)	Length (ft)	Cumulative Bends (°)	Pipe Material	Pipe Diameter (Inches)	Operating Pressure (psi)	Volume (Gall./Day)	Flow Velocity (ft/s)	Flow Generation	Flow Direction
05.B	06	837	90	PVC	12	63	678,633	1.34	Pumped	NW



Drawing Reference: MD-LEXRD-SL-005		Commercial in Confidence		Date	Name	Position	 ENGINEERING
Rev. No.	Date	Revision Details		Drawn	Checked	Approved	
01	18/11/2020	Final Drawing		Scale	Drawing Name		
				As Shown	Madison County - Lexington Road Project Link 05 - Detail		

Site 05.B - Lex Rd and Jacks Creek Rd - Object ID 2570

Latitude (°)	Longitude (°)	Element	Site Access Permit	HASL (ft)	Chamber Type	Chamber Dimensions (X/Y/Z)	Chamber Status	Overall Site Setup	Additional Duct Length (ft)
37.78011	-84.32649	Stop Valve	Free	915	A	36/36/48	New	2x Single	8



Site 06 - 2323 Lex Rd - Object ID 478

Latitude (°)	Longitude (°)	Element	Site Access Permit	HASL (ft)	Chamber Type	Chamber Dimensions (X/Y/Z)	Chamber Status	Overall Site Setup	Additional Duct Length (ft)
37.78225	-84.32716	Stop Valve	Free	945	C	36/72/48	New	1x Double	-



Product and Installation Requirements	Information
CRALEY Fibre™ Stainless Steel 4" T-Series Vertical Entry Flange Final Fitting	2 units
CRALEY Fibre™ 24/14 Armoured Messenger Pipe	966 ft
CRALEY Fibre™ 288 Fibre Cable - 288-strand	966 ft
CRALEY Fibre™ Installation Technique	De-pressurised
CRALEY Fibre™ Installation Parachute - based on reported internal condition & pipe diameter	250mm

Installation Fitting Components Required:	Upper Part	Lower Part
Draw-line Installation Fitting	Type A	Type A
Magnetic Grab & Net Capture Fitting	Type B	Type C
Messenger Pipe™ Installation Fitting	Type C	Type F

Observations/Notes
1. See section "13.3 Project Specific Installation Fittings" on page 60 for an explanation of the installation fitting components
2. See section "9.1 General Chamber Guidelines" on page 50 for information on chamber types
3. See page 57 for more information on parachute sizing
4. All images provided by Madison County
5. Where images have not been provided, a general image representing the location has been generated

Link 06 - Key Data

End A (Site #)	End B (Site #)	Length (ft)	Cumulative Bends (°)	Pipe Material	Pipe Diameter (Inches)	Operating Pressure (psi)	Volume (Gall./Day)	Flow Velocity (ft/s)	Flow Generation	Flow Direction
06	07	183	0	PVC	12	63	678,633	1.34	Pumped	NW



Drawing Reference: MD-LEXRD-SL-006		Commercial in Confidence		Date	Name	Position	 ENGINEERING
Rev. No.	Date	Revision Details		Drawn		CD	
01	18/11/2020	Final Drawing		Checked			
				Approved			
				Scale	Drawing Name		
				As Shown	Madison County- Lexington Road Project Link 06- Detail		

Site 06 - 2323 Lex Rd - Object ID 478

Latitude (°)	Longitude (°)	Element	Site Access Permit	HASL (ft)	Chamber Type	Chamber Dimensions (X/Y/Z)	Chamber Status	Overall Site Setup	Additional Duct Length (ft)
37.78225	-84.32716	Stop Valve	Free	945	C	36/72/48	New	1x Double	-



Site 07 -

Latitude (°)	Longitude (°)	Element	Site Access Permit	HASL (ft)	Chamber Type	Chamber Dimensions (X/Y/Z)	Chamber Status	Overall Site Setup	Additional Duct Length (ft)
37.78269	-84.32737	90°-elbow	Free	940	F	36/72/48	New	1x Double	-



Product and Installation Requirements	Information
CRALEY Fibre™ Stainless Steel 4" T-Series Vertical Entry Flange Final Fitting	2 units
CRALEY Fibre™ 24/14 Armoured Messenger Pipe	238 ft
CRALEY Fibre™ 288 Fibre Cable - 288-strand	238 ft
CRALEY Fibre™ Installation Technique	De-pressurised
CRALEY Fibre™ Installation Parachute - based on reported internal condition & pipe diameter	250mm

Installation Fitting Components Required:	Upper Part	Lower Part
Draw-line Installation Fitting	Type A	Type A
Magnetic Grab & Net Capture Fitting	Type B	Type C
Messenger Pipe™ Installation Fitting	Type C	Type F

Observations/Notes

1. See section "13.3 Project Specific Installation Fittings" on page 60 for an explanation of the installation fitting components
2. See section "9.1 General Chamber Guidelines" on page 50 for information on chamber types
3. See page 57 for more information on parachute sizing
4. All images provided by Madison County
5. Where images have not been provided, a general image representing the location has been generated

Link 07 - Key Data

End A (Site #)	End B (Site #)	Length (ft)	Cumulative Bends (°)	Pipe Material	Pipe Diameter (Inches)	Operating Pressure (psi)	Volume (Gall./Day)	Flow Velocity (ft/s)	Flow Generation	Flow Direction
07	08	574	90	PVC	12	63	678,633	1.34	Pumped	NW



Drawing Reference: MD-LEXRD-SL-007		Commercial in Confidence		Date	Name	Position	CRALEY Making your network smarter
Rev. No.	Date	Revision Details		Drawn	Checked	Approved	
01	18/11/2020	Final Drawing		Scale	Drawing Name		ENGINEERING
				As Shown	Madison County - Lexington Road Project Link 07- Detail		

Site 07 -

Latitude (°)	Longitude (°)	Element	Site Access Permit	HASL (ft)	Chamber Type	Chamber Dimensions (X/Y/Z)	Chamber Status	Overall Site Setup	Additional Duct Length (ft)
37.78269	-84.32737	90°-elbow	Free	940	F	36/72/48	New	1x Double	-



Site 08 - 2331 Lex Rd - Object ID 481

Latitude (°)	Longitude (°)	Element	Site Access Permit	HASL (ft)	Chamber Type	Chamber Dimensions (X/Y/Z)	Chamber Status	Overall Site Setup	Additional Duct Length (ft)
37.78401	-84.32825	Stop Valve	Free	916	C	36/72/48	New	1x Double	-



Product and Installation Requirements	Information
CRALEY Fibre™ Stainless Steel 4" T-Series Vertical Entry Flange Final Fitting	2 units
CRALEY Fibre™ 24/14 Armoured Messenger Pipe	668 ft
CRALEY Fibre™ 288 Fibre Cable - 288-strand	668 ft
CRALEY Fibre™ Installation Technique	De-pressurised
CRALEY Fibre™ Installation Parachute - based on reported internal condition & pipe diameter	250mm

Installation Fitting Components Required:	Upper Part	Lower Part
Draw-line Installation Fitting	Type A	Type A
Magnetic Grab & Net Capture Fitting	Type B	Type C
Messenger Pipe™ Installation Fitting	Type C	Type F

Observations/Notes
1. See section "13.3 Project Specific Installation Fittings" on page 60 for an explanation of the installation fitting components
2. See section "9.1 General Chamber Guidelines" on page 50 for information on chamber types
3. See page 57 for more information on parachute sizing
4. All images provided by Madison County
5. Where images have not been provided, a general image representing the location has been generated

Link 08 - Key Data

End A (Site #)	End B (Site #)	Length (ft)	Cumulative Bends (°)	Pipe Material	Pipe Diameter (Inches)	Operating Pressure (psi)	Volume (Gall./Day)	Flow Velocity (ft/s)	Flow Generation	Flow Direction
08	09.A	187	90	PVC	12	63	678,633	1.34	Pumped	NW



Drawing Reference: MD-LEXRD-SL-008		Commercial in Confidence		Drawn	Date	Name	Position	<p>ENGINEERING</p>
Rev. No.	Date	Revision Details		Checked	18/11/2020	Joan Vilaseca i Vila	CD	
01	18/11/2020	Final Drawing		Approved				
Scale				Drawing Name				
As Shown				Madison County- Lexington Road Project Link 08- Detail				

Site 08 - 2331 Lex Rd - Object ID 481

Latitude (°)	Longitude (°)	Element	Site Access Permit	HASL (ft)	Chamber Type	Chamber Dimensions (X/Y/Z)	Chamber Status	Overall Site Setup	Additional Duct Length (ft)
37.78401	-84.32825	Stop Valve	Free	916	C	36/72/48	New	1x Double	-



Site 09.A - Lex Rd and Derby Creek Dr - Object ID 480

Latitude (°)	Longitude (°)	Element	Site Access Permit	HASL (ft)	Chamber Type	Chamber Dimensions (X/Y/Z)	Chamber Status	Overall Site Setup	Additional Duct Length (ft)
37.78433	-84.32865	90°-elbow	Landowner	901	A	36/36/48	New	2x Single	6



Product and Installation Requirements	Information
CRALEY Fibre™ Stainless Steel 4" T-Series Vertical Entry Flange Final Fitting	2 units
CRALEY Fibre™ 24/14 Armoured Messenger Pipe	242 ft
CRALEY Fibre™ 288 Fibre Cable - 288-strand	242 ft
CRALEY Fibre™ Installation Technique	De-pressurised
CRALEY Fibre™ Installation Parachute - based on reported internal condition & pipe diameter	250mm

Installation Fitting Components Required:	Upper Part	Lower Part
Draw-line Installation Fitting	Type A	Type A
Magnetic Grab & Net Capture Fitting	Type B	Type C
Messenger Pipe™ Installation Fitting	Type C	Type F

Observations/Notes

1. See section "13.3 Project Specific Installation Fittings" on page 60 for an explanation of the installation fitting components
2. See section "9.1 General Chamber Guidelines" on page 50 for information on chamber types
3. See page 57 for more information on parachute sizing
4. All images provided by Madison County
5. Where images have not been provided, a general image representing the location has been generated

Link 09 - Key Data

End A (Site #)	End B (Site #)	Length (ft)	Cumulative Bends (°)	Pipe Material	Pipe Diameter (Inches)	Operating Pressure (psi)	Volume (Gall./Day)	Flow Velocity (ft/s)	Flow Generation	Flow Direction
09.B	10	700	45	PVC	12	63	678,633	1.34	Pumped	NW



Drawing Reference: MD-LEXRD-SL-009		Commercial in Confidence		Date	Name	Position	 ENGINEERING
Rev. No.	Date	Revision Details		Drawn	Checked	Approved	
01	18/11/2020	Final Drawing		Scale	Drawing Name		
				As Shown	Madison County- Lexington Road Project Link 09- Detail		

Site 09.B - Lex Rd and Derby Creek Dr - Object ID 480

Latitude (°)	Longitude (°)	Element	Site Access Permit	HASL (ft)	Chamber Type	Chamber Dimensions (X/Y/Z)	Chamber Status	Overall Site Setup	Additional Duct Length (ft)
37.78433	-84.32865	Stop Valve	Landowner	900	A	36/36/48	New	2x Single	6

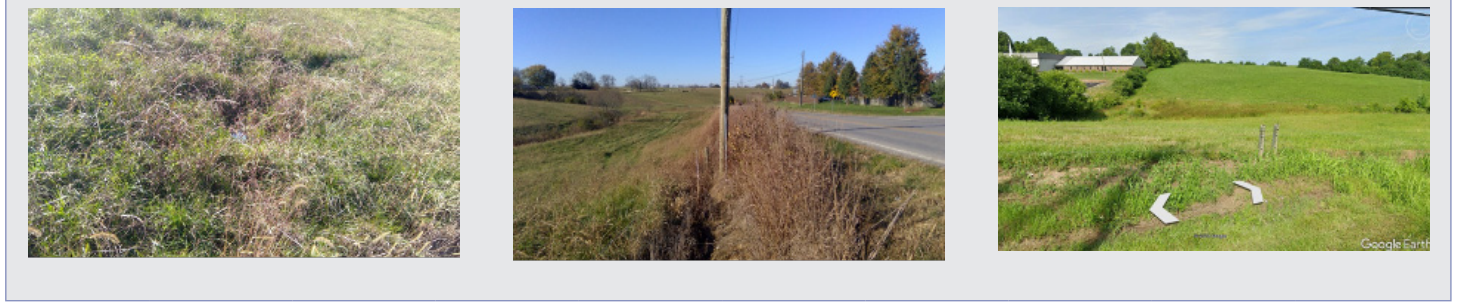

Site 10 - 2354 Lex Rd - Object ID 483

Latitude (°)	Longitude (°)	Element	Site Access Permit	HASL (ft)	Chamber Type	Chamber Dimensions (X/Y/Z)	Chamber Status	Overall Site Setup	Additional Duct Length (ft)
37.78605	-84.32958	Stop Valve	Free	877	C	36/72/48	New	1x Double	-



Product and Installation Requirements	Information
CRALEY Fibre™ Stainless Steel 4" T-Series Vertical Entry Flange Final Fitting	2 units
CRALEY Fibre™ 24/14 Armoured Messenger Pipe	806 ft
CRALEY Fibre™ 288 Fibre Cable - 288-strand	806 ft
CRALEY Fibre™ Installation Technique	De-pressurised
CRALEY Fibre™ Installation Parachute - based on reported internal condition & pipe diameter	250mm

Installation Fitting Components Required:	Upper Part	Lower Part
Draw-line Installation Fitting	Type A	Type A
Magnetic Grab & Net Capture Fitting	Type B	Type C
Messenger Pipe™ Installation Fitting	Type C	Type F

Observations/Notes
1. See section "13.3 Project Specific Installation Fittings" on page 60 for an explanation of the installation fitting components
2. See section "9.1 General Chamber Guidelines" on page 50 for information on chamber types
3. See page 57 for more information on parachute sizing
4. All images provided by Madison County
5. Where images have not been provided, a general image representing the location has been generated

Link 10 - Key Data

End A (Site #)	End B (Site #)	Length (ft)	Cumulative Bends (°)	Pipe Material	Pipe Diameter (Inches)	Operating Pressure (psi)	Volume (Gall./Day)	Flow Velocity (ft/s)	Flow Generation	Flow Direction
10	11	3,373	45	PVC	12	63	678,633	1.34	Pumped	NW

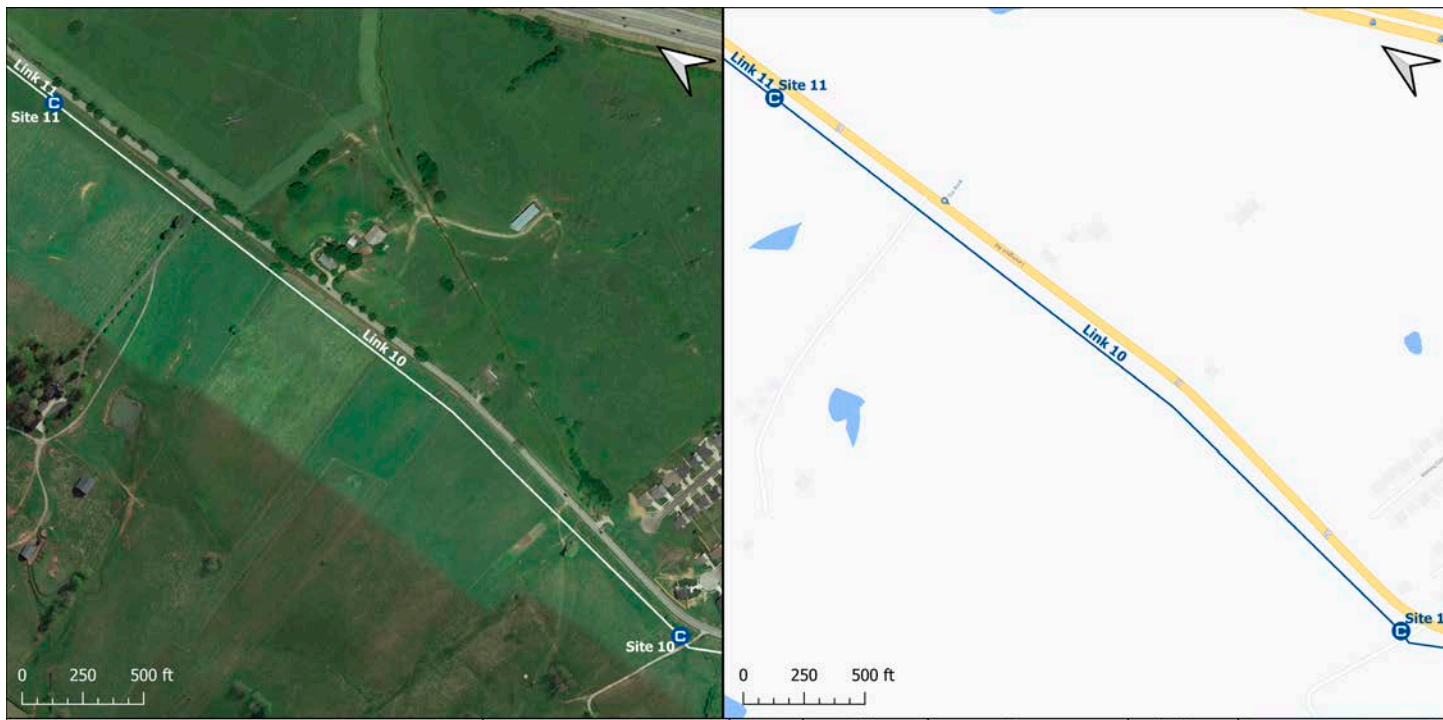

Drawing Reference: MD-LEXRD-SL-010		Commercial in Confidence		Date	Name	Position	 ENGINEERING
Rev. No.	Date	Revision Details		Drawn	Checked	Approved	
01	18/11/2020	Final Drawing		Scale	Drawing Name		
				As Shown	Madison County- Lexington Road Project Link 10- Detail		

Site 10 - 2354 Lex Rd - Object ID 483

Latitude (°)	Longitude (°)	Element	Site Access Permit	HASL (ft)	Chamber Type	Chamber Dimensions (X/Y/Z)	Chamber Status	Overall Site Setup	Additional Duct Length (ft)
37.78605	-84.32958	Stop Valve	Free	877	C	36/72/48	New	1x Double	-



Site 11 -

Latitude (°)	Longitude (°)	Element	Site Access Permit	HASL (ft)	Chamber Type	Chamber Dimensions (X/Y/Z)	Chamber Status	Overall Site Setup	Additional Duct Length (ft)
37.79526	-84.32849	None	Free	877	B	36/72/48	New	1x Double	-



Product and Installation Requirements	Information
CRALEY Fibre™ Stainless Steel 4" T-Series Vertical Entry Flange Final Fitting	2 units
CRALEY Fibre™ 24/14 Armoured Messenger Pipe	3,747 ft
CRALEY Fibre™ 288 Fibre Cable - 288-strand	3,747 ft
CRALEY Fibre™ Installation Technique	De-pressurised
CRALEY Fibre™ Installation Parachute - based on reported internal condition & pipe diameter	250mm

Installation Fitting Components Required:	Upper Part	Lower Part
Draw-line Installation Fitting	Type A	Type A
Magnetic Grab & Net Capture Fitting	Type B	Type C
Messenger Pipe™ Installation Fitting	Type C	Type F

Observations/Notes

1. See section "13.3 Project Specific Installation Fittings" on page 60 for an explanation of the installation fitting components
2. See section "9.1 General Chamber Guidelines" on page 50 for information on chamber types
3. See page 57 for more information on parachute sizing
4. All images provided by Madison County
5. Where images have not been provided, a general image representing the location has been generated

Link 11 - Key Data

End A (Site #)	End B (Site #)	Length (ft)	Cumulative Bends (°)	Pipe Material	Pipe Diameter (Inches)	Operating Pressure (psi)	Volume (Gall./Day)	Flow Velocity (ft/s)	Flow Generation	Flow Direction
11	12	3,026	50	PVC	12	63-40	678,633	1.34	Pumped	North

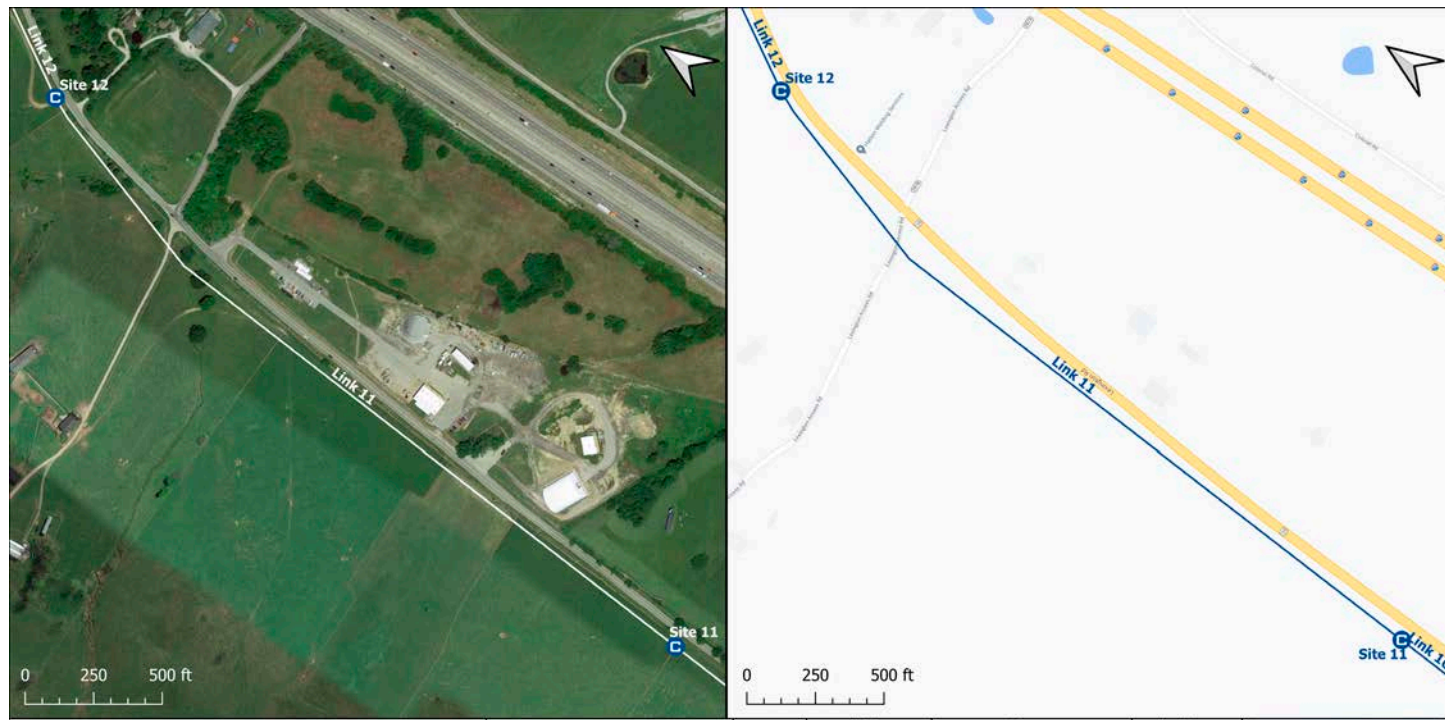

Drawing Reference: MD-LEXRD-SL-011		Commercial in Confidence		Drawn	Date	Name	Position	 ENGINEERING
Rev. No.	Date	Revision Details		Checked	18/11/2020	Joan Vilaseca I Vila	CD	
01	18/11/2020	Final Drawing		Approved				
Scale: As Shown				Drawing Name: Madison County - Lexington Road Project Link 11 - Detail				

Site 11

Latitude (°)	Longitude (°)	Element	Site Access Permit	HASL (ft)	Chamber Type	Chamber Dimensions (X/Y/Z)	Chamber Status	Overall Site Setup	Additional Duct Length (ft)
37.79526	-84.32849	None	Free	877	B	36/72/48	New	1x Double	-

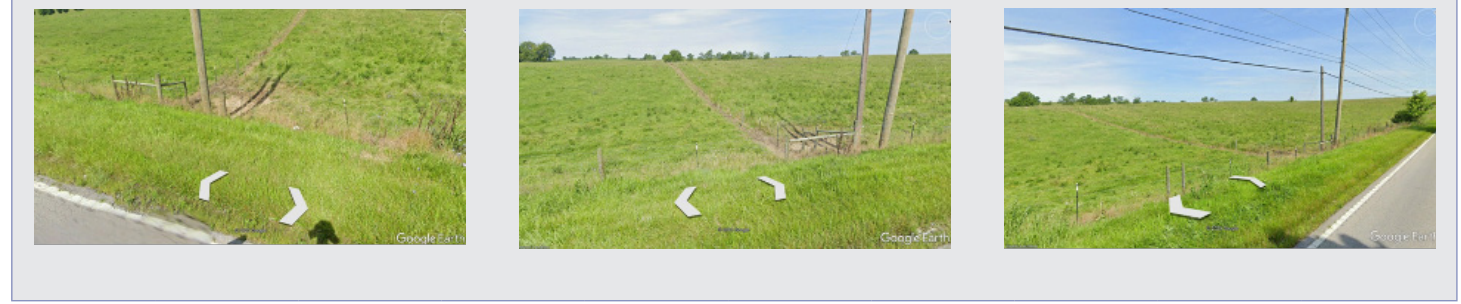

Site 12 -

Latitude (°)	Longitude (°)	Element	Site Access Permit	HASL (ft)	Chamber Type	Chamber Dimensions (X/Y/Z)	Chamber Status	Overall Site Setup	Additional Duct Length (ft)
37.80346	-84.3273	Stop Valve	Landowner	876	C	36/72/48	New	1x Double	-



Product and Installation Requirements	Information
CRALEY Fibre™ Stainless Steel 4" T-Series Vertical Entry Flange Final Fitting	2 units
CRALEY Fibre™ 24/14 Armoured Messenger Pipe	3,365 ft
CRALEY Fibre™ 288 Fibre Cable - 288-strand	3,365 ft
CRALEY Fibre™ Installation Technique	De-pressurised
CRALEY Fibre™ Installation Parachute - based on reported internal condition & pipe diameter	250mm

Installation Fitting Components Required:	Upper Part	Lower Part
Draw-line Installation Fitting	Type A	Type A
Magnetic Grab & Net Capture Fitting	Type B	Type C
Messenger Pipe™ Installation Fitting	Type C	Type F

Observations/Notes
1. See section "13.3 Project Specific Installation Fittings" on page 60 for an explanation of the installation fitting components
2. See section "9.1 General Chamber Guidelines" on page 50 for information on chamber types
3. See page 57 for more information on parachute sizing
4. All images provided by Madison County
5. Where images have not been provided, a general image representing the location has been generated

Link 12 - Key Data										
End A (Site #)	End B (Site #)	Length (ft)	Cumulative Bends (°)	Pipe Material	Pipe Diameter (Inches)	Operating Pressure (psi)	Volume (Gall./Day)	Flow Velocity (ft/s)	Flow Generation	Flow Direction
12	13	2,919	65	PVC	12	40	678,633	1.34	Pumped	North

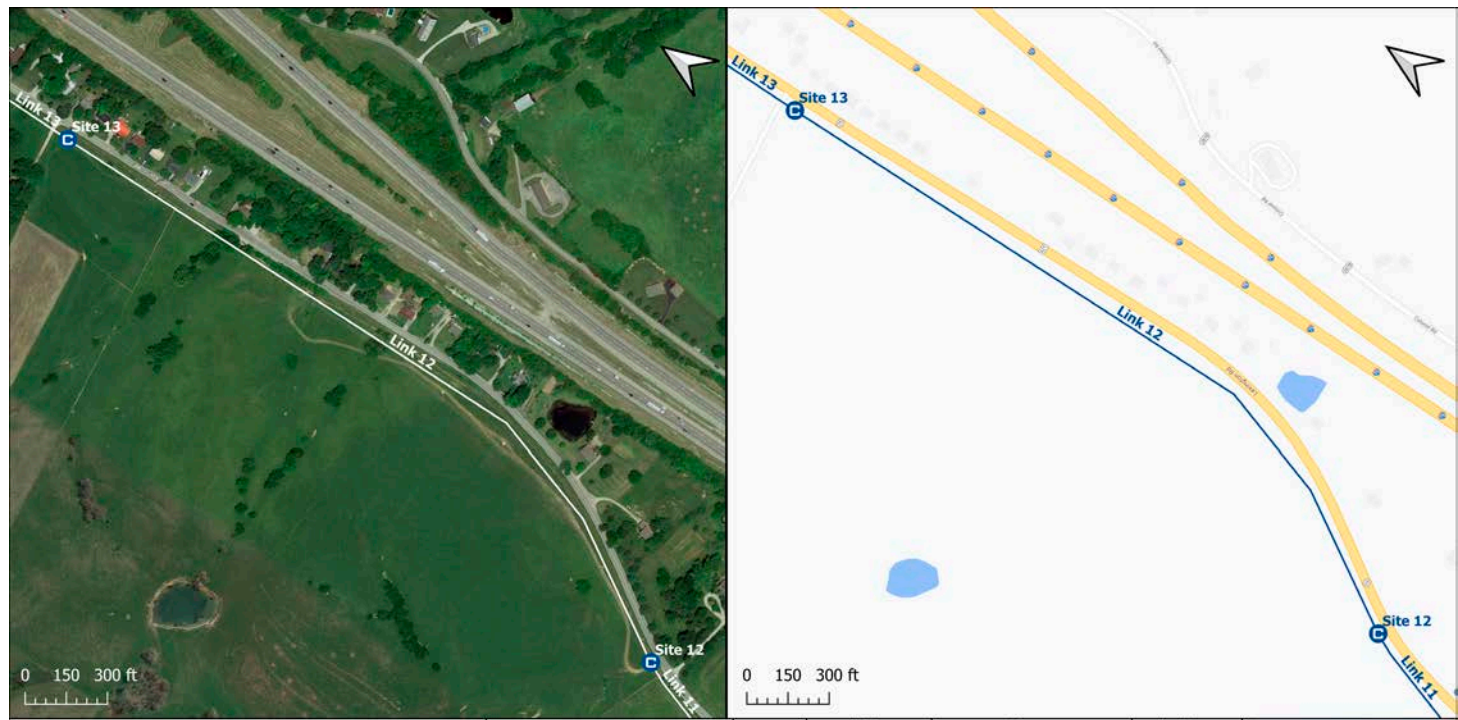

Drawing Reference: MD-LEXRD-SL-012		Commercial in Confidence		Drawn	Date	Name	Position	
Rev. No.	Date	Revision Details	Checked	18/11/2020	Joan Vilaseca i Vila	CD		
01	18/11/2020	Final Drawing	Approved					
				Scale	Drawing Name			
				As Shown	Madison County - Lexington Road Project Link 12 - Detail			

Site 12									
Latitude (°)	Longitude (°)	Element	Site Access Permit	HASL (ft)	Chamber Type	Chamber Dimensions (X/Y/Z)	Chamber Status	Overall Site Setup	Additional Duct Length (ft)
37.80346	-84.3273	Stop Valve	Landowner	876	C	36/72/48	New	1x Double	-



Site 13 - 2605 Lex Rd - Object ID 489									
Latitude (°)	Longitude (°)	Element	Site Access Permit	HASL (ft)	Chamber Type	Chamber Dimensions (X/Y/Z)	Chamber Status	Overall Site Setup	Additional Duct Length (ft)
37.81121	-84.32613	Stop Valve	Landowner	882	C	36/72/48	New	1x Double	-



Product and Installation Requirements	Information
CRALEY Fibre™ Stainless Steel 4" T-Series Vertical Entry Flange Final Fitting	2 units
CRALEY Fibre™ 24/14 Armoured Messenger Pipe	3,247 ft
CRALEY Fibre™ 288 Fibre Cable - 288-strand	3,247 ft
CRALEY Fibre™ Installation Technique	De-pressurised
CRALEY Fibre™ Installation Parachute - based on reported internal condition & pipe diameter	250mm

Installation Fitting Components Required:	Upper Part	Lower Part
Draw-line Installation Fitting	Type A	Type A
Magnetic Grab & Net Capture Fitting	Type B	Type C
Messenger Pipe™ Installation Fitting	Type C	Type F

- Observations/Notes**
1. See section "13.3 Project Specific Installation Fittings" on page 60 for an explanation of the installation fitting components
 2. See section "9.1 General Chamber Guidelines" on page 50 for information on chamber types
 3. See page 57 for more information on parachute sizing
 4. All images provided by Madison County
 5. Where images have not been provided, a general image representing the location has been generated

Link 13 - Key Data

End A (Site #)	End B (Site #)	Length (ft)	Cumulative Bends (°)	Pipe Material	Pipe Diameter (Inches)	Operating Pressure (psi)	Volume (Gall./Day)	Flow Velocity (ft/s)	Flow Generation	Flow Direction
13	14	1,256	0	PVC	12	40	678,633	1.34	Pumped	North

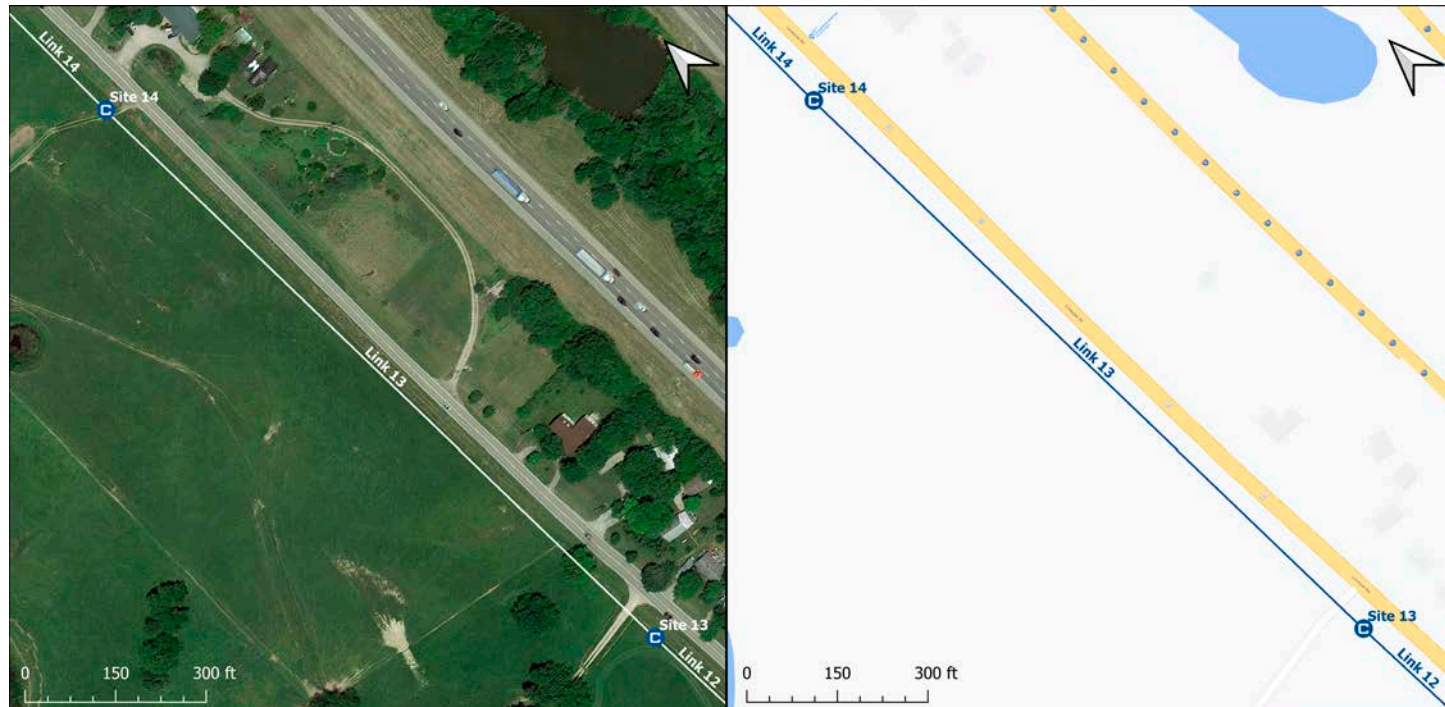

Drawing Reference: MD-LEXRD-SL-013		Commercial in Confidence		Date	Name	Position	CRALEY Making your network smarter
Rev. No.	Date	Revision Details		Drawn	Checked	Approved	
01	18/11/2020	Final Drawing		Scale	Drawing Name		ENGINEERING
				As Shown	Madison County - Lexington Road Project Link 13- Detail		

Site 13 - 2605 Lex Rd - Object ID 489

Latitude (°)	Longitude (°)	Element	Site Access Permit	HASL (ft)	Chamber Type	Chamber Dimensions (X/Y/Z)	Chamber Status	Overall Site Setup	Additional Duct Length (ft)
37.81121	-84.32613	Stop Valve	Landowner	882	C	36/72/48	New	1x Double	-

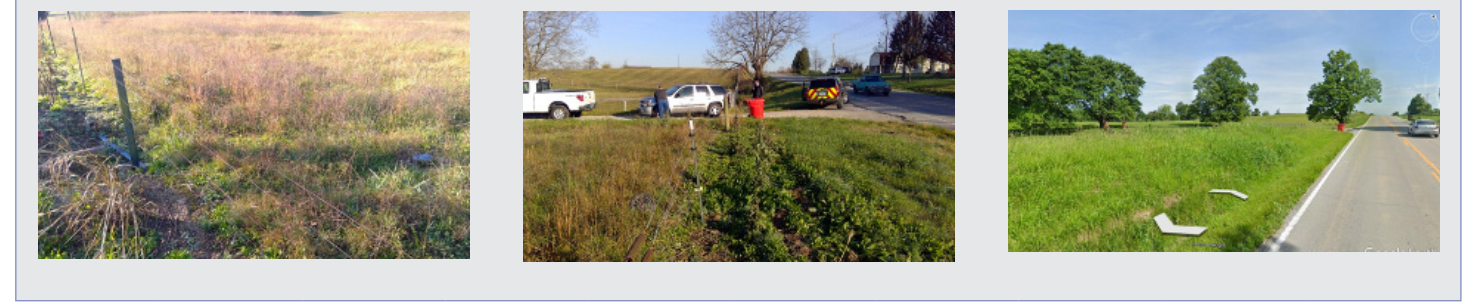

Site 14 - 2635 Lex Rd - Object ID 492

Latitude (°)	Longitude (°)	Element	Site Access Permit	HASL (ft)	Chamber Type	Chamber Dimensions (X/Y/Z)	Chamber Status	Overall Site Setup	Additional Duct Length (ft)
37.81466	-84.32622	Stop Valve	Landowner	899	C	36/72/48	New	1x Double	-



Product and Installation Requirements	Information
CRALEY Fibre™ Stainless Steel 4" T-Series Vertical Entry Flange Final Fitting	2 units
CRALEY Fibre™ 24/14 Armoured Messenger Pipe	1,418 ft
CRALEY Fibre™ 288 Fibre Cable - 288-strand	1,418 ft
CRALEY Fibre™ Installation Technique	De-pressurised
CRALEY Fibre™ Installation Parachute - based on reported internal condition & pipe diameter	250mm

Installation Fitting Components Required:	Upper Part	Lower Part
Draw-line Installation Fitting	Type A	Type A
Magnetic Grab & Net Capture Fitting	Type B	Type C
Messenger Pipe™ Installation Fitting	Type C	Type F

Observations/Notes

1. See section "13.3 Project Specific Installation Fittings" on page 60 for an explanation of the installation fitting components
2. See section "9.1 General Chamber Guidelines" on page 50 for information on chamber types
3. See page 57 for more information on parachute sizing
4. All images provided by Madison County
5. Where images have not been provided, a general image representing the location has been generated

Link 14 - Key Data

End A (Site #)	End B (Site #)	Length (ft)	Cumulative Bends (°)	Pipe Material	Pipe Diameter (Inches)	Operating Pressure (psi)	Volume (Gall./Day)	Flow Velocity (ft/s)	Flow Generation	Flow Direction
14	15	991	0	PVC	12	40	678,633	1.34	Pumped	North



Drawing Reference: MD-LEXRD-SL-014		Commercial in Confidence		Date	Name	Position	 ENGINEERING
Rev. No.	Date	Revision Details		Drawn	Checked	Approved	
01	18/11/2020	Final Drawing		Scale	Drawing Name		
				As Shown	Madison County- Lexington Road Project Link 14- Detail		

Product and Installation Requirements	Information
CRALEY Fibre™ Stainless Steel 4" T-Series Vertical Entry Flange Final Fitting	2 units
CRALEY Fibre™ 24/14 Armoured Messenger Pipe	1,126 ft
CRALEY Fibre™ 288 Fibre Cable - 288-strand	1,126 ft
CRALEY Fibre™ Installation Technique	De-pressurised
CRALEY Fibre™ Installation Parachute - based on reported internal condition & pipe diameter	250mm

Installation Fitting Components Required:	Upper Part	Lower Part
Draw-line Installation Fitting	Type A	Type A
Magnetic Grab & Net Capture Fitting	Type B	Type C
Messenger Pipe™ Installation Fitting	Type C	Type F

Site 14 - 2635 Lex Rd - Object ID 492

Latitude (°)	Longitude (°)	Element	Site Access Permit	HASL (ft)	Chamber Type	Chamber Dimensions (X/Y/Z)	Chamber Status	Overall Site Setup	Additional Duct Length (ft)
37.81466	-84.32622	Stop Valve	Landowner	899	C	36/72/48	New	1x Double	-



Site 15 - 2666 Lex Rd - Object ID 494

Latitude (°)	Longitude (°)	Element	Site Access Permit	HASL (ft)	Chamber Type	Chamber Dimensions (X/Y/Z)	Chamber Status	Overall Site Setup	Additional Duct Length (ft)
37.81738	-84.32621	Stop Valve	Landowner	907	C	36/72/48	New	1x Double	-



Observations/Notes
1. See section "13.3 Project Specific Installation Fittings" on page 60 for an explanation of the installation fitting components
2. See section "9.1 General Chamber Guidelines" on page 50 for information on chamber types
3. See page 57 for more information on parachute sizing
4. All images provided by Madison County
5. Where images have not been provided, a general image representing the location has been generated

Link 15 - Key Data

End A (Site #)	End B (Site #)	Length (ft)	Cumulative Bends (°)	Pipe Material	Pipe Diameter (Inches)	Operating Pressure (psi)	Volume (Gall./Day)	Flow Velocity (ft/s)	Flow Generation	Flow Direction
15	16.A	1,938	0	PVC	12	40	678,633	1.34	Pumped	North

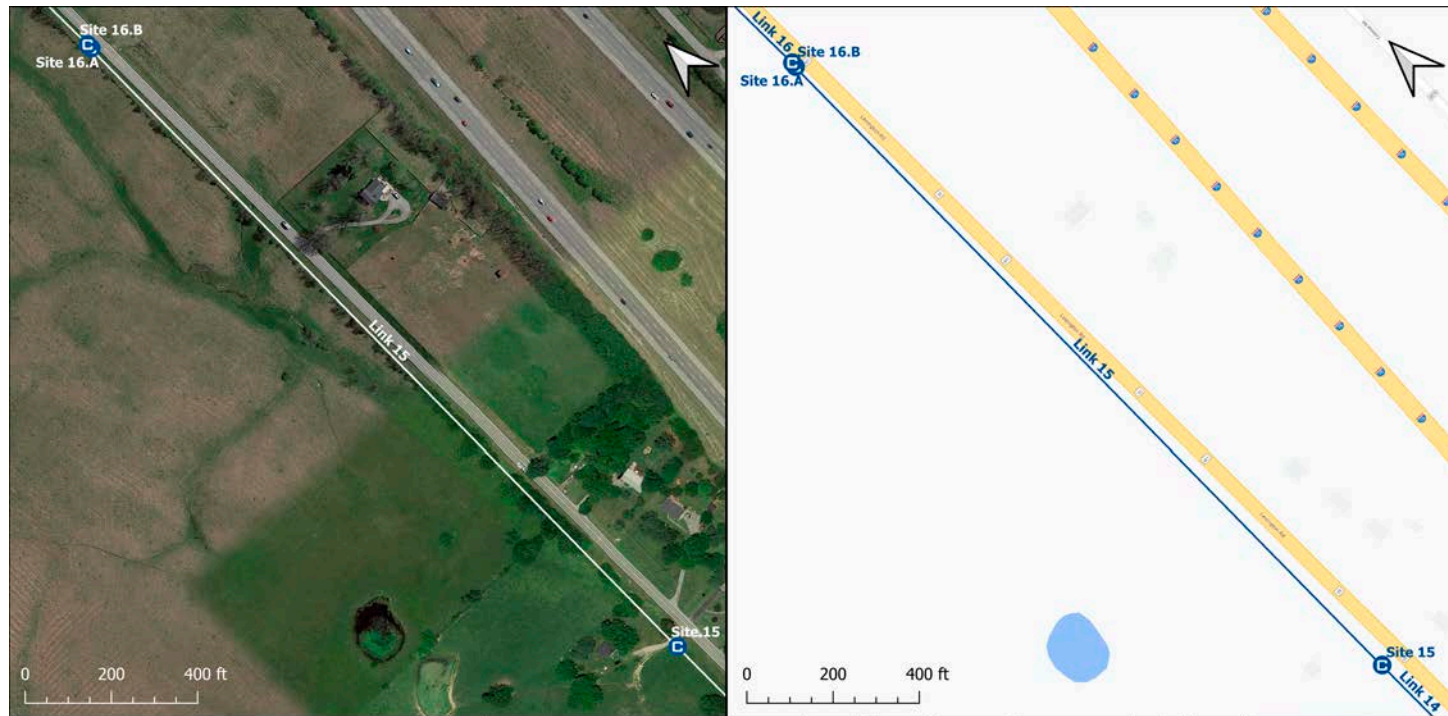

Drawing Reference: MD-LEXRD-SL-015		Commercial in Confidence		Date	Name	Position	CRALEY Making your network smarter
Rev. No.	Date	Revision Details		18/11/2020	Joan Vilaseca i Vila	CD	
01	18/11/2020	Final Drawing		Scale	Drawing Name		ENGINEERING
				As Shown	Madison County - Lexington Road Project Link 15 - Detail		

Site 15 - 2666 Lex Rd - Object ID 494

Latitude (°)	Longitude (°)	Element	Site Access Permit	HASL (ft)	Chamber Type	Chamber Dimensions (X/Y/Z)	Chamber Status	Overall Site Setup	Additional Duct Length (ft)
37.81738	-84.32621	Stop Valve	Landowner	907	C	36/72/48	New	1x Double	-



Site 16.A - 2891 Lex Rd - Object ID 496

Latitude (°)	Longitude (°)	Element	Site Access Permit	HASL (ft)	Chamber Type	Chamber Dimensions (X/Y/Z)	Chamber Status	Overall Site Setup	Additional Duct Length (ft)
37.82271	-84.32615	Stop Valve	Free	939	A	36/36/48	New	2x Single	140



Product and Installation Requirements	Information
CRALEY Fibre™ Stainless Steel 4" T-Series Vertical Entry Flange Final Fitting	2 units
CRALEY Fibre™ 24/14 Armoured Messenger Pipe	2,168 ft
CRALEY Fibre™ 288 Fibre Cable - 288-strand	2,168 ft
CRALEY Fibre™ Installation Technique	De-pressurised
CRALEY Fibre™ Installation Parachute - based on reported internal condition & pipe diameter	250mm

Installation Fitting Components Required:	Upper Part	Lower Part
Draw-line Installation Fitting	Type A	Type A
Magnetic Grab & Net Capture Fitting	Type B	Type C
Messenger Pipe™ Installation Fitting	Type C	Type F

Observations/Notes
1. See section "13.3 Project Specific Installation Fittings" on page 60 for an explanation of the installation fitting components
2. See section "9.1 General Chamber Guidelines" on page 50 for information on chamber types
3. See page 57 for more information on parachute sizing
4. All images provided by Madison County
5. Where images have not been provided, a general image representing the location has been generated

Link 16 - Key Data

End A (Site #)	End B (Site #)	Length (ft)	Cumulative Bends (°)	Pipe Material	Pipe Diameter (Inches)	Operating Pressure (psi)	Volume (Gall./Day)	Flow Velocity (ft/s)	Flow Generation	Flow Direction
16.B	17	672	0	PVC	12	40	678,633	1.34	Pumped	North

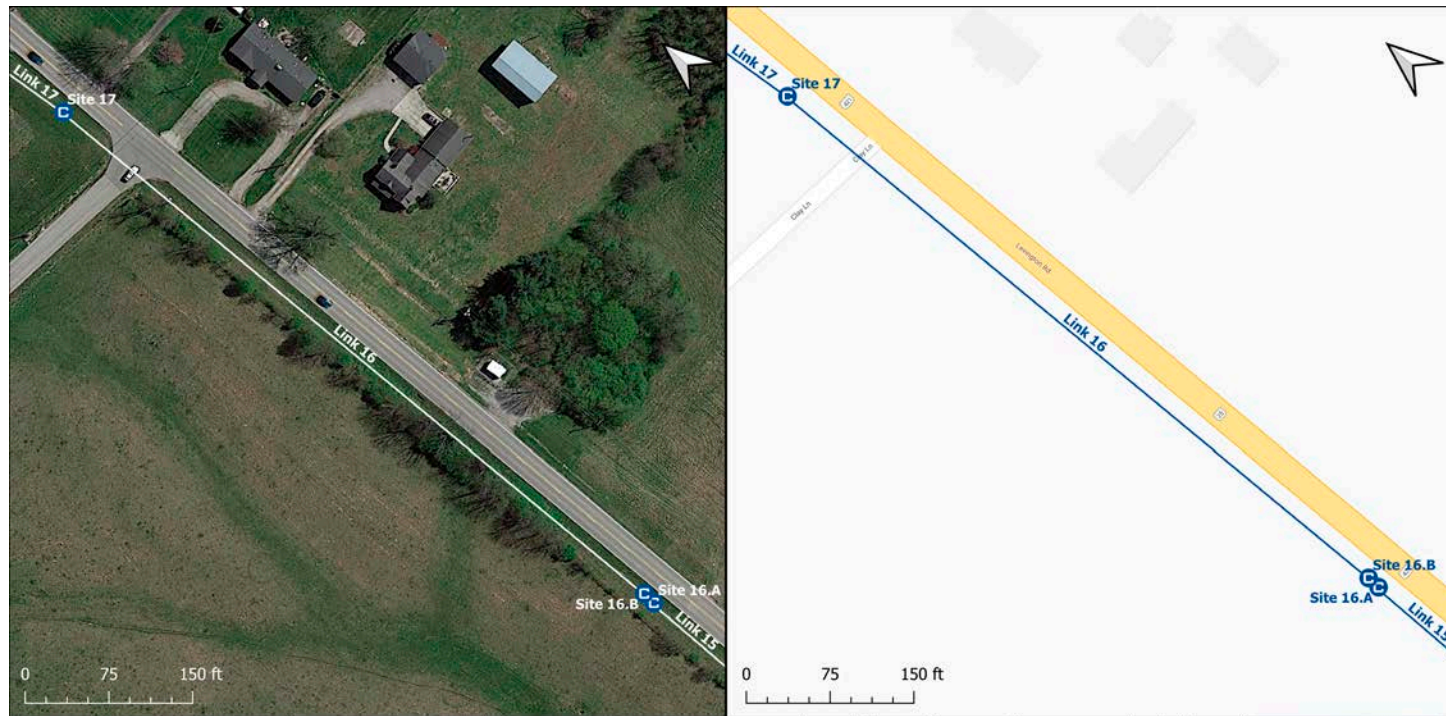

Drawing Reference: MD-LEXRD-SL-016		Commercial in Confidence		Date	Name	Position	 ENGINEERING
Rev. No.	Date	Revision Details		Drawn	Checked	Approved	
01	18/11/2020	Final Drawing		Scale	Drawing Name		
				As Shown	Madison County- Lexington Road Project Link 16- Detail		

Site 16.B - 2891 Lex Rd - Object ID 496

Latitude (°)	Longitude (°)	Element	Site Access Permit	HASL (ft)	Chamber Type	Chamber Dimensions (X/Y/Z)	Chamber Status	Overall Site Setup	Additional Duct Length (ft)
37.82271	-84.32615	Stop Valve	Free	939	A	36/36/48	New	2x Single	140



Site 17 - 2905 Lex Rd - Object ID 502

Latitude (°)	Longitude (°)	Element	Site Access Permit	HASL (ft)	Chamber Type	Chamber Dimensions (X/Y/Z)	Chamber Status	Overall Site Setup	Additional Duct Length (ft)
37.82457	-84.32616	Stop Valve	Landowner	962	C	36/72/48	New	1x Double	-



Product and Installation Requirements	Information
CRALEY Fibre™ Stainless Steel 4" T-Series Vertical Entry Flange Final Fitting	2 units
CRALEY Fibre™ 24/14 Armoured Messenger Pipe	930 ft
CRALEY Fibre™ 288 Fibre Cable - 288-strand	930 ft
CRALEY Fibre™ Installation Technique	De-pressurised
CRALEY Fibre™ Installation Parachute - based on reported internal condition & pipe diameter	250mm

Installation Fitting Components Required:	Upper Part	Lower Part
Draw-line Installation Fitting	Type A	Type A
Magnetic Grab & Net Capture Fitting	Type B	Type C
Messenger Pipe™ Installation Fitting	Type C	Type F

Observations/Notes
1. See section "13.3 Project Specific Installation Fittings" on page 60 for an explanation of the installation fitting components
2. See section "9.1 General Chamber Guidelines" on page 50 for information on chamber types
3. See page 57 for more information on parachute sizing
4. All images provided by Madison County
5. Where images have not been provided, a general image representing the location has been generated

Link 17 - Key Data

End A (Site #)	End B (Site #)	Length (ft)	Cumulative Bends (°)	Pipe Material	Pipe Diameter (Inches)	Operating Pressure (psi)	Volume (Gall./Day)	Flow Velocity (ft/s)	Flow Generation	Flow Direction
17	18	3,674	40	PVC	12	86	646,317	1.28	Pumped	North

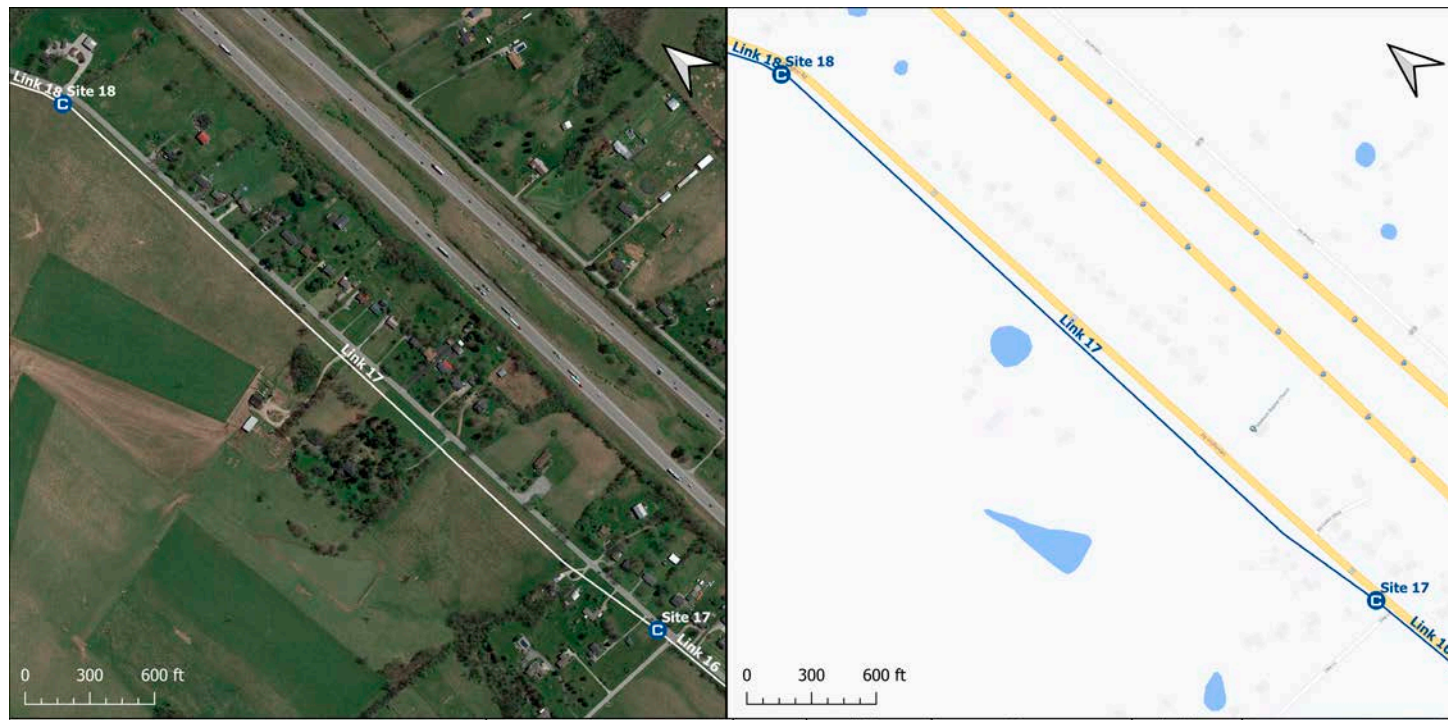

Drawing Reference: MD-LEXRD-SL-017		Commercial in Confidence		Date	Name	Position	CRALEY Making your network smarter
Rev. No.	Date	Revision Details		Drawn	Checked	Approved	
01	18/11/2020	Final Drawing		Scale	Drawing Name		ENGINEERING
				As Shown	Madison County - Lexington Road Project Link 17 - Detail		

Site 17 - 2905 Lex Rd - Object ID 502

Latitude (°)	Longitude (°)	Element	Site Access Permit	HASL (ft)	Chamber Type	Chamber Dimensions (X/Y/Z)	Chamber Status	Overall Site Setup	Additional Duct Length (ft)
37.82457	-84.32616	Stop Valve	Landowner	962	C	36/72/48	New	1x Double	-



Site 18 -

Latitude (°)	Longitude (°)	Element	Site Access Permit	HASL (ft)	Chamber Type	Chamber Dimensions (X/Y/Z)	Chamber Status	Overall Site Setup	Additional Duct Length (ft)
37.834637	-84.32584	None	Landowner	970	B	36/72/48	New	1x Double	-



Product and Installation Requirements	Information
CRALEY Fibre™ Stainless Steel 4" T-Series Vertical Entry Flange Final Fitting	2 units
CRALEY Fibre™ 24/14 Armoured Messenger Pipe	4,078 ft
CRALEY Fibre™ 288 Fibre Cable - 288-strand	4,078 ft
CRALEY Fibre™ Installation Technique	De-pressurised
CRALEY Fibre™ Installation Parachute - based on reported internal condition & pipe diameter	250mm

Installation Fitting Components Required:	Upper Part	Lower Part
Draw-line Installation Fitting	Type A	Type A
Magnetic Grab & Net Capture Fitting	Type B	Type C
Messenger Pipe™ Installation Fitting	Type C	Type F

Observations/Notes
1. See section "13.3 Project Specific Installation Fittings" on page 60 for an explanation of the installation fitting components
2. See section "9.1 General Chamber Guidelines" on page 50 for information on chamber types
3. See page 57 for more information on parachute sizing
4. All images provided by Madison County
5. Where images have not been provided, a general image representing the location has been generated

Link 18 - Key Data

End A (Site #)	End B (Site #)	Length (ft)	Cumulative Bends (°)	Pipe Material	Pipe Diameter (Inches)	Operating Pressure (psi)	Volume (Gall./Day)	Flow Velocity (ft/s)	Flow Generation	Flow Direction
18	19.A	988	125	PVC	12	86	646,317	1.28	Pumped	North



Drawing Reference: MD-LEXRD-SL-018		Commercial in Confidence		Date	Name	Position	
Rev. No.	Date	Revision Details		Drawn	Checked	Approved	
01	18/11/2020	Final Drawing		Scale	Drawing Name		
				As Shown	Madison County- Lexington Road Project Link 18- Detail		ENGINEERING

Site 18 -

Latitude (°)	Longitude (°)	Element	Site Access Permit	HASL (ft)	Chamber Type	Chamber Dimensions (X/Y/Z)	Chamber Status	Overall Site Setup	Additional Duct Length (ft)
37.834637	-84.32584	None	Landowner	970	B	36/72/48	New	1x Double	-



Site 19.A - 3085 Lex Rd - Object ID 505

Latitude (°)	Longitude (°)	Element	Site Access Permit	HASL (ft)	Chamber Type	Chamber Dimensions (X/Y/Z)	Chamber Status	Overall Site Setup	Additional Duct Length (ft)
37.837005	-84.32662	Stop Valve	Landowner	989	A	36/36/48	New	2x Single	100



Product and Installation Requirements	Information
CRALEY Fibre™ Stainless Steel 4" T-Series Vertical Entry Flange Final Fitting	2 units
CRALEY Fibre™ 24/14 Armoured Messenger Pipe	1,233 ft
CRALEY Fibre™ 288 Fibre Cable - 288-strand	1,233 ft
CRALEY Fibre™ Installation Technique	De-pressurised
CRALEY Fibre™ Installation Parachute - based on reported internal condition & pipe diameter	250mm

Installation Fitting Components Required:	Upper Part	Lower Part
Draw-line Installation Fitting	Type A	Type A
Magnetic Grab & Net Capture Fitting	Type B	Type C
Messenger Pipe™ Installation Fitting	Type C	Type F

Observations/Notes
1. See section "13.3 Project Specific Installation Fittings" on page 60 for an explanation of the installation fitting components
2. See section "9.1 General Chamber Guidelines" on page 50 for information on chamber types
3. See page 57 for more information on parachute sizing
4. All images provided by Madison County
5. Where images have not been provided, a general image representing the location has been generated

Link 19 - Key Data

End A (Site #)	End B (Site #)	Length (ft)	Cumulative Bends (°)	Pipe Material	Pipe Diameter (Inches)	Operating Pressure (psi)	Volume (Gall./Day)	Flow Velocity (ft/s)	Flow Generation	Flow Direction
19.B	20.A	632	0	PVC	12	86	646,317	1.28	Pumped	North



Drawing Reference: MD-LEXRD-SL-019		Commercial in Confidence		Date	Name	Position	
Rev. No.	Date	Revision Details		Drawn	Checked	Approved	
01	18/11/2020	Final Drawing		Scale	Drawing Name		
				As Shown	Madison County - Lexington Road Project Link 19 - Detail		

Site 19.B - 3085 Lex Rd - Object ID 505

Latitude (°)	Longitude (°)	Element	Site Access Permit	HASL (ft)	Chamber Type	Chamber Dimensions (X/Y/Z)	Chamber Status	Overall Site Setup	Additional Duct Length (ft)
37.837301	-84.32674	Stop Valve	Landowner	989	A	36/36/48	New	2x Single	100



Site 20.A - 3102 Lex Rd - Object ID 3054

Latitude (°)	Longitude (°)	Element	Site Access Permit	HASL (ft)	Chamber Type	Chamber Dimensions (X/Y/Z)	Chamber Status	Overall Site Setup	Additional Duct Length (ft)
37.83896	-84.32747	Stop Valve	Landowner	955	A	36/36/48	New	2x Single	100



Product and Installation Requirements	Information
CRALEY Fibre™ Stainless Steel 4" T-Series Vertical Entry Flange Final Fitting	2 units
CRALEY Fibre™ 24/14 Armoured Messenger Pipe	842 ft
CRALEY Fibre™ 288 Fibre Cable - 288-strand	842 ft
CRALEY Fibre™ Installation Technique	De-pressurised
CRALEY Fibre™ Installation Parachute - based on reported internal condition & pipe diameter	250mm

Installation Fitting Components Required:	Upper Part	Lower Part
Draw-line Installation Fitting	Type A	Type A
Magnetic Grab & Net Capture Fitting	Type B	Type C
Messenger Pipe™ Installation Fitting	Type C	Type F

Observations/Notes
1. See section "13.3 Project Specific Installation Fittings" on page 60 for an explanation of the installation fitting components
2. See section "9.1 General Chamber Guidelines" on page 50 for information on chamber types
3. See page 57 for more information on parachute sizing
4. All images provided by Madison County
5. Where images have not been provided, a general image representing the location has been generated

Link 20 - Key Data

End A (Site #)	End B (Site #)	Length (ft)	Cumulative Bends (°)	Pipe Material	Pipe Diameter (Inches)	Operating Pressure (psi)	Volume (Gall./Day)	Flow Velocity (ft/s)	Flow Generation	Flow Direction
20.B	21.A	1,340	0	PVC	8	86	646,317	2.87	Pumped	North

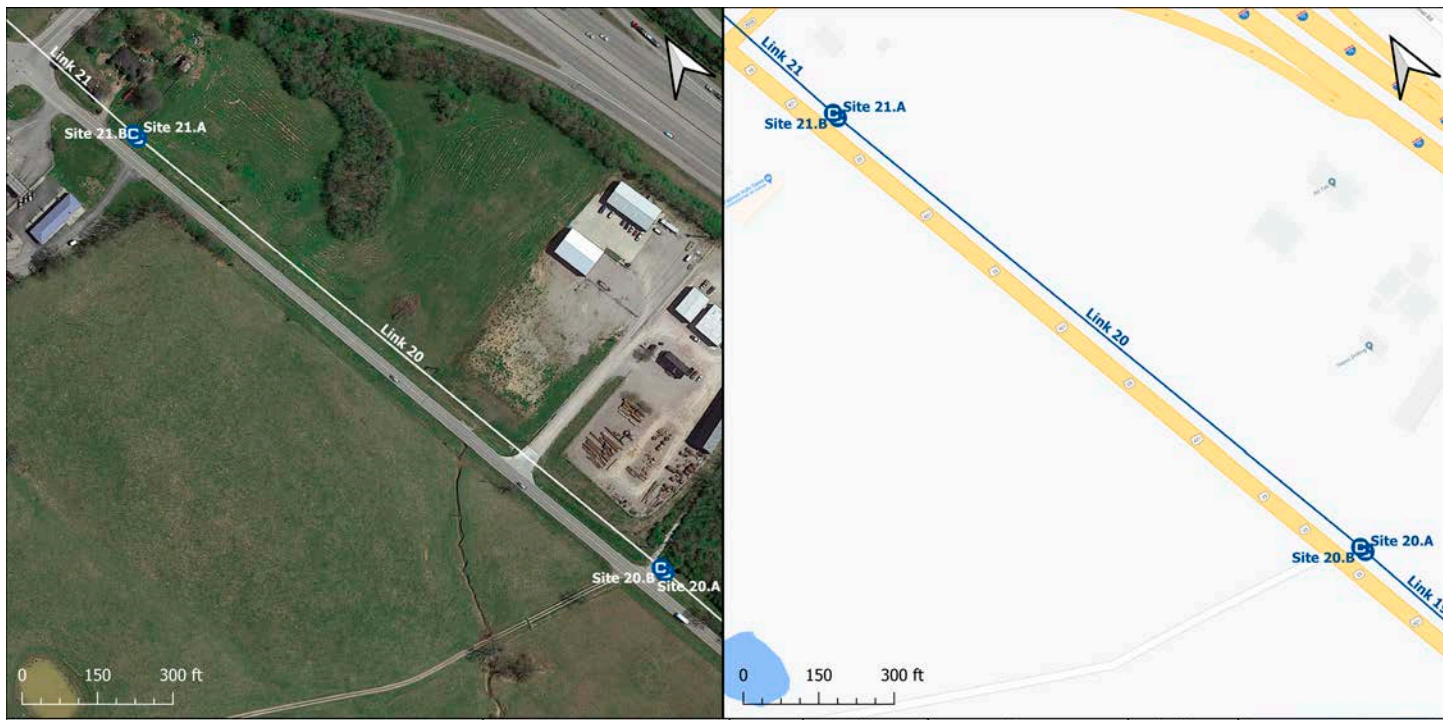

Drawing Reference: MD-LEXRD-SL-020		Commercial in Confidence		Date	Name	Position	
Rev. No.	Date	Revision Details		Drawn	Checked	Approved	
01	18/11/2020	Final Drawing		Scale	Drawing Name		
				As Shown	Madison County- Lexington Road Project Link 20- Detail		ENGINEERING

Product and Installation Requirements	Information
CRALEY Fibre™ Stainless Steel 4" T-Series Vertical Entry Flange Final Fitting	2 units
CRALEY Fibre™ 24/14 Armoured Messenger Pipe	1,576 ft
CRALEY Fibre™ 288 Fibre Cable - 288-strand	1,576 ft
CRALEY Fibre™ Installation Technique	De-pressurised
CRALEY Fibre™ Installation Parachute - based on reported internal condition & pipe diameter	150mm

Installation Fitting Components Required:	Upper Part	Lower Part
Draw-line Installation Fitting	Type A	Type A
Magnetic Grab & Net Capture Fitting	Type B	Type B
Messenger Pipe™ Installation Fitting	Type C	Type D

Site 20.B - 3102 Lex Rd - Object ID 3054

Latitude (°)	Longitude (°)	Element	Site Access Permit	HASL (ft)	Chamber Type	Chamber Dimensions (X/Y/Z)	Chamber Status	Overall Site Setup	Additional Duct Length (ft)
37.83896	-84.32747	Stop Valve	Landowner	955	A	36/36/48	New	2x Single	100



Site 21.A - 3197 Lex Rd - Object ID 3520

Latitude (°)	Longitude (°)	Element	Site Access Permit	HASL (ft)	Chamber Type	Chamber Dimensions (X/Y/Z)	Chamber Status	Overall Site Setup	Additional Duct Length (ft)
37.84242	-84.32912	Stop Valve	Landowner	960	A	36/36/48	New	2x Single	60



Observations/Notes

1. See section "13.3 Project Specific Installation Fittings" on page 60 for an explanation of the installation fitting components
2. See section "9.1 General Chamber Guidelines" on page 50 for information on chamber types
3. See page 57 for more information on parachute sizing
4. All images provided by Madison County
5. Where images have not been provided, a general image representing the location has been generated

Link 21 - Key Data

End A (Site #)	End B (Site #)	Length (ft)	Cumulative Bends (°)	Pipe Material	Pipe Diameter (Inches)	Operating Pressure (psi)	Volume (Gall./Day)	Flow Velocity (ft/s)	Flow Generation	Flow Direction
21.B	22.A	562	90	PVC	10	86	646,317	1.84	Pumped	North

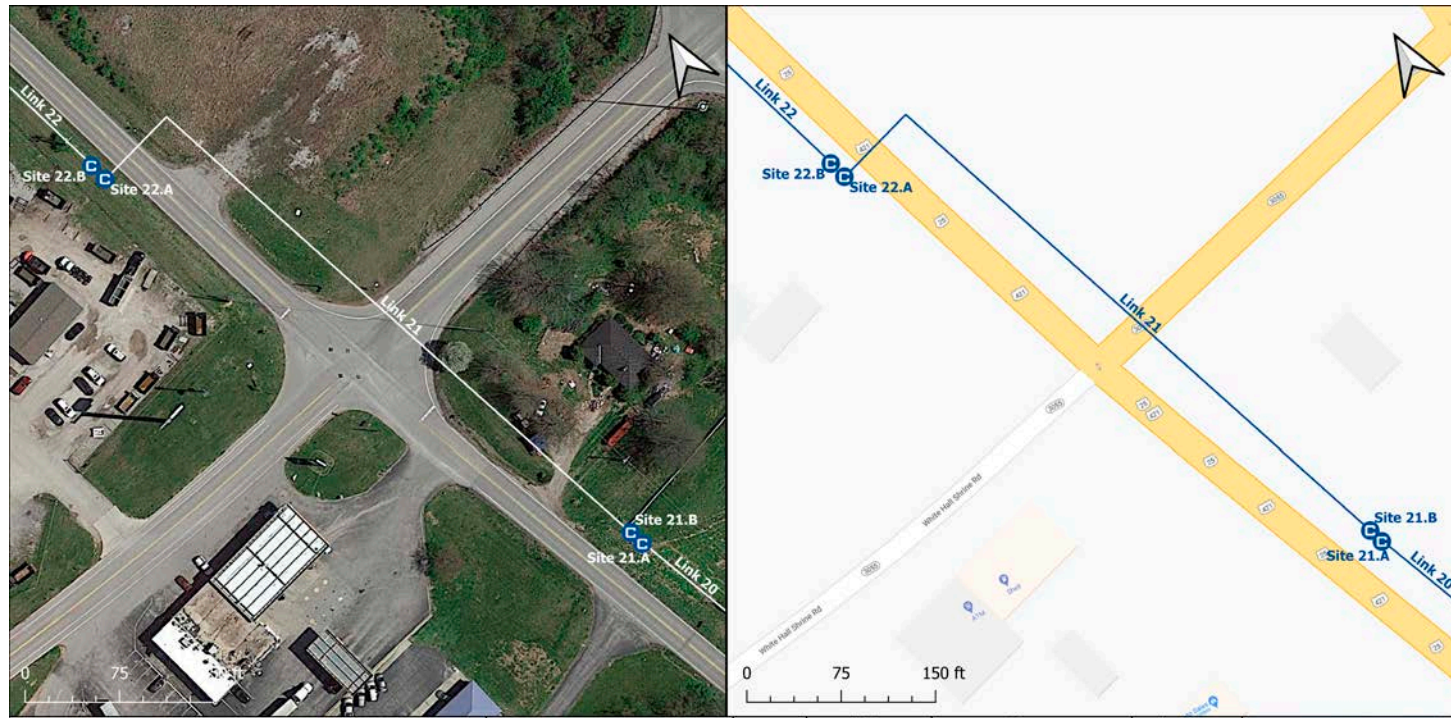

Drawing Reference: MD-LEXRD-SL-021		Commercial in Confidence		Date	Name	Position	CRALEY Making your network smarter
Rev. No.	Date	Revision Details		Drawn	Checked	Approved	
01	18/11/2020	Final Drawing		Scale	Drawing Name		ENGINEERING
				As Shown	Madison County - Lexington Road Project Link 21 - Detail		

Site 21.B - 3197 Lex Rd - Object ID 3520

Latitude (°)	Longitude (°)	Element	Site Access Permit	HASL (ft)	Chamber Type	Chamber Dimensions (X/Y/Z)	Chamber Status	Overall Site Setup	Additional Duct Length (ft)
37.84242	-84.32912	Stop Valve	Landowner	960	A	36/36/48	New	2x Single	60

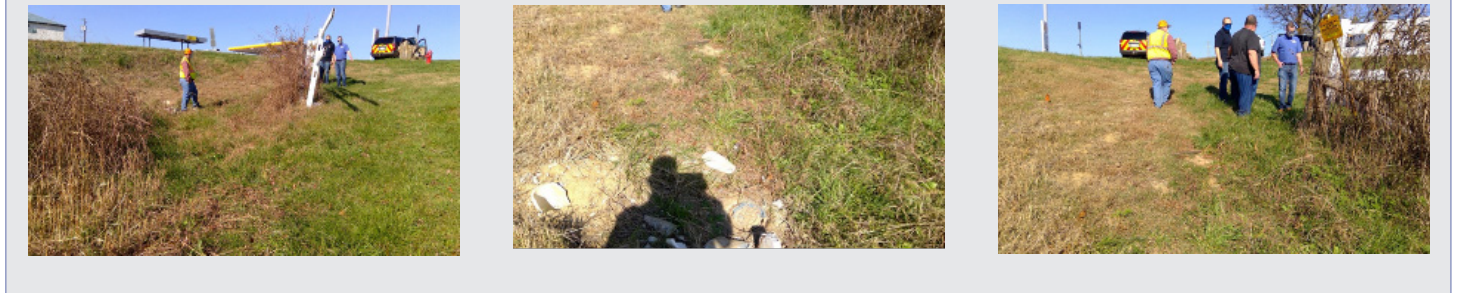

Site 22.A - 106 White Hall Shrine Rd - Object ID 3523

Latitude (°)	Longitude (°)	Element	Site Access Permit	HASL (ft)	Chamber Type	Chamber Dimensions (X/Y/Z)	Chamber Status	Overall Site Setup	Additional Duct Length (ft)
37.84369	-84.3299	Stop Valve	Landowner	970	A	36/36/48	New	2x Single	25



Product and Installation Requirements	Information
CRALEY Fibre™ Stainless Steel 4" T-Series Vertical Entry Flange Final Fitting	2 units
CRALEY Fibre™ 24/14 Armoured Messenger Pipe	682 ft
CRALEY Fibre™ 288 Fibre Cable - 288-strand	682 ft
CRALEY Fibre™ Installation Technique	De-pressurised
CRALEY Fibre™ Installation Parachute - based on reported internal condition & pipe diameter	225mm

Installation Fitting Components Required:	Upper Part	Lower Part
Draw-line Installation Fitting	Type A	Type A
Magnetic Grab & Net Capture Fitting	Type B	Type C
Messenger Pipe™ Installation Fitting	Type C	Type E

Observations/Notes
1. See section "13.3 Project Specific Installation Fittings" on page 60 for an explanation of the installation fitting components
2. See section "9.1 General Chamber Guidelines" on page 50 for information on chamber types
3. See page 57 for more information on parachute sizing
4. All images provided by Madison County
5. Where images have not been provided, a general image representing the location has been generated

Link 22 - Key Data

End A (Site #)	End B (Site #)	Length (ft)	Cumulative Bends (°)	Pipe Material	Pipe Diameter (Inches)	Operating Pressure (psi)	Volume (Gall./Day)	Flow Velocity (ft/s)	Flow Generation	Flow Direction
22.B	23	1,783	0	PVC	10	86	646,317	1.84	Pumped	North

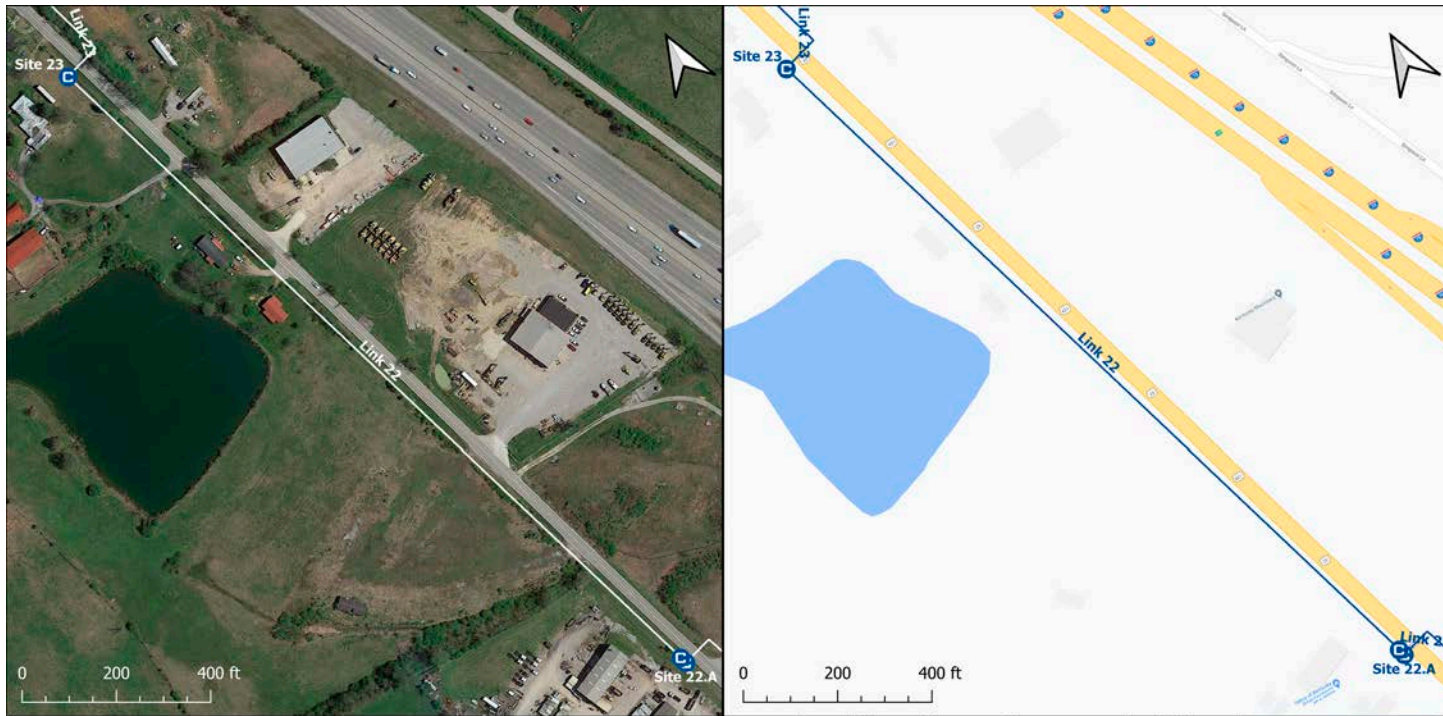

Drawing Reference: MD-LEXRD-SL-022		Commercial in Confidence		Date	Name	Position	 ENGINEERING
Rev. No.	Date	Revision Details		Drawn	Checked	Approved	
01	18/11/2020	Final Drawing		Scale	Drawing Name		
				As Shown	Madison County- Lexington Road Project Link 22- Detail		

Site 22.B - 106 White Hall Shrine Rd - Object ID 3523

Latitude (°)	Longitude (°)	Element	Site Access Permit	HASL (ft)	Chamber Type	Chamber Dimensions (X/Y/Z)	Chamber Status	Overall Site Setup	Additional Duct Length (ft)
37.84369	-84.3299	Stop Valve	Landowner	970	A	36/36/48	New	2x Single	25

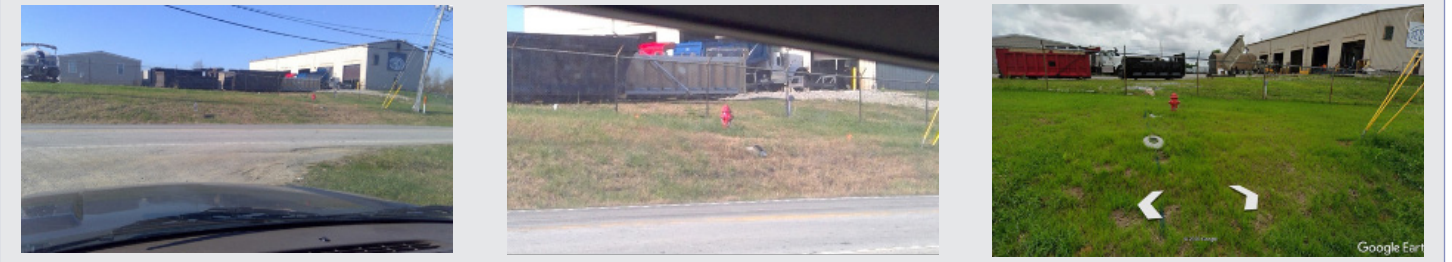

Site 23 -

Latitude (°)	Longitude (°)	Element	Site Access Permit	HASL (ft)	Chamber Type	Chamber Dimensions (X/Y/Z)	Chamber Status	Overall Site Setup	Additional Duct Length (ft)
37.84842	-84.33168	90°-elbow	Landowner	980	F	36/72/48	New	1x Double	-



Product and Installation Requirements	Information
CRALEY Fibre™ Stainless Steel 4" T-Series Vertical Entry Flange Final Fitting	2 units
CRALEY Fibre™ 24/14 Armoured Messenger Pipe	1,998 ft
CRALEY Fibre™ 288 Fibre Cable - 288-strand	1,998 ft
CRALEY Fibre™ Installation Technique	De-pressurised
CRALEY Fibre™ Installation Parachute - based on reported internal condition & pipe diameter	225mm

Installation Fitting Components Required:	Upper Part	Lower Part
Draw-line Installation Fitting	Type A	Type A
Magnetic Grab & Net Capture Fitting	Type B	Type C
Messenger Pipe™ Installation Fitting	Type C	Type E

Observations/Notes
1. See section "13.3 Project Specific Installation Fittings" on page 60 for an explanation of the installation fitting components
2. See section "9.1 General Chamber Guidelines" on page 50 for information on chamber types
3. See page 57 for more information on parachute sizing
4. All images provided by Madison County
5. Where images have not been provided, a general image representing the location has been generated

Link 23 - Key Data

End A (Site #)	End B (Site #)	Length (ft)	Cumulative Bends (°)	Pipe Material	Pipe Diameter (Inches)	Operating Pressure (psi)	Volume (Gall./Day)	Flow Velocity (ft/s)	Flow Generation	Flow Direction
23	24.A	274	90	PVC	10	86	646,317	1.84	Pumped	North

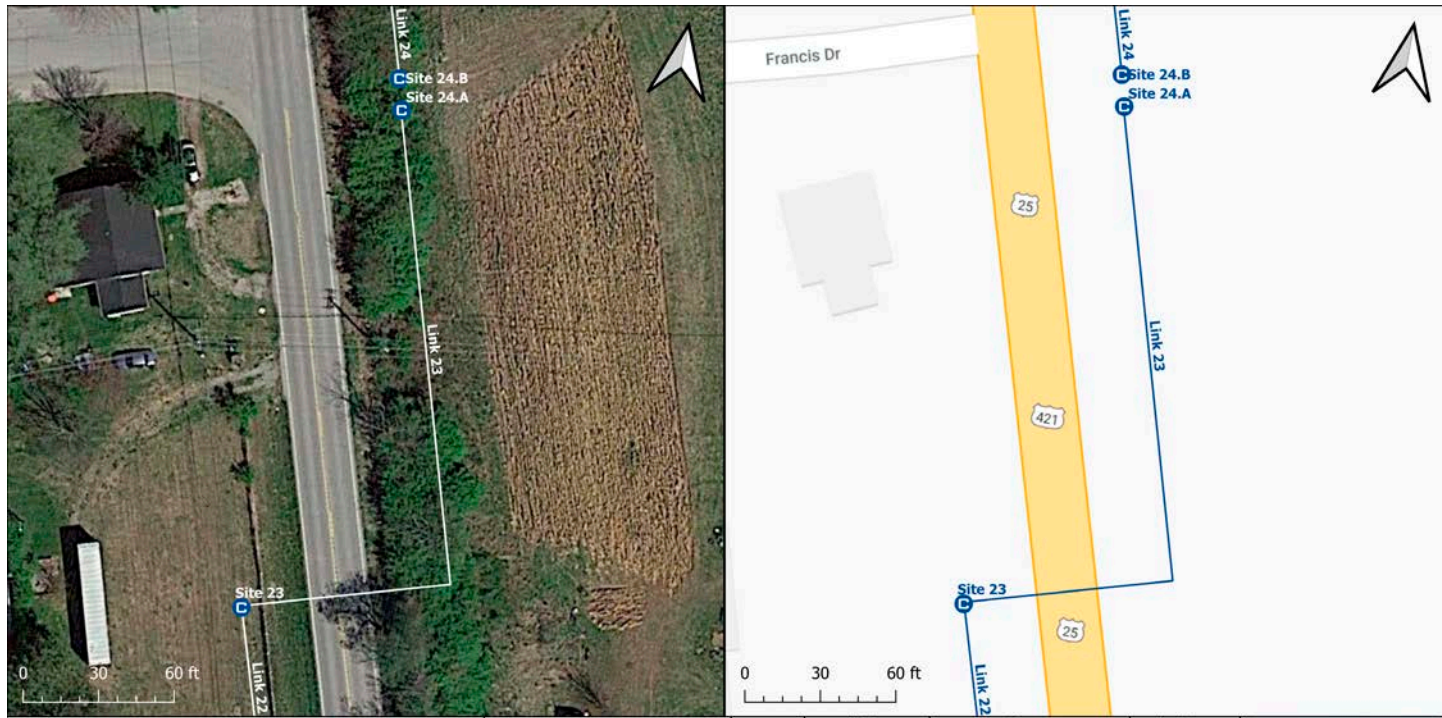

Drawing Reference: MD-LEXRD-SL-023		Commercial in Confidence		Date	Name	Position	 ENGINEERING
Rev. No.	Date	Revision Details		Drawn	Checked	Approved	
01	18/11/2020	Final Drawing		Scale	Drawing Name		
				As Shown	Madison County- Lexington Road Project Link 23- Detail		

Site 23 -

Latitude (°)	Longitude (°)	Element	Site Access Permit	HASL (ft)	Chamber Type	Chamber Dimensions (X/Y/Z)	Chamber Status	Overall Site Setup	Additional Duct Length (ft)
37.84842	-84.33168	90°-elbow	Landowner	980	F	36/72/48	New	1x Double	-



Site 24A - 3300 Lex Rd - Object ID 512

Latitude (°)	Longitude (°)	Element	Site Access Permit	HASL (ft)	Chamber Type	Chamber Dimensions (X/Y/Z)	Chamber Status	Overall Site Setup	Additional Duct Length (ft)
37.84899	-84.3316	Stop Valve	Landowner	991	A	36/36/48	New	2x Single	10



Product and Installation Requirements	Information
CRALEY Fibre™ Stainless Steel 4" T-Series Vertical Entry Flange Final Fitting	2 units
CRALEY Fibre™ 24/14 Armoured Messenger Pipe	349 ft
CRALEY Fibre™ 288 Fibre Cable - 288-strand	349 ft
CRALEY Fibre™ Installation Technique	De-pressurised
CRALEY Fibre™ Installation Parachute - based on reported internal condition & pipe diameter	225mm

Installation Fitting Components Required:	Upper Part	Lower Part
Draw-line Installation Fitting	Type A	Type A
Magnetic Grab & Net Capture Fitting	Type B	Type C
Messenger Pipe™ Installation Fitting	Type C	Type E

Observations/Notes
1. See section "13.3 Project Specific Installation Fittings" on page 60 for an explanation of the installation fitting components
2. See section "9.1 General Chamber Guidelines" on page 50 for information on chamber types
3. See page 57 for more information on parachute sizing
4. All images provided by Madison County
5. Where images have not been provided, a general image representing the location has been generated

Link 24 - Key Data

End A (Site #)	End B (Site #)	Length (ft)	Cumulative Bends (°)	Pipe Material	Pipe Diameter (Inches)	Operating Pressure (psi)	Volume (Gall./Day)	Flow Velocity (ft/s)	Flow Generation	Flow Direction
24.B	25	337	0	PVC	8	86	646,317	2.87	Pumped	North

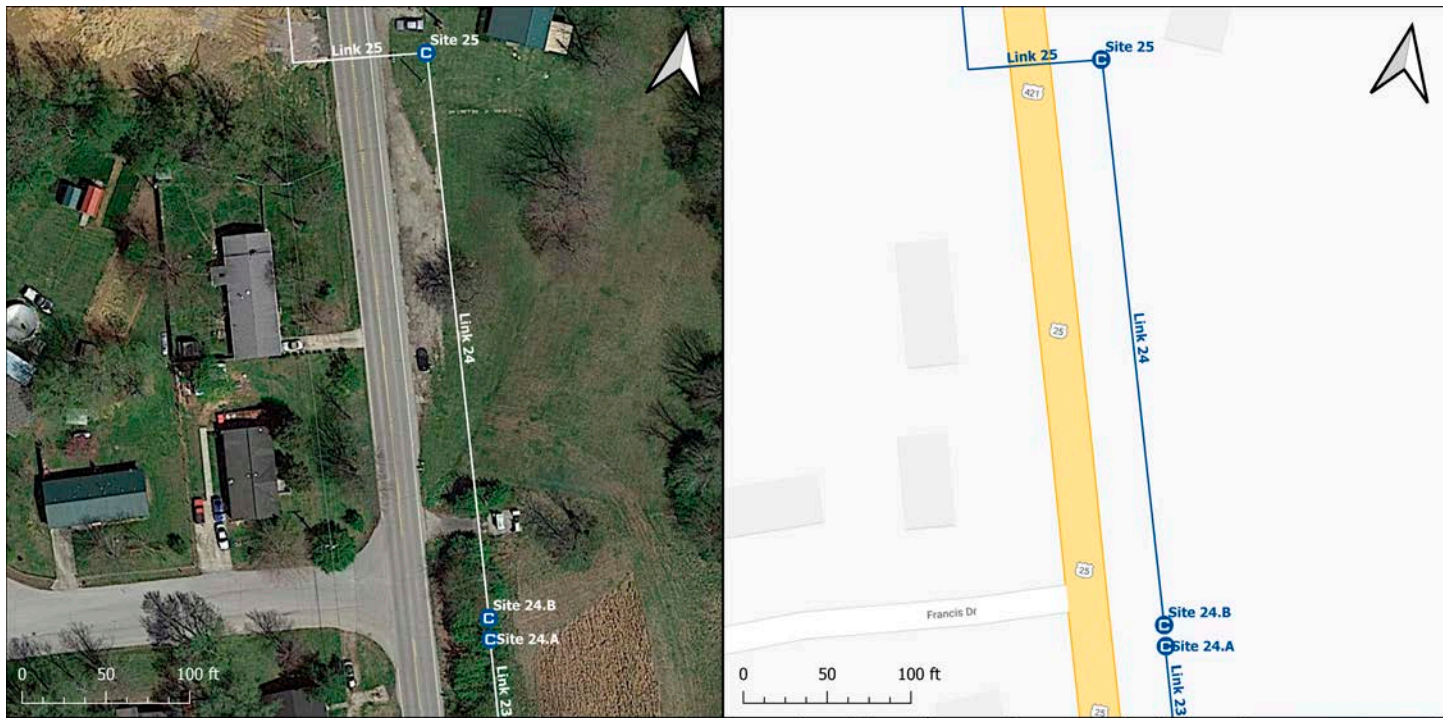

Drawing Reference: MD-LEXRD-SL-024		Commercial in Confidence		Date	Name	Position	 ENGINEERING
Rev. No.	Date	Revision Details		Drawn	Checked	Approved	
01	18/11/2020	Final Drawing		Scale	Drawing Name		
				As Shown	Madison County- Lexington Road Project Link 24- Detail		

Product and Installation Requirements	Information
CRALEY Fibre™ Stainless Steel 4" T-Series Vertical Entry Flange Final Fitting	2 units
CRALEY Fibre™ 24/14 Armoured Messenger Pipe	407 ft
CRALEY Fibre™ 288 Fibre Cable - 288-strand	407 ft
CRALEY Fibre™ Installation Technique	De-pressurised
CRALEY Fibre™ Installation Parachute - based on reported internal condition & pipe diameter	150mm

Installation Fitting Components Required:	Upper Part	Lower Part
Draw-line Installation Fitting	Type A	Type A
Magnetic Grab & Net Capture Fitting	Type B	Type B
Messenger Pipe™ Installation Fitting	Type C	Type D

Site 24B - 3300 Lex Rd - Object ID 512

Latitude (°)	Longitude (°)	Element	Site Access Permit	HASL (ft)	Chamber Type	Chamber Dimensions (X/Y/Z)	Chamber Status	Overall Site Setup	Additional Duct Length (ft)
37.84899	-84.3316	Stop Valve	Landowner	991	A	36/36/48	New	2x Single	10



Site 25 -

Latitude (°)	Longitude (°)	Element	Site Access Permit	HASL (ft)	Chamber Type	Chamber Dimensions (X/Y/Z)	Chamber Status	Overall Site Setup	Additional Duct Length (ft)
37.849905	-84.33193	90°-elbow	Landowner	986	F	36/72/48	New	1x Double	-



Observations/Notes
1. See section "13.3 Project Specific Installation Fittings" on page 60 for an explanation of the installation fitting components
2. See section "9.1 General Chamber Guidelines" on page 50 for information on chamber types
3. See page 57 for more information on parachute sizing
4. All images provided by Madison County
5. Where images have not been provided, a general image representing the location has been generated

Link 25 - Key Data

End A (Site #)	End B (Site #)	Length (ft)	Cumulative Bends (°)	Pipe Material	Pipe Diameter (Inches)	Operating Pressure (psi)	Volume (Gall./Day)	Flow Velocity (ft/s)	Flow Generation	Flow Direction
25	26.A	356	90	PVC	8	86	646,317	2.87	Pumped	North

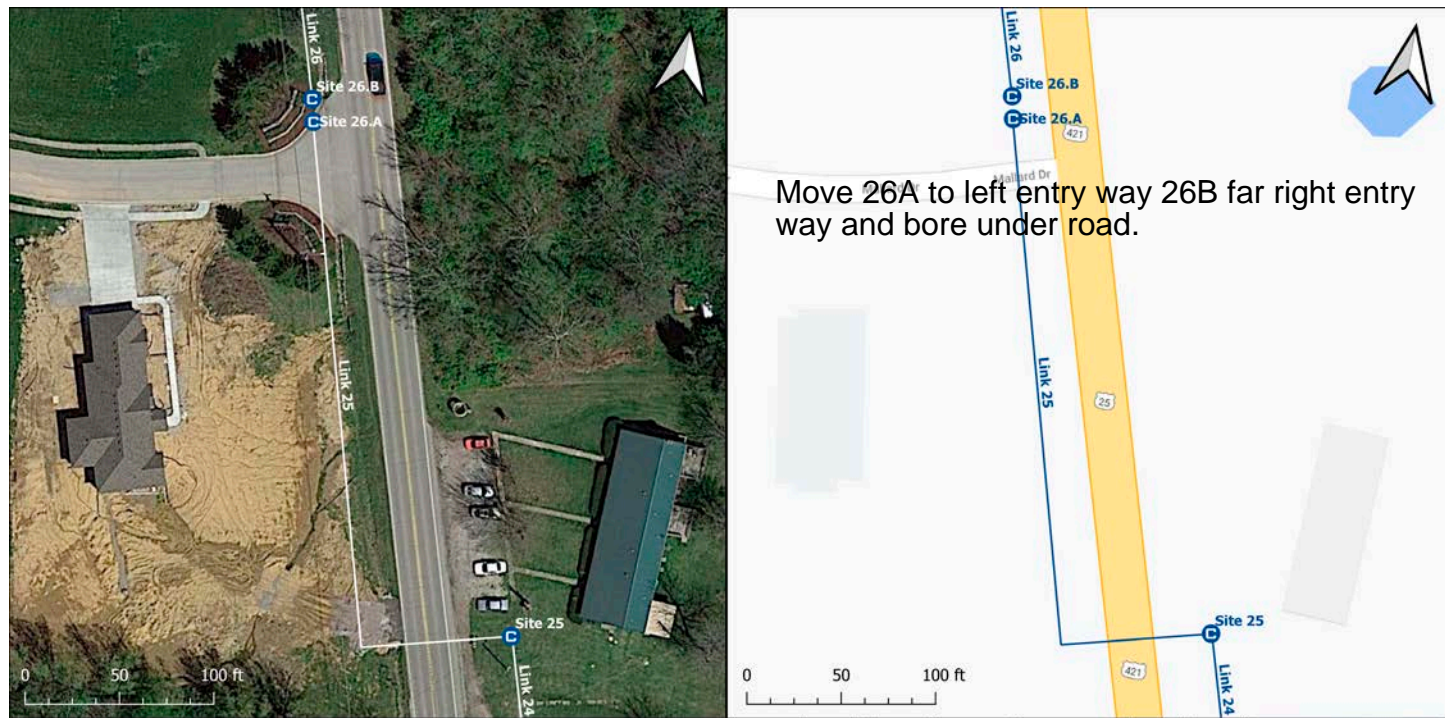

Drawing Reference: MD-LEXRD-SL-025		Commercial in Confidence		Date	Name	Position	 ENGINEERING
Rev. No.	Date	Revision Details		Drawn	Checked	Approved	
01	18/11/2020	Final Drawing		Scale	Drawing Name		
				As Shown	Madison County - Lexington Road Project Link 25 - Detail		

Site 25 -

Latitude (°)	Longitude (°)	Element	Site Access Permit	HASL (ft)	Chamber Type	Chamber Dimensions (X/Y/Z)	Chamber Status	Overall Site Setup	Additional Duct Length (ft)
37.849905	-84.33193	90°-elbow	Landowner	986	F	36/72/48	New	1x Double	-



Site 26.A - Entrance Shilo Crest - Object ID 975

Latitude (°)	Longitude (°)	Element	Site Access Permit	HASL (ft)	Chamber Type	Chamber Dimensions (X/Y/Z)	Chamber Status	Overall Site Setup	Additional Duct Length (ft)
37.8506	-84.33245	Stop Valve	Landowner	982	A	36/36/48	New	2x Single	10



Product and Installation Requirements	Information
CRALEY Fibre™ Stainless Steel 4" T-Series Vertical Entry Flange Final Fitting	2 units
CRALEY Fibre™ 24/14 Armoured Messenger Pipe	439 ft
CRALEY Fibre™ 288 Fibre Cable - 288-strand	439 ft
CRALEY Fibre™ Installation Technique	De-pressurised
CRALEY Fibre™ Installation Parachute - based on reported internal condition & pipe diameter	150mm

Installation Fitting Components Required:	Upper Part	Lower Part
Draw-line Installation Fitting	Type A	Type A
Magnetic Grab & Net Capture Fitting	Type B	Type B
Messenger Pipe™ Installation Fitting	Type C	Type D

Observations/Notes

1. See section "13.3 Project Specific Installation Fittings" on page 60 for an explanation of the installation fitting components
2. See section "9.1 General Chamber Guidelines" on page 50 for information on chamber types
3. See page 57 for more information on parachute sizing
4. All images provided by Madison County
5. Where images have not been provided, a general image representing the location has been generated

Link 26 - Key Data

End A (Site #)	End B (Site #)	Length (ft)	Cumulative Bends (°)	Pipe Material	Pipe Diameter (Inches)	Operating Pressure (psi)	Volume (Gall./Day)	Flow Velocity (ft/s)	Flow Generation	Flow Direction
26.B	27.A	1,058	30	PVC	8	86	646,317	2.87	Pumped	North

Site 26.B - Entrence Shilo Crest - Object ID 975

Latitude (°)	Longitude (°)	Element	Site Access Permit	HASL (ft)	Chamber Type	Chamber Dimensions (X/Y/Z)	Chamber Status	Overall Site Setup	Additional Duct Length (ft)
37.8506	-84.33245	Stop Valve	Landowner	982	A	36/36/48	New	2x Single	10

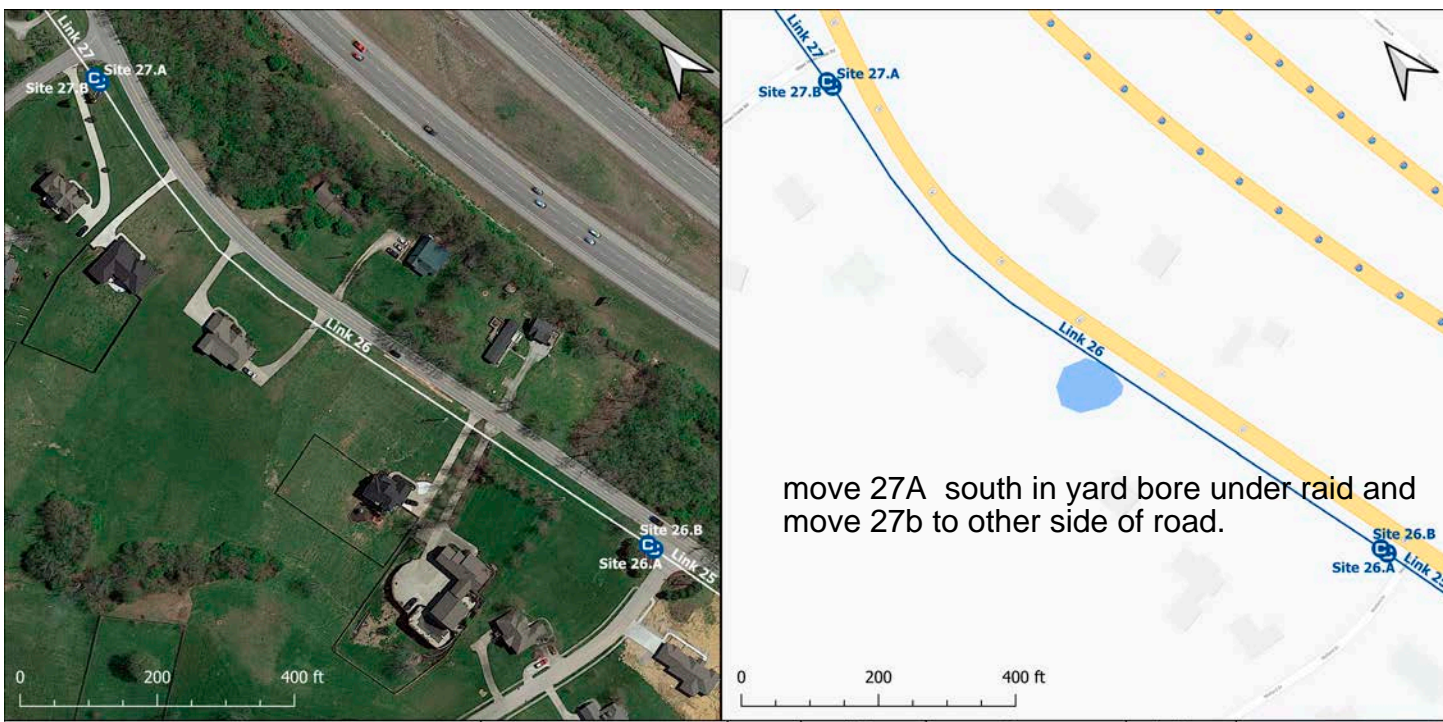

Site 27.A - 3322 Upper Hines Creek Rd - Object ID 515

Latitude (°)	Longitude (°)	Element	Site Access Permit	HASL (ft)	Chamber Type	Chamber Dimensions (X/Y/Z)	Chamber Status	Overall Site Setup	Additional Duct Length (ft)
37.85345	-84.33308	Stop Valve	Landowner	969	A	36/36/48	New	2x Single	25

Drawing Reference: MD-LEXRD-SL-026		Commercial in Confidence		Date	Name	Position	 ENGINEERING
Rev. No.	Date	Revision Details		Drawn	Checked	Approved	
01	18/11/2020	Final Drawing		Scale	Drawing Name		
				As Shown	Madison County- Lexington Road Project Link 26- Detail		



Product and Installation Requirements	Information
CRALEY Fibre™ Stainless Steel 4" T-Series Vertical Entry Flange Final Fitting	2 units
CRALEY Fibre™ 24/14 Armoured Messenger Pipe	1,228 ft
CRALEY Fibre™ 288 Fibre Cable - 288-strand	1,228 ft
CRALEY Fibre™ Installation Technique	De-pressurised
CRALEY Fibre™ Installation Parachute - based on reported internal condition & pipe diameter	150mm

Installation Fitting Components Required:	Upper Part	Lower Part
Draw-line Installation Fitting	Type A	Type A
Magnetic Grab & Net Capture Fitting	Type B	Type B
Messenger Pipe™ Installation Fitting	Type C	Type D

Observations/Notes
1. See section "13.3 Project Specific Installation Fittings" on page 60 for an explanation of the installation fitting components
2. See section "9.1 General Chamber Guidelines" on page 50 for information on chamber types
3. See page 57 for more information on parachute sizing
4. All images provided by Madison County
5. Where images have not been provided, a general image representing the location has been generated

Link 27 - Key Data

End A (Site #)	End B (Site #)	Length (ft)	Cumulative Bends (°)	Pipe Material	Pipe Diameter (Inches)	Operating Pressure (psi)	Volume (Gall./Day)	Flow Velocity (ft/s)	Flow Generation	Flow Direction
27.B	28.A	1,069	15	PVC	8	86	646,317	2.87	Pumped	North



Drawing Reference: MD-LEXRD-SL-027		Commercial in Confidence		Date	Name	Position	
Rev. No.	Date	Revision Details		Drawn	Checked	Approved	
01	18/11/2020	Final Drawing		Scale	Drawing Name		
				As Shown	Madison County - Lexington Road Project Link 27 - Detail		

Site 27.B - 3322 Upper Hines Creek Rd - Object ID 515

Latitude (°)	Longitude (°)	Element	Site Access Permit	HASL (ft)	Chamber Type	Chamber Dimensions (X/Y/Z)	Chamber Status	Overall Site Setup	Additional Duct Length (ft)
37.85345	-84.33308	Stop Valve	Landowner	969	A	36/36/48	New	2x Single	25



Site 28.A - Shilo Grove Entrance - Object ID 1084

Latitude (°)	Longitude (°)	Element	Site Access Permit	HASL (ft)	Chamber Type	Chamber Dimensions (X/Y/Z)	Chamber Status	Overall Site Setup	Additional Duct Length (ft)
37.8564	-84.33297	Stop Valve	Landowner	936	A	36/36/48	New	2x Single	72



Product and Installation Requirements	Information
CRALEY Fibre™ Stainless Steel 4" T-Series Vertical Entry Flange Final Fitting	2 units
CRALEY Fibre™ 24/14 Armoured Messenger Pipe	1,291 ft
CRALEY Fibre™ 288 Fibre Cable - 288-strand	1,291 ft
CRALEY Fibre™ Installation Technique	De-pressurised
CRALEY Fibre™ Installation Parachute - based on reported internal condition & pipe diameter	150mm

Installation Fitting Components Required:	Upper Part	Lower Part
Draw-line Installation Fitting	Type A	Type A
Magnetic Grab & Net Capture Fitting	Type B	Type B
Messenger Pipe™ Installation Fitting	Type C	Type D

Observations/Notes
1. See section "13.3 Project Specific Installation Fittings" on page 60 for an explanation of the installation fitting components
2. See section "9.1 General Chamber Guidelines" on page 50 for information on chamber types
3. See page 57 for more information on parachute sizing
4. All images provided by Madison County
5. Where images have not been provided, a general image representing the location has been generated

Link 28 - Key Data

End A (Site #)	End B (Site #)	Length (ft)	Cumulative Bends (°)	Pipe Material	Pipe Diameter (Inches)	Operating Pressure (psi)	Volume (Gall./Day)	Flow Velocity (ft/s)	Flow Generation	Flow Direction
28.B	29.A	820	0	PVC	8	86	646,317	2.87	Pumped	North

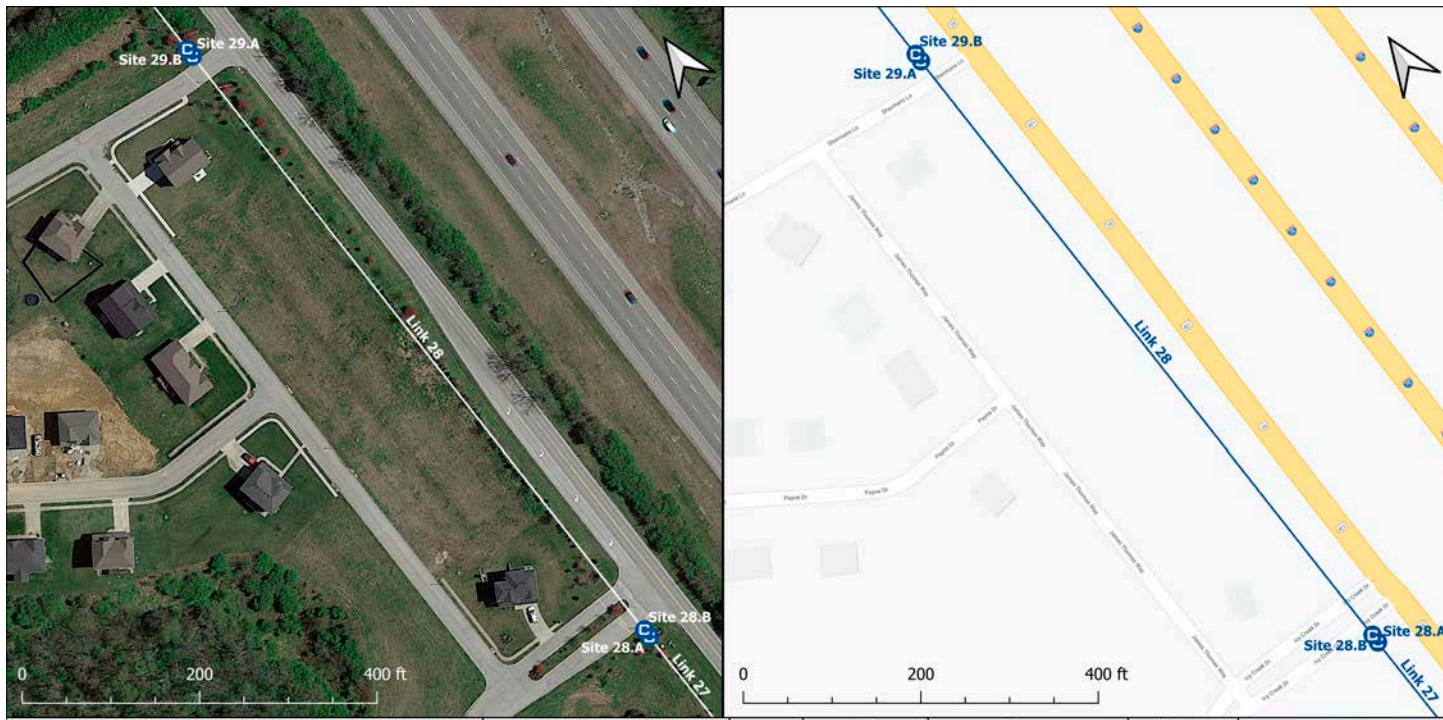

Drawing Reference: MD-LEXRD-SL-028		Commercial in Confidence		Date	Name	Position	 ENGINEERING
Rev. No.	Date	Revision Details		Drawn		CD	
01	18/11/2020	Final Drawing		Checked			
				Approved	Drawing Name		
				Scale	As Shown		
				Madison County- Lexington Road Project			
				Link 28- Detail			

Site 28.B - Shilo Grove Entrance - Object ID 1084

Latitude (°)	Longitude (°)	Element	Site Access Permit	HASL (ft)	Chamber Type	Chamber Dimensions (X/Y/Z)	Chamber Status	Overall Site Setup	Additional Duct Length (ft)
37.8564	-84.33297	Stop Valve	Landowner	936	A	36/36/48	New	2x Single	72



Site 29.A - Exit of Shilo Grove - Object ID 1093

Latitude (°)	Longitude (°)	Element	Site Access Permit	HASL (ft)	Chamber Type	Chamber Dimensions (X/Y/Z)	Chamber Status	Overall Site Setup	Additional Duct Length (ft)
37.85867	-84.33313	Stop Valve	Landowner	941	A	36/36/48	New	2x Single	12

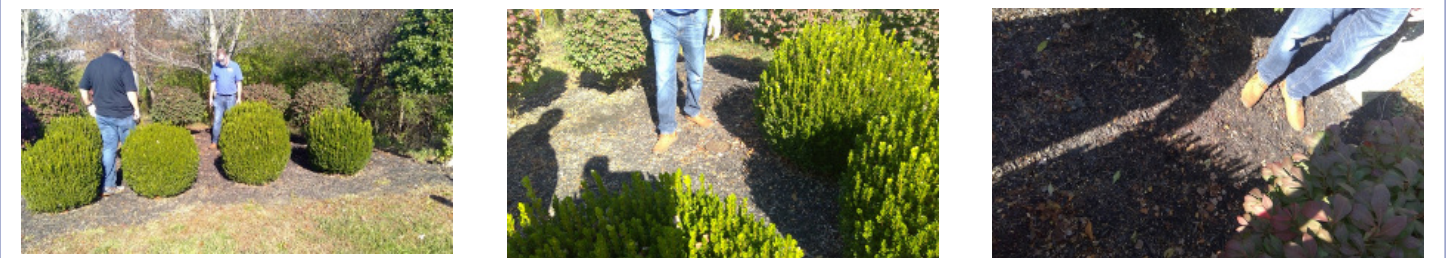

Product and Installation Requirements	Information
CRALEY Fibre™ Stainless Steel 4" T-Series Vertical Entry Flange Final Fitting	2 units
CRALEY Fibre™ 24/14 Armoured Messenger Pipe	952 ft
CRALEY Fibre™ 288 Fibre Cable - 288-strand	952 ft
CRALEY Fibre™ Installation Technique	De-pressurised
CRALEY Fibre™ Installation Parachute - based on reported internal condition & pipe diameter	150mm

Installation Fitting Components Required:	Upper Part	Lower Part
Draw-line Installation Fitting	Type A	Type A
Magnetic Grab & Net Capture Fitting	Type B	Type B
Messenger Pipe™ Installation Fitting	Type C	Type D

Observations/Notes
1. See section "13.3 Project Specific Installation Fittings" on page 60 for an explanation of the installation fitting components
2. See section "9.1 General Chamber Guidelines" on page 50 for information on chamber types
3. See page 57 for more information on parachute sizing
4. All images provided by Madison County
5. Where images have not been provided, a general image representing the location has been generated

Link 29 - Key Data

End A (Site #)	End B (Site #)	Length (ft)	Cumulative Bends (°)	Pipe Material	Pipe Diameter (Inches)	Operating Pressure (psi)	Volume (Gall./Day)	Flow Velocity (ft/s)	Flow Generation	Flow Direction
29.B	30.A	1,494	20	PVC	8	86	646,317	2.87	Pumped	North

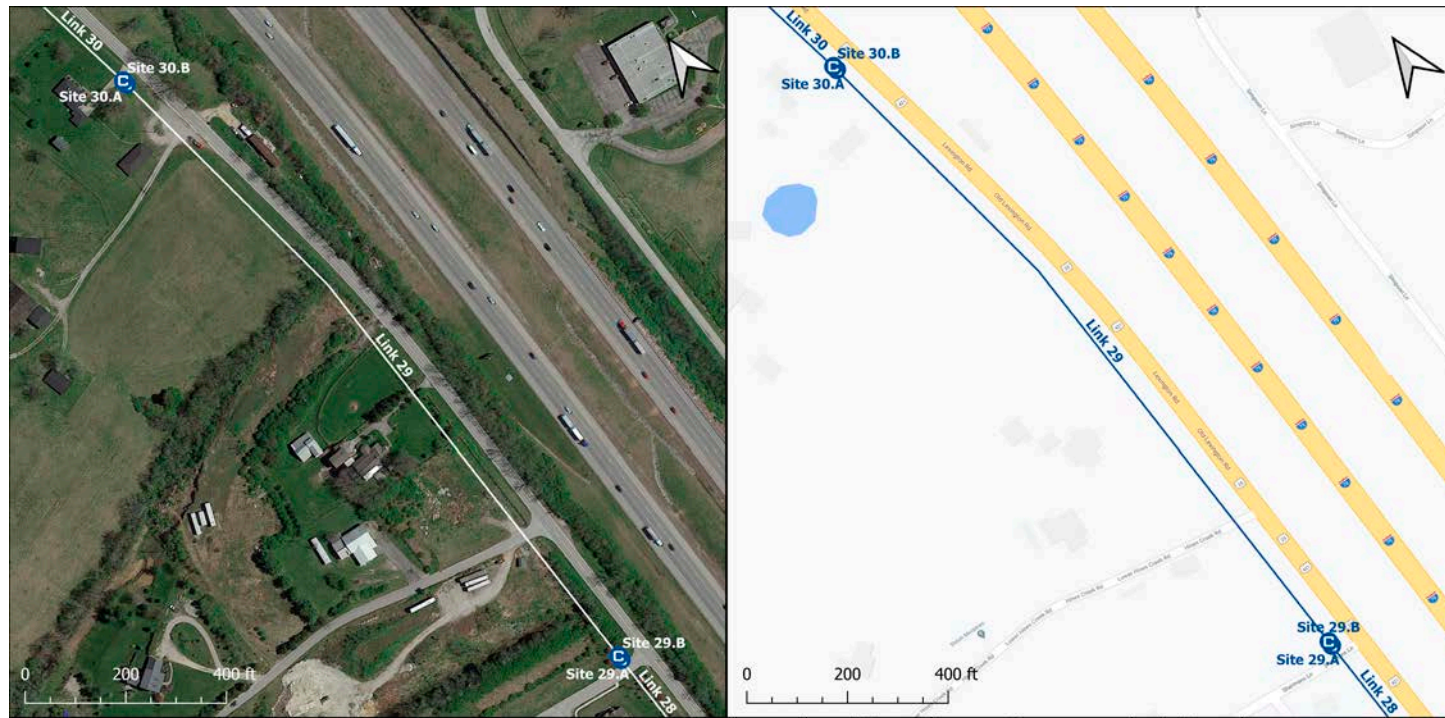

Drawing Reference: MD-LEXRD-SL-029		Commercial in Confidence		Date	Name	Position	 ENGINEERING
Rev. No.	Date	Revision Details		Drawn	Checked	Approved	
01	18/11/2020	Final Drawing		Scale	Drawing Name		
				As Shown	Madison County - Lexington Road Project Link 29 - Detail		

Site 29.B - Exit of Shilo Grove - Object ID 1093

Latitude (°)	Longitude (°)	Element	Site Access Permit	HASL (ft)	Chamber Type	Chamber Dimensions (X/Y/Z)	Chamber Status	Overall Site Setup	Additional Duct Length (ft)
37.85867	-84.33313	Stop Valve	Landowner	941	A	36/36/48	New	2x Single	12



Site 30.A - 3506 Lex Rd - Object ID 519

Latitude (°)	Longitude (°)	Element	Site Access Permit	HASL (ft)	Chamber Type	Chamber Dimensions (X/Y/Z)	Chamber Status	Overall Site Setup	Additional Duct Length (ft)
37.86276	-84.33365	Stop Valve	Landowner	945	A	36/36/48	New	2x Single	8

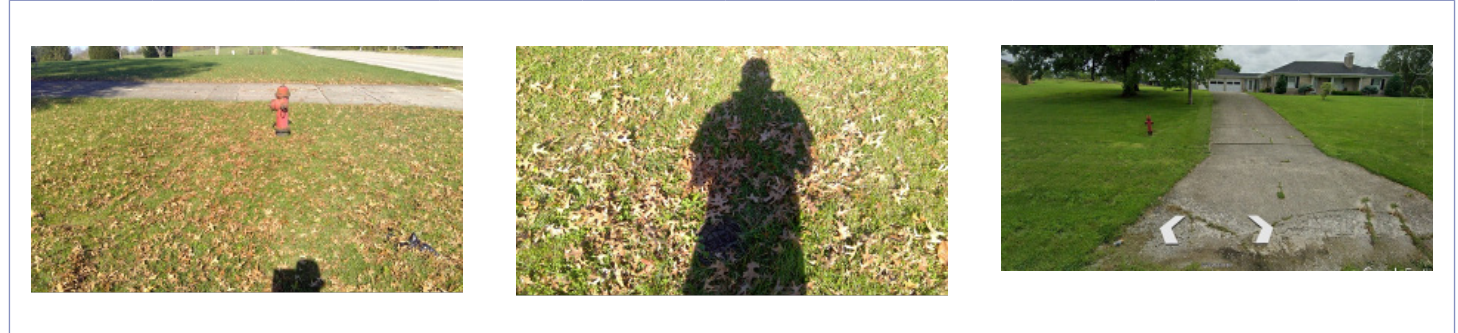

Product and Installation Requirements	Information
CRALEY Fibre™ Stainless Steel 4" T-Series Vertical Entry Flange Final Fitting	2 units
CRALEY Fibre™ 24/14 Armoured Messenger Pipe	1,689 ft
CRALEY Fibre™ 288 Fibre Cable - 288-strand	1,689 ft
CRALEY Fibre™ Installation Technique	De-pressurised
CRALEY Fibre™ Installation Parachute - based on reported internal condition & pipe diameter	150mm

Installation Fitting Components Required:	Upper Part	Lower Part
Draw-line Installation Fitting	Type A	Type A
Magnetic Grab & Net Capture Fitting	Type B	Type B
Messenger Pipe™ Installation Fitting	Type C	Type D

Observations/Notes
1. See section "13.3 Project Specific Installation Fittings" on page 60 for an explanation of the installation fitting components
2. See section "9.1 General Chamber Guidelines" on page 50 for information on chamber types
3. See page 57 for more information on parachute sizing
4. All images provided by Madison County
5. Where images have not been provided, a general image representing the location has been generated

Link 30 - Key Data

End A (Site #)	End B (Site #)	Length (ft)	Cumulative Bends (°)	Pipe Material	Pipe Diameter (Inches)	Operating Pressure (psi)	Volume (Gall./Day)	Flow Velocity (ft/s)	Flow Generation	Flow Direction
30.B	31.A	1,467	20	PVC	8	86	646,317	2.87	Pumped	North



Drawing Reference: MD-LEXRD-SL-030		Commercial in Confidence		Date	Name	Position	 ENGINEERING
Rev. No.	Date	Revision Details		Drawn	Checked	Approved	
01	18/11/2020	Final Drawing		Scale	Drawing Name		
				As Shown	Madison County- Lexington Road Project Link 30- Detail		

Site 30.B - 3506 Lex Rd - Object ID 519

Latitude (°)	Longitude (°)	Element	Site Access Permit	HASL (ft)	Chamber Type	Chamber Dimensions (X/Y/Z)	Chamber Status	Overall Site Setup	Additional Duct Length (ft)
37.86276	-84.33365	Stop Valve	Landowner	945	A	36/36/48	New	2x Single	8

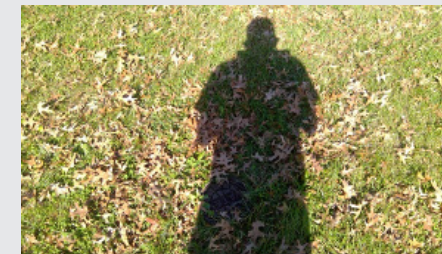

Site 31.A - 3537 Lex Rd - Object ID 522

Latitude (°)	Longitude (°)	Element	Site Access Permit	HASL (ft)	Chamber Type	Chamber Dimensions (X/Y/Z)	Chamber Status	Overall Site Setup	Additional Duct Length (ft)
37.8667	-84.33489	Stop Valve	Landowner	934	A	36/36/48	New	2x Single	6

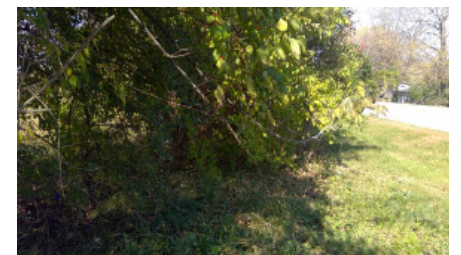
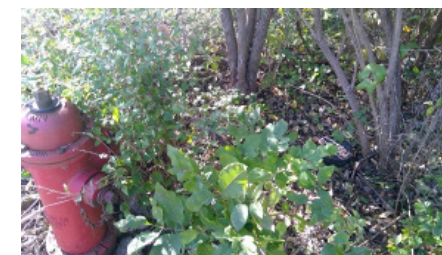
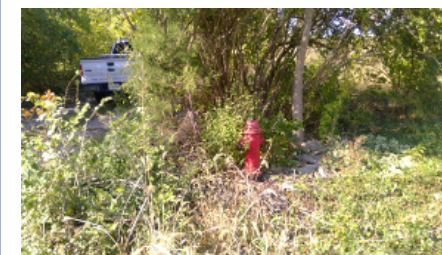

Product and Installation Requirements	Information
CRALEY Fibre™ Stainless Steel 4" T-Series Vertical Entry Flange Final Fitting	2 units
CRALEY Fibre™ 24/14 Armoured Messenger Pipe	1,657 ft
CRALEY Fibre™ 288 Fibre Cable - 288-strand	1,657 ft
CRALEY Fibre™ Installation Technique	De-pressurised
CRALEY Fibre™ Installation Parachute - based on reported internal condition & pipe diameter	150mm

Installation Fitting Components Required:	Upper Part	Lower Part
Draw-line Installation Fitting	Type A	Type A
Magnetic Grab & Net Capture Fitting	Type B	Type B
Messenger Pipe™ Installation Fitting	Type C	Type D

Observations/Notes
1. See section "13.3 Project Specific Installation Fittings" on page 60 for an explanation of the installation fitting components
2. See section "9.1 General Chamber Guidelines" on page 50 for information on chamber types
3. See page 57 for more information on parachute sizing
4. All images provided by Madison County
5. Where images have not been provided, a general image representing the location has been generated

Link 31 - Key Data

End A (Site #)	End B (Site #)	Length (ft)	Cumulative Bends (°)	Pipe Material	Pipe Diameter (Inches)	Operating Pressure (psi)	Volume (Gall./Day)	Flow Velocity (ft/s)	Flow Generation	Flow Direction
31.B	32.A	2,676	50	PVC	8	86-88	646,317	2.87	Pumped	North

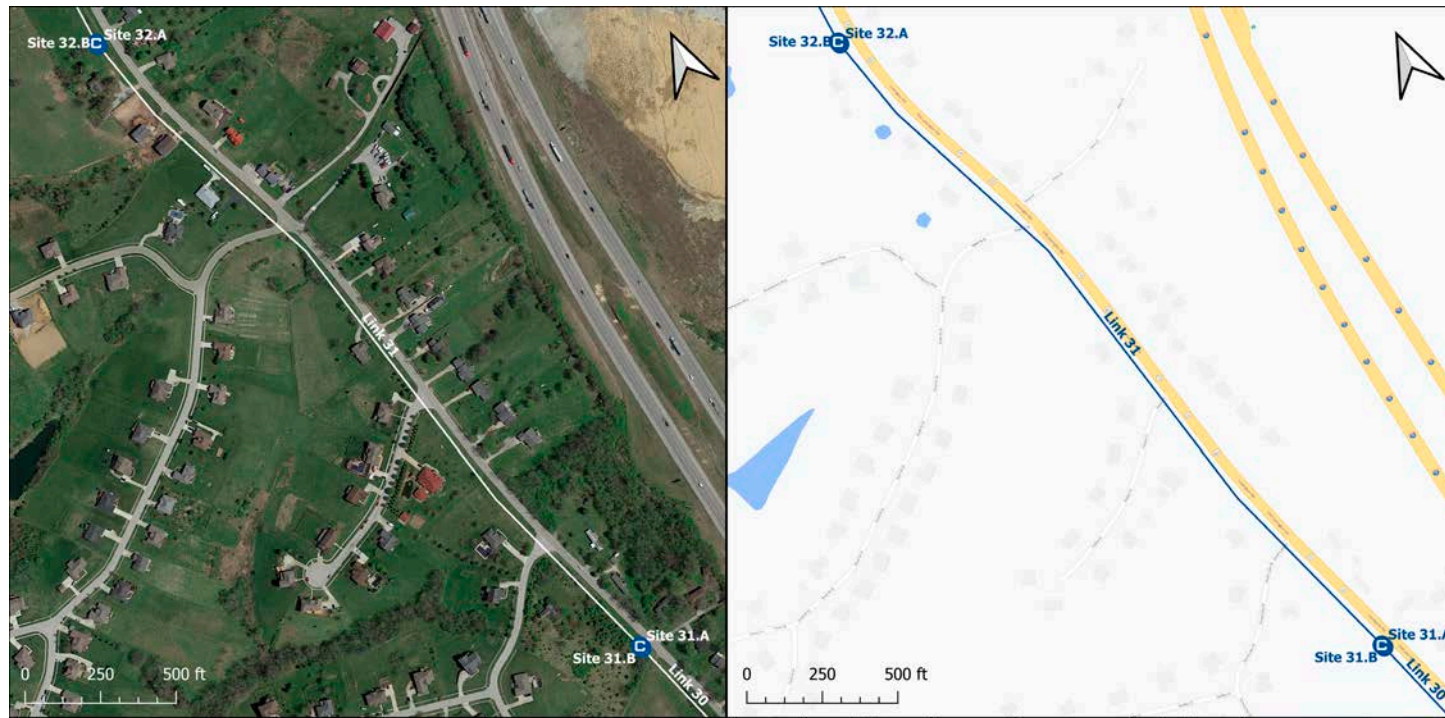

Drawing Reference: MD-LEXRD-SL-031		Commercial in Confidence		Date	Name	Position	 ENGINEERING
Rev. No.	Date	Revision Details		Drawn	Checked	Approved	
01	18/11/2020	Final Drawing		Scale	Drawing Name		
				As Shown	Madison County- Lexington Road Project Link 31- Detail		

Site 31.B - 3537 Lex Rd - Object ID 522

Latitude (°)	Longitude (°)	Element	Site Access Permit	HASL (ft)	Chamber Type	Chamber Dimensions (X/Y/Z)	Chamber Status	Overall Site Setup	Additional Duct Length (ft)
37.8667	-84.33489	Stop Valve	Landowner	934	A	36/36/48	New	2x Single	6



Site 32.A - 3600 Lex Rd - Object ID 524

Latitude (°)	Longitude (°)	Element	Site Access Permit	HASL (ft)	Chamber Type	Chamber Dimensions (X/Y/Z)	Chamber Status	Overall Site Setup	Additional Duct Length (ft)
37.87373	-84.33763	Stop Valve	Landowner	937	A	36/36/48	New	2x Single	6

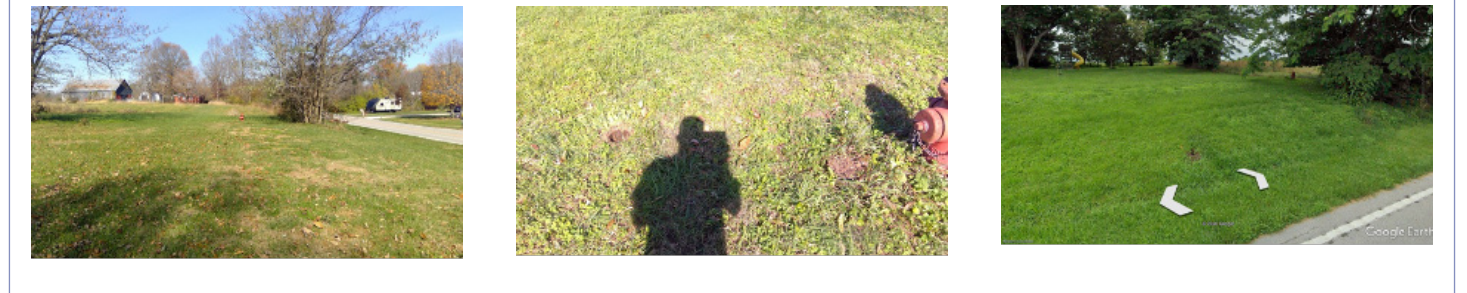

Product and Installation Requirements	Information
CRALEY Fibre™ Stainless Steel 4" T-Series Vertical Entry Flange Final Fitting	2 units
CRALEY Fibre™ 24/14 Armoured Messenger Pipe	2,987 ft
CRALEY Fibre™ 288 Fibre Cable - 288-strand	2,987 ft
CRALEY Fibre™ Installation Technique	De-pressurised
CRALEY Fibre™ Installation Parachute - based on reported internal condition & pipe diameter	150mm

Installation Fitting Components Required:	Upper Part	Lower Part
Draw-line Installation Fitting	Type A	Type A
Magnetic Grab & Net Capture Fitting	Type B	Type B
Messenger Pipe™ Installation Fitting	Type C	Type D

Observations/Notes
1. See section "13.3 Project Specific Installation Fittings" on page 60 for an explanation of the installation fitting components
2. See section "9.1 General Chamber Guidelines" on page 50 for information on chamber types
3. See page 57 for more information on parachute sizing
4. All images provided by Madison County
5. Where images have not been provided, a general image representing the location has been generated

Link 32 - Key Data

End A (Site #)	End B (Site #)	Length (ft)	Cumulative Bends (°)	Pipe Material	Pipe Diameter (Inches)	Operating Pressure (psi)	Volume (Gall./Day)	Flow Velocity (ft/s)	Flow Generation	Flow Direction
32.B	33.A	1,031	25	PVC	8	88	1.5	0.0	Gravity	North



Drawing Reference: MD-LEXRD-SL-032		Commercial in Confidence		Date	Name	Position	
Rev. No.	Date	Revision Details		Drawn	Checked	Approved	
01	18/11/2020	Final Drawing		Scale	Drawing Name		
				As Shown	Madison County- Lexington Road Project Link 32- Detail		

Site 32.B - 3600 Lex Rd - Object ID 524

Latitude (°)	Longitude (°)	Element	Site Access Permit	HASL (ft)	Chamber Type	Chamber Dimensions (X/Y/Z)	Chamber Status	Overall Site Setup	Additional Duct Length (ft)
37.87373	-84.33763	Stop Valve	Landowner	937	A	36/36/48	New	2x Single	6

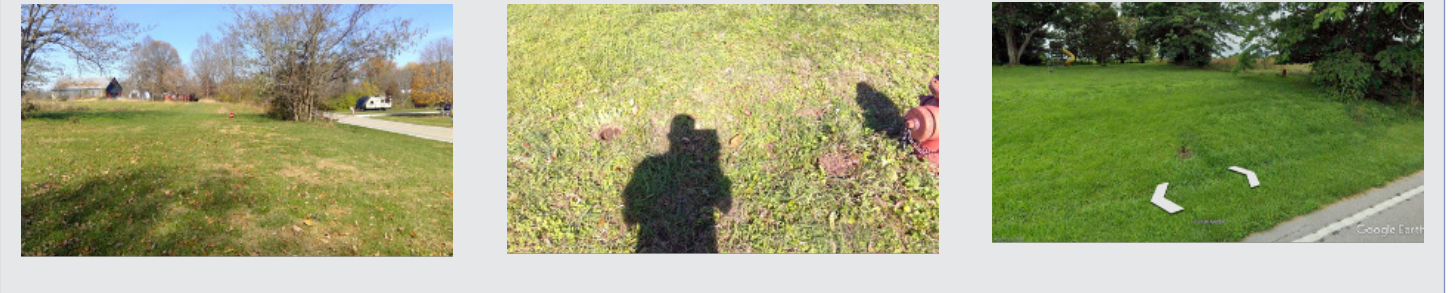

Site 33.A - Lex Rd - Object ID 525

Latitude (°)	Longitude (°)	Element	Site Access Permit	HASL (ft)	Chamber Type	Chamber Dimensions (X/Y/Z)	Chamber Status	Overall Site Setup	Additional Duct Length (ft)
37.87065	-84.33755	Stop Valve	Landowner	928	A	36/36/48	New	2x Single	15



Product and Installation Requirements	Information
CRALEY Fibre™ Stainless Steel 4" T-Series Vertical Entry Flange Final Fitting	2 units
CRALEY Fibre™ 24/14 Armoured Messenger Pipe	1,187 ft
CRALEY Fibre™ 288 Fibre Cable - 288-strand	1,187 ft
CRALEY Fibre™ Installation Technique	De-pressurised
CRALEY Fibre™ Installation Parachute - based on reported internal condition & pipe diameter	175mm

Installation Fitting Components Required:	Upper Part	Lower Part
Draw-line Installation Fitting	Type A	Type A
Magnetic Grab & Net Capture Fitting	Type B	Type B
Messenger Pipe™ Installation Fitting	Type C	Type D

Observations/Notes
1. See section "13.3 Project Specific Installation Fittings" on page 60 for an explanation of the installation fitting components
2. See section "9.1 General Chamber Guidelines" on page 50 for information on chamber types
3. See page 57 for more information on parachute sizing
4. All images provided by Madison County
5. Where images have not been provided, a general image representing the location has been generated

Link 33 - Key Data

End A (Site #)	End B (Site #)	Length (ft)	Cumulative Bends (°)	Pipe Material	Pipe Diameter (Inches)	Operating Pressure (psi)	Volume (Gall./Day)	Flow Velocity (ft/s)	Flow Generation	Flow Direction
33.B	34	507	150	PVC	8	88	1.5	0.0	Gravity	NE

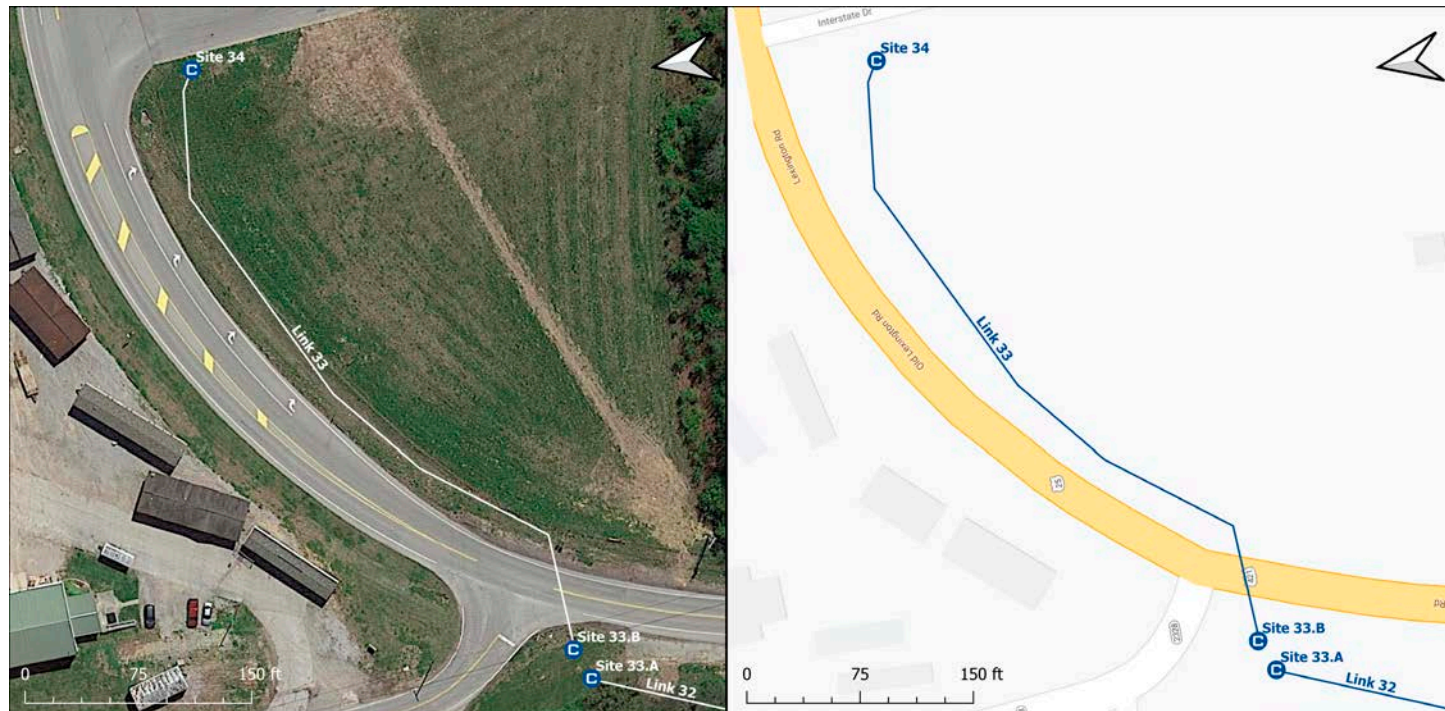

Drawing Reference: MD-LEXRD-SL-033		Commercial in Confidence		Date	Name	Position	 ENGINEERING
Rev. No.	Date	Revision Details		Drawn	Checked	Approved	
01	18/11/2020	Final Drawing		Scale	Drawing Name		
				As Shown	Madison County- Lexington Road Project Link 33- Detail		

Site 33.B - Lex Rd - Object ID 525

Latitude (°)	Longitude (°)	Element	Site Access Permit	HASL (ft)	Chamber Type	Chamber Dimensions (X/Y/Z)	Chamber Status	Overall Site Setup	Additional Duct Length (ft)
37.87065	-84.33755	Stop Valve	Landowner	928	A	36/36/48	New	2x Single	15



Site 34 - 101 Interstate - Object ID 2561

Latitude (°)	Longitude (°)	Element	Site Access Permit	HASL (ft)	Chamber Type	Chamber Dimensions (X/Y/Z)	Chamber Status	Overall Site Setup	Additional Duct Length (ft)
37.87703	-84.33599	None	Landowner	904	A	36/36/48	New	1x Single	-



Product and Installation Requirements	Information
CRALEY Fibre™ Stainless Steel 4" T-Series Vertical Entry Flange Final Fitting	2 units
CRALEY Fibre™ 24/14 Armoured Messenger Pipe	594 ft
CRALEY Fibre™ 288 Fibre Cable - 288-strand	594 ft
CRALEY Fibre™ Installation Technique	De-pressurised
CRALEY Fibre™ Installation Parachute - based on reported internal condition & pipe diameter	175mm

Installation Fitting Components Required:	Upper Part	Lower Part
Draw-line Installation Fitting	Type A	Type A
Magnetic Grab & Net Capture Fitting	Type B	Type B
Messenger Pipe™ Installation Fitting	Type C	Type D

Observations/Notes
1. See section "13.3 Project Specific Installation Fittings" on page 60 for an explanation of the installation fitting components
2. See section "9.1 General Chamber Guidelines" on page 50 for information on chamber types
3. See page 57 for more information on parachute sizing
4. All images provided by Madison County
5. Where images have not been provided, a general image representing the location has been generated

5. Bill of Materials

Final Product & Materials Requirement	Quantity
CRALEY Fibre™ Stainless Steel 4" T-Series Vertical Entry Flange Final Fitting	70 units
CRALEY Fibre™ 24/14 Armoured Messenger Pipe	44,000 ft
CRALEY Fibre™ 288 Fiber Cable - 288-strand	44,000 ft
CRALEY Fibre™ Labels	70 units
CRALEY Fibre™ 24/14 Water Blocks	70 units

Project Specific Installation Fittings	Quantity
CRALEY Fibre™ Draw Line Installation Fitting - Upper Part - Type A	1 unit
CRALEY Fibre™ Draw Line Installation Fitting - Lower Part - Type A	1 unit
CRALEY Fibre™ Mag Grab & Net Capture Installation Fitting - Upper Part - Type B	1 unit
CRALEY Fibre™ Mag Grab & Net Capture Installation Fitting - Lower Part - Type B	1 unit
CRALEY Fibre™ Mag Grab & Net Capture Installation Fitting - Lower Part - Type C	1 unit
CRALEY Fibre™ Messenger Pipe™ Installation Fitting - Upper Part - Type C	1 unit
CRALEY Fibre™ Messenger Pipe™ Installation Fitting - Lower Part - Type D	1 unit
CRALEY Fibre™ Messenger Pipe™ Installation Fitting - Lower Part - Type E	1 unit
CRALEY Fibre™ Messenger Pipe™ Installation Fitting - Lower Part - Type F	1 unit

Standard Installation Kit	Quantity
Neutral Buoyancy Sonde Transmitter & LED POD	1 Unit
Disinfection Chamber Sponge (+ 1 Spare)	1 Units
Stainless Steel Retrieval Hook	1 Unit
Pack/25 of 3mm Aluminium Crimp Ferrules	1 Unit
Pack/10 3mm Stainless Steel Cable Eyes	1 Unit
Medium length draw line reel containing 1,000m (3280ft) Dyneema® draw line	1 Unit
CRALEY Fibre™ draw line reel drill attachment	1 Units
CRALEY Fibre™ Water Grade Disinfection Pump Spray	2 Units
Pack/100 Chlorination Tablets (1 tablet to 1 Litre/2 pints of water for a 1,000ppm solution)	1 Unit

Additional Installation Accessories Required	Quantity
Disinfection Chamber Sponge	4 units
Spare Pack for Installation Fittings (including O Rings, hydraulic lip-seals, LED spare lamp)	1 unit
3mm Crimp Ferrules	100 units
Stainless Steel Retrieval Hook	2 units
24/14 Messenger Pipe™ Sock	8 units
3mm Cable Eye	20 units
Compressed Air Chlorination Spray Bottle - 1l Bottle	2 units
CRALEY Fibre™ 500m/1640ft Dyneema Draw Line Reel	1 Unit
CRALEY Fibre™ 1500m/4920ft Dyneema Draw Line Reel	1 Unit
CRALEY Fibre™ Parachute - 150mm	4 units
CRALEY Fibre™ Parachute - 175mm	4 units
CRALEY Fibre™ Parachute - 225mm	4 units
CRALEY Fibre™ Parachute - 250mm	4 units

Products to be sourced in local market	Quantity
Edge and Surface Rollers to prevent damage to the Messenger Pipe™ (See "15.6 Use of Messenger Pipe™ Rollers" on page 63)	As required
Drum Reelers or Flange Reelers (See "15.3 Unwinding the Messenger Pipe™" on page 62)	As required
Endoscope (See "13.7 Endoscope Specification" on page 60)	1 Unit
Heavy Duty Crimping Tool for 3mm Crimp Ferrules	1 Unit
Water-based, approved lubricants: In Europe: Hydro Gliss® Gel: Type Approval to EU Regulations In the USA: Phoenix XL Dispersible Pipe Joint Lubricant - NSF Certified	As required
Nitrile Gloves	As required
Hand sanitiser and cleaning cloths	As required
General hand tools	As required
Wastewater pump	As required

Optional Installation Equipment	Quantity
33kHz Utility CAT-Scanner	1 unit
Live insert flow-meter with 4" flange adaptor	1 unit
Cable length meter	1 unit

6. Minimum Product Standards

All CRALEY™ products and accessories are manufactured or sourced from company approved vendors and, whilst products can be manufactured to different standards to reflect the requirement, we have minimum product standards that our various products comply to.

6.1 Fittings

- Stainless Steel Final Fittings are all rated to PN25 (360psi)
- Stainless Steel Installation Fittings are all rated at PN16 (230psi)
- Polymer fittings, as used in our D & M-Series products are rated at PN16 (230psi)

6.2 Messenger Pipe™

- All armoured Messenger Pipes incorporating a stainless-steel armour layer are rated to PN25 (360psi)
- Standard Messenger Pipes above 5mm are rated to PN25 (360psi)
- 5mm Standard Messenger Pipe is rated to PN16 (230psi)

6.3 Fibre Cables

Fibre cables to be incorporated within a CRALEY Fibre™ or CRALEY Sensing™ installation will be enclosed within the Messenger Pipe™ and are therefore highly protected.

The minimum product standard for fibre cables used within an installation will be 9/125 OS2 grade with typical

7. Materials in Contact

7.1 Overview

All materials used, where there is contact with water, are defined to be those suitable for use in potable systems, clearly, they are also therefore suitable for use in non-potable and pre-treatment systems.

Products can be broken down into three categories:

- a) Installation Fittings – short-term water contact
- b) Final Fittings – long-term water contact
- c) Messenger PipeTM - long-term water contact

Materials used are those which may be commonly found within many products provided to and used within the water industry.

All CRALEY Fibre products and materials have been laboratory tested and certified for use by NSF under ANSI/61 and ANSI/372, in The UK and Europe under WRAS material approval and Regulation 31 approval for use in public water networks.

In addition to the international approvals and certification, we also have a number of individual, in-country or State approvals. Further details can be provided on request.

7.2 Long-term Water Contact Materials

Materials that come into long-term contact with the water fall into two categories:

- a) Final Fittings
- b) Messenger PipeTM

Final Fittings

For primary trunk and distribution main products, the CRALEY FibreTM VPFM Final Fittings are manufactured in Stainless Steel 316 grade from a certified source and internationally approved for use in products that come into contact with potable water.

Additional Materials used within a Final Fitting:

- O-Rings - Pressure containment within the VPFM Final Fittings is achieved via approved and certified NBR70 O-rings, again, from a certified source. The O Rings are interleaved with Stainless Steel 316 grade load-support washers to ensure a perfect seal. At less than 2 cm² the actual surface area of the pressure containment O-Rings is very small is minimal.
- Flange gaskets used for VPFM Final Fittings are made from approved and certified EPDM materials.

Messenger PipeTM

Messenger PipeTM is available in a range of diameters and types, according to the required use and fibre count. Currently sizes range from 5mm to 24mm outside diameter, but there is the ability to manufacture larger sizes if required.

Messenger PipesTM are either manufactured in a pure polymer format, or in a or triple-layer version that incorporates a stainless steel 316 armour layer. In either case, the material in contact is virgin high-density polyethylene (HDPE) from a certified source.

Typical pure polymer Messenger PipeTM includes sizes of 5/10/12/14/16mm outside diameter and typical armoured Messenger PipeTM includes sizes of 16/20/24mm outside diameter.

7.3 Short-term Water Contact Materials

Materials that come into short-term contact with the water fall into two categories:

- a) Installation Fittings
- b) Installation Accessories

Short-term contact items only come into contact with the water during the installation phase, which is typically less than 2 two hours for any given link installation.

Installation Fittings

Primary trunk and distribution main Installation Fittings, including those for the three installation techniques of Live, Semi-Live and De-pressurised, are manufactured from approved and certified Stainless Steel 316 grade.

As with the Final Fittings, pressure containment within Installation Fittings is achieved via approved and certified NBR70 hydraulic lip-seals from a certified source. Actual water contact surface of the pressure containment hydraulic lip-seals is very small at a nominal contact area of less than 2 cm².

Flange gaskets used for Installation Fittings are made from approved and certified EPDM materials.

Installation Accessories

Installation accessories include, but are not limited to, the following items, all of which are approved or certified for short-term contact with potable water:

- Install Parachutes
- Nylon parachute material – nominal contact area varies according to parachute size (from 150mm to 700mm) from 400cm² to 8,000cm²
- Stainless Steel 316 grade support lines
- Aluminium crimp ferrules – nominal contact area 0.7cm²
- Messenger PipeTM cable pulling socks – Stainless Steel 316 grade
- Inspection camera and LED illumination lenses – acrylic – nominal contact area 5cm² each
- Draw Line – Dyneema 3mm cord – material HDPE

8. Disinfection Process

8.1 Overview

Water safety is the number one priority for all CRALEY Fibre™ installations. There are defined procedures which must be adhered to when undertaking any potable water pipe installations, and which will ensure a completely safe installation with full disinfection of all items and product that have water contact.

A Water Company may optionally choose to not have all disinfection procedures followed where an installation is in a pipeline carrying non-potable water, for example, irrigation water or pre-treatment water. This would be considered by a Water Company case-by-case.

8.2 Chlorine Based Disinfection

The standard disinfection technique for the draw line, Messenger Pipe™ and Install Fittings when introduced into a potable water main, or otherwise having water contact, is chlorine based.

Chlorine based disinfection, is an effective and well-recognised technique, fully accepted by the AWWA and its equivalents globally. A majority of water companies use chlorine-based disinfection for their potable water supplies.

CRALEY Group processes use a high chlorine solution concentration of 1,000 ppm for dynamic disinfection of draw line and Messenger Pipe™ as they enter the pipe and for surface disinfection of tools and items which may have water contact.

8.3 Chlorine Solution Preparation

CRALEY Group recommends the use of Instachlor PR-1000 tablets, these are a range of rapid dissolving chlorine release tablets for use in professional applications for water chlorination, water treatment and water disinfection. The tablets are an effervescent formulation containing sodium dichloroisocyanurate (NaDCC) - an organic chlorine donor.

Instachlor tablets dissolve rapidly when added to water and release chlorine into the solution. Instachlor PR-1000 tablets provide a simple and effective means of preparing chlorine solutions of 1,000ppm strength for disinfection purposes, by adding one PR-1000 tablet to 1 litre of water.

Instachlor tablets are fully compliant with US NSF Standard 60 - Drinking Water Treatment Chemicals, also current European Regulations including BS EN 12931 - standard for chemicals used in the treatment of water for human consumption,

Dichloroisocyanurate is an effective and convenient alternative to the use of pure sodium hypochlorite (NaOCl).

Sodium Hypochlorite is most generally available in liquid form as a 15% solution. As an alternative to Instachlor tablets, a sodium hypochlorite solution may be used to make up the disinfectant, using 15cc of 15% solution added to 1 litre of water.

Chlorine solutions, made by the method of choice, but must be prepared freshly on the day of use to ensure full strength, any residual solution should be safely disposed of after a day's work.

It is recommended to make up 1,000ppm chlorine solution in a 1 litre pressure pumped spray bottle. This allows easy filling of the Disinfection Chambers for the Install Fittings and for surface application and tools disinfection.

8.4 Disinfection Procedures

Chlorine based spray disinfection with 1,000ppm solution is used for all items being introduced into a water pipe or having water contact. This includes tools, CRALEY Fibre™ Install Fittings & Final Fittings, and includes the service valve, pipe saddle and pipe surface - all items should be wiped clean of any surface debris prior to spray disinfection.

Messenger Pipe™ and draw line are introduced into the water pipe via an Install Fitting which includes a dynamic Disinfection Chamber. The Messenger Pipe™ and draw line are disinfected on transit through the chamber prior to entering the water pipe, hydraulic lip seals at the base of the chamber provide pressure containment and ensure a minimal amount to chlorine solution actually passes into the pipe. Before the actual installation work of insertion commences, the Disinfection Chamber is filled with 1,000ppm chlorine solution (approximately 0.5litre/1pint) via the fill port, the level in the chamber is checked every 100m/300' of Messenger Pipe™ or draw line insertion and may be topped up as necessary.

There are different procedures to be followed for the differing install types of Live, Semi-Live and De-pressurised installs, the CRALEY Fibre Instructions for Use documents details these, a brief summary is as follows:

- Live and Semi-Live techniques use a launch tube system. The launch tube is disinfected prior to an installation by placing in a PR-1000 chlorine tablet and filling with water (the launch tube has a means to enable this). The launch tube has a Disinfection Chamber at the top which is separately filled with chlorine solution prior to commencement of insertion of draw line or Messenger Pipe™.
- The De-pressurised technique does not use a launch tube, it has a Disinfection Chamber directly fitted to the pipe flange. The Disinfection Chamber

is filled with chlorine solution prior to commencement of insertion of draw line or Messenger Pipe™.

8.5 Residual Chlorine Introduced into a Water Pipe

Some incremental chlorine is added to the existing water pipe disinfection levels during the install process, however it is at a very small level compared with the standing 'background' chlorine level. Water delivered to an end customer will typically not exceed 1ppm and within a trunk main will typically not exceed 1.2ppm.

The initial disinfection of the launch tube (for Live and Semi-Live installs) will add the equivalent of 1 litre at 1,000ppm to the total content of a pipe volume across a run. A typical maximum introduction of chlorine solution from the Disinfection Chamber (as a 'surface coat' only on the item being inserted - due to the action of the hydraulic lip-seal) will be less than 0.5cc per 100m of insertion - noting all install techniques use Disinfection Chambers.

By way of an example, with a Live or Semi-Live install for a 300mm water pipe with a typical trunk main 'background' 1.2ppm chlorine level, and a CRALEY Fibre installation of 1,000m, then the incremental chlorine level would increase by < 1% (nominally 0.01ppm) averaged across the 1,000m pipe run.

The incremental chlorine introduced via the Disinfection Chambers too small to measure (noting that De-pressurised installs only use a Disinfection Chamber and not a Launch Tube).

8.6 Health and Safety Aspects

High concentration 1,000ppm chlorine solution requires care in use. CoSSH guidelines (or specific Water Company guidelines where these may apply) must be followed.

Eye goggles and latex/nitrile gloves must be used when preparing, using or applying the chlorine solution. Where spray is applied, it should only be from an upwind location and ensuring other staff onsite are at a safe distance.

8.7 Disinfection Contact Timing

Guideline contact times for chlorine solutions are as follows:

Dynamic Disinfection Chamber

- This is for all install techniques, Live, Semi-Live and De-pressurised.
- Chlorine solution concentration of 1,000ppm (made from one PR-1000 chlorine tablet per 1 litre of water)
- Items passing through the chamber are disinfected during transit, these include draw line and Messenger Pipe™.

Launch Tube Disinfection

- This is for Live and Semi-live installation techniques.
- One PR-100 tablet is placed in the Launch Tube, of nominal capacity 10 litres - chlorine concentration is 100ppm. Recommended minimum disinfection time of 120 seconds.

Surface Disinfection

- This is for all install techniques, Live, Semi-Live and De-pressurised, where pipes, pipe saddles, tools and install fittings require disinfection.
- Surface spray is used, chlorine solution concentration 1,000ppm (made from one PR-1000 chlorine tablet per 1 litre of water). Recommended minimum disinfection time of 10 seconds.

Vat Disinfection

- This is for all install techniques, Live, Semi-Live and De-pressurised, where tools and install fittings require disinfection and a vat-based approach using a lower chlorine concentration is preferred for these items.
- The below chart shows recommended minimum disinfection time in the vat, based on standard vat volumes and number of PR-1000 tablets used:

Vat Capacity	Disinfection time with 1 x PR-1000 tablet	Disinfection time with 2 x PR-1000 tablets
14 Litres	3 minutes	2 minutes
26 Litres	5 minutes	3 minutes
42 Litres	9 minutes	5 minutes
75 Litres	15 minutes	8 minutes

9. Chamber Dimensioning

9.1 General Chamber Guidelines

- All chambers are to be constructed in accordance with local Design and Construction Guidelines.
- Any chamber covers should have a clear opening of at least 600mm (2ft)
- For chambers located in highways the chamber should be of D400 weight class

9.2 Chamber Types – Overview

Depending on the requirement, there are typically 6 different chamber configurations to house the CRALEY Fibre™ equipment and, depending on preference, either round or squared chambers can be utilised.

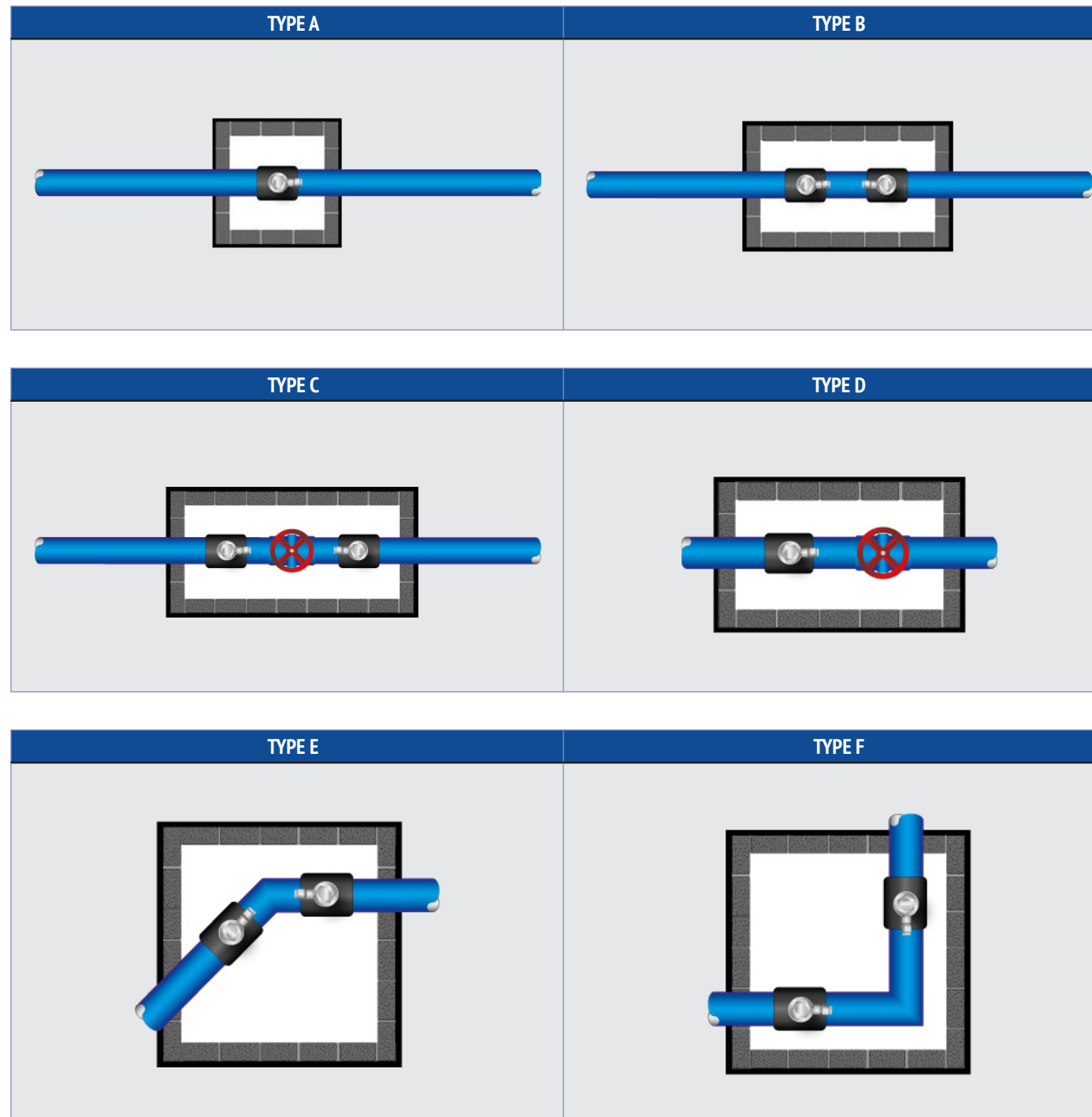

9.3 Chamber Types – Details

9.3.1 Type A

Chamber 'Type A' is used to contain a single CRALEY Fibre™ entry or exit fitting, which may be at the end of a link, or to either side of a valve.

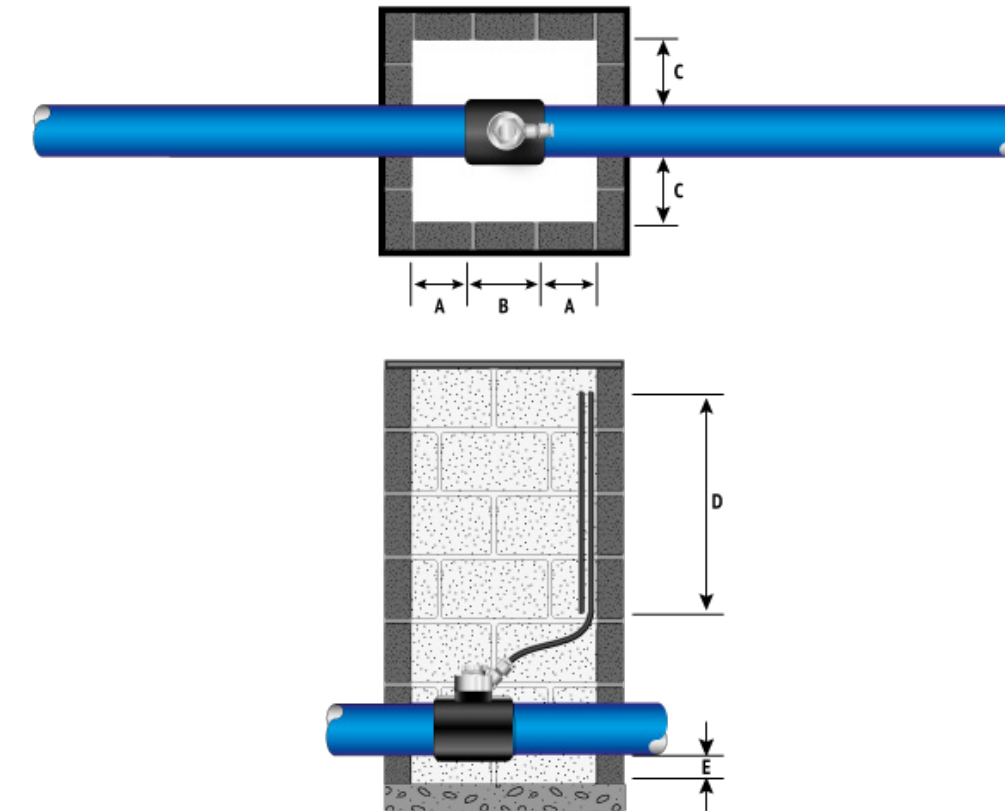

Measurement	M-Series	T-Series Angled Entry	T-Series Vertical Entry
A	150mm (6")	200mm (8")	200mm (8")
B	Selected product overall dimension		
C	150mm (6")	200mm (8")	200mm (8")
D	300mm (12")	800mm (32")	800mm (32")
E	50mm (2")	100mm (4")	100mm (4")

Measurements provided are minimum required clearances to ensure sufficient working space within the Chamber.
The minimum diameter of the Messenger Pipe™ loop ('E') is determined by the chosen Messenger Pipe™

9.3.2 Type B

Chamber 'Type B' is used to contain two CRALEY Fibre™ fittings, which may be where an additional fibre access location is needed or where it is necessary to reduce a link length.

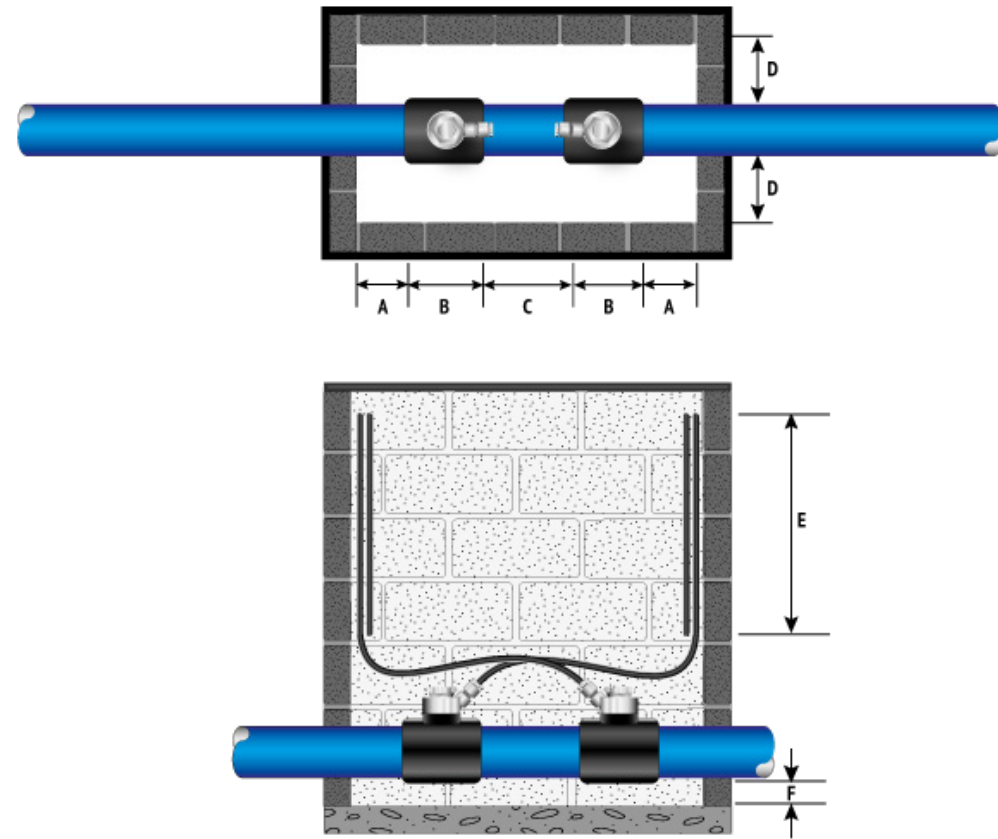

9.3.3 Type C

Chamber 'Type C' is used to contain a single CRALEY Fibre™ entry or exit fitting and a valve or similar, which may be located at the end of a run, in a valve chamber with sufficient space for just one fitting, or for a new build chamber that requires this configuration

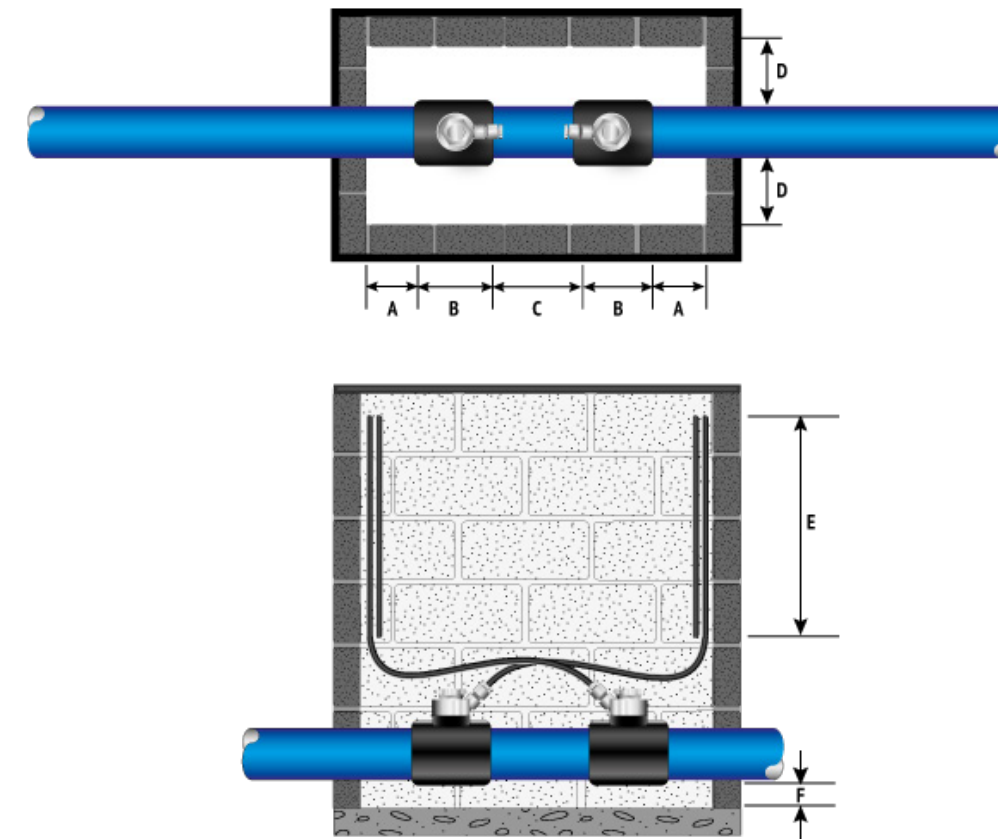

Measurement	M-Series	T-Series Angled Entry	T-Series Vertical Entry
A	150mm (6")	200mm (8")	200mm (8")
B	Selected product overall dimension		
C	100mm (4")	100mm (4")	100mm (4")
D	300mm (12")	300mm (12")	300mm (12")
E	200mm (8")	200mm (8")	200mm (8")
F	150mm (6")	150mm (6")	150mm (6")

Measurements provided are minimum required clearances to ensure sufficient working space within the Chamber.
The minimum diameter of the Messenger Pipe™ loop ('E') is determined by the chosen Messenger Pipe™

Measurement	M-Series	T-Series Angled Entry	T-Series Vertical Entry
A	150mm (6")	200mm (8")	200mm (8")
B	Selected product overall dimension		
C	100mm (4")	300mm (12")	200mm (8")
D	Overall valve dimension	300mm (12")	300mm (12")
E	150mm (6")	200mm (8")	200mm (8")
F	300mm (12")	800mm (32")	800mm (32")
G	50mm (2")	100mm (4")	100mm (4")

Measurements provided are minimum required clearances to ensure sufficient working space within the Chamber.
The minimum diameter of the Messenger Pipe™ loop ('E') is determined by the chosen Messenger Pipe™

9.3.4 Type D

Chamber 'Type D' is used to contain a CRALEY Fibre™ entry and exit fitting either side of a valve or similar, which may be located where an existing chamber is large enough to allow for two fittings, or for a new build chamber that requires this configuration

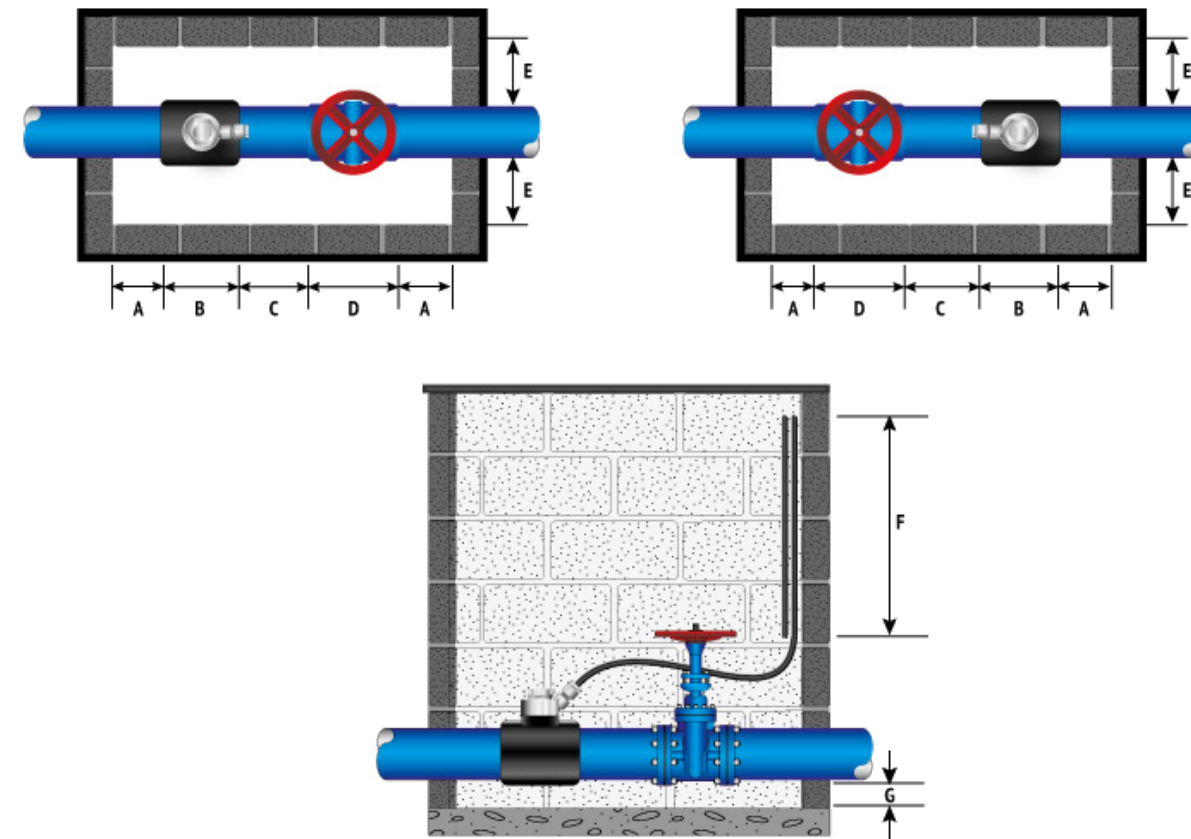

Measurement	M-Series	T-Series Angled Entry	T-Series Vertical Entry
A	150mm (6")	200mm (8")	200mm (8")
B	Selected product overall dimension		
C	100mm (4")	300mm (12")	200mm (8")
D	Overall valve dimension	300mm (12")	300mm (12")
E	150mm (6")	200mm (8")	200mm (8")
F	300mm (12")	800mm (32")	800mm (32")
G	50mm (2")	100mm (4")	100mm (4")

Measurements provided are minimum required clearances to ensure sufficient working space within the Chamber.
The minimum diameter of the Messenger Pipe™ loop ('E') is determined by the chosen Messenger Pipe™



9.3.5 Type E

Chamber 'Type E' is used to navigate swept bends. The Chamber is designed to contain an entry and exit fitting and would typically be a new build where it is necessary for the Messenger Pipe™ to avoid the bend.

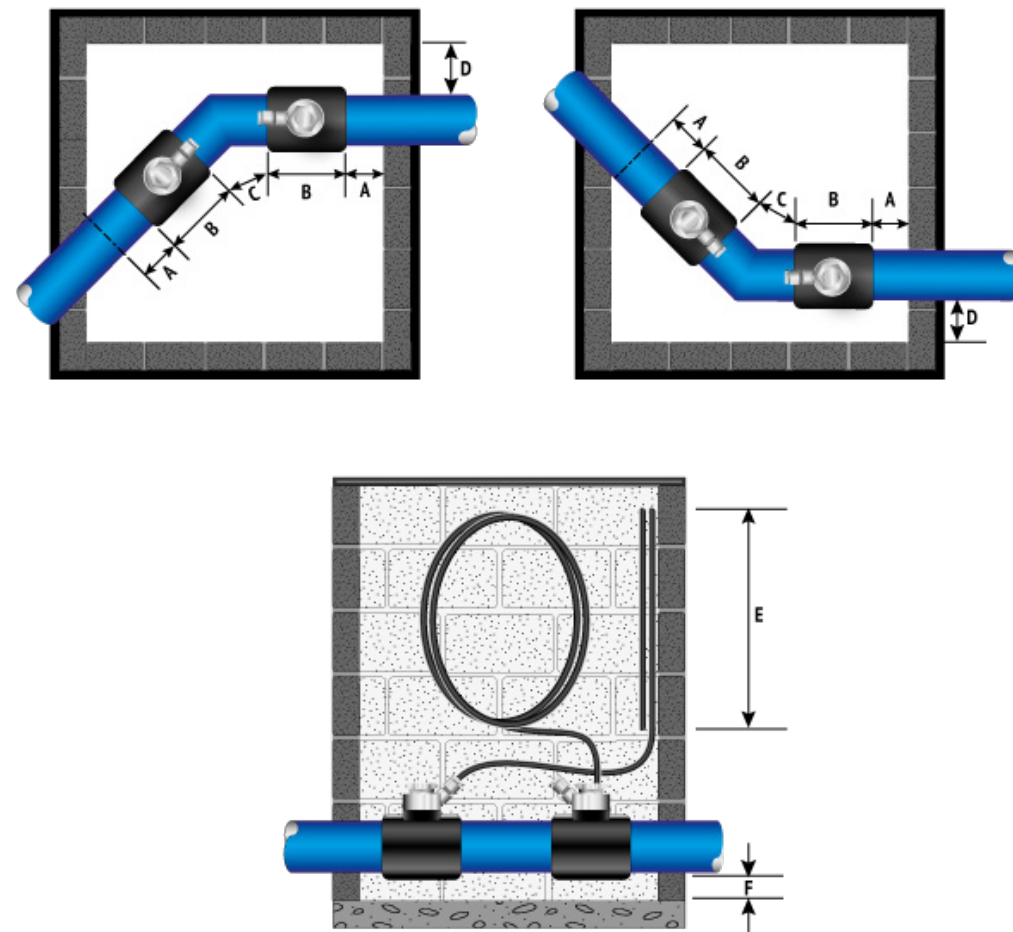

9.3.6 Type F

Chamber 'Type F' is used to navigate sharp right-angled bends. The Chamber is designed to contain an entry and exit fitting and would typically be a new build where it is necessary for the Messenger Pipe™ to avoid the bend.

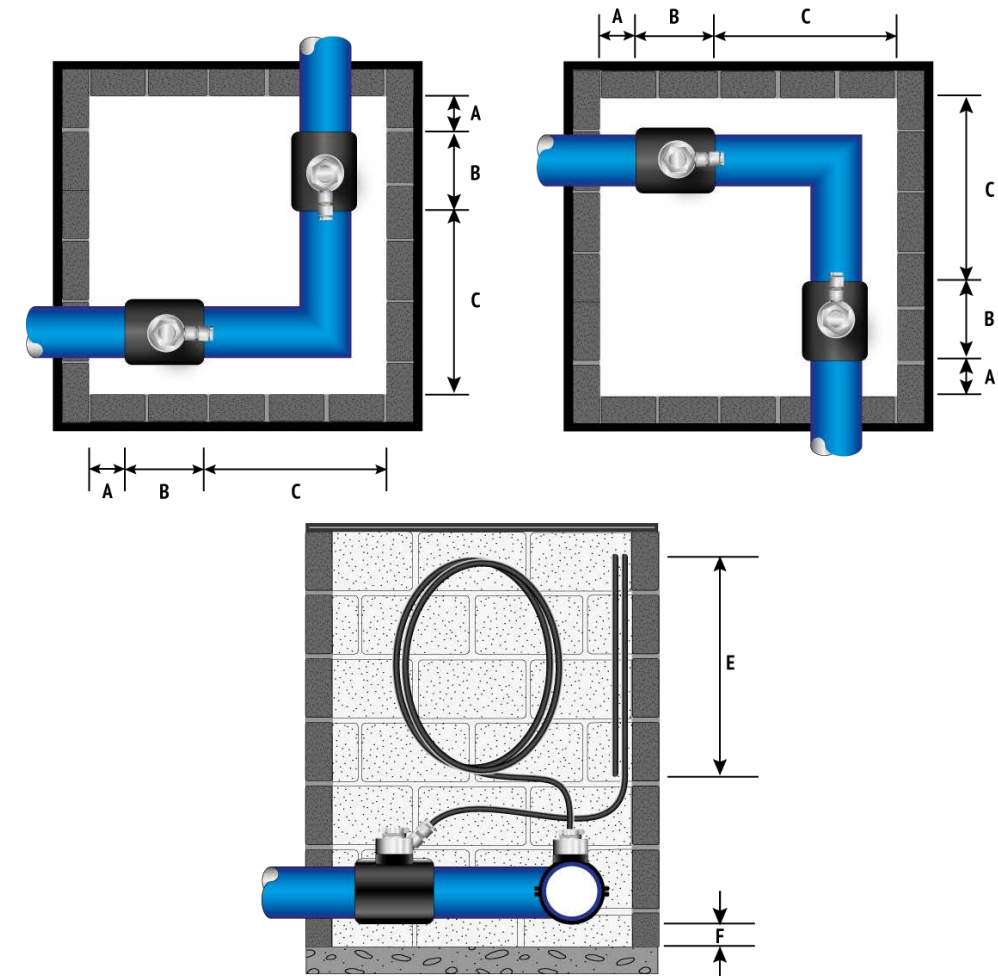

Measurement	M-Series	T-Series Angled Entry	T-Series Vertical Entry
A	150mm (6")	200mm (8")	200mm (8")
B	Selected product overall dimension		
C	100mm (4")	300mm (12")	200mm (8")
D	150mm (6")	200mm (8")	200mm (8")
E	300mm (12")	800mm (32")	800mm (32")
F	50mm (2")	100mm (4")	100mm (4")

Measurements provided are minimum required clearances to ensure sufficient working space within the Chamber.
The minimum diameter of the Messenger Pipe™ loop ('E') is determined by the chosen Messenger Pipe™

Measurement	M-Series	T-Series Angled Entry	T-Series Vertical Entry
150mm (6")	200mm (8")	200mm (8")	200mm (8")
Selected product overall dimension	Selected product overall dimension		
100mm (4")	300mm (12")	200mm (8")	200mm (8")
150mm (6")	200mm (8")	200mm (8")	200mm (8")
300mm (12")	800mm (32")	800mm (32")	800mm (32")
50mm (2")	100mm (4")	100mm (4")	100mm (4")

Measurements provided are minimum required clearances to ensure sufficient working space within the Chamber.
The minimum diameter of the Messenger Pipe™ loop ('E') is determined by the chosen Messenger Pipe™

9.4 Options for Splice Box Location



Example of a typical splice enclosure

Depending on the application, the Messenger Pipe™ loop and fibre splice enclosure can either be located:

- a) Within the main chamber containing the entry and/or exit fittings
- b) In a separate small chamber, located adjacent to the main chamber
- c) In a street cabinet located adjacent to the main chamber

Options (a) and (b) would be utilised in circumstances where the pipeline owner wishes to grant access to the Messenger Pipe™ loop and fibre splice enclosure, without providing access to the main chamber containing the final fittings and, potentially, other pipeline assets.

Options (b) and (c) may be utilised, for example, when access is required by communication engineers, but the pipeline owner does not want to provide access to the pipeline asset for health and safety or security reasons.

When utilising Option (b) or Option (c), a short length of round-profile, smooth inner ducting is used to link the main chamber with either the separate chamber or the street cabinet.

Ducting should typically be 75mm/3" diameter and should be installed as straight as possible, with only mild, sweeping bends and no right-angled joints.

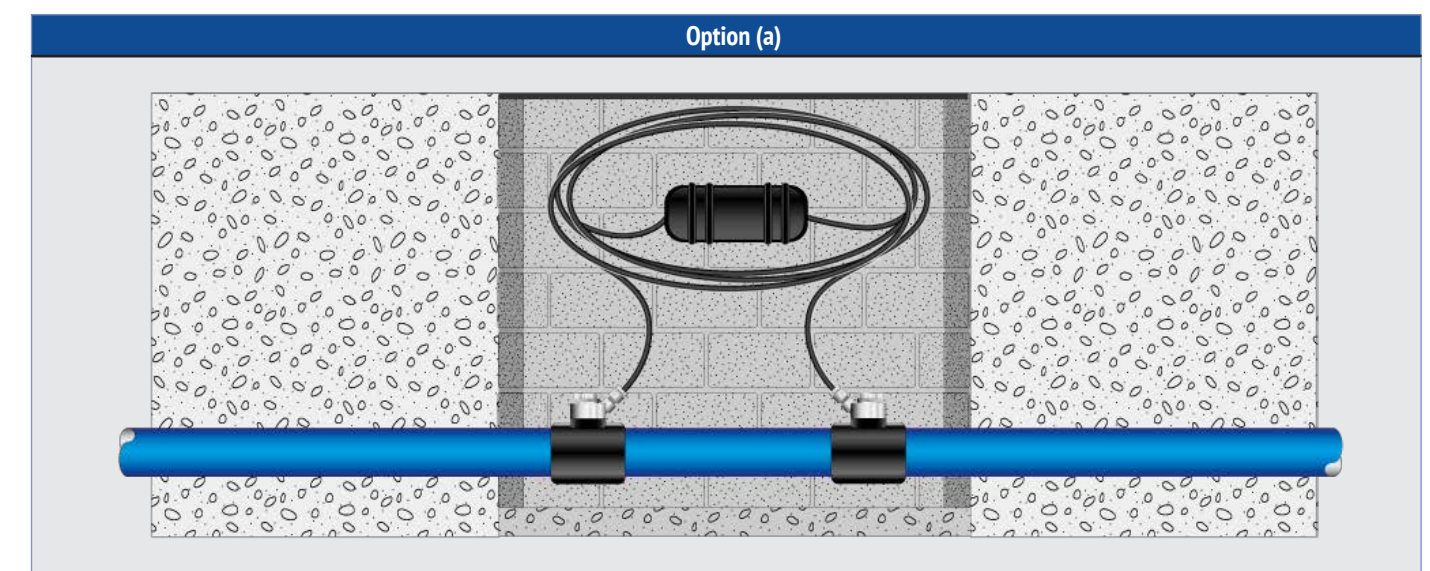

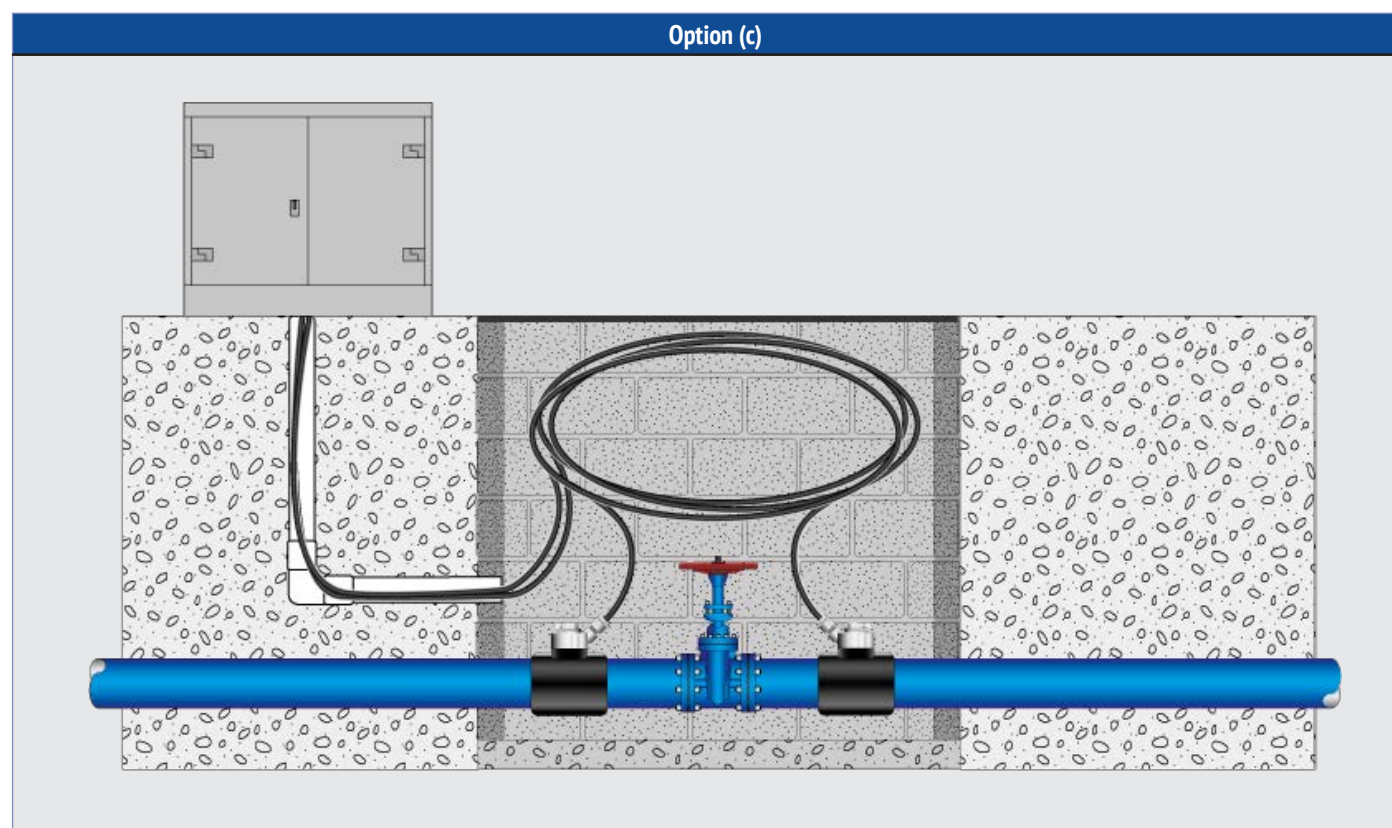
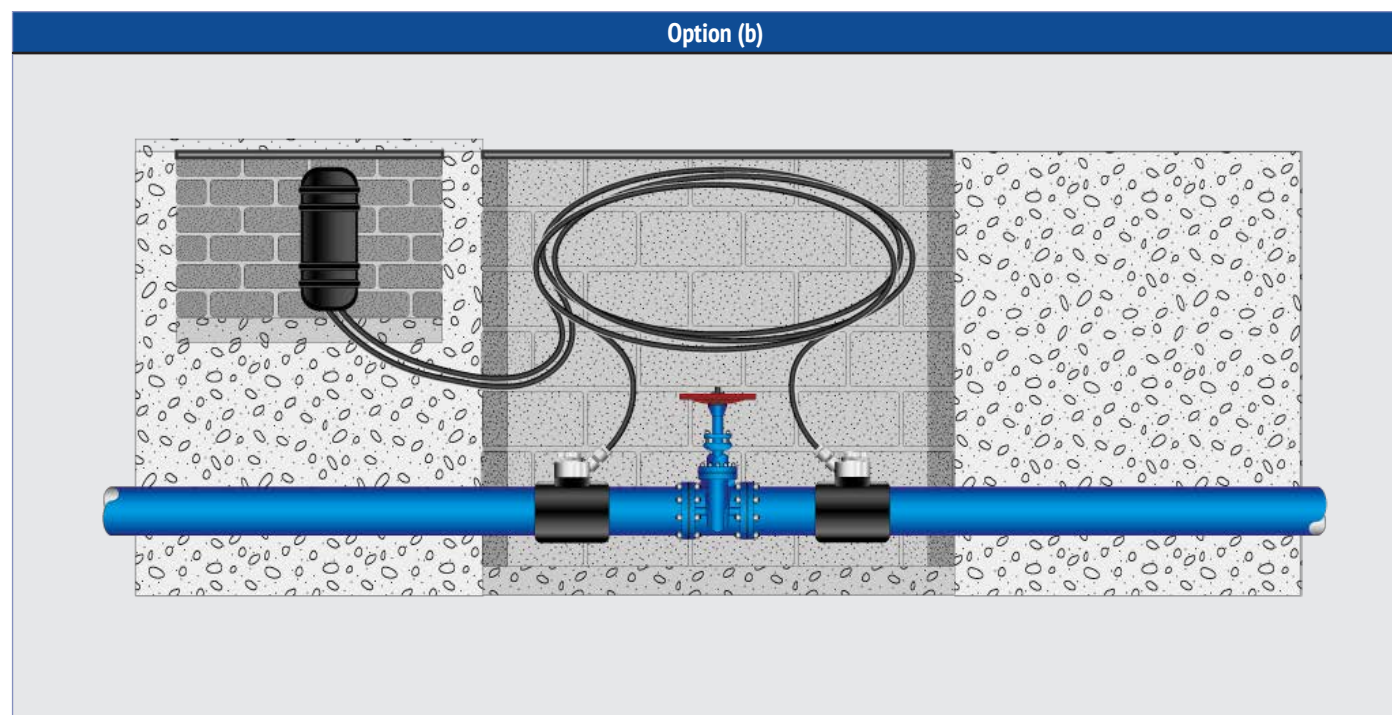

10. Pipeline Preparation

To ensure complete compatibility and familiarity, CRALEY Fibre™ Installation & Final Fittings are designed to interface with a variety of international standard saddles and ports.

10.1 Port Dimensions

The port dimensions depend on the CRALEY Fibre™ solution being utilised and, more importantly, the size of the Messenger Pipe™ and pipeline characteristics and specifications.

CRALEY Fibre™ Solution	3/4"	1"	2"	3"	4"	6"	8"
M-Series	Available	Available	Available	--	--	--	--
T-Series Vertical Entry	--	--	--	Available	Available	Available	Available
T-Series Angled Entry	--	--	--	Available	Available	Available	Available

10.2 Standard Port Interface

CRALEY Fibre™ Installation & Final Fittings can be manufactured to suit regional standards:

CRALEY Fibre™ Solution	Threaded Port		Flange Port		
	BSP ISO 228	NPT ANSI B1.20.1	EN1092	ISO7005	ASME/ANSI B16.5
M-Series Installation Fitting	Available	Available	--	--	--
M-Series Final Fitting	Available	Available	--	--	--
T-Series Vertical Entry Final Fitting	Available	Available	Available	Available	Available
T-Series Angled Entry Final Fitting	Available	Available	Available	Available	Available
T-Series Installation Fitting	Available	Available	Available	Available	Available

10.3 Example Port Options

When preparing the pipeline to accept the CRALEY Fibre™ fittings, the pipeline owner can choose their favoured port style, some examples of which are included in the following chart:

Welded Boss	Electrofusion	Mechanical
	<p>Top Fitting</p>	<p>Strap Saddle</p>
	<p>Wrap-around</p>	<p>Wrap-around Saddle</p>

11. Installation Techniques

11.1 Overview

There are three separate techniques which may be used within the CRALEY Fibre™ solutions portfolio to install a Messenger Pipe™ within a trunk or distribution water pipe.

They may be employed for either potable or non-potable/pre-treatment water pipes, full disinfection equipment and procedures may be used for both (further information may be seen in the chapter on Disinfection), or just potable water installations, depending on preference.

Each installation type has its merits for differing scenarios and the optimum technique is recommended by CRALEY Group according to circumstance.

For trunk and distribution water pipes the CRALEY Fibre™ VPFM Final Fittings are used to create the long-term pressure-proof seal for break-in/out access of the Messenger Pipe™ to the water pipe. These provide a vertical entry of the Messenger Pipe™ into the water pipe and have both upper and lower support springs to provide full protection and close containment for the Messenger Pipe™ as it enters the water pipe and exits the Final Fitting, also acting prevent kinking at these entry/exit points.

Access to the trunk/distribution water pipes for CRALEY Fibre™ installations is provided via a flange port, standard size options include DN80/3", DN100/4" and DN150/6", with dimensions and bolt hole PCDs according to local standards. Flange access is enabled using one of several methods, which can depend on pipe diameter, pipe material and sometimes Water Company preference:

- Wrap-around or strap-based saddle – typical for DI, CI, PVC & concrete pipes
- Weld-on flange boss – typical for steel pipes
- Electrofusion fittings – typical for HDPE pipes

The three techniques are as follows:

- Live Installation
- Semi-Live Installation
- De-pressurised Installation

Installation apparatus and fittings required differ among the techniques. Installation fittings for the Semi-Live technique are identical to but a sub-set of those for the Live technique. The De-pressurised technique uses its own set of simplified fittings.

All materials used in both Installation Fittings and Final Fittings are approved as safe for use within water networks and common throughout the industry (further information may be seen in the chapter on Materials in Contact).

The following are abridged descriptions of each installation method, End A is defined as the upstream location on the water pipe and End B is defined as the downstream location.

11.2 Live Installation

In this technique the water pipe maintains full pressure/flow and its normal operational regime throughout the installation.

Process flow includes the following steps:

- End A & End B saddle/boss and service valve fitted and pipe hot-tapped
- End A & End B custom spring locate device and sealing valve installed onto service valve flange
- End A the launch tube with disinfection chamber and parachute/draw-line is fitted
- End B the launch tube with magnetic grab/net capture device is fitted
- End A & End B Launch tubes and components are disinfected prior to install works
- End A the parachute is inserted live into the water flow and transits to End B
- End B the parachute is captured and withdrawn into the launch tube
- Inspection cameras allow viewing of the internal process at each end
- End B the service valve seals the draw-line
- End B the launch tube, and magnetic-grab/net-capture are removed
- End B draw-line is attached to Messenger Pipe™ via a cable-sock
- End B the Messenger Pipe™ Install Fitting and Disinfection Chamber are attached
- By combination of pull End A, and push End B the Messenger Pipe™ transits the water pipe
- End A the Messenger Pipe™ is withdrawn into the launch tube

- End A and End B the sealing valve is closed over the Messenger Pipe™
- End A & End B the launch tube assemblies removed
- End A & End B launch tube and support spring locate assemblies attached
- End A & End B sealing valve opened and support springs inserted
- End A & End B sealing valve closed over Messenger Pipe™
- End A & End B launch tube and support spring locate assemblies removed
- End A & End B Final Fittings are attached to sealing valve flange

The Live Installation technique is mainly used for larger diameter pipes (typically 300mm and above, where a Water Company requires no pipe downtime and normal operating to be maintained).

The Live Installation technique provides a benefit in not requiring downtime or pipe draining between certain installation stages, but is a more complex install process requiring more skill, taking longer and with more expensive install equipment and Final Fittings.

11.3 Semi-Live Installation

In this technique the water pipe requires one period of flow cessation, and if required pipe drain down, during the installation.

Process flow includes the following steps:

- End A & End B saddle/boss and service valve fitted and pipe hot-tapped
- End A the launch tube with disinfection chamber and parachute/draw-line is fitted
- End B the magnetic-grab capture device is fitted
- End A launch tube and components is disinfected prior to install works
- The parachute is inserted live into the water flow and transits to End B
- The parachute is captured by the magnetic-grab capture device at End B
- Inspection cameras allow viewing of the internal process at each end
- The in-line stop valves to each end of the install pipe section are closed
- The pipes section is drained as necessary
- End B the Messenger Pipe™ install fitting and disinfection chamber are attached
- End B draw-line is attached to Messenger Pipe™ via a cable-sock
- By combination of pull End A, and push End B the Messenger Pipe™ transits the water pipe
- End A the Messenger Pipe™ is withdrawn into the launch tube
- End A & End B the installation assemblies and service valves removed
- End A & End B Final Fittings are attached directly to the pipe flange
- The in-line stop valves to each end of the install pipe section are re-opened

The Semi-Live Installation technique is mainly used for medium diameter pipes (typically 200mm and above), and where larger diameter Messenger Pipe™ is required (e.g., 24/14), and for both of these where a Water Company requires minimal pipe downtime (noting smaller pipes require less drain down time where this is necessary).

The Semi-Live Installation technique provides a benefit in only requiring one pipe downtime and pipe draining period during installation, it is a less complex install process than a Live Installation requiring less skill, taking less time and with less expensive install equipment (which is a small sub-set of that required for Live Installation) and Final Fittings.

11.4 De-pressurised Installation

In this technique the water pipe requires two periods of flow cessation, and if required pipe drain down, during the installation.

Process flow includes the following steps:

- End A & End B saddle/boss and service valve fitted and pipe hot-tapped
- The in-line stop valves to each end of the install pipe section are closed
- The pipes section is drained as necessary and service valves may be removed at both ends
- End A the draw-line install fitting with disinfection chamber and parachute/draw-line is fitted
- End B the magnetic-grab capture device is fitted
- The in-line stop valves to each end of the install pipe section are re-opened
- The parachute transits via water flow to End B
- The parachute is captured by the magnetic-grab capture device at End B
- The in-line stop valves to each end of the install pipe section are closed
- The pipes section is drained as necessary
- End B the Messenger Pipe™ install fitting and disinfection chamber are attached
- End B draw-line is attached to Messenger Pipe™ via a cable-sock
- By combination of pull End A, and push End B the Messenger Pipe™ transits the water pipe
- End A the Messenger Pipe™ is withdrawn
- End A & End B the installation assemblies removed
- End A & End B Final Fittings are attached directly to the pipe flange
- The in-line stop valves to each end of the install pipe section are re-opened

The De-pressurised Installation technique is mainly used for small to medium diameter pipes (typically 100mm to 200mm), and where larger diameter Messenger Pipe™ is required (e.g. 24/14), and for both of these where a Water Company will accept two periods of pipe downtime (noting smaller pipes require much less drain down time where this is necessary).

The De-pressurised Installation technique does require two pipe downtime and pipe draining periods during installation, it is a minimal install process requiring minimal skill, more rapid in general and with least cost install equipment and Final Fittings.

11.5 Messenger Pipe™ Water Block Fittings

Once the Messenger Pipe™ has been installed in the pipe and the Final Fittings have been fitted, using whichever technique has been chosen, the system is ready for the blowing of the fibre cable (see section "16. Fibre Blowing" on page 64).

When installing the fibre, an additional length of fibre will extend beyond the end of the Messenger Pipe™. The length of this will vary case by case and according to the fibre containment method that is used; either in-Chamber, separate hand-hole or separate above-ground fibre enclosure. (see section "9.4 Options for Splice Box Location" on page 54).

It is advisable to add a Water Block Fitting to each end of the Messenger Pipe™. to provide a pressure-proofed seal to the Messenger Pipe™.

Water Blocks are optional, but recommended, purely as a precautionary measure in the unlikely event that the Messenger Pipe™ gets damaged in the pipeline, preventing water entering the chamber and/or fibre enclosure.

12. Proposed Madison County Install Technique

Proposed Madison County Technique:

DE-PRESSURISED

The following 2 pages provide a graphical description of the de-pressurised install process

Given the smaller diameter of water pipes for the installations in the Madison County projects, and the need to maximise Messenger Pipe™ sizes within these (to maximise fibre count), CRALEY Group propose that the De-pressurised Install technique would be optimal.

The relatively small diameter pipes (varying 4" to 12") and the fairly regularly placed in-line stop valves will mean that the two drain down periods per link install should be quite rapid.

This will provide for an optimally cost-effective install in terms of install fittings, final fittings and required labour skills.

The diagrams on the following 2 pages provide a graphical representation of the process-flow for the proposed de-pressurised Install technique.

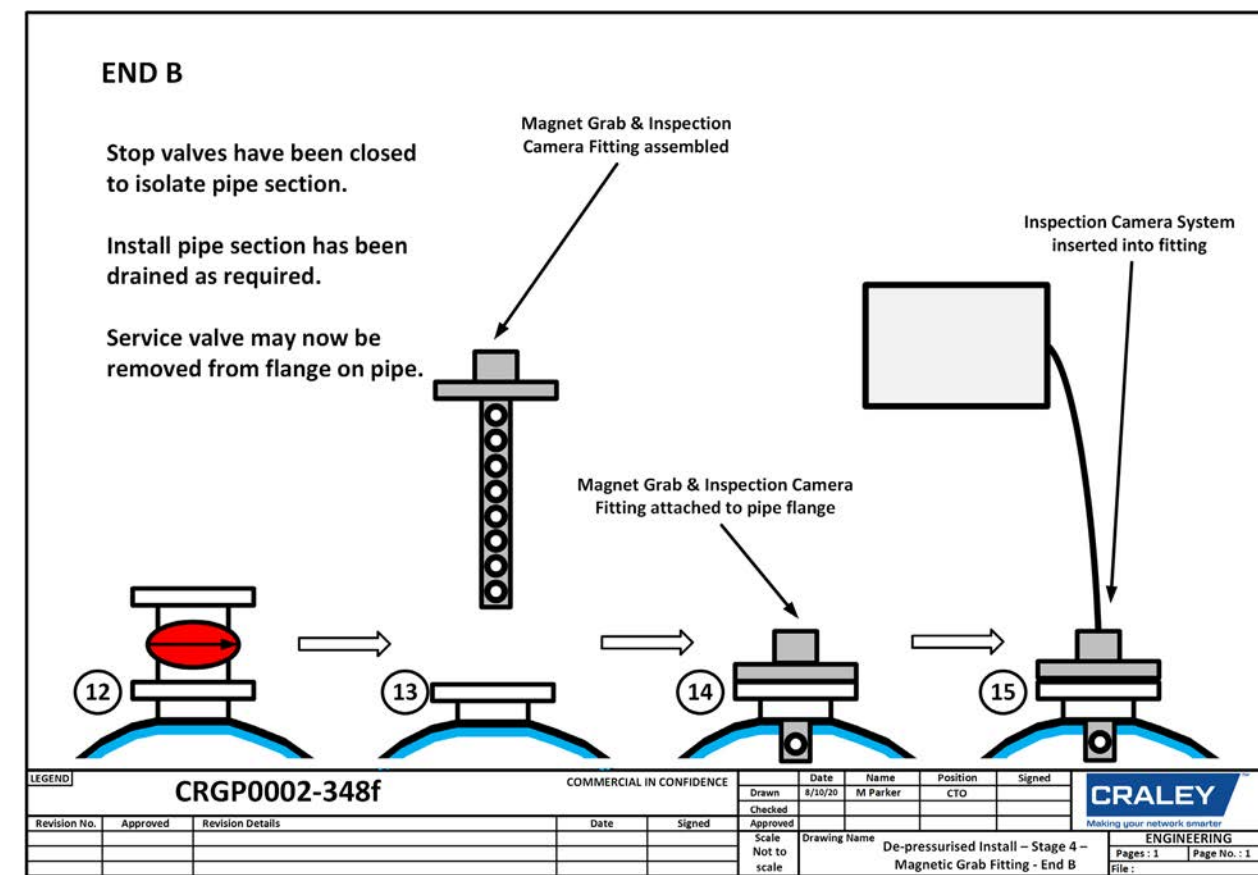
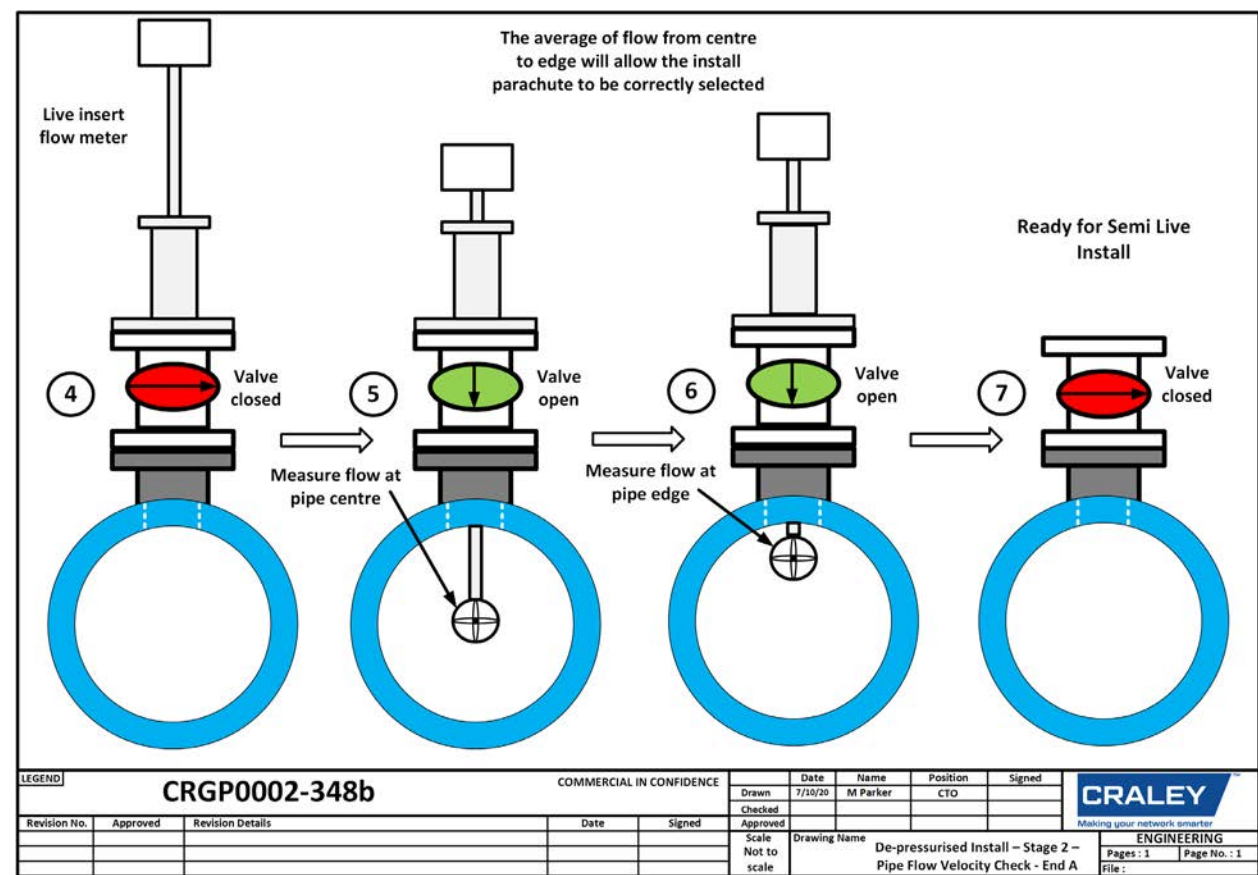
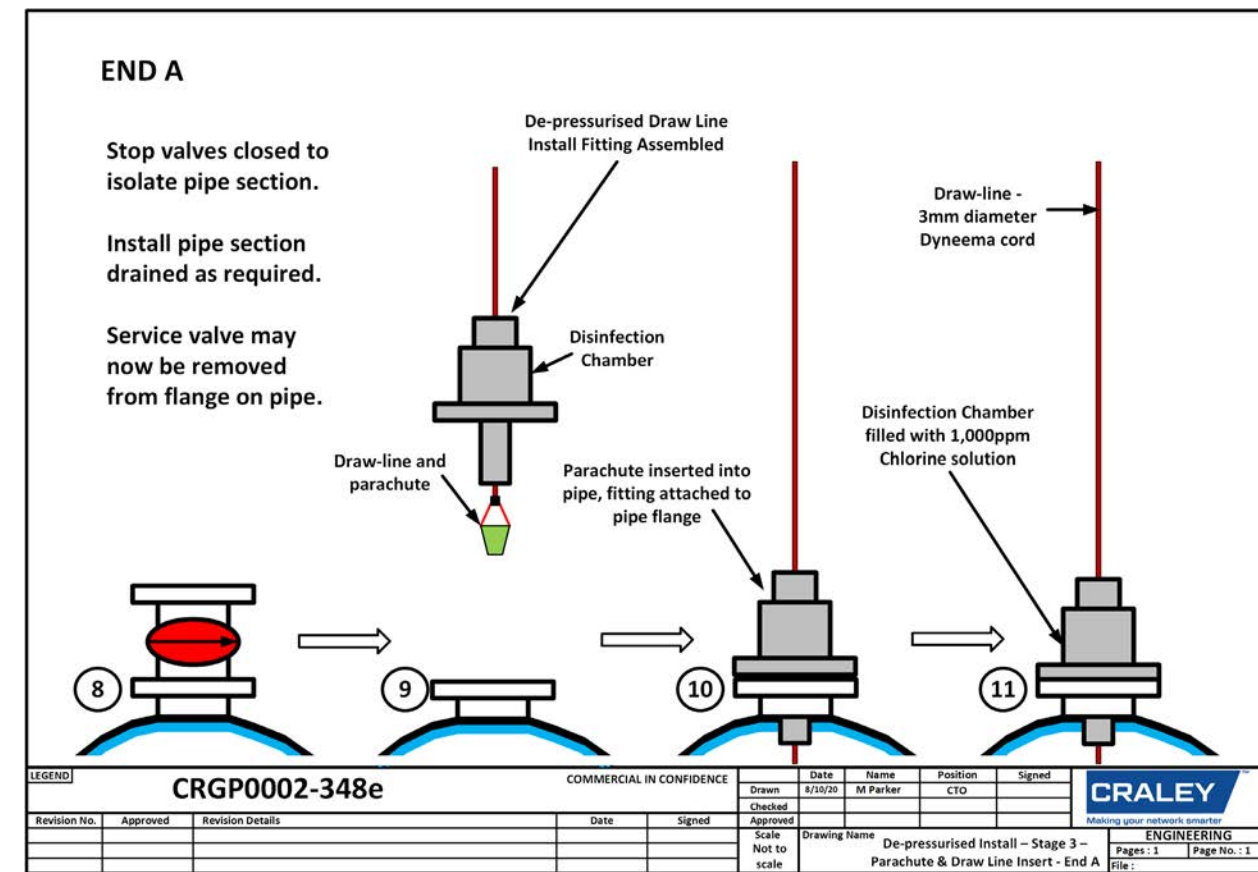
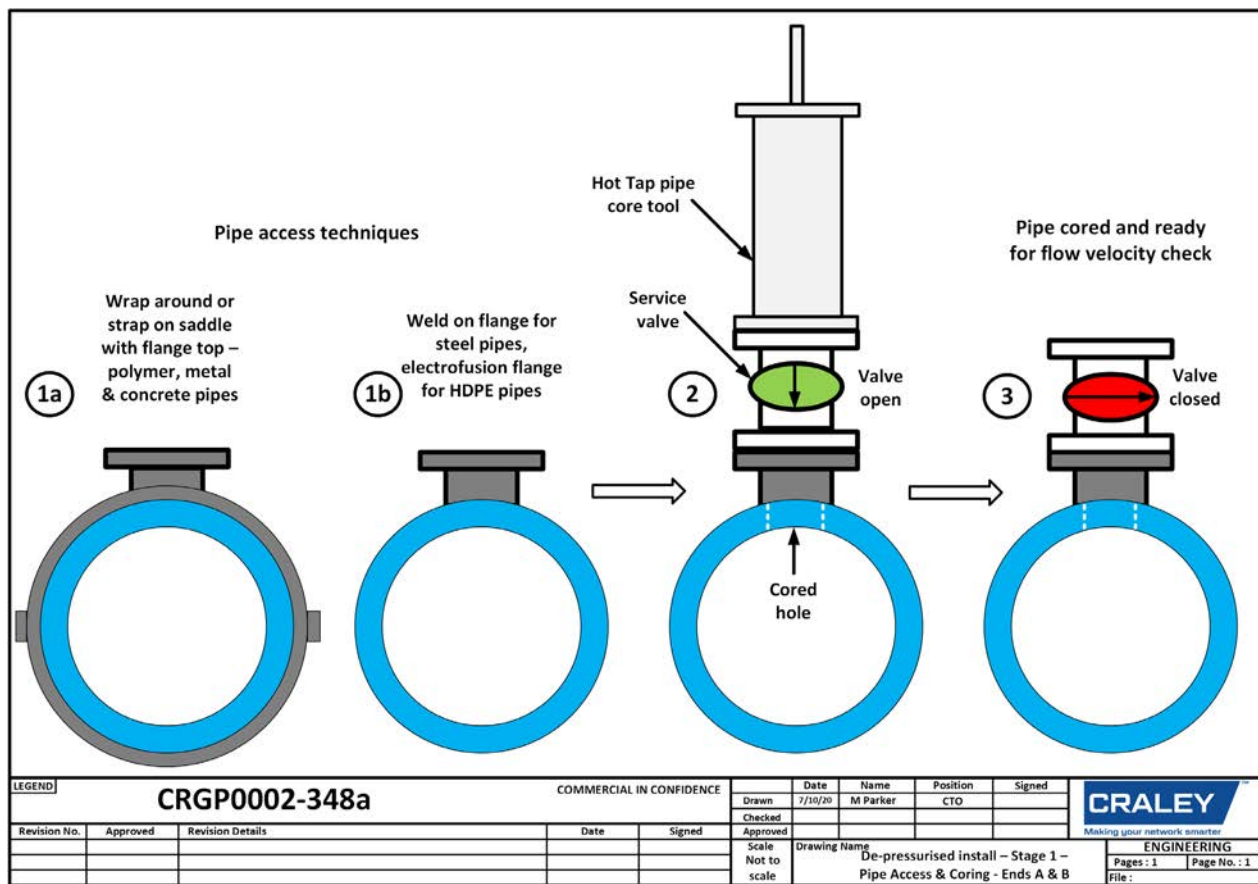

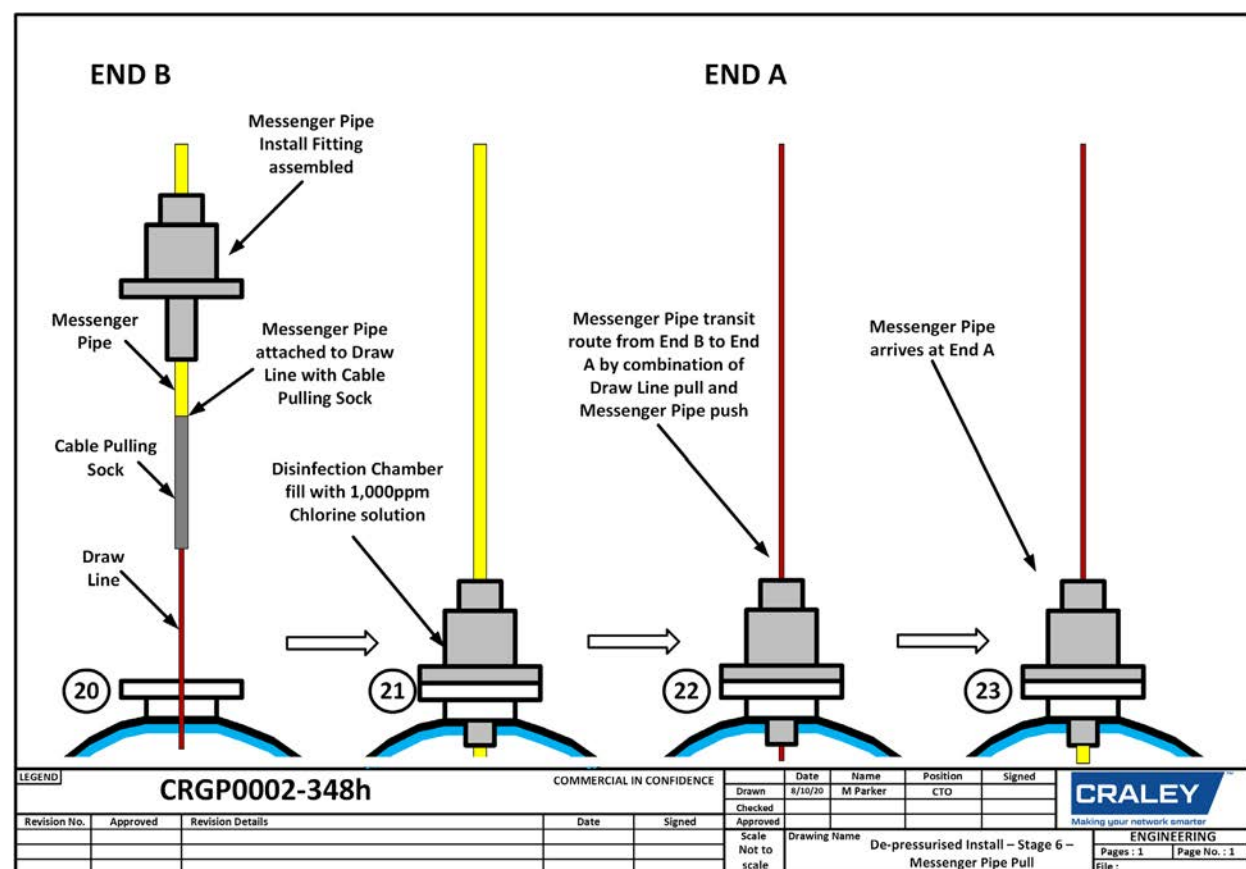
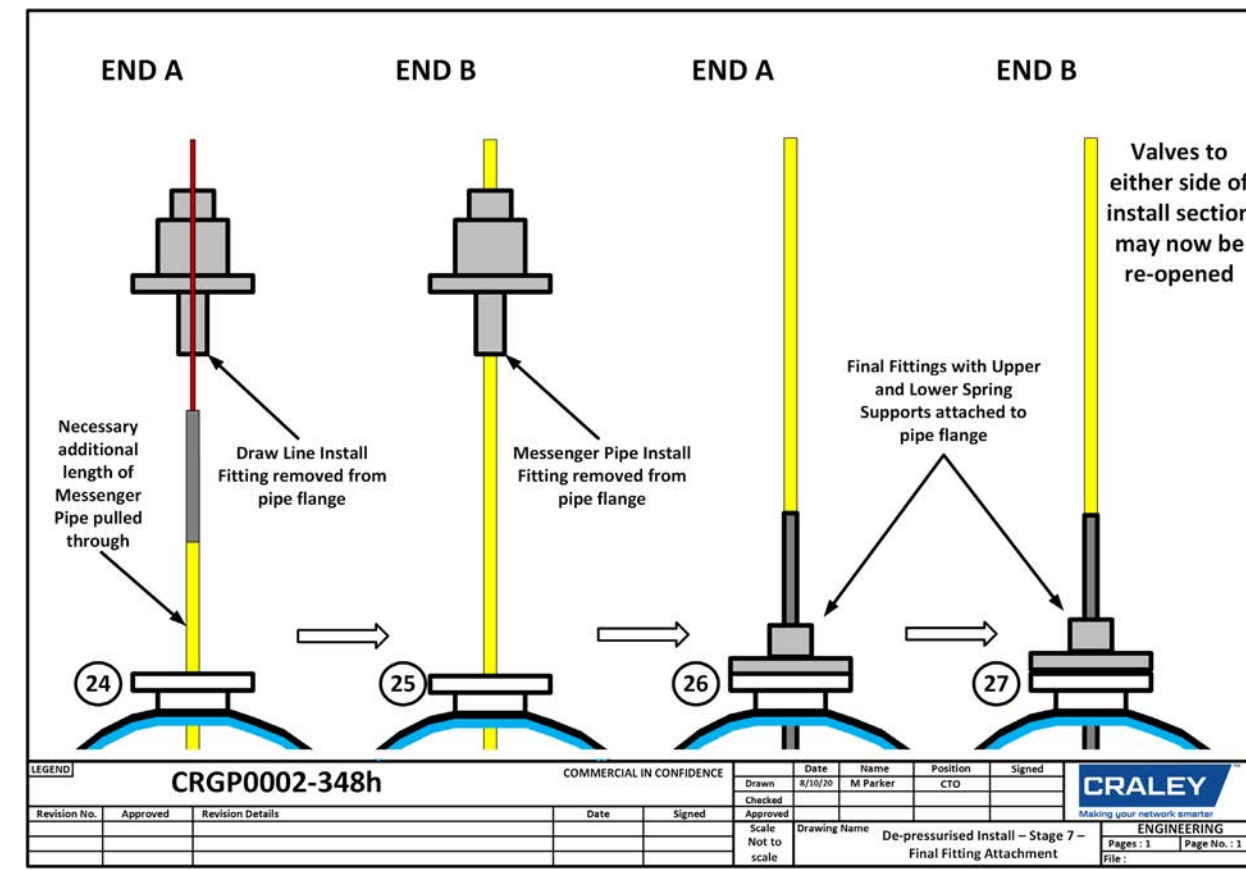
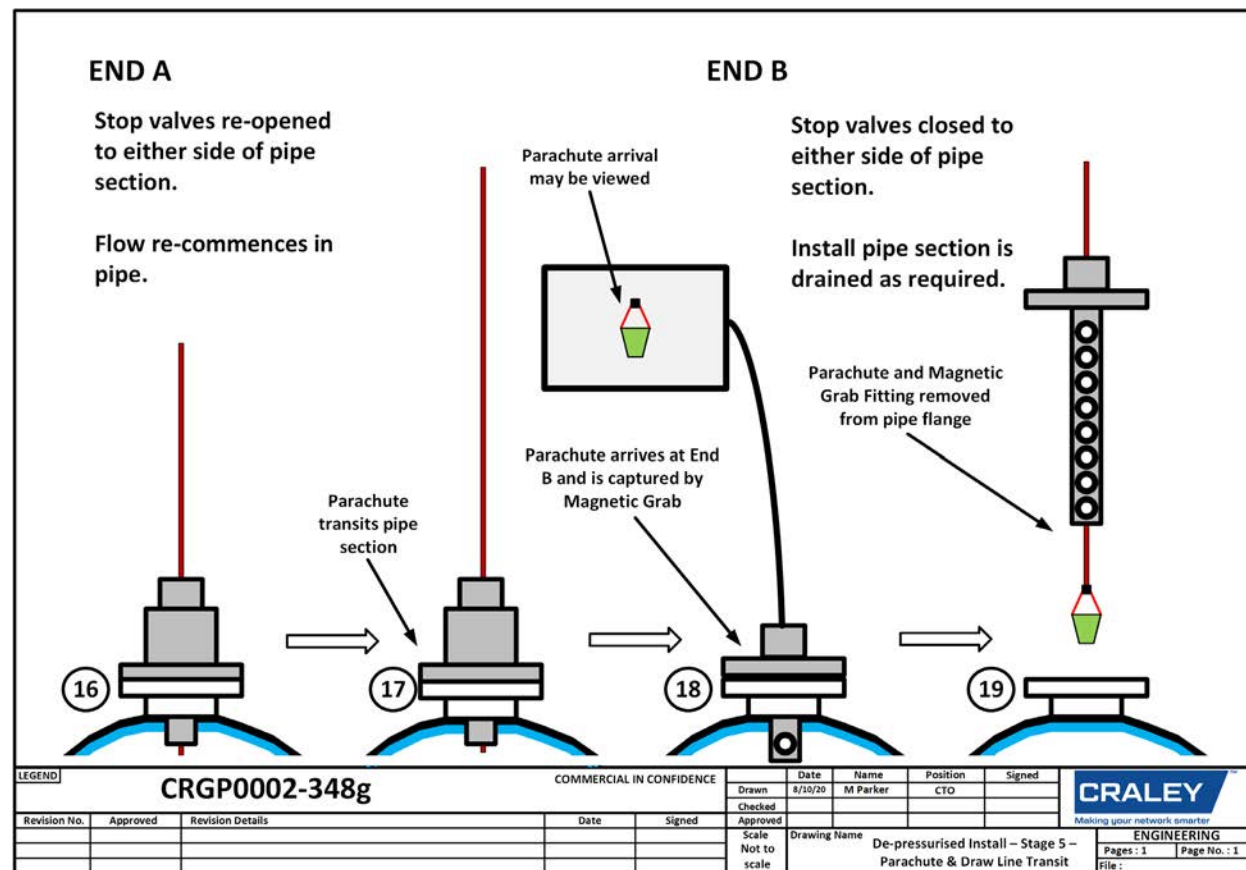

Flow m/s	Main Trunk Water Pipe Diameter - Parachute Diameter Scaling										Nominal Parachute Transit Speed	
	200mm	250mm	300mm	400mm	450mm	500mm	600mm	750mm	900mm	1,000mm	m/s	m/hour
0.3	175	225	250	350	400	450	550	700	700	700	0.06	216
0.4	175	225	250	350	400	450	550	700	700	700	0.08	288
0.5	175	225	250	350	400	400	500	600	700	700	0.1	360
0.6	175	225	250	300	350	400	450	550	600	600	0.12	432
0.7	175	225	250	300	350	400	450	500	500	500	0.14	504
0.8	175	200	250	300	350	350	400	450	450	450	0.16	576
0.9	150	200	225	250	350	350	350	400	400	400	0.18	648
1	150	175	225	250	300	300	350	350	350	350	0.2	720
1.25	150	175	200	250	250	250	250	250	250	250	0.25	900
1.5	150	150	150	200	225	225	225	225	225	225	0.3	1,080
2	100	150	150	175	175	175	175	175	175	175	0.4	1,440

Diameter

Parachute Sizing

The parachute to be used is selected on the following criteria:

- The measured flow velocity
- The water pipe diameter

The chart can be used to determine the correct size.

A typical insertion rate is <20% of the flow velocity, this will maintain tension in the draw line:

- The table shows typical parachute & draw line insertion speeds

LEGEND: CRGP0002-348c

Revision No.	Approved	Revision Details	Date	Signed

Drawn: 8/10/20, M Parker, CTO
Checked:
Approved:
Scale: Not to scale
Drawing Name: De-pressurised Install – Parachute Selection
ENGINEERING
Pages: 1 | Page No.: 1

13. Installation Equipment Required

13.1 Overview

Due to the variability of projects, installation equipment required is broken down into four specific groups:

- a) General Installation Kit
- b) Project Specific Installation Fittings and Accessories
- c) Local Market Items
- d) Optional equipment that would be useful

13.2 General Installation Kit

Comprises:

- Neutral Buoyancy Sonde Transmitter & LED POD
- Disinfection Chamber Sponge (+ 1 Spare)
- Stainless Steel Retrieval Hook
- Pack/10 of 3mm Aluminium Crimp Ferrules
- Pack/5 3mm Stainless Steel Cable Eyes
- Medium draw line drum containing 1,000m (3280ft) Dyneema® draw line
- CRALEY Fibre™ Water Grade Disinfection Pump Spray
- Pack/100 Chlorination Tablets (1 tablet to 1 Litre/2 pints of water for a 1,000ppm solution)

13.3 Project Specific Installation Fittings

Draw line Installation Fitting

- Upper Part
 - Type A: 4" ANSI Standard
- Lower Part
 - Type A: 150mm (6")

Magnetic Grab & Net Capture Fitting

- Upper Part
 - Type A: 4" ANSI Standard
- Lower Part
 - Type B: 200mm (8")
 - Type C: 250mm (10")

Messenger Pipe™ Installation Fittings

- Upper Part
 - Type C: 4" ANSI Standard
- Lower Parts
 - Type D: 400mm (16")
 - Type E: 450mm (18")
 - Type F: 500mm (20")

13.4 Project Specific Installation Accessories

- Long draw line reel containing 1,500m (4920ft) Dyneema® draw line
- Short draw line reel containing 500m (1640ft) Dyneema® draw line
- CRALEY Fibre™ 24mm Water Blocks

13.5 Items to be sourced in the local market

Tools and equipment that can be readily purchased in the local market, preventing any unnecessary shipping costs and import duties.

- Edge and Surface Rollers to prevent damage to the Messenger Pipe™ (See "15.6 Use of Messenger Pipe™ Rollers" on page 63)
- Drum Reelers or Flange Reelers (See "15.3 Unwinding the Messenger Pipe™" on page 62)
- Endoscope (See "13.7 Endoscope Specification" on page 60)
- Heavy Duty Crimping Tool for 3mm Crimp Ferrules
- Water-based, approved lubricants:
 - In Europe: Hydro Gliss® Gel: Type Approval to EU Regulations
 - In the USA: Phoenix XL Dispersible Pipe Joint Lubricant - NSF Certified
- Nitrile Gloves
- Hand sanitiser and cleaning cloths
- General hand tools
- Wastewater pump

13.6 Optional equipment which would be useful

- 33kHz Utility CAT-Scanner
- Live insert flow-meter with 4" flange adaptor
- Cable length meter

13.7 Endoscope Specification

The CRALEY Fibre™ Mag Grab & Net Capture Installation Fitting incorporates a special port in which an endoscope can be inserted to provide a visual reference of the parachute arriving at End B.

Specification :

- Standard 7mm diameter head endoscope
- USB port interface that is compatible with the chosen viewing device – phone/tablet/PC
- Minimum resolution 2MegaPixels
- USB cable with minimum length of 5m/15'

13.8 Overview of Installation Fittings and Accessories

Draw Line Installation Fitting

The Draw Line Installation Fitting is used at End A to insert and transit the draw line.

It comprises an upper flange body to interface to the provided pipe flange and a lower body, scaled in length to suit the pipe saddle flange neck length and pipe wall thickness.

The upper fitting has a disinfection chamber which uses a chlorine-based solution to disinfect the draw line prior to entry into the water pipe.

The upper fitting is additionally provided with a water vent chamber below the disinfection chamber to allow any small water seepage between the hydraulic seals and the woven draw line to be safely removed, and prevent any dilution of the chlorine solution in the disinfection chamber.

The Draw Line Fitting provides for the use of 3mm Dyneema® draw line, and is provided with hydraulic seals to provide a pressure-proofed containment.

The lower fitting is provided with rollers to allow smooth and friction-free transition of the draw line. The Draw Line Fitting is manufactured from machined Stainless Steel 316 grade.

Magnetic Grab & Net Capture Fitting

The Magnetic Grab & Net Capture Installation Fitting is used at End B to capture the parachute once it has transited the route.

It comprises an upper flange body to interface to the provided pipe flange and a lower body, scaled in length to suit the pipe saddle flange neck length and pipe diameter.

The upper fitting has hydraulic seals which allow the pressure-proofed introduction of the lower fitting components.

The lower fitting includes an expandable net capture device, a magnetic grab-bar and an inspection camera/illumination port.

The magnetic grab bar acts to catch the parachute on arrival at End B.

The inspection camera/illumination allows viewing of the arrival and capture of the parachute.

The expandable net capture element is a fail-safe device to ensure that the parachute cannot transit beyond the End B location.

The Magnetic Grab & Net Capture Fitting is manufactured from machined Stainless Steel 316 grade.

Messenger Pipe™ Installation Fitting

The Messenger Pipe™ Installation Fitting is used at End B to insert the Messenger Pipe™, which is then pulled back to End A using the inserted draw line.

It comprises an upper flange body to interface to the provided pipe flange and a lower body, scaled in length to suit the pipe saddle flange neck length and pipe diameter.

The upper fitting has a disinfection chamber which uses a chlorine-based solution to disinfect the draw line prior to entry into the water pipe.

The lower fitting is provided with a spring support device which allows smooth transition of the Messenger Pipe™, and acts to prevent any damage or kinking during the insertion process.

The Draw Line Fitting is manufactured from machined Stainless Steel 316 grade.

Parachute

A parachute is scaled appropriately to suit the internal pipe diameter and the prevailing flow velocity in the pipe in which the link is being installed to provide sufficient pull force for the draw line to transit along the pipe section.

The parachute has a central front opening to ensure centralisation within the pipe and reliable/stable transit.

The parachute is provided with a front mounted disc which is caught by the magnetic grab bar on arrival at End B.

Sonde Pod

The sonde pod is located within the parachute.

It runs a 33kHz transmitter allowing the parachute transit progress to be monitored from above ground during installation.

A standard utilities CAT scanner is used to track the parachute progress.

The sonde pod additionally has front facing LED illumination to allow easy viewing of arrival at End B via the inspection camera port in the Magnetic Grab & Net Capture Fitting.

Draw Line

The Draw Line is a 3mm diameter Dyneema® woven cord, made from high density polyethylene (HDPE).

It provides neutral buoyancy, and a very low surface friction for optimally efficient transit and parachute pull.

The 3mm Dyneema has a high breaking strain of 995kg/2,200lbs to provide a robust means to pull in the Messenger Pipe™.

Final Fitting

The Final Fitting is installed at the entry and exit locations once the installation of the Messenger Pipe™ has been completed.

It comprises an upper flange body to interface with the provided pipe flange and a lower body, scaled in length to suit the pipe saddle flange neck length and pipe diameter.

The upper fitting has a spring support device to protect the Messenger Pipe™ and prevent the possibility of kinking at the interface.

The Final Fitting is provided with triple O-Ring seals with intervening stainless load spreading discs to provide a pressure-proofed containment.

The lower fitting is a spring support device to protect the Messenger Pipe™ and prevent the possibility of kinking.

The Final Fitting is manufactured from machined Stainless Steel 316 grade.

14. Messenger Pipe™ Impact on the Hydraulic Regime

14.1 Overview

Introduction of a Messenger Pipe™ into a water pipe marginally decreases the cross-sectional area for water flow and marginally increases the internal surface area. The combination of these leads to a marginal increase in pressure head-loss when a Messenger Pipe™ is located inside a water pipe.

The effective marginal incremental pressure head-loss is a function of several parameters, including water pipe internal diameter, Messenger Pipe™ external diameter and water flow velocity. There are standard hydraulic calculation techniques to assess pressure head-loss in pipes with a fluid flow.

14.2 Madison County Lex Road Analysis

The following guideline calculations (based on Colebrook-White) have been made for the prevailing hydraulic regimes in the pipe sections for the proposed Lex Road route, which include segments with the following characteristics:

- 12" PVC – nominal 1.34 feet/second flow velocity
- 10" PVC – nominal 1.84 feet/second flow velocity
- 8" PVC – nominal 2.54 feet/second flow velocity
- 8" PVC – nominal 2.87 feet/second flow velocity

The following data shows guideline calculations assuming that a 24/14 (24mm outside diameter) Messenger Pipe™ is located within each of these water pipes for the given nominal flow velocities. It can be seen that the effect of introducing the Messenger Pipe™ is very small with no noticeable effect on the prevailing pipe hydraulic regimes.

12" PVC Pipe

- Flow velocity – 1.34 feet/second
- Cross sectional pipe area reduction – 0.56%
- Pressure head-loss with no Messenger Pipe™ - 1.069 psi/mile
- Pressure head-loss with 24/14 Messenger Pipe™ - 1.178 psi/mile
- Incremental pressure head-loss with 24/14 Messenger Pipe™ - 0.071 psi/mile

10" PVC Pipe

- Flow velocity – 1.84 feet/second
- Cross sectional pipe area reduction – 0.8%
- Pressure head-loss with no Messenger Pipe™ - 2.684 psi/mile
- Pressure head-loss with 24/14 Messenger Pipe™ - 3.028 psi/mile
- Incremental pressure head-loss with 24/14 Messenger Pipe™ - 0.345 psi/mile

8" PVC Pipe 1

- Flow velocity – 2.54 feet/second - incorrect
- Cross sectional pipe area reduction – 1.2%
- Pressure head-loss with no Messenger Pipe™ - 5.615 psi/mile
- Pressure head-loss with 24/14 Messenger Pipe™ - 6.683 psi/mile
- Incremental pressure head-loss with 24/14 Messenger Pipe™ - 1.068 psi/mile

8" PVC Pipe 2

- Flow velocity – 2.87 feet/second
- Cross sectional pipe area reduction – 1.2%
- Pressure head-loss with no Messenger Pipe™ - 7.166 psi/mile
- Pressure head-loss with 24/14 Messenger Pipe™ - 8.443 psi/mile
- Incremental pressure head-loss with 24/14 Messenger Pipe™ - 1.277 psi/mile

15. Messenger Pipe™ Handling

15.1 Storage

All complete lengths of Messenger Pipes™ will be provided on approved cable reels of various sizes and weights. For reels that contain Messenger Pipes™ larger than 10mm (3/8") in diameter, the reels should always be stored vertically on their flanges:

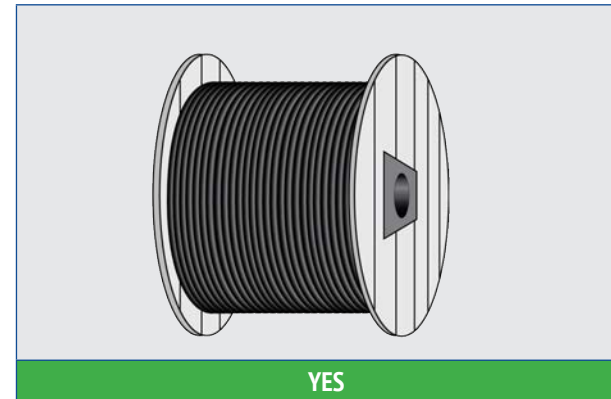
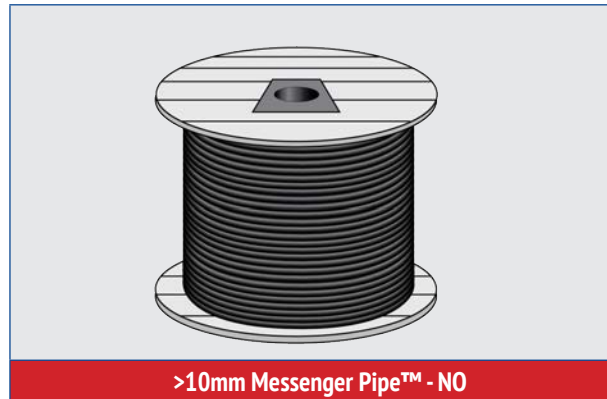

15.2 Lifting

Only lifting equipment of sufficient size and weight should be used to lift Messenger Pipe™ reels.

When lifting cable reels by forklift truck, the cable flanges should be at right angles to the forks, and the forks should be longer than the width of the drum.

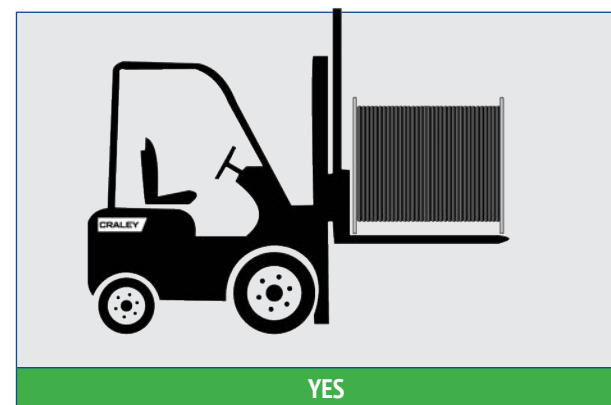
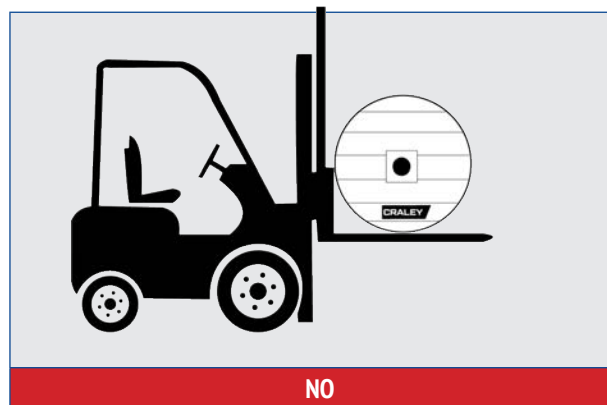
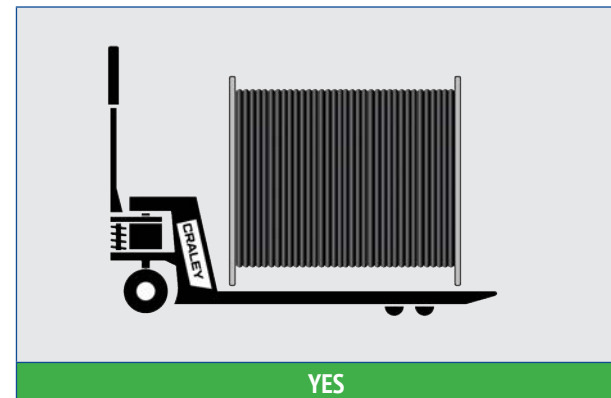
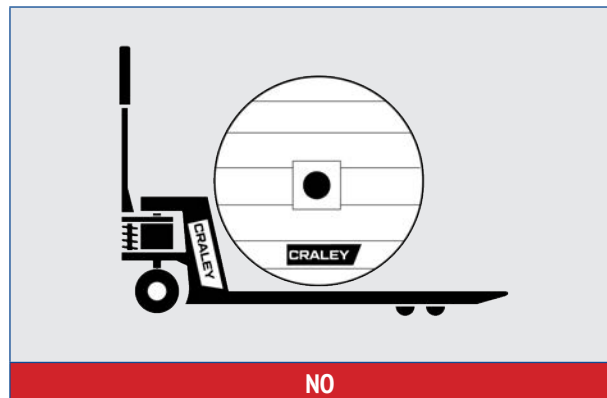

15.3 Unwinding the Messenger Pipe™

Messenger Pipe™ should only be unwound from the cable reel using appropriate cable reel handling equipment and should never be unwound from the reel whilst the reel is laying on its side, as this will cause the Messenger Pipe™ to spiral and potential cause irreparable damage.

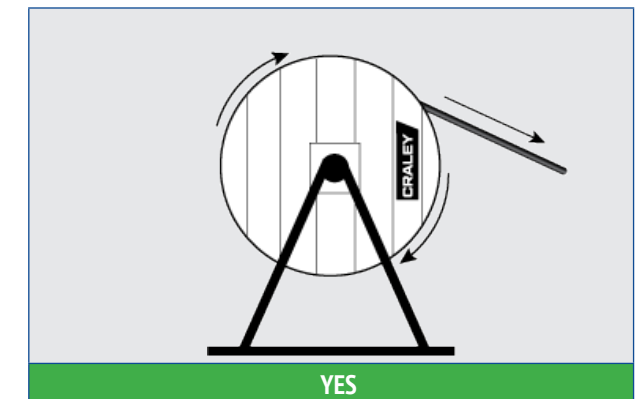
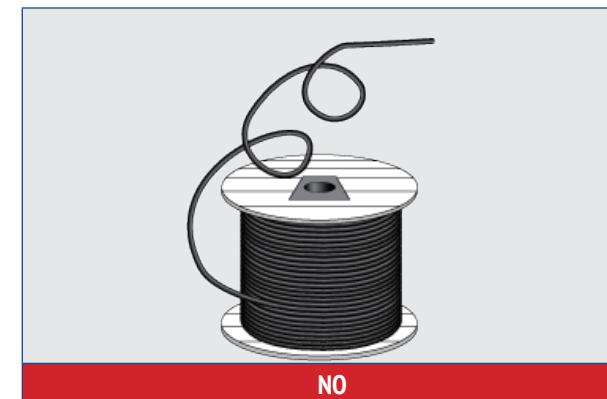

When unwinding the Messenger Pipe™, whether in a warehouse environment or on-site, you should always use cable rollers or cable jacks with the appropriate weight rating for the gross weights of the Messenger Pipe™ reel.

Examples of the correct equipment are:

- Cable Axle Stands
- Hydraulic Cable Jacks
- Cable Drum Rollers
- Cable Drum Flange Rollers

These are generally available in local markets, however, if you have any problems sourcing the correct item CRALEY™ can arrange to have the item shipped from the UK.

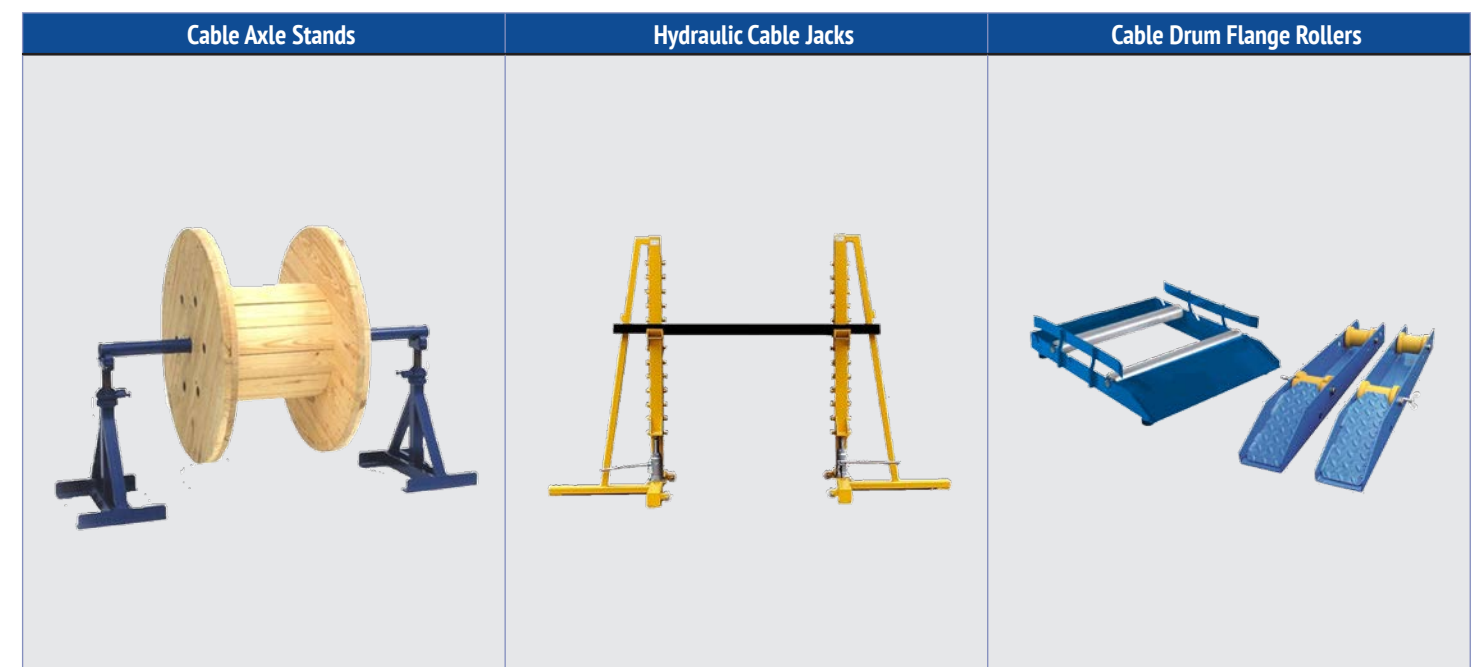

15.4 Rewinding the Messenger Pipe™

Should the need require to wind the Messenger Pipe™ from one reel to another, for example, if you need just a short length from a larger drum, ensure that the Messenger Pipe™ is wound on the new drum in the same direction as was wound on the original drum.

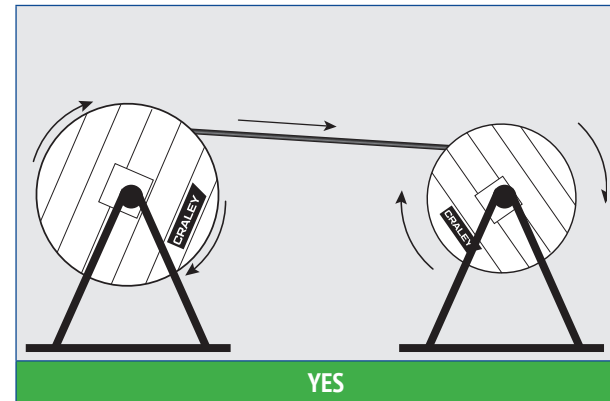
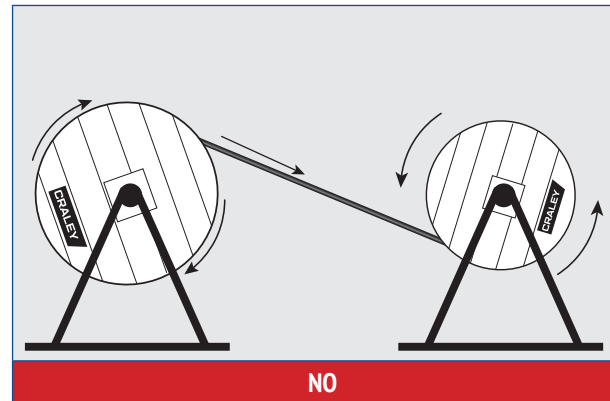

15.5 Messenger Pipe™ Minimum Bend Radius

Whilst the Messenger Pipe™ is very robust, permanent damage can occur if it is bent beyond its minimum bend radius of 15x the diameter.
e.g. 10mm (3/8") Messenger Pipe = 150mm (6")

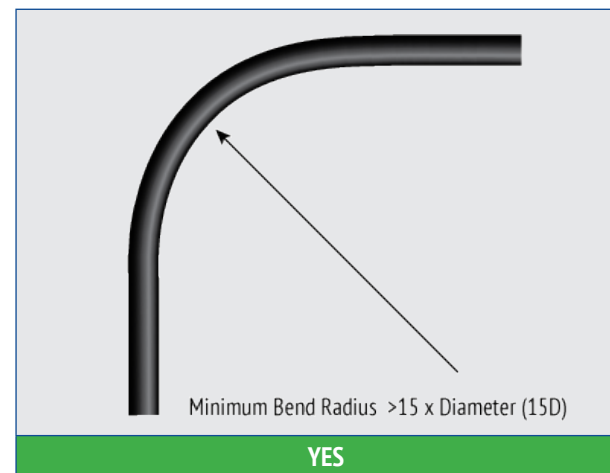
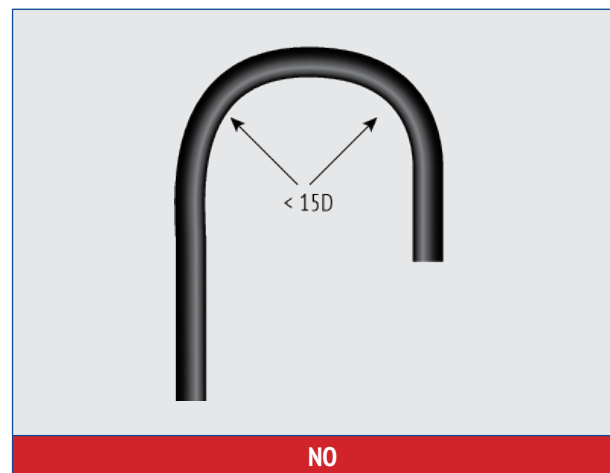

Messenger Pipe Diameter	Minimum Bend Radius - Metric	Minimum Bend Radius - Imperial
5mm	75mm	3"
10mm	150mm	6"
14mm	210mm	8 3/8"
16mm	240mm	9 3/8"
24mm	360mm	14 1/4"

15.6 Use of Messenger Pipe™ Rollers

It is important the Messenger Pipe™ rollers are used during the installation process when potential obstructions and/or objects may cause the Messenger Pipe™ to get damaged. For example, using edge rollers when the Messenger Pipe™ is entering a chamber.

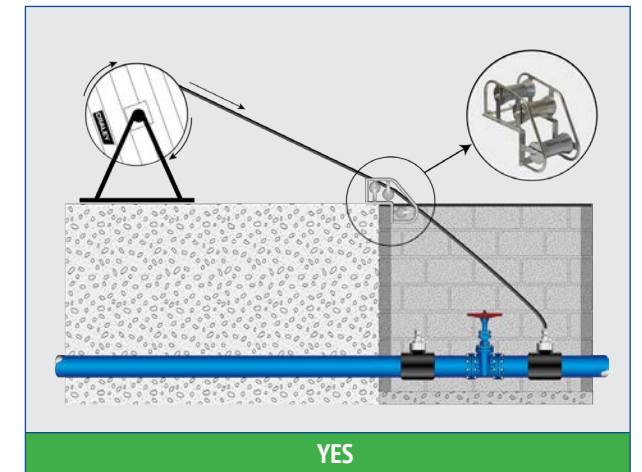
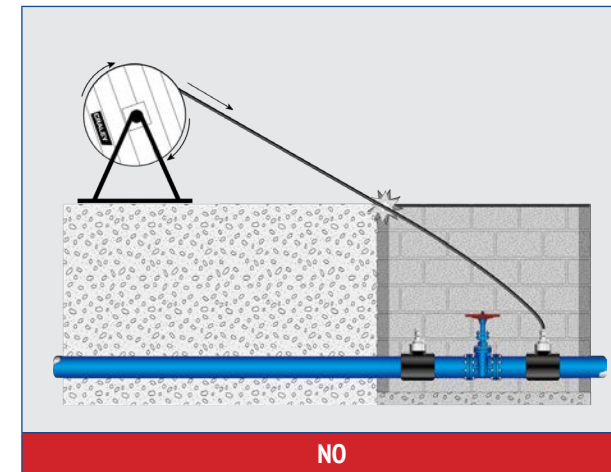

Surface Rollers should be used, when the Messenger Pipe™ is being routed over obstructions, for example, over a wall or similar:

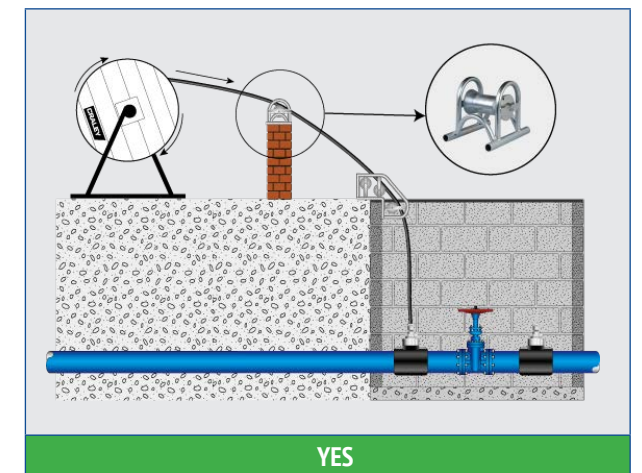
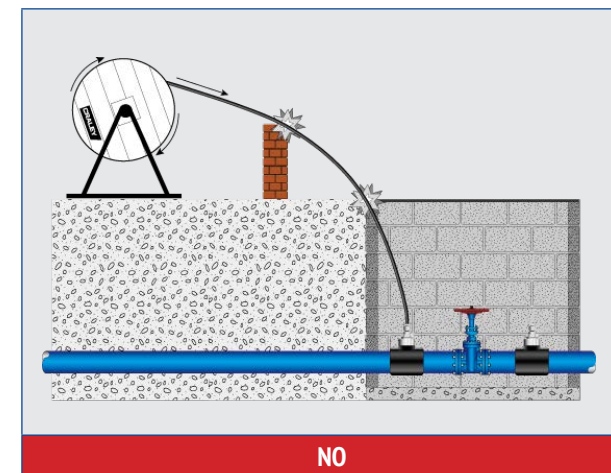

16. Fibre Blowing

16.1 Fibre Blowing Overview

Fibre Blowing, or sometimes referred to as Fibre Jetting, is a standard technique utilised within the telecommunications industry to insert a fibre cable into an existing duct, or in the case of CRALEY FibreTM, an existing Messenger PipeTM.

The fibre is inserted through the Messenger PipeTM and is propelled forward using compressed air, which is pumped into the Messenger PipeTM and effectively 'floating' the fibre cable in. The effect of the compressed air is to reduce the friction between the fibre cable and the Messenger PipeTM wall, much like the puck on an air-hockey table; without air, the puck cannot easily move, but with air, the puck glides effortlessly across the table.

It is always recommended to use a dehydrator in conjunction with the air compressor and the fibre push machine as, depending on the prevailing relative humidity %, water vapour may condense under pressure into droplets which may cause sticking of the fibre cable to the Messenger PipeTM inner wall.

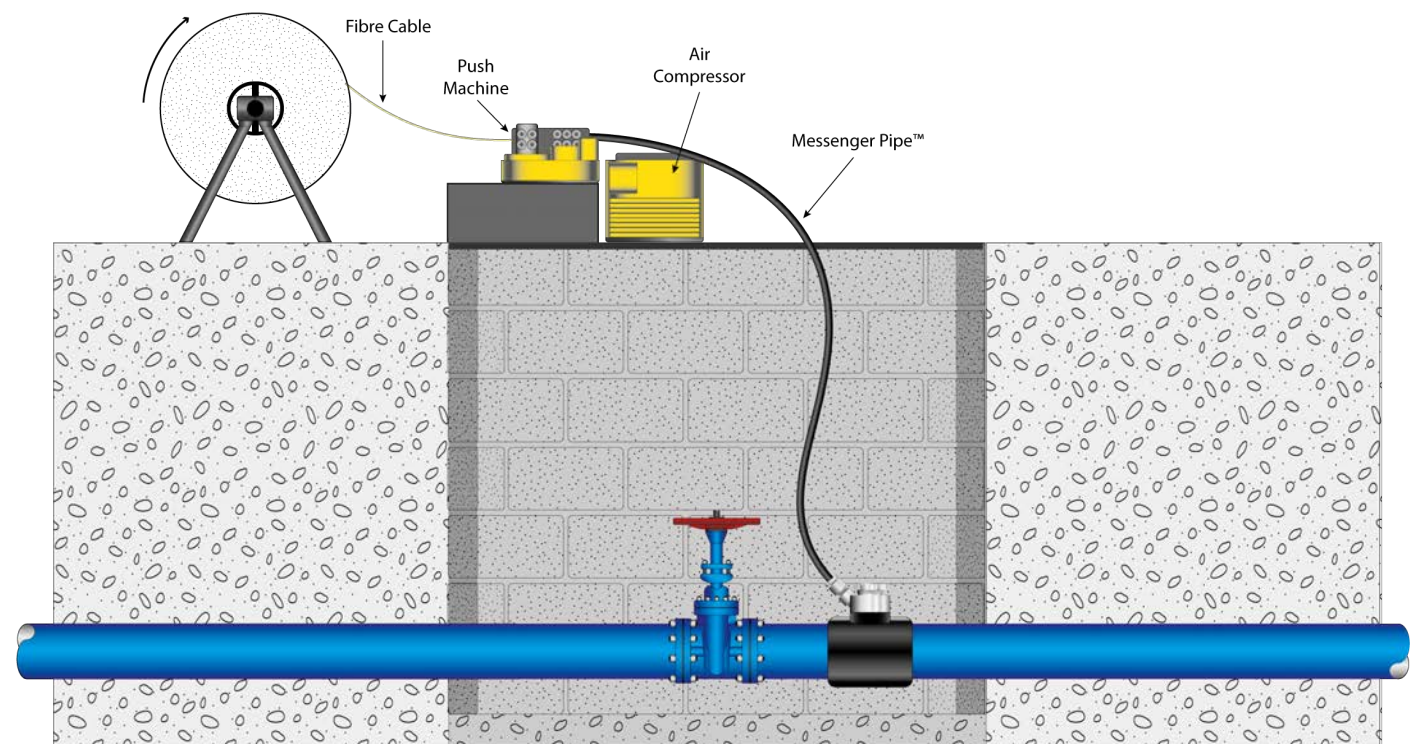

With adequate training, Fibre Blowing is a relatively easy process, and it is therefore perfectly feasible for anyone to purchase or hire the necessary equipment and carry out the fibre insertion process themselves, however, this will require some investment in training and equipment.

The decision of whether to carry out the fibre blowing in-house will depend much upon the frequency of which the process will be required, and whether investing in the necessary training and equipment offers an acceptable ROI, however, in all territories around the world there are companies that specialise in offering fibre blowing services should in-house fibre blowing not be an option.

16.2 Messenger Pipe Fill Ratio (MPFR)

The ratio between the inner Messenger Pipe™ bore and the outer diameter of the fibre cable is known as the Messenger Pipe™ Fill Ratio (MPFR).

You can easily calculate the MPFR using the formula

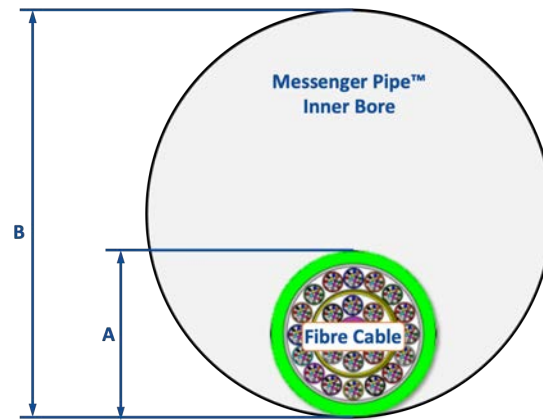

$$\text{MPFR} = \frac{A^2}{B^2} \times 100$$

A is the Outer Diameter of the Fibre Cable

B is the Inner Bore Diameter of the Messenger Pipe™

For optimal blowing performance, the ratio between the Messenger Pipe™ bore and the cable diameter should be between 30 and 80% for cable of less than 10mm (3/8") in diameter, and 30-50% for cables greater than 10mm (3/8") in diameter.

For example: The MPFR for an 8.9mm fibre cable, inserted into a Messenger Pipe™ with an internal bore of 14mm, would be:

8.9² is 79.21 and 14² "is 196, therefore:"

$$\frac{79.21}{196} \times 100 = \text{MPFR of } \mathbf{40.41\%}$$

Higher MPFR levels, but within the stated ratios, will result in greater insertion distances being achieved, particularly in any CRALEY Fibre™ links that are relatively straight. If the MPFR is exceeded, it will reduce the insertion distance capabilities, particularly in CRALEY Fibre™ link that have multiple bends.

When Fibre Blowing, air pressure is more critical than air volume; air volume is usually referred to as cubic feet per minute (CFM).

The ideal maximum and minimum pressures are:

- Minimum: 10 bar (145psi) at 18 CFM
- Maximum: 15 bar (217psi) at 35CFM

As the air pressure increases it reduces the tendency for the fibre to come into contact with the Messenger Pipe™ wall, therefore reducing the friction.

17. Training and Supervision Services Overview

Installation Training

CRALEY Fibre™ Training will be provided to nominated installation staff (both in-house and contract as applicable), this will take the form of presentation tutorials, example videos and live demonstrations. In the event of COVID related restrictions still in place at the time of the training, this will be provided in live virtual format on-line.

Training content is designed to ensure that installation staff are fully familiar with and confident in the following aspects:

- All installation equipment and its purpose
- Configuration and set-up of installation equipment
- Processes and procedures for all steps within an installation
- Disinfection and HSE aspects of installations
- Mitigation strategies for any issues that may be encountered
- A link-by-link coverage and walk-through of requirements for the project

Training courses are fully inter-active, allowing adequate time for discussions and for attendees to participate in Q&A sessions at each stage, to ensure full understanding of the course materials.

Project Set-up Support

CRALEY will work with the customer to provide assistance in joint development of project specific documentation for the following aspects:

- Scope of Works
- Finalised definitions of vault builds and civils
- Project Procedures
- RAMS (Risk Assessment & Method Statement)
- Water safety protocols, standards and regulations

Project Management Support

CRALEY will work with the customer to provide assistance on an on-going basis during the project roll-out for the following Project Management aspects:

- Monitor CRALEY Fibre™ project activities
- Provide periodic reports of CRALEY Fibre™ project activities (weekly/monthly as desired)
 - Status against schedule
 - Any identified delays, reasons, and actions for mitigation
- Coordination of CRALEY Fibre™ project activities
 - Additional sites information gathering
 - Equipment delivery and installation date co-ordination
 - Scheduling and performance of installs
 - Preventative or corrective actions to resolve any issues encountered
- Project Completion
 - Sign off documentation
 - As-built documentation

Installation Support

CRALEY will provide an initial on-site mentoring support for a period of two weeks at the commencement of the project roll-out. In the event of COVID related restrictions still in place at the time of the project roll-out commencement, this will be provided by electronic means (email, messaging, audio and live video, as appropriate).

CRALEY will provide on-going support to installation staff during the project by electronic means (email, messaging, audio and live video, as appropriate) as it may be required from time-to-time during deployment works.

18. Health & Safety

18.1 Overview

It is imperative for engineering personnel to observe all necessary processes and procedures when installing CRALEY Fibre™ products and, due to the variability of rules and regulations around the globe, local regulations related to Safe Working Practices should always be observed.

In this section we include some generic advice and guidance on Health & Safety, but engineering personnel should observe and comply with local regulations, which will always take precedence over any guidance provided here. It is assumed that all engineering personnel that will be involved in the installation of CRALEY Fibre™ have a full understating of the local Health & Safety requirements and hold the necessary qualifications and certificates to carry out the works.

18.2 Risk Assessment

Prior to any installation work taking place, the engineering team should carry out a thorough risk assessment, in accordance with local regulations, to:

- a) Identify hazards and risk factors that have the potential to cause harm (hazard identification).
- b) Analyse and evaluate the risk associated with that hazard (risk analysis, and risk evaluation).
- c) Determine appropriate ways to eliminate the hazard or control the risk when the hazard cannot be eliminated (risk control).

The purpose is to identify those things, situations, processes, etc. that may cause harm, particularly to people. After identification is made, the engineering team need to analyse and evaluate how likely and severe the risk is.

Once the risk level is determined, decisions can be made as to what measures should be put in place to effectively eliminate or control the harm from happening.

18.3 Traffic Management & Pedestrian Safety

When required, adequate traffic management in accordance with local regulations must be put in place, either using in-house expertise or by the use of specialist sub-contractors.

In the UK, traffic management should comply with the Chapter 8 traffic signs manual 1991.

It is the responsibility of the engineering personnel to make the work area safe for the engineering team and any potential pedestrian traffic that may be encountered i.e during works on a footpath or similar.

This will be carried out using signing, coning and safety barriers before any work takes place.

Machinery and materials should be stored in a safe manner and items such as draw lines, hoses and Messenger Pipes™ should be laid so as not to create risk to pedestrians and/or cyclists with appropriate signage deployed where necessary.

Any cable drums should be chocked to prevent rolling and machinery should be stored away from the public footpath.

18.4 Personal Protective Equipment (PPE)

It is recommended that the following PPE is worn by all engineering personnel when on site:

The British Standard number has been included for information, but local standards will always take precedence and the engineering personnel should ensure that all equipment meets the appropriate standards in the local area.

Statutory Sign	Details
	High Visibility Clothing British Standard BS EN 471
	Safety boots British Standard BS EN 345
	Hard Hat or 'Bump Caps' British Standard BS EN 397
	Gloves To be worn when working within access chambers to provide protection to the hands and offer protection from Weil's Disease British Standard BS EN 388
	Ear Defenders To be worn when using items of plant for any item of plant marked with a hearing protection symbol British Standard BS EN 352
	Eye Protection To be worn during all cutting operations and in any environment where dust, flying debris or pressurised water may be experienced British Standard BS EN 166
	Dust Masks To be worn during any cutting or sawing operation and where dust and/or particulates cannot be adequately controlled by dampening or extraction. British Standard BS EN 3405

19. PR1000 Chlorine Tablets Health & Safety Data



PRODUCT DATASHEET

01981333

CRALEY Fibre™ PR1000 Instachlor Chlorine Tablets
Revision: Version v1: 09-19

Protective Equipment



Eye/face protection

Chemical splash goggles should be worn

Gloves

Hand protection Chemical-resistant, impervious gloves complying with an approved standard should be worn if a risk assessment indicates skin contact is possible. It is recommended that gloves are made of Nitrile rubber.

Other skin and body protection

Wear appropriate clothing to prevent any possibility of skin contact.

Hygiene measures

No specific hygiene procedures recommended but good personal hygiene practices should always be observed when working with chemical products.

Respiratory protection

No specific recommendations. Respiratory protection may be required if excessive airborne contamination occurs.

Handling & Storage:

- Keep away from heat, sparks and open flames.
- Keep only in the original container. Keep separate from food, feedstuffs, fertilisers and other sensitive material.

Hazard Identification:

Symbol	GHS Classification	Description
	H319	Can cause serious eye irritation
	H335	May cause respiratory irritation
	H410	Very toxic to aquatic life with long lasting effects

Precautionary Statements:

- P264 Wash contaminated skin thoroughly after handling.
- P273 Avoid release to the environment.
- P280 Wear protective gloves/protective clothing/eye protection/face protection.
- P305+P351+P338 IF IN EYES: Rinse cautiously with water for several minutes. Remove contact lenses, if present and easy to do. Continue rinsing.
- P337+P313 If eye irritation persists: Get medical advice/attention.
- P501 Dispose of contents/container in accordance with local regulations.



PRODUCT DATASHEET

Supplementary Precautionary Statements:

- P261 Avoid breathing vapour/spray.
- P271 Use only outdoors or in a well-ventilated area.
- P304+P340 IF INHALED: Remove person to fresh air and keep comfortable for breathing.
- P312 Call a POISON CENTER/doctor if you feel unwell.
- P391 Collect spillage.
- P403+P233 Store in a well-ventilated place. Keep container tightly closed.
- P405 Store locked up.

First Aid:

- **Inhalation:** Move affected person to fresh air at once. If breathing stops, provide artificial respiration
- **Ingestion** Never give anything by mouth to an unconscious person. Rinse mouth thoroughly with water
- **Skin contact** Wash skin thoroughly with soap and water
- **Eye contact** Rinse immediately with plenty of water. Remove any contact lenses and open eyelids wide apart. Continue to rinse for at least 15 minutes

If in any doubt, consult a local doctor for further advice

Contains Trocloses Sodium

Chemical Properties:

- **Appearance:** Solid
- **Colour** White
- **Odour** Characteristic. Chlorine
- **Solubility** Soluble in water

Stability & Reactivity

- **Reactivity:** No data available
- **Stability** Stable under the prescribed storage conditions
- **Conditions to avoid** Avoid contact with the following materials: Acids. Oxidising agents. Avoid exposure to high temperatures or direct sunlight. Avoid contact with strong reducing agents
- **Materials to avoid** Flammable/combustible materials. Strong acids. Strong reducing agents. Oxidising materials

Toxicological Effects

Acute toxicity – oral
ATE oral (mg/kg) 3,155.5555556

- **Inhalation** Harmful: danger of serious damage to health by prolonged exposure through inhalation
- **Ingestion** May cause discomfort if swallowed. Harmful if swallowed.
- **Skin contact** Skin irritation should not occur when used as recommended. Powder may irritate skin.
- **Eye contact** Irritating to eyes.
- **Route of entry** Inhalation Ingestion. Skin and/or eye contact

20. RACI - Roles & Responsibilities Matrix

RACI = Responsible : Accountable : Consulted : Informed

Deliverable/Task	Status	CRALEY™ Team				Madison County Team					
		Project Manager	Technical Lead	Account Manager	Administration	Project Manager	CRALEY Fibre™ Installation Team Lead	Water Team Lead	Civil Works Team Lead	Fibre Team Lead	Administration
Project Managing											
Kick-Off Meeting		D	S	I	I	R	S	S	S	S	I
Follow-Up Meetings		R	D	I		A	I	I	I	I	
Additional Follow-Up Meetings *on demand*		A	D	I		R	I	I	I	I	
As-Built Documentation		A	S			R	S	S	S	S	
CRALEY Fibre™ Procurement											
Purchase Orders		I		I	A	I					R
Invoicing		I		I	R	I					A
Payments		I		I	A	I					R
Product Manufacturing		I	C	I	R	I					A
Shipment		A		I	R	I					R
Product Reception & Customs Clearance		I			I	A					R
Support *on-demand*		A		S	D	D					R
CRALEY Fibre™ Training & Supervision											
Training		S	R	I		A	R				
Supervision		S	R	I		A	R				
Support *on-demand*		S	A	D		D	R				
Enabling Works											
On-site Visit & Mark-Up		I	D			A	I	D	R	I	
Excavation, Trenching & Soil Movement		I	D			A	I	D	R	I	
Chambers Construction & Ducts Installation		I	D			A	I	D	R	I	
Saddles & Ports Installation		I	D			A	D	R	I	I	
CRALEY Fibre™ Deployment											
Messenger Pipe™ Deployment		I	D			A	R	D	I	I	
Fibre Blowing		I	D			A	D	I	I	R	
Termination Works											
Fibre Splicing & Termination		I	D			A	D	I	R	I	
Minor Civil Works		I	D			A	I	D	R	I	

KEY

D	Driver	Assists those who are responsible for a task.
R	Responsible	Assigned to complete the task or deliverable.
A	Accountable	Has final decision-making authority and accountability for completion.
S	Support	Provides support during implementation.
C	Consulted	An adviser, stakeholder, or subject matter expert who is consulted before a decision or action.
I	Informed	Must be informed after a decision or action.

21. Indicative Schedule of Works

21.1 Gantt Chart with team size assumptions

KEY		
Team	Team Size	
All teams	-	
Civil Works Team	3	
Water Network Team	2	
CRALEY Fibre Install Team	3	
Fibre Optics Team	2	
Engineering Team	1	

Activity/Task	Start	Duration	Week Number														
			1	2	3	4	5	6	7	8	9	10	11	12	13	14	
Kick-off Meeting	1	1	█														
Enabling Works																	
On-site Visit / Mark-Up	1	1	█														
Excavation, Trenching & Soil Movement	1	3	█	█	█												
Chambers Construction & Ducts Installation	2	3		█	█	█											
Saddles & Ports Installation	4	1		█	█	█											
CRALEY Fibre™ Deployment																	
Messenger Pipe™ Deployment*			* As first indication, it is assumed that 4-links will be completed per week, which may differ dependent on link length and complexity.														
- Link 1 - Link 2 - Link 3 - Link 4	5	1					█										
- Link 5 - Link 6 - Link 7 - Link 8	6	1						█									
- Link 9 - Link 10 - Link 11 - Link 12	7	1							█								
- Link 13 - Link 14 - Link 15 - Link 16	8	1								█							
- Link 17 - Link 18 - Link 19 - Link 20	9	1									█						
- Link 21 - Link 22 - Link 23 - Link 24	10	1										█					
- Link 25 - Link 26 - Link 27 - Link 28	11	1											█				
- Link 29 - Link 30 - Link 31 - Link 32	12	1												█			
- Link 33	13	1														█	
Fibre Blowing	10	4										█	█	█	█		
Termination Works																	
Fibre Splicing & Termination	10	4										█	█	█	█		
Minor Civil Works	11	3										█	█	█			
As-built Documentation	11	3										█	█	█			

22. Pricing

We are pleased to submit the following pricing based on the information provided and the subsequent recommendations of this report:

22.1 Fittings

Final Fittings & Accessories	Quantity
CRALEY Fibre™ Stainless Steel 4" T-Series Vertical Entry Flange Final Fitting	70 units
CRALEY Fibre™ 24/14 Armoured Messenger Pipe	44,000 ft
CRALEY Fibre™ 288 Fiber Cable - 288-strand	44,000 ft
CRALEY Fibre™ Labels	70 units
CRALEY Fibre™ 24/14 Water Blocks	70 units
Price (USD)	\$409,029

Installation Fittings	Quantity
CRALEY Fibre™ Draw Line Installation Fitting - Upper Part - Type A	1 Unit
CRALEY Fibre™ Draw Line Installation Fitting - Lower Part - Type A	1 Unit
CRALEY Fibre™ Mag-Grab & Inspection Installation Fitting - Upper Part - Type B	1 Unit
CRALEY Fibre™ Mag-Grab & Inspection Installation Fitting - Lower Part - Type B	1 Unit
CRALEY Fibre™ Mag-Grab & Inspection Installation Fitting - Lower Part - Type C	1 Unit
CRALEY Fibre™ Messenger Pipe™ Installation Fitting - Upper Part - Type C	1 Unit
CRALEY Fibre™ Messenger Pipe™ Installation Fitting - Lower Part - Type D	1 Unit
CRALEY Fibre™ Messenger Pipe™ Installation Fitting - Lower Part - Type E	1 Unit
CRALEY Fibre™ Messenger Pipe™ Installation Fitting - Lower Part - Type F	1 Unit
Price (USD)	\$16,116

22.2 Installation Kit & Installation Accessories

CRALEY Fibre™ Standard Installation Kit	Quantity
Neutral Buoyancy Sonde Transmitter & LED POD	1 Unit
Disinfection Chamber Sponge (+ 1 Spare)	1 Unit
Stainless Steel Retrieval Hook	1 Unit
Pack/25 of 3mm Aluminium Crimp Ferrules	1 Unit
Pack/20 3mm Stainless Steel Cable Eyes	1 Unit
Medium length draw line reel containing 1,000m (3280ft) Dyneema® draw line	1 Unit
CRALEY Fibre™ draw line reel drill attachment	1 Unit
CRALEY Fibre™ Water Grade Disinfection Pump Spray	2 Units
Pack/100 Chlorination Tablets (1 tablet to 1 Litre/2 pints of water for a 1,000ppm solution)	1 Unit
Price (USD)	\$3,852

Additional Installation Accessories Required	Quantity
Disinfection Chamber Sponge	4 Units
Spare Pack for Installation Fittings (including O Rings, hydraulic lip-seals, LED spare lamp)	1 Unit
Pack/100 3mm Crimp Ferrules	1 Unit
Stainless Steel Retrieval Hook	2 Units
24/14 Messenger Pipe™ Sock	8 Units
Pack/20 3mm Cable Eye	1 Unit
CRALEY Fibre™ Water Grade Disinfection Pump Spray - 1 Litre	2 Units
CRALEY Fibre™ 500m/1640ft Dyneema Draw Line Reel	1 Unit
CRALEY Fibre™ 1500m/4920ft Dyneema Draw Line Reel	1 Unit
CRALEY Fibre™ Parachute – 150mm	4 Units
CRALEY Fibre™ Parachute – 175mm	4 Units
CRALEY Fibre™ Parachute – 225mm	4 Units
CRALEY Fibre™ Parachute – 250mm	4 Units
Price (USD)	\$8,230

Note: The installation kit is a one-time cost and many of the items can be reused for future deployments and consumables can be retained as spare parts for further installations and deployments.

22.3 CRALEY Fibre™ Professional Oversight & Training Services

Training & Professional Oversight	Quantity
Training & Professional Oversight Services	1 Unit
Price (USD)	\$10,385*

* Excludes Travel, Accommodation & Subsistence which will be charged at cost + 10% administration

22.4 Pricing Summary

Additional Installation Accessories Required	Price
Final Fittings & Accessories	\$409,029
Installation Fittings	\$16,116
CRALEY Fibre™ Standard Installation Kit	\$3,852
Additional Installation Accessories Required	\$8,230
Training & Professional Oversight	\$10,385
TOTAL Price	\$447,612

22.5 Payment Schedule

Stage Payment	% Required	Stage Payment Value
#1: On placement of order	10%	\$44,761
#2: On sign-off for manufacturing of Final Fittings & Installation Fittings	30%	\$134,284
#3: Prior to shipping of goods to USA	30%	\$134,284
#4: On receipt of goods in USA	20%	\$89,522
#5: On completion of professional oversight & training	10%	\$44,761
	100%	\$447,612

1st Stage Payment with order

22.6 Pricing Notes:

- Prices quoted are ex-works UK
- Prices quoted are in USD and based on the prevailing rate of 1.34 USD to 1 GBP. An exchange rate protection mechanism of +/- 5% will be applied and, if the exchange rate falls outside this level, re-quoting may be required.
- Prices excludes any local taxes and import duties
- Where applicable, prices do not include Travel, Accommodation and Subsistence, which will be charged at cost plus 10% administration

CRALEY Fibre™

CRALEY Sensing™

CRALEY Liner™

Report prepared by:
CRALEY Group Limited
Abbey House, 282 Farnborough Road
Farnborough,
Hants.
GU14 7NA
United Kingdom

Tel: +44 1252 962 111
Fax: +44 1252 962 123
Email: office@craley.com
Web: www.craley.com

E&OE



Certified to
NSF/ANSI 61



Certified to
NSF/ANSI 372

