

JOHN N. HUGHES
ATTORNEY AT LAW
PROFESSIONAL SERVICE CORPORATION
124 WEST TODD STREET
FRANKFORT, KENTUCKY 40601

TELEPHONE: (502) 227-7270

JNHUGHES@JOHNNHUGHESPSC.COM

April 1, 2016

James Gardner
Acting Executive Director
Public Service Commission
211 Sower Blvd.
Frankfort, KY 40601

Re: Atmos Energy Corporation
Case No. 2016-00070

Dear Mr. Gardner:

Atmos Energy Corporation submits the responses to the Office of the Attorney General's Supplemental Data Requests. I certify that the electronic documents are true and correct copies of the original documents.

If you have any questions about this filing, please contact me.

Submitted By:

Mark R. Hutchinson
Wilson, Hutchinson and Littlepage
611 Frederica St.
Owensboro, KY 42301
270 926 5011
randy@whplawfirm.com

And

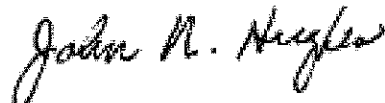

John N. Hughes
124 West Todd St.
Frankfort, KY 40601
Phone: 502 227 7270
jnhughes@johnnhughespsc.com

Attorneys for Atmos Energy Corporation

COMMONWEALTH OF KENTUCKY
BEFORE THE PUBLIC SERVICE COMMISSION

IN THE MATTER OF AN)
INVESTIGATION OF AN INCREASE) Case No. 2016-00070
IN R & D RIDER PROPOSED BY)
ATMOS ENERGY)

AFFIDAVIT

The Affiant, Mark A. Martin, being duly sworn, deposes and states that the attached responses to the Office of the Attorney General's second request for information are true and correct to the best of his knowledge and belief.



Mark A. Martin

STATE OF KENTUCKY
COUNTY OF DAVIESS

SUBSCRIBED AND SWORN to before me by Mark A. Martin on this the 28th day of March, 2016.

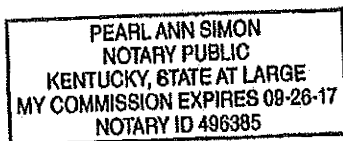

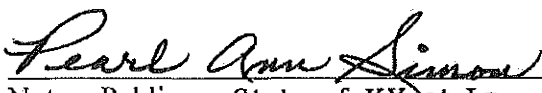

Notary Public - State of KY at Large
My Commission Expires: Sept. 26, 2017
Notary ID: 496385

Case No. 2016-00070
Atmos Energy Corporation, Kentucky Division
AG DR Set No. 2
Question No. 2-01
Page 1 of 1

REQUEST:

For each project that Atmos has funded through GTI during the most recent three year period for which data is available, please provide a calculation of the savings to Atmos customers and the allocation of those savings to Kentucky customers. If available, please provide this information by FERC account. Please provide a copy of all source documents/materials relied on for your response and all assumptions, data, calculations and electronic spreadsheets with formulas intact.

RESPONSE:

The Company does not track savings from GTI projects.

Respondent: Mark Martin

Case No. 2016-00070
Atmos Energy Corporation, Kentucky Division
AG DR Set No. 2
Question No. 2-02
Page 1 of 1

REQUEST:

Refer to Attachment 1 to the Company's response to AG 1-01.

Please provide a copy of each report filed with the Commission setting forth the manner in which the funds remitted have been invested in research and development for the most recent five years.

RESPONSE:

Please see Attachment 1 through Attachment 4.

ATTACHMENTS:

ATTACHMENT 1 - Atmos Energy Corporation, AG_2-02_Att1 - 2010 R&D Report.pdf, 21 Pages.

ATTACHMENT 2 - Atmos Energy Corporation, AG_2-02_Att2 - 2011 R&D Report.pdf, 25 Pages.

ATTACHMENT 3 - Atmos Energy Corporation, AG_2-02_Att3 - 2012 R&D Report.pdf, 178 Pages.

ATTACHMENT 4 - Atmos Energy Corporation, AG_2-02_Att4 - 2013 and 2014 R&D Reports.pdf, 467 Pages.

Respondent: Mark Martin



September 26, 2011

Mr. Jeff R. Derouen, Executive Director
Kentucky Public Service Commission
P.O. Box 615, 211 Sower Boulevard
Frankfort, Kentucky 40602-0615

Dear Mr. Derouen:

Pursuant to the requirement in Atmos' tariff on the 2nd Revised Sheet 42 we are submitting our annual report that sets forth the manner in which the Research and Development funds remitted have been invested in research and development during the past year.

The research funds are utilized to partially fund the Company's participation in two not for profit research groups administered by the Gas Technology Institute. Operations Technology Development (OTD) supports technology aimed at reducing operations costs, enhancing safety and increasing efficiencies. The Utilization Technology Development (UTD) supports a portfolio of near to mid-term technology development projects for residential, commercial and industrial markets in efforts to offer customers more efficient, cost effective and cleaner burning gas product options. A summary of each group's activities is attached.

Should you have any questions or need additional information do not hesitate to contact me at (270) 685-8024 or Leonard Matheny at (270) 685-8062.

Sincerely,

Mark Martin,
Vice-President of Rates & Regulatory Affairs

Atmos Energy Operations Technology Development (OTD) Progress Report

1.h Hand-Held Acoustic Pipe Detector

Objective: To develop and test a hand-held device that uses acoustic technology to accurately locate underground facilities, including plastic pipe.

Results: A series of field tests was conducted throughout the United States on pipes ranging from ½-inch- to six-inch-diameter sizes. A performance of 82% (within ±18 inches) to 95% (within ± 24 inches) of successful pipe detection was achieved. Overall, there were 128 field statistical tests conducted in Illinois, New Jersey, and California areas under various soil conditions. System operation in three major soil coverings – asphalt, concrete, and grass – was tested and compared in the statistical field-test results.

A new suspension mechanism was developed in the receiving transducer design. This new design approach has achieved improved acoustic isolation and its construction has been greatly simplified.

A new transmitter, receiver, and set of transducers were configured and implemented to replace out-dated transducers and provided further enhanced performance of the detection process. The receiving transducer achieved twice the sensitivity as compare to the previous design.

System software with improved user interface and signal-processing routines (implemented and optimized prior to field testing) exhibited excelled performance in field trials.

Status: This current project is complete. A Final Report was issued in August 2010.

Next steps would involve technology transfer to a commercial organization.

Negotiations are under way with potential product commercializers.

1.i Remote Leak Survey Using Lasers

Objective: To develop remote gas-leak survey to reduce the cost and the need for walking and mobile surveys.

Results: In 2010, 12 corrugated-sidewall lasers completed processing, with wavy sidewall lasers exhibiting the power and single-mode operation necessary for the development of the lasers for this project.

Research was conducted to ensure that a single lateral mode can be maintained robustly under a wide variety of current and temperature conditions, with the development of a two-level etch process in which a conventional profile with straight sidewalls is etched through the active region to define the ridge, and then a second profile with wavy sidewalls is etched just above the active region.

Status: Plans are being developed for moving forward with this concept for the development and delivery of lasers.

Final testing of the laser line-scan camera (LLC) using the newly produced semi-conductor lasers will begin when the signal and reference lasers are delivered. Once the laboratory performance testing is complete, a meeting of project investors will be held to demonstrate the correct operation of the LLC in the laboratory. A subsequent field test of the LLC in the local area is planned.

1.k Obstacle Detection System Using Ground Penetrating Radar (GPR)

Objective: To develop advanced GPR for use with horizontal directional drilling (HDD) equipment for obstacle detection.

Results: A prototype drill-head radar system using stepped frequency continuous wave modulation was designed and built. Prototype testing was conducted in laboratory and field settings to further evaluate the response characteristics of the drill-head radar.

Activities in 2010 focused on the development and testing of the synthetic aperture radar (SAR) and derivative imaging (DI) algorithms. Tests were conducted in laboratory controlled settings and in semi-controlled field sites with the radar installed on a HDD system.

While more testing needs to be performed to verify the functionality of the algorithm and increase confidence in its capability to detect targets, researchers report that good results have been obtained on both synthetic and field data.

Detection distances ranged from over one meter in sand to 0.7 meters in sandy clay, to 0.4 meters or less in a mostly loam/clay soil, for PVC, metal, and concrete targets.

The auto-target recognition algorithm was applied to several of the field data sets with good results; however, several parameters need to be set to optimize performance and minimize false alarms.

Data acquisition speed is an ongoing concern. Faster data collection will provide better spatial resolution and faster drill speeds. To investigate this, acquisition speed testing was performed and modifications were made.

Several new components and improvements were added to the DI algorithm.

Status: Research plans call for further testing of the radar in a wide variety of environments. It has been noted that before the drill-head radar can be considered a commercial technology, additional progress needs to be made on hardware, software, and physical packaging.

1.8.a Ground Positioning Satellite (GPS)-Based Excavation Encroachment Notification

Objective: To investigate the potential to use GPS technology to monitor excavation activity. The technology would provide the ability to alert excavators and utility owners when digging is encroaching upon pipelines and other facilities.

Results: An alpha version of a portal was initially developed to collect the GPS coordinates of the excavation activity and valid one-call tickets through a web-based portal. The portal has the ability to generate reports and send notifications to operators, the utility owner, and the excavator. The portal also has a web interface to allow users to view the current excavation activity in a given area through text data or through a mapping feature.

The alpha prototype was tested in a small pilot project for Phase 3A in Virginia in 2009. Based on user feedback, modifications to the GPS-monitoring system and the automated digging trigger were made to reduce the number of components and ensure a simple set-up.

In 2010, the Phase 3A pilot project was completed and a manufacturer was secured for the commercialization of pre-production digging triggers.

In Phase 3B, the portal was further developed to accept GPS coordinates from VUPS and other GPS locators. The portal was developed to allow for the export of this information in a DXF format for integration into on-board software from John Deere and Caterpillar to facilitate the creation of avoidance zones around utility lines.

Status: The research team is making preparations for a second pilot project to test the Phase 3B technology. The Phase 3B pilot project will involve the collection of utility location data using a GPS-enabled locator on a Virginia Department of Transportation project site. The data will then be sent to the Phase 3B portal. Two excavators will be equipped with the pre-production GPS digging triggers developed in Phase 3A to test the ability of the system to detect and provide adequate warning of excavator encroachment.

A second pilot project of the GPS-based system is being planned.

1.8.c & 1.9.a GPS-Enabled Leak Surveying and Pinpointing

Objective: To develop a software application that automates the leak surveying and pinpointing process with GPS. The system will automatically create and populate leak reports and record the routes of leak surveys.

Results: A software application was developed and integrated into commercially available GPS-enabled mobile equipment that is capable of receiving information from Bluetooth-enabled and configured leak-detection devices. Although only three leak-detection devices were included in the Phase 2 project, other manufacturers will be included in the future.

In 2010, development and testing with VeroTrack AST was completed and integrated with the Heath and Bascom-Turner leak detectors. VeroTrack AST is now commercially available from InMaps.

Researchers are teaming with participating utility companies to implement the GPS-enabled leak surveying and pinpointing solution through pilot projects.

Status: The next phase of the project is to conduct a series of pilot implementation projects to further test and demonstrate the system.

2.7.e Development of an External Repair Tool for Polyethylene (PE) Pipe

Objective: To develop of a thermo-chemical repair patch and mechanical tool to externally repair damaged PE pipe in-situ, eliminating the need for large-scale excavation and

replacement of pipe sections.

Results: Phase 1 development activities for this project are completed and detailed in a Final Report issued in June 2009.

A novel and effective PE foam adhesive layer was developed and included in the composition of the repair patch. The use of this foam adhesive layer saves time, facilitates preparation, and simplifies the storage and shipping requirements for the patch assemblies.

To be able to use the same tool to repair multiple pipe sizes, the patch was redesigned using an internal stitched heater within the patch. The final repair patch design uses a stitched internal heater of varying watt density on a layer of PE film that is sandwiched between two layers of PE "solvent sponge" foam.

The new design also uses nylon thermal-insulating jaw inserts that are easy to exchange in the field and are specific to various pipe sizes up to six inches in diameter.

Field demonstrations of the repair tool were performed in 2009.

For further testing, in 2010 ASTM D 2837 and ISO 13954 test matrices were developed for evaluation of repaired PE pipe samples.

Status: Overall, the results of this project established a successful design and completed development of an external repair method to permanently repair damaged PE gas pipe in a safe and cost-effective manner.

Further testing is under way.

2.7.g Composite Pipeline Repair Systems – Analysis of Adhesive Degradation to Help Establish Permanence of Repair

Objective: To evaluate the adhesives used in commercially available composite-based pipe-repair systems to establish if their performance dictates a "permanent" or "temporary" repair classification for the overall repair system.

Results: The testing program evaluated the short-term and long-term shear on the adhesive bonds of seven composite repair systems.

The results of short-term tests show that all the repair systems at operating temperatures of 70°F and 105°F had higher shear strengths than the ASME requirement.

With the exception of one marginal product, the results show that average shear strength for the composite repairs were higher than 30% of their corresponding short-term shear strength at the same temperature.

The results of long-term tests up to 10,000 hours were extrapolated to predict shear strength for longer durations.

The results show that the ultimate shear load of the products ranged from 800 lbf to 2,200 lbf, depending upon manufacturer.

An interim report detailing results of shear tests was issued in 2010.

Status: Testing is complete. A Final Report has been submitted.

2.9.c Field-Applied Pipeline Coatings: Short- and Long-Term Performance – Phase 4

Objective: To establish an unbiased, third-party basis for operators to select the most appropriate coating system for particular applications by assessing more than 80 different commercially available field-applied pipeline-coating products.

Results: In 2009, various pipes with various types of coatings were excavated at the Gas Technology Institute pipe farm, followed by inspection activities; coating-failure analysis; and visual, holiday, and destructive testing in 2009-2010.

Pipe joints were visually examined, photographed, and documented in both their pre-washed and washed conditions. At the conclusion of the post-wash inspection, each joint was wrapped with Tyvek™ to maintain uniformity of UV exposure among the joints and to protect them from any airborne contaminants.

During the non-destructive testing phase, each joint was visually inspected for abrasions, blistering, cracking, deformations, indentions, peeling, rusting, scratches, and wrinkling.

In total, researchers examined 48 FBE-compatible field-applied coatings on 216 joints from Phase 2 and the 30 three-layer PE-compatible field applied coatings on 180 joints from Phase 3.

Status: Performance data has been reviewed and the Final Report has been submitted to project sponsors.

2.9.e High-Pressure Inflatable Stoppers – Alternative to Traditional Stopping Equipment

Objective: To develop inflatable stoppers for use in high-pressure gas piping systems. A system is being designed to provide a lower- cost alternative to the conventional stopping equipment used for routine and emergency operations on various types of pipe materials.

Results: Prototypes for the four-inch and two-inch bag systems have been developed and tested in the laboratory under “live” conditions.

The bag design/prototype development went through various design iterations, with the most recent bag design being capable of holding a pressure of 130 psig for one hour.

A step-by-step operating procedure was provided in a technical report and video format.

Status: Additional launch tube modifications are being conducted for the four-inch system. The modified system will be evaluated in the pipe flow loop. Once the four-inch system is finalized, the six-inch system will be developed.

2.9.f Development of Large-Diameter Directional Bag Stop Systems for Non-Interrupted Meter Change-Out (NIMCO) Kits

Objective: To enhance the NIMCO effectiveness by expanding its use to a greater number of applications

Results : Since project activities began in December 2009, the research team has completed the design and fabrication of the multiple saddles and associated bags. All saddles were tested with positive results.

Flow tests were successfully performed on all systems.

Several bag revisions were necessary for the three- and four-inch systems based on testing results. After three revisions, a new bag was constructed that features an internal strap and reinforced ends. Based on a suggestion from a sponsor utility, a secondary sealing device was created.

Status: This research effort is complete and commercialization activities have been transferred to Mueller Co.

No. 2.6.i Adaptation of UV Curing Method for Gas-Lining Applications

Objective: To test UV-based methods in an effort to shorten the curing time for the cured-in-place lining process used to rehabilitate aging gas pipes.

Results: This project initially focused on lining-technology demonstrations and evaluations at Public Service Electric and Gas Corp. (PSE&G), Consolidated Edison Company of New York, Inc (ConEd), and National Grid.

For the demonstrations, researchers tested a new system that uses a starline[®] 2000 UV curable resin, a commercially available UV light train, and modified lining equipment to accommodate the light train.

At PSE&G, the system was used on a low-pressure, 12-inch-diameter, cast-iron main 361 feet in length. The total lining time from first mix of adhesive until the final camera inspection of the UV-cured liner was approximately five hours. The UV curing process itself took slightly less than two hours.

At ConEd, the demonstration was conducted on a low-pressure, 12-inch-diameter, cast-iron main 311 feet in length. Including a cleaning process, this project took about nine hours to complete. Curing time was 70 minutes.

A third UV curing demonstration was successfully completed with National Grid where three sections of six-inch-diameter steel and cast-iron pipe were cleaned, lined, and cured. The modified light train was used to cure the new UV-sensitive resin at an average rate of three feet per minute. The average customer outage time for each section of main was 11 hours. Each section had multiple services that were re-instated.

Tests were completed in 2009 and reports describing test results and lessons learned were subsequently issued to project sponsors.

Status: A second phase of this project has been initiated to focus on improving and purchasing the equipment used in the UV curing process, including the light train and an articulating camera/cutter device for services.

2.b Service-Applied Main Stopper

Objective: To develop a system to allow first-response teams to quickly and efficiently stop blowing gas from ruptured gas mains.

Results: In 2009, investigators researched and identified several potential manufacturers of the Service-Applied Main Stopper, and entered into agreements with three manufacturers to assemble, package, and sell the prototype and supply components.

In 2010, bag testing and design activities were conducted to address inconsistencies in performance and durability. The fabricator encountered issues inserting a new, more rugged bag and were unsuccessful in consistently reaching the main for deployment. The bag was only able to navigate the first of three 90-degree turns. When the bag was removed and inspected, tearing was observed. Additional designs and bag thicknesses were subsequently investigated and tested. The research team will make slight modifications to increase the consistency of successful insertions.

Research staff investigated various service-line and feeder-main diameters, service lengths, service-tee sizes and tap openings, service-line corrosion, operating pressures, and other variables.

Several cable/coating combinations, head designs, and springs were tested, and research proceeded with a focus on the use of a coated router cable with coated springs. Multiple coatings (e.g., PVC and nylon) were tested to find a coating that had sufficient abrasion resistance without being too rigid. Researchers also chose to pursue the development of a design with multiple universal joints, a flexible spring portion, and a tip that rotates.

Several stoppers have been constructed of a durable polyurethane material and made with a welding technique that allows technicians to easily produce multiple shapes and configurations of bags.

Once successful testing was completed, the design was finalized and turned over to the fabricator for commercialization.

Status: Engineers will design and fabricate a control box to regulate inlet gas to fill and deflate the bag, as well as monitor the bag pressure during operation.

2.7.b Qualification of Saddle and Electrofusion Joint Designs and Test Methods to Validate Safe, Long-Term Performance

Objective: To develop pipe-joining-qualification data to ensure the safe and long-term performance of various types of lateral plastic-pipe connections, including: saddle heat-fusion, electrofusion, and mechanical joining.

Results: Preliminary analytical models were developed for all three major categories of lateral joints. Additional models were developed to characterize the in-service stress states acting on the joint interface. The cumulative results of these models were used to initiate benchmark testing and validation of the model results.

Testing helped researchers to develop a better understanding of the long-term performance of each respective type of lateral joint.

Discussions with various steering committee members were conducted to establish a consensus with respect to the technical considerations for the overall program and the proposed changes being sought through the ASTM standardization process.

Significant progress was made towards developing proposed amendments to several ASTM standards, specifically: revision to ASTM F1924; revision to ASTM F905 as needed; and development of a stand-alone ASTM specification for saddle heat fusion fittings.

Status: The data developed to date is consistent with initial expectations and establishes the technical framework for implementing meaningful changes within industry guidelines and ASTM specifications.

In 2010, specially designed instrumented tests were conducted on mechanical saddles from three different suppliers. Based on the results and preliminary findings, it appears that this new test methodology (using flow-meter testing) permits a greater understanding of the impact of thermal cycling on the overall performance of mechanical joints. While the results appear to be promising and a significant amount of understanding has been achieved, an alternate test method is being investigated to determine possible correlations between the two approaches.

Interactions are ongoing with the research team and the steering committee to establish the necessary support for the proposed ASTM standardization activities and the next steps for the project.

There will continued data analysis as the various tests are being performed and data becomes available.

2.7.d Cold Adhesive Repair and Joining of Polyethylene Pipes with Minimal Surface

Preparation

Objective: To develop an economical, reliable, and safe technology to quickly and effectively repair damaged plastic gas pipes.

Results: Long-term test results of patched PE pipes found that the patching system can be effective. Testing also resulted in additional information about the effective application of the adhesive.

Researchers report that the long-term hydrostatic stress-rupture test results on the cold adhesive repair patch (CARP) pipe specimens are very significant. Test data showed that at an average field temperature of about 68°F the CARP-repaired pipes have an average projected life expectancy of greater than 50 years at a pipe service pressure of 100 psig.

The test results also showed that the growth of the crack/notch was totally arrested by the CARP-repaired patches.

Quick-burst pressure tests demonstrated that the strength of CARP-repaired pipe specimens was the same as the pipe. For these specimens, the failure occurred in the pipe away from the patch. This failure was a typical ductile rupture.

Validation testing is complete and a detailed report on testing results has been issued to project sponsors.

Technicians fabricated a "self clamping" patch to evaluate a full-encirclement-type patch with the potential for improved performance over the partial patches.

Status: Next efforts include the development of a set of testing activities for the CARP patched

system to provide a design basis for the CARP adhesive.

3.dd Development/Enhancement of Trenchless Service Installation through Keyholes

Objective: To advance the accuracy of soil piercing to provide a method for installing natural gas service lines through small, keyhole excavations.

Results: Development efforts for the piercing tool resulted in the mechanical design of a beveled tip that rotates by converting reciprocating tip motion into rotational motion. The mechanical design has progressed through five major prototypes.

A major achievement for the project was the development of a high-impact-resistant bit-orientation electronic orientation system designed to fit in a small-diameter tool measuring 30 inches long. Prototypes incorporated a bit-orientation-monitoring system capable of operating effectively in the high-vibration environment that exists at the tip of the pneumatic impact mole, which punches into the soil at a rate of up to 400 strikes per minute. Software was developed to link pitch, roll, and inclination measurements to provide the operator with the relative position of the rotating head (thus enabling steering to take place).

In 2010, rear-steered prototypes were fabricated and evaluated. Testing showed that the hydraulic cylinder had enough capacity to keep the control surface actuated during operation.

Low-strength steel was used to construct the swivel, resulting in binding and the inability to rotate the attachment to change the orientation of the control surface. A hardened steel swivel, modified to incorporate other design improvements gained from testing, is being fabricated. Experimentation with fixed-fin prototypes shows that oversizing the tip and rear portions of the device can improve turning.

Status: Development activities continue on the design, fabrication and testing of rear-steered prototypes.

A hardened, oversized swivel for the attachment will be tested to determine its ability to actuate the control surface in the bore to accomplish turning.

Plans also call for embedding an accelerometer to monitor the orientation of the steering attachment.

Researchers have concluded that the existing designs would be much more robust with a small increase in the size of the device. After the next round of testing, the research team will consider developing a larger-diameter mole (2 or 2.5 inches in diameter) to increase the turning force and improve the routing of air to the device.

Researchers are also evaluating the possibility of using long-range wireless technology for signal transmission

4.e Inspection Platforms for Unpiggable Pipelines – Phase 4

Objective: To develop an inspection platform and magnetic flux leakage (MFL) sensor for the inspection of presently “unpiggable” natural gas pipelines. The technology is being designed to help companies meet U.S. Department of Transportation regulations mandating the inspection of all pipelines (piggable and unpiggable) in High-Consequence Areas (HCAs).

Results: The design of the robotic platform has established the ability to build a platform able to propel an MFL sensor in a high-pressure pipeline while providing its own power (i.e., not depending on pipe flow for propulsion) and being able to negotiate all obstacles encountered in such pipelines. Power estimates under various scenarios have established the ability of the system to operate economically under a variety of operating conditions.

Similarly, design of the MFL sensor has established the ability to launch, operate, and retrieve the collected wall-loss data (under a variety of operating conditions) under live conditions. The availability of a sensor that can negotiate mitered bends, plug valves, and back-to-back bends – and still provide the measurement accuracy of a state-of-the-art smart pig – is expected to have a profound effect on the abilities of the natural gas industry to inspect unpiggable pipelines.

Following the identification of a commercializer in late 2008, the project continued with the redesign of the original prototype based on extensive data collected during field trials.

A new, advanced system was tested in California in a real pipeline and proved to provide superior performance compared with the original design. A new sensor configuration was implemented, in addition to new electronic and drive system designs.

Status: A final prototype system will be built and field tested in 2011, with commercialization expected in 2012.

4.7.g Yield Strength Determination through Sub-Size Samples

Objective: To develop, validate, and obtain regulatory acceptance for a method to establish pipeline yield strength that allows for a much less expensive sampling procedure that does not require line shutdown, cutout, and repair.

Results: All technical work for Phase 1 was completed and a Final Report was issued in April 2010.

Results indicated that no partial-wall technique can accurately determine a pipe's yield strength without correction factors to account for material variability. The research team subsequently developed a Phase 2 plan to develop and test full-wall sub-size samples that would not require correction factors.

Researchers completed the testing of the full-wall, longitudinal, sub-size samples and compiled the results. Results indicate that the new testing methodology can effectively be used to determine yield strength values.

Status: A Final Report has been issued to project sponsors.

The research team plans on presenting results to the American Petroleum Institute and the U.S. Department of Transportation's Pipeline and Hazardous Materials Safety Administration.

4.8.a Guided Wave Evaluation as Hydrotest Equivalent

Objective: To demonstrate and validate the use of Guided Wave Ultrasonic Testing (GWUT) technology as an equivalent to a hydrotest.

Results: Data collection involved gathering all available and acceptable data from prior GWUT

inspections and the associated dig records (defect geometry, pipe diameter, wall thickness, and grade). Data was only accepted and reported in this study if the GWUT could be verified through direct inspection.

GWUT had been used to inspect pipe segments in more than 60 dig sites where all inspection results were validated. Specifically for this project, investigators solicited and collected useable field inspections/assessments from an additional 10 operators. The collected data was used to calculate the failure pressure for rupture using the most conservative federally approved methodology, (i.e., ASME B31G) for all validated data points.

The percentage wall loss vs. anomaly length diagrams plotted to B31G confirmed that GWUT is equivalent to hydrotesting.

The GWUT methodology found all those anomalies that would have been found by the hydrostatic testing and GWUT also found anomalies that were too small to have been detected and survive in a hydrostatic test to a pressure equivalent to the pipe's Specified Minimum Yield Strength (SMYS).

All but two of the defects found by GWUT (and validated by excavation) would have passed a hydrotest to 100% SMYS by B31G.

All the corrosion discovered by visual inspection after removal of the casing and/or coatings was found by GWUT (i.e., there were no false negatives). In some cases the GWUT operator estimated the corrosion damage to be somewhat worse than what was actually observed. Therefore, there is a small potential for overcalling the severity of the actual defect (this is conservative).

Project results were compiled into a Final Report released in March 2010.

The results of this comprehensive validation effort (data sets, findings, and implementation protocol) provides the foundation of a methodology for a GWUT standard.

Status: Data indicates that GWUT is an effective technology that provides reliable and valuable information for an integrity assessment.

In 2010, the National Association of Corrosion Engineers' TG-410 subcommittee developed and revised a draft standard that could facilitate the allowance of guided wave technology to be used as an accepted inspection technique similar to hydrotesting, in-line inspection, and direct assessment. The subcommittee met in September 2010 and continued to make progress; however, the standard will likely not be fully approved until 2012.

4.8.c Live Gas Camera for Internal Inspection – Phase 2

Objective: To develop a video camera inspection system that can be launched from small excavations and used in live gas mains and to develop additional features to further enhance the camera's productivity, performance, and capabilities.

Results: Prototype camera heads were developed: one for use in yellow polyethylene (PE) pipe and one for use in black PE, cast-iron, and steel pipe. Both cameras provide good visual recognition of scratches from 5% to 15% of the wall thickness and small holes from 1/16-inch diameter to 1/2-inch diameter. Field testing with the new camera heads and modified pushrod cables began in 2010.

Significant progress has been made in integrating a 16Hz low-frequency sonde into the existing

camera system. Various iterations of the sonde were designed, fabricated, and tested to determine the appropriate configuration.

A module that will house the sonde was developed that can be mounted between the existing camera connector and the pushrod connector. The module will house the magnetic coil, the inductor, and the necessary electronics used to excite the coil.

A conceptual design was performed on a new camera-centering device. The final design will be completed following the completion of the low-frequency sonde.

A vendor has been selected to fabricate and manufacture the next-generation pushrod cable.

Status: Additional field testing of the new PE camera heads in conventional and keyhole applications is under way. Investigations are ongoing to identify field locations for testing the new camera head for black PE, steel, and cast iron and the new camera head for yellow PE.

Conceptual design and iterative experimentation continues toward the final design of the prototype camera-centering device and integration of the device with the PE camera heads.

Activities are also under way for the second iteration of an improved pushrod cable.

4.8 j Distribution Integrity Management Risk Model

Objective: To develop a comprehensive risk model to facilitate the assessment of risks associated with distribution assets and operations. The model will help to decrease system risk and lower the cost involved with new Distribution Integrity Management (DIM) regulations.

Results: This project began in 2008 with a workshop to identify the threats and assets that should be covered under the DIM risk model. Subsequently, researchers collected and analyzed additional data from a survey of project participants as well as data from the U.S. Department of Transportation's Pipeline and Hazardous Materials Safety Administration and internal sources.

Eighteen risk models were developed to provide a comprehensive risk analysis.

Status: A draft version of the risk models was delivered to project participants and is being reviewed.

4.9.a Determination of Leak-Rupture Boundary

Objective: To provide regulators and pipeline operators with information – based on sound engineering principles – to determine the boundary between failure by leak vs. failure by rupture as a percentage of specified minimum yield strength (SMYS).

Results: Draft reports for the incident review and the mathematical modeling were submitted to the project team for review. Revisions have been made to ensure that the results can be combined and formulated into one comprehensive analysis.

The incident review was conducted to provide an analysis of incident and testing data to identify trends in ruptures across different pipe attributes. Toward this goal, investigators developed a list of pipeline attributes and categories that define a failure stress range within a

certain probability (e.g., 80% or 90%). The initial data-analysis portion of the incident review was completed but yielded incomplete results that did not allow integration with the mathematical models. Subsequently, a Design of Experiments (DoE) analysis was conducted to allow for a better understanding of the interactions between the factors affecting the lower-bound rupture stress.

Results showed that for gas pipelines, diameter had the highest influence on the lower-bound rupture stress, followed by changing a combination of yield strength and diameter/thickness (D/t) ratio together. For liquid pipelines, Charpy Impact energy had the highest influence on the lower-bound rupture stress, followed by changing yield strength and D/t ratio individually.

Using the knowledge gained from the trend analysis and the DoE process, 12 categories for gas pipeline data and 4 categories for the liquid pipeline data have been produced.

Status: The research team is combining the results of the incident review and mathematical modeling into one comprehensive analysis that will be used to complete the Final Report.

4.10.c Testing and Design of Casing End Seals

Objective: Develop information on the performance of casing end seals to help reduce pipe-seal failures, enhance safety, and lower the cost of gas-system operations and maintenance.

Results: This project was initiated in mid-2010 with a project team meeting to address a variety of issues.

A questionnaire was developed for interviews and surveys with gas-system operators to further develop an assessment of industry use and needs.

Status: Survey results are being compiled and analyzed. Testing procedures are being developed and several components have been procured for investigations.

No. 5.6.e Portable Propane-Air Residential Temporary Gas Supply

Objective: Develop a small-scale propane-air delivery system to provide residential customers with gas service during times when service is normally interrupted for maintenance, repairs, or rehabilitation.

Results: Significant design, fabrication, and testing activities have been conducted, with various propane-air mixtures tested under a wide range of piping scenarios. Field testing began in 2010.

Prior to field deployment, the unit was laboratory tested and calibrated to ensure reliable performance during field testing. The propane supply regulators and plumbing were redesigned to include a pre-regulator at the tank to ensure no chance of over pressurization during field testing. Initial testing was limited to the operation of the device with a small pilot flame.

Researchers developed a prototype volumetric-mixing device that incorporates a single piston that proportions, compresses, mixes, and then delivers a user-calibrated propane-air ratio. The device is completely autonomous and adjusts instantly to the demand. The energy to drive the

mixer and compress the air is derived from pneumatic pressure within the propane tank. Since the mixer is volumetric, the ratio remains constant, independent of outside atmospheric conditions.

Status: Field testing is complete. The research team is preparing a Final Report that will include all data from laboratory and field testing.

Modifications to the device are complete. These include the addition of a safety valve to ensure at no point an excessively lean or rich mixture is allowed to leave the system.

No. 5.7.f Automated Meter Shut-Off (AMS) Device

Objective: To develop a prototype Automated Meter Shut-Off (AMS) device to provide the industry with a remotely controlled system that can be installed quickly over the meter shut-off valve (existing meter inlet valve), without interrupting gas service.

Results: The research team has identified a manufacturer with the technical capabilities to handle all of the wireless and mechanical technologies needed for successful commercialization of the AMS unit. The company is also a long-time supplier to the water- and gas-metering markets.

In 2010, investigators and the manufacturing partner began efforts to determine the project scope and product specifications.

Status: Licensing negotiations with the potential commercializer are under way.

The manufacturing partner has asked for additional input from project sponsors to assist the company in better understanding the market needs.

The manufacturer has been exploring a number of design alternatives, modified by various inputs along the way.

5.8.a Development & Testing of Advanced Automated Welding Unit for Installing Service Tees

Objective: Enhance a prototype system developed for remote and automatic welding through small-diameter (18-inch) "keyhole" excavations for wider use in conventional excavations in the gas industry.

Results: This project was initiated with a sponsor survey to identify specific standards that must be adhered to and sizes that the automated welding system must be capable of welding.

Initial work focused on developing the ability to weld a three-quarter-inch tee onto a two-inch-diameter main.

In 2010, negotiations were completed and contracts finalized with a commercialization partner chosen to design and develop the next generation of automated-welding prototypes.

Design of both the mechanical packaging and motion control has begun. The existing components include the rotational drive system, torch holder, and wire/gas feed-line system. The clamping system allows the welder to clamp and center onto any size pipe between two to

eight inches in diameter. The design keeps the welding unit at an identical offset from the top of the pipe independent of the diameter. The initial intention is to keep the design such that it can be utilized within a 24-inch keyhole.

Several design changes were made to the mechanics of the welder. In addition, the clamping mechanism was redesigned to provide a stiffer and better controlled approach. This will allow for less influence of local pipe defects or corrosion and lower the cost of the welder.

Development activities have been detailed in reports and video files for project sponsors.

Status: Fabrication of a prototype system while working with the manufacturer is under way.

Activities are also focusing on the design, fabrication, and testing of weld-automation controls. Systems being developed will allow for complete control of the entire welding operation, eliminating all previously necessary controls, programmable logic controllers, power supplies, and trim pots. This will streamline the entire welding system and present a significant cost savings to the final commercial version of the device.

8.d Tool for the External Classification of Pipe Contents

Objective: To develop a practical tool that can enhance operations safety by being able to distinguish the contents of a buried utility pipe without breaching the pipe wall. The ultimate objective is to develop an affordable tool that could be carried in each crew truck.

Results: The first step was to select and demonstrate practical technologies to reliably distinguish natural gas from electric lines, measure water depth, and estimate gas pressure.

Technicians constructed short sections of pipe materials typically used in the field, and fashioned each sample pipe so that it could be filled with water or dielectric oil to various depths.

In terms of technical difficulty, measuring the depth of water was found to be the least complicated, followed by distinguishing natural gas from electric cable carrying pipe. Determining the pressure in the gas main is the most difficult to achieve.

These measurements can be made for steel, cast-iron, and plastic pipe.

This project also tested the concept of using an electromagnetic acoustic transducer (EMAT) sensor generating longitudinal waves to estimate the pressure inside a gas distribution main. While substantial developments have been achieved in EMAT design and construction, additional research needs to be conducted before estimating pressures in metallic pipes is practical. Although it is not currently possible to perform these measurements in steel gas distribution pipes, the basic concept has some merit.

Status: Phase 1 of this project is complete. A Final Report was issued in October 2010.

This report covers Phase 1 development of a practical tool that can distinguish the contents of a utility pipe without breaching the pipe wall, and includes the results of a market survey.

Based on the results of Phase 1, researchers recommended that development of the tool be moved to a Phase 2 involving the detailed design, construction, and field trials of an alpha prototype.

7.10.a Natural-Gas-Quality Survey: Trace Constituents

Objective: To develop information to help introduce renewable “green” sources of energy into the natural gas pipeline. Information on trace constituents will facilitate a utility’s ability to assess the potential to use gas generated from wastes and other sources.

Results: This project was initiated in 2010 with the establishment of a project steering committee and an extensive literature search. Subsequently, a technical committee was formed and a web-based project seminar was conducted.

Status: A preliminary draft sampling plan was prepared and presented to the project steering committee. A Phase 2 proposal was developed and presented to OTD members for consideration.

7.10.c Improving Methane Emission Estimates from Underground Pipeline Leaks – Phase 2

Objective: To develop a technical approach to quantify methane emissions from gas mains and service pipelines. The new method will provide an increased level of accuracy and an improved ability for utilities to comply with future regulations.

Results: In Phase 1 of this project (now completed) researchers investigated the applicability of measuring leak flow rates at their above-ground state. Investigators also reviewed the limitations of existing methods and addressed the current practices in use. Measurements of above-ground methane flow rates were performed in controlled tests at various pipeline facilities. The tests focused on evaluating the repeatability of the measurements and their correlation to the applied flow rates in different soils and at various pipe sizes, pressures, and gas flow rates.

Further details are presented in the Phase 1 Final Report.

Status: Phase-2 field test activities and analyses are under way.

At the completion of Phase 2, the research plan calls for the application of the developed field-testing procedures to obtain similar emission factors for cast-iron, protected steel, and unprotected steel pipes. Investigators will interact with regulatory agencies – specifically, the EPA – to ensure acceptance of the developed methodology.

The research team plans to expand the project’s Technical Guidance Committee to include representatives from the EPA and the American Gas Association.

August 2011 | UTD Update



We're excited about the progress UTD has achieved on several fronts. Below is a summary depicting our available products and resources, projects that have accomplished significant milestones, and new awards which help leverage UTD member funds. If you have any questions regarding this report or it's content, please give us a call.

Ron Snedic
847-768-0572

Greg Maxfield
952-250-7197

Our members serve over 20 million natural gas consumers in North America. Together we are shaping the energy future with new efficient end-use technologies.

Products Commercially Available or Being Readied for Commercialization

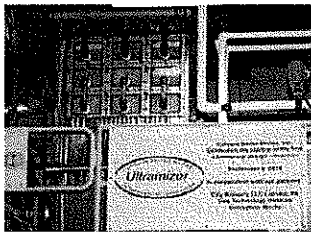

Transport Membrane Condenser (TMC) Technology

An advanced heat-and-water recovery system, including TMC technology, was installed and commissioned at Baxter Healthcare in Thousand Oaks, CA, meeting performance expectations and increasing the boiler efficiency from 80% to 93% – saving the customer 15% on fuel bills, reducing greenhouse emissions by 15%, and saving over 250,000 gallons of water. The Ultramizer® system is available from Cannon Boiler Works, Inc.

Chris Giron

Cannon Boiler Works
724-335-8541 x414
sales@cannonboilerworks.com
www.cannonboilerworks.com



Low-Oil-Volume Fryers

A new commercial foodservice low-oil-volume fryer has undergone development and pre-commercial testing with successful results. The fryer, marketed by Frymaster as Protector® fryers, increases energy efficiency while also extending cooking-oil quality and life to provide significant customer savings.

Linda Brugler

Frymaster
318-866-2488
lbrugler@frymaster.com
www.frymaster.com

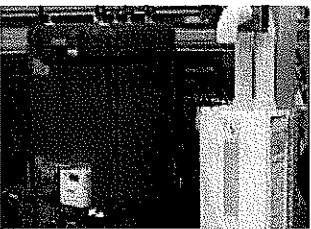

Equinox Solar-Assisted Heating System

The Equinox system is a combination thermal storage tank and instantaneous water heater capable of providing 100% of domestic hot-water and space heating needs. A staple in European and Australian markets, the technology has been made available in the U.S. through the efforts of Gas Technology Institute and Solar Usage Now, LLC. The technology – marketed as S.U.N. Equinox Heating Systems® – is one of the most energy-efficient systems available for residential and commercial applications.

Tom Rieker

Solar Usage Now, LLC
614-759-7242
service@netwalk.com
www.solarusagenow.com

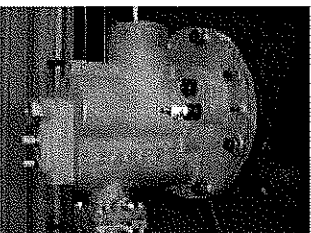

RASERT Technology

The Reverse-Annulus Single-Ended Radiant Tube (RASERT) technology increases productivity, raises thermal efficiency, and decreases NO_x emissions for industrial heat treating and other indirect heating applications.

Dennis Quinn

Fives North American
Combustion, Inc.
216-271-6000, x417
dennis.quinn@fivesgroup.com
www.fivesgroup.com

617-387-4100
866-698-3188
custserv@mfi.com
www.mfi.com
www.stellarsteam.com



▼ **Stellar Countertop Steamer**

This compact gas-fired countertop steamer for commercial food service offers enhanced cooking rates while providing users with added savings of energy and water consumption. The unit was the first gas-fired boilerless steamer with an ENERGY STAR rating.

Dave Goble

Avantec Food Service Equipment
800-322-4374
dave@twomarket.com
www.avantecequipment.com



▼ **Avantec Combi-Oven**

The combination oven uses a patented technology for improving cooking performance, quality, and efficiency. Able to operate in various cooking modes, the oven provides enhanced uniformity when compared to similar-sized ovens.

Scott Baker

Cummins Westport Inc.
604-718-2025
scott.baker@cummins.com
www.cumminswestport.com



▼ **Cummins 8.9L Ultra-Low Emissions Engine**

This is the first engine certified to the highly stringent California 2010 standards for heavy-duty vehicle engines—achieving emission levels below the 0.2 g NO_x/hp-hr requirement while also retaining high shaft efficiency. Since commercial introduction in 2007, the engine has been widely used in the United States (with 2010 sales of approximately 10,000 units) and throughout the world in transit, refuse-collection, and regional hauling applications.

Paula Hebert

IMPCO Technologies/BRC FuelMaker
714-656-1268
phebert@impcotechologies.com



▼ **FuelMaker's Phill**

A field demonstration program was conducted to assess the performance, reliability, and economics of a natural-gas-fueling system that allows for the refueling of natural gas vehicles at homes and businesses. Six units were installed and monitored for one year. Data was analyzed and a user survey was conducted at the conclusion of the demonstration. Performance met or exceeded the manufacturer's specification and users' attitudes were very positive.

Scott Janke

NovelAire Technologies
770-664-4756
sljanke@aol.com
www.novelaire.com

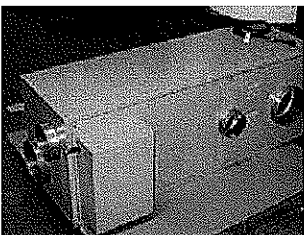

▼ **NovelAire ComfortDry™ 400**

This advanced space-conditioning system was developed for residential and light-commercial buildings where humidity or allergen concerns prevail. Research provided enhanced operation and reduced cost, weight, size, and installation requirements.

Stephen Ptucha

Westport Innovations Inc.
604-718-2024
SPtucha@westport.com
www.westport.com

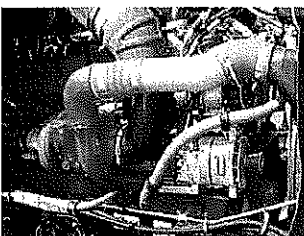

▼ **Westport HPDI NGV Fuel System**

High-Pressure, Direct-Injection (HPDI) technology enables engines designed for diesel combustion to operate with natural gas while retaining the same critical performance features of high torque, power, and fuel economy of a traditional diesel engine. A 2010 demonstration of the Westport HD-powered tractor allowed fleets to obtain first-hand experience with the new technology. Feedback was very positive and resulted in one company ordering 48 Westport HD-powered tractors.

Significant Milestones

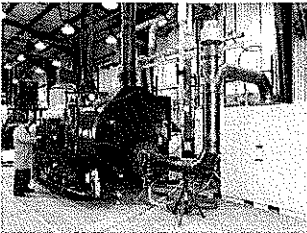

FlexCHP High Efficiency Ultra-Clean Power and Steam Package

Researchers are developing a cost-effective supplemental burner, integrated with a gas-turbine based combined heat-and-power system, that can significantly increase energy efficiency while meeting stringent air emissions regulations. Laboratory tests have shown total efficiency of over 85% and NO_x emissions that are below stringent California emission levels. Field testing is planned at a food-processing plant in California.

Dave Cygan

Gas Technology Institute
847-768-0524
david.cygan@gastechnology.org
www.gastechnology.org

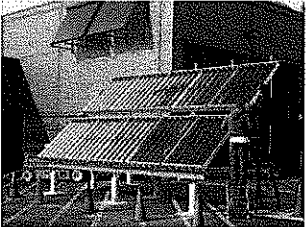

Solar-Assisted Natural Gas Energy Systems

Researchers foresee significant efficiency improvements in several applications by combining higher-temperature solar-related technologies with natural-gas-fired equipment. Progress continues with the installation of solar thermal collectors using B2U Solar's External Compound Parabolic Concentrator (XCPC) technology at Gas Technology Institute. Additional testing is planned with SABMiller at its Los Angeles area brewery.

Dave Cygan

Gas Technology Institute
847-768-0524
david.cygan@gastechnology.org
www.gastechnology.org



Wok Burner

A new commercial foodservice wok-burner range system – developed in cooperation with a major Asian restaurant chain – increases efficiency 100% (compared to current products) while enhancing kitchen comfort by lowering ambient temperatures. Activities are under way to license the wok technology to a manufacturing partner and build a prototype unit for a sponsor test site.

Frank Johnson

Gas Technology Institute
847-768-0670
frank.johnson@gastechnology.org
www.gastechnology.org

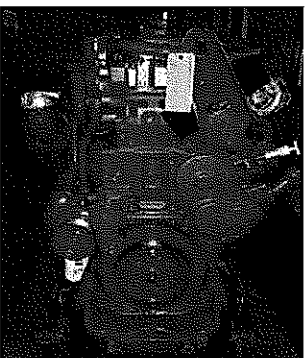

Cummins Westport (CWI) High-Horsepower NGV Engine

CWI, with UTD support, is developing a new 400-HP NGV engine for the large truck and bus market segment that includes regional haulers, refuse transfer trucks, and other larger vehicles. The new engine will satisfy the stringent California emission requirements. An alpha engine is undergoing field testing and the new engine is expected to be available in 2012.

Scott Baker

Cummins Westport Inc.
604-718-2025
scott.baker@cummins.com
www.cumminswestport.com

Analytical Tools & Information Products

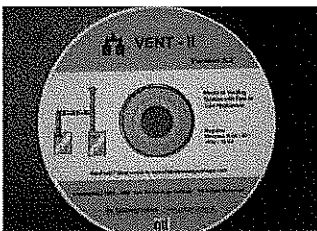

Venting Solutions

VENT-II, the industry standard software program for vent system design, offers application with commonly used desktop operating systems and spreadsheet tools. A venting Technical Advisors Group includes 30 subject matter experts, manufacturers, industry groups and associations, and GTI.

Larry Brand

Gas Technology Institute
847-768-0968
larry.brand@gastechnology.org
www.gastechnology.org

Neil Leslie

Gas Technology Institute
847-768-0926
neil.leslie@gastechnology.org
www.gastechnology.org

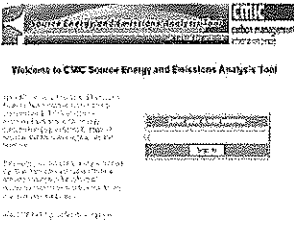

Source Energy and Emissions Analysis Tool

The Source Energy and Emissions Analysis Tool (SEEAT) allows calculation of the energy source and greenhouse-gas emissions related to point-of-use (site) energy consumption by fuel type for each energy consuming device (e.g., appliances and vehicles). SEEAT includes a source-energy and carbon-emission calculation methodology that accounts for primary energy consumption and related emissions for the full fuel cycle (extraction, processing, transportation, conversion, distribution, and consumption of energy) for residential and commercial buildings, industrial applications, and light-duty vehicles. (Available online at www.cmictools.com.)

Neil Leslie

Gas Technology Institute
847-768-0926
neil.leslie@gastechnology.org
www.gastechnology.org



International Green Construction Code (IGCC)

Based on the technical merits and societal benefits of source energy presented at code-development and hearing-committee meetings and conference calls, the International Green Construction Code (IGCC) development committee shifted from site energy to source energy and greenhouse-gas (GHG) emissions as the basis of the performance requirements in IGCC PV 1.0. The PV 2.0 hearing committee also approved a critical technical comment shifting to a single-reference building approach that will implement the source energy and GHG emission compliance requirements consistently and equitably. IGCC is scheduled to be published by the International Code Council as a model code in March 2012.

Neil Leslie

Gas Technology Institute
847-768-0926
neil.leslie@gastechnology.org
www.gastechnology.org

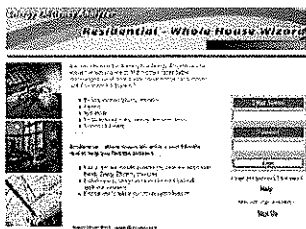

Whole House Residential Energy Efficiency Wizard (REEW)

The REEW provides UTD members and their customers with a user-friendly Internet-server-based tool allowing for the analysis and easy selection of the latest technologies applicable to residential building energy efficiency measures customized to a specific member service territory.

Marek Czachorski

Gas Technology Institute
847-768-0526
marek.czachorski@gastechnology.org
www.gastechnology.org

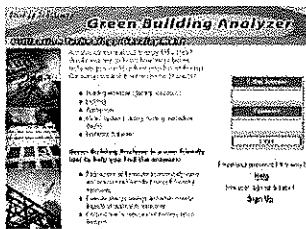

Commercial Green Building Analyzer (CGBA)

A Beta version of the CGBA, an Internet-server-based tool, has completed testing. The CGBA is designed to be a user-friendly tool allowing for easy selection of the latest applicable commercial "green" building energy efficiency measures customized to a specific member service territory.

Marek Czachorski

Gas Technology Institute
847-768-0526
marek.czachorski@gastechnology.org
www.gastechnology.org

Select New Cofunding and Leveraged Funding Sources

- > GTI signed a contract with the California Energy Commission for a new \$2 million program focused on technology development for the commercial foodservice market. Restaurants and institutional foodservice represents a major natural gas energy user. This program will develop a suite of higher-efficiency natural gas appliances for commercial kitchens. The program compliments the Conveyor Oven, Convection Oven and Commercial Range UTD projects.
- > Under a contract with the U.S. Department of Energy Building America Program, GTI will address retrofit whole house, energy efficiency, and related building efficiency initiatives.
- > Field testing of two new solarthermal systems, one at a winery in California and the other with a brewery operation in California, are being funded by the California Energy Commission.
- > Southern California Air Quality Management District awarded GTI a \$450,000 contract to address the development and testing of low NO_x emission home furnaces and space heating equipment to comply with future emission requirements.
- > GTI was awarded a \$1.8 million contract from the CEC for the demonstration of the planned Cummins 12 L natural gas vehicle (NGV) engine.



September 25, 2012

Mr. Jeff R. Derouen, Executive Director
Kentucky Public Service Commission
P.O. Box 615, 211 Sower Boulevard
Frankfort, Kentucky 40602-0615

Dear Mr. Derouen:

Pursuant to the requirement in Atmos' tariff on the 2nd Revised Sheet 42 we are submitting our annual report that sets forth the manner in which the Research and Development funds remitted have been invested in research and development during the past year.

The research funds are utilized to partially fund the Company's participation in two not for profit research groups administered by the Gas Technology Institute. Operations Technology Development (OTD) supports technology aimed at reducing operations costs, enhancing safety and increasing efficiencies. The Utilization Technology Development (UTD) supports a portfolio of near to mid-term technology development projects for residential, commercial and industrial markets in efforts to offer customers more efficient, cost effective and cleaner burning gas product options. A summary of each group's activities is attached.

Should you have any questions or need additional information do not hesitate to contact me at (270) 685-8024 or Leonard Matheny at (270) 685-8062.

Sincerely,

Mark Martin,
Vice-President of Rates & Regulatory Affairs

Atmos Energy Operations 2012 Technology Development (OTD) Progress Report

New 2011 and 2012 Projects

1.9.b Public Improvement Project Coordination with GPS, GIS, and Smart Tags

Objective: To develop and demonstrate a process that integrate Global Positioning System (GPS), Geographic Information system (GIS), and “Smart Tag” technologies to streamline public improvements projects planning and prevent damage caused by excavations.

Results: In 2011, researchers hosted a damage-prevention technology demonstration in Virginia with support from the Virginia Department of Transportation (VDOT) and several technology partners. Field demonstrations were conducted at a VDOT highway-expansion job site.

The process of programming, installing, mapping, and relocating marker balls was demonstrated by VDOT and the technology partners. Details on the process of programming the marker balls in the field prior to installation was provided. Standard vacuum excavation technology was used to excavate to a water line. GPS hardware and special software were used to map the location of the marker balls prior to installation. The use of a locator was demonstrated, showing its ability to relocate and trace the water line using previously buried marker balls.

Status: Additional marker-ball pilot projects are being developed.

1.10.g Ultra-Trac MJL

Objective: To evaluate the performance of two Ultra-Trac Metallic Joint Locators (MJLs) on behalf of Atmos Energy.

Results: The MJL’s have been purchased and tested. Results have been successful

Status: Project is completed.

1.11.c Low-Cost MEMS Methane Sensor Platform

Objective: To design, fabricate, develop, and demonstrate a novel, ultra-low-power CH₄ sensor.

Results: The fabrication of the sensor wafers has been completed. A laboratory bench evaluation board has been developed and assembled.

Status: Calibration and testing is being initiated.

1.11.d Cross Bores – Best Practices

Objective: To develop an outreach program to raise the awareness and streamline the implementation of cross bore (intersection of a sewer and natural gas line) best practices with natural gas system operators, the sewer and plumbing industry, and the contractor community at large; to reduce the risk and exposure of cross boring.

Results: The summary of best practices document has been completed.

Status: The Phase 2 activity is education and outreach and has just been initiated.

1.11.f Locatable Plastic Pipe

Objective: To design, test, and commercialize the next generation of plastic pipe locators that use resonant marker technology.

Results: The technical and market assessment of radio frequency (RF) tags that attach directly to pipe during trenchless excavations has been completed.

Status: With the assessment completed, prototype design, development, and testing is being initiated.

1.12.c DBS Process Evaluation

Objective: To perform finite element stress analysis and leak testing of selected tapped steel elbows and pipe nipples.

Results/Status: Project has just been initiated

2.8.e Structural Liners: Phase 2

Objective: To perform an evaluation of structural lining materials for the purpose of determining their ability to structurally rehabilitate distribution-pressure gas mains.

Results: GTI investigated multiple lining materials and technologies which demonstrated promise for use as a structural liner in natural gas piping systems. This investigation consisted of contacts with manufacturers, a collaborative meeting with manufacturers and the project sponsors, review of possible standards for liner evaluation, and a preliminary evaluation of the liner systems.

Eight manufacturers were contacted during the duration of this project, with varying responses and results on the capabilities of each system. Three liner manufacturers attended a collaborative meeting at the start of the project with sponsoring utilities to discuss industry needs, available products, and possible solutions. These three manufacturers included 3M, Sekisui Nordipipe (Norditube), and Quakewrap.

Status: The final report has been completed. As a continuation of the effort to establish structural liners for natural gas piping systems, GTI recommends a phase 3 of the structural liners project be conducted on the three lining materials: 3M's Scotchkote 2400, the Primus Line, and Sekisui Norditube.

2.11.d Radiography by Selective Detection (RSD) X-Ray for PE Assessment – Testing and Validation

Objective: To develop standards and procedures for the non-destructive evaluation (NDE) of plastic materials and joining processes using x-ray backscatter imaging techniques, with validation through destructive and empirical testing.

Results: In 2011, the blind testing matrix was developed, test samples specified, and fabrication completed.

A standardized defect carrier was developed to enable several categories of defects to be introduced into the fusion interface in a controlled and repeatable manner.

Approximately 19 polyethylene fusions were made with known defects and submitted for optimization purposes. Scans were completed, with results indicating very high confidence in detecting voids and physical defects. However, the system requires additional post processing for producing clearer images of regions of interest.

Review of the images indicates that voids and gaps that produce distinct surfaces can be detected with high probability. There appears to be very limited capability of detecting poor quality fusions that are not due to voids or gaps at the interface.

Status: Additional testing and evaluation is planned.

2.11.h Evaluation of Below Grade Pipe Surface Preparation Tools

Objective: To investigate and evaluate new pipe surface and preparation tools that can improve the surface preparation process for below ground piping applications.

Results: GTI communicated with two manufacturers on the pipe tool limitations that have been captured during laboratory evaluation. Two pipe tools (Pico Pipe and MBX) were selected for field testing.

Status: Field testing will be initiated.

4.11.c Magnetic Flux Leakage (MFL) Inspection System for 12-Inch Diameter Gas Lines – Phase 1

Objective: To conduct a surface demonstration of the MFL inspection capability using open-ended, unpressurized pipe segments to determine detection capability for machined defects and naturally corroded pipe segments.

Results: Design and assembly of the test apparatus continues. Progress includes successful completion of all the required electronic printed circuit boards and passing of all functionality tests, fabrication of all the mechanical elements required to mount these electronics to the magnetizer and bring power to and signals from the Hall-effect sensors, fabrication of the centralizer assemblies, construction of the open-ended steel test pipe with machined defects, completion of the push-pull system for conveying the inspection head through then test pipe, and ordering of the magnetizer from Dexter Magnetics.

Status: Significant discussion on the licensing of the technology is on-going at Axon and the license is expected to be signed. The next stage will be the assembly of the open-ended surface test pipe system.

4.11.e Evaluating Assessment Technique Effectiveness

Objective: To assemble a body of knowledge and develop a methodology that enables gas system operators to determine and compare the effectiveness of various pipeline integrity assessment techniques, and to facilitate the selection of the most appropriate technique under different operating conditions.

Results: A set of pipeline incidents was obtained from the PHMSA records of transmission pipe incident data. Direct Assessment data still needs to be obtained from the utilities.

The Analysis of Assessment Technique Effectiveness has started with various approaches to investigate and construct the fault-trees used in the analysis. Initial fault-trees have been established to assess the probabilities of the failure of certain inspection tools to detect the anomalies.

Status: Next efforts will involve data collection from participating utilities and continued analysis of assessment techniques.

4.12.b Correlating Pipeline Operations to Potential Crack Initiation, Growth, and Arrest

Objective: To develop and validate a model that correlates pressurization to crack growth rates for transmission line piping, including crack initiation and crack arrest.

Results/Status: Project has just been initiated.

4.12.c Field Test of a Cathodic Disbondment Detector

Objective: To develop and test a practical cathodic disbondment detector that allows utilities to locate potential corrosion sites before serious metal loss or leaks occur.

Results/Status: Project has just been initiated.

5.7.p GPS Consortium

Objective: To facilitate sharing of information related to the use of GPS technology for gas utility operations.

Results: In 2011, GTI conducted a field demonstration of the high accuracy GPS receiver integrated with an Android tablet using a barcode scanning application developed under a separate project.

In 2012, GTI has made significant strides in the use of the high-accuracy GPS including better integration and connectivity with Android applications. GTI has worked on the development of a control interface to integrate the NavCom GPS receiver to work more easily with other applications.

Status: GTI initiated planning for this year's annual GPS workshop, which will be held at GTI in the Fall of 2012. This year's GPS Consortium workshop will focus on demonstrating the refined prototype of the high-accuracy GPS integrated with GIS-based software running on tablets and smart phones.

5.8.e Development of Standardized Algorithms and Identifiers for Enhanced Materials Tracking and Traceability

Objective: To develop protocols that can be used as a method by gas utilities to track their underground pipes and facilities.

Results: A standardized traceability encoding system was developed to assign a series of identifiers to encode certain characteristics of various types of components in a standardized manner. The standardized approach ensures that the marking on various components is a

uniform length (16-digit alpha numeric code) with each digit representing key characteristics regardless of the type of component or the manufacturer. A web-based application was developed to establish a national registry of manufacturer identifiers.

Researchers tested and evaluated different types of bar-code formats using commercial grade scanners to determine how well these formats could be accurately read. Preliminary findings are consistent with expectations.

Status: Project is completed. Researchers successfully established a consensus based ASTM specification, which will provide a path forward for manufacturers to mark their respective products in a standardized and uniform manner. A license was given to the Plastic Pipe Institute to develop a website to the make 16 digit code available.

5.9.c Mitigating Electrical Interferences on Cathodic Protection Systems

Objective: To mitigate the effects of electrical interference on cathodic protection and telemetry systems.

Results: An extensive search of CP data-logging systems was performed to identify equipment capable of performing the measurements required for this study. A commercial unit (the WatchDogCP P2S-AC CP test station monitor and data logger) was chosen for field studies initiated in 2010 at three utility test sites.

Technicians installed New Power Technologies' Sensor Guard systems to monitor the condition of the AC power line for over and under voltage conditions. The Sensor Guard also monitors the ambient electric field to determine if a lightning strike is imminent. The Sensor Guard system has been used to protect power supplies on cellular towers for several years; however, this project represents the first Sensor Guard installations on natural gas equipment.

Status: Data are being collected from field test sites.

5.10.h Ultraviolet (UV) degradation and Static Buildup Testing of Personal Protection Equipment Fabrics

Objective: To enhance the safety of utility operations by testing and evaluation of utility vests to determine if degradation is caused by UV light and the potential for static buildup to become hazardous.

Results: Current plans call for the adaptation of a method of measuring the energies in the spark discharges from vacuum excavation hoses to vests materials.

Ten vests were tested to determine if exposure to UV affects color and static properties. Some vests also underwent limited testing with washing. These results were summarized in a report and are being used to guide selection of vests to develop a testing procedure.

Status: The development of static-discharge testing methods is under way.

5.11.e/5.11.m Intelligent Utility Installation Process – Phases 1 and 2

Objective: To develop a product that allows data collection applications to be built on iOS, Android, or Windows 8 operating systems, including a disconnected editing mode to allow data collection.

Results: The Phase 1 report presents the recommended logical data model and high level processes for use during all future field data collection. The logical data model, guidelines and processes focused on capturing the American Society of Testing and Materials (ASTM) F2897-11 tracking and traceability standards and ensuring compliance with future regulatory requirements for data tracking and traceability and distribution integrity management risk assessment and mitigation. This report also identifies the technologies to be used during field data collection to automate data capture while reducing or eliminating the opportunity for human error.

Status: Phase 1 is completed. Phase 2 of the project (tracking assets and getting the information into the company's data base) has just been initiated.

5.11.n Quality Control (QC) Procedures for High Potential Anodes

Objective: To develop a QC procedure for high potential magnesium anodes that verifies the electrical potential, current, and efficiency of the products.

Results: Samples were run through the ASTM G97 test to generate baseline data. Additional data were collected using electrochemical impedance spectroscopy.

Status: Final testing remains to be conducted, and the final report to be written.

5.11.p Smart Grid Initiative – Standards and Regulations

Objective: To ensure that smart grid infrastructure requirements that are specific to the natural gas industry are included in the ongoing technology, standards, and regulatory initiatives currently focused on the smart electric grid.

Results: In 2011, a preliminary report was completed on existing standards and regulations.

Status: GTI has created a gas technology domain expert working group to act as part of the Smart Grid Interoperability Panel (SGIP), managed by the National Institute of Standards and Technology (NIST). This panel has been presented to the SGIP Board of Directors to act as a direct link to the gas industry on interoperability discussions.

Efforts related to the establishment of an on-line reference system have continued to move forward.

5.12.g Large Diameter- Medium Pressure Inflatable Stoppers

Objective: To evaluate existing medium and high pressure inflatable stoppers as an alternative to currently employed gas stopping equipment for use on large-diameter natural gas distribution systems.

Results: In 2012, initial communications were held with Kleiss Company to identify necessary specifications and test equipment requirements.

Status: The candidate technology will be received at the laboratory and the test apparatus set up will be conducted.

7.10.d Alpha-Prototype In-Line Biofilter Testing

Objective: To develop and test a prototype Biofilter unit for removal of biological agents from processed bio-methane products prior to injection into existing natural gas pipelines and mains

Results: In 2011, all instrument and testing components were received for laboratory evaluation. An aerosol generator and optical particle sizer were installed and a testing protocol was created for each filter in the test series.

Status: Filter testing is under way. Protocols are being developed for future experiments on performance parameters of individual filters and filter combinations.

Continuing Projects

1.h Hand-Held Acoustic Pipe Detector

Objective: To develop and test a hand-held device that uses acoustic technology to accurately locate underground facilities, including plastic pipe.

Results: R&D has been successfully completed. All project goals have been met.

Status: This current project is complete. A Final Report was issued in August 2010. Technology transfer and licensing has been completed to the commercializer, Sensit Technologies. The product should be on the market within a year.

1.i Remote Leak Survey Using Lasers

Objective: To develop remote gas-leak survey to reduce the cost and the need for walking and mobile surveys.

Results: In 2011, signal and reference lasers were tested and incorporated in the Laser Line-Scan Camera (LLC) prototype equipment. Tests of the prototype were subsequently conducted in the laboratory and at field sites. Results achieved during testing substantiated the potential value of active LLC leak detection.

For the field demonstration, the breadboard LLC was installed in a cargo van and repositioned to a remote site where previously located natural gas leaks were identified. Testing was remotely conducted from within the stationary van on actual main-to-meter leaks in two different locations with differing levels of natural gas concentrations. The leaks were initially located and/or measured using an available leak-detection device. All testing was conducted under field conditions, as they were found, with sustained 10-15 mile-per-hour winds at both locations.

Status: Plans are being developed for moving forward with this concept.

1.k Obstacle Detection System Using Ground Penetrating Radar (GPR)

Objective: To develop advanced GPR for use with horizontal directional drilling (HDD) equipment for obstacle detection.

Results: R&D has been successfully completed.

Status: The GPR product has been licensed to Vermeer and it is expected to be commercialized within two years.

1.8.a Ground Positioning Satellite (GPS)-Based Excavation Encroachment Notification

Objective: To investigate the potential to use GPS technology to monitor excavation activity. The technology would provide the ability to alert excavators and utility owners when digging is encroaching upon pipelines and other facilities.

Results: The developed technology was tested and implemented in a series of demonstrations with stakeholders in Virginia. A GPS monitoring system for excavation equipment was developed that periodically transmitted active excavation-equipment-location information to a portal.

Status: The pilot project is complete. A Final Report was issued in October 2011.

A second pilot project of the GPS-based system is being planned in New York.

1.8.c & 1.9.a GPS-Enabled Leak Surveying and Pinpointing

Objective: To develop a software application that automates the leak surveying and pinpointing process with GPS. The system will automatically create and populate leak reports and record the routes of leak surveys.

Results: A software application was developed and integrated into commercially available GPS-enabled mobile equipment that is capable of receiving information from Bluetooth-enabled and configured leak-detection devices. Although only three leak-detection devices were included in the Phase 2 project, other manufacturers will be included in the future.

Development and testing with VeroTrack AST was completed and integrated with the Heath and Bascom Turner leak detectors. VeroTrack AST is now commercially available from InMaps. VeroTrack was fully implemented at Intermountain Gas Company pilot projects with three other companies are ongoing.

Status: Pilot implementation projects are under way to further test and demonstrate the system. Additional testing of the gas detectors is being incorporated into pilot projects with project participants.

2.7.e Development of an External Repair Tool for Polyethylene (PE) Pipe

Objective: To develop of a thermo-chemical repair patch and mechanical tool to externally repair damaged PE pipe in-situ, eliminating the need for large-scale excavation and

replacement of pipe sections.

Results: Phase 1 development activities for this project are completed.

A novel and effective PE foam adhesive layer was developed and included in the composition of the repair patch. The use of this foam adhesive layer saves time, facilitates preparation, and simplifies the storage and shipping requirements for the patch assemblies.

To be able to use the same tool to repair multiple pipe sizes, the patch was redesigned using an internal stitched heater within the patch. The final repair patch design uses a stitched internal heater of varying watt density on a layer of PE film that is sandwiched between two layers of PE "solvent sponge" foam.

In 2010, ASTM D 2837 and ISO 13954 test matrices were developed for evaluation of repaired PE pipe samples. In 2011, tests were performed on samples of a new PE mesh to determine their suitability for use in the repair patch. The results of the mesh tests were very consistent and showed that the new cloth will not change the bonding properties of the heater.

Status: Technicians are preparing the repaired pipe samples for long-term testing.

2.7.g Composite Pipeline Repair Systems – Analysis of Adhesive Degradation to Help Establish Permanence of Repair

Objective: To evaluate the adhesives used in commercially available composite-based pipe-repair systems to establish if their performance dictates a "permanent" or "temporary" repair classification for the overall repair system.

Results: The testing program evaluated the short-term and long-term shear on the adhesive bonds of seven composite repair systems.

The results of short-term tests show that all the repair systems at operating temperatures of 70°F and 105°F had higher shear strengths than the ASME requirement.

Status: Testing is complete. A Final Report has been submitted.

2.9.c Field-Applied Pipeline Coatings: Short- and Long-Term Performance – Phase 4

Objective: To establish an unbiased, third-party basis for operators to select the most appropriate coating system for particular applications by assessing more than 80 different commercially available field-applied pipeline-coating products.

Results: In 2009, various pipes with various types of coatings were excavated at the Gas Technology Institute pipe farm, followed by inspection activities; coating-failure analysis; and visual, holiday, and destructive testing in 2009-2010.

Pipe joints were visually examined, photographed, and documented in both their pre-washed and washed conditions. At the conclusion of the post-wash inspection, each joint was wrapped with Tyvek™ to maintain uniformity of UV exposure among the joints and to protect them from any airborne contaminants.

Status: Performance data has been reviewed and the Final Report has been submitted to

project sponsors. A training workshop was held on site and attended by Atmos personnel.

2.9.e High-Pressure Inflatable Stoppers – Alternative to Traditional Stopping Equipment

Objective: To develop inflatable bag-stopper for use in high-pressure gas piping systems

Results: In 2011, a laboratory demonstration and webcast were conducted for project sponsors. Also in 2011, the design, manufacturing, and laboratory testing of the six-inch bag system were completed and a field demonstration of the system was scheduled. Efforts have been focused on preparing for the testing of the six-inch system and the two-inch bag system. Researchers also coordinated plans for a field demonstration of the four-inch bag system.

A new split inner launch tube was constructed for the six-inch bags and has been tested with for insertion and removal.

Status: Following the field demonstration, a final report on the project will be developed.

2.9.f Development of Large-Diameter Directional Bag Stop Systems for Non-Interrupted Meter Change-Out (NIMCO) Kits

Objective: To enhance the NIMCO effectiveness by expanding its use to a greater number of applications

Results: The research team has completed the design and fabrication of the multiple saddles and associated bags. All saddles were tested with positive results.

Flow tests were successfully performed on all systems.

Status: This research effort is complete and commercialization activities have been transferred to Mueller Co.

2.6.i Adaptation of UV Curing Method for Gas-Lining Applications

Objective: To test UV-based methods in an effort to shorten the curing time for the cured-in-place lining process used to rehabilitate aging gas pipes.

Results: This project initially focused on lining-technology demonstrations and evaluations at Public Service Electric and Gas Corp. (PSE&G), Consolidated Edison Company of New York, Inc (ConEd), and National Grid.

For the demonstrations, researchers tested a new system that uses a Starline® 2000 UV curable resin, a commercially available UV light train, and modified lining equipment to accommodate the light train.

Tests were completed and reports describing test results and lessons learned were subsequently issued to project sponsors.

Status: Within the scope of this project there has been a success in developing a technology which expands the Starline® 2000 procedure to a quick curing system. This system is based on a UV curing adhesive and the special equipment which enables a UV-light train to draw through the woven fabric liner coated pipe for accelerated curing

2.b Service-Applied Main Stopper

Objective: To develop a system to allow first-response teams to quickly and efficiently stop blowing gas from ruptured gas mains.

Results: In 2009, investigators researched and identified several potential manufacturers of the Service-Applied Main Stopper, and entered into agreements with three manufacturers to assemble, package, and sell the prototype and supply components.

In 2010, bag testing and design activities were conducted to address inconsistencies in performance and durability. The fabricator encountered issues inserting a new, more rugged bag and were unsuccessful in consistently reaching the main for deployment. The bag was only able to navigate the first of three 90-degree turns. When the bag was removed and inspected, tearing was observed. Additional designs and bag thicknesses were subsequently investigated and tested. The research team will make slight modifications to increase the consistency of successful insertions.

Several stoppers have been constructed of a durable polyurethane material and made with a welding technique that allows technicians to easily produce multiple shapes and configurations of bags.

Once successful testing was completed, the design was finalized and turned over to the fabricator for commercialization.

Status: Engineers will design and fabricate a control box to regulate inlet gas to fill and deflate the bag, as well as monitor the bag pressure during operation. A bag design/material thickness will be selected for consistent performance and incorporated into the system for fabrication.

2.7.b Qualification of Saddle and Electrofusion Joint Designs and Test Methods to Validate Safe, Long-Term Performance

Objective: To develop pipe-joining-qualification data to ensure the safe and long-term performance of various types of lateral plastic-pipe connections, including: saddle heat-fusion, electrofusion, and mechanical joining.

Results: Preliminary analytical models were developed for all three major categories of lateral joints. Additional models were developed to characterize the in-service stress states acting on the joint interface. The cumulative results of these models were used to initiate benchmark testing and validation of the model results.

Long-term testing was completed on saddle heat-fusion fittings, electrofusion fittings, and mechanical fittings.

Status: The data developed to date is consistent with initial expectations and establishes the technical framework for implementing meaningful changes within industry guidelines and ASTM specifications.

Efforts are under way to develop proposed amendments to several ASTM standards, specifically: revision to ASTM F1924; revision to ASTM F905 as needed; and development of a stand-alone ASTM specification for saddle heat-fusion fittings.

In 2011, discussions with various steering committee members and sponsors were conducted to establish a consensus with respect to the technical considerations for the overall program and the proposed changes being sought through the ASTM standardization process.

2.7.d Cold Adhesive Repair and Joining of Polyethylene Pipes with Minimal Surface Preparation

Objective: To develop an economical, reliable, and safe technology to quickly and effectively repair damaged plastic gas pipes.

Results: Long-term test results of patched PE pipes found that the patching system can be effective. Testing also resulted in additional information about the effective application of the adhesive.

Researchers report that the long-term hydrostatic stress-rupture test results on the cold adhesive repair patch (CARP) pipe specimens are very significant. Test data showed that at an average field temperature of about 68°F the CARP-repaired pipes have an average projected life expectancy of greater than 50 years at a pipe service pressure of 100 psig.

The test results also showed that the growth of the crack/notch was totally arrested by the CARP-repaired patches.

Quick-burst pressure tests demonstrated that the strength of CARP-repaired pipe specimens was the same as the pipe. For these specimens, the failure occurred in the pipe away from the patch. This failure was a typical ductile rupture.

Validation testing is complete and a detailed report on testing results has been issued to project sponsors.

Technicians fabricated a "self clamping" patch to evaluate a full-encirclement-type patch with the potential for improved performance over the partial patches.

Status: Additional testing will be performed to develop a design basis for the CARP adhesives. Test specimens will be machined from standard two-inch socket fittings to produce a clam-shell repair patch matched to the two-inch pipe specimen. The testing in this phase of work is to verify the performance of the CARP system for long-term use in the field.

3.dd Development/Enhancement of Trenchless Service Installation through Keyholes

Objective: To advance the accuracy of soil piercing to provide a method for installing natural gas service lines through small, keyhole excavations.

Results: Significant progress has been made toward developing a steerable piercing tool. Testing of fixed-fin tools shows that rear steering is possible and that rear steering can be improved by increasing the tip diameter and the swivel diameter at the rear of the mole. Three

fabricated rear-steer prototypes were designed and fabricated, and two of these prototypes have been field tested.

A major achievement for the project was the development of a high-impact-resistant bit-orientation electronic orientation system designed to fit in a small-diameter tool measuring 30 inches long. Prototypes incorporated a bit-orientation-monitoring system capable of operating effectively in the high-vibration environment that exists at the tip of the pneumatic impact mole, which punches into the soil at a rate of up to 400 strikes per minute. Software was developed to link pitch, roll, and inclination measurements to provide the operator with the relative position of the rotating head (thus enabling steering to take place).

Experimentation with fixed-fin prototypes showed that oversizing the tip and rear portions of the device can improve turning. Moles turned about 50% more when the front and back of the mole had larger diameters than the body of the mole.

Status: The technical work on the tool is complete and a final report is being developed. The project has made some good technological advancements, but has also encountered some technical hurdles. Researchers have developed recommendations to address a variety of issues for system improvements. A parallel path where conceptual rear-steered mole designs are developed is under consideration. Researchers are also evaluating the possibility of using long range wireless technology for signal transmission

The third prototype is ready for field testing.

4.e Inspection Platforms for Unpiggable Pipelines – Phase 4

Objective: To develop an inspection platform and magnetic flux leakage (MFL) sensor for the inspection of presently “unpiggable” natural gas pipelines. The technology is being designed to seven companies meet U.S. Department of Transportation regulations mandating the inspection of all pipelines (piggable and unpiggable) in High-Consequence Areas (HCAs).

Results: The design of the robotic platform has established the ability to build a platform able to propel an MFL sensor in a high-pressure pipeline while providing its own power (i.e., not depending on pipe flow for propulsion) and being able to negotiate all obstacles encountered in such pipelines. Power estimates under various scenarios have established the ability of the system to operate economically under a variety of operating conditions.

Similarly, design of the MFL sensor has established the ability to launch, operate, and retrieve the collected wall-loss data (under a variety of operating conditions) under live conditions. The availability of a sensor that can negotiate mitered bends, plug valves, and back-to-back bends – and still provide the measurement accuracy of a state-of-the-art smart pig – is expected to have a profound effect on the abilities of the natural gas industry to inspect unpiggable pipelines.

Following the development of a licensing agreement with the commercializer in 2009, the project continued with the redesign of the original TIGRE prototype based on extensive data collected during field trials. A new, advanced system was subsequently tested in California in a real pipeline and proved to provide superior performance compared with the original design.

A final prototype system was built and field tested in 2011.

It was found that the MFL sensor integrated in the TIGRE platform can provide accurate and reliable data regarding the presence of defects in unpiggable pipelines, and size those defects to a level comparable with smart pigs.

Status: Explorer II has already entered the market and is carrying out inspections on a commercial basis. TIGRE is now in the final stage of its development and is expected to result in a commercial-grade prototype and commercialization by the end of this year.

4.7.g Yield Strength Determination through Sub-Size Samples

Objective: To develop, validate, and obtain regulatory acceptance for a method to establish pipeline yield strength that allows for a much less expensive sampling procedure that does not require line shutdown, cutout, and repair.

Results: In 2010, researchers completed the testing of the full wall, longitudinal, sub-size samples. Results indicate that the new testing methodology can effectively be used to determine yield strength values. The mini, full wall specimens were found to be superior to the currently specified full-size tensile specimens. On average, the sub-size sample method produces a -8.5% lower (conservative) value for yield strength when compared to the full-size test method. A sample set from the pipeline population would result in an average yield strength between -13.2% and -3.8% for the full-size method with a 95% confidence.

Status: In 2011, the research team presented the project results to the American Petroleum Institute 5L committee, the U.S. Department of Transportation's Pipeline and Hazardous Materials Safety Administration, and the ASTM A370 committee. The research team subsequently initiated a request with ASTM to make minor modifications to A370 to include sub-size specimens.

4.8.a Guided Wave Evaluation as Hydrotest Equivalent

Objective: To demonstrate and validate the use of Guided Wave Ultrasonic Testing (GWUT) technology as an equivalent to a hydrotest.

Results: Data collection involved gathering all available and acceptable data from prior GWUT inspections and the associated dig records (defect geometry, pipe diameter, wall thickness, and grade). Data was only accepted and reported in this study if the GWUT could be verified through direct inspection.

GWUT had been used to inspect pipe segments in more than 60 dig sites where all inspection results were validated. Specifically for this project, investigators solicited and collected useable field inspections/assessments from an additional 10 operators. The collected data was used to calculate the failure pressure for rupture using the most conservative federally approved methodology, (i.e., ASME B31G) for all validated data points.

The percentage wall loss vs. anomaly length diagrams plotted to B31G confirmed that GWUT is equivalent to hydrotesting.

The GWUT methodology found all those anomalies that would have been found by the hydrostatic testing and GWUT also found anomalies that were too small to have been detected

and survive in a hydrostatic test to a pressure equivalent to the pipe's Specified Minimum Yield Strength (SMYS).

All but two of the defects found by GWUT (and validated by excavation) would have passed a hydrotest to 100% SMYS by B31G.

Project results were compiled into a Final Report released in March 2010.

The results of this comprehensive validation effort (data sets, findings, and implementation protocol) provides the foundation of a methodology for a GWUT standard.

Status: Data indicates that GWUT is an effective technology that provides reliable and valuable information for an integrity assessment.

In 2010, the National Association of Corrosion Engineers' TG-410 subcommittee developed and revised a draft standard that could facilitate the allowance of guided wave technology to be used as an accepted inspection technique similar to hydrotesting, in-line inspection, and direct assessment. The subcommittee met in September 2010 and continued to make progress; however, the standard will likely not be fully approved until 2012.

4.8.c Live Gas Camera for Internal Inspection – Phase 2

Objective: To develop a video camera inspection system that can be launched from small excavations and used in live gas mains and to develop additional features to further enhance the camera's productivity, performance, and capabilities.

Results: Prototype camera heads were developed: one for use in yellow polyethylene (PE) pipe and one for use in black PE, cast-iron, and steel pipe.

Various activities were performed to develop a 16 Hz sonde capable of being integrated into the system to improve the system's location capability. Various iterations of the sonde were designed, fabricated, and tested before the appropriate configuration was selected. A module housing the sonde and electronics was developed.

Enhancements were made to allow the camera to be angularly launched into two-inch-diameter PE and steel gas mains using fusible, weld-on or bolt-on fittings. Camera systems were field tested with the participation of sponsoring utilities.

Status: This project was completed in 2011. The enhanced system is now commercially available from ULC Robotics.

4.8 j Distribution Integrity Management Risk Model

Objective: To develop a comprehensive risk model to facilitate the assessment of risks associated with distribution assets and operations. The model will help to decrease system risk and lower the cost involved with new Distribution Integrity Management (DIM) regulations.

Results: This project began in 2008 with a workshop to identify the threats and assets that should be covered under the DIM risk model. Subsequently, researchers collected and analyzed additional data from a survey of project participants as well as data from the U.S. Department of Transportation's Pipeline and Hazardous Materials Safety Administration and internal

sources.

In 2011, risk models were revised and the updated models (with supporting documentation) were delivered to project participants for review.

Investigators also reviewed a recent publication from PHMSA regarding pilot DIMP audits, reporting that the results of the pilot audits indicate that regulators may be expecting operators to formally consider threats other than the standard known threats. Examples include over-pressurization, sewer laterals, animals, and unknown materials. Consequently, there may be a need to collect additional information on these threats to allow risk models to be developed

Status: The risk model and supporting documentation were delivered in the spring of 2011. A commercial version of the risk model is now available through GL Noble Denton.

4.9.a Determination of Leak-Rupture Boundary

Objective: To provide regulators and pipeline operators with information – based on sound engineering principles – to determine the boundary between failure by leak vs. failure by rupture as a percentage of specified minimum yield strength (SMYS).

Results: The incident review was conducted to provide an analysis of incident and testing data to identify trends in ruptures across different pipe attributes. Toward this goal, investigators developed a list of pipeline attributes and categories that define a failure stress range within a certain probability (e.g., 80% or 90%).

In developing information, researchers interacted with a variety of organizations, including the U.S. Department of Transportation's PHMSA, the American Gas Association, and the Interstate Gas Association of America.

The results of the study found that the yield strength, toughness, wall thickness, and diameter of a pipe segment can be used to predict the leak-rupture boundary (LRB). The research indicated that the boundary could range from slightly below 20% SMYS for rare pipe materials to well over 30% SMYS for many others.

A review of codes and regulations found that none of the international codes and standards identified requires the application of design factors less than 0.20 (i.e., 20% SMYS). A total of 18,813 incidents were reviewed from more than 10 countries. A total of 1,014 full-size tests were reviewed from more than 10 sources.

A sensitivity study was conducted on input parameters to decide which had the greatest influence on the LRB. The most sensitive parameters (in order from most sensitive to least sensitive) were: defect length, material properties, diameter, and wall thickness. No statistically validated correlation could be made between pipeline vintage and LRB values.

Status: This project is complete. A final report was issued May 2011.

4.10.c Testing and Design of Casing End Seals

Objective: To develop information on the performance of casing end seals to help reduce pipe-seal failures, enhance safety, and lower the cost of gas-system operations and maintenance.

Results: Industry interviews were conducted and a survey completed with gas-system operators to further develop an assessment of industry use and needs. Based on industry and manufacturer input, four products were selected to be tested. Products were chosen to provide a fair representation of the product offerings for sealing cased pipe ends.

Status: Contacts with the manufacturers have been made and they have all expressed interest in the project. Technicians have started construction of a testing rig that will be used to test each of the seals for long-term performance, temperature cycling, and eccentric loading.

5.6.e Portable Propane-Air Residential Temporary Gas Supply

Objective: Develop a small-scale propane-air delivery system to provide residential customers with gas service during times when service is normally interrupted for maintenance, repairs, or rehabilitation.

Results: Significant design, fabrication, and testing activities have been conducted, with various propane-air mixtures tested under a wide range of piping scenarios. Field testing began in 2010.

Prior to field deployment, the unit was laboratory tested and calibrated to ensure reliable performance during field testing. The propane supply regulators and plumbing were redesigned to include a pre-regulator at the tank to ensure no chance of over pressurization during field testing. Initial testing was limited to the operation of the device with a small pilot flame.

Researchers developed a prototype volumetric-mixing device that incorporates a single piston that proportions, compresses, mixes, and then delivers a user-calibrated propane-air ratio. The device is completely autonomous and adjusts instantly to the demand. The energy to drive the mixer and compress the air is derived from pneumatic pressure within the propane tank. Since the mixer is volumetric, the ratio remains constant, independent of outside atmospheric conditions.

Status: Field testing is complete. The final report has been prepared.

5.7.f Automated Meter Shut-Off (AMS) Device

Objective: To develop a prototype Automated Meter Shut-Off (AMS) device to provide the industry with a remotely controlled system that can be installed quickly over the meter shut-off valve (existing meter inlet valve), without interrupting gas service.

Results: The research team has identified a manufacturer with the technical capabilities to handle all of the wireless and mechanical technologies needed for successful commercialization of the AMS unit. The company is also a long-time supplier to the water- and gas-metering markets.

In 2010, investigators and the manufacturing partner began efforts to determine the project scope and product specifications. Sponsors provided input to the manufacturer to assist in identifying industry needs. Participating utilities provided information on torque requirements, product cost, shut-off technology, pack-age size, two-way close-proximity RF communications, indoor vs. outdoor options, and other areas.

Based on the input, the manufacturer explored various design alternatives.

Status: The research team has learned of other manufacturers planning on introducing meters with internal shut-off capabilities and will investigate this further.

5.8.a Development & Testing of Advanced Automated Welding Unit for Installing Service Tees

Objective: Enhance a prototype system developed for remote and automatic welding through small-diameter (18-inch) "keyhole" excavations for wider use in conventional excavations in the gas industry.

Results: This project was initiated with a sponsor survey to identify specific standards that must be adhered to and sizes that the automated welding system must be capable of welding.

Initial work focused on developing the ability to weld a three-quarter-inch tee onto a two-inch-diameter main.

In 2010, negotiations were completed and contracts finalized with a commercialization partner chosen to design and develop the next generation of automated-welding prototypes.

Design of both the mechanical packaging and motion control has begun. The existing components include the rotational drive system, torch holder, and wire/gas feed-line system. The clamping system allows the welder to clamp and center onto any size pipe between two to eight inches in diameter. The design keeps the welding unit at an identical offset from the top of the pipe independent of the diameter. The initial intention is to keep the design such that it can be utilized within a 24-inch keyhole.

Several design changes were made to the mechanics of the welder. In addition, the clamping mechanism was redesigned to provide a stiffer and better controlled approach. This will allow for less influence of local pipe defects or corrosion and lower the cost of the welder.

Development activities have been detailed in reports and video files for project sponsors.

In 2011, control- and mechanical- packaging activities were conducted. Changes were made to the torch positioner and other components. The control unit was packaged in a field-ready case and tested for thermal stability. The wire feeder was integrated onto the bore welder head to simplify user operation, reduce cost, and increase the quality of the weld. In addition, the dimensions of the head were reduced so that it will fit down a two-foot diameter hole up to four deep, weld up to a six-inch nipple onto an up to eight-inch-diameter pipe, and be operated from the street level as well as from down in the excavation.

Status: The final design and fabrication on the PC-based welding control system is complete. Researchers report that the program currently runs flawlessly on a mock two-axis system in the laboratory. Activities are under way to complete the beta prototype and begin producing test welds.

5.8.d Tool for the External Classification of Pipe Contents

Objective: To develop a practical tool that can enhance operations safety by being able to distinguish the contents of a buried utility pipe without breaching the pipe wall. The ultimate objective is to develop an affordable tool that could be carried in each crew truck.

Results: In 2010, investigators demonstrated the ability of sensors to: accurately measure water depth with an ultrasonic sensor on the bottom of pipe; determine if the water level in a pipe is above a certain level; determine if a main is completely full of water versus a gas-filled main (natural gas or air); detect the presence of electrical cables in dielectric oil-filled steel pipe; detect live, three-phase electrical lines at voltages as low as 1200V with an acoustic sensor.

Investigators also tested the concept of using an electromagnetic acoustic transducer (EMAT) sensor generating longitudinal waves to estimate the pressure inside a gas distribution main, but the efforts were unsuccessful.

In 2011, significant progress was made in designing the system. The sensor receiver assembly was designed and components were selected. Several microprocessors were reviewed and a microcontroller evaluation kit was selected. A mechanism was designed and built so that the sensor can be held against the bottom of the pipe during measurement. A detailed review of all of the design requirements

Status: The design of the tool is ongoing, and the printed wiring layout designed and ordered. The next step is assembly and testing of the hardware, followed by automated analysis of the data, and the assembly of the components into a prototype.

7.10.a Natural-Gas-Quality Survey: Trace Constituents

Objective: To develop information to help introduce renewable “green” sources of energy into the natural gas pipeline. Information on trace constituents will facilitate a utility’s ability to assess the potential to use gas generated from wastes and other sources.

Results: This project was initiated in 2010 with the establishment of a project steering committee and an extensive literature search. Subsequently, a technical committee was formed and a web-based project seminar was conducted.

In 2011, the radon analysis technique was selected, hydro-fracturing chemicals were investigated, and the analytical implications considered.

Status: Sampling and analysis on natural gas derived from shale sources is under way.

7.10.c Improving Methane Emission Estimates from Underground Pipeline Leaks – Phase 2

Objective: To develop a technical approach to quantify methane emissions from gas mains and service pipelines. The new method will provide an increased level of accuracy and an improved ability for utilities to comply with future regulations.

Results: In Phase 1 of this project (now completed) researchers investigated the applicability of measuring leak flow rates at their above-ground state. Investigators also reviewed the limitations of existing methods and addressed the current practices in use. Measurements of above-ground methane flow rates were performed in controlled tests at various pipeline facilities. The tests focused on evaluating the repeatability of the measurements and their correlation to the applied flow rates in different soils and at various pipe sizes, pressures, and gas flow rates.

In 2011, a testing methodology was developed and tests were performed at three field sites. The leaks at two of the sites were in two-inch Aldyl-A mains and the third site was in a two-inch PE main. The tests in two of the sites evaluated both aboveground measurements using the Hi-Flow Sampler and below-ground measurements using flow meters in isolated pipe sections. The leaks at these sites were mostly at the connections of the mains with the service lines. The detected methane measurements were small and dropped from an average of 3.5% gas at the barholes to 0.5% gas. The lines operated at pressures of about 48 psig. The gas flow measurements were at the low end of the measurements of both the Hi-Flow sampler and the flow meters. This low flow rate was characteristic of most of the plastic leaks at the connections between the mains and service lines as stated by the utility operators.

Status: At the completion of Phase 2, the research plan calls for the application of the developed field-testing procedures to obtain similar emission factors for cast-iron, protected steel, and unprotected steel pipes.

Market-Ready Solutions

UTD-Sponsored Products Enter the Marketplace

The over-riding goal of Utilization Technology Development is to support the introduction of new end-use technologies into the marketplace to enhance the ability of natural gas consumers to save money, reduce emissions, improve efficiencies, and optimize the use of natural gas as a premium fuel.

Through a combination of research, development, testing, and marketing activities, every year a number of UTD-supported projects evolve into commercially available products.

UTD is proud to present highlights of some recent milestones and market-ready solutions:

Products Commercially Available or Being Readied for Commercialization

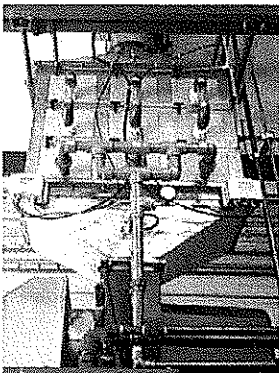

> Transport Membrane Condenser (TMC)

Cannon Boiler Works, Inc.

An advanced heat-and-water recovery system, including TMC technology, was installed and commissioned at Baxter Healthcare in Thousand Oaks, CA, meeting performance expectations and increasing the boiler efficiency from 80% to 93% – saving the customer 15% on fuel bills, reducing greenhouse emissions by 15%, and saving over 250,000 gallons of water. The Ultramizer[®] system is available from Cannon Boiler Works, Inc. (*Project Summary, p. 93.*)

Contact: Chris Giron
Cannon Boiler Works, Inc.
724-335-8541 x414
sales@cannonboilerworks.com
www.cannonboilerworks.com

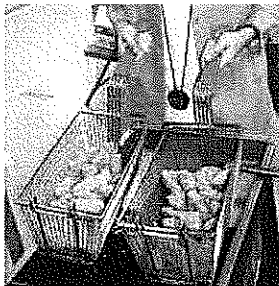

> Low-Oil-Volume Fryers

Frymaster, a Manitowoc Foodservice company

A new commercial foodservice low-oil-volume fryer has undergone development and pre-commercial testing with successful results. The fryer, marketed by Frymaster as Protector[®] fryers, increases energy efficiency while also extending cooking-oil quality and life to provide significant customer savings.

Contact: Linda Brugler
Frymaster
318-866-2488
lbrugler@frymaster.com
www.frymaster.com

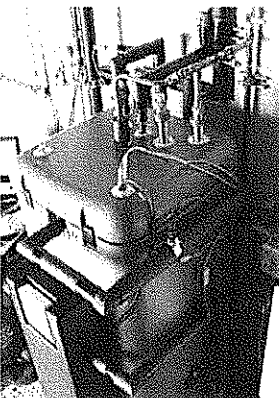

> Equinox Solar-Assisted Heating System

Solar Usage Now, LLC

The Equinox system is a combination thermal storage tank and instantaneous water heater capable of providing 100% of domestic hot-water and space-heating needs. This unit was tested in multiple residential and commercial sites and is available from Solar Usage Now as the S.U.N. Equinox Heating System.[®] (*Project Summary, p. 9.*)

Contact: Tom Rieker
Solar Usage Now, LLC
614-759-7242
service@netwalk.com
www.solarusagenow.com

CASE NO. 2016-00070
ATTACHMENT 2
Contact: Larry Klekar
10-AC-DR-NO. 2-512
Munters Corporation
210-249-3883
larry.klekar@munters.com
www.munters.com

> Dedicated Outside Air System (DOAS)

Munters Corporation

A condensing heating version of this Munters DOAS is in final development and will undergo field testing during the winter of 2012/2013 at "big box" retail store locations with participating utility Emerging Technology Programs. UTD research has been instrumental in establishing baseline store-heating energy use, developing the DOAS condensing heating module, and defining combustion condensate disposal practices from rooftops. (*Project Summary, p. 53.*)

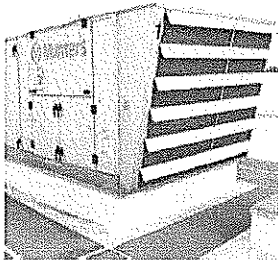

> Market Forge Countertop Steamer

Market Forge Industries Inc.

This compact gas-fired countertop steamer for commercial food service offers enhanced cooking rates while providing users with added savings of energy and water consumption. The unit is the first gas-fired boilerless steamer with an Energy Star rating.



Contact: Market Forge Industries Inc.
617-387-4100 – 866-698-3188
custserv@mfi
www.mfi.com

> Avantec Combi-Oven

Avantec Food Service Equipment

The combination oven uses a patented technology for improving cooking performance, quality, and efficiency. Able to operate in various cooking modes, the oven provides enhanced cooking uniformity when compared to similar-sized ovens.

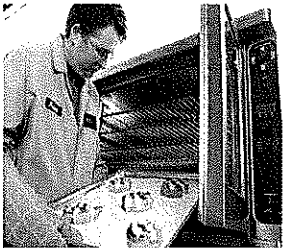

Contact: Dave Goble
Avantec Food Service Equipment
800-322-4374
dave@twomarket.com
www.avantecequipment.com

> Cummins 8.9L Ultra-Low Emissions Engine

Cummins Westport Inc. (CWI)

This is the first engine certified to the highly stringent California 2010 standards for heavy-duty vehicle engines – achieving emission levels below the 0.2 g NO_x/hp-hr requirement while also retaining high shaft efficiency. Since commercial introduction in 2007, the engine has been widely used in the United States (with over 13,000 engines now in service) and throughout the world in transit, refuse-collection, and regional hauling applications.

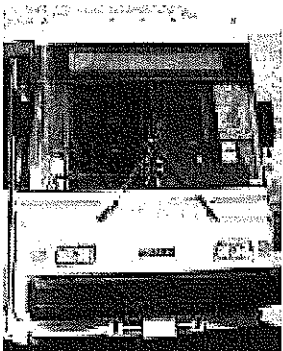

Contact: Scott Baker
Cummins Westport Inc.
604-718-2025
scott.baker@cummins.com
www.cumminswestport.com

> BRC FuelMaker's Phill

BRC FuelMaker

A field demonstration program was conducted to assess the performance, reliability, and economics of a natural-gas-fueling product that allows for the refueling of natural gas vehicles at homes and businesses. Data was analyzed and a user survey was conducted at the conclusion of the demonstration.

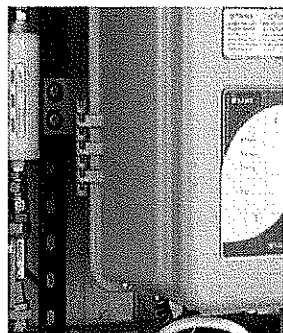

Contact: Francesco Donalisio
IMPCO Technologies /
BRC FuelMaker
+39 0172.48.68.656
F.Donalisio@brc.it

> NovelAire ComfortDry™ 400

NovelAire Technologies

This advanced supplemental dehumidifier was developed for residential and light-commercial buildings where humidity or moisture-related allergen concerns prevail. Research provided enhanced operation and reliability, along with reduced cost, weight, size, and installation requirements. (*Project Summary, p. 7.*)

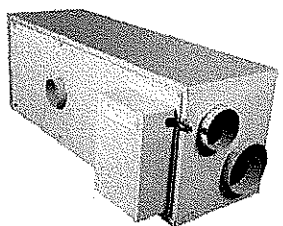

Contact: Scott Janke
NovelAire Technologies
770-664-4756
sljanke@novelaire.com
www.novelaire.com/
residential-dehumidifiers.html

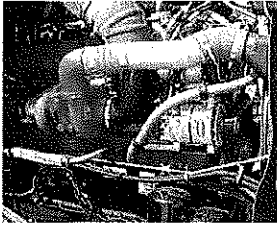

> **Westport HPDI NGV Fuel System**

Westport Innovations Inc.

High-Pressure, Direct-Injection (HPDI) technology enables engines designed for diesel combustion to operate with natural gas while retaining the same critical performance features of high torque, power, and fuel economy of a traditional diesel engine. A 2010 demonstration of the Westport HD-powered tractor allowed fleets to obtain first-hand experience with the new technology. Westport reached an agreement with Cummins in 2012 to now manufacture the engines in its Jamestown, NY, plant.

Contact: Stephen Ptucha
Westport Innovations Inc.
604-718-2024
SPtucha@westport.com
www.westport.com

Significant Milestones

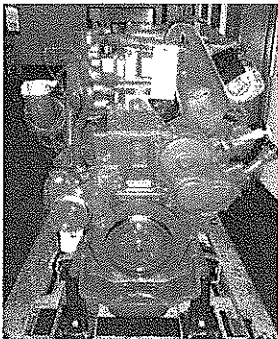

> **Cummins Westport (CWI)
High-Horsepower NGV Engine**

CWI, with UTD support, is developing a new 11.9-liter 400-HP NGV engine (ISX12G) for the large truck and bus market segment such as regional haulers, refuse transfer trucks, and other larger vehicles. The new engine will satisfy the stringent California emission requirements. Over a dozen field-demonstration units were put into service in 2012 and are performing well. The new gas engine is expected to be available in the first quarter of 2013. (*Project Summary, p. 127.*)

Contact: Scott Baker
Cummins Westport Inc.
604-718-2025
scott.baker@cummins.com
www.cumminswestport.com

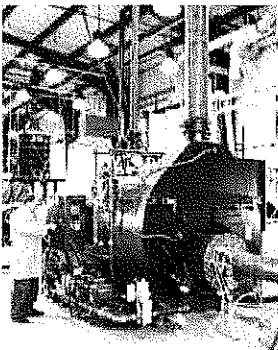

> **FlexCHP High-Efficiency Ultra-Clean
Power and Steam Package**

Researchers are developing a cost-effective supplemental burner, integrated with a gas-turbine based combined heat-and-power system. Laboratory tests have shown total efficiency of over 85% and NO_x emissions that are below stringent California emission levels. Field testing is planned at a food-processing plant in California. (*Project Summary, p. 91.*)

Contact: Dave Cygan
Gas Technology Institute
847-768-0524
david.cygan@gastechnology.org
www.gastechnology.org

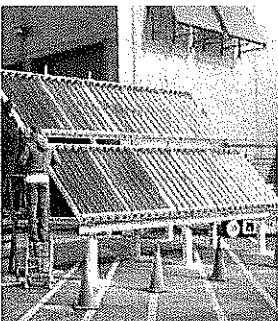

> **Solar-Assisted Natural Gas Energy Systems**

Progress continues with the installation of solar-thermal collectors using B2U Solar's higher-temperature External Compound Parabolic Concentrator (XCPC) technology. Additional testing is planned with SABMiller at its Los Angeles area brewery. (*Project Summaries, p. 9, 11, 17 and 95.*)

Contact: Dave Cygan
Gas Technology Institute
847-768-0524
david.cygan@gastechnology.org
www.gastechnology.org

Analytical Tools & Information Products

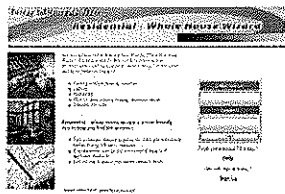

> Whole House Residential Energy Efficiency Wizard (REEW)

The REEW provides UTD members and their customers with a user-friendly Internet-server-based tool allowing for the analysis and easy selection of the latest technologies applicable to residential buildings energy-efficiency measures customized to a specific member service territory. The latest version (4.0) includes new building templates (raised floor, crawlspace, and basement) as well as an enhanced library on wall insulation and glazing. (*Project Summary, p. 3.*)

Contact: Jennifer Yang
Gas Technology Institute
847-768-0531
jennifer.yang@gastechnology.org
www.gastechnology.org

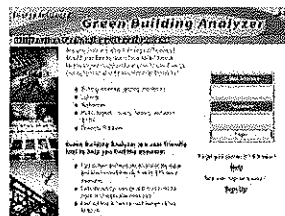

> Commercial Green Building Analyzer (CGBA)

The CGBA is designed to be a user-friendly tool allowing for easy selection of the latest applicable commercial "green" building energy-efficiency measures customized to a specific member service territory. Several new building envelope materials (walls and windows) were added to the recently released version 1.5. (*Project Summary, p. 51.*)

Contact: Jennifer Yang
Gas Technology Institute
847-768-0531
jennifer.yang@gastechnology.org
www.gastechnology.org



> Venting Solutions

VENT-II, the industry standard software program for vent system design, offers application with commonly used desktop operating systems and spreadsheet tools. A venting Technical Advisors Group includes 30 subject-matter experts, manufacturers, industry groups and associations, and Gas Technology Institute.

Contact: Larry Brand
Gas Technology Institute
847-768-0968
larry.brand@gastechnology.org
www.gastechnology.org

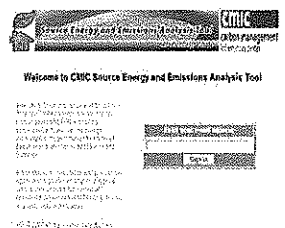

> Source Energy and Emissions Analysis Tool

The Source Energy and Emissions Analysis Tool (SEEAT) allows calculation of the energy source and greenhouse-gas emissions related to point-of-use (site) energy consumption by fuel type for each energy-consuming device (e.g., appliances and vehicles). SEEAT includes a source-energy and carbon-emission calculation methodology that accounts for primary energy consumption and related emissions for the full fuel cycle for residential and commercial buildings, industrial applications, and light-duty vehicles. (*Available online at www.cmictools.com.*)

Contact: Neil Leslie
Gas Technology Institute
847-768-0926
neil.leslie@gastechnology.org
www.gastechnology.org



> International Green Construction Code (IGCC)

The International Green Construction Code (IGCC) development committee shifted from site energy to source energy and greenhouse-gas (GHG) emissions as the basis of the performance requirements in IGCC. The latest publication includes a single-reference building approach that will implement the source energy and GHG emission-compliance requirements consistently and equitably.

Contact: Neil Leslie
Gas Technology Institute
847-768-0926
neil.leslie@gastechnology.org
www.gastechnology.org

September 11, 2013

Mr. Jeff R. DeRouen
Executive Director
Kentucky Public Service Commission
211 Sower Boulevard
Frankfort, Kentucky 40601

Dear Mr. DeRouen:

Atmos Energy Corporation (Company) herewith submits a report to be in compliance with the 2nd Revised Sheet No. 42 of the Company's tariff. The attached summaries set forth the manner in which the Research and Development Rider funds have been invested in research and development initiatives during the past year.

The research funds are utilized to partially fund the Company's participation in two not-for-profit research groups administered by the Gas Technology Institute. Operations Technology Development (OTD) supports technology aimed at reducing operations costs, enhancing safety and increasing efficiencies. The Utilization Technology Development (UTD) supports a portfolio of near to mid-term technology development projects for residential, commercial and industrial markets in efforts to offer customers more efficient, cost effective and cleaner burning gas product options.

Please contact me at (270) 685-8024 if you have any questions and/or need any additional information.

Sincerely,

Mark Martin,
Vice-President of Rates & Regulatory Affairs

Enclosures

OTD

CELEBRATING 10 YEARS

Research Project Summaries 2012



Operations Technology Development, NFP
RESEARCH PROJECT SUMMARIES

2012

Legal Notice

This report was prepared by Operations Technology Development, NFP (OTD), as an account of the results of work sponsored by OTD. Neither OTD, the members of OTD, nor any person acting on behalf of any of them:

- Makes any warranty or representation, express or implied, with respect to the accuracy, completeness, or usefulness of the information contained in this report, or that the use of any information, apparatus, method, or process disclosed in this report may not infringe privately-owned rights. Inasmuch as many projects are experimental in nature, the technical information, results, or conclusions cannot be predicted. Conclusions and analysis of results by OTD represent OTD's opinion based on inferences from measurements and empirical relationships, which inferences and assumptions are not infallible, and with respect to which competent specialists may differ.
- Assumes any liability with respect to the use of, or for any and all damages resulting from the use of, any information, apparatus, method, or process disclosed in this report; any other use of, or reliance on, this report by any third party is at the third party's sole risk.

Chairman / President's Letter

This year marks the 10th anniversary of the founding of OTD and another year of exciting new product introductions, technology developments, and innovations to benefit the natural gas industry and its customers.

Since 2003, the initial membership of 12 companies has nearly doubled, and the synergy of OTD's collaborative programs with industry leaders, government agencies, and manufacturers continues to provide significant improvements in the safety, efficiency, and reliability of the North American gas-delivery infrastructure. Today, OTD is recognized as the gas industry's premiere source for technology development and an organization with the vision, talent, and experience necessary to lead the gas industry on the path to important improvements.

Evidence of OTD's impact can be seen in the offices and field operations of the industry's leading distribution and pipeline companies, where the results of successful R&D are present in a variety of tools, technologies, and techniques. Many of these products are presented in the pages of this report – including new technologies for plastic-pipe location, leak detection, pipe inspection, information management, environmental issues, and a wide range of other applications.

This year's report details more than 70 projects – OTD's largest and most ambitious program ever. In 2012, several program developments resulted in the market introduction of new products. For example, SENSIT Technologies, Inc., is now offering an acoustic-based system capable of locating plastic pipe at depths up to five feet. Developed through OTD, the acoustic pipe locator is just one development in a portfolio of projects focused on improving the operation, integrity, and safety of gas operations. Newer efforts include the development of tools and methods to detect cross bores, an inspection system for pipeline's considered "unpiggable," sensors for determining trace constituents in fuel gases, and the development of an intelligent shut-off device.

Ten years of success has provided OTD with the advantage of long-standing relationships with leading manufacturers, research organizations, industry associations, and government entities. Together, we will continue to combine our resources to work for common goals that enhance the vital North American gas infrastructure. And we thank you for your support.

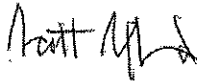

Scott Shepherd
Chairman of the Board

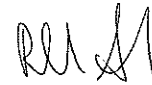
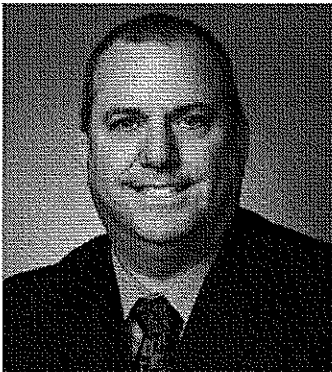

Ronald Snedic
President



OTD Members

- > Alabama Gas Corporation
- > APGA Research Foundation
- > Atmos Energy Corporation
- > Avista Utilities
- > Consolidated Edison Co. of NY, Inc.
- > Enbridge Gas Distribution Inc.
- > Intermountain Gas Company
- > Louisiana RDC
 - Atmos Energy Corporation
 - CenterPoint Energy, Inc.
 - Entergy Corporation
- > National Fuel Gas Distribution Corporation
- > National Grid
- > New York State Electric & Gas Corp. / Rochester Gas and Electric
- > Nicor Gas
- > NiSource Inc.
- > NW Natural
- > Oklahoma Natural Gas
- > PECO Energy
- > Peoples Gas / Integrys Energy Group, Inc.
- > Piedmont Natural Gas Company, Inc.
- > Questar Gas
- > Southern California Gas Co., a Sempra Energy Utility
- > Southwest Gas
- > TECO Peoples Gas
- > Washington Gas

Results in Use

For more than 10 years now, the OTD program has been providing utilities, pipeline companies, service providers, and others in the natural-gas-delivery business with innovative tools, enhanced processes, and advanced equipment developed to improve gas system operations. These products represent the results of OTD's efforts to build a stronger industry infrastructure, enhance system integrity, and improve the efficiency of a wide range of operations activities.

Selected OTD-Developed Products in the Marketplace

> Acoustic Pipe Locator

SENSIT Technologies

SENSIT's acoustic-based pipe locator provides the ability to locate plastic pipes before excavations and construction. Now commercially available, in tests the system was shown to be capable of detecting multiple buried plastic pipes at depths up to five feet. *(Project Summary, p. 17)*

Contact: Scott Kleppe | 219-465-2700 | jScottK@gasleaksensors.com | www.gasleaksensors.com

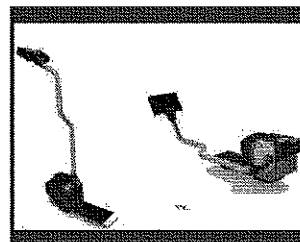

> High-Accuracy GPS for Tablets and Smart Phones

3-GIS

An application developed by OTD and GTI is now part of the 3-GIS Mobile platform to allow users to integrate external GPS receivers to improve the position accuracy of new asset mapping operations. Users can collect sub-foot accurate GPS data in real time on Android tablet computers and smart phones with no post-processing and no need for a base station.

Contact: Lee Nelson | 256-560-0744 x 222 | lnelson@3-gis.com | www.3-gis.com



> Metallic Joint Locator (MJL)

SENSIT Technologies

The SENSIT Ultra-Trac® MJL accurately locates bell joints, repair clamps, and service connections on metallic piping systems, significantly reducing excavation areas and pavement restoration costs. In field tests, the MJL was also able to detect bell and spigot joints for an eight-inch-diameter water main buried at a depth of six feet.

Contact: Scott Kleppe | 219-465-2700 | jScottK@gasleaksensors.com | www.gasleaksensors.com

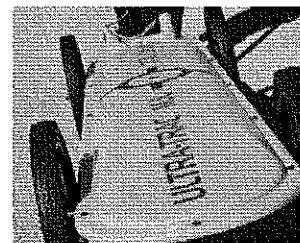

> Portable Methane Detector (PMD)

SENSIT Technologies

The handheld SENSIT® PMD uses optical-detection technology to provide sensitivity and cost advantages over conventional techniques employing flame ionization detectors. The PMD improves the efficiency of leak surveys, is less costly to maintain than other technologies, and can detect leaks from low ppm to 100% gas.

Contact: Scott Kleppe | 219-465-2700 | jScottK@gasleaksensors.com | www.gasleaksensors.com

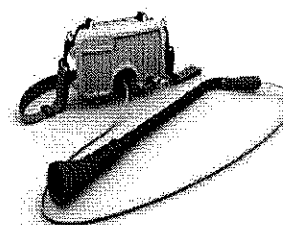

> **GPS-Enabled Leak Surveying**

Integrated Mapping Services, Inc.

Automating the leak surveying and pinpointing process with GPS eliminates paper records, providing increased efficiency and reliable compliance documentation. Implementation of the GPS-enabled system with VeroTrack AST™ software application is under way at several utility companies. (*Project Summary, p. 7*)

Contact: Langley Willauer | 207-236-3485 x306 | llangley@ubisense.net | www.ubisense.net



> **Uptime® 3.0 Distribution Integrity Management Risk Model**
GL Noble Denton

Uptime® 3.0 provides an integrated environment for the integrity management of gas distribution and transmission pipeline assets. Uptime provides core support for all the key elements of distribution integrity management program regulations.

Contact: Michael Moore | 717-724-1900 | michael.moore@gl-group.com | www.gl-group.com

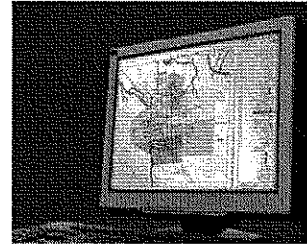

> **NO-BLO® DBS System**

Mueller Co.

Directional Bag Stopper (DBS) technology allows for routine maintenance without interruption of gas service to the customer. A portable system, it allows field technicians to perform many tasks related to the gas service line, including meter replacement and work on any part of the meter set, such as risers and regulators.

Contact: Bryan Kortte | 217-425-7516 | bkortte@muellercompany.com | www.muellercompany.com

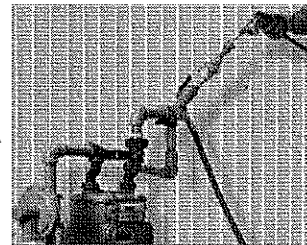

> **Meter Xchanger™**

Mueller Co.

This technology allows utilities to conduct meter change-outs without interrupting service, with the advantage of hands-on work, without shrouds and glove ports. The change-out tool can increase productivity, reduce the cost of the meter change-out process, and virtually eliminate the impact on customers.

Contact: Bryan Kortte | 217-425-7516 | bkortte@muellercompany.com | www.muellercompany.com

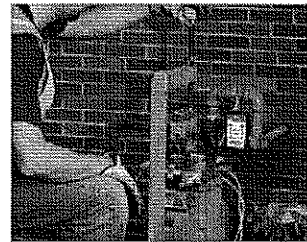

> **Lift Assists for Pavement Breakers and Rock Drills**

Integrated Tool Solutions

These devices assist workers in lifting pavement breaker and rock drills after the bits break through surface pavements and rocks and need to be repositioned for the next penetration. By eliminating the need to manually lift and re-position the heavy tools, the lift assists make breaking easier and less physically demanding.

Contact: Ryan Purczynski | 951-929-4808 | rpurczynski@integratedtoolsolutions.com | www.integratedtoolsolutions.com

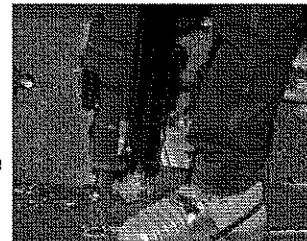

> **Keyhole Pipeline Inspection Camera System**

ULC Robotics

The PRX250K keyhole camera is an internal inspection system designed for visual assessment of live mains through conventional pits or small keyholes. The system is easily maneuverable through tight bends, allowing utilities to examine pipe segments without the need to drill additional access holes.

Contact: Greg Penza | 631-667-9200 | gpenza@ulcrobotics.com | www.ulcrobotics.com



Informational Products

Selected OTD-Developed Technical Reports

In addition to the development of new tools, processes, and products, OTD supports research that results in useful information on various aspects related to gas delivery and operations.

Listed here are some of the key reports developed under OTD sponsorship since 2003.

PIPE & LEAK LOCATION

> **Cross Bores Best Practices Guide**

Cross bores have become an industry concern because of incidents involving gas mains and services that were installed using trenchless technology that inadvertently transected a sewer line or private septic system. The Guide provides recommendations and procedures for preventing and detecting cross bores. (OTD-12/0003) (*Project Summary, p. 59*)



> **Residential Methane Gas Detector Program**

This reports provides results of a project initiated to determine whether commercially available combustible gas detectors are susceptible to giving false positive responses to an assortment of typical household chemicals, including ammonia, ethanol, acetone, toluene, isobutane, ethyl acetate, isopropanol, heptane, and hydrogen.



> **Underground Facility Pinpointing**

This report presents the results of research conducted on several technologies used by utilities to locate underground pipes and facilities. Researchers investigated standard electromagnetic locators, ground-penetrating radar, and alternative imaging tools. The report provides a comparative, technical evaluation of tools that are currently available. (OTD-06/0001)



PIPE MATERIALS, REPAIR & REHABILITATION

> **Electrofusion Coupling Evaluation and Best Practices**

Researchers investigated techniques used to perform electrofusion joining of plastic gas pipe in an effort to develop guidelines for the use and operation of electrofusion coupling. With a detailed set of guidelines, the gas industry can enhance the performance and safety of its plastic piping systems.



> **Review and Selection Guide for Pipe Rehabilitation**

The focus of this study is on reinforced thermoplastic pipe (RTP) as a pipe-rehabilitation option for use in the natural gas industry. To help pipeline operators gain a better understanding of the technology, researchers developed a product-selection guide based on thorough research of available RTP technology.



EXCAVATION & SITE RESTORATION

> **Evaluation of Lightweight Jackhammers**

A research team evaluated the performance of currently available lightweight pneumatic and hydraulic jackhammers with respect to their effectiveness in breaking asphalt and concrete pavement, while considering other operational factors such as noise, vibrations, operator impact, and performance.



> **Cold-Patch Products Performance Results**

This report provides the results of a testing program that evaluated nine commercially available cold-patch products, including two products introduced in the market as "green" patches. Cold- and warm-weather tests were performed and repeated moving loads were applied with a wheel-loading machine that conducted 50,000 wheel passes.



> **Evaluation of Flowable Fill Around Buried Pipes**

Flowable fill is required by some agencies for use as backfill material for pipe repairs, rehabilitations, and other operations. Presented in this report are the results of performance tests of flowable fill, including the effects of flowable fill on pipeline corrosion and on the detection of gas flow and leaks through the backfill. (OTD-07/0004)



> **Alternative Methods of Pavement Cutting**

In an effort to reduce the costs and improve the process of pavement cutting, researchers investigated the application of current and new pavement-cutting methods. Technologies examined and summarized in this report include impact breaking, sawing, chemical and thermal methods, water-jetting, and laser cutting.



PIPELINE INTEGRITY MANAGEMENT & AUTOMATION

> **Leak-Rupture Boundary Report and Calculator**

This report and associated software allows operators to determine the leak-rupture boundary for a pipe segment based on properties such as the diameter, toughness, and yield strength. Operators can use the calculator for risk modeling and consequence analysis. (OTD-13/0002 and OTD 13/0004) (Project Summary, p. 59)



> **Field-Applied Pipeline Coatings: Short- and Long-Term Performance**

This report presents the culmination of a 10-year research program to assess more than 80 different commercially available field-applied pipeline-coating products. The goal was to establish an unbiased, third-party basis for operators to select the most appropriate coating system for particular applications.



> **Evaluation of Guided Wave Technology as a Hydrotest Equivalent**

This report details an evaluation conducted to demonstrate and validate the use of Guided Wave Ultrasonic Testing as an equivalent to a hydrotest. A draft standard was developed and is currently under review by the National Association of Corrosion Engineers (NACE) for incorporation into an industry standard. (OTD-11/0001)



> **"Black Powder" Contamination in the Gas Industry: Survey and Best Practice Manual**

Black powder – a substance composed mainly of iron sulfides and iron oxides – can cause corrosion and create wear on pipelines. This report provides information on issues, cleanup techniques, and management methods related to "black powder" contaminants. Results were compiled into a "best practices" industry manual. (OTD-07/0002)



> **Literature Review for Elemental Sulfur Deposits in Natural Gas Transmission Pipelines**

Deposits of "elemental sulfur" – which can block natural gas pipes and equipment – are becoming an increasing concern in the natural gas industry. This report summarizes a literature review to develop a better understanding of the sources, causes, and mitigation possibilities for sulfur deposits found in gas pipelines. (OTD-09/0001)

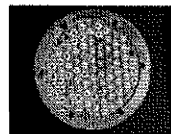

> **Flaw Acceptance Criteria and Repair Options for Low-Stress Natural Gas Pipelines**

Researchers partnered with pipeline companies and industry organizations to develop modified assessment criteria for low-stress pipelines. The goal, as outlined in this report, was to develop criteria for discriminating flaws that truly affect pipeline integrity from flaws that have no significant impact.

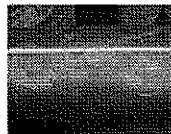

> **In-Field Corrosion Rate Measurement/Determination for Integrity Reassessment Intervals and Risk Prioritization**

Research was conducted to develop a systematic and simple method to calculate realistic corrosion growth rates for determining pipeline-reassessment intervals.

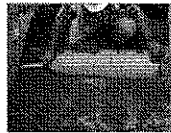

OPERATIONS INFRASTRUCTURE SUPPORT

> **Ignition Testing of Electronic Devices**

In this project, handheld electronic devices were tested to determine if ignition occurs in the presence of a flammable methane/air mixture. Laboratory tests demonstrated a large margin of safety under the scenarios investigated. (OTD-12/0001) (Project Summary, p. 123)



> **Intelligent Utility Installation Process**

This report provides a methodology, field process, and a data model for capturing data during new utility installations. The process is used to capture information regarding the location, materials, installation process, environmental considerations, and other factors. (OTD-12/0002) (Project Summary, p. 111)



> **Tracer Wire for HDD Applications**

Extensive research and testing culminated in the release of a report that provides valuable information on the properties and performance of various tracer-wire products for use in horizontal directional drilling (HDD) operations. (OTD-13/0001) (Project Summary, p. 105)



> **Regulator Vault Corrosion and Coating Rehabilitation**

This study focused on thermal-spray and its ability to mitigate the corrosion of gas piping and the components housed in utility vaults. Results from the field work include detailed information on surface preparation methods, pre-cleaning, coating applications, quality-control inspection specification for field use, and the coating-material selection process.



> **Assessment of Vehicle-Barrier Design for Aboveground Facility Protection**

Investigators compiled the latest information on the design, regulations, and installation practices of structural vehicle barriers used to protect aboveground utility facilities from vehicular damages. The Final Report also includes a review of various state and federal safety guidelines.



> **Study of Low-Impact Markings**

A variety of paints, materials, and techniques were tested and characterized in an effort to identify products and methods that can be used for temporary utility marking. Information developed in this study allows users to identify the most appropriate marker type for a given environment to achieve the desired marking duration.

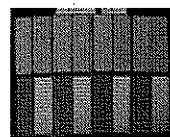

> **Solar-Powered Remote Monitoring**

In this study, solar-powered devices were investigated as power sources for the remote monitoring of various gas utility facilities to more cost-effectively obtain rectifier data, pipe-to-soil measurement, pipe-to-casing readings, and other information. (Project Summary, p. 99)

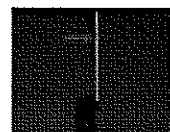

> **Integrating GPS into Routine Operations**

This report provides a set of recommendations and GPS implementation strategies developed through pilot programs, literature searches, and reviews of existing applications. Operations that were considered included meter reading, leak surveying, new installations, corrosion monitoring, and valve inspections.

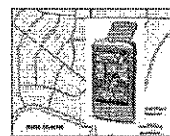

> **DVDs for Training First Responders**

DVD training products help gas companies better educate first-responding personnel about natural gas emergencies. Learning modules with realistic scenarios cover a variety of issues to enhance public and worker safety. The product also serves to improve emergency-response effectiveness and coordination.



ENVIRONMENTAL, RENEWABLES & GAS QUALITY

> **Siloxane Concentrations in Biomethane**

Biomethane from various waste products could provide consumers with a significant source of "green" renewable energy. In efforts to help develop this green resource, a study was conducted into siloxane – one of the potential constituents in biomethane – to assess its influence on health, the environment, and gas-fired appliances. (Project Summary, p. 137)

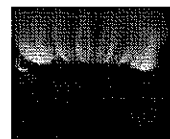

> **Field Measurement Program to Improve Uncertainties for Key Greenhouse Gas Emission Factors for Distribution Sources**

This report summarizes the results of field surveys conducted at six natural gas utilities. With the support of the American Gas Association, research updated emissions factors for metering stations, regulating stations, and customer meters. (OTD-10/0002)



> **Pipeline-Quality Methane: North American Guidance Document for Introduction of Dairy-Waste-Derived Biomethane into Existing Natural Gas Networks**

The guidance document provides reference and recommendations for the consideration of biomethane from dairy-waste digestion for introduction into gas pipeline networks. The report details results of a biogas/biomethane Gas Technology Institute research program.



Contact: Maureen Droessler
847-768-0608
maureen.droessler@otd-co.org
www.otd-co.org

OTD RESEARCH PROJECT SUMMARIES 2012

Table of Contents

Project	Page
PIPE & LEAK LOCATION	
1.i Remote Leak Survey Using Lasers	3
1.8.a GPS-Based Excavation Encroachment Notification	5
1.8.c &	
1.9.a GPS-Enabled Leak Surveying and Pinpointing	7
1.8.f Underground Obstacle-Detection System – Acoustic.....	9
1.9.b Public Improvement Project Coordination with GPS, GIS, and Smart Tags.....	11
1.9.g Automating Leak Pinpointing.....	13
1.10.a Ethane-Only Detector.....	15
1.10.c Acoustic Pipe Locator: Technology Transfer	17
1.10.e Enhancing Damage Prevention Through Implementation of New Technology	19
1.11.c Low-Cost MEMS Methane Sensor Platform – Phase 1	21
1.11.d Cross Bores Best Practices	23
1.11.e Cross Bores – National Database and Risk Model.....	25
1.11.c Locatable Plastic Pipe.....	27
1.12.b Cross-Bores Detection Using Mechanical Spring Attachment	29

PIPE MATERIALS, REPAIR & REHABILITATION

2.7.b Characterization of Long-Term Performance and Strength of Lateral Joints	33
2.7.d Cold Adhesive Repair and Joining of Polyethylene Pipes with Minimal Surface Preparation.....	35
2.7.e Development of an External Repair Tool for Polyethylene Pipe.....	37
2.9.e High-Pressure Inflatable Stoppers – Alternative to Traditional Stopping Equipment	39
2.10.b Polyurea-Coating Testing and Assessment for Gas-Industry Use.....	41
2.11.a Development of a System for Repair of Aboveground Leaks.....	43
2.11.g Composite Piping Systems Development, Application, and Evaluation Workshop	45
2.11.h Evaluation of Below-Ground, Pipe-Surface-Preparation Tools	47
2.12.a Integrated Expert Monitoring and Training System for Butt Fusion.....	49

PIPELINE INTEGRITY MANAGEMENT & AUTOMATION

4.e Inspection Platforms for Unpiggable Pipelines – Phase 4	53
4.7.g Yield Strength Determination Through Sub-Size Samples	55
4.8.a Guided Wave Evaluation as Hydrotest Equivalent.....	57
4.9.a Leak-Rupture Boundary Calculator.....	59
4.10.c Testing and Design of Casing End Seals.....	61
4.11.c MFL Inspection System for 12-Inch-Diameter Gas Lines	63
4.11.d Internal Inspection Optimization Program	65
4.11.e Evaluating Assessment-Technique Effectiveness	67
4.10.f Understanding Threat Interactions for Risk Analysis	69
4.12.a Probability-of-Failure Model for High-Risk Pipe Segments (Vintage Pipe)	71
4.12.d Continuous Threat Identification Program	73
4.12.e PipeCrawler Marker Assessment and Demonstration	75

Table of Contents (cont.)

Project Page

OPERATIONS INFRASTRUCTURE SUPPORT

5.8.d	Tool for the External Classification of Pipe Contents.....	79
5.8.e	Development of Standardized Algorithms and Identifiers for Enhanced Material Tracking and Traceability	81
5.8.l	Mitigation of Water Accumulation in Underground Regulator Vaults	83
5.9.c	Mitigating Electrical Interferences on Cathodic Protection Systems	85
5.9.f	Cathodic Protection Monitoring Technology Deployment	87
5.10.a	Evaluation of Ionix Static Suppressor on Existing Polyethylene Piping Systems	89
5.10.d	Remote Monitoring for Quality Assurance of New Installations	91
5.10.e	Large-Diameter Insulating Fittings – 8-, 10-, and 12-Inch Pipe	93
5.10.g	Indoor Air Quality and Safety Issues	95
5.10.h	UV Degradation and Static Buildup Testing of Personal Protection Equipment Fabrics.....	97
5.10.i	Solar-Powered Remote Monitoring	99
5.11.a	Dewatering Systems for Mains and Services	101
5.11.b	Development of Environmentally Conditioned Personal Protection Equipment.....	103
5.11.c	Tracer Wire for HDD Applications	105
5.11.e	Intelligent Utility System.....	107
5.11.h	Automating the Capture of Public Data for Integrity Management Database Specification.....	109
5.11.m	Intelligent Utility Installation Process	111
5.11.n	Quality-Control Procedure for High-Potential Anodes.....	113
5.11.p	Smart Grid Initiative Standards and Regulations.....	115
5.11.r	Integrating Sensors with Existing Automated Meter-Reading Systems	117
5.11.s	Breakaway Disconnect/Shut-Off for Meter Risers	119
5.11.t	Essential Data Collection for PE Fusion Operations	121
5.11.w	Ignition Testing of Electronic Devices	123
5.12.a	Development of an Intelligent Shut-Off Device for Commercial and Industrial Customers.....	125
5.12.b	Development of a Portable Flash-Fire Suppression System	127
5.12.d	Guidelines for Data-Collection Requirements.....	129
5.12.g	Large-Diameter, Medium-Pressure Inflatable Stoppers.....	131

ENVIRONMENTAL, RENEWABLES & GAS QUALITY

7.9.a	Microbiological Testing Kits for Renewable Gas – Phase 2.....	135
7.9.c	Assessment of Acceptable Siloxane Concentrations in Biomethane.....	137
7.10.a	Natural-Gas-Quality Survey: Trace Constituents	139
7.10.b	Development of a Practical Pipeline Operator Guide to Manage Odor Fade Issues.....	141
7.10.c	Improving Methane Emission Estimates from Underground Pipeline Leaks – Phase 2.	143
7.10.d	Prototype In-Line Biofilter Testing	145
7.11.a	Gas Quality Resource Center.....	147
7.11.b	Sensors for Trace Constituents in Fuel Gases	149

PIPE & LEAK LOCATION

Advances in technologies for pipe and leak location enhance the safety and maintenance of natural gas delivery systems.

Developments in this area include improvements in leak detection, plastic-pipe location, obstacle-detection capabilities for horizontal boring tools, and underground facility pinpointing.

Multiple approaches are being investigated, including the use of GPS-enabled equipment, radio-frequency markers, acoustic detection techniques, and laser-based technologies.

Research focuses on reducing third-party damage (the primary cause of gas system leaks and incidents), increasing productivity, and improving system integrity.

Recent significant efforts include projects to address and detect utility line cross bores.

OTD

Operations
Technology
Development

Remote Leak Survey Using Lasers



Remote gas-leak survey technology is being developed to reduce the cost and the need for walking and mobile surveys. Research is focused on the development of a laser that could be mounted in a vehicle for surveying both mains and services.

Project Description

Researchers are developing a new leak detection technology, called the Laser Line-Scan Camera (LLC). With the LLC, a laser beam is directed outward to detect back-scattered light at wavelengths that are sensitive to the presence of methane in the air. The remote sensing technology is designed to provide real-time detection and location techniques to detect above-ground natural gas leaks at sensitivity levels comparable to that of current flame pack surveys (5-10 ppm).

In this project, research is being conducted to determine the LLC's detection limit, inspection speed, operator interface, and system packaging. The ultimate performance goal for the LLC will be to detect gas plumes with methane concentrations as low as 10 to 20 ppm out to distances of 100 feet from a vehicle.

Deliverables

Research and testing results will be documented in a report that will include recommendations for developing and improving prototypes for further testing.

Benefits

Gas companies and their customers would benefit by having a technology that would allow leak surveys to be conducted from a distance of 60 feet or more. By mounting the laser-based device on a vehicle, surveys of both mains and services could then be performed from the street, eliminating the need to walk the gas service lines.

Technical Concept & Approach

In earlier research, a pre-prototype LLC was designed, built, and tested in the laboratory with available laser chips. Researchers noted that these chips were close to the required bandwidth. The initial system performed well but required improvements based on input from project sponsors.

The LLC technique uses two lasers and an infrared detector array to obtain information on leaks on the ground. The two lasers operate at slightly different wavelengths, where the signal from one laser is strongly absorbed by methane gas and methane is transparent

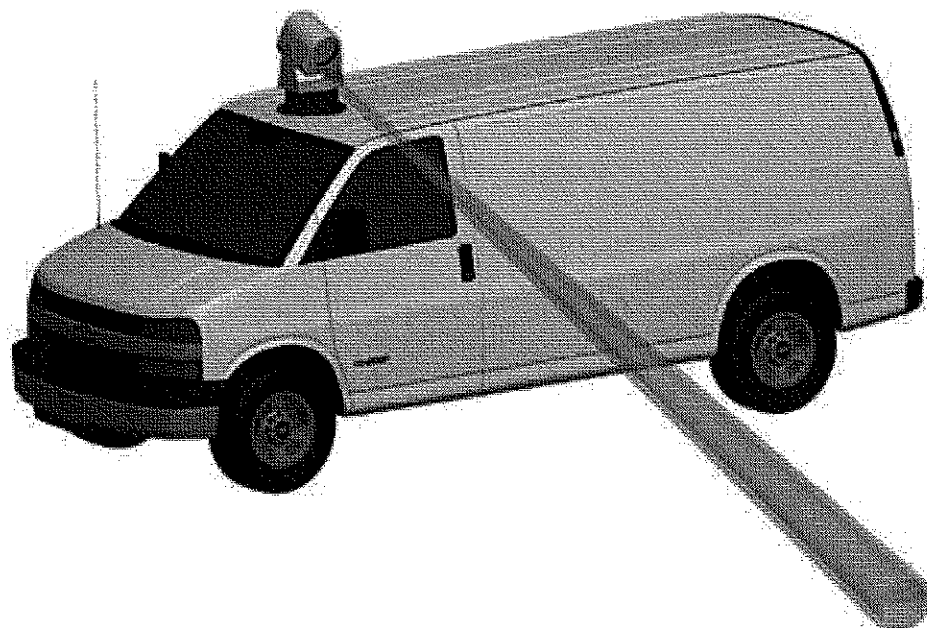

Turret installation concept.

is transparent to the other, out-of-band wavelength. This permits the LLC processor to measure the difference between the reflected laser returns and display the results to an operator. When the lasers pass over a region where a methane leakage plume is located, the relative volume of the plume is displayed to the operator as a histogram.

Results

In 2011, signal and reference lasers were tested and incorporated in the LLC prototype equipment. Tests of the prototype were subsequently conducted in the laboratory and at field sites.

Testing was conducted using a manually-controlled laboratory-grade breadboard assembly, which clearly displayed both a "no-gas" condition as well as positive "gas" detections. Results substantiated the potential value of active LLC leak detection.

In laboratory tests with the current lasers in a breadboard configuration, the detection limit of the LLC was found to be < 8 ppm, displaying a discernable/positive detection that could be used to visually alert an operator or digitally processed to provide an enhanced detection capability that could be used to generate an auto-alert and/or a leak-tagging cue. The actual detection sensitivity was estimated to be 5 to 10 ppm.

For the field demonstration, the breadboard LLC was installed in a cargo van and repositioned to a remote site where previously located natural gas leaks were identified. Testing was remotely conducted from within the stationary van on actual main-to-meter leaks in two different locations with differing levels of natural gas concentrations. The leaks were initially located and/or measured using an available leak-detection device. All testing was conducted under field conditions, as they were found, with sustained 10-15 mile-per-hour winds at both locations.

The Site 1 leak was a large natural gas leak in a low-pressure main. Both the commercial gas leak detectors and the LLC were able to successfully locate the gas leaks at Site 1. Testing at Site 2 involved a repaired low-pressure main-to-meter line. The LLC was able to remotely detect residual gas percolating from the ground at very low concentrations measured at a few ppms. The LLC was observed to show no gas signal when pointed at areas without leakage in proximity to the leak, and then showed a signal when pointed at the leak.

Subsequently, research was initiated to build, test, and complete delivery of the pre-production LLC system.

In 2012, a variety of engineering tasks were conducted,

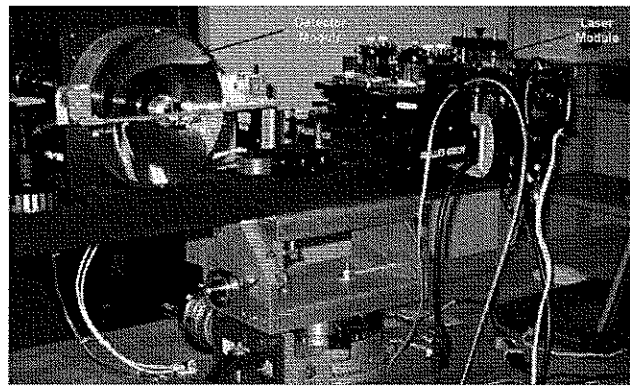

Breadboard configuration of two of the major LLC modules. The processor module is contained in a rack below the optical table.

which largely consisted of a review and update of system requirements and characterization, analysis, and modeling of critical modules and system components. The process-characterization task is designed to define and increase the repeatability of the fabrication process.

Status

System engineering is a continuing task throughout the project.

Planned activities include:

- Complete hardware/software requirements review/analysis
- Complete development of preliminary system specifications, technical performance measures, and user requirements
- Continue development and evaluation of user interface software
- Mount and test existing lasers in new laser module
- Detector electronics (preamplifiers, integrators) to be fabricated for lab testing
- Sensitivity of detector system to be quantified in the laboratory.

For more information:

Maureen Droessler
Program Administrator
Operations Technology Development, NFP
Phone: 847/768-0608
maureen.droessler@otd-co.org



Operations
Technology
Development

GPS-Based Excavation Encroachment Notification

In a project aimed at reducing excavation damage, researchers are investigating the potential to use GPS technology to monitor excavation activity. The technology would provide the ability to alert excavators and utility owners when digging is encroaching upon pipelines and other facilities. Current activities involve a field demonstration in New York.



Project Description

This project focuses on linking GPS technology with digging operations to provide a warning system to prevent excavation damages to underground facilities.

The objective is to develop and demonstrate a system to ensure that excavation activities are occurring within a valid one-call ticket (which authorizes excavation) and are not encroaching upon underground pipes and facilities.

Researchers initially partnered with Virginia Utility Protection Service (VUPS), a one-call center for utility locates, that has been conducting pilot programs to demonstrate the feasibility of using GPS-enabled cell phones (Phase 1) and GPS-enabled locators (Phase 2) to call in excavation projects, access information, and create digital maps of all locates.

The GPS-enabled cell phones allow VUPS to create an "electronic white line" of the excavation ticket based on the GPS coordinates of the phone that called in the ticket. GPS-enabled locators are used to capture the coordinates of the underground facility during routine mark-outs. Data collected with the GPS-enabled locator is transferred to both the utility company and the excavator.



Systems mounted near equipment controls alerts operators when they encroach utility lines.

Currently, efforts are aimed at developing a pilot program in New York and additional pilot programs to further demonstrate the technology.

Deliverables

Deliverables for this project include:

- A web-based portal to collect and display data
- Mobile application to allow viewing in the field
- Completion of a pilot project demonstrating the implementation of the technology
- A Final Report detailing pilot project results.

Benefits

Excavation damage is the primary threat to the integrity of natural gas distribution systems.

It is reported that about 60% of damage in the utility industry is the result of excavators failing to notify one-call centers and excavators that do not dig cautiously near underground assets.

By linking GPS technology with excavation equipment, enhanced monitoring can reduce the occurrence of excavation damage from these two causes.

Technical Concept & Approach

The key aspect of this effort is to integrate GPS monitoring into excavation activities so equipment operators can be automatically alerted to potentially hazardous situations. The GPS coordinates of the excavation activity are cross referenced with the location of valid one-call tickets (obtained through the one-call center) and the location of underground assets (obtained with GPS-enabled locators during the mark-out process). This information is collected in a portal that performs the analysis, detects violations and encroachments, and sends warnings and notifications to the stakeholders.

The current scope of this project is focused on the implementation of the GPS-based excavation encroachment notification technology with a sponsor utility construction project.

Specific tasks include:

- **Software Development and Configuration**

Activities in this task include testing the software for the selected hardware.

The software has two components. The first is a desktop version that allows users to view excavation activity and run reports. The second component is a mobile application that allows users to view excavation activity and encroachment on handheld devices. The mobile component will allow equipment operators, field managers, and other on-site personnel to view excavation activity and utility line locations. The software will send an email/text warning to pre-designated people if excavation encroachment occurs.

The system that was deployed in Virginia used a sophisticated bucket monitoring system that provided high-accuracy positional information. While the system provided highly accurate information, deployment of the system is expected to be limited by complexity and high cost. During this new pilot project, researchers will utilize a less accurate system with simpler functionality at a much lower cost.

- **Demonstration**

Researchers will demonstrate the software on a selected mobile device in a pre-pilot project demonstration to solicit feedback from end users.

- **Pilot Project**

A pilot project will be conducted to evaluate the effectiveness and feasibility of using GPS technology to monitor excavation activity. The work in this task will include training and technical support throughout the duration of the pilot project. It is anticipated that each sponsor would use the technology during a two-week test period as part of normal day-to-day work.

Results

The pilot project with VUPS was completed in 2011. The developed technology was tested and implemented in a series of demonstrations with stakeholders in Virginia. A GPS monitoring system for excavation equipment was developed that periodically transmitted active excavation-equipment-location information to a portal. The portal has a web interface to allow users to view the current excavation activity in a given area through

text data or through a mapping feature. Information was cross referenced with the GPS coordinates of all valid one-call tickets.

A more precise GPS monitoring system was developed to cross reference the location of the excavation bucket with the GPS coordinates of underground facilities (as collected during the standard mark-out process with a GPS-enabled locator). A warning was transmitted to the excavator, utility company, and/or one-call center when the bucket comes within a predetermined distance of a utility line.

A digging trigger was developed to ensure that the system only reports excavation-location information when digging is actually occurring. An on-board software system for excavation equipment was developed that provides a real-time warning to excavators based on the asset-location data collected with the GPS-enabled locators.

In 2012, the research team initiated plans for a second pilot project to occur in New York with efforts to establish a working relationship with the New York State Department of Transportation (NYSDOT) to identify a project site for a demonstration. However, the differences in the approach used to coordinate excavation activities near underground utilities in New York versus that used in Virginia resulted in the consideration of an alternative approach to coordinating the pilot where the DOT would not serve as the focal point for obtaining GPS information for the no-dig zone.

The project was re-scoped to include the use of a GPS receiver mounted on an excavator. The system will be integrated with an onboard GIS environment to access various underground utility features for excavation encroachment management. This system is unique in that it will be able to deliver utility data to the operator in real time and will be able to be integrated with utility data commonly stored in a GIS system.

Status

An alternative scope of work was developed.

Activities are under way to develop the software with pilot demonstrations expected to be initiated in mid-2013.

For more information:

Maureen Droessler
Program Administrator
Operations Technology Development, NFP
Phone: 847/768-0608
maureen.droessler@otd-co.org

GPS-Enabled Leak Surveying and Pinpointing

The objective of this project was to develop a software application that automates the leak surveying and pinpointing process with GPS. The system will automatically create and populate leak reports and record the routes of leak surveys.



Project Description

Conventional leak surveying and pinpointing processes are typically time consuming, inefficient, and subject to user error.

Additionally, documenting and proving compliance with regulations regarding leak surveying can be problematic and slow with paper records.

Currently, the process involves several steps:

1. Paper Route

Leak-surveying crews are given a paper map with leak survey routes to follow.

2. Leak Survey

Crews walk predetermined routes with leak-detection equipment. The route walked is manually recorded on the paper route map and detected leaks are recorded on a paper leak report.

3. Data Entry and Storage

The paper routes are stored with past records and leak reports are manually entered into an electronic system.

4. Work-Order Generation

Work orders are manually generated from the results of the leak survey.

5. Leak Pinpointing

Leaks are pinpointed and repaired if necessary. Follow-up inspections may be required, depending on the class of the leak.

6. Geographic Information System (GIS) Integration

The location of leaks may be manually entered into a GIS for tracking, trending, and modeling.

Recognizing the need for a complete system that automates the leak surveying and pinpointing process, in recent years the natural gas industry has been supporting the development of technology to improve information gathering and recording. Efforts in this program focused on implementing a system that automates and streamlines leak surveying and pinpointing operations through a GPS-enabled electronic leak-ticket system. The system includes a new software application, a hand-held GPS device, and Bluetooth®.



In a pilot test, a Panasonic H2 Tablet running VeroTrack Mobile was mounted to a Segway.

enabled leak-detection equipment. The system will decrease the time and error associated with entering and recording route and leak location information.

Deliverables

The deliverables from this project are a commercially available software application called VeroTrack AST™ from Integrated Mapping Services, Inc.; a Bluetooth®-enabled Gas-Rover™ from Bascom-Turner Instruments, Inc.; and a Bluetooth-enabled RMLD® and DPIR™ from Heath Consultants Incorporated.

Benefits

- Elimination of paper forms and records
- Increased efficiency in the field and office
- More efficient and reliable compliance documentation
- Improved ability to monitor contractor performance
- Streamlined integration of data into a GIS
- Increased efficiency in re-locating leaks.

Technical Concept & Approach

Phase 1 of this project involved the development of a software application to:

- Create electronic leak reports
- Automatically capture leak readings from detection equipment (surveying and pinpointing) and populate the leak report
- Automatically attach GPS coordinates to leaks
- Record and attach GPS coordinates to the route of the leak surveyor
- Facilitate the direct transmission of leak reports and leak survey routes to a GIS or other system
- Allow leak-pinning operations to be recorded and attached to the leak report.

In Phase 2, the objective was to partner with leak-detection-equipment manufacturers to Bluetooth enable their devices and configure them to integrate with the VeroTrack AST application. Heath's RMLD and DPIR and Bascom-Turner's Gas Rover were included in this phase of the project.

Results

A software application was developed and integrated into commercially available GPS-enabled mobile equipment that is capable of receiving information from Bluetooth-enabled and configured leak-detection devices. Development and testing with VeroTrack AST was completed and integrated with the Heath and Bascom-Turner leak detectors. VeroTrack AST is now commercially available from InMaps.

In 2011, VeroTrack was fully implemented at Intermountain Gas Company. Also in 2011, Atmos Energy Company participated in a 30-day pilot project to evaluate VeroTrack Mobile, which runs on Windows-based laptops and tablets including the Trimble Yuma and Panasonic Toughbook H2. These devices provide larger screens and much more processing power than the Trimble Junos that were used in the walking survey.

Overall, the pilot was a success and Atmos was able to collect leak-surveying data and leak information using VeroTrack.

During the pilot period, researchers identified areas to improve the software and devices that may enhance the operation.

Status

This project is completed. A Final Report was issued in December 2012.

Not only did the technology provide a more efficient and accurate way to perform leak surveying, but it also provided many inherent cost and risk reductions associated with the implementation of VeroTrack.

Surveyors reported time savings associated with the reduction and/or elimination of paper work as well as risk reductions associated with the breadcrumb trail feature.

While in the field or back office, the surveyors are able to identify areas that were missed. Furthermore, the transition from using paper maps to using electronic data capture methods with VeroTrack was well received.

For more information:

Maureen Droessler
Program Administrator
Operations Technology Development, NFP
Phone: 847/768-0608
maureen.droessler@otd-co.org

OTD

Operations
Technology
Development

PIPE & LEAK LOCATION

Underground Obstacle-Detection System – Acoustic

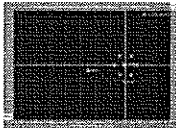

In this project, an acoustic-based system was developed to detect pipes, cables, and other buried objects in the vicinity of the drill head during horizontal directional drilling operations. Tests demonstrated the ability of the device to detect pipes made of plastic and metal to up to 20 feet of the drill head.

Project Description

Currently, there are no commercially available instruments to detect the presence of obstacles during drilling operations for installing pipes.

The objective of this project was to design, build, and test a system to provide real-time detection of underground objects during horizontal directional drilling (HDD) operations used in the installation of utilities.

The project focused on the development of a system that incorporates an array of acoustic sensors and operates above ground to detect passive objects. Information is displayed for the HDD operator.

Development involved the design and fabrication of electronics, transducers, signal processing, and information display.

Deliverables

In this project, research was conducted to develop sensing technologies that can scan in front of and radially around the drill head to detect the presence of buried objects and provide a warning to the HDD operator so the boring path can be re-directed to avoid contacting any nearby lines. Technical data and research results are compiled in detailed reports for project sponsors.

Benefits

Directional drilling is an established method of choice for installing utilities beneath roadways and other types of surfaces and landscapes. As the use of directional drilling has increased, so has the potential for underground strikes produced when either the pilot-hole drill head or back-reaming bit contacts a crossing line. These strikes can cause property damage and, in the worst circumstances, can result in injury to utility workers or the public.

Benefits include:

- Reduced risk and cost by avoiding contact with buried obstacles

- Expanded applicability of HDD
- Increased acceptance of HDD as an attractive alternative to open excavation
- Reduced cost of gas-line installations
- Enhanced safety of HDD operations.

Technical Concept & Approach

The system uses a unique technique based on use of the sonic noise emitted from a drill head from guided drilling machines to detect obstacles/pipes that are in the path of the drill head. This technology, a passive

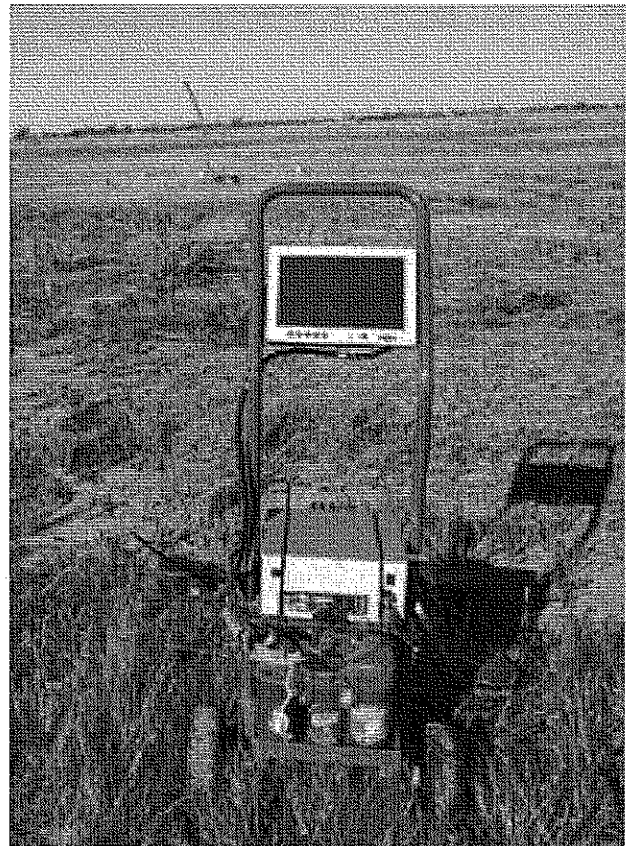

Field tests were conducted with a hexagon sensor array demonstrating the ability to detect objects up to 25 feet from the drill head.

detection approach, uses acoustic sensors on the surface to detect and locate the obstacle. With an adequate noise source from the drill head, the passive detection system can effectively locate obstacles within a range of 5 to 20 feet, depending on soil type and pipe diameter.

Results

An integrated, underground obstacle-detection system using acoustic detection technology was designed, implemented, and tested in the semi-field environment.

The system consists of a self-contained transporting cart, hexagon sensor array, electronic system controller, touch-screen LCD panel, and battery power source. The system controller uses all-digital, off-the-shelf electronic components that are cost effective and easy to maintain.

In 2011, a series of field tests were conducted nearby the facility of the potential manufacturer. More than 106 pipe-detection data sets were collected based on the test matrix developed by the manufacturing company.

The system electronics – embedded controller, data acquisition module, and touch-screen LCD display panel – were fine-tuned and bench tested with the system software. The overall system's performance was up-to-date and met the design specification and requirement. No hardware or software modification was made for the field tests.

In general, all field tests in 2011 were conducted under a grassy field with heavily compacted clay soil content.

Overall, the acoustic pipe detection system performed very well during the field tests. For all pipe sizes, 35% of all pipes can be detected within 10 feet of pipe-to-drill head distance, with accuracy better than 17 inches. More than two-thirds of all pipes can be detected from a distance greater than 10 feet and accuracy within 24 inches. Combined pipe-detection distance – array-to-pipe and pipe-to-drill head – of more than 20 feet was

obtainable. The operation time, including data acquisition and signal processing, for each test location was under five seconds.

The field tests consisted of three major test methods and conditions:

1. Straight-on, single pipe detection at various drilling depths
2. Angled detection path to simulated merging pipe line scenario, and
3. Multiple, crossed pipes detection at straight-on and angled detection paths.

All test results were validated by the electro-magnetic locators, tape measure, or other instruments.

Status

All tasks for this project have been completed. A Final Report detailing project results was issued in April 2012.

Feedback from the manufacturing partner has been very positive, encouraging, and productive. Several suggestions for improvements have been made. The primary concerns are repeatability, accuracy, and speed.

To become a viable system, it was suggested that a new, enhanced prototype system be designed, built, and tested.

For more information:

Maureen Droessler

Program Administrator

Operations Technology Development, NFP

Phone: 847/768-0608

maureen.droessler@otd-co.org

OTDOperations
Technology
Development**PIPE & LEAK LOCATION****Public Improvement Project Coordination
with GPS, GIS, and Smart Tags**

Efforts are under way to develop and demonstrate a process that integrates Global Positioning System (GPS), Geographic Information System (GIS), and "Smart Tag" technologies to streamline public-improvement project planning and prevent damage caused by excavations.

Project Description

Design and project engineers note that planning, facility location, and other processes involved in large public-improvement projects could be greatly improved with an efficient method for the timely sharing, updating, and retrieval of asset-location information.

The typical public-improvement project planning process might involve a number of steps, including interactions with the project owner and utility owner regarding asset locations, the project footprint, and facilities that require re-location due to conflicts or other requirements.

This process can become flawed if utility companies do not update their maps with new information as it becomes available. Both the project owner and utility mark-out crews may not have access to information regarding the new location of lines that were moved or recently installed. This can lead to mis-marked or un-marked lines and result in excavation damage. Additionally, sharing asset-location information via paper maps can promote inaccuracies because of spatial mismatch, different coordinate systems, and relative references.

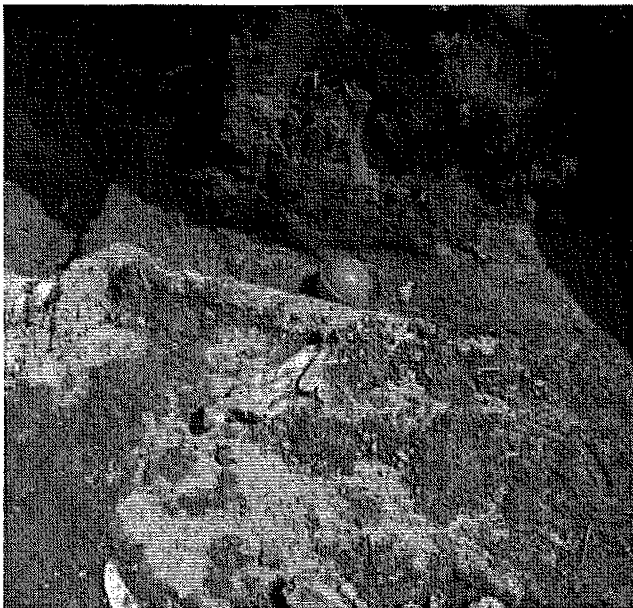

The Virginia Department of Transportation (VDOT) has initiated a project to bury Radio Frequency Identification (RFID) tags (also called "Smart Tags" or "marker balls") over utility lines when potholing is required for large public-improvement projects. While this will assist in the process, it presents an incomplete solution because there is no mechanism to store and view the location where RFID tags are buried.

In this project, research builds off these ongoing efforts. The goal is to develop and demonstrate a process that uses GPS, GIS, and marker-ball technologies to improve underground-asset locating on public-improvement project sites.

Deliverables

The deliverables for this project include the development of a process work flow for installing and capturing marker-ball data, the development of a web-based GIS system to share asset and marker-ball location data, technology demonstrations, and a detailed report on the pilot project.

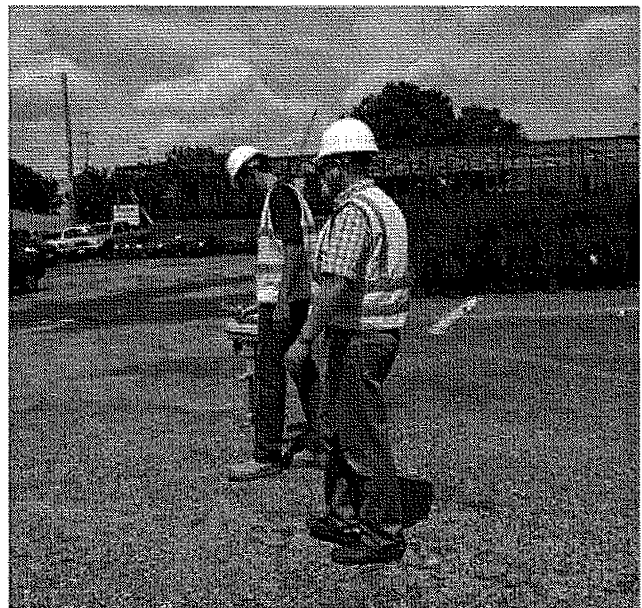

RFID devices integrated with locator, GPS, and GIS technology can provide utilities with highly accurate and timely location information.

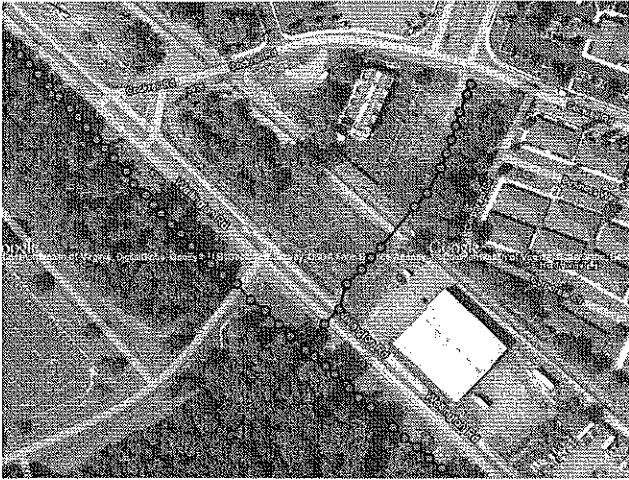

Benefits

The potential benefits of an enhanced process for utility locating on public-improvement project sites include:

- Decreased excavation damage resulting from mis-marked or unmarked facilities
- Quickly updated location information of relocated lines
- A permanent benchmark and verification method
- More efficient data sharing
- Streamlined data submission
- Reduced need for potholing
- Quick and accurate location of subsequent mark-outs.

Technical Concept & Approach

The approach for this project is to combine existing GPS, GIS, and Smart Tag technologies into a system that allows utility companies to collect and share asset-location information on a web-based shared GIS platform that can be viewed by project stakeholders in the design and construction phases.

The concept is to install RFID marker balls during new installations and test pit excavations, record the location of marker balls with GPS, and make the information available to project stakeholders, including locators in the field.

Results

In 2011, researchers hosted a damage-prevention technology demonstration in Virginia with support from the

Virginia Department of Transportation (VDOT) and several technology partners. Field demonstrations were conducted at a VDOT highway-expansion job site.

In attendance were representatives from utility companies from five states, state regulators, excavation contractors, VDOT, one-call centers, trade associations, and technology providers.

The process of programming, installing, mapping, and re-locating marker balls was demonstrated by VDOT and the technology partners. Details on the process of programming the marker balls in the field prior to installation was provided. Standard vacuum excavation technology was used to excavate to a water line. GPS hardware and special software were used to map the location of the marker balls prior to installation. The use of a locator was demonstrated, showing its ability to re-locate and trace the water line using previously buried marker balls.

Information on installation protocols, coordination with utility companies, and cost was provided.

VDOT provided several examples of situations where the marker-ball technology prevented excavation damage to newly installed utility lines that had not yet been mapped by the operator. Contract locators for utility companies have begun utilizing the marker balls to assist in performing locates on VDOT highway projects. VDOT plans to expand the use of marker balls to the rest of the state and is actively working with utility companies to promote the use of the technology.

Demonstration participants supported further implementation of the marker-ball program and some requested support to promote the technology within their organizations.

In 2012, the research team identified a job site in Fairfax County, VA, to conduct a technology demonstration of marker ball technology and a workshop to provide state DOTs with information on the marker ball program that VDOT has been implementing.

Status

Additional marker-ball pilot projects are being developed.

For more information:

Maureen Droessler

Program Administrator

Operations Technology Development, NFP

Phone: 847/768-0608

maureen.droessler@otd-co.org

OTD

Operations
Technology
Development

PIPE & LEAK LOCATION

Automating Leak Pinpointing

Researchers have designed, fabricated, and assembled hardware and software improvements to a commercially available system to simplify and accelerate the process of pinpointing a gas leak. These developments will help to reduce the difficulty, improve the productivity, and enhance the safety of leak pinpointing in complex or hazardous situations.

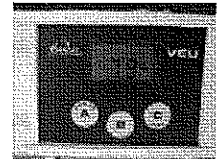

Project Description

Determining and pinpointing the location of a leak in an underground gas line – especially in a low-pressure system – has long posed difficult problems for repair crews. Although the gas line itself is often located, the soil is often saturated, which makes it difficult to pinpoint the actual location of the leak. As a result, it is not uncommon for large stretches of a surface, including paved roadways, to require excavation to locate the leak – a situation that can be costly, time consuming, and potentially hazardous.

In this project, activities are under way to improve the abilities of an advanced device to expedite leak pinpointing.

Research is focused on the Vapor Extraction Unit (VEU) manufactured by MBW Inc. and developed with the assistance of Atmos Energy Corporation. The VEU technology is being combined with natural gas sensors and wireless software commercialized by Sensit Technologies Inc. (in cooperation with New York State Electric & Gas Corporation) in its GasLess Trainer.

The goal is to design, fabricate, and assemble a hardware and software system to simplify the process, ac-

celerate operations, and enhance the safety involved in pinpointing gas leaks.

Deliverables

Deliverables include:

- A tested prototype of individual gas-concentration sensors and readout displays for probes.
- A commercial design and prototype for a set of probes and sensors, the sensor electronics, and software to display the real-time gas-concentration readings from the sensors.

Benefits

Investigators expect that implementation of an improved VEU device will result in:

- Improvement in pinpointing job efficiency
- Improvement in pinpointing false positives
- Reduced excavations.

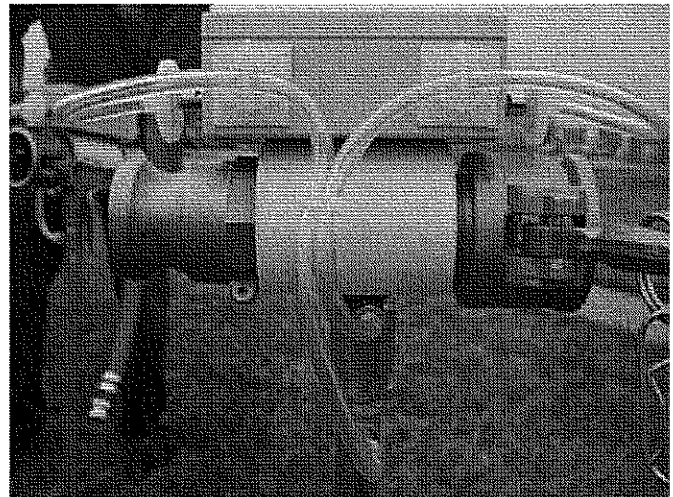
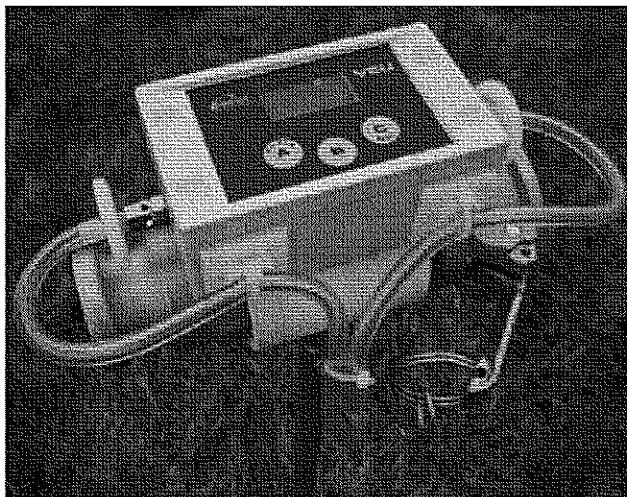

Instrumented probes were used in a field demonstration.

In addition to the potential cost savings associated with more efficient and accurate pinpointing, the system will avoid the need for a field crew member to stand over individual barholes to check readings and potentially be in the plume of the gas leak. Also, during the pinpointing operation, the area of the leak will be de-gassed, removing significant amounts of gas from the excavation site and improving the safety to the gas crews and customers.

Technical Concept & Approach

This project is comprised of the following tasks:

- **Probe Development**

This initial task focused on the design, fabrication, and testing the addition of gas sensors and readout displays to an individual VEU probe.

- **Field Evaluation**

A sensor-probe kit was installed on six probes, and the new technology will be compared with traditional pinpointing.

Results

In 2010, a field evaluation of the thermocouple (TC) gas-measurement sensor was conducted to determine if it could read gas concentrations in the probe flow stream. The testing demonstrated that the TC sensor can be used directly with the probe to determine gas concentration under simulated field operating conditions.

In 2011, work on the probe continued with development of the electronics to measure high-volume gas flows.

It was decided that a venturi system with a tube assembly and a filter in the line offered the best way to divert a portion of the gas from the probe past the sensor. Activities continued at Sensit Technologies to assemble the initial bench model prototype.

It was confirmed that the minimum reading will be approximately 1% gas volume. It was reported that the flow through the probes is highly variable depending on the operating conditions of the machine. These include such factors such as the concentration of gas in the ground, number of probes the operator is using, the permeability of the soil, etc. All of these factors can increase or decrease the flow. If the user has all six probes in line, the last one in the chain will draw slightly less flow than the first probe. MBW provided four five-foot hose sections to Sensit Technologies to attach to the probes for the analysis.

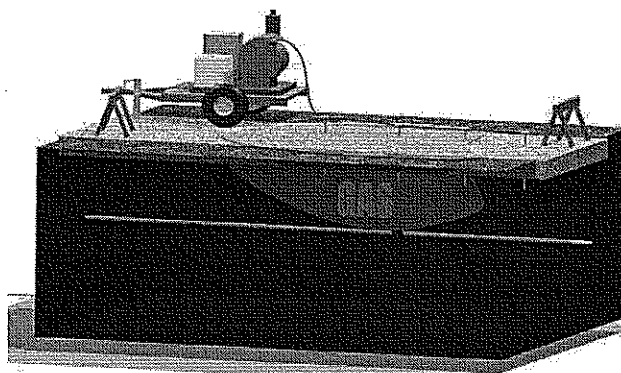

The VEU creates a vacuum at a series of boreholes over known areas of gas-saturated soil. The unit rapidly extracts gas from saturated soils and can be used to follow paths of gas migration to the leak source. Through a process of elimination, most leaks can be pinpointed to within 18 inches horizontally of the vertical location.

To confirm that the sensing configuration can operate in a high-flow environment, a velocity check was performed. It was concluded that as long as the diffusion/filter material is in place, the sensor will perform.

An alpha prototype probe was tested and necessary improvements were incorporated. The device was tested at a sponsoring utility and test results showed improvements. In addition, Sensit updated and completed software. The alpha prototype was tested with gas mixtures of 2.5, 7.5, 10, 20, 40, 75 and 100% volume methane samples. A calibration procedure was also established.

Initial testing of the device on the bench indicated that the sample flow rate needs to be reduced and location of the tube connection modified. These changes were implemented and resulted in the overall performance improvement.

In 2012, six probes were constructed and tested successfully at the Nicor leak field. Data and impressions on the instrumented VEU were gathered in the field as jobs permitted.

Status

This project has concluded and a Final Report was issued.

For more information:

Maureen Droessler
Program Administrator
Operations Technology Development, NFP
Phone: 847/768-0608
maureen.droessler@otd-co.org

OTDOperations
Technology
Development**PIPE & LEAK LOCATION****Ethane-Only Detector**

In this program, an easy-to-use handheld detector was developed for use in the field to discriminate natural gas leaks from other sources of methane (e.g., swamp gas, landfill gas, and engine exhaust) and detect trace levels of ethane.

**Project Description**

Leak-survey operators detect methane from a variety of sources in addition to natural gas leaks. Methane can emanate from swamp gas, landfill or agricultural sources, combustion exhaust, or from certain areas of heavy industrial activities.

In response, the natural gas industry supported the development of technology that can assure that leaks detected during surveys are from actual natural gas leaks and not from other sources.

Since natural gas can contain 1% to 5% ethane – and ethane is a relatively rare gas in the atmosphere – the detection of ethane can be used as a fingerprint for natural gas in situations where the origin of a methane leak signal is questioned.

Through this project, an easy-to-use handheld instrument was developed to detect ethane in the field. The technology is based on the optical method similar to the one used in the Portable Methane Detector (PMD) for detecting the ethane component of natural gas.

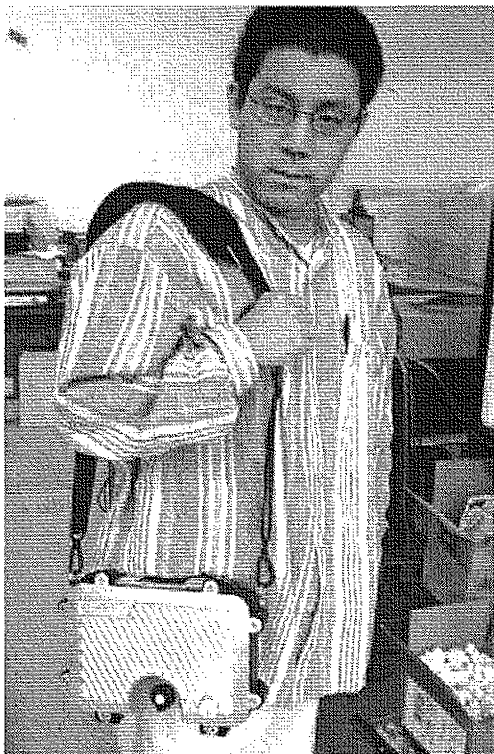

Able to detect even small leak plumes, the technique can measure ethane based on rapid electronic tuning of a spectroscopic filter for differential optical absorption measurements.

Deliverables

In addition to the development of a prototype device, deliverables include data related to testing and development activities.

Benefits

Whenever the origin of a methane leak is questionable, significant delays and expense can be encountered when gas samples are manually taken, stored, shipped, and analyzed remotely at a special off-site laboratory. The availability of an easy-to-use handheld ethane detector could save significant time and costs involved in resolving location issues, repairing leaks, and addressing system safety.

Technical Concept & Approach

Development activities are based on experience gained with configurations of the PMD technology. The PMD is commercially available and has demonstrated the ability to detect few ppm methane to 100% gas in an all-optical leak-survey tool. The ethane detector is based on technology for detecting and measuring gases by optical absorption.

Initial project activities focused on:

- Breadboard Design, Prototyping & Evaluation
- Fabrication of Demonstration Unit
- Testing and Evaluation.

Final activities included:

- Development of a detailed Invention Disclosure for the Infra-red Ethane Detector (IRED) technique and instruments to assist in pursuing a patent on the IRED technology

- Transfer of designs and documentation of the IRED technology, including mechanical, electronic, assembly, and calibration documentation of the IRED project based on the PMD techniques and platform modifications.

Results

In 2011, an IRED demonstration unit was produced and tested to demonstrate that field detection of ethane as a fingerprint species of natural gas could be fabricated and utilized as a stand-alone method to discriminate natural gas from other sources of environmental methane in the field.

The IRED unit was developed to take advantage of recent advances in technology from the newly developed PMD to simplify the path to commercialization. However, there are several important changes in the optical filtering technique and control to transfer as well as evolving manufacturing and design issues to address as the prototypes are further developed into a commercially manufactured product.

The device demonstrated the ability to detect ethane levels as low as 500 ppb under real field conditions to resolve the absence or presence of ethane as a fingerprint for natural gas.

Two of the test sites had significant methane levels but had been tested to have no ethane present; and two additional test sites were known actual natural gas leaks with ethane.

The tests were conducted in the field with below-freezing weather when ground conditions and bioactivity could be expected to be among the most challenging for the IRED instrument. Independent methane detectors (down to the ppm level) were to measure the methane concentration at each of the test sites to verify the presence of methane in the samples under test before searching for ethane content. Multiple trials were made at each site.

In all cases, the IRED demonstration unit correctly read appropriate levels of ethane at the sites of the actual gas leaks in the field and gave zero ethane readings at the sites which had tested negatively for ethane using traditional methods.

The IRED was capable of detecting leaks as dilute plumes, and was also able to accurately measure ethane gas concentrations with readings compatible with the methane readings on the reference instruments.

In 2012, the research team prepared an Invention Disclosure for the technique developed to reject the methane background interference during precision ethane detection in the presence of significant methane cross interference. Full existing documentation was included for transfer of the IRED changes required in mechanical hardware and electronics, calibration, assembly, and usage procedures.

The mechanical drawings for the IRED device were finalized, collected, reviewed, and assembled as a package for technology transfer. Numerous new drawings were made to document the modulator assembly, which has custom designs substantially differing from the current PMD design. As many of the current PMD assembly parts were used to ease the technology transfer process, the main differences involve the modulator assemblies, mounting faceplate and case redesigns, relocation of HV power supply, and pump assemblies.

Status

All activities for this project have been completed. A Final Report on the project was issued in February 2013.

The transfer of the IRED technology should result in a robust, commercially unique IRED detector. Functioning one-of-a-kind electronics and optics have been produced and software development is well under way. It is anticipated that some alpha prototypes will be developed based closely on the IRED designs and documentation as currently exists, to be followed soon thereafter by any needed modifications and IRED production.

For more information:

Maureen Droessler
Program Administrator
Operations Technology Development, NFP
Phone: 847/768-0608
maureen.droessler@otd-co.org

OTD

Operations
Technology
Development

Acoustic Pipe Locator: Technology Transfer



The objective of this project was to transfer the technology for an acoustic-based pipe locator to an appropriate manufacturer/commercializer. In tests in an earlier program, a prototype acoustic-based pipe-locating system was shown to be capable of detecting multiple buried plastic pipes at depths up to five feet.

Project Description

In a previous OTD project, an operational, hand-held, portable acoustic system for locating underground utilities was designed, built, and successfully demonstrated. The locator was developed to detect small-diameter plastic pipes at depths up to five feet in various ground-surface conditions, including topsoil, concrete, and asphalt.

The concept is to send an acoustic signal into the ground and detect the reflected signal from the pipe at ground level. The device was successfully tested in the laboratory and at several utility locations under a variety of field conditions to detect both metal and polyethylene (PE) pipes. System software provides automated pipe-detection information through an easy-to-operate user interface.

Subsequent activities sponsored by the U.S. Department of Transportation's Pipeline and Hazardous Materials Safety Administration (DOT/PHMSA) and OTD resulted in the development and testing of an improved, pre-commercial unit able to detect multiple buried pipes.

In this project, activities were conducted to facilitate the transfer of the technology to a commercial partner. The commercial partner will finalize the integrated acoustic locator based on test results and is expected to manufacture and commercialize the locator.

Deliverables

Deliverables for this project include the selection of a commercial partner to introduce the product to the market and the transfer of all technical information.

Benefits

The detection of buried natural gas pipes, especially PE pipe, will assist the gas industry and pipe-locator companies to locate pipes before excavations and construction. This will reduce the risk of third-party damages to the underground utilities, enhance the safety of natural gas distribution systems, and reduce gas industry operating costs.

Technical Concept & Approach

The project included the following tasks:

- **System Documentation and Preparation**

Preparation and validation processes were required for the integrated system before system presentation, demonstration, and system training. Under this task, electronics, sensor modules, and system software were prepared and tested. The same integrated system was delivered to the commercial partner.

- **System Presentation, Overview, and Training**

In the early stage of technology transfer, the research team conducted a system presentation and demonstration, held a system design overview meeting, and performed system operational training for the commercial partner.

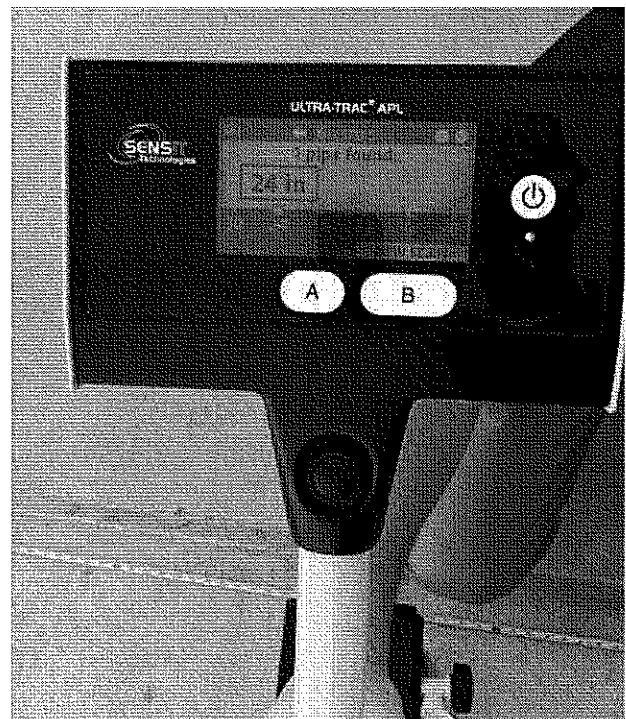

Test result/display during the field trial of the prototype unit.

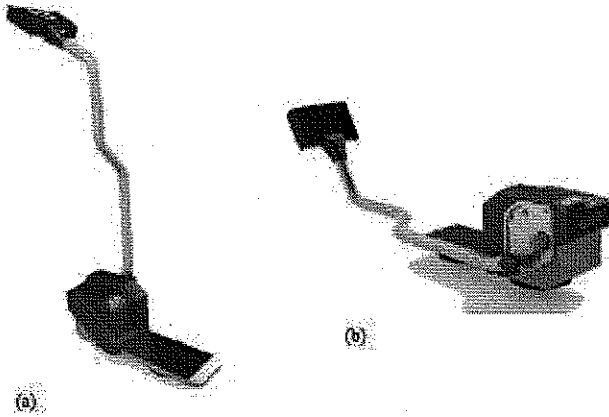

At left: 3-D rendering of the acoustic pipe locator system in (a) fully extended and operational mode and (b) folded and storage mode.
At right: system operation of the acoustic pipe locator beta unit in the field.

• System Verification and Validation

Four major system verification and validation activities were performed during the entire technology transfer process: 1) Definition of system performance per the industry requirements; 2) System design specifications, design requirements, and operational performance; 3) Hardware (electrical/electronic), software, and mechanical design criteria; and 4) System operational guideline, procedure/process, performance, and test protocol.

• Prototyping and Technical Support

The research team provided technical support throughout the entire prototyping.

Results

- Two highly integrated, acoustic-based, pipe-inspection systems were demonstrated during the presentation and design reviews. The same systems were also used in several field tests for assisting and supporting the technology transfer project. As a baseline and reference unit, the integrated unit performs well and meets the design and performance specifications. The finalized detection system is compact, portable, and robust in overall system operation and performance.
- Extensive and complete system documentation was established for the project.
- Several design review meetings were held to develop concepts for converting the beta unit into a commercially available prototype product. Design issues, product specifications, and performance criteria were analyzed, categorized, and resolved.

- Preliminary prototype units from the commercial partner were designed, fabricated, and tested. The sample alpha system performs very well and meets the design requirements.
- The overall technology transfer of the acoustic-based pipe locator project was very successful. The commercial partner was able to design, build, and test the pre-production pipe-detection systems and met the product specification and design requirements based on the design architecture and concept of the extensively field tested prototype unit.
- Comments from the field-test participants suggested that the overall system operation was easy and the final detected result was clear and simple to interpret. The availability of results in real time was beneficial for field operation.

Status

Testing and development activities have been completed. A Final Report detailing project activities was issued in February 2013.

The production of units intended for extensive field trials was initiated by the manufacturer.

The pipe-detection system is now commercially available.

For more information:

Maureen Droessler

Program Administrator

Operations Technology Development, NFP

Phone: 847/768-0608

maureen.droessler@otd-co.org

OTDOperations
Technology
Development**PIPE & LEAK LOCATION**

Enhancing Damage Prevention Through Implementation of New Technology



In an effort to reduce the potential for excavation damage and the associated costs, researchers are investigating smart-tag technologies for implementation to assist field personnel when performing locates.

Project Description

One of the major factors contributing to excavation damage is the limited information available to field crews when performing gas-facility locates.

Traditionally, mark-out crews use maps and electromagnetic tools to locate buried pipes and other facilities. A map of the mains and services is provided either on a paper record or a digitized electronic file. While these maps can provide information regarding the general location of the pipe, they cannot be relied upon to provide precise positional information because of possible record-keeping inaccuracies, referencing errors, and other issues. Electromagnetic locators are used to find metallic pipes or tracer wires. These locators perform very well in some environments; however, certain situations (e.g., broken or missing tracer wire, congested corridors, signal bleed-off, and user error) can result in inaccurate mark-outs.

Investigators have identified several technologies that could be used to provide better information to mark-out crews to enhance the locating process.

The focus of this project is on precise locating with smart tags.

Deliverables

The purpose of Phase 1 of this project was to develop an implementation strategy for smart tags, smart phones and tablets, and GPS in select operations.

The deliverable of Phase 2 will be a completed pilot project and a business case for further deployment of the smart tag system. Specific deliverables include:

- A marker ball and warning tape installation procedure
- A software application to log the location and other attribute information of new installations for smart phone or tablet devices
- Two smart phone or tablet devices running the software application
- High-accuracy GPS receiver
- A process for transferring the asset location and attribute information from the software to a sponsor's mapping system.

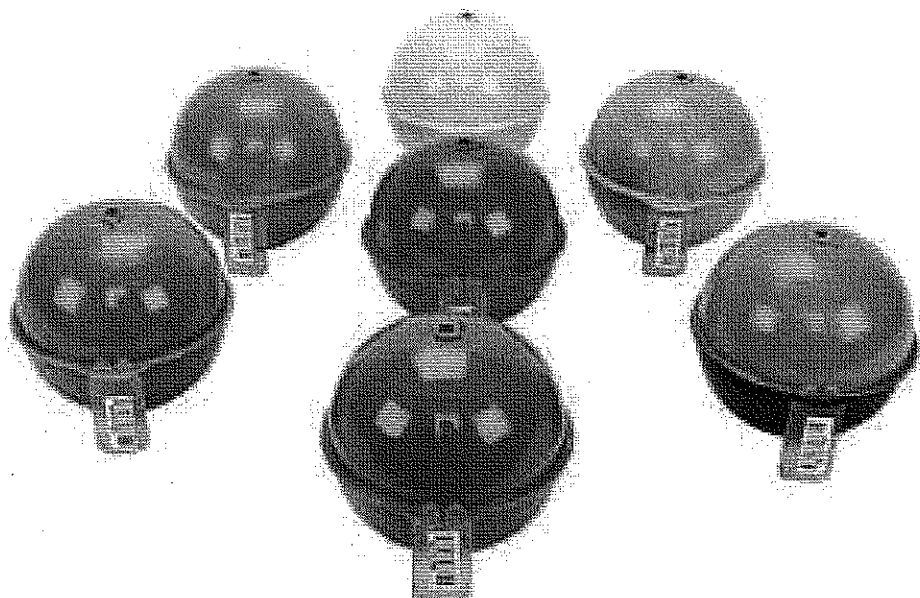

Research suggests that smart-tag technologies for pipe-location and damage prevention could provide significant cost and safety benefits.

Benefits

Industry organizations regard excavation damage as the greatest threat to the integrity of the natural gas distribution system. Implementing technologies to reduce excavation damage reduces system risk, increases public and worker safety, and lowers the costs associated with damages. Increasing the amount of information made available to locators in the field will improve their ability to locate underground facilities and will reduce excavation damage.

Smart tags are circuits and antennas housed in small devices that can be buried near pipes to facilitate detection and location in the future. Additionally, smart tags have the ability to store small amounts of information such as material, diameter, and maintenance history. A smart tag could be installed directly above any pipe that is exposed for maintenance or other types of work. The tag could then be used to determine the precise location of the pipe during subsequent mark-outs. Smart tags could be especially beneficial in situations where standard electromagnetic technology could not be used (e.g., to locate plastic pipe with no tracer wire).

Technical Concept & Approach

This project involves the following tasks:

- **Technology Review and Project Planning**

A technology-review report was prepared and a series of workshops were conducted with the R&D, damage prevention, and information technology departments of the participating utility companies to develop a strategy for collecting, storing, and accessing the data collected. Investigators subsequently developed a detailed project plan.

- **Pilot Project**

A pilot project will be conducted with a sponsoring utility. Locating times with and without the smart tags and GPS will be compared and data-collection times with and without the electronic data-capture forms will also be compared. Additionally, when programmable smart tags are used, the data will be read from the tags to determine the various attributes of the related gas facility (i.e., main, service, valve, or test station). The spatial location accuracy will be determined along with the data that is stored on the tag. Another evaluation assessing the quality of the data collected in the field using the smart tag data-logging application will be made. The assessment will consider the accuracy of the attribute data collected for each tag, the position data and the value of the data in the office to support the mapping

processes. The equipment will be evaluated on ease of use, weather resistance, cyclic use, battery life, and display quality.

Results / Status

Investigators completed Phase 1 of the project with the development of an implementation strategy for an RFID-tag-based asset-locating system.

A 60-day pilot project will be initiated in 2013 to demonstrate the procedures and technologies.

The technology uses new high-accuracy GPS technology and aerial photography to document the location of newly installed facilities. RFID tags are used to enhance the locating and mark-out process by providing field personnel with additional asset-location information. The locating system will allow operators to capture high-accuracy information using technology that is moderately priced and does not require specialized skills.

The pilot will test warning tape and active markers. The warning tape maintains its functionality even if the tape is cut or damaged because each individual RF tag operates independent of the others. The RF tags are placed at intervals (six feet apart) sufficient to allow the line to be continuously located.

The research team tested a high-accuracy GPS receiver to determine if it could overcome urban canyon effect on the island of Manhattan. The team is also investigating alternatives to collect data in areas where a GPS signal is unavailable.

Researchers also developed recommendations for the installation locations and methods of installation of RFID markers to be used in the pilot study.

The project can leverage recent advances in consumer-grade devices for field data capture to create of a mobile field data collection system with smart tags as the enabling technology.

The proposed system would be developed in two stages on a scalable platform that will allow further implementation if the results of the first pilot project justify additional investment.

For more information:

Maureen Droessler
Program Administrator
Operations Technology Development, NFP
Phone: 847/768-0608
maureen.droessler@otd-co.org

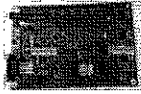
OTDOperations
Technology
Development**PIPE & LEAK LOCATION****Low-Cost MEMS Methane Sensor Platform –
Phase 1**

To improve public safety, research in this project focuses on the design and fabrication of novel, low-cost, ultra-low-power methane sensors that offer enhanced features over conventional methane-detecting technologies.

Project Description

Advisors for the natural gas industry have expressed a need for an improved methane sensor to decrease costs in current operations and increase safety for current and future applications, including monitoring of confined spaces, personnel, and especially residential dwellings.

Currently, no available sensor can meet the combined specifications for low power (microwatts), small size, long lifetime (2-20 years), and low cost, as well as have improved sensitivity, selectivity, and speed of response to methane.

In this project, investigators are building on previous research to produce a MEMS (Micro-Electro-Mechanical Systems) sensor that can meet the challenges for methane alarms and monitors.

In recent years, significant progress has been made in the design and fabrication of a novel, low-cost, ultra-low-power thermal conductivity (TC) sensor for energy gases (methane, hydrocarbons, H₂, etc). Presently, the gas industry uses heated metal oxide (HMO_x) sensors with relatively high power requirements and low selectivity. Selectivity is afforded by filters that can

wear out over time. Furthermore, the HMO_x sensors will stop working (give a false negative) when O₂ drops and CH₄ rises (>~10%). Current thermal conductivity detector (TCD) sensors can provide 0%-100% CH₄ readings, but are also high power and not selective.

This project focuses on the development of a MEMS nano-TCD. The most important features are: 1) no false negatives at high levels; 2) selectivity built in; and 3) low power and long lifetime for low installation costs and low overall cost of ownership. No other sensor has these combined features. These initial prototypes will be able to evolve with ever-improving selectivity and performance.

Plans are for the sensor to be a stand-alone unit about the size of a deck of cards that includes a proprietary sensing element, small circuit board, and novel software. Researchers will demonstrate the sensor in a practical, home CH₄ alarm unit. Additionally, the sensor technology and approach could be used in other types of fixed-site or portable residential or industrial applications. Its low power requirement allows battery operation over a very long lifetime. The unique selectivity is a significant improvement over existing sys-

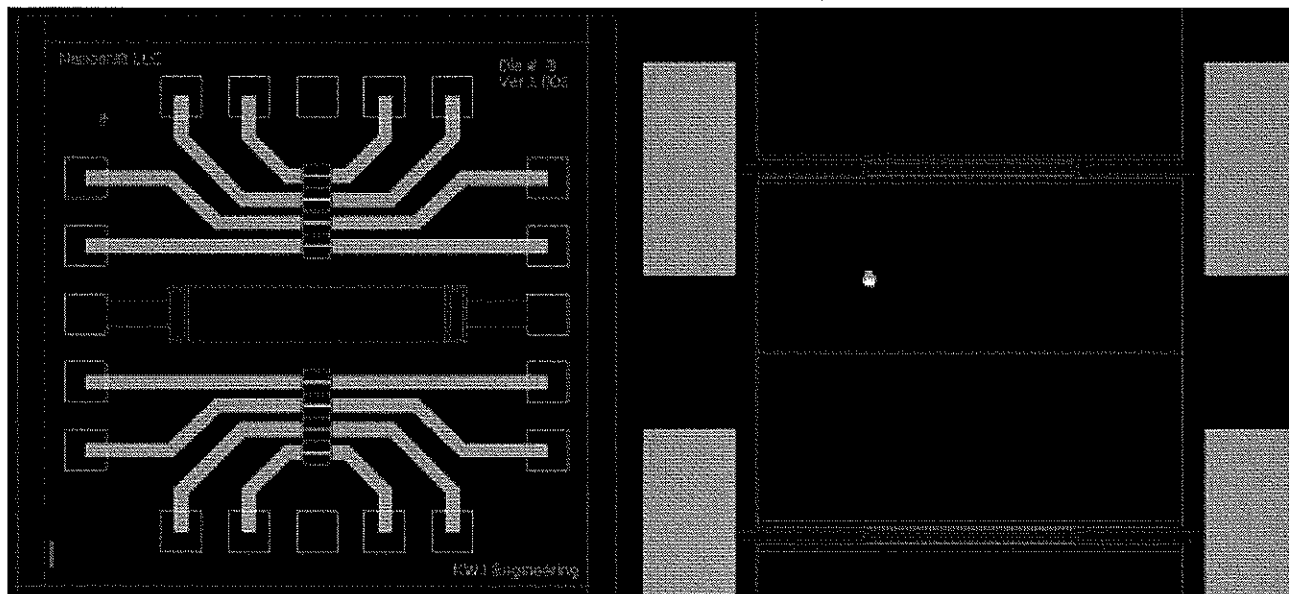

Screenshots from the CAD files prepared for fabrication of the designs.

tems and can discriminate methane in air from other gases. The unique combination of features leads to low capital cost, low installation cost, and low overall cost of ownership with increased safety. In addition, the sensor can be improved over time with added features for wireless or other product options or applications.

Deliverables

Deliverables for this project will include the development of MEMS CH₄ sensors for testing, plus a Final Report with details on the development and testing. The report will also include projected pricing information and commercialization options.

Benefits

MEMS technology provides a means to fabricate miniature, low-cost sensors with improved methane-detector characteristics. The novel sensor will provide features to increase public safety and reduce maintenance costs.

Technical Concept & Approach

In this project, prior research is leveraged in that the design for the sensor elements and the operating protocols are already established. Activities in this effort involve the fabrication of a configuration for a fully compensated methane-sensing element. These sensor elements will then be mounted, complete with the required on-board compensation elements.

Several TCD structures will be fabricated. Researchers will validate all fabrication parameters, including temperature coefficient of resistance, baseline resistance, uniformity, and compensation elements.

Sensor performance will be characterized in terms of sensitivity, selectivity, response time and stability in CH₄. Testing will be conducted in real situations to validate response and field performance to expectations.

The goal is to achieve significant progress and support to develop a package with low-cost electronics and proprietary firmware to result in a home CH₄ alarm.

Results

In 2011, the developer initiated a fabrication design for the prototype and located substrate TCDs in wafer form. After microscopic examination, several die were selected and sent for wirebonding into packages. In addition, the package and electronics for the first-generation TCD was designed and tested. Test results indicated that the response is linear at least in the 0%-3% CH₄ in air range.

A survey was sent to project sponsors to identify the key applications for this sensor.

In 2012, the wafers and other materials were sent to a commercial foundry for inspection. After several iterations and review processes, fabrication run began. In addition, a laboratory-bench evaluation board was developed and assembled. This board allows for the optimization of the operational protocol and parameters for the new die.

Status

The developer produced significant data from the wafer structures and these have demonstrated the feasibility of detection with the following properties:

- <1 nanowatt per reading (leading to long-life battery operation)
- Nanosecond response time (response times will be limited by the packaging and not the sensing element)
- Selectivity created by multiple operations and a custom algorithm (leading to improved selectivity over currently available methane alarms)
- Sensitivity sufficient for LEL alarms (better than 0.05% or 10% of the lowest alarm level desired)
- Robustness (no drift over 30 billion measurement cycles, which implies no calibration needed for many years)
- No consumables, selectivity (no false negatives at high CH₄ levels and differentiation of CH₄ signal from other gases such as H₂ – which is an improvement over current CH₄ alarms)
- Very low cost (as low as \$0.07/die; typically \$0.50/die).

Structural fabrication continues.

Plans are to obtain an initial die integration into the package for a field test.

For more information:

Maureen Droessler

Program Administrator

Operations Technology Development, NFP

Phone: 847/768-0608

maureen.droessler@otd-co.org

OTDOperations
Technology
Development**PIPE & LEAK LOCATION****Cross Bores Best Practices**

To enhance gas-system safety, a Cross Bore Best Practices Guide was developed to assist operators in addressing cross bores and/or improving the efficiency of existing practices.

**Project Description**

Cross bores have become an industry concern because of incidents involving natural gas mains and services that were installed using trenchless technology that inadvertently transected a sewer line or private septic system. Typical sewer-cleaning operations use a device that can pierce the gas line, resulting in the rapid release of gas.

Whereas some gas utilities have begun thorough programs to inspect past trenchless pipe installations to ensure cross bores have not occurred, other operators have not started such a program or are in the early stages of development.

To assist utilities in addressing cross-bore safety issues, a Cross Bore Best Practices Guide was developed through this project to serve as a single source of information that could be used by natural gas distribution system operators to investigate and remediate existing cross bores as well as prevent future cross bores.

Deliverables

A detailed report was developed that provides a set of best practices for preventing and detecting cross bores.

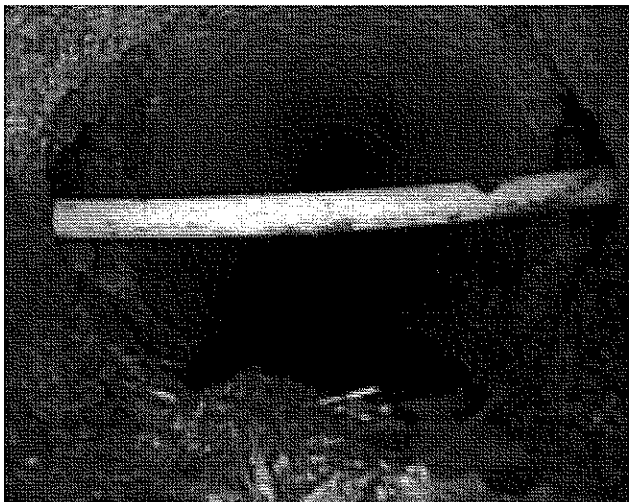

A cross bore is defined as an intersection of an existing underground utility or underground structure by a second utility installed using trenchless technology resulting in direct contact between the transactions of the utilities compromising the integrity of either utility or underground structure.

The report includes an investigation of available technologies and various industry issues.

The report includes information on:

- Practices for clearing potential cross bores
- Practices and technologies for preventing cross bores, and
- Practices and technologies for detecting legacy cross bores.

Benefits

The results of this research can be used by gas-system operators to reduce their risk and exposure to the threat of cross bores. The Best Practices Guide provides methodologies, technology recommendations, and procedures for preventing and detecting cross bores.

Technical Concept & Approach

The development of this Cross Bore Best Practices Guide included the review of information from a wide variety of sources across North America, including numerous natural gas distribution companies, installation contractors, remediation contractors, equipment providers, industry associations, and industry literature. The combined customer base of the 23 gas companies interviewed represent 80% of the 75 million natural gas customers in the United States and Canada.

Information regarding state or city-specific rules and regulations were also collected.

Researchers and an advisory group developed a methodology for creating the best practices.

Results

The core of the Best Practices Guide stems from recommendations of the National Transportation Safety Board (NTSB) following a 1976 incident, that advise:

- Complete inspection of those locations along the construction route where gas mains and sewer lat-

erals may be in proximity to one another and correct any deficiencies.

- Examining records to determine other locations where gas lines were installed near existing sewer facilities (including a review of sewer blockage complaints), then inspect these locations and take corrective action where necessary
- Revising construction standards to require that the underground facilities be located accurately before construction and to provide protection for these facilities near boring operations
- Informing inspectors and supervisory personnel of the circumstances of this accident, train them to be alert for similar conditions, and advise them of preventive actions.

Researchers found that the majority of the differences in the approach used to assess the potential for a cross bore were obvious (e.g., as the likelihood of a full basement or the need to construct a sewer at a depth below the level of frost penetration in the north). Soil conditions, the influence of existing or proposed legislation, the use of the "one-call" systems, the use of bi-lingual outreach materials, and other factors varied between companies and are identified in the Guide.

The first section of the Guide provides best practices and general guidelines for local distribution companies on the cross bore topic. A quick guide is provided that captures the primary items that should be used to focus the development of each company's best practices:

Quick Guide

- Comply with all regulations
- Dedicate resources
- Do not assume a lack of a natural gas service precludes a location from having a cross bore
- Use a record-keeping system that is fully auditable
- Use a GIS to collect and organize data
- Use a risk-based approach
- Include cross bores within a Distribution Integrity Management Program plan
- Develop operating procedures and training programs specific to cross bores
- Coordinate information exchange with one-call systems.

The second section of the Guide provides best practices for addressing cross bore events that currently exist due to previous installations, referred to in the Guide as *legacy installations* or *legacy cross bores*.

Of the companies interviewed, 39% have a legacy program in place, 17% are developing a legacy program, 13% do not have a legacy program but are exploring the option, and 30% do not have a legacy program. Several companies indicated that a "found" cross bore was the best indicator that there may be others in the immediate area.

The most cost-effective approach to the investigative efforts for legacy cross bores uses a risk-based approach that progresses from an office review of records to a focused field investigation and remediation.

The development and deployment of a communications and educational outreach program was among the first steps taken when addressing legacy installation. Sewer tags are commonly used to alert plumbers or do-it-yourselfers of the potential issue, along with websites, bill inserts, advertising, etc., to raise awareness within the general public.

The third section of the Guide focuses on preventing cross bores during new installations. The most common method used to reduce risk of a cross bore during new installations was to expose the sewer at the potential point of intersection and observe the bore as it passes each intersection as well as when the reamer is pulled back. The next most common approach was the use of a camera inspection prior to and following the installation which may be done in combination with exposing the sewer at the potential point of intersection.

The Guide also provides contact information for organizations with additional information and a series of appendices that provide the full text of the NTSB summary of the first incident investigation in 1976, examples of a wide variety of communications and education materials, a summary of cross bore related legislation and regulations, and a summary of technologies under evaluation for further development to detect if a transaction of a sewer line has taken place as part of a new installation.

Status

This project is complete. The Cross Bore Best Practices Guide was made available in January 2012.

For more information:

Maureen Droessler

Program Administrator

Operations Technology Development, NFP

Phone: 847/768-0608

maureen.droessler@otd-co.org

OTDOperations
Technology
Development**PIPE & LEAK LOCATION****Cross Bores – National Database and Risk Model**

Researchers are investigating a wide variety of issues related to cross bores in order to develop a national database and risk model for use by the natural gas industry to enhance the safety of the gas-system infrastructure.

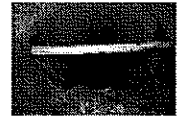
**Project Description**

Significant gas-industry research is being conducted on pipeline cross bores – situations where plastic gas mains and services inadvertently transect a sewer line when they are installed with directional boring techniques.

Gas pipeline/sewer line cross bores can lead to hazardous incidents if sewer-cleaning operations pierce the gas line.

While some companies have initiated thorough programs to inspect past installations to ensure that cross bores have not occurred, most operators have not started such a program and would benefit from a set of best practices to serve as a foundation for the development of their own programs. Even for those operators that have programs in place, additional information is desired to assist in identifying potential cross bores and for improving the accuracy and efficiency of their procedures.

The objective of this project is to develop a national database and risk model to address the cross-bore issue in the natural gas industry. The national database will collect information from natural gas operators on damages and incidents to assist in identifying trends and in

gaining a better understanding of the scope of the cross-bore threat. The risk model will be developed from the data collected in the database and populated by individual operators to provide a company-specific risk assessment.

Deliverables

The deliverables of this project include:

- A national database and two years of technical and administrative support
- A cross-bore risk model
- A report detailing project activities and results.

Benefits

The results of this research can be used by operators to reduce their risk and exposure to the threat of cross bores. The database will create information and industry knowledge regarding the frequency and factors affecting the probability of occurrence. The risk model will assist operators in assessing their risk and can be used to develop a targeted mitigation program.

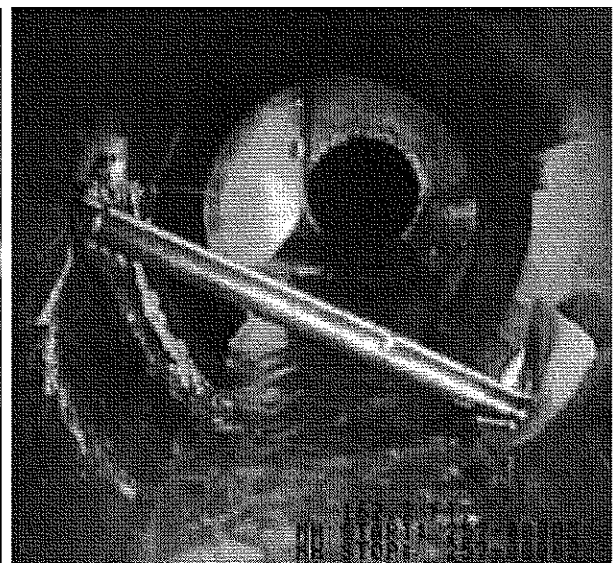
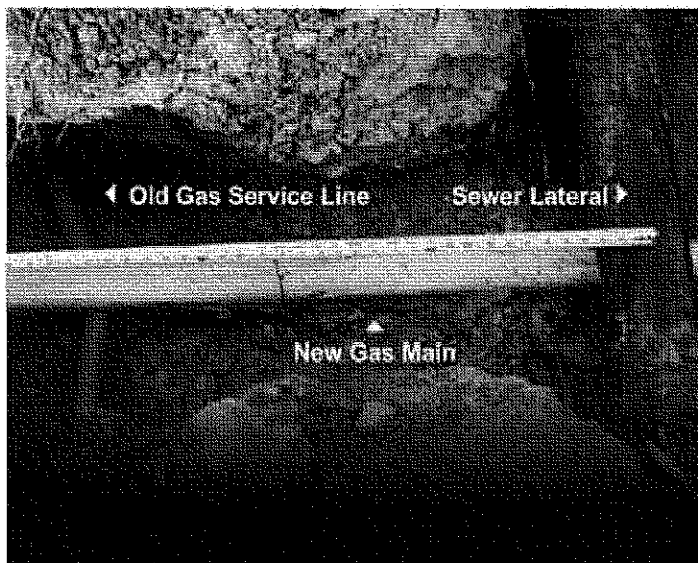

Cross bores (when a gas pipeline intersects a sewer pipe during directional-drilling installations) are a growing industry concern.

Technical Concept & Approach

This project includes the following tasks:

- **Project Initiation**

An advisory group will be created to provide industry guidance throughout the project and to help define the scope of the project, the format of the deliverables, and other project specifics.

- **National Database**

The research team will design, develop, and launch a national database to collect information on cross bores. The database will be modeled after the Common Ground Alliance's (CGA) DIRT tool (where appropriate). The purpose of the database will be to collect information on root causes, environmental and situational factors, and incident reports. Data collection will include past incidents as well as new incidents. GDM (the gas distribution data model being developed under another OTD project) will be used as the data model for the database and the data-collection forms.

- **Risk Model**

The objective of this task is to build a risk model that will assess system risk and identify potential cross-bore locations. The risk model will be built with the information collected in the national database.

- **Database Management**

The research team will continue to administer the database for two years to collect additional information on cross-bore occurrences and the effectiveness of a various prevention, detection, and mitigation activities.

Results / Status

In 2012, programming issues were identified with the CGA DIRT model and reported to the CGA model programmer. The issues were resolved, allowing for a web-based data model to be finalized and include the completion of the creation of the flex fields within the DIRT tool with the full set of data types and attributes.

The draft national database model and working prototype were reviewed with the advisory group via a webinar/conference call in April 2012. Sponsors were provided with a review of the data entry fields as well as an explanation of how each field would be populated.

It was determined that a new approach was required that would be more timely and cost effective and would also transition the database to an Esri GIS-based system that would include the requirement of anonymity while providing the ability to conduct trend analysis. The database tool will be revised and updated and the final National Database Model will be made available to the sponsors for use.

Once the database is final, the Cross Bore Safety Association and other operators will be contacted and encouraged to make use of the tool.

For more information:

Maureen Droessler
Program Administrator
Operations Technology Development, NFP
Phone: 847/768-0608
maureen.droessler@otd-co.org



Operations
Technology
Development

PIPE & LEAK LOCATION

Locatable Plastic Pipe

This project focuses on the development of radio-frequency markers for locating plastic pipe. The technology employs markers embedded in tape that attaches to the pipe to allow above-ground pinpointing and identification with low-cost tools.

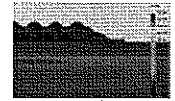

Project Description

Excavation damage continues to be the primary cause of pipeline incidents, accounting for 34% of the industry's reportable incidents according to the U.S. Department of Transportation's Pipeline and Hazardous Materials Safety Administration. While the utility and excavation-contractor industries have made improvements in damage-prevention technologies and procedures, the increased use of plastic pipe over the last 30 years has created a situation where some pipe segments cannot be easily located with currently available technology. A Common Ground Alliance (CGA) report shows that between 20% and 40% of damages or near-miss events are the result of utility companies not sufficiently locating and marking facilities.

Utility companies usually bury a tracer wire above the newly installed plastic main or service that can be located in a manner similar to metallic pipe and thus provide a mechanism to infer the location of the plastic pipe. The tracer wire must be brought up to the surface, usually at a meter set or valve box, in order to allow a direct connection with an electromagnetic locator.

Plastic pipe becomes difficult or impossible to locate when: tracer wire is not installed or installed incorrectly; tracer wire is broken or corrodes; tracer wire is not accessible from the surface; and tracer wire is located near sources of electrical interference, such as nearby utility lines.

Two techniques are widely used in the utility industry to mitigate against ineffective tracer wire: warning tape and radio frequency identification (RFID) marker balls. Warning tape is a plastic material that is buried above pipe to provide a warning to an excavator of the presence of an underground pipe or cable. RFID marker balls provide a frequency-specific tag that can be located inductively from above ground at depths of up to five feet for passive tags (no battery) and up to 20 feet for active tags (battery).

A major manufacturer of RFID tags is releasing a new product that combines these two techniques to provide enhanced functionality for asset locating. The new product will contain frequently-spaced passive RF tags imbedded into standard warning tape. The objective of this project is to develop a system to attach tags directly to pipes that will be installed through direct-burial operations.

Deliverables

Phase 1 of this program focuses on identifying the market requirements and performing a basic engineering design for the marker attachment mechanism.

Benefits

A technology that allows plastic pipe to be located will reduce the risk of excavation damage.

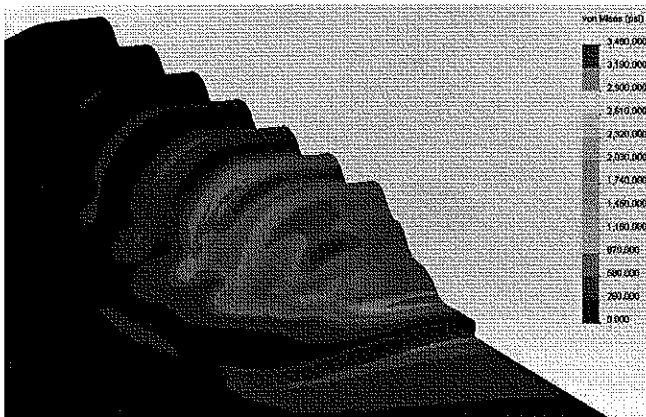

A detailed stress analysis is being conducted to ensure that the attached marker does not introduce a critical stress riser into the wall of the pipe.

Operational efficiencies result from the reduced time required to locate pipes that are difficult to locate with traditional techniques. RF tags could eliminate the need for deploying separate crews with specialized equipment (e.g., ground-penetrating radar and vacuum excavation).

Based on CGA's 2011 DIRT Report, the rate of excavation damage ranges from one to three damages per 1,000 locates, with 30% of these damages attributable to inaccurate locating. RF technology could potentially reduce overall damage rates by 15% and could reduce damage rates attributable to operator error by 50%.

Technical Concept & Approach

This project will be conducted through the following phases:

- Phase 1 – Market Analysis & Engineering Design
- Phase 2 – Prototype Development and Testing
- Phase 3 – Standards and Commercialization.

In Phase 1 researchers conducted an analysis of the potential implications on safety and codes/standards that would result from the use of the RF warning tape and attachable markers.

Potential attachment mechanisms for the markers will be designed and an engineering analysis will be performed to evaluate the impact of the attachment mechanism on pipe integrity. Field testing of an existing RF warning tape will be conducted to verify its accuracy and precision.

Results

Interviews and surveys were conducted to gather information on the market, product features, and performance requirements for a system that directly attaches RF tags to pipe during trenchless installations.

The economic downturn and the housing crisis have dampened expectations regarding new installations and most companies do not expect any significant growth in the next five years. However, pipe-replacement programs are increasingly being mandated by state public service commissions. Due to safety concerns related to an aging infrastructure, many states have implemented 10- to 20-year replacement programs for cast-iron and bare/uncoated steel mains.

The amount of new or replacement pipe anticipated to be installed each over the next five years varies greatly, ranging from 20 miles to over 900 miles per year, with the average amount being 323 miles. Service replacement programs also vary greatly. The number of new

service installations or replacements planned for the next five years varies between 3,000 and 100,000 per year, with the average amount being 24,000 per year.

Research found that:

- Burial depth is not a barrier to implementation because standard company policies regarding burial depth are within the range of the RF tag's reading capabilities
- RF-embedded warning tape is a candidate for mains installed and services using open-trench techniques
- Direct attachment of RF tags to pipes is a candidate for mains and services installed using boring or horizontal direction drilling
- Direct attachment of RF tags to pipes is *not* a candidate for mains and services installed using insertion techniques.

In 2012, testing demonstrated a nominal detection depth of 30 inches and a maximum detection depth of 42 inches. Subsequent tests achieved a detection depth in the range of 42 to 48 inches by adjusting the detection mode on the locator. The field detection test showed some dependency on soil type, but only at depths lower than 32 inches. Signal strength greatly diminished beyond 32 inches, with greater depth having signals that were slightly above the nominal (no marker) locator readings. This applied to both search and track modes.

Finite Element Analysis indicates a single attached marker patch can sustain approximately 130 pounds of compression load and an instantaneous shear load of 280 pounds. The pipe is not significantly affected by the patch under these loads or under internal pressure loading.

Status

The general conclusion from this market assessment is that there is a need for both RF-embedded warning tape (up to 46% of new mains and 15% of new services) and direct-attachment techniques (up to 47% of new mains and 45% of new services).

A Final Report on the project is being prepared.

For more information:

Maureen Droessler
Program Administrator
Operations Technology Development, NFP
Phone: 847/768-0608
maureen.droessler@otd-co.org

Cross-Bores Detection Using Mechanical Spring Attachment

Research is under way to develop a tool that will detect a hit to a sewer pipe during the installation of a gas pipe. The tool utilizes a mechanical spring system that is activated inside the sewer pipe void to provide a real-time alarm identifying a hit.



Project Description

Horizontal directional drilling (HDD) has become a common method for installing polyethylene (PE) gas pipe. Although rare, hits to sewer pipes during the HDD/mole installation process have occurred ("cross bores") that resulted in gas leaks into the sewer system when sewer-cleaning operation damaged the gas line.

Sewer laterals typically run perpendicular to the proposed route of a new gas pipeline. The laterals also rapidly change depth in that same area. Currently, there is no practical technology for locating sewer laterals and determining their depth in all types of soils.

Several approaches, including advanced utility locating and camera inspection, may contribute to reducing these threats. However, these operations are performed by different crews either before or after drilling and standard drilling technologies are still "blind" with respect to the underground environment.

The objective of this project is to develop a tool that will detect a hit to sewer laterals during the HDD or mole installation of PE gas pipe. The tool is designed with a low-cost and easy-to-use mechanical spring system that is attached to the HDD/mole head during drilling or to the PE pipe during pullback. The spring system is activated inside the sewer pipe void; thus locating the lateral and providing a real-time alarm identifying a hit.

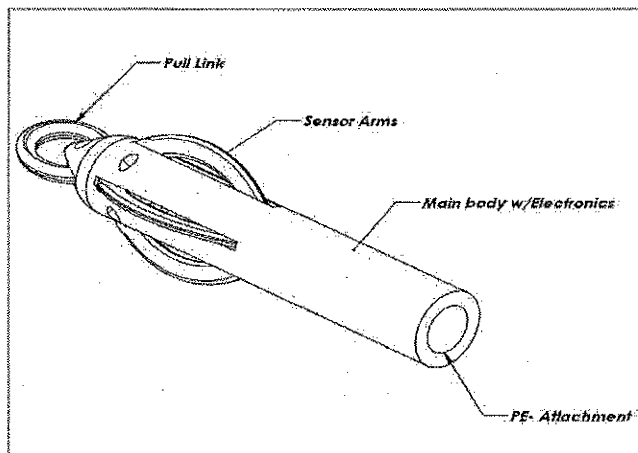

Example of an initial design of the spring attachment.

Deliverables

The deliverable for the project will be a functional prototype unit.

Benefits

The implementation of the cross-bore detection tool increases safety and enhances the installations of distribution gas lines in difficult areas where sewer lines intersect.

The ability to attach the detection system to either the drilling head or to PE pipes during pullback makes it an economic and practical solution to detect incidents of pipe encroachments during HDD and mole operations and will help minimize risks.

Technical Concept & Approach

The design consists of a cylindrical unit attached to the HDD/mole head during drilling or to the PE pipe during pullback. The unit has spring arms around its perimeter. The springs are in a closed position when confined in soil. When the unit encounters a void space inside a sewer pipe, the spring arms open and an electronic signal is sent to the surface (using a signal wire or wireless system) indicating the arms' movement.

An on/off electronic signal can be sufficient to indicate if the apparatus encountered a void representing a sewer lateral when some or all the springs are opened inside the sewer pipe.

Further calibration of the sensor will filter false signals in soil and provide an indication of the size of the sewer line when the spring system is moved back in the soil.

Specific tasks include:

- **Initial Design of the System**

The development of prototypes consists of several steps to address the following operational requirements:

- The mechanical system must sustain the forces applied during the drilling and pullback operations.
- The spring arms must function properly in drilling mud and varying soil conditions, especially in the cohesive types encountered when operating in wet clay soil.
- The electronics must be waterproof and resist the chemical and environmental conditions encountered in the soil and sewer lines.
- The electronics must be designed to transmit the signal in real time. The signal may be transmitted using the tracer wire as a communication line if it is installed during the operation or using a wireless radio transmission with automatic on/off feature.
- The system must be calibrated to identify the false signals that may result from passing through natural soil voids.

- **Prototyping, Testing & Modification**

The selected prototype will be manufactured and tested under various soil conditions in a laboratory environment. The tests will allow for modifications to the system to address the required operational requirements.

- **Field Testing and Troubleshooting**

A field test and a demonstration will take place at the Gas Technology Institute pipe farm. A sewer system will be installed and a HDD installation will be performed with the prototype. The drilling will be guided to penetrate the sewer pipe and the prototype will be evaluated for performance.

Results / Status

Activities in 2012 focused on the initial design of the cross-bore system. Various systems are being considered for the sewer detection, including the use of mechanical springs, pressure bags at the perimeter of the attachment, and installing a simple load-sensor indicator during the PE pipe pullout.

For more information:

Maureen Droessler
Program Administrator
Operations Technology Development, NFP
Phone: 847/768-0608
maureen.droessler@otd-co.org

PIPE MATERIALS, REPAIR & REHABILITATION

In this area, researchers focus on various aspects related to the evaluation and development of materials and processes used to maintain, repair, and rehabilitate gas piping systems.

Current efforts include projects to improve techniques, equipment, and quality control for the repair and maintenance of pipes, joints, and various facilities.

A wide variety of advanced techniques are under investigation, including cold adhesive repair and joining, an external repair tool, and a system for the repair of aboveground leaks. In addition, an expert training system is being developed for butt-fusion joints.

R&D results – developed in state-of-the-art testing facilities and demonstrated in the field – contribute to improvements in system safety, deliverability, and integrity.



Characterization of Long-Term Performance and Strength of Lateral Joints

Research was conducted in an effort to develop pipe-joining-qualification data to ensure the safe and long-term performance of various types of lateral plastic-pipe connections, including: saddle heat-fusion, electrofusion, and mechanical joining.



Project Description

The use of polyethylene (PE) materials for gas distribution applications has grown at an exponential rate, and modern PE materials have experienced significant improvements with respect to their mechanical and physical properties.

Currently, there are well-defined and accepted short-term and long-term tests (e.g., long-term sustained pressure tests at elevated temperatures, quick-burst testing, and tensile-strength tests) which provide a very effective representation of a given PE material's ability to withstand safe, long-term service over its anticipated design life. However, while these tests are useful for pipe and resin materials, they may not be effective in characterizing the performance of joints.

Various types of plastic-pipe joints can have significantly higher stresses acting on the pipe/fitting assembly due to geometry, thermal expansion/contraction, live soil loads, installation stresses, and other factors. These stresses can have an influence on their long-term performance. While extensive research has been conducted to quantify the life expectancy of plastic pipe, qualification requirements and technical standards for joining methods require further evaluation.

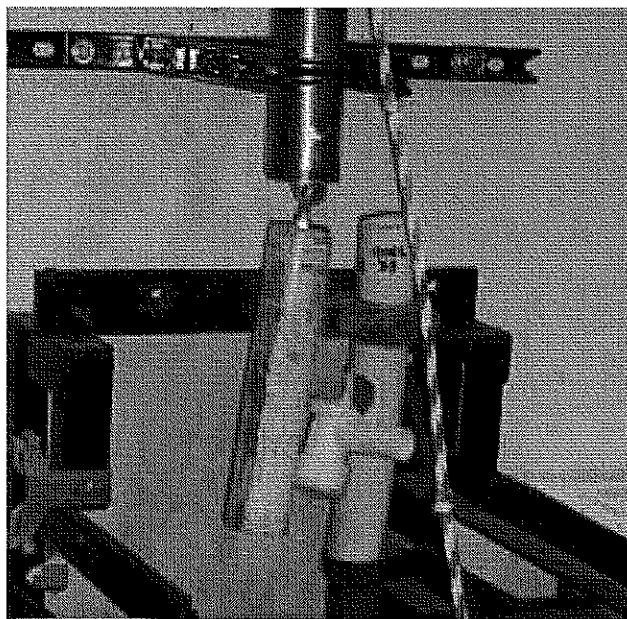

The objective of this program was to evaluate the safe long-term performance of various types of lateral joints as a function of processing/installation parameters and anticipated in-service loadings acting on the joint interface.

Deliverables

The major deliverables of this overall effort include:

- Comprehensive test data
- Proposed process/product specifications for integration within company specifications, operator-qualification initiatives, and industry standards and specifications
- A Technical Report incorporating details on each method of lateral joining: saddle heat-fusion, electrofusion, and mechanical joining.

Benefits

The benefits of the overall program include:

- An improved set of test methods and parameters for 50-year qualification of recommended joining methods
- Qualification test parameters that will incorporate (or have a means of determining) appropriate safety factors relative to anticipated stresses
- Improved product designs placed on the market, improved short- and long-term performance of joints tied to ASTM standards and specifications, and enhanced safety.

Technical Concept & Approach

The overall program essentially consisted of two independent parts. Both the electrofusion and saddle heat-fusion processes employ the use of heat energy in some manner to melt the PE surfaces of the pipe and fitting, which are then brought together and allowed to re-solidify under pressure. In contrast, mechanical

joining involves various materials acting together to form a compression seal at the interface between the pipe and fitting. Noting these differences, a comprehensive program plan was developed to investigate the long-term performance of electrofusion/saddle heat-fusion joints and mechanical saddle joints using both standardized and non-standardized tests.

Given the inherent complexities and numerous variables associated with each respective type of lateral joint, a purely empirical approach was not possible. Rather, a hybrid approach consisting of experimental testing based on sound theoretical models/considerations was favored.

As a first approximation, a comprehensive series of models was developed leveraging previous research performed by Cornell University related to the convolution integral method. The objective of the model was to develop actual thermal stress which can be experienced under field conditions as a function of various loading rates and residence times. While the models helped to predict effective test conditions to simulate the thermal stresses that are likely seen under actual in-service conditions, no formal solutions could be established to correlate the duration of testing with the intended design life of 50 years. Therefore, evaluation of the mechanical joints performance was based more heavily on empirical testing.

A series of thermal cycling tests were performed to verify the integrity of the compression seal of a mechanical joint from three manufacturers' product lines as a function of differing ramp rates and residence times.

To help guide the technical aspects of this program and ensure an objective peer review of the technical data, a joint industry steering committee was established consisting of members from key stakeholder groups.

Results

A series of standardized and non-standardized tests were performed to evaluate the integrity of fusion and mechanical joints.

The cumulative results demonstrate:

- Both methods of joining are equally capable of producing comparably strong joints provided that the surface-preparation technique is standardized.
- Current qualification tests per ASTM F905 and ASTM F1055, which require the use of a drop impact test, is not an effective predictor of overall joint integrity. The strain rates resulting from an instantaneous drop impact are quite large and the test does not provide for any useful quantitative measure of joint strength and performance.

- The use of a previously developed constant monotonically increasing load (CMIL) test is a useful means of evaluating the performance of electrofusion/saddle heat-fusion joints. The CMIL test employs reduced strain rates and permits the amplification of stress risers at the joint interface.
- The results of CMIL tests for a similar set of parametrically controlled saddle heat-fusion joints (i.e., made with the same process variables but using two different methods of surface preparation) showed that the use of the scrape technique promotes the overall integrity of the joint interface as compared to using emery cloth.
- The results of the CMIL test were validated with industry-accepted sustained pressure tests, which also showed that the use of the scrape technique promotes the overall integrity of the joint interface as compared to emery cloth preparation.
- By modifying the surface-preparation technique for saddle heat-fusion joints, gas companies can realize significant material cost savings. Moreover, the standardization of a single method of surface preparation can reduce the potential for operator error in the field.
- It can be inferred that there is an increased propensity for leaks to develop in mechanical fittings as a result of changes in ambient temperatures. That is, as the fittings transition from higher temperatures to cooler temperatures, there is an increased likelihood for fittings to leak.
- For electrofusion joints, there is minimal difference in the overall joint strength between different manufacturers' products.

To date, revisions have been made to industry-accepted ASTM standards, including ASTM F2620 which now permit the use of either scrape or emery cloth for saddle fusion joining.

Status

This project was completed in 2013 with the issuance of a Final Report in March.

For more information:

Maureen Droessler

Program Administrator

Operations Technology Development, NFP

Phone: 847/768-0608

maureen.droessler@otd-co.org

OTD

Operations
Technology
Development

Cold Adhesive Repair and Joining of Polyethylene Pipes with Minimal Surface Preparation

In this project, researchers tested a cold-adhesive repair technique in an effort to develop an economical, reliable, and safe technology to quickly and effectively repair damaged plastic gas pipes.



Project Description

Natural gas distribution companies have continued to identify the development of reliable, economical, and safe repair methods for plastic pipes as one of the industry's most important needs.

It is estimated that each year about 180,000 pipe failures occur in plastic gas distribution pipelines. While about 60% of the plastic-pipe failures are the result of excavation damage, most of the remaining failures are primarily due to the initiation of brittle-like slit failures that can grow through the pipe walls. These slit failures are commonly located at heat-fusion joints and at pipe sections subjected to squeeze-off, rock impingement, pipe bending, or excessive earth settlement.

Typically, two distinct operations are involved in the conventional repair of a plastic gas pipe. First, the flow of gas is stopped using squeeze-off techniques, which usually requires two excavations. Next, the damaged or leaking pipe section is cut, removed, and replaced with a short section of pipe (or, "pup") that is joined to the pipeline using mechanical or electrofusion couplings.

In this project, researchers are developing a Cold Adhesive Repair of Polyethylene (CARP) technology that will allow gas company crews to economically and quickly repair (and join) damaged polyethylene (PE) pipes and leaks without additional excavations, removal of the damaged pipe section, and interruption of gas

supplies to clients. With the CARP method, pipe patches are bonded to damaged pipe using special adhesives. The CARP technology does not require significant pipe-surface preparation, training, heating, or tools.

In the first phase of the project, the primary objective is to develop and commercialize a technology using modern structural cold adhesives, optimized for low-surface-energy materials such as PE. The technology is being developed for several forms of PE gas pipe damage, including pipes with holes and gouges, through-the-wall slits, surface scratches, and leaks at heat-fusion joints, impinging rocks, and other areas.

Deliverables

The deliverables for the project include:

- Easy-to-use, optimized structural adhesives and patch designs and materials (that do not require tools, heating, or pressure) and cure in air under typical field conditions within a period of about five hours, but allow for immediate burial
- A step-by-step repair procedure/protocol to perform quick in-field repairs on leaky and damaged PE pipe sections
- A written procedure guideline/manual on each step of the CARP process that takes into account different field temperatures and soil/environmental conditions
- CARP testing prototype kits that include the required repair materials and procedures
- A video demonstrating the application of the CARP process.

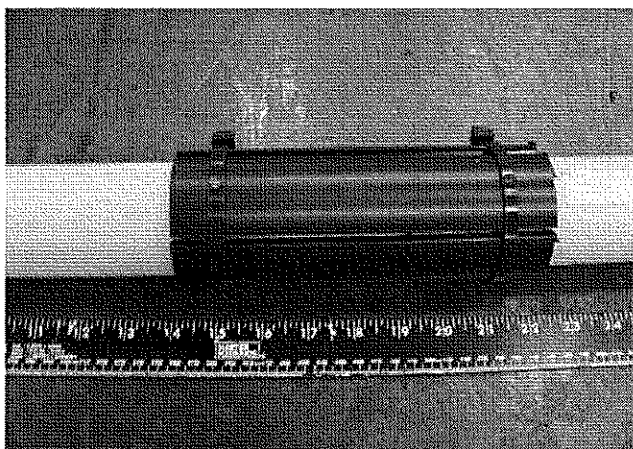

CARP patch applied to PE pipe specimen.

Benefits

The CARP technology shows promise in reducing the costs of PE pipe repair and the ability to improve the reliability and safety of PE piping systems.

The CARP prototype:

- Is economical, easy to use, and can be rapidly applied
- Requires minimal training
- Is structurally reliable and can be applied under most varying weather conditions and in most field environments.

Investigators expect the cost of the CARP technology to be low. It is envisioned that fitting manufacturers will mold the CARP patches using automated high-production molding machines.

Technical Concept & Approach

Specific activities involved:

- The design and fabrication of PE repair patches on the basis of laboratory test results and stress analysis calculations
- Validation testing, including short-term (quick-burst) and accelerated long-term laboratory tests at elevated temperatures and pressures on pipe test specimens repaired under pressure
- The formulation of a comprehensive CARP test matrix under no-pressure conditions (no blowing gas conditions)
- The preparation of pipe test specimens for implementing the CARP technique under no-pressure conditions (no blowing gas conditions)
- Short-term and accelerated long-term laboratory tests on repaired test specimens per the test matrix
- Forecasting the pressure-carrying capacity and the life expectancy of the repaired test specimens
- Preparation of a step-by-step procedure to perform cold adhesive repairs.

Results

Long-term test results of patched PE pipes found that the patching system can be effective. Testing also resulted in additional information about the effective application of the adhesive.

Researchers report that the long-term hydrostatic stress-rupture test results on the CARP pipe specimens are very significant. The initial test data showed that at an average field temperature of about 68°F the CARP-repaired pipes have an average projected life expectancy of greater than 50 years.

These initial test results also showed that the growth of the crack/notch was arrested by the CARP-repaired patches.

Quick-burst (QB) pressure tests demonstrated that the strength of CARP-repaired pipe specimens was the same as the pipe. For these specimens, the failure occurred in the pipe away from the patch. This failure was a typical ductile rupture.

Technicians fabricated a "self clamping" patch to evaluate a full-encirclement-type patch with the potential for improved performance over the partial patches.

A number of CARP-repaired PE pipe specimens were created and evaluated through a series of QB and Long-Term Hydrostatic (LTHS) tests. QB tests were conducted at both 23°C (73°F) and at elevated temperatures (80°C and 90°C). All failures occurred in the pipe wall (not through the patch); however, the QB tests at elevated temperatures created failures in the pipe wall at the closure seam of the patch (180 degrees away from the notch). The LTHS tests were conducted at 80°C and 90°C water baths and at various stresses. The specimens failed within minutes of applying the stress to the repaired specimens. The results of the initial QB and LTHS evaluations indicate that the patch and adhesive is sensitive to temperature. Upon reviewing the adhesive manufacturers specifications on the adhesive, it is evident that the shear strength is greatly reduced at elevated temperatures.

Field applications of the potential PE pipe repairs will typically occur at temperatures of 23°C and lower. Therefore, the potential sensitivity of the adhesive and repaired pipe should not be an issue for field applications; however, this does create an issue for evaluating the repaired specimens using typical elevated temperature water baths. Researchers will conduct further LTHS evaluations at 23°C and at various stress levels.

Status

Additional evaluations on the adhesive and bonding of the adhesives to the PE pipe at elevated temperatures is under way. In addition, LTHS evaluations at 23°C at various stress levels will be conducted.

For more information:

Maureen Droessler
Program Administrator
Operations Technology Development, NFP
Phone: 847/768-0608
maureen.droessler@otd-co.org

OTDOperations
Technology
Development**PIPE REPAIRS, MATERIALS & REHABILITATION****Development of an External Repair Tool
for Polyethylene Pipe**

Enhancements and modifications are being made on a tool and process for the repair of polyethylene pipe. The pipe-repair system attaches and bonds a patch to damaged pipe areas, providing a cost-saving alternative to conventional plastic-pipe repair techniques.

Project Description

Current polyethylene (PE) repair procedures require excavation, isolation, and removal of the damaged section of pipe, followed by fusion of a new section of pipe into place – techniques that can be costly and disruptive.

In an effort to provide a cost-saving alternative, this project is focused on the development of a thermo-chemical repair patch and mechanical tool to externally repair damaged PE pipe *in-situ*, eliminating the need for large-scale excavation and replacement of pipe sections.

In the completed Phase 1 of the project, activities were conducted to enhance an innovative repair tool developed by Timberline Tool and Oregon State University under a cooperative agreement with the U.S. Department of Energy's National Energy Technology Laboratory. In the current Phase 2 effort sponsored by OTD, additional testing and modifications are being conducted.

The tool uses heat fusion to attach a patch to repair damaged pipe and features a jaw design, open on the end and curved to fit the contour of the pipe as it closes. The open-jaw configuration allows the operator to fully enclose the damaged section of the pipe with the repair patch, stopping the flow of gas through the damaged pipe wall. The system operates remotely from the top-down (without requiring preparation of the pipe) and is portable and lightweight (30 pounds), allowing for one-person operation. The tool measures 11 inches wide with a 6.5-foot handle, allowing for easy use in keyhole operations.

The function of the tool is to:

- Repair gouged or scratched pipe that would otherwise have to be replaced
- Reinforce suspect butt-fusion welds that may be prone to failure due to long-term slow crack growth
- Stop leaks in pipe without shutting off the gas flow in the main.

The overall objective of Phase 2 is to further test samples of various types of damaged four-inch-diameter PE pipe repaired by the Timberline Repair Tool and Patch System.

Deliverables

The deliverables for this project include:

- Development of the final repair tool and patch ready for testing
- Regional or company-specific demonstrations or field trials of the repair tool
- Test documentation.

Benefits

The thermo-chemical repair process will allow the natural gas industry to reduce their costs for the maintenance and repair of their PE service and distribution pipelines while making the jobsite safer for their employees and the public.

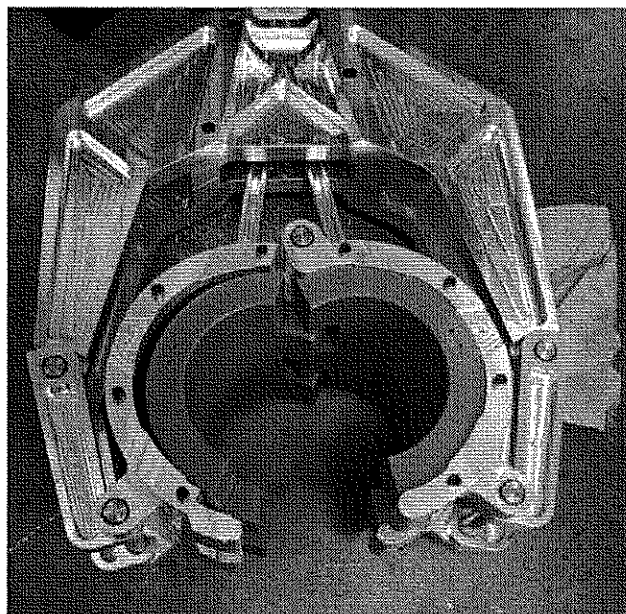

Substantial maintenance costs and potential safety incidents can be avoided by the quick and widespread implementation of the repair tool. It is estimated that the use of this system will save the industry between \$1,000 and \$3,500 per incident, depending on the size and complexity of the maintenance/repair project.

Technical Concept & Approach

The principal design challenge was to modify the system to be able to repair a large opening (e.g., breach or gouge) in the pipe wall that allows pressurized gas to escape. Another design goal was to be able to use one tool to repair more than one pipe size.

The project involves a regimen of testing activities to optimize the repair patch, the process, and the tool. In addition, the project includes an investigation into applicable codes and standards.

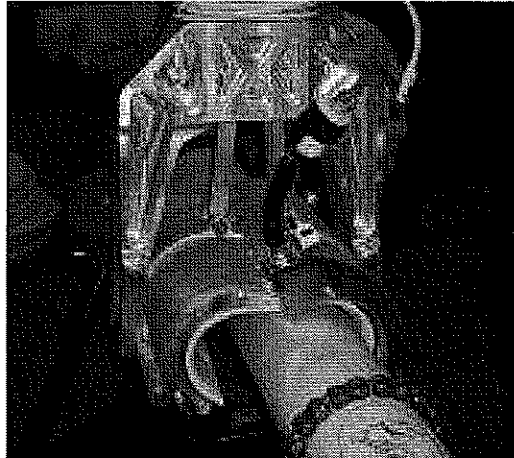

Results

Phase 1 development activities for this project are completed and resulted in various significant product improvements.

A novel and effective PE foam adhesive layer was developed and included in the composition of the repair patch. The use of this foam adhesive layer saves time, facilitates preparation, and simplifies the storage and shipping requirements for the patch assemblies.

To be able to use the same tool to repair multiple pipe sizes, the patch was redesigned using an internal stitched heater within the patch. The final repair patch design uses a stitched internal heater of varying watt density on a layer of PE film that is sandwiched between two layers of PE "solvent sponge" foam.

The new design also uses nylon thermal-insulating jaw inserts that are easy to exchange in the field and are specific to various pipe sizes up to six inches in diameter.

Field demonstrations of the repair tool were performed in 2009.

In 2010, ASTM D 2837 and ISO 13954 test matrices were developed for evaluation of repaired PE pipe samples.

In 2011, tests were performed on samples of a new PE mesh to determine their suitability for use in the repair

patch. The results of the mesh tests were very consistent and showed that the new cloth will not change the bonding properties of the heater.

The controller was completely redesigned and reprogrammed to address all pipe sizes (standard and metric). The configuration of the controller was also redesigned, which allowed for a reduction in overall size.

In 2012, all the internal stitched heaters, foam, and the electrical connectors were produced for the test pipe sample testing.

A final design was completed for a permanent plastic injection mold to replace the hand molding previously used to produce the patch backs. This is a significant achievement that allows consistency in the manufacturing process and eliminates the variables associated with producing the patch backs by hand. During these initial test runs it was noted that in order to attain the correct patch length, the temperature

within the nozzle and barrel of the mold press needed to be at the upper limit of the specifications for injection molding. This high temperature produced patch backs that were adequate, but moderately brittle.

Status

Researchers are investigating three different pipe resins to reduce the overall temperature during molding and eliminate the brittleness.

All the patch backs will be produced and then the repair patches assembled to produce 200 thermal-chemical repair patches. These repair patches will then be installed over damaged (machined notches) four-inch-diameter PE pipe samples using the Timberline system (consisting of the mechanical repair tool and controller) to apply the thermal-chemical repair patch.

It is anticipated that these samples will be delivered for accelerated age testing and quick burst tests early in 2013.

For more information:

Maureen Droessler
Program Administrator
Operations Technology Development, NFP
Phone: 847/768-0608
maureen.droessler@otd-co.org

OTD

Operations
Technology
Development

High-Pressure Inflatable Stoppers – Alternative to Traditional Stopping Equipment

The objective of this project was to develop inflatable stoppers for use in high-pressure gas piping systems. A system was designed to provide a lower-cost alternative to the conventional stopping equipment used for routine and emergency operations on various types of pipe materials.

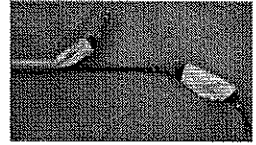

Project Description

Line-stopping equipment in the natural gas industry has changed little in 50 years. Common equipment used today is still heavy (requiring multiple people or mechanical assists to maneuver), costly to maintain, and very time consuming when installing necessary fittings.

Some vintage plastic-piping systems (e.g., Aldyl-A and PVC materials) cannot or should not be squeezed with traditional tools to control the gas flow. Cast-iron systems operating at intermediate pressures must first be lowered to pressures less than five psig for traditional bag stopping equipment to be used. The alternative to lowering the system pressure is to use conventional stopping equipment and install expensive and heavy mechanical fittings that typically require reinforcement under the pipe to minimize the risk of future main breaks. In both situations, large excavations are required.

In a project previously supported by OTD, researchers developed and tested the Inflatable Bypass Stopper (IBS) system. The IBS concept was successful in remotely sealing ruptured mains up to nearly 100 feet away from the insertion point of the bags. The IBS was

designed for two- and four-inch-diameter polyethylene (PE) mains operating at 60 psig. While this effort increased the pressure capability of the stopper bags, the system was not designed for routine flow control.

Gas Technology Institute's Keyhole Program also developed a prototype stopping system using one intermediate-pressure bag and a control box to stop flow on cast-iron piping systems operating at pounds pressure. The concept was successful and achieved its goal; however, a product was not commercialized.

This project takes the development efforts of the IBS and Keyhole Program to the next level: using high-pressure (60 psig) inflatable bags for typical flow-control operations and building a system that allows two bags to be launched through one tap hole.

Applications include:

- An alternative to squeeze off for PE pipe
- A "no blow" option for controlling gas flow on cast-iron gas mains
- A good alternative to large/heavy traditional stopping equipment for use in steel pipe

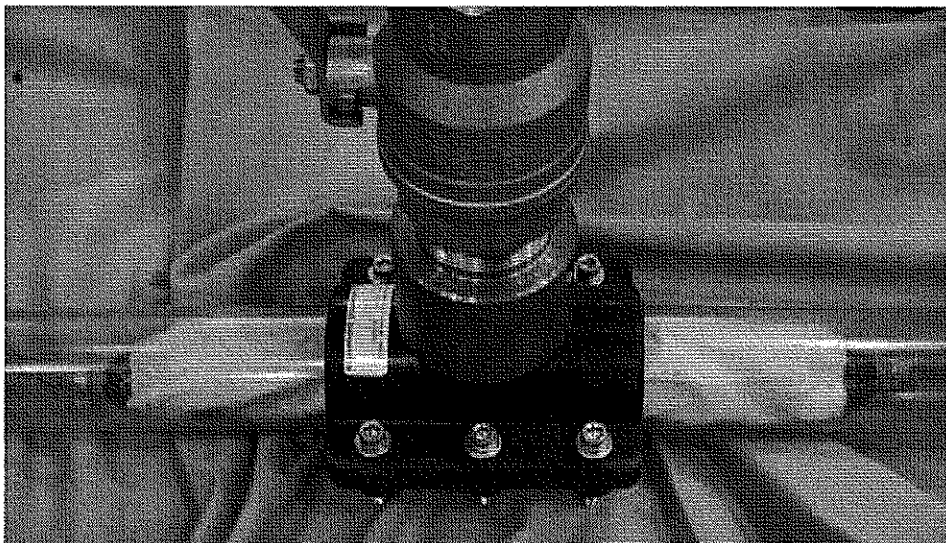

The system is designed for two bags to be inserted into the gas main through one tap to reduce the size of the excavation normally required and reduce the time required for installing and tapping fittings.

- Routine maintenance or emergency flow control for all above applications.

Deliverables

In this project, researchers developed and field tested pre-production inflatable stoppers capable of stopping-off line pressures of 60 psig in two-, four-, and six-inch-diameter pipes.

Benefits

Developments in this project can lead to the availability of lower-cost, more ergonomic alternatives to current line-stopping equipment. Experts also anticipate that smaller drilling equipment (1.5- or 2-inch hole saws) can be used to tap the entry fittings for this stopping method, thus providing additional savings. In addition, squeeze-off of some of the vintage plastic mains still in existence could lead to premature failures with the use of traditional equipment.

Technical Concept & Approach

The concept of this project is to use bags for controlling the flow of gas for routine maintenance operations (cutting-off mains, extending mains, emergencies, etc.) while minimizing the size of the equipment and size of the tap holes.

Specific tasks of the project were to:

- **Design, Develop, and Evaluate Bag Systems for Four-Inch-Diameter Mains (Steel, Cast-Iron, and PE)**
- **Develop and Evaluate Bags for Two-Inch Pipe**
- **Design, Develop, and Evaluate Bag Systems for Six-Inch-Diameter Mains (Steel, Cast-Iron, and PE)**
- **Design, Develop, and Evaluate a Control Box for the Higher-Pressure Bagging Systems**
- **Conduct a Field Demonstration.**

Results

Initially, prototypes for the four-inch and two-inch bag systems were developed and tested in the laboratory under "live" conditions. The bag design/prototype development went through various iterations.

Evaluations resulted in the following system modifications:

- The launch tube for the four-inch system was redesigned to allow for better insertion into the valve and fitting on the pipe
- The angle between the end and body of the bag was changed for better movement into the pipe
- Fish tape was connected to the inflation rod to guide the bag's direction and to improve bag compression for removal.

A step-by-step operating procedure was provided in a technical report and video format.

The design, manufacturing, and laboratory testing of the six-inch bag system were completed and a field demonstration of the system was performed.

A new split inner launch tube was constructed for the six-inch bags and was tested for insertion and removal. Technicians constructed an adjustable launch platform to assist with the bag insertion/removal process and help stabilize the outer launch tube that is connected to the main pipe.

Laboratory tests were performed on the bags for two-inch applications to determine their burst strength. The confined bags were tested in two separate quick burst tests and the bags burst at internal pressures of 218 and 227 psig.

The control box for the system was design and built. Tests were performed to evaluate the performance of the control box used in conjunction with the bagging system.

Status

This project has concluded and a Final Report is being developed.

For more information:

Maureen Droessler
Program Administrator
Operations Technology Development, NFP
Phone: 847/768-0608
maureen.droessler@otd-co.org

OTDOperations
Technology
Development**PIPE REPAIRS, MATERIALS & REHABILITATION****Polyurea-Coating Testing and Assessment
for Gas-Industry Use**

Research and testing are being conducted to provide a thorough evaluation of polyurea pipe coatings for potential use in the natural gas pipeline industry. Polyurea-coatings test results are being compared with benchmark systems.

Project Description

In recent years, utilities have expressed an increased interest in using plural-component "polyurea" coatings for natural gas industry service environment applications such as: vaults, pipe on bridge crossings, pipe for horizontal drilling applications, above-ground meter sets and distribution equipment, and vehicle truck bed-/underbodies.

In general, polyurea coatings have exceptional high elongation and toughness, which could make them exceptionally well suited for vehicle applications. Polyureas also offer rapid application rates, fast curing (i.e., < 1 minute), and a quick return of components to service. In addition, they can have strong abrasion resistance and excellent encapsulation characteristics. Permeability per mil is not as low as some epoxies and rigid polyurethanes; however, this may not be important if used at the recommended film thickness. Some systems are available in high-pigment UV-inhibited formulations, making above-ground applications acceptable.

The most problematic application of polyurea coatings is related to potential coating damage from cathodically protecting the pipe. Polyureas are generally known to perform relatively poorly compared to fusion-

bonded epoxies in ASTM cathodic-disbondment (CD) testing. However, due to their exceptional impact resistance, many fewer holidays should be expected to form. If, as expected, the polyureas do not perform well in CD testing (e.g., ASTM G95), it may not be possible to determine the real significance of these results without longer-term field testing.

Plural-component equipment is also known to be difficult to use and time consuming to set-up and clean-up. In applications where only a relatively small surface area has to be coated, a brush-on coating may be just as effective.

The objective of this project is to:

- Define potential gas-industry uses and service environments to implement plural spray-on polyurea coatings
- Establish a laboratory testing coating matrix applicable to the most promising service environments
- Obtain representative samples of polyurea and several benchmark systems (e.g., specimens coated with epoxy, organic/inorganic zinc, etc.) and subject them to the testing matrix



ASTM G8 test with pipes suspended in electrolyte (left); spraying coating on pipe specimens (right).

- Compare performance results from the laboratory testing between the benchmark systems and the polyureas and compare the results to a large database of coating systems (those that require grit blasting and hand tools to those requiring no surface preparation)
- Provide recommendations for which parts of the polyurea field trials should be instituted.

Deliverables

Research results will provide performance data and a list of potential gas industry uses and service environments to implement plural spray-on polyurea coatings.

Benefits

This research will provide utilities with the comparative, sound engineering data necessary to make decisions regarding the use of polyurea coatings.

Technical Concept & Approach

This project includes the following technical tasks:

- **Survey to Define Potential Service Environments**

This task consisted of a survey of the project sponsors to determine all potential areas desired for plural spray polyurea application. Researchers contacted all major polyurea manufacturers in the U.S. to collect product data sheets, application instructions, and information on limitations. Researchers also established a benchmark of currently available non-polyurea products which may be used for comparison tests with the polyurea systems.
- **Laboratory Testing Matrix**

The project plan calls for conducting the most important tests of physical and mechanical properties as related to the predicted service environment. Comparative (relative) test results of the polyurea systems vs. benchmark systems were conducted side by side. Test data that will be quantitatively compared to a large historic database of coating systems tested with the same methods.
- **Preparation and Testing of Laboratory Specimens**

Polyurea is applied by plural component spray. Test specimens are being coated by the coating manufacturer or a certified polyurea applicator and then provided for testing.

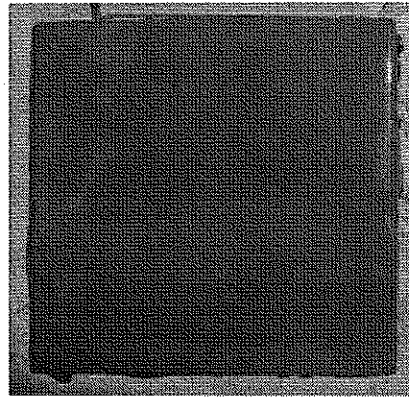

Pipe and plate specimens were grit blasted to obtain a surface profile of 3-5 mils. The coating was brushed onto the specimen surface.

- **A Comparison of the Results of Polyurea Systems to Benchmark Systems and a Database of Coating Systems**

At the completion of testing, data and results will be analyzed to determine the relative performance of the polyurea systems vs. the benchmark systems and equally important as to how they performed vs. historic systems. The data and performance comparison will be documented in table and graphical format.

- **Recommendations for Polyurea Use for Gas-Industry Applications and Field Site Trials**

Researchers will recommend where to use and where not to use polyurea in the natural gas systems and provide a prioritized list of potential field trials. Trials should be completed and graded prior to wholesale adoption of the polyurea coating systems.

Results / Status

In 2012, several available product specimens were prepared and tested. Investigations included impact tests and abrasion tests. Abrasion tests as well as cathodic-disbondment tests are ongoing and expected to be completed in 2012.

In addition, corrosion chamber testing and UV resistance testing will be conducted for all coating specimens.

Initial test results are presented in reports to project sponsors.

For more information:

Maureen Droessler
Program Administrator
Operations Technology Development, NFP
Phone: 847/768-0608
maureen.droessler@otd-co.org



Development of a System for Repair of Aboveground Leaks

Researchers are conducting a thorough evaluation of repair methods for leaks on aboveground piping in an effort to establish a basis for choosing the right repair method for a specific leak, establishing levels of adequate preparation, and providing the proper installation for increased reliability.



Project Description

Utilities are now classifying and logging leaks on aboveground piping, and many have established that a significant number of the leaks occur due to pitting corrosion or through threaded joints between components.

Removal or replacement of leaking components is not desired due to customer downtime, relights, and the time involved in conducting the repair. Additionally, many of the components (other than the thread area) may be in good working condition and do not require replacement. An understandable solution is the installation of an external leak-repair system.

Although many leak repair systems are in the market, an American Gas Association SOS regarding repair usage indicated that very few gas utilities are using these systems and, if they do, most use them only as a temporary repair.

Several of the most popular mechanical and composite-wrap systems in use today can be complicated and difficult to consistently install. Strict requirements for surface preparation, cleanliness, installation alignment, installation tension, torque requirements, and cure time all create variability in the final repair integrity.

Research found that there are several key factors that have resulted in large numbers (>10%) of these repair systems to leak within weeks or months of installation.

In this project, researchers are conducting an evaluation of the degradation of these repair systems over the long term.

Deliverables

The deliverable will be an analysis of the permanence of two tested aboveground leak repair systems. The evaluation will provide extrapolated estimates of the long-term life expectancy of these repairs based on the long-term tests at elevated temperatures.

Based on the results of this effort, an additional task may be initiated to enhance current leak-repair systems and possibly begin the development of a new leak-repair system to allow for greater repair flexibility and reliability.

Benefits

Through a long-term evaluation of aboveground leak-repair installations, a basis will be established allowing



Two repair methods for aboveground piping are being evaluated.

utilities to determine the long-term performance of the repair methods for varying types of conditions.

Technical Concept & Approach

The project consists of several key tasks:

- **Determination of Design Parameters Through Short-Term Testing**

The parameters which may have an effect on the longevity of the repair were identified. These parameters (such as leak size, temperature, operating pressure, etc.) were simulated through preliminary testing. Samples were constructed in a matter that simulates each parameter and analyzed to determine their effect on the repair permanence.

Short-term tests include hydrostatic pressure tests at varying temperatures and pressures (and possibly under cycling temperatures). The results will be analyzed using Design of Experiment (DOE) methods to determine the testing parameters which have the greatest effect on longevity. These parameters will then be used to aid in construction of the testing matrix for long-term testing.

At the completion of this task, the research team will establish the short-term performance of these repairs, determine which parameters will be evaluated, and develop a testing matrix accordingly.

- **Testing and Analysis of Repair Methods**

A long-term evaluation of two aboveground leak-repair systems will be conducted to establish their long-term life expectancy for use as permanent repairs. After designing the test specimen from the results of the DOE, a large batch of test samples will be constructed as per each manufacturer's specifications.

These samples will be evaluated in long-term hydrostatic pressure tests. The method consists of testing sets of 18 specimens at three different temperatures. The samples at each temperature are held under various pressures to create failures in the desired timeframe between 10 and 10,000 hours.

Following sample failure, the results will be plotted on log-log charts to determine the failure trend and the extrapolated life-duration for the repair systems under the testing parameters of pressures and temperatures.

- **Field Simulation Testing (Optional)**

As an option, researchers will assist sponsoring utilities with implementing pilot programs based on knowledge gained throughout the project.

Results

In 2011, the research team established the testing platform, procedures, and parameters for the evaluation of two aboveground leak-repair systems.

Following initial contact with the system manufacturers, test results from the manufacturers were gathered, and initial product orders were completed. Prototype test samples were then constructed to simulate aboveground leaks from varying levels of corrosion (pin holes) and from threaded joints. The test samples were then fabricated, fitted with the corresponding repairs, and hydrostatically tested to failure.

Following hydrostatic initial burst testing, a series of short-term samples were constructed to aid in establishing the long-term test pressure.

A test apparatus was constructed to determine both leak and burst failures and to condition the test samples to temperatures ranging from 23°C-60°C.

In 2012, a total of 30 samples from two manufacturers were evaluated.

Following completion of the short-term test evaluation, an initial analysis was performed. Results are detailed in a report to project sponsors.

To reduce test pressures during the long-term evaluation, a larger pinhole (1/8-inch diameter) was used. In addition, a long-term test system was constructed to safely contain test samples at the high pressures encountered.

Status

Activities for 2013 include the development of a procedure for pipe-sample preparation and repair, followed by the initiation of long-term testing.

For more information:

Maureen Droessler

Program Administrator

Operations Technology Development, NFP

Phone: 847/768-0608

maureen.droessler@otd-co.org

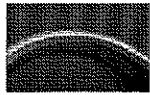

Example of leak-detection dye seen upon a sample leak failure.

OTDOperations
Technology
Development**PIPE REPAIRS, MATERIALS & REHABILITATION****Composite Piping Systems Development,
Application, and Evaluation – Workshop**

A Composite Piping Systems Workshop was held to help develop an industry roadmap to address various issues, approaches, research gaps, and development needs for the application of composite pipe for the distribution of gas and liquids.

Project Description

New materials are continuously being introduced and considered for the replacement and rehabilitation of aged transmission pipelines and high-pressure distribution systems. These new materials include composite piping that satisfy the high strength and environmental durability requirements with minimum corrosion potential.

Because of the benefits of composite materials, pipeline operators often seek special permits to allow for the use of composite piping. The qualification of these materials requires an integrated approach to determine the material characteristics and long-term performance.

In an effort to establish standard procedures for these requirements and disseminate information, a workshop was held in Springfield, VA, on July 17, 2012, with key representatives from state and federal regulatory agencies, natural gas and hazardous-liquid pipeline operators, composite pipe developers and manufacturers, and research organizations.

The key objective of the workshop was to develop a matrix that roadmaps the issues, approaches, research gaps, and development needs of the following focus areas:

- **Material Properties and Characterization** (including identifying short- and long-term performance, failure mechanisms, and testing requirements)
- **Installation Standards for Rehabilitation and Replacement of Pipes** (including quality control and assurance issues)
- **Risk Assessment** (including identifying the modes and probabilities of failure)
- **Inspection Methods and Interval** (including incorporating the assessment process into existing integrity management requirements)
- **Repair Techniques for Composite Pipe Systems**
- **Standardization** (including the development needs for new standards).

Deliverables

A report was prepared that details the workshop discussions and identifies the implementation gaps and research and development roadmap.

Benefits

The workshop has the potential to cut out one to two years from the desired implementation time for composite pipe into the industry.

The workshop provided pipeline operators and others with key information to benefit their operations and enhance the safety of their systems.

Technical Concept & Approach

In general, two types of composite pipe are in use:

1. A combination of reinforcement material (such as fiberglass, carbon fibers, plastic, and steel) in a thermoset matrix; and
2. Reinforced thermoplastic piping systems.

The application of these composite materials in the pipeline industry includes:

- New installation and replacement of old or damaged pipeline segments by composite pipes, and

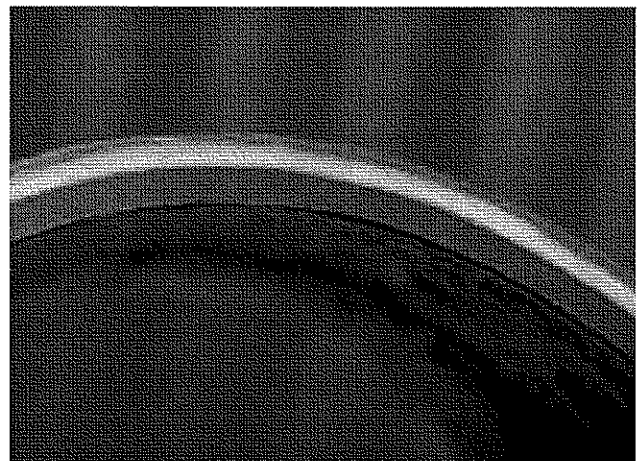

- Repair of steel pipeline sections using composite wraps and liners.

The main difference between the two is that the repair application addresses localized damages by applying outside wraps or inside liners, and its load-carrying capacity generally includes a contribution from the original pipe.

The workshop focused only on the first application – the continuous composite pipes used in new installations or replacement of degraded steel pipe segments. These composite systems are designed to carry the full internal and external loading capacity of the original pipe and are subjected internally to the transmitting components and externally to the outside environment of the pipeline.

The one-day workshop consisted of two sessions:

- **Session 1:** The session included presentations from various stakeholders to provide the technical expertise and current state of practice. The presentations addressed the regulatory perspective and requirements for use in regulated pipeline segments, utility and pipeline operators' perspective and implementation needs, and industry activities and system developments.
- **Session 2:** This discussion session addressed the qualification, research gaps, and development needs of the following focus areas:
 - *Performance* (including performance and testing requirements)
 - *Fitness-for-Service* (including material inspection, installation, and flaw assessment)
 - *Integrity Management* (including risk assessment and repair procedures).

Results / Status

The workshop identified the current state of technology and future development needs for composite piping systems for use in liquid and gas transmission and distribution of pipelines.

Conclusions

The use of composite systems has been established for more than 15 years in unregulated pipeline applications in the upstream sector of oil and gas industry. The application of composite pipelines in the downstream sector is still in its early stages and requires special permits in the regulated transmission and distribution lines. Due to the time and effort required to apply for the special permits, there is reluctance from the pipeline operators for their use.

Advancing the application of composites in the rehabilitation of the aging infrastructure requires further work to establish the performance criteria for the acceptance and selection of these systems. A significant concern in terms of evaluating the safety of these systems is a long-term assessment and inspection plan.

The qualification of these materials requires an integrated approach to determine the material characteristics and long-term performance. The integrated approach can utilize current efforts in the API RP 15S, which provides the requirements for the qualification of spoolable reinforced plastic pipes; ASME PCC2, which provides performance requirements for composite repairs; and API 579, for the fitness-for-service requirements.

The workshop agenda and presentations are available at:

<http://gasapps.gastechnology.org/webroot/app/gtiishome/workshop.aspx>

A link is also available under OTD Applications on the OTD website: otd-co.org

For more information:

Maureen Droessler
Program Administrator
Operations Technology Development, NFP
Phone: 847/768-0608
maureen.droessler@otd-co.org

OTDOperations
Technology
Development**PIPE REPAIRS, MATERIALS & REHABILITATION**

Evaluation of Below-Ground, Pipe-Surface-Preparation Tools

In this project, researchers investigated and evaluated new pipe-surface-preparation tools with the potential to improve the surface-preparation process for below-ground piping applications.



Project Description

Current methods for preparing and cleaning underground gas-pipe surfaces can be time consuming and difficult to conduct.

Common techniques include the use of hand wraps, pneumatic de-scalers, wire wheels, and sand blasting. However, these surface-preparation methods are labor intensive, inefficient, and can create airborne particulates. They also require the operator to spend considerable time in the trench to clean the underside of the pipe in a uniform manner.

In this project, a research team investigated technologies with the potential to reduce operator trench time while providing more uniformly cleaned surfaces.

One of the products under investigation was the Rustibus® Pipe Tool, a new machine designed for de-scaling and cleaning outer pipe surface (360 degrees) in one operation. It has been used to clean horizontal steel pipes in refineries, ships, and on offshore installations. The cleaning process is executed with rotating hammers with an attached cemented carbide unit hammer to scrape off the coating and rust on the pipe surface. Rustibus is a clamp-on system and includes models designed for various pipe sizes ranging from 4-inch to 12-inch outside diameters. The system is driven by air and simple to operate, with no extra tools or skilled labor required. The Rustibus can hammer and scrape

off coatings and rust at a capacity of up to 75 linear feet per hour.

Researchers also examined the MBX® Bristle Blaster® Technology from MONTI-Werkzeuge GmbH, based in Bonn, Germany. The MBX system is a new process that uses a specially designed rotary bristle tool for achieving both corrosion removal and an anchor profile. The rotating bristles are dynamically tuned to the power tool, which results in impact and immediate retraction of the bristle tips from the corroded surface. The bristle tips strike the corroded surface with kinetic energy that is equivalent to grit blast media, generating a texture and visual cleanliness that mimics the grit-blasting process. The tool has excellent mobility and eliminates the need for complex equipment, work suites, breathing apparatus, and grit-recovery systems that are commonly required for ordinary abrasive-blasting processes.

Other pipe-surface-preparation/cleaning tools were also reviewed. Depending on the results, a future phase may further develop and refine tools for wider applications.

Deliverables

Research results were presented in detailed reports to project sponsors.

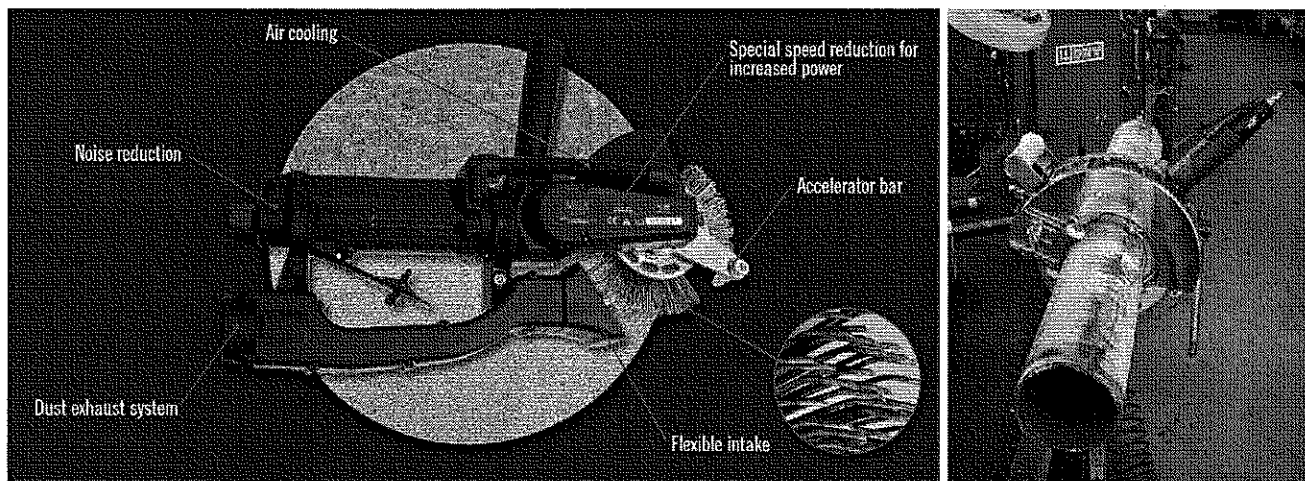

The MBX Bristle Blaster (left) and the Rustibus Pipe Tool (right).

Benefits

The commercially available Rustibus pipe-cleaning tool, MBX hand tool, and possibly other pipe-preparation tools have recently been developed and may provide improved efficiencies when compared to currently used tooling.

Benefits of the new pipe-preparation tools include:

- Consistent, clean surfaces around the entire pipe circumference due to an automated, clamp-on system
- Improved pipe profiles
- Cost-effective and environmentally friendly operations
- No damage on existing neighboring pipelines, coatings, or valves during operation
- Ergonomically friendly operations.

Applying such power tools to clean or prepare pipe surfaces in support of repair and maintenance operations could provide an improved and uniform pipe surface with significantly reduced labor cost.

Technical Concept & Approach

Phase 1 of this project focused on the investigation of new, advanced, commercially available tools in comparison with surface-preparing tools that are currently used (e.g., wire wheels and/or de-scalers) and sand/grit blasting. The efficiency and the surface cleanliness/profiles performed by these new tools in both simulated and field conditions will be compared with those cleaned by manual tools.

Specific tasks included: an industry survey and review, laboratory testing, and field evaluations.

Results

In 2012, a survey questionnaire was prepared and sent to project sponsors. Survey results were summarized in a report.

According to survey respondents, hand tools (e.g., knives, water spray, hammers, metal files, pneumatic chippers, and wire brushes/wheels) were the most commonly used surface-preparation tools. However, grinders, de-scalers, and grit blasting were also used.

The coatings being removed with surface-preparation tools include fusion-bonded epoxy (FBE), wax tape, and coal tar.

Survey results show that surface-preparation tools are used for pipe leak repair, installation of service tees, and fitting-leak repair.

A variety of tools were reviewed, including:

- **Rustibus Tools** (products include the Walk Behind Series, Hand Series, and Pipe Series).
- **Pinovo Tools** (e.g., PiBlaster and PiCo) from Pipeline Solutions AS
- **The MBX Bristle Blasting System**
- **3M™ SandBlaster™ Clean-N-Strip Discs**

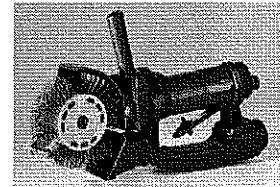

The research team identified candidate pipe-preparation tools for testing: Rustibus® Pipe, PiCo Pipe, the MBX system, Rustibus® 20, and PiCo Midi.

Rustibus Pipe, PiCo Pipe, and MBX system were tested on straight pipes. MBX, Rustibus 20, and PiCo Midi were tested on the pipes with fittings. The wire brush and grinder with 40-80 grit paper disc were included in the laboratory test as benchmark tools for evaluating the new tools. A five-foot long straight pipe with FBE coating or thick scale/rust was tested with different tools for a comparison test. The new tools were also tested with bare pipe containing deep corrosion pits to evaluate their capabilities to clean the pitted pipe surface. Tests were conducted with barriers installed on the sides and bottom to simulate trench conditions in the field.

Testing at controlled ambient conditions was conducted in the laboratory, followed by tests at field sites that covered the potential field conditions mostly encountered for the utilities.

Status

The research team completed the laboratory and field evaluation of the candidate pipe tools. Results were summarized in a Final Report.

For more information:

Maureen Droessler
Program Administrator
Operations Technology Development, NFP
Phone: 847/768-0608
maureen.droessler@otd-co.org

OTDOperations
Technology
Development**PIPE REPAIRS, MATERIALS & REHABILITATION****Integrated Expert Monitoring and Training
System for Butt Fusion**

A set of critical fusion variables are being developed in an effort to provide the gas industry with an integrated technology package for use in pipe-fusion training and field operations.

Project Description

In this project, researchers are investigating technology that could be used to help reduce the likelihood of human error in the plastic-pipe fusion process.

Currently, data-logging systems for butt-fusion machines reflect an operating window that captures common practice and, on average, ensures a reliable butt-fusion joint. Inspection protocols rely mainly on visual cues (e.g., bead size and shape) that reflect a large body of experience with historic materials. It is possible to produce sub-standard joints while following the existing procedure and complying with all visual-inspection criteria. (These uncommon circumstances arise when the polymer state at the interface does not meet the minimum requirements to ensure successful co-crystallization across the interface.)

The technology being applied in this project relies on polymer physics and accurate displacement and temperature control to derive a variable that is directly driven by proper displacement of the interface. Using pressure as the primary control variable, as is the case with current technology, does not ensure optimal interfacial end states in all circumstances. Unusual interactions of drag, materials, heater-plate temperature, and ambient conditions can fool a pressure- and visual-cue controlled system. These unusual combinations will be specifically addressed in the design and control approach of the new technology.

The method was used in a recent NYSEARCH project that evaluated the integrity of butt-fused joints. This same project utilized a full pipe creep-rupture test to evaluate the robustness of joints fused under different conditions. The full pipe creep-rupture test proved to be sensitive to joint-quality variation, but the project did not develop sufficient quantitative data to attach a reliable quality score to joints fused under different conditions. In this new project, researchers will use this experience with the full pipe creep-rupture test in conjunction with the rate-process method and standard ASTM test methods to fill this knowledge gap.

The goal is to produce a system capable of flagging marginal fusions in all operating conditions and provide guidance on how to adjust the process to achieve

a good fusion, or instruct the operator to abandon a joint that is not within prescribed limits.

A key of this project is the ability to reliably and repeatedly produce fusion joints in a controlled environment that have measurable quality variations. To this end, a bench-top machine that is fully controlled and programmable will be built.

A follow-on phase may be conducted to move the technology to market. The technology will be applicable to manual, semi-automatic and fully automatic butt-fusion machines.

Deliverables

The deliverables of this project include:

- A list of essential variables and their acceptable limits for the butt-fusion process
- A set of procedures and protocols for realizing a robust butt-fusion process
- A comprehensive data set validating the effectiveness of the preferred processes
- A set of quality-control parameters that will be logged with each fusion and will be sufficient to provide an acceptable confidence level that the fusions were performed in the optimal process window

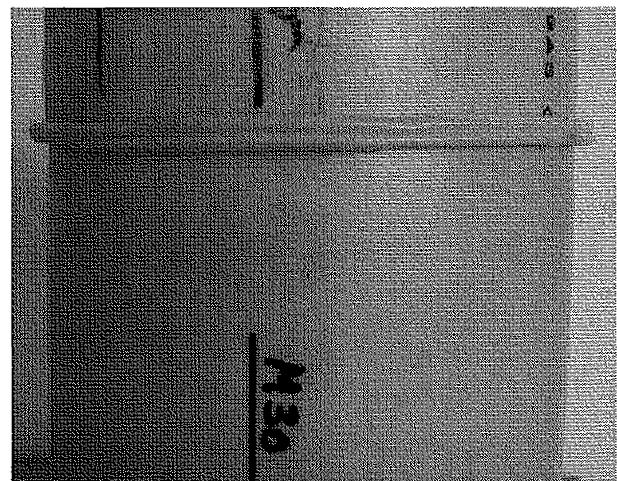

- A set of utility specific data that will be logged by the data logger and uploaded to GIS or other databases for integrity management
- A pre-commercial prototype that demonstrates the viability of the method
- Recommendations for the next steps towards commercialization activities.

Benefits

Intelligent monitoring and logging of the butt-fusion process will enhance safety, help ensure compliance with Distribution Integrity Management regulations, and minimize risk to the gas utility.

Integrated and interactive expert guidance during the butt-fusion process will be a valuable aid to field operators as well as an excellent training system for novice fusion operators. Installation crews will need less specialized training to achieve reliable and robust joint quality in the field under a wide range of ambient conditions.

An expert system would ultimately help to reduce the risk of fusion joints susceptible to long-term failure due to improper fusion.

Technical Concept & Approach

This project includes the following activities:

- **Analyze the Fusion Process and Identify the Preferred Butt-Fusion Process Window**

A literature review will be performed to identify all butt-fusion procedures used for gas piping. The optimal fusion window within commonly accepted outer bounds will be identified. The focus will be on identifying the optimal control strategy from a polymer-property perspective, with the objective of creating ideal conditions for the re-solidification of the joint interface. This knowledge will be used to support, and enhance where necessary, the long-standing fusion procedures used by gas utilities.

- **Specify the Butt-fusion Machine and Manufacture of Equipment**

The equipment will incorporate modular and off-the-shelf components. Due to the parametric nature of the programming, the software will be easily updatable to accommodate knowledge gained in the course of the project. The equipment will be capable of displacement, pressure, temperature, and energy control of the fusion process. All these parameters can be uniquely adjusted to accommodate environmental conditions and variations in polymer

properties for different pipe resins. These features will allow technicians to repeatedly produce joints of known quality under a wide range of operating conditions. The detailed data-log of each fusion will be used in correlating fusion-procedure settings to performance test results.

- **Conduct RPM Testing and Assemble Data Package**

The various fusion conditions employed will be evaluated in a statistically sound manner by full Rate Process Method (RPM) testing at 90°C, 80°C, and 70°C. The primary test method will be the full pipe creep-rupture method. This test has been shown to be capable of detecting differences in fusion joint quality. The RPM approach will allow an expected lifetime of the fusion joints to be estimated. Standard ASTM tests as described in ASTM D2513 will also be carried out (hydrostatic and tensile testing). A statistically significant number of samples will be tested outside the typical process window for comparison.

- **Prepare Technology Package and Final Report**

The essential process variables, their limits and a full set of protocols and procedures for the successful implementation of a robust butt-fusion process will be compiled into a detailed report.

This report will form the basis of a technology package that can be licensed to interested commercial partners.

Results / Status

The design and manufacture of the prototype butt-fusion machine is progressing. DoE test matrices have been developed and investigators received a number of pipe samples sent from sponsors.

Preparations for fusion testing and post-fusion joint testing began in 2012. In addition, a cataloging of pipe samples and baseline testing of material properties was initiated.

The basic motion control for the prototype butt-fusion machine is operational; however, additional engineering work is needed to ensure the machine has the necessary rigidity.

For more information:

Maureen Droessler
Program Administrator
Operations Technology Development, NFP
Phone: 847/768-0608
maureen.droessler@otd-co.org

PIPELINE INTEGRITY MANAGEMENT & AUTOMATION

Projects in this area focus on the development of tools, techniques, and risk assessments to assist companies in meeting integrity requirements in a cost-effective manner.

To meet the challenges of pipeline integrity management, researchers are developing risk-assessment models, in-line pipe-inspection systems, and other technologies to improve the safety, efficiency, and reliability of gas delivery systems.

Through R&D in this area, pipeline and distribution system integrity can be maintained and improved based on sound, scientific developments related to inspection, testing, and other activities.

OTD

Operations
Technology
Development

Inspection Platforms for Unpiggable Pipelines – Phase 4

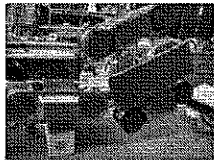

The objective of this project is to develop an inspection platform and MFL sensor for the inspection of presently unpiggable natural gas pipelines. The technology is being designed to negotiate all obstacles encountered in transmission pipelines and to help companies meet regulations mandating the inspection of pipelines in High-Consequence Areas.

Project Description

Regulations requiring the inspection of all transmission pipelines – including those that are now deemed “unpiggable” – have triggered the search for technologies that would make the inspection of unpiggable pipelines possible.

With the option of modifying unpiggable pipelines so that they are rendered piggable being prohibitively expensive in most cases, currently the only methods available for inspection are direct assessment and hydrotesting. However, these methods can not provide the comprehensive information produced by in-line inspection (ILI) tools and are also expensive.

To address the issue, in 2001 NYSEARCH initiated an effort to develop ILI technologies for unpiggable pipelines. Following a feasibility study that proved the potential of robotics and sensory technologies to meet system requirements, a collaborative development effort was undertaken in 2004 with NYSEARCH, the U.S. Department of Transportation, and OTD to develop the necessary tools. The objective was to develop two robotics platforms (called Explorer II and TIGRE) equipped with non-destructive evaluation (NDE) sensors to provide ILI of unpiggable natural gas transmission pipelines. Explorer II is for the inspection of six- to eight-inch-diameter pipelines with pressures up to 750 psig, using a Remote Field Eddy Current (RFEC)

sensor for NDE inspection of the pipeline’s walls. TIGRE – the focus of Phase 4 of this effort – is for the inspection of 20- to 26-inch-diameter pipelines with pressures up to 750 psig, using a Magnetic Flux Leakage (MFL) sensor for NDE inspection of the pipeline’s walls.

Efforts resulted in the development of the first commercial unpiggable-pipeline inspection system able to function with or without gas flow and in the presence of major obstacles such as short-radius and mitered bends, tees, back-to-back bends and, in the case of TIGRE, plug valves.

The focus of Phase 4 of this project with NYSEARCH was to:

- Design, construct, and test an MFL sensor for inspecting unpiggable pipelines that is able to negotiate all obstacles in a pipeline (including plug valves and mitered bends)
- Design, construct, and test a robotic platform (also able to negotiate all obstacles in the pipeline) that will deploy the above-mentioned MFL sensor
- Integrate the MFL sensor onto the platform and test the integrated system in the laboratory and field.

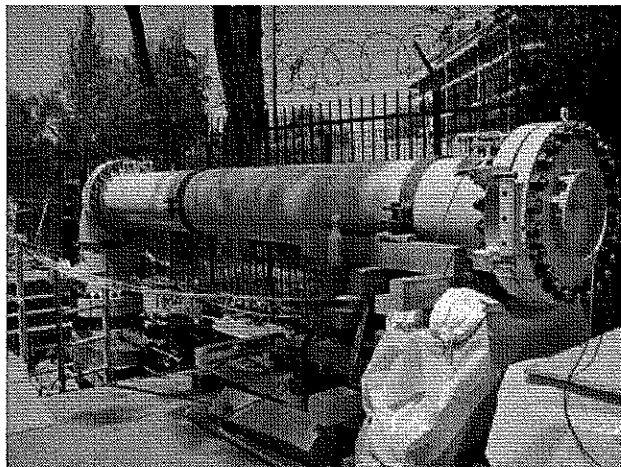

Explorer II (TIGRE) field deployment in southern California.

Deliverables

In this project, a fully tested prototype will be developed, documented, and commercialized.

Benefits

The ability for gas utilities to inspect their unpiggable pipelines is of paramount importance due to imposed regulations.

While hydrotesting and direct assessment are viable alternatives to ILI, these two methods do not provide all the information that an MFL inspection provides. In addition, these methods can be costly. As a result, ILI using robotic devices that do not need the flow to be propelled and can negotiate all obstacles encountered in a pipeline can provide an important inspection option.

Technical Concept & Approach

The focus of this project is on the further development of the TIGRE system for pipe sizes of 20 to 26 inches in diameter and pressures up to 750 psi. It features a modular design that allows for the efficient configuration of the system for the particular needs of a certain inspection (visual and/or MFL). Onboard batteries provide the necessary power to propel the robot in the pipeline, while wireless communication ensures command and control between operator and robot. The drive mechanism design is similar to that used in the Explorer II system, which is now commercially available through Pipetel Technologies, Ltd.

The MFL sensor that is being developed will allow for the inspection of a pipeline to a level of accuracy that matches that of a state-of-the-art "smart" pig. It will be able to negotiate all obstacles in a pipeline and travel through a plug valve. It will also be able to be launched under live conditions using commercial access fittings and a specially designed launching tube.

Results

The design of the robotic platform established the ability to build a platform able to propel an MFL sensor in a high-pressure pipeline while providing its own power (i.e., not depending on pipe flow for propulsion) and being able to negotiate all obstacles encountered in such pipelines. Power estimates under various scenarios have established the ability of the system to operate economically under a variety of operating conditions.

Similarly, design of the MFL sensor established the ability to launch, operate, and retrieve the collected wall-loss data (under a variety of operating conditions) under live conditions.

Following the development of a licensing agreement with the commercializer in 2009, the project continued with the redesign of the original TIGRE prototype based on extensive data collected during field trials. A new, advanced system was subsequently tested in California in a real pipeline and proved to provide superior performance compared with the original design.

The system is designed to be launched using off-the-shelf commercial fittings. Real-time data – including snapshot-video-imagery, sensory, and system-status data – are relayed through the pipe via wireless telemetry to an antenna deployed into the line through the launcher. Information is displayed on a local control console and/or relayed back to a remote location for monitoring. The system is capable of traversing large distances, without requiring either power recharging or downstream antenna taps into the transmission line. Traversing at a rate of four inches per second, it is expected that the system can perform a one-mile inspection in an eight-hour shift.

The original TIGRE system was simplified and made more operationally efficient and user-friendly without any sacrifice in performance.

A final prototype system was built and field tested at the NYSEARCH Test Bed in late 2011.

In 2012, three field deployments of the integrated system were conducted in 20- to 22-inch-diameter pipelines operating at 175 and 300 psig. The focus of all three deployments was to inspect cased pipeline segments, an application of particular interest to pipeline operators due to the lack of other technologies able to provide reliable and high-quality data. All operational procedures were conducted without any issues. The system inspected a cased pipeline segment that was particularly challenging due to the unanticipated presence of a bend very close to the launching point. Operators were able to maneuver the system without any incident; however, a number of technical issues were identified. Modifications to the system were made to address these issues.

Status

The program has been successfully completed with the commercial deployment of the robotic system in early 2013.

For more information:

Maureen Droessler

Program Administrator

Operations Technology Development, NFP

Phone: 847/768-0608

maureen.droessler@otd-co.org



Operations
Technology
Development

Yield Strength Determination Through Sub-Size Samples



The objective of this multi-phase project is to develop, validate, and obtain regulatory acceptance for a method to establish pipeline yield strength that allows for a less expensive sampling procedure that does not require the line to be taken out of service.

Project Description

In this project, research is being conducted to develop a method where six-inch hot-tap coupons can be removed from a pipeline without interrupting service, and subsequently sent for machining and laboratory testing to determine yield strength values.

The objective is to demonstrate that sub-size samples provide the same yield strength values as traditional full-size samples.

In Phase 1, researchers evaluated three techniques for establishing yield-strength values – a partial-wall, sub-size sample and two surface micro-indentation (stress-strain probe) methods. Results indicated that material variability through the pipe wall was too great for surface techniques to be used effectively.

Phase 2 focused on validating that a full-wall, longitudinal, sub-size sample can produce results that are equivalent to – or more conservative than – a standard full-size sample.

The objective of the current Phase 3 effort is to develop a methodology for statistical sampling and field verification to determine yield-strength properties for undocumented pipe.

Deliverables

The deliverables for this project include a set of research findings demonstrating that full-wall, longitudinal,

sub-size samples are equivalent to full-size samples for determining yield strength.

Benefits

Utilities and their customers will benefit from the ability to determine yield-strength values in a less expensive and more efficient method than currently allowed.

Many natural gas utilities operate pipeline segments that do not have historical documentation to validate the pipe's Specified Minimum Yield Strength (SMYS). In these situations, operators must either: 1) assume a low SMYS of 24,000 psi (per 49 CFR 192), which results in many pipe segments being categorized as a transmission line vs. a distribution line and, therefore, must be operated and maintained accordingly; or 2) establish the SMYS with laboratory testing, which is currently time consuming, expensive, and inconvenient as the requirements for specimen size necessitates a complete shutdown and removal of circumferential pipe samples for laboratory testing.

Technical Concept & Approach

In Phase 1, a variety of tests (e.g., carbon segregation tests and carbon profiling) were performed and researchers addressed a number of issues, including:

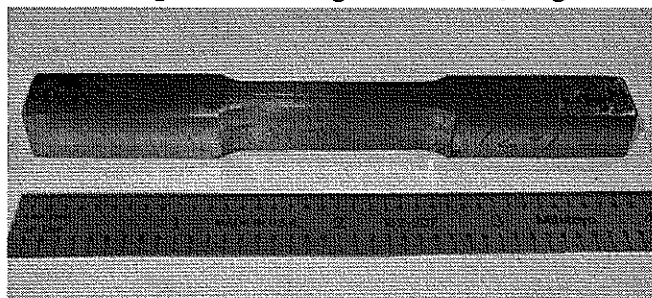

Research was conducted to determine if small pipe specimens can provide the same testing results as larger samples that are more costly to extract and test.

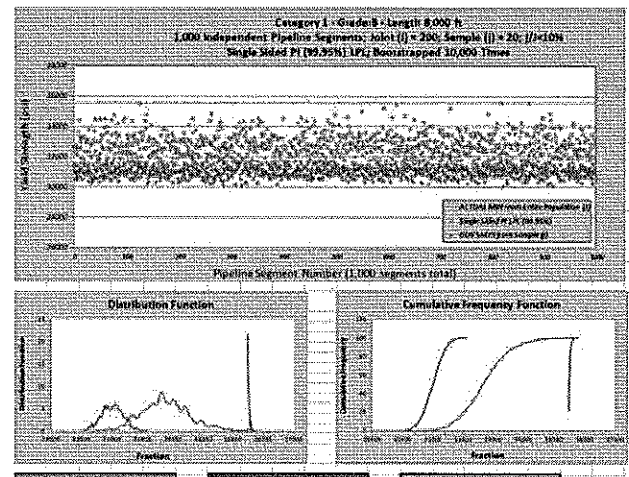

Example analysis plot.

- The possible lack of uniformity of both the steel microstructure and the chemistry of the pipes
- The possibility that a centerline specimen may be unrepresentative (through segregation) of the full-section properties
- The need for greater precision in machining and testing smaller specimens.

Phase 2 included the following tasks:

- The design of a longitudinal, full-wall specimen that can be extracted from a standard hot-tap coupon.
- Using 20 pipe segments from Phase 1, a total of 100 tensile specimens (20 pipes x 5 per pipe) were extracted, machined, prepared, and tested.
- The original micrographs from Phase 1 were reanalyzed for oriented grain size (longitudinal and transverse). Phase 1 full-size transverse and Phase 2 longitudinal tensile test data were compared.
- Research results were presented to appropriate industry organizations.

For Phase 3, a comprehensive series of synthetic pipeline segments were developed. The sets form "pipeline populations" to perform yield strength sampling and analysis.

Sampling activities are using four technical approaches:

1. The current federal code requirements will be used for samples from the synthetic segments. This will include all the variations allowed by the federal code based on segment length (number of joints that make up the pipeline segment). Computerized sampling methods will be used to randomly sample tens of thousands of times from each pipeline segment.
2. A series of random samples will be drawn from each of the pipeline segments. Nonparametric statistical analysis will be used to calculate the estimated average and likely minimum yield strengths of the segment.
3. Probabilistic analysis (Bayesian) analysis will be used to calculate the proportions (categories or buckets) of yield strengths.
4. Adaptive sampling will draw an initial *smaller* sample set, completely at random, and will analyze the results before additional sampling is conducted.

Results

Results from Phase 1 indicated that no partial-wall technique can accurately determine a pipe's yield strength without correction factors to account for material variability. The research team subsequently developed a Phase 2 plan to develop and test full-wall sub-size samples that would not require correction factors.

In 2010, researchers completed the testing of the full-wall, longitudinal, sub-size samples. Results indicate that the new testing methodology can effectively be used to determine yield strength values. The mini, full-wall specimens were found to be superior to the currently specified full-size tensile specimens. On average, the sub-size sample method produces a -8.5% lower (conservative) value for yield strength when compared to the full-size test method. A sample set from the pipeline population would result in an average yield strength between -13.2% and -3.8% for the full-size method with a 95% confidence.

In 2011, the research team presented the project results to the American Petroleum Institute 5L committee, the U.S. Department of Transportation's Pipeline and Hazardous Materials Safety Administration, and the ASTM A370 committee. The research team subsequently initiated a request with ASTM to make minor modifications to A370 to include sub-size specimens.

In 2011, Phase 3 of this project was initiated. Six pipeline segment categories were established and used to generate thousands of randomly generated segments. These synthetic segments were used to carry out sampling experiments in 2012 that use the following methods:

- Currently approved (federal Code) method for sampling and SMYS calculation
- Advanced non-parametric statistical methods with random sampling
- Advanced probabilistic techniques (Bayesian methods).

Status

This project is complete. A Final Report detailing project results is being developed.

For more information:

Maureen Droessler
Program Administrator
Operations Technology Development, NFP
Phone: 847/768-0608
maureen.droessler@otd-co.org

OTD

Operations
Technology
Development

Guided Wave Evaluation as Hydrotest Equivalent



In this project, analysis was performed to demonstrate and validate the use of Guided Wave Ultrasonic Testing (GWUT) technology as an equivalent to a hydrotest.

Project Description

Guided Wave Ultrasonic Testing (GWUT) has been shown to be a promising technology for inspecting casings and other difficult-to-access sections of pipe. However, under current regulations, GWUT use requires compliance with an "18-point checklist" of the U.S. Department of Transportation's Pipeline and Hazardous Materials Safety Administration (PHMSA).

GWUT can be a lower-cost, more accurate alternative for pipe inspection, especially in areas where hydrotesting cannot be used. However, with the expense and uncertainty involved with the regulatory approval process, few companies have pursued the use of GWUT as a stand-alone for pipe-inspection method.

While numerous R&D efforts have been conducted to evaluate GWUT, the results have never been combined to provide a validation that equates GWUT with hydrotesting.

In this project, data was gathered and a validation of GWUT performed that is expected to lead to the acceptance of GWUT as an inspection technique equal to hydrotesting.

Deliverables

The results from this project provide a validated methodology that could be used as the basis for a new standard that could be referenced by Part 192 in the 18-point checklist and the required prior approval.

Benefits

The ability to use GWUT to inspect casings and other difficult-to-access pipe sections (via a PHMSA-referenced consensus standard, without the need to navigate the waiver process) will facilitate compliance in a cost-effective manner. Additionally, the use of GWUT as a stand-alone inspection tool will provide a means of compliance where, in some situations, no alternative exists.

Technical Concept & Approach

This project was built on previous research, including:

- More than 60 GWUT assessments performed by Gas Technology Institute (GTI) – all of which were 100% validated through visual inspection and, in some cases, additionally with high-resolution magnetic flux leakage inspection.
- A theoretical correlation between GWUT inspection results and typical failure criteria output being developed by the Interstate Natural Gas Association of America
- Inspections performed by operators to evaluate the ability to correlate GWUT with direct assessment.

The specific tasks for this project were to:

- Compile data from GWUT inspections that have been validated by design, in-line inspection, or direct measurement
- Demonstrate that GWUT finds defects that would pass a hydrotest (therefore substantiating that GWUT will find larger defects)
- Provide a validated methodology for a new standard.

Collected data was used to calculate the failure pressure for rupture using several two-parameter methods

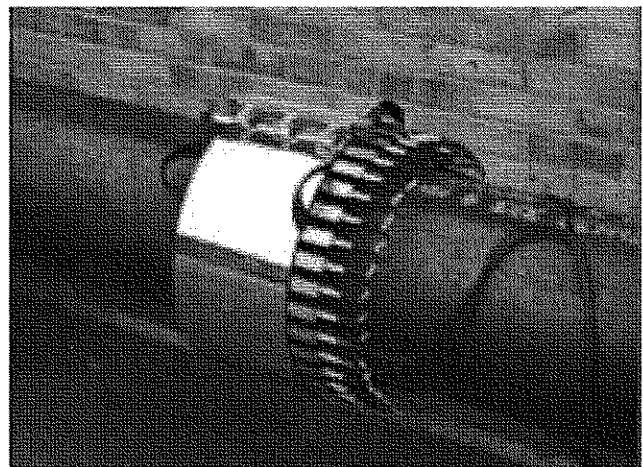

(depth/wall vs. axial length) for all validated data points. Additionally, the validation effort will determine the limits of detection and identification and provide suggestions for limits on field use and applications.

Results

Data collection involved gathering all available and acceptable data from prior GWUT inspections and the associated dig records (defect geometry, pipe diameter, wall thickness, and grade). Data was only accepted and reported in this study if the GWUT could be verified through direct inspection.

GWUT had been used to inspect pipe segments in more than 60 dig sites where all inspection results were validated. Specifically for this project, investigators solicited and collected useable field inspections/assessments from an additional 10 operators. The collected data was used to calculate the failure pressure for rupture using the most conservative federally approved methodology, (i.e., ASME B31G) for all validated data points.

The validation calculations were undertaken to confirm or substantiate the following hypothesis:

- GWUT misses no defects that would fail a hydrotest, and
- GWUT misses no defects that were found in the direct examination.

The percentage wall loss vs. anomaly length diagrams plotted to B31G confirmed that GWUT is equivalent to hydrotesting.

The GWUT methodology found all those anomalies that would have been found by the hydrostatic testing and GWUT also found anomalies that were too small to have been detected and survive in a hydrostatic test to a pressure equivalent to the pipe's Specified Minimum Yield Strength (SMYS).

Four pipe diameters were studied and plotted:

- 16-inch-diameter, API 5L X52, 0.250-inch wall
- 20-inch-diameter, API 5L X52, 0.281-inch wall
- 24-inch-diameter, API 5L X52, 0.344-inch wall
- 30-inch-diameter, API 5L X42, 0.312-inch wall.

All but two of the defects found by GWUT (and validated by excavation) would have passed a hydrotest to 100% SMYS by B31G.

All the corrosion discovered by visual inspection after removal of the casing and/or coatings was found by GWUT (i.e., there were no false negatives). In some cases the GWUT operator estimated the corrosion damage to be somewhat worse than what was actually observed. Therefore, there is a small potential for over-calling the severity of the actual defect (this is conservative).

Project results were compiled into a Final Report released in March 2010.

The results of this comprehensive validation effort (data sets, findings, and implementation protocol) provides the foundation of a methodology for a GWUT standard.

In 2010, the National Association of Corrosion Engineers' (NACE) TG-410 subcommittee developed and revised a draft standard that could facilitate the allowance of guided wave technology to be used as an accepted inspection technique similar to hydrotesting, in-line inspection, and direct assessment. The subcommittee met in September 2010 and continued to make progress.

Status

Data indicates that GWUT is an effective technology that provides reliable and valuable information for an integrity assessment.

The NACE TG-410 Committee addressed all of the negatives for the Guided Wave Technology for Piping Applications standard and it is expected to be up for a final vote in March 2013. Researchers and an operator presented the project results with a state regulator to introduce the concept of using guided wave as an alternative to hydrotesting.

Researchers initiated additional work to identify other technologies that could complement guided wave technology to meet hydrotesting requirements.

For more information:

Maureen Droessler

Program Administrator

Operations Technology Development, NFP

Phone: 847/768-0608

maureen.droessler@otd-co.org

OTD

Operations
Technology
Development

Leak-Rupture Boundary Calculator

The objective of this project was to develop a tool that allows operators to determine the leak-rupture boundary for a pipe segment based on properties such as the diameter, toughness, and yield strength. Operators can use the calculator for risk modeling and consequence analysis.

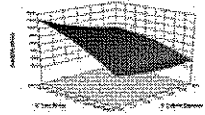

Project Description

Transmission pipes operating at pressures greater than 20% Specific Minimum Yield Strength (SMYS) in High-Consequence Areas (HCAs) are required to comply with the U.S. Department of Transportation's Pipeline and Hazardous Materials Safety Administration's Subpart O Integrity Management regulations.

For pipeline operators to ensure that their limited assessment resources are focused on the highest-risk segments, a technical basis is needed to understand which segments could possibly fail by leak versus rupture, and regulators need the technical justification that forms the basis of integrity-management regulations.

Two studies on the topic have been conducted in recent years. These studies (*Leak vs. Rupture Considerations for Steel, Low-Stress Natural Gas Transmission Pipelines* and *Criteria for Reinspection Intervals for Low-Stress Steel Pipelines*) indicate that failure by rupture may occur at a pressure that produces a hoop stress above 30% of the pipeline's SMYS. While these reports provide valuable information, the industry could benefit through further validation.

In this project, research involved an international incident review and mathematical modeling to develop a calculator to determine the leak-rupture boundary (LRB) for specific pipe segments.

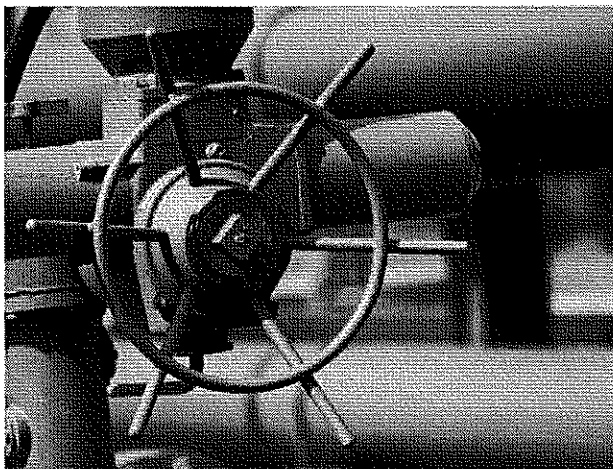

Deliverable

The deliverable for this project includes a closed-form solution that allows the calculation of the LRB as a percentage of SMYS with a confidence that 97.5% of pipelines with the selected attributes of yield strength, toughness, diameter, and wall thickness would fail by leak instead of rupture. A user-friendly calculator was created to allow operators to perform analysis for specific pipe segments.

Benefits

Research performed in this project provides operators and regulators with a new body of knowledge regarding the boundary between failure by leak and failure by rupture. Results provide an enhanced understanding of the parameters influencing failure modes to allow integrity-management programs to consider the proximity of a pipe segment's operating pressure in relation to the leak-rupture boundary. The information could also be used by regulators to update integrity management regulations to reflect the risk associated with different pipe materials.

Technical Concept & Approach

The project involved an international incident review and mathematical modeling to determine the LRB for different material types. The review included an expanded data set of 10 additional years of incidents not accounted for in the earlier research, as well as pertinent international incident data. The deliverable of this task was a report summarizing the past and recent U.S. and international incidents and a lower boundary for the transition in failure modes.

Mathematical models to determine the appropriate boundary for failure by rupture vs. failure by leak were identified, reviewed, selected, modified if necessary, and validated. The mathematical models considered both corrosion and mechanical damage defects.

Results

The incident review was initially conducted to provide an analysis of incident and testing data to identify trends in ruptures across different pipe attributes.

A total of 18,813 incidents were reviewed from more than 10 countries. A total of 1,014 full-size tests were reviewed from more than 10 sources.

The 20,095 reported failures were filtered to a conclusive failure-by-rupture set with supporting pipeline feature data. The final conclusive rupture data set included 638 confirmed ruptures with supporting data. The four-coefficient, full-factor regression model was then overlaid with the incident and full-size-test rupture data set. When these 638 confirmed ruptures were overlaid on the regression model failure surfaces, a total of 14 confirmed ruptures fell below the lower confidence limit surface. This equates to 2.19% of the population that is in line with the 2.5% confidence level of the model and validates the accuracy of the model.

Toward this goal, investigators developed a list of pipeline attributes and categories that define a failure stress range within a certain probability (e.g., 80% or 90%).

A sensitivity study was conducted on input parameters to decide which had the greatest influence on the LRB. The most sensitive parameters (in order from most sensitive to least sensitive) were: defect length, yield strength and toughness, diameter, and wall thickness. No statistically validated correlation could be made between pipeline vintage and LRB values.

Multiple models were reviewed. The most reliable and easiest to use were the Maxey/Folias and Maxey Arrest Stress models, and they defined the same LRB with the same inputs. Model predictions were compared and validated to 268 leak/rupture full-scale pressurized-

pipe experiments. The practical use of the models is problematic due to the assumptions and limitations. The most limiting characteristic of the models in their current form is that they do not take into account the probability of error for the model, standard error of the solution, or provide confidence levels for the LRB.

The uncertainty and variability of actual measurements for diameter, thickness, toughness, and yield strength were factored into the solution and the standard errors of the models were calculated. This information was used to calculate a closed-form solution. The 95% confidence interval-solution surfaces for both the lower and upper confidence limits were calculated and plotted to capture 95% of confirmed ruptures.

The results of the study found that the yield strength, toughness, wall thickness, and diameter of a pipe segment can be used to predict the LRB. The research indicated that the boundary could range from slightly below 20% SMYS for rare pipe materials to well over 30% SMYS for many others.

Status

This project is complete.

A Final Report titled *Leak-Rupture Boundary Determination Project* was issued in May 2011. The LRB Calculator is now available through OTD.

For more information:

Maureen Droessler
Program Administrator
Operations Technology Development, NFP
Phone: 847/768-0608
maureen.droessler@otd-co.org

OTD

Operations
Technology
Development

Testing and Design of Casing End Seals



Research in this project is focused on developing information on the performance of casing end seals to help reduce pipe end-seal failures, enhance safety, and lower the cost of gas-system operations and maintenance. A variety of commonly used technologies will be assessed under simulated in-field conditions.

Project Description

In gas utility operations, a variety of casing end seals are used in pipe-crossing installations. Common methods – some of which have been used for more than 50 years – include link seals, z-boots, bricks and mortar, and weld-on end caps.

While most casing seals appear to hold up well under various circumstances, some operators that experience wet-and-dry seasons (with the associated changes in soil moisture and the water-table height) have reported significant (>80%) partial or total failure of their end seals. Many casings are either totally or partially flooded when they are excavated, and ones that are not flooded can show signs of water infiltration when the casing seal is opened. In some cases, companies may not know if they have an issue. Other operators are now discovering issues with seal leakage as they assess their cased pipe sections.

To address the issue, research in this project is focused on developing quantitative testing information on seals to help determine their performance under specific circumstances.

The variables of concern for the laboratory testing in this project include:

1. Types of coating on carrier pipe

2. Temperature
3. Types of end seal.

A literature review found no known projects or reports that provide seal performance as a function of service and environmental variables.

The objective of this project is to develop recommendations and supporting testing information to:

- Allow operators to properly specify new casing end seals (as a function of service environment and system design) to mitigate or prevent the likelihood of water leakage
- Test existing end seals specifically for casing mitigation/rehabilitation work
- Potentially modify or redesign an end-seal system for either new or rehabilitation applications.

Deliverable

Research results will include the analysis of several types of end-seal products and/or methods. The Final Report will also include recommendations to assist in determining an appropriate type of end seal for use when new casing end seals must be installed.

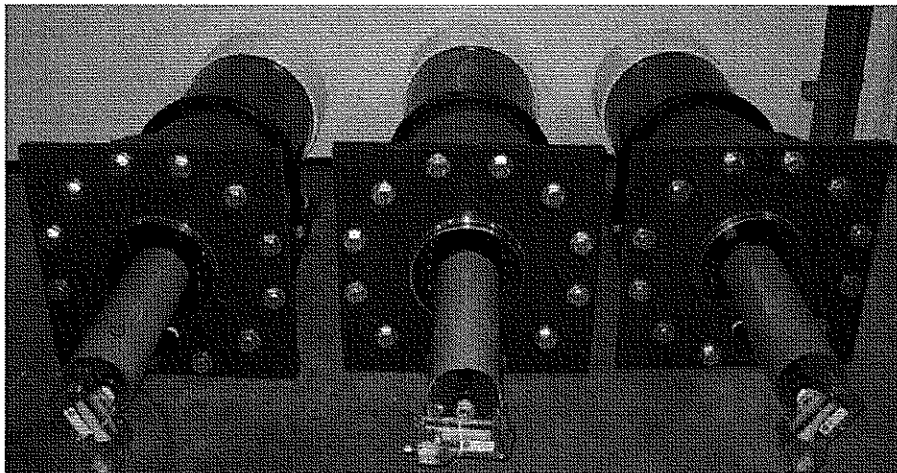

Test setups (left) and in the environmental chamber (right).

Benefits

Different factors come into play to design, build, and/or specify an effective end seal. By knowing which type of seal works best under what circumstance, operators will be better able to make appropriate decisions for both new installations and seal rehabilitation. If the project can further document the root cause(s) for seal leakage, then this information also could be used to improve sealing designs.

The ultimate goal is to develop data that leads to fewer failed cased pipes due to end-seal failures and a reduced cost for rehabilitation and maintenance.

By reducing the number of seal leaks, the number of shorting situations (electrolytic) will be also reduced, greatly lowering risk and the cost of required periodic assessments. If applied to the hundreds to thousands of end seals (two per cased pipe section) that many operators have, the overall cost to maintain cased pipe sections can be greatly reduced by keeping the annular space dry and isolated.

Technical Concept & Approach

This project is focused on the research of end seals for smaller-diameter host and casing pipe (six- to eight-inch host-pipe diameters).

The project includes the following tasks:

- **Research Review and Operator Survey** – An investigation of past manufacturer testing (if any) and an operator survey to address the types of seals currently used and the success or failure of various seals.
- **Design of Testing Procedures and Matrix** – An effort based on findings from the previous task.
- **Selection and Procurement of End-Seal Systems and Testing Components** – A selection of a variety of domestic sealing methods.
- **Simulated In-Field Testing** – The design and testing of sections of casing and pipe combinations under various conditions.
- **Post Testing Analysis and Root Cause Determination** – Post-failure analysis to determine why the end seals leaked or did not leak.

Results

Industry interviews were conducted and a survey completed with gas-system operators to further develop an assessment of industry use and needs. Based on industry and manufacturer input, four products were selected

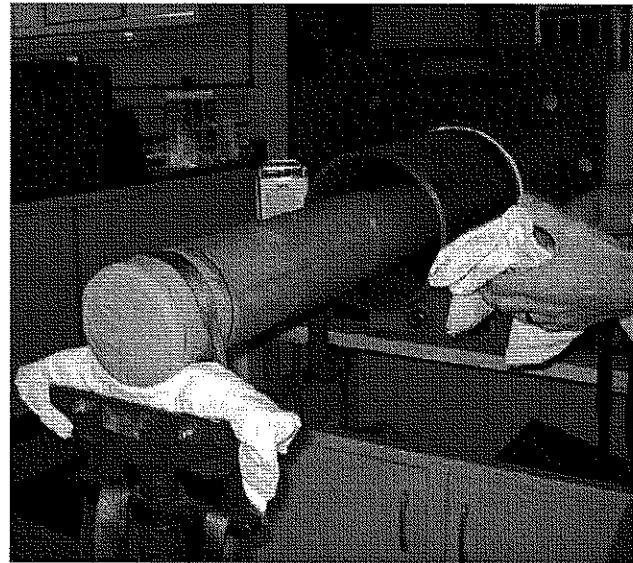

to be tested. Products were chosen to provide a fair representation of the product offerings for sealing cased pipe ends. These include:

- A compression-based seal that once installed provides a water-tight seal between the carrier and casing pipe without the need for boots or any further encapsulation
- A new product with a technique that is significantly different than conventional end seals in that the sealing mechanism is polyolefin putty
- A product that provides sealing through encapsulation of the casing pipe against the carrier pipe
- A seal wrap often used for in-field repair method.

In 2012, fabrication of the test setups and end-seal installation was completed. The test setups were filled with water and maintained at four-foot water head during the test. The test setups were first tested at room temperature for five days, and then moved into the environmental chamber for cyclic temperatures.

Status

Testing and analysis is complete. The Final Report is being developed.

For more information:

Maureen Droessler
Program Administrator
Operations Technology Development, NFP
Phone: 847/768-0608
maureen.droessler@otd-co.org

OTDOperations
Technology
Development**PIPELINE INTEGRITY MANAGEMENT & AUTOMATION**

MFL Inspection System for 12-Inch-Diameter Gas Lines



The applications for a magnetic flux leakage (MFL) system capable of inspecting gas pipes under live conditions is being expanded to be able to examine 12-inch-diameter gas lines. Currently, the system can be used in four-inch-diameter low-pressure pipelines.

Project Description

In a previous project, a magnetic flux leakage (MFL) inspection system for four-inch-diameter gas pipes was successfully developed to detect corrosion pitting and other forms of metal loss in real-time under live (pressurized) operating conditions.

The system was successfully field tested at numerous utilities.

In this project, research is under way to expand the system to be able to inspect the larger-diameter pipe operating at higher pressures.

Key aspects of the smaller-diameter MFL system include:

- Real-time inspection results.
- The ability to keep gas flowing throughout the entire inspection process with no interruption to customer gas delivery. Field tests have been conducted at gas pressures ranging from inches of water column to 65 psig.
- Entry is gained by first welding an angled entry fitting onto the pipe and then cutting out a coupon from the original pipe wall using a bi-metal saw. The coupon is retained within the cutting device and is discarded upon removal. The entry fitting is later plugged and blind-flanged to provide a permanent, redundant seal. The fitting can be re-used to conduct re-inspection at a later date.
- Flow control of the gas is accomplished through the use of a full-open valve and a stripper seal. The gate valve allows the inspection head to be admitted or removed from the gas pipeline while the stripper seal creates a gas-tight seal between the coiled tubing and its rubber elements as the head is being pushed or pulled through the pipe.
- The MFL head is moved through the gas main using coiled steel tubing. A multi-conductor electrical cable resides inside the coiled tubing to provide power and data communication with the surface control and display electronics. The coiled tubing

has proven to be very robust and has been used to push the four-inch-diameter MFL inspection head to its 1,000-foot reel-storage capacity on numerous field applications.

- The complete MFL inspection system is delivered to the field location on a small trailer towed by a pickup truck. Its small physical footprint makes it ideal for use in congested environments.

For the first phase of this project, a 12-inch-diameter MFL system will be designed, fabricated, and tested in a surface demonstration using open-ended, unpressurized pipe segments.

Deliverables

Initial deliverables include a prototype MFL inspection device operating in an open pipe and data sets from the tests.



A 12-inch-diameter open-ended test pipe with machined defects.

Benefits

Pipeline system safety will be enhanced with the development of an improved MFL inspection system applicable to a wider range of pipe sizes than can be addressed with currently available technologies. In addition, inspection costs can be reduced and activities accelerated. The ultimate result from all future phases of the project is expected to provide a tool for short-distance, high-pressure pipeline inspection.

Technical Concept & Approach

The 12-inch MFL inspection system will be composed of four main sub-assemblies: 1) the MFL inspection head, 2) the coiled-tubing delivery system, 3) an angled end fitting, and 4) surface controls and data displays.

The four-inch MFL head has an overall length of 6-1/2 inches. The 12-inch MFL head has an overall length of 21 inches. In their preliminary embodiments, the 12-inch system is expected to weigh approximately 200 pounds. Centralizing wheels will be used to keep the MFL head centered inside the pipe and the sensors will be spring-loaded against the pipe wall to prevent lift off.

The maximum distance that a given size MFL head can be pushed through a pipe is dictated by the pipeline inside diameter, MFL head weight, and the magnetic drag force. Preliminary calculations indicate a maximum distance between 580 and 1,160 feet should be achievable.

A commercial control valve will be employed to control gas flow while inserting and removing the MFL inspection head.

Once all the individual sub-tasks are completed, a series of laboratory tests will be conducted using a 12-inch-diameter pipeline having machined defects of accurately known dimensions.

In tests, comparisons will be made of the real-time inspection results against actual defects in the pipeline to confirm detection and sizing results.

Following successful laboratory tests, the research team plans on updating the system for inspection of high-pressure pipelines in future phases of the project.

Results

Researchers report that significant progress was achieved during in 2012. This includes:

- Successful completion of all the required electronic printed circuit boards
- Fabrication of all the mechanical elements required to mount the electronics to the magnetizer and bring power to and signals from the sensors
- Fabrication of the centralizer assemblies
- Construction of the open-ended steel test pipe with machined defects
- Completion of the push-pull system for conveying the inspection head through the test pipe.

The components for the test pipe section allowing the MFL head to be bi-directionally pulled through the pipe were designed, ordered, and are being assembled.

The coil tubing injector system was modified to create a capstan for accomplishing bi-directional movement of the 12-inch MFL system through the pipe. Flaws have been machined into two sections of the 110-foot test pipe.

Status

Significant discussion on the licensing of the technology is ongoing.

Activities to be completed include:

- Assembly of the complete MFL head upon magnetizer delivery
- Complete system testing and system refinement as required
- Demonstration of the system.

For more information:

Maureen Droessler

Program Administrator

Operations Technology Development, NFP

Phone: 847/768-0608

maureen.droessler@otd-co.org



Operations
 Technology
 Development

Internal Inspection Optimization Program



An Internal Inspection Optimization Program was initiated to facilitate the development of new pipeline inspection technologies, address industry needs, and develop a thorough understanding of the existing piping infrastructure.

Project Description

The past five years have brought significant opportunities as well as formidable challenges to the natural gas industry.

An increase in domestic supplies from unconventional gas and high demand forecasts will enhance the importance of natural gas in the energy industry. However, increasing concern over safety and an aging infrastructure have raised public and regulatory apprehension over the design, construction, and integrity of the infrastructure that supplies natural gas.

To address these issues, a project team consisting of inspection experts is developing a program plan to facilitate the introduction of new inspection technologies.

Phase 1 of this program focused on the development of an R&D Roadmap that will guide the direction of subsequent projects.

Deliverable

The deliverable of Phase 1 will be an R&D Roadmap that presents a plan for further technology development.

Benefits

The results of this program will provide the industry with technologies and information to:

- Reduce risk through an enhanced understanding of the piping infrastructure to facilitate fact-based decision making
- Increase safety by more accurately identifying high-risk pipe segments
- Optimize infrastructure usage by gathering information that can assist operators in determining the integrity of existing assets

Program Overview

Threats	Parameters of Interest	Sensor Technology	Platforms	Overarching Influencers / Other Considerations
<ul style="list-style-type: none"> • External Corrosion • Internal Corrosion • Stress Corrosion Cracking (surface and subsurface) • 3rd Party Damage • Fabrication / Weld Quality • Wrinkle Bends / Miter Bend • Residual Stresses • Soil and Other Superimposed Stresses 	<ul style="list-style-type: none"> • Wall Thickness and Loss • Cracking • Residual Stress Levels • Hardness and Ultimate Strength • Yield Strength • Toughness • Physical Dimensions (ID) • Internal Defects (Porosity, Laminations, etc.) • Physical Contact to Other Structures 	<ul style="list-style-type: none"> • Ultrasonic/microwave • Eddy Current/RFEC • Guided Wave UT • X-Rays • Magnetic Flux Leakage • Magnetic Field Strength • Electromagnetic • Optical/IR/UV • Video/Stills • Caliper • Hardness • Modulus • Stress-Strain Probe 	<ul style="list-style-type: none"> • Tethered (e.g., mechanical cable or coiled tube pulled) • Push Rod (e.g., coiled tube pushed) • Robotic Tethered (e.g., self-driven brush drive but with trailing power cord) • Robotic Autonomous (no tether for power, etc.) • Flowable Sensors (e.g., Fluidized Sensors, Smart Balls, etc.) 	<ul style="list-style-type: none"> • Existing and Impending Regulations (i.e., Post San Bruno) • Market Size (diameters, distances, obstructions) • Cost (development and per inspection unit) • Time to market • Sponsors • Repeatability of Inspections • Commercializers

FACETS OF THE PROGRAM

- PHASE - 1 {
 1. Perform overlap analysis of sensors and platform capabilities.
 2. Determine current state of sensor and platform development.
 3. Perform gap analysis: Threats and Parameters of Interest ⇔ Sensor and Platforms in existence.
- PHASE - 2 {
 4. Identify off-the-shelf manufacturers and commercializers (short and long-term view).
 5. Fund technical development in critical gap areas.
 6. Work with regulators and SDOs on acceptable internal inspection technologies.

- Ensured compliance with existing and new integrity management regulations.

Technical Concept & Approach

For the technology development stages of the program, a research team is engaging a wide range of participants, including national laboratories, universities, research organizations, vendors, and manufacturers. Specific tasks for Phase 1 include:

- Threat Analysis
- Parameter Identification
- Current Technology Review
- Gap Analysis
- R&D Roadmap

Results

A literature search, survey, and interviews were conducted to determine what state of the art for inline inspection tools for piggable pipelines followed. These efforts focused on literature that provided quantitative results for Probability of Detection (POD), Probability of Identification (POI), and sizing capability for inline inspection tools. Summary tables were created by tool/sensor type for POI by feature as well as POD and sizing accuracy by anomaly type. In addition to corrosion and crack anomalies, the work included summaries of inspection tool performance for dents and ovalities, as well as anomalies in bends. The literature search included domestic and international pipeline conferences conducted over the last three years. The resulting data was summarized quantitatively in a series of POD, POI, and sizing capability charts by anomaly type and location.

The project then summarized all threats to natural gas pipelines using the categories in ASME B31.8S Managing System Integrity of Gas Pipelines. The threats included external, internal, and SCC corrosion; defective seams; defective pipe; defective girth and seam welds; wrinkle bends and buckles; broken couplings, third-party damage; lightning, rains, and floods; and earthquakes and land subsidence.

For each pipeline threat, a list of base elements that could be measured by a sensor from the inside of a pipe was developed. The base elements are the physical, mechanical, or chemical attributes of the pipeline system that contribute to its integrity or likewise to its risk of failure and include dents, wall loss, depth of cover, seam type, microstructure and metallurgy, gas quality and cracks. When combined across all threats, a comprehensive list of 119 base elements was created. Fault Tree Analysis (FTA) was used to cross link the 119 dif-

ferent base elements with weighted priorities to the pipeline threats they contribute to or reveal. A list of 36 sensor technology classes were identified that could be placed inside of a pipe to measure one or more of the base elements. Each sensor class was assigned a relative sensitivity and technology maturity level (high, medium, or low),

The list of threats, base elements, and sensors were integrated in a set of matrices. A semi-quantitative gap analysis was performed to prioritize where the largest gaps in sensor performance were in relation to providing meaningful information to assess for threats. Based on the importance of a base element and the maturity of the sensor and its sensitivity, a gap analysis was performed and a roadmap produced a listing what gaps should be addressed to provide better assessments for pipeline threats. The highest priority gaps were identified as:

A review of current issues and solutions related to unpiggable pipelines was also conducted. The highest priority gaps for unpiggable pipe were identified as:

1. Platforms for low flow conditions
2. Platforms and sensors for smaller diameter pipelines
3. Additional options in tractor or robotic platforms
4. Portfolio of field demonstrations and case studies
5. Platforms for inspecting branch lines
6. Navigation through plug valves and other reduced diameter fittings

Status

A Final Report on Phase 1 of the project was issued in November 2012. Recommendations were made on how to combine the results of this report with other data and results from recently complete or ongoing research projects from INGAA, PRCI, and OTD into a user-friendly Internal Inspection Strategy Tool. Such a tool would allow one to select the most appropriate inspection technology for a specific pipe segment(s) based on vintage, material characteristics, weld type, construction technique and geometry.

For more information:

Maureen Droessler
Program Administrator
Operations Technology Development, NFP
Phone: 847/768-0608
maureen.droessler@otd-co.org

OTD

Operations
Technology
Development

Evaluating Assessment-Technique Effectiveness

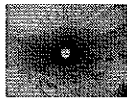

Researchers are developing a body of knowledge and a methodology to enable operators to determine the effectiveness of various pipeline-assessment techniques and select the most appropriate methods for particular conditions.

Project Description

Current regulations allow operators to use three specific methods to inspect/establish pipeline integrity of transmission piping segments in high-consequence areas: 1) in-line inspection (ILI), 2) hydro-pressure tests, and 3) direct assessment (DA).

To select the most optimal method to use, operators need to have knowledge on how effective each option is at ensuring the safety and integrity of the system and reducing risk. Each of the three main methods provides different data and information on pipeline-system integrity. As noted in the applicable standards:

- ILI provides 100% axial coverage of wall thickness (at a particular resolution) but does not directly provide coating damage sites and/or sites of "active" internal or external corrosion.
- Pressure testing provides a 100% system validation of pressure integrity but does not directly provide wall thickness, coating quality, or active corrosion locations.
- DA provides a coarse coverage of all or some of the system as to areas of coating damage and active corrosion hot spots, but does not provide wall thickness or pressure-carrying ability (integrity).

There are multiple sources of data in existence that could be collected, organized, analyzed, compared, and compiled, including:

- Operator DA, ILI, and pressure-test results from the pre-2002 and, more importantly, post-2002 assessments and inspections
- Reported incident data with corresponding pre-incident inspection data
- Validation digs and data from the 2002-2012 baseline implementation period for pipeline integrity management
- Operator assessments that used multiple methods of assessment on the same pipeline segment
- Tracking and trending data on inspection method on the same pipeline segment, (e.g., repeat assessments)

- Audit and inspection results from regulatory bodies
- Past research work.

In this project, a research team is developing a body of knowledge and a methodology to enable operators to determine the effectiveness of various assessment techniques and facilitate the selection of the most appropriate technique under different operating conditions.

Deliverables

The deliverables for this project will include:

- Definitions and methodologies to analyze assessment-technique effectiveness
- An assessment-effectiveness database
- A report providing an analysis of assessment-technique effectiveness.

Benefits

Selecting the most appropriate and effective assessment-technique, tool, or combination of tools for an integrity management program will reduce an operator's

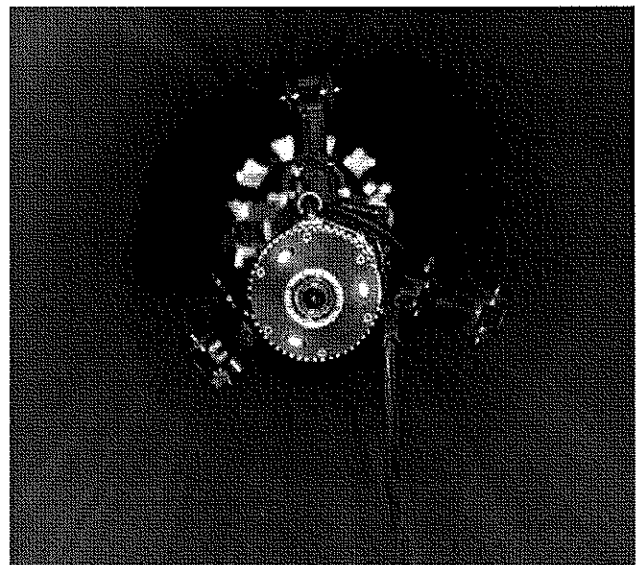

tor's risk to incidents. This also helps to ensure the safe operation of the delivery system and improve the ability of the operator to meet regulatory compliance.

Information on the appropriateness and effectiveness of various assessment techniques in different operating conditions will also allow operators to make better informed life-cycle decisions for managing their facilities.

Technical Concept & Approach

The results of this project will provide an analysis based on the best information available today, and will also provide a technique for continued industry data collection to enhance the level of understanding.

Specific tasks include:

- **Project Scoping**
 - Developing a definition of a methodology for measuring effectiveness
 - Defining data needed to be collected
 - Identifying and listing potential sources of data
 - Selecting assessment and inspection technologies to be included in the analysis
 - Developing a database design.
- **Collection, Assembly, and Organization of Data**

Data will be collected through interviews, surveys, records, integrity management program documents, research reports, and other methods and sources.
- **Prepare Searchable Database**

Commercial database products will be examined for their capability in meeting the needs of the design. The database will be built specifically for use in this project, and will also be designed for further use by individual companies to continue data collection after the project.
- **Analysis of Assessment-Technique Effectiveness**

A detailed process for using the database and performing the analysis/comparison will be created. Similar to the database design, the comparison process will be developed for use in this project but with the understanding that it could be adopted by operators after the completion of the project.

Fault Tree Analysis (FTA) is being employed as the primary method to analyze and compare the collected data. Tracking of pipeline failures would be the ideal way to measure effectiveness; however, pipeline failures are relatively rare. FTA allows one to track and analyze the causes that act alone or in combination to cause a pipeline failure. FTA starts with the top undesired event and then graphically develops all potential causes of that event. Probabilities can be assigned to each individual cause. This ability to identify combinations that can induce the top undesired event is a major FTA advantage.

FTA was developed by Bell Laboratories, Boeing, and the U.S. Air Force to identify single-point causes and combinations of causes that could result in an unintended nuclear missile launch or unacceptable event or risk.

Research results will be disseminated through a Final Report and webinar. Potential follow-on work could include the development of a long-term industry data collection effort and incorporation of the developed methodology into a standard.

Results / Status

In 2012, a variety of data was collected, including a set of pipeline incidents obtained from the U.S. Department of Transportation Pipeline and Hazardous Materials Safety Administration records of transmission pipe incident data.

The analysis of assessment-technique effectiveness was initiated with various approaches to investigate and construct the fault-trees used in the analysis.

For more information:

Maureen Droessler
Program Administrator
Operations Technology Development, NFP
Phone: 847/768-0608
maureen.droessler@otd-co.org

OTDOperations
Technology
Development**PIPELINE INTEGRITY MANAGEMENT & AUTOMATION**

Understanding Threat Interactions for Risk Analysis

Research in this project is focused on developing an understanding of the interactions of various threats to pipeline integrity. Research results and a new methodology will be used to support integrity management programs and risk analyses to enhance pipeline safety.



Project Description

The objective of this project is to increase the level of understanding of the interactions of various threats to pipeline integrity that impact the likelihood of failure to a pipeline segment.

The knowledge developed through this research will be used to support operators' integrity management programs and risk analyses to help ensure that threats are adequately identified, tracked, and mitigated.

The focus is on developing a methodology for calculating the risk associated with a super-imposed set of threats and a process for addressing unknown threats.

Currently, regulations and supporting standards provide guidance on *individual* threats and how they should be assessed. Although standards specifically mention that threat interactions should be addressed, there is limited industry knowledge on the *interactions* of various threats and how they influence the overall risk of a segment of pipe. Current models may only simplistically look at single combinations of threats and then assign a "should consider" vs. "should not consider" label to each. This type of analysis does not

provide a relative ranking of the most severe interactions per pipeline segment or sub-segment.

Specific questions to be addressed include:

- Can single threats, when considered individually, each present risks at "acceptable" levels, but multiple, super-imposed threats result in a significant risk to the pipeline?
- Which combinations of threats are most important to understand and control?
- How should threat interactions be calculated and mitigated?
- What process should an operator use to identify unknown or hidden threats and how should they be incorporated into the pipeline integrity assessment?
- Can a process or methodology be employed to continuously monitor threat interactions and identify concerns at defined thresholds of risk?

Deliverables

Deliverables will include:

- A methodology for calculating the risk of a super-imposed set of threats
- A generic threat-interaction protocol that can be used as the basis and starting point for individual company customization
- Reports detailing research results.

Pipe Characteristics	Pipe #1	Pipe #2
Pipe Diameter (inch)	24	24
Wall Thickness (inch)	0.25	0.25
SMYS (psi)	52000	60000
Pipe Spec	API 5L	API 5L (X60)
Pipe Seam Type	DSAW	ERW (Longitudinal)
Pipe Manufacture Yr	1952	1992
Pipe Coating Type	Coal Tar	FBE
Installation Yr	1952	1992
Pipe Material	Carbon Steel	Carbon Steel
Release Type	Longitudinal Rupture (Length 640, Width 75.4)	Leak from a crack on a dent caused by rock where pipe was sitting
Underground	Yes	Yes
CP Start Yr	CP since 1963	Yes
Shielding	No	Unknown?
CP Survey	Yes	Unknown?

Sample pipes for FTA/ETA analysis.

Benefits

Developing a more thorough understanding of the interactions between a variety of threats will allow operators to develop integrity management programs that adequately identify combinations of threats and the associated risks that should be addressed and mitigated. The results of this research will also be used to reduce an operator's risk and will enhance compliance regulations.

This work will ultimately lead to an enhanced level of safety in the operation of the natural gas transmission infrastructure. For operators, the developed method to identify, rank, mitigate, and continually track threat interactions will demonstrate continual improvement to the pipeline integrity process.

Technical Concept & Approach

This project includes the following tasks:

- **Project Scoping**

Researchers will prepare a list of data, data sources, and contributors. Such data will include assessment information and data pertinent to assessing the relative likelihood of pipeline failures due to combinations of threats.

- **Literature Review, Data Collection, and Data Assembly**

Relevant literature will be reviewed and compiled. This will include relevant codes for developing integrity management plans and research reports on pipeline threats and their potential interactions. Data from the sponsoring companies will be collected and assembled for use later in the project. Investigators have collected "threat interaction" modules from some operators' integrity plans.

- **Determining a Risk Calculation Method for Threat Interactions**

Researchers will examine potential threat combinations/interactions and determine a method for computing the risk associated with a super-imposed set of threats. The catalog of threats found in *ASME B31.8S-2010 Managing System Integrity of Gas Pipelines* will provide input to this work. Investigators will utilize Fault Tree Analysis (FTA) for logically dissecting the threats. FTA allows one to track and analyze the causes that act alone or in combination to cause a pipeline failure as the measure of effectiveness.

- **Final Report**

A Final Report and a webinar will be provided.

"We've made enormous strides to identify, address, and mitigate threats to our pipeline systems within our integrity management programs. This project focuses on enhancing our ability to analyze the interaction of these threats. This study has the potential to take our risk management process to the next level and lead us further along the path to realizing our goal of zero pipeline incidents."

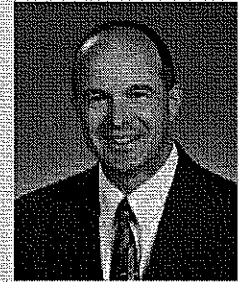

*- Pete M. Kirsch
Sr. VP Midstream Technical & Compliance Services
CenterPoint Energy*

Results

This project was initiated in 2011 with a literature review and data collection for developing the threat-attribute index and risk-calculation methodology. The project team reviewed broad risk-management literature to compile threat-interaction solutions from other disciplines (e.g., water infrastructure).

A methodology using FTA and Event Tree Analysis (ETA) was developed to conduct threat-interaction analysis. A demonstration was made to project sponsors using simplified examples to show the process.

A statistically sound threat-interaction protocol was also developed to address distinct interaction mechanisms.

Status

The literature review and data collection continues to provide input into the project.

Activities are under way to:

- Develop the threat-attribute index and identify unknown threats
- Define the methodology for quantifying threat-interaction severity.
- Develop the generic threat-interaction protocol.
- Compile a standard library of individual threats, with all relevant parameters, etc.

For more information:

Maureen Droessler
Program Administrator
Operations Technology Development, NFP
Phone: 847/768-0608
maureen.droessler@otd-co.org

OTD

Operations
Technology
Development

Probability-of-Failure Model for High-Risk Pipe Segments (Vintage Pipe)

Researchers are developing a methodology and risk protocol to provide likelihood-of-failure distributions for specific high-risk pipe materials and threats. The methodology uses sampling, operating conditions, and advanced risk-modeling techniques to quantify risk and allow mitigation techniques to be effectively applied.



Project Description

Various legacy materials, including some vintage polyethylene (PE) and cast-iron pipe, are known to have higher-than average risk profiles. Currently, most available risk models are simplistic in their analysis of these materials and do not have the ability to modify risk profiles as new information becomes available.

The objective of this project is to develop a methodology and risk protocol that provides likelihood-of-failure distributions for specific high-risk pipe materials and threats.

The methodology uses sampling, operating conditions, and advanced risk-modeling techniques to provide a targeted approach for quantifying the risk of specific pipe segments to allow mitigation techniques to be effectively applied. A generic methodology will be developed and then applied to vintage PE and cast-iron pipe to demonstrate the use of the methodology.

Specific attention is being placed on the analysis of vintage Aldyl-A plastic pipe and cast-iron pipe.

Deliverables

Deliverables include:

- A general probability-of-failure methodology
- Demonstration of the methodology applied to Aldyl-A and cast-iron materials.

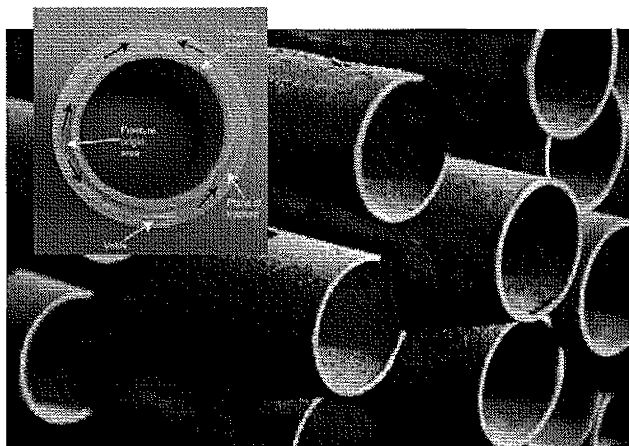

Benefits

The results of this project will provide operators with a tool that can quantify the risk of failure using a systematic and probabilistic method that is able to isolate problematic segments. These methods can support a highly targeted approach to identify and mitigate risk.

This methodology will not only improve system integrity but will also provide operators with tools to improve pipe-replacement-prioritization and resource-allocation decisions.

Technical Concept & Approach

Specific project tasks include:

- **Project Scoping and Literature Review**

A literature review of known microstructure-related problems and interactions for select materials of interest will be performed.

- **Risk Methodology Development**

The objective of this task is to develop the general risk-profiling methodology that can be applied to various threats. The scope of this project is limited to material-related failures with a specific focus on Aldyl-A and cast iron; however, the methodology developed in this task can be extended to other threats, including non-material failure mechanisms.

Fault Tree Analysis will be one of the tools used to provide a formal framework, whereby an undesired state of the system is specified and the system is then analyzed in the context of its environment and operational parameters to identify the root cause of the undesired event occurrence.

- **Sample Collection and Analysis**

Recently developed microstructure analyses techniques show promise in allowing researchers to establish the likelihood of failure by Slow Crack Growth (SCG) for Aldyl-A and failure by graphitic corrosion for cast-iron pipe segments through ex-

amination of a small coupon that can be removed from the pipe via a tapping tee without the need for removing an entire section of pipe. Correlation of the sampled microstructures, environmental conditions, and installation conditions to actual failure records (and testing on historic pipe with known microstructures) will provide a significant knowledge base and method for assessing pipe segments in a cost-effective manner.

Researchers are working with participating companies to collect pipe samples and supporting information. A microstructure analysis of the pipe samples using Scanning Electron Microscopy (SEM) and Cross-Polarized Light Microscopy (CPLM) will be performed.

- **Application to Aldyl-A and Cast Iron Materials**

The output of the models will be a likelihood-of-failure calculation for specific pipe segments. The probability-of-failure calculations will be validated against actual failure histories.

- **Final Report**

Research results will be presented in a Final Report and through a sponsor webinar. The Final Report will provide an assessment of the overall effectiveness of the modeling techniques for calculating probability-of-failure distributions for specific pipe segments. The report will recommend further applications for the modeling techniques, deployment, and implementation.

Results / Status

Modeling the probability of failure for plastic pipe segments is based on two major sets of principles:

1. Quantify the likelihood of failure given surface conditions such as oxidation that are known to drive SCG initiation. Microstructure of the plastic pipe has a large impact on the initiation and propagation of surface defects into the body of the pipe.
2. Ductile or brittle failure of a pipe is driven by the stress field in the pipe. The stresses are the bulk stress due to the working pressure of the pipe and the installation conditions, together with localized stress intensifications due to pipe and fitting geometry, or point loads.

To support the first point above, researchers have initiated the cataloging of vintage pipe specimens. CPLM and SEM to catalog microstructures and internal surface conditions is under way and progressing well. A database has been designed and is close to final implemen-

tation. The database will allow easy correlation of microstructures to physical test results and will form the basis of a knowledge base collating the project research results for future reference.

To support the second point above, a well-constructed test protocol was developed based on Dynamic Mechanical Analysis (DTMA) and cyclic loading and unloading of test specimens at various strain rates and temperatures. This testing will allow the proper constitutive models of the materials to be extracted and will also provide accurate bi-directional shift factors for the individual pipe materials. These shift factors will be the basis for residual life estimates for pipes installed under known conditions.

Researchers are developing the Finite Element Analysis (FEA) damage-propagation models. This element of the project is essential to developing likelihood-of-failure of pipe segments under known conditions. Test methods for generating detailed constitutive models of polymeric materials that can be incorporated into FEA models were refined, specified and detailed cost information was obtained.

A literature review was completed for the cast-iron portion of the project and an experimental test plan was developed for cast-iron coupons. A questionnaire for operators was sent to project sponsors to gather baseline information essential for the proper design of the graphitic corrosion test cells.

CPLM and SEM microscopic analyses of Aldyl-A specimens has begun.

Very useful dynamic thermo-mechanical analysis insights were gained from a separate failure analysis project and the lessons learned have been incorporated into the methods that will be utilized in developing the Aldyl-A risk models. These methods will enrich the material data sets and allow more rapid development of useful risk models.

An efficient work plan was developed for correlating cast iron microstructures to soil chemistry via a Design of Experiment (DOE) based on soil chemistries that will be prepared in the laboratory and used to develop baseline correlations of microstructure, soil and flow conditions to corrosion.

For more information:

Maureen Droessler
Program Administrator
Operations Technology Development, NFP
Phone: 847/768-0608
maureen.droessler@otd-co.org

OTD

Operations
Technology
Development

Continuous Threat Identification Program



The Continuous Threat Identification Program (C-TIP) is being developed to collect, analyze, and disseminate information on new and previously unidentified pipeline threats. This program will provide information to operators for their use in enhancing the safety and operation of their systems.

Project Description

As gas-system operators initiate Distribution Integrity Management Programs (DIMPs), information on new and previously unidentified threats is expected to become available. The objective of this project is to develop and implement a program to collect, analyze, and disseminate this information.

The program – called the Continuous Threat Identification Program (C-TIP) – focuses on threats specific to distribution systems and will provide information on existing and emerging system threats to operators for their use in identifying and assessing risks to their system.

The C-TIP, led by an independent third-party organization, will also facilitate the collection and further investigation of information that would lead to meaningful and transparent analysis.

Analysis by an independent organization will provide regulators and the public with assurance that the results are nonbiased and based on a rigorous scientific processes.

Deliverables

Information developed through this project will be disseminated through semi-annual webinars and annual reports.

Benefits

The C-TIP will help reduce operator risk for both distribution and transmission systems by improving system integrity and safety.

Risk will be reduced by providing comprehensive industry information to assist in identifying threats and quantifying the associated risk.

The C-TIP will also help to:

- Demonstrate to regulators and the public that the industry is pro-actively identifying new and emerging threats

- Standardize the data sets that operators use when developing and executing integrity management plans to further increase confidence in the results
- Improve the efficiency of data collection, threat identification, and risk analysis by providing a collaborative mechanism for sharing information.

Technical Concept & Approach

Researchers will define the potential sources of data and create a data-collection template and form. A database will be designed and developed to store the collected data.

The C-TIP will systematically collect new and emerging threat information from operators and regulators. The collected data will be compiled, analyzed, and disseminated through semi-annual webinars and an annual report.

Results / Status

The CTIP was initiated in second quarter of 2012.

Data is being collected from OTD operators to identify threats and determine how each company identifies

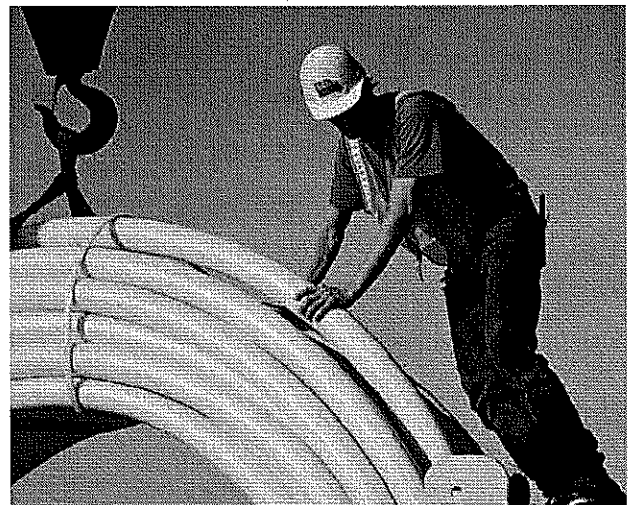

threats. Additionally, state regulators are being contacted to obtain data on their findings related to new and emerging threats.

Interviews were completed with 19 natural gas utility DIMP managers or a representative familiar with the company's DIMP. A summary of the responses was compiled. Threats and sub-threats from the DIM plans of 17 of those companies interviewed have been compiled into tables.

Threats being investigated are in the following categories:

- Corrosion
- Natural Forces (e.g., flooding and earth movement)
- Excavation Damage
- Other Outside Force Damage (e.g., vehicular damage or vandalism)

- Material, Weld, or Joint Failure
- Equipment Failure
- Incorrect Operation.

Data is being analyzed and a webinar is being scheduled to discuss the results.

State and federal regulators are scheduled to be interviewed as well.

For more information:

Maureen Droessler
Program Administrator
Operations Technology Development, NFP
Phone: 847/768-0608
maureen.droessler@otd-co.org

OTD

Operations
Technology
Development

Pipecrawler Market Assessment & Demonstration

Researchers are investigating a pipeline-inspection system used in subsea and off-shore applications for its potential development for use in onshore gas-pipeline segments that currently can not be inspected with conventional equipment.



Project Description

The natural gas pipeline infrastructure contains a considerable amount of "unpiggable" pipe segments that can not be inspected with conventional devices. Through this project, researchers are investigating technology with the potential to inspect long segments of unpiggable pipe and thus reduce an operator's exposure to integrity threats and unknown pipe defects.

Specifically, investigators are focusing on Pipecrawler systems available through the Genesis Group, an engineering and technical services company for the upstream oil and gas sector. Currently, the technology is being deployed in subsea and offshore applications for inspecting unpiggable pipe segments.

Pipecrawler is a tethered inspection platform that uses brush-drive units that are powered by electric linear-drive motors for propulsion. The Pipecrawler is a modular inspection platform that can be integrated with multiple sensors. The current version is available with magnetic flux leakage (MFL) sensors, but the company is in the process of integrating a variety of other sensors as well. The Pipecrawler has been shown to be able inspect up to 3,000 feet of pipe in pressures up to

700 psi. Current models can inspect pipe 10-to-12 inches in diameter; however products for other pipe sizes are in development.

The brush drive and suspension system gives Pipecrawlers the ability to access a pipeline from a single location. Motion, control, and data transmission is managed from a topside console via an umbilical tether which enables the tool to be run at any speed from zero to maximum. The ability of the crawler to stop and secure itself in position anywhere in a pipeline (including risers) is particularly useful for many inspection tasks.

By incorporating the speed control and the product flow bypass capability of the tool, controlled quantities of pipewall deposits can be removed while the pipeline is still operating. Once clean, the system can return to the launch position

Genesis is interested in bringing this technology to the natural gas distribution and transmission industry and has partnered with Gas Technology Institute in this project to perform a market assessment and coordinate a field demonstration.

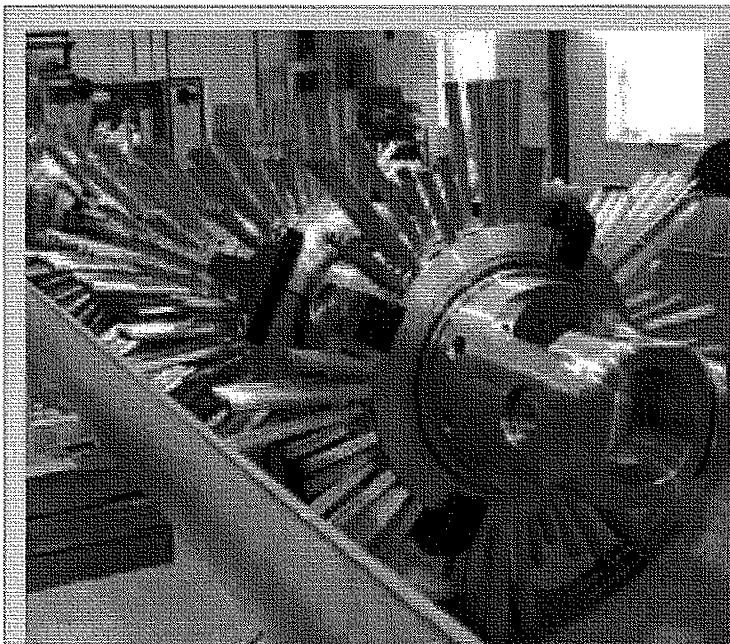

Pipecrawler

Features:

- Patented "brush Drive" technology
- Single entry and recovery point
- Fully bi-directional travel
- Can operate "with" or "against" the flow
- Can operate in no flow
- Can stop at any point in the pipeline system
- Multiple 3D bend passing
- Powered deployment and powered recovery
- Onboard internal and external temperature sensors
- Onboard internal and external pressure sensors
- Variable speeds from 0 to 900 meters/hour
- Emergency recovery via tether

Deliverables

The objective of this project is to provide the technical requirements needed to guide technology development for Pipecrawler technology and to demonstrate the size of the U.S. market. The market analysis will be used by Genesis to justify further investment in the technology that may be required to serve gas-industry markets.

Research results will be presented in a Final Report to sponsors.

Benefits

Pipeline system safety can be enhanced through the introduction of a system capable of inspecting unpiggable pipelines.

Pipecrawler systems have the ability to navigate through pipe bends, debris, rotated fittings, reduced-port ball valves and gate valves, plug valves, tees, and intersection points.

Technical Concept & Approach

For this project, a market assessment will be conducted to gather information on the technical requirements, regulatory drivers, and market size of the onshore natural gas distribution and transmission industry in the U.S. Genesis has requested that the assessment be performed to understand the desired business models, delivery channels, pricing mechanisms, and service models.

The assessment will include surveys, interviews, literature reviews, and analysis of other, similar industries.

Genesis will perform a demonstration of the Pipecrawler technology using the 10-to-12-inch platform with an MFL sensor. The demonstration will be performed on a live gas system if a suitable line can be provided by an operator.

The Pipecrawler will be assessed for its ability to:

- Navigate through bends
- Navigate through rotated fittings
- Navigate reduced-port ball valves and gate valves
- Navigate plug valves
- Navigate unbarred tees
- Accommodate a 50% diameter reduction
- Navigate through tees and intersection points

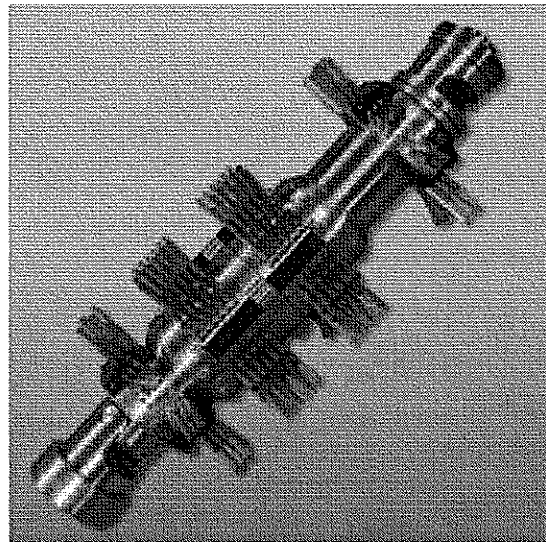

- Navigate drop sections with two bottom-out/side-out fittings
- Navigate through debris such as black powder, scale, rust, grease, metal shavings, salt, and paraffin.

Results

In 2012, researchers conducted an industry survey and investigated the feasibility of using the Pipecrawler inspection platform for pipe configurations typically found in OTD member company systems. The results from the engineering assessment will be used to complete the market analysis.

Based on the initial engineering assessment, some of the features and geometries that make lines unpiggable can be addressed with the Pipecrawler inspection platform, while others, such as a 50% diameter reduction, cannot be accommodated. Other features and geometries will require testing or modifications of the current version of the inspection platform.

Status

The market assessment is complete.

Efforts are under way for a 2013 demonstration.

For more information:

Maureen Droessler
Program Administrator
Operations Technology Development, NFP
Phone: 847/768-0608
maureen.droessler@otd-co.org

OPERATIONS INFRASTRUCTURE SUPPORT

Addressing issues often beyond the traditional areas, this research involves the development of tools and techniques for metering, gas shut-off, vault maintenance, remote monitoring, cathodic protection, data collection, and other applications.

Developed technologies are subjected to a regimen of laboratory and field evaluations to ensure their safety and efficiency.

New efforts include the development of large-diameter stoppers and a flash-fire suppression system.

OTDOperations
Technology
Development**OPERATIONS INFRASTRUCTURE SUPPORT****Tool for the External
Classification of Pipe Contents – Phase 2**

Research is being conducted to develop a practical tool that can enhance operations safety by being able to distinguish the contents of a buried utility pipe without breaching the pipe wall. The ultimate objective is to develop an affordable tool that could be carried in each crew truck.

Project Description

Natural gas pipelines, water lines, electric cable, and other underground facilities can be buried near each other, often making it difficult to distinguish one utility from another. Compounding the difficulty is the fact that gas pipelines can be at a variety of pressures, and electric lines can be pressurized with mineral oil or nitrogen. Misidentifying an electric line for a gas line or tying a low-pressure gas main to a high-pressure gas main can cause potential hazards for utility workers and the general public.

In this project, research is focused on the development a practical tool that can distinguish the contents of a utility pipe without breaching the pipe wall.

In Phase 1 (now completed), the research team identified potential technologies, performed a system design, and developed a work plan. In Phase 2 (now under way), the objectives are to develop a fully tested alpha prototype device.

Deliverable

The ultimate project goal is to design a practical tool that can measure the depth of water in steel, plastic, and cast-iron mains and distinguish between natural gas and electric lines.

Benefits

The successful development of a tool for externally classifying pipe contents would provide significant benefits for utilities and their customers by preventing accidents that occur when steel pipe containing high-voltage electrical lines are drilled into because they are assumed to be natural gas lines.

The tool could also identify standing water in mains and measure the water depth in these areas of standing water. The tool would minimize costs associated with water removal from gas mains by being able to detect and measure fluid depth from outside of the pipe.

Technical Concept & Approach

In Phase 2, the research team will construct and test a prototype tool suitable for applications for 3- to 10-inch pipe diameters for steel, cast-iron, and polyethylene (PE) pipe.

A user-friendly interface is planned so that measurements can be obtained without the operator viewing waveforms. Operator input will be limited to preparing the pipe surface and holding the sensor. Additionally, the operator will not have to enter the pipe diameter or material.

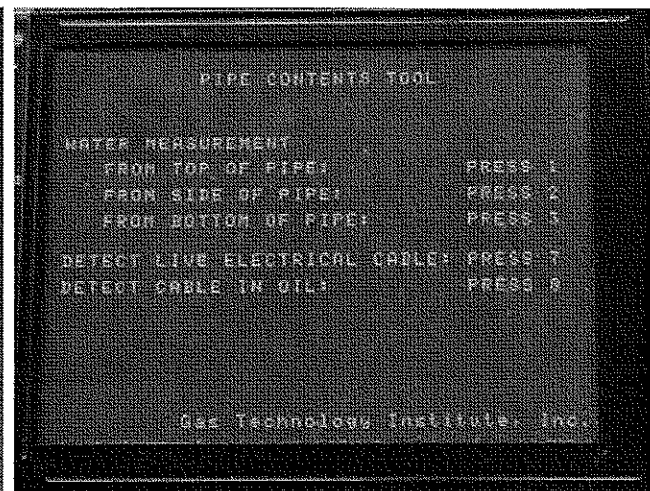
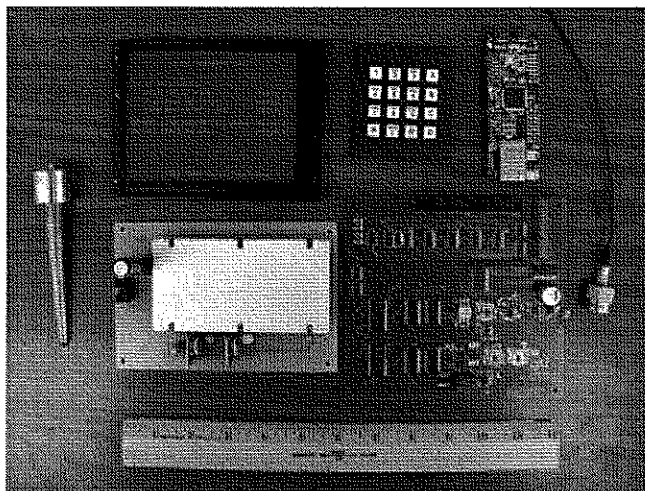

Left: Overview of the components of the pipe contents tool. Right: Close-up of display.

Signal processing techniques will be designed to measure water depth and to identify the presence of water and three-phase electric cables. Measurement techniques will be programmed into the prototype tool.

Phase 3 will focus on the search and selection of a manufacturer to commercialize the tool.

Results

In 2010, investigators demonstrated the ability of sensors to:

- Accurately measure water depth with an ultrasonic sensor on the bottom of pipe
- Determine if the water level in a pipe is above a certain level
- Determine if a main is completely full of water – either a water main or a gas main filled to the top with water – versus a gas-filled main (natural gas or air)
- Detect the presence of electrical cables in dielectric oil-filled steel pipe
- Detect live, three-phase electrical lines at voltages as low as 1200V with an acoustic sensor.

In 2011, the sensor receiver assembly was designed and a mechanism was designed and built so that the sensor can be held against the bottom of the pipe during measurement.

Other accomplishments included:

- Design of an ultrasonic sensor drive assembly, including design of a 100-volt pulse generator with an adjustable pulse width
- Design of the signal-processing assembly, including determining the memory storage requirements and the speed of transferring information into memory
- Selection of an analog-to-digital converter with sufficient amplitude resolution and conversion speed to be able to resolve the critical details of the waveforms
- Definition of the user interface.

Information displayed to the operator will note water depth and the presence of water, three-phase cables, and inactive cables.

In 2012, a hardware printed wiring board was assembled and the software to determine water depth was refined. Hardware and software were tested for functionality. The algorithm to process the ultrasonic data and determine the water depth functions correctly.

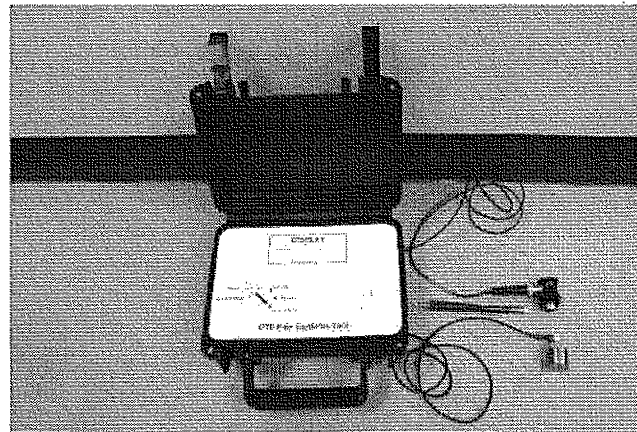

The envisioned prototype would contain all of the electronics and batteries. The two sensors (an ultrasonic and a vibration sensor) will be housed in the same or separate housings.

Status

Shakedown testing uncovered a number of issues that are being addressed.

Assuming approval to proceed from the sponsors, the following technical activities are planned:

- Continue debugging the hardware/software to identify problems in the pulser chain
- Continue debugging the hardware/software to identify the problems in the data collection/storage chain
- Create a new printed wiring board, including re-routing several traces
- Assemble the components on the new board and test the components that were previously functioning to ensure they still function correctly
- Confirm that the ultrasonic sensor is reading correctly
- Construct a new front panel
- Demonstrate correct functioning of the prototype
- Test the unit to detect water depths.

For more information:

Maureen Droessler
Program Administrator
Operations Technology Development, NFP
Phone: 847/768-0608
maureen.droessler@otd-co.org

OTD

Operations
Technology
Development

Development of Standardized Algorithms and Identifiers for Enhanced Material Tracking and Traceability

Industry investigations are being conducted to develop a series of protocols that can be used as a method for utilities to track their facilities. Current efforts build upon a standardized classification system developed in this program for underground utility assets to include meters, regulators, and transmission pipeline components.



Project Description

The precise identification of underground assets and other gas-system facilities is critical to utility infrastructure planning, risk management, and a wide range of other company activities.

Currently, there are various tools available and under development to aid gas utilities in locating buried pipe and facilities. However, even with the latest technologies, the data obtained is not standardized and may be insufficient for appropriate planning purposes. Adding to the issue are pending distribution integrity management initiatives, which emphasize the need for identifying buried underground assets and mitigating risks. While ASTM standards address marking, the guidelines lack the specificity needed to be able to accurately track materials and products throughout the entire supply chain.

In response, project researchers developed a series of standardized algorithms and unique identifiers (standardized nomenclature or “language”) to more accurately characterize gas-utility assets. These “identifiers” can subsequently be used as building blocks to track materials (e.g., subcomponent fabrication, manufacturing, assembly, distribution, storage, and installation) both from an individual gas-company perspective and from an industry-wide perspective.

In Phase 1 of the project (now complete), a standardized classification system (base-62 encoding system)

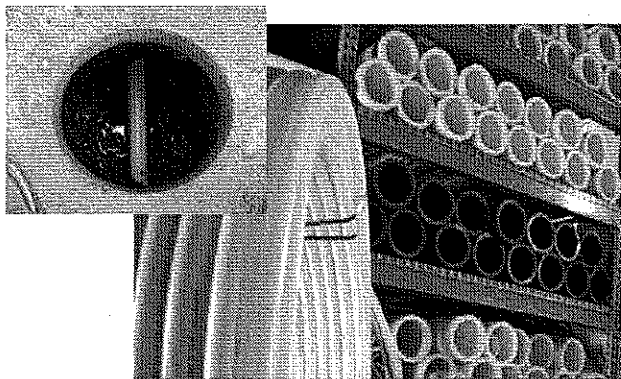

With a standardized set of protocols, utilities will be better able to manage their assets and respond to critical situations.

was developed to provide the basis to codify key attributes of a given component in discrete sizes and format to facilitate more effective tracking and traceability. Specifically, the 16-digit alpha-numeric code consists of datasets that provide information related to the manufacturer name, characterization of the component (size, material type, and component type), and product logistics (lot number and date of production).

The objective of Phase 2 is to validate the effectiveness of the base-62 encoding system through field testing to establish a standardized means of marking and to promulgate the newly developed ASTM F2897 methodology within the marking-requirements sections of various ASTM product specifications.

Additional tasks have been added to expand applications of the classification system to include transmission pipeline components, meters, and regulators.

Deliverables

Phase 1 deliverable include a validated series of algorithms to assist in the identification of the 20% high-use gas-distribution products; a set of validated “modules” (e.g., spreadsheets and database libraries) which can be integrated within gas utility company operations; and a draft standard for inclusion within ASTM standards and specifications.

Phase 2 deliverables include a petition to the U.S. Department of Transportation to reference the use of the algorithms and technical guidelines for each sponsoring company with respect to implementation options and requirements specific to their operations.

Benefits

Inaccurate or insufficient information related to buried assets during a critical time (such as a product recall, problematic pipe and fittings, etc.) can result in significant expense, lost time, and productivity losses. In addition, the development of standardized language at a national level would provide an effective method for

tracking the assets of the overall gas distribution piping system throughout the entire supply chain. A standardized approach also provides the appropriate framework for the implementation of new techniques and technologies for better data handling and exchange throughout the various stages of the installation process.

Technical Concept & Approach

Researchers collaborated with various pipe and fitting manufacturers to develop a comprehensive set of key criteria to more effectively track/trace components throughout their respective supply chains. This information established a technical basis for determining the pertinent information for each respective component.

A database was developed in a relational database management structure to develop relevant queries to create relationships and identify commonalities among various components and respective suppliers. The results were then used to create the necessary construction of identifiers. Identifiers provide a means to develop sufficient marking requirements that establish the uniqueness of the various components. In addition to developing a series of unique standardized identifiers, additional data was gathered on manufacturability and the traceability of information for each respective supplier.

The Gas Distribution Component Traceability Identifier includes pertinent information such as: part manufacturer, attributes of a given part, and the pedigree of the part.

To date, all facets of initial program are complete and a Final Report was prepared. Leveraging this momentum, in 2013 additional tasks were added to extend the base-62 encoding system methodology to transmission pipeline components, meters, and regulators. The research team will:

- Document current procurement practices for steel pipes and components, meters, and regulators
- Review applicable code and ANSI certified standards governing the physical, traceability, and marking requirements for steel pipe and components, meters, and regulators
- Document and finalize the key items of interest that need (must) be encoded through the base-62 encoding system for the vast number of gas transmission pipeline components (pipe, fittings, and appurtenances), meters, and regulators
- Develop a standardized 16-character identifier to encode key characteristics of transmission pipeline components, meters, and regulators.

Results

A standardized base-62 (16-character code) traceability encoding system was developed for distribution facilities. This standardized approach ensures that the marking on various types of components is a uniform length (16-digit alphanumeric code) with each digit representing key characteristics regardless of the type of component or the respective manufacturer.

A web-based application – www.componentid.org – was developed to establish a national registry of manufacturer identifiers. The website is now fully functional and enables manufacturers to obtain their 2-digit ID.

To provide guidelines for the use of the base-62 traceability encoding system, researchers established a consensus-based stand-alone ASTM specification – ASTM F2897-11 *Standard Specification for Tracking and Traceability Encoding System of Natural Gas Distribution Components (Pipe, Tubing, Fittings, Valves, and Appurtenances)*. The specification will provide a path forward for manufacturers to mark their respective products in a uniform and standardized manner and for gas utility companies to address recent regulatory initiatives and reporting requirements.

In 2012, testing was initiated to ensure the ability for a commercial-grade scanner to collect various bar code symbologies in various formats. All available scanners can effectively read the 1D bar code formats provided that the manufacturer can reproduce bar codes consistent with ISO standards.

Status

Expanding on the success of this initial standardized identifier for distribution components, the research team has initiated efforts towards the development of the base-62 16-character code for characterizing transmission pipeline components, meters, and regulators. This follow-on effort will ensure a single calculation methodology for all aspects and components for the entire gas delivery network.

Researchers continue interactions with various industry stakeholders to establish consensus on the next steps and gain support for the proposed changes at the ASTM level.

For more information:

Maureen Droessler

Program Administrator

Operations Technology Development, NFP

Phone: 847/768-0608

maureen.droessler@otd-co.org

OTD

Operations
Technology
Development

Mitigation of Water Accumulation in Underground Regulator Vaults



Research is being conducted in efforts to mitigate water accumulation in underground regulator vaults to reduce corrosion and extend the useful life of control regulators and associated equipment. The focus of this project was on the investigation of utility vaults and an evaluation of a pump system.

Project Description

Utility regulator vaults can be prone to the infiltration of water, which is the primary contributor to corrosion and degradation of system components. The primary source of the accumulated water includes storm run-off and groundwater infiltration. When the water contains contaminants, corrosion can rapidly accelerate, frequently resulting in the premature replacement of components.

Current practice is to manually pump water from vaults following storms and prior to entry into the vault. This process prolongs the exposure of components to a corrosive environment, increases the required maintenance on certain components, and makes some components (e.g., valves) increasingly difficult to operate. Additionally, immediate access to water-prone vaults is not possible due to the required pumping operation – a reality which could be problematic in emergency situations.

One utility identified, but not yet tested, a water pump driven by gas-differential pressure. The system requires further refinement and analysis to ensure a comprehensive and safe system design, adequate contaminant-filtering capability, optimum discharge location (s), and compliance with environmental regulations.

The objective of this effort was to investigate the pump technology.

Deliverables

- Results of a vault-system analysis
- Performance data of pumps under varying conditions and setups
- Information on regulators and valves that best work with pumps and pressures available
- Data on discharge methods for different vaults and locations
- Information on filter systems required for meeting local water-discharge standards.

Benefits

Corrosion of piping and components within regulator vaults can result in premature replacement. Utilities indicate that components in many vaults require replacement after just 10 to 15 years of service, which is less than half of the expected useful life.

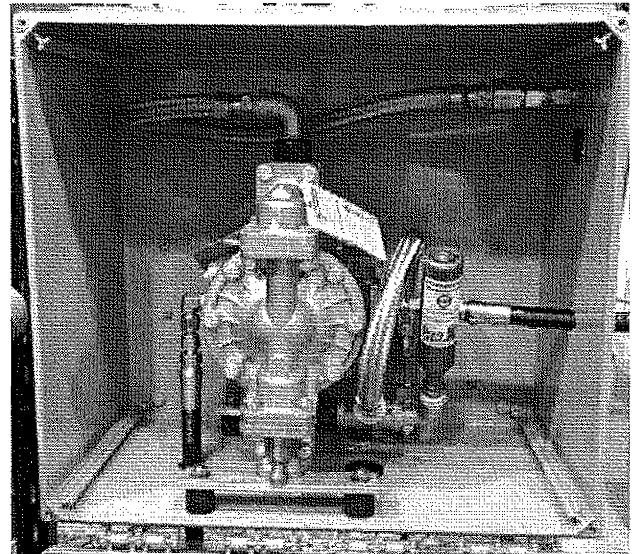
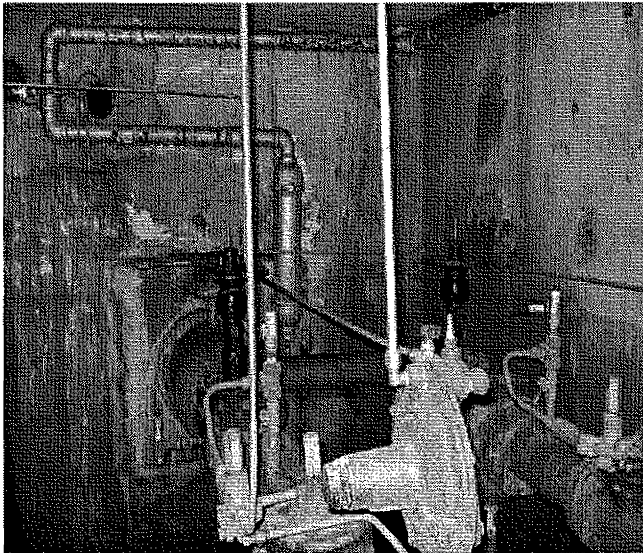

Left: Typical view of vault walls and piping structure. Right: Water infiltration management system, modified for improved longevity.

Full replacement of regulator-vault components, including associated labor, costs in the range of \$40,000 to \$150,000 (typical is \$65,000/vault), depending on the size of the components. The overall cost to the utility is multiplied by their number of vaults prone to corrosion, which can range from single digits to more than 100 vaults per utility.

A water-management system in conjunction with an appropriate coating system could extend the useful life of the regulator components to their full design life, potentially saving utilities and their customers millions of dollars in regulator-station replacement expenses.

Technical Concept & Approach

In this project, engineers tested and modified the pneumatic, gas-differential pumping system and validated its applicability for water management within regulator vaults. The system is a pro-active approach to corrosion control by preventing the water levels within the vaults from reaching and impacting critical components.

Research tasks include:

- **A Comprehensive Vault-System Analysis**

Investigators evaluated various types of vault systems, pipes, valves, regulators, actuators, and ventilation systems.

- **An Evaluation of a Pump System**

Investigators tested a pneumatic pump driven by gas-pressure differential and provided a system pump design. Tests were performed to determine the possible failure modes and the corresponding impact on the distribution systems.

- **Water-Quality Management Research**

This task addressed the environmental requirements at the city and state levels, and appropriate safe-discharge points for the water. A random water-sampling process of various vaults was performed to determine possible contaminants at different geographic locations.

Results

The project began with the evaluation of seven regulator vaults with relatable parameters that can be summarized with the following points:

- Water accumulation in the underground vaults ranged from 1 to 48 inches.
- Dimensions of the inspected vaults found an aver-

age size of 11 feet long x 6 feet wide x 7 feet in height.

- Distance from the manhole to the drainage grates varied from 25 to 100 feet.
- Two vault styles were commonly observed: 1) those with inlet pressure of between 50-60 psig and outlets of 8-15 psig; and more commonly, those with inlet pressures of 7-15 psig, and 7-10 inches water column outlet pressures.

After determination of general vault parameters, and a test apparatus, the Water Infiltration Management System (WIMS), was evaluated. During evaluation of the WIMS, several issues were found with the system, including limited gas flow through the shut-off valve restricting operation, pump stalls requiring manual pump reset, and higher-than-desirable required inlet pressures (15psig).

The WIMS pump was first rebuilt, and then later replaced with one of the same make and model. In every situation these issues were consistent. Following several levels of refinement, focus turned to management of vault water quality. The local city wastewater discharge limits were compared with a total of nine water samples from vaults throughout the distribution system. In summary, the results of this evaluation found the water quality of eight of nine vaults to be within limits of direct discharge with no filtration installed. A three-stage filtration system is supplied with the WIMS, which, if the system were to be installed, should be specified to contaminants found at each location.

A field evaluation of the WIMS was not performed due to challenges in obtaining a waiver for system installation by the sponsoring utility's environmental health and safety office. Alternatively, a field-simulated evaluation was conducted on the WIMS. This evaluation cycled all components of the WIMS, including the pump, shut off valve, as well as a single stage of the filtration system at a rate exceeding that expected in a field situation.

Status

This project is complete. A Final Report detailing testing and results was issued in January 2012.

For more information:

Maureen Droessler

Program Administrator

Operations Technology Development, NFP

Phone: 847/768-0608

maureen.droessler@otd-co.org

OTDOperations
Technology
Development**OPERATIONS INFRASTRUCTURE SUPPORT**

Mitigating Electrical Interferences on Cathodic Protection Systems



To enhance the safety and lower the maintenance costs on steel gas-piping systems, research is being conducted to identify or develop practices that mitigate the effects of electrical interference on cathodic protection and telemetry systems.

Project Description

Electrical interference can impair or entirely negate the effectiveness of cathodic protection (CP) systems used to prevent corrosion on steel pipelines.

Power-line surges, lightning strikes, and other transients will follow the path of least resistance from exposed points into the CP system. Examples of exposure points include: instrumented regulator vaults, meters and custody-transfer points, parallel high-tension lines, facility crossings, and rectifier stations.

Current electrical-mitigation practices address the steady-state levels of interference seen under normal conditions; however, the performance of these systems under extreme conditions, such as lightning strikes or power-line faults, is not well understood. A remote CP system that is disabled may go undetected for a long period. In addition, there is some evidence that AC interference can cause corrosion on gas pipelines, even with CP, but it is unclear whether this is caused by steady-state or transient events. (A transient or fault that does not disable the CP system may still leave some cumulative damage.)

While National Association of Corrosion Engineers (NACE) guidelines (e.g., RP1077) establish acceptable limits of induced AC or the interference from other facilities, these guidelines assume that the other facilities are operating normally.

In this project, research is being conducted to identify or develop practices that mitigate the effects of electrical interference on CP and telemetry systems.

This project seeks to answer various questions about the operation of CP and instrumentation in the presence of electrical interference, including:

- Does AC interference cause cumulative corrosion damage over time?
- How often do transient events impair the operation of these systems?
- When an unattended CP and instrument system fails, what is the root cause?

Deliverable

Investigations will result in the development of detailed information on CP-interference issues, practices to address these issues, and recommendations for improvements.

Benefits

This project is being conducted to improve the reliability of remote CP and telemetry systems – equipment that must operate unattended in order to be cost effective.

Application of research results can be used to assure that CP and telemetry systems can withstand transient events and continue operating safely and efficiently. In addition, research could lead to a reduction in the need to repair or reset equipment in remote locations.

In the case of CP systems, research results can be used to initiate practices to prevent possible AC corrosion. This will avoid future costs of repair to both the CP system and the infrastructure itself.



Technical Concept & Approach

- **Review of Utility Experiences**

Representative site data from participating utilities is being used to better direct the investigation. Researchers are also reviewing interference-mitigation practices in the gas industry.

- **Instrument Field Sites**

Selected field sites were instrumented to capture data on steady-state and transient interferences on CP systems. The instrumentation consists of battery-powered data-loggers and appropriate sensors. In addition to the normal sensors for CP parameters, the sites are instrumented for the detection of lightning strikes and power-line surges. The inclusion of these sensors will provide new insights into the performance of unattended CP systems during transients.

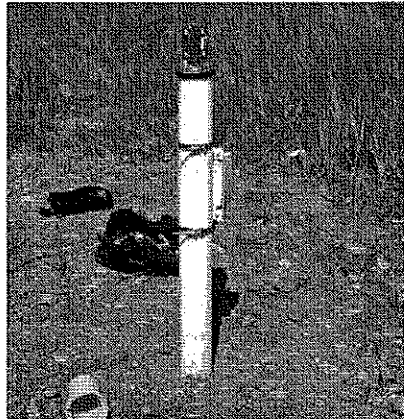

- **Investigation of AC Interference**

The objective of this task is to collect field data on suspected AC corrosion in conjunction with the data collection from the instrumented sites. Investigators will interact with corrosion departments of the participating utilities to review the existing survey data and to collect additional field data.

- **Investigation of Transient Interference**

Researchers note that currently there is little data in this area and that lightning and power-line events may be occurring unnoted. The data-loggers will record both the standard CP data and transient events. The records from the data-loggers will be examined periodically to determine if significant transient events, such as lightning strikes or power-line surges, have occurred. These events would be cross-referenced with the standard CP data to determine if the two can be correlated. If a significant event was indicated, investigators will conduct a direct examination of the CP system and, possibly, of the facility under protection.

- **Development of Conclusions and Recommendations**

Investigators will produce a technical report that details the project results and provides recommendations on practices and equipment that can protect CP and telemetry systems from interference damages. The goal is to address the issues that were initially identified by the participating utilities.

Results

Initially, an extensive search of CP data-logging systems was performed to identify equipment capable of performing the measurements required for this study. A commercial unit (the WatchDogCP P2S-AC CP test station monitor and data logger) was chosen for field studies initiated in 2010 at utility test sites in Idaho, Missouri, and Utah.

Technicians installed New Power Technologies' Sensor Guard systems to monitor the condition of the AC power line for over and under voltage conditions. The systems also monitor the ambient electric field to determine if a lightning strike is imminent. The Sensor Guard system has been used to protect power supplies on cellular towers for several years; however, this project represents the first Sensor Guard installations on natural gas equipment.

There was significant turnover in the equipment at two of the sites. The lightning and AC interferences at these locations was more severe than anticipated. The research team worked through these problems with the utilities and the manufacturers. In 2012, all of the deployed instrumentation was brought back on line.

Status

Data was collected on all three sites through the end of 2012. A mitigation strategy is being tested on one site for which data collection is still ongoing.

The draft Final Report is in the process of being prepared with the findings and recommendations to date. The report will be finalized when the mitigation deployment at the third site is more advanced.

Data from the WatchDog units is now being analyzed for inclusion in the final report. Several instances of lightning strikes and AC outages have been clearly identified during the course of the project.

For more information:

Maureen Droessler

Program Administrator

Operations Technology Development, NFP

Phone: 847/768-0608

maureen.droessler@otd-co.org

OTD

Operations
Technology
Development

Cathodic Protection Monitoring Technology Deployment



In this project, a research team is providing training and data gathering to support the deployment of cathodic protection (CP) technology. The focus of the project is on a low-cost CP monitor to provide more rapid and improved data collection to maintain safe operations.

Project Description

To maintain safe operations, gas utilities are required to take periodic pipe-to-soil readings on their infrastructure.

The current method for obtaining the necessary data requires that the utility maintain cathodic protection (CP) test stations that are routinely visited by corrosion technicians. It is required for some structures to obtain at least one reading per calendar year.

The focus of this project is on the deployment of a CP monitoring product that could greatly accelerate data collection and eliminate the maintenance of the test stations.

The monitor is a wireless, permanently buried device developed in a project co-funded by the Gas Technology Institute (GTI) Sustaining Membership Program and National Grid. Beta units were tested at several locations and found to be effective. A further development phase was conducted by 3M Dynatel that produced engineering prototypes that are compatible with

the same Dynatel handheld reading devices used for ID marker balls.

Once in place, the CP monitor can be located and read using off-the-shelf devices from 3M Dynatel. The locating and reading process is very rapid and can be done by an operator with minimal training.

In Phase 1 of the project, a modified CP monitor prototype was developed and tested in a field trial. Phase 2 focuses on modifications and further testing activities.

Deliverables

Deliverables include:

- A modified CP monitor prototype with enhanced features
- Locating devices and training for participating companies
- A commercialization plan.

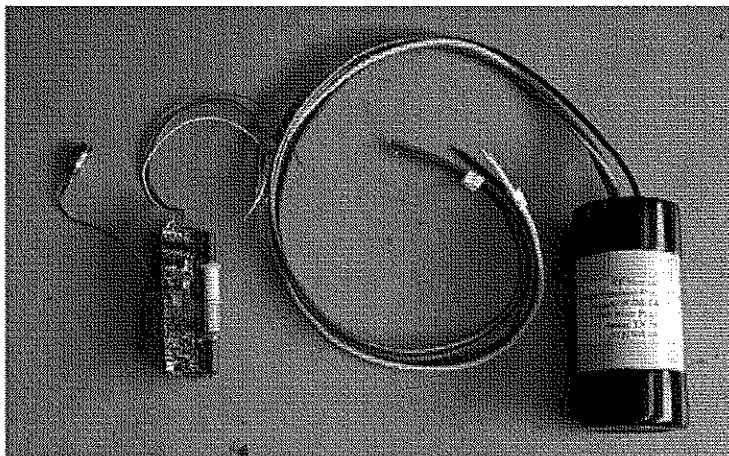

The current version of the wireless CP monitor consists of a sealed transponder that is connected to a buried reference cell. The monitor is placed in an excavation adjacent to the facility to be monitored. A wire from the monitor is attached to the main, with the reference cell attached to the monitor placed near the main. An exposed station above ground is not required.

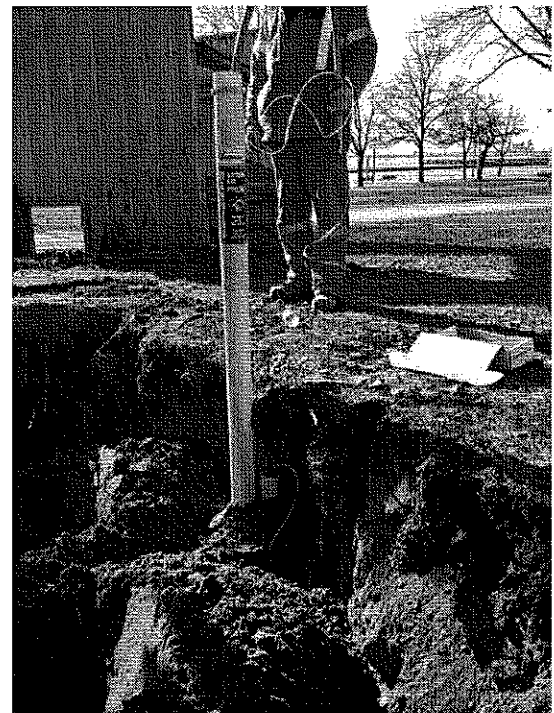

Benefits

The buried, wireless CP monitor eliminates the need to maintain test stations between readings. It allows the routine readings to be taken rapidly by less skilled personnel, allowing the corrosion technicians to concentrate on more critical work. Monitoring of high-consequence areas can be recorded monthly and collected at the utility's convenience.

Technical Concept & Approach

Efforts are under way to develop a completely encapsulated, direct-burial monitoring device. A handheld locator/reader is used to retrieve the readings electronically from above ground without requiring a direct connection. The data can be downloaded from the handheld devices as tabular data. The monitor records and stores a pipe-to-soil potential reading once every 30 days. When an operator takes the reading, 12 months of data is recovered. This helps assure that the requirement of one read per calendar year can be met. In high-consequence areas, monthly reads can be obtained without monthly visits.

The first version of the CP monitor was successfully tested in Phase 1. As a result of testing additional product requirements were identified.

The objective of Phase 2 is to develop and test a modified CP monitor prototype with some or all of the following features:

- Ability to record AC potential readings to detect stray currents
- Increased data storage
- Improved range with the ability to capture readings from a moving vehicle
- Programmable data recording intervals, and

- Ability to transfer data to other handheld devices via Bluetooth™ for direct GIS integration.

Results

In Phase 1, four experimental units were installed near GTI facilities for long-term monitoring.

In 2012, four additional units were installed in the field and training was provided to utility personnel. Information will be gathered on the experience with the field-trial samples.

Status

The project team is reviewing the desired modifications to the CP monitor with project sponsors and the potential impact on the development of the new prototypes.

The ability to read the CP monitor from a moving vehicle will be the most problematic of the additional capabilities desired by the sponsors. The current version of the CP monitor requires the reader to be in close proximity with a reader for about one minute. Given that another capability desired is for greater internal data storage, this issue will require some effort to resolve. It will require increased range for both the reader and the buried CP Monitor.

For more information:

Maureen Droessler
Program Administrator
Operations Technology Development, NFP
Phone: 847/768-0608
maureen.droessler@otd-co.org

OTD

Operations
Technology
Development

Evaluation of Ionix Static Suppressor on Existing Polyethylene Piping Systems



To maintain safe operations, utilities use a variety of products and methods to reduce or eliminate static associated with plastic pipes. In this project, an evaluation is being conducted of two different types of suppressors that may prove to be more effective and efficient than conventional static-suppression methods.

Project Description

The reduction or elimination of static in and on polyethylene (PE) gas distribution systems is critical to safe utility operations.

When PE pipe is charged by particulates (dust, rust, etc.) flowing in the gas stream, charges are generated initially in the interior of the pipe. The electric field resulting from the interior charge induces an exterior charge on the pipe via conducting paths through moist atmosphere and contamination effects.

Standard safety procedures involve wrapping the pipe with wet, soapy burlap. This procedure is effective for neutralizing exterior charge accumulations, but does not affect the interior charge and may even increase the likelihood of a static-through-wall discharge event.

To reduce static, some utilities are using or considering the use of two products: Ionix Aerosol Static Suppressor and Ionix MA. The manufacturer claims that these are true antistatic products and therefore superior to soapy burlap. It is also reported that the Ionix MA product can be used *inside* of PE piping systems.

This project focuses on an evaluation of the effectiveness of the two Ionix products to assure that their use on or in PE piping systems eliminates static charge without reducing the pipes' life or the long-term performance of the associated fusion joints.

Experts note that there is a significant need for research aimed at evaluating Ionix products to better understand how they may affect the life of the system, long-term performance of fusion joints, and slow crack growth of early generation PE materials.

According to the manufacturer, the Ionix spray is less expensive, more effective, and easier to use than soapy-burlap or plastic-film techniques. Ionix also notes that the point-and-spray product:

- Will not affect butt-fusion or electrofusion as long as the surface is being fused according to the manufacturer's instructions.
- Will not affect mechanical couplings that are cleaned properly

- Contains no environmentally harmful or hazardous chemicals and does not need to be removed after use.

The Ionix MA is a chemical additive to mercaptan. According to Ionix, when added to the mercaptan tank, Ionix MA is carried off through the gas distribution system with the mercaptan and eliminates any static inside the gas system downstream of odorizing.

Deliverable

Testing results will be presented in a detailed report to project sponsors.

Benefits

Reducing the risk of static discharge can help to assure the safe operation of PE piping systems. The aerosol may provide a greater level of safety during PE pipeline repair operations and the integrity of the PE pipeline will not be compromised.

According to the manufacturer, companies can easily save 30 minutes of labor per \$12 aerosol can through the elimination of the time required to wrap the pipe in burlap or plastic film.



Ionix products may be able to provide the natural gas industry with enhanced safety, improved operations, and reduced costs.

Technical Concept & Approach

The initial task of this project involves several activities to better define the products and product-evaluation needs. Research includes:

- In-depth discussions with Ionix and others to obtain detailed information regarding the products and product performance
- A thorough literature review
- A survey of OTD members to determine current practices, extent of use related to Ionix products, information regarding known static-related incidences, cost of current practices, and possible revisions to current procedures if Ionix products are implemented
- A static-flow-loop evaluation to review the performance of the Ionix spray, Ionix MA, and a combination of both
- The development of a business-impact study.

Based on the findings of the initial task, the testing protocol may include:

- Long-term hydrostatic testing
- ASTM D638 tensile testing
- ASTM D543 chemical-resistance testing
- Impact and/or cyclic load testing on lateral-type joints
- Butt-fusion evaluations
- Mechanical-joint-integrity evaluations
- Tests on the effects on elastomers found in mechanical fittings.

To frame testing activities, researchers will perform a chemical analysis using gas chromatography mass spectrometry, ICP, and ion chromatography to identify the constituents of the Ionix products. This information will lead to a better understand of the risk, if any, the spray poses to a piping system. Since the Ionix product can be used as a low-load-constant gas additive, additional testing regarding potential health risks will also be performed in both pre- and post- "combustion" conditions. Any potentially harmful compounds will be identified and, if appropriate, toxicology tests will be performed.

Plans are for the research team to subsequently partner with a gas utility in Kentucky, use its system as a case study, and perform long-term testing on samples removed from the system that have been exposed to Ionix MA product for more than three years. The project in-

cludes short- and long-term testing on both control and in-field piping specimens removed. In addition, various butt-fusion and lateral-joint-fusion tests will be conducted on PE pipe specimens that have been exposed to the Ionix products.

Considerations will be given to the fact that the Ionix products can be used both on the outside as well as the inside of the pipe.

Positive results may lead to future investigations into use of the products to eliminate static from the inside of pipes by directly injecting it into the gas stream.

Results

A flow loop for product testing was devised based on technical operation of the Ionix products and previous flow-loop experience. A test procedure was also developed. A number of samples of PE pipe that had been used with Ionix MA for approximately two years were evaluated for degradation. Tests indicated no notable diffusion of Ionix into the PE. Additionally, no oxidation was detected.

The Ionix MA dilution in t-butanol was also successfully evaluated.

Flow-loop tests with Ionix MA and Ionix Static Suppressor were completed in 2012. Results indicate that Ionix MA can reduce internal static charge provided that there is a grounding path from the flow stream. The degree of charge reduction is dependent on the amount of Ionix MA injected. Regular Static Suppressor and cold temperature formulation (40% propylene glycol) show similar results. The charge remains low after wiping and washing with water.

Status

Combustion testing of Ionix MA and flow-loop tests using a common non-Ionix external static mitigation procedure are expected to be completed in 2013.

A survey is being developed for submittal to project sponsors to determine current practices and the extent of use of Ionix Aerosol.

For more information:

Maureen Droessler

Program Administrator

Operations Technology Development, NFP

Phone: 847/768-0608

maureen.droessler@otd-co.org



Operations
Technology
Development

Remote Monitoring for Quality Assurance of New Installations

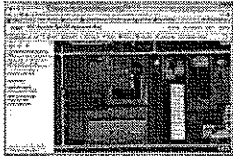

Researchers are developing technologies and procedures to allow operators to remotely monitor and record the quality of various utility operations. The focus of this project is on monitoring new installations using a step-by-step procedure, smartphones, and geographic information systems (GIS) to capture, store, and share images that can be used to reduce the risk of various operations.

Project Description

Emerging regulations, increased use of contractors, and a retiring workforce are increasing the need for enhanced quality monitoring of utility operations.

Traditional monitoring has involved the use of manual inspections requiring physical site visits and significant driving time. While these methods are effective, conventional inspections are usually only able to capture a small portion of installations.

Regulatory agencies have noted a number of concerns that call for enhanced inspections, including coating quality, welding, material quality, and installation procedures. In addition to regulatory concerns, operators may experience internal issues with operational quality from contractors as increasing amounts of external resources are used to perform operations. Retiring workers and less-experienced replacements are also causing quality concerns for operators.

In this project, researchers are investigating the use of remote monitoring – a technique that offers the potential for increasing the *quantity* of operations that are

inspected and, in some cases, could also increase the *quality* of the inspection. A remote monitoring system would use a combination of sensors, data transmission, and analysis technologies to capture and analyze data in the field that can be used by inspectors in the office to monitor operational quality remotely.

Deliverable

The deliverable for this project will be a set of procedures and smartphone applications to facilitate the remote capture of images that can be used to monitor the quality of new installations.

Benefits

Tools and practices that allow managers to monitor and enhance the quality of operations will reduce the risk of human errors during the installation process. Remote monitoring will increase inspection coverage and could potentially decrease the overall cost of per-

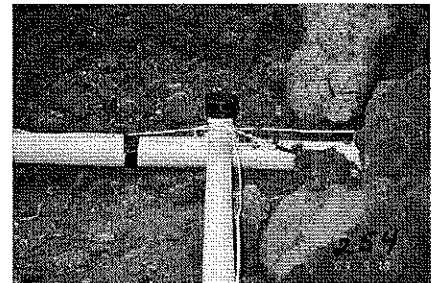
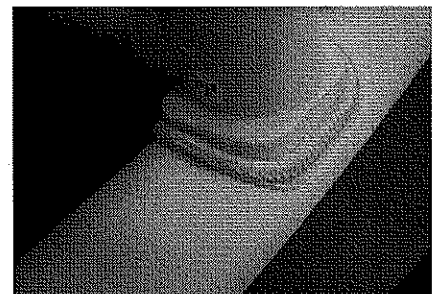
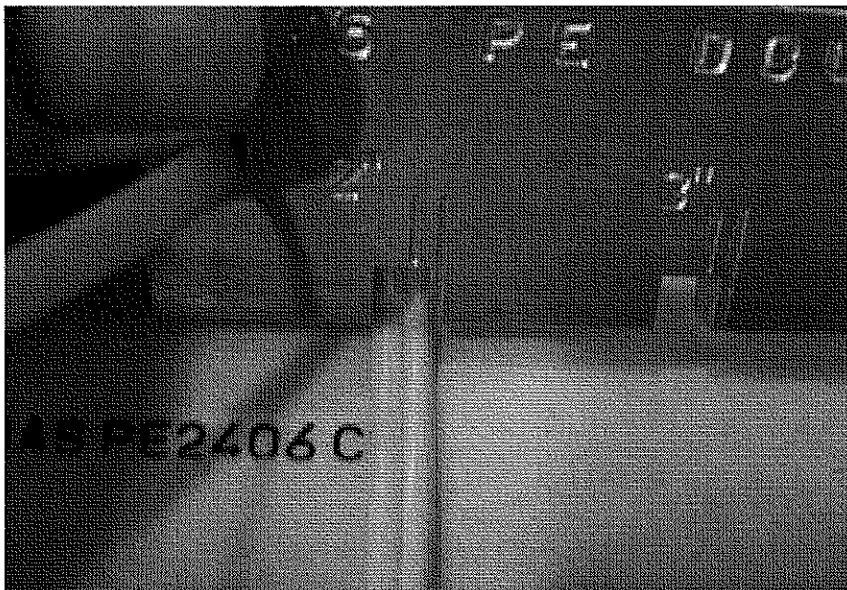

Protocols were developed for capturing a variety of images in order to record and verify main connections, pressure tests, service lengths, post installation, and other aspects of the operation.

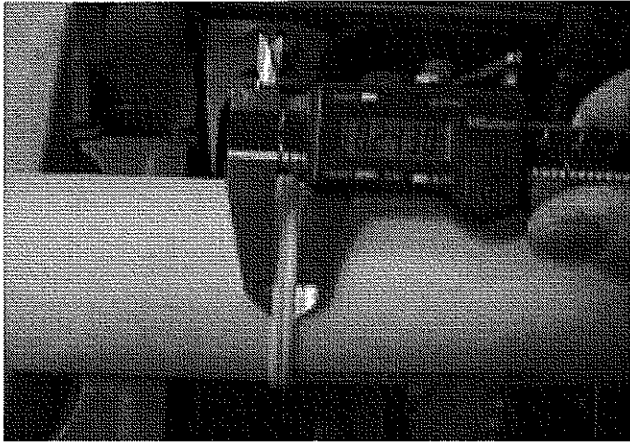

forming inspections. Additionally, deployment of technologies to increase and improve inspections and monitoring could demonstrate a proactive response to regulatory concerns.

Technical Concept & Approach

The technology used in this project is comprised of three different components to provide the ability to remotely conduct QA/QC on service-line installations from a laptop or desktop computer without the need to physically visit each inspection site:

- Esri ArcGIS mobile application
- ArcGIS Online, and
- Amazon EC2 Server.

Using the Esri ArcGIS application on a smartphone, the phone's GPS is used to create a point at the location of the service installation. Once the location point and appropriate data is entered, the user will take a specific variety of photos to capture the necessary data. When the user has collected the data, an inspector will use a computer or mobile phone to view the images and approve or disapprove of the installation.

All of the data collected during the pilot program will be stored in a database located on the Amazon EC2 server and available in real-time via website, an ArcSDE connection, or mobile device.

The following applications are available in the respective application marketplaces:

- Esri ArcGIS for Android
- Esri ArcGIS for iOS
- Esri ArcGIS for Windows Phone

Using the Esri application will allow users of any mobile platform the ability to capture inspection data and

store the data securely in a central location in ArcGIS Server.

The ArcGIS Online platform serves as the middle-tier to provide a secure access path between the ArcGIS Server and the user.

Results

In 2011, researchers completed Phase 1 with the implementation of technology and associated protocols for performing remote monitoring of butt-fusion operations through the use of a GPS-enabled smartphone for capturing pictures throughout the fusion process. Images are electronically sent to a third-party web-based repository that allows inspectors and managers in the office to view the pictures in real time. The web repository allows the pictures to be geo-coded and placed in files based on project number or geographic location. Video, audio, and other types of supporting information can also be stored on the web-repository. Submitted data can also be downloaded into an operator's GIS or other information system.

In 2012, a seven-step process was developed for using a GPS-enabled digital camera to record pictures of the various steps in the installation process for new services. An additional protocol (with step-by-step instructions for filing images) and user guidelines for a web-based server were also developed.

Status

As part of this Phase 2 effort, researchers are developing a smartphone application that can run on Apple and Android devices. Additionally, the new application will insert the photos directly into the GIS to avoid the need for a third-party application.

Research on alternative data-collection software was conducted in order to propose options for moving forward with the project. The proposed solution will incorporate portions of the existing technology environment while providing a more simplified data-collection application. Upon selection of the software solution, researchers will begin configuration of the devices and provide an on-site workshop and demonstration of the solution.

For more information:

Maureen Droessler

Program Administrator

Operations Technology Development, NFP

Phone: 847/768-0608

maureen.droessler@otd-co.org

OTDOperations
Technology
Development**OPERATIONS INFRASTRUCTURE SUPPORT****Large-Diameter Insulating Fittings –
8-, 10-, and 12-Inch Pipe**

In this project, researchers investigated various products, manufacturers, and modification options in an effort to address the need for developing insulating fittings for use with larger-diameter gas pipe sizes.

Project Description

Insulating fittings are used in a variety of gas-system situations, including:

- The repair of failed insulating joints
- The cathodic protection of early (1950's and 1960's vintage) uncoated steel mains, and
- The segmenting of protected mains from unprotected mains.

Appropriate fittings exist that are for smaller – two-inch- through six-inch-diameter – pipe sizes. One available fitting allows for the use of tapping machines equipped with shell cutters to completely sever the main inside the sleeve. However, no manufacturers have offered pipe insulating sleeves for 8-inch through 12-inch pipes.

The objective of this project was to identify existing fittings that have the potential to be used as an isolation fitting on large-diameter steel gas mains

Researchers investigated technologies used by the water industry that may be able to be used by the natural gas industry. One potential product used by the water industry is a technology to install in-line valves onto a live water main by attaching a fitting and milling a pocket for a rubber valve core to be inserted. Researchers expect that with modification and testing this system could be used to cut all the way around a main instead of only the upper third of the pipe, therefore isolating the pipe segment. This would allow for the ability to isolate the pipe segment and eliminate the need to shut off gas service to accomplish this same task.

Researchers also investigated the potential of modifying fittings commonly used in the gas industry to accommodate the need to insulate larger-diameter pipe sizes.

Deliverables

- A report detailing results of research to identify potential products and technologies

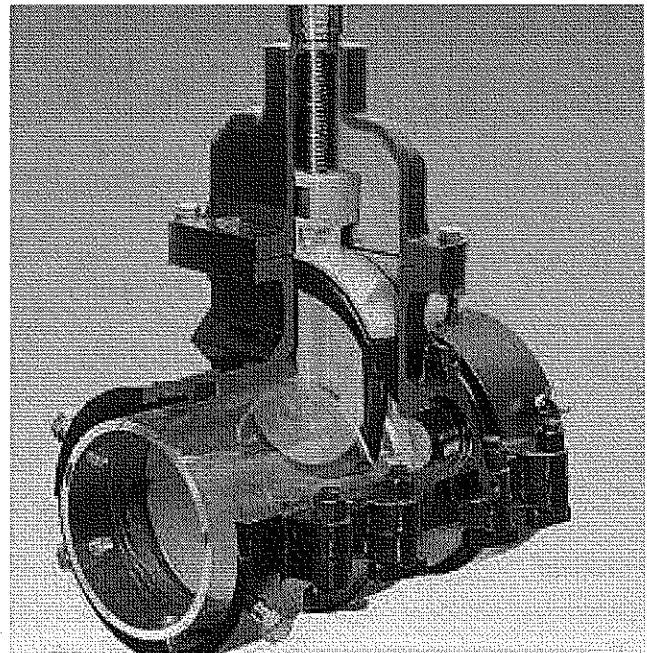
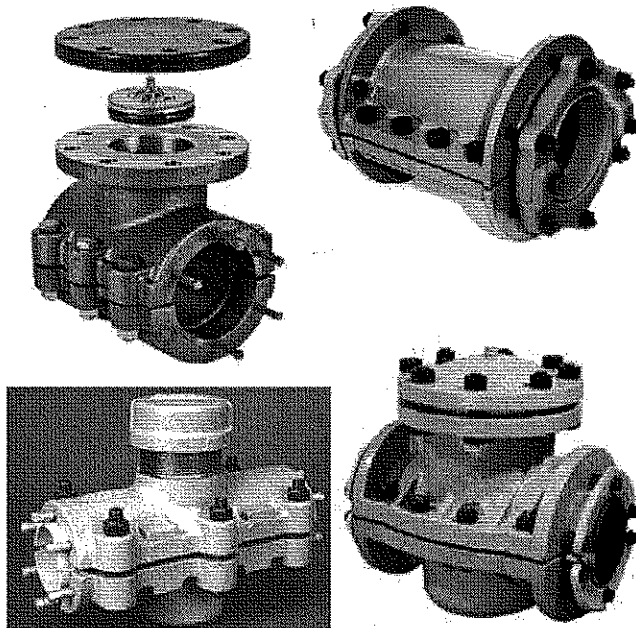

Researchers investigated fittings and valves from a range of manufacturers.

Benefits

The goal of this project was to identify a path toward developing the ability to electrically isolate sections of piping for cathodically protected systems on large-diameter mains without the need to perform a time-consuming, costly, and risky main cut-out procedure. A system for larger-diameter gas pipe would eliminate the need for segmenting the main via the high-cost method of installing stops, cutting in an insulating fitting, or cutting and capping the pipe. It would also limit the risk of premature pipe failure due to corrosion.

Technical Concept & Approach

Specific tasks included:

- Determining the initial design criteria (e.g., diameters, pressures, and other requirements required)
- Contacting major fitting manufacturers
- Investigating the potential to modify a technology to allow for the ability to cut out an entire section around the pipe.

Results

Investigators contacted numerous manufacturers that produce gas fittings; however, most are hesitant to venture into larger-diameter insulated fittings due to limited market demand and high development costs.

One manufacturer did show an interest in a larger-diameter insulating fitting, and numerous discussions

were held regarding the development of a R&D proposal.

Researchers identified one fitting as a potential candidate for modification. Modifications to the design would be necessary to incorporate insulating features. A larger hole saw would be required to isolate the main, and the current design does not allow for its use.

Another product – a mechanical split sleeve – may be able to be modified to utilize a milling head around the circumference of the pipe.

Status

This project is complete. A Final Report was issued in February 2012.

During this project, an issue regarding resistance to pipe pullout was identified. Currently, several insulating fittings have only one means of resisting pipe pull out – the use of a rubber seal. This is an area of concern for these fittings, and further design of a larger fitting should examine the possibility of incorporating additional restraint to prevent pipe pullout.

For more information:

Maureen Droessler
Program Administrator
Operations Technology Development, NFP
Phone: 847/768-0608
maureen.droessler@otd-co.org



Operations
 Technology
 Development

OPERATIONS INFRASTRUCTURE SUPPORT

Indoor Air Quality and Safety Issues

Through this project, a website of vital information on indoor air quality and safety issues was developed for OTD members. The site provides a center of expertise and a single-point access to scientific data, performance information, and natural-gas-related issues.



Project Description

When seeking to determine causes for an indoor-air-related incident or health trend, products of combustion are often assumed to be the culprits, when other conditions could be responsible.

Experts contend that to address the issue considerable information needs to be developed – and existing information needs to be more readily available.

The natural gas industry has long supported R&D to generate data and advance technologies to address indoor air quality and related environmental and safety issues. Also, in recent years a variety of information on air-quality issues has been developed by various other organizations, including the American Lung Association and the U.S. Consumer Products Safety Commission. Among other issues, research has focused on the efficacy of carbon monoxide (CO) alarms under varying indoor temperature and humidity conditions, emissions from unvented space heaters and residential ranges, and nitrogen dioxide (NO₂) emissions from

several forms of burners used in gas appliances. Research findings have been used to provide a sound basis for government regulation and a response to other audiences seeking solutions to large and complex issues.

Cause for particular industry concern is the widespread recommendation of the use of CO alarms in manufacturers' installation instructions. The general association of CO alarms with gas-fired appliances further emphasizes a need for the industry to provide an ongoing technical resource.

The Phase 1 objective of this project was to develop single-point access to gas-appliance-related indoor-air-quality information generated over the last 30 years and to establish a center of expertise on indoor air quality and safety to provide ongoing industry support. In 2011, an website was established as an industry resource for responding to indoor CO, NO_x, and other issues.

The Phase 2 objective is to support the ongoing industry need for indoor air quality and safety information.



A website for OTD members provides easy access to pertinent information from a wide range of sources.

Deliverables

The deliverables of this project are:

- An organized database of indoor-air-quality and related safety information generated over the last 30 years
- Information from gas industry experts in the field of residential appliances and indoor air quality
- Development of a consortium to advise, fund, and establish priorities for the effort
- The establishment of a center of expertise on indoor air quality and related safety issues.

Benefits

Traditional gas-fired appliances have a long history of safe operation. In addition, new appliances are built

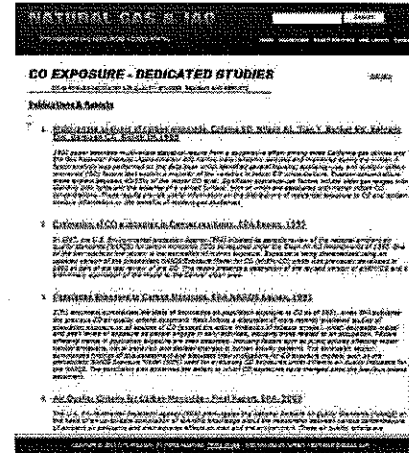
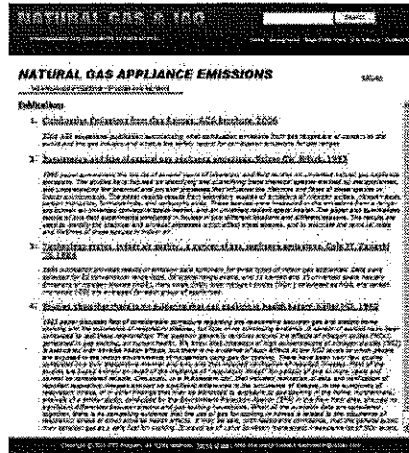
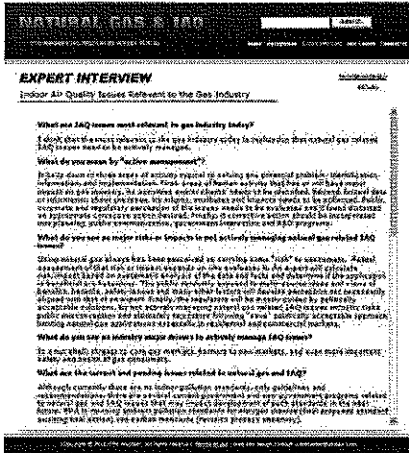

The Natural Gas & IAQ website provide answers to some of the gas industry's most critical questions.

with advanced control systems, negative-pressure operation, vent safety switches, and new burner technology that minimize the frequency and severity of issues relating to poor combustion and the impact to indoor air quality. By developing and disseminating information, safety can be maintained while savings can be realized by avoiding the cost for unnecessary controls.

Technical Concept & Approach

Data Search and Organization

A significant amount of literature from Gas Research Institute – beginning in the 1980s and continuing past 2000 – provided a foundation of published literature for this effort.

Sponsor Involvement

Initially, sponsors reviewed records provided by experts, were involved in interviews, and assembled a consortium to support the effort into the future.

Additional Activities

Additional phases of work will be proposed to support industry needs for technical consultation, interactions with the consortium, and the preparation of reports and presentations.

Results

An extensive literature search generated a list of more than 270 publications related to natural gas appliance indoor air quality. The publications were reviewed to eliminate redundant or less relevant materials.

In 2011, a website titled *Natural Gas & Indoor Air Quality* was developed and made available to OTD members through the OTD website (otd-co.org).

The website includes an extensive indoor-air-quality library, providing on-line access to:

- Gas Research Institute Reports
- Information on Natural Gas Appliance Emissions
- Indoor Pollutants Exposure Studies
- Dedicated Studies on CO Exposure
- Information on CO Detection and Prevention
- Dedicated Studies on NO₂ Exposure
- NO₂ Measurement and Mitigation Information

The site also provides links to information on industry programs and activities related to natural gas and indoor air quality.

Interviews with industry experts were consolidated into a Q&A format to address the most pertinent issues for the natural gas industry.

Status

In Phase 2, researchers are adding data to the website, performing analyses, and responding to industry requests.

For more information:

Maureen Droessler
Program Administrator
Operations Technology Development, NFP
Phone: 847/768-0608
maureen.droessler@otd-co.org



UV Degradation and Static Buildup Testing of Personal Protection Equipment Fabrics

In this project, researchers tested various utility-vest materials to determine if degradation is caused by ultraviolet light and to evaluate the potential for static buildup to become hazardous.



Project Description

Natural gas utilities have observed that the color and static properties of safety-vest materials change as the material ages. In some cases, these changes occurred after only one or two months of use.

In this project, tests were performed to determine if exposure to ultraviolet (UV) light was causing these changes. Measurements confirmed that vest color and static properties do change as a function of exposure to UV. In the case of static electricity, the surface resistance of some, but not all, vest materials changed with UV exposure.

Additional testing was conducted to determine if static charge buildup on a safety vest can be generated and, if so, can it be high enough to cause ignition in a natural gas/air mixture.

Deliverable

Deliverables include:

- A methodology for measuring energy in static discharge sparks from vests
- Testing and quantification of amount of spark energy that can be generated and discharged from vest materials with a range of surface resistances.

- A report documenting the results for each submitted vest.

Benefits

Safety vests provide an important visual alert that utility crew members are present. Results from this project will help to enhance the safety of utility operations for both utility workers and the public.

Technical Concept & Approach

Initially, UV testing was conducted on several materials used in utility vests. This project also involved the development of a testing procedure for measuring spark energies and an initial assessment of ignition hazard from safety-vest sparks.

The research team identified vest samples with surface resistances that span those of the previous measurements. Each sample was charged to voltages up to 60,000 and the spark energy measured. Because surface resistance is the controlling factor in spark energy, measuring discharges from materials with a wide range of surface-resistance values identifies potential safety hazards.

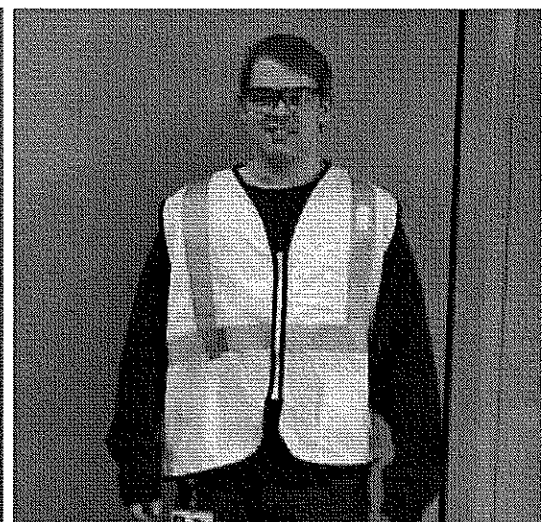

An experimental apparatus (left) was developed to measure energy in a static discharge.

Results

Project activities for this effort began in 2011 with a request to utilities to provide safety-vest materials for testing. Investigators also reviewed vest materials that were previously tested.

Ten vests were tested to determine if exposure to UV affects color and static properties. Some vests also underwent limited testing with washing. These results were summarized in a report and are being used to guide selection of vests to develop a testing procedure.

Research also addressed the risk of static discharges from safety vests.

Significant Findings from Static Discharge Research:

- The risk to static discharges involves more than the charge build-up on safety vests. For example, it is known that the body can store enough static charge to ignite a natural gas/air mixture. Therefore, any source of static build-up in an operator's body is an issue. The measurements were limited to the charge build-up and discharge on the vest material itself. It did not address discharges of static electricity from the body or other articles of clothing worn by natural gas operators.
- It is difficult to generate and maintain static electricity on vest materials with low surface resistance. The charge dissipates/recombines quickly, preventing energetic sparks. Low surface resistance can be achieved in a number of ways, including use of a surface coating and special fibers woven into the material. In some cases, humidity will sufficiently reduce the surface resistance.
- Having a modest amount of surface resistance is beneficial if it permits recombination of charge at a controlled rate.
- A person wearing a vest with high surface resistance over a 100% wool sweater can generate static voltages in excess of -25,000 volts.
- Researchers successfully adapted a method of measuring the energy in a spark discharge to vest materials. High static voltages (in excess of -28,000 volts) were generated on some vest materials with high surface resistance. In some cases, the measured spark discharge energies were large enough to ignite a 9% natural-gas-in-air mixture. In other cases, the surface resistance is so high that the spark will not ignite a natural gas mixture. Such materials still present a hazard if the charge transfers to the body and is discharged by a path not involving the vest.

- Measurements demonstrated that for some high resistance materials, a static discharge to a grounded object does not remove all of the charge from the surface. It often reduces the amount of static charge so that it is low enough that a second discharge does not occur.
- An alternative method of identifying potential hazardous materials is the Shirley Method 138: 2000. It does not measure the energy directly. Rather, the static is discharged in the presence of a combustible gas. If after 50 attempts, no ignition occurs, the material is considered safe. Of the five vest materials tested with the Shirley Method using hydrogen, ignitions were observed from three vests.

Status

A report on Phase 1 of the safety-vest testing was issued in June 2012.

Based on the experimental results and additional information obtained in this project, researchers provided the following recommendations:

- The number of vests tested in this phase of the project was limited. Utilities should review the list of vest materials and select additional items for testing as appropriate. In addition, new vest materials should be tested as they are developed. Testing should be applied to used as well as new vests.
- The Shirley Method 138: 2000 should be used as the screening method for acceptance of vest and overall materials.
- To provide an extra factor of safety, the Shirley Method should be used with hydrogen rather than 9% methane in air.
- Care should be taken when selecting combinations of garments (e.g., the safety vest and the undergarment). Seat material in vehicles can also be a factor in static built-up.
- Care should be taken when selecting other garments and shoe materials.

For more information:

Maureen Droessler
Program Administrator
Operations Technology Development, NFP
Phone: 847/768-0608
maureen.droessler@otd-co.org

OTD

Operations
Technology
Development

Solar-Powered Remote Monitoring

Solar-powered devices are being investigated as power sources for the remote monitoring of various gas utility facilities to more cost-effectively obtain rectifier data, pipe-to-soil measurement, pipe-to-casing readings, and other information.



Project Description

Automated and remote monitoring of utility equipment can provide significant cost savings, eliminate or reduce the need to drive to facilities and collect data, and increase the frequency of data collection. However, most operators must connect remote-monitoring devices to the electric grid to supply the required power. This grid connection can be prohibitively expensive and require significant coordination with the electric company.

To address these issues, this project is investigating the use of solar power as the supply source for automated and remote-monitoring applications. The objective is to implement and test a solar-powered system to allow the collection of operational and security information without requiring a connection to the electric grid.

The overall program is being conducted in three phases:

Phase 1 – SCADA (Supervisory Control and Data Acquisition) Systems

Phase 2 – Security Camera and Lighting

Phase 3 – Corrosion Monitoring.

In the recently completed Phase 1, researchers investigated commercially available solar-powered remote monitoring devices. During this investigation, a survey was conducted to determine and rank which measurements were of the greatest interest and need.

Deliverables

The deliverables for this project include the results and analysis of the testing and demonstration of a commercially available solar-powered system for remote monitoring. Research will address the ease of remote data retrieval and transmittal and provide a comparison of the remotely acquired data with control data.

Benefits

Solar-powered remote monitoring increases the cost-effectiveness of remote monitoring and allows operators to collect more frequent operational data to decrease system risk and increase security.

Remote monitoring has the potential to reduce the amount of time spent driving to, reading, and inspecting devices such as cathodic-protection (CP) test stations and rectifiers. The use of solar power to energize these remote monitoring devices could result in significant cost reductions by eliminating the cost and time involved with connecting to the electric grid. Safety will also be increased by minimizing the number of electrical connections made by operator personnel.

The results of this project will be used to encourage the adoption of solar-power technology to reduce the cost of remote and automated data collection.

Technical Concept & Approach

Plans call for a six-month data-collection testing process. The manufacturer will collect the data, which will be analyzed by independent third-party experts. The selected equipment will either be solar powered or powered by batteries that are automatically recharged using solar power.

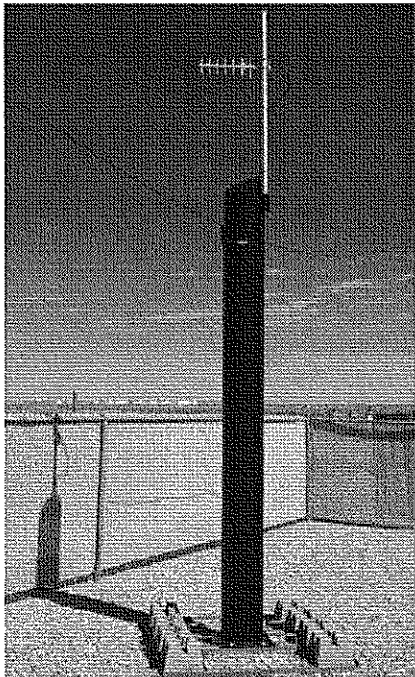

Solar-powered automatic remote-monitoring equipment is being evaluated at a test site near Boise, ID. The pole pictured at left is 3/4 wrapped in solar cells.

Initially, equipment will be installed in a laboratory setting, followed by field installations.

Two components of a system will be installed in one section of protected pipe to monitor pipe-to-soil and casing-to-soil voltages. Each monitor will be configured for solar-power operation and the test system will be configured to take readings at specified intervals. In addition, applications for testing include rectifier monitoring.

Results

Research began with an investigation of commercially available technologies and the selection of equipment for testing. A report was issued detailing the results of the investigation of off-the-shelf, remote-monitoring systems that are either specifically designed for CP and/or pressure regulator stations, or can be adapted to report CP and/or pressure regulator station readings. These remote-monitoring systems are either solar-powered, battery-powered with solar-power charging, or capable of being solar powered, which practically eliminates battery replacement management.

Seven manufacturers were found that produced equipment (13 models) as a standard product. In almost all cases, the systems were either solar powered or solar-power capable. One manufacturer offered products that monitored the three main areas under consideration: transformer rectifier monitoring, CP voltage and current monitoring, and pressure regulator station/wellhead/city gate monitoring.

In 2011, solar-based equipment was installed at a utility test site near Boise, ID. The site contains a custody-transfer point and an odorizer. The unit is currently powering two temperature sensors and a 928MHz radio. Technicians plan to add a security camera and possibly an odorant-tank-level monitor to simulate a more realistic load.

Data was collected on the test site and monitored via a 900 MHz SCADA radio network. The raw data was gathered every 15 minutes. The system was very lightly loaded. The battery voltage never sagged below 12 volts and the load current was at the low end of what was measurable with the instrumentation in hand.

The system was capable of supporting a much higher power demand than this testing program generated. It was estimated that, at the loading levels observed, the system would have several weeks of up time without daily solar charging.

The power system performed very well within the constraints of this test. The testing regimen was very conservative, never using more than 1%-2% of the capacity of the solar power system.

The solar pole platform performed well over the entire test period. The performance was verified by regular data transmissions to the utility SCADA system. Because the solar power platform was not substantially loaded, the battery was maintained at nearly 100% charge throughout the test period. Now that the solar power platform has passed basic testing, the available power capacity should support additional testing.

Status

Data is being collected and monitored at the utility site.

A Phase 1 Final Report was issued in 2012.

The report recommends that follow-on testing exercise the capacity of the power system more thoroughly.

The report notes that:

- Tank-level monitoring for commodities such as mercaptan or propane could benefit utilities by allowing utilities to schedule visits as needed rather than on a strict calendar basis.
- Regulator-vault monitoring is another potential application. Regulator vaults often have vent stacks and utilities now often visit vaults on a 30-day schedule to check for methane leaks or water intrusion. A wireless, solar-powered telemetry system could alert crews to conditions on an as-needed basis.
- Back-up power at critical installations is an issue. In regulator stations, some vaults have active pressure controls. Utilities need to maintain communication with these critical installations even (and sometime especially) during power outages. An outage of more than a few hours can exhaust the backup capacity of many current installations.
- Monitoring the right-of-way in high-consequence areas is a growing concern. The ability to deploy a picket line of sensor stations with no ties to telecom or power lines would be attractive for this class of application. High-pressure lines tend to run in (ever narrower) right-of-ways that could easily support a low-footprint monitoring installation.

For more information:

Maureen Droessler

Program Administrator

Operations Technology Development, NFP

Phone: 847/768-0608

maureen.droessler@otd-co.org

OTD

Operations
Technology
Development

Dewatering Systems for Mains and Services

In this project, investigators studied novel and commercially available dewatering technologies in an effort to develop a new system for the removal of residual water from gas mains and services.

Project Description

The presence of residual water in intermediate- and low-pressure natural gas lines can increase the potential rate and extent of corrosion, create hydrate formation, and cause outages during months of high demand.

Residual water presents a particular concern in cold-weather climates as gas velocity increases with demand. Water can migrate to meters and regulators and freeze, causing failures and service interruptions.

Currently, dewatering intermediate- and low-pressure mains and services can be an expensive and time-consuming process. Traps and drips are commonly used to mitigate the issue; however, these can become clogged or leak, and it is not possible to place them in all locations where water is present. Although traps have worked well for capturing large amounts of water, they require gas flow or gravity to function properly. Often, low points in a piping system without traps installed will accumulate residual water during low flow conditions. The residual water continues to collect until higher flow conditions exist, which then distributes the water throughout the system in droplet form.

Methanol addition is another commonly used solution to reduce the affects of residual water. Methanol functions by creating a methanol-water slurry, containing the residual water, and thus reducing the dew point of

the flowing gas stream. One property of methanol-water mixtures is that methanol evaporates faster than the water. Through time, as evaporation of the methanol-water mixture occurs, the concentration of water to methanol increases. Eventually, water concentration reaches a point where it once again becomes a potential hazard in droplet form. To eliminate this time effect, additional methanol is required to ensure adequate concentrations during winter months.

In this project, researchers investigated two water removal methods: 1) foam lifting products to move the water out of the low areas, and 2) fixtures, such as separators and desiccant filters, which can be strategically placed throughout the piping system.

Deliverables

The deliverables for this project include a Final Report detailing the results of investigation into current water-removal systems and a working prototype system for dewatering mains and services.

Benefits

Direct benefits of an enhanced dewatering system include: lower utility operations costs; reduction in pavement restoration due to fewer road cuts; fewer operational failures; fewer customer outages; and enhanced

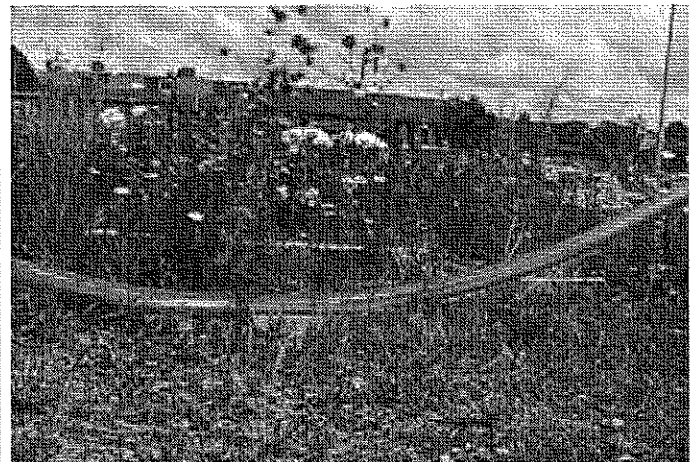
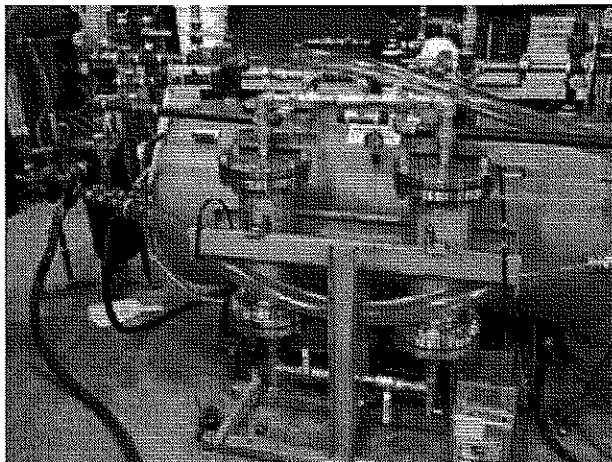

Left: testing configuration for foaming agents; right: testing in the field.

Technical Concept & Approach

This project consists of several tasks:

- **Investigation of Industry Standards and Current Market Solutions**

This task included surveys and other methods to examine current water-removal practices and common occurrences. Technologies explored included camera and vacuum operations, pigging operations, surfactants, as well as tools from other pipeline industries for water displacement or production.

- **Evaluation and Transfer of Technologies**

Desiccant systems and foaming agents were investigated.

Desiccant systems are currently used in gas storage operations prior to introducing fuel gas into generators and other small scale operations. As the gas flows through containers filled with desiccant tablets, the moisture is absorbed by the tablets prior to transportation downstream. Through time, the tablets dissolve into brine, which flows to a trap at the bottom of the container to later be removed and disposed.

Foaming agents are commonly used to lower the density of water, which would allow it to be distributed throughout the system from its natural holding points.

- **Evaluation/ Design/ Modification of Solutions**

Prototype systems will be constructed of the most promising technologies, and evaluated for adequate operation.

- **Data Collaboration and Reporting**

Reports will be issued with the results and findings.

Results

This project began in 2011 with the initiation of an investigation into current industry standards and market solutions. Numerous technologies were found to be available to handle water and moisture and were evaluated.

Researchers evaluated two water-removal methods:

1. The first method addressed the removal of water from low points in the gas distribution system using foam surfactant products to move the stranded water in the pipe under low gas flow conditions.
2. The second removal method included an examination of the devices installed on the pipeline that are

designed to remove the water from the system. Included are drip pots, separators, and filtering devices. The capture points can be above ground or, ideally, in a vault below ground.

Some of the technologies that were studied included vane flow separators, regenerative desiccant technologies, and foaming chemical surfactants (alcohol based and soap sticks).

The focus of implementing these products was to keep implementation and maintenance costs to a minimum. The vane flow separator is fully automatic with a float valve discharge at the bottom, which minimizes ongoing maintenance requirements. Also, the molecular sieve desiccant is regenerative so it does not need to be replaced and requires little maintenance.

Test results show that the vane flow separator is effective in removing at least 80%-95% of the water at pressures ranging from 1 to 60 psig. The regenerative desiccant technology is effective in removing mist and vapor in the gas stream. In combination, these two technologies were effective in removing water and vapor from the system.

Surfactant foam can effectively facilitate the moving of water out of low-laying areas (e.g., under roads, rivers, railroad tracks, and other areas). It provides a way to move major accumulations of water which may reduce gas flow or cause flow alterations. Foam can carry the water to other areas of the pipe and to water removal devices such as drips. It is also cost effective and quick to utilize. However, the foaming agents may cause the water to move to locations where it can cause other problems if not removed during the process.

Status

A Final Report detailing testing results was issued in October 2012. Three videos of field-testing operating are available at the OTD website.

Additional research is needed to conduct further simulated and actual field trials on pipelines and further evaluate the foaming agents to validate their effectiveness on various size pipes, pressures, and conditions. In addition, further investigation is needed to determine if any hazards exist with introducing the various foaming agents into the pipeline.

For more information:

Maureen Droessler

Program Administrator

Operations Technology Development, NFP

Phone: 847/768-0608

maureen.droessler@otd-co.org

OTDOperations
Technology
Development**OPERATIONS INFRASTRUCTURE SUPPORT**

Development of Environmentally Conditioned Personal Protective Equipment

To help ease the strain on utility workers and reduce heat-related injuries, research is being conducted to investigate and develop environmentally conditioned devices for use with personal protective equipment (PPE). Both wearable and area-cooling systems are being studied.



Project Description

Utility workers in elevated-temperature environments often contend with heat accumulation inside the increasing layers of personal protective equipment (PPE) equipment required for employee safety. Wearing layered PPE creates an environment where heat-affected injuries can easily occur.

While solutions to cooling the human body underneath protective garments exist in other industries, many of the methods are not rated for use in a gaseous atmosphere or will not function properly when applied underneath the multiple layers of PPE sometimes required in the gas industry. This project focuses on the evaluation and modification of PPE technologies specifically for the natural gas industry.

Auto-racing pit crews, firefighters, military personnel, and other heat-affected personnel use cooling systems integrated into their PPE. In addition to these integrated PPE solutions, other cooling methods are available to condition entire workspaces. Both styles – worn cooling systems and area cooling systems – are being investigated.

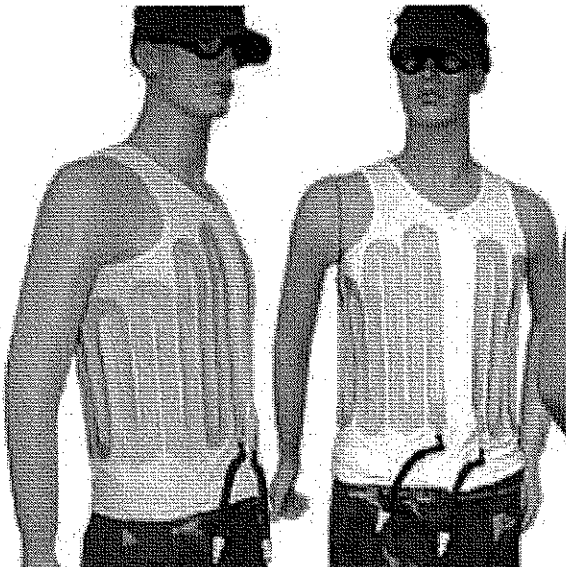

Active cooling designs use an auxiliary heat exchanger located in a backpack or side pack to cool a liquid which is then pumped through a cooling grid sewn into a vest.

Deliverables

The main deliverable will be a prototype cooling system able to reduce the user's core body temperature while not affecting the efficiency of the PPE. In addition to the prototype, an analysis of current market solutions will be supplied.

Benefits

If unchecked, elevated core body temperature and internal suit humidity levels (which initially lead to degraded worker performance) can eventually lead to incapacitation through dehydration, fatigue, heat stroke, and possibly even death. To avoid heat-related injuries, utilities often employ replacement workers onsite, creating a rotation allowing workers to cool down on a regular basis. While this does much to improve worker comfort, the added financial burden can be cumbersome.

A proper cooling solution designed for natural gas industry personnel wearing personal protective equipment will reduce accidents and injuries caused from heat exposure, as well as increase productivity.

Technical Concept & Approach

This project includes the following tasks:

- **Analysis of Existing Practices**
- **Evaluation of Current Market Solutions**
- **Design, Modification, and Testing of Industry-Specific Solutions**
- **Analysis and Reporting**

At the conclusion of this effort, a Final Report will be issued with the results and analysis of currently available cooling systems.

The goal is to design, fabricate, and test a prototype system for use in the natural gas industry.

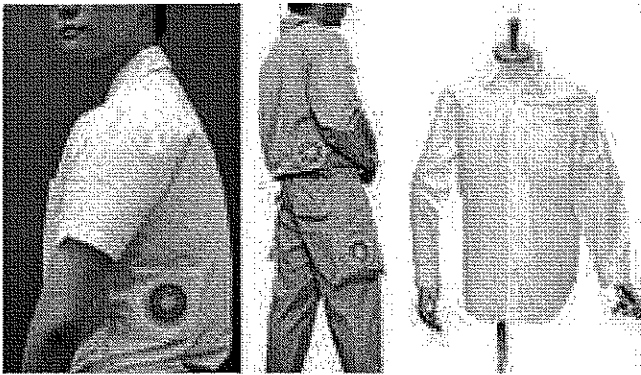

Air-conditioned clothing.

Results

In 2011, researchers began investigations into current industry use, PPE requirements, and available systems to establish the design parameters for a cooling solution. Activities focused on gaining an adequate background of current government standards set by the Occupational Safety & Health Administration and the National Institute for Occupational Safety and Health, gathering educational materials on heat-related injuries, gaining information from utilities, and reviewing currently available market products.

In 2011-2012, five cooling conditions were evaluated:

1. **No Cooling (Control)**
2. **Circulating Water Vest**
3. **Frozen Polymer Vest**
4. **CO₂,liq Vest**
5. **Air-Cooled Vest**

All conditions included the standard protective clothing and equipment (extraction suit with full-face respirator mask). The no-cooling control provided a standard reference for the cooling systems.

The primary testing environment was a standard desert condition (called Desert II in military studies) at 40°C at 30% relative humidity. A second environment was a subtropical condition (called Jungle in military studies) at 35°C at 50% relative humidity.

Work was simulated by walking on a treadmill.

The results were a statistical comparison of the four cooling systems to the no-cooling control and comparisons among the pairs of cooling systems for relative differences.

Three cooling systems were all significantly better than the no-cooling control. There were no effects due to environment, which suggested that the results could apply to a variety of environmental conditions because the protective clothing isolates the person from the environment. The early evidence on the CO₂,liq vest is that it is somewhat better than no cooling but not as effective as the other systems. All of the systems reduced the heat storage rate by one-half compared to no-cooling condition.

Status

Evaluations of currently available PPE solutions are ongoing. Once complete, the research team will prepare a report of the findings for the project sponsors and a webinar will be scheduled.

For more information:

Maureen Droessler
Program Administrator
Operations Technology Development, NFP
Phone: 847/768-0608
maureen.droessler@otd-co.org

OTDOperations
Technology
Development**OPERATIONS INFRASTRUCTURE SUPPORT****Tracer Wire for HDD Applications**

Extensive research and testing has culminated in the release of a new report that provides valuable information on tracer-wire products for use in horizontal directional drilling (HDD) operations.

**Project Description**

For more than 20 years, the installation of solid copper tracer wire – buried alongside polyethylene (PE) pipes – has been the standard practice used to help utilities locate underground plastic piping. Copper wire is readily available, highly conductive, and relatively easy to handle. However, the increased use of more demanding operations – such as horizontal directional drilling (HDD) operations – creates challenges and can cause breaks in solid copper tracer wire during installation.

In HDD operations, some utilities pull multiple wires, while others may rely on a single large-gauge wire. The desire for a stronger tracer wire has even led some utilities to turn to copper-clad steel (CCS) wire.

Other options for tracing plastic pipe have been brought to market with mixed levels of satisfaction. These systems primarily lack the needed tensile strength.

The objective of this project is to provide the gas industry with information on the properties and performance of currently used tracer wire products as well as new, potentially stronger, tougher-to-cut, and more “HDD friendly” products.

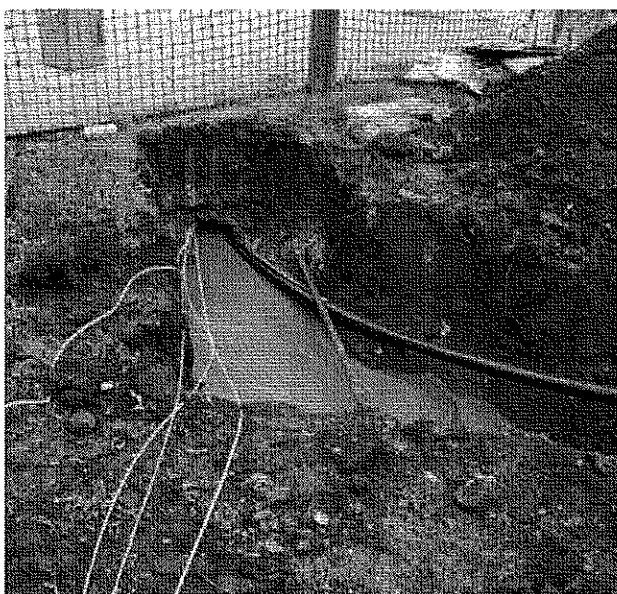

Tracer wires being pulled through the borehole along with the pipe.

Researchers are also investigating a product that may overcome the tensile-strength issue. The product differs from common tracer wire in that traditional tracer-wire construction employs a layer of insulation placed over the conductive metallic core, where the new product uses a polymeric woven fiber strip with an insulated wire integrally woven to it. Such woven-fiber configurations have a very high strength-to-weight ratio and in larger sizes are commonly used in industrial lifting and towing applications with very high levels of loading.

In theory, the woven fabric would contribute to the bulk of the product’s tensile strength and afford additional abrasion resistance, both protecting the wire from damage and reducing the chance of breakage.

Deliverable

Data is provided in a technical report available through the OTD website.

Benefits

Information developed in this project is expected to set researchers on a path toward providing an improved product that can be used for trenchless HDD applications.

A more effective tracer wire that is readily locatable, strong, and easy to handle would improve the safety and efficiency of gas operations by:

- Preventing wire breaks which result in unlocatable plastic (therefore, reducing the risk of third-party damage and potential incidents)
- Reducing cost by allowing for the use of a single wire for a directional-bore pullback instead of using multiple tracer wires
- Providing faster installations by reducing the time required to address breakage of the wire during challenging HDD pipe operations.

Technical Concept & Approach

This project included the following tasks:

- Product Review and Test Protocol Development
- Laboratory Testing
- Field Testing
- Development of Recommendations.

Products tested in this program are manufactured by: Agave Wire, Ltd.; Copperhead Industries, LLC; Kris-Tech Wire; NEPTCO, Inc.; Paige Electric Company, LLP; and Pro-Line Safety Products Company.

Results

In 2011, a project survey was conducted and summarized in a report.

The survey focused on:

- Currently Used Tracer Wire Products for HDD
- Installation Processes for HDD
- Tracer Wire Failure
- Connectors
- Additional Information and Expected Improvement for Trenchless Installation.

Based on survey results, tension load could result in the wire breaking during the installation. Previous tensile tests show that the same type of tracer wires with the same gauge but manufactured from different manufacturers have varied peak tensile loads. This indicates that the manufacturing process may significantly affect the tensile properties of the tracer wire, and the performance of the wires might be significantly different even though the same type of wire is used. Therefore, tensile testing was needed to verify the tensile strength of each candidate wire. In the tensile test, the load at which the plastic insulation yields was also recorded and compared.

Wearing off of the plastic jacket on the tracer wire – or the jacket breaking by the pull – could result in wire corrosion during the service. The jacket materials from different manufacturers may vary because the physical properties of PE material may be different depending on the type of PE and manufacture process. To address the issue, researchers conducted combined Taber abrasion-resistance and scrape-resistance testing of the wire insulation to simulate worst-scenario conditions in the field (e.g., where the wire is pulling through a rocky area) that may cause coating breakage by the combination of abrasion and scrape damage.

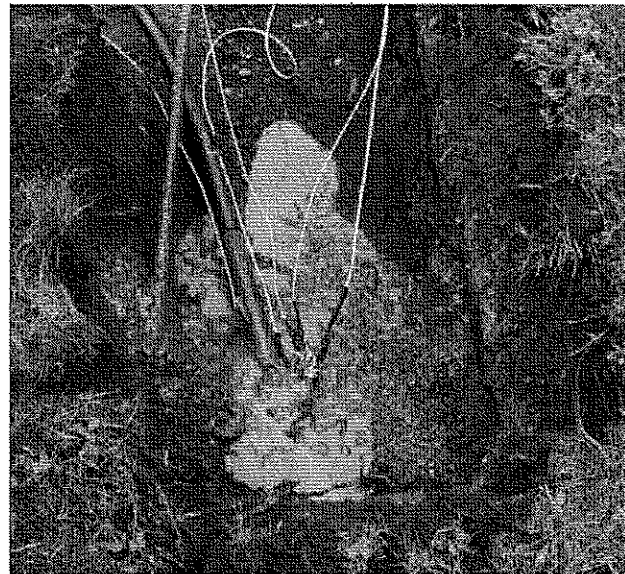

Five tracer wires were used during an HDD pipe installation field test.

The research team received different tracer wires from the sponsoring companies and the woven-fiber wire from the manufacturer for laboratory testing.

A field HDD installation was performed in 2011. Four wires were installed through the HDD installation process. Except for one wire that was left in the field, the tracer wires were pulled out and evaluated.

A second field test was conducted on April 30, 2012, in Batavia, IL. This approximately 340-foot HDD water-pipe installation project was in a very rocky area. Four wires were pulled through and brought back for inspection.

Researchers also evaluated the tensile properties of the various wires that were tested in this project and initiated corrosion chamber tests.

Status

Testing is completed. Data is presented in a new technical report, *Tracer Wire for HDD Applications*, which is available through the OTD website: otd-co.org.

For more information:

Maureen Droessler
Program Administrator
Operations Technology Development, NFP
Phone: 847/768-0608
maureen.droessler@otd-co.org

OTDOperations
Technology
Development**OPERATIONS INFRASTRUCTURE SUPPORT****Intelligent Utility System**

Research is under way to develop a low-cost, user-friendly Intelligent Utility System that reduces the cost of collecting and managing operational data and improves the quality of field-collected data.

Project Description

For gas operations, rising costs and regulatory pressures are generating the need for an Intelligent Utility System that can create, collect, transmit, merge, and utilize data to develop knowledge for optimizing O&M and capital expenditures while ensuring compliance in the most cost-effective manner.

In an effort to develop such a system, researchers are teaming with utility company and using smartphones, cloud computing, and other technologies to provide a low-cost, easy-to-use system that can be extended to a variety of operations.

Several current research projects initiated in recent years focused on the development and investigation of emerging technologies to automate the data-collection and management process. The objective of the Intelligent Utility System is to combine the results of these individual projects into one comprehensive program.

Ongoing projects include:

- **Gas Distribution Model (GDM)** – an industry data model that will serve as the data exchange format between an operator's existing data model, software, and sensors.
- **Leveraging Consumer Technologies** – an effort to identify technologies (e.g., smartphones, social media, and web-editing) that could be used for utility operations.

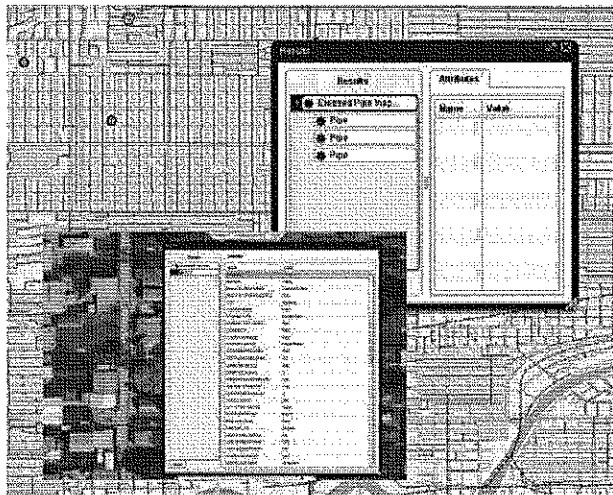

- **Smart Tag Expert User Group** – a project to identify emerging technologies and potential applications for smart tags in utility operations.
- **Remote Monitoring and Inspections** – an investigation of sensors that can be used to remotely monitor and inspect operations to increase coverage and reduce the cost of inspections.

In addition, researchers are working with individual sponsoring companies to develop specific applications as part of the Intelligent Utility System. These include:

- Applications for collecting new service-installation data utilizing mobile devices
- A pilot project to demonstrate the procedures and technologies for implementing an radio-frequency identification (RFID) tag marker-ball asset-locating system to reduce excavation damage
- An investigation on the use of smartphones and mobile GIS to automate field data collection for exposed pipe surveys.

Deliverables

The initial deliverable will be a forms-based and a map-based application for two utility operations. Seven pilot projects will be conducted to test and demonstrate the use of the developed applications. The deliverables for two sponsors will be smartphone/tablet devices with the new mobile service-installation application.

Benefits

Adoption of the Intelligent Utility System will provide value in both the short and long term.

Short-term value will result from reducing the cost of collecting field data as part of routine operations and compliance activities. Long-term value will result from reducing system risk and optimizing maintenance, repair, and inspection activities.

Data collection and management is labor intensive and represents a large cost to operators. The cost of data

management – including collection in the field and processing in the office – could be decreased in two ways:

1). The data could be automatically created with sensors and stored on smart tags. The data could then be captured with low-cost electronic data collectors (e.g., smartphones) or it could be remotely transmitted in real time to eliminate the need for field visits.

2) The electronic data could be collected in a standardized way that allows it to be seamlessly transferred to a permanent database repository where it can be combined with other data and used for populating models, compliance reports, or operational software.

Automated and electronic data capture will lead to a reduction in data-entry errors, eliminate labor costs due to back-office processing, and improve overall data quality. Enhanced data will allow for the optimization of various activities including surveys, inspections, work order dispatching, and repair/replace decisions.

Technical Concept & Approach

Operators currently collect large amounts of data to record the location and monitor the condition of their utility assets. Some of this data is collected as part of regulatory requirements while other data is proactively collected to ensure the integrity of the infrastructure.

Most utility companies have already invested in a GIS for mapping and data-management purposes. The GIS is an ideal platform for redefining and improving the utilization of labor, materials, and contract services. Using a low-cost data collection methodology integrated with GIS technology is at the heart of the Intelligent Utility System.

The Intelligent Utility System research program will be conducted in three phases:

Phase 1 will focus on reducing the cost of data collection and management using smartphones, smart tags, and cloud computing.

Phase 2 will focus on automating the collection of inspection and survey data to reduce (or even eliminate) the time required for on-site collection.

Phase 3 will focus on developing analysis tools to improve operating knowledge, recommend specific actions, and provide logistical support functions for optimizing the dispatch, warehousing, and deployment of field resources.

The chameleon software and the disconnected editing environment that is being developed in this project will create a mobile computing environment that can be used to collect geospatial data and any associated inspection data for a natural gas system independent of a

connection to a server environment. This development is key in mobile data collection as it allows for the collection and synchronization of a variety of gas features and associated inspection records regardless of the presence of a cellular network connection to the internet. Automatic update of both the gas features and changes to any inspection records are managed completely under program control, relieving the field technician of manually synchronizing data at a file level as is often the case with similar technologies. This system also will allow the utility to create their own data-collection system through the use of a user-friendly tool set.

A Final Report will be provided that details the applications-development process, best practices, business-case considerations, and pilot results.

Results

In 2012, several pilot projects with sponsoring utilities were initiated. Specific accomplishments include:

- Deployment of a 2nd-version iPad application for exposed pipe
- A study of devices and training for an RFID marker-ball locating systems
- Deployment of marker balls using a high-accuracy GPS receiver
- The deployment on an application for high-consequence areas
- The development and deployment of an Esri ArcGIS-based web-mapping application for the purposes of data visualization and data sharing.

In addition, Phase 2 activities were outlined and include disconnected editing to alleviate some of the connectivity issues experienced in pilot projects.

Status

The research team continues to support the ongoing pilot projects and will make updates and improvements as necessary.

For more information:

Maureen Droessler
Program Administrator
Operations Technology Development, NFP
Phone: 847/768-0608
maureen.droessler@otd-co.org



Operations
Technology
Development

Automating the Capture of Public Data for Integrity Management Database Specifications

A new program was initiated to create an industry database of publicly available data – such as population density, permitting, soil, encroachment, and seismic activity – to assist in executing integrity-management programs.

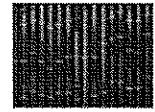

Project Description

Gas companies are responsible for maintaining accurate information on structure locations and population density in order to determine high-consequence areas (HCAs). Defining business districts also requires the identification of areas for extra surveys and inspections. Additionally, risk analysis for distribution systems will involve the collection of similar information for determining the likelihood and consequence of failures.

Gas operators gather information on environmentally sensitive areas, pavement cover, wetlands, and structures and locations where people congregate, conduct business, or receive medical care. In some cases, such as home-based childcare providers, occupancy information is nearly impossible to gather through the use of traditional techniques. The burden of ensuring that this information is complete and current falls on the operator.

While data may be available, the cost to collect, process, normalize, and conflate the data can be excessive compared to the value that it provides. Automation and batch processing could potentially reduce the cost of turning public data into useable information, especially

if this were performed on a consortium basis instead of by an individual operator. A single database for publicly available data would also reduce or eliminate duplicative data collection efforts that might be occurring within a company.

Researchers have teamed with a utility GIS and data-management services company to create an industry database of publicly available information (e.g., population density, permitting, soil, encroachment, and seismic activity) to assist operators in executing integrity-management programs.

Deliverables

Phase 1 project results include database specifications to provide a:

- Description of what data will be collected
- Methodology for data modeling and normalization
- Process for data extraction and migration
- Process for automated updates and expansion.

GDIM Initial Version 1.1
Geographic Data Integration Manager for Integrity Management

The screenshot displays the main interface of the GDIM software. It features a central map area with several data tables overlaid. The tables include columns for various attributes such as 'Structure ID', 'Structure Name', 'Structure Type', 'Structure Address', 'Structure Status', 'Structure Age', 'Structure Height', 'Structure Area', 'Structure Volume', 'Structure Weight', 'Structure Material', 'Structure Color', 'Structure Orientation', 'Structure Orientation Angle', 'Structure Orientation Angle (Degrees)', 'Structure Orientation Angle (Radians)', 'Structure Orientation Angle (Degrees) (Normalized)', 'Structure Orientation Angle (Radians) (Normalized)', 'Structure Orientation Angle (Degrees) (Normalized) (Rounded)', 'Structure Orientation Angle (Radians) (Normalized) (Rounded)', 'Structure Orientation Angle (Degrees) (Normalized) (Rounded) (Integer)', 'Structure Orientation Angle (Radians) (Normalized) (Rounded) (Integer)', 'Structure Orientation Angle (Degrees) (Normalized) (Rounded) (Integer) (String)', 'Structure Orientation Angle (Radians) (Normalized) (Rounded) (Integer) (String)', 'Structure Orientation Angle (Degrees) (Normalized) (Rounded) (Integer) (String) (Lowercase)', 'Structure Orientation Angle (Radians) (Normalized) (Rounded) (Integer) (String) (Lowercase)', 'Structure Orientation Angle (Degrees) (Normalized) (Rounded) (Integer) (String) (Uppercase)', 'Structure Orientation Angle (Radians) (Normalized) (Rounded) (Integer) (String) (Uppercase)', 'Structure Orientation Angle (Degrees) (Normalized) (Rounded) (Integer) (String) (Titlecase)', 'Structure Orientation Angle (Radians) (Normalized) (Rounded) (Integer) (String) (Titlecase)'. The interface also includes a 'Structure Check and Add Feature Dialog' and a 'Structure Check and Add Feature Dialog'.

The screenshot shows a GIS application window with a map of a region. A data table is overlaid on the map, displaying columns for 'Structure ID', 'Structure Name', 'Structure Type', 'Structure Address', 'Structure Status', 'Structure Age', 'Structure Height', 'Structure Area', 'Structure Volume', 'Structure Weight', 'Structure Material', 'Structure Color', 'Structure Orientation', 'Structure Orientation Angle', 'Structure Orientation Angle (Degrees)', 'Structure Orientation Angle (Radians)', 'Structure Orientation Angle (Degrees) (Normalized)', 'Structure Orientation Angle (Radians) (Normalized)', 'Structure Orientation Angle (Degrees) (Normalized) (Rounded)', 'Structure Orientation Angle (Radians) (Normalized) (Rounded)', 'Structure Orientation Angle (Degrees) (Normalized) (Rounded) (Integer)', 'Structure Orientation Angle (Radians) (Normalized) (Rounded) (Integer)', 'Structure Orientation Angle (Degrees) (Normalized) (Rounded) (Integer) (String)', 'Structure Orientation Angle (Radians) (Normalized) (Rounded) (Integer) (String)', 'Structure Orientation Angle (Degrees) (Normalized) (Rounded) (Integer) (String) (Lowercase)', 'Structure Orientation Angle (Radians) (Normalized) (Rounded) (Integer) (String) (Lowercase)', 'Structure Orientation Angle (Degrees) (Normalized) (Rounded) (Integer) (String) (Uppercase)', 'Structure Orientation Angle (Radians) (Normalized) (Rounded) (Integer) (String) (Uppercase)', 'Structure Orientation Angle (Degrees) (Normalized) (Rounded) (Integer) (String) (Titlecase)', 'Structure Orientation Angle (Radians) (Normalized) (Rounded) (Integer) (String) (Titlecase)'. The map shows a network of roads and structures.

The screenshot shows a GIS application window with a map of a region. A data table is overlaid on the map, displaying columns for 'Structure ID', 'Structure Name', 'Structure Type', 'Structure Address', 'Structure Status', 'Structure Age', 'Structure Height', 'Structure Area', 'Structure Volume', 'Structure Weight', 'Structure Material', 'Structure Color', 'Structure Orientation', 'Structure Orientation Angle', 'Structure Orientation Angle (Degrees)', 'Structure Orientation Angle (Radians)', 'Structure Orientation Angle (Degrees) (Normalized)', 'Structure Orientation Angle (Radians) (Normalized)', 'Structure Orientation Angle (Degrees) (Normalized) (Rounded)', 'Structure Orientation Angle (Radians) (Normalized) (Rounded)', 'Structure Orientation Angle (Degrees) (Normalized) (Rounded) (Integer)', 'Structure Orientation Angle (Radians) (Normalized) (Rounded) (Integer)', 'Structure Orientation Angle (Degrees) (Normalized) (Rounded) (Integer) (String)', 'Structure Orientation Angle (Radians) (Normalized) (Rounded) (Integer) (String)', 'Structure Orientation Angle (Degrees) (Normalized) (Rounded) (Integer) (String) (Lowercase)', 'Structure Orientation Angle (Radians) (Normalized) (Rounded) (Integer) (String) (Lowercase)', 'Structure Orientation Angle (Degrees) (Normalized) (Rounded) (Integer) (String) (Uppercase)', 'Structure Orientation Angle (Radians) (Normalized) (Rounded) (Integer) (String) (Uppercase)', 'Structure Orientation Angle (Degrees) (Normalized) (Rounded) (Integer) (String) (Titlecase)', 'Structure Orientation Angle (Radians) (Normalized) (Rounded) (Integer) (String) (Titlecase)'. The map shows a network of roads and structures.

Research is under way to create an easy-to-use database of publicly available information.

Benefits

This project will provide a low-cost method to leverage economies of scale to collaboratively collect publicly available data for operators using a common platform.

The objectives are to:

- Decrease the cost of data collection by leveraging public, and often free, data
- Decrease the cost of data processing by creating an automated normalization process that prepares data for direct integration into an operator's system
- Decrease the cost of field data collection by using publicly available data to pinpoint areas for further investigation
- Decrease risk by increasing the amount of information made available to improve risk modeling
- Decrease risk by ensuring timely and standardized data update intervals
- Decrease risk by providing a defensible and documented approach to data collection and classifications such as HCAs and business districts.

Technical Concept & Approach

Advances in computing power, modeling, sensors and open-source data aggregation have created new opportunities to improve the quality and reduce the cost of data collection. Specifically, data sets from the government and other organizations are now available to the public in a format that allows integration with mapping systems. The purpose of this project is to determine the feasibility and value of developing a system to automate the capture and integration of publicly available data to supplement integrity management analysis.

Specific tasks include:

- **Identification of Data Needs**
- **Identification of Data Sources**
- **Development of Database Specifications.**

Results

The results of a data-needs survey indicated that limited mobility sites and building footprints were most im-

portant, with landbase layers such as street centerline, right-of-way, railroads, and easements also ranking as important.

A data-availability assessment was performed to determine the availability of the data sets that would meet the needs identified in the data needs survey. The results indicate the required data is available in a format that will allow collection and integration with standard GIS platforms.

A data model was developed to provide structure to the data-needs and data-availability assessment results. A map service was prepared to provide a demonstration of how a publicly available data set could be integrated into a GIS.

The results of this project indicate that it is not only feasible to develop an industry database of publicly available data, but that such a database would provide value to operators. The industry database would allow operators to supplement existing data layers in the GIS and in some cases would represent new information that is currently not available.

Status

The next step in this program is to conduct a proof-of-concept demonstration in one geographic region that will further test the feasibility and value of an industry database of publicly available information to support integrity-management analysis.

In terms of data availability, about 70% of the survey respondents indicated that the majority of data is not readily available within their organization. This indicates that the industry data needs are not currently being satisfied, resulting in the need to acquire and distribute these data sets to address regulatory requirements. The survey responses also indicated that although some important data sets are readily available within their organizations, these data sets may need to be updated and maintained more frequently and efficiently.

For more information:

Maureen Droessler
Program Administrator
Operations Technology Development, NFP
Phone: 847/768-0608
maureen.droessler@otd-co.org



Operations
 Technology
 Development

OPERATIONS INFRASTRUCTURE SUPPORT

Intelligent Utility Installation Process

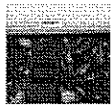

A research team developed an Intelligent Utility Installation Process to provide a methodology, field process, and a data model for capturing data during new utility installations.

Project Description

New installations, replacement programs, and extension projects are ideal opportunities for capturing and documenting asset and related gas-system information. However, many operators are using outdated methods to collect this information or are not collecting it at all.

Existing and future requirements obligate local distribution companies to maintain complete and accurate data that will be important for Distribution Integrity Management (DIM) compliance, risk analysis, and future system use considerations.

The objective of this project was to develop an Intelligent Utility Installation Process that provides a methodology, field process, and a data model for capturing data during new installations. The process is used to capture information regarding the location, materials, installation process, environmental considerations, and other factors.

Deliverables

Deliverables for this project include data-collection guidelines; a data model; field-data-collection procedures for GPS; smart tag programming protocols and installation procedures; a methodology for determining and documenting data quality; technology recommendations; and regional workshops.

Benefits

There are many existing and future beneficial uses for the type of data to be collected through the Intelligent Installation Process, including:

- **DIM Compliance** – New DIM regulations will require operators to collect information during new installations and exposures to facilitate the execution of a DIM program.
- **Analysis** – Increased and improved data will facilitate a full and proper risk analysis and optimization of risk management efforts.
- **Industry Standardization and Adoption** – The development of industry standards in data collec-

tion will enable widespread adoption and use by utilities and their contractors.

- **Future Considerations** – Gathering information during construction will ensure that future issues or opportunities can be evaluated with quality data without incurring the cost of collecting it.

Technical Concept & Approach

The Intelligent Utility Installation Process provides a methodology to collect information during new installations (as well as exposures during routine maintenance). The methodology includes field-data-collection procedures, as-built drawing guidelines, and data model formats.

Examples of information to be collected include:

- Location
- Changes in direction
- Location of abandoned facilities

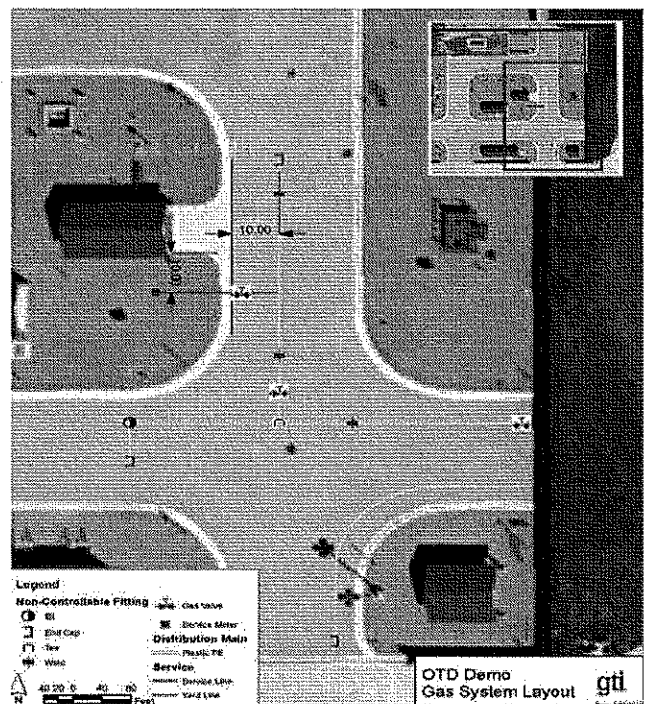

- Material properties
- Installation method
- Environmental conditions
- Supporting assets (e.g., tracer wire, marker balls, and warning tape)
- Coupling and joining information
- Contractor and field personnel information
- Pressure test records
- Inspection records.

The research team provided recommendations for such technologies as GPS, RFID and smart tags, laser scanning, barcode scanning, and other field-data-collection devices.

Results

Several assumptions were required to develop the recommended logical data model and high-level processes for capturing data during field installations. It was important to realize that this is a data-capture process that would be used for all future field work and must be capable of providing full tracking and traceability, trend analysis, risk identification, and threat mitigation.

A geographic information system (GIS) was recommended to be the data repository, providing a spatially enabled relational database. It was also important to develop a data-capture process with the flexibility of "turning on" features as they are needed to make the data acquisition possible.

The data modeling development progressed in parallel with the development of the data-capture process with the model becoming more complex and detailed, transitioning from a conceptual data model to a logical model. The logical model is an abstract representation of the things that are most important and how they relate to one another. The logical model will be the foundation of the physical model.

Activities focused on:

- Providing high-level summaries and flowcharts of the data-collection processes
- Providing a Logical Data Model that would serve as the framework for the final data model, and
- Providing recommendations on the technologies needed to collect the proposed data.

Barcoding technology integrated with high-accuracy GPS and a hand-held field-data-collection device was

chosen as the first combination of technologies to demonstrate.

A set of guidelines for operators and manufacturers is recommended to support the implementation of the material and manufacturing marking standards described in ASTM F2897-11. The recommended guidelines would address the issues related to the permanency and durability of the barcode markings, how frequently the markings should be made, how the various fittings and appurtenances should be marked, and what type of marking techniques should be used. The development of the guidelines will be included Phase 2 of this project.

Other technologies and information that were investigated include:

- An automated polyethylene-pipe-welding machine
- GIS
- GIS barcode decoding tools
- Groundbed and backfill sensing devices
- Hand-held field-data-collection devices
- High-accuracy GPS
- Life-cycle tracking of specifications and procedures
- Long-term traceability
- Mobile device area networks
- Publically available data integrated in the GIS.

Status

Phase 1 of the project is completed. A report was issued in September 2012.

High-level summaries as well as graphically illustrated flowcharts were presented to provide clear descriptions and show the inter-relationships of each step and sub-process. The report also identifies the technologies to be used during field-data collection to automate data capture while reducing or eliminating the opportunity for human error.

For more information:

Maureen Droessler
Program Administrator
Operations Technology Development, NFP
Phone: 847/768-0608
maureen.droessler@otd-co.org

OTD

Operations
Technology
Development

OPERATIONS INFRASTRUCTURE SUPPORT

Quality-Control Procedure for High-Potential Anodes

A series of laboratory tests is being conducted in an effort to develop a quality-control procedure for high-potential magnesium anodes used in cathodic-protection systems. The goal is to develop a method that verifies the potential, current, and efficiency of the anodes.



Project Description

Utilities apply high-potential (HP) magnesium anodes to challenging locations that need a maximum of cathodic protection (CP). However, there is a growing concern about the efficiency and service life of these anodes.

A simple and common method for testing an anode is performed by wetting the anode and reading its potential with a digital multi-meter referenced to a copper-copper sulfate electrode (CSE). This test only addresses the open circuit potential and *not* the current or efficiency performance of these HP anodes – both key parameters for the anode's ability to protect assets and meet expected service life.

Utility anode purchases are typically from a variety of suppliers, some of which are offshore. The ability to acquire HP magnesium anodes from multiple sources and at competitive prices is desirable; however, a simple and effective quality-control (QC) procedure is needed.

The objective of this project is to develop a QC procedure for HP magnesium anodes that verifies the potential, current, and efficiency of the products. The procedure must provide a reasonable correlation to the ASTM G97 efficiency test result, but be much less labor intensive.

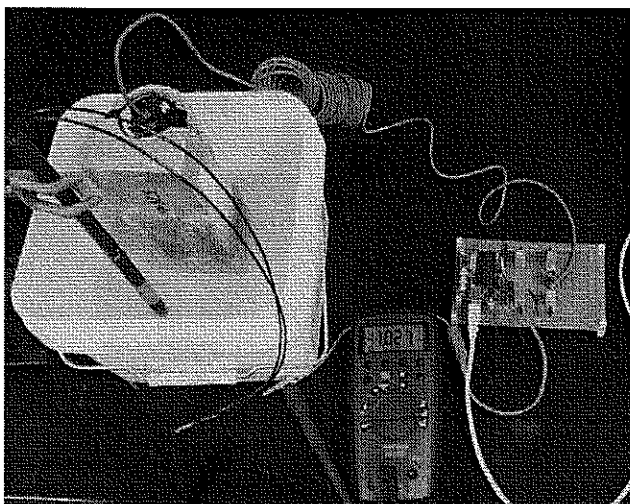

Efficiency testing of high-performance magnesium anodes.

Deliverables

The deliverables include:

- A complete analysis and test reports for all processed samples
- A recommended QC procedure that can quickly provide a determination of the quality of an HP magnesium anode.

Benefits

Utilities pay a premium price for HP magnesium anodes; however, the performance of these anodes is not always representative of high-purity materials. The HP anodes are usually installed in known trouble areas, where additional reinforcement of the cathodic protection is required.

There is a risk involved with installing off-spec anodes in challenging locations where high performance is needed: the asset that needs CP may not receive it. Even anodes that initially perform well may have lower-than-stated efficiency, causing the anode to have a shorter-than-expected service life.

Information developed through this research project will help utilities provide adequate protection for their buried assets and maximize the benefit CP systems.

Technical Concept & Approach

The scope for this project is to develop a simple QC procedure for the testing of incoming HP anodes. In addition to the potential and current of the anodes, a rapid means of quantifying the efficiency is also being pursued. Since efficiency has a direct impact on the longevity of the anode, correctly sizing the anode for its service life requires accurate knowledge of the efficiency.

The rapid QC procedure will need to be validated against the ASTM G97 standard.

This project includes the following tasks:

- **Potential and Current Testing**

This test involves removing the anode from the bag of fill material and placing it in a water bath with a known chemistry. The bath also contains a reference electrode and a steel coupon of known surface area and composition. An electronics package measures the anodes potential for both open circuit and under load as well as the current to the coupon.

At the end of initial testing, the anode is sectioned into three pieces. These pieces are used for chemical-composition testing, electrochemical-impedance testing, and ASTM G97 efficiency testing

- **Electrochemical-Impedance Testing**

One section of the anode is subjected to longer-term electrochemical-impedance testing. This checks for purity throughout the anode – and not just the outer layer – to guard against sub-standard material/ally use in the core with a superficial outer coating of high-performance material. The purpose of this testing is to develop a DC-potential-versus-current curve for each sample anode. The AC electrochemical impedance will also be measured. These curves will provide a prediction of corrosion rate over the lifetime of the anode.

- **Validation of Efficiency**

This ASTM G97 test is the accepted standard for quantifying the efficiency of anodes. This test involves destructive testing of the anode over a period of 14 days. The efficiency of each sample anode will be recorded. A set of anodes will be sent to an external laboratory for the G97 test to provide baseline validation for the test apparatus.

- **Analysis and Procedure Synthesis**

Data will be correlated with anode-efficiency information. The goal is to determine if any of the shorter test procedures can quantify the overall quality of the anode. Research will address the following questions:

- Will the potential remain high?
- Will the current output be sufficient?
- Is the efficiency adequate to provide the expected service life?

A recommended QC procedure will be written based on these findings.

The ASTM G97 and electrochemical-impedance spectroscopy (EIS) data from all the samples will be

analyzed. The potential method for determining efficiency will be compared with benchmark tests to rate its accuracy. A Final Report will be prepared providing recommendations for the method for determining the anode efficiency without the use of a full G97 test.

Results

In 2012, initial potentials were measured from pieces of anodes to complete EIS testing.

Eight anode samples completed EIS testing at three contact positions per sample. Three positions on the plate were tested in order to provide a reasonable cross-section across the body of the anode and to test the behavior of the anode at varying voltage settings, comparable to those experienced during G97 testing.

Graphic plots were developed to show the relationship between several anodes, each with different G97 efficiency ratings. The plots show the impedance at different frequencies, sweeping from 0.001 Hz (nearly DC) to 1 kHz. These plots indicate significant differences in impedance under three voltage scenarios, which may explain the swing in G97 rated efficiencies. Conclusions will be made after a formal analysis.

Three samples were shipped to a third-party testing facility in Ohio. Samples were selected based on the performance during G97 testing. A summary of samples and other information was provided in a report to project sponsors.

Status

Potential and current testing on additional samples are ongoing. Data are being analyzed. Results from third-party testing are being incorporated into the analysis. A longer-term potential and current test that requires very little preparatory machining is being evaluated.

Researchers will compare measurements and results of the EIS tests to the initial readings and the G97 efficiency ratings and report any correlations or discrepancies.

Experiments will be performed to correlate initial potential, EIS, and G97 findings with possible new efficiency testing procedures.

For more information:

Maureen Droessler

Program Administrator

Operations Technology Development, NFP

Phone: 847/768-0608

maureen.droessler@otd-co.org

OTDOperations
Technology
Development**OPERATIONS INFRASTRUCTURE SUPPORT****Smart Grid Initiative Standards and Regulations**

This project is focused on the development and operation of a working group and specific activities designed to represent the technology needs for the natural gas industry in current and future smart-grid initiatives.

Project Description

This project is the first phase of a series of planned smart-grid infrastructure projects.

The objective is to ensure that the infrastructure requirements that are specific to the natural gas industry are included in the ongoing technology, standards, and regulatory initiatives currently focused on electric smart-grid initiatives.

One of the goals of this project is to develop and deploy technologies and processes that effectively use two-way communications and intelligent field devices to enhance the safety and efficiency of the natural gas infrastructure to effectively serve new demand and supply sources and integrate with other infrastructure grids.

Industry experts note that while there is a growing need for the natural gas industry to improve the ability to track the complex information, technology can help to address a variety of related issues:

- New sources of demand for natural gas (e.g., power generation, direct end use, and vehicles) and new sources of gas supply (renewable and shale gas) are having an impact on the industry. As a result, load monitoring, load balancing, and the need for real-time information on supply and demand becomes increasingly more important.

- Energy efficiency and emissions-reduction targets could place new requirements on natural gas operators to provide real-time usage information to customers through smart meters. Variable energy pricing schemes to influence consumer behavior would also require smart meters and two-way communications.
- Existing and pending regulations for increased integrity management and enhanced system safety and functionality could effectively be achieved through sensors and remote controls capable of detecting excavation encroachment, corrosion, and leaks, and providing remote controls to shutoff valves.
- Operators are under increasing pressure to reduce operational costs. A sensor-enabled infrastructure could reduce the need for manual data collection and reduce the labor costs associated with surveys, inspections, and other manual data-collection activities.

This project would provide the natural gas industry with a focal point where the overlap of technology, standards, and regulations is known and understood, reference materials can be accessed, issues and concerns can be discussed, and enhancements and/or new or novel capabilities can be addressed.

This initiative provides the gas industry with:

- Active participation in standards development for sensors, automation, and smart-grid connectivity
- Representation at organizations recognized for their efforts to create an open forum for technology development and deployment
- An on-line source for standards, documents, reference designs, testing results, and case studies
- An assessment of how regulatory issues may drive the need for new technologies and a framework for regulatory interactions to ensure natural gas infrastructure is considered.

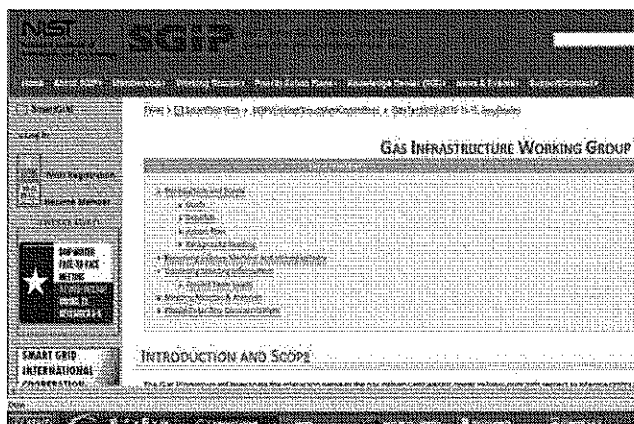

Public information is maintained at Smart Grid Interoperability Panel web-site at:

<http://collaborate.nist.gov/wiki-sggrid/bin/view/SmartGrid.GasTechWG>

Benefits

Benefits include:

- The ability to monitor and measure new supply sources
- Risk reduction resulting from enhanced monitoring for leaks, ruptures, and excavation damage
- Reduced costs resulting from automated data collection
- Reduced risk through the use of automated meter shutoffs
- The ability to collect information that can be used to better estimate infrastructure loads
- The ability to monitor volume to prevent Lost and Unaccounted For (LAUF) gas and theft
- The ability to enhance customer interactions through smart meters
- The ability to monitor customer-usage information for improved load balancing and modeling
- The ability to provide customers with real-time usage information through smart meters to improve energy efficiency and to facilitate interruptible service.

Deliverables

The deliverables of Phase 1 include the following:

- Quarterly newsletters
- Results of standards activities
- A White Paper providing recommendations for regulatory interactions, and
- An on-line reference system.

Technical Concept & Approach

Project Tasks:

- **Participation in Industry Standards Development Organizations**

On behalf of the Smart Grid Initiative, Gas Technology Institute will establish and maintain memberships in organizations with the potential to influence the technologies and standards in use or being developed that could optimize the natural gas delivery infrastructure. These memberships will provide

the gas industry with a focused, unified voice in the emerging technology forums.

- **Examination of Regulatory Issues**

In this task, a White Paper will be developed to provide guidance and recommendations for coordinating infrastructure development between electric and gas smart grids from a regulatory perspective.

- **Establishment of an On-line Reference System**

GTI will develop an on-line reference system that contains technology, standards, and regulatory information related to smart grid topics.

Results / Status

The research team recognized that working with the Smart Grid Interoperability Panel (SGIP), organized and managed under the leadership of the National Institute of Standards and Technology (NIST), would provide a direct link to the industry's most influential standards-review process for interoperability.

Efforts to create a Gas Technology Domain Expert Working Group (GT DEWG) under the SGIP were successfully completed with the first meeting of the GT DEWG taking place in August 2012. Future meetings will address interoperability for public/private networks and end-use devices, data and cyber security, and the need for common emergency communications channels, reconfigurable communications strategies, and other topics.

An on-line reference system was established, consisting of two parts:

1. The GT DEWG under the SGIP uses the Twiki site for all Working Group related activities and an on-line newsletter. This site is available to the public at:

<http://collaborate.nist.gov/twiki-sgrid/bin/view/SmartGrid.GasTechWG>

2. Separate and distinct from this public site, an on-line newsletter will be located on the OTD website in a section only accessible to the sponsors.

For more information:

Maureen Droessler

Program Administrator

Operations Technology Development, NFP

Phone: 847/768-0608

maureen.droessler@otd-co.org

OTDOperations
Technology
Development**OPERATIONS INFRASTRUCTURE SUPPORT**

Integrating Sensors with Existing Automated Meter-Reading Systems

Efforts are under way to demonstrate the feasibility of adapting sensors to existing automated meter-reading systems in order to acquire additional information about specific distribution systems.



Project Description

Many operators of gas utilities have implemented automated meter-reading (AMR) systems of varying extent. These systems represent an existing data communication and database infrastructure that could be used to capture additional operational and engineering information – beyond meter readings – to enhance system monitoring and control.

As part of this project, an operator's existing AMR system was equipped with additional sensor technology to record pressure readings at select locations. The overall objective is to evaluate and demonstrate the integration of pressure sensors and other types of sensors into legacy AMR and advanced metering-infrastructure systems.

Pressure sensors were identified as beneficial to integrate with existing AMR infrastructures. However, AMR systems could be adapted to work with other sensors to provide information on:

- Cathodic protection (CP) potentials
- Rectifier currents
- Water and methane levels in vaults, and
- Entries and exits from secure areas.

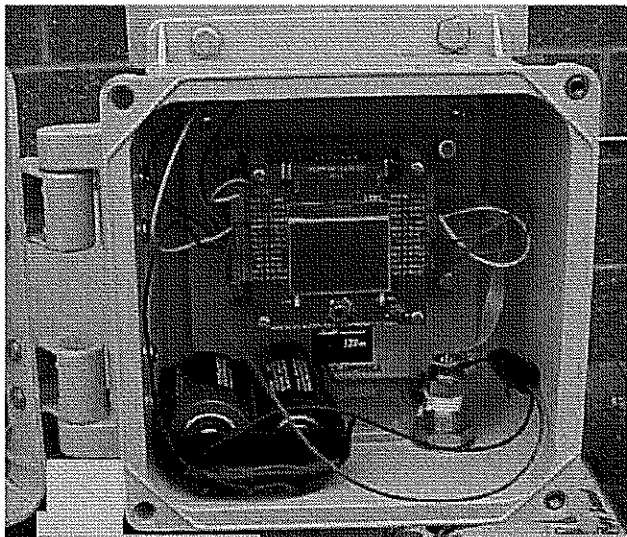

Pressure-sensor technology was adapted for an AMR radio.

Deliverables

The deliverables of this project include:

- A set of AMR-enabled sensors that are compliant with the operator's AMR system
- A defined format and collection methodology that allows the sensor data to be extracted from the meter-reading database
- A pilot project that demonstrates the capability of providing existing AMR systems with additional sensors.

Benefits

The results of this project will facilitate the use of existing AMR systems to gather operational data (e.g., pressure and corrosion readings) and help to lower operating costs and reduce risk.

Cost reduction will be achieved by decreasing the labor requirements for field-data collection. Risk reduction will result from receiving more frequent access to operational data that could alert operators of a potential issue. Leveraging existing AMR systems will reduce the cost of implementing a sensor network.

Technical Concept & Approach

This project initially focuses on using an operator's existing AMR system with additional sensor technology to capture pressure readings at select locations.

Most AMR product lines have generic radio "heads" that allow data to be transmitted to a handheld unit, reading truck, or stationary tower. The goal is provide an interface between the generic AMR radio and pressure sensors.

Specific project tasks include:

- **Technology Review and Selection**

This task involves a review of currently available sensors and AMR devices in order to make recommendations for the pilot project. Sensor and AMR vendors will also be engaged to participate.

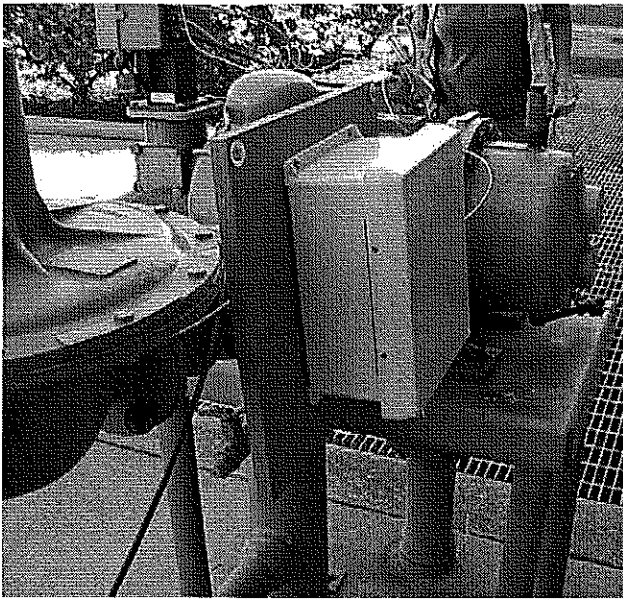

Prototype deployed at utility site.

- **Pilot Project**

Sensors will be placed at specific locations selected by the operator.

- **Back Office Data Collection**

A methodology for extracting pressure or other sensor data from the AMR database will be developed. A data format will also need to be defined to allow the pressure data to fit within the standard record field used for meter readings.

- **Final Report**

A final report will be generated that incorporates the results of the technology analysis, pilot project, and data-collection methodology.

Itron radios were selected to be used since the majority of the project sponsors used Itron as their AMR provider. Researchers modified a communication protocol using Itron water meters to establish interconnectivity.

Results

A pressure logging system that had been developed under a GTI Sustaining Membership Program project was used as the basis for the AMR-enabled pressure monitor. An off-the-shelf Itron radio product was interfaced to the pressure loggers, enabling them to transmit a current pressure reading to a standard handheld meter-reading device. The monitors were placed at two sites to measure low pressure points on a gas distribution system. Additionally, the monitors record pressure data on a secure digital memory card on a minute-by-minute basis.

The AMR-enabled pressure monitors are located near existing utility pressure sensors, allowing an independent verification of their accuracy. Thus far, the new pressure monitors readings have tracked accurately with the pre-existing equipment. The pressure monitors are periodically read by utility personnel using the same model of handheld device that is currently used to read gas meter AMR end points.

Three prototypes were constructed to read pressure readings in the 0 to 30 psig range. Prior to deploying the prototypes in the field, bench testing was performed.

Two prototypes were delivered to a local utility in February 2012. The remaining prototype was removed from the test fixture and was demonstrated in May 2012.

The utility personnel supporting the pilot used a standard Itron FC300 handheld device to capture pressure readings. This is commonly used by meter readers performing walk-by reads. They are also used by technicians who set up and service the meters. The only modification required to the handheld was the installation of a custom configuration file on the device.

Researchers were able to successfully establish communication between pressure sensors and an Itron AMR system. In addition to capturing pressure readings with a handheld AMR device, pressures are also logged to a SD memory card every minute.

Prototypes collected data for several months. Deployment of additional prototypes for an extended duration is necessary to evaluate critical technical issues.

Status

In an additional phase for this project, researchers will extend the testing of the current hardware and examine the issues of collecting the pressure data in a more accessible fashion.

Testing may also be conducted to cover the evaluation of AMR-enabled CP-monitoring devices if prototypes can be secured in a timely fashion.

For more information:

Maureen Droessler

Program Administrator

Operations Technology Development, NFP

Phone: 847/768-0608

maureen.droessler@otd-co.org

OTDOperations
Technology
Development**OPERATIONS INFRASTRUCTURE SUPPORT****Breakaway Disconnect/Shut-off for Meter Risers**

To enhance gas-system safety, various design concepts are being investigated in an effort to develop a breakaway disconnect/shut-off fitting for meter risers and other above-ground gas facilities. In the event of an impact to a meter assembly, the device would automatically stop the flow of gas to the environment.

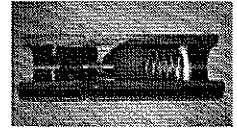
**Project Description**

Meter Set Assemblies (MSAs) and other above-ground gas facilities are often damaged by various outside forces, namely vehicular damage. To reduce the risk of gas leaks, fire, explosion, property damage and possible injury from an MSA impact, research is being conducted to develop a breakaway disconnect/shut-off fitting for MSAs.

Currently, many industries use breakaway disconnects. For example, vehicle fueling stations use them on their fuel pumps. If a car accidentally drives away with the fuel nozzle still in the gas tank, the breakaway disconnect shuts off the fuel line and eliminates the leak and possible hazard. Portable gas grills use similar disconnects, which are designed to be pulled apart manually. The liquid- and compressed-fuels industries also use disconnects in filling and recharging cylinders, tanks, and vehicles.

The objective of this project is to develop a breakaway disconnect/shut-off fitting MSA so that if an external force is large enough to sever the meter riser connection (e.g., a vehicle collision or impact from falling ice or snow), the breakaway disconnect will release from the riser and close, preventing natural gas from leaking to the surroundings.

Deliverables

Prototypes for field testing will be developed. Reports will be issued documenting the findings and results of the program.

Benefits

The introduction of a new breakaway disconnect/shut-off fitting will reduce potential hazards and enhance the overall safety in the delivery of natural gas.

Technical Concept & Approach

For this project, a research team is partnering with a manufacturer to create a prototype breakaway disconnect/shut-off fitting, which will be tested in a variety of conditions under Phase 1 of the project. Upon successful field trials, a production model will be manufactured in Phase 2.

Testing will be performed to determine the load needed to crack the breakaway. Once the correct load is determined, the prototypes will undergo live testing. Upon completion of the live testing, prototypes will be tested in field locations.

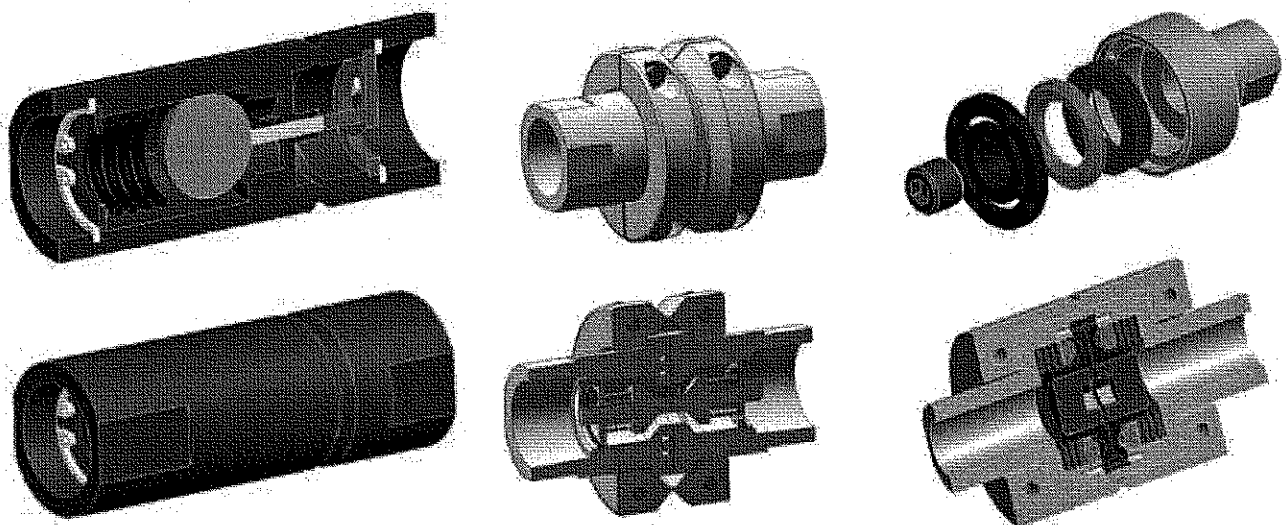

Researchers are investigating several design concepts developed for breakaway disconnect/shut-off fittings.

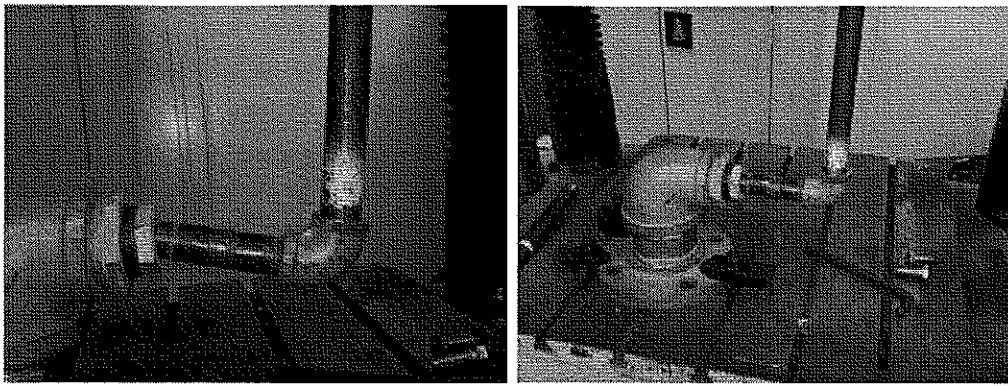

Baseline testing was conducted to determine the force when a pipe destructively breaks to simulate when a car hits the meter set through the use of a Tinius Olsen force machine, which can test tension, compression, flexure, shear, tear and peel.

Specific tasks include:

- **Reviewing Industry Needs and Identifying System Manufacturers**

System considerations include the size, function, pressure and flow ranges, location of device, and the installation methods.

- **Defining System Development Requirements**

Researchers will establish parameters for the configuration of breakaway fittings as they relate to meter sets and other identified applications. The range of forces that the breakaway fitting is required to address will be determined. Researchers will also establish size restrictions and flow requirements for industry use to assist the manufacturer with design and cost estimation of the breakaway fitting.

- **Developing Manufactured Prototype and Testing Breaker Fittings (Phase 2)**

Phase 2 will include laboratory testing and modification of the developed breakaway fitting prototype. The development of installation and reconnection procedures will also be produced. A research team, the manufacturer, and project sponsors will conduct field installations and evaluations.

Results

Initially, a survey was conducted to develop a better understanding of the natural gas industry needs and to determine design specifications. Subsequently, numerous concept designs were developed for the manufacture of a breakaway fitting for above-ground natural gas facilities.

The concept designs allow for various installation and operational needs. Some concepts involve components that are designed to be discarded when separated, while others allow for replacement of certain components to reassemble after breakage. Some concepts are designed

to be installed and operated above the service valve while others may work below the valve.

All designs have a built-in weak point that breaks when an external force acts on them. When the weak point breaks and the fitting moves apart, a check valve is activated inside the fitting, shutting off the flow of gas from the service line.

Various destructive pipe and fitting tests were conducted to determine the failure forces as they relate to meter sets. This included various sizes and types of risers in both used and new conditions. Based on this test data, engineers can design the breakaway to trigger well before any damage results to the other components.

To better understand the design requirements of the breakaway fitting, researchers worked with project sponsors and various industry manufacturers of anodeless service risers. The laboratory received various types, sizes, and styles of gas risers in both new and used conditions for a series of tests on various fittings.

Baseline testing was conducted to determine the force when a pipe destructively breaks to simulate when a car hits the meter set.

A riser set assembly unit was constructed to investigate the variety of riser sizes and styles that can be found in the natural gas industry.

Status

Field testing is expected to commence in early 2013.

For more information:

Maureen Droessler
Program Administrator
Operations Technology Development, NFP
Phone: 847/768-0608
maureen.droessler@otd-co.org



Essential Data Capture for PE Fusion Operations

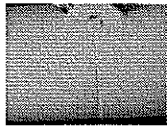

Researchers are developing a methodology to automate the data-capture process for PE fusion operations. Currently under development are a model to standardize the type and format of data, protocols for data transfer to a handheld device, and an assessment of supporting technologies.

Project Description

In this project, research is focused on developing a methodology to automate data capture during polyethylene (PE) pipe-joining processes to help determine the root cause of a pipe-joint or fitting failure and provide added information for Distribution Integrity Management (DIM) programs and other company activities.

Currently, when operators examine failed joints or fittings, they are often inhibited with a lack of information on how these fittings were assembled, the weather conditions during the joining process, equipment used to assemble the fittings, procedures followed, employee performing the fusion, and other factors. Even when failures do not occur, there is a need to have this data readily available so that quality audits can verify that proper processes and procedures were followed.

Plastic-pipe fusion processes (e.g., electrofusion and heat fusion) have remained the same for many years. Only minor technological upgrades have been incorporated into the electrofusion process, such as the use of barcodes to assist with fitting recognition. Also, data-logging technologies have recently been made available for use with some of the hydraulic butt-fusion equipment. The development of fusion data protocols will allow some of these recent technological advances to provide more meaningful information to the operator.

System knowledge is also essential to improved DIM efforts. One of the needs of the industry is to better monitor and control who is qualified to perform the various PE joining processes during the assembly of the PE piping system. A need exists to allow fusion systems to manage operator qualifications and restrict users (company and contractor personnel) that are not properly qualified and/or with expired qualifications. New technologies could facilitate the implementation of a system that requires employees to be "approved" before using a specific piece of equipment or performing an operation.

The objective is to develop a methodology for capturing data on:

- Process parameters during the fusion
- Environmental conditions during the fusion process
- Employee and contractor information and status of operation qualification (OQ) certification
- Material and fitting information.

Deliverables

The deliverables of this project will provide the industry with a standardized methodology to capture information during the PE fusion process. At the conclusion of this project, a Final Report will be issued documenting the findings and results of the program (technical and business).

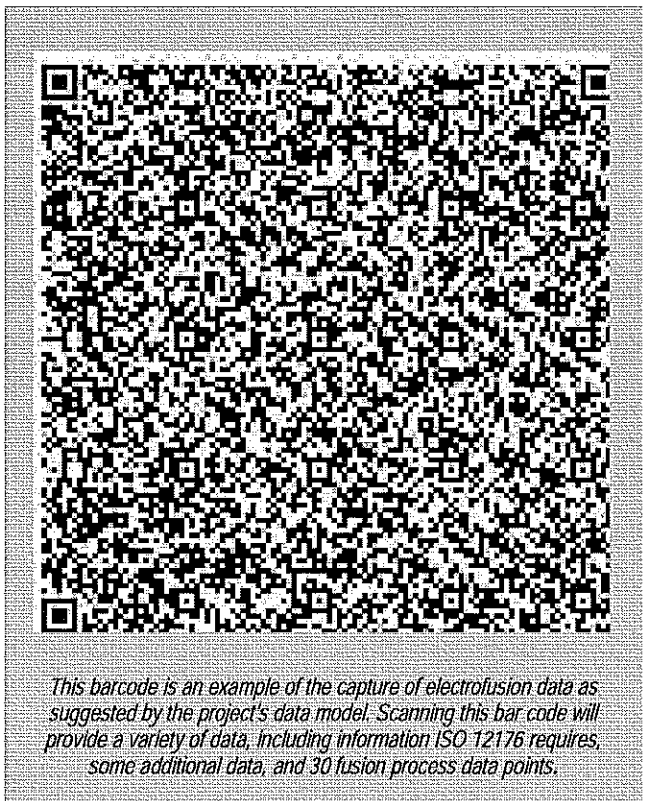

Benefits

A data model and data transfer protocol will assist manufacturers in incorporating automated data capture into PE fusion equipment. A standardized methodology will create an interoperable system to allow operators to utilize different fusion equipment and handheld devices without the need to modify data-collection procedures.

Capturing this information during routine operations will reduce operator risk and will demonstrate proactive DIM compliance. Collecting parameter information during operations will allow an inspector, in the office or in the field, to verify that the process was completed according to company specifications. The operational parameters can also be stored and later compared against leak records and other inspection results to identify trends.

In addition to capturing parameters, the system could be developed to include operator qualification (OQ) verification. Real-time verification would reduce a company's exposure to the risk of inappropriate operations and violation of OQ requirements, leading to enhanced monitoring of contractors without the need to increase field inspectors.

Technical Concept & Approach

This project includes the following tasks:

- **Capture Project Requirements and Communication with Industry**

This task includes a review of existing electrofusion control boxes and butt- and heat-fusion data loggers to assess their capability of serving as an input station for tracking installation information. This will also include communication with the various manufacturers to solicit their support of the standardized data-collection approach.

- **Develop Standardized Data Model**

Essential variables and their limits (e.g., operator, ambient temperature, etc.) will be established. The variables will differ based on the type of PE fusion processes addressed. The standard data model needs to be flexible and expandable to account for future processes and information needs.

- **Identify Operator Qualification Parameters**

One of the optional variables is the ability to determine OQ status. The research team will develop recommendations for utilities and manufacturers to allow for the acquisition of OQ information. An overview of the potential technological solutions to allow for OQ status to be monitored by various types of fusion equipment will be provided. This

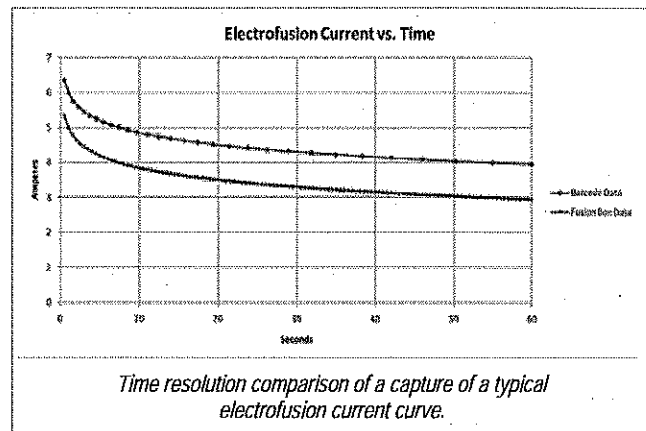

information will assist with future advances to provide the ability for utilities to reflect OQ to enable the fusion equipment to “approve” or “reject” use by operators based on OQ status.

- **Identify Data Transfer Protocol**

Researchers will identify existing data-transfer technologies that can be used to collect information during the fusion process.

- **Develop ASTM Standard or Other Industry Accepted Practice**

The research team will draft a new ASTM standard(s) or industry practice(s) to formalize a standard data structure and define standard codes of practice.

Results / Status

In 2012, researchers investigated various potential methods of capturing PE fusion data and transferring information into existing GIS databases, finding 2D barcodes well suited for this purpose.

An operator data survey was developed to assess industry needs and interests.

A detailed refinement of the data-capture model, relational database, input masks, and data-transfer methods is under way.

A draft of the data-capture standard(s)/practice(s) document was initiated for consideration by ASTM and/or other industry organizations.

For more information:

Maureen Droessler

Program Administrator

Operations Technology Development, NFP

Phone: 847/768-0608

maureen.droessler@otd-co.org

OTDOperations
Technology
Development**OPERATIONS INFRASTRUCTURE SUPPORT**

Ignition Testing of Electronic Devices



In this project, handheld electronic devices were tested to determine if ignition occurs in the presence of a flammable methane/air mixture. Laboratory tests demonstrated a large margin of safety under the scenarios investigated.

Project Description

Natural gas distribution companies issue electronic devices (e.g., cell phones, smart-phones, and data collectors) to employees for use in day-to-day activities, including entry into spaces that on rare occasions contain flammable mixtures of 4.5%-14.5% methane and air. Cell phone manufacturers issue a general warning that the product should not be used in the presence of flammable gases; for example, at gasoline stations. Utilities instruct employees to turn off the cell phone before entering a basement.

The industry would benefit from information that helps to understand the likelihood that these devices could act as a source of ignition under various operating conditions. However, determining the intrinsic safety of an electrical device is a complex process. To be classified as intrinsically safe, a device cannot have any component with stored energy greater than the minimum ignition energy. Often, the battery used to power the electronic device exceeds this energy level. Therefore very few electronic devices are intrinsically safe.

This project involved a straight-forward approach to testing by operating electronic devices in the most hazardous conditions (9% methane in air) and monitoring for ignition.

The results of this project do not certify the devices as intrinsically safe but provides operators with testing results under specific conditions.

Deliverables

The results of testing program will be compiled into a report. Information was presented to sponsors through a webinar and video documentary.

Benefits

Project results provide operators with information to assist with the development of company policies regarding electronic-device usage in various situations. The project results can be used to better understand the risk associated with the use of electronic devices in the presence of natural gas.

Technical Concept & Approach

Several potential laboratories were investigated to provide the testing, with the research team choosing a laboratory with experience testing in the presence of other explosive materials.

A survey was conducted to help select the 12 phones to use in the testing.

The equipment manufacturers were informed of the project work and invited to participate as advisors.

Testing was performed to determine if ignition occurs under the most hazardous natural gas operating condi-

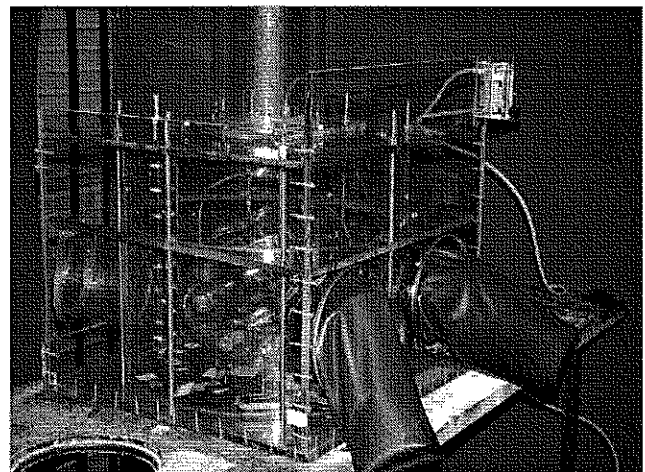
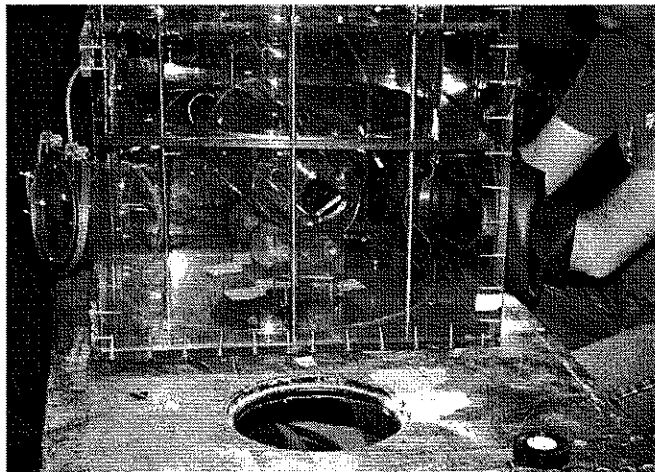

A special chamber was designed and built to conduct the measurements and tests in a flammable mixture.

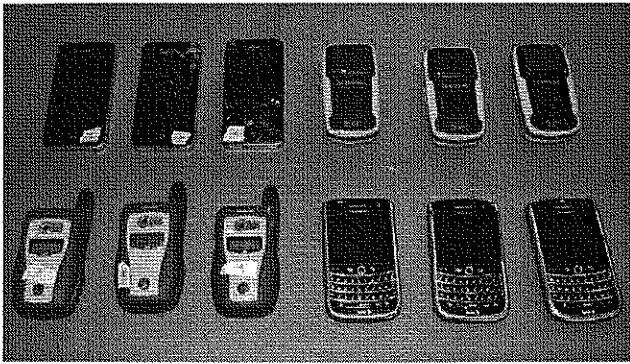

A variety of electric devices were tested.

tions. The approach was to build a facility specific to natural gas to create and maintain a flammable mixture, while permitting operation of an electronic device.

Each electronic device was operated multiple times and subjected to a variety of tests and conditions while in the 9%-gas mixture. Specific testing (involving battery removal, a drop and impact test, and use of a controlled mechanism to jar internal components) was conducted to determine if sparks can occur because of damage during use.

Results

Tests were performed in this project to determine what types of cell phone activities can cause an ignition. All tests were performed in a mixture containing 9% to 10% methane in air. (This ratio was selected because it is the easiest to ignite.)

Four cell phone models were selected based on a survey of the sponsors. Three samples of each model were tested. Before testing, each unit had its back removed and was placed in the flammable mixture for 15 minutes so the flammable gas mixture could diffuse into the phone interior. The first tests performed all of the activities and features provided by the units (e.g., turning the unit on and off, making calls, receiving calls, and receiving data).

One area of concern is disconnecting and reconnecting the battery, since the battery is the most likely source of ignition energy in the cell phone. The 4.1-volt cell phone battery was removed, wires were attached to each terminal, and the two wires brought close and then shorted together. In each of the multiple tests performed, a spark was observed; however, no ignition occurred. Similar tests were performed with three 9-volt

batteries wired in series (yielding 27 volts). A continuous series of sparks was observed, but no ignition.

Following a standard test procedure, each of the 12 phones was dropped six times in a flammable mixture from a height of 40 inches onto concrete. During each drop, the phone was constrained to land on one edge. Because a cell phone has six sides, each phone was dropped six times. Next, each phone was placed in a tumbler inside the flammable mixture for 15 minutes. None of these tests resulted in an ignition. The testing may not have created all scenarios for ignition; however, these tests demonstrate that it would take very unusual conditions for ignition to occur. It should be noted that some sparks do not have sufficient energy to cause ignition of natural gas.

An igniter was used after each series of tests to demonstrate that ignition would have occurred with a sufficiently energetic spark.

Status

All planned testing has been completed. A video documentary is available that summarizes the results.

Based on the results of this project, it appears difficult for one of the cellular devices in this study to cause an ignition in flammable mixtures of natural gas, either under routine usage scenarios or under common scenarios in which the phone may incur damage by dropping.

It is recommended that each utility develop its own policies on using electronic devices in hazardous natural gas environments. However, if devices such as those tested in this report are used in flammable mixtures, there appears to be a large margin of safety under the scenarios investigated within this work.

It is recommended that additional testing of cell phones be conducted with super-capacitor LED flash units if utilities issue them.

For more information:

Maureen Droessler
Program Administrator
Operations Technology Development, NFP
Phone: 847/768-0608
maureen.droessler@otd-co.org

OTDOperations
Technology
Development**OPERATIONS INFRASTRUCTURE SUPPORT****Development of an Intelligent Shut-Off Device
for Commercial and Industrial Customers**

Efforts are under way to develop an intelligent gas shut-off device with the ability to detect third-party damage to facilities and, in response, limit the flow of natural gas to minimize the potential hazard from the incident.

**Project Description**

Recent gas-industry Distribution Integrity Management Program standards are expanding the requirements of excess flow valve (EFV) installations from solely single-family residential locations to multi-family, commercial, and industrial gas customers. Consequently, the large-scale implementation of EFVs in the commercial and industrial market requires long-term planning to be effective.

The application to commercial and industrial customers presents several issues:

- From a safety standpoint, multi-family, commercial and industrial customers expect a highly reliable gas supply. An inadvertent shutoff of commercial or industrial facilities (e.g., such as hospitals, manufacturing, or chemical plants) could create a greater hazard than the gas leak it was intended to address. For other businesses, the financial implications of a false EFV closure could, at a minimum, temporarily close a business, resulting in high associated financial losses.
- The challenge of load variability is inherent to commercial and industrial locations as customers who occupy these spaces frequently change based on rental agreements (such as from a small retail clothing store to a restaurant), which can signifi-

cantly change the required loads. Due to this variability, life-cycle loads (50-100 years) often differ considerably compared to that at the time of service installation. As a result, pre-installed EFVs with a set flow rate tend to be sized either too small (creating false trips) or too large (rendering the EFVs ineffective at times when they are needed).

- As the cost to replace an incorrectly sized EFV may vary from \$5,000 to \$50,000 (if the municipality allows the street to be cut), replacing improperly sized EFVs can become a costly endeavor.

In response to these issues, this project is focused on the development of an intelligent shut-off device (ISOD) to address regulations and risks associated with service and Meter Set Assembly (MSA) damage and associated leaks. The device will be designed to have the ability to detect third-party damage to the service or MSA and, in response, limit the flow of natural gas, thereby reducing the hazard from the incident.

Several commercial systems exist for use within the natural gas infrastructure as remote shut off devices. These devices can automatically shut off gas flow by control of a wireless device. Through prior evaluations, it was discovered that some of these wireless remote shut-off devices were able to communicate even through structural materials such as concrete walls and soil to a handheld device at distances of several hundred feet. One solution under investigation is the modification of one of these devices for use in underground applications. Once flow rates have been determined at the device, the values could then be compared with flow measurements at the meter set. Discrepancies between the determined flow rates would then determine third-party damage or leaks along the service line, triggering an alarm. Once alarmed, the ISOD at the main could be programmed to automatically close, eliminating the leak from the upstream location.

Other possible transfer technologies have been found in use in the water industry. One system continuously monitors water flow and can automatically shut off the service if it detects low- or high-flow conditions. A

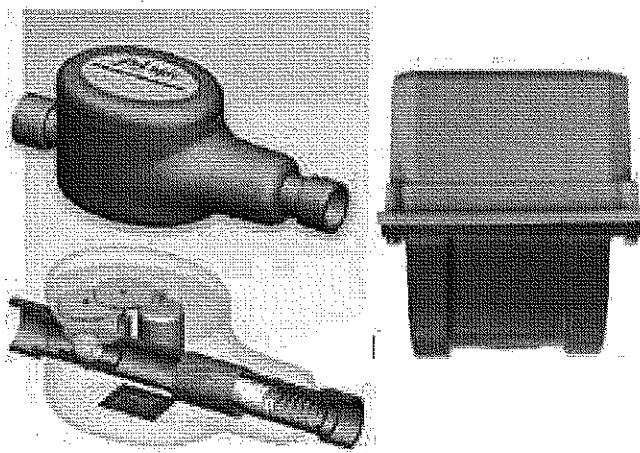

Researchers are investigating various remote shut-off devices.

system similar could be constructed with ability to sense gas flow rate and compare it with a reprogrammable set of flow parameters. If the sensed flow rate or rate of change of flow rate is not within set parameters, the device automatically closes. Then, if the required load changed at the building, the system could simply be reprogrammed.

Deliverables

A research team will provide comprehensive details on the development process of the ISOD system. In addition, possible proposals will be gathered for consideration for a potential follow-on development phase.

Benefits

Third-party damage is the number one threat to natural gas distribution systems. Service lines and MSAs are particularly vulnerable to damage from third-party excavators and vehicular traffic. The goal of this project is to develop technology to minimize this risk by limiting the volume of gas released from such incidents.

Technical Concept & Approach

Tasks for this project include:

- **Market Review and Development of Design Parameters**

This task includes a review of historical data to help to determine the influential design constraints of the ISOD.

Items addressed during this task include:

- Best location of ISOD (e.g., on a service connection, tee, or the service line)
- Common system sizing
- Pressure and flow range for normal or alarm conditions
- Wireless transmission requirements (range, penetration ability, and frequency limits).

- **Development of Evaluation Methods**

This task involves the development of a testing strategy for the prototype ISOD systems.

In addition, any systems found to show promise for use with the ISOD will be sourced and used to help develop the testing protocol.

- **Development and Evaluation of Prototype System** (*potential follow-on phase*)

This task would focus on the development of a prototype system based on the set of design constraints developed in an earlier task.

This task could proceed in two directions: 1) aiding manufacturers in modifications to existing systems, or 2) developing a prototype in house.

Following the development of prototype devices, the testing protocol will be used to ensure that the systems adhere to the original design parameters.

Results

During 2012 activities focused on:

- Developing the initial design constraints with which to find possible market-ready devices
- Completing a review of possible market-ready devices
- Developing a list of manufacturers to contact regarding development of an intelligent shut-off device
- Initiating development of the initial test parameters which would be used to evaluate the devices.

Status

No manufacturer was found to produce a device that could be directly applied to the initial design constraints of the ISOD without further design modifications.

The next step will be contacting the manufacturers to discuss development of a device specifically built to meet the project needs.

For more information:

Maureen Droessler

Program Administrator

Operations Technology Development, NFP

Phone: 847/768-0608

maureen.droessler@otd-co.org

OTDOperations
Technology
Development**OPERATIONS INFRASTRUCTURE SUPPORT**

Development of a Portable Flash-Fire Suppression System

Research is being conducted to advance the development of an automated, portable flash-fire suppression system for use in confined spaces and excavations during gas maintenance and repair operations.



Project Description

Currently, utility procedures for combating flash fires involve a combination of preventative and reactive methods, including the use of oxygen sensors, fire suits, breathing apparatus, and manual fire extinguishers.

While these systems help to improve safety, they are still limited in effectiveness. Preventative methods of gas detection are not consistently used, which leaves personnel unprotected when unexpected leaks occur. Once a flash fire does erupt, fire protective suits only provide protection for a limited period of time, and manual fire extinguishers are often used too late.

Development of a system that can detect a flash fire just after ignition and begin immediate suppression will allow workers the time needed to egress a worksite.

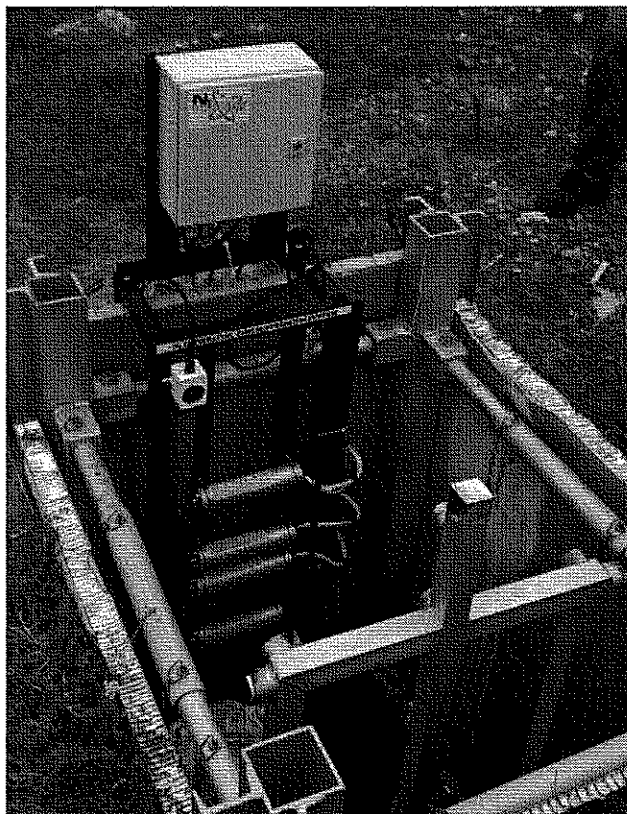

Prototype flash-fire suppression system.

Beginning in the fall of 2009 and continuing into the fall of 2011, the Sustaining Membership Program (SMP) sponsored a project at Gas Technology Institute (GTI) to investigate technologies that have the ability to detect and suppress flash fires.

Multiple detection systems (including optical flame detection, heat-sensitive wire, and thermocouple-embedded clothing) were evaluated for effectiveness, reaction time and susceptibility to false alarms. Researchers also evaluated several fire-suppression systems with the ability to quickly react and adequately suppress or extinguish natural gas flash fires. As a result, several promising solutions – with varying capabilities – were found.

For this new project, a research team will establish which system is most acceptable to utilities, determine what situations it will most likely be used, and then fabricate, evaluate, and refine the system in order to make a versatile portable flash-fire suppression system for use in confined spaces and excavations during gas maintenance and repair operations.

Deliverables

The initial deliverable for the project will be a prototype of a portable flash-fire suppression system. The next step in the project will include interactions with potential manufacturers to determine interest and commercialization opportunities. In addition to the prototype, a report will be supplied including data on all system refinements and testing results.

Benefits

Although the likelihood of flash fires in excavations is remote, if one does occur, the consequences can be serious.

A “standby” system with the ability to automatically detect and then suppress a flash fire (without relying on human intervention) will drastically reduce the likelihood and severity of human injury from a flash fire.

Technical Concept & Approach

Tasks for this project include:

- **Refinement of Design Goals**

Design goals for the portable flash-fire suppression system will be reviewed and refined with sponsoring utilities.

During this task, a survey will be distributed to the sponsors to determine the expectations of the final product (e.g., response time, range of expected costs, and scenarios that require false alarm resistance). Final design parameters and standards for evaluation will be established based on survey results.

- **Prototype Construction and Refinement**

An operational portable prototype will be designed and fabricated, with necessary modifications to adhere to requirements.

Researchers will investigate:

- Integrated engineering and human controls for reducing false alarms
- Designs for increasing mobility and versatility
- Integration of auxiliary monitoring equipment
- Wireless controls for remote actuation and data collection.

- **System Evaluation**

An evaluation of the prototype system will be conducted to ensure that proper progress towards design goals is achieved. Testing will be conducted in the GTI field-scale testing pit constructed during the SMP project.

Results / Status

Activities in 2012 focused on establishing a solid evaluation system and the initiation of the design and construction of the flash-fire suppression system itself.

Modifications included:

- Disassembly and maintenance of the evaluation system constructed during the SMP flash-fire project
- Design and construction of new heat flux sensors to be installed on the thermal manikin

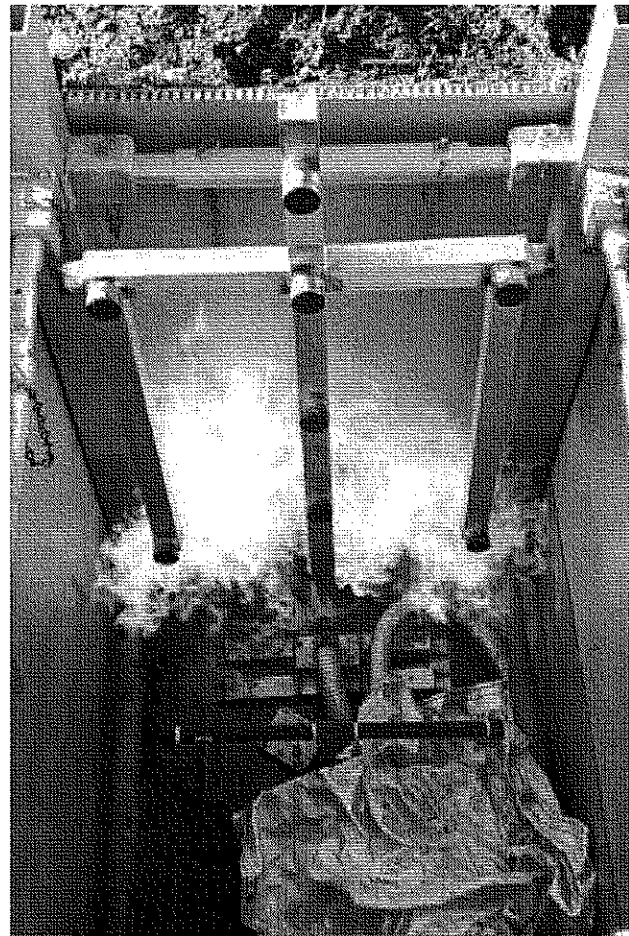

Field-scale testing.

- Development of a controls strategy for data acquisition and control of the flash-fire pit.
- Purchase of a slow-motion camera for evaluation of response times of the system.

In addition to modifications to the evaluation system, work also began on construction of the inert-gas-spray portable flash-fire suppression system.

In order to adequately evaluate the system developed in this project, the evaluation pit created during the SMP project required updating.

For more information:

Maureen Droessler
Program Administrator
Operations Technology Development, NFP
Phone: 847/768-0608
maureen.droessler@otd-co.org



Operations
 Technology
 Development

OPERATIONS INFRASTRUCTURE SUPPORT

Guidelines for Data-Collection Requirements

Industry guidelines for data-collection requirements are being developed to assist the industry in determining the data that needs to be collected for regulatory compliance as well as for integrity-management and risk-management programs.



Project Description

At Gas Technology Institute's recent *Intelligent Utility Workshop*, gas industry executives identified a variety of needs related to data collection.

Specific discussion points included the need for:

- "Point-and-click" GIS for detailed information on a pipe from mill records to the results of the last inspection
- Industry standards to help determine the data that should be collected, and
- Information on what factors drive 80% of the risk in order to better focus data-collection efforts.

Discussions also focused on improving data storage, integration and visualization, and improved and lower-cost tools for field data collection.

The objective of this project is to develop industry guidelines for data-collection requirements that include manufacturing, engineering and design, installation and construction, integrity management, and operations and maintenance data. The results of this project will be used to assist the industry in determining the data that needs to be collected for regulatory compliance as well as for internal integrity-management and risk-management programs.

This project takes a holistic perspective of natural-gas assets and operations to determine the data-collection requirements. This project complements two other OTD projects, which are limited to specific operations: (5.11.m) *Intelligent Utility Installations* and (5.11.t) *Essential Data Capture for PE Fusion Operations*.

Deliverables

The deliverables from this project include data-collection guidelines and a data dictionary.

Benefits

Collecting data that allows operators to know and understand the performance and condition of their assets will reduce risk and improve system integrity.

As operators review their records in response to recent National Transportation Safety Board recommendations, many are identifying noteworthy gaps in the data needed to substantiate system design and Maximum Allowable Operating Pressure (MAOP), as well as risk modeling and trending.

The results of this project will assist operators in developing data-collection and integrity-management pro-

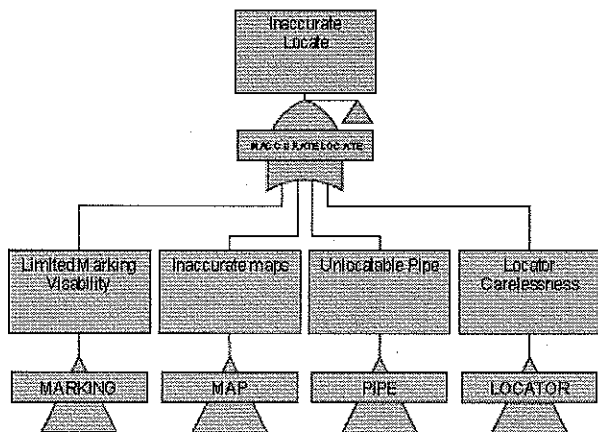

Fault Tree Diagrams for 3rd Party Damage-Inaccurate Locate

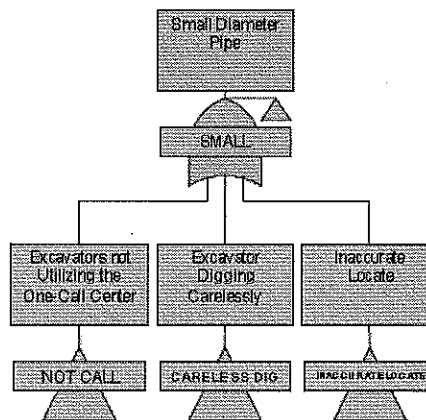

Fault Tree Diagrams for 3rd Party Damage-Small Diameter Pipe

Analysts are using Fault Trees to identify system risks and their potential impacts.

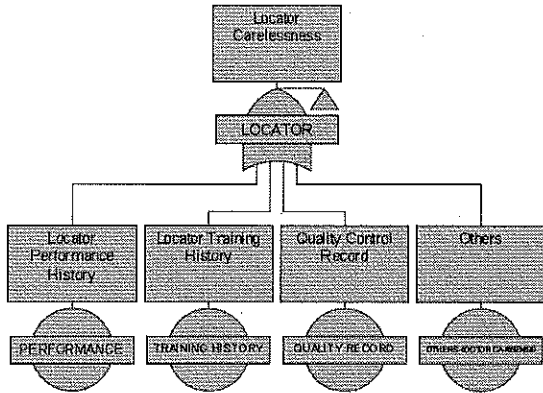

Fault Tree Diagrams for 3rd Party Damage-Locator Carelessness

grams that ensure that the most important data (i.e., that which defines risk) is collected. This industry guideline will capture the best collective information of all participating utilities and avoid costly data-collection re-design.

Technical Concept & Approach

This project expands upon the two existing OTD projects related to defining data-collection requirements.

The work in this project will identify the data requirements and will also update the Gas Distribution Model (GDM) based on these new requirements. (GDM is a new vendor-neutral data model that standardizes database design to reduce customization and facilitate interoperability.)

Researchers initiated this project with an analysis of the factors that fundamentally influence risk and are important for integrity management and risk modeling. The analysis begins at manufacturing and will end at asset decommissioning.

The analysis will include the data required to support the following risk categories:

- Third-party damage (contractor and excavator type, map and record accuracy)
- Corrosion (atmospheric vs. external [buried] vs. internal, coating, cathodic protection)
- Design (material response to stress, impact resistance)
- Incorrect operations (over-pressurization, contaminant introduction).

Researchers will leverage recent work and Fault Tree Analysis/Fields from the *Threat Interaction* and *Assessment Effectiveness* projects as a starting point.

A data dictionary will be developed to structure data-collection forms, defining the format, fields, drop-down menus, and relationships of the data.

Results / Status

In 2012, the research team completed a gap analysis between the deliverables of this project and the *Intelligent Utility Installation Process Outline* developed under another project. The analysis report was sent to the sponsors for review.

Researchers continued the analysis of the threats presented in the natural gas distribution system to identify the contributing factors to system risk. The fault tree diagrams for steel pipe external corrosion and third-party damage have been developed. The diagrams include the contributing factors that drive the system risk, together with the logic between the factors and the conditions at which the combination of the contributing factors could result in a system failure.

Analyses of other threat classes and development of the data-collection guidelines are ongoing.

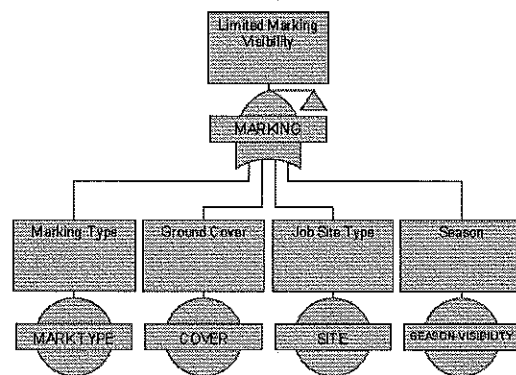

Fault Tree Diagrams for 3rd Party Damage-Limited Marking Visibility

For more information:

Maureen Droessler
 Program Administrator
 Operations Technology Development, NFP
 Phone: 847/768-0608
maureen.droessler@otd-co.org

OTDOperations
Technology
Development**OPERATIONS INFRASTRUCTURE SUPPORT**

Large-Diameter, Medium-Pressure Inflatable Stoppers

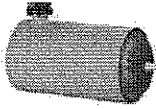

Researchers are evaluating a new flow-stopping system for use on gas pipe diameters up to 24 inches and pressures up to 60 psig. The system, which is manufactured in Europe, is being investigated to validate its use in the U.S. gas industry.

Project Description

Line-stopping equipment used in the natural gas industry is usually heavy, takes multiple people or mechanical assists to maneuver, is costly to maintain, and is very time consuming when installing and tapping necessary fittings.

In response, researchers are investigating new line-stopping equipment that can reduce these problematic issues while providing the same assurance of safety and performance.

Research is addressing several industry needs:

- One application is use on larger-diameter (12-inch to 24-inch) cast-iron and steel piping systems that operate at pressures greater than five psig and have limited options to control gas flow. Currently, bag stopping equipment can only be used up to five psig. Therefore, when cast-iron and/or steel systems that are operating at medium pressures (greater than five psig) the options for shutdown are either valves – which may negatively impact customers – or costly line stoppers.
- Another application is related to the natural gas industry's increasing use of larger-diameter polyethylene (PE) pipe. Hydraulic squeeze tools are manufactured to squeeze the PE pipe to stop the flow of gas, but an alternative is needed.
- New bag stopping equipment may have the potential to be used in combination with traditional line-stopping equipment to provide additional safety. The bag can act as a secondary stop with a vent (bleed) between the primary stop (traditional equipment) and the bag. This application can potentially be used on higher-pressure systems (greater than 60 psig). The traditional stopping equipment can be used to stop-off the majority of the flow of gas; however, at times complete flow stoppage cannot be obtained. The bag system could be used to completely stop off the gas flow while the "blow by" from the traditional stopper is vented to atmosphere. Therefore, the high pressures in the pipe will not be seen by the bag stopper.

In this project, researchers are evaluating a system from a European manufacturer of equipment and materials, including several styles of flow-stopping products able to be used on gas pipes with diameters up to 24 inches and pressures up to 60 psig.

Deliverables

This project will result in a laboratory- and field-tested large-diameter, medium-pressure stop-off system(s) and some validation of smaller-diameter systems. An alternative line-stopping prototype system will be developed that can be used not only as an emergency response tool, but also as a routine stopper for use on PE, steel, and cast-iron piping systems.

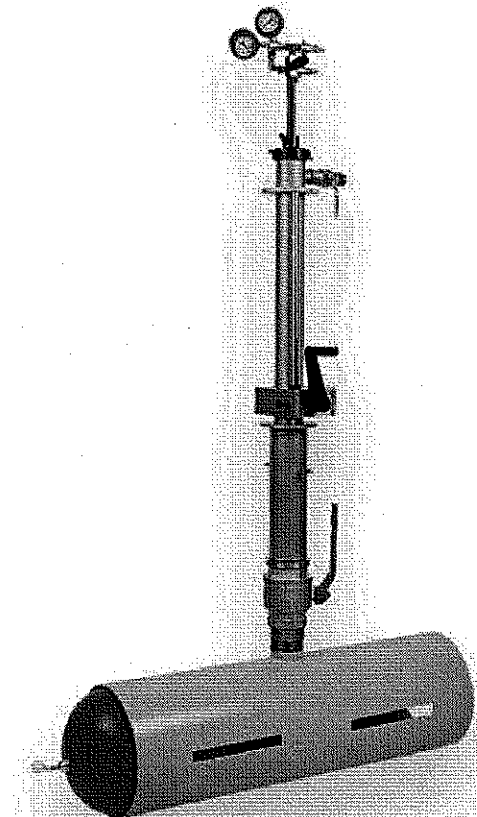

Benefits

New bag-stopping technologies currently used overseas have the potential to provide the U.S. natural gas industry significant savings in day-to-day operations while increasing operational efficiencies and safety.

Technical Concept & Approach

This project will assist with the technology transfer and evaluation of currently manufactured flow-stopping equipment in Europe for the U.S. natural gas industry. Activities are being coordinated between Gas Technology Institute (GTI) and GDF SUEZ. GDF will focus its efforts on the bag system for pipe sizes eight inches and less in diameter; GTI efforts are on a system for pipe diameters of 12 inches and larger.

The evaluation includes an investigation of fittings (or recommended fittings), tapping equipment, bag system, bags, and other associated components.

A research team will:

- Review the system(s) and the overall procedure, safety, and ability to work on U.S.-sized pipes and fittings
- Evaluate the bags for effectiveness in stopping the flow by simulating various field conditions (e.g., temperatures, debris, and pressures)
- Evaluate the system and bags for flow control by cycling pressure, temperature, and time
- Evaluate the bags for durability.

If initial testing proves promising, further evaluations will be conducted in the field in cooperation with sponsoring utilities.

Results / Status

This project was initiated in second quarter of 2012 with efforts to identify the necessary equipment and piping components required to perform the evaluations on low- and medium-pressure natural gas systems up to 24 inches in diameter.

In addition to identifying the bagging equipment needed, researchers have been reviewing past bagging projects to better understand the needs, applications, and

fittings available. The majority of the past efforts focused on six-inch diameter and less. Therefore, project sponsors are being surveyed to obtain additional information on larger-diameter stopping.

GTI laboratories have received the first shipment of bag-stopping equipment. The shipment contains equipment and bags to stop off flow up to 20 psig in pipes up to 16 inches in diameter and for 60 psig systems up to eight inches in diameter. GTI obtained steel, cast iron, and PE pipe and installed various fittings to allow for the system to be applied. The test pipes included:

- Four-inch-, six-inch-, and eight-inch-diameter steel pipe with various-size weld-on fittings
- Four-inch-, six-inch-, and eight-inch-diameter steel pipe with various-size electrofused fittings

Based on the equipment received and the needs of the project sponsors, GTI developed a test matrix for the bag-stopping systems received to date (7.5 psi system, 15 psi system, and 60 psi system) and completed an initial evaluation of each of the stopping systems.

Additional tests are scheduled, including:

- Debris-in-pipe test
- 24-hour standard pressure test monitoring bag pressure
- Pipe pressure cycling
- Bag burst test to failure
- Bag system over pressurized
- Cycle bag insertion and removal
- Overview of tapping machine operation under pressure.

GTI will assist the manufacturer in identifying a potential commercialization partner in North America.

For more information:

Maureen Droessler
Program Administrator
Operations Technology Development, NFP
Phone: 847/768-0608
maureen.droessler@otd-co.org

ENVIRONMENTAL, RENEWABLES & GAS QUALITY

Research in this area provides technical solutions for various gas industry concerns.

Results from these efforts help companies to reduce operations costs, minimize environmental impacts, and more cost-effectively comply with regulations.

Significant initiatives are addressing greenhouse-gas issues and the use of biomass and other forms of renewable energy. Additional developments include kits for the simplified testing of contaminants, industry guidance documents, improved methods for estimating pipeline leak emissions, and the investigation of sensors to measure trace constituents in fuel gases.

OTD

Operations
Technology
Development

Microbiological Testing Kits for Renewable Gas – Phase 2

Prototype field kits were developed to provide simple microbiological sampling and testing to monitor for the presence of potentially harmful biological agents in renewable gases such as biomethane. This technology will help to ensure the quality and safety of renewable gases injected into existing natural gas pipelines.



Project Description

The trend towards identifying and using new sources of renewable energy is gaining momentum across the United States with utilities, regulatory agencies, and environmental groups.

Initiatives aimed at introducing alternative sources of methane into natural gas pipelines have already begun in several states, and many states have issued Renewable Portfolio Standards that require an increase in the proportion of renewable energy. While gas utilities have increased incentives to pursue renewable energy sources, companies often lack the technical expertise to exploit “green” energy sources, including biomethane.

Biomethane (processed biogas generated from biomass sources such as dairy waste, landfill, and wastewater-treatment sludge) has been injected into natural gas pipelines; however, several issues have been raised regarding the gas quality. In addition, pipeline tariffs for most companies do not address the specific impurities that may be present in these new methane sources. Of particular concern is corrosion-causing bacteria and other types of microorganisms that may threaten pipeline integrity and pose health risks.

Currently, sampling of biomethane and the detection of microbes is difficult and requires highly trained per-

sonnel in specialized laboratories. Under a project sponsored by Gas Technology Institute’s Sustaining Membership Program (SMP) (Phase 1 of this overall effort), a sampling device (alpha prototype) was designed for the field assessment of microbiological constituents in biomethane derived from a variety of sources. The device is user friendly and can be used by a technician with minimal or no training in microbiology. Phase 1 focused on the development of a device for the detection of anaerobic heterotrophic bacteria.

In this project (Phase 2), the objective was to develop and optimize a sampling and detection test kit for field microbiological testing of biomethane.

Deliverables

- A prototype test kit for the detection of anaerobic heterotrophic bacteria
- A field standard operating procedure.

Benefits

Developing a user-friendly and field-applicable testing kit for biological materials of concern will help maintain the integrity of pipelines and prevent health and safety risks. Through the implementation of a regular testing regime with an easy-to-use kit, companies will be able to identify biologically derived risks, avoid costly damage to their systems, and prevent health and safety hazards to their employees and customers.

Technical Concept & Approach

The development of the microbiological testing kits is being conducted in three phases. In Phase 1, an alpha prototype device was developed and tested under laboratory conditions with ambient air containing various target micro-organisms (as well as actual natural gas). The operational parameters (e.g., sampling volume, flow rate, and bacterial recovery rate) were also preliminarily tested to enhance the prototype design.

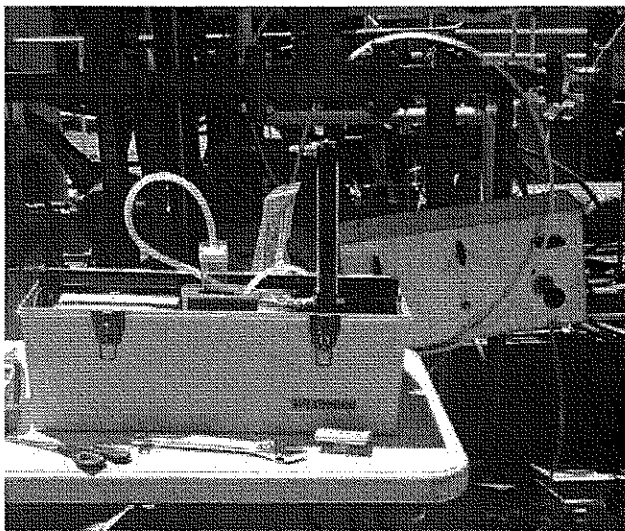

Phase 2 activities included:

- **Development of Beta Prototype Device**

Based on the preliminary testing data from the alpha prototype device developed in the SMP program, several versions of the prototype devices with different configurations were investigated. Each prototype version was rigorously tested in the laboratory and the results used for the improvement of subsequent versions.

- **Field Testing and Assembly of Test Kits**

The beta prototype was tested under field conditions to determine the proper operation and detection conditions for different target microbes in biogas. At the end of this task, a complete list of components and a standard operating procedure for each sampling and detection kit was developed, evaluated in the laboratory, and tested in the field to ensure the proper composition of kits and documentations for easy field application.

- **Laboratory Analysis**

After the beta prototype was finalized, biogas samples were collected with the new sampling devices from different biogas sources for in-depth biological analysis. The parameters for biological analysis in this task included the enumeration of live heterotrophic anaerobic bacteria, sulfate-reducing bacteria, and acid-producing bacteria; and the identification of the bacteria population. The results indicate the efficacy of filtering removal of live bacteria from biogas, filter integrity, detection sensitivity, and the recovery rate of microbes for the beta prototype kits.

Results

Leveraging knowledge from the previous SMP effort, the project team designed, fabricated, and performed laboratory and field testing of a beta prototype testing kit suitable for sampling microbes present in gases.

The kit is able to capture microbial bacteria in renewable gas streams at both low pressure (typically raw gas) and high pressure (typically processed biogas or "biogas"). The kit was assembled to include a sampling device and procedure that is user friendly and designed for use by natural gas operators with no microbiology or laboratory experience.

The testing kit includes a sampling device in which the gas passes through a nutrient medium followed by a 0.2 µm filter. The nutrient medium contains ingredients to enhance growth of bacteria, namely anaerobic heterotrophic bacteria, acid-producing bacteria (APB), and

sulfate-reducing bacteria (SRB), which are known to contribute to microbial induced/influenced corrosion (MIC) in pipelines. As the gas bubbles through the bottom of the device where the medium is located, the bacteria are captured. The filter at the top of the device is used to catch remaining bacteria, especially from the aerosols produced once the bubbles break as the gas passes the medium. Once the device collects 250L of renewable gas, the device is inverted, allowing the bacteria present on the filter access to nutrients necessary for growth. After up to a week of incubation at room temperature, the presence of bacteria can be qualitatively assessed by observing the turbidity of the media; turbidity (cloudy) indicates the presence of bacteria, whereas lack of turbidity (clear) indicates no bacteria.

During the design of the beta prototype, many adjustments were made to optimize the performance of the device. Supplementary testing in the field provided further improvements to the kit. After an initial field test, it became apparent that the device, as a stand-alone item, could not withstand the conditions of being outside. (The wind constantly knocked the device over, despite being contained in a box.) The final kit design uses a foam holder to support the device and prevent it from being affected by outdoor field conditions.

The results from the second field test included sampling from a low-pressure raw biogas, a high-pressure biogas, and a control (no gas). Tests indicate that the device is able to capture MIC bacteria. However, the control taken in the field also indicated presence of bacteria. It is likely that the contamination was introduced because of a leak in the device. Results from quantitative analysis show that with the control data used to blank subtract the results from the gas sample, the devices are able to capture bacteria and spores.

Status

Phase 2 of the project is complete and a Final Report was issued.

The research team recommends moving forward with commercialization of the device for Phase 3. Leak and contamination issues can be eliminated during the industrial manufacturing process of the MIC devices.

For more information:

Maureen Droessler
Program Administrator
Operations Technology Development, NFP
Phone: 847/768-0608
maureen.droessler@otd-co.org

OTDOperations
Technology
Development**ENVIRONMENTAL, RENEWABLES & GAS QUALITY**

Assessment of Acceptable Siloxane Concentrations in Biomethane

Biomethane from various waste products could provide consumers with a significant source of "green" renewable energy. For this project, a study was conducted into siloxane – one of the potential constituents in biomethane – to assess its influence on health, the environment, and gas-fired appliances.

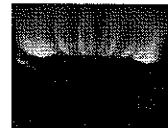

Project Description

Local gas distribution companies are increasingly asked to purchase and take delivery (interchange) of fully processed biomethane from the anaerobic digestion of waste into existing lines for general distribution. However, the original raw biogas can contain many different trace constituents. While methods being developed upgrade raw biogas to high-Btu biomethane, this fully processed biomethane is not often accepted into existing pipeline systems.

One constituent of concern is siloxane, a man-made organic compound that contains silicon, oxygen, and methyl groups. Due to the increase in silicon-containing personal hygiene, healthcare, and industrial products, the presence of siloxane in waste streams has increased. As the silicon-containing waste stream/biomass is digested, smaller weight siloxane compounds volatilize and become entrained in the biogas. When this gas is combusted, silicon dioxide is formed. Over time, the silicon dioxide builds up and can cause damage. Certain concentrations in biomethane may lead to environmental health and safety concerns; however, the potential toxicity and risk of siloxanes is being debated.

Currently, there is no tariff for the concentration of siloxane in gas (natural gas and biomethane), although some engine manufacturers have their own specific limits.

To address various siloxane issues, in Phase 1 of this project (now completed) an extensive study was conducted to provide documentation to support guidance in the area of acceptable levels of siloxane in biomethane. The objective of Phase 2 (now under way) is to perform laboratory testing on vented and unvented gas-fired appliances to evaluate equipment tolerance and potential indoor air concerns with siloxane, respectively, in order to determine adequate concentrations for safe acceptance of biogas in distributions systems. Data collected from laboratory testing will be used to develop a preliminary risk assessment model.

Deliverables

The deliverable for Phase 1 of this project was a technical summary with data to provide guidance for natural gas companies and biogas project developers in their efforts to introduce renewable gas into natural gas pipelines.

Phase 2 deliverables will include a preliminary risk assessment that may be used by utilities to analyze their risks with respect to their unique requirements. Depending on results from Phase 2, additional laboratory testing may be performed in Phase 3 to allow for a comprehensive risk assessment.

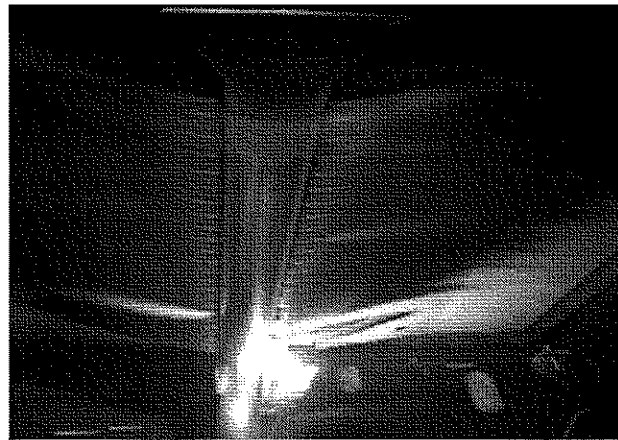
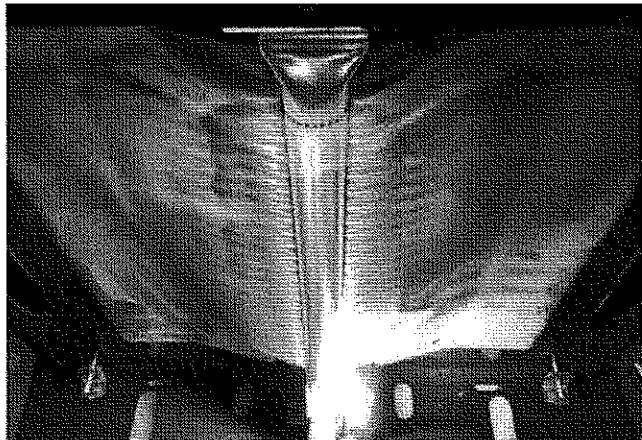

An image of the water heater flame was taken weekly to document any visual changes. At left is the baseline flame image. At right is the last flame image recorded in June 2012. A consistent change in the flame pattern was not observed during the 2nd quarter.

Benefits

Results from this project could provide a variety of significant benefits, including guidance to utilities on assessing the risks associated with siloxane concentrations for biomethane interchange.

The results from laboratory testing will provide more information on requirements for most sensitive equipment. end-use applications will benefit from the overall interchange of biomethane with natural gas. In addition, liability may be avoided if more accurate information on the impacts of siloxane concentrations is known.

Importantly, the potential health effects of siloxane concentrations will be viewed with the benefit of scientific information.

Technical Concept & Approach

Research tasks include:

- A Review of Existing Data
- Manufacturer Interviews and Data Collection
- Laboratory Testing on Vented and Unvented Gas Appliances (water heater and oven, respectively)
- Development of a Preliminary Risk Assessment.

Results

In 2010, a report was issued that summarizes the initial research of Phase 1 and formed the foundation for field studies.

This research found that:

- The concentration and types of siloxane differ from each landfill and digester plant. Typically, closed landfills contain relatively low levels of siloxane.
- The need for real-time monitoring equipment has increased due to the waste disposal of siloxane in landfills and sanitary sewers.
- Since there exists no standard for the collection and analysis of siloxanes, inconsistencies in the types of siloxane analyzed arise from laboratory to laboratory.
- Many types of siloxane removal techniques are commercially available. Most removal methods are by physical adsorption.
- There is some debate on whether the presence of trace constituents in a gas would have an impact on odor fade.

- Unlike with residential appliances, the affect of siloxane in biogas is well understood pertaining to energy-generating equipment. Manufacturers have set siloxane limits on their equipment since silica buildup on various parts of equipment requires additional and more frequent maintenance. There exists no information regarding siloxane buildup in residential applications.
- Siloxane may enter the indoor air environment due to the delay from the ignition. However, the amount entering the home would be in trace amounts.

In 2012, testing began with a water heater for the vented appliance and an oven for the unvented appliance with siloxane spiking of the fuel gas. The units operated Monday through Friday for eight hours per day. Fuel gas samples were collected weekly to monitor siloxane content. To date, no significant change has been seen in the major components of the flue gas samples. The flue gas has also been periodically checked for particulates. To date, no particulates have been detected in the flue gases.

The water-valve timer was set to a period of 40 minutes with a 10% on time, thus resulting in a typical water draw for testing and still allowing enough time for the water tank temperature to return to the set point before cycling the burner again.

Status

The development of a preliminary risk assessment model is under way.

Testing, monitoring, and sample collection and analysis continues. The siloxane mixture will be replaced with a fresh mixture. If necessary, adjustments will be made to the flow for the spike line to return siloxane concentrations back to their target levels.

Researchers are exploring alternate sampling techniques for collecting flue gas (e.g., extending burner cycle time during sample collection by raising the oven temperature).

For more information:

Maureen Droessler
Program Administrator
Operations Technology Development, NFP
Phone: 847/768-0608
maureen.droessler@otd-co.org

OTD

Operations
Technology
Development

Natural-Gas-Quality Survey: Trace Constituents



This research project is aimed at developing information to help introduce renewable "green" sources of energy into the natural gas pipeline. Information on trace constituents will facilitate a utility's ability to assess the potential to use gas generated from wastes and other sources.

Project Description

Natural gas – as well as renewable gas from wastes and other sources – contains specific properties and compositions which are complex and a function of many factors, including: 1) resource supply characteristics, 2) level of gas processing, and 3) degree of gas co-mingling prior to and during transportation.

In recent years, significant research has been conducted to analyze and characterize renewable natural gas (RNG) from dairy-waste conversion, landfills, and wastewater-treatment facilities. Through these projects, natural gas utilities have developed a greater understanding of renewable gas products and the ability to engage in productive dialogs with potential vendors of biomethane (cleaned biogas or RNG).

In previous research, samples of RNG products were analyzed for major components as well as trace constituents. Results were used in the development of guidance documents for the purposes of assisting natural gas companies in evaluating RNG products. The profiling was extensive; however, the sample set was limited (less than 100 samples total for all RNG sources from a limited number of sites).

This project is aimed at developing an improved understanding of trace constituents in natural gas to make a meaningful comparison with renewable and uncon-

ventional fuels. Without this information, some companies have been hesitant to accept these alternative fuel products into their systems.

To address the issue, researchers are developing an analytical survey of trace constituents in natural gas supplies throughout North America.

Through this research, the industry will develop an enhanced understanding of the variety and concentrations of organic, inorganic, and biological constituents in currently available natural gas supplies.

This survey entails sampling and analysis of natural gas samples only.

Activities are divided in two phases.

Phase 1 focused on data collection, information dissemination, and project development. Sample collection/analysis is being conducted in Phase 2.

Deliverables

The overall goal of Phase 1 of this project was to fully scope and understand activities to be executed in Phase 2. Phase 1 deliverables include: 1) a definition and consensus specific to the use of the information gath-

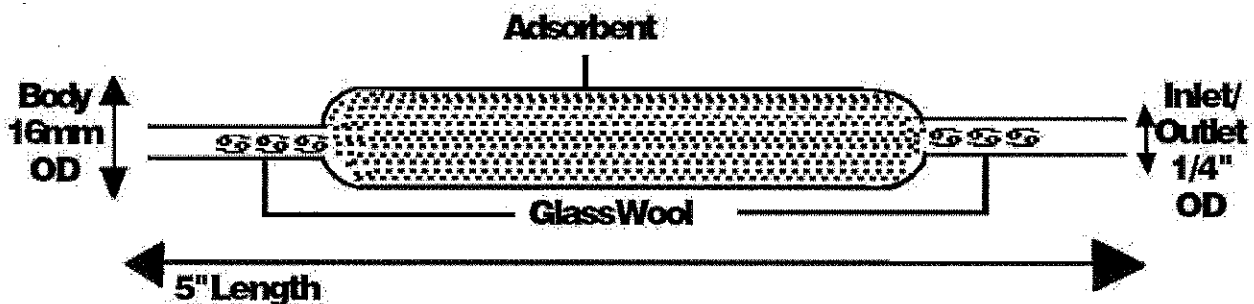

Sorbent tube used for radon sampling.

consensus specific to the use of the information gathered as part of the overall project, 2) establishment of an oversight committee with responsibilities discussed and determined, and 3) detailed scoping and preparation for all Phase 2 activities, including definition of the sampling sites, sampling sets, analytical profiling, field-crew assignments, data-reporting requirements, and Phase 2 costing.

Benefits

Results of the research will help increase the ability to employ "green" sources of energy and demonstrate an environmental commitment.

The purpose of the overall study is to more fully understand the trace constituent profile in natural gas so that more accurate comparisons of alternative fuels with existing natural gas supplies may be facilitated.

Technical Concept & Approach

Initial activities in Phase 1 involved interactions with project sponsors and others to develop a mechanism by which the data collected in this project can be effectively disseminated and shared throughout the natural gas industry and with other interested parties. To this end, an oversight committee was assembled to assist with industry communication and project planning.

In Phase 1, the project team developed plans for sampling activities in Phase 2. There are numerous options for natural gas sampling points, and efforts were made to determine the most appropriate natural gas sampling program (including variables such as the number of gas samples to be collected and the size and function of sampling teams).

Natural gas sample locations will be determined and access to sampling points will be arranged. The objective of this task is to decide upon the most useful sources for natural gas testing at points which are most representative of the conventional and unconventional supply sources throughout North America.

Phase 1 will yield an understanding of the costs associated with the work moving forward and will form a collective plan for project execution.

In Phase 2, investigators will attempt to sample a wide variety of natural gas supplies from differing locations throughout the United States and Canada.

Results

This project was initiated in 2010 with the establishment of a project steering committee and an extensive

literature search. Subsequently, a technical committee was formed and a web-based project seminar was conducted.

To expedite the sampling and analysis, it was decided to outsource some of the sampling activities with an environmental firm.

In 2011, the radon analysis technique was selected, hydrofracturing chemicals were investigated, and the analytical implications considered.

In 2012, sampling was performed and all samples analyzed for the Marcellus and Devonian shale gas sites. Data sets were included in a report to project sponsors.

The research team has experienced some difficulty in obtaining active field test sites, and some companies are reluctant to provide gas samples. In response, contact was initiated with several producers and pipeline companies to expedite sampling.

A consultant was added to the project team to assist in validation of the radon test methodology.

The radon collection media was modified to concentrate the samples and keep the sampling volume lower in order to eliminate potential interferences.

Status

Ongoing activities include:

- Sampling and analysis of natural gas derived from conventional sources
- Sampling and analysis of the tight sands gas, coal-bed methane and LNG gases.

Several sponsors requested that hydrofracturing chemicals be added to the trace constituents list. A number of these hydrofracturing chemicals have significant vapor pressure (e.g., >10 mm Hg) at room temperature and some of the chemicals are volatile enough that they could be present in the gas phase. These potential chemicals can be analyzed by either the gas chromatography mass spectroscopic trace constituent analysis, or, in the case of nitrogen containing constituents, by the same gas chromatography with nitrogen chemiluminescence detection technique used for the ammonia analysis.

For more information:

Maureen Droessler
Program Administrator
Operations Technology Development, NFP
Phone: 847/768-0608
maureen.droessler@otd-co.org

OTDOperations
Technology
Development

ENVIRONMENTAL, RENEWABLES & GAS QUALITY

Development of a Practical Pipeline Operator Guide to Manage Odor Fade Issues

Research is being conducted to help determine the variables that can contribute to odor fade in natural gas. The results will be presented in a guide to aid pipeline operators in managing their systems and maintaining safe operations.



Project Description

Loss or change of odor in natural gas is usually attributed to two different causes: odor fade and odor masking. These are two distinct/separate issues requiring separate research efforts.

Odor fade is the actual loss of odorant by chemical or physical processes, including adsorption/absorption onto internal surfaces of metal or plastic pipe or the chemical reaction of gas odorants with pipeline contaminants and/or trace constituents in the gas stream.

Currently, supplemental odorant injection and control is, for the most part, based on a non-technical approach. Anecdotal information forms the basis of most current guidelines and the "Rule of Thumb" approach is also employed, where some pipeline operators use an odorizing "cookbook" with very mixed results.

This project focuses on research, model design, and the validation of issues associated with natural gas odor fade in an effort to provide a "Practical Pipeline Operator Guide" to manage odor fade issues associated with typical gas system operating conditions and materials of construction.

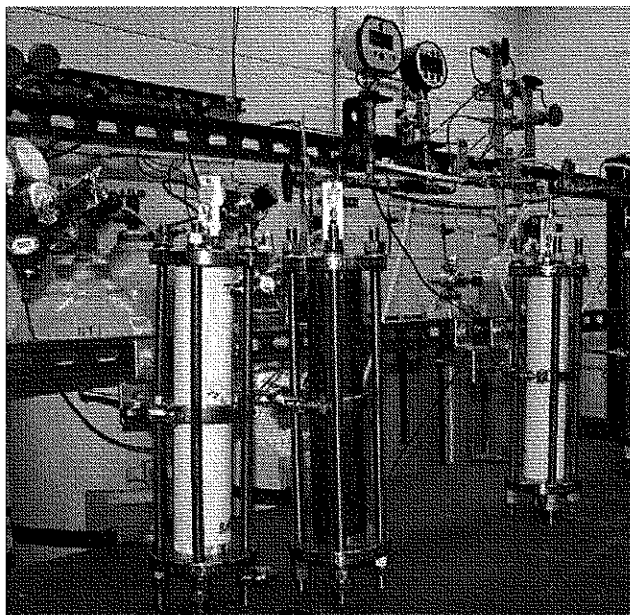

Laboratory setup for static testing of pipe specimens.

The research team will develop a tested methodology to validate additional combinations of gas, system, and material scenarios. Ideally, the project results, guide, and validation data will also be incorporated into the next update of the American Gas Association (AGA) Odorization Manual. Although the AGA Odorization Manual highlights some potential fade causes, currently it does not provide specific guidance or solutions to manage the odor fade problem.

Odor masking (not the subject of this research effort) is the change in *perception* of the characteristic gassy smell of odorants present in natural gas.

Deliverables

Deliverables for this project include:

- **A Practical Pipeline Operator Guide** to manage odor fade issues for a particular number of subsets of the combinations of gas, system, and material variables
- **A Tested Methodology** to validate additional combinations of gas, system, and material scenarios.

Benefits

- Reduction in the number of odorant-related incidents and resulting litigation
- Improved safety, public relations, and regulatory compliance, including DIMP compliance
- An improved ability to promote the acceptability of renewable gas sources by quantifying the impact of trace constituents (if any) on odorants within gas supplies
- The assured continuity of safe pipeline operations as the loss of experience and expertise (due to the retirement of odorant experts) impacts the industry
- Reduction in operating costs for odorant programs through the optimization of supplemental odorant-injection rates.

Technical Concept & Approach

This project includes the following tasks:

- **Definition of Project Boundaries, Literature Search and Dissemination of Results**
- **Identification and Definition of Variables that Affect Odor Fade**
- **Prioritization of Variable Effects**
- **Development of a Simplified Odor Fade Model Based on Key Variables**
- **Validation and Refinement of the Model with Specific (Select) Physical Testing**
- **Development of an Operator Guide and Final Report.**

Results

This project was initiated in early 2010 with the development of a detailed project plan and an extensive literature search. A steering committee was also established. Although not part of this project work, the research team responded to the U.S. Department of Transportation Pipeline Hazardous Materials Safety Administration announcement (Pipeline Safety Research and Development R&D) and was awarded funding to further validate the mathematical model with extensive field testing.

In 2011, surveys on pipeline odor fade and pickling/conditioning procedures were developed and sent to the steering committee and OTD member companies to help direct the laboratory and field testing and build the model.

Based on information obtained to date, it was expected that rust coatings on steel pipe would have the greatest impact on odorant fade. This was borne out by initial laboratory static testing, where the fading phenomena occur within minutes when typical pipeline levels of t-butyl mercaptan (TBM) are introduced to sections of used and off-the-shelf gas pipe specimens. Some fading was also noted in a plastic pipe (polyethylene) test specimen. The TBM reactivity of the plastic pipe is much lower than that observed in the steel pipes, but higher than that of the passivated control reactor.

To simplify the model and reduce the amount of validation testing, the number of model variables needs to be reduced. Based on thermodynamic prescreening, prior testing, literature, and operator experience, the most critical variables will be selected to develop a simplified model with a reduced set of inputs. This task assumes that the variables can be reduced to the three to four variables that affect fade the most.

Research found that there is the potential for a significant number of reactions to occur in an odorized pipeline gas system. In addition to forming disulfides and iron sulfides (mainly), mercaptans might also decompose or react with trace gas processing constituents.

Although odor fade is generally recognized in the gas industry and has led to the practice of pickling new (or old) lines, there has been little in the literature in terms of the quantity of odorant or duration that might be required to "quench" the reactivity of the pipe or "condition" the line.

Results indicate that by using the technique of injection of highly odorized gas, some 0.2 to 0.4 mL/ft³ of odorant addition was required to achieve full conditioning of six-inch-diameter pipe. Nearly double the odorant addition rate was required when using the continuous liquid addition technique.

Laboratory static testing of test pipes with odorants and trace constituents continued in 2012. The results were reported with a statistical evaluation. There was no odorant fading in the presence of 1000 ppmv oxygen, 19 ppmv methanol, 1000-ppmv hexanes, and 141-ppmv water. There was evidence of odor fade in the presence of 152 ppmv methanol and ~60 and 21 ppmv monoethanol amine (MEA). MEA was selected as a surrogate amine compound to represent volatile amine compounds in hydrofracturing fluids. Additional testing will be performed at a higher hexane concentration.

Status

Laboratory static testing of test pipes with odorants is expected to be completed in 2013.

The integration of the static testing and survey data into a first-draft model equation is under way. This information will be used to scale up to field testing in order to validate the model.

Gas sampling activities will be performed at one eastern gas company that is installing new steel pipe.

Solicitation and planning for additional field tests continues.

For more information:

Maureen Droessler
Program Administrator
Operations Technology Development, NFP
Phone: 847/768-0608
maureen.droessler@otd-co.org

OTDOperations
Technology
Development**ENVIRONMENTAL, RENEWABLES & GAS QUALITY**

Improving Methane Emission Estimates from Underground Pipeline Leaks – Phase 2



In an overall effort to control the release of greenhouse gases, research is being conducted to develop a technical approach to quantify methane emissions from gas mains and service pipelines. The new method will provide an increased level of accuracy and an improved ability for utilities to comply with future regulations.

Project Description

Due to the growing concern over climate change and greenhouse gas (GHG) emissions, the natural gas industry has recognized the need for more accurate emission-estimation methodologies. However, the regulation and reporting of GHG emissions can have significant operational and financial impacts for local gas distribution companies. Consequently, a company's ability to accurately baseline and report GHG emissions (specifically methane emissions) will be critical in complying with the current GHG Reporting Rule (as well as future mandates) and demonstrating the company's efforts to reduce GHG emissions.

While various climate initiatives are evaluating approaches to reduce GHG emissions, these initiatives do not address methodologies for quantifying fugitive and methane emissions (a large source of emissions in the distribution sector) or opportunities to capture credits for reducing these emissions. Furthermore, most of these approaches rely on information derived from an outdated study on gas-industry methane emissions.

In response, a multi-phase project was initiated that focuses on an assessment of existing methodologies, design of a technical research approach, and studies to establish and validate methodologies, seek regulatory acceptance, and develop tools to allow for integration into existing distribution-management software.

In Phase 1 of the project (completed in 2010), researchers assessed existing methodologies and proposed a technical approach for measuring leak flow rates at their aboveground state. Measurements of aboveground methane flow rates were performed in controlled tests where gas leaks were captured at the surface and measured using the Hi Flow Sampler™. The results of the tests showed good correlation with the applied leak rates from the pipes.

Phase 2 of the research program included performing field tests at utility sites with known leaks to evaluate surface measurements in various site conditions. The measurements correlated to below-ground measurements in isolated pipe segments.

Deliverables

Phase 2 provides the following:

- Improved estimates for methane emissions of plastic pipes with an increased number of below-ground measurement tests from the current Gas Research Institute/U.S. Environmental Protection Agency (EPA) procedure. These results will update the existing emission factors for plastic pipe.
- A new methodology for more accurate estimation of methane emissions using above-ground measurements of plastic-pipe leaks.

Benefits

Results from this project will directly improve a company's ability to:

- Provide accurate, cost-effective, and manageable emissions management
- Satisfy regulatory requirements
- Implement methodologies that can be integrated with existing gas-distribution software and system tools.

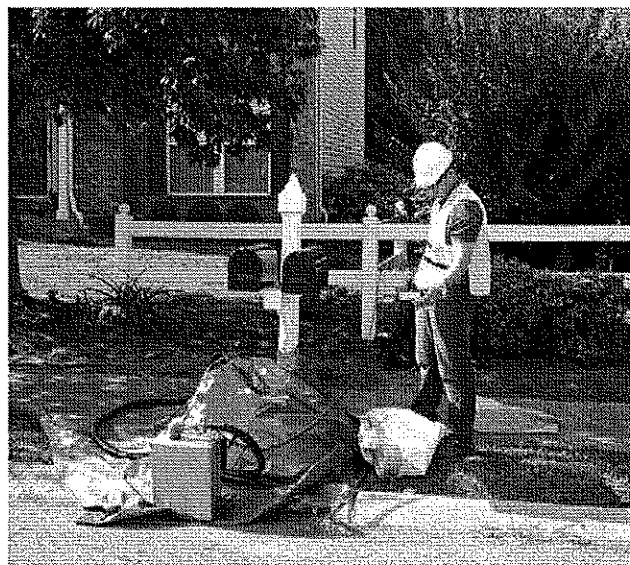

Measurement of a surface leak around a mailbox.



Testing at a site in Las Vegas (left) and in Arcadia, LA (right).

With the new methodology, records are updated regularly using a combination of various technologies to search, pinpoint, and classify leaks. The estimates of activity data from utility inventory will also allow for the development of custom-made emission factors that address company-specific infrastructure characteristics.

Technical Concept & Approach

This project is being executed in four phases:

- Phase 1: Technical Approach and Methodology Assessment (*Complete*)
- Phase 2: Field Measurement of Emission Factors of Plastic Pipelines (*Ongoing*)
- Phase 3: Field Measurement of Emission Factors of Steel and Cast-Iron Pipelines
- Phase 4: Deployment and Implementation.

Results

In Phase 1 of this project (now completed) researchers investigated the applicability of measuring leak flow rates at their aboveground state. Investigators also reviewed the limitations of existing methods and addressed the current practices in use.

In 2011, a testing methodology was developed and tests were performed at three field sites. The leaks at two of the sites were in two-inch Aldyl-A mains and the third site was in a two-inch PE main. The tests in two of the sites evaluated both aboveground measurements using the Hi-Flow Sampler and below-ground measurements using flow meters in isolated pipe sections. The leaks at these sites were mostly at the connections of the mains with the service lines. The detected methane measurements were small and dropped from an average of 3.5% gas at the barholes to 0.5% gas. The lines operated at

pressures of about 48 psig. The gas flow measurements were at the low end of the measurements of both the Hi-Flow sampler and the flow meters, at about 0.01 to 0.02 ft³/min (cfm). This low flow rate was characteristic of most of the plastic leaks at the connections between the mains and service lines as stated by the utility operators.

In 2012, field tests were performed at four sites in Tennessee. Leak measurements were taken at each site to cover the various factors associated with leaks in PE pipes. Additional tests will be performed at a Gas Technology Institute (GTI) test site. The tests will be at higher leak rates than the those that have been measured at the utility sites. These tests will provide the dataset needed to cover the range of leaks in the field.

A workshop was held in August 2012 with GTI, the American Gas Association (AGA), and other research groups (e.g., National Institute of Standards and Technology, the Environmental Protection Agency, and the Environmental Defense Fund). The methodology and results of the field tests were presented and valuable feedback as provided by the participants on how to improve the testing program.

Status

Phase 3 of the research plan calls for the application of the developed field-testing procedures to obtain similar emission factors for cast-iron, protected steel, and unprotected steel pipes.

For more information:

Maureen Droessler
Program Administrator
Operations Technology Development, NFP
Phone: 847/768-0608
maureen.droessler@otd-co.org

OTD

Operations
Technology
Development

Prototype In-Line Biofilter Testing



In the second phase of this four-phase project, researchers tested an alpha-prototype biofilter unit for the removal of biological agents from processed biomethane products prior to injection into existing natural gas pipelines.

Project Description

As natural gas utilities begin to interchange biomethane (e.g., gas produced through the anaerobic digestion of wastes) with natural gas supplies, it is important that certain constituents are kept from entering the pipeline network.

While research has shown that biological elements such as spores and microbes can be carried over into "cleaned biomethane" products, testing indicates that the removal of biologicals is possible through filtering with a biofilter or other device suitable for the removal and/or sanitization of biomethane. However, such a device is not readily available.

Recent research has involved the testing and analysis of renewable gas samples from a wide variety of sources. In this project, research is focused on the development of an alpha-prototype biofilter unit for the removal of biological agents from processed biomethane products prior to injection into existing natural gas pipelines.

Deliverables

The final deliverables for this project will be a field-tested prototype biofilter and a Final Report providing project details.

Benefits

Developing an in-line biofilter or other type of microbe-removal device may be highly useful for the final cleanup of biomethane prior to its introduction to the pipeline network and help to accelerate the use of renewal sources of energy.

The project provides the following specific benefits:

- A method to prevent biological agents in biomethane products from entering the natural gas network
- A way to remove the most resistant biologicals (e.g., as spores and viruses) from biomethane products

- Protection against biological agents of concern
- Protection against initiating or exacerbating microbial-induced corrosion
- Potential cost savings for utilities to purchase renewable biogas.

Technical Concept & Approach

In previous research (Phase 1), investigators reviewed currently available technologies and subsequently developed and constructed a small-scale alpha-prototype in-line biofilter. This project (Phase 2) involved laboratory and field testing of the alpha prototype.

Project results will lead to design optimization and construction of a full-scale beta prototype. Laboratory and field testing of the beta prototype will be conducted during Phase 3. The final phase (Phase 4) will address the commercialization of the biofilter unit.

Phase 1 included an extensive literature review that identified appropriate technologies available for destroying vegetative bacteria, bacterial spores, and viruses. Available cleanroom technologies commonly used in the nuclear, electronics, aerospace, pharmaceutical, and medical industries (which generally address airborne constituents) are not applicable to the gas industry. Due to the different characteristics of natural gas and air, the natural gas industry generally uses var-

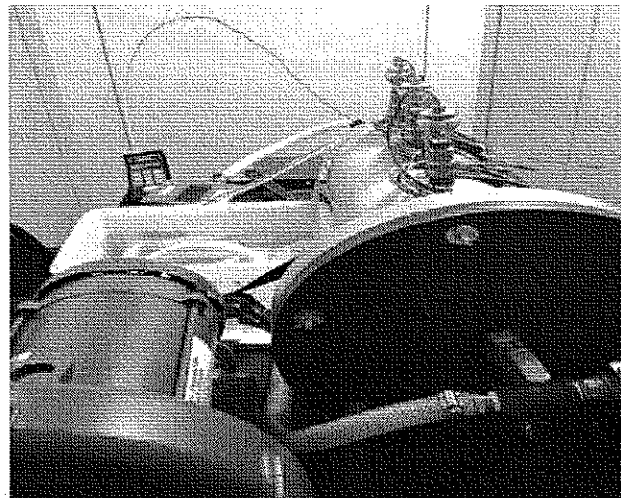

Biomethane - A New, Renewable Energy Product

Biomethane is derived from the anaerobic digestion of biomass materials. This process involves the degradation of raw materials through microbial action, resulting in gases and other products. Biomass materials may be derived from animal waste (manure), landfill deposits, wastewater-treatment sludge, and a wide variety of food-grade industrial wastes (e.g., oils, fats, animal renderings, agricultural waste, and winery waste).

Biomethane is considered a relatively new fuel for introduction to the gas pipeline, but it holds much potential as a renewable gas for the natural gas industry.

various designs of coalescer filters for the cleanup of raw natural gas. Coalescer filter systems apply centrifugal force and/or use gravity (with liquids such as oil, water, and aerosols) to drop the large particulates out of the gas. However, this type of wet filter system does not work efficiently with dry biomethane. The currently available dry gas filters are generally designed for the removal of larger particulates in natural gas, not for the removal of biological materials that can be present in biomethane.

For Phase 1, researchers developed and constructed a 108,000-cubic-foot-per-day alpha-prototype biofilter unit with a compact design to take advantage of low-cost off-the-shelf filter components. The unit includes three-stage filter elements for the removal of various sizes of particulates. The three-stage design prevents clogging and prolongs the working lifespan of the unit. Simulated laboratory tests with filter materials used in the last filter element achieved a 4.88 to 8.59 log (or 99.999% to 99.999997%) removal of representative bacterial spores most commonly present in processed biomethane samples.

This Phase 2 project consisted of two experimental setups for the testing of the alpha-prototype biofilter:

1. Laboratory testing of individual filter elements for filter efficiency and/or particle penetration, dust holding capacity, and in-place leak test
2. Simulated environmental testing of an alpha-prototype in-line biofilter in a closed flow loop to observe gas temperature variations and gas flow-rate variations against the pressure change across each filter element.

Results

Testing of the biofilter was conducted in a closed loop located in an environmental chamber for flow capacity and filter performance with clean filter elements and the previous clogged filter elements.

Results from the testing highlight the large dust-holding capacity and filter efficiency of the filter elements used when challenged by an array of different sized particulates. Furthermore, the pressure drop across the filter elements during a field-simulated experiment overall did not impede the gas flow.

Researchers will propose design, construction, and field testing of an American Society of Mechanical Engineers (ASME) certified beta prototype in-line biofilter that will be field tested in a biomethane producer's pipeline network.

Status

The alpha-prototype biofilter technology proved to be an effective tool in removing a variety of different sized particulates. In addition to the uniqueness of the three-stage filter elements, the biofilter allows for easy implementation, real-time data recording, and a long shelf life.

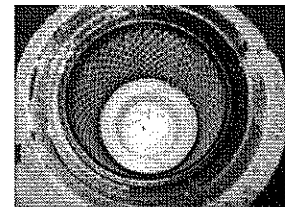

The testing of the alpha-prototype biofilter has led to opportunities for design modifications and enhancements of a beta-prototype. It is expected that the full-scale beta prototype will be designed and constructed as modules to accommodate a wide range of biomethane gas flow rates in biomethane production plants (5,000 to 40,000 scfm).

For more information:

Maureen Droessler

Program Administrator

Operations Technology Development, NFP

Phone: 847/768-0608

maureen.droessler@otd-co.org



Operations
 Technology
 Development

Gas Quality Resource Center

A web-based Gas Quality Resource Center is being established to provide information and expertise on issues surrounding gas quality, interchangeability, and potential implications from the introduction of new supply sources into gas transmission and distribution systems.



Project Description

Natural gas transmission pipeline and distribution companies are increasingly being asked to evaluate opportunities and accept new supply sources into their systems. This phenomenon has created a marked shift from traditional gas-supply flow patterns – a trend that is expected to continue as these new supply sources (e.g., shale gas production and the introduction of renewable gas) are brought to market.

Along with this change in supply comes a change in the gas composition. Traditional supplies and gas compositions that have been relatively stable and consistent for decades are now beginning to change, and stakeholders are looking to ensure that these compositional changes will not have an adverse effect on their gas-delivery infrastructure or their customers' end-use applications.

Foundational knowledge in gas quality and interchangeability is readily available. A study was conducted through an industry collaborative effort that resulted in the 2005 White Paper on Natural Gas Interchangeability and Non-Combustion End Use by the NGC+ Interchangeability Working Group. This document contains Interim Guidelines for Gas Interchange-

ability that have been widely used; however, the White Paper also recognized that there are significant informational or data gaps that require further research. Additionally, the NGC+ report does not address renewable gas at all.

Since the NGC+ report was published, the natural gas industry has generally taken a localized approach in understanding end-use performance and infrastructure issues through the initiation of isolated research efforts to address these increasingly global, systemic issues. Information generated from these research and development efforts is very useful and of great value, but generally fragmented and potentially proprietary.

Utilities and pipeline operators have indicated a need for a centralized informational resource center that can be accessed easily and queried efficiently.

For this project, a research team will identify gaps in information and technology development and develop a Gas Quality Resource Center (GQRC) to serve the industry. The GQRC will provide access to recent and historical information resources and provide expertise and guidance in this technically complex area. The Center will serve as a centralized clearinghouse for

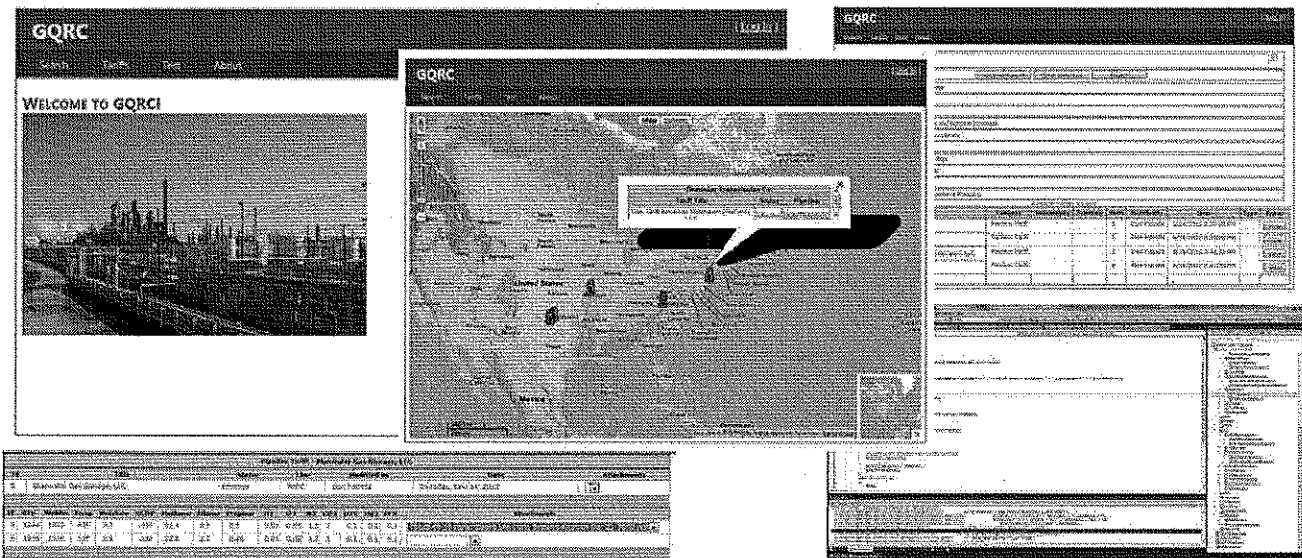

A web-based resource center is under development to provide for information on gas quality and unconventional/renewable sources of gas.

information related to gas quality, analysis of current flowing gas supplies in North America, identification of constituent trends across identified regions, analysis of current technical regulatory trends associated with pipeline tariff negotiations, and identification of research needed to help fill information gaps.

Deliverables

The initial deliverable for this project will be the creation of a dedicated Gas Quality Resource Center website and significant content.

Benefits

The Gas Quality Resource Center will help to allow for the safe introduction of new supply sources. The goal is to establish a common understanding and provide a sound technical basis upon which gas industry stakeholders can make informed decisions regarding new supply options.

The GQRC will help to ensure continued system integrity and reliability, allow for an expanded use of clean-burning natural gas in growth sectors such as power generation and transportation, help to reduce greenhouse gases through the addition/substitution of renewable gas.

Technical Concept & Approach

For this project, a research team is interfacing with an industry advisory committee comprised of subject-matter experts to develop a subscription-based Gas Quality Resource Center.

Researchers are developing an on-line database on gas-quality-related information derived from publically published data as well as proprietary information garnered from various stakeholder groups.

Information focuses on renewable and unconventional gas. Within the renewable gas domain, the resource center will contain information on resource assessments, conversion options, clean-up systems, gas-quality expectations, and studies on potential concerns, implications, and mitigating measures. Within the unconventional gas domain, the resource center will contain information on historical and expected compositions from North American resource basins, gas-processing technology, gas-processing facilities and capabilities, blending capabilities, regional historic supply profiles, publicly available tariff requirements, and studies on known/potential implications to infrastructure and end uses as well as mitigating measures.

Phase 1 of the effort focuses on providing information and technical support.

In Phase 2 of the project, various GQRC research projects are expected to be initiated. Examples of potential high-priority activities for consideration include:

- Development of a dynamic, long-range, gas-quality planning model on a national or regional basis to ensure that renewable and unconventional gas streams can be produced, processed, and seamlessly transported through the pipeline network given the varying tariff specifications and requirements
- A regional analysis of the high-percentage and high-variability of ethane levels produced from the western region of the Marcellus shale play and its potential impacts on transmission and distribution systems, compression facilities (emissions), and impacts sensitive end-use receptors.

Results / Status

Considerable progress was made on the database design and implementation.

The major building blocks and the underlying database architecture were defined using tools in Microsoft Visual Studio 2010. Table structures were identified and modeled, and the relationships between them defined. This information was used to create the database schema. On-line resources for gas quality information were identified.

Specific accomplishments include:

- Modeling of classes and user controls corresponding to the basic entities of the application: search, gas, pipeline, and tariff
- Design and implementation the Pipeline Tariffs information interface
- Design and implementation the basic Search functionality
- Identification of on-line resources of GQRC data
- Creation of the database schema.

For more information:

Maureen Droessler
Program Administrator
Operations Technology Development, NFP
Phone: 847/768-0608
maureen.droessler@otd-co.org



Operations
 Technology
 Development

Sensors for Trace Constituents in Fuel Gases

Research is being conducted to identify candidate sensors or sensor technologies for measuring trace constituents in fuel gases, with the ultimate objective to develop a field instrument.



Project Description

In efforts to develop renewable sources of energy, the natural gas industry has been investigating issues related to the introduction of various types of fuel gases into customer gas supplies.

Of concern is that many unconventional gas sources contain a wide variety of constituents. In landfill gas, for example, a set of some 500 trace compounds have been identified as potential components. The need to understand the composition of the fuel gases and to monitor their critical components is increasing as the number and variety of sources grows.

In this project, research is being conducted to identify candidate sensors or sensor technologies for measuring trace constituents in fuel gases such as landfill gas, biomethane derived from a variety of biomass sources, and unconventional supplies such as tight sands and coalbed methane.

This research is a Phase 1 effort in a multi-phase project to develop a field instrument for determining trace constituents in various fuel gases.

Deliverables

The deliverables for this project will consist of:

- Design criteria
- A list of candidate technologies that either meet, or have the potential to meet, the design specifications
- A Final Report that summarizes the project's findings on the technology assessment and that identifies the leading technologies
- A written proposal for Phase 2 development and demonstration initiatives.

Benefits

The natural gas industry is devising a sustainable energy strategy that includes the use of renewable and unconventional gas.

Monitoring the composition of fuel gases provides the industry with an enhanced capability to maintain valuable underground assets, deliver gas that meets end-use requirements, and protect human health.

Technical Concept & Approach

Phase 1 activities began with interactions with project sponsors to determine monitoring specifications (e.g., how frequently, how precisely, how accurately, over what dynamic range, and at what price can the measurement of trace constituent concentrations be performed).

Subsequently, investigators conducted a search to identify candidate instruments or technologies that would be capable of meeting specified performance criteria.

Issue / Material	Largest Trace Constituent Threats
Cast Iron	CO ₂ , H ₂ S, chlorobenzene, trichlorofluoromethane
Carbon Steel	CO ₂ , H ₂ S, arsenic, carbon disulfide, BTEX
Aluminum	Antimony, zinc, dimethyl sulfide, mercury, chlorinated organics
Polyethylene	C6+ alkanes, BTEX, dimethyl sulfide, chlorinated organics
Polyamide 12	CO ₂ , H ₂ S, aromatics, BTEX, some chlorinated organics
SBR	CO ₂ , H ₂ S, SO ₂ , C6+, BTEX, carbonyl sulfide, dimethyl sulfide, some chlorinated organics
NBR	CO ₂ , H ₂ S, C6+, BTEX, carbonyl sulfide, dimethyl sulfide, some chlorinated organics
CR	H ₂ S, C6+, BTEX, carbonyl sulfide, dimethyl sulfide, some chlorinated organics
SI	H ₂ S, C6+, BTEX, carbonyl sulfide, dimethyl sulfide, some chlorinated organics
Equipment Fouling	Siloxanes

Largest trace constituent threats to natural gas pipelines.

Technology solutions are being considered from a variety of sources. Potential solutions include:

- A special setup of a gas chromatograph with single (or multiple), specialized detection mechanism(s)
- Molecularly imprinted polymers with quartz crystal balances
- Nanotechnology.

After the technology identification is completed, researchers will assess the candidate instruments. Examination of the candidate instruments or methods will entail contacting the developers or manufacturers and assembling performance data. The assessment will consider the ability of a candidate instrument or technology to meet the scientific and engineering design criteria, the measurement cost point, and the timetable for development.

As part of the Phase 1 work, researchers will also prepare plans for Phase 2 efforts, which would include – depending on application readiness – further research, development, and demonstration activities. Sponsors will participate in the consideration and final selection of an appropriate technology to meet their identified specifications.

Results

In 2011, the research team established a set of criteria for measuring trace constituents in fuel gas. Based on the information that was available, a set of relative risk rankings were prepared. These rankings aid in identifying the trace components that are the greatest threats to the gas delivery infrastructure and to end-use applications.

Investigators also identified a set of techniques or methods that could be tailored to measuring the threat constituents and that would meet the following criteria:

- Measurement in real time
- Accuracy and precision in the ppm regime
- Autonomous operation
- Remote-control capable.

The risk rankings, which define the targeted trace components, are not without uncertainty. Some information

for assessing threat severities is unavailable. This information probably leads to an incomplete list of target compounds and perhaps to a conservative selection of the parameters defining the measurement specifications. Additionally, extensive modeling or empirical investigations were not within the scope of this work. This and the fact that some information was unavailable for conducting this assessment means that only a relative risk scoring was prepared.

Information currently available on the compositions of fuel gas from a variety of sources was gathered. An examination of the potential risks to gas infrastructure and to end-use equipment from trace components was conducted.

Information was assembled on the compositions of the following potential sources of fuel gas:

- Coalbed gas
- Dairy-derived biogas
- Landfill gas
- Liquefied natural gas
- Natural gas
- Shale gas
- Thermo-chemically gasified biomass
- Tight sands gas
- Biogas derived from wastewater treatment.

Status

A report on the identification of instrument parameters and design criteria is in preparation.

For more information:

Maureen Droessler
Program Administrator
Operations Technology Development, NFP
Phone: 847/768-0608
maureen.droessler@otd-co.org

**Operations Technology
Development, NFP**

1700 S Mount Prospect Rd
Des Plaines, IL 60018

info@OTD-co.org

847-544-3400

www.otd-co.org

OTD

CELEBRATING 10 YEARS

Research Project Summaries 2012

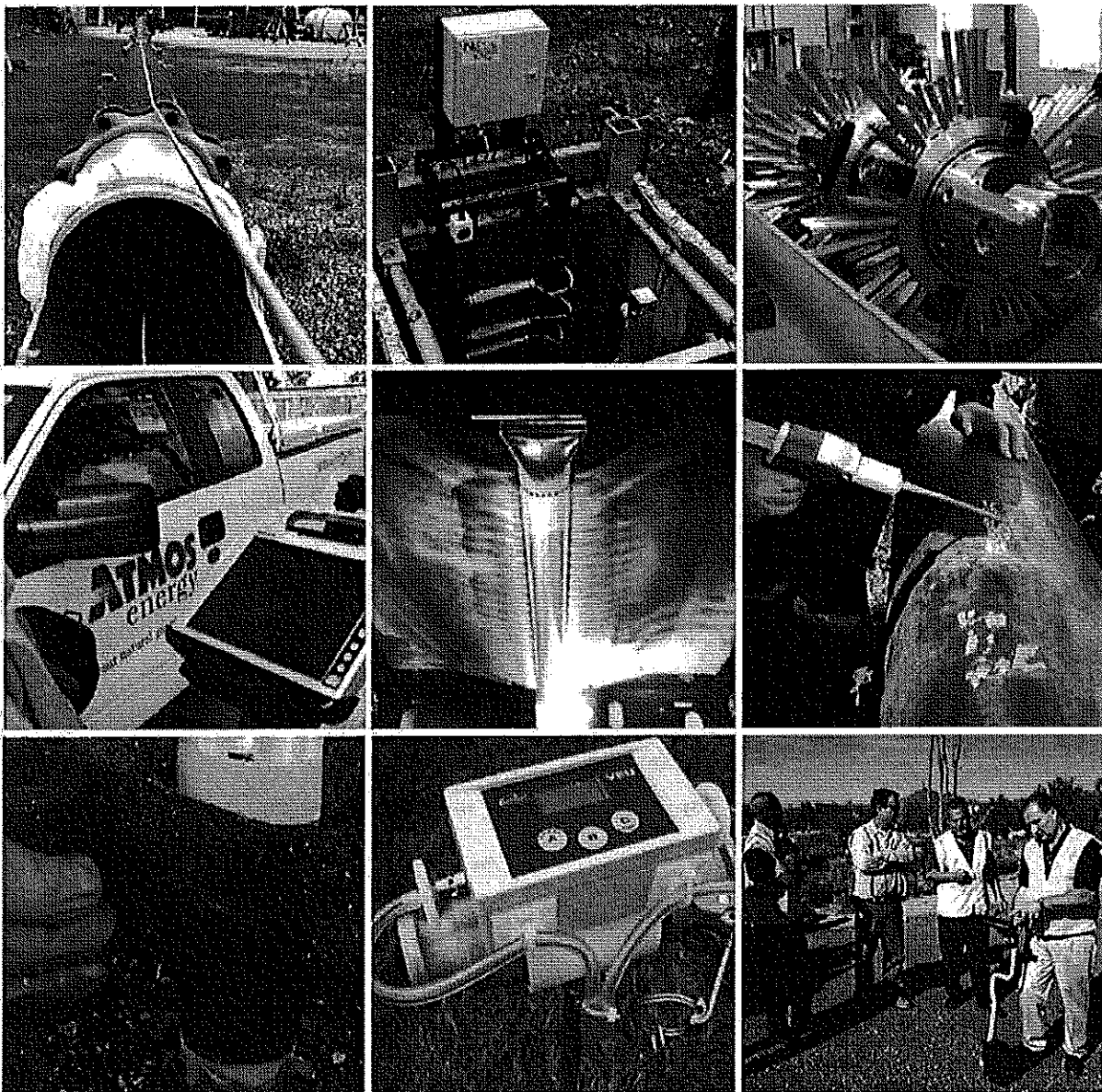

Operations Technology Development, NFP

RESEARCH PROJECT SUMMARIES

2012

Legal Notice

This report was prepared by Operations Technology Development, NFP (OTD), as an account of the results of work sponsored by OTD. Neither OTD, the members of OTD, nor any person acting on behalf of any of them:

- Makes any warranty or representation, express or implied, with respect to the accuracy, completeness, or usefulness of the information contained in this report, or that the use of any information, apparatus, method, or process disclosed in this report may not infringe privately-owned rights. Inasmuch as many projects are experimental in nature, the technical information, results, or conclusions cannot be predicted. Conclusions and analysis of results by OTD represent OTD's opinion based on inferences from measurements and empirical relationships, which inferences and assumptions are not infallible, and with respect to which competent specialists may differ.
- Assumes any liability with respect to the use of, or for any and all damages resulting from the use of, any information, apparatus, method, or process disclosed in this report; any other use of, or reliance on, this report by any third party is at the third party's sole risk.

Chairman / President's Letter

This year marks the 10th anniversary of the founding of OTD and another year of exciting new product introductions, technology developments, and innovations to benefit the natural gas industry and its customers.

Since 2003, the initial membership of 12 companies has nearly doubled, and the synergy of OTD's collaborative programs with industry leaders, government agencies, and manufacturers continues to provide significant improvements in the safety, efficiency, and reliability of the North American gas-delivery infrastructure. Today, OTD is recognized as the gas industry's premiere source for technology development and an organization with the vision, talent, and experience necessary to lead the gas industry on the path to important improvements.

Evidence of OTD's impact can be seen in the offices and field operations of the industry's leading distribution and pipeline companies, where the results of successful R&D are present in a variety of tools, technologies, and techniques. Many of these products are presented in the pages of this report – including new technologies for plastic-pipe location, leak detection, pipe inspection, information management, environmental issues, and a wide range of other applications.

This year's report details more than 70 projects – OTD's largest and most ambitious program ever. In 2012, several program developments resulted in the market introduction of new products. For example, SENSIT Technologies, Inc., is now offering an acoustic-based system capable of locating plastic pipe at depths up to five feet. Developed through OTD, the acoustic pipe locator is just one development in a portfolio of projects focused on improving the operation, integrity, and safety of gas operations. Newer efforts include the development of tools and methods to detect cross bores, an inspection system for pipeline's considered "unpiggable," sensors for determining trace constituents in fuel gases, and the development of an intelligent shut-off device.

Ten years of success has provided OTD with the advantage of long-standing relationships with leading manufacturers, research organizations, industry associations, and government entities. Together, we will continue to combine our resources to work for common goals that enhance the vital North American gas infrastructure. And we thank you for your support.

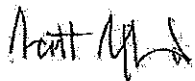

Scott Shepherd
Chairman of the Board

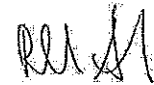
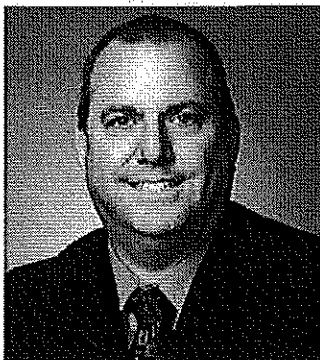

Ronald Snedic
President



OTD Members

- > Alabama Gas Corporation
- > APGA Research Foundation
- > Atmos Energy Corporation
- > Avista Utilities
- > Consolidated Edison Co. of NY, Inc.
- > Enbridge Gas Distribution Inc.
- > Intermountain Gas Company
- > Louisiana RDC
 - Atmos Energy Corporation
 - CenterPoint Energy, Inc.
 - Entergy Corporation
- > National Fuel Gas Distribution Corporation
- > National Grid
- > New York State Electric & Gas Corp. / Rochester Gas and Electric
- > Nicor Gas
- > NiSource Inc.
- > NW Natural
- > Oklahoma Natural Gas
- > PECO Energy
- > Peoples Gas / Integrys Energy Group, Inc.
- > Piedmont Natural Gas Company, Inc.
- > Questar Gas
- > Southern California Gas Co., a Sempra Energy Utility
- > Southwest Gas
- > TECO Peoples Gas
- > Washington Gas

Results in Use

For more than 10 years now, the OTD program has been providing utilities, pipeline companies, service providers, and others in the natural-gas-delivery business with innovative tools, enhanced processes, and advanced equipment developed to improve gas system operations. These products represent the results of OTD's efforts to build a stronger industry infrastructure, enhance system integrity, and improve the efficiency of a wide range of operations activities.

Selected OTD-Developed Products in the Marketplace

> Acoustic Pipe Locator

SENSIT Technologies

SENSIT's acoustic-based pipe locator provides the ability to locate plastic pipes before excavations and construction. Now commercially available, in tests the system was shown to be capable of detecting multiple buried plastic pipes at depths up to five feet.
(Project Summary, p. 17)

Contact: Scott Kleppe | 219-465-2700 | jscottk@gasleaksensors.com | www.gasleaksensors.com

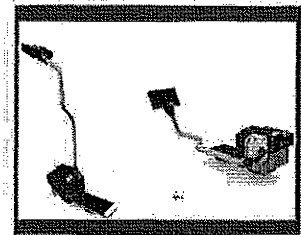

> High-Accuracy GPS for Tablets and Smart Phones

3-GIS

An application developed by OTD and GTI is now part of the 3-GIS Mobile platform to allow users to integrate external GPS receivers to improve the position accuracy of new asset mapping operations. Users can collect sub-foot accurate GPS data in real time on Android tablet computers and smart phones with no post-processing and no need for a base station.

Contact: Lee Nelson | 256-560-0744 x 222 | lnelson@3-gis.com | www.3-gis.com



> Metallic Joint Locator (MJL)

SENSIT Technologies

The SENSIT Ultra-Trac® MJL accurately locates bell joints, repair clamps, and service connections on metallic piping systems, significantly reducing excavation areas and pavement restoration costs. In field tests, the MJL was also able to detect bell and spigot joints for an eight-inch-diameter water main buried at a depth of six feet.

Contact: Scott Kleppe | 219-465-2700 | jscottk@gasleaksensors.com | www.gasleaksensors.com

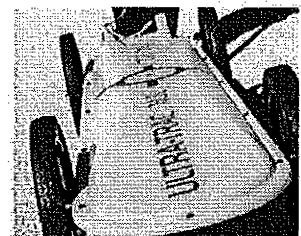

> Portable Methane Detector (PMD)

SENSIT Technologies

The handheld SENSIT® PMD uses optical-detection technology to provide sensitivity and cost advantages over conventional techniques employing flame ionization detectors. The PMD improves the efficiency of leak surveys, is less costly to maintain than other technologies, and can detect leaks from low ppm to 100% gas.

Contact: Scott Kleppe | 219-465-2700 | jscottk@gasleaksensors.com | www.gasleaksensors.com

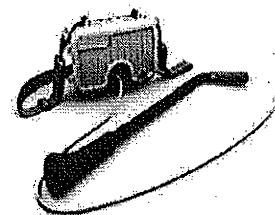

> **GPS-Enabled Leak Surveying**

Integrated Mapping Services, Inc.

Automating the leak surveying and pinpointing process with GPS eliminates paper records, providing increased efficiency and reliable compliance documentation. Implementation of the GPS-enabled system with VeroTrack .AST™ software application is under way at several utility companies. (*Project Summary, p. 7*)

Contact: Langley Willauer | 207-236-3485 x306 | langley@ubisense.net | www.ubisense.net



> **Uptime® 3.0 Distribution Integrity Management Risk Model**
GL Noble Denton

Uptime® 3.0 provides an integrated environment for the integrity management of gas distribution and transmission pipeline assets. Uptime provides core support for all the key elements of distribution integrity management program regulations.

Contact: Michael Moore | 717-724-1900 | michael.moore@gl-group.com | www.gl-group.com



> **NO-BLO® DBS System**

Mueller Co.

Directional Bag Stopper (DBS) technology allows for routine maintenance without interruption of gas service to the customer. A portable system, it allows field technicians to perform many tasks related to the gas service line, including meter replacement and work on any part of the meter set, such as risers and regulators.

Contact: Bryan Kortte | 217-425-7516 | bkortte@muellercompany.com | www.muellercompany.com

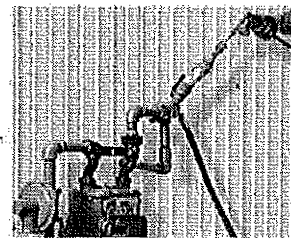

> **Meter Xchanger™**

Mueller Co.

This technology allows utilities to conduct meter change-outs without interrupting service, with the advantage of hands-on work, without shrouds and glove ports. The change-out tool can increase productivity, reduce the cost of the meter change-out process, and virtually eliminate the impact on customers.

Contact: Bryan Kortte | 217-425-7516 | bkortte@muellercompany.com | www.muellercompany.com

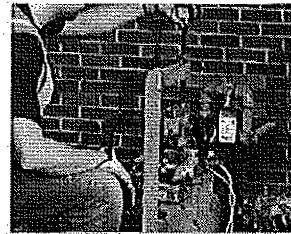

> **Lift Assists for Pavement Breakers and Rock Drills**

Integrated Tool Solutions

These devices assist workers in lifting pavement breaker and rock drills after the bits break through surface pavements and rocks and need to be repositioned for the next penetration. By eliminating the need to manually lift and re-position the heavy tools, the lift assists make breaking easier and less physically demanding.

Contact: Ryan Purczynski | 951-929-4808 | rpurczynski@integratedtoolsolutions.com | www.integratedtoolsolutions.com



> **Keyhole Pipeline Inspection Camera System**

ULC Robotics

The PRX250K keyhole camera is an internal inspection system designed for visual assessment of live mains through conventional pits or small keyholes. The system is easily maneuverable through tight bends, allowing utilities to examine pipe segments without the need to drill additional access holes.

Contact: Greg Penza | 631-667-9200 | gpenza@ulcrobotics.com | www.ulcrobotics.com



Informational Products

Selected OTD-Developed Technical Reports

In addition to the development of new tools, processes, and products, OTD supports research that results in useful information on various aspects related to gas delivery and operations.

Listed here are some of the key reports developed under OTD sponsorship since 2003.

PIPE & LEAK LOCATION

> Cross Bores Best Practices Guide

Cross bores have become an industry concern because of incidents involving gas mains and services that were installed using trenchless technology that inadvertently transected a sewer line or private septic system. The Guide provides recommendations and procedures for preventing and detecting cross bores. (OTD-12/0003) (Project Summary, p. 59)



> Residential Methane Gas Detector Program

This report provides results of a project initiated to determine whether commercially available combustible gas detectors are susceptible to giving false positive responses to an assortment of typical household chemicals, including ammonia, ethanol, acetone, toluene, isobutane, ethyl acetate, isopropanol, heptane, and hydrogen.

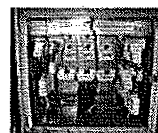

> Underground Facility Pinpointing

This report presents the results of research conducted on several technologies used by utilities to locate underground pipes and facilities. Researchers investigated standard electromagnetic locators, ground-penetrating radar, and alternative imaging tools. The report provides a comparative, technical evaluation of tools that are currently available. (OTD-06/0001)



PIPE MATERIALS, REPAIR & REHABILITATION

> Electrofusion Coupling Evaluation and Best Practices

Researchers investigated techniques used to perform electrofusion joining of plastic gas pipe in an effort to develop guidelines for the use and operation of electrofusion coupling. With a detailed set of guidelines, the gas industry can enhance the performance and safety of its plastic piping systems.



> Review and Selection Guide for Pipe Rehabilitation

The focus of this study is on reinforced thermoplastic pipe (RTP) as a pipe-rehabilitation option for use in the natural gas industry. To help pipeline operators gain a better understanding of the technology, researchers developed a product-selection guide based on thorough research of available RTP technology.



EXCAVATION & SITE RESTORATION

> Evaluation of Lightweight Jackhammers

A research team evaluated the performance of currently available lightweight pneumatic and hydraulic jackhammers with respect to their effectiveness in breaking asphalt and concrete pavement, while considering other operational factors such as noise, vibrations, operator impact, and performance.



> Cold-Patch Products Performance Results

This report provides the results of a testing program that evaluated nine commercially available cold-patch products, including two products introduced in the market as "green" patches. Cold- and warm-weather tests were performed and repeated moving loads were applied with a wheel-loading machine that conducted 50,000 wheel passes.



➤ **Evaluation of Flowable Fill Around Buried Pipes**

Flowable fill is required by some agencies for use as backfill material for pipe repairs, rehabilitations, and other operations. Presented in this report are the results of performance tests of flowable fill, including the effects of flowable fill on pipeline corrosion and on the detection of gas flow and leaks through the backfill. (OTD-07/0004)



➤ **Alternative Methods of Pavement Cutting**

In an effort to reduce the costs and improve the process of pavement cutting, researchers investigated the application of current and new pavement-cutting methods. Technologies examined and summarized in this report include impact breaking, sawing, chemical and thermal methods, water-jetting, and laser cutting.



PIPELINE INTEGRITY MANAGEMENT & AUTOMATION

➤ **Leak-Rupture Boundary Report and Calculator**

This report and associated software allows operators to determine the leak-rupture boundary for a pipe segment based on properties such as the diameter, toughness, and yield strength. Operators can use the calculator for risk modeling and consequence analysis. (OTD-13/0002 and OTD-13/0004.) (Project Summary, p. 59)



➤ **Field-Applied Pipeline Coatings: Short- and Long-Term Performance**

This report presents the culmination of a 10-year research program to assess more than 80 different commercially available field-applied pipeline-coating products. The goal was to establish an unbiased, third-party basis for operators to select the most appropriate coating system for particular applications.



➤ **Evaluation of Guided Wave Technology as a Hydrotest Equivalent**

This report details an evaluation conducted to demonstrate and validate the use of Guided Wave Ultrasonic Testing as an equivalent to a hydrotest. A draft standard was developed and is currently under review by the National Association of Corrosion Engineers (NACE) for incorporation into an industry standard. (OTD-11/0001)



➤ **"Black Powder" Contamination in the Gas Industry: Survey and Best Practice Manual**

Black powder – a substance composed mainly of iron sulfides and iron oxides – can cause corrosion and create wear on pipelines. This report provides information on issues, cleanup techniques, and management methods related to "black powder" contaminants. Results were compiled into a "best practices" industry manual. (OTD-07/0002)



➤ **Literature Review for Elemental Sulfur Deposits in Natural Gas Transmission Pipelines**

Deposits of "elemental sulfur" – which can block natural gas pipes and equipment – are becoming an increasing concern in the natural gas industry. This report summarizes a literature review to develop a better understanding of the sources, causes, and mitigation possibilities for sulfur deposits found in gas pipelines. (OTD-09/0001)

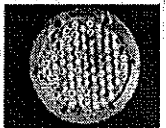

➤ **Flaw Acceptance Criteria and Repair Options for Low-Stress Natural Gas Pipelines**

Researchers partnered with pipeline companies and industry organizations to develop modified assessment criteria for low-stress pipelines. The goal, as outlined in this report, was to develop criteria for discriminating flaws that truly affect pipeline integrity from flaws that have no significant impact.

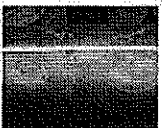

➤ **In-Field Corrosion Rate Measurement/Determination for Integrity Reassessment Intervals and Risk Prioritization**

Research was conducted to develop a systematic and simple method to calculate realistic corrosion growth rates for determining pipeline-reassessment intervals.



OPERATIONS INFRASTRUCTURE SUPPORT

➤ **Ignition Testing of Electronic Devices**

In this project, handheld electronic devices were tested to determine if ignition occurs in the presence of a flammable methane/air mixture. Laboratory tests demonstrated a large margin of safety under the scenarios investigated. (OTD-12/0001) (Project Summary, p. 123)



➤ **Intelligent Utility Installation Process**

This report provides a methodology, field process, and a data model for capturing data during new utility installations. The process is used to capture information regarding the location, materials, installation process, environmental considerations, and other factors. (OTD-12/0002) (Project Summary, p. 111)



> **Tracer Wire for HDD Applications**

Extensive research and testing culminated in the release of a report that provides valuable information on the properties and performance of various tracer-wire products for use in horizontal directional drilling (HDD) operations. (OTD-13/0001) (Project Summary, p. 105)



> **Regulator Vault Corrosion and Coating Rehabilitation**

This study focused on thermal-spray and its ability to mitigate the corrosion of gas piping and the components housed in utility vaults. Results from the field work include detailed information on surface preparation methods, pre-cleaning, coating applications, quality-control inspection specification for field use, and the coating-material selection process.



> **Assessment of Vehicle-Barrier Design for Aboveground Facility Protection**

Investigators compiled the latest information on the design, regulations, and installation practices of structural vehicle barriers used to protect aboveground utility facilities from vehicular damages. The Final Report also includes a review of various state and federal safety guidelines.



> **Study of Low-Impact Markings**

A variety of paints, materials, and techniques were tested and characterized in an effort to identify products and methods that can be used for temporary utility marking. Information developed in this study allows users to identify the most appropriate marker type for a given environment to achieve the desired marking duration.



> **Solar-Powered Remote Monitoring**

In this study, solar-powered devices were investigated as power sources for the remote monitoring of various gas utility facilities to more cost-effectively obtain recifier data, pipe-to-soil measurement, pipe-to-casing readings, and other information. (Project Summary, p. 99)

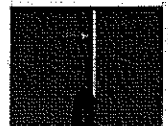

> **Integrating GPS into Routine Operations**

This report provides a set of recommendations and GPS implementation strategies developed through pilot programs, literature searches, and reviews of existing applications. Operations that were considered included meter reading, leak surveying, new installations, corrosion monitoring, and valve inspections.



> **DVDs for Training First Responders**

DVD training products help gas companies better educate first-responding personnel about natural gas emergencies. Learning modules with realistic scenarios cover a variety of issues to enhance public and worker safety. The product also serves to improve emergency-response effectiveness and coordination.



ENVIRONMENTAL, RENEWABLES & GAS QUALITY

> **Siloxane Concentrations in Biomethane**

Biomethane from various waste products could provide consumers with a significant source of "green" renewable energy. In efforts to help develop this green resource, a study was conducted into siloxane – one of the potential constituents in biomethane – to assess its influence on health, the environment, and gas-fired appliances. (Project Summary, p. 137)

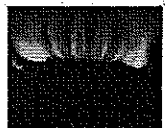

> **Field Measurement Program to Improve Uncertainties for Key Greenhouse Gas Emission Factors for Distribution Sources**

This report summarizes the results of field surveys conducted at six natural gas utilities. With the support of the American Gas Association, research updated emissions factors for metering stations, regulating stations, and customer meters. (OTD-10/0002)



> **Pipeline-Quality Methane: North American Guidance Document for Introduction of Dairy-Waste-Derived Biomethane into Existing Natural Gas Networks**

The guidance document provides reference and recommendations for the consideration of biomethane from dairy-waste digestion for introduction into gas pipeline networks. The report details results of a biogas/biomethane Gas Technology Institute research program.



Contact: Maureen Droessler
847-768-0608
maureen.droessler@otd-co.org
www.otd-co.org

December 2012 | UTD Update



We're excited about the progress UTD has achieved on several fronts. Below is a summary depicting our available products and resources, projects that have accomplished significant milestones, and new awards which help leverage UTD member funds. If you have any questions regarding this report or it's content, please give us a call.

Ron Snedic
847-768-0572

Greg Maxfield
952-250-7197

Our members serve over 20 million natural gas consumers in North America. Together we are shaping the energy future with new efficient end-use technologies.

Products Commercially Available or Being Readied for Commercialization

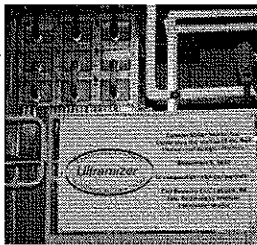

➤ **Transport Membrane Condenser (TMC)**

Cannon Boiler Works, Inc.

An advanced heat-and-water recovery system, including TMC technology, was installed and commissioned at Baxter Healthcare in Thousand Oaks, CA, meeting performance expectations and increasing the boiler efficiency from 80% to 93% – saving the customer 15% on fuel bills, reducing greenhouse emissions by 15%, and saving over 250,000 gallons of water. The Ultramizer® system is available from Cannon Boiler Works, Inc.

Chris Giron

Cannon Boiler Works
724-335-8541 x414
sales@cannonboilerworks.com
www.cannonboilerworks.com

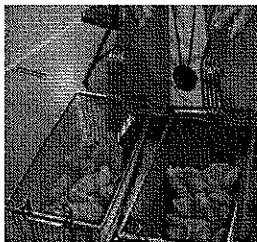

➤ **Low-Oil-Volume Fryers**

Frymaster, a Manitowoc Foodservice company

A new commercial foodservice low-oil-volume fryer has undergone development and pre-commercial testing with successful results. The fryer, marketed by Frymaster as Protector® fryers, increases energy efficiency while also extending cooking-oil quality and life to provide significant customer savings.

Linda Brugler

Frymaster
318-866-2488
lbrugler@frymaster.com
www.frymaster.com

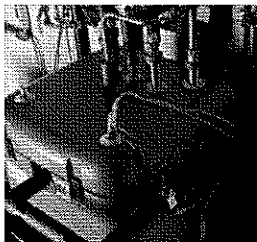

➤ **Equinox Solar-Assisted Heating System**

Solar Usage Now, LLC

The Equinox system is a combination thermal storage tank and instantaneous water heater capable of providing 100% of domestic hot-water and space-heating needs. This unit was tested in multiple residential and commercial sites and is available from Solar Usage Now as the S.U.N. Equinox Heating System®.

Tom Rieker

Solar Usage Now, LLC
614-759-7242
service@netwalk.com
www.solarusagenow.com

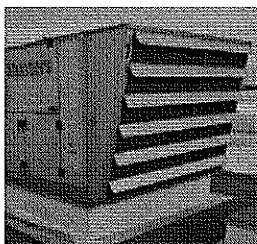

➤ **Dedicated Outside Air System (DOAS)**

Munters Corporation

A condensing heating version of this Munters DOAS is in final development and will undergo field testing during the winter of 2012/2013 at "big box" retail store locations with participating utility Emerging Technology Programs. UTD research has been instrumental in establishing baseline store-heating energy use, developing the DOAS condensing heating module, and defining combustion condensate disposal practices from rooftops.

Larry Klekar

Munters Corporation
210-249-3883
larry.klekar@munters.com
www.munters.com

Market Forge Industries

617-387-4100
866-698-3188
custserv@mfi
www.mfi.com

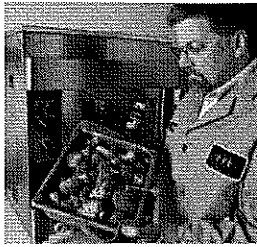

> **Market Forge Countertop Steamer**

Market Forge Industries Inc.

This compact gas-fired countertop steamer for commercial food service offers enhanced cooking rates while providing users with added savings of energy and water consumption. The unit is the first gas-fired boilerless steamer with an Energy Star rating.

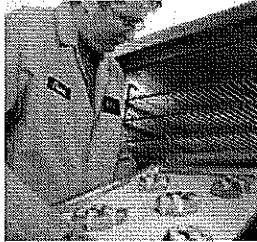

> **Avantec Combi-Oven**

Avantec Food Service Equipment

The combination oven uses a patented technology for improving cooking performance, quality, and efficiency. Able to operate in various cooking modes, the oven provides enhanced cooking uniformity when compared to similar-sized ovens.

Dave Goble

Avantec Food Service
Equipment

800-322-4374

dave@twomarket.com

www.avantecequipment.com



> **Cummins 8.9L Ultra-Low Emissions Engine**

Cummins Westport Inc. (CWI)

This is the first engine certified to the highly stringent California 2010 standards for heavy-duty vehicle engines – achieving emission levels below the 0.2 g NO_x/hp-hr requirement while also retaining high shaft efficiency. Since commercial introduction in 2007, the engine has been widely used in the United States (with over 13,000 engines now in service) and throughout the world in transit, refuse-collection, and regional hauling applications.

Scott Baker

Cummins Westport Inc.

604-718-2025

scott.baker@cummins.com

www.cumminswestport.com



> **BRC FuelMaker's Phill**

BRC FuelMaker

A field demonstration program was conducted to assess the performance, reliability, and economics of a natural-gas-fueling product that allows for the refueling of natural gas vehicles at homes and businesses. Data was analyzed and a user survey was conducted at the conclusion of the demonstration.

Francesco Donalisio

IMPCO Technologies/
BRC FuelMaker

+39 0172.48.68.656

F.Donalisio@brc.it

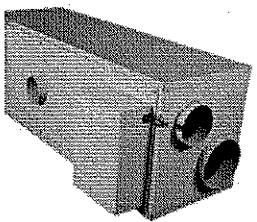

> **NovelAire ComfortDry™ 400**

NovelAire Technologies

This advanced supplemental dehumidifier was developed for residential and light-commercial buildings where humidity or moisture-related allergen concerns prevail. Research provided enhanced operation and reliability, along with reduced cost, weight, size, and installation requirements.

Scott Janke

NovelAire Technologies

770-664-4756

sljanke@novelaire.com

www.novelaire.com/

residential-dehumidifiers.html

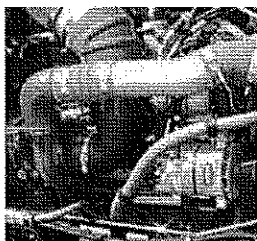

> **Westport HPDI NGV Fuel System**

Westport Innovations Inc.

High-Pressure, Direct-Injection (HPDI) technology enables engines designed for diesel combustion to operate with natural gas while retaining the same critical performance features of high torque, power, and fuel economy of a traditional diesel engine. A 2010 demonstration of the Westport HD-powered tractor allowed fleets to obtain first-hand experience with the new technology. Westport reached an agreement with Cummins in 2012 to now manufacture the engines in its Jamestown, NY, plant.

Stephen Ptucha

Westport Innovations Inc.

604-718-2024

SPtucha@westport.com

www.westport.com

Significant Milestones

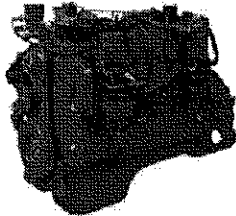

- > **Cummins Westport (CWI) High-Horsepower NGV Engine**
CWI, with UTD support, is developing a new 11.9-liter 400-HP NGV engine (ISX12G) for the large truck and bus market segment such as regional haulers, refuse transfer trucks, and other larger vehicles. The new engine will satisfy the stringent California emission requirements. Over a dozen field-demonstration units were put into service in 2012 and are performing well. The new gas engine is expected to be available in the first quarter of 2013.

Scott Baker
Cummins Westport Inc.
604-718-2025
scott.baker@cummins.com
www.cumminswestport.com

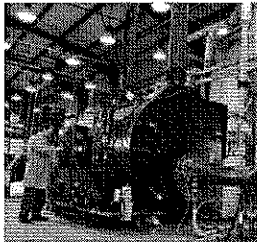

- > **FlexCHP High-Efficiency Ultra-Clean Power and Steam Package**
Researchers are developing a cost-effective supplemental burner, integrated with a gas-turbine based combined heat-and-power system. Laboratory tests have shown total efficiency of over 85% and NOx emissions that are below stringent California emission levels. Field testing is planned at a food-processing plant in California.

Dave Cygan
Gas Technology Institute
847-768-0524
david.cygan@gastechnology.org
www.gastechnology.org

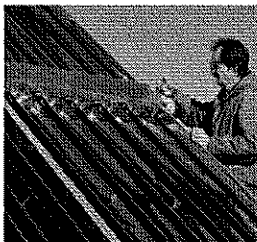

- > **Solar-Assisted Natural Gas Energy Systems**
Progress continues with the installation of solar-thermal collectors using B2U Solar's higher-temperature External Compound Parabolic Concentrator (XCPC) technology. Additional testing is planned with SABMiller at its Los Angeles area brewery.

Dave Cygan
Gas Technology Institute
847-768-0524
david.cygan@gastechnology.org
www.gastechnology.org

Analytical Tools & Information Products

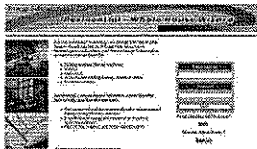

- > **Whole House Residential Energy Efficiency Wizard (REEW)**
The REEW provides UTD members and their customers with a user-friendly Internet-server-based tool allowing for the analysis and easy selection of the latest technologies applicable to residential buildings energy efficiency measures customized to a specific member service territory. The latest version (4.0) includes new building templates (raised floor, crawlspace, and basement) as well as an enhanced library on wall insulation and glazing.

Jennifer Yang
Gas Technology Institute
847-768-0531
jennifer.yang@gastechnology.org
www.gastechnology.org



- > **Commercial Green Building Analyzer (CGBA)**
The CGBA is designed to be a user-friendly tool allowing for easy selection of the latest applicable commercial "green" building energy-efficiency measures customized to a specific member service territory. Several new building envelope materials (walls and windows) were added to the recently released version 1.5.

Jennifer Yang
Gas Technology Institute
847-768-0531
jennifer.yang@gastechnology.org
www.gastechnology.org



- > **Venting Solutions**
VENT-II, the industry standard software program for vent system design, offers application with commonly used desktop operating systems and spreadsheet tools. A venting Technical Advisors Group includes 30 subject matter experts, manufacturers, industry groups and associations, and Gas Technology Institute.

Larry Brand
Gas Technology Institute
847-768-0968
larry.brand@gastechnology.org
www.gastechnology.org

Neil Leslie

Gas Technology Institute

847-768-0926

neil.leslie@gastechnology.org

www.gastechnology.org



➤ **Source Energy and Emissions Analysis Tool**

The Source Energy and Emissions Analysis Tool (SEEAT) allows calculation of the energy source and greenhouse-gas emissions related to point-of-use (site) energy consumption by fuel type for each energy consuming device (e.g., appliances and vehicles). SEEAT includes a source-energy and carbon-emission calculation methodology that accounts for primary energy consumption and related emissions for the full fuel cycle for residential and commercial buildings, industrial applications, and light-duty vehicles. (Available online at www.cmictools.com.)

➤ **International Green Construction Code (IGCC)**

The International Green Construction Code (IGCC) development committee shifted from site energy to source energy and greenhouse-gas (GHG) emissions as the basis of the performance requirements in IGCC. The latest publication includes a single-reference building approach that will implement the source energy and GHG emission compliance requirements consistently and equitably.

Neil Leslie

Gas Technology Institute

847-768-0926

neil.leslie@gastechnology.org

www.gastechnology.org



Select New Cofunding and Leveraged Funding Sources

- GTI signed a \$4.5 million contract with the California Energy Commission for the demonstration and deployment of new NGV engine and vehicle technologies.
- GTI is part of a \$4.5 million U.S. Department of Energy Advanced Research Projects Agency-Energy (USDOE ARPA-E) program to develop a novel free-piston compressor for NGV home fueling.
- GTI signed a \$500K contract with the USDOE's Building America program to address a range of energy efficiency issues associated with using natural gas in homes, including whole house energy efficiency retrofit solutions for cold-weather climates.
- In 2012, GTI established the Emerging Technology Program (ETP). This consortium of seventeen utility organizations is helping to address the field testing, demonstration, and deployment of new natural gas end use technologies and products. ETP will work closely to take the output from UTD-funded efforts toward broader commercial impact.



September 9, 2015

Mr. Jeff R. DeRouen
Executive Director
Kentucky Public Service Commission
211 Sower Boulevard
Frankfort, Kentucky 40601

Dear Mr. DeRouen:

Atmos Energy Corporation (Company) herewith submits reports to be in compliance with Original Sheet No. 37 of the Company's tariff. The reports are contained on a CD due to their voluminous nature. Also, the CD includes reports for 2013 and 2014 as the reports for 2013 were inadvertently omitted from being filed last year. The Company apologizes for the oversight and is committed to filing all future reports on a timely basis. The attached reports set forth the manner in which the Research and Development Rider funds have been invested in research and development initiatives during the past two years.

The research funds are utilized to partially fund the Company's participation in two not-for-profit research groups administered by the Gas Technology Institute. Operations Technology Development (OTD) supports technology aimed at reducing operations costs, enhancing safety and increasing efficiencies. The Utilization Technology Development (UTD) supports a portfolio of near to mid-term technology development projects for residential, commercial and industrial markets in efforts to offer customers more efficient, cost effective and cleaner burning gas product options.

Please contact me at (270) 685-8024 if you have any questions and/or need any additional information.

Sincerely,

A handwritten signature in black ink, appearing to read "Mark A. Martin".

Mark Martin,
Vice-President of Rates & Regulatory Affairs

Enclosures

OTD

Operations
Technology
Development

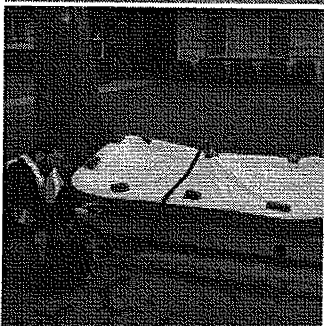
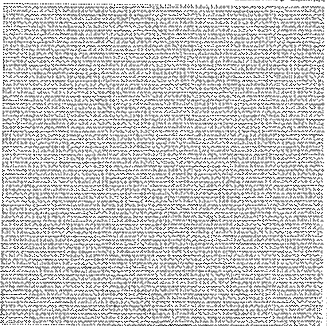
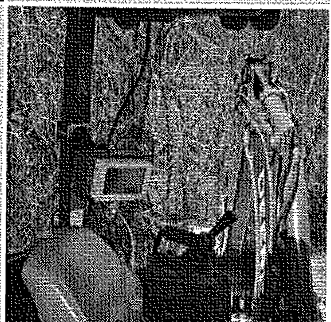
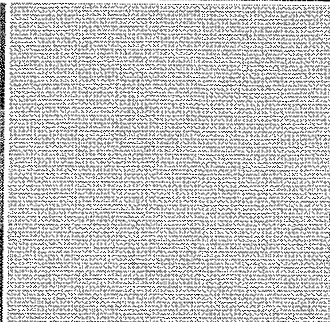
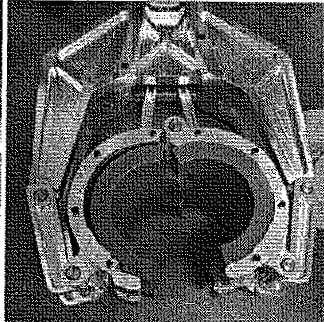
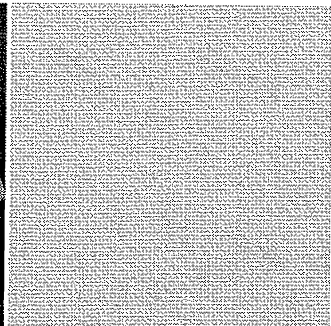

RESEARCH PROJECT SUMMARIES 2013

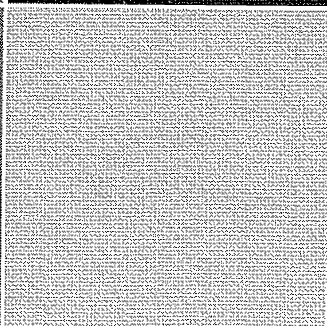
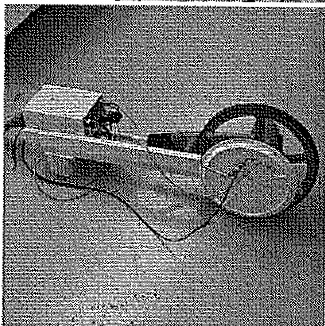
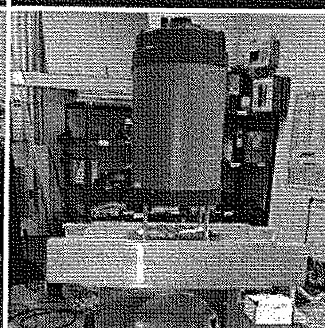
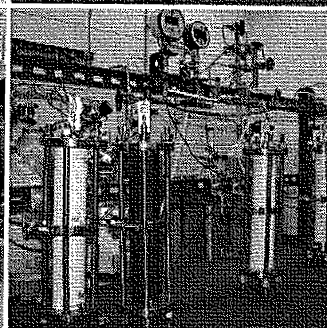
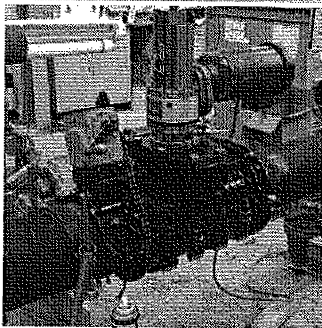

Operations Technology Development, NFP

RESEARCH PROJECT SUMMARIES

2013

Legal Notice

This report was prepared by Operations Technology Development, NFP (OTD), as an account of the results of work sponsored by OTD. Neither OTD, the members of OTD, nor any person acting on behalf of any of them:

- Makes any warranty or representation, express or implied, with respect to the accuracy, completeness, or usefulness of the information contained in this report, or that the use of any information, apparatus, method, or process disclosed in this report may not infringe privately-owned rights. Inasmuch as many projects are experimental in nature, the technical information, results, or conclusions cannot be predicted. Conclusions and analysis of results by OTD represent OTD's opinion based on inferences from measurements and empirical relationships, which inferences and assumptions are not infallible, and with respect to which competent specialists may differ.
- Assumes any liability with respect to the use of, or for any and all damages resulting from the use of, any information, apparatus, method, or process disclosed in this report; any other use of, or reliance on, this report by any third party is at the third party's sole risk.

Chairman / President's Letter

In this report, we're proud to present another outstanding year of OTD-supported R&D success and new initiatives. While the results of OTD's collaborative efforts provide significant benefits for the companies involved in the delivery of natural gas, it is, of course, the consumers who are the ultimate beneficiaries of OTD efforts. In these pages, you will find a wealth of information on projects designed to deliver benefits to gas consumers through lower-cost operations, improved reliability, and enhanced safety.

Since OTD was established in 2003, we have grown to become recognized as the natural gas industry's key source for technology development and product introduction. Through a unique structure, focused planning, and built-in flexibility, the OTD program addresses the industry's major needs and research challenges while providing companies with opportunities to support initiatives of specific interest.

In recent years, OTD helped to introduce several new technologies for plastic-pipe location, leak detection, pipe inspection, information management, environmental issues, and other applications. However, the development of key data, software, and web-based information is also essential to maintaining the integrity of the natural gas infrastructure. Several projects also involve the incorporation of GPS and other information technologies to provide easy ways for companies to maintain data bases, improve planning, and address costs.

With safety always the industry's top priority, most OTD efforts have a significant safety-improvement component. Others address codes, standards, environmental concerns, and regulatory-compliance issues by developing and presenting R&D results that help companies in meeting the often complex government requirements facing the industry.

As the industry progresses, OTD will continue to be a major force in the progression toward even safer, more reliable, and more productive operations. Through collaborative programs with leading manufacturers, research organizations, industry associations, and government entities, OTD is well positioned to bring a wide array of benefits for both the users and providers of natural gas.



Jamie Milner
Chairman of the Board

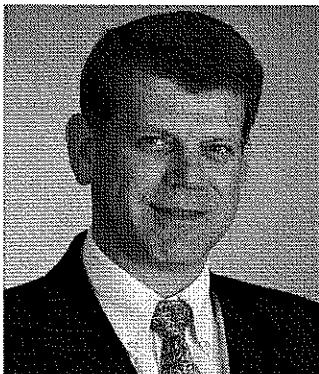

OTD Members

- > Alabama Gas Corporation
- > APGA Research Foundation
- > Atmos Energy Corporation
- > Avista Utilities
- > Consolidated Edison Co. of NY, Inc.
- > Enbridge Gas Distribution Inc.
- > Intermountain Gas Company
- > Louisiana RDC
 - Atmos Energy Corporation
 - CenterPoint Energy, Inc.
 - Entergy Corporation
- > National Fuel Gas Distribution Corporation
- > National Grid
- > New York State Electric & Gas Corp. / Rochester Gas and Electric
- > NiSource Inc.
- > NW Natural
- > Oklahoma Natural Gas
- > Pacific Gas and Electric Company (2014)
- > Peoples Gas / Integrys Energy Group, Inc.
- > Piedmont Natural Gas Company, Inc.
- > Questar Gas
- > Southern California Gas Co., a Sempra Energy Utility
- > Southwest Gas
- > TECO Peoples Gas
- > Washington Gas

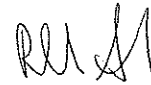

Ronald Snedic
President



Results in Use

Since 2003, the OTD program has been providing utilities, pipeline companies, service providers, and others in the natural-gas-delivery business with innovative tools, enhanced processes, and advanced equipment developed to improve gas system operations.

These products represent the results of OTD's efforts to build a stronger industry infrastructure, enhance system integrity, and improve the efficiency of a wide range of operations activities.

Selected OTD-Developed Products in the Marketplace

> Acoustic Pipe Locator (APL)

SENSIT Technologies

SENSIT's ULTRA-TRAC® APL acoustic-based pipe locator provides the ability to locate plastic pipes before excavations and construction. Now commercially available, in tests the system was shown to be capable of detecting multiple buried plastic pipes at depths up to five feet.

Contact: Scott Kleppe | 219-465-2700 | jScottK@gasleaksensors.com | info@gasleaksensors.com

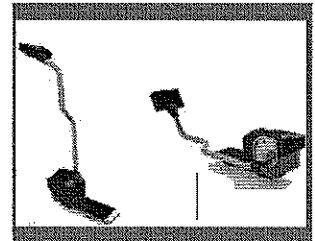

> Metallic Joint Locator (MJL)

SENSIT Technologies

The SENSIT Ultra-Trac® MJL accurately locates bell joints, repair clamps, and service connections on metallic piping systems, significantly reducing excavation areas and pavement restoration costs. In field tests, the MJL was also able to detect bell and spigot joints for an eight-inch-diameter water main buried at a depth of six feet.

Contact: Scott Kleppe | 219-465-2700 | jScottK@gasleaksensors.com | info@gasleaksensors.com



> Portable Methane Detector (PMD)

SENSIT Technologies

The handheld SENSIT® PMD uses optical-detection technology to provide sensitivity and cost advantages over conventional techniques employing flame ionization detectors. The PMD improves the efficiency of leak surveys, is less costly to maintain than other technologies, and can detect leaks from low ppm to 100% gas.

Contact: Scott Kleppe | 219-465-2700 | jScottK@gasleaksensors.com | info@gasleaksensors.com

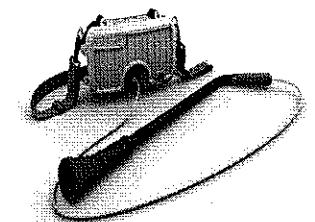

> Mobile GIS for Automated Mapping and Lifecycle Tracking

3-GIS LLC

A software platform developed through OTD is now part of the 3-GIS Mobile product suite to allow users to collect new installation data directly within a GIS environment. Applications to integrate real-time, sub-foot accurate GPS and barcode scanning are included.

Contact: Jerry Golden | 256-560-0744 x223 | jgolden@3.gis.com | www.3-gis.com



> **GPS-Enabled Leak Surveying**

Integrated Mapping Services, Inc.

Automating the leak surveying and pinpointing process with GPS eliminates paper records, providing increased efficiency and reliable compliance documentation. Implementation of the GPS-enabled system with VeroTrack AST™ software application is under way at several utility companies.

Contact: Langley Willauer | 207-236-3485 x306 | langley@ubisense.net |



> **Uptime® 3.0 Distribution Integrity Management Risk Model**

GL Noble Denton

Uptime® 3.0 provides an integrated environment for the integrity management of gas distribution and transmission pipeline assets. Uptime provides core support for all the key elements of distribution integrity management program regulations.

Contact: Michael Moore | 717-724-1900 | michael.moore@gl-group.com | www.gl-group.com



> **Meter Xchanger™**

Mueller Co.

This technology allows utilities to conduct meter change-outs without interrupting service, with the advantage of hands-on work, without shrouds and glove ports. The change-out tool can increase productivity, reduce the cost of the meter change-out process, and virtually eliminate the impact on customers.

Contact: Bryan Kortte | 217-425-7516 | bkortte@muellercompany.com
www.muellergas.com

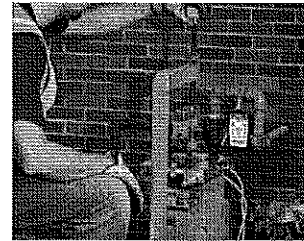

> **Lift Assists for Pavement Breakers and Rock Drills**

Integrated Tool Solutions, LLC

These devices assist workers in lifting pavement breaker and rock drills after the bits break through surface pavements and rocks and need to be repositioned for the next penetration. By eliminating the need to manually lift and re-position the heavy tools, the lift assists make breaking easier and less physically demanding.

Contact: Ryan Purczynski | 951-929-4808 | rpurczynski@integratedtoolsolutions.com |
www.integratedtoolsolutions.com



> **Keyhole Pipeline Inspection Camera System**

ULC Robotics

The PRX250K keyhole camera is an internal inspection system designed for visual assessment of live mains through conventional pits or small keyholes. The system is easily maneuverable through tight bends, allowing utilities to examine pipe segments without the need to drill additional access holes.

Contact: Greg Penza | 631-667-9200 | gpenza@ulcrobotics.com | www.ulcrobotics.com



Informational Products

Selected OTD-Developed Technical Reports

In addition to the development of new tools, processes, and products, OTD supports research that results in useful information on various aspects related to gas delivery and operations.

Listed here are some of the key reports developed under OTD sponsorship.

PIPE & LEAK LOCATION

> **RFID Marker Technology Implementation Guidelines**

A set of guidelines was developed for the implementation and application of integrated Global Positioning Systems (GPS), Geographic Information Systems (GIS), and "Smart Tag" technologies to streamline public-improvement project planning and prevent damage caused by excavations. (*Project Summary, p. 9*)



> **Cross Bores Best Practices Guide & Videos**

Significant research was conducted to investigate gas line/sewer line cross bores. The Guide and "how-to" videos (available through the OTD website) provide recommendations and procedures for preventing and detecting cross bores. (OTD-12/0003) (*Project Summary, p. 15*)



> **Residential Methane Gas Detector Program**

This reports provides results of a project initiated to determine whether commercially available combustible gas detectors are susceptible to giving false positive responses to an assortment of typical household chemicals, including ammonia, ethanol, acetone, toluene, isobutane, ethyl acetate, isopropanol, heptane, and hydrogen.



> **Underground Facility Pinpointing**

Reports from this project present the results of research conducted on several technologies used by utilities to locate underground pipes and facilities. Researchers investigated standard electromagnetic locators, ground-penetrating radar, and alternative imaging tools. The reports provide a comparative, technical evaluation of tools that are currently available. (*Project Summary, p. 3*)



PIPE MATERIALS, REPAIR & REHABILITATION

> **Polyurea Coating Testing and Assessment for Gas-Industry Use**

A Final Report is available on research into field-applied polyurea coatings for gas industry use. Through a new initiative, long-term field trials will be conducted to evaluate these additional coatings and determine a cost-effective coating-application method and process.



> **Electrofusion Coupling Evaluation and Best Practices**

Researchers investigated techniques used to perform electrofusion joining of plastic gas pipe in an effort to develop guidelines for the use and operation of electrofusion coupling. With a detailed set of guidelines, the gas industry can enhance the performance and safety of its plastic piping systems.

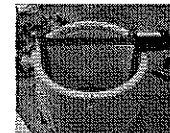

> **Review and Selection Guide for Pipe Rehabilitation**

The focus of this study is on reinforced thermoplastic pipe (RTP) as a pipe-rehabilitation option for use in the natural gas industry. To help pipeline operators gain a better understanding of the technology, researchers developed a product-selection guide based on thorough research of available RTP technology.



EXCAVATION & SITE RESTORATION

> Evaluation of Lightweight Jackhammers

A research team evaluated the performance of currently available lightweight pneumatic and hydraulic jackhammers with respect to their effectiveness in breaking asphalt and concrete pavement, while considering other operational factors such as noise, vibrations, operator impact, and performance. Expanded evaluations are under way. (Project Summary, p. 45)



> Cold-Patch Products Performance Results

This report provides the results of a testing program that evaluated nine commercially available cold-patch products, including two products introduced in the market as "green" patches. Cold- and warm-weather tests were performed and repeated moving loads were applied with a wheel-loading machine that conducted 50,000 wheel passes.



> Evaluation of Flowable Fill Around Buried Pipes

Flowable fill is required by some agencies for use as backfill material for pipe repairs, rehabilitations, and other operations. Presented in this report are the results of performance tests of flowable fill, including the effects of flowable fill on pipeline corrosion and on the detection of gas flow and leaks through the backfill. (OTD-07/0004)



> Alternative Methods of Pavement Cutting

In an effort to reduce the costs and improve the process of pavement cutting, researchers investigated the application of current and new pavement-cutting methods. Technologies examined and summarized in this report include impact breaking, sawing, chemical and thermal methods, water-jetting, and laser cutting.



PIPELINE INTEGRITY MANAGEMENT & AUTOMATION

> Inspection Technology Strategy Tool

An on-line software tool was developed to assist pipeline operators in evaluating and selecting appropriate inspection tools. A website provides a centralized resource for technical information and expertise related to internal inspection issues and concerns. (Project Summary, p. 65)



> Leak-Rupture Boundary Report and Calculator

This report and associated software allows operators to determine the leak-rupture boundary for a pipe segment based on properties such as the diameter, toughness, and yield strength. Operators can use the calculator for risk modeling and consequence analysis. (OTD-13/0002 and OTD 13/0004)

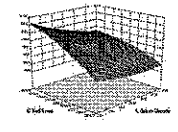

> Field-Applied Pipeline Coatings: Short- and Long-Term Performance

This report presents the culmination of a 10-year research program to assess more than 80 different commercially available field-applied pipeline-coating products. The goal was to establish an unbiased, third-party basis for operators to select the most appropriate coating system for particular applications.



> Evaluation of Guided Wave Technology as a Hydrotest Equivalent

This report details an evaluation conducted to demonstrate and validate the use of Guided Wave Ultrasonic Testing as an equivalent to a hydrotest. A draft standard was developed and is currently under review by the National Association of Corrosion Engineers (NACE) for incorporation into an industry standard. (OTD-11/0001)



> "Black Powder" Contamination in the Gas Industry: Survey and Best Practice Manual

Black powder – a substance composed mainly of iron sulfides and iron oxides – can cause corrosion and create wear on pipelines. This report provides information on issues, cleanup techniques, and management methods related to "black powder" contaminants. Results were compiled into a "best practices" industry manual. (OTD-07/0002)



> Literature Review for Elemental Sulfur Deposits in Natural Gas Transmission Pipelines

Deposits of "elemental sulfur" – which can block natural gas pipes and equipment – are becoming an increasing concern in the natural gas industry. This report summarizes a literature review to develop a better understanding of the sources, causes, and mitigation possibilities for sulfur deposits found in gas pipelines. (OTD-09/0001)



- > **Flaw Acceptance Criteria and Repair Options for Low-Stress Natural Gas Pipelines**
Researchers partnered with pipeline companies and industry organizations to develop modified assessment criteria for low-stress pipelines. The goal, as outlined in this report, was to develop criteria for discriminating flaws that truly affect pipeline integrity from flaws that have no significant impact.

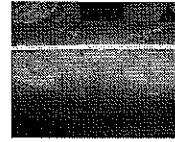

- > **In-Field Corrosion Rate Measurement/Determination for Integrity Reassessment Intervals and Risk Prioritization**
Research was conducted to develop a systematic and simple method to calculate realistic corrosion growth rates for determining pipeline-reassessment intervals.



OPERATIONS INFRASTRUCTURE SUPPORT

- > **Natural Gas & Indoor Air Quality Website**
A website of vital information on indoor air quality and safety issues was developed for OTD members through the OTD website (otd-co.org). The site provides a center of expertise and a single-point access to scientific data, performance information, and natural-gas-related issues. (*Project Summary, p. 89*)

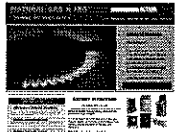

- > **UV Degradation and Static Buildup Testing of Personal Protection Equipment Fabrics**
Researchers tested various utility-vest materials to determine if degradation is caused by ultraviolet light and to evaluate the potential for static buildup to become hazardous. The results of safety vest testing are available in technical reports. . . (*Project Summary, p. 91*)



- > **Ignition Testing of Electronic Devices**
In this project, handheld electronic devices were tested to determine if ignition occurs in the presence of a flammable methane/air mixture. Laboratory tests demonstrated a large margin of safety under the scenarios investigated. (OTD-12/0001)



- > **Intelligent Utility Installation Process**
This report provides a methodology, field process, and a data model for capturing data during new utility installations. The process is used to capture information regarding the location, materials, installation process, environmental considerations, and other factors. (OTD-12/0002) (*Project Summary, p. 99*)

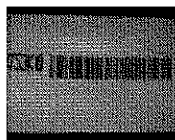

- > **Tracer Wire for HDD Applications**
Extensive research and testing culminated in the release of a report that provides valuable information on the properties and performance of various tracer-wire products for use in horizontal directional drilling (HDD) operations. (OTD-13/0001)



- > **Regulator Vault Corrosion and Coating Rehabilitation**
This study focused on thermal-spray and its ability to mitigate the corrosion of gas piping and the components housed in utility vaults. Results from the field work include detailed information on surface preparation methods, pre-cleaning, coating applications, quality-control inspection specification for field use, and the coating-material selection process.



- > **Assessment of Vehicle-Barrier Design for Aboveground Facility Protection**
Investigators compiled the latest information on the design, regulations, and installation practices of structural vehicle barriers used to protect aboveground utility facilities from vehicular damages. The Final Report also includes a review of various state and federal safety guidelines.

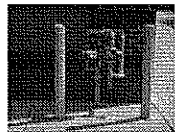

- > **Study of Low-Impact Markings**
A variety of paints, materials, and techniques were tested and characterized in an effort to identify products and methods that can be used for temporary utility marking. Information developed in this study allows users to identify the most appropriate marker type for a given environment to achieve the desired marking duration.

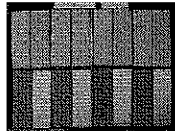

> **Solar-Powered Remote Monitoring**

In this study, solar-powered devices were investigated as power sources for the remote monitoring of various gas utility facilities to more cost-effectively obtain rectifier data, pipe-to-soil measurement, pipe-to-casing readings, and other information.

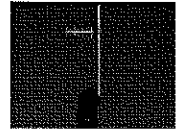

> **Integrating GPS into Routine Operations**

This report provides a set of recommendations and GPS implementation strategies developed through pilot programs, literature searches, and reviews of existing applications. Operations that were considered included meter reading, leak surveying, new installations, corrosion monitoring, and valve inspections.



> **DVDs for Training First Responders**

DVD training products help gas companies better educate first-responding personnel about natural gas emergencies. Learning modules with realistic scenarios cover a variety of issues to enhance public and worker safety. The product also serves to improve emergency-response effectiveness and coordination.



ENVIRONMENTAL, RENEWABLES & GAS QUALITY

> **Siloxane Concentrations in Biomethane**

Biomethane from various waste products could provide consumers with a significant source of "green" renewable energy. In efforts to help develop this green resource, a study was conducted into siloxane – one of the potential constituents in biomethane – to assess its influence on health, the environment, and gas-fired appliances. (*Project Summary, p. 131*)

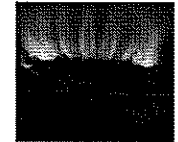

> **Field Measurement Program to Improve Uncertainties for Key Greenhouse Gas Emission Factors for Distribution Sources**

This report summarizes the results of field surveys conducted at six natural gas utilities. With the support of the American Gas Association, research updated emissions factors for metering stations, regulating stations, and customer meters. (OTD-10/0002)



> **Pipeline-Quality Methane: North American Guidance Document for Introduction of Dairy-Waste-Derived Biomethane into Existing Natural Gas Networks**

The guidance document provides reference and recommendations for the consideration of biomethane from dairy-waste digestion for introduction into gas pipeline networks. The report details results of a biogas/biomethane Gas Technology Institute research program.



Contact: Maureen Droessler
847-768-0608
maureen.droessler@otd-co.org
www.otd-co.org

OTD RESEARCH PROJECT SUMMARIES 2013

Table of Contents

Project	Page
PIPE & LEAK LOCATION	
1.i Remote Leak Survey Using Lasers	3
1.6.d Underground Facility Pinpointing Field Demonstrations	5
1.8.a GPS-Based Excavation Encroachment Notification	7
1.9.b Public Improvement Project Coordination with GPS, GIS, and Smart Tags	9
1.10.e Enhancing Damage Prevention Through Implementation of New Technology	11
1.11.c Low-Cost MEMS Methane Sensor Platform	13
1.11.d Cross Bores Best Practices Education and Outreach	15
1.11.e Cross Bores – National Database and Risk Model	17
1.11.f Locatable Plastic Pipe	19
1.12.b Cross-Bores Detection Using Mechanical Spring Attachment	21
1.12.c Performance-Analysis Methods and Metrics for Leak-Detection Technologies	23
1.13.c Testing and Field Evaluation of No-Blow Fish Tape Technology to Locate PE Mains	25
PIPE MATERIALS, REPAIR & REHABILITATION	
2.7.d Cold Adhesive Repair and Joining of Polyethylene Pipes with Minimal Surface Preparation	29
2.7.e Development of an External Repair Tool for Polyethylene Pipe	31
2.10.b In-Service Field Evaluation of Polyurea Coating Systems	33
2.11.a Development of a System for Repair of Aboveground Leaks	35
2.12.a Integrated Expert Monitoring and Training System for Butt Fusion	37
2.12.e Liners/Composites for the Rehabilitation of Distribution and Transmission Lines	39
2.13.b Guidelines for Special Permits for Structural Composite Rehabilitations	41
EXCAVATION & SITE RESTORATION	
3.10.b Evaluation of Lightweight Jackhammers	45
PIPELINE INTEGRITY MANAGEMENT & AUTOMATION	
4.11.c MFL Inspection System for 12-Inch-Diameter Gas Lines	49
4.11.e Evaluating Assessment-Technique Effectiveness	51
4.11.f Understanding Threat Interactions for Risk Analysis	53
4.12.a Probability-of-Failure Model for High-Risk Pipe Segments (Vintage Pipe)	55
4.12.b Correlating Pipeline Operations to Potential Crack Initiation, Growth, and Arrest	57
4.12.c Field Test of a Cathodic Disbondment Detector	59
4.12.d Continuous Threat Identification Program	61
4.12.e Pipecrawler Marker Assessment and Demonstration	63
4.12.f Inspection Technology Strategy Tool	65
4.13.a Distribution Integrity Management Plan Consequence Model	67
4.13.b Validation of 3D Scanners for Pipeline Anomaly Assessment	69

Table of Contents (cont.)

Project	Page
---------	------

OPERATIONS INFRASTRUCTURE SUPPORT

5.6.e	Portable Propane/Air Residential Gas Supply.....	73
5.8.d	Tool for the External Classification of Pipe Contents.....	75
5.8.e	Development of Standardized Algorithms and Identifiers for Enhanced Material Tracking and Traceability.....	77
5.9.c	Mitigating Electrical Interferences on Cathodic Protection Systems.....	79
5.9.f	Cathodic Protection Monitoring Technology Deployment.....	81
5.9.h	North American Manufacturer Outreach Program.....	83
5.9.l	Enhancing the EZ Valve by Developing a Weld-On Steel Housing for Gas-Distribution Use.....	85
5.10.a	Evaluation of Static Suppressors on Existing Polyethylene Piping Systems.....	87
5.10.g	Indoor Air Quality and Safety Issues.....	89
5.10.h	UV Degradation and Static Buildup Testing of Personal Protection Equipment Fabrics.....	91
5.11.a	Dewatering Systems for Mains and Services.....	93
5.11.b	Development of Environmentally Conditioned Personal Protection Equipment.....	95
5.11.e	Intelligent Utility System.....	97
5.11.m	Intelligent Utility Installation Process (Asset Tracking).....	99
5.11.n	Quality-Control Procedure for High-Potential Anodes.....	101
5.11.p	Smart-Grid Initiative Standards and Regulations.....	103
5.11.r	Integrating Sensors with Existing Automated Meter-Reading Systems.....	105
5.11.s	Breakaway Disconnect/Shut-Off for Meter Risers.....	107
5.11.t	Essential Data Collection for PE Fusion Operations.....	109
5.12.a	Development of an Intelligent Shut-Off Device for Commercial and Industrial Customers.....	111
5.12.b	Development of a Portable Flash-Fire Suppression System.....	113
5.12.d	Guidelines for Data-Collection Requirements.....	115
5.12.g	Large-Diameter, Medium-Pressure Inflatable Stoppers.....	117
5.12.n	Advanced Tools for Improved AC Corrosion Prevention and Mitigation.....	119
5.12.o	Guidelines for Cast-Iron Piping Winter Operations.....	121
5.13.a	Evaluation of Commercial-/Light-Industrial-Sized Excess Flow Valves (EFVs).....	123
5.13.c	PE Pipe-Splitting Evaluation, Enhancements, and Standardization of Tool Kits.....	125
5.13.d	EZ Valve for Transmission Mains.....	127

ENVIRONMENTAL, RENEWABLES & GAS QUALITY

7.9.c	Assessment of Acceptable Siloxane Concentrations in Biomethane.....	131
7.10.a	Natural-Gas-Quality Survey: Trace Constituents.....	133
7.10.b	Development of a Practical Pipeline Operator Guide to Manage Odor Fade Issues.....	135
7.10.c	Improving Methane Emission Estimates from Underground Pipeline Leaks.....	137
7.11.a	Gas Quality Resource Center.....	139
7.11.b	Sensors for Trace Constituents in Fuel Gases.....	141
7.12.a	Odor Pill to Address Odorant Fade Issues.....	143

PIPE & LEAK LOCATION

Advances in technologies for pipe and leak location enhance the safety and maintenance of natural gas delivery systems.

Developments in this area include improvements in leak detection, plastic-pipe location, obstacle-detection capabilities for horizontal boring tools, and underground facility pinpointing.

Multiple approaches are being investigated, including the use of GPS-enabled equipment, radio-frequency markers, and laser-based technologies.

Research focuses on reducing third-party damage (the primary cause of gas system leaks and incidents), increasing productivity, and improving system integrity.

Significant efforts include projects to address, detect, and prevent utility line cross bores.



Operations
Technology
Development

Remote Leak Survey Using Lasers



Remote gas-leak survey technology is being developed to reduce the cost and the need for walking and mobile surveys. Research is focused on the development of a laser that could be mounted in a vehicle for surveying both mains and services.

Project Description

Researchers are developing a new leak-detection technology, called the Laser Line-Scan Camera (LLC). With the LLC, a laser beam is directed outward to detect back-scattered light at wavelengths that are sensitive to the presence of methane in the air. The remote sensing technology is designed to provide real-time detection and location techniques to detect above-ground natural gas leaks at sensitivity levels comparable to that of current flame pack surveys (5-10 ppm).

In this project, research is being conducted to determine the LLC's detection limit, inspection speed, operator interface, and system packaging. The ultimate performance goal for the LLC is to detect gas plumes with methane concentrations as low as 10-20 ppm out to distances of 100 feet from a vehicle.

In the current Phase 2A of the project, a vehicle-installed demonstration is being conducted to transition the past LLC technology into a ruggedized configuration for proving the feasibility of remote leak-sensing technology for services.

Deliverables

Research and testing results will be documented in a report that will include recommendations for developing and improving prototypes for further testing.

Benefits

Gas companies and their customers would benefit by having a technology that would allow leak surveys to be conducted from a distance of 60 feet or more. By mounting the laser-based device on a vehicle, surveys of both mains and services could then be performed from the street, eliminating the need to walk the gas service lines.

Technical Concept & Approach

In earlier research, a pre-prototype LLC was designed, built, and tested in the laboratory with available laser chips. The initial system performed well but required improvements based on input from project sponsors.

The LLC technique uses two lasers and an infrared detector array to obtain information on leaks on the ground. The two lasers operate at slightly different wavelengths, where the signal from one laser is strongly absorbed by methane gas and methane is transparent to the other, out-of-band wavelength. This permits the LLC processor to measure the difference between the reflected laser returns and display the results to an operator. When the lasers pass over a region where a methane leakage plume is located, the relative volume of the plume is displayed to the operator as a histogram.

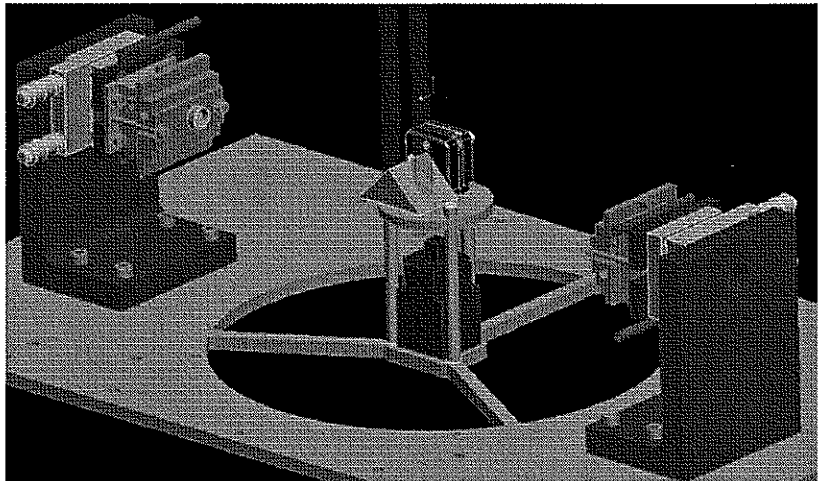

Laser module installed on ILDA.

Results

This project involved the incorporation of signal and reference lasers in an LLC prototype system. Tests of the pre-prototype were conducted in the laboratory and at field sites.

In laboratory tests with the current lasers in a breadboard configuration, the detection limit of the LLC was found to be < 8 ppm, displaying a discernable/positive detection that could be used to visually alert an operator or digitally processed to provide an enhanced detection capability that could be used to generate an auto-alert and/or a leak-tagging cue. The actual detection sensitivity was estimated to be 5 to 10 ppm.

For the field demonstration, the breadboard LLC was installed in a cargo van and repositioned to a remote site where previously located natural gas leaks were identified. Testing was remotely conducted from within the stationary van on actual main-to-meter leaks in two different locations with differing levels of natural gas concentrations. The leaks were initially located and/or measured using an available leak-detection device. All testing was conducted under field conditions, as they were found, with sustained 10-15 mile-per-hour winds at both locations.

The Site 1 leak was a large natural gas leak in a low-pressure main. Both the commercial gas leak detectors and the LLC were able to successfully locate the gas leaks at Site 1. Testing at Site 2 involved a repaired low-pressure main-to-meter line. The LLC was able to remotely detect residual gas percolating from the ground at very low concentrations measured at a few ppms. The LLC was observed to show no gas signal when pointed at areas without leakage in proximity to the leak, and then showed a signal when pointed at the leak.

In 2013, fabrication, assembly, and testing of a redesigned Integrated Laser/Detector Assembly (ILDA) were completed, resulting in the final scanner configuration. Additional testing was performed with the Interband Cascade Laser (ICL) and the HgCdTe infrared detector, pre-amplifier, and thermoelectric cooler/controller module that were subsequently installed and integrated on the ILDA/scanner assembly. Integration and testing of the improved Cassegrain optics configuration with the detection and laser modules proved proper performance of the integrated optical system; however, unexpected levels of noise were discovered in the video/processing chain, which was degrading system performance. Corrective actions required an extensive investigative effort to localize and contain the source of the noise.

Laser module integration and readiness testing proved expected ICL laser characteristics and performance of the lasers suitable to progress with the field demonstration.

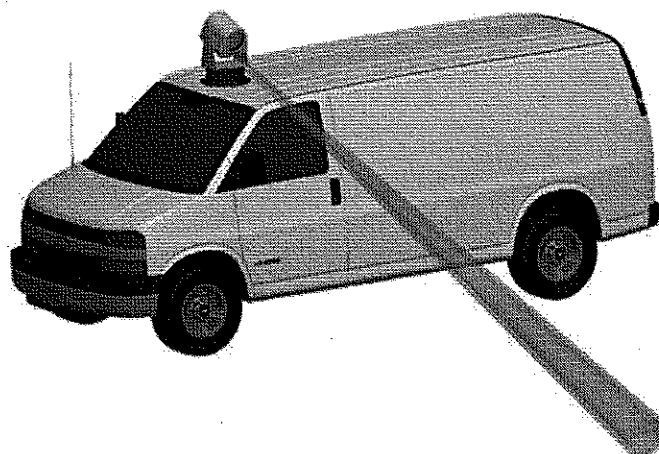

Turret installation concept.

System software was developed to scan, process, and display detection alerts.

In Phase 1, the prototype plus the power and processor modules was mounted on a roll-on/roll-off cart for installation and operation in a service van. The Phase 2A assembly includes a sealed optical enclosure to protect the scanner, electronics, and optical modules mounted on the ILDA, plus a manual turntable to permit pointing the device to the desired survey area.

The entire Phase 2A unit is being installed in a pedestal that mounts to the bed of a standard service vehicle (pickup truck).

Status

System engineering is a continuing task throughout the project. In Phase 2A, the system was integrated, system modules were tested, and the actual performance was measured.

Following the integration, modifications, and testing of redesigned scanner on the ILDA, the system was tested in the outdoor environment to detect methane concentrations of 10-40 ppm-m from a distance ranging from 5-15 meters. The unit was in the van moving at a speed of 5-10 mph.

These test results are being analyzed and will be reported in the Final Report for Phase 2A with recommendations for project continuation.

For more information:

Maureen Droessler
Program Administrator
Operations Technology Development, NFP
Phone: 847/768-0608
maureen.droessler@otd-co.org

OTDOperations
Technology
Development**PIPE & LEAK LOCATION****Underground Facility Pinpointing
Field Demonstration**

In this project, a comparative study was conducted on new technologies for locating buried utility facilities. Project results provide utilities with information to help determine the most appropriate locating equipment to use for specific applications.

Project Description

Natural gas piping systems are buried in a large variety of soil types and moisture contents – and soil properties, such as soil resistivity and dielectric permittivity, vary greatly by location and time.

In addressing these variations, locating equipment is continually being introduced with new features and technologies to improve the efficiency, lower the costs, and enhance the ability to locate pipes and other buried facilities. In addition, some existing locating products may no longer be available. Keeping abreast of these changes can be challenging.

In 2004, OTD sponsored an underground facility pinpointing project that compared various standard electromagnetic locators and evaluated the capabilities and limitations of ground penetrating radar (GPR) and other new, alternative tools in the market.

The objective of this project is to provide a comparative technical evaluation of the new technologies for locating buried utility facilities that have emerged in recent years. The study will build on the earlier OTD study on the assessment of pipe-locating and pinpointing technologies.

Deliverables

The deliverables for this project include the established locating and pinpointing criteria and the results of the equipment evaluation and testing program.

Benefits

This project provides the information to enhance the ability to choose the appropriate products and technologies that may offer greater accuracy, ease of use, lower costs, and greater ability to locate pipes in difficult conditions.

The appropriate selection of equipment will improve pipeline pinpointing procedures and reduce the risks and costs associated with third-party damage by more effectively conducting damage-prevention programs.

Technical Concept & Approach

This follow-on study updates the previous locator-technology assessment.

Evaluations were conducted in a similar fashion to the first phase, where the horizontal and vertical pinpointing accuracy, ease of use, cost, and other equipment features were examined.

Specific tasks included:

- **Equipment Selection and Planning**

The first part of this task included the identification of the technologies (e.g., electromagnetic and GPR), manufacturers, and locating equipment that provides enhanced technologies and features. Investigators developed criteria to define the requirements for the horizontal and vertical pinpointing accuracy, repeatability, ease of use, cost, and other equipment features.

- **Acquire Equipment and Identify Testing Requirements**

The selected equipment was acquired and evaluated for its performance according to manufacturers specifications. Environmental factors (e.g., soil type, depth of soil cover, and soil moisture) were evaluated for their effect on the reliability, sensitivity, and repeatability of equipment.



View of the locators at the Staking University



Placement of the pipes at the GTI test section.

• **Equipment Evaluation**

Tests were performed at the Gas Technology Institute (GTI) outdoor testing facility on buried steel, plastic, and cast-iron pipes to evaluate the sensitivity and performance of the equipment under controlled testing conditions. Equipment evaluations were conducted under various controlled testing conditions that may not exist in the field testing. These include simulating underground pipes in various soil types, moisture contents, and surface conditions (e.g., paved and un-paved sections).

• **Equipment Testing in the Field**

Locating equipment was tested for the ability to detect and pinpoint underground facilities under realistic field conditions during a routine walk-through by the operators. Similar to the tests of Phase 1 of the project, these tests were performed at Staking University, an independent training facility for teaching and evaluating the locating technologies of underground facilities.

Results

Phase 2 was initiated in 2012 with a sponsor survey, literature review, and interviews with subject-matter experts. Subsequently, locator equipment was obtained from manufacturers and training was completed.

Testing compared the horizontal and vertical accuracy of 10 locators, and assessed the mean width of their “confidence intervals,” defined as the narrowest bands within which a user can be confident the pipe is con-

tained. In addition, the user-interface and user-friendliness in field conditions were evaluated. Analysis of test results was also performed.

Most of the locators tested were based on electromagnetic (EM) sensing antennas. While there were several differences in their features, most of the locators tested displayed “maturity” and could be recommended for basic locating tasks.

This process was documented on paper forms, using digital photographs, and also with the device’s own logging capabilities if available.

In addition to EM locators, two GPR locators were tested (albeit much less extensively). While these instruments have their unique strengths, they also present major disadvantages (compared to EM locators), such as soil-dependent depth limitations, extensive training requirements, and cost. While these tools may have some niche uses, on the basis of observations, they are not recommended for the purpose of standard locating operations.

A variety of new features were encountered in one or more of the models, including:

- GPS capabilities ranging from on-board GPS modules to connectivity for third-party high-resolution GPS units
- Bluetooth connectivity for in-field communication with mobile devices and external/attached GPS units or other transmitters
- Inbuilt data logging and storage capability, or mobile-device applications for wireless data-logging on mobile devices
- Remote control over key transmitter settings, such as transmission frequency.

The Final Report provides details and comments on each of the products tested and information on the testing methodology.

Status

This project was completed in 2013. A Final Report was issued in September 2013.

For more information:

Maureen Droessler
Program Administrator
Operations Technology Development, NFP
Phone: 847/768-0608
maureen.droessler@otd-co.org



GPS-Based Excavation Encroachment Notification

In a project aimed at reducing excavation damage, researchers are investigating the potential to use GPS technology to monitor excavation activity. The technology would provide the ability to alert excavators and utility owners when digging is encroaching upon pipelines and other facilities.



Project Description

This project focuses on linking GPS technology with digging operations to provide a warning system to prevent excavation damages to underground facilities.

The objective is to develop and demonstrate a system to ensure that excavation activities are occurring within a valid one-call ticket (which authorizes excavation) and are not encroaching upon underground pipes and facilities.

Researchers initially partnered with Virginia Utility Protection Service (VUPS), a one-call center for utility locates that has been conducting pilot programs to demonstrate the feasibility of using GPS-enabled cell phones (Phase 1) and GPS-enabled locators (Phase 2) to call in excavation projects, access information, and create digital maps of all locates. The GPS-enabled cell phones allow VUPS to create an “electronic white line” of the excavation ticket based on the GPS coordinates of the phone that called in the ticket. GPS-enabled locators are used to capture the coordinates of the underground facility during routine mark-outs. Data collected with the GPS-enabled locator is transferred to both the utility company and the excavator.

Deliverables

Deliverables for this project include:

- A web-based portal to collect and display data
- Mobile application to allow viewing in the field
- Completion of a pilot project demonstrating the implementation of the technology
- A Final Report detailing pilot project results.

Benefits

Excavation damage is the primary threat to the integrity of natural gas distribution systems. It is reported that about 60% of damage in the utility industry is the result of excavators failing to notify one-call centers and excavators that do not dig cautiously near underground assets.

By linking GPS technology with excavation equipment, enhanced monitoring can reduce the occurrence of excavation damage from these two causes.



Systems mounted near equipment controls alerts operators when they encroach utility lines.

Technical Concept & Approach

The key aspect of this effort is to integrate GPS monitoring into excavation activities so equipment operators can be automatically alerted to potentially hazardous situations. The GPS coordinates of the excavation activity are cross referenced with the location of valid one-call tickets (obtained through the one-call center) and the location of underground assets (obtained with GPS-enabled locators during the mark-out process). This information is collected in a portal that performs the analysis, detects violations and encroachments, and sends warnings and notifications to the stakeholders.

The project is focused on the implementation of the GPS-based excavation encroachment notification technology with a sponsor utility construction project.

Specific tasks include:

- **Software Development and Configuration**

The software has two components: 1) a desktop version that allows users to view excavation activity and run reports and 2) a mobile application that allows users to view activity and encroachment on handheld devices. The mobile component will allow equipment operators, field managers, and other on-site personnel to view excavation activity and utility line locations. The software will send an email/text warning to pre-designated people if excavation encroachment occurs.

- **Demonstration**

Researchers will demonstrate the software on a selected mobile device in a pre-pilot project demonstration to solicit feedback from end users.

- **Pilot Project**

A pilot project will be conducted to evaluate the effectiveness and feasibility of using GPS technology to monitor excavation activity. Activities in this task will include training and technical support throughout the duration of the pilot project. It is anticipated that each sponsor would use the technology during a two-week test period as part of normal day-to-day work.

Results

The developed technology was tested and implemented in a series of demonstrations with stakeholders in Virginia. A GPS monitoring system for excavation equipment was developed that periodically transmitted active excavation-equipment-location information to a portal. The portal has a web interface to allow users to view the current excavation activity in a given area through

text data or through a mapping feature. Information was cross referenced with the GPS coordinates of all valid one-call tickets.

Upon evaluation of potential software and hardware, researchers identified using lower-accuracy GPS and existing GIS records to monitor for potential encroachment as a viable option for a pilot project in New York.

Software development, testing, and demonstration was completed in 2013.

The research team initiated setup of a testing environment to evaluate the technical feasibility of the options. The mobile computing environment arranged and basic communication protocol between mobile and Amazon server has been developed. Some simulation data has been collected.

In 2013, plans were developed to re-design existing technology to develop a lower-cost, less complex system to use GPS and GIS to monitor for encroachments in the right of way (ROW). Plans are for five prototype systems to be tested with cars in a full-scale pilot project in California. The new system will be more feasible for widespread adoption based on the ease-of-implementation and lower-cost hardware.

Status

Current activities are focused on improving communications protocols and designing system improvements.

Efforts are targeted at:

- Using lower-cost GPS (less than \$500)
- Replacing the digging trigger with movement-pattern software
- Replacing the high-accuracy GPS locator with ROW data in the GIS
- Developing a lower-cost messaging system to provide encroachment warning
- Integration into an operator's GIS
- Development of a non-proprietary server/web system.

For more information:

Maureen Droessler
Program Administrator
Operations Technology Development, NFP
Phone: 847/768-0608
maureen.droessler@otd-co.org

OTDOperations
Technology
Development**PIPE & LEAK LOCATION****Public Improvement Project Coordination
with GPS, GIS, and Smart Tags**

In this project, a set of guidelines was developed for the implementation and application of integrated Global Positioning Systems (GPS), Geographic Information Systems (GIS), and "Smart Tag" technologies to streamline public-improvement project planning and prevent damage caused by excavations.

Project Description

Design and project engineers note that planning, facility location, and other processes involved in large public-improvement projects could be greatly improved with an efficient method for the timely sharing, updating, and retrieval of asset-location information.

The typical public-improvement project planning process might involve a number of steps, including interactions with the project owner and utility owner regarding asset locations, the project footprint, and facilities that require re-location due to conflicts or other requirements.

This process can become flawed if utility companies do not update their maps with new information as it becomes available. Both the project owner and utility mark-out crews may not have access to information regarding the new location of lines that were moved or recently installed. This can lead to mis-marked or unmarked lines and result in excavation damage. Additionally, sharing asset-location information via paper maps can promote inaccuracies because of spatial mismatch, different coordinate systems, and relative references.

The Virginia Department of Transportation (VDOT) has initiated a project to bury Radio Frequency Identification (RFID) tags (also called "Smart Tags" or "marker balls") over utility lines when potholing is required for large public-improvement projects. In this project, research built on these efforts resulted in the development and demonstration of process that uses GPS, GIS, and marker-ball technologies to improve underground-asset locating on public-improvement project sites.

Deliverables

The deliverables for this project include the development of a process work flow for installing and capturing marker-ball data, technology demonstrations, and a detailed report on the pilot project.

**RFID Technology**

RFID markers consist of a sealed shell containing a passive antenna and a low-frequency resonance circuit tuned to a specific frequency. RFID markers for natural gas applications are typically tuned to 83 kHz. An above-ground locator sends a signal to energize the buried RFID marker. The energized marker then reflects a signal back to the locator, allowing for the precise location of the buried RFID marker.

RFID markers are tolerant to congestion and signal interference from nearby electrical sources. Also, RFID markers are not subject to the limitations of tracer wire (i.e., corrosion and breakage).

RFID markers also provide a positive identification to ensure that the correct asset is being located.

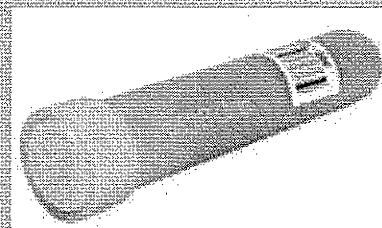
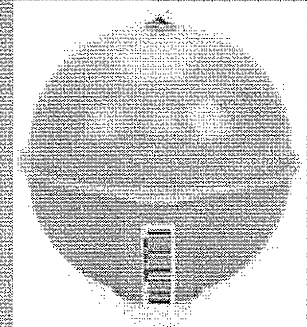
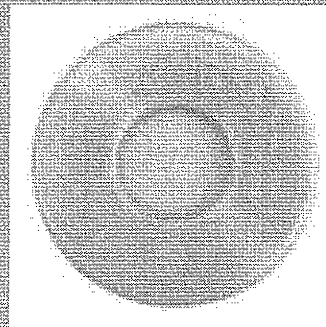

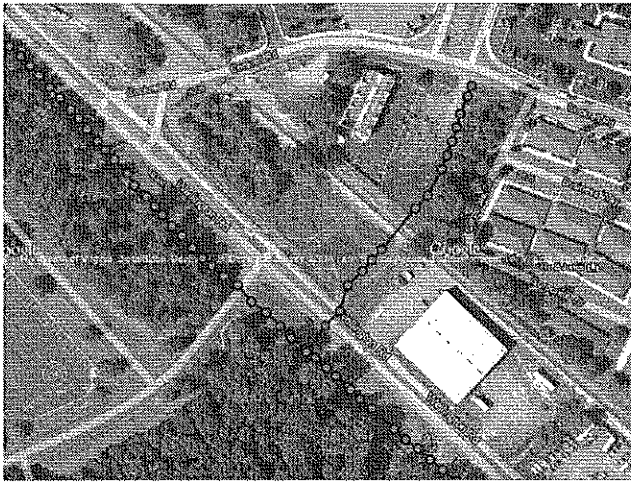

Benefits

The potential benefits of an enhanced process for utility locating on public-improvement project sites include:

- Decreased excavation damage resulting from mis-marked or unmarked facilities
- Quickly updated location information of relocated lines
- A permanent benchmark and verification method
- More efficient data sharing
- Streamlined data submission
- Reduced need for potholing
- Quick and accurate location of subsequent mark-outs.

Technical Concept & Approach

The approach for this project was to combine existing GPS, GIS, and Smart Tag technologies into a system that allows utility companies to collect and share asset-location information on a web-based shared GIS platform that can be viewed by project stakeholders in the design and construction phases.

The concept is to install RFID marker balls during new installations and test pit excavations, record the location of marker balls with GPS, and make the information available to project stakeholders, including locators in the field.

Results

Information developed through technology demonstrations with VDOT, workshops, and other research resulted in the development of a set of guidelines for the implementation of RFID markers.

In the guidelines, the process of programming, installing, mapping, and re-locating marker balls is detailed. Information on installation protocols, coordination with utility companies, and pilot programs is also provided.

The guidelines are intended to serve as recommendations for implementing RFID marker technology at a natural gas utility. The guidelines can generally be applied to any RFID marker or related technology designed for underground utility locating purposes. The document includes a list of the types of RFID markers and a brief description of the typical application for each.

Status

This project was completed in 2013 with the release of the *RFID Marker Technology Implementation Guidelines* in May 2013

For more information:

Maureen Droessler
Program Administrator
Operations Technology Development, NFP
Phone: 847/768-0608
maureen.droessler@otd-co.org



Operations
Technology
Development

Enhancing Damage Prevention Through Implementation of New Technology



In an effort to reduce the potential for excavation damage and the associated costs, researchers are investigating smart-tag technologies for implementation to assist field personnel when performing locates.

Project Description

One of the major factors contributing to excavation damage is the limited information available to field crews when performing gas-facility locates.

Traditionally, mark-out crews use maps and electromagnetic tools to locate buried pipes and other facilities. A map of the mains and services is provided either on a paper record or a digitized electronic file. While these maps can provide information regarding the general location of the pipe, they cannot be relied upon to provide precise positional information because of possible record-keeping inaccuracies, referencing errors, and other issues. Electromagnetic locators are used to find metallic pipes or tracer wires. These locators perform very well in some environments; however, certain situations (e.g., broken or missing tracer wire, congested corridors, signal bleed-off, and user error) can result in inaccurate mark-outs.

Investigators have identified several technologies that could be used to provide better information to mark-out crews to enhance the locating process.

The focus of this project is on precise locating with smart tags.

A pilot project is being conducted to demonstrate the procedures and technologies for implementing an electronic process and radio-frequency (RF)-tag-based asset-locating system. The technology uses new high-accuracy GPS technology and aerial photography to document the location of newly installed facilities. RF tags are used to enhance the locating and mark-out process by providing field personnel with additional asset location information.

Deliverables

The purpose of Phase 1 of this project was to develop an implementation strategy for smart tags, smart phones and tablets, and GPS in select operations.

The deliverable of Phase 2 will be a completed pilot project and a business case for further deployment of the smart tag system. Specific deliverables include:

- A marker ball and warning tape installation procedure
- A software application to log the location and other attribute information of new installations for smart phone or tablet devices

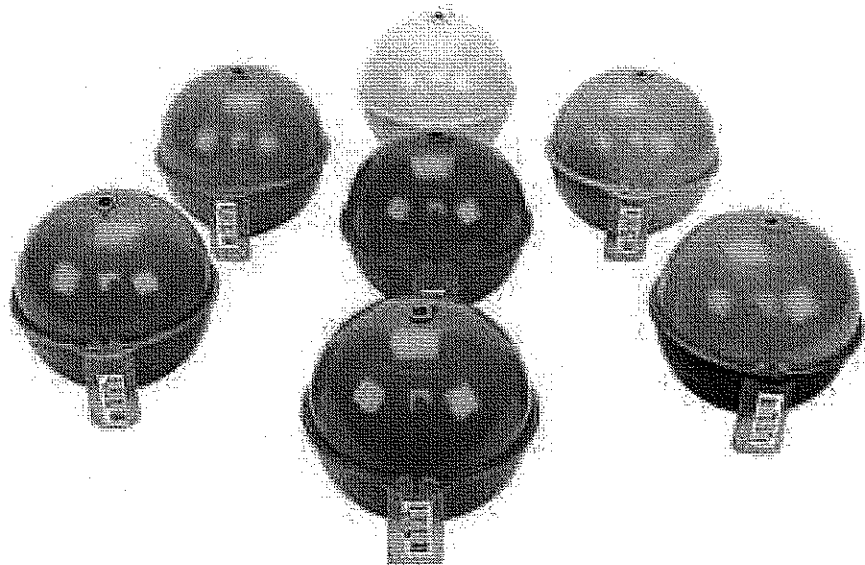

Research suggests that smart-tag technologies for pipe-location and damage prevention could provide significant cost and safety benefits.

- Two smart phone or tablet devices running the software application
- High-accuracy GPS receiver
- A process for transferring the asset location and attribute information from the software to a sponsor's mapping system.

Benefits

Industry organizations regard excavation damage as the greatest threat to the integrity of the natural gas distribution system. Implementing technologies to reduce excavation damage reduces system risk, increases public and worker safety, and lowers the costs associated with damages. Increasing the amount of information made available to locators in the field will improve their ability to locate underground facilities and will reduce excavation damage.

Smart tags are circuits and antennas housed in small devices that can be buried near pipes to facilitate detection and location in the future. Additionally, smart tags have the ability to store small amounts of information such as material, diameter, and maintenance history. A smart tag could be installed directly above any pipe that is exposed for maintenance or other types of work. The tag could then be used to determine the precise location of the pipe during subsequent mark-outs. Smart tags could be especially beneficial in situations where standard electromagnetic technology could not be used (e.g., to locate plastic pipe with no tracer wire).

Technical Concept & Approach

This project involves the following tasks:

- **Technology Review and Project Planning**

A technology-review report was prepared and a series of workshops were conducted with the R&D, damage prevention, and information technology departments of the participating utility companies to develop a strategy for collecting, storing, and accessing the data collected.

- **Pilot Project**

A pilot project is under way with a sponsoring utility. Locating times with and without the smart tags and GPS will be compared and data-collection times with and without the electronic data-capture forms will also be compared. Additionally, when programmable smart tags are used, the data will be read from the tags to determine the various attributes of the related gas facility (i.e., main, service,

valve, or test station). The spatial location accuracy will be determined along with the data that is stored on the tag.

Results

Investigators completed Phase 1 of the project with the development of an implementation strategy for an RFID-tag-based asset-locating system.

A pilot project was initiated in 2013 to demonstrate the procedures and technologies. The pilot involves the testing of warning tape and active markers.

The research team also tested a high-accuracy GPS receiver to determine if it could overcome urban canyon effect on the island of Manhattan and investigated alternatives to collect data in areas where a GPS signal is unavailable.

A logging application was developed and tested. Researchers also developed recommendations for the installation locations and methods of installation of RFID markers to be used in the pilot study.

A two-day workshop was conducted with the pilot sponsor to review the installation procedures, programming the RFID markers, use of the software, the locator for programming the RFID markers. The sponsor was provided with additional information on the use of laser rangefinders in the overall mapping process to better locate the RFID markers and their associated gas piping system components.

Specifically equipped laser range finders (optics that only see highly reflective services) have been tested to improve the reliability of any measurements taken in the field and avoid the collection of information that may lead to erroneous data. The employment of this technology should improve the overall appeal and ease of use when using laser rangefinders to precision map gas system components.

Status

A Final Report detailing the results of the pilot project is being prepared.

For more information:

Maureen Droessler
Program Administrator
Operations Technology Development, NFP
Phone: 847/768-0608
maureen.droessler@otd-co.org

OTDOperations
Technology
Development**PIPE & LEAK LOCATION****Low-Cost MEMS Methane Sensor Platform**

Research in this project focused on the design and fabrication of novel, low-cost, ultra-low-power methane sensors that offer enhanced features over conventional methane-detecting technologies.

Project Description

Advisors for the natural gas industry have expressed a need for an improved methane sensor to decrease costs in current operations and increase safety for current and future applications, including the monitoring of confined spaces, personnel, and especially residential dwellings.

Currently, no available sensor can meet the combined specifications for low power (microwatts), small size, long lifetime (2-20 years), and low cost, as well as have improved sensitivity, selectivity, and speed of response to methane.

In this project, research focused on the development of a MEMS (Micro-Electro-Mechanical Systems) sensor that can meet the challenges for methane alarms and monitors.

In recent years, significant progress has been made in the design and fabrication of a novel, low-cost, ultra-low-power thermal conductivity (TC) sensor for energy gases (methane, hydrocarbons, H₂, etc). Presently, the gas industry uses heated metal oxide (HMO_x) sensors with relatively high power requirements and low selectivity. Selectivity is afforded by filters that can wear out over time. Furthermore, the HMO_x sensors

will stop working (give a false negative) when O₂ drops and CH₄ rises (>~10%). Current thermal conductivity detector (TCD) sensors can provide 0%-100% CH₄ readings, but are also high power and not selective.

This project focused on the development of a MEMS nano-TCD. The most important features are: 1) no false negatives at high levels; 2) selectivity built in; and 3) low power and long lifetime for low installation costs and low overall cost of ownership. No other sensor has these combined features. These initial prototypes will be able to evolve with ever-improving selectivity and performance.

Plans are for the sensor to be a stand-alone unit about the size of a deck of cards that includes a proprietary sensing element, small circuit board, and novel software. The sensor technology and approach could be used in other types of fixed-site or portable residential or industrial applications. Its low power requirement allows battery operation over a very long lifetime. The unique selectivity is a significant improvement over existing systems and can discriminate methane in air from other gases. The unique combination of features leads to low capital cost, low installation cost, and low overall cost of ownership with increased safety. In ad-

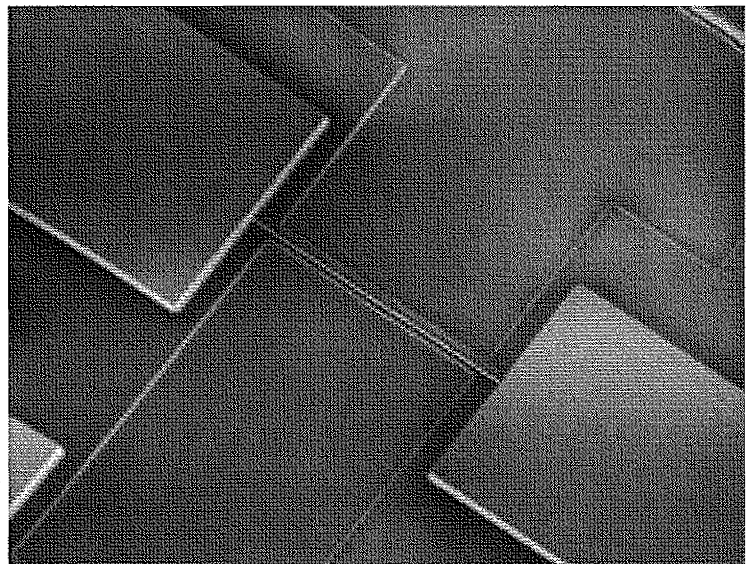
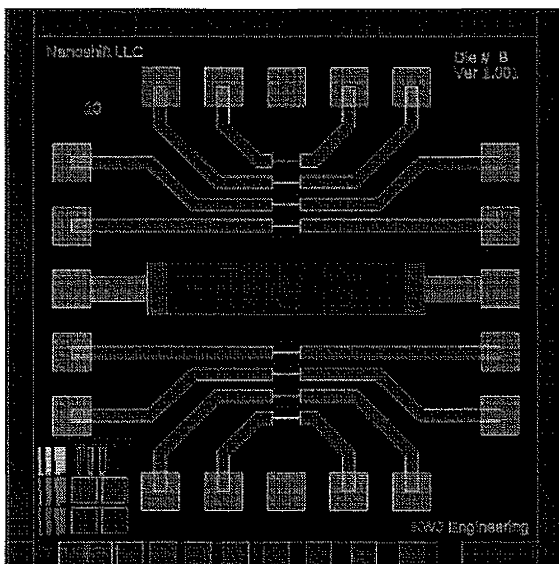

Sensor and die structure.

dition, the sensor can be improved over time with added features for wireless or other product options or applications.

Deliverables

Deliverables for this project include the development of MEMS CH₄ sensors for testing plus a Final Report with details on the development and testing.

Benefits

MEMS technology provides a means to fabricate miniature, low-cost sensors with improved methane-detector characteristics. The novel sensor will provide features to increase public safety and reduce maintenance costs. A commercial product that results from optimization would enable many applications for the gas industry that were previously impossible, especially selective home monitoring, remote monitoring, and cell phone or tablet integration.

Technical Concept & Approach

In this project, prior research was leveraged in that the design for the sensor elements and the operating protocols are already established. Activities involved the fabrication of a configuration for a fully compensated methane-sensing element.

The goal is to achieve significant progress and support to develop a package with low-cost electronics and proprietary firmware to result in a home CH₄ alarm.

Results

For this project, the research team demonstrated the MEMS low-power methane sensor for home methane alarms and other natural gas industry applications.

The MEMS sensor die was produced at a commercial foundry, then packaged and interfaced with electronics, operational firmware, and software. The sensor assembly was calibrated and tested with CH₄ exposures over time, temperature, humidity, and the presence of interfering gases. The manufacturer continued development of the sensor, hardware, and firmware and performed additional tests to show improvement in compensation algorithms for ambient temperature and humidity effects, as well as opportunities for optimization.

Specifically, the sensor met or exceeded the target specifications for measuring range, interferents (specificity to methane), and power consumption (significantly lower), but narrowly missed reaching the sensitivity and lower detection limit specification due to

noise issues in the electronics. The demonstrated sensitivity and lower detection limit are more than sufficient for a variety of safety applications, and it can be improved with optimization of the electronics.

Testing demonstrated the feasibility of detection with the following properties:

- <1 nanowatt per reading (leading to long-life battery operation)
- Nanosecond response time (response times will be limited by the packaging and not the sensing element)
- Selectivity created by multiple operations and a custom algorithm (leading to improved selectivity over currently available methane alarms)
- Sensitivity sufficient for LEL alarms (better than 0.05% or 10% of the lowest alarm level desired)
- Robustness (no drift over 30 billion measurement cycles, which implies no calibration needed for many years)
- No consumables, selectivity (no false negatives at high CH₄ levels and differentiation of CH₄ signal from other gases such as H₂ – which is an improvement over current CH₄ alarms)
- Very low cost (as low as \$0.07/die; typically \$0.50/die).

Status

Phase 1 of this project was completed in 2013. A Final Report was issued in September 2013.

The project team reports that a recommended path forward is supported by the data and indicates that optimization of the circuits and sensor will lead to improved performance specifications and pave the way to commercial products.

A two-pronged approach to improvement (sensor and circuit) will lead to the selection of the best sensor structure and the optimum operating protocol with sensitivity, selectivity, and stability to detect and measure methane with minimal power, size, and cost.

For more information:

Maureen Droessler
Program Administrator
Operations Technology Development, NFP
Phone: 847/768-0608
maureen.droessler@otd-co.org



Cross Bores Best Practices Education and Outreach

As a follow-on project that resulted in the development of a Cross Bore Best Practices Guide, an education and outreach program was initiated to inform the natural gas industry and other groups on the results of research and ways to reduce risk.



Project Description

Cross bores have become an industry concern because of incidents involving natural gas mains and services that were installed using trenchless technology that inadvertently transected a sewer line or private septic system. Typical sewer-cleaning operations use a device that can pierce the gas line, resulting in the rapid release of gas.

To assist utilities in addressing cross-bore safety issues, a Cross Bore Best Practices Guide was developed through OTD to serve as a single source of information that could be used by natural gas distribution system operators to investigate and remediate existing cross bores as well as prevent future cross bores. The guide, which was made available in November 2012, can be used by operators to educate internal personnel and the public about cross bores. The guide provides methodologies, technology recommendations, and procedures for preventing and detecting cross bores.

This follow-on project involved the development of an outreach program to raise awareness and streamline implementation of cross bore best practices with natural gas system operators, other utility operators, the sewer and plumbing industry, contractors, homeowners and the general public.

Deliverables

Deliverables include:

- Presentations at industry conferences
- Outreach information in a variety of formats
- Distribution of the Cross Bore Best Practices Guide
- Website links
- Downloadable information
- Webinars
- "How To" videos of selected best practices.

Benefits

Information presented through this project can be used by gas-system operators to reduce their risk and exposure to the threat of cross bores.

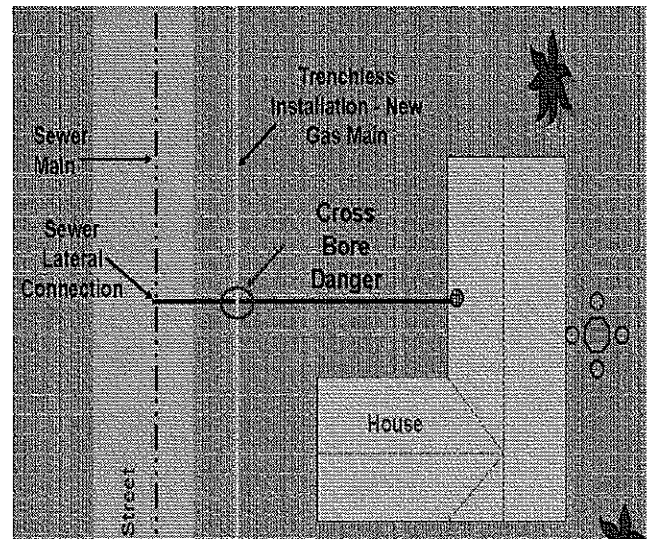
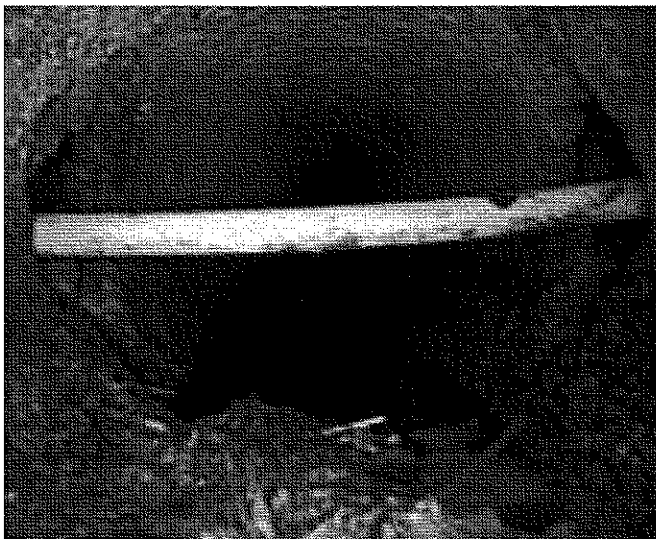

A cross bore is defined as an intersection of an existing underground utility or underground structure by a second utility installed using trenchless technology resulting in direct contact between the transactions of the utilities compromising the integrity of either utility or underground structure.

Technical Concept & Approach

The development of this Cross Bore Best Practices Guide included the review of information from a wide variety of sources across North American, including numerous natural gas distribution companies, installation contractors, remediation contractors, equipment providers, industry associations, and industry literature. The combined customer base of the 23 gas companies interviewed represent 80% of the 75 million natural gas customers in the United States and Canada.

Information regarding state or city-specific rules and regulations were also collected.

The goal of the education and outreach program is to make the industry aware of the availability of the Best Practices Guide, emphasize the importance of the topic, and provide information on the ability to improve safety.

Results / Status

In 2013, information on cross bores research was presented at the following conferences:

- SGA Public Awareness and Cross Bore Best Practices Workshop
- Western Regional Gas Conference. Additional presentations
- Northeast Gas Association Fall Operations Conference
- Midwest Energy Association Fall Gas Distribution Learning Summit

- Two industry webinars.

Other presentation opportunities are being investigated.

In addition, the Cross Bore Safety Association and OTD will be coordinating the appearance of links between their websites.

The preparation of three "How To" videos was completed. The audience and the topics for each video are:

- Plumbers – how to safely investigate a clogged sewer
- Homeowner – how to safely decide if they should clear a clogged sewer
- Field Crews – how to safely install a gas main/service using trenchless technology.

Information developed through this project is available to all interested parties through the OTD website (otd-co.org).

For more information:

Maureen Droessler
Program Administrator
Operations Technology Development, NFP
Phone: 847/768-0608
maureen.droessler@otd-co.org

OTD

Operations
Technology
Development

Cross Bores – National Database and Risk Model

Researchers investigated a wide variety of issues related to cross bores in an effort to develop a national database and risk model for use by the natural gas industry to enhance the safety of the gas-system infrastructure.



Project Description

Significant gas-industry research is being conducted on pipeline cross bores – situations where plastic gas mains and services inadvertently transect a sewer line when they are installed with directional boring techniques.

Gas pipeline/sewer line cross bores can lead to hazardous incidents if sewer-cleaning operations pierce the gas line.

While some companies have initiated thorough programs to inspect past installations to ensure that cross bores have not occurred, most operators have not started such a program and would benefit from a set of best practices to serve as a foundation for the development of their own programs. Even for those operators that have programs in place, additional information is desired to assist in identifying potential cross bores and for improving the accuracy and efficiency of their procedures.

The objective of this project is to develop a national database and risk model to address the cross-bore issue in the natural gas industry. The national database will collect information from natural gas operators on damages and incidents to assist in identifying trends and in

gaining a better understanding of the scope of the cross-bore threat. The risk model will be developed from the data collected in the database and populated by individual operators to provide a company-specific risk assessment.

Deliverables

The deliverables of this project include:

- A national database and two years of technical and administrative support
- A cross-bore risk model
- A report detailing project activities and results.

Benefits

The results of this research can be used by operators to reduce their risk and exposure to the threat of cross bores. The database will create information and industry knowledge regarding the frequency and factors affecting the probability of occurrence. The risk model will assist operators in assessing their risk and can be used to develop a targeted mitigation program.

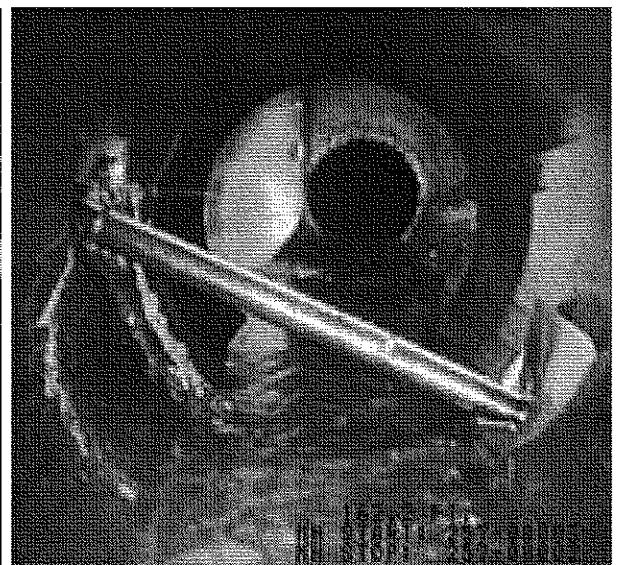
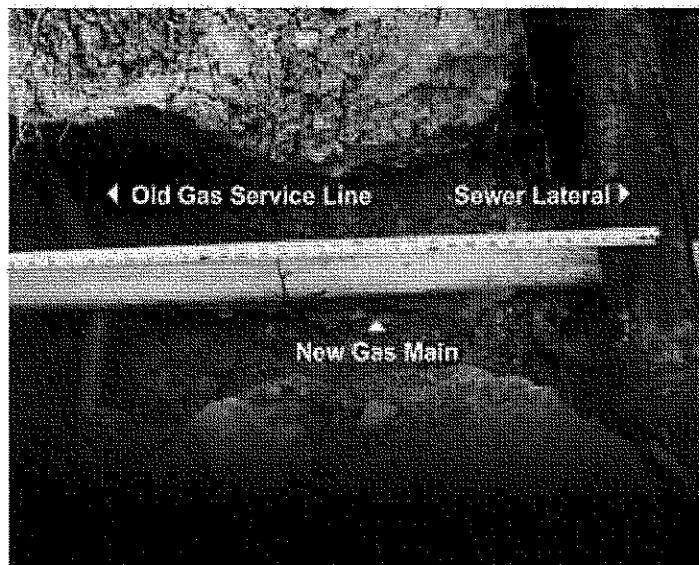

Cross bores (when a gas pipeline intersects a sewer pipe during directional-drilling installations) are a growing industry concern.

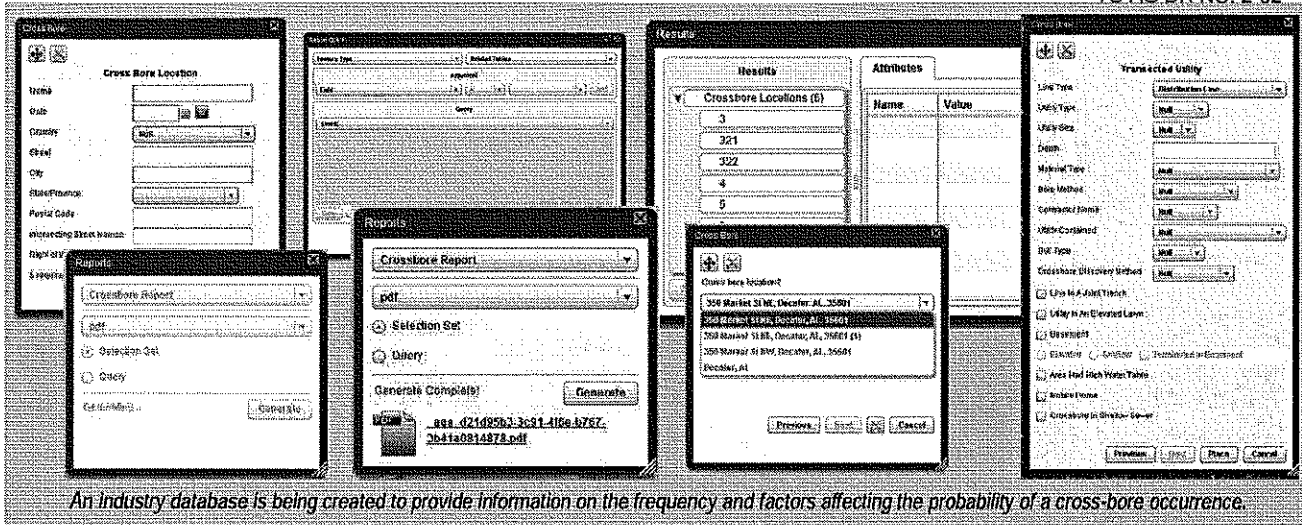

An industry database is being created to provide information on the frequency and factors affecting the probability of a cross-bore occurrence.

Technical Concept & Approach

This project includes the following tasks:

- **National Database**

The research team will design, develop, and launch a national database to collect information on cross bores. The database will be modeled after the Common Ground Alliance's (CGA) DIRT tool (where appropriate). The purpose of the database will be to collect information on root causes, environmental and situational factors, and incident reports. Data collection will include past incidents as well as new incidents. GDM (the gas distribution data model being developed under another OTD project) will be used as the data model for the database and the data-collection forms.

- **Risk Model**

The objective of this task is to build a risk model that will assess system risk and identify potential cross-bore locations. The risk model will be built with the information collected in the national database.

- **Database Management**

The research team will continue to administer the database for two years after its launch to collect additional information on cross-bore occurrences and the effectiveness of various prevention, detection, and mitigation activities.

An advisory group was created to provide industry guidance throughout the project to help define the scope of the project, the format of the deliverables, and other project specifics.

Once the database is final, the Cross Bore Safety Association and other operators will be contacted and encouraged to make use of the tool.

Results

In 2012, programming issues were identified with the CGA DIRT model and reported to the CGA model programmer. The issues were resolved, allowing for a web-based data model to be finalized and include the completion of the creation of the flex fields within the DIRT tool with the full set of data types and attributes.

The research team focused on the use of a GIS system. The Esri system was chosen due to its being the most widely used system in the industry.

In 2013, the Esri GIS-based system was completed and turned over to the sponsors. It was agreed that the sponsors would populate the database with their company-specific data. Sponsors were trained on the use of the database and identified improvements that were subsequently made to enhance the system.

Status

The project has been extended to allow sponsors and others interested in using the database time to populate the system.

Technical support (if needed) will be provided as sponsors populate the system with company-specific data.

For more information:

Maureen Droessler
 Program Administrator
 Operations Technology Development, NFP
 Phone: 847/768-0608
maureen.droessler@otd-co.org

OTD

Operations
Technology
Development

Locatable Plastic Pipe



This project focused on the development of radio-frequency markers for locating plastic pipe. The technology employs markers embedded in tape that attaches to the pipe to allow above-ground pinpointing and identification with low-cost tools.

Project Description

Excavation damage continues to be the primary cause of pipeline incidents, accounting for 34% of the industry's reportable incidents according to the U.S. Department of Transportation's Pipeline and Hazardous Materials Safety Administration. While the utility and excavation-contractor industries have made improvements in damage-prevention technologies and procedures, the increased use of plastic pipe over the last 30 years has created a situation where some pipe segments cannot be easily located with currently available technology. A Common Ground Alliance (CGA) report shows that between 20% and 40% of damages or near-miss events are the result of utility companies not sufficiently locating and marking facilities.

Utility companies usually bury a tracer wire above the newly installed plastic main or service that can be located in a manner similar to metallic pipe and thus provide a mechanism to infer the location of the plastic pipe. The tracer wire must be brought up to the surface, usually at a meter set or valve box, in order to allow a direct connection with an electromagnetic locator.

Plastic pipe becomes difficult or impossible to locate when: tracer wire is not installed or installed incorrectly; tracer wire is broken or corrodes; tracer wire is not accessible from the surface; and tracer wire is located near sources of electrical interference, such as nearby utility lines.

Two techniques are widely used in the utility industry to mitigate against ineffective tracer wire: warning tape and radio frequency identification (RFID) marker balls. Warning tape is a plastic material that is buried above pipe to provide a warning to an excavator of the presence of an underground pipe or cable. RFID marker balls provide a frequency-specific tag that can be located inductively from above ground at depths of up to five feet for passive tags (no battery) and up to 20 feet for active tags (battery).

A major manufacturer of RFID tags is releasing a new product that combines these two techniques to provide enhanced functionality for asset locating. The new product will contain frequently-spaced passive RF tags

imbedded into standard warning tape. The objective of this project is to develop a system to attach tags directly to pipes that will be installed through direct-burial operations.

Deliverables

Phase 1 of this program focused on identifying the market requirements and performing a basic engineering design for the marker attachment mechanism.

Benefits

A technology that allows plastic pipe to be located will reduce the risk of excavation damage.

Operational efficiencies result from the reduced time required to locate pipes that are difficult to locate with traditional techniques. RF tags could eliminate the need for deploying separate crews with specialized equipment (e.g., ground-penetrating radar and vacuum excavation).

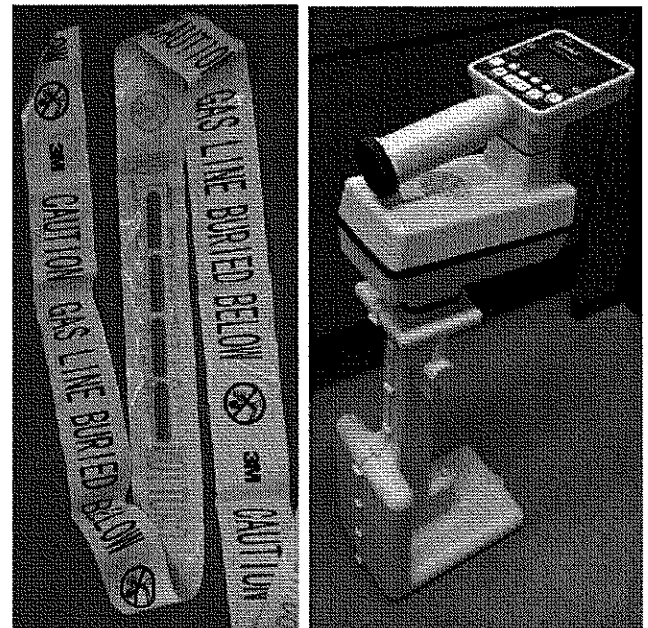

RF resonant marker tape and locator device.

Based on CGA's 2011 DIRT Report, the rate of excavation damage ranges from one to three damages per 1,000 locates, with 30% of these damages attributable to inaccurate locating. RF technology could potentially reduce overall damage rates by 15% and could reduce damage rates attributable to operator error by 50%.

Technical Concept & Approach

This project will be conducted through the following phases:

- Phase 1 – Market Analysis & Engineering Design
- Phase 2 – Prototype Development and Testing
- Phase 3 – Standards and Commercialization.

In Phase 1 researchers conducted an analysis of the potential implications on safety and codes/standards that would result from the use of the RF warning tape and attachable markers.

Potential attachment mechanisms for the markers will be designed and an engineering analysis will be performed to evaluate the impact of the attachment mechanism on pipe integrity. Field testing of an existing RF warning tape will be conducted to verify its accuracy and precision.

Results

Engineering assessments indicated that radio frequency resonant markers could be attached to a pipe without significant risk to pipe or marker integrity.

Lightning strike tests showed that the use of caution tape did not increase risk to pipe integrity.

Field detection tests have shown limited detectability at depths greater than 32 inches, limiting use in trenchless applications that require greater depths. However, this depth limit is not a barrier to implementation because standard utility policies regarding burial depth are within this depth range. Detection depths may be improved via further development.

A market analysis was conducted to determine the suitability of the marker technology in different applications. The general conclusion is that there is a need for both RF-embedded warning tape (up to 46% of new mains and 15% of new services) and direct attachment techniques (up to 47% of new mains and 45% of new services). Regulatory drivers and large-scale replacement programs are providing the incentives and the opportunities to deploy technologies to assist in future locating and damage prevention. The full results of the market analysis were presented in a report to project sponsors.

Four potential pipe-attachment methods were identified: heat tacking, ultrasonic tacking, adhesive bonding, and mechanical (tie) attachments. Method choice and development will be determined by the manufacturer.

In 2012, testing demonstrated a nominal detection depth of 30 inches and a maximum detection depth of 42 inches. Subsequent tests achieved a detection depth in the range of 42 to 48 inches by adjusting the detection mode on the locator. The field detection test showed some dependency on soil type, but only at depths lower than 32 inches. Signal strength greatly diminished beyond 32 inches, with greater depth having signals that were slightly above the nominal (no marker) locator readings. This applied to both search and track modes.

Finite Element Analysis indicates a single attached marker patch can sustain approximately 130 pounds of compression load and an instantaneous shear load of 280 pounds. The pipe is not significantly affected by the patch under these loads or under internal pressure loading.

Possible safety issues during installation and operations were evaluated. With respect to the installation of the markers, no safety concerns were foreseen.

Assessments of static charge buildup on the resonant markers were conducted, finding that since the markers are highly electrically insulated and are physically static, there is no triboelectric mechanism that will induce static charge buildup inside the marker. Even during excitation, the strong electrical insulation maintains the net charge within the marker, thereby preventing static buildup within, and conduction through the marker's encapsulation.

Lightning strike tests showed no increased risk of lightning strike due to the proximity of the resonant markers to the pipe and no critical damage (i.e., pipe puncture) occurs in the event of a lightning strike.

Status

This project was completed in 2013. A Final Report on the project was issued in April 2013.

For more information:

Maureen Droessler
Program Administrator
Operations Technology Development, NFP
Phone: 847/768-0608
maureen.droessler@otd-co.org



Operations
Technology
Development

PIPE & LEAK LOCATION

Cross-Bores Detection Using Mechanical Spring Attachment

Research is under way to develop a tool that will detect a hit to a sewer pipe during the installation of a gas pipe. The tool utilizes a mechanical spring system that is activated inside the sewer pipe void to provide a real-time alarm identifying a hit.



Project Description

Horizontal directional drilling (HDD) has become a common method for installing polyethylene (PE) gas pipe. Although rare, hits to sewer pipes during the HDD/mole installation process have occurred ("cross bores") that resulted in gas leaks into the sewer system when sewer-cleaning operation damaged the gas line.

Sewer laterals typically run perpendicular to the proposed route of a new gas pipeline. The laterals also rapidly change depth in that same area. Currently, there is no practical technology for locating sewer laterals and determining their depth in all types of soils.

Several approaches, including advanced utility locating and camera inspection, may contribute to reducing these threats. However, these operations are performed by different crews either before or after drilling and standard drilling technologies are still "blind" with respect to the underground environment.

The objective of this project is to develop a tool that will detect a hit to sewer laterals during the HDD or mole installation of PE gas pipe. The tool is designed with a low-cost and easy-to-use mechanical spring system that is attached to the HDD/mole head during drilling or to the PE pipe during pullback. The spring system is activated inside the sewer pipe void; thus locating the lateral and providing a real-time alarm identifying a hit.

Deliverables

The deliverable for the project will be a functional prototype unit.

Benefits

The implementation of the cross-bore detection tool increases safety and enhances the installations of distribution gas lines in difficult areas where sewer lines intersect.

The ability to attach the detection system to either the drilling head or to PE pipes during pullback makes it an economic and practical solution to detect incidents of pipe encroachments during HDD and mole operations and will help minimize risks.

Technical Concept & Approach

The design consists of a cylindrical unit attached to the HDD/mole head during drilling or to the PE pipe during pullback. The unit has spring arms around its perimeter. The springs are in a closed position when confined in soil. When the unit encounters a void space inside a sewer pipe, the spring arms open and an electronic signal is sent to the surface (using a signal wire or wireless system) indicating the arms' movement.

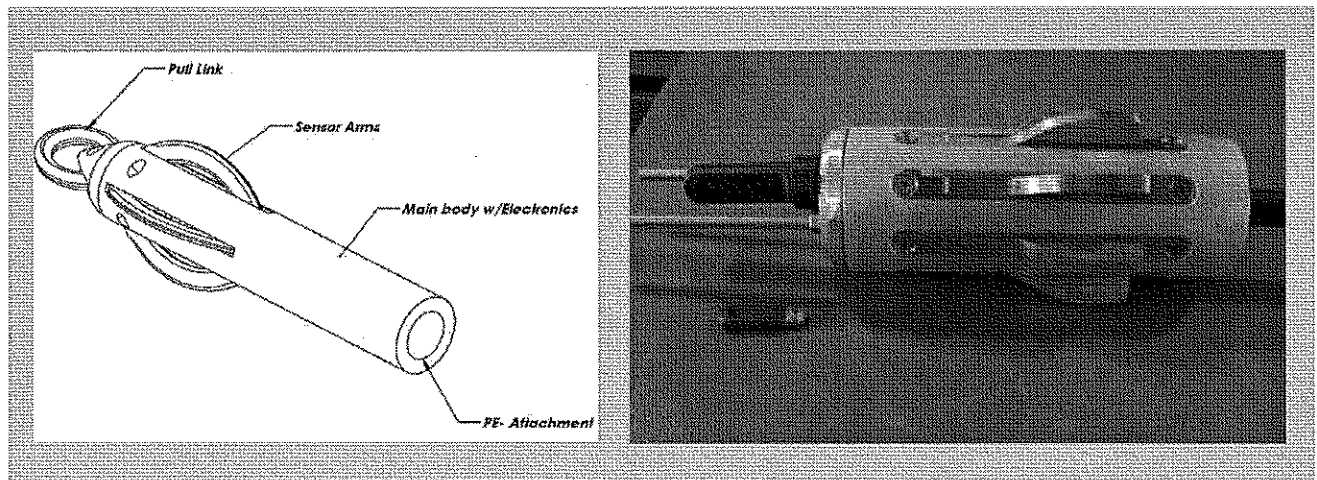

Initial design of the spring attachment (left) and current prototype (right).

An on/off electronic signal can be sufficient to indicate if the apparatus encountered a void representing a sewer lateral when some or all the springs are opened inside the sewer pipe.

Specific tasks include:

- **Initial Design of the System**

The development of prototypes consisted of several steps to address the following operational requirements:

- The mechanical system must sustain the forces applied during the drilling and pullback operations.
- The spring arms must function properly in drilling mud and varying soil conditions, especially in the cohesive types encountered when operating in wet clay soil.
- The electronics must be waterproof and resist the chemical and environmental conditions encountered in the soil and sewer lines.
- The electronics must be designed to transmit the signal in real time. The signal may be transmitted using the tracer wire as a communication line if it is installed during the operation or using a wireless radio transmission with automatic on/off feature.
- The system must be calibrated to identify the false signals that may result from passing through natural soil voids.

- **Prototyping, Testing & Modification**

The selected prototype will be manufactured and tested under various soil conditions in a laboratory environment.

- **Field Testing and Troubleshooting**

A field test and a demonstration will take place at the Gas Technology Institute (GTI) pipe farm. A sewer system will be installed and a HDD installation will be performed with the prototype. The drilling will be guided to penetrate the sewer pipe and the prototype will be evaluated for performance.

Results

In 2012, two designs of the system with mechanical springs were built as preliminary prototypes. Various systems were considered, including the use of pressure bags at the perimeter of the attachment and installing a simple load-sensor indicator during the PE pipe pullout.

In addition, the electronic system for transmitting the signal to a readout box at the surface was designed and a prototype of the system was built.

A prototype for field testing at GTI was subsequently built. This prototype includes a set of eight mechanical arms around the perimeter configured to improve the detection of voids with minimum soil intrusion inside the tool. Data is collected during the pullback process of the PE pipe and stored in a memory stick mounted inside the tool.

The prototype was tested in 2013 in a soil test box where the 4-inch-diameter pipe crosses a 4.5-inch sewer pipe. Further tests are in progress to evaluate the tool in wet soil conditions.

Communications were initiated with manufacturers to adopt the tool and to determine further development needs.

A patent application was filed in June 2013.

Based on the testing of the prototype, the following options are considered for further modification of the prototype:

- *Facilitate data storage:* Have data storage directly in the circuit board rather than in the memory stick. The memory stick is then used only to download the data after the completion of one or several installations.
- *Facilitate data display and downloading:* Include a green/red light signal outside the unit to indicate if a hit occurred or not.
- *Extend battery life:* Battery life was not tested but may run for several hours. Possibly use rechargeable lithium batteries for longer battery life and to simplify replacing the batteries.
- *Evaluate the need for sealing:* To be determined after further testing in wet soils.

Status

Field tests are under way at GTI. For the tests, several different size sewers, made of several different materials to drill through, are being used.

For more information:

Maureen Droessler

Program Administrator

Operations Technology Development, NFP

Phone: 847/768-0608

maureen.droessler@otd-co.org

OTDOperations
Technology
Development**PIPE & LEAK LOCATION****Performance-Analysis Methods and Metrics
for Leak-Detection Technologies**

In this project, investigators are developing methods for the testing and analysis of a wide variety of gas-leak-detection technologies. Initial research focuses on the identification and study of equipment-specific and site-specific essential variables that need to be addressed.

Project Description

The ability to maximize the effectiveness of the leak-survey process is critically important for distribution and transmission gas pipelines.

While various leak-survey products are available, and new technologies are emerging, it can be time-consuming and difficult for pipeline operators to determine the effectiveness of leak-survey options. The goal of this project is to provide the industry with the information necessary to quantitatively assess the performance of current and future leak-survey equipment.

Researchers will investigate several leak-survey technologies, including:

- Technologies used in walking surveys, such as Flame-Ionization Detectors (FIDs), the Portable Methane Detector (PMD), and the Remote Methane Leak Detector (RMLD); and
- Technologies used in drive-by leak surveys, such as FIDs, the OMD, Infrared Spectroscopy (DP-IR), and Cavity Ring-Down Spectroscopy (CRDS).

These technologies are included in this project to specify the essential variables, testing methods, and performance metrics required for a technology assessment.

Deliverables

The deliverables for this project will include a Final Report and conference call with the project sponsors to discuss the essential variables, test methods, and performance metrics developed.

Benefits

This project will provide methods and procedures to help enhance public safety and the efficiency of natural-gas-industry leak-detection programs.

The project will provide the required essential variables and testing methods to measure technology performance metrics such as sensitivity, precision, accuracy, probability of detection, and false-negative/false-positive rates.

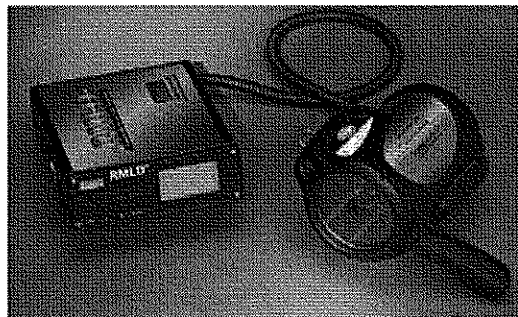
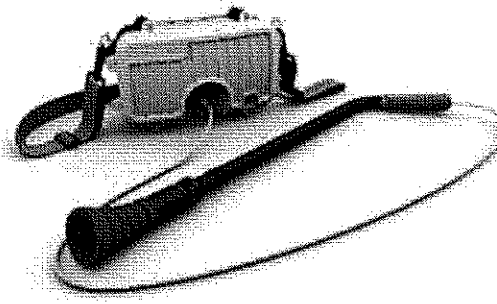
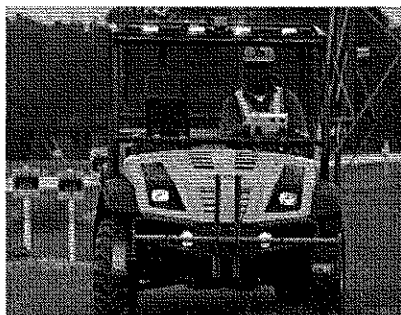

To develop testing methodologies and metrics, researchers are investigating a variety of gas-leak-detection technologies.

Technical Concept & Approach

This project addresses:

- **Equipment-specific and site-specific essential variables required to specify the testing methods and metrics.** These essential variables include environmental conditions such as wind speed and direction, temperature, and pressure differentials. Operating variables, such as speed of transit over the line and detector proximity to the ground, are also included.
- **Testing methods.** This may include ASME and other standard methods.
- **Performance Metrics.** This includes metrics to address sensitivity, precision, accuracy, repeatability, probability of detection, false-negative and false-positive rates, etc.

A Technical Guidance Committee (TGC) consisting of project sponsors, manufacturers, and industry organizations will be formed to guide the project.

Results

In 2013, initial data was collected on various leak-survey technologies to determine essential variables as they relate to specific equipment and site conditions.

The results were summarized in a table format in a report to project sponsors. The report includes key information on FIDs, the OMD, the RMLD, the PMD, DP-IR, and CRDS.

Information is provided on vendors, product operating principles, key device parameters, and advantages/disadvantages.

Manufacturers of leak survey technologies were contacted and information exchanged.

Status

The research team continues to collect information regarding the specific operating conditions for the selected tools and the controlling variables.

This project is expected to be completed in early 2014.

For more information:

Maureen Droessler

Program Administrator

Operations Technology Development, NFP

Phone: 847/768-0608

maureen.droessler@otd-co.org

OTD

Operations
Technology
Development

PIPE & LEAK LOCATION

Testing and Field Evaluation of No-Blow Fish-Tape Technology to Locate PE Mains



Testing and evaluation is being conducted on a recently developed gas-line tracer system and process to allow for no-blow insertion of a fish tape into PE gas mains for locating purposes.

Project Description

The problems that can result from unlocatable plastic pipe are some of the natural gas industry's greatest concerns, due primarily to the potential for third-party damage. While tracer wire is commonly installed along with polyethylene (PE) pipes, wires that are broken or missing, never installed, inaccessible, and providing distorted signals from nearby utility lines are all causes for making PE pipe unlocatable.

Adding to the issue is the fact that more gas pipe is being installed at deeper depths using directional drilling techniques. This can cause weak or lost signals. While there have been advancements in plastic pipe locating (e.g., radar and acoustics), the safety of gas systems will be enhanced with a system that allows plastic pipe to be located with low-cost technologies.

This project involves the testing a new Gas Line Tracer Kit from Jameson LLC. The fish-tape system that was designed in conjunction with Gas Technology Institute (GTI) as part of the GTI Keyhole Consortium Program.

The system addresses the need to locate previously unlocatable PE gas service lines. This product allows for utility operators to use traditional pipe- and cable-locating equipment and includes a gas-line fish-tape system and unique stuffing box. When used properly, targeted pipes can be precisely located while still pressurized, without the need to disconnect from the gas main.

This system was designed to be inserted into the service riser of the gas *service*. However, there is a growing need to use this system for unlocatable PE *mains*.

Jameson recently developed an electrofusion fitting to allow access into two-inch-diameter PE pipe. The company has also initiated development on a stuffing box to allow a one-quarter-inch-diameter fish tape to be installed "no blow" through the fitting into the two-inch pipe.

In this project, a research team will test and evaluate the recently developed system and process to allow for no blow insertion of a fish tape into PE pipe. This development is focused on PE mains where access through the riser is not available.

Deliverables

Detailed results of the evaluation will be made available. In addition, case studies will be developed for various field trials to be conducted and information for the development of operating procedures will be provided.

Benefits

The use of locating fish tape is increasingly being used by utilities. Currently this process has been mostly limited to service tubing or PE mains that have been taken out of service. The development of a system (fitting, stuffing box, and accessories) to allow for the no-blow insertion of a fish tape into PE pipe would significantly improve the process of locating PE pipe.

Live insertion of a fish tape saves time and money because the pipe remains in service. There is no need to re-light services and the main does not need to be repaired after the tracing is complete.



Line tracer system accessible through a valve box.

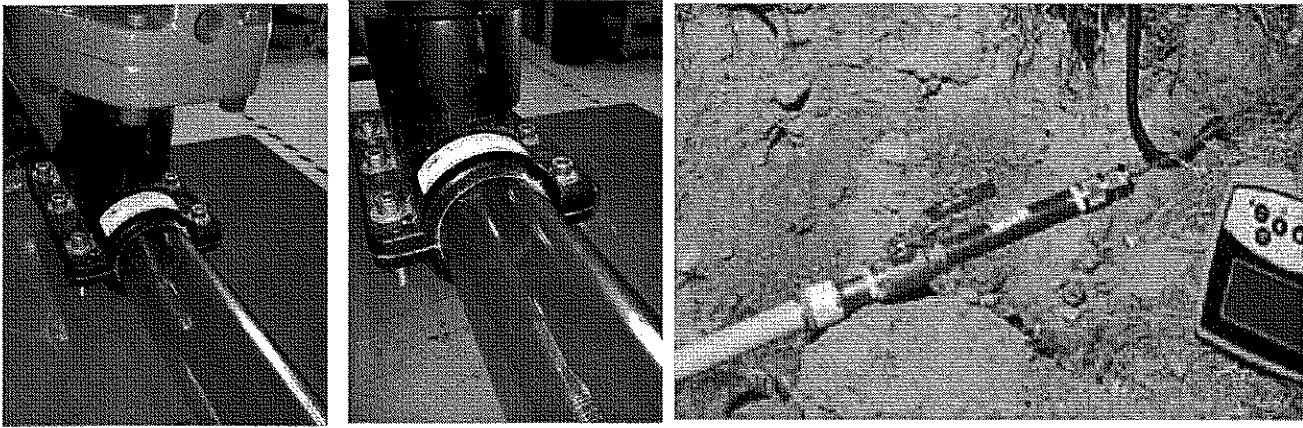

Left and Center: Fish tape being pushed into the pipe in the laboratory. Right: Service line tracer installed in a PE main after the pipe was segmented.

Technical Concept & Approach

Based on the initial development of an electrofusion access fitting and stuffing box, initial laboratory and “backyard” field tests are being conducted prior to field tests on unlocatable gas facilities.

The evaluation tests are performed first in the laboratory to assure performance of the electrofusion fitting and tracer line components. After this initial evaluation, researchers will conduct simulated field evaluations at GTI’s field site on two-inch PE pipe pressurized with air. GTI and Jameson will also develop and finalize procedures for the use of the tracer line in PE mains.

Based on initial results, further evaluations will be conducted in the field. Utilities will be asked to identify a two-inch PE piping system (preferably unlocatable pipe) to install the Jameson tracer line.

Results

The project team reviewed the system as sold by Jameson (with an angled fitting) and also designed and developed a new directional insertion tool to allow the fish tape to be used with currently available mechanical and electrofusion vertical entry fittings. The review in-

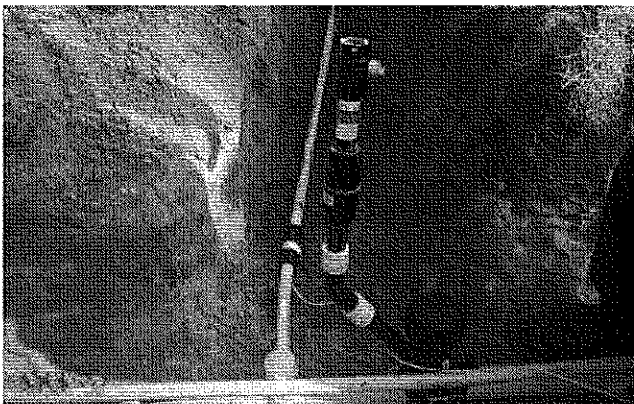

Angled fitting installed with a 45-degree fitting.

cluded running through the complete process of installing the fish-tape system – fusing on the fitting, installing the fish tape, locating the tape, and removing the tape – in a simulated pipe system. (Photos and a video are available of this process.)

It was successfully demonstrated that the Jameson fish tape can be inserted, under pressure, into a two-inch PE pipe. Also, the fish tape can be directed in either direction from the one single entry point. Upon initial examination, the existing main line tracer system could not make the 90-degree bend into the two-inch pipe. Subsequently, researchers pursued the concept of using a directional insertion tube to assist the tape entry through the 90-degree angle.

Status

Remaining activities include:

- Completion of benchtop testing of the directional insertion tool
- Testing of the newly developed directional insertion tool using both Jameson fish tapes (thicker main line and thinner service line) through 200-400 feet of two-inch PE pipe under live conditions (60 psig air pressure).
- The development of procedures for using the Jameson fish tape for locating PE mains. Both options will be documents (angled entry and vertical entry using the directional insertion tool).

For more information:

Maureen Droessler
Program Administrator
Operations Technology Development, NFP
Phone: 847/768-0608
maureen.droessler@otd-co.org

PIPE MATERIALS, REPAIR & REHABILITATION

In this area, researchers focus on various aspects related to the evaluation and development of materials and processes used to maintain, repair, and rehabilitate gas piping systems.

Current efforts include projects to improve techniques, equipment, and quality control for the repair and maintenance of pipes, joints, and various facilities.

A wide variety of advanced techniques are under investigation, including cold adhesive repair and joining, an external repair tool, and a system for the repair of aboveground leaks. New initiatives include investigations into the use of composite materials for pipeline rehabilitation.

R&D results – developed in state-of-the-art testing facilities and demonstrated in the field – contribute to improvements in system safety, deliverability, and integrity.

OTD

Operations
Technology
Development

Cold Adhesive Repair and Joining of Polyethylene Pipes with Minimal Surface Preparation

In this project, researchers are testing a cold-adhesive repair technique in an effort to develop an economical, reliable, and safe technology to quickly and effectively repair damaged plastic gas pipes.

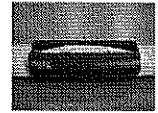

Project Description

Natural gas distribution companies have continued to identify the development of reliable, economical, and safe repair methods for plastic pipes as one of the industry's most important needs.

It is estimated that each year about 180,000 pipe failures occur in plastic gas distribution pipelines. While about 60% of the plastic-pipe failures are the result of excavation damage, most of the remaining failures are primarily due to the initiation of brittle-like slit failures that can grow through the pipe walls. These slit failures are commonly located at heat-fusion joints and at pipe sections subjected to squeeze-off, rock impingement, pipe bending, or excessive earth settlement.

Typically, two distinct operations are involved in the conventional repair of a plastic gas pipe. First, the flow of gas is stopped using squeeze-off techniques, which usually requires two excavations. Next, the damaged or leaking pipe section is cut, removed, and replaced with a short section of pipe (or, "pup") that is joined to the pipeline using mechanical or electrofusion couplings.

In this project, researchers are developing a Cold Adhesive Repair of Polyethylene (CARP) technology that will allow gas company crews to economically and quickly repair (and join) damaged polyethylene (PE) pipes and leaks without additional excavations, removal of the damaged pipe section, and interruption of

gas supplies to clients. With the CARP method, pipe patches are bonded to damaged pipe using special adhesives. The CARP technology does not require significant pipe-surface preparation, training, heating, or tools:

The primary objective is to develop and commercialize a technology using modern structural cold adhesives, optimized for low-surface-energy materials such as PE. The technology is being developed for several forms of PE gas pipe damage, including pipes with holes and gouges, through-the-wall slits, surface scratches, and leaks at heat-fusion joints, impinging rocks, and other areas.

Deliverables

The deliverables for the project include:

- Easy-to-use, optimized structural adhesives and patch designs and materials (that do not require tools, heating, or pressure) and cure in air under typical field conditions within a period of about five hours, but allow for immediate burial
- A step-by-step repair procedure/protocol to perform quick in-field repairs on leaky and damaged PE pipe sections
- A written procedure guideline/manual on each step of the CARP process that takes into account different field temperatures and soil/environmental conditions
- CARP testing prototype kits that include the required repair materials and procedures
- A video demonstrating the application of the CARP process.

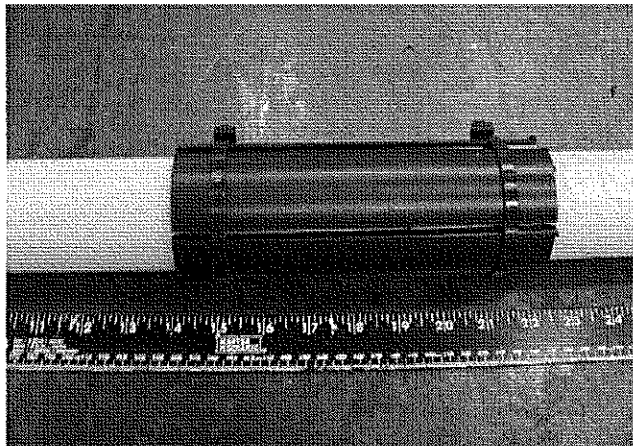

CARP patch applied to PE pipe specimen.

Benefits

The CARP technology shows promise in reducing the costs of PE pipe repair and the ability to improve the reliability and safety of PE piping systems.

Investigators expect the cost of the CARP technology to be low. It is envisioned that fitting manufacturers will mold the CARP patches using automated high-production molding machines.

Technical Concept & Approach

Specific activities:

- The design and fabrication of PE repair patches on the basis of laboratory test results and stress analysis calculations
- Validation testing, including short-term (quick-burst) and accelerated long-term laboratory tests at elevated temperatures and pressures on pipe test specimens repaired under pressure
- The formulation of a comprehensive CARP test matrix under no-pressure conditions (no blowing gas conditions)
- Short-term and accelerated long-term laboratory tests on repaired test specimens per the test matrix
- Forecasting the pressure-carrying capacity and the life expectancy of the repaired test specimens
- Preparation of a step-by-step procedure to perform cold adhesive repairs.

Results

Long-term test results of patched PE pipes found that the patching system can be effective. Testing also resulted in additional information about the effective application of the adhesive.

Test data showed that at an average field temperature of about 68°F the CARP-repaired pipes have an average projected life expectancy of greater than 50 years.

These initial test results also showed that the growth of the crack/notch was arrested by the CARP-repaired patches.

Quick-burst (QB) pressure tests demonstrated that the strength of CARP-repaired pipe specimens was the same as the pipe. For these specimens, the failure occurred in the pipe away from the patch. This failure was a typical ductile rupture.

Technicians fabricated a "self clamping" patch to evaluate a full-encirclement-type patch with the potential for improved performance over the partial patches.

Throughout 2012-2013, a number of CARP-repaired PE pipe specimens were created and evaluated through a series of QB and Long-Term Hydrostatic (LTHS) tests.

QB tests were conducted at both 23°C (73°F) and at elevated temperatures (80°C and 90°C). All failures occurred in the pipe wall (not through the patch); however, the QB tests at elevated temperatures created failures in the pipe wall at the closure seam of the patch (180 degrees away from the notch). The LTHS tests were conducted at 80°C and 90°C water baths and at various stresses.

The results of the initial LTHS evaluations indicate that the patch and adhesive is sensitive to temperature. Specimens failed within a short time of pressure loading. Therefore, additional testing of the adhesive and bonding was required in order to properly relate accelerated LTHS results to operating condition lifetime predictions.

The research team experimented with varying the test pressures, temperatures, and materials of the pipe specimens in order to resolve some of the recent issues with early failures in the hot water baths. Based on the current ongoing tests, it appears that the lower water bath temperatures have allowed for good results with the tests.

Based on the preliminary test results, it appears that the patch is providing protection for the artificially induced damaged pipes. Medium-Density (MD) PE and High-Density PE pipes and patches were tested. Results indicated that MDPE pipe/HDPE patch samples are performing better than the HDPE pipe/HDPE patch samples.

Status

Current activities include:

- Monitoring the status of the current specimens being tested.
- Generating additional data points and regression lines for both HDPE- and MDPE-patched pipe samples at 23°C, 60°C, 80°C, and 90°C.
- Reviewing the mode of failure of recent specimens. It was also decided to produce pipe specimens with a breach through the pipe wall, then patch and test these specimens. These additional specimens will provide a better understanding of the performance of the patch after the PE pipe wall is breached.

For more information:

Maureen Droessler
Program Administrator
Operations Technology Development, NFP
Phone: 847/768-0608
maureen.droessler@otd-co.org

OTDOperations
Technology
Development**PIPE MATERIALS, REPAIR & REHABILITATION****Development of an External Repair Tool
for Polyethylene Pipe**

Enhancements and modifications are being made on a tool and process for the repair of polyethylene pipe. The pipe-repair system attaches and bonds a patch to damaged pipe areas, providing a cost-saving alternative to conventional plastic-pipe repair techniques.

Project Description

Current polyethylene (PE) repair procedures require excavation, isolation, and removal of the damaged section of pipe, followed by fusion of a new section of pipe into place – techniques that can be costly and disruptive.

In an effort to provide a cost-saving alternative, this project is focused on the development of a thermo-chemical repair patch and mechanical tool to externally repair damaged PE pipe *in-situ*, eliminating the need for large-scale excavation and replacement of pipe sections.

In the completed Phase 1 of the project, activities were conducted to enhance an innovative repair tool developed by Timberline Tool and Oregon State University under a cooperative agreement with the U.S. Department of Energy's National Energy Technology Laboratory. In the current Phase 2 effort sponsored by OTD, additional testing and modifications are being conducted.

The tool uses heat fusion to attach a patch to repair damaged pipe and features a jaw design, open on the end and curved to fit the contour of the pipe as it closes. The open-jaw configuration allows the operator to fully enclose the damaged section of the pipe with the repair patch, stopping the flow of gas through the damaged pipe wall. The system operates remotely from the top-down (without requiring preparation of the pipe) and is portable and lightweight (30 pounds), allowing for one-person operation. The tool measures 11 inches wide with a 6.5-foot handle, allowing for easy use in keyhole operations.

The function of the tool is to:

- Repair gouged or scratched pipe that would otherwise have to be replaced
- Reinforce suspect butt-fusion welds that may be prone to failure due to long-term slow crack growth
- Stop leaks in pipe without shutting off the gas flow in the main.

Deliverables

The deliverables for this project include:

- Development of the final repair tool and patch ready for testing
- Regional or company-specific demonstrations or field trials of the repair tool
- Test documentation.

Benefits

The thermo-chemical repair process will allow the natural gas industry to reduce their costs for the maintenance and repair of their PE service and distribution pipelines while making the jobsite safer for their employees and the public.

Substantial maintenance costs and potential safety incidents can be avoided by the quick and widespread implementation of the repair tool. It is estimated that the use of this system will save the industry between \$1,000 and \$3,500 per incident, depending on the size and complexity of the maintenance/repair project.

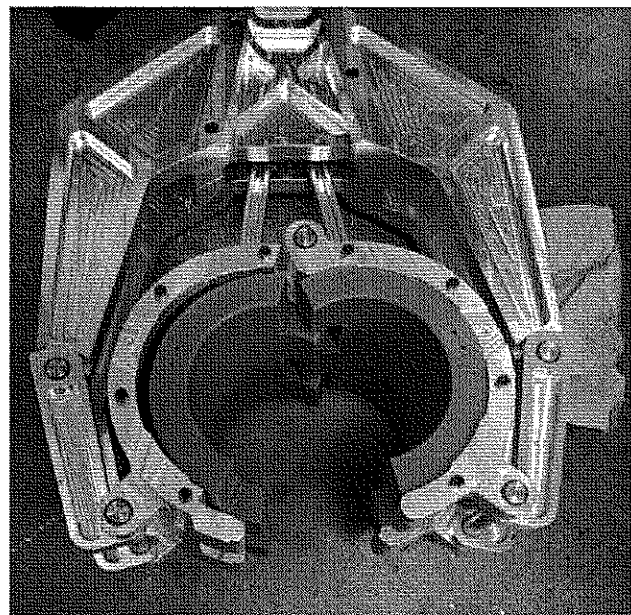

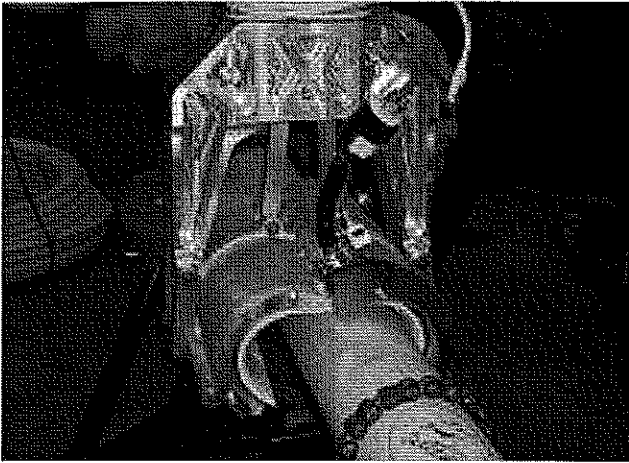

Technical Concept & Approach

The principal design challenge was to modify the system to be able to repair a large opening (e.g., breach or gouge) in the pipe wall that allows pressurized gas to escape. Another design goal was to be able to use one tool to repair more than one pipe size.

The project involves a regimen of testing activities to optimize the repair patch, the process, and the tool. In addition, the project includes an investigation into applicable codes and standards.

Results

Phase 1 development activities for this project are completed and resulted in various product improvements.

A novel and effective PE foam adhesive layer was developed and included in the composition of the repair patch. The use of this foam adhesive layer saves time, facilitates preparation, and simplifies the storage and shipping requirements for the patch assemblies.

To be able to use the same tool to repair multiple pipe sizes, the patch was redesigned using an internal stitched heater within the patch. The final repair patch design uses a stitched internal heater of varying watt density on a layer of PE film that is sandwiched between two layers of PE "solvent sponge" foam. The new design also uses nylon thermal-insulating jaw inserts that are easy to exchange in the field and are specific to various pipe sizes up to six inches in diameter.

The controller was completely redesigned and reprogrammed to address all pipe sizes (standard and metric). The configuration of the controller was also redesigned, which allowed for a reduction in overall size.

A final design was completed in 2012 for a permanent plastic injection mold to replace the hand molding previously used to produce the patch backs. This allows for consistency in the manufacturing process and eliminates

the variables associated with producing the patch backs by hand. During these initial test runs it was noted that in order to attain the correct patch length, the temperature within the nozzle and barrel of the mold press needed to be at the upper limit of the specifications for injection molding. This high temperature produced patch backs that were adequate, but moderately brittle.

In 2013, researchers investigated three different pipe resins to reduce the overall temperature during molding and eliminate the brittleness. After the research team was unable to attain satisfactory results using the new HDPE pipe resins, it was determined that the mold needed to be modified in order to produce patch backs to specification.

The plastic injection mold was manufactured, initial patch backs were produced, and testing of the mold was performed.

A test run of 36 patch backs were then produced. The injection pressure was kept constant for all of the six sets with the temperatures and hold time being varied. This resulted in an investigation into the effect temperature and time play in the injection process. This testing confirmed the optimum process controls needed for the injection molding of the patch backs.

During this last set of tests, it was observed that the parts produced later in the run were exhibiting more shrinkage. On further research it was determined that the cooling lines within the mold were unable to maintain a constant temperature thus causing the mold to heat up and the polymer to shrink more. The mold was subsequently modified and re-machined to allow for the lesser amount of shrinkage.

Status

The cooling lines within the mold are being redesigned and modified so that the mold will maintain a constant temperature during production runs. The mold will also be modified to ensure the finished part dimensions are to specifications.

Patch backs are being prepared and repair patches assembled to produce 200 thermal-chemical repair patches for accelerated age testing and quick-burst tests in 2014.

For more information:

Maureen Droessler
Program Administrator
Operations Technology Development, NFP
Phone: 847/768-0608
maureen.droessler@otd-co.org

OTDOperations
Technology
Development**PIPE MATERIALS, REPAIR & REHABILITATION**

In-Service Field Evaluation of Polyurea Coating Systems



As a follow-on to a previous project, research into field-applied polyurea coatings for gas industry use has been extended to focus on two promising coatings. Through this new initiative, long-term field trials will be conducted to evaluate these coatings and determine a cost-effective coating-application method and process.

Project Description

In recent years, gas utilities have expressed increased interest in using plural-component "polyurea" coatings for service applications such as vaults, pipe on bridge crossings, pipe for horizontal drilling applications, above-ground meter sets and distribution equipment, and vehicle truck beds/underbodies.

In general, polyurea coatings have exceptional high elongation and toughness. Polyureas also offer rapid application rates, fast curing (< 1 minute), and a quick return of components to service. In addition, they can have strong abrasion resistance and excellent encapsulation characteristics. Some systems are available in high-pigment UV-inhibited formulations, making above-ground applications acceptable.

The most problematic application of polyurea coatings is related to potential coating damage from cathodically protecting the pipe. Polyureas are generally known to perform relatively poorly compared to fusion-bonded epoxies (FBE) in ASTM cathodic-disbondment (CD) testing. However, due to their exceptional impact resistance, many fewer holidays should be expected to form.

Plural-component equipment is also known to be difficult to use and time consuming to set-up and clean-up. In applications where only a relatively small surface area has to be coated, a brush-on coating may be just as effective.

In Phase 1 of this project (now complete), a comprehensive evaluation of polyurea pipe coatings was conducted.

Tests were conducted to determine:

- Cathodic disbondment
- Impact resistance
- Abrasion resistance
- UV resistance, and
- Corrosion resistance.

In Phase 1, two types of polyurea coatings from Nukote Coating Systems (HAR and HTD) performed well in laboratory testing and appeared promising for use in the natural gas industry. Their impact and corrosion resistance outperformed the benchmark liquid epoxy

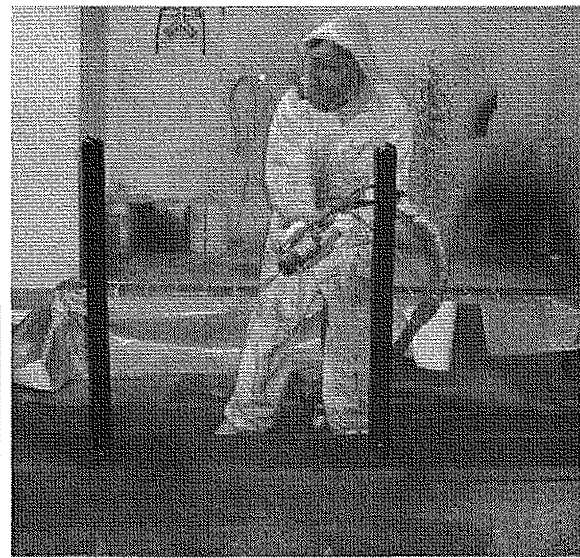
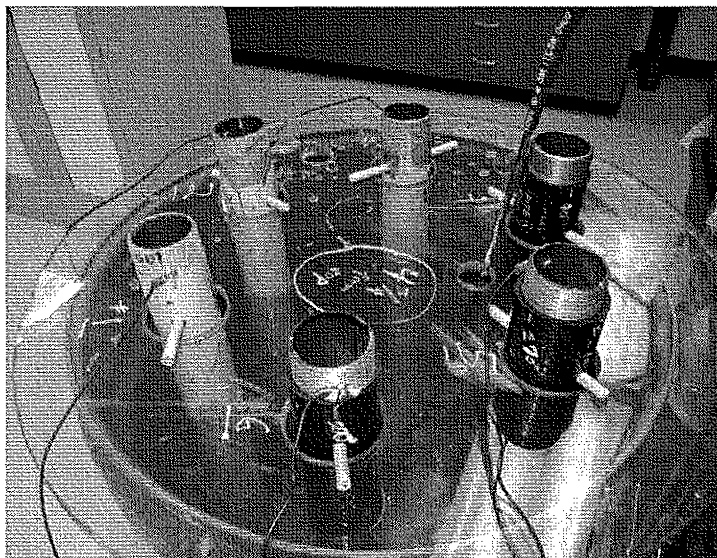

ASTM G8 testing from Phase 1: Pipes suspended in electrolyte (left); spraying coating on pipe specimens (right).

coating. In addition, the formulation of Nukote HAR and HTD coatings significantly improved their cathodic-disbondment resistance in comparison with other types of polyurea coatings.

In the current Phase 2 initiative, these Nukote coatings will be further tested through long-term field trials in several applications.

Deliverables

Deliverables will include a report on the application of the coatings at various field sites. The report will also provide guidance for the polyurea applications method and process.

Benefits

This research will provide utilities with the comparative, sound engineering data necessary to make decisions regarding the use of polyurea coatings.

Technical Concept & Approach

Specific tasks include:

- **Identification of Field Test Sites and Coating Applicators**

The research team will survey project sponsors to determine/verify potential applications in the natural gas distribution system, identify coating applicators, and secure sponsors and sites for conducting field tests of the polyurea coatings.

- **Establishment of a Field Testing Matrix**

This includes:

- Selecting the coating for the typical application
- Determining coating application methods and processes based on the field application, and
- Determining the total test duration and coating evaluation frequency over the entire field-test period.

- **Evaluation of Field-Coating Applications**

Technical staff will witness the coating preparation and application process and document the application parameters, field conditions, and completed installation.

- **Coating Evaluation**

Evaluations of the in-field coatings will be conducted after one year of in-service conditions. Investigators will then re-evaluate the in-field coatings after three and five years of in-service conditions. The inspections will include visual and non-destructive coating evaluation to locate coating color change, blisters, peeling, rust, holidays, and adhesion.

- **Guidance for Polyurea Applications**

Based on the field-test results, the research team will recommend the applications in the natural gas distribution system where polyurea coatings could be used. A guidance document on coating application methods and processes related to the specific applications will be developed.

Results

Phase 1 evaluations were completed in 2013. A Final Report was issued in February 2013.

The Phase 2 project focusing on Nukote coatings was initiated in August 2013.

A project survey was prepared to assist in identifying the sponsors and the sites for conducting field tests of polyurea coatings.

The research team is working in cooperation with Nukote, who is willing to supply the coating applications to support the field tests.

Status

Activities are currently focused on:

- Compiling survey feedback
- Determining the two to three field test sites and identifying field environmental and application conditions
- Establishing a field testing matrix, and
- Preparing field tests.

For more information:

Maureen Droessler
Program Administrator
Operations Technology Development, NFP
Phone: 847/768-0608
maureen.droessler@otd-co.org

OTD

Operations
Technology
Development

Development of a System for Repair of Aboveground Leaks

Researchers are conducting a thorough evaluation of repair methods for leaks on aboveground piping in an effort to establish a basis for choosing the right repair method for a specific leak, establishing levels of adequate preparation, and providing the proper installation for increased reliability.



Project Description

Utilities are now classifying and logging leaks on aboveground piping, and many have established that a significant number of the leaks occur due to pitting corrosion or through threaded joints between components. Removal or replacement of leaking components is not desired due to customer downtime, relights, and the time involved in conducting the repair. Additionally, many of the components (other than the thread area) may be in good working condition and do not require replacement.

Although many leak-repair systems are available, very few gas utilities are using these systems and, if they do, most use them only as a temporary repair.

Several of the most popular mechanical and composite-wrap systems in use today can be complicated and difficult to consistently install. Strict requirements for surface preparation, cleanliness, installation alignment,

installation tension, torque requirements, and cure time all create variability in the final repair integrity.

Research found that there are several key factors that have resulted in large numbers (>10%) of these repair systems to leak within weeks or months of installation.

In this project, researchers are conducting an evaluation of repair methods for leaks on aboveground piping in an effort to establish permanency of the repairs and determine their life expectancy.

Deliverables

The deliverable will be an analysis of the permanence of two tested aboveground leak repair systems. The evaluation will provide extrapolated estimates of the long-term life expectancy of these repairs based on the long-term tests at elevated temperatures.

Based on the results of this effort, an additional task may be initiated to enhance current leak-repair systems and possibly begin the development of a new leak-repair system to allow for greater repair flexibility and reliability.

Benefits

Through a long-term evaluation of aboveground leak-repair installations, a basis will be established allowing utilities to determine the long-term performance of the repair methods for varying types of conditions. Benefits include improvements in the efficiency of utility personnel at resolving leaks, the quality of leak repairs installed, and the longevity of the repairs.

Technical Concept & Approach

This project currently consists of two main technical tasks:

- **Determination of Design Parameters**

The project was initiated with an in-depth review of current repair systems for aboveground leaks.

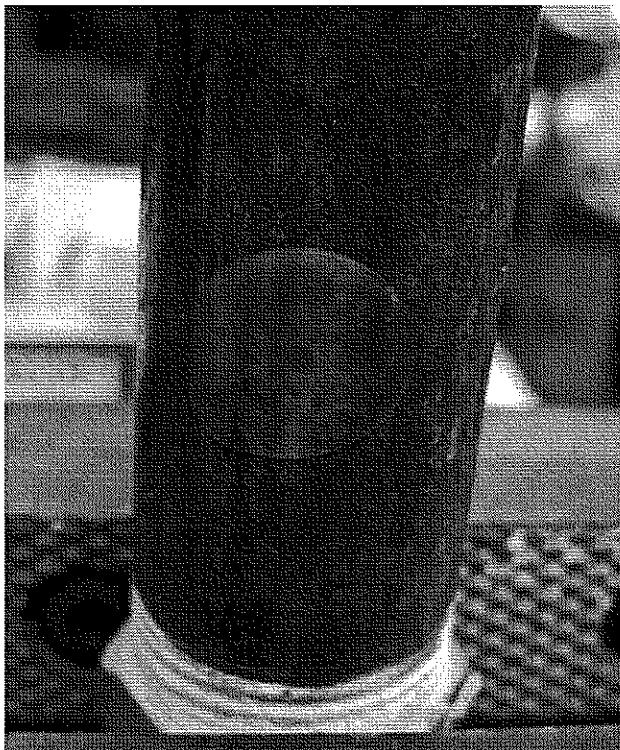

Repair on 1/16" pinhole.

This was performed by reviewing current industry standards and practices, as well as conducting surveys of sponsoring utilities. Hydrostatic burst tests were also performed on leaky joint and pinhole repair samples.

- **Testing & Analysis of Available Repair Methods**

Researchers will conduct a thorough evaluation of specific systems to establish their long-term life expectancy for use as permanent repairs.

Test samples will be prepared, and the testing platforms fabricated. The samples will be constructed to represent leaking joints and pinholes in the field.

Samples will be evaluated in long-term hydrostatic pressure tests. The method consists of testing sets of specimens at three different temperatures. The samples at each temperature are held under various pressures to create failures in the desired timeframe.

Results

Initial activities involved the establishment of the testing platform, procedures, and parameters for the evaluation of two aboveground leak-repair systems.

Following initial contact with the system manufacturers, test results from the manufacturers were gathered, and initial product orders were completed. Prototype test samples were then constructed to simulate aboveground leaks from varying levels of corrosion (pin holes) and from threaded joints. The test samples were then fabricated, fitted with the corresponding repairs, and hydrostatically tested to failure.

Following hydrostatic initial burst testing, a series of short-term samples were constructed to aid in establishing the long-term test pressure.

A test apparatus was constructed to determine both leak and burst failures and to condition the test samples to temperatures ranging from 23°C-60°C.

In 2012, a total of 30 samples from two manufacturers were evaluated.

Following completion of the short-term test evaluation, an initial analysis was performed. Results are detailed in a report to project sponsors.

Activities for 2013 included the development of a procedure for pipe-sample preparation and repair, followed by the initiation of long-term testing.

The scope of the program was revised to include an updated testing matrix and another product to add to the

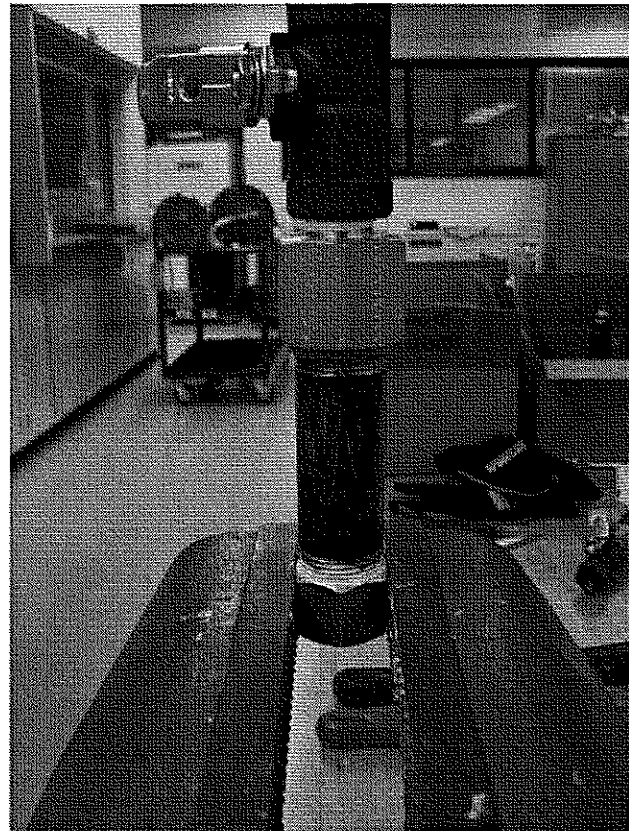

Repair on a leaking joint.

testing program. Based on the revised project scope, the project team requested that the sponsors provide 10-15 vertical lengths of 12-inch pipe cut from a riser. A total of approximately 100 field samples are required for the revised testing program.

The project team met with representatives from the manufacturers of the fourth repair product (called "StopIt"), who provided 40 of their repair kits as in-kind material contribution towards the project.

Status

The test protocol is being revised to address simulated field repairs.

Testing activities will continue through 2014.

For more information:

Maureen Droessler

Program Administrator

Operations Technology Development, NFP

Phone: 847/768-0608

maureen.droessler@otd-co.org

OTD

Operations
Technology
Development

Integrated Expert Monitoring and Training System for Butt Fusion

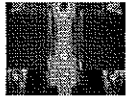

A set of critical fusion variables are being developed in an effort to provide the gas industry with an integrated technology package for use in pipe-fusion training and field operations.

Project Description

In this project, researchers are investigating technology that could be used to help reduce the likelihood of human error in the plastic-pipe fusion process.

Currently, data-logging systems for butt-fusion machines reflect an operating window that captures common practice and, on average, ensures a reliable butt-fusion joint. Inspection protocols rely mainly on visual cues (e.g., bead size and shape) that reflect a large body of experience with historic materials. It is possible to produce sub-standard joints while following the existing procedure and complying with all visual-inspection criteria. (These uncommon circumstances arise when the polymer state at the interface does not meet the minimum requirements to ensure successful co-crystallization across the interface.)

The technology being applied in this project relies on polymer physics and accurate displacement and temperature control to derive a variable that is directly driven by proper displacement of the interface. Using pressure as the primary control variable, as is the case with current technology, does not ensure optimal interfacial end states in all circumstances. Unusual interactions of drag, materials, heater-plate temperature, and

ambient conditions can fool a pressure- and visual-cue controlled system. These unusual combinations will be specifically addressed in the design and control approach of the new technology.

The method was used in a recent NYSEARCH project that evaluated the integrity of butt-fused joints. This same project utilized a full pipe creep-rupture test to evaluate the robustness of joints fused under different conditions. The full pipe creep-rupture test proved to be sensitive to joint-quality variation, but the project did not develop sufficient quantitative data to attach a reliable quality score to joints fused under different conditions. In this new project, researchers will use this experience with the full pipe creep-rupture test in conjunction with the rate-process method and standard ASTM test methods to fill this knowledge gap.

The goal is to produce a system capable of flagging marginal fusions in all operating conditions and provide guidance on how to adjust the process to achieve a good fusion, or instruct the operator to abandon a joint that is not within prescribed limits.

The short-term objective is to develop a well-defined set of critical variables and their bounds that will en-

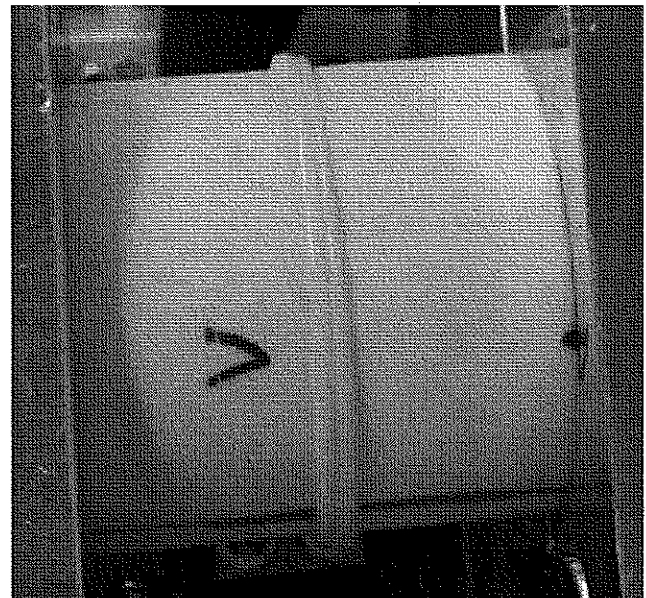
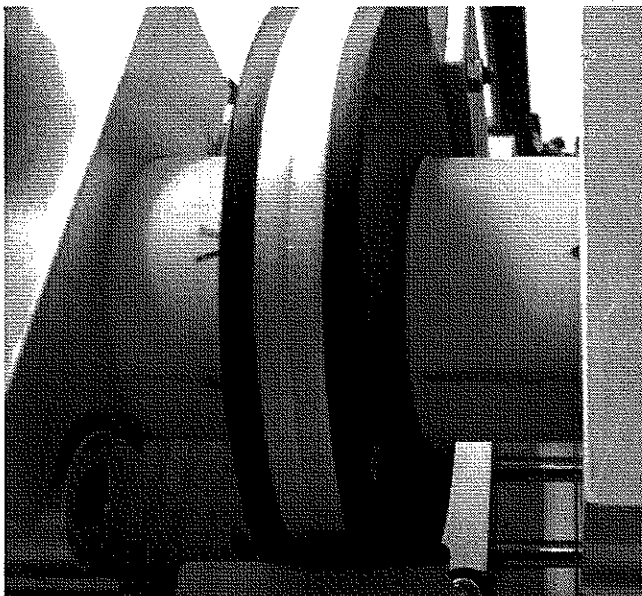

Butt-fusion joint during heat soak (left) and cooling (right) phases.

sure robust butt-fusion joints under widely varying fusion conditions. These variables are critical in developing a complete integrated expert monitoring and training system technology package.

Deliverables

The deliverables for this project include:

- A list of essential variables and their acceptable limits for the butt-fusion process
- A set of procedures and protocols for realizing a robust butt-fusion process
- A comprehensive data set validating the effectiveness of the preferred processes
- A set of quality-control parameters that will be logged with each fusion and will provide an acceptable confidence level that the fusions were performed in the optimal process window
- A set of utility specific data that will be logged by the data logger and uploaded to GIS or other databases for integrity management
- A pre-commercial prototype that demonstrates the viability of the method.

Benefits

Intelligent monitoring and logging of the butt-fusion process will enhance safety, help ensure compliance with Distribution Integrity Management regulations, and minimize risk to the gas utility.

Integrated and interactive expert guidance during the butt-fusion process will be a valuable aid to field operators as well as an excellent training system for novice fusion operators. Installation crews will need less specialized training to achieve reliable and robust joint quality in the field under a wide range of ambient conditions.

An expert system would ultimately help to reduce the risk of fusion joints susceptible to long-term failure due to improper fusion.

Technical Concept & Approach

This project includes the following activities:

- **Analyze the Fusion Process and Identify the Preferred Butt-Fusion Process Window**

A literature review was performed to identify all butt-fusion procedures used for gas piping.

- **Specify the Butt-fusion Machine and Manufacture of Equipment**

The equipment is capable of displacement, pressure, temperature, and energy control of the fusion process.

- **Conduct RPM Testing and Assemble Data Package**

The various fusion conditions employed will be evaluated in a statistically sound manner by full Rate Process Method (RPM) testing .

- **Prepare Technology Package and Final Report**

The essential process variables, their limits and a full set of protocols and procedures process will be compiled into a detailed report.

Results

This project began in 2012 with a cataloging of pipe samples and baseline testing of material properties.

A prototype butt-fusion machine was developed and modified.

In 2013, a butt-fusion testing matrix was developed. Preliminary butt fusions showed a need for fusion-process modifications (to closely replicate field procedures) with software changes and optimizations related to datalogging. A testing procedure was developed and validated for the extraction of time-temperature shift factors, ultrasonic inspection of two-inch IPS butt-fusion joints, and infrared video capture of fusions. A fusion and testing work-flow was also developed for execution of the Design-of-Experiment test matrices.

The detailed information gathered on actual fusion conditions and the test results will become the input for the models needed to develop an expert system that can be used for monitoring butt-fusion joints.

Status

Testing of butt-fusion joints is ongoing. Also under way is baseline material property testing in parallel to samples from joints.

For more information:

Maureen Droessler

Program Administrator

Operations Technology Development, NFP

Phone: 847/768-0608

maureen.droessler@otd-co.org

OTD

Operations
Technology
Development

Liners/Composites for the Rehabilitation of Distribution and Transmission Lines

Phase 1 of this project focuses on creating an implementation roadmap for the development, testing, and regulatory-approval process for new composite materials and technologies that allow for the rehabilitation of distribution and transmission pipelines through the trenchless insertion of composite pipe and/or structural liners.

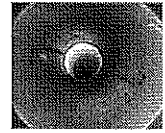

Project Description

The overall objective of this program is to implement new composite materials and technologies which allow for the rehabilitation of distribution and transmission pipelines through the trenchless insertion of a composite pipe and/or structural liners.

Some pipeline operators have recently obtained special permits to use composite-material piping systems – such as Smart Pipe®, Fiberspar®, and FlexSteel® – to rehabilitate their pipe infrastructures. These special permits were for natural gas distribution and transmission lines that operate in Class 1 and 2 locations.

Discussions with the U.S. Department of Transportation's Pipeline and Hazardous Materials Safety Administration (PHMSA) indicated that the administration is open to continue considering the acceptance of new materials through the special-permit process, providing that testing and evaluation is completed according to the appropriate material standards.

A composites workshop held in July, 2012 – which included pipeline operators, regulators, and other industry experts – identified several concerns over the development needs for long-term implementation and the long timeline required for regulatory acceptance. Significant findings included the following:

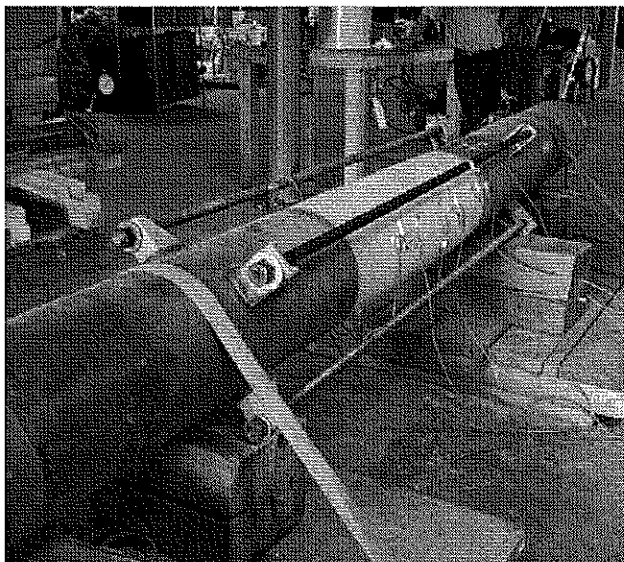

- **Composite Pipe Material Development, Testing, and Evaluation**

Composite pipe systems are currently being used in upstream applications such as gas gathering and oil-field production. The application to existing pipeline infrastructure introduces challenges which include the evaluation of the long-term performance and the development and evaluation of the necessary fittings and appurtenances for certain natural gas applications (e.g., service taps and transition fittings).

- **Regulatory Approval**

The special permit process appears to be the appropriate path forward for regulatory approval until full regulatory acceptance is achieved. Based on recent experiences, the timeline for obtaining regulatory approval of composite materials through the special permit process is approximately one year. The timeframe for full acceptance within the federal code is not well defined due to the lack of comprehensive standards for these materials and an ambiguous regulatory approval process. Past experience suggests that a minimum of three to five years is needed for standards development and that regulatory acceptance on the basis of these standards can take longer and include field trials installed under a special permit. Composite pipe special permit applications submitted to date for transmission applications have been in Class 1 and 2 locations and, therefore, have not addressed the significant pipeline integrity requirements. One key goal of this project is to perform a detailed analysis of all federal and state regulatory requirements and outline the pipeline-integrity implications of utilizing any of the commercially available composite pipe/liner technologies.

Deliverables

The deliverable of Phase 1 will be an implementation roadmap for the selection of the composite pipe materials and rehabilitation techniques, testing, and permitting requirements.

Benefits

Modernization of the gas infrastructure is a challenge to distribution and transmission pipeline operators and it is particularly problematic in urban areas with very limited right-of-way space and high excavation and restoration costs. The trenchless installation of composite materials can potentially provide cost-effective means of restoring aging pipelines to full capability.

Technical Concept & Approach

Phase 1 involves the development of an operator-specific implementation roadmap for composite-pipe rehabilitation technologies (e.g., cured-in-place liners, structural liners, and composite pipe for insertion) installed using trenchless techniques for both distribution and high-pressure systems (e.g., 350 psig). This phase focuses on existing technologies that can meet the business, engineering, and regulatory requirements for high-priority pipe.

The research team will develop an implementation roadmap for each of the composite-pipe-rehabilitation-material options. The implementation roadmap will include the following:

- Technology Selection Criteria
- Installation Considerations
- Operating and Maintenance Consideration
- Integrity-Management Considerations
- Regulatory Acceptance Strategy.

The following specific concerns will also be assessed and included:

- Failure-mode assessment for low-ductile-strength pipe and the impact on the failure mode of the host pipe on the composite materials
- Failure-mode assessment of composite materials from excavation damage
- Opportunities and challenges for complying with integrity-management regulations, including the use of in-line inspection and direct-assessment techniques
- Opportunities and challenges for installation and maintenance, including joining techniques of the composite pipe materials and the need to maintain cathodic protection systems
- Ability to increase Maximum Allowable Operating Pressure (MAOP) with composite materials

- Ability to install service taps.

A timeline for material testing, component development and testing, standards development, and regulatory acceptance will be estimated and included in the roadmap.

Results

In 2013, researchers investigated the use of liners in the rehabilitation of medium-pressure mains and high-pressure distribution line systems.

Three potential rehabilitations systems were selected for study: starline[®] HPL-250, Primus Line[®], and Smart Pipe[®].

The Primus Line is a multi-layered composite structure for the rehabilitation of gas pipelines. The system is planned for use in the rehabilitation of coated steel gas distribution lines with typical operating pressure of 220 psig and maximum operating pressure of 250 psig. The test consists of testing one size of the Primus flexible high-pressure lines installed into a typical 12-inch pipe. The pipe will have an open section to simulate a 36-inch free span. The system will be pressurized to twice the pipe operating pressure using water pressure. Strain gages will be installed to monitor the strains at the free-span section.

A field test for the installation of Primus liners was developed.

The team also entered into negotiations with the manufacturers of Smart Pipe for potential application of its system in segments with limited to no service lines.

Status

Pending sponsor approval of the test plan, as well as a contractual scope change, researchers will initiate the test on the Primus Line.

Other activities include the identification of potential segments for possible rehabilitation and continued coordination with the special permit project for a field installation.

For more information:

Maureen Droessler
Program Administrator
Operations Technology Development, NFP
Phone: 847/768-0608
maureen.droessler@otd-co.org



Operations
Technology
Development

Guidelines for Special Permits for Structural Composite Rehabilitations



In many cases, the use of composite materials for pipe rehabilitation may be a cost-effective alternative to open-trench operations. However, special permits are required for the use of composites. In this project, guidelines are being developed for facilitating the process for submitting special permits to use composite materials for structural pipe rehabilitation.

Project Description

The need for new techniques to repair and replace gas distribution piping will continue to increase as the natural gas infrastructure continues to age.

While open-trench replacement will be the most cost-effective technique for many applications, some situations will require the use of trenchless or alternative techniques that use the host pipe as a conduit for installing a new pipe.

Research is finding that composite materials hold much promise for use in pipeline rehabilitation. Composite materials can have properties that are superior to steel and can be installed in flexible configurations.

The U.S. Department of Transportation's Pipeline and Hazardous Materials Safety Administration (PHMSA) suggested that the industry undertake a program that includes special permits, testing, standards development and pilot projects to obtain regulatory acceptance.

In response, this project is focused on developing information on the approval process and guidelines for submitting special permits for approval to use composite materials for structural pipe rehabilitation.

Current regulations do not prohibit the use of composites; however, special permits are required because they are not specifically approved. Furthermore, some sections of the regulation are not applicable or difficult to apply to composite pipes. (For example, the design requirements and pressure limitations for plastic and steel are not directly applicable to composite materials.)

Deliverables

The deliverable for this project will be a set of guidelines to assist operators in filing special permit applications to allow for the use of composite materials for structural pipe rehabilitation.

Benefits

Guidelines for submitting special permit requests will reduce the cost and time associated with filing the application. Guidelines will also improve the likelihood of obtaining approval through a special permit by ensuring that permit applications are complete and address issues of interest to state and federal regulators.

Technical Concept & Approach

A research team is developing special permit guidelines that include the following information:

- Sections of the regulation for which the waiver is requested
- Pipe segment characteristics
- Environmental conditions
- Technical properties of the composite material
- Compliance with industry standards

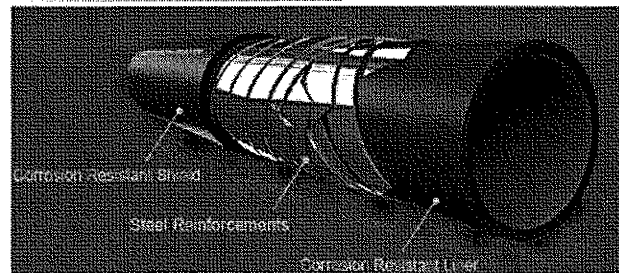
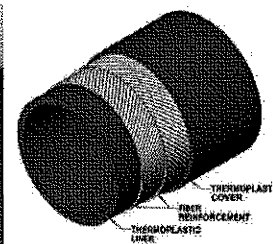
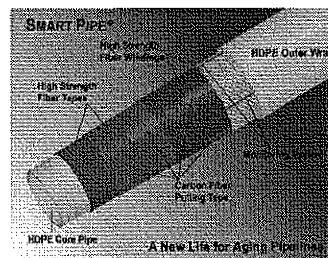

Through a previous OTD project, researchers identified several candidate technologies for both low-pressure distribution mains and high-pressure transmission lines.

- Performance history of the composite material
- Lessons learned from previous installations
- “Best Practices” for design, installation, testing, monitoring, operations, and maintenance.

This project involves a review of accepted and denied special permit applications to identify the information that must be included in an application. Federal and state regulators will also be engaged in developing the guidelines.

Results

This project was initiated in early 2013 with an investigation of previous accepted and denied special permits related to composites and rehabilitation techniques.

Special permit language for the use of a brand of semi-structural cured-in-place liners was drafted.

The guidelines include the following sections:

- Wavier Request
- Situation
- Material Description
- Benefits
- Past Experience
- Engineering Design
- MAOP and Design Strength
- Design Life and Long-Term Performance
- Gas Permeation
- Installation
- Operator Qualifications
- Post-Construction Testing
- Operations and Maintenance

- Monitoring
- Integrity Management
- Regulatory Oversight.

The project team reviewed candidate pipe segment information from one of the project sponsors. The team will present the recommended liner/composite to the sponsor/utility for approval. Investigators will subsequently write special permit language for the specific line segment and the selected technology for the sponsoring utility to submit to its public utility commission.

Status

In cooperation with participating operators, the project team will select a candidate pipe segment and one or more potential technologies for consideration. Upon selection of the pipe segment and the structural liner/composite, special permit language will be drafted.

Potential structural liner/composite system information will be gathered and shared with sponsors. Backyard installations may even be considered for some of the technologies.

The PHMSA recently added a category called “Reconditioned Cast Iron Pipe” to its annual report. This new category could potentially eliminate the need to submit a special permit for cured-in-place liners. Efforts are under way to determine how this new category will impact this project, as well as special permits in general.

For more information:

Maureen Droessler
Program Administrator
Operations Technology Development, NFP
Phone: 847/768-0608
maureen.droessler@otd-co.org

EXCAVATION & SITE RESTORATION

Excavation and site restoration are traditionally costly and time-consuming operations. In this area, research is conducted to lower those costs and improve efficiencies through investigations and developments in materials, construction procedures, and equipment.

Current efforts are focused on an evaluation of lightweight jackhammers.

OTD

Operations
Technology
Development

Evaluation of Lightweight Jackhammers



The use of lightweight equipment can provide a variety of benefits for utility workers and customers. In this project, a research team evaluated the performance of currently available lightweight jackhammers with respect to their effectiveness in breaking asphalt and concrete pavement.

Project Description

Utility pavement cuts are traditionally performed using 90-pound pneumatic jackhammers. However, research has found that 60-pound jackhammers achieve comparable productivity while providing the benefits of reducing fatigue and potential injuries.

In this project – a continuation of an earlier OTD project – investigators evaluated the use of lightweight jackhammers with lift-assist devices, evaluated newly developed high-powered electric jackhammers, and further established the relationships between the operator's weight and physical capability versus the jackhammer weight.

In Phase 1 (completed in 2011), the performance of 60-pound jackhammers was compared to the conventional 90-pound jackhammers. More than 80 tests were performed. In each test, the completion time, noise level, tool and hand-arm vibrations, grip pressure, and muscle activities were monitored and analyzed. Operators were also surveyed regarding product features, comfort, control, and ease of use. The research showed that the lightweight jackhammers could efficiently be used to break pavements of up to six inches thick. They caused less fatigue and less overall grip pressure, vibrations, and muscle activity. Conventional 90-

pound jackhammers generally had faster excavation completion times.

In this Phase 2 effort, the scope of the study was expanded to evaluate and provide results on:

- The use of the lightweight jackhammer with the Lift-Assist Pavement Breaker device, a product developed through OTD to assist utility workers in lifting the jackhammer after the bit has broken through the pavement
- The efficiency of using 60-pound electric jackhammers in comparison to a pneumatic device of the same weight
- The process of loading and unloading the various jackhammers from utility vehicles
- The benefits of using the lightweight jackhammers in relation to the operator's physical capabilities (e.g., weight, height, and gender).

Deliverables

The testing information and a summary with recommendations will be provided.

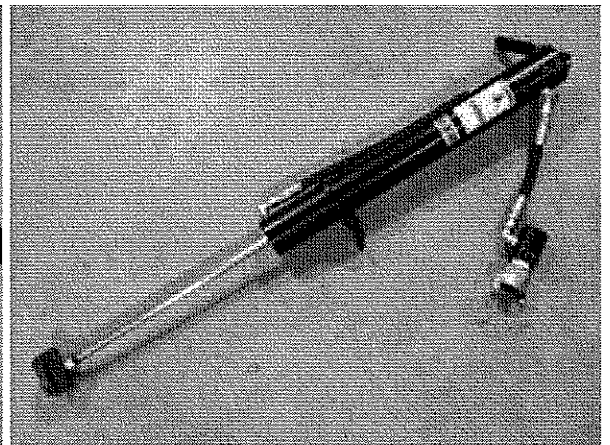

Various jackhammers were tested with and without the use of the lift-assist device (above).

Deliverables

The testing information and a summary with recommendations will be provided.

Benefits

The use of lightweight jackhammers allow utilities to employ a wider range of the workforce for pavement-breaking operations, help minimize workforce injuries, and reduce lost-time costs.

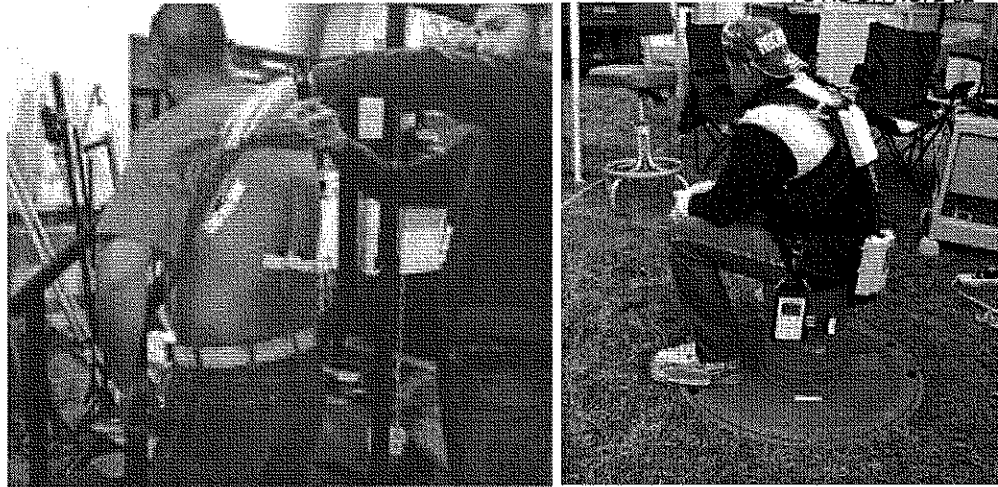

Ergonomic Testing: Sensors being placed on back muscles (left). Operator equipped with experimental spine alignment and measurement device (right.)

Technical Concept & Approach

A comparative testing program was performed with selected types of jackhammers. The tests were conducted in pavement test beds with construction consistent with that normally encountered in side streets and residential areas. Tests were performed using a variety of operators to cover the scope of weight, height, and gender.

The tests were performed on lightweight and standard pneumatic jackhammers with and without the lift-assist device. Tests evaluated time and efficiency in breaking the pavement areas, noise level, tool and hand-arm vibrations, grip pressure, and muscle fatigue.

The process of loading and unloading jackhammers from the utility vehicle and moving them to the test area was evaluated using various scenarios and types of moving options.

The research team investigated the optimum jackhammer for use with various operators based on their physical capabilities (e.g., weight, height, and gender). These tests monitored various performance-evaluation parameters.

Results

Two concrete test sites were designed and constructed. Jackhammers were selected that have compatible mounts with the lift-assist device. Also, a previously utilized hammer from Phase 1 was selected to provide a data link to the previous testing information.

In addition to the pneumatic hammers, an electric hammer was added to evaluate its performance and its effect on the operator.

Phase 2 testing was completed in 2013. The research team analyzed data for eight subjects with and without a lift assist and performed a comparative evaluation of the efficiency of a 60-pound electric jackhammer against a 60-pound pneumatic jackhammer.

Findings:

- Lift assist reduced lifting and operating-grip pressure
- Research suggests that lift assist could potentially benefit the operator
- There is a potential learning curve associated with lift assist, which affects efficiency
- Using the lift assist could potentially decrease task time
- The electric hammer was found to be less efficient
- Ergonomic evaluations suggest that jackhammer loading/unloading task in general poses a high risk for injury for all populations.

Status

The evaluation of the results is being completed and will be summarized and included in the Final Report.

For more information:

Maureen Droessler
Program Administrator
Operations Technology Development, NFP
Phone: 847/768-0608
maureen.droessler@otd-co.org

PIPELINE INTEGRITY MANAGEMENT & AUTOMATION

Projects in this area focus on the development of tools, techniques, and risk assessments to assist companies in meeting integrity requirements in a cost-effective manner.

To meet the challenges of pipeline integrity management, researchers are developing risk-assessment models, in-line pipe-inspection systems, and other technologies to improve the safety, efficiency, and reliability of gas delivery systems.

Through R&D in this area, pipeline and distribution system integrity can be maintained and improved based on sound, scientific developments related to inspection, testing, and other activities.

OTD

Operations
Technology
Development

MFL Inspection System for 12-Inch-Diameter Gas Lines



In this project, a magnetic flux leakage (MFL) system capable of inspecting gas pipes under live conditions is being enhanced to be able to examine 12-inch-diameter gas lines. Currently, the system can be used in four-inch-diameter low-pressure pipelines.

Project Description

In a previous project, a magnetic flux leakage (MFL) inspection system for four-inch-diameter gas pipes was successfully developed to detect corrosion pitting and other forms of metal loss in real-time under live (pressurized) operating conditions.

The system was successfully field tested at numerous utilities.

In this project, research expanded the capabilities of the system to allow inspection of the larger-diameter pipe operating at higher pressures.

Key aspects of the smaller-diameter MFL system include:

- Real-time inspection results.
- The ability to keep gas flowing throughout the entire inspection process with no interruption to customer gas delivery. Field tests were conducted at gas pressures ranging from inches of water column to 65 psig.

- Entry is gained by first welding an angled entry fitting onto the pipe and then cutting out a coupon from the original pipe wall using a bi-metal saw. The coupon is retained within the cutting device and is discarded upon removal. The entry fitting is later plugged and blind-flanged to provide a permanent, redundant seal. The fitting can be re-used to conduct re-inspection at a later date.
- Flow control of the gas is accomplished through the use of a full-open valve and a stripper seal. The gate valve allows the inspection head to be admitted or removed from the gas pipeline while the stripper seal creates a gas-tight seal between the coiled tubing and its rubber elements as the head is being pushed or pulled through the pipe.
- The MFL head is moved through the gas main using coiled steel tubing. A multi-conductor electrical cable resides inside the coiled tubing to provide power and data communication with the surface control and display electronics. The coiled tubing has proven to be very robust and has been used to push the four-inch-diameter MFL inspection head

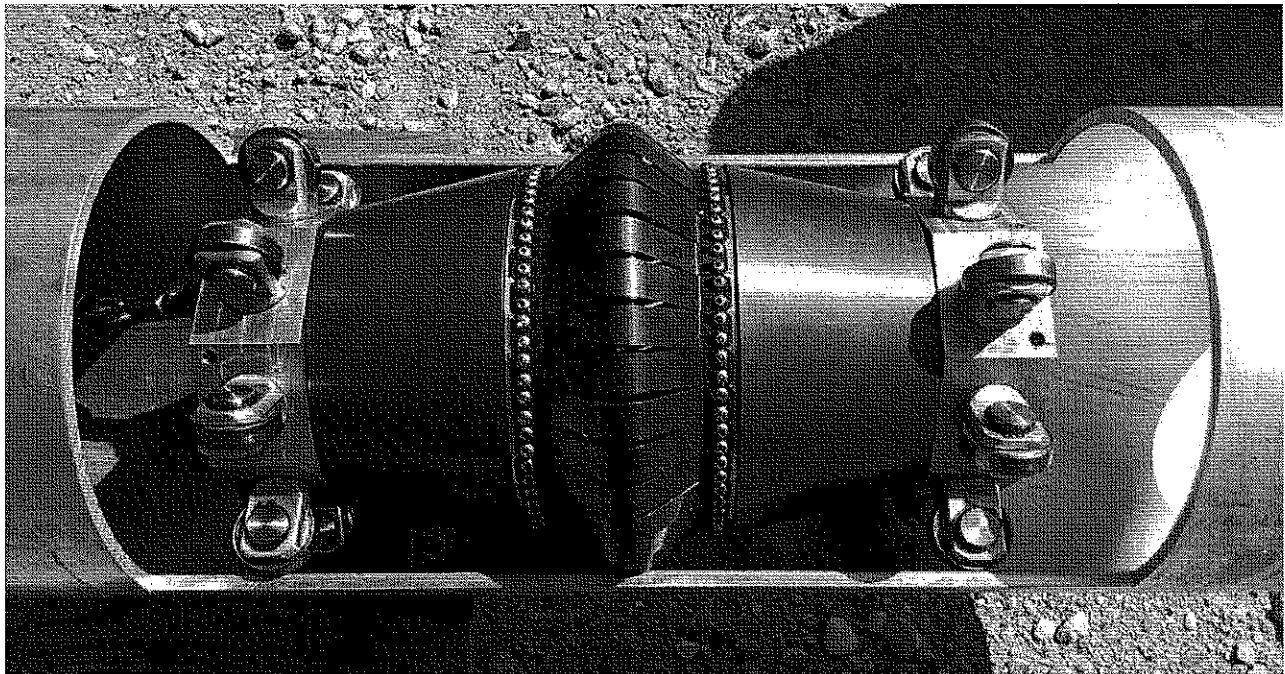

to its 1,000-foot reel-storage capacity on numerous field applications.

- The complete MFL inspection system is delivered to the field location on a small trailer towed by a pickup truck. Its small physical footprint makes it ideal for use in congested environments.

For the first phase of this project, a 12-inch-diameter MFL system was designed, fabricated, and tested in a surface demonstration using open-ended, unpressurized pipe segments.

Deliverables

Deliverables include a prototype MFL inspection device operating in an open pipe and data sets from the tests.

Benefits

Pipeline system safety will be enhanced with the development of an improved MFL inspection system applicable to a wider range of pipe sizes than can be addressed with currently available technologies. In addition, inspection costs can be reduced and activities accelerated. The ultimate result from all future phases of the project is expected to provide a tool for short-distance, high-pressure pipeline inspection.

Technical Concept & Approach

The 12-inch MFL inspection system is composed of four main sub-assemblies: 1) the MFL inspection head, 2) the coiled-tubing delivery system, 3) an angled entry fitting, and 4) surface controls and data displays.

The four-inch MFL head has an overall length of 6-1/2 inches. The 12-inch MFL head has an overall length of 21 inches. Centralizing wheels are used to keep the MFL head centered inside the pipe and the sensors are spring-loaded against the pipe wall to prevent lift off.

The maximum distance that a given size MFL head can be pushed through a pipe is dictated by the pipeline inside diameter, MFL head weight, and the magnetic drag force. Calculations indicated a maximum distance between 580 and 1,160 feet should be achievable.

A commercial control valve is employed to control gas flow while inserting and removing the MFL inspection head.

A series of laboratory tests were conducted using a 12-inch-diameter pipeline having machined defects of accurately known dimensions. Comparisons were made of the real-time inspection results against actual defects in the pipeline to confirm detection and sizing results.

Results

The Phase I program objectives were successfully met and a prototype was developed. The system is capable of identifying metal loss (e.g., that caused by corrosion, dents, or pits) in real time.

In the testing program, all of the machined defects were clearly identified in all test runs.

The performance of the MFL inspection head was ascertained by assembling an open-ended test pipe of which two sections had machined flaws of known dimensions. The MFL head was moved through the pipe by making a capstan using wire rope.

The MFL inspection system is comprised of four major subassemblies:

- A magnetizer used to saturate the pipe wall with magnetic flux
- Mechanical elements to mount and seal the on-board electronics from pressurized natural gas, centralize the inspection head inside the pipe, attach the sensors used to detect corrosion defects, and move the head through the pipeline
- Electronics to provide power, signal conditioning, and data acquisition of each sensor and communicate this data over high-speed communications to the surface
- Software in both the inspection head and the surface electronics for processing and display of inspection data in real time.

Status

This project (Phase 1) was completed in 2013. A Final Report detailing the project results was issued in February 2013.

The research team recommended that the project proceed to Phase 2 to demonstrate the MFL inspection system in pressurized pipe with the head delivered through a weld-on angled entry fitting and moved through the use of coiled tubing.

For more information:

Maureen Droessler
Program Administrator
Operations Technology Development, NFP
Phone: 847/768-0608
maureen.droessler@otd-co.org



Operations
 Technology
 Development

Evaluating Assessment-Technique Effectiveness

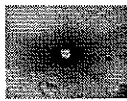

Researchers are developing a body of knowledge and a methodology to enable operators to determine the effectiveness of various pipeline-assessment techniques and select the most appropriate methods for particular conditions.

Project Description

Current regulations allow operators to use three specific methods to inspect/establish pipeline integrity of transmission piping segments in high-consequence areas: 1) in-line inspection (ILI), 2) hydro-pressure tests, and 3) direct assessment (DA).

To select the most optimal method to use, operators need to have knowledge on how effective each option is at ensuring the safety and integrity of the system and reducing risk. Each of the three main methods provides different data and information on pipeline-system integrity. As noted in the applicable standards:

- ILI provides 100% axial coverage of wall thickness (at a particular resolution) but does not directly provide coating damage sites and/or sites of "active" internal or external corrosion.
- Pressure testing provides a 100% system validation of pressure integrity but does not directly provide wall thickness, coating quality, or active corrosion locations.
- DA provides a coarse coverage of all or some of the system as to areas of coating damage and active corrosion hot spots, but does not provide wall thickness or pressure-carrying ability (integrity).

For this project, research team is developing a body of knowledge and a methodology to enable operators to determine the effectiveness of various assessment techniques and facilitate the selection of the most appropriate technique under different operating conditions.

Deliverables

The deliverables for this project will include:

- Definitions and methodologies to analyze assessment-technique effectiveness
- An assessment-effectiveness database
- A report providing an analysis of assessment-technique effectiveness.

Benefits

Selecting the most appropriate and effective assessment-technique, tool, or combination of tools for an integrity management program will reduce an operator's risk to incidents. This also helps to ensure the safe operation of the delivery system and improve the ability of the operator to meet regulatory compliance.

A	B	C	D	E	F	G	H	I
Inspection date	Segment ID	Inspection cost	Pass/fail	Corrective action?	Corrective action cost	Subsequent inspection scheduled/performed	Incident date	Incident/damage cost
1/1/1980	837147	\$ 4,646	Pass	NA	\$ -	11/19/1991	NA	NA
1/2/1980	174187	\$ 4,993	Fail	Yes	\$ 16,794	1/19/1991	NA	NA
1/3/1980	131417	\$ 3,770	Pass	NA	\$ -	8/4/1991	3/5/1982	\$ 60,101
1/4/1980	315310	\$ 4,587	Pass	NA	\$ -	2/28/1991	NA	NA
1/5/1980	597542	\$ 4,373	Pass	NA	\$ -	11/29/1992	NA	NA
1/6/1980	915838	\$ 4,084	Pass	NA	\$ -	7/8/1991	NA	NA
1/7/1980	745861	\$ 3,608	Pass	NA	\$ -	6/19/1992	NA	NA
1/8/1980	416412	\$ 4,553	Pass	NA	\$ -	8/26/1991	NA	NA
1/9/1980	649214	\$ 3,779	Pass	NA	\$ -	1/26/1991	NA	NA
1/10/1980	935952	\$ 4,867	Fail	Yes	\$ 5,240	9/6/1991	NA	NA
1/11/1980	718900	\$ 4,309	Pass	NA	\$ -	10/16/1992	8/1/1988	\$ 186,267
1/12/1980	535348	\$ 4,244	Pass	NA	\$ -	6/25/1991	NA	NA
1/13/1980	653177	\$ 5,166	Pass	NA	\$ -	5/29/1992	NA	NA

Portion of synthetic ILI database

Information on the appropriateness and effectiveness of various assessment techniques in different operating conditions will also allow operators to make better informed life-cycle decisions for managing their facilities.

Technical Concept & Approach

The results of this project will provide an analysis based on the best information available today, and will also provide a technique for continued industry data collection to enhance the level of understanding.

Specific tasks include:

- **Project Scoping**

- Developing a definition of a methodology for measuring effectiveness
- Defining data needed to be collected
- Identifying and listing potential sources of data
- Selecting assessment and inspection technologies to be included in the analysis
- Developing a database design.

- **Collection, Assembly, and Organization of Data**

Data will be collected through interviews, surveys, records, integrity management program documents, research reports, and other methods and sources.

- **Prepare Searchable Database**

Commercial database products will be examined for their capability in meeting the needs of the design. The database will be built specifically for use in this project, and will also be designed for further use by individual companies to continue data collection after the project.

- **Analysis of Assessment-Technique Effectiveness**

A detailed process for using the database and performing the analysis/comparison will be created. Similar to the database design, the comparison process will be developed for use in this project but with the understanding that it could be adopted by operators after the completion of the project.

Fault Tree Analysis (FTA) is being employed as the primary method to analyze and compare the collected data. Tracking of pipeline failures would be the ideal way to measure effectiveness; however, pipeline failures are relatively rare. FTA allows one to track and analyze the causes that act alone or in combination to cause a pipeline failure. FTA starts with the top undesired event and then graphically develops all potential causes of that event. Prob-

abilities can be assigned to each individual cause. This ability to identify combinations that can induce the top undesired event is a major FTA advantage.

FTA was developed by Bell Laboratories, Boeing, and the U.S. Air Force to identify single-point causes and combinations of causes that could result in an unintended nuclear missile launch or unacceptable event or risk.

Research results will be disseminated through a Final Report and webinar. Potential follow-on work could include the development of a long-term industry data collection effort and incorporation of the developed methodology into a standard.

Results

For this project, a variety of data was collected, including a set of pipeline incidents obtained from the U.S. Department of Transportation Pipeline and Hazardous Materials Safety Administration records of transmission pipe incident data.

Researchers are developing a probabilistic methodology for maximizing each assessment method's utility function.

A database was populated with simulated inspection and incident data. These were processed and presented in a spreadsheet interface ("front-end"). Simulated data was used as the project team received limited data from sponsors. (To improve the accuracy of the model, additional data is needed.)

In 2013, the project team improved the methodology previously developed and started adding constraints that would assist in assessing the effectiveness of each method and selecting the optimal method for each circumstance.

Status

Efforts are under way to populate the database with real data, expand its fields and attributes, and present the results in terms of a well-defined assessment effectiveness measure.

For more information:

Maureen Droessler

Program Administrator

Operations Technology Development, NFP

Phone: 847/768-0608

maureen.droessler@otd-co.org

OTDOperations
Technology
Development**PIPELINE INTEGRITY MANAGEMENT & AUTOMATION**

Understanding Threat Interactions for Risk Analysis

Research on developing an understanding of the interactions of various threats to pipeline integrity resulted in the development of a new methodology and software program to support integrity-management programs and risk analyses to enhance pipeline safety.



Project Description

Utilities and pipeline operators continually seek to enhance the understanding of various threats in the industry – such as corrosion, earthquakes, and others – in order to prevent and mitigate threats and ultimately deliver safer and more reliable service. However, developing a clear understanding of threats is complicated by the fact that incidents often occur not due to a single root cause, but rather when several distinct threats happen to converge, or interact.

These interactions affect the probabilities of adverse events, their frequency, and also potentially their severity. This project was conducted in response to a need for a fundamental and systematic understanding of the mechanics of threat interactions in order to build a methodological framework to assess, quantify, and process these interacting threats.

The focus of this project was on developing a methodology for calculating the risk associated with a super-imposed set of threats and a providing a process for addressing unknown threats.

Currently, regulations and supporting standards provide guidance on *individual* threats and how they should be assessed. Although standards specifically mention that threat interactions should be addressed,

there is limited industry knowledge on the *interactions* of various threats and how they influence the overall risk of a segment of pipe. Current models may only simplistically look at single combinations of threats and then assign a “should consider” vs. “should not consider” label to each. This type of analysis does not provide a relative ranking of the most severe interactions per pipeline segment or sub-segment.

Specific questions addressed in this project included:

- Can single threats, when considered individually, each present risks at “acceptable” levels, but multiple, super-imposed threats result in a significant risk to the pipeline?
- Which combinations of threats are most important to understand and control?
- How should threat interactions be calculated and mitigated?
- What process should an operator use to identify unknown or hidden threats and how should they be incorporated into the pipeline integrity assessment?
- Can a process or methodology be employed to continuously monitor threat interactions and identify concerns at defined thresholds of risk?

The objective of this project was to increase the level of understanding of the interactions of various threats to pipeline integrity that impact the likelihood of failure to a pipeline segment.

The knowledge developed through this research will be used to support operators’ integrity management programs and risk analyses to help ensure that threats are adequately identified, tracked, and mitigated.

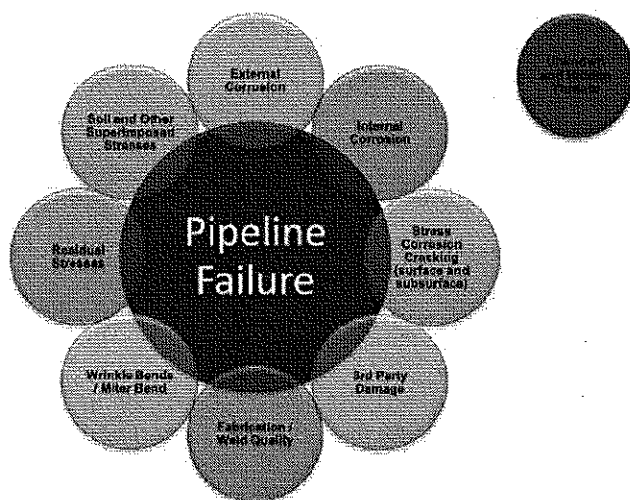

This project studied the variety of threat interactions and the potential impact on pipeline operations.

Deliverables

Deliverables include a software program that integrates user’s existing risk models; calculates threat interactions; and displays risks by rank, interaction degree, and/or pipeline segment number.

Benefits

Developing a more thorough understanding of the interactions between a variety of threats will allow operators to develop integrity management programs that adequately identify combinations of threats and the associated risks that should be addressed and mitigated. The results of this research will also be used to reduce an operator's risk, enhance compliance regulations, and ultimately lead to an enhanced level of safety in the operation of the natural gas transmission infrastructure.

Technical Concept & Approach

Researchers examined potential threat combinations/interactions and determined a method for computing the risk associated with a super-imposed set of threats. The catalog of threats found in *ASME B31.8S-2010 Managing System Integrity of Gas Pipelines* was used as input. Investigators used Fault Tree Analysis (FTA) for logically dissecting the threats. FTA allows one to track and analyze the causes that act alone or in combination to cause a pipeline failure as the measure of effectiveness.

Results

This project was initiated in 2011 with a literature review and data collection for developing the threat-attribute index and risk-calculation methodology.

A methodology using FTA and Event Tree Analysis ETA was developed to conduct threat-interaction analysis.

In 2012-2013, the research team:

- Developed the threat-attribute index and identified unknown threats
- Defined the methodology for quantifying threat-interaction severity
- Developed the generic threat-interaction protocol
- Compiled a standard library of individual threats, with all relevant parameters, etc.

The research team found that the threat-interactions framework can be very effective: once set up, it could automatically assess risk for thousands of combinations with a click of a mouse button.

This "GTI Threat Interactions" computer program delivered on the MATLAB platform and compiled for use on Windows PCs. As an implementation of the theoretical Threat Interactions framework, this program relies on input of pre-existing risk models for individual threats, and requests the user to direct the program to the relevant files containing records of those threats.

"We've made enormous strides to identify, address, and mitigate threats to our pipeline systems within our integrity management programs. This project focused on enhancing our ability to analyze the interaction of these threats. This study has the potential to take our risk-management process to the next level and lead us further along the path to realizing our goal of zero pipeline incidents."

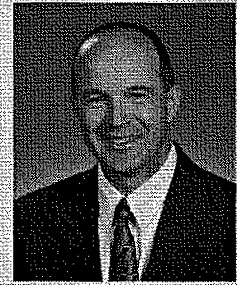

*Pete M. Kirsch
Sr. VP. Midstream Technical & Compliance Services
CenterPoint Energy*

Status

This project was completed in 2013. A Final Report was issued in April 2013.

This project revealed many features – and deficiencies – of the risk models that operators currently use. As a first step in implementing the Threat Interactions framework, operators are encouraged to revise their models and to increase compatibility with the requirements of the Threat Interactions framework. This includes, for example, developing explicit expressions for the components discussed in the Final Report.

The next step should be to discuss and develop threat-interactions mechanisms that support the nature of the existing risk models. The best threat-interaction mechanisms would be those that are specifically designed for a particular set of single-threat risk models, possible (but not necessarily) modeled after the threat-interaction mechanisms presented in the Final Report.

For each threat, there may be multiple models which quantify its "behavior" and/or probability. The sponsoring parties have much to gain by maintaining a collection of risk models, which could be constantly discussed, enhanced, and updated. Such a library could have an associated collection of compatible threat-interaction models, which would be much easier to implement for the included risk models.

To be more effective, these tools should be dynamically connected to decision-support tools and other models in an organization. This would enable efficient data capture and data assimilation (for immediate use in the models) on the input side of the model, and model-backed decision making, on the output side.

For more information:

Maureen Droessler
Program Administrator
Operations Technology Development, NFP
Phone: 847/768-0608
maureen.droessler@otd-co.org

OTDOperations
Technology
Development**PIPELINE INTEGRITY MANAGEMENT & AUTOMATION****Probability-of-Failure Model for High-Risk
Pipe Segments (Vintage Pipe)**

Researchers are developing a methodology and risk protocol to provide likelihood-of-failure distributions for specific high-risk pipe materials and threats. The methodology uses sampling, operating conditions, and advanced risk-modeling techniques to quantify risk and allow mitigation techniques to be effectively applied.

**Project Description**

Various legacy materials, including some vintage polyethylene (PE) and cast-iron pipe, are known to have higher-than-average risk profiles. Currently, most available risk models are simplistic in their analysis of these materials and do not have the ability to modify risk profiles as new information becomes available.

The objective of this project is to develop a methodology and risk protocol that provides likelihood-of-failure distributions for specific high-risk pipe materials and threats.

The methodology uses sampling, operating conditions, and advanced risk-modeling techniques to provide a targeted approach for quantifying the risk of specific pipe segments to allow mitigation techniques to be effectively applied. A generic methodology will be developed and then applied to vintage PE and cast-iron pipe to demonstrate the use of the methodology.

Specific attention is being placed on the analysis of vintage Aldyl-A plastic pipe and cast-iron pipe.

Deliverables

Deliverables include:

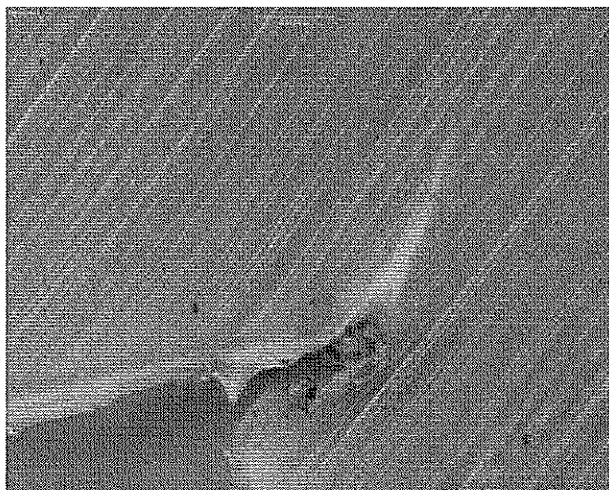

SCG caused by stress concentrations in fitting (above), surface oxidation (top right), and bending (bottom right).

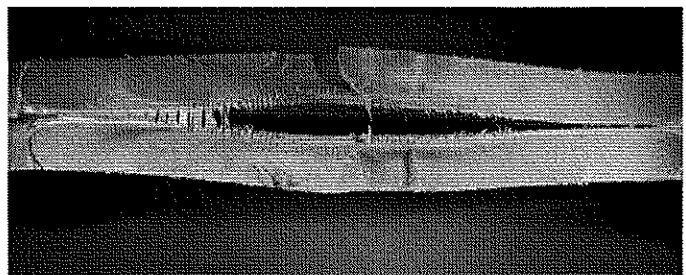
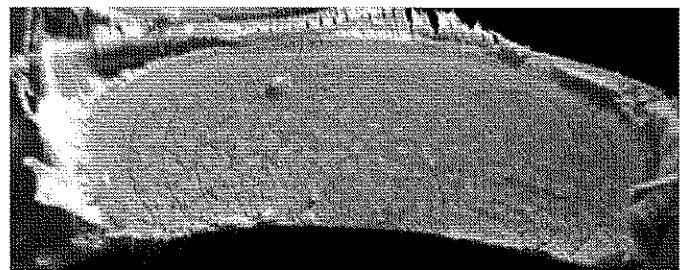

- A general probability-of-failure methodology
- Demonstration of the methodology applied to Aldyl-A and cast-iron materials.

Benefits

The results of this project will provide operators with a tool that can quantify the risk of failure using a systematic and probabilistic method that is able to isolate problematic segments. These methods can support a highly targeted approach to identify and mitigate risk.

This methodology will not only improve system integrity but will also provide operators with tools to improve pipe-replacement-prioritization and resource-allocation decisions.

Technical Concept & Approach

Specific project tasks include:

- **Project Scoping and Literature Review**

A literature review of known microstructure-related problems and interactions for select materials of interest was performed.

- **Risk Methodology Development**

The objective of this task is to develop the general risk-profiling methodology that can be applied to various threats. The scope of this project is limited to material-related failures with a specific focus on Aldyl-A and cast iron; however, the methodology developed in this task can be extended to other threats, including non-material failure mechanisms.

Fault Tree Analysis will be one of the tools used to provide a formal framework, whereby an undesired state of the system is specified and the system is then analyzed in the context of its environment and operational parameters to identify the root cause of the undesired event occurrence.

- **Sample Collection and Analysis**

Recently developed microstructure analyses techniques show promise in allowing researchers to establish the likelihood of failure by Slow Crack Growth (SCG) for Aldyl-A and failure by graphitic corrosion for cast-iron pipe segments through examination of a small coupon that can be removed from the pipe via a tapping tee without the need for removing an entire section of pipe.

A microstructure analysis of the pipe samples using Scanning Electron Microscopy (SEM) and Cross-Polarized Light Microscopy (CPLM) will be performed.

- **Application to Aldyl-A and Cast Iron Materials**

The output of the models will be a likelihood-of-failure calculation for specific pipe segments. The probability-of-failure calculations will be validated against actual failure histories.

Results

In 2012, researchers investigated vintage pipe specimens, using CPLM and SEM to catalog microstructures and internal surfaces. A database was designed to allow for easy correlation of microstructures to physical test results and will form the basis of a knowledge base collating the project research results for future reference.

A test protocol was developed based on Dynamic Mechanical Analysis (DTMA). This testing allows for the proper constitutive models of the materials to be extracted and will also provide accurate bi-directional shift factors for the individual pipe materials. These shift factors will be the basis for residual life estimates for pipes installed under known conditions.

Specimen testing was initiated in 2013. CPLM and SEM microscopic analyses of Aldyl-A specimens were conducted.

The Aldyl-A results database was fully populated and verified. Work was initiated on developing the probabilistic risk model for Aldyl-A pipe that will incorporate threat interactions. The model will be used to rank Aldyl-A pipe sections based on the evidence obtained from coupon extraction, microscopic examination, installation records, and leak records.

Researchers are developing the Finite Element Analysis (FEA) damage-propagation models. This element of the project is essential to developing likelihood-of-failure of pipe segments under known conditions. Test methods for generating detailed constitutive models of polymeric materials that can be incorporated into FEA models were refined, specified and detailed cost information was obtained.

A literature review was completed for the cast-iron portion of the project and an experimental test plan was developed for cast-iron coupons.

Good progress was made in developing hybrid Bayesian Network and Monte Carlo risk models that can be used in scenario analysis related to the integrity management of vintage pipe systems. These methods will be integrated into the final deliverable of the project.

A method for calculating the conditional probabilities of SCG in the presence of root causes was developed and a coupon sampling method was proposed. The ways to combine coupon data with leak data is understood, and the combination of these two data sets will provide a reasonable risk model.

Status

DTMA testing was completed in January of 2014 and correlation with long-term hydrostatic testing, microscopy, and pipe vintages will be conducted as the project progresses.

Development of the risk model for Aldyl-A is under way.

To fully understand cast-iron graphitic corrosion severity with various microstructure and operating conditions, laboratory tests with controlled soil and environmental parameters and cast-iron coupons with the selected microstructures were proposed.

For more information:

Maureen Droessler
Program Administrator
Operations Technology Development, NFP
Phone: 847/768-0608
maureen.droessler@otd-co.org

OTD

Operations
Technology
Development

Correlating Pipeline Operations to Potential Crack Initiation, Growth, and Arrest

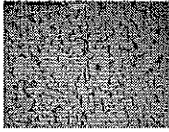

The objective of this project is to develop and validate a model for pipeline operations that correlates pressurization to pipe crack-growth rates, crack initiation, and crack arrest. The model will help to reduce risks associated with vintage transmission pipeline materials.

Project Description

Based on recent recommendations from the National Transportation Safety Board and other regulatory actions, the natural gas industry is expected to be required to increase hydro-testing and spike testing on vintage pipes. While there are many advantages to hydro-testing, there are concerns about the impact of this testing on pipe crack initiation and growth. Additionally, current practices allow operators to use spike testing every five years to maintain maximum allowable operating pressure status.

To address these concerns, this project is focused on the development of a model that can provide operators with information on the predicted effect of pressure-based testing. Researchers are investigating a variety of gas transmission line crack types, including:

- Hook cracks in LF-ERW
- “Cold Spots” (high hardness, Martensitic micro-structure) in weld zones
- Stress risers from steel inclusions (defects at the steel and rolling mill)
- Stress risers from construction (partial DSAW welds, lap welds)
- Defects from pipe mill, field construction, and fabrication
- Knife-line corrosion defects from selective seam corrosion that continue to grow
- Propagation of pre-existing cracks from hydrogen and stress cracking
- Growth of mechanical damage, gouges, and arc strikes.

Deliverables

The primary deliverable of this project will be a predictive model that relates the historical and planned pipeline operational pressure envelope to time for crack initiation, crack growth rates, and the potential for crack arrest.

Benefits

The model will allow operators to identify high-risk pipe segments based on historical pressurization records. The model will also allow operators to predict the impact on pipe integrity of hydro-testing and spike testing as well as select the optimal operating pressure.

The results of this project will reduce systemic risk associated with vintage transmission pipeline materials. The model will assist in targeting inspections of vintage pipe segments with the greatest risk of propagating cracks due to hydro/spike testing.

Technical Concept & Approach

The first phase of this project, researchers will develop the predictive model and will then use small pipe samples for model validation. If necessary, a second-phase project will be conducted using full-size samples for further model validation.

A Design of Experiments (DoE) approach will be used to develop the model. Inputs include factors such as steel type, chemistry, toughness, manufacturing methods (welded or seamless), and operating conditions (temperature and stress levels). These will be corre-

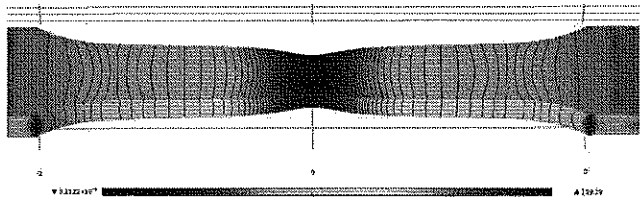
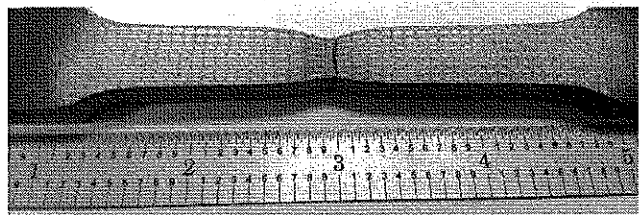

The simulation captures the essential behavior of the material.
Top image: ASTM A370 test sample after failure (typical).
Bottom image: Simulated ASTM A370 tensile test, von Mises Stress plot (in ksi) with effective plastic strain contours.

lated to crack growth initiation time and rates from physical testing.

The DoE will provide the necessary structure for establishing the most efficient data set; completing a full sensitivity analysis for all input factors, and deriving the model for crack-initiation stress, growth rate, and arrest stress with confidence intervals.

The experiment will be designed with an adequate number of replicates to capture the variability of steels from within a grade. There will also be sufficient center points (of the design space) to capture experimental error.

Small-scale, center-notched specimens will be fabricated from vintage pipeline steels provided from Gas Technology Institute's (GTI) historic steel pipe library. The pipe library contains vintages from the 1950s through 2000.

GTI will perform fatigue and toughness testing in its laboratory.

Fatigue testing will be conducted with center-notched specimens prepared from the pipe library. This testing will be performed at very low frequency, but still allow for decades of spike testing to be compressed into hours.

The results will include cycles to failure, as well as arrest and propagation stress levels at various crack geometries.

The model will be delivered in a format that will be agreed to by project sponsors. A web-based training session on the model will be provided, including a demonstration.

Results

An ASTM A36-grade steel plate sized 0.312"x12"x36" was acquired from a local steel service center to be used for tensile and fatigue testing. This grade was specified because its chemistry limits and physical specifications are similar to that of plain carbon steel pipe grades at lower strength levels. Tensile tests using this material were used to identify integration issues between the video extensometers and the tensile test machine. Several fixtures were custom made to ensure proper alignment and stability throughout the testing process.

The test data was analyzed and the conversions from engineering stress/strain to true stress/strain were validated. Video extensometers produced reliable true stress/strain information beyond the necking point of the material. This information will be very useful in the full 3D finite element modeling of the crack propagation process.

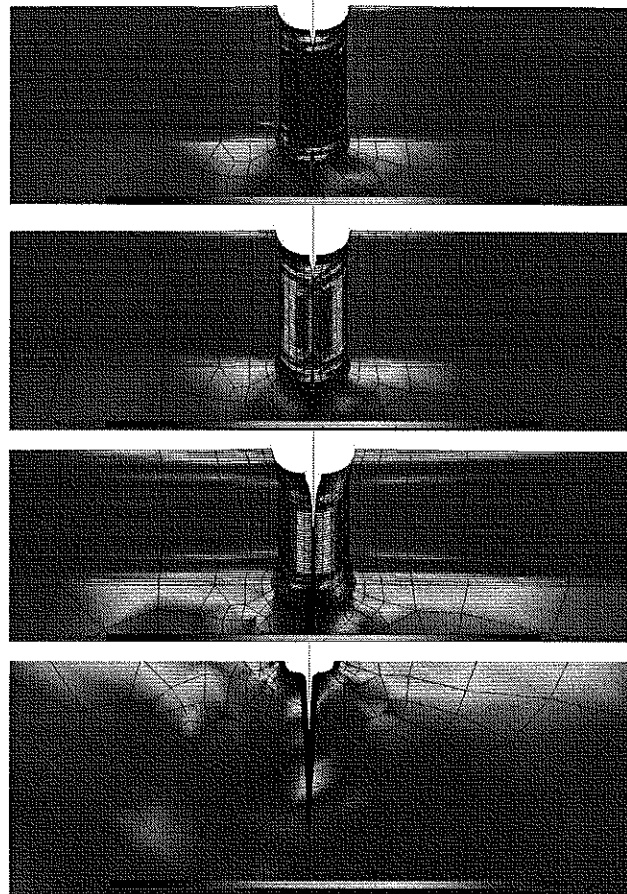

From top to bottom, stress plots indicate an initial crack at the corners of a round notch, the crack propagated through the thickness of the specimen, continued full-thickness crack propagation, and the crack at end of the simulation.

Status

The A36 steel plate will be cut and notched to produce standard specimens for testing. These specimens will be used to validate the 3D finite element analysis (FEA) model.

Once the test setup and model have been validated, specimens will be cut from pipe from GTI's pipe library for fatigue and toughness testing. A minimum of three specimens per suitable grade will be tested. The maximum number of specimens actually tested is dependent on the cost per specimen, that is still being determined, but the highest possible number of specimens will be prepared and tested.

For more information:

Maureen Droessler

Program Administrator

Operations Technology Development, NFP

Phone: 847/768-0608

maureen.droessler@otd-co.org



Field Test of a Cathodic Disbondment Detector

This project focuses on the development of a practical cathodic disbondment detector that would enhance the safety of steel gas piping systems by providing the ability to locate potential pipe-corrosion sites before leaks or serious metal loss occurs.

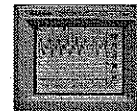

Project Description

A significant amount of the steel pipe used in gas distribution systems is more than 50 years old. To ensure system safety, these older pipes are often assessed for corrosion.

Current assessment methods require exposing the pipe for inspection, often requiring the removal of a coating. Since exposing the entire pipe is prohibitively expensive, these inspections assume that a statistical sampling of an area is representative of the pipe condition.

Corrosion can be severe under a coating disbondment when the fusion-bonded epoxy, coal-tar enamel, or field-applied tapes separate from the steel. Water can migrate under the coating, forming an active corrosion cell that is shielded from cathodic protection (CP). Uncoated steel pipes may develop general corrosion or localized pits if CP is compromised.

The objective of this project is to develop a tool to assess a high percentage of metal pipe from the surface of the ground. The tool will be composed of a mobile platform, sensors to detect magnetic fields, sensors to determine the orientation of the pipe, and computational means to extract coating disbondment and corrosion locations from this data. In operation, the system

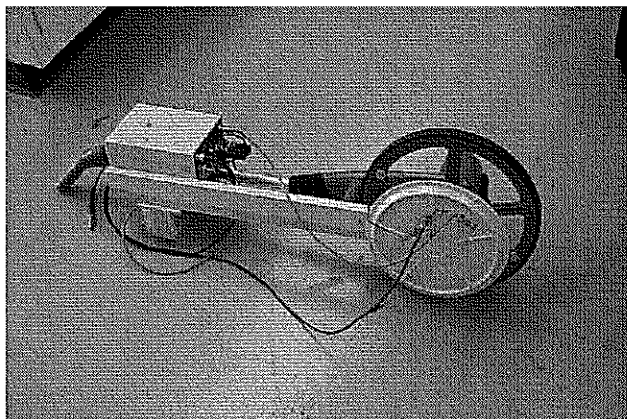

The Cathodic Disbondment Detector (pre-prototype): The orange wheel on the right provides odometer information. Magnets attached to the wheel trigger a sensor; the pulses are counted both to provide location and to ensure that readings are taken at regular intervals. Electronics generate a signal composed of mixed sine waves. A coil housed inside the yellow disk detects the signal radiated by the pipe.

will move over the pipe semi-autonomously, stopping at regularly spaced locations to capture data.

The project builds on several projects funded by U.S. Department of Transportation's Pipeline and Hazardous Materials Safety Administration (PHMSA), OTD, and Gas Technology Institute's Sustaining Membership Program. These project include the development of a tool to detect perturbations in magnetic fields caused by cast-iron joints and services and the development of cathodic disbondment detection.

Deliverables

Deliverables will include a field-tested beta prototype, results of three field tests, and a report summarizing the findings of the field tests and containing recommendations for commercialization steps.

Benefits

Accurate assessment is needed to identify pipe in good condition and to distinguish it from pipe that should be replaced. Replacing pipe past its useful lifetime will improve the safety of the system.

The ability to locate potential corrosion sites before serious metal loss or leaks occur will improve public safety, corrosion-mitigation strategies, and the life-cycle of steel pipelines.

Currently, there is no tool to identify external corrosion from above ground and most gas-distribution mains are not accessible to in-line inspection tools. Exposing large lengths of main for inspection is cost prohibitive. Record keeping and direct assessments are the currently used tools for predicting pipe conditions. However, direct assessment is limited because pipe condition can vary dramatically within feet.

A tool able to assess a high percentage of pipe from the surface of the ground has the potential to save utilities millions of dollars of inspection costs annually. Savings will also result from prioritization of pipes needing repair in a timely manner and those with substantial remaining lifetimes.

Technical Concept & Approach

The primary technical objective of this project is to build a prototype of the cathodic disbondment detector and conduct further testing with follow-up investigation. This will allow for the performance of the apparatus to be more rigorously quantified at several sites.

The approach is to directly inject an alternating current signal into the pipe, generating magnetic fields around it. For a long straight steel pipe in good condition, these magnetic fields are perpendicular to the axis of the pipe – the basic principle of electromagnetic pipe locators. Coating flaws and corrosion will distort the magnetic field around the pipe by the increased attenuation of the current along the pipe and by creating current flows not parallel to the pipe axis. The challenge is to map these field distortions to features on the pipe.

A manual version of a Cathodic Disbondment Detector will be tested at several utility sites. These early field tests will establish a baseline for the current capabilities of the technology. They will also provide an opportunity to test some of the additional candidate sensor packages under field conditions prior to integrating them with a self-propelled system.

The data from the field tests will be reported to the sponsors with recommendations on features that may require investigation.

In order to facilitate a self-propelled platform to carry the sensors, a chassis and drive mechanism will be required. The expected outcome is a wheeled platform of moderate size, possibly with sensor trailers to isolate magnetic sensors from interferences such as large masses of metal. Initial testing will verify the ability of the chassis to be remotely controlled by an operator. It will also verify the load-carrying capacity, battery life, and ability to traverse unpaved areas.

To facilitate the rapid and accurate collection of pipe-condition data, the sensor platform will need to navigate in a semi-autonomous manner. An algorithm will be developed that allows the platform to follow the pipe route by using the on-board sensors and tracing signal.

The project team will design and construct a data-acquisition and processing system and develop software to capture the data from multiple, orthogonal sense coils and orientation sensors to extract the field phase and magnitude data. This data will be processed in order to maintain the course of the platform within reasonable alignment of the pipe route. The on-board sensors will provide sufficient data to correct for minor misalignment of the platform with the pipe.

In addition to collecting the magnetic-field signature data, it will be necessary to store this data properly cor-

related with platform attitude, GPS location, and a time stamp for every point in the survey. The stored data will need to be formatted such that it will be compatible with a utility geographic database. It will also be necessary to provide a local display of the data.

The entire system will be subjected to testing to verify the proper integration of the chassis with data collection and data storage.

The first round of testing will take place at a buried pipe test bed with known flaws. This facility will be used in the initial shake-down testing and refinement of the pre-prototype instrument.

Once the pre-prototype equipment is functioning correctly, it will be tested at three natural gas utility sites.

Results

In 2012, the project team identified several upgrades for the prototype instrument to prepare it for more extended field testing. The primary improvements are the inclusion of GPS data with the cathodic disbondment survey data, the ability to vary the frequency of the signal injected into the pipe to suit field conditions, and the ability to store greater amounts of survey data. These improvements are on-going.

A PHMSA proposal (*Above-ground Detection Tools Including Disbondment and Metal Loss for All Metals Including Cast Iron Graphitization*) with OTD cofunding was approved. The project schedule impact has been assessed and the end date of the OTD project extended to accommodate the greater scope of work.

Discussions with manufacturers were initiated to determine the specific set of equipment that best fits the requirements of the project.

Status

A prototype is being readied for field testing.

Cofunding from the PHMSA may provide an opportunity to increase the number of field tests and developments.

For more information:

Maureen Droessler

Program Administrator

Operations Technology Development, NFP

Phone: 847/768-0608

maureen.droessler@otd-co.org

OTD

Operations
Technology
Development

Continuous Threat Identification Program



The Continuous Threat Identification Program (C-TIP) is being developed to collect, analyze, and disseminate information on new and previously unidentified pipeline threats. This program will provide information to operators for their use in enhancing the safety and operation of their systems.

Project Description

As gas-system operators initiate Distribution Integrity Management Programs (DIMPs), information on new and previously unidentified threats is expected to become available. The objective of this project is to develop and implement a program to collect, analyze, and disseminate this information.

The program – called the Continuous Threat Identification Program (C-TIP) – focuses on threats specific to distribution systems and will provide information on existing and emerging system threats to operators for their use in identifying and assessing risks to their system.

The C-TIP, led by an independent third-party organization, will also facilitate the collection and further investigation of information that would lead to meaningful and transparent analysis.

Analysis by an independent organization will provide regulators and the public with assurance that the results are nonbiased and based on a rigorous scientific processes.

Deliverables

Information developed through this project will be disseminated through semi-annual webinars and annual reports.

Benefits

The C-TIP will help reduce operator risk for both distribution and transmission systems by improving system integrity and safety.

Risk will be reduced by providing comprehensive industry information to assist in identifying threats and quantifying the associated risk.

The C-TIP will also help to:

- Demonstrate to regulators and the public that the industry is pro-actively identifying new and emerging threats
- Standardize the data sets that operators use when developing and executing integrity management plans to further increase confidence in the results

Threats being investigated include:

- Corrosion
- Natural Forces (e.g., flooding and earth movement)
- Excavation Damage
- Other Outside Force Damage (e.g., vehicular damage or vandalism)
- Material, Weld, or Joint Failure
- Equipment Failure
- Incorrect Operation.

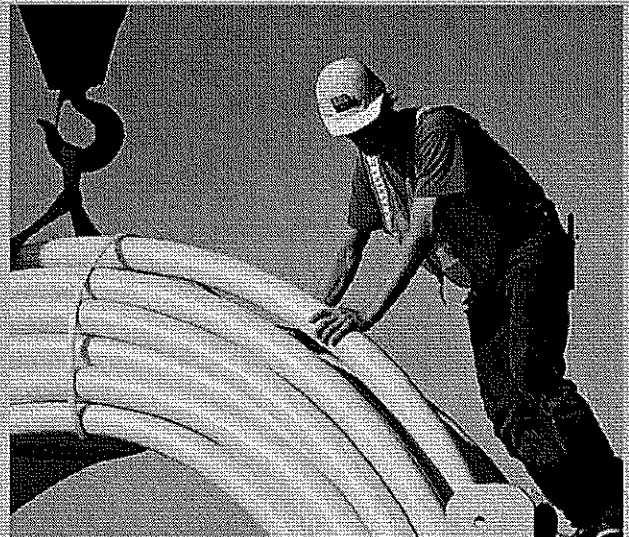

- Improve the efficiency of data collection, threat identification, and risk analysis by providing a collaborative mechanism for sharing information.

Technical Concept & Approach

Researchers will define the potential sources of data and create a data-collection template and form. A database will be designed and developed to store the collected data.

The C-TIP will systematically collect new and emerging threat information from operators and regulators.

Results

Initially, data was collected from OTD operators to identify threats and determine how each company identifies threats. Additionally, state regulators were contacted to obtain data on their findings related to new and emerging threats.

Interviews were conducted with various natural gas utility DIMP managers or a representative familiar with the company's DIMP. A summary of the responses was compiled. Threats and sub-threats from the DIM plans of those companies interviewed were compiled into tables.

Data was analyzed and webinars were held to discuss the results. A DIMP workshop was held in 2013 as part

of the DIMP Risk Model project. Many operators requested standard definitions for all sub-threats in order to facilitate improved identification/categorization.

In 2013, the project team completed the initial version of the C-TIP database that combines the threats and sub-threats from the operator and regulator interviews as well as the information from DIMP plans. Definitions, examples, contributing factors, and commentary was provided for each threat and sub-threat.

Additional information/responses from regulators were collected with feedback on reviewed operator DIMP plans.

Status

The research team continues to review, refine, and add information to the threat database.

A proposal is being prepared to create an online database that is searchable and allows users to add and modify information.

For more information:

Maureen Droessler
Program Administrator
Operations Technology Development, NFP
Phone: 847/768-0608
maureen.droessler@otd-co.org

OTD

Operations
Technology
Development

Pipecrawler Market Assessment & Demonstration

Researchers investigated a pipeline-inspection system used in subsea and offshore applications for its potential development for use in onshore gas-pipeline segments that currently can not be inspected with conventional equipment.

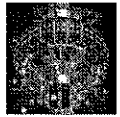

Project Description

The natural gas pipeline infrastructure contains a considerable amount of "unpiggable" pipe segments that can not be inspected with conventional devices. Through this project, researchers investigated technology with the potential to inspect long segments of unpiggable pipe and thus reduce an operator's exposure to integrity threats and unknown pipe defects.

Specifically, research focused on Pipecrawler systems available through the Genesis Group, an engineering and technical services company for the upstream oil and gas sector. Currently, the technology is being deployed in subsea and offshore applications for inspecting unpiggable pipe segments.

Pipecrawler is a tethered inspection platform that uses brush-drive units that are powered by electric linear-drive motors for propulsion. The Pipecrawler has a modular inspection platform that can be integrated with multiple sensors. The current version is available with magnetic flux leakage (MFL) sensors, but the company is in the process of integrating a variety of other sensors as well. The Pipecrawler has been shown to be able inspect up to 3,000 feet of pipe in pressures

up to 700 psi. Current models can inspect pipe 10 to 12 inches in diameter.

The brush drive and suspension system gives Pipecrawlers the ability to access a pipeline from a single location. Motion, control, and data transmission is managed from a topside console via an umbilical tether which enables the tool to be run at any speed from zero to maximum. The ability of the crawler to stop and secure itself in position anywhere in a pipeline (including risers) is particularly useful for many inspection tasks. By incorporating the speed control and the product flow bypass capability of the tool, controlled quantities of pipewall deposits can be removed while the pipeline is still operating. Once clean, the system can return to the launch position.

Genesis is interested in bringing this technology to the natural gas distribution and transmission industry and partnered with Gas Technology Institute in this project to perform a market assessment and coordinate a field demonstration. The objective of this project was to provide the technical requirements needed to guide technology development for Pipecrawler technology and to demonstrate the size of the U.S. market.

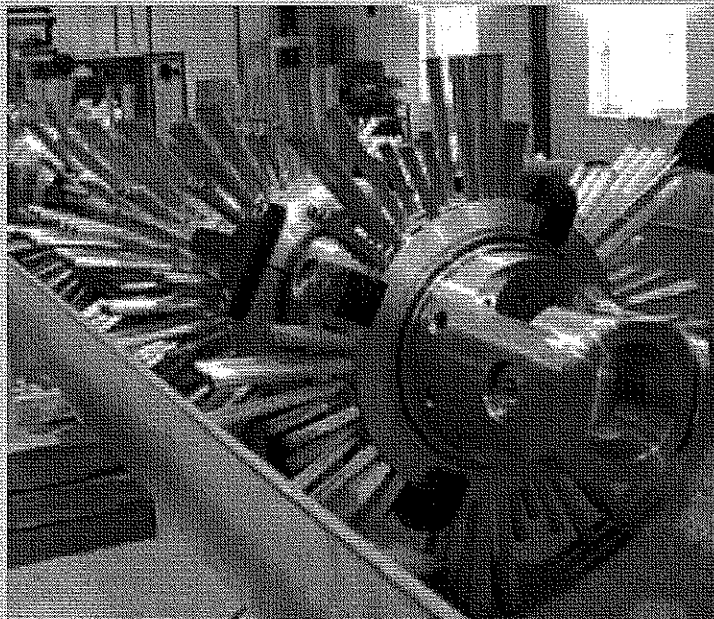

Pipecrawler

Features:

- Patented "brush drive" technology
- Single entry and recovery point
- Fully bi-directional travel
- Can operate "with" or "against" the flow
- Can operate in no flow
- Can stop at any point in the pipeline system
- Multiple 3D bend passing
- Powered deployment and powered recovery
- Onboard internal and external temperature sensors
- Onboard internal and external pressure sensors
- Variable speeds from 0 to 900 meters/hour
- Emergency recovery via tether.

Deliverables

Research results will be presented in a Final Report to sponsors.

The market analysis will be used to justify further investment in the technology that may be required to serve gas-industry markets.

Benefits

Pipeline system safety can be enhanced through the introduction of a system capable of inspecting unpiggable pipelines and navigate through pipe bends, debris, rotated fittings, reduced-port ball valves and gate valves, plug valves, tees, and intersection points.

Technical Concept & Approach

For this project, a market assessment was conducted to gather information on the technical requirements, regulatory drivers, and market size of the onshore natural gas distribution and transmission industry in the U.S.

A laboratory demonstration of the Pipecrawler technology was also performed.

Results

The Pipecrawler market assessment was completed and delivered in November 2012. The assessment provides information on the current gaps in inspection technologies for unpiggable pipe and the ability of Pipecrawler to meet the needs of the market.

In 2013, a successful Pipecrawler demonstration was conducted in a 10-inch-diameter laboratory test loop with 3D bends.

Research found that the Pipecrawler has many of the features required by operators to meet the market needs for inspecting unpiggable pipes:

- Operates live in low and no-flow conditions
- Allows for single entry and exit points
- Navigates some bends and reduced-diameter fittings
- Passes through debris and contaminants
- Accommodates up to 30% change in diameter
- Able to inspect dead legs.

The Pipecrawler is able to negotiate the most frequent and important pipe configurations and operating conditions that make segments unpiggable, including low-

flow conditions and lack of launchers and receivers. However, some features (such as plug valves and tight-diameter bends) can not be accommodated with Pipecrawler and will therefore limit the size of the market.

Status

The market assessment and laboratory demonstrations are complete.

Based on the cost, market, and industry-trend data collected in this assessment, the following conclusions can be drawn:

- If Direct Assessment (DA) is a feasible assessment technique in rural or suburban areas, operators will continue to use DA because costs are significantly lower (up to 50% less expensive) than a Pipecrawler inspection.
- If converting a line to be piggable only involves installing launchers and receivers and/or minor modifications, operators are likely to choose this option because it will allow traditional lower-cost inspection tools to be used. Up to 20% of the target market for Pipecrawler is expected to be converted over the next 3-5 years.
- Pre-1970s pipe accounts for up to 60% of the regulated transmission pipe in the ground and represents a potentially strong market for Pipecrawler. Replacing pipe installed prior to 1970 has the benefits of mitigating potential hydrotesting and pressure regulations as well as reducing risk by removing pipe with problematic vintage materials and construction practices. New lines have the benefit of being piggable with the ability to use traditional in-line inspection tools as well as having an extended service life. Replacement of line segments in some areas is extremely expensive and the use of Pipecrawler is a viable inspection solution.
- The distance that can be inspected in between access points with Pipecrawler will have a significant impact on the cost competitiveness compared with other options. Pipecrawler will be a viable alternative in areas with high excavation and restoration costs, such as urban areas and crossings, if longer distances can be inspected between access points.

For more information:

Maureen Droessler

Program Administrator

Operations Technology Development, NFP

Phone: 847/768-0608

maureen.droessler@otd-co.org

OTD

Operations
Technology
Development

Inspection Technology Strategy Tool



Through this project, an on-line software tool was developed to assist pipeline operators in evaluating and selecting appropriate inspection tools. A website provides a centralized resource for technical information and expertise related to internal inspection issues and concerns.

Project Description

The Pipeline Safety, Regulatory Certainty, and Job Creation Act of 2011 requires that pipeline operators validate Maximum Allowable Operating Pressures with traceable, verifiable, and complete records. Operators that are unable to provide the required documentation may have to conduct pressure tests to demonstrate the safe operation of the pipeline.

Due to the cost and burden of pressure testing (for up to 100,000 miles of transmission pipe), the industry is in need of technologies that can provide an integrity assessment that is equivalent to hydrotesting. While various inspection technologies are available, operators require detailed, third-party information on new inspection tools and issues.

This project was initiated to provide the pipeline-operator community with information that will help to increase pipeline safety and support the development of new technologies.

Deliverables

This project resulted in the establishment of an on-line Inspection Technology Strategy Tool. The website combines the datasets and information being developed by Gas Technology Institute (GTI), the Interstate Natural Gas Association of America (INGAA), Pipeline Research Council International (PRCI), and OTD in a software tool to assist the industry in selecting the most appropriate inspection tools and in understanding the market needs for new inspection technologies.

Benefits

The tool and relational database enables users to:

- **Assess Technology:** Assess the ability of currently available internal inspection technologies to detect and quantify typical mill and construction defects that would fail a post-construction hydrotest.

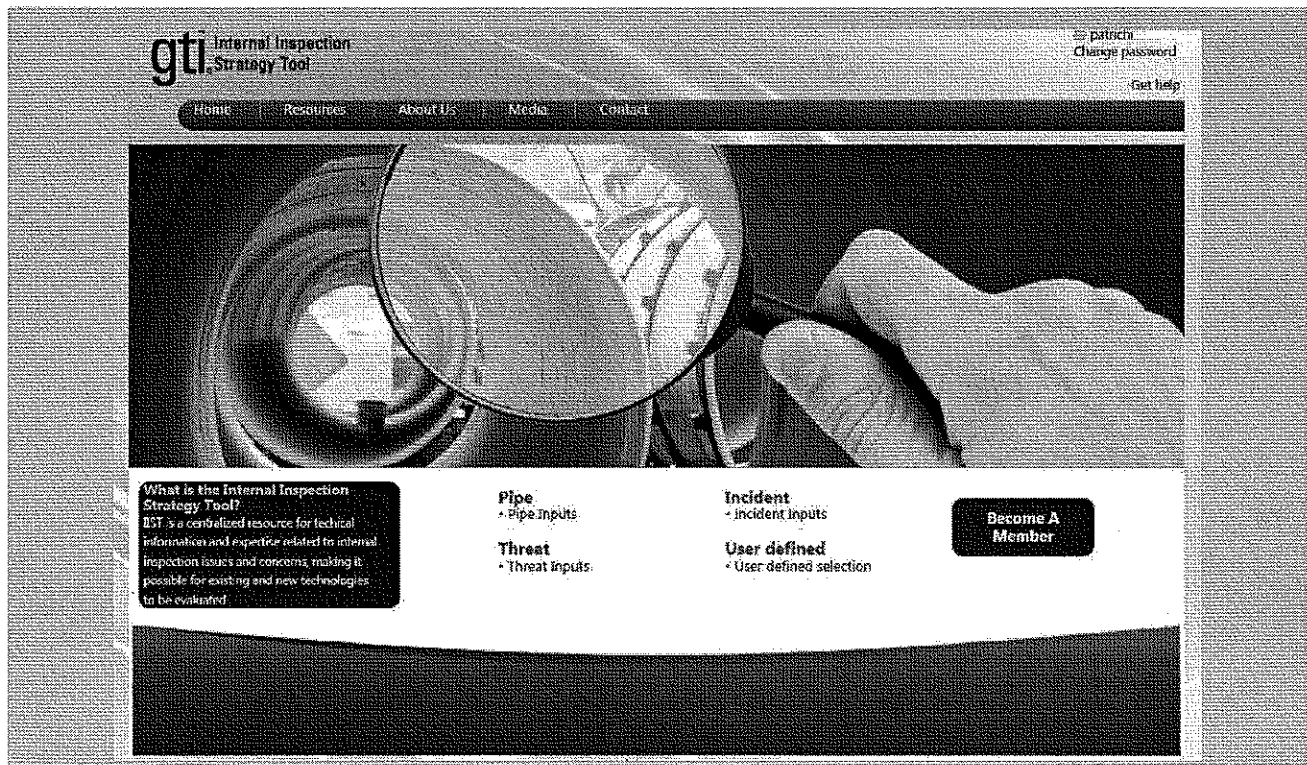

- **Quantify Failure Frequencies:** Quantify the prevalence of failure frequencies for a variety of individual and interactive threats based on pipe vintage and other factors such as diameter, wall thickness, coating type, seam type, etc.
- **Characterize Mileage with Assessment Challenges:** Quantify and characterize the mileage of pipe that cannot be assessed with currently available internal inspection technologies.
- **Communicate with the Public:** Satisfy the need for public communications that is based on sound engineering and scientific principles.

The output of the tool will provide the industry with the information required to develop a strategy and business case for deploying *current* internal inspection technologies. This tool can also be used as the underpinning of a program to develop *new* pipeline-assessment technology through collaborative R&D to fill identified gaps.

The on-line tool can also:

- Assist operators, vendors, and integrity-management service providers in formulating a strategy for developing new inspection technologies that can replace the need for hydrotesting, and
- Assist when working with other trade associations to prioritize and provide a business case for new inspection technologies based on the mileage and characteristics of pipe without verifiable hydrotest records.

Technical Concept & Approach

Information for the Inspection Technology Strategy Tool is based primarily on three ongoing industry research projects:

1. **INGAA's Integrity Management Continuous Improvement (IMCI) Program.** INGAA is implementing an action plan to address National Transportation Safety Board recommendations. As part of INGAA's IMCI Program, a database is being developed that will provide the industry with an understanding of the expected and probable threats and defects for various pipe vintages based on historical performance records. Incident data will be used to determine the mill sources and failure distributions for specific threats. The database will allow operators to predict and quantify integrity threats of a pipe based on pipe vintage and construction practices.
2. **GTI's Internal Inspection Optimization Project.** In this project, research is assessing the ability of

currently available inspection technologies to detect and quantify various defects and threats. The results of this project will provide both an understanding of current technology capabilities and provide an R&D roadmap to fill in critical inspection technology gaps.

3. **GTI's Threat Interactions Project.** The objective of this project is to develop a body of knowledge for understanding the interactions of various threats to pipeline integrity that impact the likelihood of failure to a pipeline segment. The knowledge created in this research will be used to support integrity management programs and risk analysis to ensure threats are adequately identified, tracked, and mitigated.

Additionally, PRCI information will be included if and when it becomes available. This includes efforts that are adding depth to the background and fingerprinting of vintage pipes; additional field data from unique, vintage pipes; and other information.

Results

In 2012 and 2013, the project team created an application using Microsoft's Visual Studio, defined and populated the specific component projects, and imported data on reported incidents, pipe vintage, sensor platforms, and other factors.

Components were designed, developed, and tested.

Multiple webinars were held with sponsors to provide insight into the use of the software tool and communicate the results of the program.

The system is designed to provide a detailed view of each of the summary search results: Mileage, Sensor, Platform, and Incident.

Status

This project was completed in 2013. The Inspection Technology Strategy Tool is available for use by OTD members through the Applications page at the OTD website: otd-co.org.

For more information:

Maureen Droessler

Program Administrator

Operations Technology Development, NFP

Phone: 847/768-0608

maureen.droessler@otd-co.org

OTD

Operations
Technology
Development

Distribution Integrity Management Plan Consequence Model



Researchers are developing a model to quantify the consequence of failure for natural gas distribution systems based on a wide variety of factors, including population density, proximity of critical infrastructure and business districts, and failure mode.

Project Description

Federal regulations for natural gas system operations provide specific requirements for determining the consequence of a system failure, including calculations for the Potential Impact Radius (PIR) and High Consequence Areas (HCA).

Distribution Integrity Management (DIM) regulations do not mandate a specific method for modeling the consequence of failure; however, the regulations require operators to consider the consequence of failure when assessing risk. Regulations imply that a risk model cannot be considered final and complete without proper consequence quantification.

Through OTD sponsorship, a comprehensive risk model for DIM was developed and is now commercially available through GL Noble Denton. This model provides a methodology for calculating the likelihood of failure for eight threats for various asset classes. However, this model does not provide a methodology for calculating the consequence of failure.

Some risk modeling software tools have built-in functions that assist operators in determining the consequence of failure for specific line segments. Some operators have developed their own methods for modeling consequences based on factors such as pressure and population density, while other operators use an SME approach to assign relative consequence scores.

The goal of this new effort is to develop a model that quantifies the consequence of failure for distribution systems based on factors such as population density, proximity of critical infrastructure and business districts, failure mode, gas migration patterns, soil and surface conditions, pressure, and potential energy.

Deliverables

The deliverable of this project will be a DIM plan consequence model that operators and software vendors can incorporate into existing risk-modeling tools.

The model will be provided to OTD companies and licensed to software vendors and non-OTD companies.

The DIMP Consequence Model takes into account a wide range of pipeline variables, including:

- Pipe material
- Outer diameter
- Wall thickness
- Depth (of cover)
- Pressure
- Location
- Local population density
- Soil and surface conditions
- Threats (corrosion, natural forces, excavation damage, etc.)
- Repair costs
- Litigation and liability



Benefits

A DIM plan consequence model will enhance the ability to comply with regulations while reducing system risk by assisting operators in understanding the risk of specific pipe segments based on the consequence of failure.

This risk-based model will assist in prioritizing replacements and the deployment of other mitigation techniques.

Technical Concept & Approach

Specific tasks in this project include:

- **Industry Review**

This activity included a survey of sponsors and a literature review.

- **Development of a Modeling Approach**

This task included the analysis of several existing risk-modeling approaches for compatibility with potential consequence-modeling approaches. Several distinct units of consequence measurement (e.g., volume of gas release or value of property damage) were considered.

- **Model Development**

The model will be modular in order to integrate with a variety of existing risk-modeling approaches and flexible enough to allow for the use of different consequence units.

- **Model Testing**

This task involves testing the consequence model with simulated and real data.

Results

In 2013, the consequence literature review was completed to assess the current state of the art. The investigation included reviews of regulations, templates,

guides, and surveys, examples from operator DIM plans, academic papers, and government reports.

The modeling approach was developed and consists of the following modeling steps :

1. Develop a set of consequence categories
2. Develop a list of affecting factors and quantify (or parameterize) their contributions.
3. Quantify consequence.

Model component quantification was initiated, using several sources. Several important equations were introduced into the model to account for various possible consequences on structures and people, under various conditions. Thermal radiation, gas ingress, and ignition formulas were introduced into the model, as well as various receptors (i.e., buildings and people), distributed according to class location and additional parameters.

Status

Development of the model is ongoing.

All equations and "sub-models" (for each consequence component) will be clearly presented in order to refine lists of variables and parameters required.

Ranges and typical values for each of the variables will be gleaned from relevant credible sources. Probability distribution functions or tables will be created for each variable.

Overall consequence function will be shown as a superposition of component functions.

For more information:

Maureen Droessler

Program Administrator

Operations Technology Development, NFP

Phone: 847/768-0608

maureen.droessler@otd-co.org

OTD

Operations
Technology
Development

Validation of 3D Scanners for Pipeline Anomaly Assessment

Research into the capabilities of two currently available 3D scanners was conducted. Demonstrations of the products found that 3D scanners could potentially replace manual pit-gauge measurements by providing more accurate measurements in an automated operation.



Project Description

Gas pipeline operators are required to assess the severity of anomalies found in direct assessment and in-line inspections to determine the need for repair. This often involves investigating indications and manually performing in-the-ditch measurements with a pit gauge. However, accurate pit-gauge measurements can be difficult to obtain if the anomaly is on the side or bottom of the pipe. Additionally, the accuracy, repeatability, and reliability of pit-gauge measurements are highly dependent on the skill and experience of the user.

Several 3D optical-scanner products have entered the market that are intended to automate in-ditch anomaly measurement and assessment, increase data quality, and improve operational efficiencies.

In this project, research on the capabilities of two currently available 3D scanners was conducted. Demonstrations of the products were performed with the participation of the manufacturers. Research found that these products could potentially replace manual pit-gauge measurements.

Deliverables

Results of the testing and validation program of 3D scanning technologies was provided in a report issued in October 2013.

Benefits

A validated tool that eliminates manual data collection of in-the-ditch anomaly measurements using a pit gauge will improve data quality and increase operational efficiency.

Automating the process of measuring anomalies found through direct assessment and in-line inspection runs was identified as a significant opportunity.

Technical Concept & Approach

Specific tasks for this project included:

- **Technology Search**

A technology search was conducted to identify laser or structured light-scanning tools that could

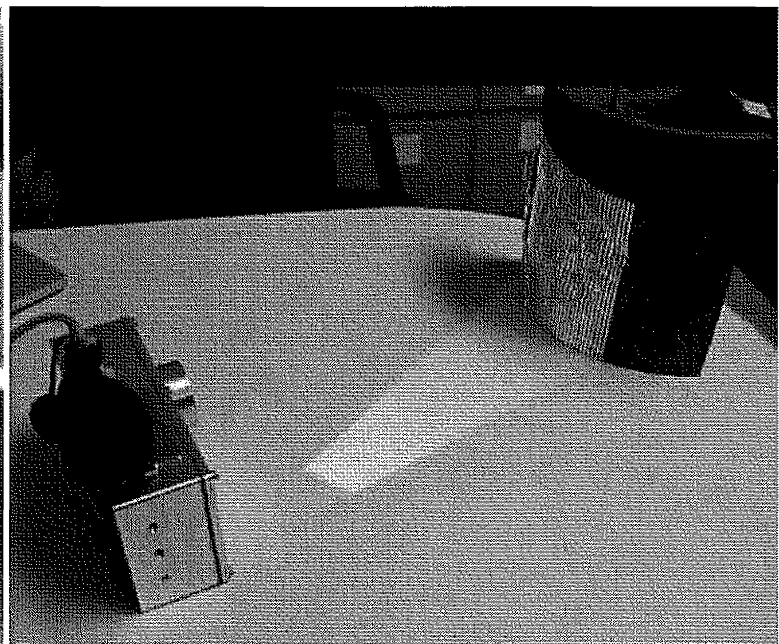
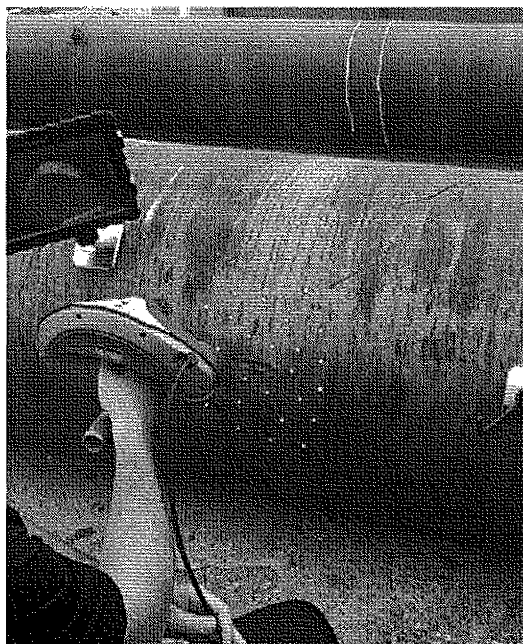

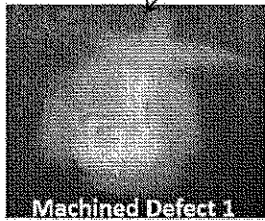

Machined Defect 1

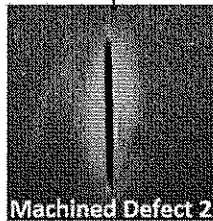

Machined Defect 2

be applied to pipeline anomaly measurement. Previously performed testing was also reviewed.

- **Testing and Validation**

A testing methodology was developed to allow the performance of the 3D scanner measurement tools to be validated for the capabilities to measure external corrosion, dents, and gouges. The testing was performed on pipe samples with real and manufactured anomalies.

- **Demonstrations**

Upon completion of the testing and validation, demonstrations of the selected technologies were conducted with participating operators.

Results

Two 3D scanner technologies suitable for external pipeline anomaly assessments were evaluated. Both products feature analysis software tailored specifically to external pipeline anomaly assessment and proved capable of generating virtual 3D surface representation of pipeline features at greater accuracy and resolution than is typically achieved with conventional manual pit-gauge readings.

These non-contact measurement technologies permit more reliable and repeatable assessments of anomalies and offer significant potential to streamline in-ditch assessments via the largely automated analysis and reporting systems provided in both vendors' products.

A workshop to evaluate the performance of the 3D scanners was conducted. Each vendor provided background presentation material, answered questions, and performed live field scans on a set of prepared pipe samples. Machined defects and general corrosion features were scanned and results compared.

Some limitations were observed during the surface-image acquisitions, including difficulties scanning features exhibiting shiny surfaces or high-aspect ratios. Apart from features such as deep, narrow gouges or cracks, these devices proved capable of acquiring and assessing most anomalies.

An in-depth comparison of device set-up, calibration, 3D surface acquisition, analysis, and reporting features was provided a report.

Status

This project was completed in 2013.

The two 3D scanners that were tested demonstrated the ability to provide more accurate and reliable anomaly assessments compared to manual pit-gauge measurements.

Recommendations for further assessment include:

- Evaluating the cost of the products in relation to the value that they provide in terms of improved data accuracy, reliability, and time savings during data collection and management
- Ensuring that 3D scanners are compliant with federal and state regulations
- Discussing product performance with existing customers.

For more information:

Maureen Droessler

Program Administrator

Operations Technology Development, NFP

Phone: 847/768-0608

maureen.droessler@otd-co.org

OPERATIONS INFRASTRUCTURE SUPPORT

Addressing issues often beyond the traditional areas, this research involves the development of tools and techniques for metering, gas shut-off, vault maintenance, remote monitoring, cathodic protection, data collection, and other applications.

Developed technologies are subjected to a regimen of laboratory and field evaluations to ensure their safety and efficiency.

New efforts include evaluations of PE pipe splitting and excess flow valves.



Operations
Technology
Development

Portable Propane/Air Residential Temporary Gas Supply



In this project, research is focused on the design, testing, and deployment of a portable propane/air system that can be used as a means to temporarily serve the gas load while upstream maintenance operations are being performed.

Project Description

Many utilities trust and use propane/air technology during high demand times as a peak shaving method; however, currently available units are too large and expensive to be considered portable or cost effective for small operations. Currently, there is no a small-scale propane/air delivery system available to the industry.

In Phase 1 of this project, a device was designed, fabricated, and tested in an effort to offer a temporary propane/air mix to single residential customers. A prototype was successfully constructed that was powered by the propane tank pressure, had a self-regulating output pressure, and a fixed propane/air mix ratio.

The alpha device was tested and performed as designed. However, testing indicated that further refinements were necessary to the design.

The objective of this Phase 2 effort is to design, test, and deploy a beta portable propane/air system to the natural gas industry as a means to temporarily serve the gas load while upstream maintenance operations are being performed by the utility.

Deliverables

The deliverables for this project include end-use testing, a summary of field-test observations, and the development of an initial commercialization strategy.

Benefits

A portable propane/air supply system could supply customers with uninterrupted service during rehabilitation, maintenance, or any other unforeseen circumstance. With such a device it would be possible to economically disconnect a residence or business from the main for an extended period of time. This would allow for more elaborate forms of rehabilitation and allow crews to perform higher-quality work.

Some forms of rehabilitation and maintenance that would become more cost effective if a portable propane/air supply system existed include:

- Cured-in-place lining
- Sliplining of mains
- Main cleaning
- Service replacement/rehabilitation
- Inspections
- Major repairs.

It could also be possible to integrate a system with other technologies to provide the customer with a completely uninterrupted disconnection and reconnection to the street main once the work is completed. The system would be small enough for a single technician to carry to the house, not require the transportation and refill of compressed natural gas, and be very low cost.

Technical Concept & Approach

Specific tasks include:

- **Laboratory Testing of Propane-Air Mixture**

The mix was verified via gas chromatography to ensure the propane/air mixture is within the range previously determined as the "sweet spot" for simulating natural gas. This testing focused on conducting an interchangeability test using the same methods as with the alpha prototype.

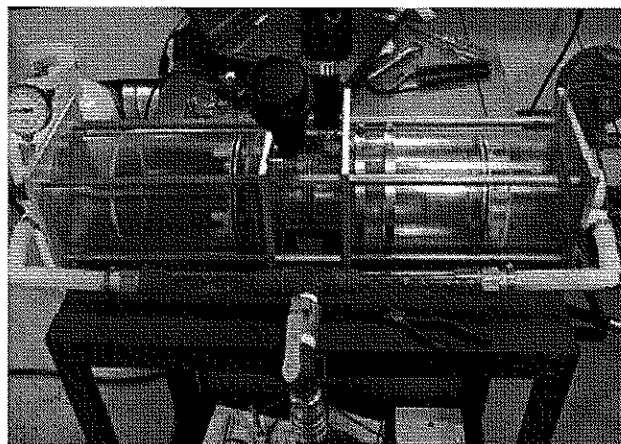

Alpha prototype.

The appliances tested included two tanked water heaters (new, not previously tested incorporating flammable vapor safety designs), one tankless instant water heater, and one dryer. Each appliance was installed and combustion tests performed in compliance with applicable standards. Data collected included burner firing rate, temperatures, and emissions. Tests were also conducted with various flame retardants added to the propane/air mixture to determine their effectiveness against appliance shutoff.

- **Beta Prototype Redesign**

The previous mixer was constructed with clear plastic to verify and troubleshoot its operation. Now that the operation is known to be consistent and sustainable, a more commercial ready unit will be constructed out of stainless steel. The use of stainless steel will also come with several other benefits, including higher delivery pressure, permanent lubrication, smoother low-demand operation, and higher flow operation. The new design may also incorporate provisions for introducing different fortifying agents to “cool” the burning propane/air mix, thus preventing appliance shutdown.

- **Fabrication of Beta Prototype Propane/Air System**

The design of the mixer will incorporate a safety feature to shut down the mixer supply in the case the propane pressure drops too low or raises too high for safe operation. (Preliminary efforts to design such a valve were abandoned in the first phase due to time constraints.) The newer design will also be more compact and simpler to assemble.

- **Field Testing of Prototype**

The beta prototype will be field tested for four months. This will allow ample time for sponsoring utilities to demonstrate the device. Sponsors will then be surveyed to determine the operational value of the device.

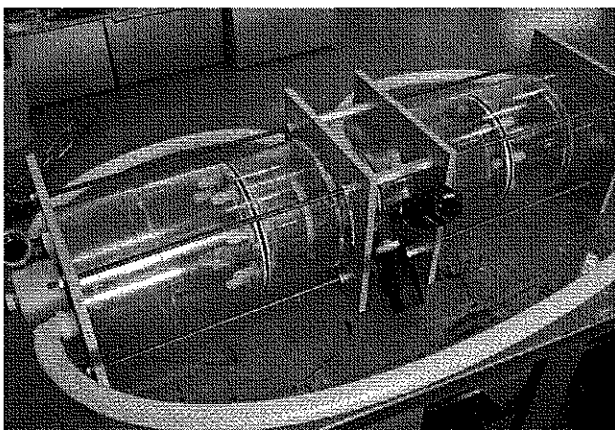

- **Commercialization Initiation**

A market analysis will be conducted to determine the commercial feasibility of the beta prototype device. Discussions with potential manufacturers will be initiated to determine the logistics of moving forward with commercialization as well as development of an initial commercialization strategy.

Results

Propane/air interchangeability tests were completed in 2012. No operational issues were encountered and test results show similar emissions and gas temperatures between propane/air and natural gas for the appliances tested. The results were presented in a report to sponsors.

Testing in Phase 1 of the project showed that a propane/air mixture is generally interchangeable with natural gas in natural gas appliances. Emissions and flame temperatures were shown to be comparable, and most tested appliances (legacy range, new water heater, new oven, new furnace) operated normally. There were, however, two cases in which interchangeability was questionable. It was noted that the interchangeability issues encountered may be solved by fine-tuning the propane-air mixture ratio.

Three water heaters and one dryer were tested in Phase 2 to supplement Phase 1 testing with different types of appliances. No issues were encountered with any of these appliances. Flue gas temperatures and emissions from a 56.7%-43.3% propane/air mixture were similar to those of natural gas, with the exception of one water heater where NO_x emissions were 18%-85% higher.

Status

Due to unresolved questions regarding propane/air interchangeability with certain water heaters, additional research may be necessary to further evaluate the use of the propane/air mix. Two proposals are being developed: 1) a proposal to evaluate how many other appliances may have similar thermocouples to the one that failed in the first test, and 2) a proposal to determine how prevalent they are in the market. (The second proposal will include a statistically significant sample set of appliances for testing to validate the results to date.)

For more information:

Maureen Droessler
Program Administrator
Operations Technology Development, NFP
Phone: 847/768-0608
maureen.droessler@otd-co.org



Operations
Technology
Development

Tool for the External Classification of Pipe Contents



Research is being conducted to develop a practical tool that can enhance operations safety by being able to distinguish the contents of a buried utility pipe without breaching the pipe wall. The ultimate objective is to develop an affordable tool that could be carried in each crew truck.

Project Description

Natural gas pipelines, water lines, electric cable, and other underground facilities can be buried near each other, often making it difficult to distinguish one utility from another. Compounding the difficulty is the fact that gas pipelines can be at a variety of pressures, and electric lines can be pressurized with mineral oil or nitrogen. Misidentifying an electric line for a gas line or tying a low-pressure gas main to a high-pressure gas main can cause potential hazards for utility workers and the general public.

In this project, research is focused on the development a practical tool that can distinguish the contents of a utility pipe without breaching the pipe wall.

Deliverables

In Phase 1 (now completed), the research team identified potential technologies, performed a system design, and developed a work plan. In Phase 2 (completed in 2013), the research team developed and tested an alpha prototype device.

Benefits

The successful development of a tool for externally classifying pipe contents would help to prevent accidents that can occur when steel pipe containing high-voltage electrical lines are drilled into because they are assumed to be natural gas lines. The tool could also identify standing water in mains and measure the water depth in these areas of standing water. The tool would minimize costs associated with water removal from gas mains by being able to detect and measure fluid depth from outside of the pipe.

Technical Concept & Approach

This project is being conducted in three phases:

- Phase 1: Select technologies to be used, perform a system design, assess the market, and develop a work plan to be conducted in Phase 2.

Phase 2: Develop a fully tested (laboratory and field trials) alpha prototype device suitable for applications for 3- to 10-inch pipe diameters for steel, cast-iron, and polyethylene pipe. A user-friendly interface is planned so that measurements can be obtained without the operator viewing waveforms. Operator input will be limited to preparing the pipe surface and holding the sensor. Additionally, the operator will not have to enter the pipe diameter or material. Signal processing techniques will be designed to measure water depth and to identify the presence of water and three-phase electric cables. Measurement techniques will be programmed into the prototype tool.

- Phase 3 will focus on the search and selection of a manufacturer to commercialize the tool.

Results

Phase 1 demonstrated that it is possible to:

- Accurately measure water depth with an ultrasonic sensor on the bottom of pipe

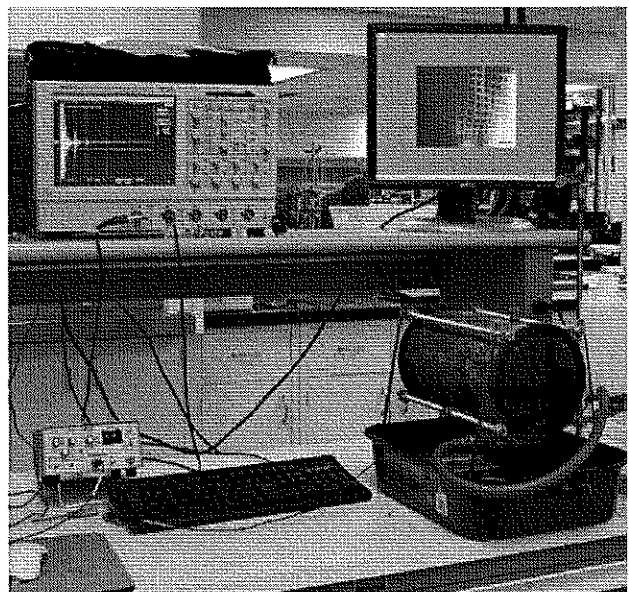

Experimental set-up to test the ability to measure water and oil depth.

- Determine if the water level in a pipe is above a certain level
- Determine if a main is completely full of water – either a water main or a gas main filled to the top with water – versus a gas-filled main (natural gas or air)
- Detect the presence of electrical cables in dielectric oil-filled steel pipe
- Detect live, three-phase electrical lines at voltages as low as 1200V with an acoustic sensor.

Phase 1 also demonstrated that estimation of gas pressure inside a conducting, nonferromagnetic pipe is possible using an Electromagnetic Acoustic Transducer (EMAT). Measurement of gas pressure inside a steel pipe would be possible if an EMAT that efficiently generates longitudinal waves in ferromagnetic material existed. However, substantial development work is required before such a sensor is viable.

A survey on the technology needs/market size found a viable market for a practical pipe contents tool. The market survey also found making measurements of water depth from the bottom of the main and the amount of pipe preparation required are both acceptable.

In Phase 2, an ultrasonic transducer (UT) is used to generate waveforms that can yield water depth and the presence of electrical cables from the outside of the pipe. A large number of waveforms were collected from pipes of different materials, diameters, and water depths. Using these data, an algorithm was developed to recognize the appropriate reflections automatically, and calculate an estimate the water depth. Algorithms were developed that determine the depth of water to + 1/8-inch. The appropriate depth information is displayed without the operator viewing or analyzing waveforms or data.

An algorithm was also developed to identify the vibrations created by three-phase electrical cables and alert the operator. The sensor used for live cables can be used on the surface of the pipe or the surface of the ground.

A prototype sensor holder was designed and built to hold the UT sensor against the bottom of the pipe.

Alpha prototype hardware was designed and an operator interface was designed and implemented. A LCD display is used to guide the operator through the measurement process in logical steps. The operator reads a menu and enters choices via a 16- key pad.

The hardware was assembled and tested; however, a functioning alpha prototype was not completed due to a variety of issues related to the commercial components used in the device.

Status

Various modifications are under way, including improvements to the pulser, which did not function as anticipated in testing. With a redesign of the pulse circuitry for the ultrasonic transducer and new components, the pulse circuitry is performing as expected, and transducer signal transmission is propagating in the material correctly.

Reflections of the ultrasonic signal are being amplified, and clear signals are received for digital signal processing.

Phase 2 activities were completed and the system was demonstrated in the laboratory.

To encourage engineers to use their microprocessors, manufacturers offer evaluation boards that include the hardware needed to evaluate the microprocessor. This provides engineers a method for evaluating the product. The manufacturer hopes its microprocessor will be the basis for a custom-design product that will sell in large numbers. For smaller markets, the evaluation board can be used as the basis of the product, substantially saving on non-recurring development costs. The latter approach was taken in Phase 2. Unfortunately, the hardware selected did not match the manufacturer's specifications and a functioning pre-prototype was not completed.

The Final Report for the Phase 2 was published and a proposal for the continuation of the project (Phase 3) was prepared and submitted to the current project sponsors.

Phase 3 involves the construction and demonstration of a pre-production prototype tool. There are three options

1. Select new evaluation hardware capable of providing all of the necessary functions
2. Develop a tool that only detects live three-phase electrical cables, or
3. Select new evaluation hardware capable of providing all of the necessary functions to measure water only.

For more information:

Maureen Droessler

Program Administrator

Operations Technology Development, NFP

Phone: 847/768-0608

maureen.droessler@otd-co.org

OTDOperations
Technology
Development**OPERATIONS INFRASTRUCTURE SUPPORT**

Development of Standardized Algorithms and Identifiers for Enhanced Material Tracking and Traceability

Efforts are under way to develop a series of protocols that can be used as a method for utilities to track their facilities. Current efforts build upon a standardized classification system developed in this program for underground utility assets to include meters, regulators, and transmission pipeline components.



Project Description

The precise identification of underground assets and other gas-system facilities is critical to utility infrastructure planning, risk management, and a wide range of other company activities.

Currently, there are various tools available and under development to aid gas utilities in locating buried pipe and facilities. However, even with the latest technologies, the data obtained is not standardized and may be insufficient for appropriate planning purposes. Adding to the issue are pending distribution integrity management initiatives that emphasize the need for identifying buried underground assets and mitigating risks. While ASTM standards address marking, the guidelines lack the specificity needed to be able to accurately track materials and products throughout the entire supply chain.

In response, project researchers developed a series of standardized algorithms and unique identifiers (standardized nomenclature or “language”) to more accurately characterize gas-utility assets. These “identifiers” can subsequently be used as building blocks to track materials (e.g., subcomponent fabrication, manufacturing, assembly, distribution, storage, and installation) both from an individual gas-company perspective and from an industry-wide perspective.

In Phase 1 of the project (now complete), a standardized classification system (base-62 encoding system)

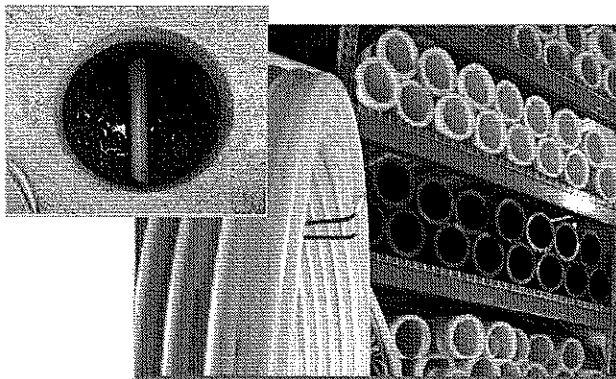

With a standardized set of protocols, utilities will be better able to manage their assets and respond to critical situations.

was developed to provide the basis to codify key attributes of a given component in discrete sizes and format to facilitate more effective tracking and traceability. Specifically, the 16-digit alpha-numeric code consists of datasets that provide information related to the manufacturer name, characterization of the component (size, material type, and component type), and product logistics (lot number and date of production).

The objective of Phase 2 is to validate the effectiveness of the base-62 encoding system through field testing to establish a standardized means of marking and to promulgate the newly developed ASTM F2897 methodology within the marking-requirements sections of various ASTM product specifications.

Deliverables

The Phase 1 deliverable included a validated series of algorithms to assist in the identification of the 20% high-use gas-distribution products; a set of validated “modules” (e.g., spreadsheets and database libraries) which can be integrated within gas utility company operations; and a draft standard for inclusion within ASTM standards and specifications.

Phase 2 deliverables include a petition to the U.S. Department of Transportation to reference the use of the algorithms and technical guidelines for each sponsoring company with respect to implementation options and requirements specific to their operations.

Benefits

Inaccurate or insufficient information related to buried assets during a critical time (such as a product recall, problematic pipe and fittings, etc.) can result in significant expense, lost time, and productivity losses. The development of standardized language at a national level would provide an effective method for tracking the assets of the overall gas distribution piping system throughout the entire supply chain. A standardized approach also provides the appropriate framework for the implementation of new techniques and technologies.

OTDOperations
Technology
Development**OPERATIONS INFRASTRUCTURE SUPPORT****Mitigating Electrical Interferences on
Cathodic Protection Systems**

To enhance the safety and lower the maintenance costs on steel gas-piping systems, research was conducted to identify or develop practices that mitigate the effects of electrical interference on cathodic protection and telemetry systems.

Project Description

Electrical interference can impair or entirely negate the effectiveness of cathodic protection (CP) systems used to prevent corrosion on steel pipelines.

Power-line surges, lightning strikes, and other transients will follow the path of least resistance from exposed points into the CP system. Examples of exposure points include: instrumented regulator vaults, meters and custody-transfer points, parallel high-tension lines, facility crossings, and rectifier stations.

Current electrical-mitigation practices address the steady-state levels of interference seen under normal conditions; however, the performance of these systems under extreme conditions, such as lightning strikes or power-line faults, is not well understood. A remote CP system that is disabled may go undetected for a long period. In addition, there is some evidence that AC interference can cause corrosion on gas pipelines, even with CP, but it is unclear whether this is caused by steady-state or transient events. (A transient or fault that does not disable the CP system may still leave some cumulative damage.)

While National Association of Corrosion Engineers (NACE) guidelines (e.g., RP1077) establish acceptable limits of induced AC or the interference from other facilities, these guidelines assume that the other facilities are operating normally.

In this project, research was conducted to identify practices that mitigate the effects of electrical interference on CP and telemetry systems.

Deliverable

Investigations will result in the development of detailed information on CP-interference issues, practices to address these issues, and recommendations for improvements.

Benefits

This project is being conducted to improve the reliability of remote CP and telemetry systems – equipment

that must operate unattended in order to be cost effective.

Application of research results can be used to assure that CP and telemetry systems can withstand transient events and continue operating safely and efficiently. In addition, research could lead to a reduction in the need to repair or reset equipment in remote locations.

In the case of CP systems, research results can be used to initiate practices to prevent possible AC corrosion. This will avoid future costs of repair to both the CP system and the infrastructure itself.

Technical Concept & Approach

- **Review of Utility Experiences**

Representative site data from participating utilities was used to better direct the investigation. Researchers also reviewed interference-mitigation practices in the gas industry.



- **Instrument Field Sites**

Selected field sites were instrumented to capture data on steady-state and transient interferences on CP systems. The instrumentation consists of battery-powered data-loggers and appropriate sensors. In addition to the normal sensors for CP parameters, the sites are instrumented for the detection of lightning strikes and power-line surges.

- **Investigation of AC Interference**

Investigators will interact with corrosion departments of the participating utilities to review the existing survey data and to collect additional field data.

- **Investigation of Transient Interference**

Researchers note that currently there is little data in this area and that lightning and power-line events may be occurring unnoted. The data-loggers will record both the standard CP data and transient events. The records from the data-loggers will be examined periodically to determine if significant transient events, such as lightning strikes or power-line surges, have occurred. These events would be cross-referenced with the standard CP data to determine if the two can be correlated.

- **Development of Conclusions and Recommendations**

Investigators will produce a technical report that details the project results and provides recommendations on practices and equipment that can protect CP and telemetry systems from interference damages.

Results

Initially, an extensive search of CP data-logging systems was performed to identify equipment capable of performing the measurements required for this study. A commercial unit (the WatchDogCP P2S-AC CP test station monitor and data logger) was chosen for field studies initiated at utility test sites in Idaho, Missouri, and Utah.

Technicians installed New Power Technologies' Sensor Guard systems to monitor the condition of the AC power line for over and under voltage conditions. The systems also monitor the ambient electric field to determine if a lightning strike is imminent.

There was significant turnover in the equipment at two of the sites. The lightning and AC interferences at these locations was more severe than anticipated. The re-

search team worked through these problems and all of the deployed instrumentation was brought back on line.

Data was collected at all three sites in 2012 and at one site in 2013 (the site with the most severe AC interference problem).

During the course of the experimental investigation and collection of data, it became apparent that both AC interference and transient events caused by lightning are distributed threats to cathodic protection integrity. A typical cause of AC interference is the parallel installation of power lines and gas lines that is becoming more common in congested utility corridors. The project also added to the empirical evidence that lightning strikes can couple into long runs of pipe. There is also the possibility that the local potential between the pipe and the soil in the immediate vicinity of the strike can be, momentarily, high enough to break down the coating.

These observations lead to the conclusion that a distributed mitigation may provide superior results to those located at a single point on the pipeline.

An additional observation is that in every instance that a rectifier sustained damage, the current causing the damage appeared to have originated from the pipe.

A hybrid approach was put through some early testing. This approach involves placing anodes in boreholes at regular intervals along the pipe. The anodes are connected to the pipe through an electronics package that drains off AC currents from the pipe while leaving the negative DC levels required for CP undisturbed. The approach can be thought of as "micro-wells" or a distributed ground bed.

The mitigation program will include a series of shallow wells connected to the pipe through AC decoupling devices. The wells will be added one at a time and the impact of each observed using the data logging equipment installed earlier in the project.

Status

The Final Report is in the process of being prepared.

For more information:

Maureen Droessler

Program Administrator

Operations Technology Development, NFP

Phone: 847/768-0608

maureen.droessler@otd-co.org

OTD

Operations
Technology
Development

Cathodic Protection Monitoring Technology Deployment



In this project, a research team is providing training and data gathering to support the deployment of cathodic protection (CP) technology. The focus of the project is on a low-cost CP monitor to provide more rapid and improved data collection to maintain safe operations.

Project Description

To maintain safe operations, gas utilities are required to take periodic pipe-to-soil readings on their infrastructure.

The current method for obtaining the necessary data requires that the utility maintain cathodic protection (CP) test stations that are routinely visited by corrosion technicians. It is required for some structures to obtain at least one reading per calendar year.

The focus of this project is on the deployment of a CP monitoring product that could greatly accelerate data collection and eliminate the maintenance of the test stations.

The monitor is a wireless, permanently buried device developed in a project co-funded by the Gas Technology Institute (GTI) Sustaining Membership Program and National Grid. Beta units were tested at several locations and found to be effective. A further development phase was conducted by 3M Dynatel that produced engineering prototypes that are compatible with

the same Dynatel handheld reading devices used for ID marker balls.

Once in place, the CP monitor can be located and read using off-the-shelf devices from 3M Dynatel. The locating and reading process is very rapid and can be done by an operator with minimal training.

In Phase 1 of the project, a modified CP monitor prototype was developed and tested in a field trial. Phase 2 focuses on modifications and further testing activities.

Deliverables

Deliverables include:

- A modified CP monitor prototype with enhanced features
- Locating devices and training for participating companies
- A commercialization plan.

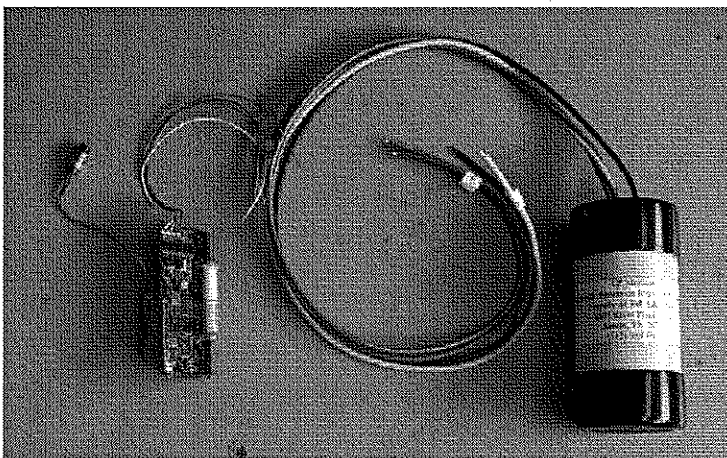

The current version of the wireless CP monitor consists of a sealed transponder that is connected to a buried reference cell. The monitor is placed in an excavation adjacent to the facility to be monitored. A wire from the monitor is attached to the main, with the reference cell attached to the monitor placed near the main. An exposed station above ground is not required.

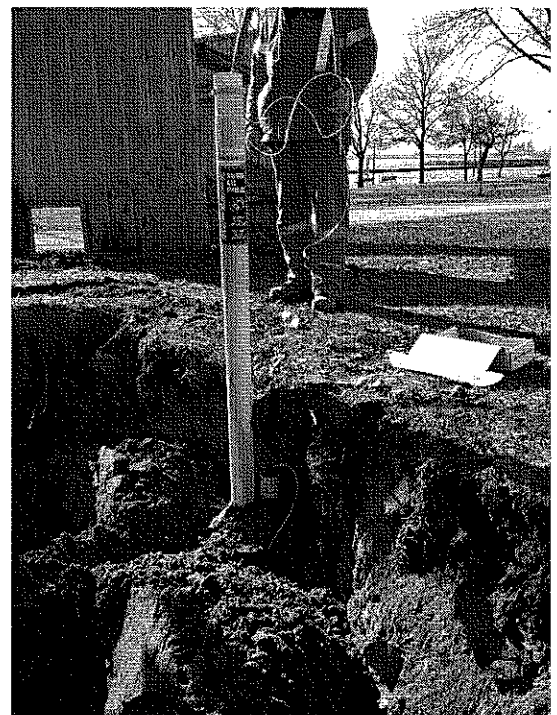

Benefits

The buried wireless CP monitor eliminates the need to maintain test stations between readings. It allows the routine readings to be taken rapidly by less skilled personnel, allowing the corrosion technicians to concentrate on more critical work. Monitoring of high-consequence areas can be recorded monthly and collected at the utility's convenience.

Technical Concept & Approach

Efforts are under way to develop a completely encapsulated, direct-burial monitoring device. A handheld locator/reader is used to retrieve the readings electronically from above ground without requiring a direct connection. The data can be downloaded from the handheld devices as tabular data. The monitor records and stores a pipe-to-soil potential reading once every 30 days. When an operator takes the reading, 12 months of data is recovered. This helps assure that the requirement of one read per calendar year can be met. In high-consequence areas, monthly reads can be obtained without monthly visits.

The first version of the CP monitor was successfully tested in Phase 1. As a result of testing, additional product requirements were identified.

The objective of Phase 2 is to develop and test a modified CP monitor prototype with some or all of the following features:

- Ability to record AC potential readings to detect stray currents
- Increased data storage
- Programmable data recording intervals, and
- Ability to transfer data to other handheld devices via Bluetooth™ for direct GIS integration.

Results

In Phase 1, four experimental units were installed near GTI facilities for long-term monitoring. Subsequently, four additional units were installed in the field and training was provided to utility personnel.

The schematics for the CP monitor were revised in preparation for a production run of prototypes. There

was also a need to upgrade the internal software of the handheld device that is used to locate and read the CP monitor.

The research team collaborated with 3M in the production of 100 beta samples for distribution to host utilities for testing.

Several utilities have responded to a set of requirements for test sites.

In 2013, qualification testing of the current generation of the CP monitor was completed and the first set of samples were sent to a project sponsor. A second field deployment and training trip occurred in April of 2014. (A third test site is being negotiated.)

The reader and PC software have required several iterations.

In-house testing of the CP monitor at GTI was completed. This included both indoor testing and testing on the GTI Pipe Farm.

GTI and 3M collaborated in producing a manual for the CP monitor.

All 100 sample parts of the 3M CP monitor were received. Some of these have been deployed to utilities.

Status

The project team is reviewing the desired modifications to the CP monitor with the manufacturer and the potential impact on the development of new prototypes.

A training session is schedule with a utility that will be sponsoring a field test sites. Efforts are under way to secure additional test sites and identify other avenues for field testing, such as independent corrosion contractors that may be willing to test the system.

For more information:

Maureen Droessler
Program Administrator
Operations Technology Development, NFP
Phone: 847/768-0608
maureen.droessler@otd-co.org



Operations
Technology
Development

North American Manufacturer Outreach Program



Research was conducted to identify promising technologies that could provide significant benefits to the North American natural gas industry and its customers. Efforts are directed at potential development opportunities in various gas-operations areas.

Project Description

The North American Manufacturer Outreach Program is an effort to identify new gas-operations-related technologies that are not currently available from North American manufacturers, facilitate development, and accelerate the introduction of new products into practical applications.

The intent is to find technologies that are promising but not currently in full development due to a lack of financial resources or for other reasons.

In this project, market research was conducted to identify technologies through a formal program of interaction with technology developers and manufacturers. This program solicits proposal ideas for new or improved technologies from manufacturers and assists with the proposal development for projects of interest in an effort to facilitate and accelerate the development and introduction of new technologies to meet gas industry needs.

Deliverables

The results of this research will be a collection of ideas for consideration for OTD support.

Reports will be assembled to provide company-by-company summaries of the responses gathered from the manufacturers.

Benefits

The results of this project will be used to guide further implementation of technologies that reduce operational costs, improve safety, or reduce risk. Through this program, new and innovative ideas and product concepts are identified through a streamlined process designed to shorten product-development times.

Technical Concept & Approach

This project focused on identifying technologies for potential further investigation and demonstration.

OTD participants will have the opportunity to sponsor further development efforts, laboratory testing, field tests, and/or commercialization efforts.

The types of technologies reviewed included:

- Products from manufacturers' product development roadmaps

Interactions with various organizations identified promising products and opportunities.



Information was developed on:

- > Application of Equipment
- > Stage of Development
- > Potential Benefits
- > Economics and Costs
- > Safety Considerations
- > Market Readiness
- > Training Needs
- > Patent and License Issues
- > Potential for Adapting to the North American Market.

- “Second-best” ideas from manufacturers that may be a higher technology risk
- Technologies that need field trials during the development stage.

Manufacturers were contacted to determine their interest in participating with OTD in new product development and exploration activities.

Information was gathered through literature searches, conferences, patents, and various websites. Phone interviews were conducted with personnel representing consultants and manufacturers.

Results

Through this project, many manufacturers were identified and informed of the opportunities through OTD. Several manufacturers submitted quality ideas for proposal considerations; others submitted ideas for review, but were not ready to submit them for proposals.

A page on the OTD website was developed to assist in the dissemination of information to interested manufacturers.

Among the submitted concepts currently under consideration are:

- A low-cost ultrasonic collision warning system for low-speed collision avoidance that produces driver alerts and if/when necessary, automatic braking for utility vehicles

- A spray-on coating system for 12-inch-diameter pipe rehabilitation (the system currently exists for 24-inch and above)
- Robotic internal pipe-coating equipment that meets the requirements of natural gas distribution operations
- Tension and pressure monitoring with data logging for small-diameter horizontal directional drilling applications
- A cured-in-place liner system to reconstruct or repair existing gas distribution and service pipe.

Status

The research team continues to contact previous companies that indicated there was a potential for a project idea and identify new companies with potential project ideas.

Investigators are also providing assistance to companies in submitting proposals.

For more information:

Maureen Droessler
Program Administrator
Operations Technology Development, NFP
Phone: 847/768-0608
maureen.droessler@otd-co.org

OTDOperations
Technology
Development**OPERATIONS INFRASTRUCTURE SUPPORT****Enhancing the EZ Valve by Developing a
Weld-On Steel Housing for Gas-Distribution Use**

In a follow-on project to a previous effort, enhancements are being made to the EZ Valve for natural gas applications through the development of a steel-bodied version that can be welded on after installation to allow for a more permanent, leak-free system.

Project Description

The EZ Valve from Advanced Valve Technologies, Inc. (AVT), is a versatile fitting designed to perform multiple flow-stopping tasks on water- and gas-distribution pipes. It is mounted (bolted on) as an encirclement pipe fitting after a slot is milled in the top portion of the pipe. The operation does not interrupt the flow of gas and can function as a temporary line stop or as a permanent mainline valve.

This project involves modifying the EZ Valve housing design so that the valve can be welded onto the pipe after its installation to allow for a more permanent, leak-free fitting. The goal is to develop and test a weld-on housing to provide the ability to use the valve on natural gas distribution systems at pressures of 125 psig without leaking.

Deliverables

The deliverables for this project will include a field-ready prototype, weld-on steel EZ Valve fitting in one size (size to be determined). Based on the results of the beta prototype EZ Valve, a follow-on project may be recommended to perform field evaluations of the EZ Valve.

Benefits

The gas distribution industry would benefit from a lightweight valve or line-stop fitting that can be quickly installed and operated to control the flow in gas mains. Current line-stopping equipment and fittings are large, expensive, and time consuming to install. The EZ Valve can benefit the industry if used as a line-stop fitting for cut offs or stopping the flow in gas mains when a bypass is not required.

The benefits for an enhanced EZ Valve include the following:

- The EZ Valve can still be used for emergency shutdown with greater efficiencies and can then be welded in place after the situation has been addressed.

- A boom or backhoe is not necessary to install the fitting. A two-person crew can lift all the parts and perform the installation and tapping of the valve in under an hour.
- The EZ Valve can be welded onto the pipe by a certified welder after the valve has been installed.
- The EZ Valve can be used as a typical line stop or it can be used as a permanent mainline valve.

The EZ Valve has the potential to make an impact on how the gas industry controls the flow of gas in pipelines. It can replace a portion of today's older, much heavier flow-control equipment that can be more time consuming to install.

The EZ Valve can be installed in strategic locations in the distribution system without the need to shut off the flow of gas, therefore resulting in smaller excavations, less time for installations, and lower costs.

Technical Concept & Approach

The scope of this project is to jointly develop an EZ valve weld-on housing for the natural gas industry. AVT will manufacture prototypes for laboratory testing and evaluation. Gas Technology Institute (GTI)

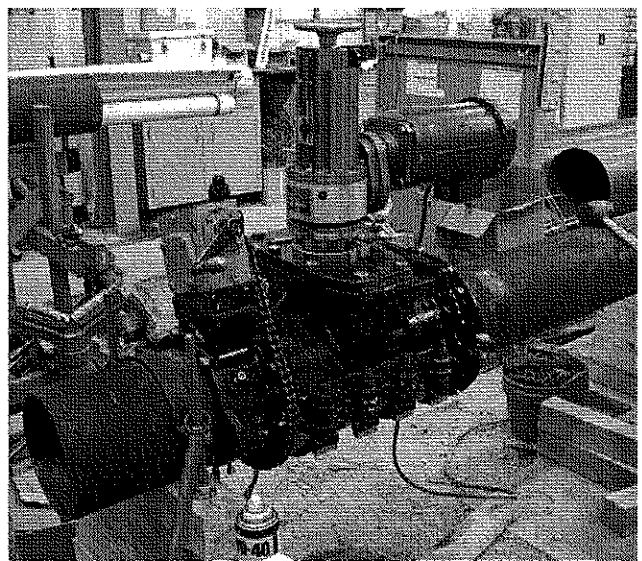

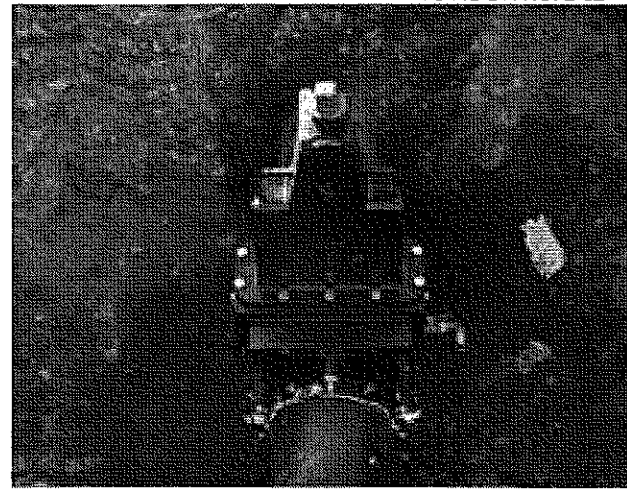
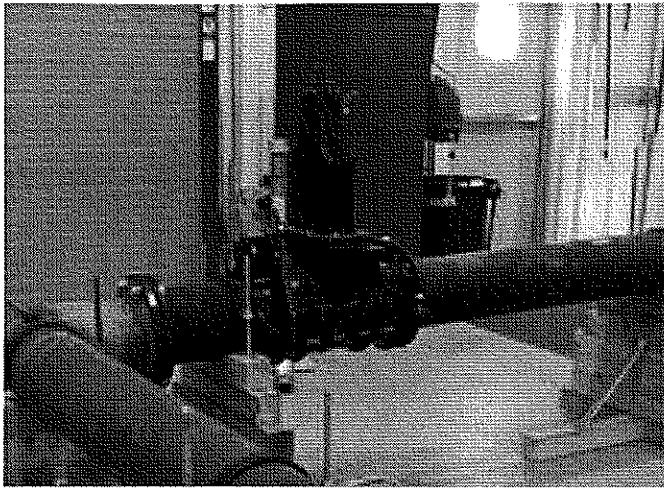

will provide testing and assist with the functional specifications of the component.

Initial testing will determine the fit and material quality of housing. Once the correct sizing has been established, the prototypes will be transferred for evaluation of operational function, welding, and pressure testing.

Upon completion of the live testing, the project sponsors will decide whether the need exists to further test the product.

Specific tasks include:

- The Generation of Concepts for the Steel-Bodied Housing for the EZ Valve
- The Development of Detailed Manufacturing Drawings
- The Creation of an Alpha Prototype Housing Made of Steel
- Alpha Prototype Evaluation and Testing
- Redesign and Modification of Alpha Prototype Housing .

The basic installation and operation of the current EZ Valve is displayed in a six-minute video on the AVT website: atvfittings.com. The installation includes bolting the fitting, milling out a slot across an arc of the circumference of the pipe, cleaning out the chips, and installing a flat gate valve. The EZ Valve is currently available in 4-inch to 16-inch sizes (maximum pressure is 250 psig). The valve can be applied on both steel and cast-iron pipe

Results

A set of design assumptions (based on an initial survey and other input from sponsors) was used in developing an initial conceptual design.

The concept allows the user to bolt on the fitting, mill the slot in the top of the pipe, and either perform the stopping operation and then weld it in place or weld it in place first and then perform the stopping operation.

These needs were considered when creating the conceptual designs:

- Applications for both line stopper and line valve (for emergency and scheduled maintenance situations)
- Applications for steel pipe
- Diameter ranges: four inch to eight inch
- Pressure ranges – up to 60 psig (100 psig desired)
- Bolt on fitting which can then be welded on after tapping/cutting
- Material costs less than \$3,000 - \$4,000.

Status

Interactions are under way with the manufacturer to review and finalize the concept design. AVT is investigating products from past fittings with similar designs to incorporate into a weld-on product.

Draft designs have been completed. Next steps include the development of manufacturing drawings based on the final design concept and determining the schedule and details of prototype production.

For more information:

Maureen Droessler
Program Administrator
Operations Technology Development, NFP
Phone: 847/768-0608
maureen.droessler@otd-co.org

OTDOperations
Technology
Development**OPERATIONS INFRASTRUCTURE SUPPORT**

Evaluation of Static Suppressors on Existing Polyethylene Piping Systems

To maintain safe operations, utilities use a variety of products and methods to reduce or eliminate static associated with plastic pipes. In this project, an evaluation is being conducted of different types of suppressors that may prove to be more effective and efficient than conventional static-suppression methods.



Project Description

The reduction or elimination of static in and on polyethylene (PE) gas distribution systems is critical to safe utility operations. When PE pipe is charged by particulates (dust, rust, etc.) flowing in the gas stream, charges are generated initially in the interior of the pipe. The electric field resulting from the interior charge induces an exterior charge on the pipe via conducting paths through moist atmosphere and contamination effects.

Standard safety procedures involve wrapping the pipe with wet, soapy burlap. This procedure is effective for neutralizing exterior charge accumulations, but does not affect the interior charge and may even increase the likelihood of a static-through-wall discharge event.

To reduce static, some utilities are using or considering the use aerosol static suppressors and other products. The manufacturers claim that these are true antistatic products and therefore superior to soapy burlap.

This project initially focused on an evaluation of the effectiveness of the two Ionix products to assure that their use on or in PE piping systems eliminates static

charge without reducing the pipes' life or the long-term performance of the associated fusion joints.

According to the manufacturer, the Ionix spray is less expensive, more effective, and easier to use than soapy-burlap or plastic-film techniques.

The Ionix MA is a chemical additive to mercaptan. According to Ionix, when added to the mercaptan tank, Ionix MA is carried off through the gas distribution system with the mercaptan and eliminates any static inside the gas system downstream of odorizing.

In 2013, a third product – Statikil PE spray – was added to the evaluation. According to the manufacturer, Statikil PE effectively eliminates static charges on PE gas pipe by increasing surface conductivity. It also eliminates the need for bulky burlap or pipe wraps.

Deliverable

Testing results will be presented in a detailed report to project sponsors.

Benefits

Reducing the risk of static discharge can help to assure the safe operation of PE piping systems. The products under evaluation may provide a greater level of safety during PE pipeline repair operations and the integrity of the PE pipeline will not be compromised.

Technical Concept & Approach

Research includes:

- In-depth discussions with manufacturers and others to obtain detailed information regarding the products and product performance
- A thorough literature review
- A survey of OTD members to determine current practices, extent of use related to Ionix products,

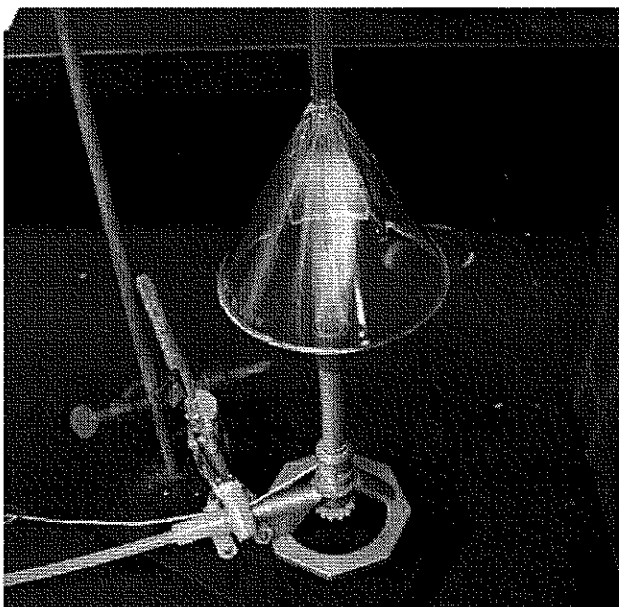

Laboratory testing.

information regarding known static-related incidences, cost of current practices, and possible revisions to current procedures if Ionix products are implemented

- A static-flow-loop evaluation to review the performance of the Ionix spray, Ionix MA, and a combination of both
- An evaluation of Statikil PE
- The development of a business-impact study.



To frame testing activities, researchers will perform a chemical analysis to identify the constituents of the Ionix products.

Plans are for the research team to subsequently partner with a gas utility in Kentucky, use its system as a case study, and perform long-term testing on samples removed from the system that have been exposed to Ionix MA product for more than three years. The project includes short- and long-term testing on both control and in-field piping specimens removed. In addition, various butt-fusion and lateral-joint-fusion tests will be conducted on PE pipe specimens that have been exposed to the Ionix products.

Considerations will be given to the fact that the Ionix products can be used both on the outside as well as the inside of the pipe.

Positive results may lead to future investigations into use of the products to eliminate static from the inside of pipes by directly injecting it into the gas stream.

Results

A flow loop for product testing was devised based on technical operation of the Ionix products and previous flow-loop experience. A test procedure was also developed. A number of samples of PE pipe that had been used with Ionix MA for approximately two years were evaluated for degradation. Tests indicated no notable diffusion of Ionix into the PE. Additionally, no oxidation was detected.

The Ionix MA dilution in t-butanol was also successfully evaluated.

Flow-loop tests with Ionix MA and Ionix Static Suppressor were completed in 2012. Results indicate that Ionix MA can reduce internal static charge provided that there is a grounding path from the flow stream. The degree of charge reduction is dependent on the amount of Ionix MA injected. Regular Static Suppressor and cold temperature formulation (40% propylene

glycol) show similar results. The charge remains low after wiping and washing with water.

Flow loop tests with Ionix Static Suppressor indicate an immediate and significant reduction in external net charge upon application. Regular Static Suppressor and cold temperature formulation (40% propylene glycol) show similar results. The charge remains low after wiping and washing with water.

Combustion testing of Ionix MA and flow-loop tests using a common non-Ionix external static mitigation procedure were completed in 2013. Results indicate that Ionix MA does not significantly affect the flame when vaporized in the gas. Flow-loop tests with Ionix MA were repeated using digital datalogging of the electrostatic field meter to obtain improved data quality.

Flow-loop and sidewall fusion testing with Statikil PE was performed, showing that Statikil PE does neutralize the external static field.

Status

Statikil PE is being evaluated using the closed flow-loop setup used with the Ionix product. Sand is being used for inducing static charge in the PE pipe. Statikil PE is being applied to the PE piping and a series of measurements will be carried out to determine how effective Statikil PE is in eliminating static charge. The results of this testing will be compared with those of other anti-static products.

For more information:

Maureen Droessler
Program Administrator
Operations Technology Development, NFP
Phone: 847/768-0608
maureen.droessler@otd-co.org

OTDOperations
Technology
Development**OPERATIONS INFRASTRUCTURE SUPPORT****Indoor Air Quality and Safety Issues**

Through this project, a website of vital information on indoor air quality and safety issues was developed for OTD members. The site provides a center of expertise and a single-point access to scientific data, performance information, and natural-gas-related issues.

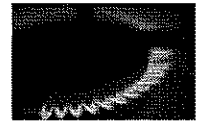
**Project Description**

When seeking to determine causes for an indoor-air-related incident or health trend, products of combustion are often assumed to be the culprits, when other conditions could be responsible.

Experts contend that to address the issue considerable information needs to be developed – and existing information needs to be more readily available.

The natural gas industry has long supported R&D to generate data and advance technologies to address indoor air quality and related environmental and safety issues. Also, in recent years a variety of information on air-quality issues has been developed by various other organizations, including the American Lung Association and the U.S. Consumer Products Safety Commission. Among other issues, research has focused on the efficacy of carbon monoxide (CO) alarms under varying indoor temperature and humidity conditions, emissions from unvented space heaters and residential ranges, and nitrogen dioxide (NO₂) emissions from

several forms of burners used in gas appliances. Research findings have been used to provide a sound basis for government regulation and a response to other audiences seeking solutions to large and complex issues.

Cause for particular industry concern is the widespread recommendation of the use of CO alarms in manufacturers' installation instructions. The general association of CO alarms with gas-fired appliances further emphasizes a need for the industry to provide an ongoing technical resource.

Through this project, a research team developed and is supporting a website as an industry resource for responding to indoor CO, NO_x, and other issues.

Deliverables

The deliverables for this project are:

- An organized database of indoor-air-quality and related safety information generated over the last 30 years
- Information from gas industry experts in the field of residential appliances and indoor air quality
- Development of a consortium to advise, fund, and establish priorities for the effort
- The establishment of a center of expertise on indoor air quality and related safety issues.



A website for OTD members provides easy access to pertinent information from a wide range of sources.

Benefits

Through the development and dissemination of information on indoor air quality, the natural gas industry can enhance customer and worker safety while providing operational savings.

Technical Concept & Approach

- **Data Search and Organization**

A significant amount of literature from Gas Re-

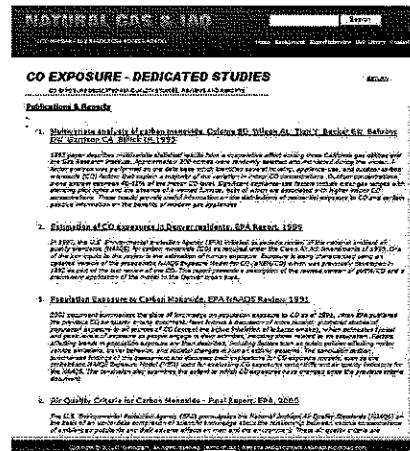
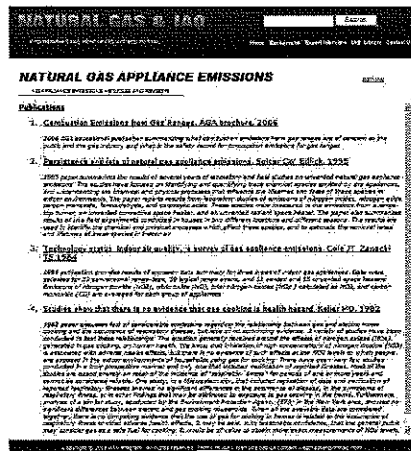
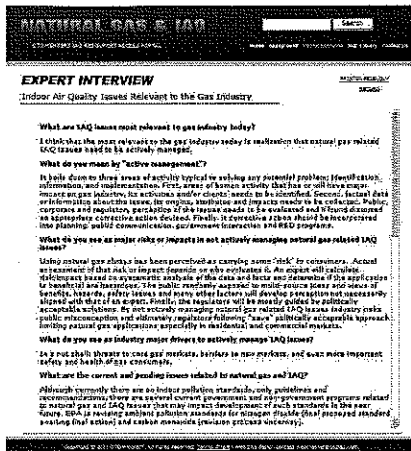

The Natural Gas & IAQ website provide answers to some of the gas industry's most critical questions.

Search Institute – beginning in the 1980s and continuing past 2000 – provided a foundation of published literature for this effort.

Sponsor Involvement

Initially, sponsors reviewed records provided by experts, were involved in interviews, and assembled a consortium to support the effort into the future.

Additional Activities

Additional phases of work may be proposed to support industry needs for technical consultation, interactions with the consortium, and the preparation of reports and presentations.

Results

An extensive literature search generated a list of more than 270 publications related to natural gas appliance indoor air quality. The publications were reviewed to eliminate redundant or less relevant materials.

In 2011, a website titled *Natural Gas & Indoor Air Quality* was developed and made available to OTD members through the OTD website (otd-co.org).

The website includes an extensive indoor-air-quality library, providing on-line access to:

- Gas Research Institute Reports
- Information on Natural Gas Appliance Emissions
- Indoor Pollutants Exposure Studies

- Dedicated Studies on CO Exposure
- Information on CO Detection and Prevention
- Dedicated Studies on NO₂ Exposure
- NO₂ Measurement and Mitigation Information

The site also provides links to information on industry programs and activities related to natural gas and indoor air quality.

Interviews with industry experts were consolidated into a Q&A format to address the most pertinent issues for the natural gas industry.

Since the introduction of the website, researchers have been adding data to the website, performing analyses, and responding to industry requests.

Status

Pending further developments, all activities for this project are expected to end in 2014.

For more information:

Maureen Droessler
Program Administrator
Operations Technology Development, NFP
Phone: 847/768-0608
maureen.droessler@otd-co.org



UV Degradation and Static Buildup Testing of Personal Protection Equipment Fabrics

In this project, researchers tested various utility-vest materials to determine if degradation is caused by ultraviolet light and to evaluate the potential for static buildup to become hazardous.



Project Description

Natural gas utilities have observed that the color and static properties of safety-vest materials change as the material ages. In some cases, these changes occurred after only one or two months of use.

In this project, tests were performed to determine if exposure to ultraviolet (UV) light was causing these changes. Measurements confirmed that vest color and static properties do change as a function of exposure to UV. In the case of static electricity, the surface resistance of some, but not all, vest materials changed with UV exposure.

Additional testing was conducted to determine if static charge buildup on a safety vest can be generated and, if so, can it be high enough to cause ignition in a natural gas/air mixture.

Deliverables

Deliverables include:

- A methodology for measuring energy in static discharge sparks from vests
- Testing and quantification of amount of spark energy that can be generated and discharged from vest materials with a range of surface resistances.

- A report documenting the results for each submitted vest.

Benefits

Safety vests provide an important visual alert that utility crew members are present. Results from this project will help to enhance the safety of utility operations for both utility workers and the public.

Technical Concept & Approach

Initially, UV testing was conducted on several materials used in utility vests. This project also involved the development of a testing procedure for measuring spark energies and an initial assessment of ignition hazard from safety-vest sparks.

The research team identified vest samples with surface resistances that span those of the previous measurements.

Each sample was charged to voltages up to 60,000 and the spark energy measured. Because surface resistance is the controlling factor in spark energy, measuring discharges from materials with a wide range of surface-resistance values identifies potential safety hazards.

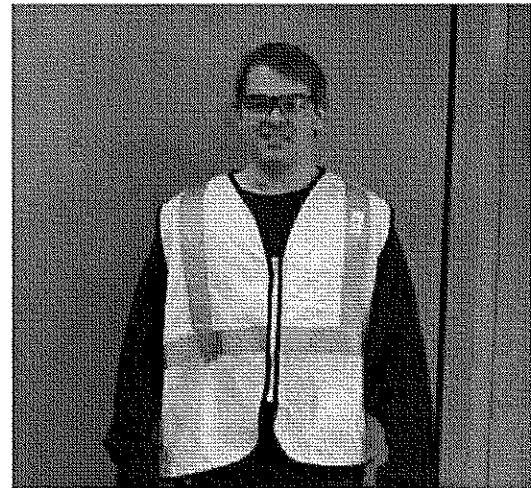
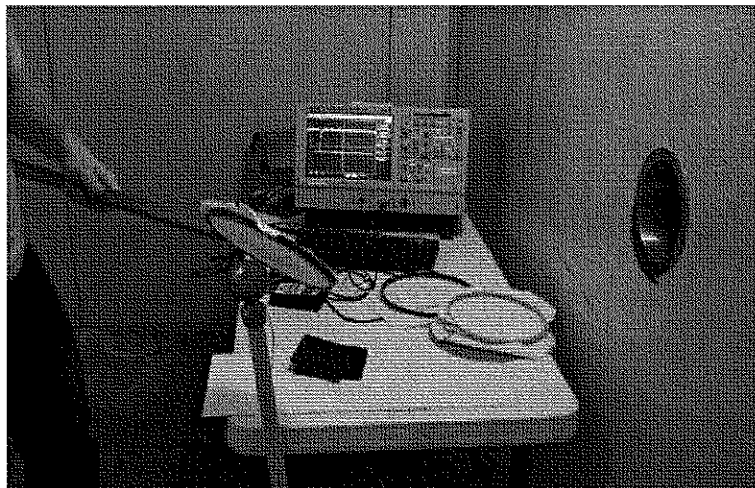

An experimental apparatus (left) was developed to measure energy in a static discharge.

Results

During the project, researchers conducted assessments of hazards from static discharges with a technique called the Shirley Method 138: 2000. This method does not measure energy directly; rather, the static is discharged in the presence of a combustible gas. If after 50 attempts, no ignition occurs, the material is considered safe.

In addition to performing the tests in hydrogen, the laboratory modified the Shirley Method equipment to use natural gas.

Three rounds of Shirley Method testing were performed on a total of 12 vests. Testing conditions were selected to present worst case scenarios. Test methods demonstrated that static electricity from some commonly used vest materials can ignite an air/natural gas mixture.

Ten vests were tested to determine if exposure to UV affects color and static properties. Some vests also underwent limited testing with washing. Measurements confirmed that vest color and static properties do change as a function of exposure to UV. In the case of static electricity, the surface resistance of some, but not all, vest materials changed with UV exposure. As discussed in a report to sponsors, the surface resistance of the material is an important factor controlling the amount of static voltage buildup on the material and the energy in the spark discharge.

Significant Findings from Static Discharge Research:

- The risk to static discharges involves more than the charge build-up on safety vests. For example, it is known that the body can store enough static charge to ignite a natural gas/air mixture. Therefore, any source of static build-up in an operator's body is an issue. The measurements were limited to the charge build-up and discharge on the vest material itself. It did not address discharges of static electricity from the body or other articles of clothing worn by natural gas operators.
- It is difficult to generate and maintain static electricity on vest materials with low surface resistance. The charge dissipates/recombines quickly, preventing energetic sparks. Low surface resistance can be achieved in a number of ways, including use of a surface coating and special fibers woven into the material.
- Having a modest amount of surface resistance is beneficial if it permits recombination of charge at a controlled rate.
- A person wearing a vest with high surface resistance over a 100% wool sweater can generate static voltages in excess of -25,000 volts.

- High static voltages (in excess of -28,000 volts) were generated on some vest materials with high surface resistance. In some cases, the measured spark discharge energies were large enough to ignite a 9% natural-gas-in-air mixture. In other cases, the surface resistance is so high that the spark will not ignite a natural gas mixture. Such materials still present a hazard if the charge transfers to the body and is discharged by a path not involving the vest.
- Measurements demonstrated that for some high resistance materials, a static discharge to a grounded object does not remove all of the charge from the surface. It often reduces the amount of static charge so that it is low enough that a second discharge does not occur.

Status

All testing was completed in 2013. A Final Report was issued in May 2013.

Based on the experimental results and additional information obtained in this project, researchers provided the following recommendations:

- The number of vests tested in this phase of the project was limited. Utilities should review the list of vest materials and select additional items for testing as appropriate. In addition, new vest materials should be tested as they are developed. Testing should be applied to used as well as new vests.
- The Shirley Method 138: 2000 should be used as the screening method for acceptance of vest and overall materials. To provide an extra factor of safety, the Shirley Method should be used with hydrogen rather than 9% methane in air.
- Care should be taken when selecting combinations of garments (e.g., the safety vest and the undergarment). Seat material in vehicles can also be a factor in static built-up.
- Vests should be inspected to insure they are labeled and that there are no obvious discrepancies between the label and the vest.

For more information:

Maureen Droessler
Program Administrator
Operations Technology Development, NFP
Phone: 847/768-0608
maureen.droessler@otd-co.org

OTDOperations
Technology
Development**OPERATIONS INFRASTRUCTURE SUPPORT****Dewatering Systems for Mains and Services**

In this project, investigators studied novel and commercially available dewatering technologies in an effort to develop a new system for the removal of residual water from gas mains and services. Current research focuses on an evaluation of chemical surfactants and the development of guidelines for product use.

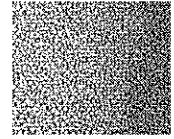
**Project Description**

The presence of residual water in intermediate- and low-pressure natural gas lines can increase the potential rate and extent of corrosion, create hydrate formation, and cause outages during months of high demand.

Residual water presents a particular concern in cold-weather climates as gas velocity increases with demand. Water can migrate to meters and regulators and freeze, causing failures and service interruptions.

Currently, dewatering intermediate- and low-pressure mains and services can be an expensive and time-consuming process.

In Phase 1 of this project, researchers investigated two water-removal methods: 1) foam lifting products to move the water out of the low areas, and 2) fixtures, such as separators and desiccant filters, which can be strategically placed throughout the piping system.

Phase 2 includes: 1) Further research and evaluations of chemical foaming surfactants that demonstrated good promise in the first phase of the project; 2) Analysis of the potential safety issues and impact of these products when used to remove unwanted residual water in natural gas piping systems; and 3) The establishment of guidelines for the products' use based on the research and evaluations.

Deliverables

The deliverables for this project include reports detailing the results of the investigation into current water-removal systems, information on the use of surfactants for dewatering mains and service lines, and a set of guidelines on applying this technology to assist in the removal of residual water from natural gas distribution systems.

Benefits

Direct benefits of an enhanced dewatering system include: lower utility operations costs; reduction in pavement restoration due to fewer road cuts; fewer operational failures; fewer customer outages; and enhanced system integrity and reliability.

Technical Concept & Approach

Phase 1 included:

- **An Investigation of Industry Standards and Current Market Solutions**

This task included surveys and other methods to examine current water-removal practices and common occurrences. Technologies explored included

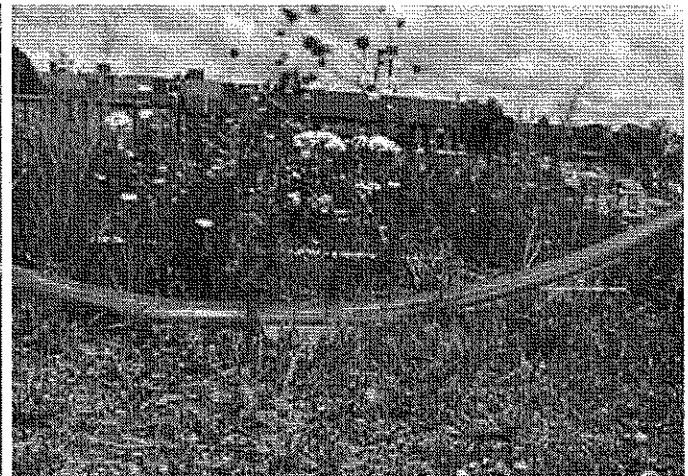
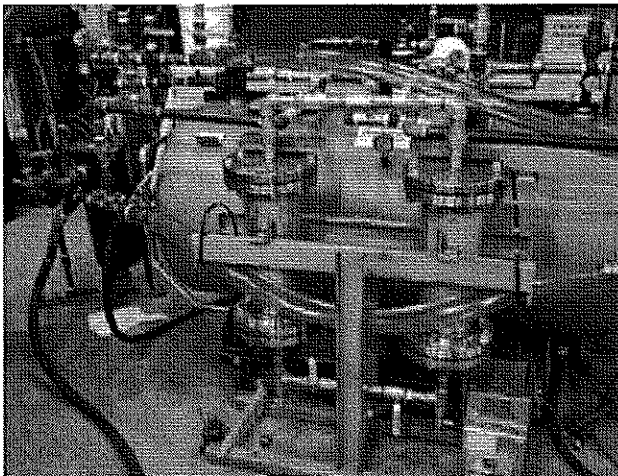

Left: Testing configuration for foaming agents. Right: Testing in the field.

camera and vacuum operations, pigging operations, surfactants, as well as tools from other pipeline industries for water displacement or production.

- **Evaluation and Transfer of Technologies**

Desiccant systems and foaming agents were investigated.

- **Evaluation/ Design/ Modification of Solutions**

Prototype systems will be constructed of the most promising technologies, and evaluated for adequate operation.

Phase 2 focuses on the further investigation of one of the promising foaming surfactants.

Individual tasks include:

- **Investigation of Health Concerns of Surfactants**

Researchers will analyze the various surfactants in the marketplace and determine whether they pose any potential risks to human health.

- **Evaluation of the Effects of Surfactants on Gas Systems**

Researchers will determine how surfactants may affect the natural gas system, including pipe materials, regulators, meters, and other components.

- **Development of Guidelines**

A set of guidelines will be developed for the use of surfactants to assist with dewatering efforts. This may include recommendations on the implementation of other technologies, such as separators and desiccant technologies.

- **Field Demonstration**

This may be conducted on an actual natural gas system or a simulated system setup.

Results

This project began in 2011 as an investigation into current industry standards and market solutions.

Researchers evaluated two water-removal methods: 1) a method for the removal of water from low points in the gas distribution system using foam surfactant products and 2) a method that included an examination of the devices installed on the pipeline that are designed to remove the water from the system (e.g., drip pots, separators, and filtering devices).

In Phase 2, further research was conducted into the chemical makeup of foaming agents and their use on natural gas systems. Research found that makeup varies

across industry and function with different ingredients added for specific applications. The health effects of the different chemicals were also investigated.

Research indicates that:

- Filtration membranes may be used to cheaply generate N_2 in the field. This can then be used to introduce a slug of dry N_2 to reduce the dewpoint in a line to near zero for effective drying (even from saturated porous sidewalls of pipes) or to push dewatering pigs through lines.
- Foaming/defoaming agents could potentially be a useful option for eliminating water in low gas-flow-rate regions of a distribution system, provided a correct dose can be ascertained.
- Dehydrators do not appear to be suited to best practices. The expense, maintenance requirements, and use of flaring all make this approach unattractive for use on gas distribution systems.
- Pigging is an attractive option for use on straight runs of pipe where lateral branch lines are absent. If present, these side branches will be charged with fluid on approach of the pig, and simply empty water back into the main line after the pig has passed.
- Portable jet (venture) vacuums may be used in distribution pipes as a less expensive solution to vacuum trucks, although they face some of the same technical limitations as vacuum trucks.
- Autodumps can be added to existing or new sump installations to reduce frequency of maintenance.

Status

A Final Report detailing Phase 1 testing results was issued in October 2012. Three videos of field-testing operations are available at the OTD website.

Test foaming of defoaming agents is ongoing.

The research team is interacting with dewatering service providers (mostly for production wells) and manufacturers of fluid filtration systems to gain their expertise and assistance to meeting the needs of the natural gas industry.

For more information:

Maureen Droessler

Program Administrator

Operations Technology Development, NFP

Phone: 847/768-0608

maureen.droessler@otd-co.org

OTDOperations
Technology
Development**OPERATIONS INFRASTRUCTURE SUPPORT**

Development of Environmentally Conditioned Personal Protective Equipment

For this project, researchers investigated environmentally conditioned devices for use with personal protective equipment (PPE). Both wearable and area-cooling systems were studied. The goal is to develop a prototype system designed for use by gas industry personnel.



Project Description

Utility workers in elevated-temperature environments often contend with heat accumulation inside the increasing layers of personal protective equipment (PPE) required for employee safety. Wearing layered PPE creates an environment where heat-affected injuries can easily occur.

While solutions to cooling the human body underneath protective garments exist in other industries, many of the methods are not rated for use in a gaseous atmosphere or will not function properly when applied underneath the multiple layers of PPE sometimes required in the gas industry.

This project focused on the evaluation and modification of PPE technologies specifically for the natural gas industry.

Deliverables

The main deliverable will be information needed to develop a prototype cooling system able to reduce the user's core body temperature while not affecting the

efficiency of the PPE. In addition, an analysis of current market solutions will be supplied.

Benefits

If unchecked, elevated core body temperature and internal suit humidity levels (which initially lead to degraded worker performance) can eventually lead to incapacitation through dehydration, fatigue, heat stroke, and possibly even death. To avoid heat-related injuries, utilities often employ replacement workers onsite, creating a rotation allowing workers to cool down on a regular basis. While this does much to improve worker comfort, the added financial burden can be cumbersome.

A proper cooling solution designed for natural gas industry personnel wearing personal protective equipment will reduce accidents and injuries caused from heat exposure, as well as increase productivity.

Technical Concept & Approach

This project included the following tasks:

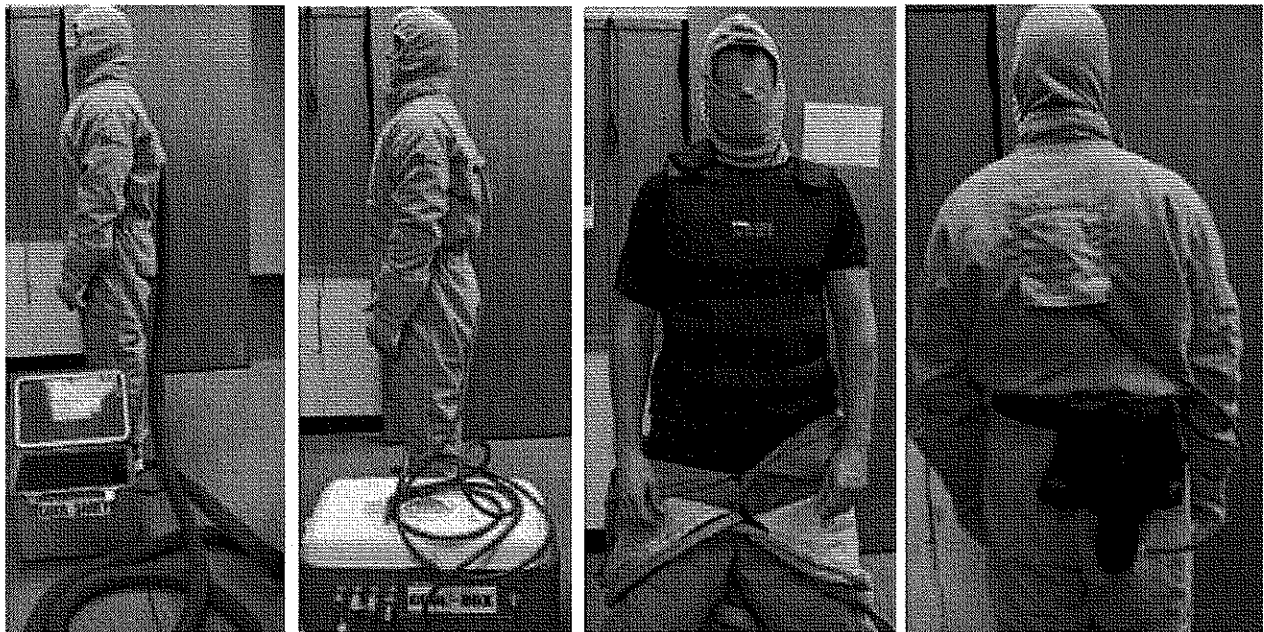

The research team investigated (from left to right): Water Cooling Vest, Air Cooling Vest, Frozen Polymer Vest, and Liquid CO₂ Vest

- Analysis of Existing Practices
- Evaluation of Current Market Solutions
- Design, Modification, and Testing of Industry-Specific Solutions
- Analysis and Reporting.

Results

Initial activities focused on gaining an adequate background of current government standards set by the Occupational Safety & Health Administration and the National Institute for Occupational Safety and Health; gathering educational materials on heat-related injuries; gaining information from utilities; and reviewing currently available market products.

To ensure that the system designed properly fits the needs of the industry, a survey was developed to gain a better understanding of sponsor needs.

Five cooling conditions were evaluated: 1) No Cooling (Control); 2) Circulating Water Vest; 3) Frozen Polymer Vest; 4) Liquid CO₂ Vest, and 5) Air-Cooled Vest.

All conditions included the standard protective clothing and equipment (extraction suit with full-face respirator mask). The no-cooling control provided a standard reference for the cooling systems.

The primary testing environment was a standard desert condition (called Desert II in military studies) at 40°C at 30% relative humidity. A second environment was a subtropical condition (called Jungle in military studies) at 35°C at 50% relative humidity.

Work was simulated by walking on a treadmill.

The results were a statistical comparison of the four cooling systems to the no-cooling control and comparisons among the pairs of cooling systems for relative differences.

Three cooling systems were all significantly better than the no-cooling control. There were no effects due to environment, which suggested that the results could apply to a variety of environmental conditions because the protective clothing isolates the person from the environment. The early evidence on the Liquid CO₂ Vest is that it is somewhat better than no cooling but not as effective as the other systems. All of the systems reduced the heat storage rate by one-half compared to no-cooling condition.

Based on the testing results, two of the tested cooling systems presented clear evidence that they can manage

the heat storage: The were the Air Vest and the Water Vest. Both suits require a tether between the heat sink and the operator. Selection of either of these can be made considering the local logistics. There is an advantage to the Water Vest because additional cooling rate can be accomplished by covering a greater body surface area with a jacket and/or pants. In addition, the Water Vest requires a much lighter cooling reservoir of 26 pounds compared to the 90-pound Air Vest heat exchange cooler. However, the Water Vest requires an A/C power source to power the water circulation pump.

The Frozen Polymer Vest is more difficult and will require doffing most of the clothing to accomplish it. The Liquid CO₂ Vest is also easy to recharge (replace the bottle). Another usage note for the Air and Water Vests is that the user can stage the hook-up point at either the worksite or a standby site in a fashion that they can attach the cooling system at either location and not have to drag the tether with them. The staging point should be where they spend most of their time.

If being free of a tether is important and/or providing a source of compressed air or electrical power is not feasible, the Frozen Polymer Vest is an acceptable system. The advantage is that the heat sink can be easily re-frozen in an ice chest with ice water (not evaluated). The service time at a moderate rate of work was under two hours. If more time is needed, then a change-out will be required. Frozen Water Vests are a good alternative, but they tend to have a higher cooling rate and thus may have a shorter service life for similar heat sink weights. Another alternative, especially for drier climates, is to use a powered air-purifying respirator blower to circulate air under the clothing.

If the levels of heat stress are substantially higher than the conditions tested here, then cooling systems that provide cooling to a greater surface area of the body become important.

Status

This project was completed in 2013. A Final Report was issued in March 2013.

For more information:

Maureen Droessler
Program Administrator
Operations Technology Development, NFP
Phone: 847/768-0608
maureen.droessler@otd-co.org

OTDOperations
Technology
Development**OPERATIONS INFRASTRUCTURE SUPPORT****Intelligent Utility System**

Research is under way to develop a low-cost, user-friendly Intelligent Utility System that reduces the cost of collecting and managing operational data and improves the quality of field-collected data.

Project Description

For gas operations, rising costs and regulatory concerns are generating the need for an Intelligent Utility System that can create, collect, transmit, merge, and utilize data to develop knowledge for optimizing O&M and capital expenditures while ensuring compliance in the most cost-effective manner.

In an effort to develop such a system, researchers are teaming with utility companies and using smartphones, cloud computing, and other technologies to provide a low-cost, easy-to-use system that can be extended to a variety of operations.

Several current research projects are focused on the development and investigation of emerging technologies to automate the data-collection and management process. The objective of the Intelligent Utility System is to combine the results of these individual projects into one comprehensive program.

Ongoing projects include:

- **Gas Distribution Model (GDM)** – an industry data model that will serve as the data exchange format between an operator's existing data model, software, and sensors.
- **Leveraging Consumer Technologies** – an effort to identify technologies (e.g., smartphones, social media, and web-editing) that could be used for utility operations.

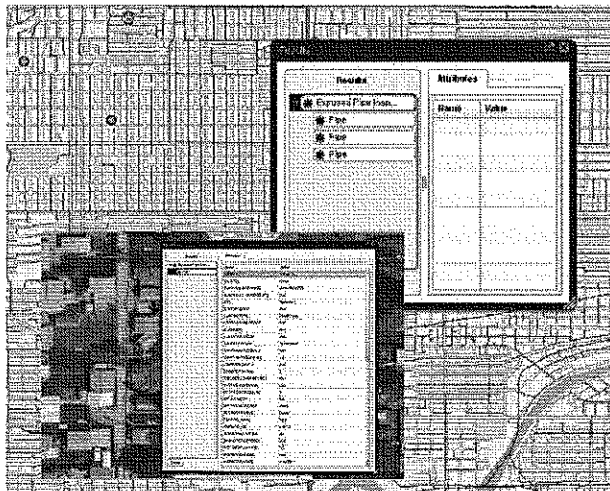

- **Smart Tag Expert User Group** – a project to identify emerging technologies and potential applications for smart tags in utility operations.
- **Remote Monitoring and Inspections** – an investigation of sensors that can be used to remotely monitor and inspect operations to increase coverage and reduce the cost of inspections.

In addition, researchers are working with individual sponsoring companies to develop specific applications as part of the Intelligent Utility System. These include:

- Applications for collecting new service-installation data utilizing mobile devices
- A pilot project to demonstrate the procedures and technologies for implementing an radio-frequency identification (RFID) tag marker-ball asset-locating system to reduce excavation damage
- An investigation on the use of smartphones and mobile GIS to automate field data collection for exposed pipe surveys.

As part of this project, researchers will demonstrate the concepts of using consumer-grade devices and cloud-computing technology to collect field data. Software is being developed to provide automated, real-time validation of components and equipment installed during construction. This software will create a set of construction records at the time of installation that will reflect the actual components that were installed in the field.

Deliverables

The initial deliverable will be a forms-based and a map-based application for two utility operations. Seven pilot projects will be conducted to test and demonstrate the use of the developed applications. The deliverables for two sponsors will be smartphone/tablet devices with the new mobile service-installation application.

In addition, the research team will develop a prototype software system that provides automated, real-time validation of components and equipment installed during construction.

Benefits

Data collection and management is labor intensive and represents a large cost to gas utilities and their customers. Adoption of the Intelligent Utility System will provide value in both the short and long term. Short-term value will result from reducing the cost of collecting field data as part of routine operations and compliance activities. Long-term value will result from reducing system risk and optimizing maintenance, repair, and inspection activities.

Automated and electronic data capture will lead to a reduction in data-entry errors, eliminate labor costs due to back-office processing, and improve overall data quality. Enhanced data will allow for the optimization of various activities including surveys, inspections, work order dispatching, and repair/replace decisions.

Technical Concept & Approach

Since most utility companies have already invested in a GIS for mapping and data-management purposes, using a low-cost data-collection methodology integrated with GIS technology is at the heart of the Intelligent Utility System.

The Intelligent Utility System research program will be conducted in three phases:

Phase 1 (now completed) focused on reducing the cost of data collection and management using smartphones, smart tags, and cloud computing.

Phase 2 (now under way) focuses on automating the collection of inspection and survey data to reduce (or even eliminate) the time required for on-site collection.

Phase 3 will focus on developing analysis tools to improve operating knowledge, recommend specific actions, and provide logistical support functions for optimizing the dispatch, warehousing, and deployment of field resources.

A proof-of-concept prototype will be demonstrated with three operators.

Results

Through the Intelligent Utility System project, a computing infrastructure was developed to deliver data from the field for verification and validation.

As part Phase 1 of the program, several pilot projects with sponsoring utilities were initiated in 2012 that resulted in:

- Deployment of an iPad application for exposed pipe

- A study of devices and training for an RFID marker-ball locating system
- Deployment of marker balls using a high-accuracy GPS receiver
- The deployment of an application for high-consequence areas
- The development and deployment of an Esri Arc-GIS-based web-mapping application for data visualization and data sharing.

The research team prepared a business case to support the cost of use of RFID markers and the acquisition of the systems needed to map the markers.

Phase 2 activities include disconnected editing to alleviate some of the connectivity issues experienced in pilot projects. Researchers developed a more stable set of editing tools, providing the ability to create and edit features locally with little difficulty. In all cases, the new software was able to read the data from the receiver and create a mapping or survey-quality point feature. The software and the disconnected editing environment create a mobile computing environment that can be used to collect geospatial data and any associated inspection data for a natural gas system independent of a connection to a server environment.

In 2013, a Native Android application was completed and readied for commercial release. The configuration components of the application have been extensively tested and the configuration processes (barcode reading, external GPS, selecting different map layers, etc.) are performing as expected. Based on user feedback, a number of enhancements were made and tested.

The integration of the barcode scanner was challenging and components were reengineered to improve the connection and reliability of the connection with the barcode scanner. This very important component of the system has worked very reliably since the system software was redesigned and rewritten.

Status

The research team continues to support the ongoing pilot projects and will make updates and improvements as necessary.

For more information:

Maureen Droessler
Program Administrator
Operations Technology Development, NFP
Phone: 847/768-0608
maureen.droessler@otd-co.org

OTDOperations
Technology
Development**OPERATIONS INFRASTRUCTURE SUPPORT****Intelligent Utility Installation Process
(Asset Tracking)**

A research team developed an Intelligent Utility Installation Process to provide a methodology, field process, and a data model for capturing data during new utility installations. The focus of the current phase of the project is on providing operators with the ability to track assets from manufacturing through replacement while geospatially associating engineering and operational data to specific assets.

**Project Description**

New installations, replacement programs, and extension projects are ideal opportunities for capturing and documenting asset and related gas-system information. However, many operators are using outdated methods to collect this information or are not collecting it at all.

Existing and future requirements obligate local distribution companies to maintain complete and accurate data that will be important for Distribution Integrity Management (DIM) compliance, risk analysis, and future system use considerations.

In Phase 1 of this project, an Intelligent Utility Installation Process was developed that provides a methodology, field process, and a data model for capturing data during new installations. The process is used to capture information regarding the location, materials, installation process, environmental considerations, and other factors.

The current Phase 2 of the project is focused on providing operators with the ability to track assets from manufacturing through replacement while geospatially associating engineering and operational data to specific

assets. This project supports the implementation of ASTM F2897-11a *Standard Specification for Tracking and Traceability Encoding System of Natural Gas Distribution Components (Pipe, Tubing, Fittings, Valves, and Appurtenances)* by developing field-data-collection software, conducting pilot projects, developing best practices, executing a testing program, and coordinating a working group.

Deliverables

Deliverables for this project include data-collection guidelines; a data model; field-data-collection procedures for GPS; smart tag programming protocols and installation procedures; a methodology for determining and documenting data quality; technology recommendations; and regional workshops.

Benefits

There are many existing and future beneficial uses for the type of data to be collected through the Intelligent Utility Installation Process, including:

DIM Compliance – New DIM regulations will require operators to collect information during new installations and exposures to facilitate the execution of a DIM program.

Analysis – Increased and improved data will facilitate a full and proper risk analysis and optimization of risk management efforts.

Industry Standardization and Adoption – The development of industry standards in data collection will enable widespread adoption and use by utilities and their contractors.

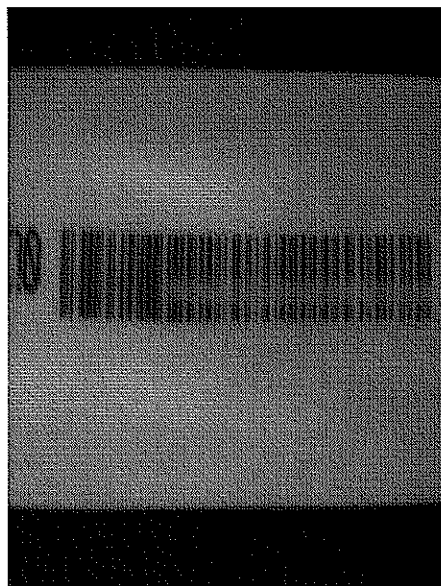

Before and after Taber Abrasion Testing.

Future Considerations – Gathering information during construction will ensure that future issues or opportunities can be evaluated with quality data without incurring the cost of collecting it.

Technical Concept & Approach

The Intelligent Utility Installation Process provides a methodology to collect information during new installations (as well as exposures during routine maintenance). The methodology includes field-data-collection procedures, as-built drawing guidelines, and data model formats.

Examples of information being collected include:

- Location
- Changes in direction
- Location of abandoned facilities
- Material properties
- Installation method
- Environmental conditions
- Supporting assets (e.g., tracer wire, marker balls, and warning tape)
- Coupling and joining information
- Contractor and field personnel information
- Pressure test records
- Inspection records.

Results

Data-modeling development progressed in parallel with the development of the data-capture process with the model becoming more complex and detailed, transitioning from a conceptual data model to a logical model.

Barcoding technology integrated with high-accuracy GPS and a hand-held field-data-collection device was chosen as the first combination of technologies to demonstrate.

A set of guidelines for operators and manufacturers was developed for Phase 2 of the project to support the implementation of the material and manufacturing marking standards described in ASTM F2897-11a (a new industry standard that will allow manufacturers to label assets with tracking and traceability information, such as lot number and material type, in a standardized way). The guidelines address the issues related to the permanency and durability of the barcode markings, how frequently the markings should be made, how the various fittings and appurtenances should be marked, and what type of marking techniques should be used.

In 2013, the *Purchasing Specification Guidelines for Marking Polyethylene Gas System Components* was published. Barcode testing was also initiated to verify scanning and decoding barcodes per ASTM F2897-11a.

Significant progress was made in the development of the software for data-collection activities and integration of barcode scanners and GPS devices.

Pilot projects were initiated with four utilities. For each test, barcodes will be scanned before and after installation to determine the change in barcode readability.

Field demonstrations were conducted with a prototype system that uses barcode scanners, high accuracy GPS, and GIS-enabled software that runs on smartphones and tablet computers.

Taber abrasion testing was completed. Initial results indicate that over half of the samples did not withstand more than two or three swipes with 600 grams of weight placed on top of the eraser.

Researchers prepared a survey to gather information to create a White Paper on the industry's current and future plans for implementing asset-tracking programs. This survey focuses on the implementation of ASTM F2897-11a and the technologies and work practices required to realize the value of a standardized approach for asset life cycle tracking.

Status

Phase 1 of the project is completed. A report was issued in September 2012.

Phase 2 testing is ongoing. The UV testing is anticipated to be completed in 2014 based on the deterioration rate observed at the end of 2013. In addition, salt fog testing will be performed for six months with barcodes scanned weekly. An environmental chamber will be used elevated-temperature testing.

For more information:

Maureen Droessler
Program Administrator
Operations Technology Development, NFP
Phone: 847/768-0608
maureen.droessler@otd-co.org

OTD

Operations
Technology
Development

Quality-Control Procedure for High-Potential Anodes

A series of laboratory tests is being conducted in an effort to develop a quality-control procedure for high-potential magnesium anodes used in cathodic-protection systems. The goal is to develop a method that verifies the potential, current, and efficiency of the anodes.



Project Description

Utilities apply high-potential (HP) magnesium anodes to challenging locations that need a maximum of cathodic protection (CP). However, there is a growing concern about the efficiency and service life of these anodes.

A simple and common method for testing an anode is performed by wetting the anode and reading its potential with a digital multi-meter referenced to a copper-copper sulfate electrode (CSE). However, this test only addresses the open circuit potential (OCP) and *not* the current or efficiency performance of these HP anodes – both key parameters for the anode's ability to protect assets and meet expected service life.

Utility anode purchases are typically from a variety of suppliers, some of which are offshore. The ability to acquire HP magnesium anodes from multiple sources and at competitive prices is desirable; however, a simple and effective quality-control (QC) procedure is needed to verify the efficiency of anodes. The current verification test (ASTM G97) is expensive in terms of both labor and processing time, sample preparation requires extensive machining of the magnesium, and the actual test requires 14 days.

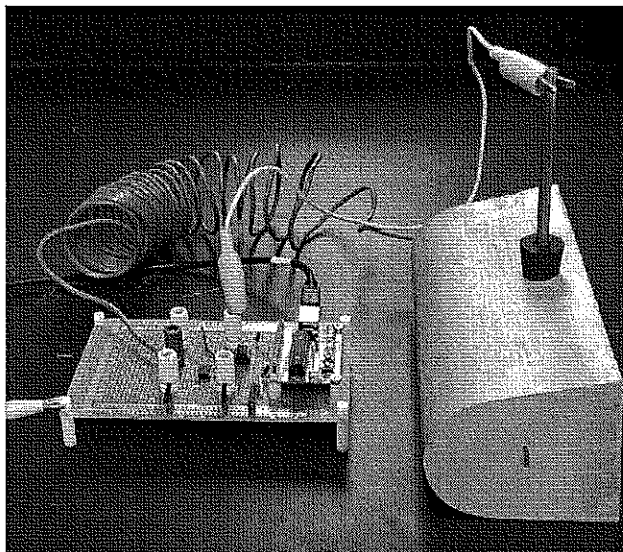

Coupon in Bore test cell.

The objective of this project is to develop a QC procedure for HP magnesium anodes that verifies the potential, current, and efficiency of the products. The procedure must provide a reasonable correlation to the ASTM G97 efficiency test result, but be much less labor intensive.

Phase 1 of this project (now completed) provided baseline data on the performance of anodes from several manufacturers. The ASTM G97 test was performed on sample anodes. In addition, Electrochemical Impedance Spectroscopy (EIS) testing was conducted to provide impedance data at given potentials and input conditions. A new method, Coupon in Bore (CIB), was also developed and tested. The CIB method eliminates most of the machining required by the G97 testing but still exposes a sufficient amount of surface area of the anode for testing.

In Phase 2 (now under way), continued testing is being conducted.

Deliverables

The deliverables include:

- A complete analysis and test reports for all processed samples
- A recommended QC procedure that can quickly provide a determination of the quality of an HP magnesium anode.

Benefits

There is a risk involved with installing off-spec anodes in challenging locations where high performance is needed: the asset that needs CP may not receive it. Even anodes that initially perform well may have lower-than-stated efficiency, causing the anode to have a shorter-than-expected service life.

Information developed through this research project will help utilities provide adequate protection for their buried assets and maximize the benefit CP systems.

Technical Concept & Approach

The scope for Phase 2 of this project is to complete the development of a simple QC procedure for the testing of high-potential anodes.

The working hypothesis developed in Phase 1 is that the OCP collected near the end of the standard G97 test is a reasonable metric of the anode efficiency. However, the CIB may provide a lower-cost method of obtaining the OCP of the anode after it has been aged. The CIB method exposes the interior surface area of the anode by drilling a hole and then using a hand-reamer to further polish the interior surface of the bore. The bore is then filled with a salt solution and a steel coupon with a known surface area is inserted. Instrumentation is connected between the coupon and the magnesium.

Phase 2 of this project includes the following tasks:

- **Sample Testing**

The samples already in hand will be tested using the CIB method. One feature of the testing is that the anode must be used or aged for some period in order to determine if it can maintain sufficient potential over time. Establishing the minimum period of testing that can determine the efficiency with confidence is one goal of this task.

Two different methods of putting wear on the anode will be tested: self-potential and constant current. The self-potential method uses the magnesium-to-steel coupon potential to drive current through a salt solution. For the constant-current method, an additional voltage source is added to maintain a fixed current through the salt solution. In both cases, the current will be monitored and recorded continuously. At fixed intervals, the magnesium-to-steel circuit will be opened and a potential measurement recorded. In this way, the OCP value will be tracked as the anode is aged.

The measurement cycle for each test will be approximately three weeks in order to obtain trend data and several tests can be run simultaneously. The reason for this duration is to exceed the time for the standard G97 and determine if the rate of change of the OCP so the technique can be rapidly moved.

- **Data Analysis and Reporting**

Data will be correlated with the data gathered during Phase 1 of the project. The CIB method will be compared with ASTM G97 efficiency measurements.

- **Optional Testing**

At the sponsors' discretion, new anodes may be introduced for testing.

Results

In 2012, eight anode samples completed EIS testing at three contact positions per sample. Three positions were tested in order to provide a reasonable cross-section across the body of the anode and to test the behavior of the anode at varying voltage settings, comparable to those experienced during G97 testing.

The execution of multiple ASTM G97 tests in Phase 1 testing led to two important observations: the setup of G97 requires very significant effort and that the anode samples must be "worked" or "aged" to obtain accurate efficiency data. These observations led to the development of the CIB method for anode testing.

During Phase 1, some initial testing was carried out with the CIB apparatus that allowed the iron-magnesium cell to run with no current restriction. The output of the cell was simply connected to a 350 ohm high-precision resistor and the voltage monitored as a function of time. This was then scaled into milliamps for data display. This approach did not provide any clear correlation between the current curves and the efficiency. In the current phase, the testing is being carried out at a constant 1.6 mA current: the same value as used in the G97 test.

The data analysis in 2013 consisted of examining data from preliminary runs that were performed to calibrate the CIB apparatus.

Status

Testing for eight samples of anodes that were provided by the utilities using the CIB method is ongoing. The time series data will be collected in an electronic format.

Data from the CIB testing will be correlated with the past data sets and conclusions drawn for the best indicators for efficiency. A detailed description of the testing apparatus will be prepared. A procedure for preparing the sample and applying the CIB test apparatus will be prepared.

For more information:

Maureen Droessler

Program Administrator

Operations Technology Development, NFP

Phone: 847/768-0608

maureen.droessler@otd-co.org



Operations
Technology
Development

Smart-Grid Initiative Standards and Regulations

This project is focused on the development and operation of a Working Group to support specific activities designed to represent the technology needs for the natural gas industry in current and future smart-grid initiatives.



Project Description

The overall objective of this project is to provide information and representation to support the infrastructure requirements that are specific to the natural gas industry in technology, standards, and regulatory initiatives currently focused on electric smart-grid initiatives.

One of the goals is to develop and deploy technologies and processes that effectively use two-way communications and intelligent field devices to enhance the safety and efficiency of the natural gas infrastructure to serve new demand and supply sources and integrate with other infrastructure grids.

Industry experts note that technology can help to address a variety of issues:

- New sources of demand for natural gas (e.g., power generation, direct end use, and vehicles) and new sources of gas supply (renewable and shale gas) are having an impact on the industry. As a result, load monitoring, load balancing, and the need for real-time information on supply and demand becomes increasingly more important.
- Energy efficiency and emissions-reduction targets could place new requirements on natural gas operators to provide real-time usage information to customers through smart meters.

- Regulations for increased integrity management and enhanced system safety and functionality could effectively be achieved through sensors and remote controls capable of detecting excavation encroachment, corrosion, and leaks, and providing remote controls to shutoff valves.
- Operators are under increasing pressure to reduce operational costs. A sensor-enabled infrastructure could reduce the need for manual data collection and reduce the labor costs associated with surveys, inspections, and other manual data-collection activities.

This project provides the natural gas industry with a focal point where the overlap of technology, standards, and regulations is known and understood, reference materials can be accessed, issues and concerns can be discussed, and enhancements and/or new or novel capabilities can be addressed.

In Phase 1 of this project, the research team established: active participation in standards development for sensors, automation, and smart-grid connectivity; representation at organizations recognized for their efforts to create an open forum for technology development and deployment; and an on-line source for standards, documents, reference designs, testing results, and case studies.

The objective of Phase 2 is focused on efforts to ensure that standards and regulations governing sensors, controllers, and communications devices are compatible with natural gas distribution operations while ensuring that cyber-security standards are integrated into each device capable of communications.

Deliverables

The deliverables for this project include newsletters, the results of standards activities, a White Paper providing recommendations for regulatory interactions, and an on-line reference system.

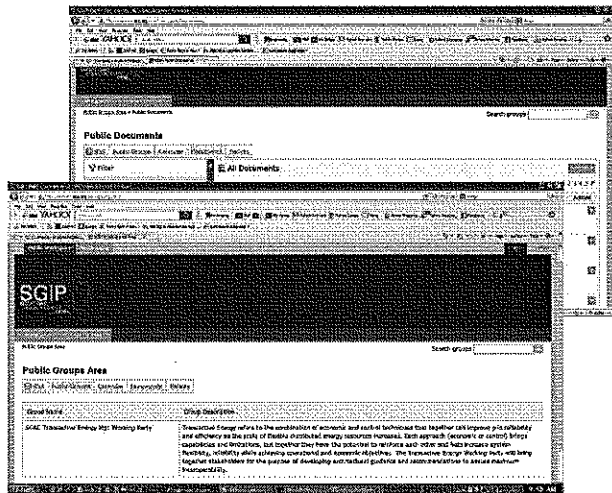

Public information is maintained at the Smart Grid Interoperability Panel:
<http://collaborate.nist.gov/wiki-sggrid/bin/view/SmartGrid.GasTechWG>

Benefits

Through this effort, the interests of natural gas customers and suppliers can be better positioned to demonstrate the benefits of natural gas technologies and incorporate gas-related products into smart-grid initiatives.

The goal is to provide the gas industry with a focused, unified voice in emerging technology forums.

Technical Concept & Approach

Project Tasks:

- **Participation in Industry Standards Development Organizations**

On behalf of the Smart-Grid Initiative, Gas Technology Institute (GTI) has established and will maintain memberships in organizations with the potential to influence the technologies and standards in use or being developed that could optimize the natural gas delivery infrastructure.

- **Examination of Regulatory Issues**

In this task, a White Paper will be developed to provide guidance and recommendations for coordinating infrastructure development between electric and gas smart grids from a regulatory perspective.

- **Establishment of an On-line Reference System**

GTI developed an on-line reference system to include technology, standards, and regulatory information related to smart-grid topics.

- **Investigation of Sensors, Controllers, and Communications Devices**

- Automatic flow monitoring and control
- Automatic load balancing
- Automatic feeder reconfiguration
- Automatic switching of gas sources
- Automatic meter reading
- Remote meter shut-off
- Automatic leak detection and locating.

- **Develop Interoperability Standards for the Integration of Gas Systems into the Electric-Centric Smart Grid**

The standards will address both the commonalities and the interdependency of electric and natural gas

grids. The emphasis is on Distribution Automation and cyber security.

Results

The research team coordinated with the Smart Grid Interoperability Panel (SGIP) – organized and managed under the leadership of the National Institute of Standards and Technology – to create a Gas Technology Domain Expert Working Group (GT DEWG) under the SGIP in 2012. This platform provides a direct connection to the premier standards development organization in the United States. This site is available to the public at:

<http://collaborate.nist.gov/wiki-sggrid/bin/view/SmartGrid.GasTechWG>

Separate and distinct from this public site, an on-line newsletter will be located on the OTD website in a section only accessible to the sponsors.

The Working Group was established to address such topics as unified communications, cyber security, the “Green Button,” and the interoperability for public/private networks and end-use devices.

In Phase 2, activities are focused on cyber security and pressure monitoring. The pressure-monitoring case provides a concrete example of an application of interest to gas utilities that is distinct from electric grid issues. The SGIP catalog of standards should provide methods of capturing and transporting this data in a secure manner. This particular test case will allow the Working Group to test the SGIP process and determine its value to the gas community.

Status

The research is soliciting additional potential Working Group participants (e.g., representatives from manufacturer and standards organizations).

The potential collaboration with the Electric Power Research Institute is also being explored.

For more information:

Maureen Droessler

Program Administrator

Operations Technology Development, NFP

Phone: 847/768-0608

maureen.droessler@otd-co.org

OTD

Operations
Technology
Development

Integrating Sensors with Existing AMR and AMI Systems



Efforts are under way to demonstrate the feasibility of adapting sensors to existing automated meter-reading (AMR) and advanced metering infrastructure (AMI) systems in order to acquire additional information about specific distribution systems.

Project Description

Many operators of gas utilities have implemented automated meter-reading (AMR) systems. These systems represent an existing data communication and database infrastructure that could be used to capture additional operational and engineering information – beyond meter readings – to enhance system monitoring and control.

In this project, a pilot program is being conducted to evaluate and demonstrate the integration of pressure and other sensors into legacy AMR and AMI systems. In tests, AMR systems were equipped with additional sensor technology to record pressure readings at select locations.

Pressure sensors were identified as beneficial to integrate with existing AMR infrastructures. However, AMR systems could be adapted to work with other sensors to provide information on:

- Cathodic protection (CP) potentials
- Rectifier currents
- Water and methane levels in vaults, and
- Entries and exits from secure areas.

Deliverables

The deliverables for this project include:

- A set of AMR-enabled sensors that are compliant with the operator's AMR system
- A defined format and collection methodology that allows the sensor data to be extracted from the meter-reading database
- A pilot project that demonstrates the capability of providing existing AMR systems with additional sensors.

Benefits

The results of this project will facilitate the use of existing AMR systems to gather operational data (e.g.,

pressure and corrosion readings) and help to lower operating costs and reduce risk. Technical success in this project will enable utilities to collect significantly more system data in a cost-effective manner.

Cost reduction will be achieved by decreasing the labor requirements for field-data collection. Risk reduction will result from receiving more frequent access to operational data that could alert operators of a potential issue. Leveraging existing AMR systems will reduce the cost of implementing a sensor network.

Technical Concept & Approach

This project initially focuses on using an operator's existing AMR system with additional sensor technology to capture pressure readings at select locations.

Most AMR product lines have generic radio "heads" that allow data to be transmitted to a handheld unit, reading truck, or stationary tower. The goal is provide an interface between the generic AMR radio and pressure sensors.

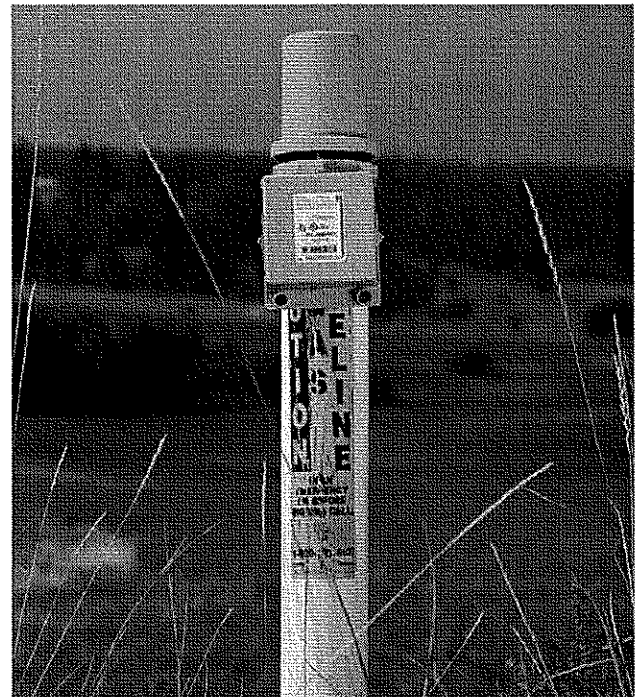

Specific project tasks include:

- **Technology Review and Selection**

This task involved a review of currently available sensors and AMR devices in order to make recommendations for the pilot project. Sensor and AMR vendors were engaged to participate.

- **Pilot Project**

Sensors were placed at specific locations selected by the operator.

Itron radios were selected to be used since the majority of the project sponsors used Itron as their AMR provider. Researchers modified a communication protocol using Itron water meters to establish interconnectivity.

Results

In 2012, an off-the-shelf Itron radio product was interfaced to pressure loggers to transmit a current pressure reading to a standard handheld meter-reading device. The monitors were placed at two sites to measure low-pressure points on a gas distribution system. The monitors recorded pressure data on a secure digital memory card on a minute-by-minute basis.

The AMR-enabled pressure monitors were located near existing utility pressure sensors, allowing for an independent verification of their accuracy. The new pressure-monitors reading have tracked accurately with the pre-existing equipment. The pressure monitors are periodically read by utility personnel using the same model of handheld device that is currently used to read gas meter AMR end points.

Three prototypes were constructed, bench tested, and demonstrated to provide pressure readings for the 0 to 30 psig range.

The utility personnel supporting the pilot used a standard Itron FC300 handheld device to capture pressure readings. This is commonly used by meter readers performing walk-by reads. They are also used by technicians who set up and service the meters. The only modification required to the handheld was the installation of a custom configuration file on the device.

In 2013, long-term testing of the Itron 100T-CP device was initiated. This device is a CP data logger that is readable using the Itron AMI infrastructure. The current version can be read using either a fixed tower network or a handheld reading device. The 100T-CP can acquire and store daily readings of the DC and AC pipe-to-soil potential for 480 days. Testing of sample devices indicated that they are accurate and stable. Samples of the



Prototype deployed at utility site.

100T-CP product were made available to project sponsors in lots of 10 pieces.

Throughout the project, a number of technical issues were encountered and subsequently resolved. In May, 2013, activity with the pressure monitors was discontinued due to communications issues.

An overview on the project was presented at the 2013 American Gas Association Gas Operations Conference.

Status

Additional field testing of the 100T-CP modules can begin at the utilities' discretion. Sample quantities are available from Gas Technology Institute.

The efforts on the AMI-enabled pressure logging device remain suspended. These had been stopped due to technical difficulties and the effort focused on advancing the CP sensor.

For more information:

Maureen Droessler
Program Administrator
Operations Technology Development, NFP
Phone: 847/768-0608
maureen.droessler@otd-co.org

OTDOperations
Technology
Development**OPERATIONS INFRASTRUCTURE SUPPORT****Breakaway Disconnect/Shut-off for Meter Risers**

To enhance gas-system safety, a breakaway disconnect/shut-off fitting for meter risers and other above-ground gas facilities is being developed and tested. In the event of an impact to a meter assembly, the device would automatically stop the flow of gas to the environment.



Project Description

Meter Set Assemblies (MSAs) and other above-ground gas facilities are often damaged by various outside forces, primarily vehicular damage. To reduce the risk of gas leaks, fire, explosion, property damage and possible injury from an MSA impact, research is being conducted to develop a breakaway disconnect/shut-off fitting for MSAs.

Currently, many industries use breakaway disconnects. For example, vehicle fueling stations use them on their fuel pumps. If a car accidentally drives away with the fuel nozzle still in the gas tank, the breakaway disconnect shuts off the fuel line and eliminates the leak and possible hazard. Portable gas grills use similar disconnects, which are designed to be pulled apart manually. The liquid- and compressed-fuels industries also use disconnects in filling and recharging cylinders, tanks, and vehicles.

The objective of this project is to develop a breakaway disconnect/shut-off fitting for MSAs so that if an external force is large enough to sever the meter riser connection (e.g., a vehicle collision or impact from falling ice or snow), the breakaway disconnect will release from the riser and close, preventing natural gas from leaking to the surroundings.

Deliverables

Prototypes for field testing will be developed. Reports will be issued documenting the findings and results of the program.

Benefits

The introduction of a new breakaway disconnect/shut-off fitting will reduce potential hazards and enhance the overall safety in the delivery of natural gas.

Technical Concept & Approach

For this project, the research team is partnering with a manufacturer to create a prototype breakaway disconnect/shut-off fitting, which was tested in a variety of

conditions under Phase 1 of the project. Upon successful field trials, a production model will be manufactured in Phase 2. Testing will be performed to determine the load needed to crack the breakaway. Once the correct load is determined, the prototypes will undergo live testing. Upon completion of the live testing, prototypes will be tested in field locations.

Specific tasks include:

- **Reviewing Industry Needs and Identifying System Manufacturers**

System considerations include the size, function, pressure and flow ranges, location of device, and the installation methods.

- **Defining System Development Requirements**

Researchers established parameters for the configuration of breakaway fittings as they relate to meter sets and other identified applications. Researchers will also establish size restrictions and flow requirements for industry use to assist the manufacturer with the design and cost estimation of the breakaway fitting.

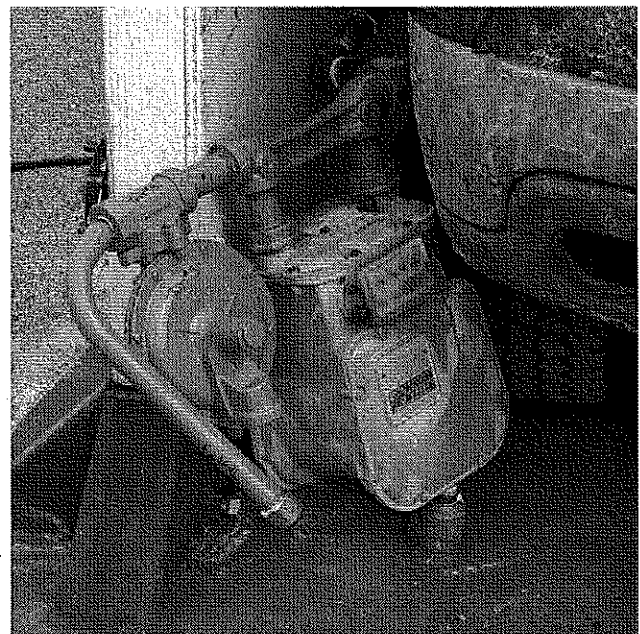

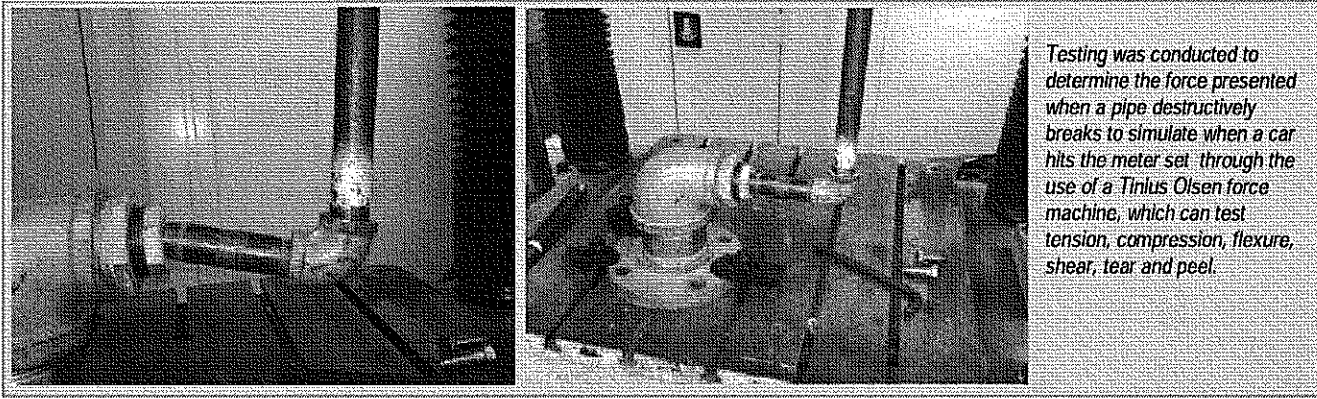

- **Developing Manufactured Prototype and Testing Breaker Fittings (Phase 2)**

Phase 2 includes laboratory testing, field evaluations, and modification of the developed breakaway fitting prototype. Installation and reconnection procedures will also be produced.

vehicles moving at five mph. All breakaway fittings sized 0.809 and less broke upon impact no matter if the fitting was installed above or below the meter set valve. The breakaways sized 0.818 and above did not break when installed above the meter set valve. However, all broke as designed when installed below the meter set valve.

Results

In Phase 1 of the project (now complete), a manufacturer was selected to team with researchers in developing initial concept designs and planning. The project team created a series of breakaway fitting design concepts. The fittings are designed with weak points that break when an external force acts on them. When the weak point breaks and the fitting separates, a check valve is activated inside the fitting, shutting off the flow of gas from the service line.

Numerous destructive-pipe and riser-fitting tests were conducted to determine the failure forces as they relate to meter sets. The results of Phase 1 research were presented in a report issued in June 2012.

In 2012-2013, the project team created two working prototypes.

Testing equipment was developed to specifically test the fitting and simulated field evaluations were conducted within a controlled laboratory environment.

Initial testing showed poor results with the initial design. The fitting was subsequently redesigned. Modifications provided improved flow and pressure through the fitting (less pressure drop).

A series of impact tests were conducted on various-size (wall thicknesses at the machined weak point) breakaway fittings. The fittings were tested both above the meter valve and below. The results of the impact and static load testing were used to assist with identifying the appropriate dimensions of the valve.

Researchers initiated a field-simulated crash test with impact meter sets with and without the breakaway with

Status

Modifications to the breakaway fitting are being made based on results of field simulation tests. Next steps are to complete the design of a method to crash test a meter set assembly in the field with a vehicle.

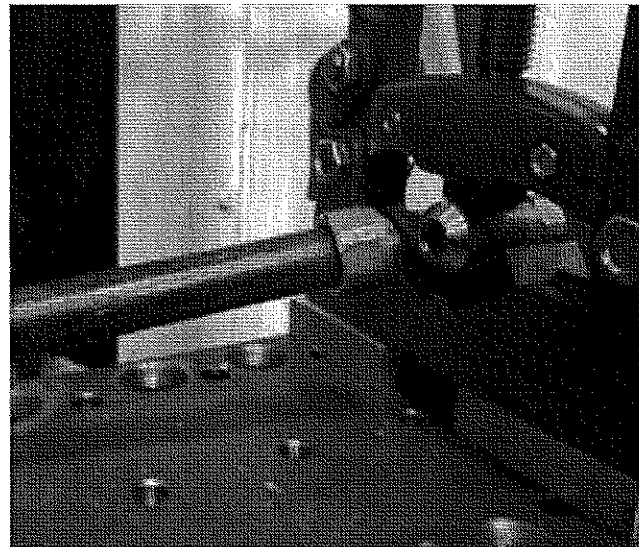

Impact testing of the breakaway fitting.

For more information:

Maureen Droessler
Program Administrator
Operations Technology Development, NFP
Phone: 847/768-0608
maureen.droessler@otd-co.org



Essential Data Capture for PE Fusion Operations

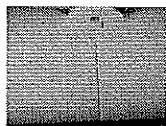

Researchers are developing a methodology to automate the data-capture process for PE fusion operations. Currently under development are a model to standardize the type and format of data, protocols for data transfer to a handheld device, and an assessment of supporting technologies.

Project Description

In this project, research is focused on developing a methodology to automate data capture during polyethylene (PE) pipe-joining processes to help determine the root cause of a pipe-joint or fitting failure and provide added information for Distribution Integrity Management (DIM) programs and other company activities.

Currently, when operators examine failed joints or fittings, they are often inhibited with a lack of information on how these fittings were assembled, the weather conditions during the joining process, equipment used to assemble the fittings, procedures followed, employee performing the fusion, and other factors. Even when failures do not occur, there is a need to have this data readily available so that quality audits can verify that proper processes and procedures were followed.

Plastic-pipe fusion processes (e.g., electrofusion and heat fusion) have remained the same for many years. Only minor technological upgrades have been incorporated into the electrofusion process, such as the use of barcodes to assist with fitting recognition. Also, data-logging technologies have recently been made available for use with some of the hydraulic butt-fusion equipment. The development of fusion data protocols will allow some of these technological advances to provide more meaningful information to the operator.

System knowledge is also essential to improved DIM efforts. One of the needs of the industry is to better monitor and control who is qualified to perform the various PE joining processes during the assembly of the PE piping system. A need exists to allow fusion systems to manage operator qualifications and restrict users (company and contractor personnel) that are not properly qualified and/or with expired qualifications. New technologies could facilitate the implementation of a system that requires employees to be "approved" before using a specific piece of equipment or performing an operation.

The objective is to develop a methodology for capturing data on: process parameters during the fusion; environmental conditions during the fusion process; employee and contractor information and status of opera-

tion qualification (OQ) certification; and material and fitting information.

Deliverables

The deliverables for this project will provide the industry with a standardized methodology to capture information during the PE fusion process. Deliverables will include a software application that captures fusion and weld parameter data from Bluetooth and/or barcode-enabled equipment and incorporates this data as asset attributes in the GIS or other asset management system.

Benefits

A data model and data transfer protocol will assist manufacturers in incorporating automated data capture into PE fusion equipment. A standardized methodology will create an interoperable system to allow operators to utilize different fusion equipment and handheld devices without the need to modify data-collection procedures.

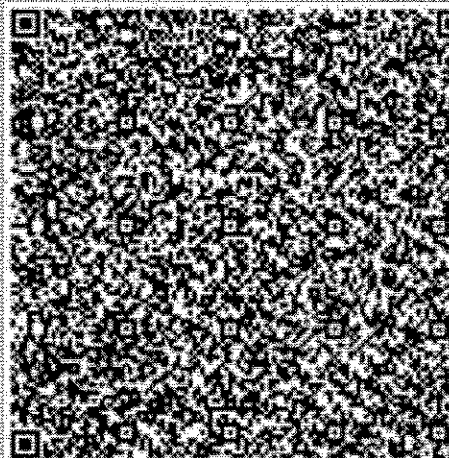

This barcode is an example of the capture of electrofusion data as suggested by the project's data model. Scanning this bar code will provide a variety of data, including information ISO 12176 requires, some additional data, and 30 fusion process data points.

Capturing this information during routine operations will reduce operator risk and will demonstrate proactive DIM compliance. Collecting parameter information during operations will allow an inspector, in the office or in the field, to verify that the process was completed according to company specifications. The operational parameters can also be stored and later compared against leak records and other inspection results to identify trends. In addition to capturing parameters, the system could be developed to include OQ verification.

Technical Concept & Approach

This project includes the following tasks:

Phase 1

- **Capture Project Requirements and Communication with Industry**

This task included a review of existing electrofusion control boxes and butt- and heat-fusion data loggers to assess their capability of serving as an input station for tracking installation information.

- **Develop Standardized Data Model**

Essential variables and their limits (e.g., operator, ambient temperature, etc.) will be established. The variables will differ based on the type of PE fusion processes addressed.

- **Identify Operator Qualification Parameters**

The research team will develop recommendations for utilities and manufacturers to allow for the acquisition of OQ information.

- **Identify Data Transfer Protocol**

Researchers will identify existing data-transfer technologies that can be used to collect information during the fusion process.

- **Develop ASTM Standard or Other Industry Accepted Practice**

The research team will draft a new ASTM standard or industry practice to formalize a standard data structure and define standard codes of practice.

Phase 2

- **Equipment Selection**

The research team will identify existing equipment that provides the required functionality.

- **Software and Process Development**

Software will be expanded to include an application

that captures fusion and weld parameter data from Bluetooth-enabled equipment.

- **Testing and Demonstrations**

Three demonstrations with operators will be performed.

Results/ Status

In 2012, researchers at Gas Technology Institute (GTI) investigated various potential methods of capturing PE fusion data and transferring information into existing GIS databases, finding 2D barcodes well suited for this purpose.

An operator data survey was developed to assess industry needs and interests.

A draft of the data-capture standard/practice document was initiated for consideration by ASTM and/or other industry organizations.

A detailed refinement of the data-capture model, relational database, input masks, and data-transfer methods is also conducted.

In 2013, the project team solicited the support of manufacturers for the development of an ASTM standard to standardize the output of the fusion data for the various PE fusion operations.

Efforts are being made to incorporate all three fusion data-capture standardizations (butt, saddle, and electrofusion) into the same standard.

Investigators identified five different workflow options for data capture in the field.

Significant progress was made in determining a database design for OQ parameters.

In a related development, in September, 2013, it was announced that GTI was awarded funding from the Binational Industrial Research and Development (BIRD) Foundation, a US-Israeli program to promote technology transfer program, which will be used as co-funding for this project. GTI is teaming with Nortec, a leading Israeli-based manufacturer, to develop and manufacture an innovative barcoding solution for underground asset lifecycle tracking.

For more information:

Maureen Droessler

Program Administrator

Operations Technology Development, NFP

Phone: 847/768-0608

maureen.droessler@otd-co.org

OTDOperations
Technology
Development**OPERATIONS INFRASTRUCTURE SUPPORT****Development of an Intelligent Shut-Off Device
for Commercial and Industrial Customers**

Efforts are under way to develop an intelligent gas shut-off device with the ability to detect third-party damage to facilities and, in response, limit the flow of natural gas to minimize the potential hazard from the incident.

**Project Description**

Recent gas-industry distribution integrity management program standards are expanding the requirements of excess flow valve (EFV) installations from solely single-family residential locations to multi-family, commercial, and industrial gas customers. Consequently, the large-scale implementation of EFVs in the commercial and industrial market requires long-term planning to be effective.

The application to commercial and industrial customers presents several issues:

- From a safety standpoint, multi-family, commercial and industrial customers expect a highly reliable gas supply. An inadvertent shutoff of commercial or industrial facilities (e.g., such as hospitals, manufacturing, or chemical plants) could create a greater hazard than the gas leak it was intended to address. For other businesses, the financial implications of a false EFV closure could, at a minimum, temporarily close a business, resulting in high associated financial losses.
- The challenge of load variability is inherent to commercial and industrial locations as customers who occupy these spaces frequently change based on rental agreements (such as from a small retail clothing store to a restaurant), which can signifi-

cantly change the required loads. Due to this variability, life-cycle loads (50-100 years) often differ considerably compared to that at the time of service installation. As a result, pre-installed EFVs with a set flow rate tend to be sized either too small (creating false trips) or too large (rendering the EFVs ineffective at times when they are needed).

- As the cost to replace an incorrectly sized EFV may vary from \$5,000 to \$50,000 (if the municipality allows the street to be cut), replacing improperly sized EFVs can become a costly endeavor.

In response to these issues, this project is focused on the development of an intelligent shut-off device (ISOD) to address regulations and risks associated with service and meter-set-assembly (MSA) damage and associated leaks. The device will be designed to have the ability to detect third-party damage to the service or MSA and, in response, limit the flow of natural gas, thereby reducing the hazard from the incident.

Several commercial systems exist for use within the natural gas infrastructure as remote shut-off devices. These devices can automatically shut off gas flow by control of a wireless device. Through prior evaluations, it was discovered that some of these wireless remote shut-off devices were able to communicate even through structural materials such as concrete walls and soil to a handheld device at distances of several hundred feet.

Other possible transfer technologies have been found in use in the water industry. One system continuously monitors water flow and can automatically shut off the service if it detects low- or high-flow conditions. A system similar could be constructed with the ability to sense gas flow rate and compare it with a reprogrammable set of flow parameters. If the sensed flow rate or rate of change of flow rate is not within set parameters, the device automatically closes. Then, if the required load changed at the building, the system could simply be reprogrammed.

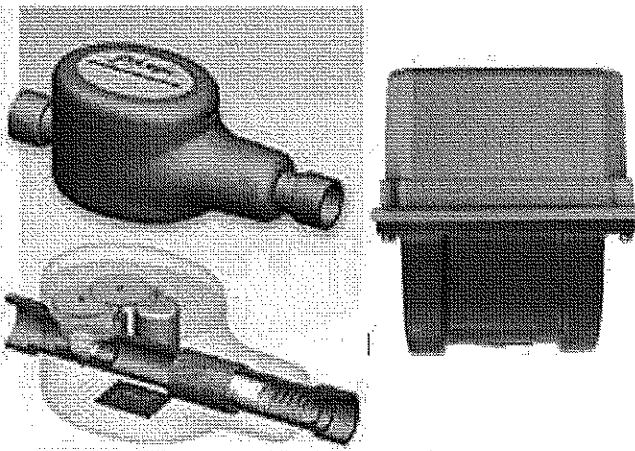

Researchers are investigating various remote shut-off devices.

Deliverables

A research team will provide comprehensive details on the development process of the ISOD system. In addition, proposals will be gathered for consideration for a potential follow-on development phase.

Benefits

Third-party damage is the number one threat to natural gas distribution systems. Service lines and MSAs are particularly vulnerable to damage from third-party excavators and vehicular traffic. The goal of this project is to develop technology to minimize this risk by limiting the volume of gas released from such incidents.

Technical Concept & Approach

Tasks for this project include:

- **Market Review and Development of Design Parameters**

This task included a review of historical data to help to determine the influential design constraints of the ISOD.

Items addressed during this task included:

- Best location of ISOD (e.g. on a service connection, tee, or the service line)
- Common system sizing
- Pressure and flow range for normal or alarm conditions
- Wireless transmission requirements (range, penetration ability, and frequency limits).

- **Development of Evaluation Methods**

This task involves the development of a testing strategy for the prototype ISOD systems.

In addition, any systems found to show promise for use with the ISOD will be sourced and used to help develop the testing protocol.

- **Development and Evaluation of Prototype System** (*potential follow-on phase*)

This task focuses on the development of a prototype system based on the set of design constraints developed in an earlier task.

This task could proceed in two directions: 1) aiding manufacturers in modifications to existing systems, or 2) developing a prototype in house.

Following the development of prototype devices, the testing protocol will be used to ensure that the systems adhere to the original design parameters.

Results

Initial activities focused on:

- Developing the initial design constraints with which to find possible market-ready devices
- Completing a review of possible market-ready devices
- Developing a list of manufacturers to contact regarding development of an intelligent shut-off device
- Initiating development of the initial test parameters which would be used to evaluate the devices.

Status

As no device exists that currently fits the desired application, proposals were solicited from manufacturers that produce a product that has potential for modification.

Several manufacturers have remote shut-off valves that are installed at the meter. After discussions with manufacturers, several companies expressed interest in participating in development of an ISOD for commercial and industrial customers that is installed on the service line at the tee.

The research team subsequently developed a proposal for the development of a prototype of ISOD.

For more information:

Maureen Droessler
Program Administrator
Operations Technology Development, NFP
Phone: 847/768-0608
maureen.droessler@otd-co.org

OTD

Operations
Technology
Development

Development of a Portable Flash-Fire Suppression System

Research is being conducted to advance the development of an automated, portable flash-fire suppression system for use in confined spaces and excavations during gas maintenance and repair operations.



Project Description

Currently, utility procedures for combating flash fires involve a combination of preventative and reactive methods, including the use of oxygen sensors, fire suits, breathing apparatus, and manual fire extinguishers.

While these systems help to improve safety, they are still limited in effectiveness. Preventative methods of gas detection are not consistently used, which leaves personnel unprotected when unexpected leaks occur. Once a flash fire does erupt, fire protective suits only provide protection for a limited period of time, and manual fire extinguishers are often used too late.

Development of a system that can detect a flash fire just after ignition and begin immediate suppression will allow workers the time needed to egress a work-site.

From 2010-2011, the Sustaining Membership Program (SMP) sponsored a project at Gas Technology Institute (GTI) to investigate technologies that have the ability to detect and suppress flash fires. Multiple detection systems (including optical flame detection, heat-sensitive wire, and thermocouple-embedded clothing) were evaluated for effectiveness, reaction time, and susceptibility to false alarms. Researchers also evaluated several fire-suppression systems with the ability

to quickly react and adequately suppress or extinguish natural gas flash fires. As a result, several promising solutions – with varying capabilities – were found.

For this new project, a research team will establish which system is most acceptable to utilities, determine what situations it will most likely be used, and then fabricate, evaluate, and refine the system in order to make a versatile portable flash-fire suppression system for use in confined spaces and excavations during gas maintenance and repair operations.

Deliverables

The initial deliverable for the project will be a prototype of a portable flash-fire suppression system. The next step in the project will include interactions with potential manufacturers to determine interest and commercialization opportunities. In addition to the prototype, a report will be supplied including data on all system refinements and testing results.

Benefits

Although the likelihood of flash fires in excavations is remote, if one does occur, the consequences can be serious.



A “standby” system with the ability to automatically detect and then suppress a flash fire (without relying on human intervention) will significantly reduce the likelihood and severity of human injury from a flash fire.

Technical Concept & Approach

Tasks for this project include:

- **Refinement of Design Goals**

During this task, a survey will be distributed to the sponsors to determine the expectations of the final product (e.g., response time, range of expected costs, and scenarios that require false alarm resistance).

- **Prototype Construction and Refinement**

An operational portable prototype will be designed and fabricated, with necessary modifications to adhere to requirements.

- **System Evaluation**

An evaluation of the prototype system will be conducted to ensure that proper progress towards design goals is achieved. Testing will be conducted in the GTI field-scale testing pit constructed during the SMP project.

Results

Activities in 2012 focused on establishing a solid evaluation system and the initiation of the design and construction of the flash-fire suppression system itself.

Modifications were made to the suppression nozzles to maximize the effectiveness of the system. In testing, the modified nozzles displayed high level of effectiveness, fully suppressing fire in less than half a second after receiving a signal from sensor. However, the flame-detection camera was responding 3-5 seconds after the ignition. Additionally, false signals were received from sunlight and movement of the camera. Consequently, the flame detector was replaced with a model from a different manufacturer. This flame detector should provide a response time less than 150 msec. A power supply with 24V DC battery was ordered to create system that can be used independently from an outside power source.

Testing of the full modified system was made in the laboratory to detect reaction of the flame detector on the following different radiation sources:

- *Indirect or reflected sunlight:* The detector did not alarm or react to the indirect or reflected sunlight.

- *Arc welding:* The detector did not alarm or react on distances more than 6 feet.
- *Flashlight:* The detector did not alarm or react.
- *Lit cigarette:* The detector did not alarm or react.
- *Propane welding torch:* The detector did not alarm or react on distances more than four feet.
- *Indirect vehicle headlights (low beam):* The detector did not alarm or react.
- *Bright safety orange clothing:* The detector did not alarm or react.
- *Radiation heater:* The detector did not alarm or react.

Status

Final testing of the system in the field test pit is under way.



For more information:

Maureen Droessler
Program Administrator
Operations Technology Development, NFP
Phone: 847/768-0608
maureen.droessler@otd-co.org



Operations
 Technology
 Development

Guidelines for Data-Collection Requirements

Guidelines for natural gas distribution and transmission data-collection requirements were developed to assist the industry in determining the data that needs to be collected for regulatory compliance, integrity-management programs, and risk management.



Project Description

For regulatory compliance, natural gas distribution and transmission operators have prescriptive data-collection requirements such as leak surveys and cathodic-protection readings. They must also assess risk for integrity management programs, which can involve the use of sophisticated models that may require data and inputs that are not readily available.

As operators review their records in response to National Transportation Safety Board recommendations, many are identifying noteworthy gaps in the data needed to substantiate system design, maximum allowable operating pressure, and risk modeling and trending. One of the top priorities noted by industry experts is the need for industry standards and guidelines to assist operators in understanding the importance of various pieces of data in terms of risk-modeling accuracy and reliability. These guidelines could be used to develop data-collection strategies and prioritize records operations based on how important the data is to understand the risk.

The objective of this project was to develop industry guidelines for data-collection requirements that are important for risk assessment in natural gas transmission and distribution systems. The data-collection guidelines are based on an analysis of the factors that fundamentally influence risk and are important for in-

tegrity management and risk modeling. The analysis includes the data required during manufacturing, engineering and design, installation and construction, integrity management, and operations and maintenance.

The results of this project will be used to assist the industry in determining what data needs to be collected for regulatory compliance as well as internal integrity management and risk management.

This project takes a holistic perspective of natural-gas assets and operations to determine the data-collection requirements. This project complements two other OTD projects, which are limited to specific operations: (5.11.m) *Intelligent Utility Installations* and (5.11.t) *Essential Data Capture for PE Fusion Operations*.

Deliverables

The deliverables from this project include data-collection guidelines and a data dictionary.

Benefits

Collecting data that allows operators to know and understand the performance and condition of their assets will reduce risk and improve system integrity.

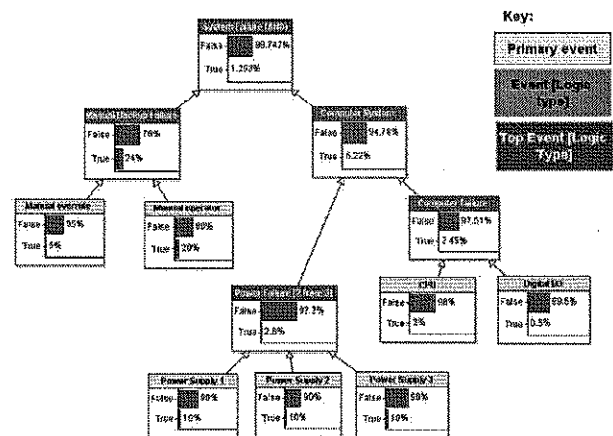
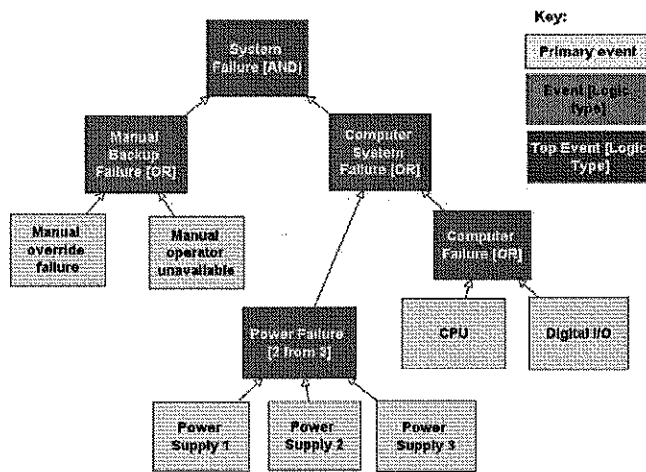

Example of a fault tree analysis realized in a causal network.

This industry guidelines capture the best collective information of all participating utilities and avoids costly data-collection re-design.

Technical Concept & Approach

This project expands upon the two existing OTD projects related to defining data-collection requirements.

This specific effort identifies data requirements and updates the Gas Distribution Model (GDM) based on these new requirements. (GDM is a vendor-neutral data model that standardizes database design to reduce customization and facilitate interoperability.)

Researchers initiated this project with an analysis of the factors that fundamentally influence risk and are important for integrity management and risk modeling. The analysis begins at manufacturing and ends at asset decommissioning.

The analysis includes the data required to support the following risk categories:

- Third-party damage (contractor and excavator type, map and record accuracy)
- Corrosion (atmospheric vs. external [buried] vs. internal, coating, cathodic protection)
- Design (material response to stress, impact resistance)
- Incorrect operations (over-pressurization, contaminant introduction).

A data dictionary was developed to structure data-collection forms, defining the format, fields, drop-down menus, and relationships of the data.

Results

In 2012, the research team completed a gap analysis between the deliverables of this project and the *Intelligent Utility Installation Process Outline* developed under another project.

Researchers analyzed the threats presented in the natural gas distribution system to identify the contributing factors to system risk. Fault tree diagrams for steel pipe external corrosion and third-party damage were developed. The diagrams include the contributing factors that drive the system risk, together with the logic between

the factors and the conditions at which the combination of the contributing factors could result in a system failure.

The guidelines for transmission systems were developed according to the requirements in ASME B31.8S. Additional data were considered necessary based on the risk-calculating algorithm that is used by the operators.

A sensitivity analysis using an existing risk algorithm for natural gas transmission system was conducted to show the importance of the data elements to the risk assessment and integrity-management process.

The guidance for collecting the necessary data to conduct risk assessment in natural gas distribution systems was also developed. The guidance addresses the probabilities of failure from the various threats and their consequences.

A methodical approach to collect and store data was presented that will assist in developing the appropriate probability distributions for datasets. Examples of how to apply these distributions in data analysis, determining the likelihood of unobserved events, and causal probabilistic risk models are discussed. Sensitivity analyses on these alternative risk models are presented.

It should be noted that the calculations in the analysis present a methodology for assessing the effect of the data, but not meant to represent the actual risk associated with any real pipeline system. The operators should use this guideline to collect the necessary data for assessing the risk in their system. Additional data may be required based on the risk algorithm they prefer to use.

Status

This project was completed in 2013. A Final Report that included the guidelines was issued in November 2013.

For more information:

Maureen Droessler
Program Administrator
Operations Technology Development, NFP
Phone: 847/768-0608
maureen.droessler@otd-co.org

OTD

Operations
Technology
Development

Large-Diameter, Medium-Pressure Inflatable Stoppers

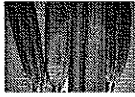

Researchers are evaluating a new flow-stopping system for use on gas pipe diameters up to 24 inches and pressures up to 60 psig. The system, which is manufactured in Europe, is being investigated to validate its use in the U.S. gas industry.

Project Description

Line-stopping equipment used in the natural gas industry is usually heavy, takes multiple people or mechanical assists to maneuver, is costly to maintain, and is very time consuming when installing and tapping necessary fittings.

In response, researchers are investigating new line-stopping equipment that can reduce these problematic issues while providing the same assurance of safety and performance.

Research is addressing several industry needs:

- One application is used on larger-diameter (12-inch to 24-inch) cast-iron and steel piping systems that operate at pressures greater than five psig and have limited options to control gas flow. Currently, bag stopping equipment can only be used up to five psig. Therefore, when cast-iron and/or steel systems that are operating at medium pressures (greater than five psig) the options for shut-down are either valves – which may negatively impact customers – or costly line stoppers.
- Another application is related to the natural gas industry's increasing use of larger-diameter poly-

ethylene (PE) pipe. Hydraulic squeeze tools are manufactured to squeeze the PE pipe to stop the flow of gas, but an alternative is needed.

- New bag stopping equipment may have the potential to be used in combination with traditional line-stopping equipment to provide additional safety. The bag can act as a secondary stop with a vent (bleed) between the primary stop (traditional equipment) and the bag. This application can potentially be used on higher-pressure systems (greater than 60 psig). The traditional stopping equipment can be used to stop-off the majority of the flow of gas; however, at times complete flow stoppage cannot be obtained. The bag system could be used to completely stop off the gas flow while the “blow by” from the traditional stopper is vented to atmosphere. Therefore, the high pressures in the pipe will not be seen by the bag stopper.

In this project, researchers are evaluating a system from a European manufacturer of equipment and materials, including several styles of flow-stopping products able to be used on gas pipes with diameters up to 24 inches and pressures up to 60 psig.

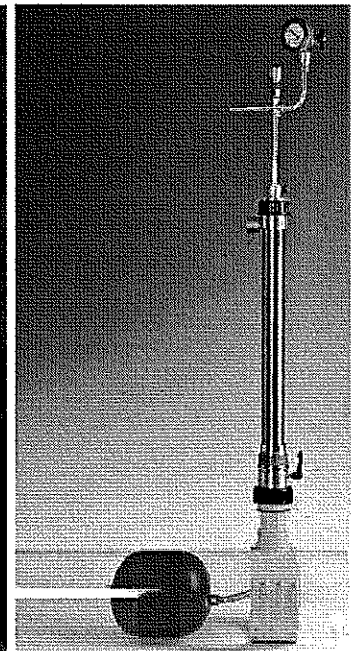
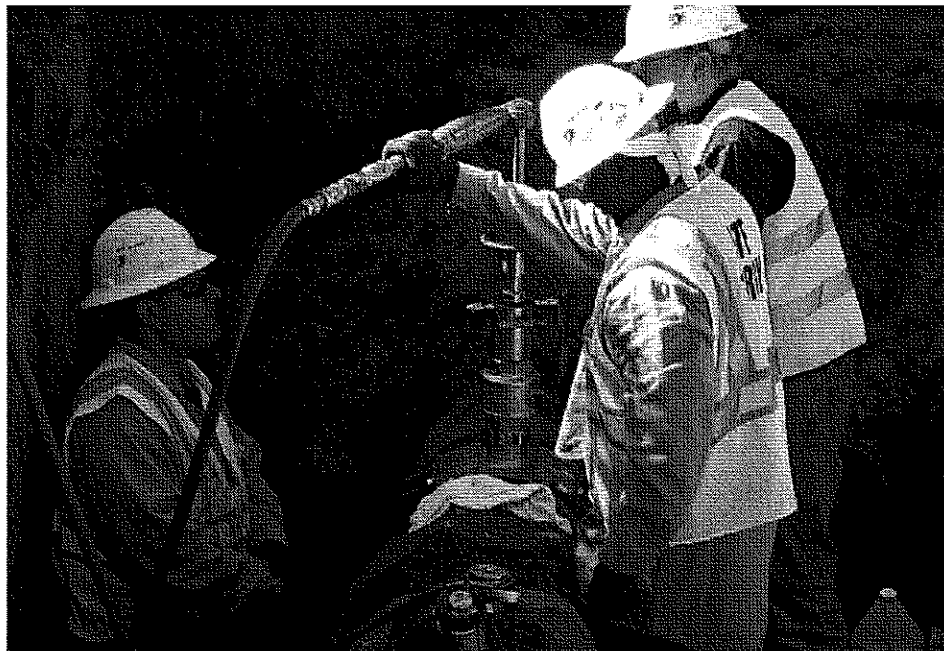

Deliverables

This project will result in a laboratory- and field-tested large-diameter, medium-pressure stop-off system(s) and some validation of smaller-diameter systems. An alternative line-stopping prototype system will be developed that can be used not only as an emergency response tool, but also as a routine stopper for use on PE, steel, and cast-iron piping systems.

Benefits

New bag-stopping technologies currently used overseas have the potential to provide the U.S. natural gas industry significant savings in day-to-day operations while increasing operational efficiencies and safety.

Technical Concept & Approach

This project will assist with the technology transfer and evaluation of currently manufactured flow-stopping equipment in Europe for the U.S. natural gas industry. Activities are being coordinated between Gas Technology Institute (GTI) and GDF SUEZ. GDF will focus its efforts on the bag system for pipe sizes eight inches and less in diameter; GTI efforts are on a system for pipe diameters of 12 inches and larger.

An investigation of fittings (or recommended fittings), tapping equipment, bag system, bags, and other associated components was conducted and included:

- A review the system(s) and the overall procedure, safety, and ability to work on U.S.-sized pipes and fittings
- An evaluation of the bags for effectiveness in stopping the flow by simulating various field conditions (e.g., temperatures, debris, and pressures)
- An evaluation of the system and bags for flow control by cycling pressure, temperature, and time
- An evaluation the bags for durability.

When testing is completed, the project team will assist the manufacturer in identifying a potential commercialization partner in North America.

Results

This project was initiated in 2012 with efforts to identify the necessary equipment and piping components required to perform the evaluations on low- and medium-pressure natural gas systems up to 24 inches in diameter. In addition to identifying the bagging equipment needed, researchers reviewed past bagging projects to better understand the needs, applications, and

fittings available. The majority of the past efforts focused on six-inch diameter and less. Therefore, project sponsors were surveyed to obtain additional information on larger-diameter stopping.

A test matrix was developed that included the following laboratory tests:

- Debris-in-pipe test
- 24-hour standard pressure tests
- Pipe pressure cycling
- Bag burst test to failure
- Bag system over pressurized
- Cycle bag insertion and removal
- Test of tapping machine operation under pressure.

Several modifications and improvements to the system were made based on the recommendations of the research team.

In 2013, a live demonstration of the medium-pressure stopping system was conducted in Michigan on a 16-inch-diameter low-pressure cast-iron main. Overall the demonstration was successful and the system performed well.

Status

Development and testing activities are ongoing and include:

- Increasing the tap size for the eight-inch high-pressure system to allow for easier bag retrieval
- Re-testing 16-inch bags with a grit surface
- Developing written procedures for using all systems
- Testing the new 60 psig system for larger-diameter pipes.

The research team is seeking to develop an additional field demonstration.

For more information:

Maureen Droessler
Program Administrator
Operations Technology Development, NFP
Phone: 847/768-0608
maureen.droessler@otd-co.org

OTDOperations
Technology
Development**OPERATIONS INFRASTRUCTURE SUPPORT****Advanced Tools for Improved AC Corrosion
Prevention and Mitigation**

To help operators reduce the risk of pipeline failures, researchers are developing a probabilistic model and calculator designed to predict AC corrosion rates in natural gas pipelines.

Project Description

Corrosion by alternating current (AC) is one of the threats to the integrity of the buried gas pipelines, which often share the right-of-way with high-tension electrical lines. Typically, AC interference sources are high-voltage transmission lines and AC traction systems.

To address the issue, this project focuses on the development of a probabilistic model and calculator to be used on gas pipelines to accurately determine AC corrosion rates and predict the effect of various mitigation efforts (e.g., coating rehabilitation) or changes in environmental factors (e.g., power line up rates).

AC-induced corrosion is not as commonly encountered as traditional, chemically based, external corrosion. However, when it does occur, it happens much faster than traditional corrosion mechanisms. AC corrosion rate is unpredictable for AC densities between 20 A/m² to 100 A/m², and there is conflicting guidance on what value of current density is needed to start AC corrosion.

The objective of this project is to develop clear and consistent guidelines on the current density required for AC corrosion, particularly in the "unpredictable" zone.

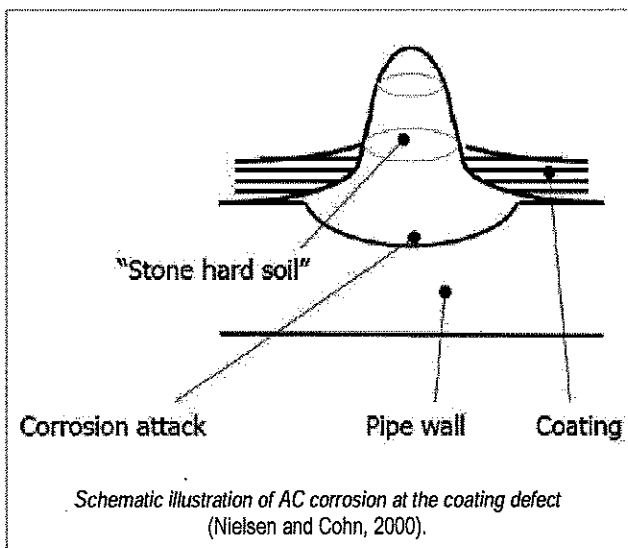

Specific goals are to:

- Develop a probabilistic model that calculates the rate of AC-induced corrosion with confidence, intervals including the "unpredictable" zone between 20 A/m² to 100 A/m².
- Develop a calculator with a simple interface that allows users to input site-specific conditions to obtain predicted AC corrosion rates and run scenario analyses to determine the most effective mitigation techniques.

Deliverables

The deliverables include:

- **An AC Corrosion Model that:**
 - Defines the likelihood of corrosion within the currently defined "unpredictable zone"
 - Accounts for uncertainty, allowing confidence intervals to be calculated on risk predictions
 - Is validated with a significant data set from operators and the public literature.
- **An AC Corrosion Calculator that:**
 - Provides operators with a tool to effectively select preventive and mitigation measures
 - Has an easy to use and flexible input process
 - Allows multiple mitigation strategies to be "tested" for effectiveness
 - Addresses current operator needs.

Benefits

The ability to accurately predict AC corrosion rates will reduce the risk of sudden pipeline failures due to AC corrosion by identifying specific pipe segments in need of additional preventive and mitigative measures.

Information on AC corrosion rates will allow operators to target validation excavations and other assessments towards segments of pipe with the greatest risk.

The model/calculator could be used on existing lines, new lines, in the pre-construction stage, and to optimize proposed designs to reduce the threat of AC-induced corrosion.

Technical Concept & Approach

The scope of this Phase 1 project includes developing an AC corrosion-rate model and incorporating the model into a user-friendly software tool. The tool will allow inputs and mitigation techniques to be adjusted.

A software tool that optimizes the selection of the mitigation techniques from a cost perspective could be developed in a Phase 2 effort.

The research team will develop an AC corrosion model by performing the following:

- Collect and quality-filter publicly available and peer-reviewed data on AC corrosion criteria, rates, and severity levels
- Construct a model that accounts for uncertainty and provides the required confidence levels
- Conduct a statistical analysis (e.g., regression study) on all available corrosion rate data in the 20-200 A/m² region to provide relationships for the predictive corrosion model
- Define operator system knowledge needed to input into AC corrosion determination models
- Establish measurement uncertainty and variability of these inputs as typically encountered in practice.
- Validate and refine the closed-form solution with the physical data set.

The research team will use the model developed to create a software tool that allows operators to predict corrosion rates and run scenario analysis for various mitigation techniques. The calculator will be built specifically for ease of use and flexibility.

Results

This project was initiated in 2012 with the formation of an advisory committee and the preparation of an industry survey to collect information on AC corrosion, field conditions, corrosion data availability, and the requirements for the software tool.

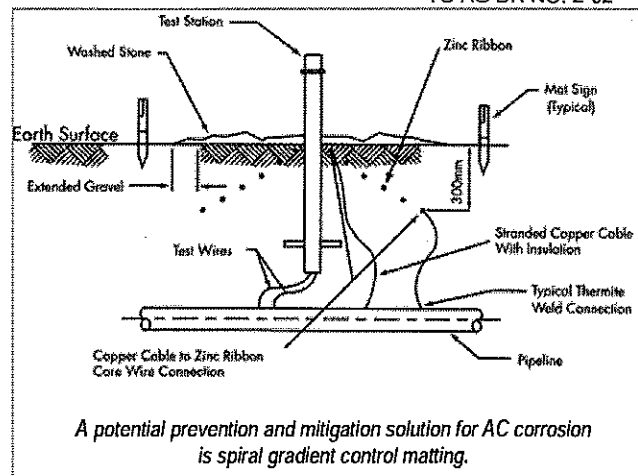

The currently used Pipeline Research Council International (PRCI) AC corrosion model was reviewed as part of a comprehensive literature search of research studies and laboratory/field test results on AC corrosion.

Corrosion simulation using corrosion/surface chemistry modeling module was initiated. However, researchers experienced technical challenges with constructing the corrosion model.

In 2013, the research team investigated options for adapting the capabilities of corrosion models to meet the objectives of this project.

Status

The project technical plan is being finalized to move forward with the model integration.

Database entities are being finalized (e.g., tables, stored procedures, and relationships).

Specific modules are being developed to add the required functionality.

For more information:

Maureen Droessler
Program Administrator
Operations Technology Development, NFP
Phone: 847/768-0608
maureen.droessler@otd-co.org



Operations
Technology
Development

OPERATIONS INFRASTRUCTURE SUPPORT

Guidelines for Cast-Iron Piping Winter Operations

To address concerns with cast-iron piping systems for natural gas distribution, researchers investigated the frost impact on a cast-iron system in New England and developed guidelines for initiating a leak-surveillance program for winter operations.

Project Description

Federal regulations require pipeline operators to have a procedure for continuing surveillance of their facilities, to identify problems, and take appropriate action for various situations, including leaks, breaks, and, for cast-iron (CI) piping systems, graphitization.

Recent incidents with cast-iron pipe have prompted state regulators in Pennsylvania to evaluate and modify the procedures regarding the frequencies of the CI winter surveillance. In response, a utility in the Northeast initiated a research program through OTD to provide an engineering-supported approach and procedure that can be used to identify the locations, durations, and frequencies of its CI winter surveillance.

In this project, a research team investigated the frost impact on the CI distribution system and provided guidelines regarding when to initiate and terminate a winter-surveillance program, and under what conditions.

A goal of the project was to provide an understanding of the changes of gas migration patterns under different soil types and operating conditions due to soil freeze above the CI piping system.

Deliverables

The deliverables for this project include the research methodology, analysis of results, and user-friendly guidelines to assist in the condition assessment of the CI system and support a leak-surveillance program.

Benefits

The guidelines identify high-risk scenarios, pipe-condition ratings, and survey procedures for CI piping systems in winter operations. The analysis also provides indicators on the freeze effects which are tailored to the local characteristics and experience of each region in the study.

Technical Concept & Approach

The approach for this project involved:

- The establishment of a database of the leak-surveillance data, inspection and repair records, and historical data from participating utilities
- The correlation of existing CI leaks and breakage data due to frost impact with local site conditions, such as soil, weather, and construction practices

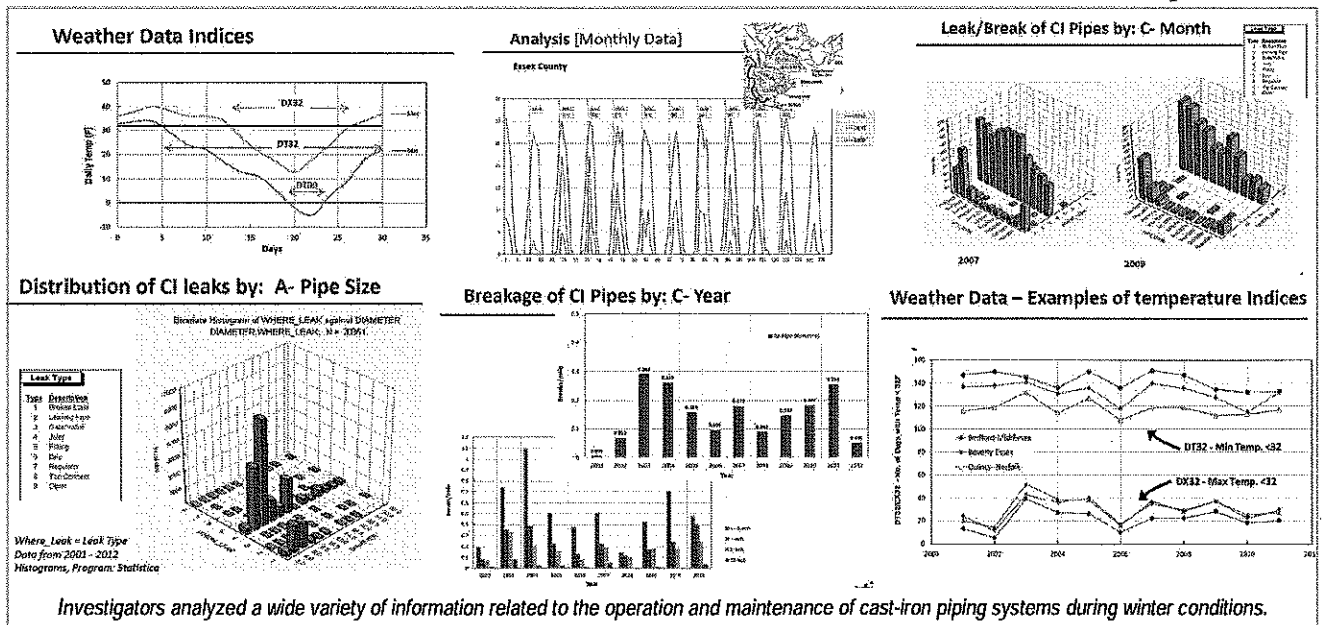

- The use of risk-analysis techniques for modeling the relationships between the various parameters and providing a risk-based assessment of the probabilities of failures (i.e., leak and breakage).

Specific tasks included:

- **An Assessment of the Utility CI Distribution System**

Researchers investigated the characteristics of a cast-iron piping system in a utility's distribution network in terms of miles, location, and pipe properties (e.g., diameter, wall thickness, joint types, and age). Since soil data and environmental conditions change significantly within small areas, well-defined and discrete areas were selected to provide representative samples of the region and enable using manageable sets of weather and soil data.

- **Identification of the Parameters Affecting CI Performance**

Researchers investigated the key factors that are associated with CI failures due to frost action. These factors include environmental conditions (e.g., soil temperature, freeze depth, and duration), site characteristics (e.g., pipe and joint types, pipe size, and soil properties) and operation conditions.

The potential for frost action depends on many factors which cause frost heave and the subsequent loss of soil strength during thawing. Temperature, soil type, and depth of the water table are important factors in evaluating the potential for frost action.

- **A Risk-based Analysis for Condition Assessment**

The technique for the assessment of the cast-iron pipes in frost conditions was based on the Fault Tree Analysis model and used the Isograph Reliability Workbench Program. The analysis relied on quantitative data obtained from the leak-survey databases provided by the utility. When such data was not available or insufficient to produce reliability prediction, qualitative terms were produced, such as high, moderate, or low comparative numerical values.

- **An Evaluation of Gas Migration Patterns**

Work in this task will provide an evaluation of the change of gas migration patterns due to soil freeze above the piping system. Gas migration in soil is a complicated process due to the significant number of parameters that control gas flow in soil (e.g., soil type and structure, pavement type, ground water, pipe type, gas pressure and leak characteristics). Investigators reviewed previous research on gas flow in soil and the effects of soil properties and leak characteristics on gas migration, followed by a

study of available leak-surveillance data, inspection and repair records, historical data, and the operators' observations.

- **The Development of Implementation Guidelines**

These guidelines will allow the utility to focus its leak-surveillance program on when and at what conditions it should initiate its response to frost impact on the cast-iron pipeline system.

Results

In 2013, investigators completed a statistical analysis of data sets of leaks and breakages of cast-iron pipes in the a major New England metropolitan area. The results established the basis for the evaluation of the frost impact on cast iron pipes. Researchers established correlations of the pipe breakage with the weather data and provided preliminary recommendations regarding the start and end dates for the winter leak survey.

The break ratio (number of breaks per mile) was identified for area grids and related them to the number of freeze days. Monthly temperatures were analyzed in the grids for selected towns.

Findings:

- Pipe size did not correlate to leaks.
- Pipe size correlated to pipe breaks: Smaller diameters had more breaks. No breaks were recorded for pipes >18 inches in diameter.
- No correlation to age of pipes for pipes from 70 to 110 years old.
- Records of "frost-free" days did not show significant correlation with pipe breaks.

Status

Remaining activities include the completion of the evaluation of gas-migration patterns and completion of the final data analysis and conclusions.

Next steps include evaluating the potential to extend the study to other New England areas.

For more information:

Maureen Droessler

Program Administrator

Operations Technology Development, NFP

Phone: 847/768-0608

maureen.droessler@otd-co.org

OTDOperations
Technology
Development**OPERATIONS INFRASTRUCTURE SUPPORT****Evaluation of Commercial-/Light-Industrial-Sized Excess Flow Valves (EFVs)**

Researchers are evaluating the performance of high-volume EFVs for commercial, multi-residential, and light-industrial applications in response to new regulations requiring an expanded use of EFVs.

Project Description

While EFVs are being increasingly used for commercial and light-industrial applications, there is little historical information on the use of these higher-capacity EFVs. No studies have been performed on their performance, and currently, the only performance data available on commercial- and light-industrial-sized EFVs are from the manufacturers of the devices.

In this project, a third-party evaluation of the performance of high-volume EFVs is being conducted to provide utility operators with a better understanding of high-volume EFV performance capabilities and limitations.

Some of the concerns regarding the installation of high-volume EFVs include:

- The transient nature of businesses
- Additional load without notification
- Breadth of capacity
- Size of service line requirements.

Deliverables

The deliverable for this project will be information to provide guidance for selecting commercial EFVs when considering the variables of commercial and light-industrial customers.

Benefits

The Pipeline Transportation Safety Improvement Act (S.B. 275) – which addresses safety issues such as the use of automatic shutoff valves and EFVs – includes expanded requirements for EFVs to include multifamily buildings and small commercial/industrial facilities. With the new requirement, the number of higher-capacity, larger-sized EFVs installed will increase substantially.

This project will provide information to assist utilities in EFV selection, installation, and training.

Additionally, this project is expected to lead to the commercial availability of standardized tooling packages for purchase by utilities and their contractors.

Technical Concept & Approach

The scope of this project is to evaluate high-volume EFVs from five manufacturers.

Activities for this project involve the following:

Industry Input – A survey and conference call were conducted to address the use of commercial EFVs by manufacturer and type, occurrence of accidental or unwanted closures, service length range, and other issues.

Performance Evaluation – In order to evaluate these high-capacity EFVs, a flow-testing apparatus was upgraded by increasing the volume capacity to test EFVs up to two inches in diameter.

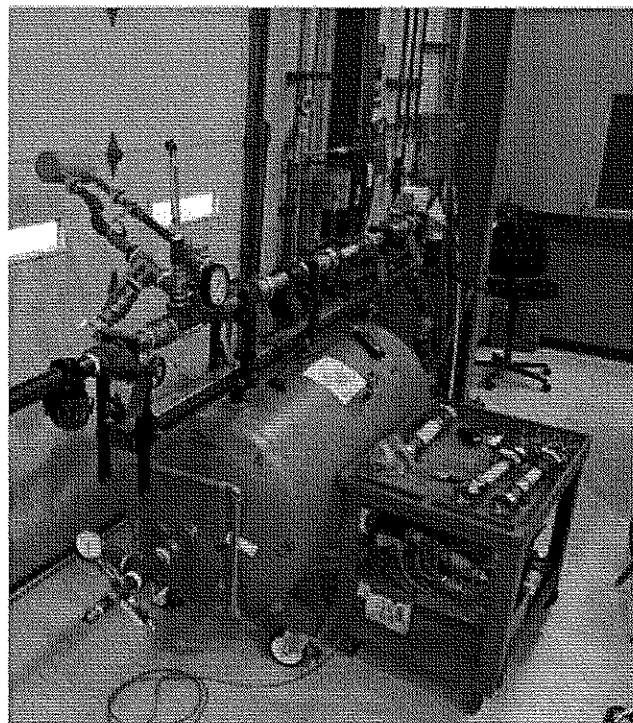

High-volume EFV testing apparatus.

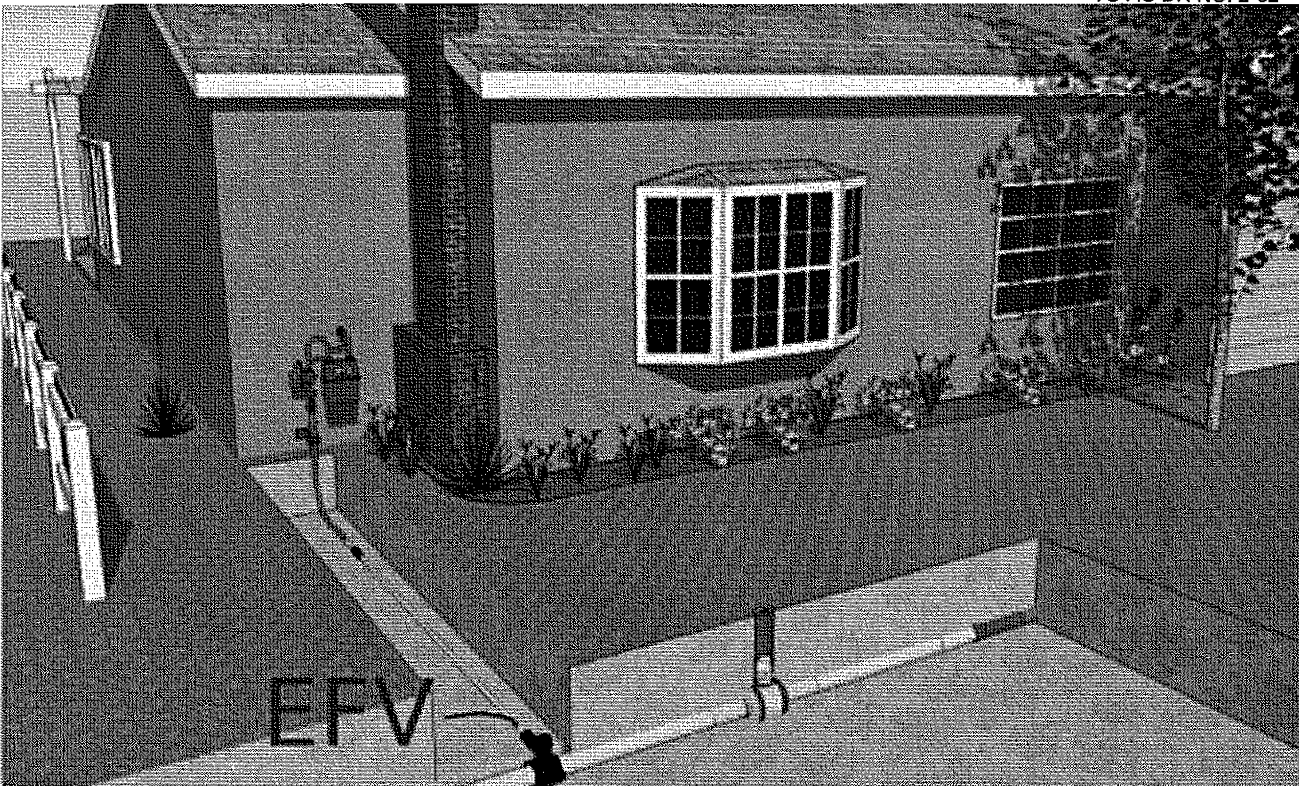

Installation of residential EFV

Test parameters may include:

- Performance differences between manufacturers for closure (trip) and bypass flows
- Amount of gas released during EFV activation
- Effect of service length
- Instantaneous load (demand surge)
- Over loading.

Results

In 2013, investigators completed an industry survey and summarized the results, identifying the EFVs to be evaluated.

A test matrix and test-apparatus designs were also completed.

A rig was built for testing 1¼-inch- and two-inch-diameter high-volume EFVs. The apparatus was validated to yield repeatable and accurate data. There were some modifications to the design to accommodate added lengths of pipe required for testing.

Several EFV samples were procured from the manufacturers.

Standard procedural testing based on ASTM F1802, ASTM F2138, and MSS 115-1999 was initiated with 10 psig inlet pressure. This provided an opportunity to validate the testing apparatus against manufacturer data.

Validation of EFVs were performed and compared directly to test data from one of the EFV manufacturers.

Status

Testing has been completed and data is being analyzed.

For more information:

Maureen Droessler
Program Administrator
Operations Technology Development, NFP
Phone: 847/768-0608
maureen.droessler@otd-co.org

OTD

Operations
Technology
Development

OPERATIONS INFRASTRUCTURE SUPPORT

PE Pipe-Splitting Technical Evaluation, Enhancements, and Standardization of Tool Kits

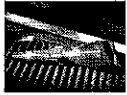

For this project, a research team will evaluate and refine existing PE pipe-splitting equipment and develop standardized commercially available tooling packages and operating procedures.

Project Description

In recent years, research organizations, manufacturers, and others have partnered to develop splitting systems to replace old, small-diameter plastic pipe with new polyethylene (PE) pipe for gas distribution. In these projects, pipe-splitting technology was used to simultaneously slice the existing service line or main, while pulling in a new pipe behind the splitter.

Past efforts proved successful in splitting and replacing gas distribution piping ranging from diameters as small as one-half inch to two inches. However, there were some shortcomings that this new project addresses.

Currently, splitting systems are pieced together by the manufacturer or the pipe contractor to meet the specific needs of the job at hand. The availability of a standard commercial system is the first step to allow this system to be accepted and used by the gas industry.

The focus of this project is on the evaluation and refinement of existing PE pipe-splitting equipment such that standardized tooling packages become commercially available along with operating procedures.

Deliverables

Demonstrations of pipe-splitting systems will be conducted at simulated field sites and at sponsor field sites.

Case Studies on the operation and application of the various splitting technologies will be developed to allow for a better understanding of the systems available and their operations.

In addition, operating procedures for each standardized tool kit will be developed.

Benefits

Utilities are becoming more aggressive in the systematic replacement of certain vintage PE piping systems. Pipe splitting can offer significant cost savings while performing the operation more efficiently with less disruption to traffic and the general public. One utility – measuring savings based on reductions in pavement restoration – reduced pavement restoration with pipe splitting by 2/3 vs. open-cut and by 1/3 versus horizontal directional drilling.

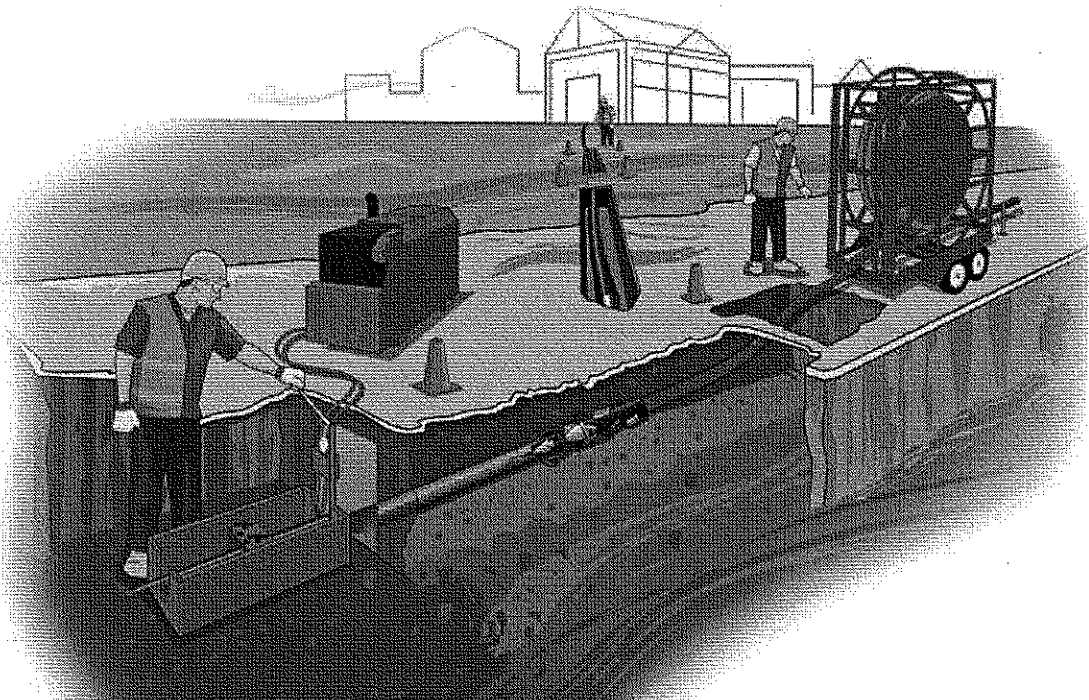

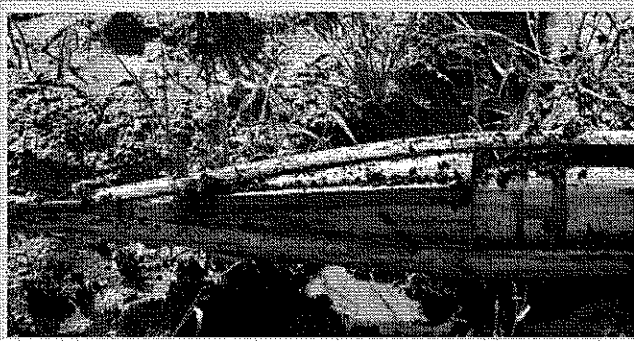

PIPE SPLITTING ADVANTAGES

- New pipe can be equal to, greater than, or less than the existing diameter of the old pipe being split.
- Reduced disruption to traffic and local businesses.
- Reduced excavation and restoration costs.
- Using the same host pipe as a pathway for the new PE main reduces the risk of third-party damage within crowded right-of-ways.
- No need to remove the retired gas pipe.
- On segments that have few services, splitting pipe can save approximately 20% of the costs over traditional open-cut construction methods.
- Savings can increase to up to 35% for pipes under pavement and in heavy urban locations.
- Pipe splitting technology's capital costs are less than horizontal directional drilling rigs.

Participants will gain first-hand knowledge of the existing and enhanced splitting systems, the specific applications where these systems perform best, and system limitations and be positioned to make informed decisions on purchase and implementation strategies.

Additionally, this project is expected to lead to the commercial availability of standardized tooling packages for purchase by utilities and their contractors.

Technical Concept & Approach

Specific tasks in this project include:

- **Establishing Product Specifications, Requirements, and Capabilities**

The research team and project sponsors will determine pipe-splitting application parameters and system requirements. In addition, the currently available splitting technologies and their applications and limitations will be identified.

- **Simulated Pipe-System Evaluation of Splitting Units**

Field tests with selected trenchless-technology manufacturers will be conducted to evaluate the splitting

systems and to verify the capability to perform the applicable operations.

- **Field Evaluations/Modifications of Splitting Technologies**

Upon satisfactory simulated pipe evaluations and refinements of the identified splitting systems, field evaluations on sponsor system piping (this pipe may be abandoned facilities or pipe in training areas) will be conducted. These evaluations of the various splitting systems will provide actual field assessments to determine the effectiveness of the splitting systems. Based on these trials, feedback will be provided to the manufacturers.

- **Reporting and Case Studies**

Case studies of successful systems will be developed from the demonstration projects.

Results

This project was initiated during the second quarter of 2013 with an initial identification of available splitting systems for PE pipe. Several discussions were held with manufacturers in order to gain a better understanding of the systems and also to gain their support with this project.

Status

Ongoing activities include:

- Continued identification of additional PE splitting equipment
- Obtain specifications on the various PE splitting equipment
- Development of procedures for both PE main and service splitting
- Identification of potential field-test sites with project sponsors.

For more information:

Maureen Droessler

Program Administrator

Operations Technology Development, NFP

Phone: 847/768-0608

maureen.droessler@otd-co.org

OTDOperations
Technology
Development**OPERATIONS INFRASTRUCTURE SUPPORT****EZ Valve for Transmission Mains**

The objective of this project is develop a concept for a commercially available valve to allow for its use on natural gas transmission lines. The design has the potential to provide a compact and fast alternative to traditional valve installation methods.

Project Description

In 2012, the U.S. Department of Transportation's Pipeline and Hazardous Materials Safety Administration held an R&D forum to identify key pipeline technical challenges facing industry and government.

Identified challenges associated with installing automatic and remote control shutoff valves include:

- Lack of above/underground space for valve placement, especially in urban environments and
- Costs to install these valves on new and existing transmission pipelines (which can be greater than \$1,000,000 per valve installed).

To address these issues, this project is focusing on a valve-system concept (similar to the EZ Valve system) designed for higher-pressure distribution and transmission pipes. The current EZ Valve system is used in the water industry and bolts to the pipe to allow for the installation of an in-line valve without shutting off the flow. Advanced Valve Technologies, Inc., developed the EZ2™ valve system that can be installed under pressure in one excavation, eliminating expensive multiple excavations.

OTD previously funded a project to evaluate the EZ Valve for use in the natural gas industry. Technical work included:

- Determining the desired operating characteristics and the benefits seen by its application in the water industry
- Modifying the valve to address the gas industry need and to resolve the issue of the large number of chips (cuttings) generated during the milling process inside the gas pipe
- Testing the EZ Valve to validate the operational parameters as they relate to the gas industry standards.

This Phase 2 involves R&D to allow the EZ Valve fitting to be permanently welded to a steel pipe after installation.

This is a proof-of-concept project.

This project will model the design of a transmission-style EZ Valve for higher-pressure natural gas pipelines and will consider all material issues, geometric constraints, and operational needs.

This system will be a unique design that meets all material and performance expectations while delivering a compact and fast alternative to traditional valve installation methods. It will be developed to provide important performance and installation benefits to pipeline operators working under difficult conditions and with critical needs. Initially, researchers will develop a concept for a transmission EZ Valve for sizes up to 12 inches in diameter with working pressures up to 300 psig.

Deliverables

Deliverables include:

- A conceptual design of EZ valve
- Listing of geometric constraints and operational limitations
- Identification of material components and system specifications.

The deliverables from this project would feed into a follow-on project to develop an alpha prototype.

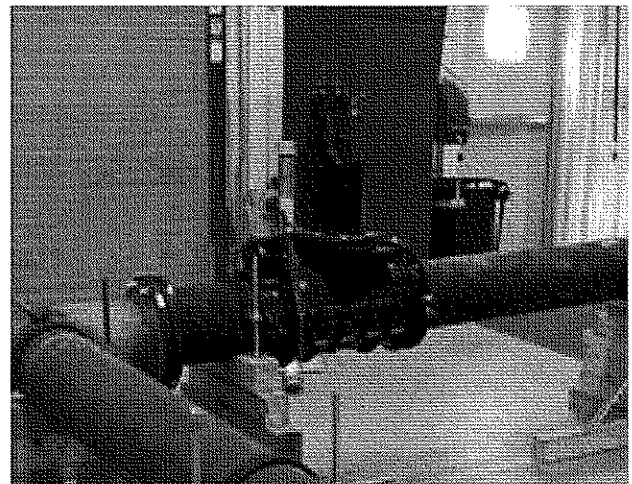

Benefits

Issues with installing traditional valves on an existing pipeline include high costs, the need for large excavations, the need for the installation of several fittings to allow for flow stopping, and, in many cases, the need for by-pass of the pipeline.

The adaptation of the EZ valve system will give operators options for the placement of these valves, along with the benefit of greatly reducing the cost of installation.

Benefits of the valve concept include:

- Faster installation times, especially in urban environments
- No need for flow control and/or by-pass
- Only single excavations needed since there is no need to stop off the flow in the pipe and no need to install a by-pass
- Enhanced safety
- Lower cost of installation.

Technical Concept & Approach

Specific key tasks for this project include:

- **Developing Sponsor Input of Technology Needs**

A series of conference calls and other communications were held with the project sponsors to review the needs and issues with transmission (higher-pressure) valves. System details and constraints were identified.

- **Valve Modeling**

The design from the existing EZ valve system and other current valve designs were evaluated. The transmission-style EZ Valve will be designed for higher-pressure natural gas pipelines and will consider all material issues, geometric constraints, and operational needs.

- **Conceptual Designs**

Conceptual valve designs are being created. Various designs will be reviewed with the project sponsors and possibly industry valve manufacturers and experts. Modifications to the design will be made based on feedback. The design must take into consideration the system pressures and valve type that will be inserted into the pipe to stop off the flow of gas. This will determine the type of cutting operation that is required. Once this is determined, the means of cutting can then be considered. Due to the

operating conditions, the fitting will be required to be welded in place and therefore the fitting will not be able to be rotated during the cutting operation as with the current EZ Valve system.

- **Reporting**

At the conclusion of this effort, a Final Report will be issued detailing the various design constraints and final conceptual design(s).

Results

In 2012, concepts and initial designs for a live insertable transmission valve were generated. The designs focused on a valve that could be installed without shutting off the flow of gas on steel transmission (or high-pressure distribution) pipelines. The focus was on pipelines ranging from four inches to 12 inches in diameter and pressures up to 300 psig. However, pressures up to 600 psig may be feasible.

CAD drawings of the weld-on split sleeve fitting, insertable ball valve cartridge, and tapping and insertion tooling were created. In addition, Finite Element Analysis (FEA) modeling was created for the weld-on split sleeve.

A series of reviews and modifications were also performed on the design and an invention disclosure was submitted for consideration.

Manufacturing detailed drawings were developed for both a six-inch "cut-in" valve and for the equipment to install/insert the valve. An animation simulation of the six-inch "cut-in" valve and the installation process was also created.

Status

The research team is completing revisions to the manufacturing drawings for the higher-pressure "cut-in" valve with a full-port opening.

Manufacturing drawings are also being made for the installation/insertion equipment necessary for installing the "cut-in" valve.

Patent filing activities are under way.

For more information:

Maureen Droessler

Program Administrator

Operations Technology Development, NFP

Phone: 847/768-0608

maureen.droessler@otd-co.org

ENVIRONMENTAL, RENEWABLES & GAS QUALITY

Research in this area provides technical solutions for various gas industry concerns.

Results from these efforts help companies to reduce operations costs, minimize environmental impacts, and more cost-effectively comply with regulations.

Significant initiatives are addressing greenhouse-gas issues, the use of biomass and other forms of renewable energy, and odorant fade issues. Additional efforts include the development industry guidance documents, improved methods for estimating pipeline leak emissions, and the investigation of sensors to measure trace constituents in fuel gases.

OTD

Operations
Technology
Development

Assessment of Acceptable Siloxane Concentrations in Biomethane

Biomethane from various waste products could provide consumers with a significant source of "green" renewable energy. For this project, a study was conducted into siloxane – one of the potential constituents in biomethane – to assess its influence on health, the environment, and gas-fired appliances.

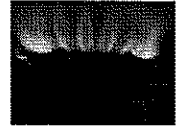

Project Description

Local gas distribution companies are increasingly asked to purchase and take delivery (interchange) of fully processed biomethane from the anaerobic digestion of waste into existing lines for general distribution. However, the original raw biogas can contain many different trace constituents. While methods being developed can upgrade raw biogas to high-Btu biomethane, this fully processed biomethane is not often accepted into existing pipeline systems.

One constituent of concern is siloxane, a man-made organic compound that contains silicon, oxygen, and methyl groups. Due to the increase in silicon-containing personal hygiene, healthcare, and industrial products, the presence of siloxane in waste streams has increased. As the silicon-containing waste stream/biomass is digested, smaller weight siloxane compounds volatilize and become entrained in the biogas. When this gas is combusted, silicon dioxide is formed. Over time, the silicon dioxide builds up and can cause damage. Certain concentrations in biomethane may lead to environmental health and safety concerns; however, the potential toxicity and risk of siloxanes is being debated.

To address various siloxane issues, in Phase 1 of this project (now completed) an extensive study was conducted to provide documentation to support guidance in the area of acceptable levels of siloxane in biomethane. The objective of Phase 2 (also completed)

was to perform laboratory testing on vented and unvented gas-fired appliances to evaluate equipment tolerance and potential indoor air concerns with siloxane, respectively, in order to determine adequate concentrations for safe acceptance of biogas in distributions systems. Data collected from laboratory testing will be used to develop a preliminary risk assessment model.

Deliverables

The deliverable for Phase 1 of this project was a technical summary with data to provide guidance for natural gas companies and biogas project developers in their efforts to introduce renewable gas into natural gas pipelines.

Phase 2 deliverables include a preliminary risk assessment that may be used by utilities to analyze their risks with respect to their unique requirements. Depending on results from Phase 2, additional laboratory testing may be performed in Phase 3 to allow for a comprehensive risk assessment.

Benefits

Results from this project could provide a variety of significant benefits, including guidance to utilities on assessing the risks associated with siloxane concentrations for biomethane interchange.

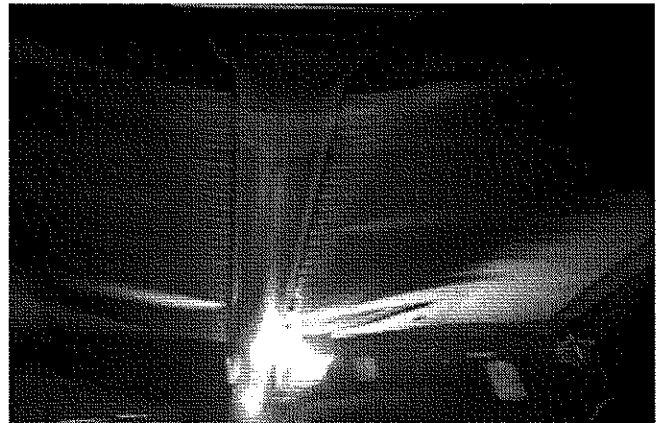
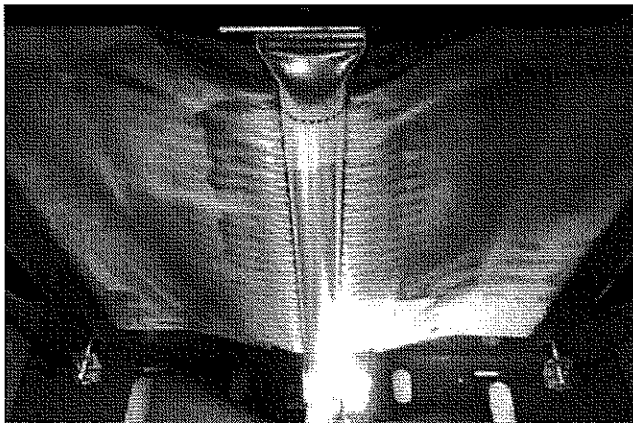

Images of the water-heater flame were taken weekly to document any visual changes. At left is the baseline flame image.

Importantly, the potential health effects of siloxane concentrations will be viewed with the benefit of scientific information.

Technical Concept & Approach

Research tasks include:

- A Review of Existing Data
- Manufacturer Interviews and Data Collection
- Laboratory Testing on Vented and Unvented Gas Appliances (water heater and oven, respectively)
- Development of a Preliminary Risk Assessment.

Results

In 2010, a report was issued that summarizes the initial research of Phase 1 and formed the foundation for field studies. The results of Phase 2 are presented in a report issued in October 2013.

In 2012, testing began with a water heater for the vented appliance and an oven for the unvented appliance with siloxane spiking of the fuel gas. The units operated Monday through Friday for eight hours per day. During the testing period, samples of the fuel gases were periodically analyzed to monitor siloxane concentrations. Flue gas samples were also analyzed to monitor changes in component levels, particularly carbon monoxide and carbon dioxide. Air samples were taken above the oven and monitored for particulates, and coupons were placed inside the oven to monitor surface accumulation.

The water-valve timer was set to a period of 40 minutes with a 10% on time, thus resulting in a typical water draw for testing and still allowing enough time for the water tank temperature to return to the set point before cycling the burner again.

Periodic analysis of the flue gas showed no significant changes to carbon dioxide and carbon monoxide during the length of testing. Internal inspection of the water heater showed significant accumulation of silica deposits on all surfaces in contact with the flue gas, and a large deposit of material on top of the burner. Analysis of this material showed it to contain a mixture of silica and iron, most likely due to rust.

Operation of the unvented oven showed no effects due to siloxanes until the oven's ignitor coil began to sporadically fail as the accumulation of silica deposits on the ignitor coil increased its resistance to a point where the circuit struggled to reach the current threshold for opening the gas valve.

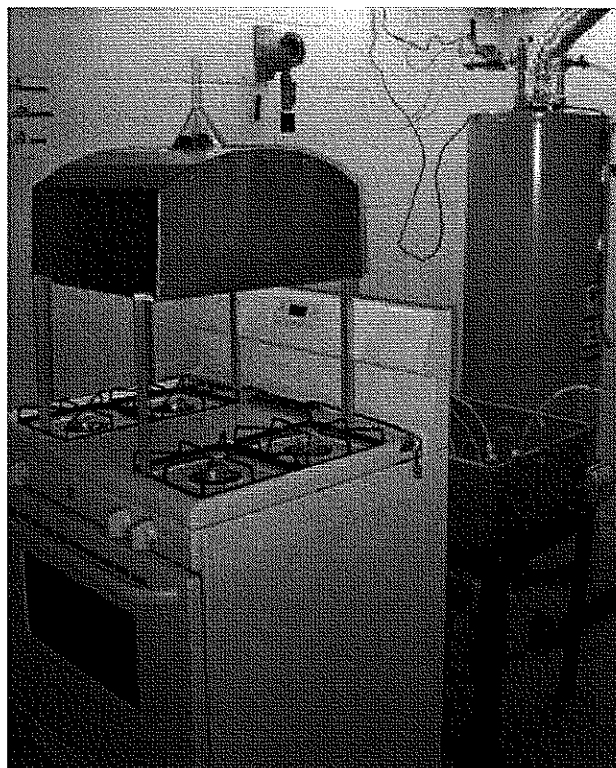

Laboratory testing.

Sampling of the oven flue gas above the range did not produce any observable particulates above a detection limit of 0.07 mg/m³. A significant amount of deposits was observed on all surfaces of the oven and flue vent, and scrapings of these deposits confirmed that they were amorphous silicon dioxide.

Data collected during the testing period was used to create a preliminary risk assessment model, which showed the exposure risk to be minimal, but there is a potential impact risk on increased cost in appliance maintenance and/or accelerated replacement due to silicon dioxide deposits.

Status

The research team is developing a risk assessment that describes and evaluates the likelihood of adverse effects, and includes a hazard assessment, exposure and impact assessment, and risk characterization.

For more information:

Maureen Droessler
Program Administrator
Operations Technology Development, NFP
Phone: 847/768-0608
maureen.droessler@otd-co.org



Operations
Technology
Development

Natural-Gas-Quality Survey: Trace Constituents



This research project is aimed at developing information to help introduce renewable "green" sources of energy into the natural gas pipeline. Information on trace constituents will facilitate a utility's ability to assess the potential to use gas generated from wastes and other sources.

Project Description

Natural gas – as well as renewable gas from wastes and other sources – contains specific properties and compositions which are complex and a function of many factors, including: 1) resource supply characteristics, 2) level of gas processing, and 3) degree of gas co-mingling prior to and during transportation.

In recent years, significant research has been conducted to analyze and characterize renewable natural gas (RNG) from dairy-waste conversion, landfills, and wastewater-treatment facilities. Through these projects, natural gas utilities have developed a greater understanding of renewable gas products and the ability to engage in productive dialogs with potential vendors of biomethane (cleaned biogas or RNG).

In previous research, samples of RNG products were analyzed for major components as well as trace constituents. Results were used in the development of guidance documents for the purposes of assisting natural gas companies in evaluating RNG products. The profiling was extensive; however, the sample set was limited (less than 100 samples total for all RNG sources from a limited number of sites).

This project is aimed at developing an improved understanding of trace constituents in natural gas to make a meaningful comparison with renewable and unconventional fuels. Without this information, some companies have been hesitant to accept these alternative fuel products into their systems.

To address the issue, researchers are conducting an analytical survey of trace constituents in natural gas supplies throughout North America.

Through this research, the industry will develop an enhanced understanding of the variety and concentrations of organic, inorganic, and biological constituents in currently available natural gas supplies.

This survey entails sampling and analysis of natural gas samples only.

Activities are divided in two phases.

Phase 1 focused on data collection, information dissemination, and project development. Sample collection/analysis is being conducted in the current Phase 2.

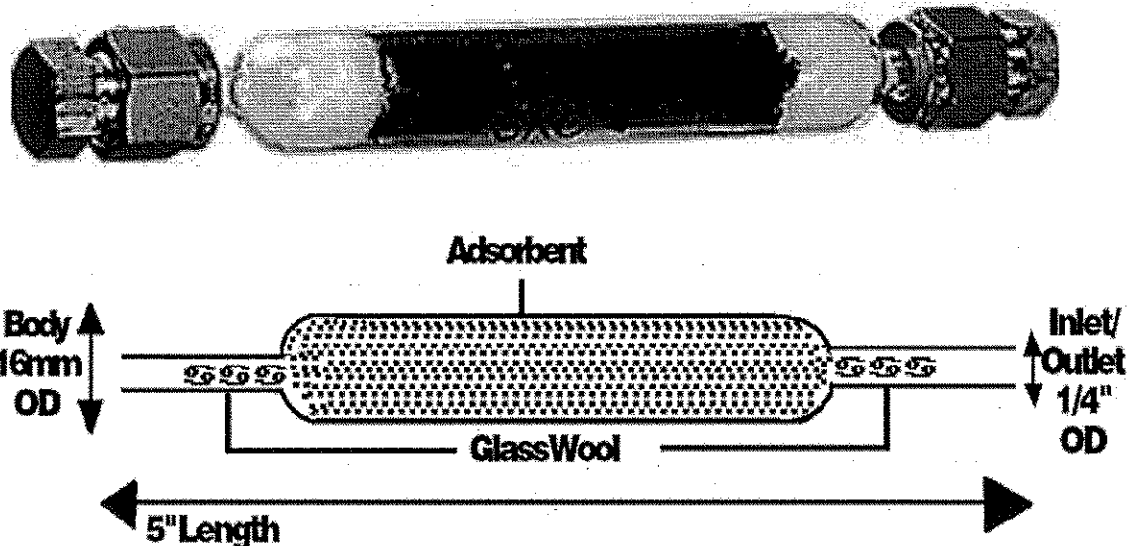

Sorbent tube used for radon sampling.

Deliverables

The overall goal of Phase 1 of this project was to fully scope and understand activities to be executed in the Phase 2 sampling activities. Phase 1 deliverables included: 1) a definition and consensus specific to the use of the information gathered as part of the overall project, 2) establishment of an oversight committee with responsibilities discussed and determined, and 3) detailed scoping and preparation for all Phase 2 activities, including a definition of the sampling sites, sampling sets, analytical profiling, field-crew assignments, data-reporting requirements, and Phase 2 costing.

Benefits

Results of the research will help increase the ability to employ "green" sources of energy and demonstrate an environmental commitment.

The purpose of the overall study is to more fully understand the trace constituent profile in natural gas so that more accurate comparisons of alternative fuels with existing natural gas supplies may be facilitated.

Technical Concept & Approach

Initial activities in Phase 1 involved interactions with project sponsors and others to develop a mechanism by which the data collected in this project can be effectively disseminated and shared throughout the natural gas industry and with other interested parties. To this end, an oversight committee was assembled to assist with industry communication and project planning.

In Phase 1, the project team developed plans for sampling activities in Phase 2. There are numerous options for natural gas sampling points, and efforts were made to determine the most appropriate natural gas sampling program (including variables such as the number of gas samples to be collected and the size and function of sampling teams).

Natural gas sample locations will be determined and access to sampling points will be arranged. The objective is to decide upon the most useful sources for natural gas testing at points which are most representative of the conventional and unconventional supply sources throughout North America.

In Phase 2, investigators will attempt to sample a wide variety of natural gas supplies from differing locations throughout the United States and Canada.

Results

In 2012, sampling was performed and all samples analyzed for the Marcellus and Devonian shale gas sites. Data sets were included in a report to project sponsors.

The research team experienced some difficulty in obtaining active field test sites, and some companies are reluctant to provide gas samples. In response, contact was initiated with several producers and pipeline companies to expedite sampling.

The radon collection media was modified to concentrate the samples and keep the sampling volume lower in order to eliminate potential interferences.

Sampling activities continued in 2013. Several distribution companies offered access to collect gas samples, the only concern being able to identify the source of the gas.

Information on the project was presented at the Gas Processors Association meeting in San Antonio, TX, in April, 2013.

Status

Ongoing activities include:

- Sampling and analysis of natural gas derived from conventional sources
- Sampling and analysis of the tight sands gas, coal-bed methane and LNG gases.

Efforts are under way to add more funders and communicate with sponsors to secure additional test sites.

For more information:

Maureen Droessler
Program Administrator
Operations Technology Development, NFP
Phone: 847/768-0608
maureen.droessler@otd-co.org

OTD

Operations
Technology
Development

Development of a Practical Pipeline Operator Guide to Manage Odor Fade Issues

Research was conducted to help determine the variables that can contribute to odor fade in natural gas. The results will be presented in a guide to aid pipeline operators in managing their systems and maintaining safe operations.



Project Description

Loss or change of odor in natural gas is usually attributed to two different causes: odor fade and odor masking. These are two distinct/separate issues requiring separate research efforts.

Odor fade is the actual loss of odorant by chemical or physical processes, including adsorption/absorption onto internal surfaces of metal or plastic pipe or the chemical reaction of gas odorants with pipeline contaminants and/or trace constituents in the gas stream.

Currently, supplemental odorant injection and control is, for the most part, based on a non-technical approach. Anecdotal information forms the basis of most current guidelines and the "Rule of Thumb" approach is also employed, where some pipeline operators use an odorizing "cookbook" with very mixed results.

This project focused on research, model design, and the validation of issues associated with natural gas odor fade in an effort to provide a "Practical Pipeline Operator Guide" to manage odor fade issues associated with typical gas system operating conditions and materials of construction.

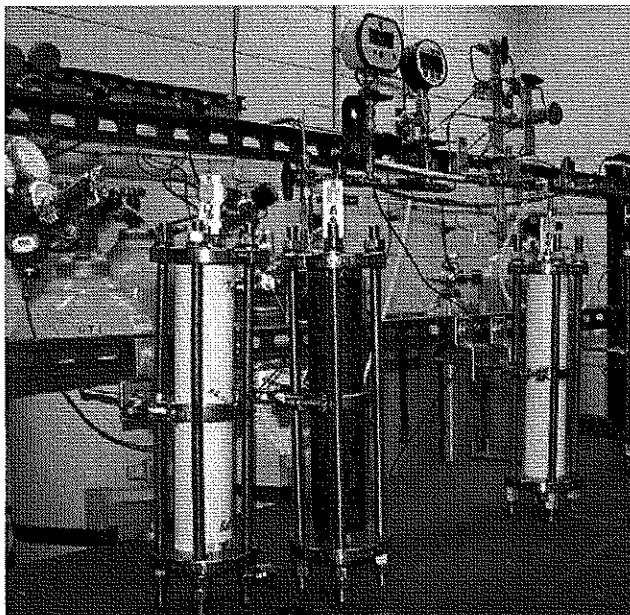

Laboratory static testing of pipe specimens.

The research team developed a methodology to validate combinations of gas, system, and material scenarios. Ideally, the project results, guide, and validation data will also be incorporated into the next update of the American Gas Association (AGA) Odorization Manual. Although the AGA Odorization Manual highlights some potential fade causes, currently it does not provide specific guidance or solutions to manage the odor fade problem.

Odor masking (not the subject of this research effort) is the change in *perception* of the characteristic gassy smell of odorants present in natural gas.

Deliverables

Deliverables for this project include:

- **A Practical Pipeline Operator Guide** to manage odor fade issues for a particular number of subsets of the combinations of gas, system, and material variables
- **A Tested Methodology** to validate combinations of gas, system, and material scenarios.

Benefits

- Reduction in the number of odorant-related incidents and resulting litigation
- Improved safety, public relations, and regulatory compliance, including Distribution Integrity Management Program compliance
- An improved ability to promote the acceptability of renewable gas sources by quantifying the impact of trace constituents (if any) on odorants within gas supplies
- The assured continuity of safe pipeline operations as the loss of experience and expertise (due to the retirement of odorant experts) impacts the industry
- Reduction in operating costs for odorant programs through the optimization of supplemental odorant-injection rates.

Technical Concept & Approach

This project included the following tasks:

- Definition of Project Boundaries, Literature Search and Dissemination of Results
- Identification and Definition of Variables that Affect Odor Fade
- Prioritization of Variable Effects
- Development of a Simplified Odor Fade Model Based on Key Variables
- Validation and Refinement of the Model with Specific (Select) Physical Testing
- Development of an Operator Guide.

Results

A preliminary literature survey reviewed the availability of current and historical data. The review found that the primary causes of odorant fading are: 1) surface interactions of odorants with different pipe materials, 2) scrubbing or dissolution by condensates or cleaning fluids, 3) chemical reaction/oxidation of odorant with other components in the gas stream, and 4) other system state variables.

To obtain specific detailed data from project stakeholders, survey questionnaires were designed for pipeline odor-fade events and preconditioning (pickling) and supplemental odorization.

Laboratory batch or "static" testing was conducted to obtain data regarding odorant loss under various selected conditions of gas composition, temperature, and pipe material. Containers used for testing odorant loss consisted of sections of plastic and steel pipes and two inerted stainless steel sampling cylinders. Analysis of sulfur compounds was by gas chromatography with a pulsed flame photometric detector.

Results confirm expectations that the variable that most impacted t-butyl mercaptan concentration in the gas phase was the presence of rust on the pipe surface. The concentration of t-butyl mercaptan in a steel pipe fades very rapidly until active sites are quenched.

Testing with trace contaminants in the inerted reactor were reported with a statistical evaluation of the data.

Field data was used to obtain some correlations with system variables. An increase in gas pressure appeared to induce increased absorption and adsorption, and concurrently an increase in oxidation from surface rust induced odor fade. Pipe diameter also showed some correlation as would be expected, with larger pipes requiring more odorant to be added.

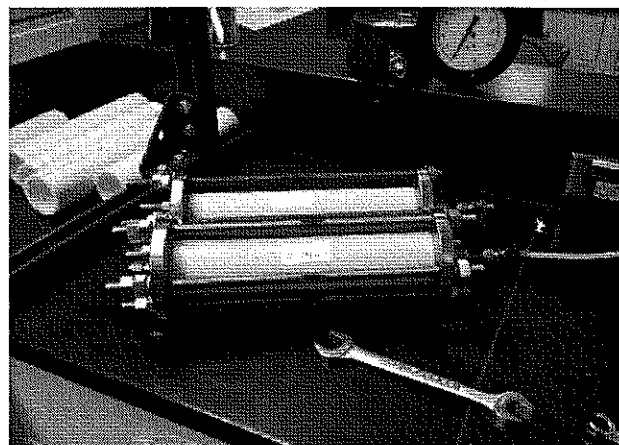

Plastic pipe test specimens.

Research found that there is the potential for a significant number of reactions to occur in an odorized pipeline gas system. In addition to forming disulfides and iron sulfides (mainly), mercaptans might also decompose or react with trace gas processing constituents.

Results indicate that by using the technique of injection of highly odorized gas, some 0.2 to 0.4 mL/ft² of odorant addition was required to achieve full conditioning of six-inch-diameter pipe. Nearly double the odorant addition rate was required when using the continuous liquid addition technique.

The information gained in this project was used to prepare a suggested revision to the AGA Odorization Manual, last revised in 2000.

Recommendations were also made for further testing.

Status

This project was completed in 2013. A Final Report with preliminary guidelines on odorant-injection rates was issued in December 2013. A full set of guidelines is being finalized.

A team was being formed to begin revisions to the AGA Odorization Manual in 2014.

The project team intends to be involved in this process and the information developed in this project will guide the odor fade section.

For more information:

Maureen Droessler
Program Administrator
Operations Technology Development, NFP
Phone: 847/768-0608
maureen.droessler@otd-co.org

OTDOperations
Technology
Development**ENVIRONMENTAL, RENEWABLES & GAS QUALITY**

Improving Methane Emission Estimates from Underground Pipeline Leaks



In this project, research is being conducted to develop a technical approach to quantify methane emissions from gas mains and service pipelines. The new method will provide an increased level of accuracy and an improved ability for utilities to comply with future regulations.

Project Description

Due to the growing concern over climate change and greenhouse gas (GHG) emissions, the natural gas industry is developing more accurate emission-estimation methodologies.

In this project, the research is addressing methodologies for quantifying fugitive and methane emissions (a large source of emissions in the distribution sector).

In Phase 1 of the project (completed in 2010), researchers assessed existing methodologies and proposed a technical approach for measuring leak flow rates at their aboveground state. Measurements of aboveground methane flow rates were performed in controlled tests where gas leaks were captured at the surface and measured using the Hi Flow Sampler™. The results of the tests showed good correlation with the applied leak rates from the pipes.

Phase 2 of the research program (completed in 2013) included field tests at utility sites with known leaks to evaluate surface measurements in various site conditions. The measurements correlated to below-ground measurements in isolated pipe segments.

The current Phase 3 of the project focuses on performing field measurements to establish the emission factors for emissions from cast-iron and unprotected steel pipes.



Deliverables

Deliverables include:

- Updated emissions factors for methane emissions from plastic, cast-iron, and unprotected steel pipes.
- A new methodology for more accurate estimation of methane emissions using above-ground measurements of pipe leaks.

Benefits

Results from this project will directly improve a company's ability to:

- Provide accurate, cost-effective, and manageable emissions management
- Satisfy regulatory requirements
- Implement methodologies that can be integrated with existing gas-distribution software and system tools.

With the new methodology, records are updated regularly using a combination of various technologies to search, pinpoint, and classify leaks. The estimates of activity data from utility inventory will also allow for the development of custom-made emission factors that address company-specific infrastructure characteristics.



Capturing the gas leak area for rate measurements.



Left: Pinpointing the leak source at a cast-iron main. Right: Covering the leak area and using the Hi-Flow device to measure the gas leak rate.

Technical Concept & Approach

This project is being executed in four phases:

- Phase 1: Technical Approach and Methodology Assessment (*Completed*)
- Phase 2: Field Measurement of Emission Factors of Plastic Pipelines (*Completed*)
- Phase 3: Field Measurement of Emission Factors of Steel and Cast-Iron Pipelines (*Ongoing*)
- Phase 4: Implementation.

Results

In Phase 1 of this project (now completed) researchers assessed the previous methodologies used in estimating leak rates from below-ground pipelines and proposed a technical approach for surface measurements of the flow rates at leak sites. Above-ground measurements were performed in controlled tests where gas leak areas were covered and the leak rates were measured using the Hi-Flow Sampler device. The results of these tests demonstrated the applicability of using the Hi-Flow device to measure gas flow rates at the surface and provided a framework for the tests at utility sites in the subsequent phases.

Following the development of a testing methodology, 30 tests at utility sites and field-testing facilities were performed. Leak measurements were taken at each site to cover the various factors associated with leaks in polyethylene pipe.

The field measurements consisted of identifying the leakage areas using the standard utility leak-detection tools and the Hi-Flow device in measuring gas flow rates in the covered leak areas at the surface.

The results validated the Hi-Flow surface measurements and provided an updated estimate of the Emission Factor for the PE mains. Most of the PE leaks at the utility

sites were characterized by low gas concentration readings at the surface and low emission-rate measurements. The field measurements provided a representative distribution of the full range of the gas concentrations in the utility records.

Most of the leaks in the mains were characterized as joint leaks, located at the joints between the main lines and the service lines.

Reports were issued in 2013 presenting Phase 2 field-test results and procedures for above-ground and below-ground measurements of methane emissions from plastic pipes.

Phase 3 – which was initiated in 2013 – involves the application of the developed field-testing procedures to obtain similar emission factors for cast-iron and unprotected steel pipes. Surface leak measurements were performed in Birmingham, AL, at sites with cast-iron mains. Gas leak measurements were also performed in Chicago with surface measurements taken at cast-iron mains at four sites. (Below-ground measurements were also performed in one of the sites.)

Status

The following activities are scheduled:

- Field tests (surface and below-ground measurements) on cast iron at selected sites
- Coordination and performance of field tests at other locations with participating utilities.

For more information:

Maureen Droessler
Program Administrator
Operations Technology Development, NFP
Phone: 847/768-0608
maureen.droessler@otd-co.org



Operations
Technology
Development

Gas Quality Resource Center

A web-based Gas Quality Resource Center is being established to provide information and expertise on issues surrounding gas quality, interchangeability, and potential implications from the introduction of new supply sources into gas transmission and distribution systems.



Project Description

Natural gas transmission pipeline and distribution companies are increasingly being asked to evaluate opportunities and accept new supply sources into their systems. This situation has created a marked shift from traditional gas-supply flow patterns – a trend that is expected to continue as these new supply sources (e.g., shale gas production and the introduction of renewable gas) are brought to market.

Along with this change in supply comes a change in the gas composition. Traditional supplies and gas compositions that have been relatively stable and consistent for decades are now beginning to change, and stakeholders are looking to ensure that these compositional changes will not have an adverse effect on their gas-delivery infrastructure or their customers' end-use applications.

Foundational knowledge in gas quality and interchangeability is readily available. A study was conducted through an industry collaborative effort that resulted in the 2005 White Paper on Natural Gas Inter-

changeability and Non-Combustion End Use by the NGC+ Interchangeability Working Group. This document contains Interim Guidelines for Gas Interchangeability that have been widely used; however, the White Paper also recognized that there are significant informational or data gaps that require further research. Additionally, the NGC+ report does not address renewable gas at all.

Since the NGC+ report was published, the natural gas industry has generally taken a localized approach in understanding end-use performance and infrastructure issues through the initiation of isolated research efforts to address these increasingly global, systemic issues. Information generated from these research and development efforts is very useful and of great value, but generally fragmented and potentially proprietary.

For this project, a research team is developing a Gas Quality Resource Center (GQRC) to provide access to recent and historical information resources and provide expertise and guidance in this technically complex area. The Center will serve as a centralized clearing-

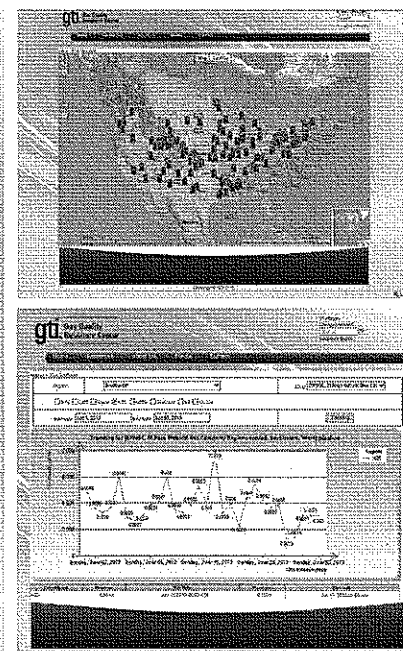
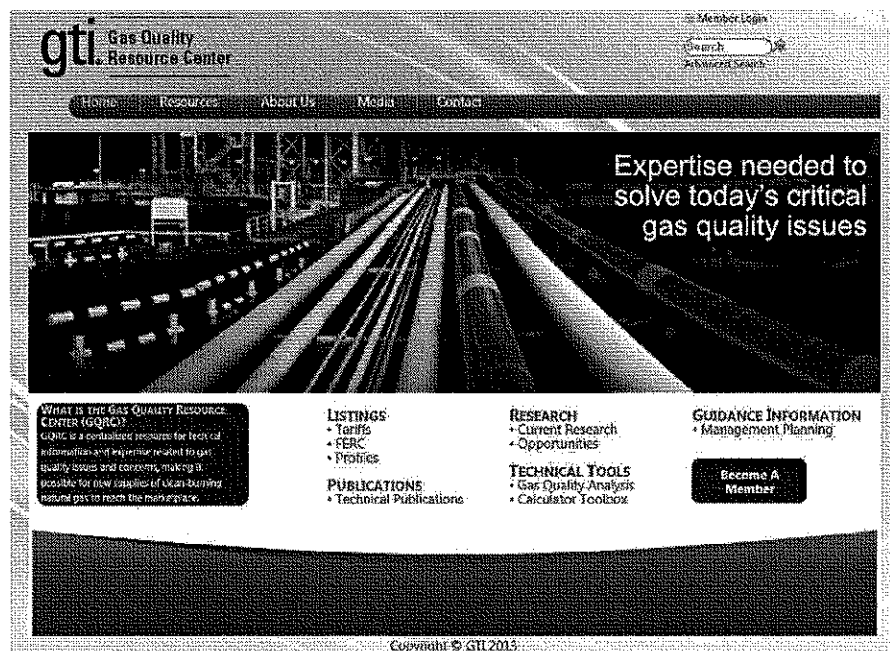

A web-based resource center is under development to provide for information on gas quality and unconventional/renewable sources of gas.

house for information related to gas quality, analysis of current flowing gas supplies in North America, identification of constituent trends across identified regions, analysis of current technical regulatory trends associated with pipeline tariff negotiations, and identification of research needed to help fill information gaps.

Deliverables

The initial deliverable for this project will be the creation of a dedicated Gas Quality Resource Center website and significant content.

Benefits

The Gas Quality Resource Center will help to allow for the safe introduction of new supply sources. The goal is to establish a common understanding and provide a sound technical basis upon which gas industry stakeholders can make informed decisions regarding new supply options. The GQRC will help to ensure continued system integrity and reliability, allow for an expanded use of clean-burning natural gas in growth sectors such as power generation and transportation, and help to reduce greenhouse gases through the addition/substitution of renewable gas.

Technical Concept & Approach

For this project, a research team is interfacing with an industry advisory committee comprised of subject-matter experts to develop a subscription-based Gas Quality Resource Center.

Researchers are developing an on-line database on gas-quality-related information derived from publically published data as well as proprietary information garnered from various stakeholder groups.

Information focuses on renewable and unconventional gas. Within the renewable gas domain, the resource center will contain information on resource assessments, conversion options, clean-up systems, gas-quality expectations, and studies on potential concerns, implications, and mitigating measures. Within the unconventional gas domain, the resource center will contain information on historical and expected compositions from North American resource basins, gas-processing technology, gas-processing facilities and capabilities, blending capabilities, regional historic supply profiles, publicly available tariff requirements, and studies on known/potential implications to infrastructure and end uses as well as mitigating measures.

Phase 1 of the effort focuses on providing information and technical support.

In Phase 2 of the project, various GQRC research projects are expected to be initiated.

Results

With the major building blocks and the underlying database architecture completed (e.g., the design and implementation of basic functions and database schema), 2013 activities mainly involved populating various categories in the on-line data base. The overall interface was updated for functionality and ease of use.

The project team:

- Populated the Technical Publications module with more than 500 documents and articles pertaining to odorization, gas-quality measurement, and analysis
- Created packages for importing the gas constituent values for 68 pipelines
- Re-factored the data access layer and the search mechanism for Tariffs, FERC, Profiles, Current Research, Technical Publications, Management Planning, Gas Quality Analysis, and Advanced Search in order to improve the user experience
- Added the Password change and Password retrieve functionality
- Configured the production environment

A Webinar to demonstrate a working prototype was held for industry representatives in September 2013. Information was also presented at an American Gas Association meeting in May.

Status

The project team continues to modify and populate database information, layout, functionality and adding filtering capabilities.

The first phase of the project is complete, with a working web-based prototype database established at: gqrc.gastechnology.org. However, additional time and budget has been requested to complete the population of various categories and continue to build on the current functionality.

For more information:

Maureen Droessler

Program Administrator

Operations Technology Development, NFP

Phone: 847/768-0608

maureen.droessler@otd-co.org

OTDOperations
Technology
Development**ENVIRONMENTAL, RENEWABLES & GAS QUALITY**

Sensors for Trace Constituents in Fuel Gases

Research was conducted to identify candidate sensors or sensor technologies for measuring trace constituents in fuel gases, with the ultimate objective to develop a field instrument.



Project Description

In efforts to develop renewable sources of energy, the natural gas industry has been investigating issues related to the introduction of various types of fuel gases into customer gas supplies.

Of concern is that many unconventional gas sources contain a wide variety of constituents. In landfill gas, for example, a set of some 500 trace compounds have been identified as potential components. The need to understand the composition of the fuel gases and to monitor their critical components is increasing as the number and variety of sources grows.

In this project, research was conducted to identify candidate sensors or sensor technologies for measuring trace constituents in fuel gases such as landfill gas, biomethane derived from a variety of biomass sources, and unconventional supplies such as tight sands and coalbed methane.

This research is a Phase 1 effort in a multi-phase project to develop a field instrument for determining trace constituents in various fuel gases.

Deliverables

The deliverables for this project consist of:

- Design criteria
- A list of candidate technologies that either meet or have the potential to meet the design specifications
- A Final Report that summarizes the project's findings on the technology assessment and identifies the leading technologies
- A written proposal for Phase 2 development and demonstration initiatives.

Benefits

The natural gas industry is devising a sustainable energy strategy that includes the use of renewable and unconventional gas. Monitoring the composition of fuel gases provides the industry with an enhanced capability to maintain valuable underground assets, deliver gas that meets end-use requirements, and protect human health.

'Nano-Silicon' GC

Analytical Pixels Technology (APIX Technology) is a company spun off from a collaboration between Sandia National Laboratories, Caltech, and the French Atomic Energy and Alternative Energies Commission in order to commercialize their "Nano-Silicon" GC technology.

In a "Nano-Silicon" GC, the GC column is affixed to a functionalized NEMS (Nano-electrical-mechanical system) array which allows it to be flexible and versatile while working outside the constraints of a traditional GC system. This "Nano-Silicon" GC technology won the best new product award at PittCon 2013.

Apix Technology already has one commercial device on the market, the GCAP, that is marketed for research, biomedical, environmental and petrochemical applications. A second device, the Max-One, is currently in beta testing.

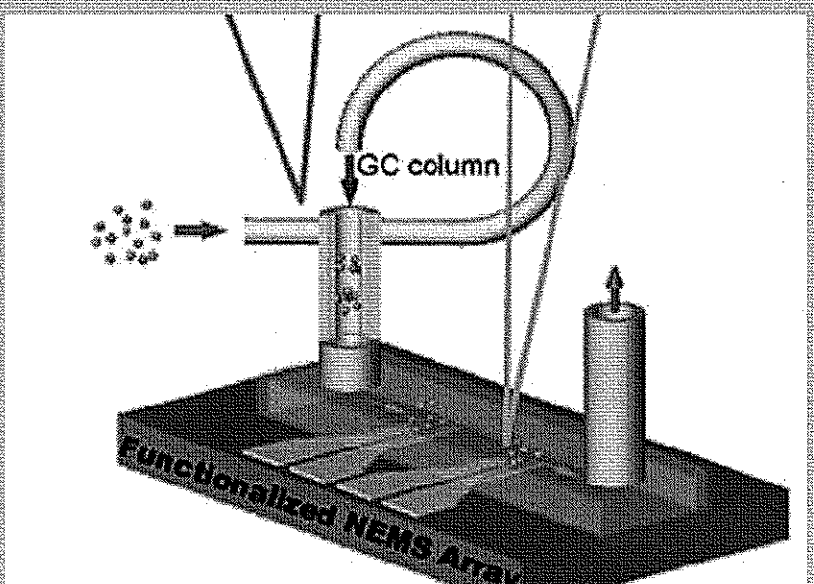

Technical Concept & Approach

Phase 1 activities began with interactions with project sponsors to determine monitoring specifications (e.g., how frequently, how precisely, how accurately, over what dynamic range, and at what price can the measurement of trace constituent concentrations be performed).

Subsequently, investigators conducted a search to identify candidate instruments or technologies that would be capable of meeting specified performance criteria.

The examination of the candidate instruments or methods entailed contacting the developers or manufacturers. The assessment considered the ability of a candidate instrument or technology to meet the scientific and engineering design criteria, the measurement cost point, and the timetable for development.

Results

The research team established a set of criteria for measuring trace constituents in fuel gas and prepared a set of relative risk rankings. These rankings aid in identifying the trace components that are the greatest threats to the gas delivery infrastructure and to end-use applications.

Information currently available on the compositions of fuel gas from a variety of sources was gathered. An examination of the potential risks to gas infrastructure and to end-use equipment from trace components was conducted.

Information was assembled on the compositions of the following sources of fuel gas:

- Coalbed gas
- Dairy-derived biogas
- Landfill gas
- Liquefied natural gas
- Natural gas
- Shale gas
- Thermo-chemically gasified biomass
- Tight sands gas
- Biogas derived from wastewater treatment.

Several promising techniques – including photoacoustic spectroscopy, IR/UV Dual Analyzers and “Optical GC” – were evaluated in depth. None of these techniques were determined to be suitable for reasons including spectral overlap and cross interference of the targeted

Issue / Material	Largest Trace Constituent Threats
Cast Iron	CO ₂ , H ₂ S, chlorobenzene, trichlorofluoromethane
Carbon Steel	CO ₂ , H ₂ S, arsenic, carbon disulfide, BTEX
Aluminum	Antimony, zinc, dimethyl sulfide, mercury, chlorinated organics
Polyethylene	C6+ alkanes, BTEX, dimethyl sulfide, chlorinated organics
Polyamide 12	CO ₂ , H ₂ S, aromatics, BTEX, some chlorinated organics
SBR	CO ₂ , H ₂ S, SO ₂ , C6+, BTEX, carbonyl sulfide, dimethyl sulfide, some chlorinated organics
NBR	CO ₂ , H ₂ S, C6+, BTEX, carbonyl sulfide, dimethyl sulfide, some chlorinated organics
CR	H ₂ S, C6+, BTEX, carbonyl sulfide, dimethyl sulfide, some chlorinated organics
SI	H ₂ S, C6+, BTEX, carbonyl sulfide, dimethyl sulfide, some chlorinated organics
Equipment Fouling	Siloxanes

Largest trace constituent threats to natural gas pipelines.

trace constituents and the inability to detect trace constituents at the desired ppm levels.

It was determined that analysis of the targeted trace constituents required a separation technique prior to analysis. The Max-One “Nano-Silicon” GC is an instrument currently in beta testing that uses a heated silicon-based micro-column to separate constituents and prevent cross interference and spectral overlap. The Max-One system fulfills the majority of the sponsor-desired criteria and appears to be the best option for trace constituent analysis.

Status

This project is complete and a Final Report was issued.

A Phase 2 follow-on project was proposed.

For more information:

Maureen Droessler
 Program Administrator
 Operations Technology Development, NFP
 Phone: 847/768-0608
 maureen.droessler@otd-co.org

OTD

Operations
Technology
Development

Odor Pill to Address Odorant-Fade Issues

To improve public safety and enhance the operations of the natural gas infrastructure, researchers are developing an odor pill prototype to overcome odor fade that can occur in stranded or low-flow distribution services and mains.



Project Description

Since methane is odorless, odorants are added to natural gas streams to allow for the easy recognition of the fuel. The main purpose of the odorant is for people to quickly detect a leak. However, using only the sense of smell to detect a combustible gas can present a safety concern under certain conditions where the perceived odor has diminished or faded.

Loss of odorant effectiveness in natural gas has become a high-profile issue for the gas transmission and distribution industry due to some recent incidents and increased litigation due to perceived odor fade. The U.S. Chemical Safety Board investigated five cases in which the odor of natural gas was called into question.

New pipelines have their own unique odor-fade issues. The current practice is for operators to add extra odorant to supplement the existing concentrations, often renting temporary injection equipment or wick odorizers. Sometimes this increased injection rate is the answer; however, some operators have reported no success with significantly increased injection rates. The problem can be exasperated when a known odor-fade

issue is resolved by over-odorizing one part of a system and causes leak-call complaints in another part of the system due to the extra odorant added.

Typically, supplemental odorant injection and control operations are based on a non-technical approach and stranded gas may swiftly become unodorized.

The objective of this project is to build and laboratory test a working "odor pill" prototype that overcomes odor fade in stranded or low-flow distribution pipelines for services and mains.

Gas Technology Institute's Sustaining Membership Program (SMP) sponsored the initial Phase 1 of this project, where two potential solutions were identified. This Phase 2 project builds on the SMP effort through continued technology development and implementation.

Deliverables

The deliverable for this project will be a prototype device (the "odor pill") and recommendations for future testing and development. Based on the outcome of the prototype device test, the next steps would include a demonstration of the device at a field site.

Benefits

- **Enhanced safety and risk reduction for new pipe installations.** Operators will greatly benefit from alternative methodologies to mitigate odor fade in low-flow situations that might arise in new pipe.
- **Odorization of stranded services and mains.** One specific odor-fade concern is the loss of odorant in stranded gas services and mains. When the main is put back on line, it may not have the right level of odorant present – or no odorant at all – depending on conditions. An ideal solution would be a device or technology that could be implemented as new gas services and mains are installed or put in the stranded configuration.

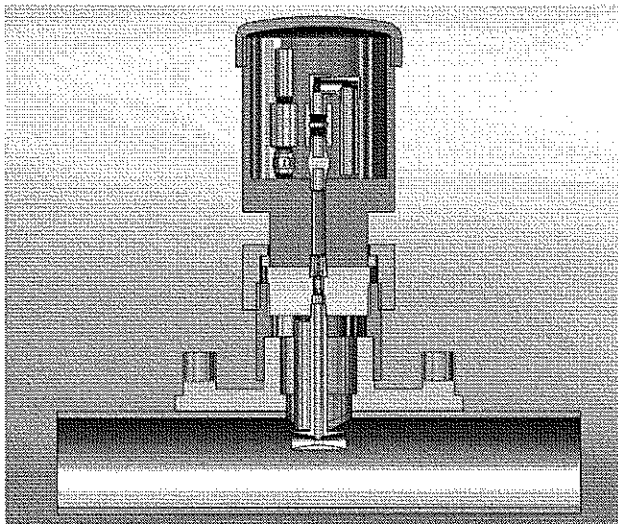

Odor pill concept drawing for mains and service lines. The Odor pill contains liquid odorant and directs a portion of the pipeline flow through the canister on the top of the tee. The gas then flows through the odorant headspace inside the canister. The concentration of the odorant in the gas stream is a function of the vapor pressure and density of the odorant, as well as the Venturi orifice diameter and stem diameter and length.

Technical Concept & Approach

The SMP project identified several areas of concern and forms for a device that might serve as an odorant supplement. Several ideas were investigated with the most promising being a membrane or orifice plate-like device which would rupture upon initiation of gas flow. It would have to be capable of being kept under static pressure for an undetermined amount of time prior to its initial response. Two versions of this concept were identified.

For this project, the following tasks are being conducted:

- **Modeling of Virtual Prototype**
- **Cost/Benefit Analysis**
- **Prototype Fabrication.**

Results

In 2012, drawings of an odor pill concept were developed for two-inch-diameter plastic pipe to retrofit the odor pill canister into commercially available internally threaded tees. Computerized Fluid Dynamic (CFD) models were performed, proving the concept for the odor pill to be successful for mains and services. The concept design was enhanced to prevent over-consumption.

In 2013, a cost-benefit analysis was performed of the odor pill versus traditional odorant methods. The projected annual costs of the odor pill is cost effective when compared to traditional odorization methods for new or rehabilitated services.

Some Findings:

- Costs for conventional spot odorization were difficult to estimate because it is highly dependent on gas flow rates and the type of odorizer used.
- For low-flow applications and as supplemental odorization techniques, the same type of equipment is used that is used with traditional odorization of high- to medium-flow and high- to medium-pressure transmission and distribution lines.
- Wick-type odorizers are the oldest type of odorizers. They utilize the property of chemical absorption. Wick odorizers operate in a similar fashion to kerosene lanterns, where the odorant climbs a wick and combines with the gas stream. They are used mostly in farm-tap applications. (Farm taps are a common facility on gas transmission pipelines and are used to supply gas to rural residential and industrial customers.)

- Bypass odorizers split off a portion of the gas flowing through a pipeline and pass the gas stream through an odorant storage tank. The odorant vaporizes into the flowing natural gas which then flows back in the main system. Chemical injection odorizers inject odorant into the flowing gas stream from a storage tank in proportion to the flow rate of the natural gas. The bypass odorizer is mechanically simpler and would fall at the lower end of this price range, whereas injection type models are more complex and would fall at the upper end.
- Costs for a five-gallon cylinder of odorant would depend on the odorant. A typical mercaptan blend would cost \$575 plus \$150 deposit for the cylinder and averages \$175 shipping, for a total cost of approximately \$900. The cylinders incorporate both a liquid and a vapor port for pressurizing the cylinder to the proper pressure specified in the odorizer. Other costs to consider are environmental issues. Cleanup and disposal costs should be factored in and will also vary depending on the odorizer. (Assume at least \$1,000 for hazardous waste disposal and cleanup of each odorant cylinder replacement.)
- Some companies construct special units to house their odorizers, especially if the units are located near a residential neighborhood. The costs of this may vary from \$5,000 to \$10,000.
- While the cost of the prototype does not include commercialization or manufacturing costs, it has the potential to save utilities in both operating costs and maintenance costs. Estimating a total odor pill tee assembly cost of \$4,000 and canister replacement of \$400, the net savings in the first year of using the odor pill is estimated at \$16,700. Since the chemical injection odorizer has a high one-time cost, the savings in subsequent years is estimated at \$5,700. This does not include the labor savings.

Status

Fabrication of the alpha version of the odor pill prototype was initiated in 2013.

For more information:

Maureen Droessler
Program Administrator
Operations Technology Development, NFP
Phone: 847/768-0608
maureen.droessler@otd-co.org

Technical Concept & Approach

A database was developed in a relational database management structure to address relationships and identify commonalities among various components and respective suppliers. The results were then used to create the necessary construction of identifiers. Identifiers provide a means to develop sufficient marking requirements that establish the uniqueness of the various components.

The Gas Distribution Component Traceability Identifier includes pertinent information such as: part manufacturer, attributes of a given part, and the pedigree of the part.

To date, all facets of the initial program are complete and a Final Report was prepared. Leveraging this momentum, in 2013 additional tasks were added to extend the base-62 encoding system methodology to transmission pipeline components, meters, and regulators. The research team will:

- Document current procurement practices for steel pipes and components, meters, and regulators
- Review applicable code and ANSI certified standards governing the physical, traceability, and marking requirements for steel pipe and components, meters, and regulators
- Document and finalize the key items of interest that need to be encoded through the base-62 encoding system for the vast number of gas transmission pipeline components (pipe, fittings, and appurtenances), meters, and regulators
- Develop a standardized 16-character identifier to encode key characteristics of transmission pipeline components, meters, and regulators.

Results

A standardized base-62 (16-character code) traceability encoding system was developed for distribution facilities. This standardized approach ensures that the marking on various types of components is a uniform length (16-digit alphanumeric code) with each digit representing key characteristics regardless of the type of component or the respective manufacturer.

A web-based application – www.componentid.org – was developed to establish a national registry of manufacturer identifiers.

To provide guidelines for the use of the base-62 traceability encoding system, researchers established a consensus-based stand-alone ASTM specification – ASTM F2897-11 *Standard Specification for Tracking and Traceability Encoding System of Natural Gas Distribu-*

tion Components (Pipe, Tubing, Fittings, Valves, and Appurtenances). The specification will provide a path forward for manufacturers to mark their respective products in a uniform and standardized manner and for gas utility companies to address recent regulatory initiatives and reporting requirements.

In 2012, testing was initiated to ensure the ability for a commercial-grade scanner to collect various bar code symbologies in various formats.

Expanding on the success of this initial standardized identifier for distribution components, in 2013 the research team initiated efforts towards the development of the base-62 16-character code for characterizing transmission pipeline components, meters, and regulators. This follow-on effort will ensure a single calculation methodology for all aspects and components for the entire gas delivery network.

Issues related to proposed changes to ASTM F2897 to incorporate key data related to transmission pipeline components (pipe/appurtenances) were addressed. The initial ballot for the F17.60 subcommittee ballot was submitted in December, 2013, and revised amendments were submitted for voting during the February 2014 ballot.

There were continued discussions with various stakeholders to resolve how to address the separation of distribution and transmission line components within applicable standards. Based on feedback, it was resolved that ASTM F2897 should serve as a central repository of identifiers to characterize all components regardless of application. That is, since steel piping can also be used for distribution applications, it is important to provide a means to characterize the pipe (or component) since at the time of ordering, it is generally not known in which application it may be used. Once these identifiers are placed in the ASTM F2897 specification, they can then be referenced by other standards which may or may not be application specific.

Status

The research team continues to interact with stakeholders and monitor progress of ASTM F2897 changes. Modifications to ASTM F2897 will be made based on voting results.

For more information:

Maureen Droessler
Program Administrator
Operations Technology Development, NFP
Phone: 847/768-0608
maureen.droessler@otd-co.org

**Operations Technology
Development, NFP**

1700 S Mount Prospect Rd
Des Plaines, IL 60018

info@OTD-co.org
847-544-3400
www.otd-co.org

OTD

Operations
Technology
Development

RESEARCH PROJECT SUMMARIES 2014

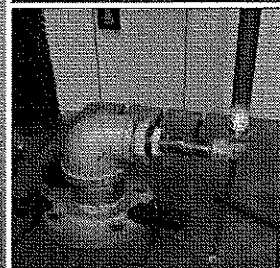
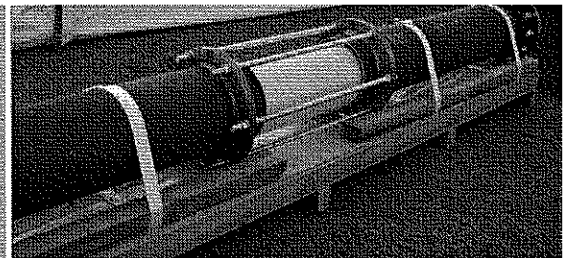
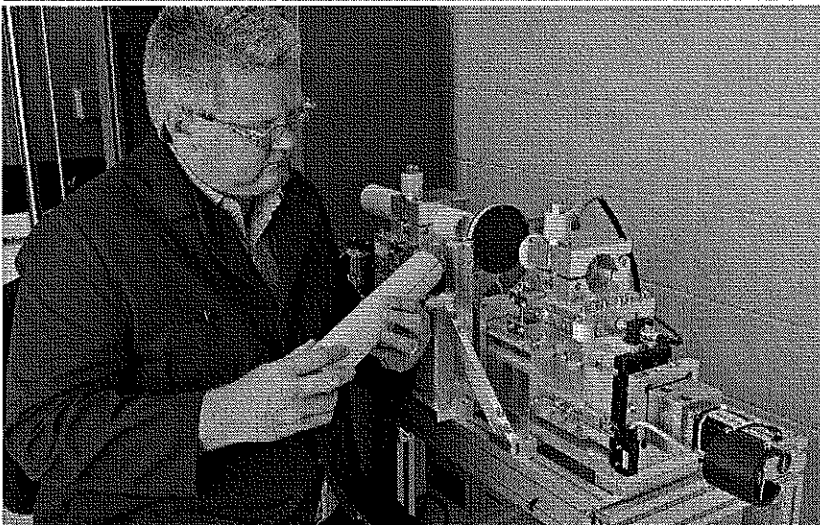
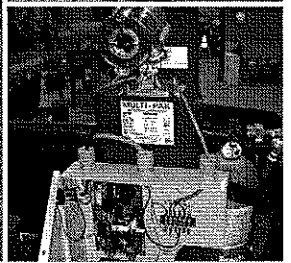
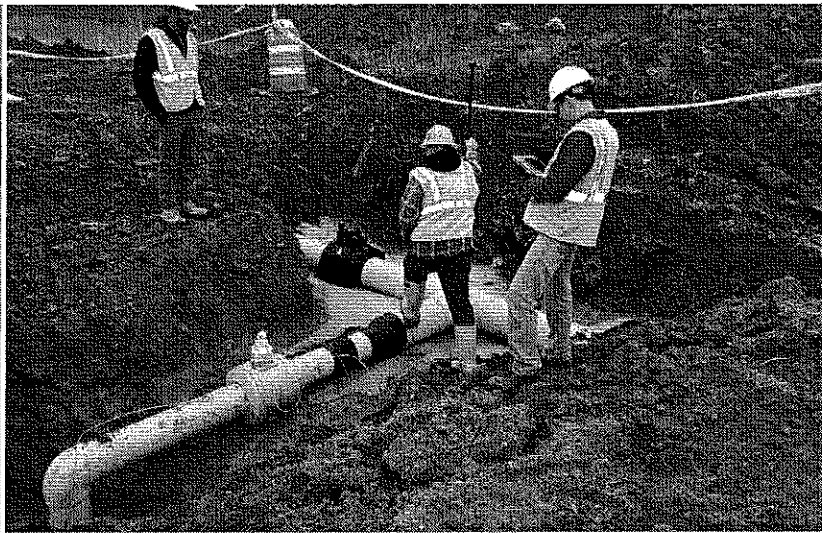
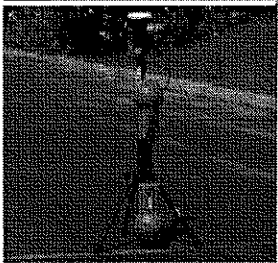
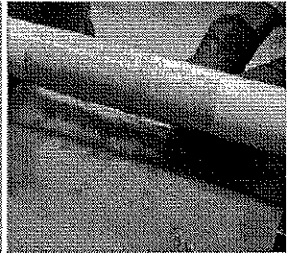

Operations Technology Development, NFP
RESEARCH PROJECT SUMMARIES

2014

Legal Notice

This report was prepared by Operations Technology Development, NFP (OTD), as an account of the results of work sponsored by OTD. Neither OTD, the members of OTD, nor any person acting on behalf of any of them:

- Makes any warranty or representation, express or implied, with respect to the accuracy, completeness, or usefulness of the information contained in this report, or that the use of any information, apparatus, method, or process disclosed in this report may not infringe privately-owned rights. Inasmuch as many projects are experimental in nature, the technical information, results, or conclusions cannot be predicted. Conclusions and analysis of results by OTD represent OTD's opinion based on inferences from measurements and empirical relationships, which inferences and assumptions are not infallible, and with respect to which competent specialists may differ.
- Assumes any liability with respect to the use of, or for any and all damages resulting from the use of, any information, apparatus, method, or process disclosed in this report; any other use of, or reliance on, this report by any third party is at the third party's sole risk.

Chairman / President's Letter

Technology development has always been essential in ensuring and enhancing the safety of our natural gas delivery systems. Today, OTD is taking the lead in these efforts for North American gas customers.

You can see the results of OTD's collaborative research at work in our streets and utility offices, and you can read about them in the pages of this report – a wide range of developments to improve the safety, integrity, and reliability of the natural gas infrastructure.

There is no doubt R&D has made gas operations and maintenance activities safer and more efficient than ever. However, today the industry is faced with new and pending regulations that make compliance more expensive, more complicated, and more challenging than ever. In response, OTD has put in place a robust program to analyze the issues, investigate solutions, and provide gas distribution and transmission companies with the tools they need to be able to comply with regulations in a cost-effective way based on sound, scientific study. In addition, researchers are investigating methane emissions, pipe splitting, advanced materials for pipe repair, horizontal directional drilling, pipe-location techniques, pipe inspection, and other developing technologies needed to enhance gas operations and safety.

In recent years, OTD has not only helped to introduce several new products but has also supported the establishment of information websites and guidelines. Our technology is entering the marketplace, providing valuable services through companies including LocusView, which provides mapping and survey services to track and trace company assets. Through OTD's efforts in advance of the Integrity Verification Process regulation, researchers developed on-line calculators, testing techniques, sampling methods, and inspection methodologies as lower-cost alternatives to conventional, legacy practices – and are continuing to provide support.

Since established in 2003, OTD has become the industry's premier source for meeting the challenges of an industry faced with an aging infrastructure, increasing costs, and compliance challenges. Today's gas customers are benefitting significantly from the efforts of OTD and its members. And as we continue on the path of progress, even more benefits will be realized.

We thank you for your support.



Charles E. Shafer II
Chairman of the Board

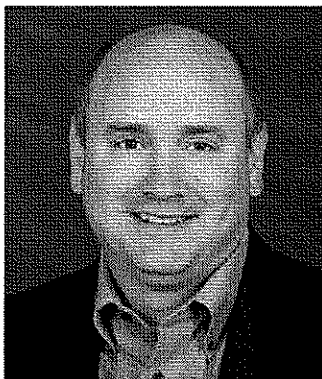

OTD Members

- > Alabama Gas Corporation
- > APGA Research Foundation
- > Atmos Energy Corporation
- > Avista Utilities
- > Consolidated Edison Co. of NY, Inc.
- > Duke Energy Corporation
- > Enbridge Gas Distribution Inc.
- > Intermountain Gas Company
- > Louisiana RDC
 - Atmos Energy Corporation
 - CenterPoint Energy, Inc.
 - Entergy Corporation
- > National Fuel Gas Distribution Corporation
- > National Grid
- > New York State Electric & Gas Corp. / Rochester Gas and Electric
- > NiSource Inc.
- > NW Natural
- > Oklahoma Natural Gas
- > Pacific Gas and Electric Company
- > Peoples Gas / Integrys Energy Group, Inc.
- > Piedmont Natural Gas Company, Inc.
- > Questar Gas
- > Southern California Gas Co., a Sempra Energy Utility
- > Southwest Gas
- > TECO Peoples Gas
- > Washington Gas

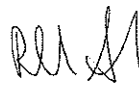

Ronald Snedic
President



Results in Use

Since 2003, the OTD program has provided utilities, pipeline companies, service providers, and others in the natural-gas-delivery business with innovative tools, enhanced processes, and advanced equipment for improving gas system operations.

These products represent the results of OTD efforts to build a stronger industry infrastructure, enhance system integrity, and improve the efficiency of a wide range of operations activities.

Selected OTD-Developed Products in the Marketplace

> Large-Diameter, Medium-Pressure Inflatable Stoppers

Mainline Control Systems

Marketed as the Kleiss MCS Flow Stopping System, this new system is used to stop the flow of gas in polyethylene, steel, cast-iron, and PVC pipes at diameters up to 18 inches and pressures up to 60 psig. The system, which is manufactured in Europe, was investigated through OTD to validate its operation and potential savings in the U.S. gas industry. (*Project Summary, p. 109*)

Contact: Wade Farr | 812-459-3936 | wfarr@mainlinecs.com | www.mainlinecontrolsystems.com

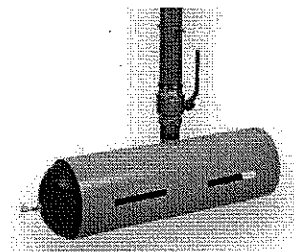

> IRED Infrared Portable Ethane Detector

SENSIT Technologies

This easy-to-use handheld detector was developed for use in the field to discriminate natural gas leaks from other sources of methane (e.g., swamp gas, landfill gas, and engine exhaust) and detect trace levels of ethane. The detection of ethane can be used as a fingerprint for natural gas in situations where the origin of a methane leak signal is questioned.

Contact: Scott Kleppe | 219-465-2700 | jscottk@gasleaksensors.com | info@gasleaksensors.com

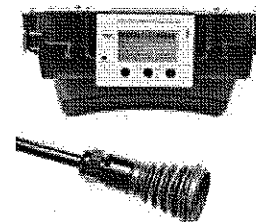

> Acoustic Pipe Locator (APL)

SENSIT Technologies

SENSIT's ULTRA-TRAC® APL acoustic-based pipe locator provides the ability to locate plastic pipes before excavations and construction. Now commercially available, in tests the system was shown to be capable of detecting multiple buried plastic pipes at depths up to five feet.

Contact: Scott Kleppe | 219-465-2700 | jscottk@gasleaksensors.com | info@gasleaksensors.com



> Mobile GIS for Automated Mapping and Lifecycle Tracking

3-GIS LLC

A software platform developed through OTD is now part of the 3-GIS Mobile product suite to allow users to collect new installation data directly within a GIS environment. Applications to integrate real-time, sub-foot accurate GPS and barcode scanning are included.

Contact: Jerry Golden | 256-560-0744 x223 | jgolden@3.gis.com | www.3-gis.com



> LocusMap Mobile GIS Solution

LocusView

This system maps new installations with comprehensive tracking and traceability data, creating GIS features in a format that allows field-collected data to be directly integrated into the enterprise GIS. Barcode scanning and high-accuracy GPS automate the system and help create high-accuracy maps.

Contact: Alicia Farag | 847-387-9412 | alicia@locusview.com | www.locusview.com



> GPS-Enabled Leak Surveying

Ubisense

Automating the leak surveying and pinpointing process with GPS eliminates paper records, providing increased efficiency and reliable compliance documentation. Pilots of the GPS-enabled system with the VeroTrack AST™ software application were conducted at several utility companies.

Contact: Langley Willauer | 207-236-3485 x306 | langley@ubisense.net | www.ubisense.net



> LocusSurvey for Tracking Leak-Survey Routes

LocusView

LocusSurvey uses tablet computers and GPS to track leak-survey routes. The GPS breadcrumb trail is overlaid in a GIS to track pipe segments that are surveyed to provide real-time reporting and monitoring. LocusSurvey eliminates paper maps and records, automating the process of documenting surveys and leak locations.

Contact: Alicia Farag | 847-387-9412 | alicia@locusview.com | www.locusview.com



> Uptime® 3.0 Distribution Integrity Management Risk Model

GL Noble Denton

Uptime® 3.0 provides an integrated environment for the integrity management of gas distribution and transmission pipeline assets. Uptime provides core support for all the key elements of distribution integrity management program regulations.

Contact: Michael Moore | 717-724-1900 | michael.moore@gl-group.com | www.gl-group.com

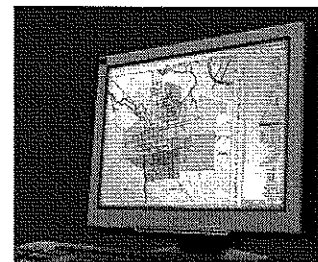

> NO-BLO® DBS System

Mueller Co.

Directional Bag Stopper (DBS) technology allows for routine maintenance without interruption of gas service to the customer. A portable system, it allows field technicians to perform many tasks related to the gas service line, including meter replacement and work on any part of the meter set, such as risers and regulators.

Contact: Bryan Kortte | 217-425-7516 | bkortte@muellercompany.com | www.muellergas.com

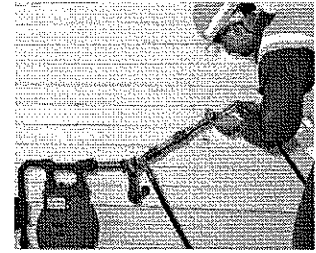

> Portable Methane Detector (PMD)

SENSIT Technologies

The handheld SENSIT® PMD uses optical-detection technology to provide sensitivity and cost advantages over conventional techniques employing flame ionization detectors. The PMD improves the efficiency of leak surveys, is less costly to maintain than other technologies, and can detect leaks from low ppm to 100% gas.

Contact: Scott Kleppe | 219-465-2700 | jscottk@gasleaksensors.com | info@gasleaksensors.com

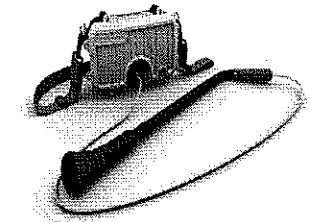

> Lift Assists for Pavement Breakers and Rock Drills

Integrated Tool Solutions, LLC

These devices assist workers in lifting pavement breaker and rock drills after the bits break through surface pavements and rocks and need to be repositioned for the next penetration. By eliminating the need to manually lift and re-position the heavy tools, the lift assists make breaking easier and less physically demanding.

Contact: Ryan Purczynski | 951-929-4808 | rpurczynski@integratedtoolsolutions.com | www.integratedtoolsolutions.com



> Keyhole Pipeline Inspection Camera System

ULC Robotics

The PRX250K keyhole camera is an internal inspection system designed for visual assessment of live mains through conventional pits or small keyholes. The system is easily maneuverable through tight bends, allowing utilities to examine pipe segments without the need to drill additional access holes.

Contact: Greg Penza | 631-667-9200 | gpenza@ulcrobotics.com | www.ulcrobotics.com

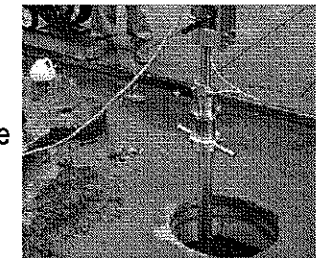

> Metallic Joint Locator (MJL)

SENSIT Technologies

The SENSIT Ultra-Trac® MJL accurately locates bell joints, repair clamps, and service connections on metallic piping systems, significantly reducing excavation areas and pavement restoration costs. In field tests, the MJL was also able to detect bell and spigot joints for an eight-inch-diameter water main buried at a depth of six feet.

Contact: Scott Kleppe | 219-465-2700 | jscottk@gasleaksensors.com | info@gasleaksensors.com

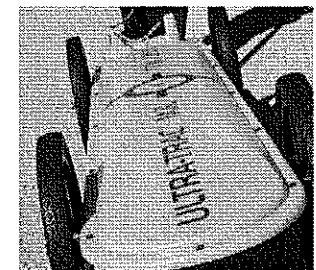

Informational Products

Selected OTD-Developed Technical Reports

In addition to the development of new tools, processes, and products, OTD supports research that results in useful information on various aspects related to gas delivery and operations. Listed here are some of the key reports developed under OTD sponsorship.

PIPE & LEAK LOCATION

> **RFID Marker Technology Implementation Guidelines**

A set of guidelines was developed for the implementation and application of integrated Global Positioning Systems (GPS), Geographic Information Systems (GIS), and "Smart Tag" technologies to streamline public-improvement project planning and prevent damage caused by excavations.



> **Cross Bores Best Practices Guide & Videos**

Significant research was conducted to investigate gas line/sewer line cross bores. The Guide and "how-to" videos (available through the OTD website) provide recommendations and procedures for preventing and detecting cross bores. (OTD-12/0003) (*Project Summary, p. 15*)

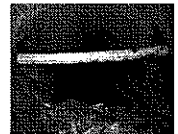

> **Residential Methane Gas Detector Program**

This reports provides results of a project initiated to determine whether commercially available combustible gas detectors are susceptible to giving false positive responses to an assortment of typical household chemicals, including ammonia, ethanol, acetone, toluene, isobutane, ethyl acetate, isopropanol, heptane, and hydrogen. (OTD-13/0003)

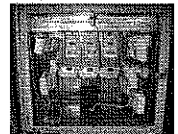

> **Underground Facility Pinpointing**

Reports from this project present the results of research conducted on several technologies used by utilities to locate underground pipes and facilities. Researchers investigated standard electromagnetic locators, ground-penetrating radar, and alternative imaging tools. The reports provide a comparative, technical evaluation of tools that are currently available. (OTD-6/0001)



PIPE MATERIALS, REPAIR & REHABILITATION

> **Liners/Composites for the Rehabilitation of Distribution and Transmission Lines**

A report titled *Transmission Infrastructure Roadmap* was prepared to address the implementation of composite piping materials in the rehabilitation of gas transmission systems. This report includes information on composite pipes, trenchless repairs, and cured-in-place structural liners. (*Project Summary, p. 33*)



> **Polyurea Coating Testing and Assessment for Gas-Industry Use**

A Final Report is available on research into field-applied polyurea coatings for gas industry use. Through a new initiative, long-term field trials will be conducted to evaluate these additional coatings and determine a cost-effective coating-application method and process.



> **Electrofusion Coupling Evaluation and Best Practices**

Researchers investigated techniques used to perform electrofusion joining of plastic gas pipe in an effort to develop guidelines for the use and operation of electrofusion coupling. With a detailed set of guidelines, the gas industry can enhance the performance and safety of its plastic piping systems.



> **Review and Selection Guide for Pipe Rehabilitation**

The focus of this study is on reinforced thermoplastic pipe (RTP) as a pipe-rehabilitation option for use in the natural gas industry. To help pipeline operators gain a better understanding of the technology, researchers developed a product-selection guide based on thorough research of available RTP technology.



EXCAVATION & SITE RESTORATION

> Evaluation of Lightweight Jackhammers

A research team evaluated the performance of currently available lightweight pneumatic and hydraulic jackhammers with respect to their effectiveness in breaking asphalt and concrete pavement, while considering other operational factors such as noise, vibrations, operator impact, and performance. Expanded evaluations are under way. (*Project Summary, p. 45*)

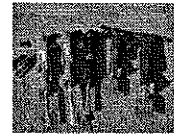

> Cold-Patch Products Performance Results

This report provides the results of a testing program that evaluated nine commercially available cold-patch products, including two products introduced in the market as "green" patches. Cold- and warm-weather tests were performed and repeated moving loads were applied with a wheel-loading machine that conducted 50,000 wheel passes.



> Evaluation of Flowable Fill Around Buried Pipes

Flowable fill is required by some agencies for use as backfill material for pipe repairs, rehabilitations, and other operations. Presented in this report are the results of performance tests of flowable fill, including the effects of flowable fill on pipeline corrosion and on the detection of gas flow and leaks through the backfill. (OTD-07/0004)



> Alternative Methods of Pavement Cutting

In an effort to reduce the costs and improve the process of pavement cutting, researchers investigated the application of current and new pavement-cutting methods. Technologies examined and summarized in this report include impact breaking, sawing, chemical and thermal methods, water-jetting, and laser cutting.



PIPELINE INTEGRITY MANAGEMENT & AUTOMATION

> Inspection Technology Strategy Tool

An on-line software tool was developed to assist pipeline operators in evaluating and selecting appropriate inspection tools. A website provides a centralized resource for technical information and expertise related to internal inspection issues and concerns.



> Leak-Rupture Boundary Report and Calculator

This report and associated software allows operators to determine the leak-rupture boundary for a pipe segment based on properties such as the diameter, toughness, and yield strength. Operators can use the calculator for risk modeling and consequence analysis. (OTD-13/0002 and OTD 13/0004)

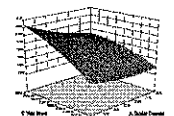

> Field-Applied Pipeline Coatings: Short- and Long-Term Performance

This report presents the culmination of a 10-year research program to assess more than 80 different commercially available field-applied pipeline-coating products. The goal was to establish an unbiased, third-party basis for operators to select the most appropriate coating system for particular applications.



> Evaluation of Guided Wave Technology as a Hydrotest Equivalent

This report details an evaluation conducted to demonstrate and validate the use of Guided Wave Ultrasonic Testing as an equivalent to a hydrotest. A standard was developed and incorporated by the National Association of Corrosion Engineers (NACE) into the NACE TG410 committee standard. (OTD-11/0001)



> "Black Powder" Contamination in the Gas Industry: Survey and Best Practice Manual

Black powder – a substance composed mainly of iron sulfides and iron oxides – can cause corrosion and create wear on pipelines. This report provides information on issues, cleanup techniques, and management methods related to "black powder" contaminants. Results were compiled into a "best practices" industry manual. (OTD-07/0002)



> Literature Review for Elemental Sulfur Deposits in Natural Gas Transmission Pipelines

Deposits of "elemental sulfur" – which can block natural gas pipes and equipment – are becoming an increasing concern in the natural gas industry. This report summarizes a literature review to develop a better understanding of the sources, causes, and mitigation possibilities for sulfur deposits found in gas pipelines. (OTD-09/0001)



- > **Flaw Acceptance Criteria and Repair Options for Low-Stress Natural Gas Pipelines**
Researchers partnered with pipeline companies and industry organizations to develop modified assessment criteria for low-stress pipelines. The goal was to develop criteria for discriminating flaws that truly affect pipeline integrity from flaws that have no significant impact.
- > **In-Field Corrosion Rate Measurement/Determination for Integrity Reassessment Intervals and Risk Prioritization**
Research was conducted to develop a systematic and simple method to calculate realistic corrosion growth rates for determining pipeline-reassessment intervals.

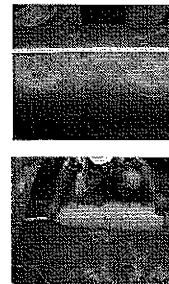

OPERATIONS INFRASTRUCTURE SUPPORT

- > **Assessment of Frost Impact on Cast-Iron Pipes**
This study of winter leak-breakage records correlated pipe breakage due to freeze conditions with local site conditions, such as soil properties, weather patterns, and pipe attributes (e.g., depth, diameter, and age). Statistical analysis established relationships between various parameters to enhance winter leak-surveillance procedures. (*Project Summary, p. 113*)
- > **Evaluation of Static Suppressors on Existing Polyethylene Piping Systems**
Researchers evaluated selected commercially available static suppressors for suitability for use on polyethylene piping systems to eliminate static charge and assess their effects on heat-fusion-joint performance and pipe materials. (*Project Summary, p. 85*)
- > **Evaluation of Commercial/Light-Industrial-Sized Excess Flow Valves (EFVs)**
This reports presents the results of an evaluation of the performance of high-volume EFVs for commercial, multi-residential, and light-industrial applications in response to regulations requiring an expanded use of EFVs. (*Project Summary, p. 115*)
- > **Natural Gas & Indoor Air Quality Website**
A website of vital information on indoor air quality and safety issues was developed for OTD members through the OTD website (*otd-ca.org*). The site provides a center of expertise and a single-point access to scientific data, performance information, and natural-gas-related issues. (*Project Summary, p. 87*)
- > **UV Degradation and Static Buildup Testing of Personal Protection Equipment Fabrics**
Researchers tested various utility-vest materials to determine if degradation is caused by ultraviolet light and to evaluate the potential for static buildup to become hazardous. The results of safety vest testing are available in technical reports.
- > **Ignition Testing of Electronic Devices**
In this project, handheld electronic devices were tested to determine if ignition occurs in the presence of a flammable methane/air mixture. Laboratory tests demonstrated a large margin of safety under the scenarios investigated. (OTD-12/0001)
- > **Intelligent Utility Installation Process**
This report provides a methodology, field process, and a data model for capturing data during new utility installations. The process is used to capture information regarding the location, materials, installation process, environmental considerations, and other factors. (OTD-12/0002) (*Project Summary, p. 93*)
- > **Tracer Wire for HDD Applications**
Extensive research and testing culminated in the release of a report that provides valuable information on the properties and performance of various tracer-wire products for use in horizontal directional drilling (HDD) operations. (OTD-13/0001)
- > **Regulator Vault Corrosion and Coating Rehabilitation**
This study focused on thermal-spray and its ability to mitigate the corrosion of gas piping and the components housed in utility vaults. Results from the field work include detailed information on surface preparation methods, pre-cleaning, coating applications, quality-control inspection specification for field use, and the coating-material selection process.

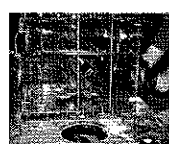
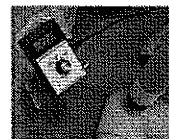

> **Assessment of Vehicle-Barrier Design for Aboveground Facility Protection**

Investigators compiled the latest information on the design, regulations, and installation practices of structural vehicle barriers used to protect aboveground utility facilities from vehicular damages. The Final Report also includes a review of various state and federal safety guidelines.

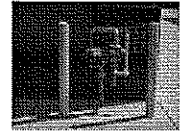

> **Study of Low-Impact Markings**

A variety of paints, materials, and techniques were tested and characterized in an effort to identify products and methods that can be used for temporary utility marking. Information developed in this study allows users to identify the most appropriate marker type for a given environment to achieve the desired marking duration. (OTD-11/0002)

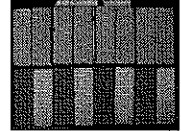

> **Solar-Powered Remote Monitoring**

In this study, solar-powered devices were investigated as power sources for the remote monitoring of various gas utility facilities to more cost-effectively obtain rectifier data, pipe-to-soil measurement, pipe-to-casing readings, and other information.

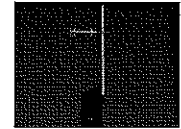

> **Integrating GPS into Routine Operations**

This report provides a set of recommendations and GPS implementation strategies developed through pilot programs, literature searches, and reviews of existing applications. Operations that were considered included meter reading, leak surveying, new installations, corrosion monitoring, and valve inspections.



> **DVDs for Training First Responders**

DVD training products help gas companies better educate first-responding personnel about natural gas emergencies. Learning modules with realistic scenarios cover a variety of issues to enhance public and worker safety. The product also serves to improve emergency-response effectiveness and coordination.



ENVIRONMENTAL, RENEWABLES & GAS QUALITY

> **Siloxane Concentrations in Biomethane**

Biomethane from various waste products could provide consumers with a significant source of "green" renewable energy. In efforts to help develop this green resource, a study was conducted into siloxane – one of the potential constituents in biomethane – to assess its influence on health, the environment, and gas-fired appliances.

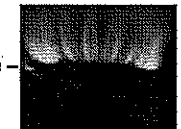

> **Field Measurement Program to Improve Uncertainties for Key Greenhouse Gas Emission Factors for Distribution Sources**

This report summarizes the results of field surveys conducted at six natural gas utilities. With the support of the American Gas Association, research updated emissions factors for metering stations, regulating stations, and customer meters. (OTD-10/0002)



> **Improving Methane Emission Estimates for Natural Gas Distribution Companies**

This report details Phase 2 of a four-phase field-testing program to evaluate gas leak rates from belowground pipelines, provide a simplified procedure that can be used to monitor pipeline leaks from surface measurements, and update the methane emission estimates for the main lines in a distribution system. (Project Summary, p. 141)



> **Pipeline-Quality Methane: North American Guidance Document for Introduction of Dairy-Waste-Derived Biomethane into Existing Natural Gas Networks**

The guidance document provides reference and recommendations for the consideration of biomethane from dairy-waste digestion for introduction into gas pipeline networks. The report details results of a biogas/biomethane Gas Technology Institute research program.



Contact: Maureen Droessler
847-768-0608
maureen.droessler@otd-co.org
www.otd-co.org

OTD RESEARCH PROJECT SUMMARIES 2014

Table of Contents

Project	Page
PIPE & LEAK LOCATION	
1.i Remote Leak Survey Using Lasers.....	3
1.8.a GPS-Based Excavation Encroachment Notification.....	5
1.10.e Enhancing Damage Prevention Through Implementation of New Technology	7
1.11.c Low-Cost MEMS Methane Sensor Platform.....	9
1.11.d Cross Bores Best Practices Education and Outreach.....	11
1.11.e Cross Bores – National Database and Risk Model.....	13
1.12.b Cross-Bores Detection Using Mechanical Spring Attachment.....	15
1.13.a Integration of Acoustic and GPR Technologies for HDD Operations	17
1.13.c Testing and Field Evaluation of No-Blow Fish-Tape Technology to Locate PE Mains.....	19

PIPE MATERIALS, REPAIR & REHABILITATION

2.7.d Cold Adhesive Repair and Joining of Polyethylene Pipes with Minimal Surface Preparation.....	23
2.7.e Development of an External Repair Tool for Polyethylene Pipe	25
2.10.b In-Service Field Evaluation of Polyurea Coating Systems	27
2.11.a Development of a System for Repair of Aboveground Leaks	29
2.12.a Integrated Expert Monitoring and Training System for Butt Fusion.....	31
2.12.e Liners/Composites for the Rehabilitation of Distribution and Transmission Lines	33
2.13.b Guidelines for Special Permits for Structural Composite Rehabilitations	35
2.13.c Accelerated Dynamic Testing for Long-Term Performance of Liners & Composite Pipe Materials	37
2.14.a Composite Repair Wrap for Polyethylene Systems	39
2.14.b Pipe System Repair Technique.....	41

EXCAVATION & SITE RESTORATION

3.14.a Soil Compaction Supervisor Enhancements.....	45
---	----

PIPELINE INTEGRITY MANAGEMENT & AUTOMATION

4.11.e Evaluating Assessment-Technique Effectiveness	49
4.12.a Probability-of-Failure Model for High-Risk Pipe Segments (Vintage Pipe)	51
4.12.b Correlating Pipeline Operations to Potential Crack Initiation, Growth, and Arrest.....	53
4.12.c Field Test of a Cathodic Disbondment Detector.....	55
4.12.d Continuous Threat Identification Program.....	57
4.12.e Pipecrawler Marker Assessment and Demonstration	59
4.13.a Distribution Integrity Management Plan Consequence Model	61
4.13.c EMAT Sensor for Small-Diameter and Unpiggable Pipe.....	63
4.13.d Hydro-Testing Alternative Program.....	65
4.14.c Surface Indentation for Material Characterization	67

Table of Contents (cont.)

Project Page

OPERATIONS INFRASTRUCTURE SUPPORT

5.8.a	Development of Automated Welding Unit for Installing Laterals.....	71
5.8.d	Tool for the External Classification of Pipe Contents	73
5.8.e	Development of Standardized Algorithms and Identifiers for Enhanced Material Tracking and Traceability	75
5.9.c	Mitigating Electrical Interferences on Cathodic Protection Systems	77
5.9.f	Cathodic Protection Monitoring Technology Deployment.....	79
5.9.h	North American Manufacturer Outreach Program.....	81
5.9.i	Enhancing the EZ Valve by Developing a Weld-On Steel Housing for Gas-Distribution Use.....	83
5.10.a	Evaluation of Static Suppressors on Existing Polyethylene Piping Systems.....	85
5.10.g	Indoor Air Quality and Safety Issues	87
5.11.a	Dewatering Systems for Mains and Services	89
5.11.e	Intelligent Utility System.....	91
5.11.m	Intelligent Utility Installation Process (Asset Tracking)	93
5.11.n	Quality-Control Procedure for High-Potential Anodes.....	95
5.11.p	Smart-Grid Initiative Standards and Regulations.....	97
5.11.r	Integrating Sensors with Existing Automated Meter-Reading Systems	99
5.11.s	Breakaway Disconnect/Shut-Off for Meter Risers.....	101
5.11.t	Essential Data Collection for PE Fusion Operations	103
5.12.a	Development of an Intelligent Shut-Off Device for Commercial and Industrial Customers.....	105
5.12.b	Development of a Portable Flash-Fire Suppression System.....	107
5.12.g	Large-Diameter, Medium-Pressure Inflatable Stoppers	109
5.12.n	Advanced Tools for Improved AC Corrosion Prevention and Mitigation	111
5.12.o	Guidelines for Cast-Iron Piping Winter Operations.....	113
5.13.a	Evaluation of Commercial-/Light-Industrial-Sized Excess Flow Valves (EFVs)	115
5.13.b	GPS-Based GIS Conflation System	117
5.13.c	PE Pipe-Splitting Evaluation, Enhancements, and Standardization of Tool Kits.....	119
5.13.d	EZ Valve for Transmission Mains.....	121
5.13.f	Low-Cost Collision-Avoidance System.....	123
5.14.a	RFID Testing Program.....	125
5.14.c	Improving Cybersecurity for LDCs – Needs-Identification Workshop	127
5.14.d	Tracking and Traceability for Transmission Pipe Materials	129
5.14.f	Battery- and Electric-Powered Tool Evaluation	131
5.14.j	Residual Gas Removal – Identifying Technologies, Limitations, and Best Practices	133

ENVIRONMENTAL, RENEWABLES & GAS QUALITY

7.10.a	Natural-Gas-Quality Survey: Trace Constituents.....	137
7.10.b	Development of a Practical Pipeline Operator Guide to Manage Odor Fade Issues.....	139
7.10.c	Improving Methane Emission Estimates from Underground Pipeline Leaks	141
7.11.a	Gas Quality Resource Center.....	143
7.14.a	Next-Generation Water-Cleanup Technology	145

PIPE & LEAK LOCATION

Advances in technologies for pipe and leak location enhance the safety and maintenance of natural gas delivery systems.

Developments in this area include improvements in leak detection, plastic-pipe location, obstacle-detection capabilities for horizontal boring tools, and underground facility pinpointing.

Multiple approaches are being investigated, including the use of GPS-enabled equipment, radio-frequency markers, and laser-based technologies.

Research focuses on reducing third-party damage (the primary cause of gas system leaks and incidents), increasing productivity, and improving system integrity.

Significant efforts include projects to address, detect, and prevent utility line cross bores.

OTD

Operations
Technology
Development

Remote Leak Survey Using Lasers



In this project, research focused on the development of laser-based gas-leak-survey equipment that could be incorporated into a moving vehicle for surveying both mains and services. The technology would reduce the cost of leak surveys.

Project Description

Research in this project involved the investigation of a leak-detection technology, called the Laser Line-Scan Camera (LLC).

With the LLC, a laser beam is directed outward to detect back-scattered light at wavelengths that are sensitive to the presence of methane in the air. The remote sensing technology is designed to provide real-time detection and location techniques to detect above-ground natural gas leaks at sensitivity levels comparable to that of current flame pack surveys (5-10 ppm).

In this project, research was conducted to determine the LLC's detection limit, inspection speed, operator interface, and system packaging. The ultimate performance goal for the LLC is to detect gas plumes with methane concentrations as low as 10-20 ppm out to distances of 100 feet from a vehicle. A vehicle-installed demonstration was conducted to transition the past LLC technology into a ruggedized configuration for proving the feasibility of remote leak-sensing technology for services.

Deliverables

Research and testing results are documented in a report that includes recommendations for developing and improving prototypes for further testing.

Benefits

Gas companies and their customers would benefit by having a technology that would allow leak surveys to be conducted from a distance of 60 feet or more. By mounting the laser-based device on a vehicle, surveys of both mains and services could then be performed from the street, eliminating the need to walk the gas service lines.

Technical Concept & Approach

In earlier research, a pre-prototype LLC was designed, built, and tested in the laboratory with available laser chips. The initial system performed well but required improvements based on input from project sponsors.

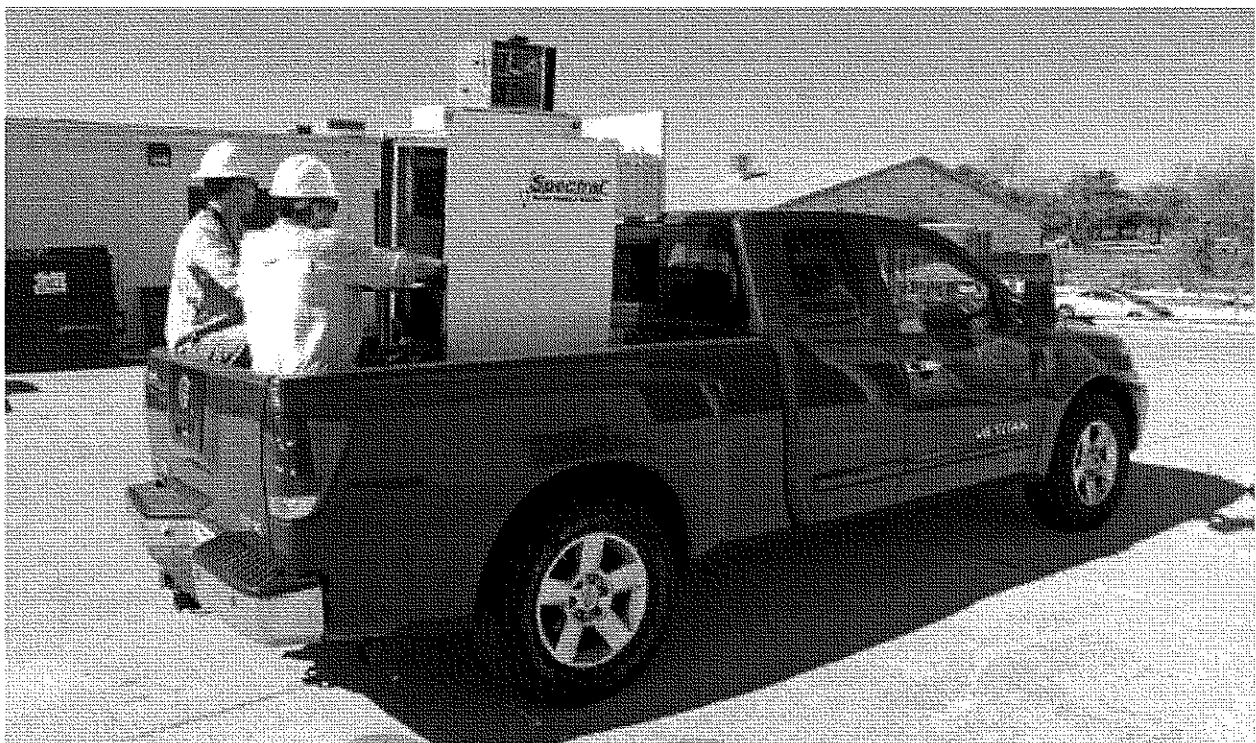

The LLC technique uses two lasers and an infrared detector array to obtain information on leaks on the ground. The two lasers operate at slightly different wavelengths, where the signal from one laser is strongly absorbed by methane gas and methane is transparent to the other, out-of-band wavelength. This permits the LLC processor to measure the difference between the reflected laser returns and display the results to an operator. When the lasers pass over a region where a methane leakage plume is located, the relative volume of the plume is displayed to the operator as a histogram.

Results

This project involved the incorporation of signal and reference lasers in an LLC prototype system. Tests of the pre-prototype were conducted in the laboratory and at field sites.

In laboratory tests with the current lasers in a breadboard configuration, the detection limit of the LLC was found to be < 8 ppm, displaying a discernable/positive detection that could be used to visually alert an operator or digitally processed to provide an enhanced detection capability that could be used to generate an auto-alert and/or a leak-tagging cue. The actual detection sensitivity was estimated to be 5 to 10 ppm.

For the initial field demonstration, the breadboard LLC was installed in a cargo van and repositioned to a remote site where previously located natural gas leaks were identified. Testing was remotely conducted from within the stationary van on actual main-to-meter leaks in two different locations with differing levels of natural gas concentrations. The leaks were initially located and/or measured using an available leak-detection device. All testing was conducted under field conditions, as they were found, with sustained 10-15 mile-per-hour winds at both locations.

In 2013, fabrication, assembly, and testing of a redesigned Integrated Laser/Detector Assembly (ILDA) were completed, resulting in the final scanner configuration. Additional testing was performed with the Interband Cascade Laser (ICL) and the HgCdTe infrared detector, pre-amplifier, and thermoelectric cooler/controller module that were subsequently installed and integrated on the ILDA/scanner assembly. Integration and testing of the improved Cassegrain optics configuration with the detection and laser modules proved proper performance of the integrated optical system; however, unexpected levels of noise were discovered in the video/processing chain, which was degrading system performance. Corrective actions required an extensive investigative effort to localize and contain the source of the noise.

Laser module integration and readiness testing proved expected ICL laser characteristics and performance of the lasers suitable to progress with the field demonstration.

System software was developed to scan, process, and display detection alerts.

In Phase 1, the prototype plus the power and processor modules were mounted on a roll-on/roll-off cart for installation and operation in a service van. The Phase 2A assembly includes a sealed optical enclosure to protect the scanner, electronics, and optical modules mounted on the ILDA, plus a manual turntable to permit pointing the device to the desired survey area. Following the integration, modifications, and testing of redesigned scanner on the ILDA, the system was tested in the outdoor environment to detect methane concentrations of 10-40 ppm-m from a distance ranging from 5-15 meters. The unit was in the van moving at a speed of 5-10 mph.

In 2014, the entire Phase 2A unit was installed in a pedestal that mounts to the bed of a standard service vehicle (pickup truck). Five field tests were conducted over two days to verify in-vehicle performance. Testing was conducted using simulated leaks in grass and on concrete.

Status

This project was completed in 2014. A Final Report was issued in June 2014.

The results achieved during both laboratory and field testing substantiated the potential value of a vehicle-installed laser leak-detection system.

The project team provided recommendations for further research, including evaluations during moving-vehicle applications under user control and operation.

Updating the Phase 2A system from its current prototype configuration to a pre-production vehicle-mounted system is the recommended path to move this technology forward.

For more information:

Maureen Droessler
Program Administrator
Operations Technology Development, NFP
Phone: 847/768-0608
maureen.droessler@otd-co.org

OTD

Operations
Technology
Development

GPS-Based Excavation Encroachment Notification

In a project aimed at reducing excavation damage, researchers are investigating the potential to use GPS technology to monitor excavation activity. The technology would provide the ability to alert excavators and utility owners when digging is encroaching upon pipelines and other facilities.



Project Description

This project focuses on linking GPS technology with digging operations to provide a warning system to prevent excavation damages to underground facilities.

The objective is to develop and demonstrate a system to ensure that excavation activities are occurring within a valid one-call ticket (which authorizes excavation) and are not encroaching upon underground pipes and facilities.

Researchers initially partnered with Virginia Utility Protection Service (VUPS), a one-call center for utility locates that has been conducting pilot programs to demonstrate the feasibility of using GPS-enabled cell phones (Phase 1) and GPS-enabled locators (Phase 2) to call in excavation projects, access information, and create digital maps of all locates. The GPS-enabled cell phones allow VUPS to create an “electronic white line” of the excavation ticket based on the GPS coordinates of the phone that called in the ticket. GPS-enabled locators are used to capture the coordinates of the underground facility during routine mark-outs. Data collected with the GPS-enabled locator is transferred to both the utility company and the excavator.

Deliverables

Deliverables for this project include:

- A web-based portal to collect and display data
- Mobile application to allow viewing in the field
- Completion of a pilot project demonstrating the implementation of the technology
- A Final Report detailing pilot project results.

Benefits

Excavation damage is the primary threat to the integrity of natural gas distribution systems. It is reported that about 60% of damage in the utility industry is the result of excavators failing to notify one-call centers and excavators that do not dig cautiously near underground assets.

By linking GPS technology with excavation equipment, enhanced monitoring can reduce the occurrence of excavation damage from these two causes.



Systems mounted near equipment controls alerts operators when they encroach utility lines.

Technical Concept & Approach

The key aspect of this effort is to integrate GPS monitoring into excavation activities so equipment operators can be automatically alerted to potentially hazardous situations. The GPS coordinates of the excavation activity are cross referenced with the location of valid one-call tickets (obtained through the one-call center) and the location of underground assets (obtained with GPS-enabled locators during the mark-out process). This information is collected in a portal that performs the analysis, detects violations and encroachments, and sends warnings and notifications to the stakeholders.

The project is focused on the implementation of the GPS-based excavation encroachment notification technology with a sponsor utility construction project.

Specific tasks include:

- **Software Development and Configuration**

The software has two components: 1) a desktop version that allows users to view excavation activity and run reports and 2) a mobile application that allows users to view activity and encroachment on handheld devices.

- **Demonstration**

Researchers will demonstrate the software on a selected mobile device in a pre-pilot demonstration.

- **Pilot Project**

A pilot project will be conducted to evaluate the effectiveness and feasibility of using GPS technology to monitor excavation activity.

Results

The developed technology was tested and implemented in a series of demonstrations with stakeholders in Virginia. A GPS monitoring system for excavation equipment was developed that periodically transmitted active excavation-equipment-location information to a portal. The portal has a web interface to allow users to view the current excavation activity in a given area through text data or through a mapping feature. Information was cross referenced with the GPS coordinates of all valid one-call tickets.

Upon evaluation of potential software and hardware, researchers identified using lower-accuracy GPS and existing GIS records to monitor for potential encroachment as a viable option for a pilot project in New York.

Software development, testing, and demonstration were completed in 2013.

The research team initiated setup of a testing environment to evaluate the technical feasibility of the options. The mobile computing environment was arranged and basic communication protocol between mobile and the Amazon server was developed. Some simulation data was collected.

Plans were developed to re-design existing technology to develop a lower-cost, less complex system to use GPS and GIS to monitor for encroachments in the right of way (ROW). Plans are for five prototype systems to be tested with cars in a full-scale pilot project in California. The new system will be more feasible for widespread adoption based on the ease-of-implementation and lower-cost hardware.

In 2014, the project team prepared a technical design document to summarize the design of system components, which includes hardware, software, data files, database, alerts, and web applications. The server environment was tested and server/processors upgraded.

A preliminary web application was created to monitor the excavation activities. A webinar was hosted to discuss the technical elements as well as to demonstrate the proof-of-concept system.

Status

Current efforts are targeted at:

- Improving the mobile data-collection application interface
- Improving the data analysis with more simulation data
- Server stress and load testing
- Improving the web interface for alert messages and to monitor more excavators
- Testing the application on excavators
- Conducting a demonstration
- Initiating the pilot project in New York state.

For more information:

Maureen Droessler
Program Administrator
Operations Technology Development, NFP
Phone: 847/768-0608
maureen.droessler@otd-co.org

OTDOperations
Technology
Development**PIPE & LEAK LOCATION**

Enhancing Damage Prevention Through Implementation of New Technology



In an effort to reduce the potential for excavation damage and the associated costs, researchers are investigating smart-tag technologies for implementation to assist field personnel when performing locates.

Project Description

One of the major factors contributing to excavation damage is the limited information available to field crews when performing gas-facility locates.

Traditionally, mark-out crews use maps and electromagnetic tools to locate buried pipes and other facilities. A map of the mains and services is provided either on a paper record or a digitized electronic file. While these maps can provide information regarding the general location of the pipe, they cannot be relied upon to provide precise positional information because of possible record-keeping inaccuracies, referencing errors, and other issues. Electromagnetic locators are used to find metallic pipes or tracer wires. These locators perform very well in some environments; however, certain situations (e.g., broken or missing tracer wire, congested corridors, signal bleed-off, and user error) can result in inaccurate mark-outs.

Investigators have identified several technologies that could be used to provide better information to mark-out crews to enhance the locating process. The focus of this project is on precise locating with smart tags.

A pilot project was conducted to demonstrate the procedures and technologies for implementing an electronic process and radio-frequency (RF)-tag-based asset-locating system. The technology uses new high-accuracy GPS technology and aerial photography to document the location of newly installed facilities. RF tags are used to enhance the locating and mark-out process by providing field personnel with additional asset location information. An additional pilot project is being conducted to demonstrate an enhanced system linked with mobile GIS software integrated with laser range-finding capabilities to overcome the "urban canyon" effects that limit effectiveness in some locations.

Deliverables

Specific deliverables include:

- An implementation strategy for smart tags, smart phones and tablets, and GPS in select operations
- A marker ball and warning tape installation procedure

- A software application to log the location and other attribute information of new installations for smart phone or tablet devices
- Two smart phone or tablet devices running the software application
- A high-accuracy GPS receiver
- A process for transferring the asset location and attribute information from the software to a sponsor's mapping system.

Benefits

Industry organizations regard excavation damage as the greatest threat to the integrity of the natural gas distribution system. Implementing technologies to reduce excavation damage reduces system risk, increases public and worker safety, and lowers the costs associated with damages. Increasing the amount of information made available to locators in the field will improve their ability to locate underground facilities and will reduce excavation damage.

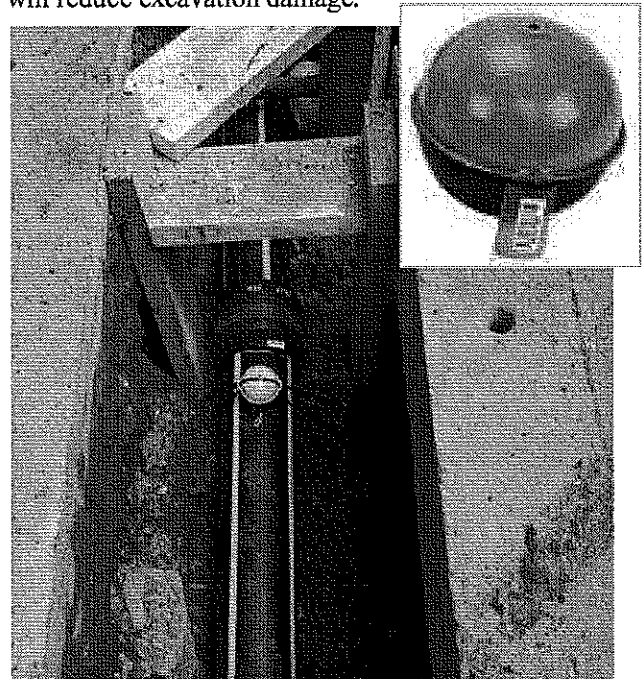

Marker ball installation.

The use of RF identification marker balls to locate underground assets can enhance damage prevention by alerting the presence of underground natural gas distribution assets using a unique frequency. This technology can be especially useful in areas where the density of underground assets is high and in situations where standard electromagnetic technology could not be used (e.g., to locate plastic pipe with no tracer wire).

Technical Concept & Approach

Smart tags are circuits and antennas housed in small devices that can be buried near pipes to facilitate detection and location in the future. Smart tags also have the ability to store small amounts of information such as material, diameter, and maintenance history. A smart tag could be installed directly above any pipe that is exposed for maintenance or other types of work. The tag could then be used to determine the precise location of the pipe during subsequent mark-outs.

This project involves the following tasks:

- **Technology Review and Project Planning**

A technology-review report was prepared and a series of workshops were conducted with the R&D, damage prevention, and information technology departments of the participating utility companies to develop a strategy for collecting, storing, and accessing the data collected.

- **Pilot Projects with Sponsoring Utilities**

Locating times with and without the smart tags and GPS will be compared and data-collection times with and without the electronic data-capture forms will also be compared. Additionally, when programmable smart tags are used, the data will be read from the tags to determine the various attributes of the related gas facility (i.e., main, service, valve, or test station). The spatial location accuracy will be determined along with the data that is stored on the tag.

Results

A pilot project was initiated in 2013 to demonstrate the procedures and technologies. The initial pilot involved the testing of warning tape and active markers. The research team also tested a high-accuracy GPS receiver to determine if it could overcome the urban canyon effect. The goals were to identify areas that were ideal for marker ball placement as well as to map the location of the marker balls with high precision to enable future relocation prior to excavation activities. The project team prepared guidelines to assist in installing 42 marker balls to evaluate the performance of the marker

balls under certain conditions. Using a tablet device with the 3-GIS Mobile Native Android application configured with high-accuracy aerial photography, the locations of 23 re-locatable marker balls were digitized. The virtual measurements from the application were compared to the physical measurements taken during installation, which resulted in 70% of the marker balls locations within a three-foot radius of the physical measurement.

The evaluation of high-accuracy GPS units resulted in urban canyon effects and blockage of the correction satellite. The expected accuracy was between 15-27 feet. Researchers evaluated other technologies in an effort to improve the precision mapping of the marker balls. The sponsor was provided with information on the use of laser rangefinders in the overall mapping process to better locate the RF markers and their associated gas piping system components.

The pilot project successfully demonstrated areas where marker balls can be reliably installed and located. While not tested during the pilot project, the detection and presence of the marker balls can alert the presence of a natural gas distribution system prior to excavation activity and thereby enhance damage prevention. The pilot project identified areas where marker balls are unable to be read from above ground due to interferences such as the presence of steam or curb valves and close proximity to electrical lines. The guidelines were updated to reflect consideration of the installation of marker balls in such conditions.

The technology used during the pilot project has many advantages, such as streamlined data collection, the ability for real-time data review in the back office, and possible integration with a GIS system. However, the accuracy of the location of the marker balls using the high-accuracy aerial photography and virtual measurements resulted in 30% of the markers outside the read range of the locators.

Status

In a planned additional pilot project, specifically equipped laser rangefinders (optics that only see highly reflective services) will be tested in the field. The employment of this technology should improve the overall appeal and ease of use when using laser rangefinders to precision map gas system components.

For more information:

Maureen Droessler
Program Administrator
Operations Technology Development, NFP
Phone: 847/768-0608
maureen.droessler@otd-co.org

OTD

Operations
Technology
Development

PIPE & LEAK LOCATION

Low-Cost MEMS Methane Sensor Platform



Research in this project is focused on the design and fabrication of novel, low-cost, ultra-low-power methane sensors that offer enhanced features over conventional methane-detecting technologies.

Project Description

Advisors for the natural gas industry have expressed a need for an improved methane sensor to decrease costs in current operations and increase safety for current and future applications, including the monitoring of confined spaces, personnel, and especially residential dwellings.

Currently, no available sensor can meet the combined specifications for low power (microwatts), small size, long lifetime (2-20 years), and low cost, as well as have improved sensitivity, selectivity, and speed of response to methane.

In this project, research is focused on the development of a MEMS (Micro-Electro-Mechanical Systems) sensor that can meet the challenges for methane alarms and monitors.

In recent years, significant progress has been made in the design and fabrication of a novel, low-cost, ultra-low-power thermal conductivity (TC) sensor for energy gases (methane, hydrocarbons, H₂, etc). Presently, the gas industry uses heated metal oxide (HMO_x) sensors with relatively high power requirements and low selectivity. Selectivity is afforded by filters that can wear out over time. Furthermore, the HMO_x sensors will stop working (give a false negative) when O₂ drops and CH₄ rises (>~10%). Current thermal conductivity detector (TCD) sensors can provide 0%-100% CH₄ readings, but are also high power and not selective.

This project focuses on the development of a MEMS nano-TCD. The most important features are: 1) no false negatives at high levels; 2) selectivity built in; and 3) low power and long lifetime for low installation costs and low overall cost of ownership. No other sensor has these combined features. These initial prototypes will be able to evolve with ever-improving selectivity and performance.

Plans are for the sensor to be a stand-alone unit about the size of a deck of cards that includes a proprietary sensing element, small circuit board, and novel software. The sensor technology and approach could be used in other types of fixed-site or portable residential or industrial applications. Its low power requirement

allows battery operation over a very long lifetime. The unique selectivity is a significant improvement over existing systems and can discriminate methane in air from other gases. The unique combination of features leads to low capital cost, low installation cost, and low overall cost of ownership with increased safety. In addition, the sensor can be improved over time with added features for wireless or other product options or applications.

Deliverables

Deliverables for this project include the development of MEMS CH₄ sensors for testing plus a Final Report with details on the development and testing.

Benefits

MEMS technology provides a means to fabricate miniature, low-cost sensors with improved methane-detector characteristics. The novel sensor will provide features to increase public safety and reduce maintenance costs. A commercial product that results from optimization would enable many applications for the gas industry that were previously impossible, especially selective home monitoring, remote monitoring, and cell phone or tablet integration.

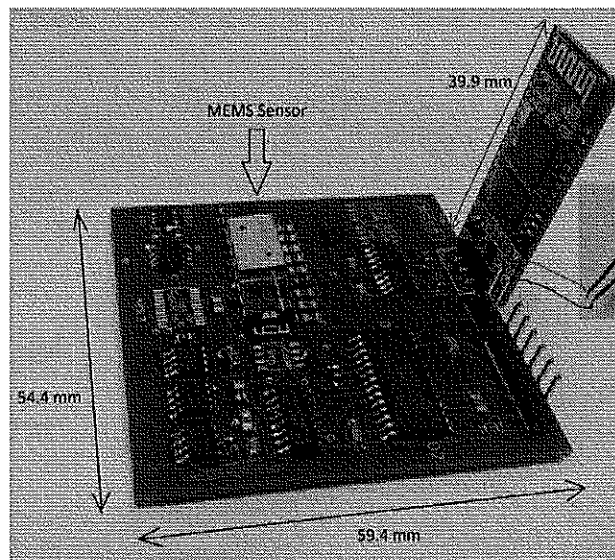

Technical Concept & Approach

In this project, prior research was leveraged in that the design for the sensor elements and the operating protocols are already established. Activities involved the fabrication of a configuration for a fully compensated methane-sensing element.

The goal is to achieve significant progress and support to develop a package with low-cost electronics and proprietary firmware to result in a home CH₄ alarm.

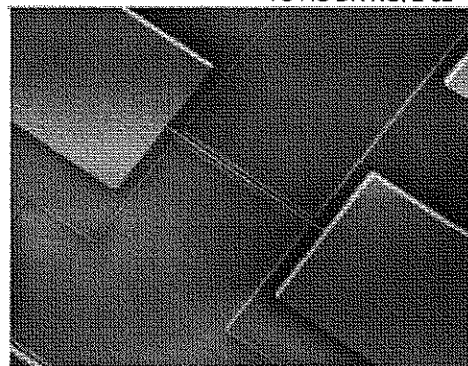
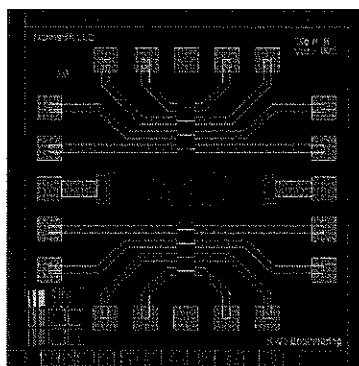

Sensor and die structure.

Results

For this project, the research team demonstrated the MEMS low-power methane sensor for home methane alarms and other natural gas industry applications.

For Phase 1 of the project, the MEMS sensor die was produced at a commercial foundry, then packaged and interfaced with electronics, operational firmware, and software. The sensor assembly was calibrated and tested with CH₄ exposures over time, temperature, humidity, and the presence of interfering gases. The manufacturer continued development of the sensor, hardware, and firmware and performed additional tests to show improvement in compensation algorithms for ambient temperature and humidity effects, as well as opportunities for optimization.

Specifically, the sensor met or exceeded the target specifications for measuring range, interferents (specificity to methane), and power consumption (significantly lower), but narrowly missed reaching the sensitivity and lower detection limit specification due to noise issues in the electronics. The demonstrated sensitivity and lower detection limit are more than sufficient for a variety of safety applications, and it can be improved with optimization of the electronics.

Testing demonstrated the feasibility of detection with the following properties:

- <1 nanowatt per reading (leading to long-life battery operation)
- Nanosecond response time (response times will be limited by the packaging and not the sensing element)
- Selectivity created by multiple operations and a custom algorithm (leading to improved selectivity over currently available methane alarms)
- Sensitivity sufficient for LEL alarms (better than 0.05% or 10% of the lowest alarm level desired)

- Robustness (no drift over 30 billion measurement cycles, which implies no calibration needed for many years)
- No consumables, selectivity (no false negatives at high CH₄ levels and differentiation of CH₄ signal from other gases such as H₂ – which is an improvement over current CH₄ alarms)
- Very low cost (as low as \$0.07/die; typically \$0.50/die).

Phase 1 of this project was completed in 2013. A Final Report was issued in September 2013.

The project team recommended a two-pronged approach to improvement (sensor and circuit) that will lead to the selection of the best sensor structure and the optimum operating protocol with sensitivity, selectivity, and stability to detect and measure methane with minimal power, size, and cost.

Status

Phase 2 commenced in March of 2014. The specific objectives of Phase 2 are to perform independent calibration and testing of sensor platforms. A testing program was developed that will expose sensors to varying levels of methane, humidity, and temperature.

Researchers will characterize sensor performance and compare the results to commercial sensors by performing a series of tests on the subject sensors and several equivalent sensors from other manufacturers to provide baseline data.

For more information:

Maureen Droessler
Program Administrator
Operations Technology Development, NFP
Phone: 847/768-0608
maureen.droessler@otd-co.org

OTD

Operations
Technology
Development

PIPE & LEAK LOCATION

Cross Bores Best Practices Education and Outreach

As a follow-on project that resulted in the development of a Cross Bore Best Practices Guide, an education and outreach program was initiated to inform the natural gas industry and other groups on the results of research and ways to reduce risk.



Project Description

Cross bores have become an industry concern because of incidents involving natural gas mains and services that were installed using trenchless technology that inadvertently transected a sewer line or private septic system. Typical sewer-cleaning operations use a device that can pierce the gas line, resulting in the rapid release of gas.

To assist utilities in addressing cross-bore safety issues, a Cross Bore Best Practices Guide was developed through OTD to serve as a single source of information that could be used by natural gas distribution system operators to investigate and remediate existing cross bores as well as prevent future cross bores. The guide can be used by operators to educate internal personnel and the public about cross bores. The guide provides methodologies, technology recommendations, and procedures for preventing and detecting cross bores.

This follow-on project involved the development of an outreach program to raise awareness and streamline implementation of cross bore best practices with natural gas system operators, other utility operators, the sewer and plumbing industry, contractors, homeowners and the general public.

Deliverables

Deliverables include:

- Presentations at industry conferences
- Outreach information in a variety of formats
- Distribution of the Cross Bore Best Practices Guide
- Website links
- Downloadable information
- Webinars
- "How To" videos of selected best practices.

Benefits

Information presented through this project can be used by gas-system operators to reduce their risk and exposure to the threat of cross bores.

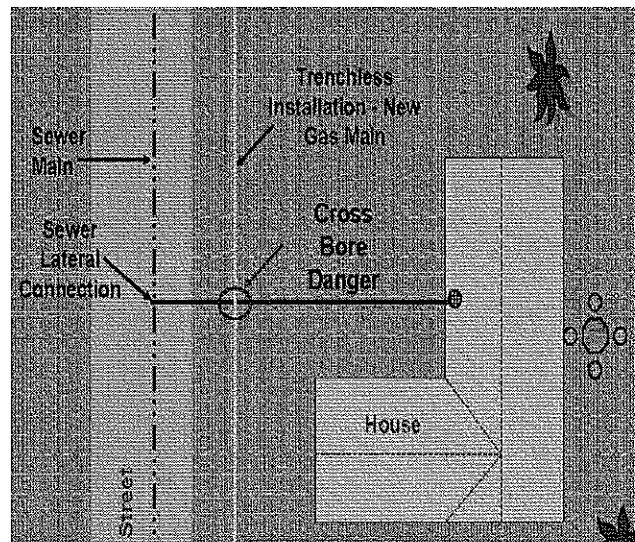
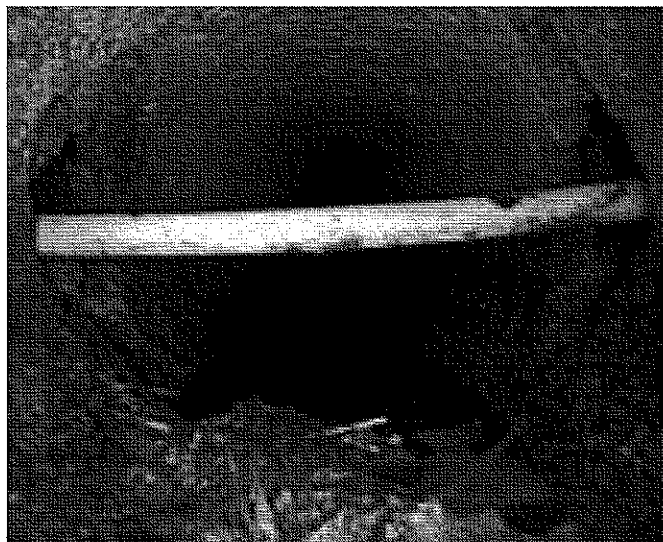

A cross bore is defined as an intersection of an existing underground utility or underground structure by a second utility installed using trenchless technology resulting in direct contact between the transactions of the utilities compromising the integrity of either utility or underground structure.

Technical Concept & Approach

The development of this Cross Bore Best Practices Guide included the review of information from a wide variety of sources across North American, including numerous natural gas distribution companies, installation contractors, remediation contractors, equipment providers, industry associations, and industry literature. The combined customer base of the 23 gas companies interviewed represent 80% of the 75 million natural gas customers in the United States and Canada.

Information regarding state or city-specific rules and regulations were also collected.

The goal of the education and outreach program is to make the industry aware of the availability of the Best Practices Guide, emphasize the importance of the topic, and provide information on the ability to improve safety.

Results

In 2013 and 2014, information on cross bores research was presented at various conferences and industry meetings, including the:

- SGA Public Awareness and Cross Bore Best Practices Workshop
- Western Regional Gas Conference
- Northeast Gas Association Fall Operations Conference
- Midwest Energy Association Fall Gas Distribution Learning Summit
- KGA Operations Conference.

Industry webinars were also presented.

Plans are under way with the Cross Bore Safety Association and OTD to coordinate the appearance of links between their websites.

The preparation of three "How To" videos was completed. The audience and the topics for each video are:

- Plumbers – how to safely investigate a clogged sewer
- Homeowner – how to safely decide if they should clear a clogged sewer

- Field Crews – how to safely install a gas main/service using trenchless technology.

Information developed through this project is available to all interested parties through the OTD website (otd-co.org).

Special handouts and tailgate briefing cards were prepared to provide easy reference. Information was supplemented with YouTube videos, reports, and other information.

Status

The research team is addressing a number of specific issues related to cross bores, including:

- Sewer Operator Fixing Cross Bores and Then Billing Utility
- Sewer Company Cleared Cross Bores Then Called Due to Leaks
- Sewer Line Notched to go Around Gas Line
- New Line Inserted in Old Line – Old Line was a Cross Bore
- Public Awareness Programs
- Plumber Issues (e.g., codes)
- Inclusion in Fire Marshals Training Program for Pipeline Emergencies
- Guide Stops Prior to – "Best Practices in an Emergency Response"
- Mock Drills – Up to Four Times/Year
- Manhole Cover Grounding
- Inflatable Ball to Stop Gas Flow.

For more information:

Maureen Droessler
Program Administrator
Operations Technology Development, NFP
Phone: 847/768-0608
maureen.droessler@otd-co.org



Operations
Technology
Development

Cross Bores – National Database and Risk Model

Researchers investigated a wide variety of issues related to cross bores in an effort to develop a national database and risk model for use by the natural gas industry to enhance the safety of the gas-system infrastructure.

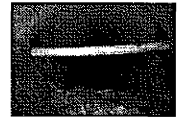

Project Description

Significant gas-industry research is being conducted on pipeline cross bores – situations where plastic gas mains and services inadvertently transect a sewer line when they are installed with directional boring techniques.

Gas pipeline/sewer line cross bores can lead to hazardous incidents if sewer-cleaning operations pierce the gas line.

While some companies have initiated thorough programs to inspect past installations to ensure that cross bores have not occurred, most operators have not started such a program and would benefit from a set of best practices to serve as a foundation for the development of their own programs. Even for those operators that have programs in place, additional information is desired to assist in identifying potential cross bores and for improving the accuracy and efficiency of their procedures.

The objective of this project is to develop a national database and risk model to address the cross-bore issue in the natural gas industry. The national database will collect information from natural gas operators on damages and incidents to assist in identifying trends and in

gaining a better understanding of the scope of the cross-bore threat. The risk model will be developed from the data collected in the database and populated by individual operators to provide a company-specific risk assessment.

Deliverables

The deliverables of this project include:

- A national database and two years of technical and administrative support
- A cross-bore risk model
- A report detailing project activities and results.

Benefits

The results of this research can be used by operators to reduce their risk and exposure to the threat of cross bores. The database will create information and industry knowledge regarding the frequency and factors affecting the probability of occurrence. The risk model will assist operators in assessing their risk and can be used to develop a targeted mitigation program.

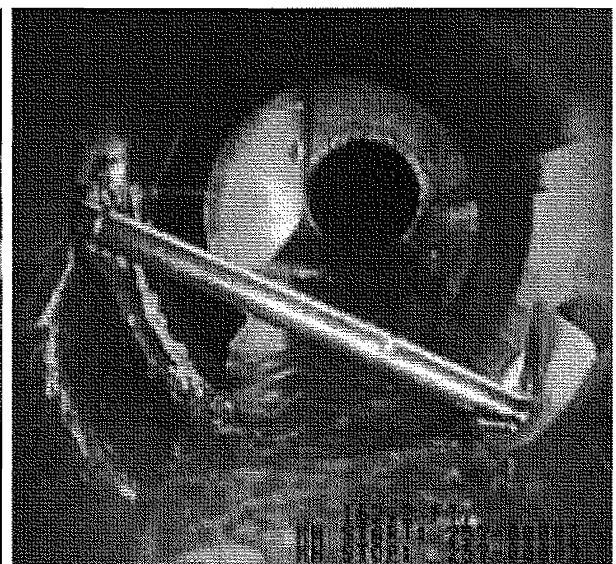
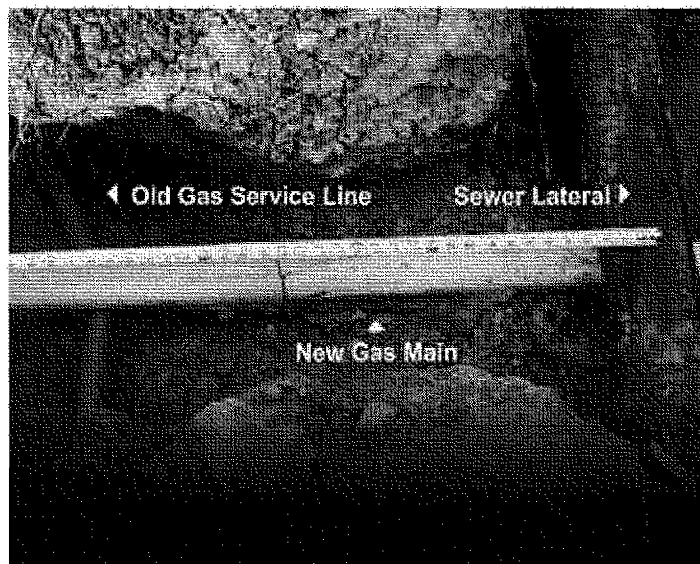

Cross bores (when a gas pipeline intersects a sewer pipe during directional-drilling installations) are a growing industry concern.

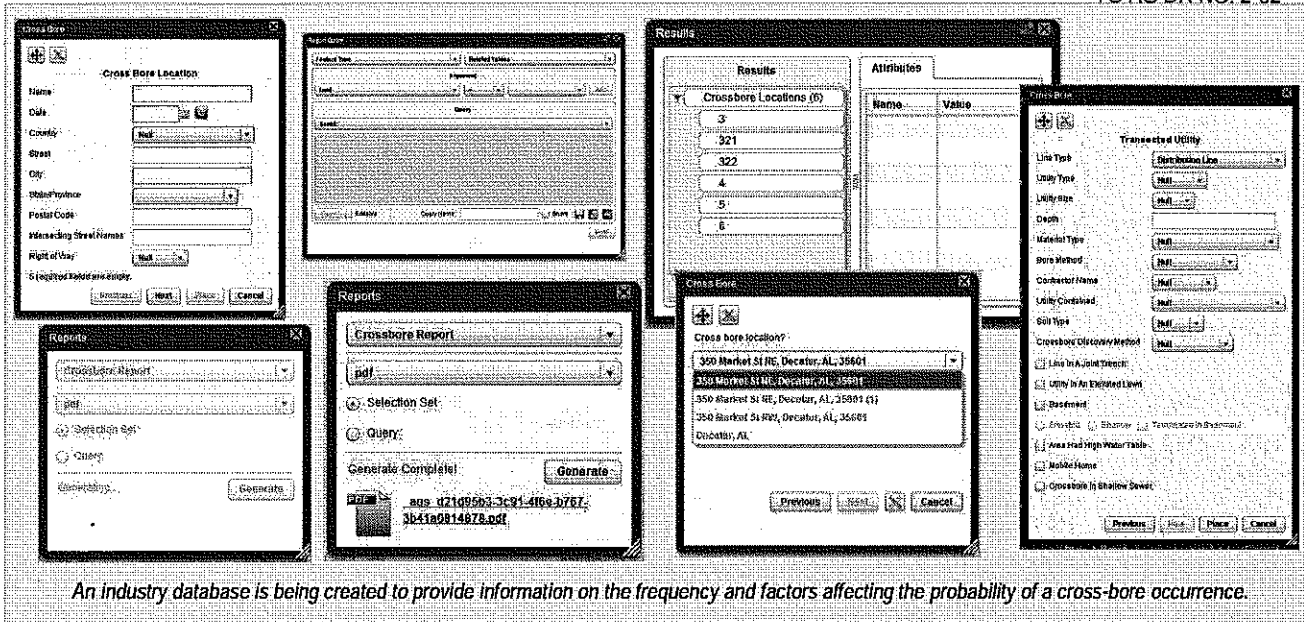

An industry database is being created to provide information on the frequency and factors affecting the probability of a cross-bore occurrence.

Technical Concept & Approach

This project includes the following tasks:

- **National Database**

The research team will design, develop, and launch a national database to collect information on cross bores. The database will be modeled after the Common Ground Alliance's (CGA) DIRT tool (where appropriate). The purpose of the database will be to collect information on root causes, environmental and situational factors, and incident reports. Data collection will include past incidents as well as new incidents. GDM (the gas distribution data model being developed under another OTD project) will be used as the data model for the database and the data-collection forms.

- **Risk Model**

The objective of this task is to build a risk model that will assess system risk and identify potential cross-bore locations. The risk model will be built with the information collected in the national database.

- **Database Management**

The research team will continue to administer the database for two years after its launch to collect additional information on cross-bore occurrences and the effectiveness of various prevention, detection, and mitigation activities.

An advisory group was created to provide industry guidance throughout the project to help define the scope of the project, the format of the deliverables, and other project specifics.

Once the database is final, the Cross Bore Safety Association and other operators will be contacted and encouraged to make use of the tool.

Results

Initially, a web-based data model was developed with a full set of data types and attributes. The research team focused on the use of a GIS system. The Esri system was chosen due to its being the most widely used system in the industry.

In 2013, the Esri GIS-based system was completed and turned over to the sponsors. It was agreed that the sponsors would populate the database with their company-specific data. Sponsors were trained on the use of the database and identified improvements that were subsequently made to enhance the system. A user guide for the database tool was also developed.

Status

The project was extended to allow sponsors and others interested in using the database time to populate the system.

Technical support (if needed) will be provided as sponsors populate the system with company-specific data.

For more information:

Maureen Droessler
 Program Administrator
 Operations Technology Development, NFP
 Phone: 847/768-0608
 maureen.droessler@otd-co.org



Operations
Technology
Development

PIPE & LEAK LOCATION

Cross-Bores Detection Using Mechanical Spring Attachment

Research is under way to develop a tool that will detect a hit to a sewer pipe during the installation of a gas pipe. The tool utilizes a mechanical spring system that is activated inside the sewer pipe void to provide a real-time alarm identifying a hit.



Project Description

Horizontal directional drilling (HDD) has become a common method for installing polyethylene (PE) gas pipe. Although rare, hits to sewer pipes during the HDD/mole installation process have occurred ("cross bores") that resulted in gas leaks into the sewer system when sewer-cleaning operation damaged the gas line.

Sewer laterals typically run perpendicular to the proposed route of a new gas pipeline. The laterals also rapidly change depth in that same area. Currently, there is no practical technology for locating sewer laterals and determining their depth in all types of soils.

Several approaches, including advanced utility locating and camera inspection, may contribute to reducing these threats. However, these operations are performed by different crews either before or after drilling and standard drilling technologies are still "blind" with respect to the underground environment.

The objective of this project is to develop a tool that will detect a hit to sewer laterals during the HDD or mole installation of PE gas pipe. The tool is designed with a low-cost and easy-to-use mechanical spring system that is attached to the HDD/mole head during drilling or to the PE pipe during pullback. The spring system is activated inside the sewer pipe void; thus locating the lateral and providing a real-time alarm identifying a hit.

Deliverable

The deliverable for the project will be a functional prototype unit.

Benefits

The implementation of the cross-bore detection tool increases safety and enhances the installations of distribution gas lines in difficult areas where sewer lines intersect.

The ability to attach the detection system to either the drilling head or to PE pipes during pullback makes it an economic and practical solution to detect incidents of pipe encroachments during HDD and mole operations and will help minimize risks.

Technical Concept & Approach

The design consists of a cylindrical unit attached to the HDD/mole head during drilling or to the PE pipe during pullback. The unit has spring arms around its perimeter. The springs are in a closed position when confined in soil. When the unit encounters a void space inside a sewer pipe, the spring arms open and an electronic signal is sent to the surface (using a signal wire or wireless system) indicating the arms' movement.



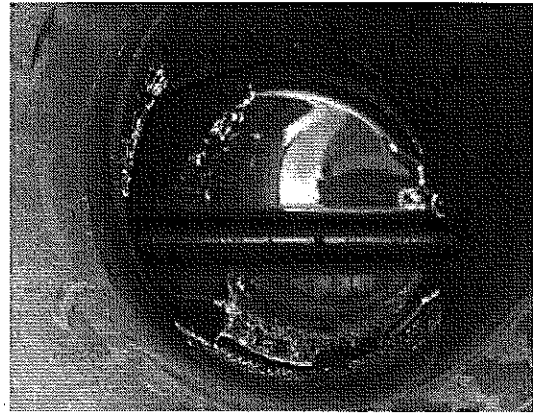

Left: Alignment of the sewer lines in the test section. Right: HDD tool crossing the sewer pipe in field tests.

An on/off electronic signal can be sufficient to indicate if the apparatus encountered a void representing a sewer lateral when some or all the springs are opened inside the sewer pipe.

Specific tasks included:

- **Initial Design of the System**

The development of prototypes consisted of several steps to address the operational requirements.

- **Prototyping, Testing & Modification**

The selected prototype was tested under various soil conditions in a laboratory environment.

- **Field Testing and Troubleshooting**

A field test and a demonstration was conducted at the Gas Technology Institute (GTI) pipe farm.

Results

In 2012, two designs of the system with mechanical springs were built as preliminary prototypes. Various systems were considered, including the use of pressure bags at the perimeter of the attachment and installing a simple load-sensor indicator during the PE pipe pullout. In addition, the electronic system for transmitting the signal to a readout box at the surface was designed and a prototype of the system was built.

A prototype for field testing at GTI was subsequently built. This prototype includes a set of eight mechanical arms around the perimeter configured to improve the detection of voids with minimum soil intrusion inside the tool. Data is collected during the pullback process of the PE pipe and stored in a memory stick mounted inside the tool.

The prototype was tested in 2013 in a soil test box where the 4-inch-diameter pipe crosses a 4.5-inch sewer pipe. Further tests were conducted to evaluate the tool

in wet soil conditions. Various sizes of sewer lines (6-, 8-, and 12-inch PVC and clay pipes) were installed at a GTI test facility for testing of the tool. The pipes were placed vertically in the test section to monitor the cross boring process from the surface.

Communications were initiated with manufacturers to adopt the tool and to determine further development needs.

A patent application was filed in 2013.

In 2014, researchers completed a field test of the cross-bore tool in an HDD installation of two-inch-diameter PE pipe. The tool was connected to the back reamer during the PE pipe pullback. The crossing of the tool inside the pipes was recorded by the tool and visually monitored and photographed. The tool was able to successfully indicate the voids in pipes which were hit (i.e., providing positive indications). The pullback reamer did not go through two pipes and there was no signal in the tool accordingly (i.e., successful negative indications).

Several modification of the prototype may be performed with future commercializers. These may include a real-time data display during pullback.

Status

A report on the results of field-test activities is being prepared. The report will include an initial investigation of future Phase 2 of the project if warranted. Phase 2 tasks may include working with an HDD vendor/contractor to modify and produce the product.

For more information:

Maureen Droessler

Program Administrator

Operations Technology Development, NFP

Phone: 847/768-0608

maureen.droessler@otd-co.org

OTD

Operations
Technology
Development

PIPE & LEAK LOCATION

Integration of Acoustic and GPR Technologies for HDD Operations

Researchers and manufacturing representatives are investigating the potential for integrating acoustic-based and GPR technologies to detect obstacles during horizontal directional drilling (HDD) operations. The ultimate goal is to develop a system that can automatically and rapidly detect buried pipes/obstacles in front of and adjacent to the drill-head of HDD machines.

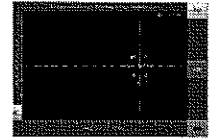

Project Description

A significant amount of gas distribution pipes are installed with horizontal directional drilling (HDD) machines due to the reduced pipe-installation costs associated with this construction method.

To avoid incidents during the installation process, it is important to locate other obstacles/pipes as they are approached by the drill-head. If these pipes are made of plastic, PVC, or other non-metallic materials, they can be difficult to locate during pre-construction surveys from above ground. Without an accurate obstacle-detection method, there is the potential for the drill-head to penetrate these obstacles during installation.

In completed OTD-sponsored projects, two technologies for detecting neighboring/approaching pipes during HDD operations were developed – one based on ground penetrating radar (GPR) and the other based on acoustic methods. GPR-based technology was successfully installed in the drill-head of an HDD tool to provide accurate pipe location in real time. However, the system has limited range for pipe-detection distance. Acoustic methods detected pipes as far as 25 feet in front and around the drill-head; however, the accuracy of detection is somewhat coarse.

The GPR-based technology was licensed to a major manufacturer of HDD equipment for commercial application; however, the system has had limited success due to the limitation of detection range. In this project, researchers and staff from the HDD-equipment manufacturer are investigating the potential to integrate the acoustic and GPR technologies.

The acoustic technology is based on a unique method of listening to noise made by the drill-head and reflected by the approaching pipes/objects. The highly sensitive accelerometers on the ground “listen” to the reflected signals from objects/pipes and analyze the data to provide real-time information on the underground infrastructure.

The GPR technology is based on stepped-frequency continuous-wave modulation. A prototype drill-head radar was designed and built for a smaller class of HDD machines than are normally used. The drill-head was installed on a commercial HDD machine and tested in both laboratory and in semi-field settings. A unique technique to inject and receive reflected signals from pipes/objects near the drill-head improved the radar operation in the detection of pipes in many more types of soils than commercially available GPR sys-

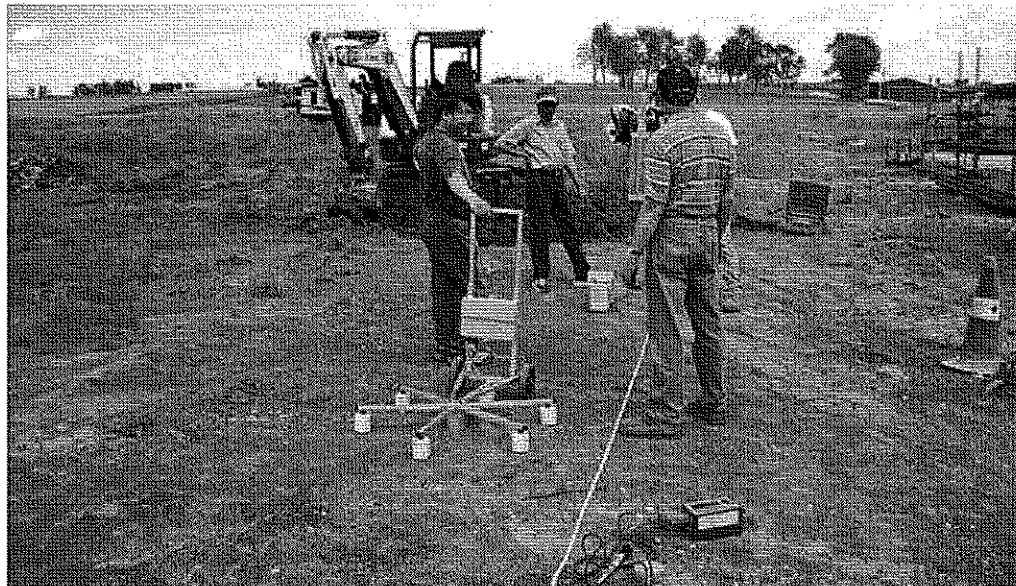

tems operated at the ground level. Also, significant improvements were made in the software to provide information on the buried pipes near the drill-head in real time.

The overall project is structured to support four objectives: 1) update the acoustic system and test it in the semi-field environment (local area); 2) improve noise generators and evaluate with the acoustic system in the local area; 3) integrate acoustic and GPR systems; and 4) perform field trials.

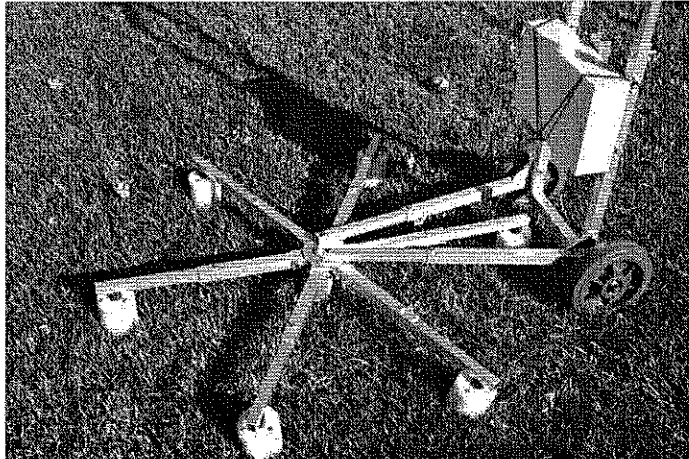

Deliverable

The deliverable for this phase of the project will be a report outlining the next steps on integrating the two technologies for HDD operations.

Benefits

The integrated system would assist in accurately determining the location of pipes and other objects during HDD operations. This will reduce or eliminate hits to pipes (e.g., sewer and other pipes or cables) resulting in decreased future incidents, increased use of HDD equipment, reduced pipe-installation costs, and increased safety.

Technical Concept & Approach

The initial scope of this project is to consult with an HDD equipment manufacture to explore the potential of integrating acoustic technology into a product and defining a specific path for the integration of acoustic and GPR technologies.

The plan is for the integrated system to be designed with the acoustic technology providing an alert for objects in front of the drill-head, and the HDD operator then activating the GPR system as the drill-head approaches the object to obtain the accuracy.

Results

A semi-field test site (local area) was constructed that included various noise generators: three down-hole sources (axial motor, radial motor, and buried concrete blocks in the test area) and two devices (a device to impact ground surface to produce axial and transverse mo-

tion and a pneumatic piercing tool. The acoustic system was tested with all available seismic/noise sources and under differing attack angles. Data were collected and the locations of any data solutions for obstacle locations were logged.

Test results were described in detail in a separate report submitted to project sponsors, including the U.S. Department of Transportation's Pipeline and Hazardous Materials Safety Administration.

During data collection over a four-day test period, obstacle locations generated by the acoustic sensor were recorded

in the storage device of the system along with the sensor and source locations. The data on various distances between sensors, drill-head positions, and pipe detection from the display were also recorded manually. A total of 800+ trial solutions were recorded and grouped into 11 different data sets depending on the source used. The results varied from a high of 70% for a concrete drilling source to 24% for the seismic actuator, with the average of 47% to detect pipes. The data analysis, with corrected drill-head position, resulted in 159 data sets that were validated to be meaningful data sets in evaluating the performance of the HDD acoustic system.

The corrected system performance from these 159 data sets was separated into two categories: static and dynamic. The static data represent the stationary field test with the noise source in operation (no drilling machine movement); whereas the dynamic data refer to when the drill-head is advancing (push/rotate) with the noise source in operation. Overall, for both stationary and moving drill-head processes, the acoustic pipe-detection system was able to achieve the average detection accuracy average pipe detection accuracy of ± 2.1 feet during the trials.

Status

The project plan includes additional tests with improved noise sources in the local test area.

For more information:

Maureen Droessler
Program Administrator
Operations Technology Development, NFP
Phone: 847/768-0608
maureen.droessler@otd-co.org

OTD

Operations
Technology
Development

PIPE & LEAK LOCATION

Testing and Field Evaluation of No-Blow Fish-Tape Technology to Locate PE Mains



Testing and evaluation were conducted on a recently developed gas-line tracer system and process to allow for no-blow insertion of a fish tape into PE gas mains for locating purposes.

Project Description

The problems that can result from unlocatable plastic pipe are some of the natural gas industry's greatest concerns, due primarily to the potential for third-party damage. While tracer wire is commonly installed along with polyethylene (PE) pipes, wires that are broken or missing, never installed, inaccessible, and providing distorted signals from nearby utility lines are all causes for making PE pipe unlocatable.

Adding to the issue is the fact that more gas pipe is being installed at deeper depths using directional drilling techniques. This can cause weak or lost signals. While there have been advancements in plastic pipe locating (e.g., radar and acoustics), the safety of gas systems will be enhanced with a system that allows plastic pipe to be located with low-cost technologies.

This project involved the testing a new Gas Line Tracer Kit from Jameson LLC. The fish-tape system that was designed in conjunction with Gas Technology Institute (GTI) as part of the GTI Keyhole Consortium Program.

The system addresses the need to locate previously unlocatable PE gas service lines. This product allows for utility operators to use traditional pipe- and cable-locating equipment and includes a gas-line fish-tape system and unique stuffing box. When used properly, targeted pipes can be precisely located while still pressurized, without the need to disconnect from the gas main.

This system was designed to be inserted into the service riser of the gas *service*. However, there is a growing need to use this system for unlocatable PE *mains*.

Jameson recently developed an electrofusion fitting to allow access into two-inch-diameter PE pipe. The company has also initiated development on a stuffing box to allow a one-quarter-inch-diameter fish tape to be installed "no blow" through the fitting into the two-inch pipe.

In this project, a research team tested and evaluated the recently developed system and process to allow for no blow insertion of a fish tape into PE pipe. This development is focused on PE mains where access through the riser is not available.

Deliverables

Detailed results of the evaluation will be made available. In addition, case studies will be developed for various field trials to be conducted and information for the development of operating procedures will be provided.

Benefits

The use of locating fish tape is increasingly being used by utilities. Currently this process has been mostly limited to service tubing or PE mains that have been taken out of service. The development of a system (fitting, stuffing box, and accessories) to allow for the no-blow insertion of a fish tape into PE pipe would significantly improve the process of locating PE pipe.

Live insertion of a fish tape saves time and money because the pipe remains in service. There is no need to re-light services and the main does not need to be repaired after the tracing is complete.

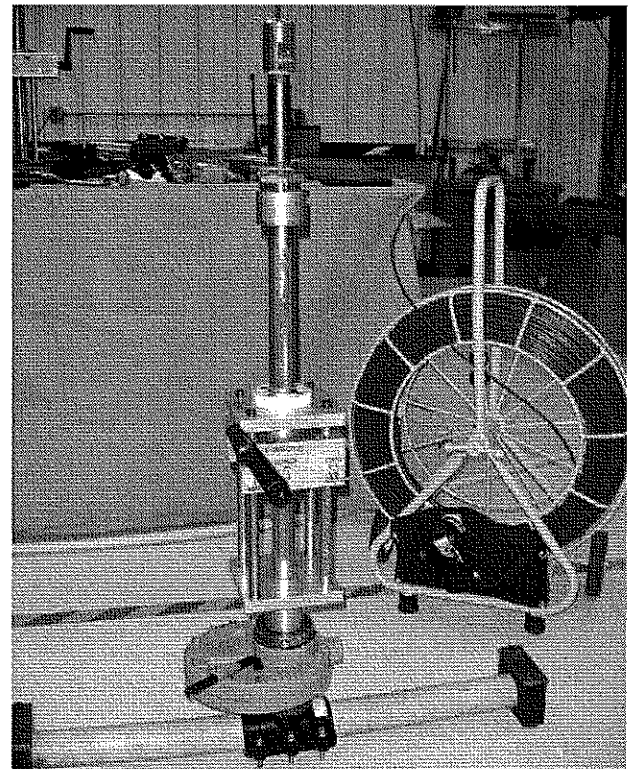



Line tracer system accessible through a valve box.

Technical Concept & Approach

Based on the initial development of an electrofusion access fitting and stuffing box, initial laboratory and “backyard” field tests were conducted prior to field tests on unlocatable gas facilities.

The evaluation tests were performed first in the laboratory to assure performance of the electrofusion fitting and tracer line components. After this initial evaluation, researchers conducted simulated field evaluations at GTI’s field site on two-inch PE pipe pressurized with air. GTI and Jameson will also develop and finalize procedures for the use of the tracer line in PE mains.

Based on initial results, further evaluations were conducted in the field. Utilities will be asked to identify a two-inch PE piping system (preferably unlocatable pipe) to install the Jameson tracer line.

Results

In 2013, the project team reviewed the system as sold by Jameson (with an angled fitting) and also designed and developed a new directional insertion tool to allow the fish tape to be used with currently available mechanical and electrofusion vertical entry fittings.

The review included running through the complete process of installing the fish-tape system – fusing on the fitting, installing the fish tape, locating the tape, and removing the tape – in a simulated pipe system. (Photos and a video are available of this process.)

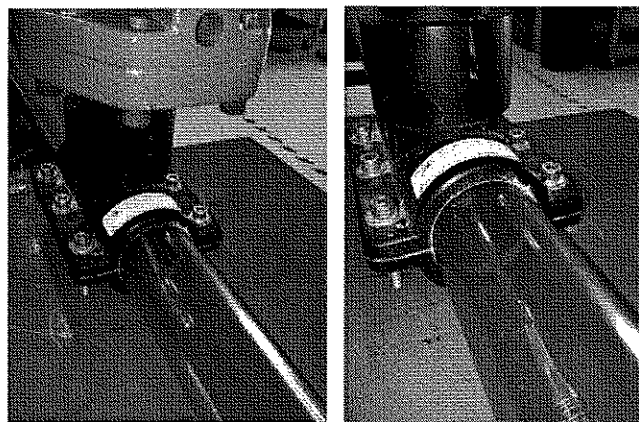

Fish tape being pushed into the pipe in the laboratory.

It was successfully demonstrated that the Jameson fish tape can be inserted, under pressure, into a two-inch PE pipe. Also, the fish tape can be directed in either direction from the one single entry point.

Upon initial examination, the existing main line tracer system could not make the 90-degree bend into the two-inch pipe. Subsequently, researchers pursued the concept of using a directional insertion tube to assist the tape entry through the 90-degree angle.

Enhancements were made to the directional tool to allow for its use on various fittings and for various applications.

In 2014, the project team completed the review of the Jameson Fish Tape and developed various procedures that can be used for its application on live gas pipes. This includes using the angled entry fitting and existing vertical entry fittings.

Status

A licensing agreement was drafted and put in place with Jameson for the commercialization of the product.

The research team is finalizing the draft Final Report for submission and review by the project sponsors.

For more information:

Maureen Droessler
Program Administrator
Operations Technology Development, NFP
Phone: 847/768-0608
maureen.droessler@otd-co.org

PIPE MATERIALS, REPAIR & REHABILITATION

In this area, researchers focus on various aspects related to the evaluation and development of materials and processes used to maintain, repair, and rehabilitate gas piping systems.

Current efforts include projects to improve techniques, equipment, and quality control for the repair and maintenance of pipes, joints, and various facilities.

A wide variety of advanced techniques are under investigation, including cold adhesive repair and joining and a system for the repair of aboveground leaks. Newer initiatives include investigations into the use of composite materials for pipeline rehabilitation.

R&D results – developed in state-of-the-art testing facilities and demonstrated in the field – contribute to improvements in system safety, deliverability, and integrity.

OTD

Operations
Technology
Development

Cold Adhesive Repair and Joining of Polyethylene Pipes with Minimal Surface Preparation

In this project, researchers are testing a cold-adhesive repair technique in an effort to develop an economical, reliable, and safe technology to quickly and effectively repair damaged plastic gas pipes.

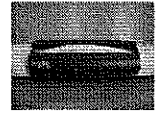

Project Description

Natural gas distribution companies have continued to identify the development of reliable, economical, and safe repair methods for plastic pipes as one of the industry's most important needs.

It is estimated that each year about 180,000 pipe failures occur in plastic gas distribution pipelines. While about 60% of the plastic-pipe failures are the result of excavation damage, most of the remaining failures are primarily due to the initiation of brittle-like slit failures that can grow through the pipe walls. These slit failures are commonly located at heat-fusion joints and at pipe sections subjected to squeeze-off, rock impingement, pipe bending, or excessive earth settlement.

Typically, two distinct operations are involved in the conventional repair of a plastic gas pipe. First, the flow of gas is stopped using squeeze-off techniques, which usually requires two excavations. Next, the damaged or leaking pipe section is cut, removed, and replaced with a short section of pipe (or, "pup") that is joined to the pipeline using mechanical or electrofusion couplings.



CARP patch applied to PE pipe specimen.

In this project, researchers are developing a Cold Adhesive Repair of Polyethylene (CARP) technology that will allow gas company crews to economically and quickly repair (and join) damaged polyethylene (PE) pipes and leaks without additional excavations, removal of the damaged pipe section, and interruption of gas supplies to clients. With the CARP method, pipe patches are bonded to damaged pipe using special adhesives. The CARP technology does not require significant pipe-surface preparation, training, heating, or tools.

The primary objective is to develop and commercialize a technology using modern structural cold adhesives, optimized for low-surface-energy materials such as PE. The technology is being developed for several forms of PE gas pipe damage, including pipes with holes and gouges, through-the-wall slits, surface scratches, and leaks at heat-fusion joints, impinging rocks, and other areas.

Deliverables

The deliverables for the project include:

- Easy-to-use, optimized structural adhesives and patch designs and materials (that do not require tools, heating, or pressure) and cure in air under typical field conditions within a period of about five hours, but allow for immediate burial
- A step-by-step repair procedure/protocol to perform quick in-field repairs on leaky and damaged PE pipe sections
- A written procedure guideline/manual on each step of the CARP process that takes into account different field temperatures and soil/environmental conditions
- CARP testing prototype kits that include the required repair materials and procedures
- A video demonstrating the application of the CARP process.

Benefits

The CARP technology shows promise in reducing the costs of PE pipe repair and the ability to improve the reliability and safety of PE piping systems.

Technical Concept & Approach

Specific activities:

- The design and fabrication of PE repair patches on the basis of laboratory test results and stress analysis calculations
- Validation testing, including short-term (quick-burst) and accelerated long-term laboratory tests at elevated temperatures and pressures on pipe test specimens repaired under pressure
- The formulation of a comprehensive CARP test matrix under no-pressure conditions (no blowing gas conditions)
- Short-term and accelerated long-term laboratory tests on repaired test specimens per the test matrix
- Forecasting the pressure-carrying capacity and the life expectancy of the repaired test specimens
- Preparation of a step-by-step procedure to perform cold adhesive repairs.

Results

Long-term test results of patched PE pipes found that the patching system can be effective. Testing also resulted in additional information about the effective application of the adhesive.

Test data showed that at an average field temperature of about 68°F the CARP-repaired pipes have an average projected life expectancy of greater than 50 years.

These initial test results also showed that the growth of the crack/notch was arrested by the CARP-repaired patches.

Quick-burst (QB) pressure tests demonstrated that the strength of CARP-repaired pipe specimens was the same as the pipe. For these specimens, the failure occurred in the pipe away from the patch. This failure was a typical ductile rupture.

Technicians fabricated a "self clamping" patch to evaluate a full-encirclement-type patch with the potential for improved performance over the partial patches.

Throughout 2012-2014, a number of CARP-repaired PE pipe specimens were created and evaluated through a series of QB and Long-Term Hydrostatic (LTHS) tests.

QB tests were conducted at both 23°C (73°F) and at elevated temperatures (80°C and 90°C). All failures occurred in the pipe wall (not through the patch); however, the QB tests at elevated temperatures created failures in the pipe wall at the closure seam of the patch (180 degrees away from the notch). The LTHS tests were conducted at 80°C and 90°C water baths and at various stresses.

For the tests, a longitudinal notch (four inches long) is introduced in the center of MDPE and HDPE pipe samples to simulate a damaged pipe. The notch is filled with a resin, and a patch made from HDPE material is applied over the indented area. Pipe samples are then capped, filled with water, and exposed to hydrostatic pressure testing in a water bath.

The results of the initial LTHS evaluations indicate that the patch and adhesive is sensitive to temperature. Specimens failed within a short time of pressure loading. Therefore, additional testing of the adhesive and bonding was required in order to properly relate accelerated LTHS results to operating condition lifetime predictions.

The research team experimented with varying the test pressures, temperatures, and materials of the pipe specimens in order to resolve some of the recent issues with early failures in the hot water baths. Based on the current ongoing tests, it appears that the lower water bath temperatures have allowed for good results with the tests.

Based on the preliminary test results, it appears that the patch is providing protection for the artificially induced damaged pipes. Results indicated that MDPE pipe/HDPE patch samples are performing better than the HDPE pipe/HDPE patch samples.

In 2014, researchers finalized the test data and reported the long-term performance of the CARP specimens to sponsors and other OTD.

Discussions were held with potential manufacturers at the Plastics Pipes XVII Conference in Chicago.

Status

A Final Report on the project is being prepared.

For more information:

Maureen Droessler
Program Administrator
Operations Technology Development, NFP
Phone: 847/768-0608
maureen.droessler@otd-co.org

OTD

Operations
Technology
Development

PIPE MATERIALS, REPAIR & REHABILITATION

Development of an External Repair Tool for Polyethylene Pipe



Enhancements and modifications were made on a tool and process for the repair of polyethylene pipe. The concept for the pipe-repair system is to bond a patch to damaged pipe areas, providing a cost-saving alternative to conventional plastic-pipe repair techniques.

Project Description

Current polyethylene (PE) repair procedures require excavation, isolation, and removal of the damaged section of pipe, followed by fusion of a new section of pipe into place – techniques that can be costly and disruptive.

In an effort to provide a cost-saving alternative, this project focused on the development of a thermochemical repair patch and mechanical tool to externally repair damaged PE pipe *in-situ*, eliminating the need for large-scale excavation and replacement of pipe sections.

In the completed Phase 1 of the project, activities were conducted to enhance an innovative repair tool developed under a cooperative agreement with the U.S. Department of Energy's National Energy Technology Laboratory. In the Phase 2 effort sponsored by OTD, additional testing and modifications were performed.

The tool uses heat fusion to attach a patch to repair damaged pipe and features a jaw design, open on the end and curved to fit the contour of the pipe as it closes. The open-jaw configuration allows the operator to fully enclose the damaged section of the pipe with the repair patch, stopping the flow of gas through the damaged pipe wall. The system operates remotely from the top-down (without requiring preparation of the pipe) and is portable and lightweight (30 pounds), allowing for one-person operation. The tool measures 11 inches wide with a 6.5-foot handle, allowing for easy use in keyhole operations.

The function of the tool is to:

- Repair gouged or scratched pipe that would otherwise have to be replaced
- Reinforce suspect butt-fusion welds that may be prone to failure due to long-term slow crack growth
- Stop leaks in pipe without shutting off the gas flow in the main.

Deliverables

The deliverables for this project included:

- Demonstrations/field trials of the repair tool
- Test documentation.

Benefits

This project was initiated due to the substantial maintenance costs and potential safety incidents that could be avoided with the use of the repair tool. It was estimated that the system could save the industry between \$1,000 and \$3,500 per incident, depending on the size and complexity of the maintenance/repair project.

Technical Concept & Approach

The principal design challenge was to modify the system to be able to repair a large opening (e.g., breach or gouge) in the pipe wall that allows pressurized gas to escape. Another design goal was to be able to use one tool to repair more than one pipe size.

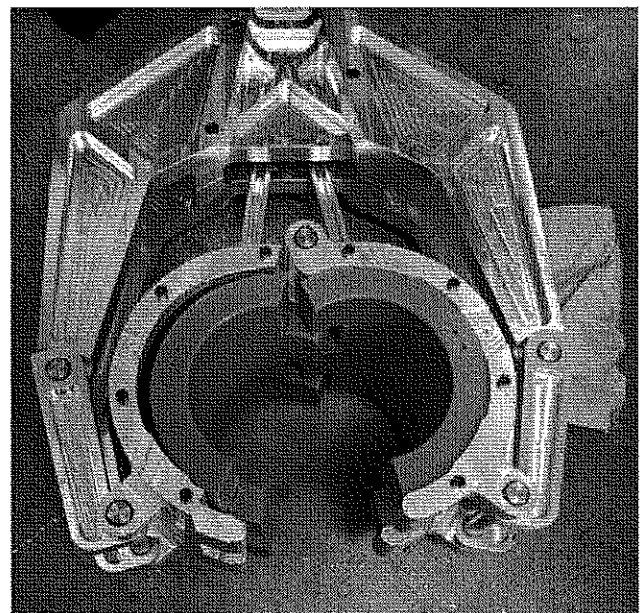

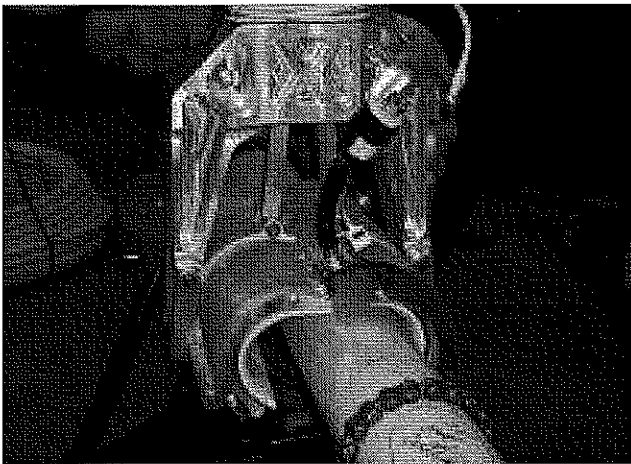

The project involved a regimen of testing activities to optimize the repair patch, the process, and the tool. In addition, the project included an investigation into applicable codes and standards.

Results

Phase 1 development activities for this project are completed and resulted in various product improvements.

A novel and effective PE foam adhesive layer was developed and included in the composition of the repair patch. The use of this foam adhesive layer saves time, facilitates preparation, and simplifies the storage and shipping requirements for the patch assemblies.

To be able to use the same tool to repair multiple pipe sizes, the patch was redesigned using an internal stitched heater within the patch. The final repair patch design uses a stitched internal heater of varying watt density on a layer of PE film that is sandwiched between two layers of PE "solvent sponge" foam. The new design also uses nylon thermal-insulating jaw inserts that are easy to exchange in the field and are specific to various pipe sizes up to six inches in diameter.

The controller was completely redesigned and reprogrammed to address all pipe sizes (standard and metric). The configuration of the controller was also redesigned, which allowed for a reduction in overall size.

A final design was completed in 2012 for a permanent plastic injection mold to replace the hand molding previously used to produce the patch backs. This allows for consistency in the manufacturing process and eliminates the variables associated with producing the patch backs by hand. During these initial test runs it was noted that in order to attain the correct patch length, the temperature within the nozzle and barrel of the mold press needed to be at the upper limit of the specifications for injection molding. This high temperature produced patch backs that were adequate, but moderately brittle.

In 2013, researchers investigated three different pipe resins to reduce the overall temperature during molding and eliminate the brittleness. After the research team was unable to attain satisfactory results using the new HDPE pipe resins, it was determined that the mold needed to be modified in order to produce patch backs to specification.

The plastic injection mold was manufactured, initial patch backs were produced, and testing of the mold was performed. A test run of 36 patch backs were then produced. The injection pressure was kept constant for all of the six sets with the temperatures and hold time being varied. This resulted in an investigation into the effect temperature and time play in the injection process. This testing confirmed the optimum process controls needed for the injection molding of the patch backs.

During this last set of tests, it was observed that the parts produced later in the run were exhibiting more shrinkage. On further research, it was determined that the cooling lines within the mold were unable to maintain a constant temperature thus causing the mold to heat up and the polymer to shrink more. The mold was subsequently modified and re-machined to allow for the lesser amount of shrinkage.

Following the modification to the mold, a sample run of the patch backs was performed at varying temperatures, pressures, and times. Each of these sets was then subjected to brittleness testing. These tests showed that the polymer was performing to specification and was not being crystallized by the injection process.

It was determined, however, that another test run of patch backs was necessary to qualify the shrink factor, and confirm the process controls. Testing confirmed the optimum process controls needed for the injection molding of the patch backs and the shrink expected.

Various other project issues centered on the manufacture of the patch backs.

Status

Testing revealed a variety of issues that need to be addressed. Due to the complexity of the issues and increased cost that must be incurred, activities for this project were halted in 2014.

For more information:

Maureen Droessler
Program Administrator
Operations Technology Development, NFP
Phone: 847/768-0608
maureen.droessler@otd-co.org

OTDOperations
Technology
Development**PIPE MATERIALS, REPAIR & REHABILITATION****In-Service Field Evaluation of
Polyurea Coating Systems**

As a follow-on to a previous project, research into field-applied polyurea coatings for gas industry use is being conducted on promising coatings. Through this initiative, long-term field trials will be conducted to evaluate these coatings and determine a cost-effective coating-application method and process.

Project Description

In recent years, gas utilities have expressed increased interest in using plural-component "polyurea" coatings for service applications such as vaults, pipe on bridge crossings, pipe for horizontal drilling applications, above-ground meter sets and distribution equipment, and vehicle truck beds/underbodies.

In general, polyurea coatings have exceptional high elongation and toughness. Polyureas also offer rapid application rates, fast curing (< 1 minute), and a quick return of components to service. In addition, they can have strong abrasion resistance and excellent encapsulation characteristics. Some systems are available in high-pigment UV-inhibited formulations, making above-ground applications acceptable.

The most problematic application of polyurea coatings is related to potential coating damage from cathodically protecting the pipe. Polyureas are generally known to perform relatively poorly compared to fusion-bonded epoxies (FBE) in ASTM cathodic-disbondment (CD) testing. However, due to their exceptional impact resistance, many fewer holidays should be expected to form.

Plural-component equipment is also known to be difficult to use and time consuming to set up and clean up. In applications where only a relatively small surface area has to be coated, a brush-on coating may be just as effective.

In Phase 1 of this project (now complete), a comprehensive evaluation of polyurea pipe coatings was conducted.

Tests were conducted to determine:

- Cathodic disbondment
- Impact resistance
- Abrasion resistance
- UV resistance, and
- Corrosion resistance.

In Phase 1, two types of polyurea coatings from Nukote Coating Systems (HAR and HTD) performed well in laboratory testing and appeared promising for use in the natural gas industry. Their impact and corrosion resistance outperformed the benchmark liquid epoxy



ASTM G8 testing from Phase 1: Pipes suspended in electrolyte (left); spraying coating on pipe specimens (right).