

Assessment of Dam Safety Coal Combustion Surface Impoundments (Task 3) Final Report

American Electric Power
Big Sandy
Generating Station
Louisa, Kentucky



Prepared for

Lockheed Martin

2890 Woodridge Ave #209
Edison, New Jersey 08837

February 17, 2010

CHA Project No. 20085.7000.1510





I acknowledge that the management units referenced herein:

- Bottom Ash Complex
- Fly Ash Pond

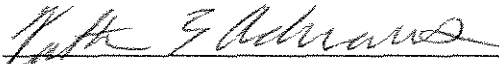
have been assessed on October 29, 2009.

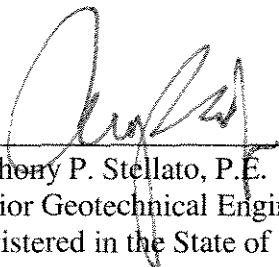
Signature: 
Katherine E. Adnams, P.E.
Senior Geotechnical Engineer

Signature: 
Anthony P. Stellato, P.E.
Senior Geotechnical Engineer
Registered in the State of Kentucky



Reviewer: 
Warren A. Harris, P.E.
Geotechnical Operations Manager

TABLE OF CONTENTS

| SECTION | PAGE NUMBER |
|--|--------------------|
| 1.0 INTRODUCTION & PROJECT DESCRIPTION..... | 1 |
| 1.1 Introduction..... | 1 |
| 1.2 Project Background..... | 2 |
| 1.2.1 State Issued Permits | 3 |
| 1.3 Site Description and Location..... | 3 |
| 1.3.1 Fly Ash Pond Construction History | 3 |
| 1.3.2 Bottom Ash Complex | 5 |
| 1.3.3 Other Impoundments | 6 |
| 1.4 Previously Identified Safety Issues..... | 6 |
| 1.5 Geology..... | 6 |
| 1.5.1 Regional Geology | 6 |
| 1.5.2 Coal Seam | 7 |
| 1.6 Bibliography | 7 |
| | |
| 2.0 FIELD ASSESSMENT..... | 20 |
| 2.1 Visual Observations..... | 20 |
| 2.2 Visual Observation – Saddle Dam and Horseford Creek Dam..... | 21 |
| 2.2.1 Saddle Dam Embankments and Crest..... | 21 |
| 2.2.2 Horseford Creek Dam Embankments and Crest..... | 22 |
| 2.2.3 Fly Ash Pond Control Structure and Discharge Channel | 23 |
| 2.3 Visual Observations – Bottom Ash Complex..... | 23 |
| 2.3.1 Bottom Ash Complex Embankments and Crest | 23 |
| 2.3.2 Bottom Ash Complex Control and Discharge Structures..... | 24 |
| 2.4 Monitoring Instrumentation | 25 |
| 2.4.1 Horseford Creek Dam Piezometers | 25 |
| 2.4.2 Horseford Creek Dam Seepage Measurement Weirs | 26 |
| 2.4.3 Horseford Creek Dam Deformation Monitoring | 26 |
| 2.4.4 Horseford Creek Dam Slope Inclinometers..... | 27 |
| | |
| 3.0 DATA EVALUATION..... | 78 |
| 3.1 Design Assumptions | 78 |
| 3.2 Hydrologic and Hydraulic Design | 78 |
| 3.2.1 Fly Ash Pond..... | 79 |
| 3.2.2 Bottom Ash Complex | 80 |
| 3.3 Structural Adequacy & Stability..... | 80 |
| 3.3.1 Stability Analysis Conditions – Fly Ash Pond | 81 |
| 3.3.1.1 Soil Strength Parameters – Fly Ash Pond..... | 82 |
| 3.3.1.2 Stability Analysis Results – Fly Ash Pond | 83 |
| 3.3.1.3 Liquefaction Analysis – Fly Ash Pond Dams..... | 84 |
| 3.3.2 Bottom Ash Complex | 85 |
| 3.4 Foundation Conditions..... | 85 |



TABLE OF CONTENTS - continued

| SECTION | PAGE NUMBER |
|--|--------------------|
| 3.4.1 Foundation Conditions at the Horseford Creek Dam | 85 |
| 3.4.2 Seepage at Horseford Creek Dam..... | 86 |
| 3.4.3 Foundation Conditions at the Saddle Dam | 87 |
| 3.4.4 Foundation Conditions at Bottom Ash Complex..... | 87 |
| 3.5 Operations & Maintenance | 87 |
| 3.6 Inspections | 88 |
| 3.6.1 Inspections by Power Company..... | 88 |
| 3.6.2 Inspections by Engineering Consultants..... | 90 |
| 3.6.3 State of Kentucky Inspections | 92 |
| 4.0 CONCLUSIONS/RECOMMENDATIONS | 99 |
| 4.1 Acknowledgement of Management Unit Condition | 99 |
| 4.2 General Condition Monitoring and Maintenance | 99 |
| 4.2.1 Saddle Dam and Horseford Creek Dam..... | 99 |
| 4.2.2 Bottom Ash Complex Dikes | 100 |
| 4.3 Toe Drain Cleaning..... | 100 |
| 4.4 Bottom Ash Complex Standing Water | 101 |
| 4.5 Seepage at the Fly Ash Pond | 101 |
| 4.6 Instrumentation | 101 |
| 4.7 Rapid Drawdown Stability Analysis..... | 102 |
| 4.8 Analysis for Bottom Ash Complex..... | 102 |
| 5.0 CLOSING | 103 |

TABLES

| | |
|---|----|
| Table 1 - Approximate Precipitation Prior to Site Visit | 20 |
| Table 2 - Summary of Vertical Movement at Horseford Creek Pond | 28 |
| Table 3 – Factors of Safety from KY Guidelines | 81 |
| Table 4- Minimum Safety Factors Recommended by US Army Corps of Engineers..... | 81 |
| Table 5 - Soil Strength Properties – Horseford Creek Dam Foundation Soils | 83 |
| Table 6 - Soil Strength Properties – Saddle Dam Foundation Soils | 83 |
| Table 7 - Soil Strength Properties – Construction Materials | 83 |
| Table 8 – Summary of Safety Factors..... | 84 |



LIST OF FIGURES

| | |
|--|----|
| Figure 1 - Project Location Map..... | 9 |
| Figure 2 - Photo Site Plan | 10 |
| Figure 3 - Critical Infrastructure Map..... | 11 |
| Figure 4A - Cross Section Through Horseford Creek Dam Phase 2 | 12 |
| Figure 4B - Horseford Creek Dam Phase 3 Proposed Grades | 13 |
| Figure 4C - Cross Section Through Horseford Creek Dam Phase 3 | 14 |
| Figure 5A - Saddle Dam Final Proposed Grades..... | 15 |
| Figure 5B - Selected Saddle Dam Propsoed Cross Sections | 16 |
| Figure 6A - Bottom Ash Complex Propsoed Construction | 17 |
| Figure 6B - Bottom Ash Complex Cross Sections | 18 |
| Figure 6C - Bottom Ash Complex Recent Grades..... | 19 |
| Figure 7A - Photo Location Plan | 29 |
| Figure 7B - Photo Location Plan | 30 |
| Figure 7C - Photo Location Plan | 31 |
| Figure 8 - Piezometer Data | 67 |
| Figure 9 - Flow Data..... | 68 |
| Figure 10 - Horseford DMP Location Plan..... | 69 |
| Figure 11A - Horizontal Deformation | 70 |
| Figure 11B - Horizontal Deformation..... | 71 |
| Figure 11C - Horizontal Deformation..... | 72 |
| Figure 11D - Horizontal Deformation | 72 |
| Figure 11E - Horizontal Deformation..... | 73 |
| Figure 11F - Horizontal Deformation..... | 75 |
| Figure 12A - Inclinator Data..... | 76 |
| Figure 12B - Inclinator Data | 77 |
| Figure 13A - Stability Analysis – End of Construction Static Condition..... | 93 |
| Figure 13B - Stability Analysis – End of Construction Seismic Condition..... | 94 |
| Figure 13C - Stability Analysis – Long Term Pond Static Condition | 95 |
| Figure 13D - Stability Analysis – Long Term Pond Seismic Condition..... | 96 |
| Figure 13E - Stability Analysis - Surcharge Pool Static Condition | 97 |
| Figure 13F - Stability Analysis – Surcharge Pool Seismic Condition | 98 |

APPENDIX

Appendix A - Completed EPA Coal Combustion Dam Inspection Checklists and Coal Combustion Waste (CCW) Impoundment Inspection Forms



1.0 INTRODUCTION & PROJECT DESCRIPTION

1.1 Introduction

CHA was contracted by Lockheed Martin (a contractor to the United States Environmental Protection Agency) to perform site assessments of selected coal combustion surface impoundments (Project #0-381 Coal Combustion Surface Impoundments/Dam Safety Inspections). As part of this contract, CHA was assigned to perform a site assessment of American Electric Power's (AEP's) Big Sandy Generating Station, which is located in Louisa, Kentucky as shown on Figure 1 – Project Location Map.

CHA made a site visit on October 29, 2009 to inventory coal combustion surface impoundments at the Big Sandy facility, to perform visual observations of the containment dikes, and to collect relevant information regarding the site assessment.

CHA Engineers Anthony Stellato, P.E. and Katherine Adnams, P.E. were accompanied by the following individuals:

| Company or Organization Name | Name |
|---|---------------|
| American Electric Power | Gary Zych |
| American Electric Power | Brett Dreger |
| American Electric Power | Keith Sergent |
| American Electric Power | Deanna King |
| American Electric Power | Mitch Thomas |
| American Electric Power | Ken Borders |
| American Electric Power | Davis Mall |
| Kentucky Dept. for Environmental Protection | Scott Phelps |



1.2 Project Background

The Fly Ash Pond and Bottom Ash Complex at the Big Sandy Generating Station are under the jurisdiction of the Commonwealth of Kentucky Department of Environmental Protection (DEP) – Division of Water, Dam Safety and Flood Compliance Section of the Water Infrastructure Branch. The EPA Coal Combustion Dam Inspection Checklist Forms for each impoundment are included in Appendix A.

The Fly Ash Pond is confined by the Horseford Creek Dam (also referred to as the Main Fly Ash Dam and Big Sandy Dam in reports by others; Kentucky Dam ID 0367, National Inventory of Dams ID KY00367) to the north and the Saddle Dam to southeast. According to the Kentucky Revised Statute (KRS) Chapter 151, the KDEP Engineering Memo No. 5 (adopted 02-01-1975), Section B and KAR 401:030 – Design Criteria for Dams and Associated Structures, the Kentucky DEP has classified the Horseford Creek Dam confining the Fly Ash Pond as high hazard based on the potential for loss of life if the dam were to fail.

The Saddle Dam had not been classified by the Kentucky DEP as a separate structure. The Saddle Dam contains the emergency spillway for the impoundment therefore the Saddle Dam should be classified as high hazard as well because it works in concert with the Horseford Creek Dam.

The Bottom Ash Pond Complex dikes are not classified by the Kentucky DEP. This structure would be classified by the EPA criteria as significant hazard, meaning that failure of the dam would not be expected to cause loss of human life, but will likely cause economic losses and environmental damage to the adjacent river and watershed.

1.2.1 State Issued Permits

Commonwealth of Kentucky Permit No. KY0000221 has been issued to AEP authorizing discharge under the National Pollutant Discharge Elimination System (NPDES) to the Big Sandy River in accordance with effluent limitations, monitoring requirements and other conditions set forth in the permit. The permit became effective on February 4, 2003 and was set to expire on March 31, 2007. AEP indicated that they submitted an application for renewal in September 2005 to the Kentucky Department of Water (KYDOW). KYDOW has not provided correspondence regarding the status of the application. Therefore, the site has been operating in accordance with the expired permit.

1.3 Site Description and Location

Figure 2 – Photo Site Plan shows the two impoundments constructed for the Big Sandy Generating Station. The Fly Ash Pond is located approximately 1.3 miles northwest of the plant. The Bottom Ash Complex is located west of the Station. The Station site is bounded by State Route 23 to the north and the Big Sandy River to the east, south, and west.

An aerial photograph of the region indicating the location of the Big Sandy Generating Plant facilities and identifying schools, hospitals, or other critical infrastructure located within approximately five miles down gradient of Fly Ash Pond and Bottom Ash Complex is provided as Figure 3.

1.3.1 Fly Ash Pond Construction History

The following is a summary of the construction history of the fly ash impoundment.

- Construction of Horseford Creek Dam Phase 1 began in late 1968 and continued incrementally through mid-February 1970 when the dam crest reached El. 625 which

corresponds to a maximum dam height of 85 feet. This portion of the dam was constructed of homogeneous compacted clay. Incremental construction was required due to unanticipated settlement and lateral spreading of the dam. Geotechnical explorations and assessments indicated that the movement may have been the result of a layer of soft clay beneath the dam and/or due to some embankment fill being placed too wet. Rock fill berms were constructed on both sides (upstream and downstream) of the embankment in January 1969; these berms were enlarged in late 1969. Piezometers were installed in late 1969 to monitor the pore water pressures in the embankment fill and foundation soils. The pond began to receive fly ash in 1970.

- Design for Horseford Creek Dam Phase 2 began in April 1976 and construction was completed in 1979 with the crest at El. 675 which corresponds to a maximum dam height of 135 feet. A cross section through the Phase 2 dam is shown in Figure 4A. The Phase 2 dam was designed as a zoned embankment with a compacted upstream rock shell, clay core, near vertical bottom ash chimney drain, and a downstream compacted rock shell. During this phase of construction, a portion of the area near the downstream side of the west abutment of the Phase 1 dam reportedly sloughed. A stabilizing berm, which later became part of the clay core, was constructed. Berms are present on the upstream side at El. 575 and 625 as shown on Figure 4A. The downstream berm was approximately 250 ft-wide at about El. 600. The service spillway tower and discharge pipe were constructed as part of Phase 2. A Saddle Dam and Emergency Spillway were also constructed in Phase 2.
- Phase 3 construction included raising the crest of the Horseford Creek Dam to El. 711, constructing a new Saddle Dam, filling the old Emergency Spillway, and constructing a new emergency spillway. Plan view and cross sections views from the 1993 Phase 3 construction drawings are shown on Figures 4B and 4C, respectively. The Horseford Creek Dam was reportedly raised by extending the core zone with compacted low to medium plasticity clay with 2.75H:1V slopes on the upstream face. The downstream

shell and chimney drain were constructed from bottom ash with finished 1.75H:1V slopes. Construction of Phase 3 is substantially complete and the crest of the Horseford Creek Dam is currently at about El. 711.

Plan and section views of the Saddle Dam from the 1993 construction drawings are shown in Figures 5A and 5B, respectively. The section views show an existing bottom ash dike located upstream of the proposed construction. The impervious zone of the Saddle Dam was constructed with compacted low to medium plasticity clay with 2.75H:1V upstream slopes. The downstream shell and chimney drain were constructed from compacted bottom ash with finished 1.75H:1V slopes. The former emergency spillway was plugged with a fly ash/bottom ash stabilized mixture (also called RCC in reports by others) below the clay core.

The emergency spillway was constructed on the left abutment of the Saddle Dam by excavating into weathered rock. The emergency spillway crest was excavated to El. 706.5.

1.3.2 Bottom Ash Complex

The Bottom Ash Complex is divided into five cells: North Bottom Ash Pond (NBAP), North Clearwater Pond (NCWP), South Bottom Ash Pond (SBAP), South Clearwater Pond (SCWP), and Reclaim Water Pond (RWP). Plant personnel indicated that the operations at the Bottom Ash Complex consist of alternating sluicing of bottom ash to the north and south ponds with subsequent dredging. At the time of CHA's site visit, the SBAP was dry and the collected bottom ash had been excavated and bottom ash was being sluiced to the NBAP.

The east and south sides of the complex are impounded by earth dikes. The western portion of the complex is incised. The west end of the north side is incised and the east end is impounded by earth dikes. Based on a construction drawing provided by AEP shown in Figure 6A, the

configuration of the Bottom Ash Complex was modified in the late 1960's to its current configuration. Information on the material used to construct the dikes was not provided. The cross sections on Figure 6B shows that the perimeter dikes were constructed with upstream slopes of 1.75H:1V and downstream slopes of 2H:1V; the splitter dikes are shown with 2H:1V slopes on both sides of the embankment. A grading plan based on a 2001 survey is included in Figure 6C.

1.3.3 Other Impoundments

No other impoundments were identified at the Big Sandy Generating Station.

1.4 Previously Identified Safety Issues

Based on our review of the information provided to CHA and as reported by AEP, there have been no identified safety issues at the Fly Ash Pond or the Bottom Ash Complex in the last 10 years.

1.5 Geology

1.5.1 Regional Geology

Based on a review of an available geology map (*Geologic map of the Fallsburg quadrangle, Kentucky-West Virginia and the Prichard quadrangle in Kentucky: U.S. Geological Survey, Geologic Quadrangle Map GQ-584, 1967*), the valley floor below the Fly Ash Pond and the area below the Bottom Ash Complex consisted of alluvial deposits of silt, sand, and gravel. The map also indicates that the Princess No. 7 coal bed of the Breathitt Formation is exposed partway up the hill sides above the Fly Ash Pond; and the hill tops consist of Brush Creek Limestone of the Conemaugh Formation.

1.5.2 Coal Seam

The geology map indicates that the Princess No. 7 coal bed is very thin south and east of the Blaine Creek which includes the area of the Fly Ash Pond. Woodward-Clyde Consultant's (WCC's) 1981 inspection report indicated that an approximately 2-foot-thick coal seam was encountered at approximately El. 600. The bottom of the valley at the toe of the dam is at about El. 550.

G. Reynolds (1978) reported that a coal mine was located approximately 500 feet south of the Horseford Creek Dam which would be within the Fly Ash Impoundment. A review of information available on-line from the Kentucky Division of Mine Permits indicates an active surface mine about 1 mile west and a closed surface mine about 1.3 miles southwest of the Fly Ash Pond.

1.6 Bibliography

CHA reviewed the following documents provided by AEP and the Kentucky DEP in preparing this report:

- *Construction Permit for Modifications to Horseford Creek Flyash Dam*, from Commonwealth of Kentucky Natural Resources and Environmental Protection Cabinet to Kentucky Power Company, April 1993.
- *Kentucky Power Company, Big Sandy Plant, Fly Ash Retention Dam Stage 3 Raising Engineering Report*, prepared by AEP Civil Engineering Department Geotechnical Section, March 1993.
- *Big Sandy River Basin, Horseford Creek Dam, Lawrence County Kentucky (KY 00367), Phase I Inspection Report, National Dam Safety Program*. G. Reynolds Watkins/ATEC Associates, July 1978.

- *Report on Dam Safety Inspection, Big Sandy Fly Ash Dam and Big Sandy Bottom Ash Dikes.* Woodward-Clyde Consultants, March 1981.
- *2008 Inspection Report, Main Fly Ash Dam, Saddle Dam, Bottom Ash Complex, Big Sandy Power Plant.* AEP Service Corporation, Geotechnical Engineering, December 2008.
- *Design Drawings for Horseford Creek Flyash Dam, Big Sandy Plant, Louisa, Kentucky;* Sheets 12-30029 through 12-30037, 12-30039, and 12-30041; Prepared by American Electric Power Service Corp, March 1993.
- *As Built Cross-Sections, Big Sandy Plant.* Drawings 12-30801, revision 0; and 12-30900, revisions 0, 1, 5, 6, and 7.
- *SKS-Main Dam Rock El.* Undated sketch.
- *Main Dam – Big Sandy Present Grading.* Undated drawing.

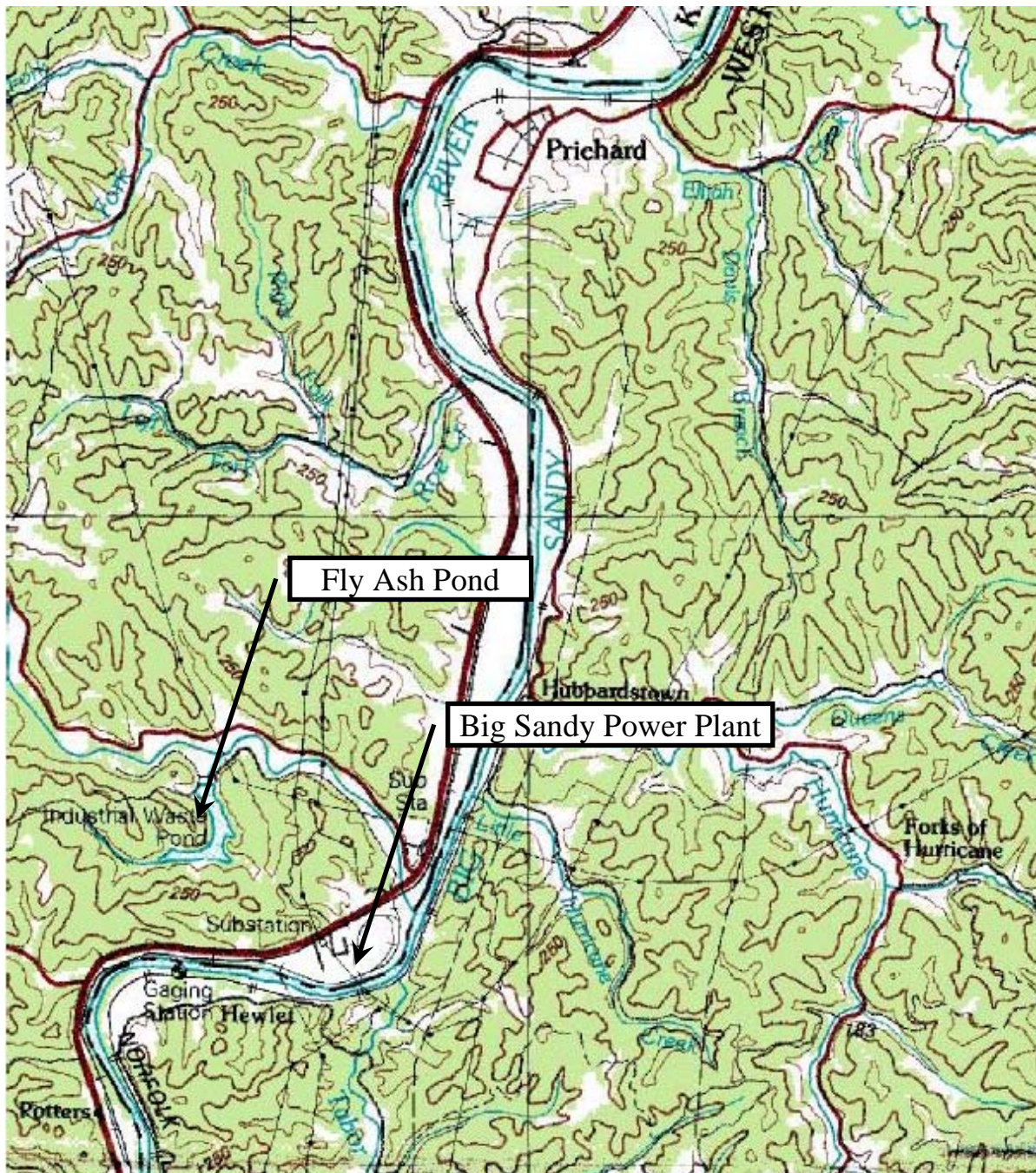
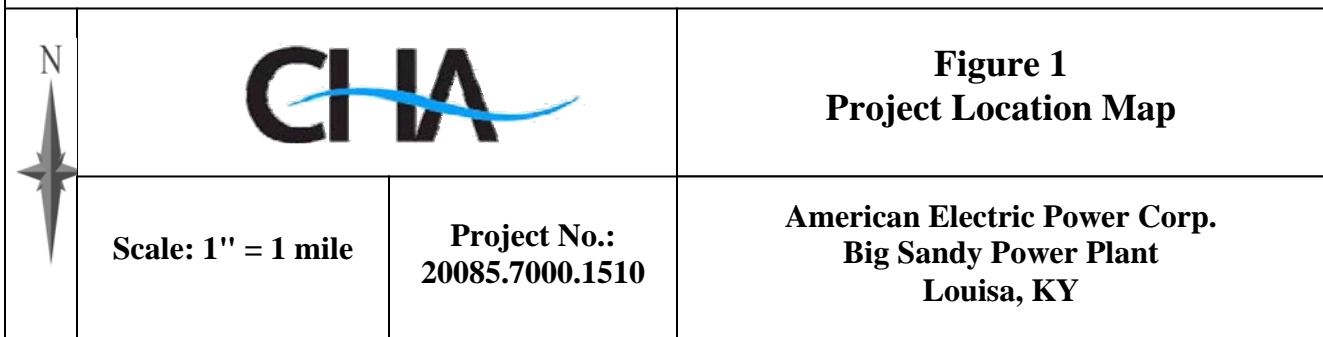

IMAGE DATE: 07/01/1975





PROJECT NO.
20085.7000

DATE: JULY 2008

FIGURE 7

PHOTO SITE PLAN
BIG SANDY POWER PLANT
LOUISA, KENTUCKY

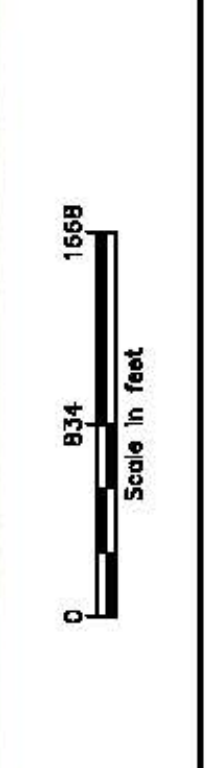
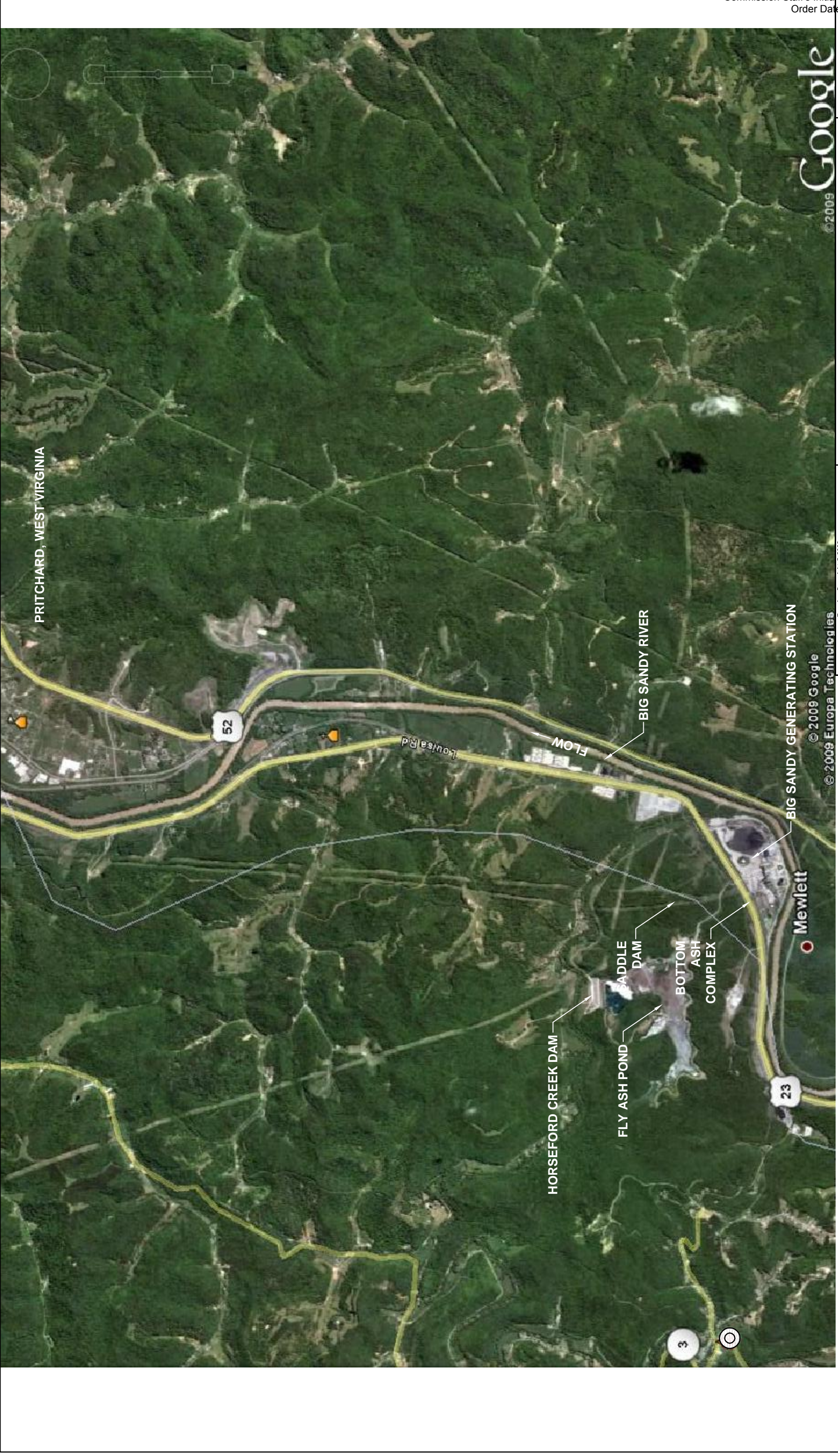

IMAGE REFERENCE: GOOGLE EARTH, IMAGE DATED MAY 22, 2005.

PROJECT NO.
20085.7000
 DATE: 12/2/2009
 FIGURE
16 of 125



Google
©2009

PRITCHARD, WEST VIRGINIA

CRITICAL INFRASTRUCTURE MAP
 BIG SANDY POWER PLANT
 LOUISA, KENTUCKY

CH2M
 Drawing Copyright © 2009
 III Winners Circle, PO Box 5289 · Albany, NY 12205-0289
 Mtn: (618) 483-4500 · www.ch2m.com

LEGEND

- 23
- Mewlett
- STREET, HIGHWAY
- SCHOOL
- CHURCH
- FIRE DEPARTMENT

IMAGE REFERENCE: GOOGLE EARTH, IMAGE DATED JUNE 20, 2004.

Scale in feet
 0 3,089 6,178

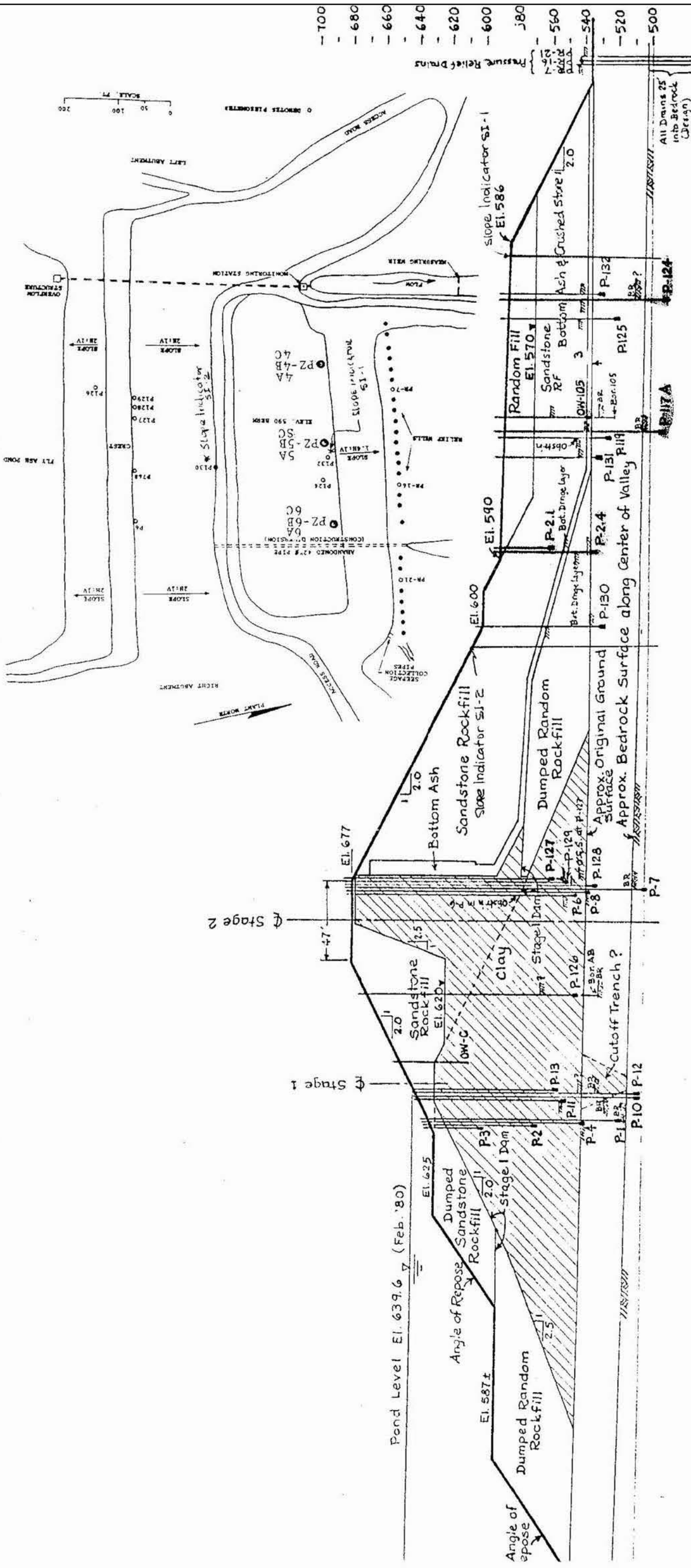

IMAGE REFERENCE: "FLY ASH RETENTION DAM, STAGE 3 RAISING ENGINEERING REPORT, FIGURE A-13" PREPARED BY AEP SERVICE CORPORATION, MARCH 1993

CROSS SECTION THROUGH HORSEFORD
 CREEK DAM PHASE 2
 BIG SANDY POWER PLANT
 LOUISA, KENTUCKY



PROJECT NO. 20085.7000
 DATE: 12/20/09
 FIGURE 7

PROJECT NO. 20085.7000
 DATE: 12/20/09
 FIGURE 13

HORSEFORD CREEK DAM PHASE 3
 PROPOSED GRADES
 BIG SANDY POWER PLANT
 LOUISA, KENTUCKY

Drawing Copyright © 2009



III Wilshire Circle, PO Box 6289 - Albany, NY 12204-0629
 Mchz: (518) 483-4600 • www.ciacorporate.com

IMAGE REFERENCE: AMERICAN ELECTRIC POWER CORP., MAIN FLY ASH DAM GRADING PLAN, DWG. 12-30036-C, 5/15/1998.

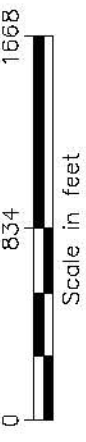

LEGEND - EXISTING

- SPOT ELEVATION
- INTERMEDIATE CONTOUR
- DEPRESSION CONTOUR
- TREES AND TREELINE
- STRUCTURE AND BUILDING
- FENCE
- ROADS
- EDGE OF WATER
- MANHOLES / CATCH BASIN
- POWER POLE

REFERENCE DRAWINGS

- 12-2009 GENERAL ARRANGEMENT
- 12-2001 MAIN FLY ASH DAM PLAN OF SODING
- 12-2002 SADDLE DAM AND EMERGENCY SPILLWAY PLAN OF SODING
- 12-2003 MAIN FLY ASH DAM SECTIONS
- 12-2004 SADDLE DAM AND EMERGENCY SPILLWAY GRADING PLAN
- 12-2005 SADDLE DAM AND EMERGENCY SPILLWAY SECTIONS
- 12-2007 SADDLE DAM ROUINITY PLAN & PROFILE
- 12-2008 ACCESS STAIRWAY AND COLLECT RETAILS
- 12-2009 PSEB - PLAN AND SECTIONS
- 12-2006 RESEB - MISCELLANEOUS DETAILS
- 12-2001 TYPICAL CROSS-SECTION SECTIONS MAIN DAM

REVISIONS

| NO. | DATE | DESCRIPTION |
|-----|----------|-------------------------|
| 1 | 12/20/09 | ISSUED FOR CONSTRUCTION |

S/S/BS/12/GHS/30036.DGN

DESIGNED BY: [Signature]

CHECKED BY: [Signature]

PROJECT: BIG SANDY POWER PLANT HORSEFORD CREEK

DATE: 12/20/09

DWG. NO. 12 - 30036 - 0

CIVIL ENGINEERING DIVISION

Carl S. Tappin

AMERICAN ELECTRIC POWER
 COLUMBIANA OH 43081

PROJECT NO. 20085.7000
 DATE: 12/20/08
 FIGURE 46

CROSS SECTION THROUGH HORSEFORD
 CREEK DAM PHASE 3
 BIG SANDY POWER PLANT
 LOUISA, KENTUCKY

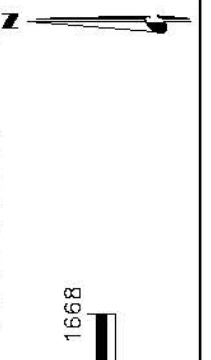

IMAGE REFERENCE: AMERICAN ELECTRIC POWER CORP., MAIN FLY ASH
 DAM SECTIONS, DWG. 12-30033-C, 5/15/1998.

REFERENCE DRAWINGS

| | |
|---------|--|
| 12-3009 | RADIAL ARRANGEMENT |
| 12-3011 | MAIN FLY ASH DAM PLAN OF BARRINGS |
| 12-3022 | SHOULDER DAM AND EMERGENCY SPILLWAY PLAN OF BARRINGS |
| 12-3004 | SHOULDER DAM AND EMERGENCY SPILLWAY CHANNEL PLAN |
| 12-3005 | SHOULDER DAM AND EMERGENCY SPILLWAY SECTIONS |
| 12-3007 | SHOULDER DAM ROUGH PLAN & PROFILE |
| 12-3008 | ACCESS STAIRWAY AND CURBET DETAILS |
| 12-3040 | RISER - PLAN AND SECTIONS |
| 12-3040 | RISER - MISCELLANEOUS DETAILS |
| 12-3041 | TYPICAL SURFACE SECTIONS, MAIN DAM |

| | | |
|----------|-------------------------|-----|
| DATE | ISSUED FOR CONSTRUCTION | BY |
| 12/20/08 | 12/20/08 | CAJ |
| DATE | ISSUED FOR CONSTRUCTION | BY |
| | | |

REVISIONS

| | |
|-----|-----------------------|
| NO. | DESCRIPTION |
| 1 | S/BS/12/GHS/30033.DGN |

THIS DRAWING IS THE PROPERTY OF THE AMERICAN ELECTRIC POWER SERVICE CORP. AND IS LOANED TO YOU FOR YOUR INFORMATION ONLY. IT IS NOT TO BE REPRODUCED OR COPIED, IN WHOLE OR IN PART, OR USED FOR ANY OTHER PURPOSE WITHOUT THE WRITTEN CONSENT OF THE AMERICAN ELECTRIC POWER SERVICE CORP. FOR ANY PURPOSES RELATING TO THIS PROJECT, YOU SHALL BE RESPONSIBLE FOR VERIFYING THE ACCURACY OF THE INFORMATION SHOWN ON THIS DRAWING.

KENTUCKY POWER COMPANY
BIG-SANDY
 HORSEFORD CREEK
 LAWRENCE, KENTUCKY

MAIN FLY ASH DAM
 SECTIONS

DWG. NO. 12-30033 - 0
 SCALE: 1" = 20' HORIZ & VERT
 CHECKED BY: [Signature]
 DESIGNED BY: [Signature]
 DATE: 12/20/08

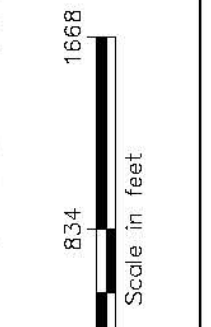
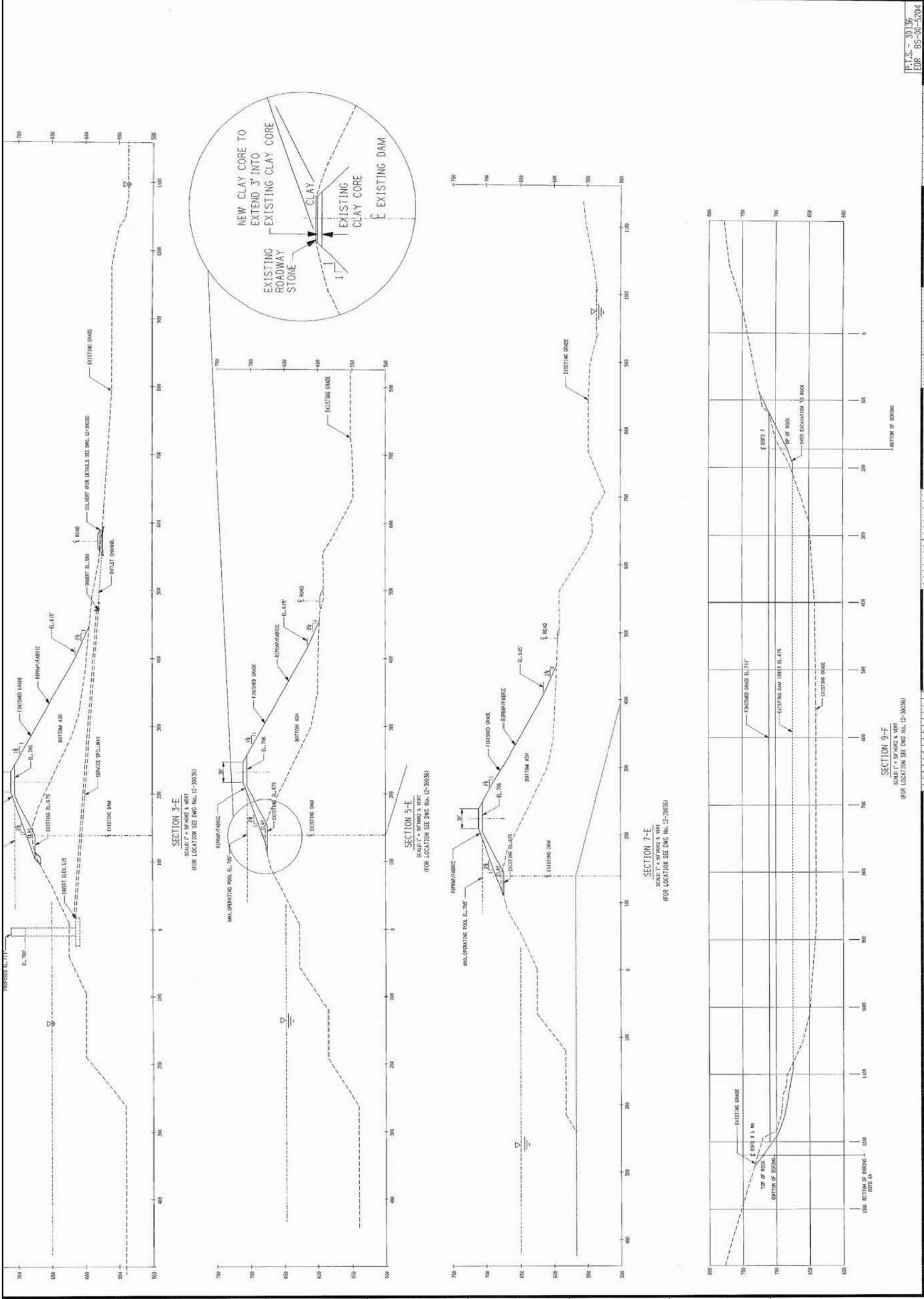

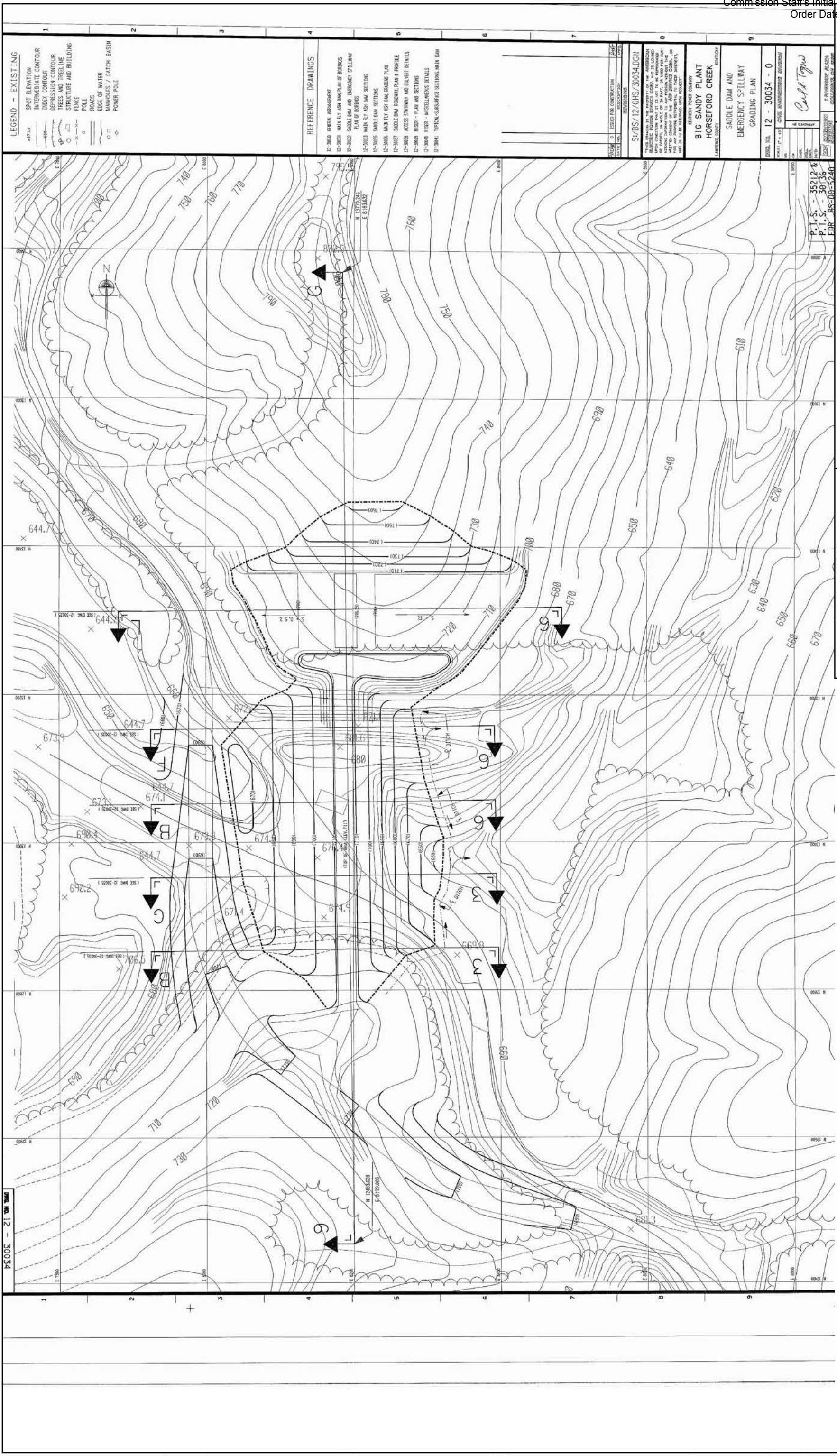

LEGEND - EXISTING

- SPOT ELEVATION
- INTERMEDIATE CONTOUR
- INDEX CONTOUR
- DEPRESSION CONTOUR
- TREES AND TREELINE
- STRUCTURE AND BUILDING
- FENCE
- POLE
- ROADS
- EDGE OF WATER
- MANHOLES / CATCH BASIN
- POWER POLE

REFERENCE DRAWINGS

- 12-2000 GENERAL ARRANGEMENT
- 12-2001 MAIN ELY ASH DAM PLAN OF BODICES
- 12-2002 SADDLE DAM AND EMERGENCY SPILLWAY PLAN OF BODICES
- 12-2003 MAIN ELY ASH DAM SETTINGS
- 12-2005 SADDLE DAM SETTINGS
- 12-2005 MAIN ELY ASH DAM GRADING PLAN
- 12-2007 SADDLE DAM HOUSING PLAN & PROFILE
- 12-2008 ACCESS STAIRWAY AND COLLECT DETAILS
- 12-2009 RISEY - PLAN AND SETTINGS
- 12-2008 RISEY - MISCELLANEOUS DETAILS
- 12-2004 TYPICAL SUBSURFACE SECTIONS MAIN DAM

S/BS/12/GHS/30034.DGN
 THIS DRAWING IS THE PROPERTY OF THE AMERICAN ELECTRIC POWER CORPORATION. IT IS TO BE USED ONLY FOR THE PROJECT AND SITE SPECIFICALLY IDENTIFIED HEREON. NO PART OF THIS DRAWING IS TO BE REPRODUCED OR TRANSMITTED IN ANY FORM OR BY ANY MEANS, ELECTRONIC OR MECHANICAL, INCLUDING PHOTOCOPYING, RECORDING, OR BY ANY INFORMATION STORAGE AND RETRIEVAL SYSTEM, WITHOUT THE WRITTEN PERMISSION OF THE AMERICAN ELECTRIC POWER CORPORATION. THE USER OF THIS DRAWING SHALL BE RESPONSIBLE FOR OBTAINING ALL NECESSARY PERMITS AND APPROVALS FROM THE APPROPRIATE AGENCIES AND AGENCIES OF THE STATE OF OHIO. THE USER SHALL BE RESPONSIBLE FOR OBTAINING ALL NECESSARY PERMITS AND APPROVALS FROM THE APPROPRIATE AGENCIES AND AGENCIES OF THE STATE OF OHIO.

| | |
|--|------------|
| BIG SANDY PLANT | |
| HORSEFORD CREEK | |
| SADDLE DAM AND EMERGENCY SPILLWAY GRADING PLAN | |
| PROJECT NO. | 20085.7000 |
| DATE: | 12/20/08 |
| FIGURE | 5A |

SADDLE DAM FINAL PROPOSED GRADES
 BIG SANDY POWER PLANT
 LOUISA, KENTUCKY

CIMA
 Drawing Copyright © 2008
 III Whisman Circle, PO Box 6289 - Albany, NY 12205-0289
 Phone: (518) 483-4600 - www.cimainc.com

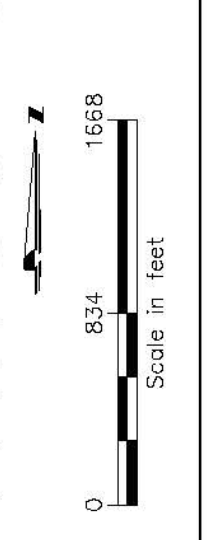

IMAGE REFERENCE: AMERICAN ELECTRIC POWER CORP., SADDLE DAM AND EMERGENCY SPILLWAY GRADING PLAN, DWG. 12-30034-C, 5/15/1998.

PROJECT NO.
 20085.7000
 DATE: 12/20/09
 FIGURE 3-B

SELECTED SADDLE DAM PROPOSED
 CROSS-SECTIONS
 BIG SANDY POWER PLANT
 LOUISA, KENTUCKY



IMAGE REFERENCE: AMERICAN ELECTRIC POWER CORP., SADDLE DAM AND
 EMERGENCY SPILLWAY CROSS-SECTIONS, DWG. 12-30035-C, 5/15/1998.

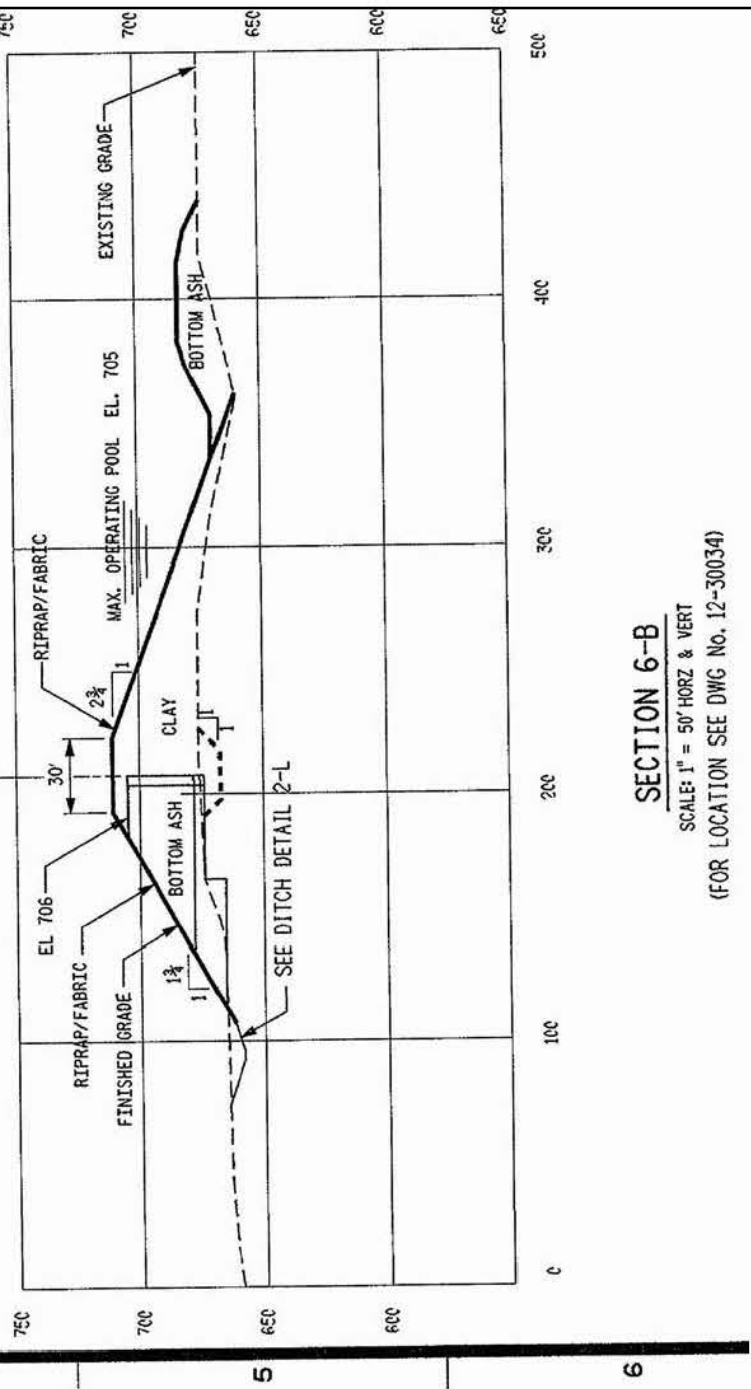

SECTION 6-B

SCALE: 1" = 50' HORZ & VERT

(FOR LOCATION SEE DWG No. 12-30034)

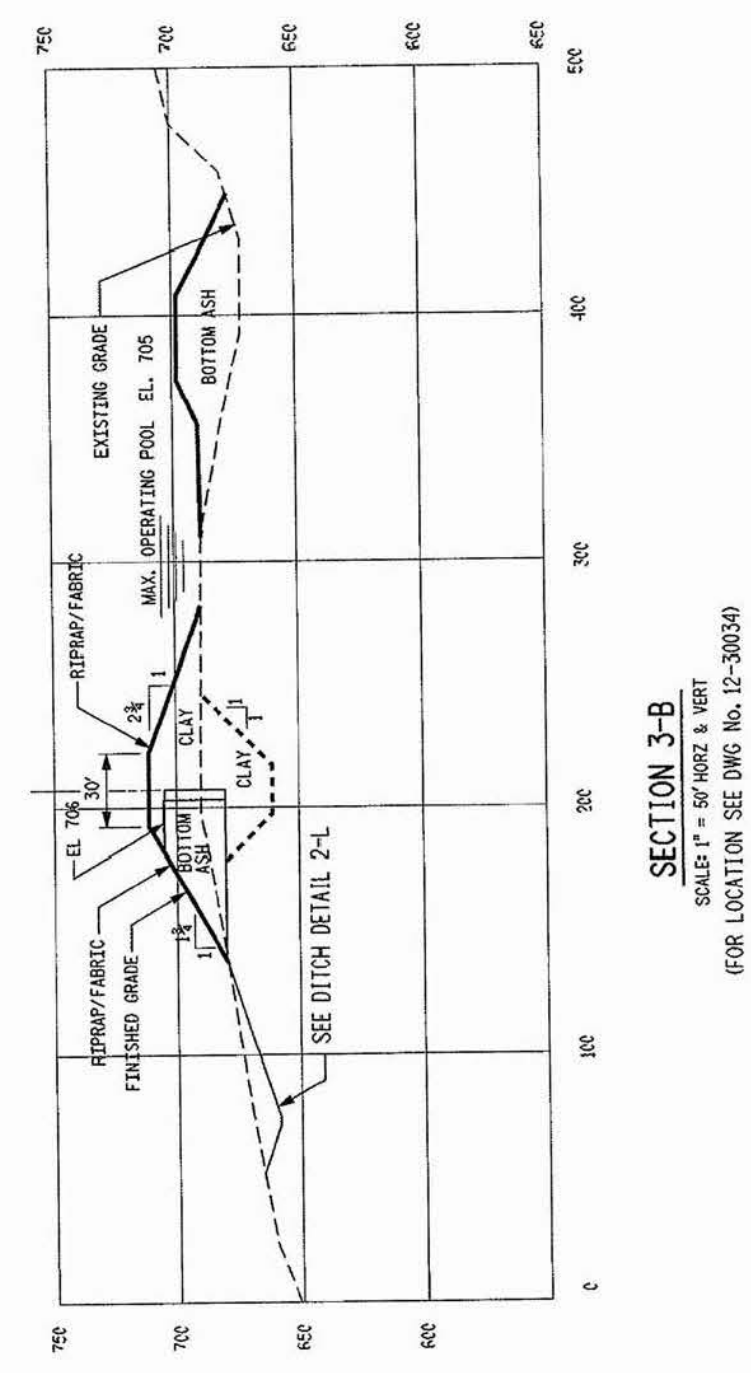

SECTION 3-B

SCALE: 1" = 50' HORZ & VERT

(FOR LOCATION SEE DWG No. 12-30034)

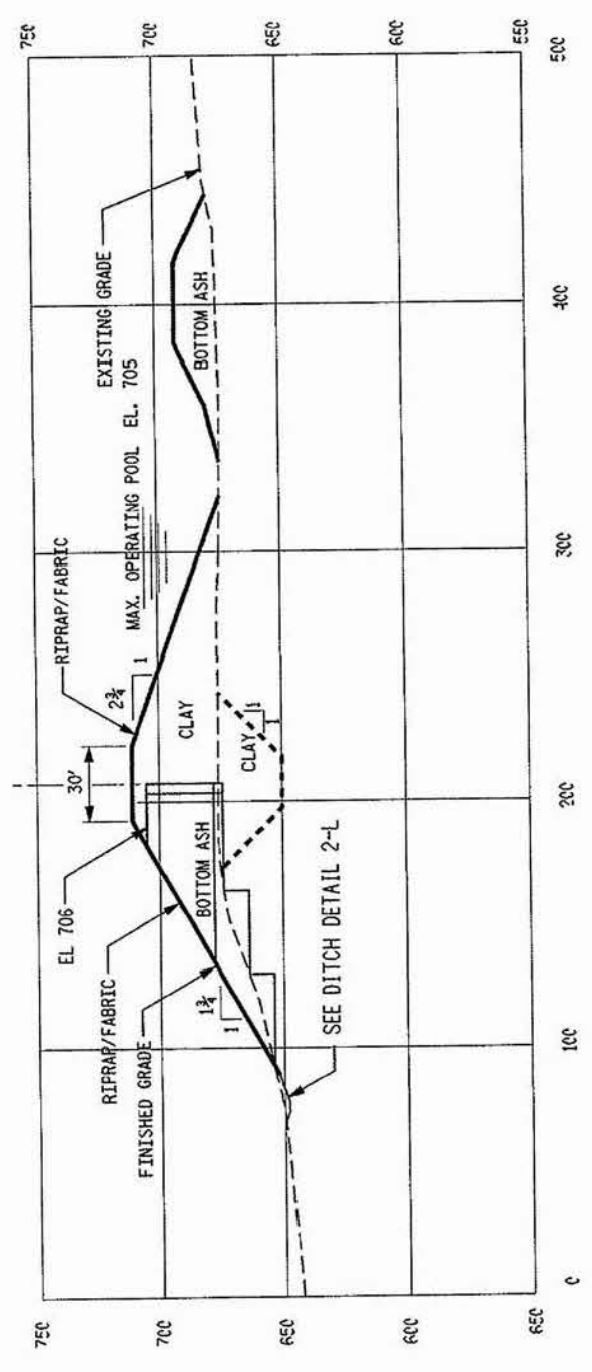

SECTION 3-G

SCALE: 1" = 50' HORZ & VERT

(FOR LOCATION SEE DWG No. 12-30034)



PROJECT NO.
 20085.7000
 DATE: 12/10/09
 FIGURE 6-A-4

BOTTOM ASH COMPLEX PROPOSED CONSTRUCTION
 BIG SANDY POWER PLANT
 LOUISA, KENTUCKY

Drawing Copyright © 2009



III Wilshire Circle, PO Box 5289 • Albany, NY 12205-0289
 Main: (618) 453-4500 • www.chocompanies.com

IMAGE REFERENCE: AMERICAN ELECTRIC POWER CORP., BOTTOM ASH STORAGE AREA, DWG. 12-3642-6, 4/17/1975.

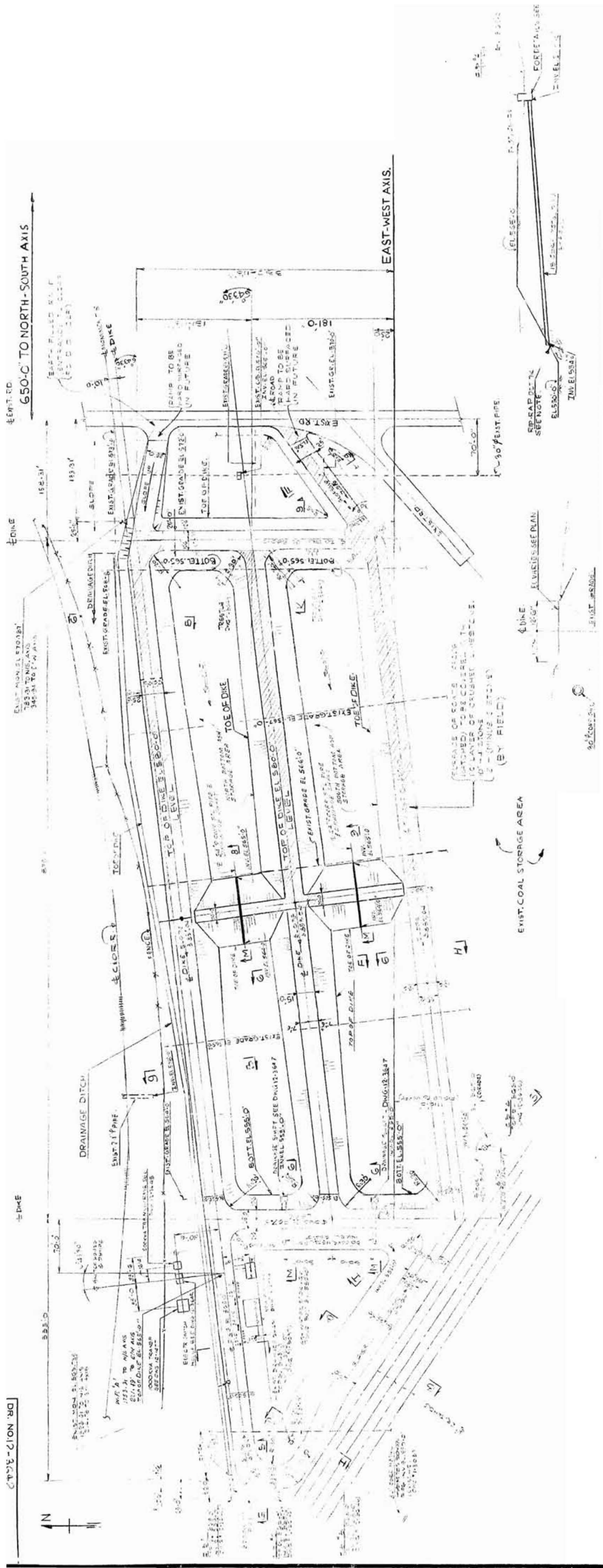
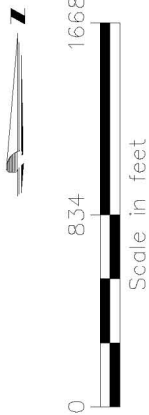

| | |
|-------------|------------|
| PROJECT NO. | 20085.7000 |
| DATE: | 12/20/09 |
| FIGURE | 68 |

SELECTED BOTTOM ASH COMPLEX
 PROPOSED CROSS-SECTIONS
 BIG SANDY POWER PLANT
 LOUISA, KENTUCKY

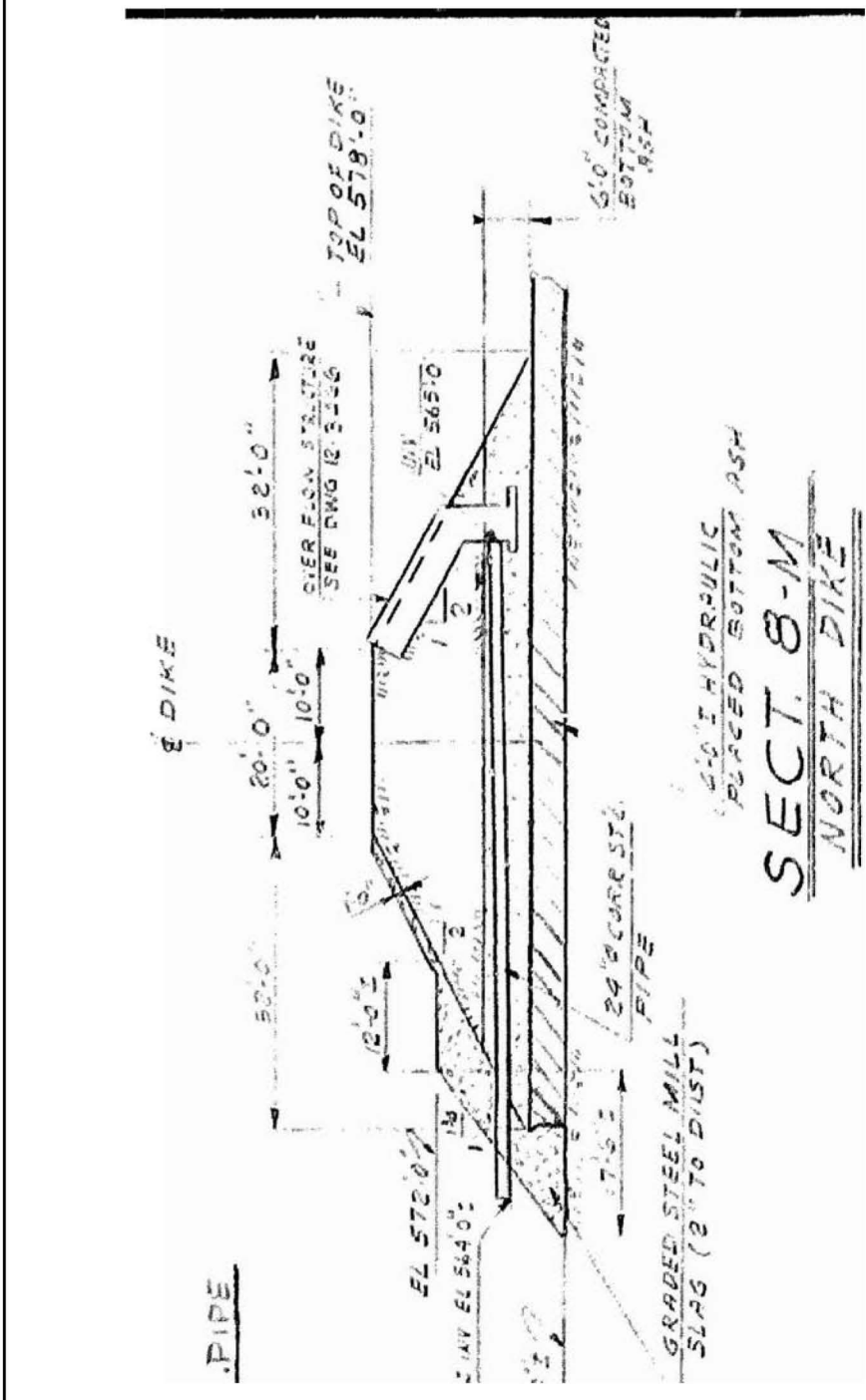

SECT. 8-M
NORTH DIKE

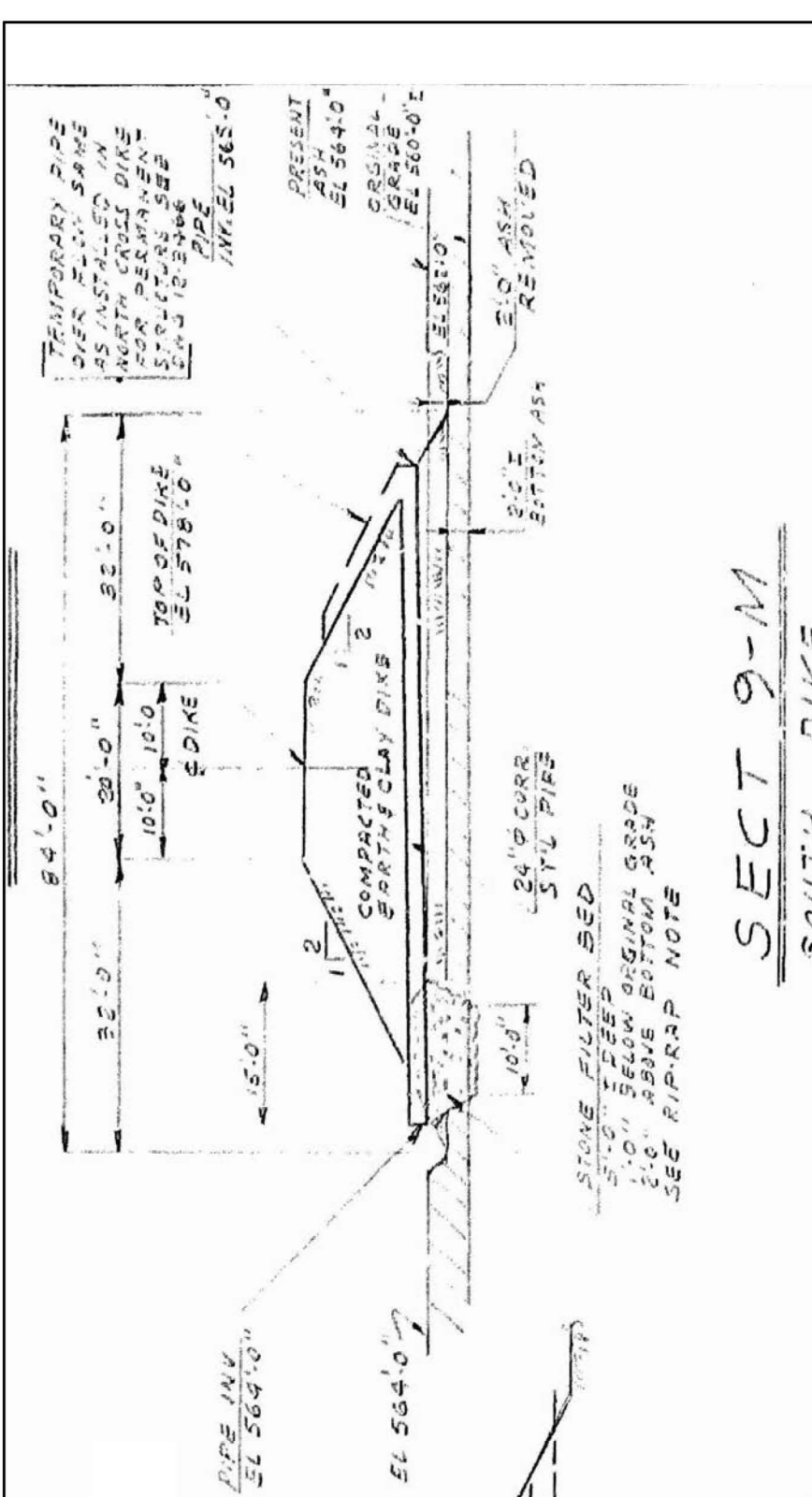

SECT 9-M
SOUTH DIKE
 1" = 20'-0"

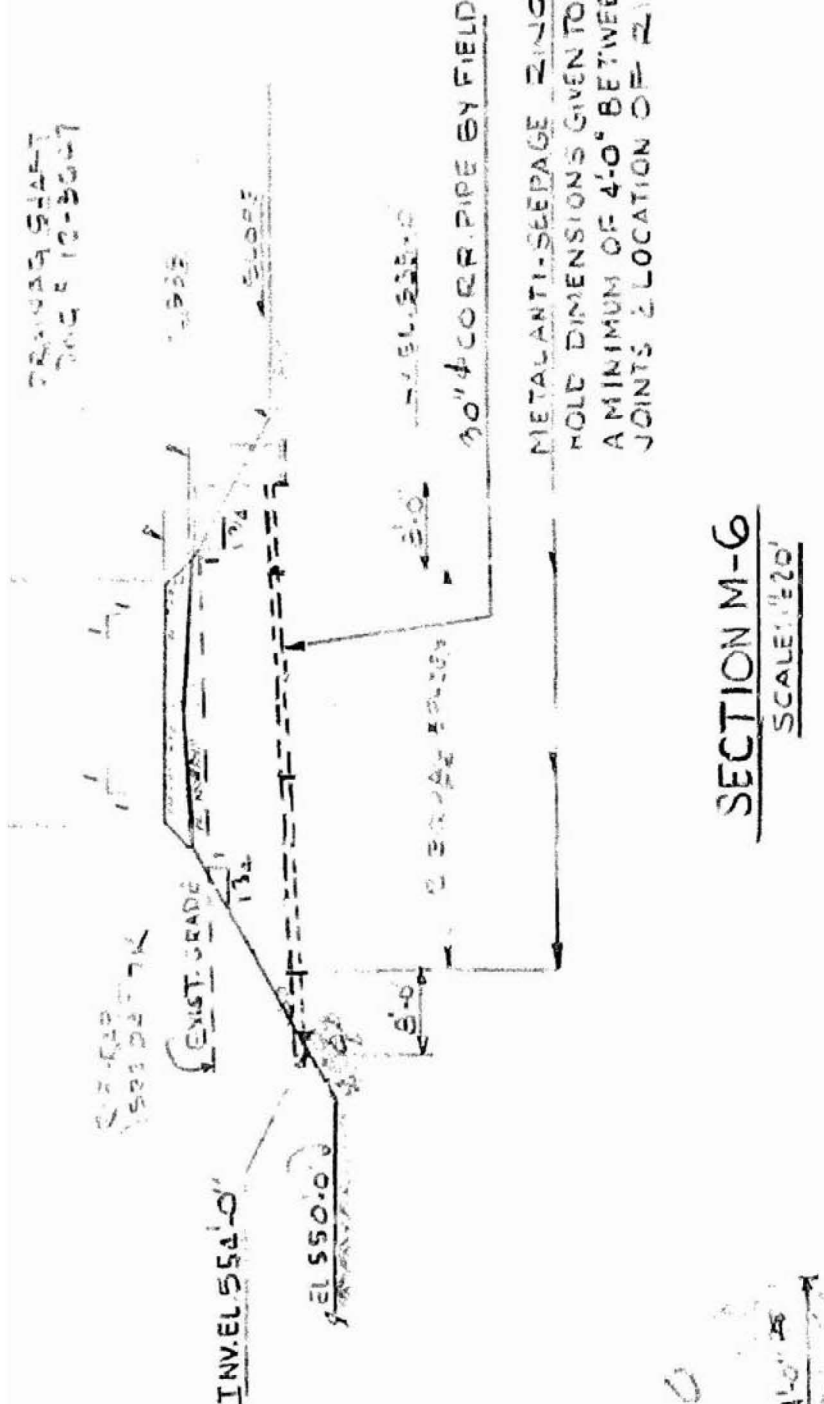

SECTION M-6
 SCALE: 1" = 20'

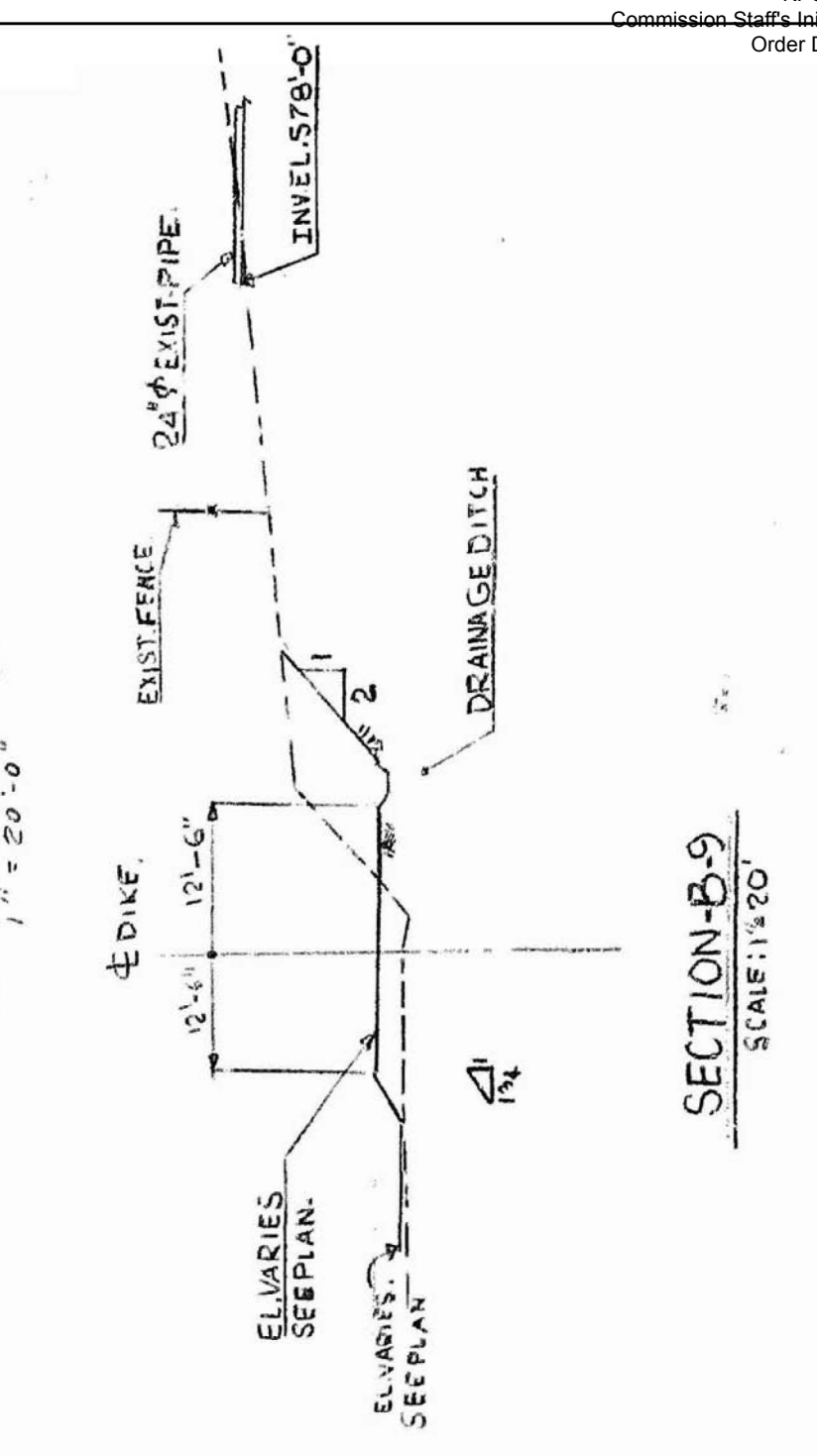

SECTION-B-9
 SCALE: 1" = 20'

IMAGE REFERENCE: AMERICAN ELECTRIC POWER CORP., BOTTOM ASH STORAGE AREA, DWG. 12-3642-6, 4/17/1975.

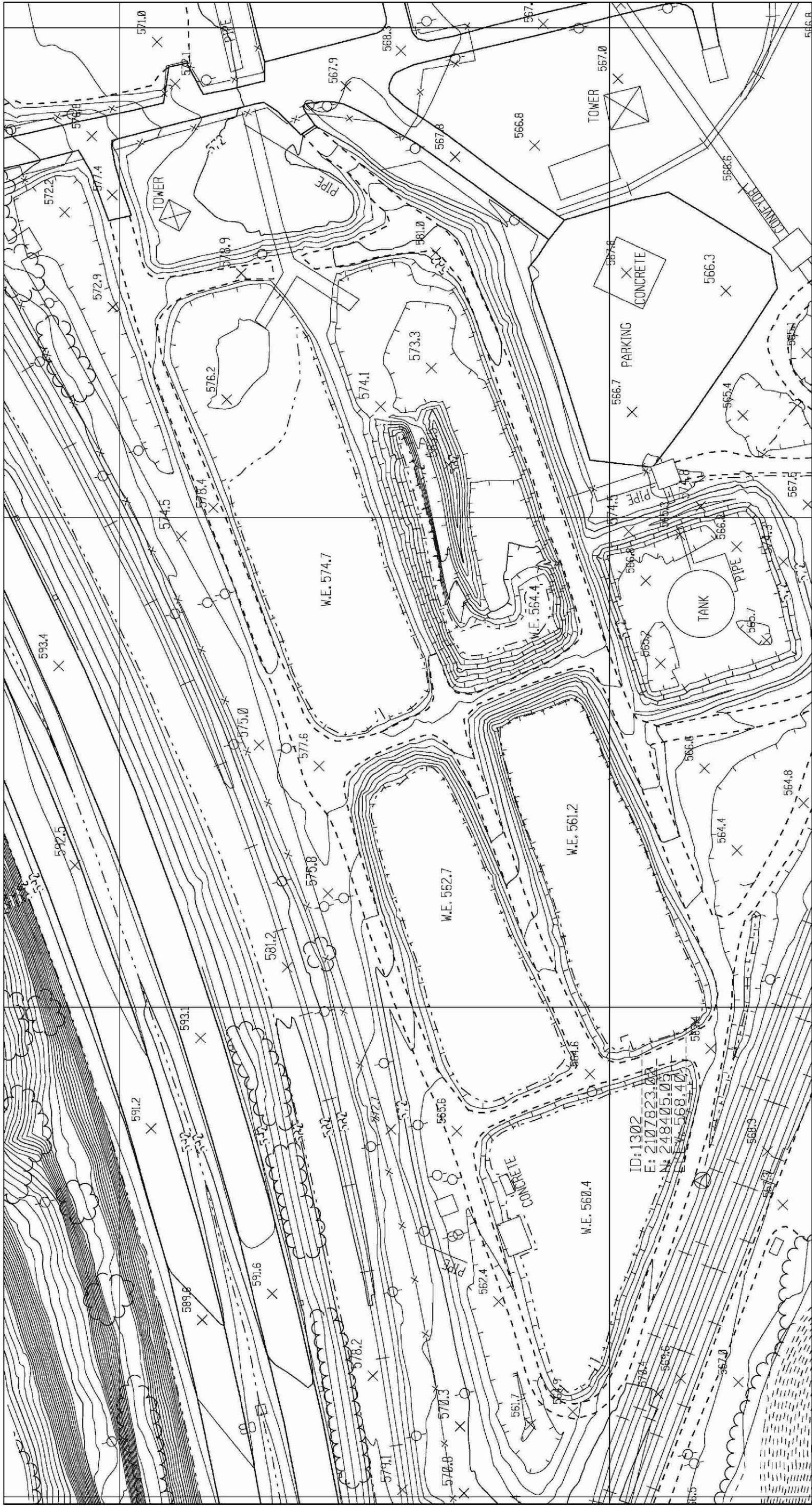

BIG SANDY PLANT
 Scale: 1" = 100 ft
 2-ft contour interval
 2001 topography

BOTTOM ASH COMPLEX RECENT GRADES

BIG SANDY POWER PLANT
 LOUISA, KENTUCKY

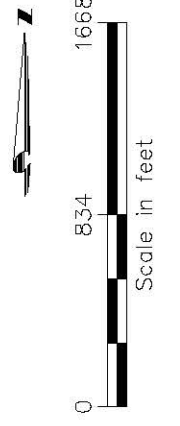

IMAGE REFERENCE: 2001 TOPOGRAPHY PLAN PROVIDED BY AMERICAN ELECTRIC POWER CORP.

...\\geo_hydro_site\BS_SCR_2001.dgn 10/30/2009 3:47:17 PM

2.0 FIELD ASSESSMENT

2.1 Visual Observations

CHA performed visual observations of the Fly Ash Pond and Bottom Ash Complex dikes following the general procedures and considerations contained in Federal Emergency Management Agency's (FEMA's) *Federal Guidelines for Dam Safety* (April 2004), and Federal Energy Regulatory Commission (FERC) Part 12 Subpart D to make observations concerning settlement, movement, erosion, seepage, leakage, cracking, and deterioration. A Coal Combustion Dam Inspection Checklist and Coal Combustion Waste (CCW) Impoundment Inspection Form, prepared by the US Environmental Protection Agency, were completed on-site during the site visit. Copies of the completed forms were submitted via email to a Lockheed Martin representative approximately three days following the site visit to the Big Sandy Generating Station. Copies of these completed forms are included in Appendix A. A photo log and Site Photo Location Plan (Figures 7A, 7B and 7C) are also located at the end of Section 2.4.4.

CHA's visual observations were made on October 29, 2009. The weather was sunny with temperatures between 50 and 70 degrees Fahrenheit. Prior to the days we made our visual observations the following approximate rainfall amounts occurred (as reported by www.wunderground.com).

Table 1 - Approximate Precipitation Prior to Site Visit

| Date of Site Visit – October 29, 2009 | | |
|--|------------------|-------------------------------|
| Day | Date | Precipitation (inches) |
| Thursday | October 22, 2009 | 0.00 |
| Friday | October 23, 2009 | 0.28 |
| Saturday | October 24, 2009 | 0.01 |
| Sunday | October 25, 2009 | 0.05 |
| Monday | October 26, 2009 | 0.00 |
| Tuesday | October 27, 2009 | 0.51 |
| Wednesday | October 28, 2009 | 0.17 |

| Date of Site Visit – October 29, 2009 | | |
|--|---------------------------------|-------------------------------|
| Day | Date | Precipitation (inches) |
| Total | Week Prior to Site Visit | 1.02 |
| Total | Month of October | 2.75 |

2.2 Visual Observation – Saddle Dam and Horseford Creek Dam

On October 29, 2009, the freeboard was approximately 45 feet, corresponding to a pool at about El. 666.

2.2.1 Saddle Dam Embankments and Crest

CHA performed visual observations of the Saddle Dam, which is about 500 feet long and up to approximately 61 feet high. In general, the Saddle Dam does not show signs of changes in horizontal alignment from the proposed alignment; construction of the final raising of the Saddle Dam was completed within a month prior to our site visit. Pictures of the Saddle Dam and Emergency Spillway are included in Photos 1 through 18.

The upstream and downstream slopes were reasonably uniformly graded. The grass cover on the upstream slope appeared well maintained as shown in Photo 1. As shown in Photo 9, there is some grading irregularity on the south end of the upstream slope where the upstream slope meets the crest. The stone covered downstream slope appeared generally clear of vegetation as shown in Photo 2. However, brush and small trees were observed within the stone at the south and north groins (Photos 2 through 6). Plant personnel indicated that the small trees have been sprayed with herbicide.

The toe drain outlet pipe from the main portion of the Saddle Dam was obscured by vegetation which was cleared back by the plant personnel (Photos 10 and 11) during the site visit. Plant personnel indicated that this drain has a constant flow.

The Saddle Dam was constructed across the original emergency spillway, as shown in Photos 12 and 13, as part of the Phase 3 construction. A seepage drain is located within the old spillway as shown in Photos 7 and 14; plant personnel indicated that this drain has a constant flow. Apparent calcium deposits have formed at the seepage drain within the old emergency spillway as shown in Photo 14. Plant personnel indicated that the filter blanket materials for this seepage drain were derived from crushed limestone which is readily available in the area. A “new” emergency spillway was constructed at the north abutment of the Saddle Dam as shown in Photos 15 and 16. The Emergency Spillway outlet and inlet are shown in Photos 17 and 18, respectively.

2.2.2 Horseford Creek Dam Embankments and Crest

In general, the Horseford Creek Dam does not show signs of changes in horizontal alignment from the proposed alignment. Construction for the final raising of Horseford Creek Dam was completed within a month prior to our site visit. Pictures of this dam are included in Photos 19 through 29 and 37 through 41. The upstream and downstream slopes were reasonably uniformly graded. The downstream slope and buttress are covered with large rip rap as shown in Photos 22 through 26. Sparse grass is growing through the gravel as shown in Photo 26.

The upstream slope is grass covered as shown in Photo 27. Seeding was completed about three weeks prior to the site visit and the grass appeared to be germinating and spreading. Brush and small trees, which the plant personnel reportedly have sprayed with herbicide, have grown at the waterline as seen in Photos 28 and 29. A gravel lined drainage swale has been constructed to convey stormwater from the crest into the pond.

Relief wells, shown in Photo 37, have been installed as part of the Horseford Dam Drainage system. A submerged underdrain pipe was partially blocked by gravel and cobbles (Photo 40). We understand that there may be additional drain pipes in this area. The ground adjacent to the wells is wet from seepage from the blanket drain/relief well system. Water draining from the

east abutment has a milky appearance, as shown in Photo 39, due to calcium deposits in the water from the limestone deposits.

2.2.3 Fly Ash Pond Control Structure and Discharge Channel

Pictures of the overflow structure and discharge channel are included in Photos 30 through 36. The outlet control structure for the Fly Ash Pond is located in the northwest corner of the pond. The outlet control structure is a twin stop log controlled drop inlet, which discharges to a discharge channel which directs the water to the Blaine Creek which is a tributary to the Big Sandy River. The outlet structure is equipped with two sluice gates at the bottom of the tower to control the discharge and pond drawdown, if required. The Phase 1 dam outlet was filled with concrete and abandoned in place as shown in Photo 38.

2.3 Visual Observations – Bottom Ash Complex

CHA performed visual observations of the Bottom Ash Complex. The perimeter dike around the complex is about 2,900 feet long and up to 10 feet high. The crest elevation ranges from about El. 581 on the east end to about El. 565 on the west end. A geotechnical exploration program was in progress during the site visit.

2.3.1 Bottom Ash Complex Embankments and Crest

At the time of CHA's site visit, the SBAP was dry and excavated to the approximate bottom of the pond as shown in Photo 42. Grout was being pumped into the rip rap on the upstream slopes of the SBAP to assist with vegetation and erosion control. AEP representatives indicated that the same treatment will be applied to the NBAP after it is excavated; the NBAP was nearing capacity at the time of our site visit. The downstream slope adjacent to the Bottom Ash Pond, which is graded at about a 1.75H:1V slope, was grass covered and appeared well maintained as

shown in Photo 44. The crest of the south dike slopes down along the SCWP to natural grade at the west end near the RWP as shown in Photo 45.

Sparse grass cover was observed on the downstream and upstream slopes of the south dike adjacent to the SCWP (Photos 46 and 47). Rip rap has been recently placed on the upstream slopes at the west end of the SCWP as shown in Photos 48 through 50.

The western end of the north side of the NCWP is incised as shown in Photo 60. Tall grass was observed on the upstream slope of the north dike adjacent to the NBAP as shown in Photo 65. The standing water shown in the photo is from recent rain.

The crest of the east dike shows evidence of tire tracks (Photo 67) but standing water was not observed. Most of these tracks are from the construction activity that was on-going at the time of the site visit. Erosion rills had developed on the downstream slope of the east dike as shown in Photo 68 and 70. The grade of the slope changes to support the sluice lines as shown in Photo 69.

Standing water was observed in tire ruts on the crest of the splitter dike between the NCWP and SCWP as seen in Photo 56. Erosion has occurred at the water line on the northern toe of the splitter dike between the NCWP and SCWP due to wave action as seen in Photo 58. This mode of erosion is part of the reason for the current work to cover the slopes with grouted rip rap. Several bushes were observed growing on the west slope of the splitter dike between the NBAP and NCWP as shown in Photo 61. The crest of the splitter dike between the SBAP and SCWP is uneven as shown in Photo 63.

2.3.2 Bottom Ash Complex Control and Discharge Structures

Water from the Bottom Ash Ponds enters drop inlet structures (Photos 50, 62, and 64) which discharge into the Clearwater Ponds (Photos 52 and 61). Water from the Bottom Ash Pond

flows to the Clearwater Ponds through 24-inch-diameter CMP pipes buried in the splitter dikes as shown in Photos 52 and 61.

The water from the SCWP and NCWP typically decants into outfall structures (Photos 53, 54, and 59) which flow into the RWP. The decant structures are connected to 30-inch-diameter CMP pipes buried in the splitter dike.

Water from the RWP is pumped back to the plant for reuse or to the Fly Ash Pond when excess water exists from storm run-off. A non-permitted overflow to the Big Sandy River located in the RWP is shown in Photo 57. Plant representatives indicated that the water level in the pond is closely monitored and when the water reaches the yellow line marked on the outside of the structure, pumping is initiated to the Fly Ash Pond

2.4 Monitoring Instrumentation

Active instrumentation at the Horseford Creek Dam includes the following: 19 piezometers located on or near the dam and abutments; two discharge weirs; deformation monitoring points; and two slope inclinometers. Data from these instruments is discussed below. CHA is unaware of instrumentation installed at the Saddle Dam.

We understand that piezometers were being installed around the Bottom Ash Complex as part of the geotechnical exploration program that was being conducted at the time of our site visit. Data from these instruments was not available at the time this report was completed.

2.4.1 Horseford Creek Dam Piezometers

During construction of Phase 2 of the Horseford Creek Dam 18 piezometers and one observation well were installed. Three pneumatic piezometer arrays consisting of three piezometers per array were installed in 1990 along the downstream edge of the El. 590 berm. Based on information

presented in Stantec's 2009 report, we understand that 19 of the 27 piezometers are operational. Figure 8 presents a plot of the piezometer data from December 1988 through June 2009.

Stantec (2009) reported that the piezometer data indicated maximum differential readings during the past year of -2.54 feet at PZ6C and -2.77 at P9305-A in June 2008 which corresponded to the highest piezometric levels recorded in recent years at these locations. Stantec further reported that subsequent measurements indicated piezometric levels within their historic ranges.

2.4.2 Horseford Creek Dam Seepage Measurement Weirs

Stantec (2009) provided seepage rate measurements as measured at the V-notch, 60 degree weir collecting seepage from the dam's collection blanket and chimney drain. A plot of the data is included in Figure 9. The flow rate on December 30, 2008 was approximately 37 gallons per minute (gpm); this rate is on the lower end of the historic range of seepage measurements. Stantec indicated that the increase flow rate in mid-2008 may correspond to an increase in the pond level from El. 660.7 in April 2008 to El. 663.5 in October 2008 and that the flow rate readings subsequently reduced to within the lower range of the historic readings.

2.4.3 Horseford Creek Dam Deformation Monitoring

Horizontal and vertical deformations are monitored by 10 active survey points at the locations shown on Figure 10: six points on the middle slope between the El. 580 and El. 690 berms installed in 1996 (SM-9601 through SM-9606), two points on the lower slope below the El. 580 berm installed in 1978 (SM-4-1 and SM-6-2), and two points near the toe installed in 1978 (SM-6-6 and SM-10). The most recent survey data is from October 21, 2008. We understand that AEP reviews the deformation data approximately every six months.

Table 2 provides vertical survey information for the past five years. The settlement of the two points on the lower slope installed in 1978 were about 3.5 and 1.4 inches. The two points at the

toe of the slope indicated 0.9 to 1.1 inches of heave. A brief review of the data indicated up to ½ inch of scatter in the data. The vertical movement at the six middle slope points installed in 1996 indicate settlement between 0.960 to 4.152 inches. AEP (2008) indicated that the observed settlements correlate to about 3% strain of the soil layers above rock and therefore are within the expected values for a dam the height of the Horseford Creek Dam.

Figures 11A through 11F show plots of the horizontal deformation data from the active survey points.

2.4.4 Horseford Creek Dam Slope Inclinerometers

Inclinometer casings were installed in 1991 and 1992 to monitor movements of the slope during placement of the bottom ash fill during Phase 3 construction. Data has been reported between 11/6/1996 through 10/20/2008; CHA has not been provided with more recent data.

Inclinometer SI-1 is located in the crest of the berm at El. 590; a cumulative deformation plot is included in Figure 12A. The maximum movement in the downstream direction is approximately 1.07 inches. Inclinometer SI-2 is located on the downstream slope at approximately El. 665; a cumulative deformation plot is included in Figure 12B. The top of this instrument was struck by a bulldozer during a previous construction period resulting in the large displacements between El. 631 and 611 within the embankment fill indicated on the plot on Figure 12B. Accounting for this damage, AEP (2008) reported that the maximum movement in the downstream direction is approximately 1.04 inches.

Table 2 - Summary of Vertical Movement at Horseford Creek Pond

| Location: | Lower Slope | | Downstream Toe | |
|---|--------------------|---------------|-----------------------|--------------|
| Point: | SM 4-1 | SM 6-2 | SM 6-6 | SM 10 |
| <i>First Initial Reading:</i> | | | | |
| 10/25/1978 | 589.945 | 589.185 | 543.812 | 547.1 |
| 1/7/2004 | 589.664 | 589.070 | 543.904 | 547.211 |
| 5/25/2004 | 589.666 | 589.074 | 543.904 | 547.207 |
| 10/26/2004 | 589.670 | 589.078 | 543.907 | 547.208 |
| 4/5/2005 | 589.658 | 589.066 | 543.906 | 547.215 |
| 10/11/2005 | 589.662 | 589.072 | 543.889 | 547.183 |
| 4/4/2006 | 589.656 | 589.068 | 543.900 | 547.204 |
| 10/17/2006 | 589.660 | 589.071 | 543.912 | 547.202 |
| 4/10/2007 | 589.651 | 589.064 | 543.902 | 547.211 |
| 10/23/2007 | 589.658 | 589.073 | 543.894 | 547.174 |
| 4/8/2008 | 589.651 | 589.058 | 543.911 | 547.209 |
| 10/21/2008 | 589.656 | 589.072 | 543.888 | 547.191 |
| Change since Jan 7 2004 (inches): | | | | |
| | 3.372 | 1.380 | -1.104 | -1.332 |
| Change from First Initial Reading (inches): | | | | |
| | 3.468 | 1.356 | -0.912 | -1.092 |

| Location: | middle slope between the El. 580 and El. 690 berms | | | | | |
|-------------------------------|---|-------------|-------------|-------------|-------------|-------------|
| Point: | 9601 | 9602 | 9603 | 9604 | 9605 | 9606 |
| <i>First Initial Reading:</i> | | | | | | |
| 6/24/1996 | 625.062 | 628.762 | 623.155 | 649.058 | 648.488 | 648.558 |
| 1/7/2004 | 624.878 | 628.499 | 623.039 | 648.868 | 648.153 | 648.405 |
| 5/25/2004 | 624.934 | 628.433 | 623.042 | 648.878 | 648.083 | 648.373 |
| 10/26/2004 | 624.928 | 628.458 | 623.030 | 648.862 | 684.111 | 648.396 |
| 4/5/2005 | 624.900 | 628.458 | 623.031 | 648.846 | 648.120 | 648.394 |
| 10/11/2005 | 624.862 | 628.476 | 623.037 | 648.865 | 648.104 | 648.411 |
| 4/4/2006 | 624.888 | 628.465 | 623.050 | 648.873 | 648.126 | 648.417 |
| 10/17/2006 | 624.861 | 628.696 | 623.050 | 648.832 | 648.129 | 648.409 |
| 4/10/2007 | 624.891 | 628.448 | 623.020 | 648.870 | 648.130 | 648.417 |
| 10/23/2007 | 624.906 | 628.463 | 623.040 | 648.903 | 648.198 | 648.487 |
| 4/8/2008 | 624.892 | 628.457 | 623.095 | 648.865 | 648.117 | 648.424 |
| 10/21/2008 | 624.923 | 628.466 | 623.075 | 648.881 | 648.142 | 648.448 |
| Change since Jan 7 2004: | | | | | | |
| | 2.208 | 3.156 | 1.392 | 2.280 | 4.020 | 1.836 |
| Change from FIR (inches): | | | | | | |
| | 1.668 | 3.552 | 0.960 | 2.124 | 4.152 | 1.320 |



PHOTO LOCATION PLAN - FLY ASH POND

BIG SANDY POWER PLANT
 LOUISA, KENTUCKY

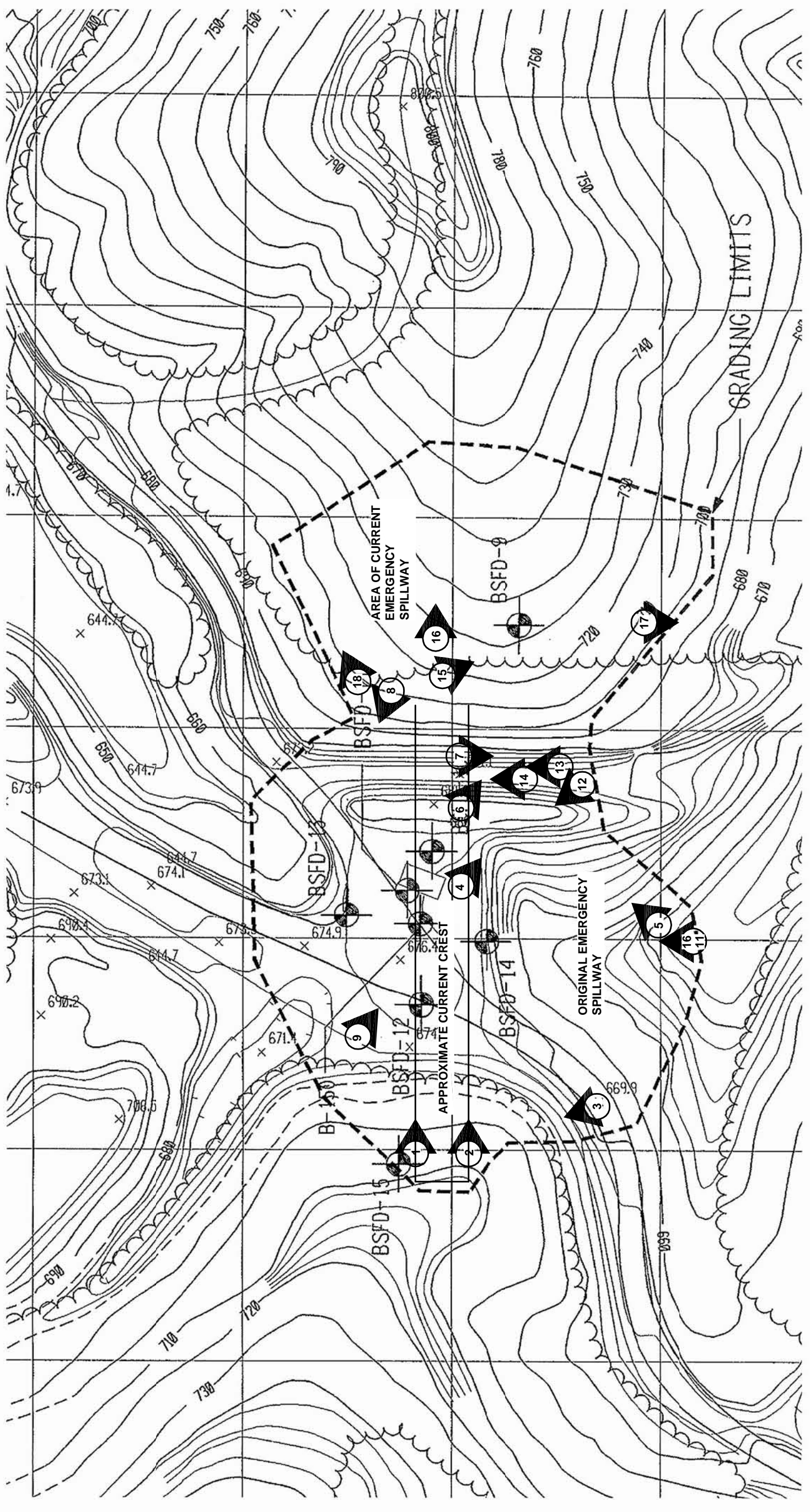

IMAGE REFERENCE: AMERICAN ELECTRIC POWER CORP., SADDLEDAM AND EMERGENCY SPILLWAY BORING LOCATION PLAN, DWG. 12-30032-0, 5/18/1998.

| | |
|-------------|------------|
| PROJECT NO. | 20085.7000 |
| DATE: | 12/20/09 |
| FIGURE | 16 |

PHOTO LOCATION PLAN -
 HORSEFORD CREEK DAM
 BIG SANDY POWER PLANT
 LOUISA, KENTUCKY

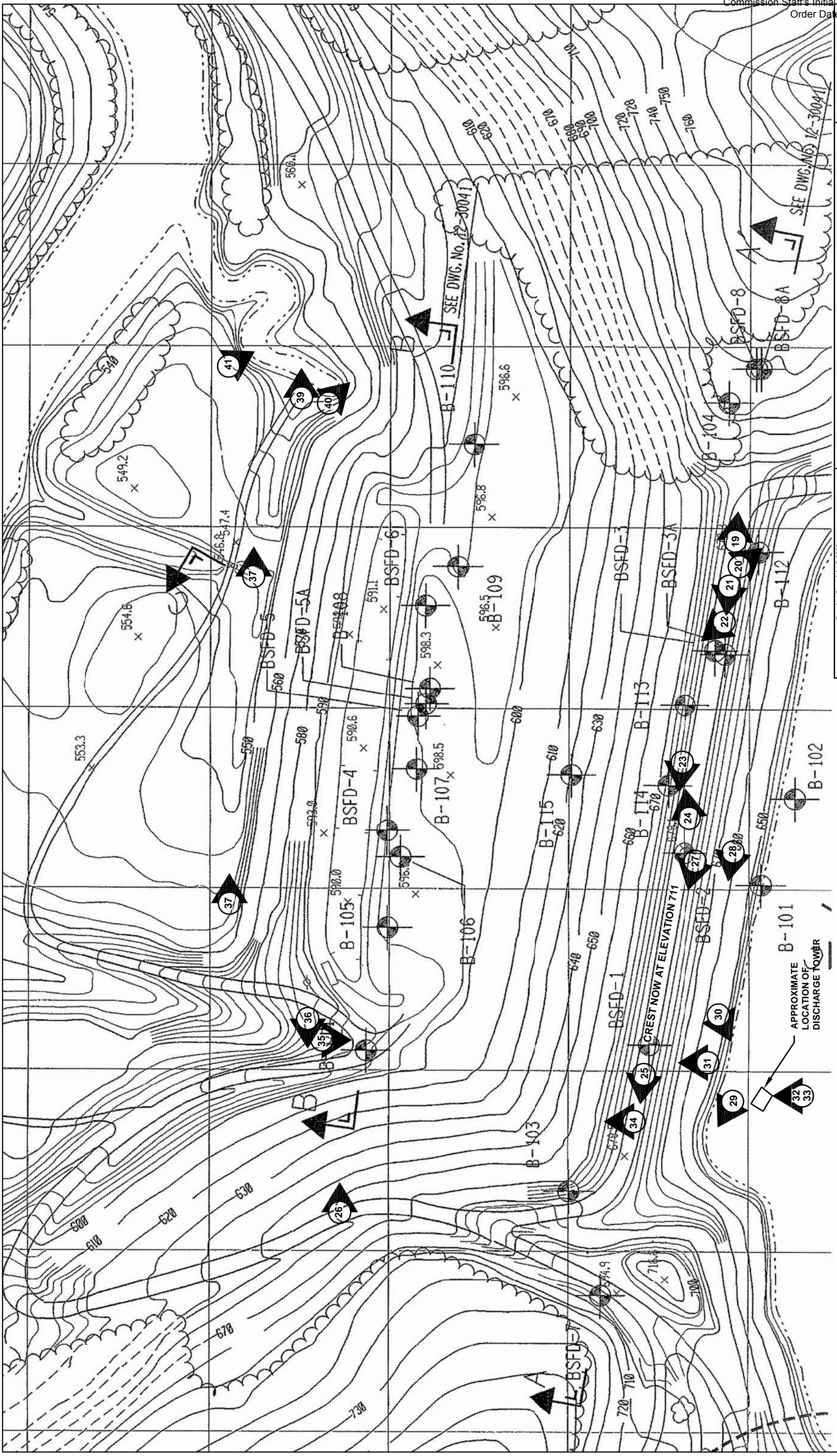
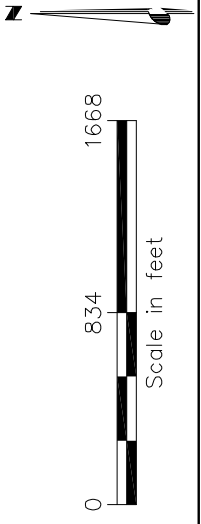

IMAGE REFERENCE: AMERICAN ELECTRIC POWER CORP., MAIN FLY ASH
 DAM BORING LOCATION PLAN, DWG. 12-30031-0, 5/18/1998.

PHOTO LOCATION PLAN -
 BOTTOM ASH COMPLEX
 BIG SANDY POWER PLANT
 LOUISA, KENTUCKY

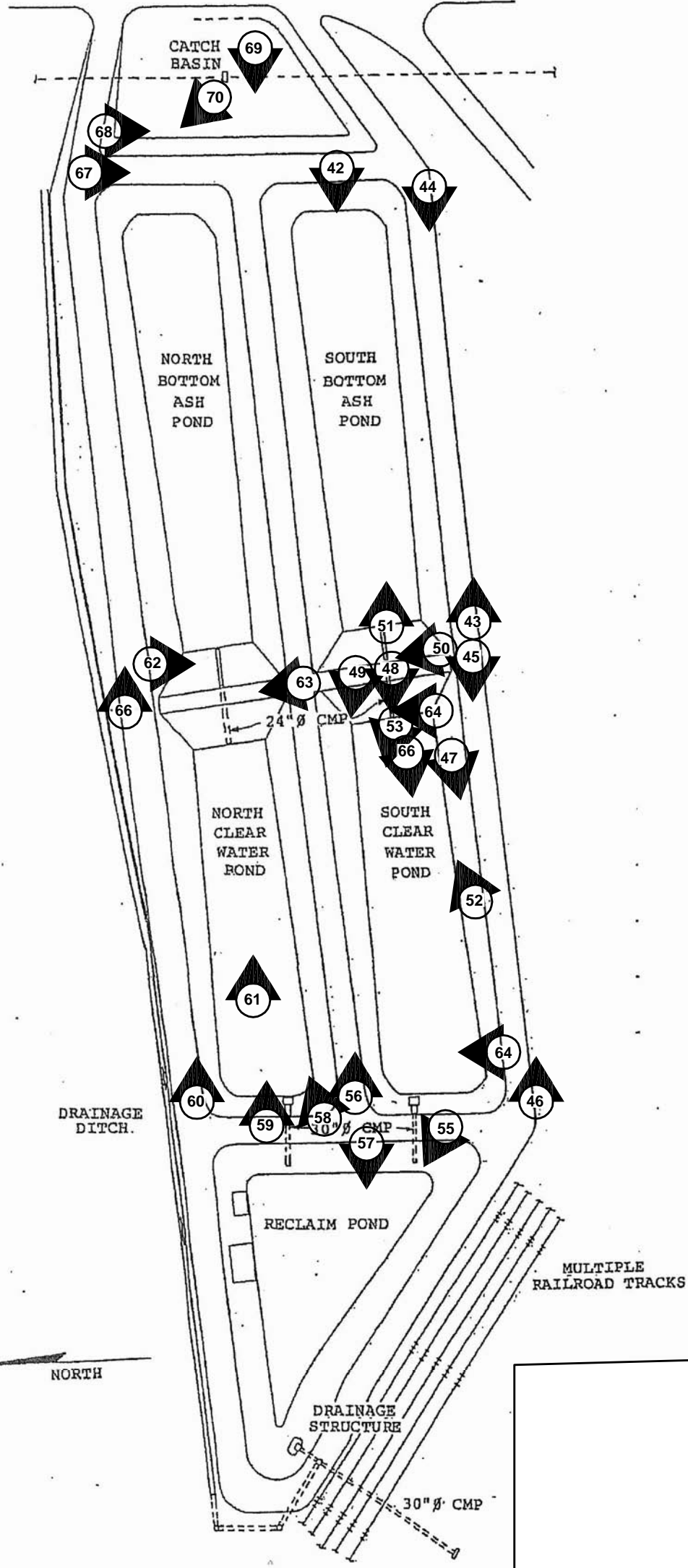
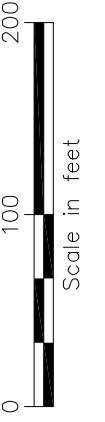

IMAGE REFERENCE: AMERICAN ELECTRIC POWER CORP., BIG SANDY
 PLANT BOTTOM ASH COMPLEX INSPECTION LOCATION PLAN.

1



Crest and upstream slope of Saddle Dam, looking north.

2



Downstream slope of Saddle Dam, looking north.



**AMERICAN ELECTRIC POWER
BIG SANDY GENERATING STATION
LOUISA, KY
SADDLE DAM AND E. SPILLWAY**

CHA Project No.: 20085.7000.1510

October 29, 2009

3



South groin of downstream slope and abutment at Saddle Dam.

4



North downstream groin of Saddle Dam looking northeast. Bedrock in upper left is part of original emergency spillway channel which is now plugged.
Note small trees in groin have been sprayed with herbicide.



**AMERICAN ELECTRIC POWER
BIG SANDY GENERATING STATION
LOUISA, KY
SADDLE DAM AND E. SPILLWAY**

CHA Project No.: 20085.7000.1510

October 29, 2009

5



Close-up of trees in north downstream groin.

6



Downstream slope in original emergency spillway, looking north.



**AMERICAN ELECTRIC POWER
BIG SANDY GENERATING STATION
LOUISA, KY
SADDLE DAM AND E. SPILLWAY**

CHA Project No.: 20085.7000.1510

October 29, 2009

7



Original emergency spillway.
Seepage drain at approximate midpoint of channel.

8



Upstream slope of Saddle Dam, looking south.



**AMERICAN ELECTRIC POWER
BIG SANDY GENERATING STATION
LOUISA, KY
SADDLE DAM AND E. SPILLWAY**

CHA Project No.: 20085.7000.1510

October 29, 2009

9



Irregularity to grading at upstream slope/crest intersection on Saddle Dam.

10



Toe drain outlet from under main portion of Saddle Dam.
Note the pipe is covered with vegetation.



**AMERICAN ELECTRIC POWER
BIG SANDY GENERATING STATION
LOUISA, KY
SADDLE DAM AND E. SPILLWAY**

CHA Project No.: 20085.7000.1510

October 29, 2009

11



Toe drain outlet after clearing vegetation.

12



Downstream slope of Saddle Dam filling original emergency spillway.



**AMERICAN ELECTRIC POWER
BIG SANDY GENERATING STATION
LOUISA, KY
SADDLE DAM AND E. SPILLWAY**

CHA Project No.: 20085.7000.1510

October 29, 2009

13



Downstream slope of Saddle Dam filling original emergency spillway.

14



Seepage drain from original emergency spillway plug.
Note calcium deposits from granular fill used in filter blanket.



**AMERICAN ELECTRIC POWER
BIG SANDY GENERATING STATION
LOUISA, KY
SADDLE DAM AND E. SPILLWAY**

CHA Project No.: 20085.7000.1510

October 29, 2009

15



“New” emergency spillway at north abutment of Saddle Dam.

16



North abutment contact of “new” emergency spillway.



**AMERICAN ELECTRIC POWER
BIG SANDY GENERATING STATION
LOUISA, KY
SADDLE DAM AND E. SPILLWAY**

CHA Project No.: 20085.7000.1510

October 29, 2009

17



Downstream condition of "new" emergency spillway.

18



Entrance of "new" emergency spillway.



**AMERICAN ELECTRIC POWER
BIG SANDY GENERATING STATION
LOUISA, KY
SADDLE DAM AND E. SPILLWAY**

CHA Project No.: 20085.7000.1510

October 29, 2009

19



East abutment and crest of Horseford Creek Dam, looking east.

20



Access road up east abutment/Horseford Creek Dam contact, looking east.



**AMERICAN ELECTRIC POWER
BIG SANDY GENERATING STATION
LOUISA, KY
HORSEFORD CREEK DAM**

CHA Project No.: 20085.7000.1510

October 29, 2009

21



Crest of Horseford Creek Dam, looking east.

22



Downstream slope and buttress of Horseford Creek Dam looking north.
Channel in field is original discharge channel which is now abandoned.



**AMERICAN ELECTRIC POWER
BIG SANDY GENERATING STATION
LOUISA, KY
HORSEFORD CREEK DAM**

CHA Project No.: 20085.7000.1510

Site Visit on December 11, 2009

23



Downstream slope Horseford Creek Dam, looking west.

24



East abutment of Horseford Creek Dam, looking northeast.



**AMERICAN ELECTRIC POWER
BIG SANDY GENERATING STATION
LOUISA, KY
HORSEFORD CREEK DAM**

CHA Project No.: 20085.7000.1510

October 29, 2009

25



West abutment of Horseford Creek Dam, looking west.

26



Downstream slope and buttress of Horseford Creek Dam, looking east.



**AMERICAN ELECTRIC POWER
BIG SANDY GENERATING STATION
LOUISA, KY
HORSEFORD CREEK DAM**

CHA Project No.: 20085.7000.1510

October 29, 2009

27



Upstream slope of Horseford Creek Dam, looking east.

28



Brush and small trees in rip rap along the water line have been sprayed with herbicide at Horseford Dam.



**AMERICAN ELECTRIC POWER
BIG SANDY GENERATING STATION
LOUISA, KY
HORSEFORD CREEK DAM**

CHA Project No.: 20085.7000.1510

October 29, 2009

29



Upstream west abutment groin and large rip rap at Horseford Creek Dam.

30



Outlet structure near west end of Horseford Creek Dam.



**AMERICAN ELECTRIC POWER
BIG SANDY GENERATING STATION
LOUISA, KY
HORSEFORD CREEK DAM & SPILLWAY**

CHA Project No.: 20085.7000.1510

October 29, 2009

31



Access ramp to Horseford Creek Dam outlet structure.

32



Twin stop log opening at Horseford Creek Dam outlet structure.



CHA Project No.: 20085.7000.1510

**AMERICAN ELECTRIC POWER
BIG SANDY GENERATING STATION
LOUISA, KY
FLY ASH POND CONTROL STRUCTURE
AND DISCHARGE CHANNEL**

October 29, 2009

33



Close-up on one stop log opening at Horseford Creek Dam outlet structure.

34



Discharge channel for Horseford Creek Dam.



CHA Project No.: 20085.7000.1510

**AMERICAN ELECTRIC POWER
BIG SANDY GENERATING STATION
LOUISA, KY
FLY ASH POND CONTROL STRUCTURE
AND DISCHARGE CHANNEL**

October 29, 2009

35



Discharge pipe at toe of Horseford Creek Dam.
Stairs on slope provide access to instrumentation.

36



Stilling basin and NPDES outfall for Horseford Creek Dam outlet.



**AMERICAN ELECTRIC POWER
BIG SANDY GENERATING STATION
LOUISA, KY
FLY ASH POND CONTROL STRUCTURE
AND DISCHARGE CHANNEL**

CHA Project No.: 20085.7000.1510

October 29, 2009

37



Relief wells part of Horseford Creek Dam toe drain system.
Area in taller grass is wet from seepage.

38

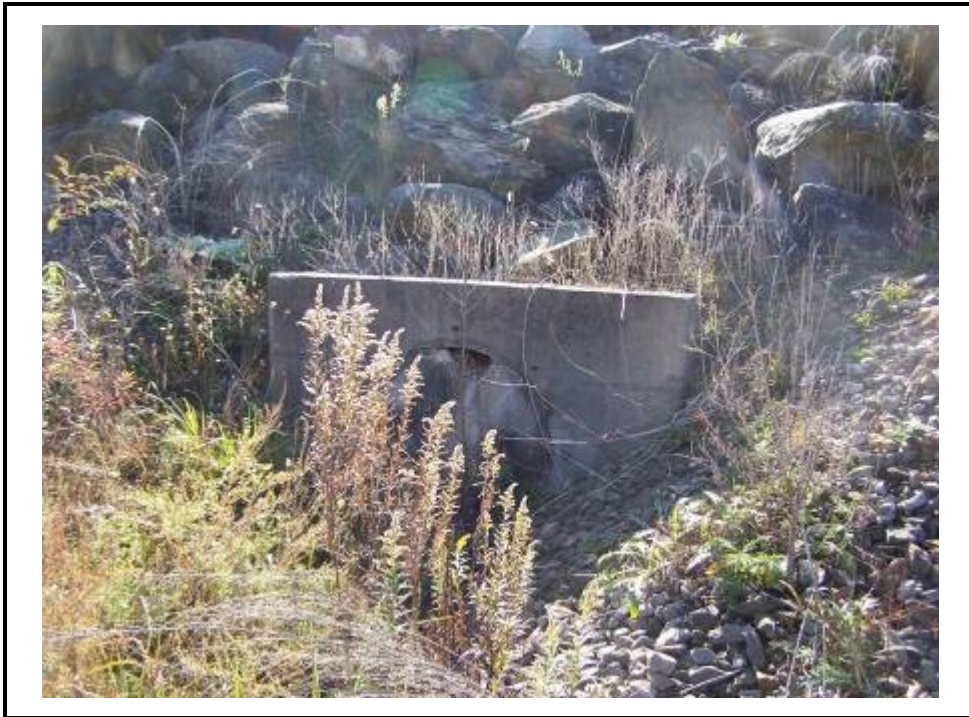

Phase I outlet pipe was abandoned in place.



**AMERICAN ELECTRIC POWER
BIG SANDY GENERATING STATION
LOUISA, KY
HORSEFORD CREEK DAM**

CHA Project No.: 20085.7000.1510

October 29, 2009

39



Drain pipe from east abutment area of Horseford Creek Dam.
Note calcium deposits in water from limestone formations.

40



Toe drain discharge pipe is buried in sand and rock but flowing.



**AMERICAN ELECTRIC POWER
BIG SANDY GENERATING STATION
LOUISA, KY
HORSEFORD CREEK DAM**

CHA Project No.: 20085.7000.1510

October 29, 2009

41



Monitoring weir at east abutment and toe drain discharge area.

42



South Bottom Ash Pond looking west. AEP ws installing grouted rip rap on the inside slopes to reduce vegetation and erosion type maintenance.



**AMERICAN ELECTRIC POWER
BIG SANDY GENERATING STATION
LOUISA, KY
HORSEFORD CREEK DAM &
BOTTOM ASH COMPLEX**

CHA Project No.: 20085.7000.1510

October 29, 2009

43

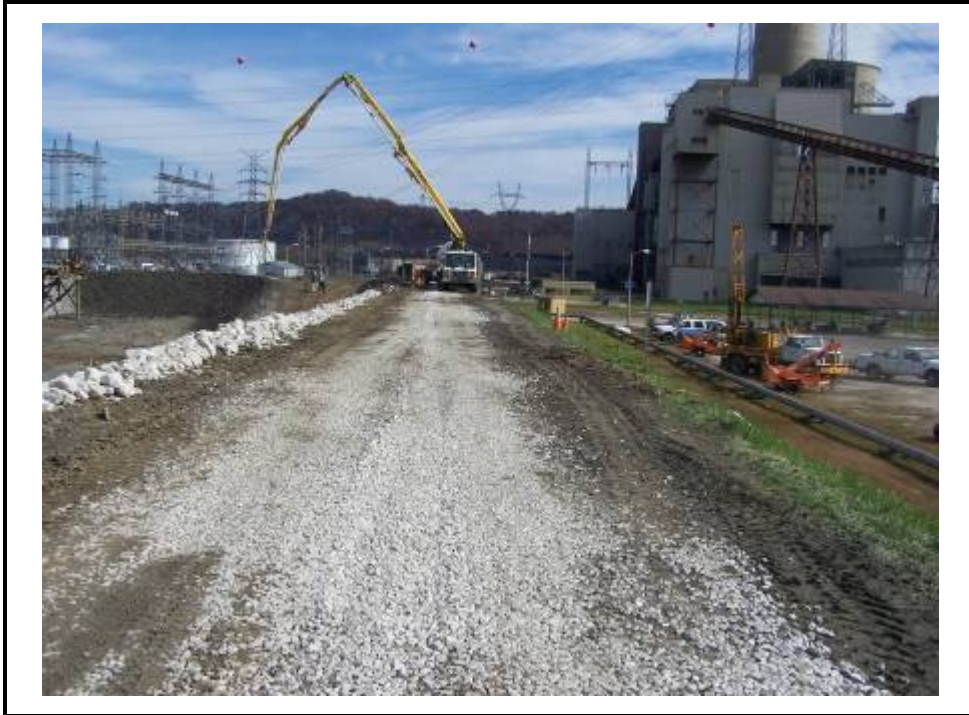

Crest of the South Dike at the Bottom Ash Complex, looking east.

44



Downstream slope of South Dike at the Bottom Ash Complex along the south Bottom Ash Pond.



**AMERICAN ELECTRIC POWER
BIG SANDY GENERATING STATION
LOUISA, KY
BOTTOM ASH COMPLEX**

CHA Project No.: 20085.7000.1510

October 29, 2009

45



Crest of the South Dike at the Bottom Ash Complex looking west. Note dike crest slopes to about original grade adjacent to the south clear water pond. Liner on downstream slope is part of chemical spill containment berms.

46



Downstream slope of South Dike at Bottom Ash Complex adjacent to south clear water pond, looking east.



**AMERICAN ELECTRIC POWER
BIG SANDY GENERATING STATION
LOUISA, KY
BOTTOM ASH COMPLEX**

CHA Project No.: 20085.7000.1510

October 29, 2009

47



Upstream slope of South Dike of Bottom Ash Complex at south Clearwater Pond, looking west.

48



Upstream slope of South Dike of Bottom Ash Complex at south Clearwater Pond, recently placed rip rap protection at east end.



**AMERICAN ELECTRIC POWER
BIG SANDY GENERATING STATION
LOUISA, KY
BOTTOM ASH COMPLEX**

CHA Project No.: 20085.7000.1510

October 29, 2009

49



South side of Splitter Dike between south and north Clearwater Ponds.

50



Decant structure (platform near top of slope) and pond drain (pipe near bottom of slope) from south Bottom Ash Pond into south Clearwater Pond.



**AMERICAN ELECTRIC POWER
BIG SANDY GENERATING STATION
LOUISA, KY
BOTTOM ASH COMPLEX**

CHA Project No.: 20085.7000.1510

October 29, 2009

51



Close-up of south Bottom Ash Pond decant structure.

52



Discharge from South Bottom Ash Pond into South Clearwater Pond.



**AMERICAN ELECTRIC POWER
BIG SANDY GENERATING STATION
LOUISA, KY
BOTTOM ASH COMPLEX**

CHA Project No.: 20085.7000.1510

October 29, 2009

53



Decant structure from south Clearwater Pond to the Reclaim Pond.

54



Splitter Dike between south Clearwater Pond (right side of photo)
and the Reclaim Pond (upper left of photo).



**AMERICAN ELECTRIC POWER
BIG SANDY GENERATING STATION
LOUISA, KY
BOTTOM ASH COMPLEX**

CHA Project No.: 20085.7000.1510

October 29, 2009

55



Reclaim Pond (incised) looking west. Building is the pump station which diverts flows back to the plant or to Horseford Reservoir. At west end of pond is a non-permitted overflow to the Big Sandy River.

56



Crest of Splitter Dike between north and south Clearwater Ponds, looking east.



**AMERICAN ELECTRIC POWER
BIG SANDY GENERATING STATION
LOUISA, KY
BOTTOM ASH COMPLEX**

CHA Project No.: 20085.7000.1510

October 29, 2009

57



Close-up of non-permitted overflow to the Big Sandy River. Plant Personnel indicated that when water level reaches yellow line on the structure, pumping is initiated to Horseford Reservoir to prevent discharge to the river.

58



North side of Splitter Dike between north and south Clearwater Ponds, looking east.



**AMERICAN ELECTRIC POWER
BIG SANDY GENERATING STATION
LOUISA, KY
BOTTOM ASH COMPLEX**

CHA Project No.: 20085.7000.1510

October 29, 2009

59



Discharge structure from north Clearwater Pond to Reclaim Pond
and upstream slope of North Dike of Bottom Ash Complex.
Note crest of North Dike slopes down to the west.

60



Crest of North Dike of Bottom Ash Complex along
north Clearwater Pond where Bottom Ash Complex is incised.



**AMERICAN ELECTRIC POWER
BIG SANDY GENERATING STATION
LOUISA, KY
BOTTOM ASH COMPLEX**

CHA Project No.: 20085.7000.1510

October 29, 2009

61



West slope of Splitter Dike between North Bottom Ash and Clearwater Ponds showing discharge pipe from North Bottom Ash Pond.

62



East slope of Splitter Dike between north Bottom Ash and Clearwater Ponds and decant structure.



**AMERICAN ELECTRIC POWER
BIG SANDY GENERATING STATION
LOUISA, KY
BOTTOM ASH COMPLEX**

CHA Project No.: 20085.7000.1510

October 29, 2009

63



Crest of Splitter Dike between south Bottom Ash and south Clearwater Ponds.

64



Close-up of decant structure in north Bottom Ash Pond.



**AMERICAN ELECTRIC POWER
BIG SANDY GENERATING STATION
LOUISA, KY
BOTTOM ASH COMPLEX**

CHA Project No.: 20085.7000.1510

October 29, 2009

65



Upstream slope of North Dike at the Bottom Ash Complex adjacent to north Bottom Ash Pond, looking east.

66



Downstream slope of North Dike and Bottom Ash Complex adjacent to north Bottom Ash Pond, looking east.
Note that the north side of the Bottom Ash Complex is largely incised.



**AMERICAN ELECTRIC POWER
BIG SANDY GENERATING STATION
LOUISA, KY
BOTTOM ASH COMPLEX**

CHA Project No.: 20085.7000.1510

October 29, 2009

67



Crest of East Dike of the Bottom Ash Pond, looking south.

68



Downstream slope of East Dike of the Bottom Ash Pond, looking south.



**AMERICAN ELECTRIC POWER
BIG SANDY GENERATING STATION
LOUISA, KY
BOTTOM ASH COMPLEX**

CHA Project No.: 20085.7000.1510

October 29, 2009

69



Sluice lines on downstream slope of East Dike.

70



Minor sloughing or erosion on downstream slope of East Dike.



**AMERICAN ELECTRIC POWER
BIG SANDY GENERATING STATION
LOUISA, KY
BOTTOM ASH COMPLEX**

CHA Project No.: 20085.7000.1510

October 29, 2009

Big Sandy Piezometric Pressure Head

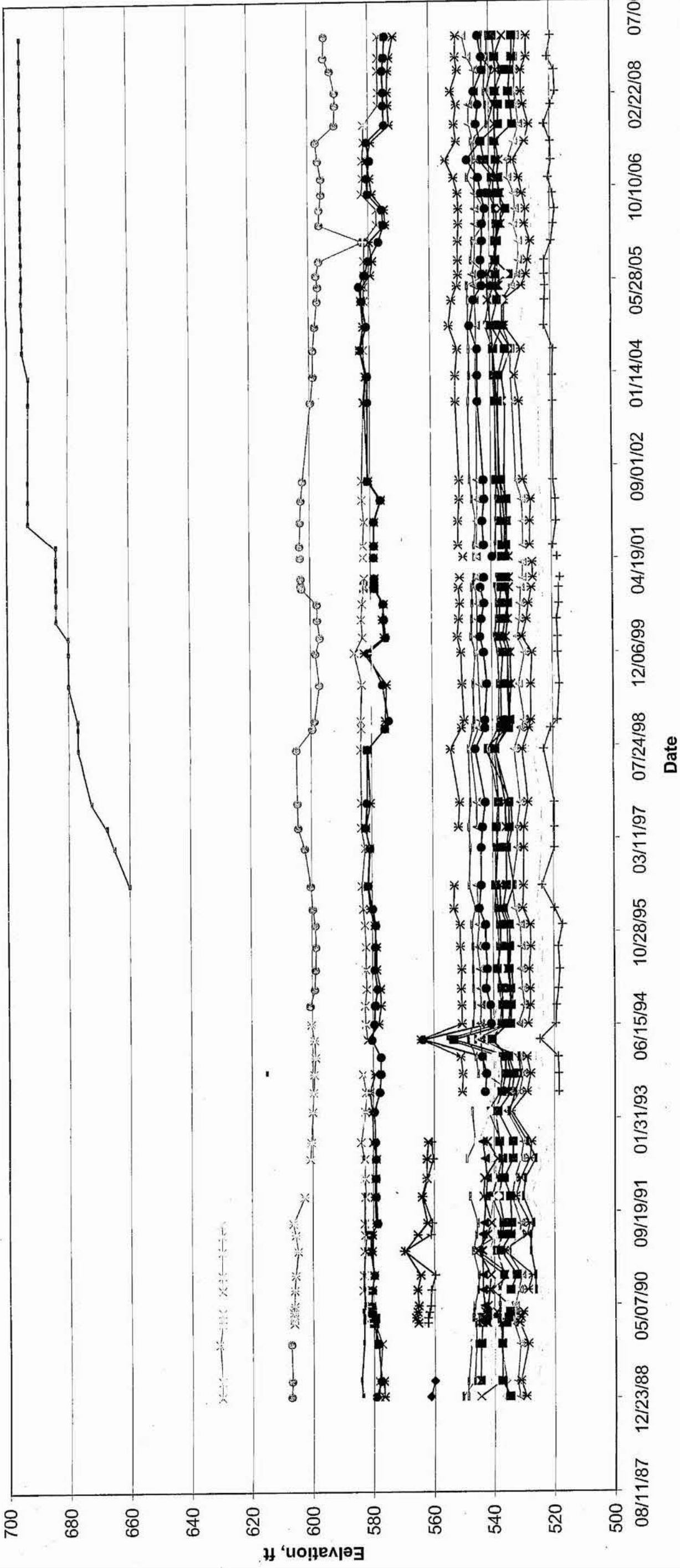

| Piezometer | Symbol | Piezometer | Symbol | Piezometer | Symbol | Piezometer | Symbol | Piezometer | Symbol | Piezometer | Symbol |
|------------|--------|------------|--------|------------|--------|------------|--------|------------|--------|------------|--------|
| P-2.1 | ◆ | P-2.4R | ▲ | P-6 | * | P-7 | ● | P-8 | ● | P-12 | + |
| P-128 | ○ | P-129 | ○ | P-130 | ○ | P-131 | ○ | P-132 | ○ | PR-16 | * |
| PZ-4B | * | PZ-4C | * | PZ-5A | + | PZ-5B | + | PZ-5C | + | PZ-6A | + |
| | | | | | | | | | | PZ-6B | ■ |
| | | | | | | | | | | PZ-6C | ■ |
| | | | | | | | | | | P-13 | ○ |
| | | | | | | | | | | P-117A | ○ |
| | | | | | | | | | | P-119 | ○ |
| | | | | | | | | | | P-124 | ○ |
| | | | | | | | | | | P-125 | ○ |
| | | | | | | | | | | P-126 | ○ |
| | | | | | | | | | | P-127 | ○ |
| | | | | | | | | | | P-127R | ○ |
| | | | | | | | | | | PZ-4A | ▲ |
| | | | | | | | | | | PE | ■ |
| | | | | | | | | | | PD | ● |
| | | | | | | | | | | PC | ○ |
| | | | | | | | | | | 9304-C | ○ |
| | | | | | | | | | | 9305-A | + |
| | | | | | | | | | | 9305-B | + |
| | | | | | | | | | | Fill | — |

08/11/87 12/23/88 05/07/90 09/19/91 01/31/93 06/15/94 10/28/95 03/11/97 07/24/98 12/06/99 04/19/01 09/01/02 01/14/04 05/28/05 10/10/06 02/22/08 07/06/09

Date

Fly Ash Pond Main Dam
Downstream Toe Seepage

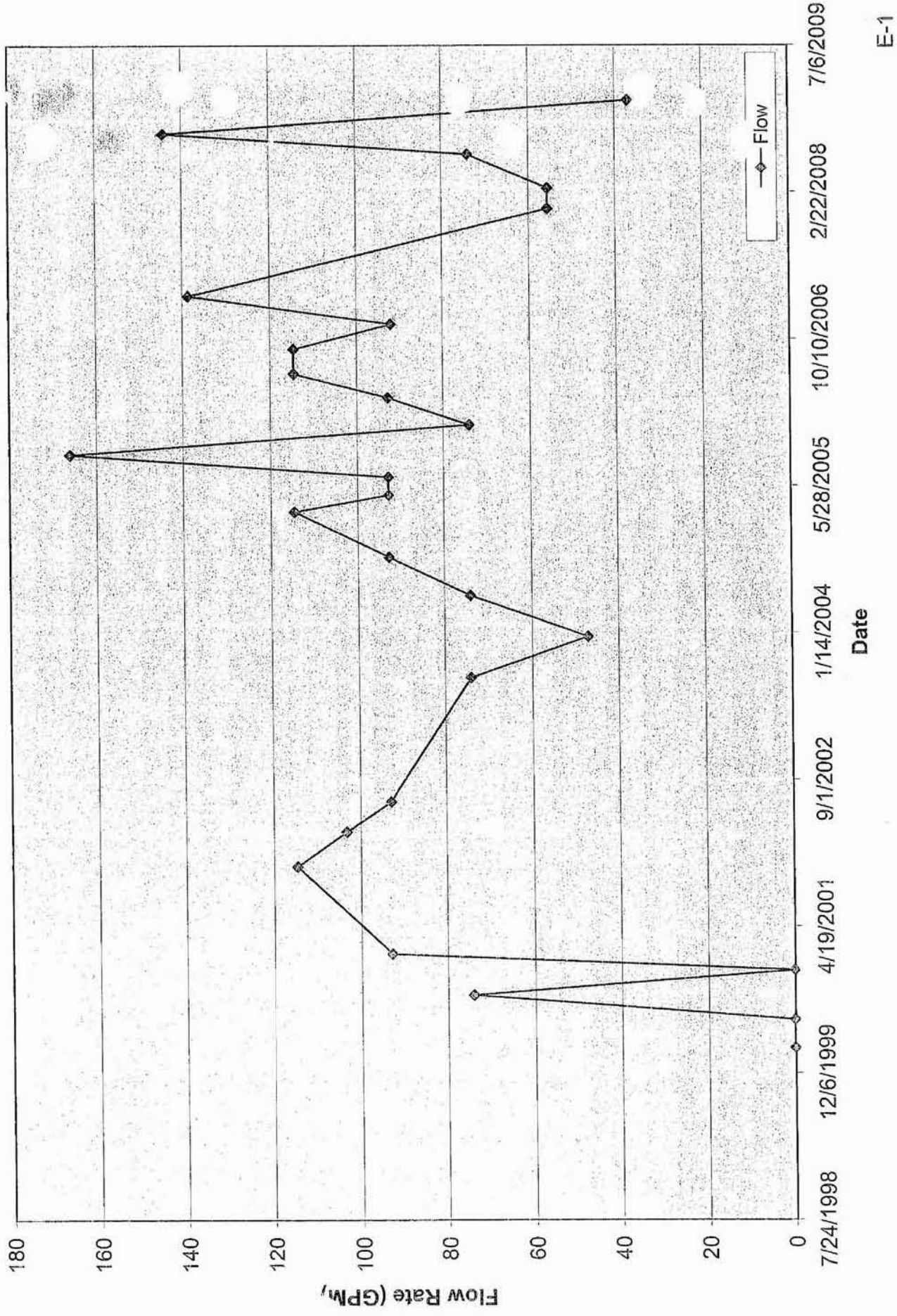

AEPBSP-001174

IMAGE REFERENCE: AMERICAN ELECTRIC POWER CORP., 2008 INSPECTION REPORT MAIN FLY ASH DAM, SADDLE DAM, BOTTOM ASH COMPLEX, DECEMBER 2008, PAGE 113.



HORSEFORD CREEK DAM SEEPAGE
MEASUREMENTS
BIG SANDY POWER PLANT
LOUISA, KENTUCKY

PROJECT NO.
20085.7000
DATE: 12/20/08
FIGURE
06
of
125

HORSEFORD CREEK DEFORMATION
 MONITORING POINT PLAN
 BIG SANDY POWER PLANT
 LOUISA, KENTUCKY

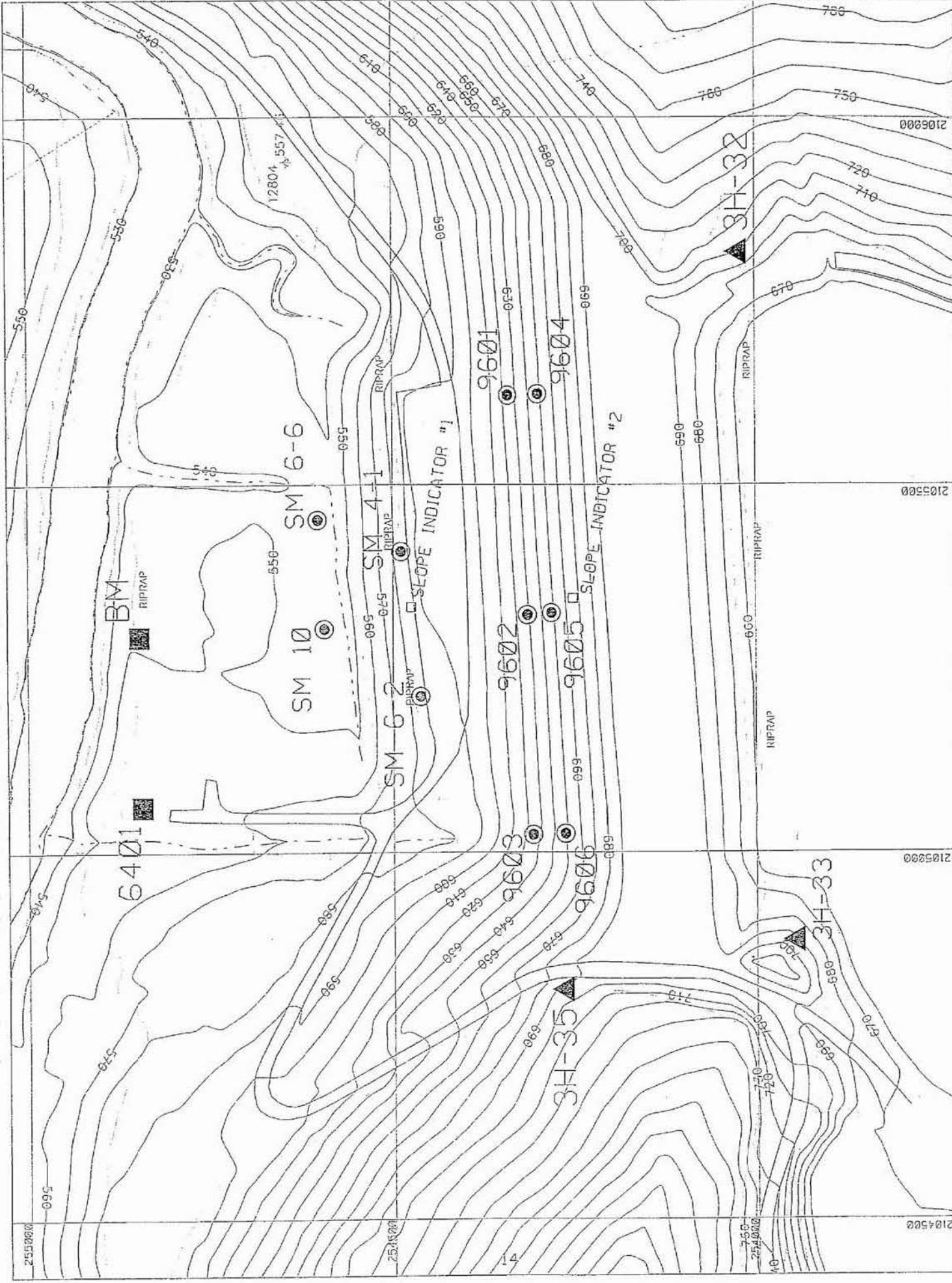

...1\DATA\BIGSANDY\IDGN\bsfad02.dgn 1/4/2008 9:45:35 AM

AEPBSP-001011

IMAGE REFERENCE: STANTEC REPORT OF DIKE AND DAM VISUAL EVALUATION, MAY 7, 2009, PAGE 81.

File: K:\20085\CADD\ACAD\FIGURES\7000 BIG SANDY\FIGURES\7000 BIG SANDY FIGURES.DWG Saved: 12/21/2009 4:14:05 PM Plotted: 12/21/2009 4:15:52 PM User: Gray, Timmolyn

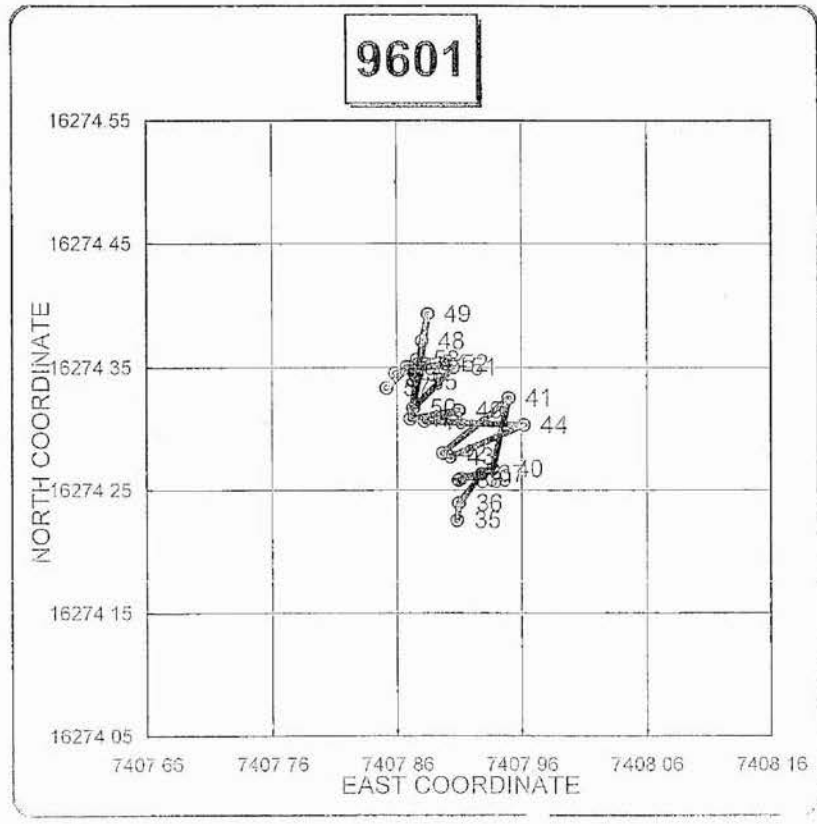

22

AEPBSP-001134

IMAGE REFERENCE: AMERICAN ELECTRIC POWER CORP., 2008 INSPECTION REPORT MAIN FLY ASH DAM, SADDLE DAM, BOTTOM ASH COMPLEX, DECEMBER 2008, PAGE 73.

| | | |
|---|--|---------------------------|
| <p>Drawing Copyright © 2008</p>  <p>111 Winners Circle, PO Box 5269 • Albany, NY 12205-0269 Main: (518) 453-4500 • www.checompanies.com</p> | <p>HORIZONTAL DEFORMATION – POINT 9601 BIG SANDY POWER PLANT LOUISA, KENTUCKY</p> | PROJECT NO. 20085.7000 |
| | | DATE: 12/2009 |
| | | FIGURE 11A |

AMERICAN ELECTRIC POWER BIG SANDY FLY ASH DAM

File: K:\20085\CADD\ACAD\FIGURES\7000 BIG SANDY\FIGURES.DWG Saved: 12/21/2009 4:14:05 PM Plotted: 12/21/2009 4:16:11 PM User: Gray, Timmolyn

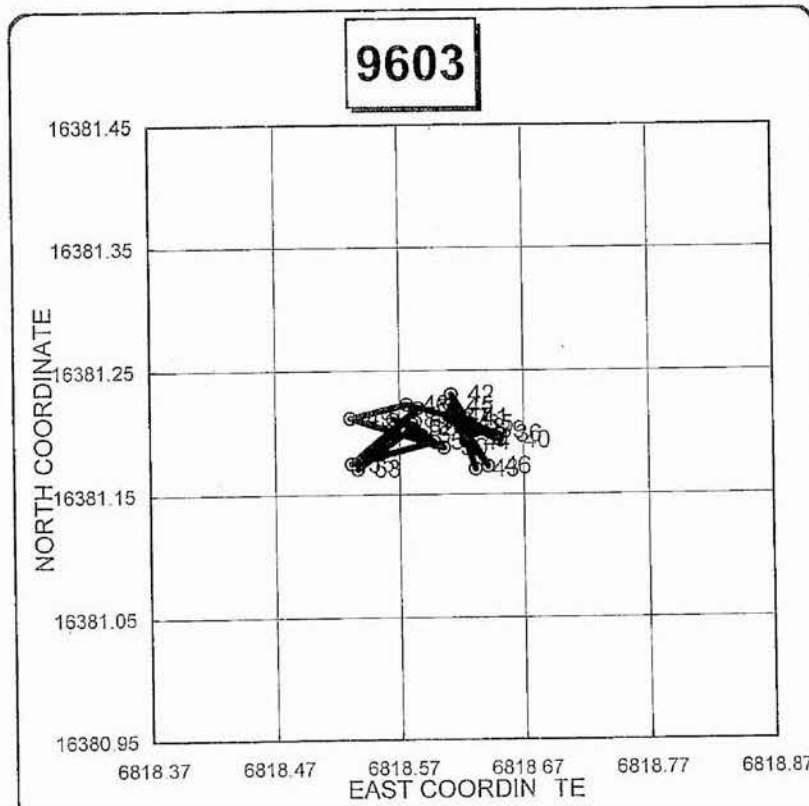
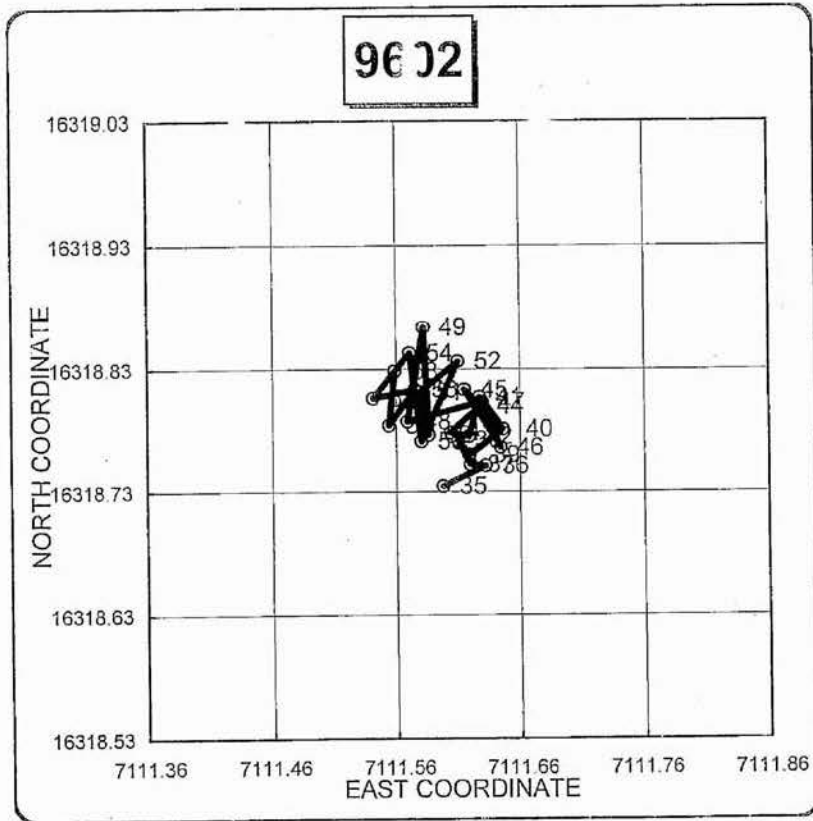

IMAGE REFERENCE: AMERICAN ELECTRIC POWER CORP., 2008 INSPECTION REPORT MAIN FLY ASH DAM, SADDLE DAM, BOTTOM ASH COMPLEX, DECEMBER 2008, PAGE 74.

Drawing Copyright © 2008



111 Winners Circle, PO Box 5269 • Albany, NY 12205-0269
Main: (518) 453-4500 • www.checompanies.com

HORIZONTAL DEFORMATION —
POINTS 9602 AND 9603
BIG SANDY POWER PLANT
LOUISA, KENTUCKY

PROJECT NO.
20085.7000

DATE: 12/2009

FIGURE 11B

BIG SANDY FLY ASH DAM

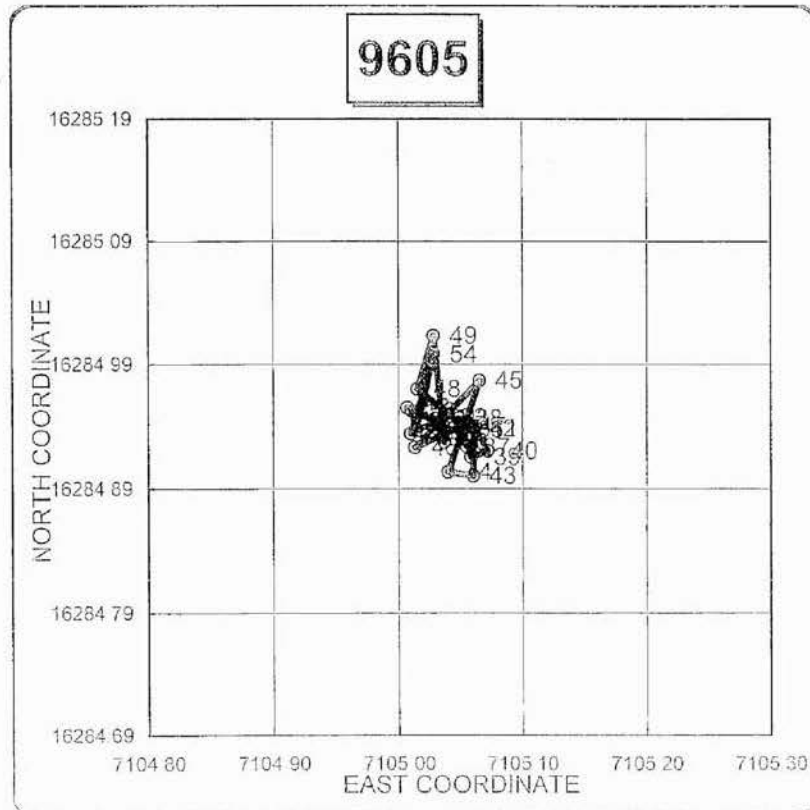
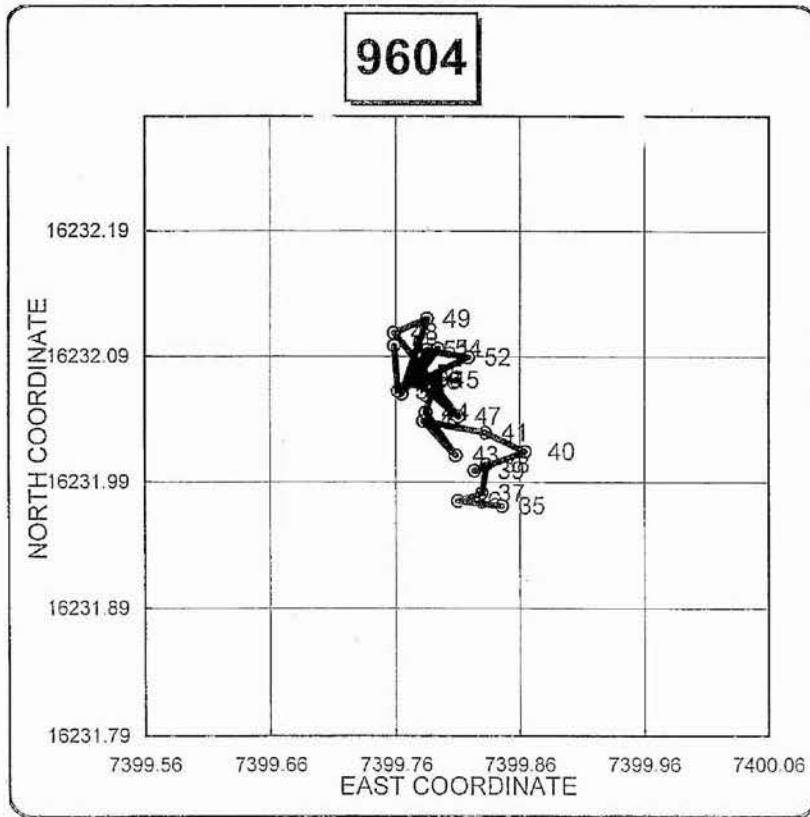

IMAGE REFERENCE: AMERICAN
ELECTRIC POWER CORP., 2008
INSPECTION REPORT MAIN FLY
ASH DAM, SADDLE DAM, BOTTOM
ASH COMPLEX, DECEMBER 2008,
PAGE 75.

File: K:\20085\CADD\ACAD\FIGURES\7000 BIG SANDY\FIGURES.DWG Saved: 12/21/2009 4:14:05 PM Plotted: 12/21/2009 4:16:28 PM User: Gray, Timmolyn

Drawing Copyright © 2008



111 Winners Circle, PO Box 5269 • Albany, NY 12205-0269
Main: (518) 453-4500 • www.checompanies.com

HORIZONTAL DEFORMATION —
POINTS 9604 AND 9605
BIG SANDY POWER PLANT
LOUISA, KENTUCKY

PROJECT NO.
20085.7000

DATE: 12/2009

FIGURE 11C

KENTUCKY POWER COMPANY BIG SANDY FLY ASH DAM

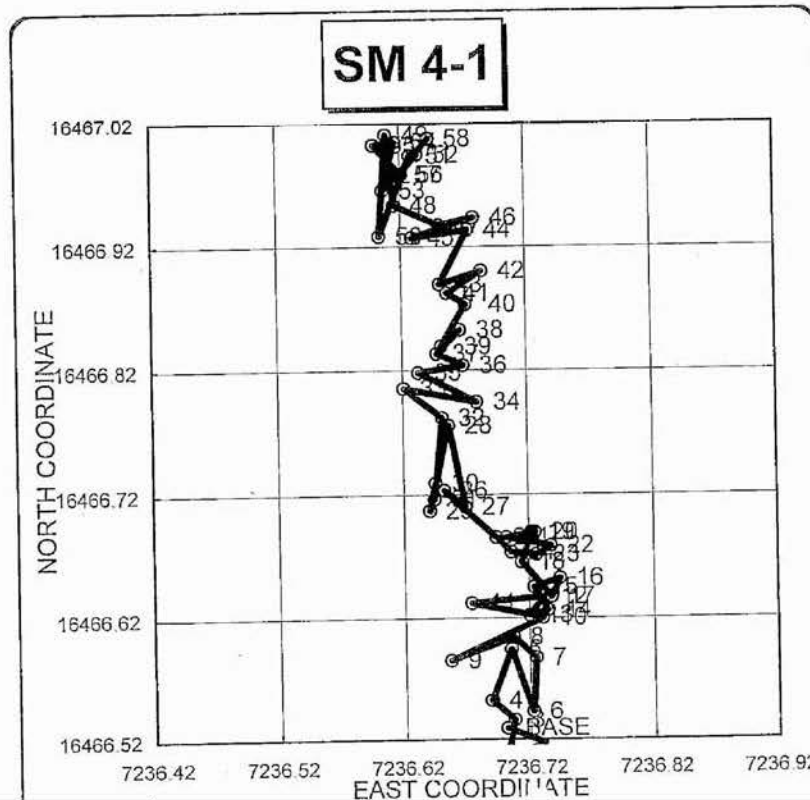
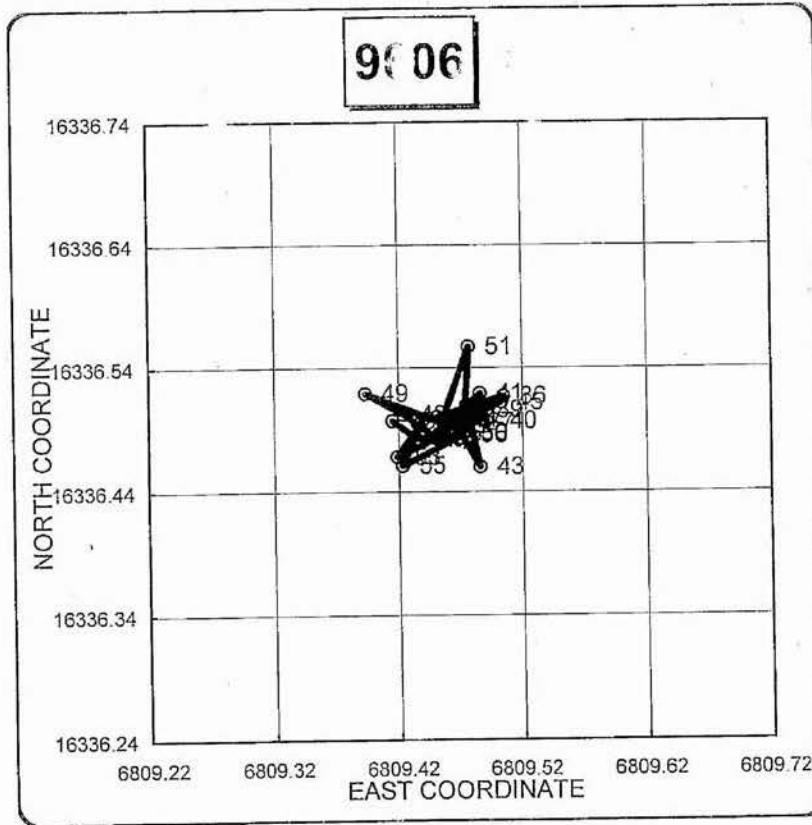

IMAGE REFERENCE: AMERICAN
ELECTRIC POWER CORP., 2008
INSPECTION REPORT MAIN FLY
ASH DAM, SADDLE DAM, BOTTOM
ASH COMPLEX, DECEMBER 2008,
PAGE 76.

File: K:\20085\CADD\ACAD\FIGURES\7000 BIG SANDY\FIGURES.DWG Saved: 12/21/2009 4:14:05 PM Plotted: 12/21/2009 4:16:45 PM User: Gray, Timmolyn

Drawing Copyright © 2008



111 Winners Circle, PO Box 5269 • Albany, NY 12205-0269
Main: (518) 453-4500 • www.checompanies.com

HORIZONTAL DEFORMATION –
POINTS 9606 AND SM 4-1
BIG SANDY POWER PLANT
LOUISA, KENTUCKY

PROJECT NO.
20085.7000

DATE: 12/2009

FIGURE 11D

AMERICAN ELECTRIC POWER
 BIG SANDY FLY ASH DAM

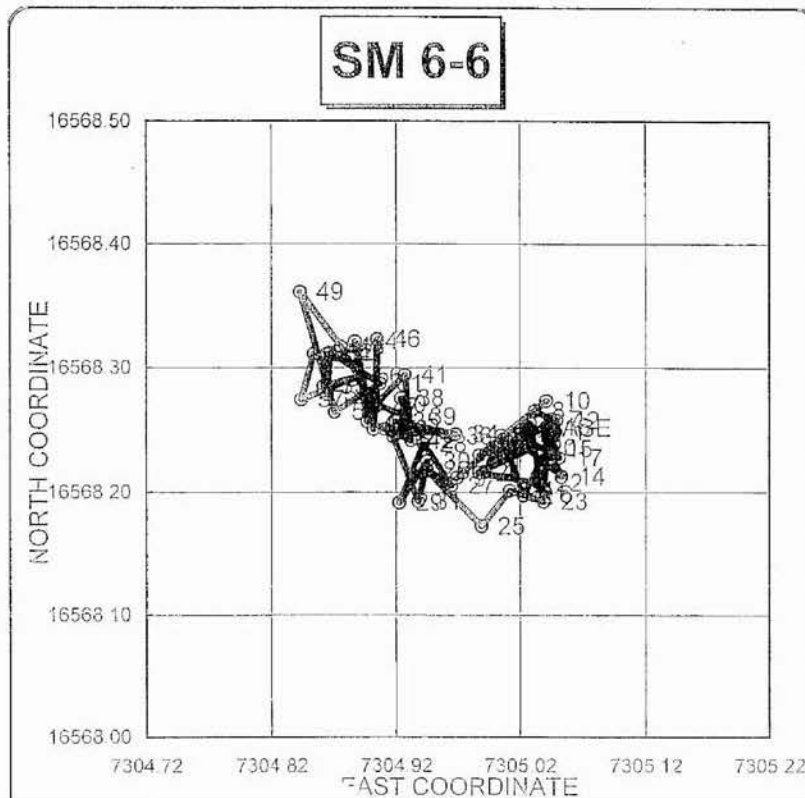
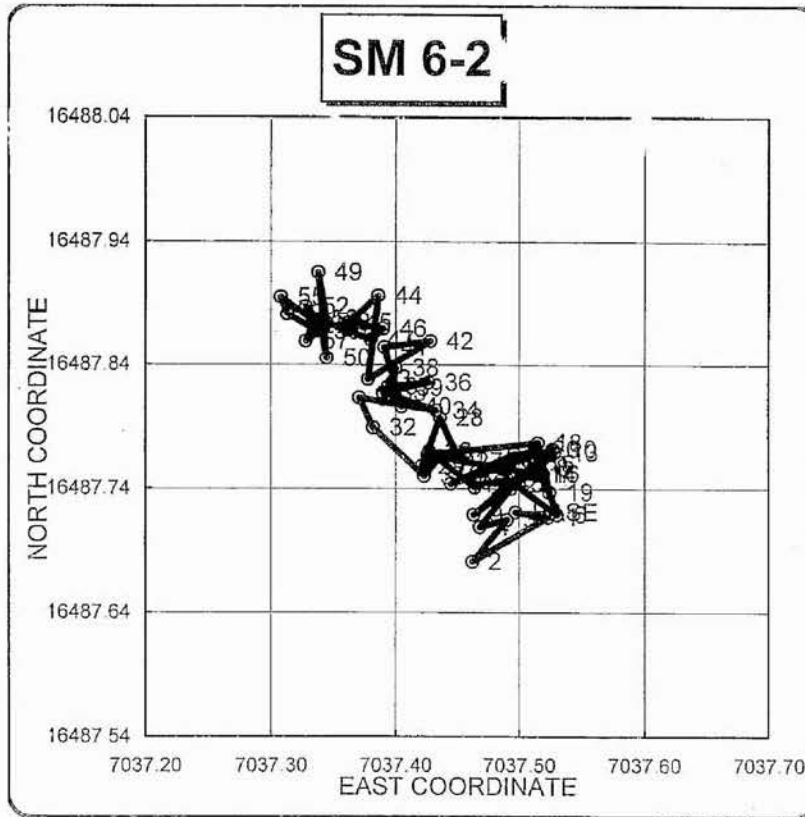

IMAGE REFERENCE: AMERICAN ELECTRIC POWER CORP., 2008 INSPECTION REPORT MAIN FLY ASH DAM, SADDLE DAM, BOTTOM ASH COMPLEX, DECEMBER 2008, PAGE 77.

File: K:\20085\CADD\ACAD\FIGURES\7000 BIG SANDY\7000 BIG SANDY FIGURES.DWG Saved: 12/21/2009 4:14:05 PM Plotted: 12/21/2009 4:17:05 PM User: Gray, Timmoyn

Drawing Copyright © 2008



11 Winners Circle, PO Box 5269 • Albany, NY 12205-0269
 Main: (518) 453-4500 • www.checompanies.com

HORIZONTAL DEFORMATION –
 POINTS SM 6-2 AND SM 6-6
 BIG SANDY POWER PLANT
 LOUISA, KENTUCKY

PROJECT NO.
 20085.7000

DATE: 12/2009

FIGURE 11E

File: K:\20085\CADD\ACAD\FIGURES\7000 BIG SANDY\7000 BIG SANDY FIGURES.DWG Saved: 12/21/2009 4:14:05 PM Plotted: 12/21/2009 4:17:20 PM User: Gray, Timmolyn

AMERICAN ELECTRIC POWER
 BIG SANDY FLY ASH DAM

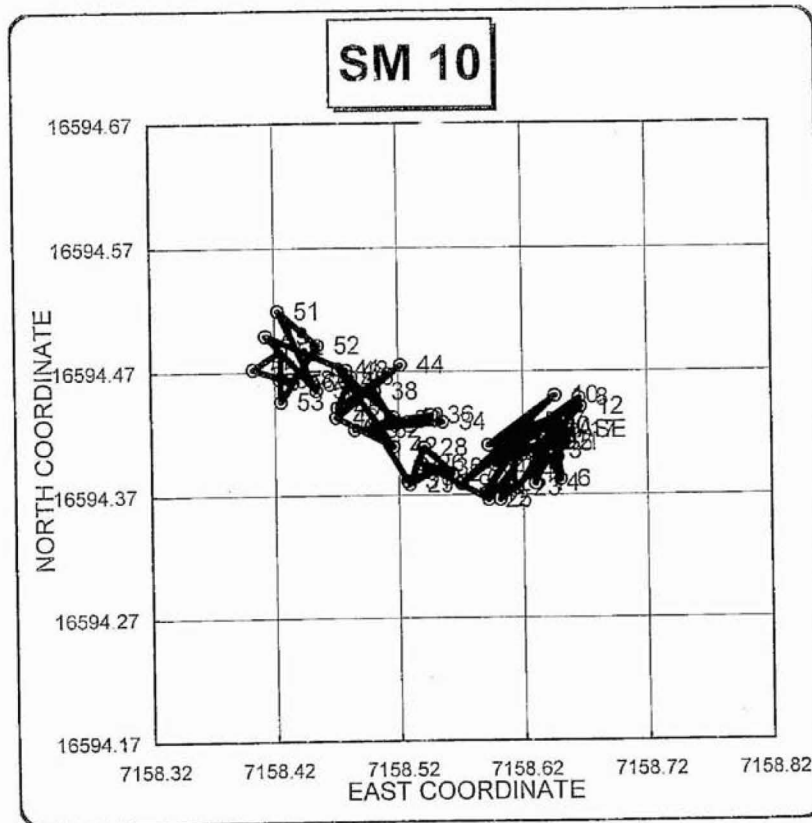

IMAGE REFERENCE: AMERICAN ELECTRIC POWER CORP., 2008 INSPECTION REPORT MAIN FLY ASH DAM, SADDLE DAM, BOTTOM ASH COMPLEX, DECEMBER 2008, PAGE 78.

Drawing Copyright © 2009



111 Winners Circle, PO Box 5269 - Albany, NY 12205-0269
 Main: (518) 453-4500 • www.chacompanies.com

HORIZONTAL DEFORMATION —
 POINT SM 10
 BIG SANDY POWER PLANT
 LOUISA, KENTUCKY

PROJECT NO.
 20085.7000

DATE: 12/2009

FIGURE 11F

BS SI-1, A-Axis

BS SI-1, B-AXIS

File: K:\20085\CADD\ACAD\FIGURES\7000 BIG SANDY\FIGURES.DWG Saved: 12/21/2009 1:47:01 PM Plotted: 12/21/2009 2:08:02 PM User: Gray, Timmolyn

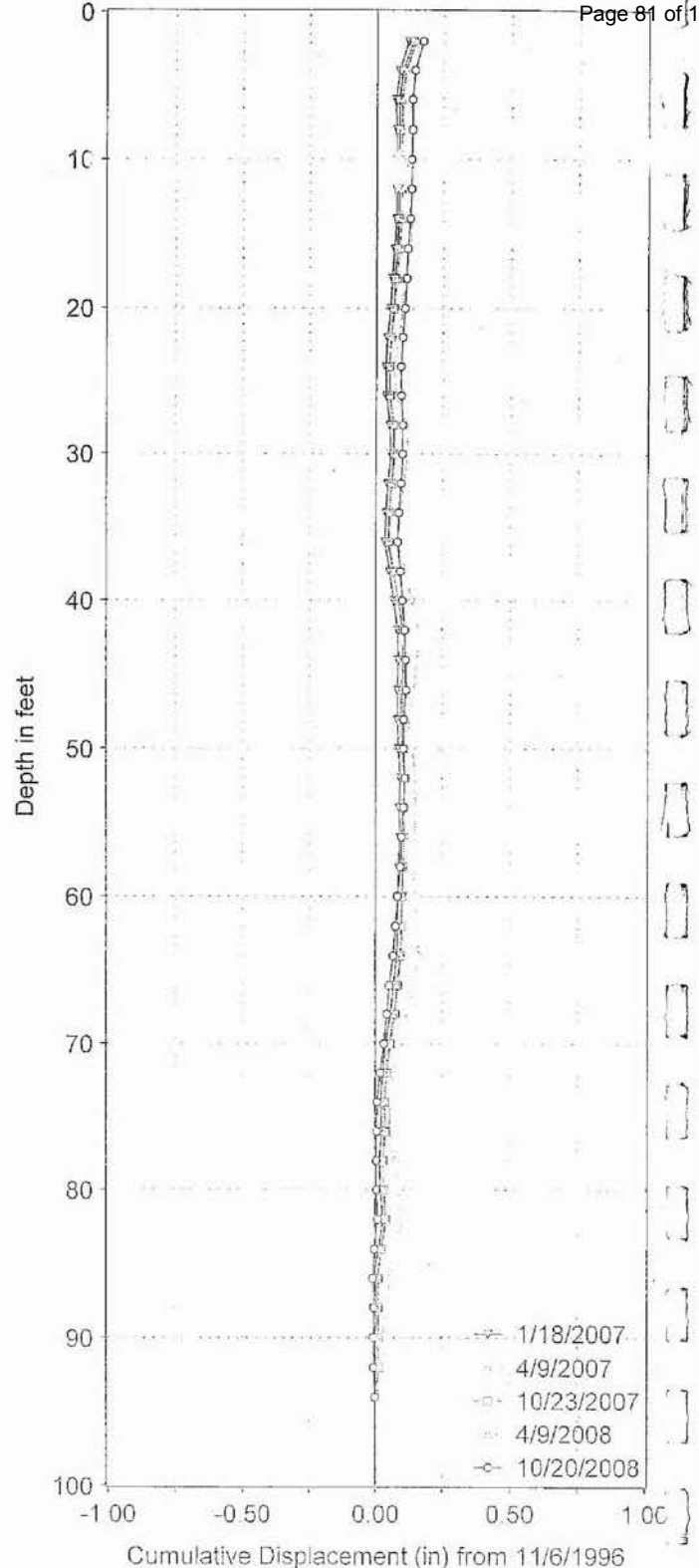
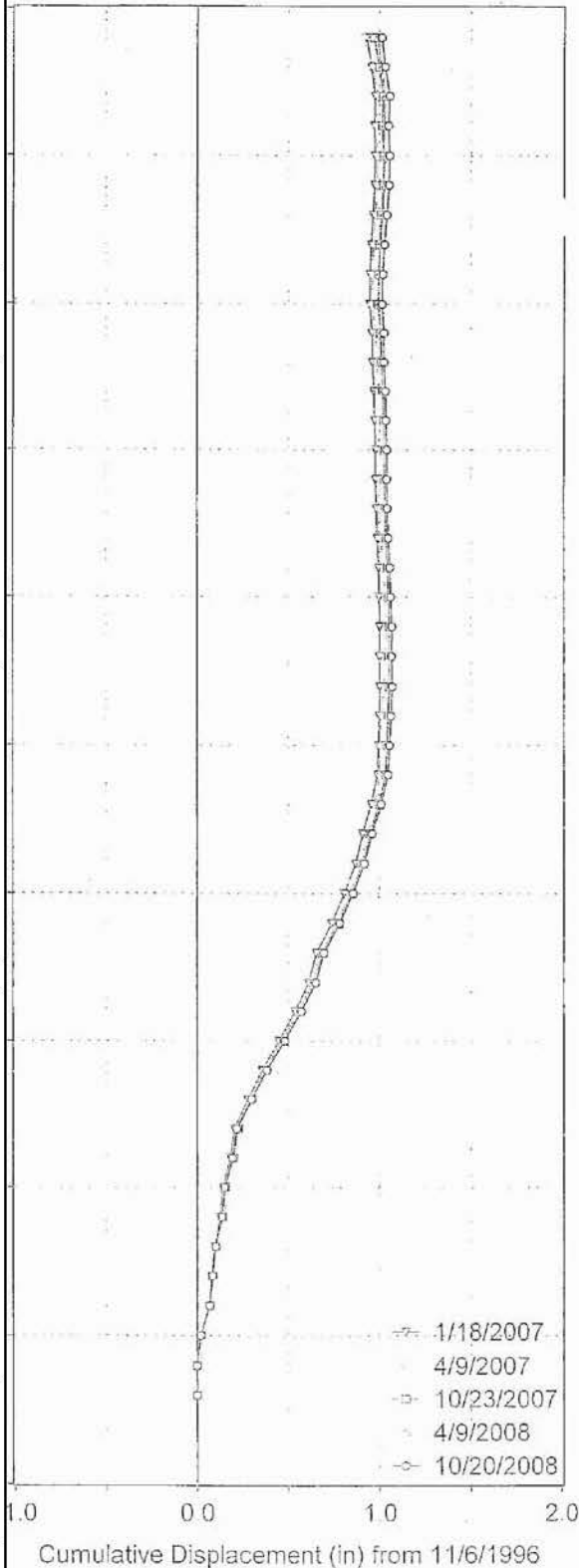

IMAGE REFERENCE: AMERICAN ELECTRIC POWER CORP., 2008 INSPECTION REPORT MAIN FLY ASH DAM, SADDLE DAM, BOTTOM ASH COMPLEX, DECEMBER 2008, PAGE 103.

Drawing Copyright © 2008



111 Winners Circle, PO Box 5269 • Albany, NY 12205-0269
Main: (518) 453-4500 • www.checompanies.com

HORSEFORD CREEK DAM INCLINOMETER
SI-1 DEFORMATION
BIG SANDY POWER PLANT
LOUISA, KENTUCKY

PROJECT NO.
20085.7000

DATE: 12/2009

FIGURE 12A

BS SI-2, A-Axis

File: K:\20085\CADD\ACAD\FIGURES\7000 BIG SANDY\FIGURES.DWG Saved: 12/21/2009 1:47:01 PM PLOTTED: 12/21/2009 2:08:22 PM User: Gray, Timmolyn

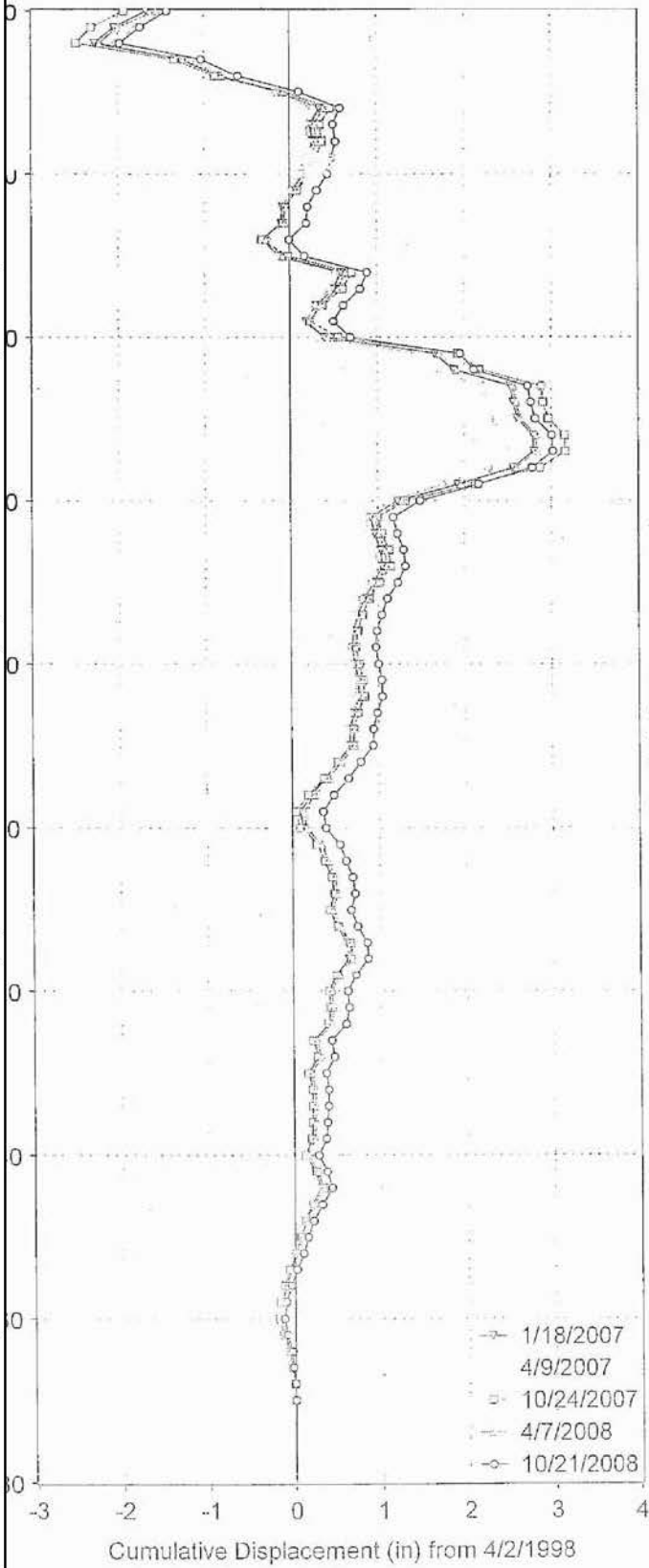

Depth in feet

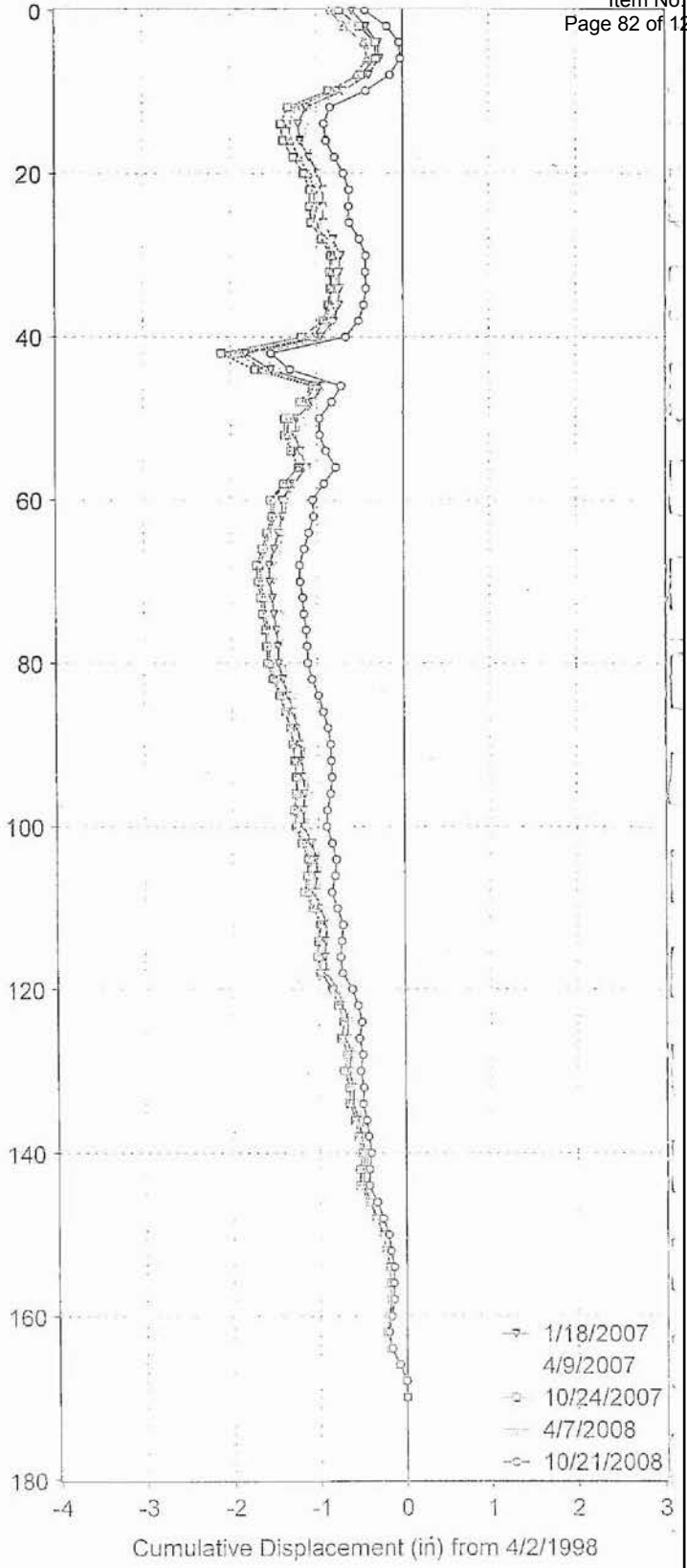

IMAGE REFERENCE: AMERICAN ELECTRIC POWER CORP., 2008 INSPECTION REPORT MAIN FLY ASH DAM, SADDLE DAM, BOTTOM ASH COMPLEX, DECEMBER 2008, PAGE 111.

Drawing Copyright © 2008



111 Winners Circle, PO Box 5269 • Albany, NY 12205-0269
Main: (518) 453-4500 • www.checompanies.com

HORSEFORD CREEK DAM INCLINOMETER
SI-2 DEFORMATION
BIG SANDY POWER PLANT
LOUISA, KENTUCKY

PROJECT NO.
20085.7000

DATE: 12/2009

FIGURE 12B

3.0 DATA EVALUATION

3.1 Design Assumptions

CHA has reviewed the design assumptions related to the design and analysis of the hydraulic adequacy and stability of the Fly Ash Pond and the Horseford Creek and Saddle Dams, which were available at the time of our site visits and provided to us by AEP. The design assumptions are listed with the applicable summary of analysis in the following sections.

At the time of our site visit, information on the design and construction of the Bottom Ash Complex was not available. We understand that AEP has engaged an engineering consultant to perform a geotechnical subsurface exploration program and corresponding analyses.

3.2 Hydrologic and Hydraulic Design

The Kentucky regulations regarding hydrologic and hydraulic design requirements are found in DNR&EP Engineering Memorandum 5 pertaining to KRS 151.250. The regulations are based upon P_{100} which refers to the 6-hour, 100-year precipitation and the PMP which represents the 6-hour Probable Maximum Precipitation. For Louisa, Kentucky, the P_{100} is 4.3 inches and the reported PMP is 28.1 inches. The reported 50-year, 1 day and 10 day storms have rainfall values of 5.1 and 8.9 inches, respectively.

The Kentucky guidelines suggest that the principal spillway have the capacity to drain the stored volume of storm flows in 10 days or less. This requirement is considered to be met if 80 percent of the design storm (based on hazard classification) storage is drained within 10 days.

3.2.1 Fly Ash Pond

The Fly Ash Pond (impounded by the Horseford Creek Dam and the Saddle Dam) at the Big Sandy Generating Station is classified as high hazard (Class C) suggesting that loss of life is probable in the event of a failure. The Kentucky regulations require high hazard impoundments to safely store or pass the PMP. Guidance is provided for the design of an Emergency Spillway as passing a flow equivalent to the P_{100} plus 26 percent of the difference between the PMP and the P_{100} [$P_{100} + 0.26(PMP - P_{100})$]. The Emergency Spillway must be placed such that the full design storm (PMP for high hazard dams) passes without overtopping the dam. At the same time the Emergency Spillway must be set such that it does not flow during a storm smaller than the P_{100} storm when vegetated earth, or a storm smaller than the 50-year storm when constructed in bedrock.

AEP prepared an engineering report in 1993 regarding raising the crest of the Horseford Creek Dam which included a hydrologic and hydraulic analysis for the Fly Ash Pond. CHA reviewed this document.

Land use within the drainage area consists of the pond and abutting wooded hills; therefore, raising the dam crest will not affect the total watershed area. The following basin characteristics were used in their assessment:

- Drainage Area - 675 acres
- Average Land Slope - 28%
- Hydrologic Soil Group - C
- SCS Curve Number (weighted) - 73
- Time of Concentration - 0.25 hour
- Normal Pool at El. 705
- Stop Logs at El. 704

AEP utilized the U.S. Army Corps of Engineer's HEC-1 computer program to perform rainfall-runoff computations and reservoir flood routings.

The Fly Ash Pond was designed to originally convey inflows from the plant of about 10 cubic feet per second (cfs) as a routine course, as well as pass flows from the PMP. The computed principal spillway hydrograph (PSH) for design of the emergency spillway following the procedures in the SCS National Engineering handbook indicated a maximum pool elevation of 706 with a peak outflow of 54 cfs. The emergency spillway invert was set at El. 706.25 which is above the PSH reservoir elevation.

AEP assumed that a 50-year rainfall even would produce the 50-year flood for design of the emergency spillway crest elevation. Development of the corresponding hydrograph for design of the emergency spillway indicated a peak storm water inflow of 10,610 cfs and outflow of 1672 cfs. The corresponding reservoir level was El. 709.4. Analysis of the 6-hour PMF indicated a peak inflow of 15,687 cfs, peak outflow of 2,433 cfs and a maximum pool level at El. 710.5.

3.2.2 Bottom Ash Complex

The Bottom Ash Complex is not regulated by KYDEP therefore there are no specific H&H guidelines for its design. CHA suggests the impoundment be evaluated for susceptibility to overtopping during a reasonable design storm.

3.3 Structural Adequacy & Stability

The Kentucky Department for Natural Resources and Environmental Protection provides guidelines for minimum accepted factors of safety associated with various loading conditions and the reservoir at normal pool level in Table 2 – Factors of Safety of the *Guidelines for the Geotechnical Investigation and Analysis of Existing Earth Dams*. These factors of safety are outlined in Table 3.

Table 3 – Factors of Safety from KY Guidelines

| Load Case | Required Minimum Factor of Safety |
|--------------------------------|--|
| Rapid Drawdown | 1.2 |
| Long-Term Steady State Seepage | 1.5 |
| Earthquake Loading | 1.0 |

In addition to the load cases outlined in Table 3 CHA recommends that the end of construction and the maximum surcharge load cases as found in the US Army Corps of Engineers Engineering Manual (EM) 1110-2-1902 be modeled and analyzed. This load case and associated minimum recommended safety factor is outlined in Table 4.

Table 4- Minimum Safety Factor Recommended by US Army Corps of Engineers

| Load Case | Required Minimum Factor of Safety |
|--|--|
| End of Construction | 1.3 |
| Maximum Surcharge Pool (Flood) Condition | 1.4 |

Louisa, Kentucky falls into Seismic Zone 1, which for deterministic based evaluation of seismic acceleration results in an acceleration value of 0.05g for seismic analysis. Based on more recent probabilistic hazard analyses performed by the United States Geological Society (USGS) accelerations of about 0.036g and 0.099g are representative of seismic accelerations with a 10 and 2 percent probability of exceedance in 50 years, respectively (about 500-year and 2,500-year events, respectively). AEP used an acceleration value of 0.1g in their analysis.

In Sections 3.3.1 and 3.3.2 we discuss our review of the stability analyses for the Fly Ash Pond and Bottom Ash Complex, respectively.

3.3.1 Stability Analysis Conditions – Fly Ash Pond

CHA reviewed the stability analyses performed by AEP (1993) for the Phase 3 raising of the Horseford Creek Dam. They analyzed a typical cross section for the following load cases:

- Case 1: End of construction when excess pore water pressures are anticipated because consolidation of the fine grained material will be incomplete under the imposed load from the fill. Therefore, the results of undrained unconsolidated (UU) tests were used in the analysis.
- Case 2 and 3: Rapid drawdown of the pond may result in development of excess pore water pressures assuming the pond level decreases faster than the pore water can escape. Therefore, the design shear strength was based upon the minimum of the combined CU and CD envelopes. Case 2 assumes a rapid drawdown from the maximum operating pool level and Case 3 assumes rapid drawdown from the spillway crest elevation. However, AEP concluded that use and operation of the pond precluded development of rapid draw down conditions; therefore shear strength parameters were not provided.
- Case 4: Partial pool analysis of the upstream slope at intermediate reservoir stages assuming that steady state seepage has been established and submerging the toe of a failure surface reduces the factor of safety due to a change to effective unit weight and soil strength parameters.
- Case 5: Steady state seepage at the maximum pool elevation assuming sufficient time has elapsed to establish steady state seepage conditions.
- Case 6: Steady state seepage with surcharge pool assuming an additional horizontal thrust is applied near the top of the embankment due to surcharge pool
- Case 7: Seismic stability was analyzed by applying an additional horizontal force to the critical failure plane for Cases 1, 4, 5, and 6.

3.3.1.1 Soil Strength Parameters – Fly Ash Pond

Design soil strength parameters were developed for undrained loading conditions (Case 1) and for steady state conditions (Cases 4 through 7). AEP did not analyze the rapid drawdown condition and therefore soil parameters were not provided for this case. Tables 5 and 6 provide the soil strength parameters for the Horseford Creek and Saddle Dams, respectively.

Table 5 - Soil Strength Properties – Horseford Creek Dam Foundation Soils

| Dam Zone | Design Shear Strength (tsf) | | Comments |
|--|--|---|----------------------------|
| | Undrained | Steady State | |
| Foundation Soil Under existing berm Under existing dam | $0.70 + \sigma \cdot \tan 13^\circ$ $1.14 + \sigma \cdot \tan 11^\circ$ | $\sigma' \cdot \tan 25^\circ$ $0.05 + \sigma' \cdot \tan 23^\circ$ | Kc=1; $\alpha=90^\circ$ |
| Foundation Soil Under existing berm Under existing dam | $0.70 + \sigma \cdot \tan 13^\circ$ $0.82 + \sigma \cdot \tan 12^\circ$ | $\sigma' \cdot \tan 27^\circ$ $0.40 + \sigma \cdot \tan 23^\circ$ | Kc=1; $\alpha=45^\circ$ |
| Foundation Soil Under existing berm Under existing dam | $1.55 + \sigma \cdot \tan 9^\circ$ $1.65 + \sigma \cdot \tan 9^\circ$ | $\sigma' \cdot \tan 30^\circ$ $\sigma' \cdot \tan 30^\circ$ | Kc=1.75; $\alpha=45^\circ$ |

Table 6 - Soil Strength Properties – Saddle Dam Foundation Soils

| Dam Zone | Design Shear Strength (tsf) | | Comments |
|-----------------|-----------------------------|-------------------------------|----------|
| | Undrained | Steady State | |
| Foundation Soil | 1.4 | $\sigma' \cdot \tan 34^\circ$ | |

Table 7 - Soil Strength Properties – Construction Materials

| Dam Zone | Design Shear Strength (tsf) | | Comments |
|---|------------------------------------|-------------------------------|-------------------------|
| | Undrained | Steady State | |
| Clay in existing Horseford Creek Dam | $1.40 + \sigma \cdot \tan 6^\circ$ | $\sigma' \cdot \tan 25^\circ$ | Kc=1; $\alpha=90^\circ$ |
| Random Rockfill | $\sigma' \cdot \tan 32^\circ$ | $\sigma' \cdot \tan 24$ | - |
| Bottom ash | $\sigma' \cdot \tan 38^\circ$ | $\sigma' \cdot \tan 38^\circ$ | Kc=1 |
| Compacted clay from proposed borrow | 0.48 | $\sigma' \cdot \tan 27^\circ$ | |

3.3.1.2 Stability Analysis Results – Fly Ash Pond

AEP utilized the computer program XSTABLE to analyze circular arc and sliding wedge failure mechanisms. Two sets of output data from December 1992 and January 1993 are included in the



appendix to AEP's report. The computed factor of safety is lower in the December 1992 results; unfortunately a discussion regarding the difference in the two sets of analysis is not presented in the report. For a typical section of the embankment the AEP December 22, 1992 analyses resulted in the factors of safety summarized in Table 8. Figures 13A through 13F show the stability analysis cross sections. AEP indicated that use and operation of the Fly Ash Pond precluded development of a rapid draw down condition; therefore a stability analysis was not performed.

Table 8 – Summary of Safety Factors

| Load Case | Required Min Factor of Safety | Calculated Minimum Factor of Safety | | |
|--|-------------------------------|-------------------------------------|---------------|-----|
| | | Horseford Creek Dam | Saddle Dam | |
| End of Construction Pond at El. 670 | Static | 1.3 | 1.635 | 1.8 |
| | Seismic | 1.0 | 1.398 | 1.6 |
| Long Term Condition DS Slope, Pond at El. 705 | Static | 1.5 | 1.464 | 1.8 |
| | Seismic | 1.0 | 1.198 | 1.5 |
| Long Term Condition DS Slope, Surcharge Pool | Static | 1.4 | 1.388 | 1.7 |
| | Seismic | 1.0 | 1.146 | 1.4 |
| Rapid Drawdown | 1.2 | Not Performed | Not Performed | |

3.3.1.3 Liquefaction Analysis – Fly Ash Pond Dams

CHA has not been provided with a liquefaction analysis of the dams impounding the Fly Ash Pond. Based upon our review of the regional and site geology information, the primary soil overlying bedrock consists of clayey soils which are unlikely to undergo liquefaction deformations. However, we recommend that AEP or their engineering consultant review the available data.

3.3.2 Bottom Ash Complex

CHA has not been provided with an engineering assessment for the stability of the existing dikes around the Bottom Ash Complex. A geotechnical exploration program was underway at the time of CHA's site visit on October 29, 2009. AEP provided CHA with a preliminary analysis indicating the required soil strengths needed to achieve the minimum factors of safety. AEP indicated that these minimum strengths were within the expected range of parameters for the soil encountered which will be confirmed with lab testing. We understand that the geotechnical report has not been submitted as of the date of this report and we anticipate that stability analysis will be included.

3.4 Foundation Conditions

3.4.1 Foundation Conditions at the Horseford Creek Dam

The Casagrande December 1976 report provides information regarding field explorations and geotechnical engineering assessment for the Phase 1 and Phase 2 portions of the Horseford Creek Dam. CHA has not received a copy of this report. AEP (1993) summarized that these borings indicated clayey foundation soil thicknesses ranging from about 5 feet on the east side to 36 feet on the west side.

The 1993 report prepared by AEP indicates that the foundation soils below the Horseford Creek Dam consist of clayey soils containing particles of weathered rock. At the east abutment, the soil was five to 10 feet thick and at the west abutment the soil was about 20 feet thick near the bottom of the slope. Bedrock outcrops were visible on both abutment slopes.

Bedrock formations are of sedimentary origin with approximately horizontal bedding. The primary bedrock type is sandstone with layers ranging between a few inches to over 100 feet thick. In the upper portions of the abutment slopes, the sandstone is layered with siltstone,



cemented shale, and clay shale with thicknesses ranging between less than one inch to about 20 feet.

3.4.2 Seepage at Horseford Creek Dam

A 1976 inspection report by Casagrande Consultants (WCC 1981) indicated that eight seepage areas were observed on the downstream slope of the Stage 1 dam. The majority of the seepage was issuing from the east and west abutments at the approximate level of the coal seam. Therefore, Casagrande recommended placing a clay blanket on the upstream slope and a drainage blanket on the downstream slope as part of the Stage 2 construction. G. Reynolds (1978) indicated that a concrete plug was reportedly constructed across the coal seam.

WCC 1981 reported seepage and white precipitate in a collection ditch at the downstream toe of the Horseford Creek Dam and at the junction of the downstream toe and east abutment at a 4-inch diameter underdrain pipe. This is similar to the conditions observed during our site visit. WCC speculated that the white precipitate may be dissolved calcium from the limestone drainage blanket which was installed up the rock abutments as part of the Stage 2 construction.

WCC (1981) noted that the exposed sandstone at the left abutment had been blanketed with a silty clay below the reservoir level (about El. 639) and at about El. 645. The inclination of the sandstone precluded continuing the clay blanket further up the slope. An open, near vertical fracture in the sandstone parallel to the west abutment and day-lighting in the reservoir opposite the service spillway was also observed; undesirable seepage into the abutment could occur through this fracture. AEP indicated that an attempt was made to grout this fracture during Stage 2 construction, however, results are not available. WCC recommended analyzing the potential benefit of constructing a concrete wall over this fracture.

3.4.3 Foundation Conditions at the Saddle Dam

AEP (1993) reported that the foundation conditions below the Saddle Dam consisted of approximately 3 feet of bottom ash mixed with sand overlying glacial outwash deposits. It is unclear if the bottom ash mixture was part of the blanket drain installed for the original Saddle Dam and if this material was left in place or removed during construction of the new Saddle Dam. The glacial outwash, ranging in thickness from a few feet to 25 feet at the east abutment, is comprised of interbedded sandy silt, sandy clay, and clayey sand. Bedrock consisting of thin alternating layers of sandstone, claystone, and silty shale was encountered at the ground surface in the vicinity of the abutments or below the glacial outwash deposits.

3.4.4 Foundation Conditions at Bottom Ash Complex

Based upon section details shown on the AEP 1968 drawing, ash was stored in this area prior to the reconfiguration of the Complex. In particular, the splitter dike between the NBAP and NCWP was constructed above 6 feet of compacted bottom ash and the splitter dike between the SBAP and SCWP was constructed above 2 feet of existing ash. Sections of the perimeter dikes suggest they were constructed on natural soils.

A geotechnical exploration program was underway at the time of CHA's site visit on October 29, 2009.

3.5 Operations & Maintenance

AEP provided CHA with a copy of the Monitoring and Emergency Action Plan and Procedures for the Horseford Creek Dam prepared by Geo/Environmental Associates, Inc. and dated February 2009. Tasks required under the program are performed by E-On plant personnel, AEP personnel and outside consultants. The manual includes the following:

- Monitoring Plan;
- Emergency Warning Plan;
- Post Evacuation Plan, and
- Administrative and Record Keeping

The report indicates that inspections will be conducted according to the prescribed schedule, however the schedule is not described. A copy of a blank inspection report dated September 1991 is included in Appendix II of the report. The inspection checklist includes spaces for the following information:

- Reservoir elevation at the Fly Ash Pond and Bottom Ash Complex
- Comments on embankment conditions;
- Comments on condition of Fly Ash Pond service and emergency spillway;
- Piezometer readings at Horseford Creek Dam; and
- Comments on condition of overflow structures between cells in the Bottom Ash Complex;

Although the manual does not stipulate the inspection frequency, we understand that plant personnel make quarterly inspections and AEP Civil Group make annual inspections.

3.6 Inspections

3.6.1 Inspections by Power Company

CHA was provided with copies of the visual inspection reports prepared by AEP Services Corporation based upon their site visits on November 15, 2005 and October 30, 2007. The report indicates that the inspections were part of AEP's Dam Inspection and Maintenance Program in which dikes and dams are inspected annually. The following conditions were noted in the more recent report:



- Routine maintenance activities at the Bottom Ash Complex dikes consist of slope mowing and brush removal and/or spraying.
- The perimeter dikes, interior slopes, drainage structures, and roadways on the crests at the Bottom Ash Complex were generally in good condition except for the interior slopes around the SBAP which were in fair condition.
- Sections of old conveyor belt which have been placed to protect the splitter dike between the NBAP and SBAP are missing or in disarray. It was recommended that the sections of old conveyor belt be removed and the slopes regraded and stabilized with suitable material.
- Poor drainage conditions were noted along the north side of the complex.
- The upstream and downstream slopes of the Saddle Dam have been regraded in conjunction with the construction activities to raise the dam. The slopes and crest were in good condition except for an area of erosion on the upstream side of the right groin. It was recommended that the groin areas be reseeded to preclude erosion and the right groin should be regraded and stabilized with stone.
- The former emergency spillway for the Fly Ash Pond had been plugged with Roller Compacted Concrete (RCC) to allow for completion of the Saddle Dam.
- The new emergency spillway is a rectangular channel cut into rock with a crest at El. 706.
- A seepage drain had been installed at the toe of the downstream rip-rap to collect observed drainage.
- The crest of the Horseford Creek Dam at the time of the inspection was at about El. 660 and the water level was about 35 feet below the crest.
- The upstream slope was generally in good condition. The majority of the exposed slope was seeded and rip rap had been placed across and slightly above the water line.
- The unfinished crest of the dam, the exposed clay core, and bottom ash fill were generally in good condition.
- The downstream rip rap slope was generally in good condition. The vegetation at the toe had been recently mowed. Significant cattail growth was observed in front of the culvert for the outlet channel passing below access road to the left abutment area.

- Drainage was observed at the right abutment which is collected by the facility drainage collection system. Continued monitoring and evaluation was recommended to identify changes in the flow.

3.6.2 Inspections by Engineering Consultants

CHA was provided with a copy of the visual inspection reports prepared by G. Reynolds Watkins/A TEC Associates based upon their site visit on July 20, 1978 as part of the National Dam Safety Program; Woodward-Clyde Consultants based upon their site visit on August 26, 1980; and Stantec Consulting Services based upon their site visit on April 2, 2009. The reports included a discussion, sketches, and photos.

The following conditions and recommendations were noted in the most recent report by Stantec:

- The perimeter dikes of the Bottom Ash Complex were generally in good condition. Several small animal burrows were observed on the downstream slope of the south dike. The burrows should be repaired and the area monitored for burrowing animal activity.
- Poor surface drainage was observed along the east side of the complex as indicated by several small areas of standing water.
- The crest and slopes of the splitter dikes within the BAPs were in fair to poor condition. Erosion and sparse vegetation were observed on the crest and sections of the old conveyor belt across the splitter dike between the NBAP and SBAP were missing or in disarray. The old conveyor belts should be removed and the embankment should be regraded and stabilized.
- Some minor erosion and rutting was observed along the roadway between the BAPs and CWP. The erosion and rutting should be repaired.
- Small trees and brush along the interior slopes of the CWPs should be removed.
- The splitter dikes and interior slopes within the CWPs were in satisfactory condition with signs of minor erosion and rutting.

- The condition of the discharge pipe from the RWP is uncertain and should be evaluated.
- The upstream and downstream slopes of the Saddle Dam was generally good. Vegetation on the upstream slope was sparse and erosion from storm water run-off was evident at the south abutment. The erosion area should be regraded and stabilized with stone. The rip rap on the downstream slope was generally good. Some small trees and brush was observed at the abutments and should be removed.
- A toe drain and clean-out access were evident at the downstream toe within the old emergency spillway. Vegetation was partially obstructing the flow but a small amount of clear seepage was observed.
- The toe drain discharge for the rip rap on the main portion of the Saddle Dam was overgrown with vegetation. Some measurable amount of clear seepage was observed. AEP representatives indicated that this amount of flow is typical. The vegetation should be cleared and flow measurements should be taken as the same frequency as the instrumentation at the Horseford Creek Dam.
- The crest of the Horseford Creek Dam at the time of the inspection was at about El. 692 and the water level was about 28 feet below the crest.
- Small trees and brush was observed on the grassy portion of the upstream slope. Some small animal burrows were also observed. The trees should be removed and small animal burrows should be filled. The area should be monitored for burrowing animal activity.
- The principal spillway appeared in satisfactory condition. A section of the access walkway at the bottom of the slope was submerged making access to the riser difficult.
- Small trees and brush was observed in the outlet channel and around the discharge weir. The vegetation should be removed to aid in visual observation of the area and collection of flow measurement. Flow measurements should resume immediately at the discharge weir.
- The downstream toe, crest of the rock stability berm, and rip rap slope were in good condition.
- Seepage was observed along the west abutment of the downstream slope near the principal spillway outlet. AEP indicated that this seepage comes from a French drain

installed within the stability berm to collect seepage previously observed along the downstream toe. Seepage was also observed along the east abutment along the stability berm and at the toe of the dam. Seepage monitoring devices should be installed at these locations.

3.6.3 State of Kentucky Inspections

CHA was provided with a copy of a June 24, 2008 letter from the Kentucky Department for Environmental Protection, Division of Water regarding their inspection of the Horsford Creek Dam. The following conditions were noted in the letter:

- All small trees, weeds, vines, and brush are to be removed from the dam.
- The structure needs to be mowed on a regular schedule per KRS 151.293.
- Drawdown valve must be operated at least once a year.
- Monitor seepage for change in flow or color.

W:SR-C 12-22-92 14:26

Big Sandy EOC El. 711; Water El.670
 10 most critical surfaces, MINIMUM JANBU FOS = 1.635

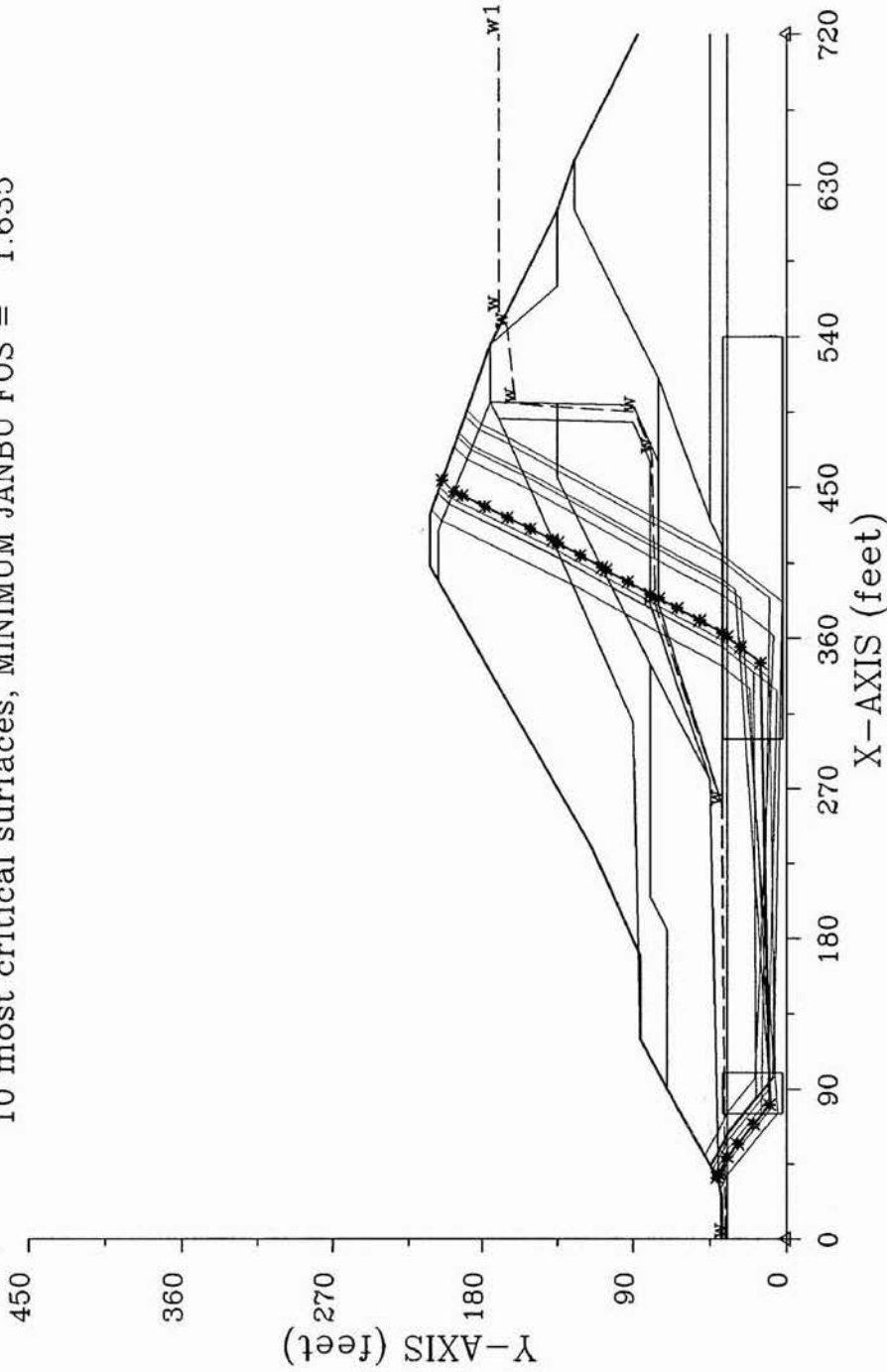

AEPBSP-C

IMAGE REFERENCE: "FLY ASH RETENTION DAM, STAGE 3 RAISING ENGINEERING REPORT" PREPARED BY AEP SERVICE CORPORATION, MARCH 1993, PAGE 167

Drawing Copyright © 2008



111 Whittier Circle, PO Box 5269 • Albany, NY 12205-0269
 Main: (518) 433-4300 • www.cimacompany.com

STABILITY ANALYSIS – END OF
 CONSTRUCTION – STATIC LOADING
 BIG SANDY POWER PLANT
 LOUISA, KENTUCKY

PROJECT NO.
 20085.7000

DATE: 12/22/09

FIGURE
 93

W 3R-CE 12-22-92 14:33

Big Sandy EOC WATER EL. 670 EA
 10 most critical surfaces, MINIMUM JANBU FOS = 1.398

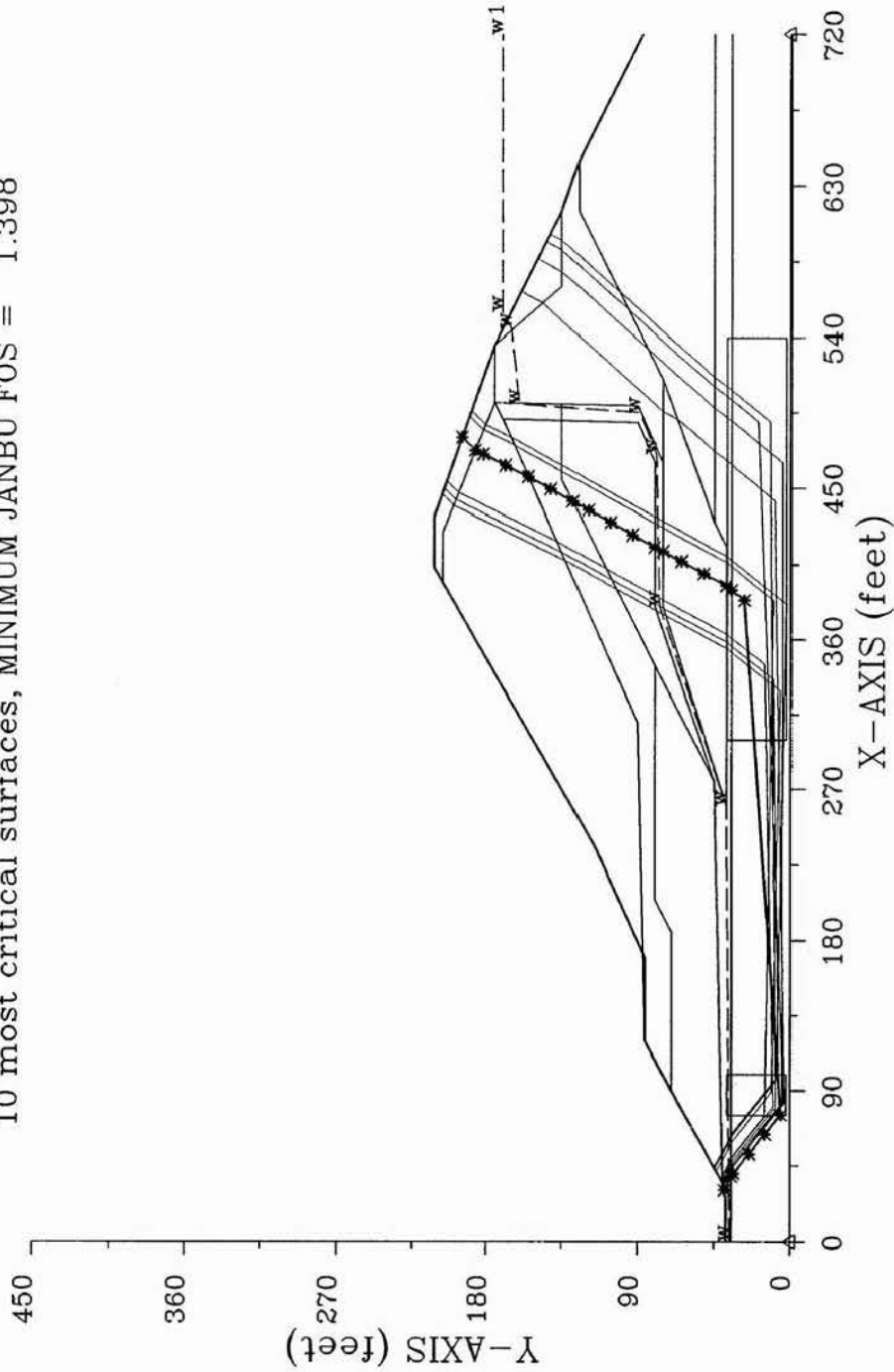

AEPBSP-C

IMAGE REFERENCE: "FLY ASH RETENTION DAM, STAGE 3 RAISING ENGINEERING REPORT" PREPARED BY AEP SERVICE CORPORATION, MARCH 1993, PAGE 168

Drawing Copyright © 2009



111 Winners Circle, PO Box 5288, Albany, NY 12205-0288
 Main (518) 433-4300 • www.cimainc.com

STABILITY ANALYSIS – END OF CONSTRUCTION – SEISMIC LOADING
 BIG SANDY POWER PLANT
 LOUISA, KENTUCKY

PROJECT NO.
 20085.7000
 DATE: 12/22/09
 FIGURE 1.3B

VF TP 12-30-92 12:34

STEADY SEEPAGE MAX. STORAGE POOL 705
 10 most critical surfaces, MINIMUM JANBU FOS = 1.464

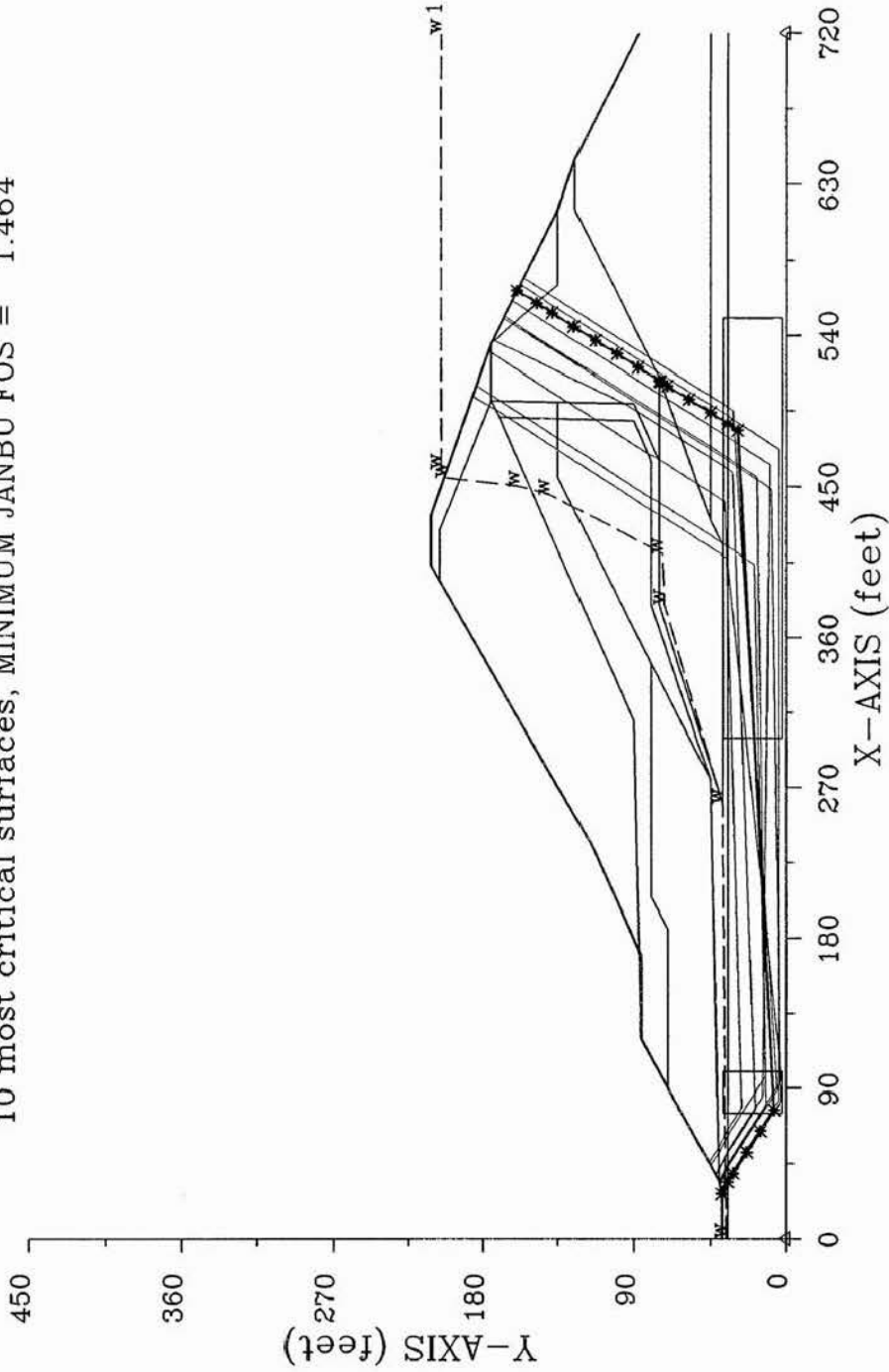

AEPBSP-0

IMAGE REFERENCE: "FLY ASH RETENTION DAM, STAGE 3 RAISING ENGINEERING REPORT" PREPARED BY AEP SERVICE CORPORATION, MARCH 1993, PAGE 169

Drawing Copyright © 2009



111 Winners Circle, PO Box 5288, Albany, NY 12205-0288
 Main (518) 433-4300 • www.cimacompany.com

STABILITY ANALYSIS – LONG TERM POND
– STATIC CONDITION
 BIG SANDY POWER PLANT
 LOUISA, KENTUCKY

PROJECT NO.
 20085.7000
 DATE: 12/20/09
 FIGURE 136

V: 'PE 12-30-92 12:39

STEADY SEEPAGE MAX. STRG. PL. 705 EA
 10 most critical surfaces, MINIMUM JANBU FOS = 1.198

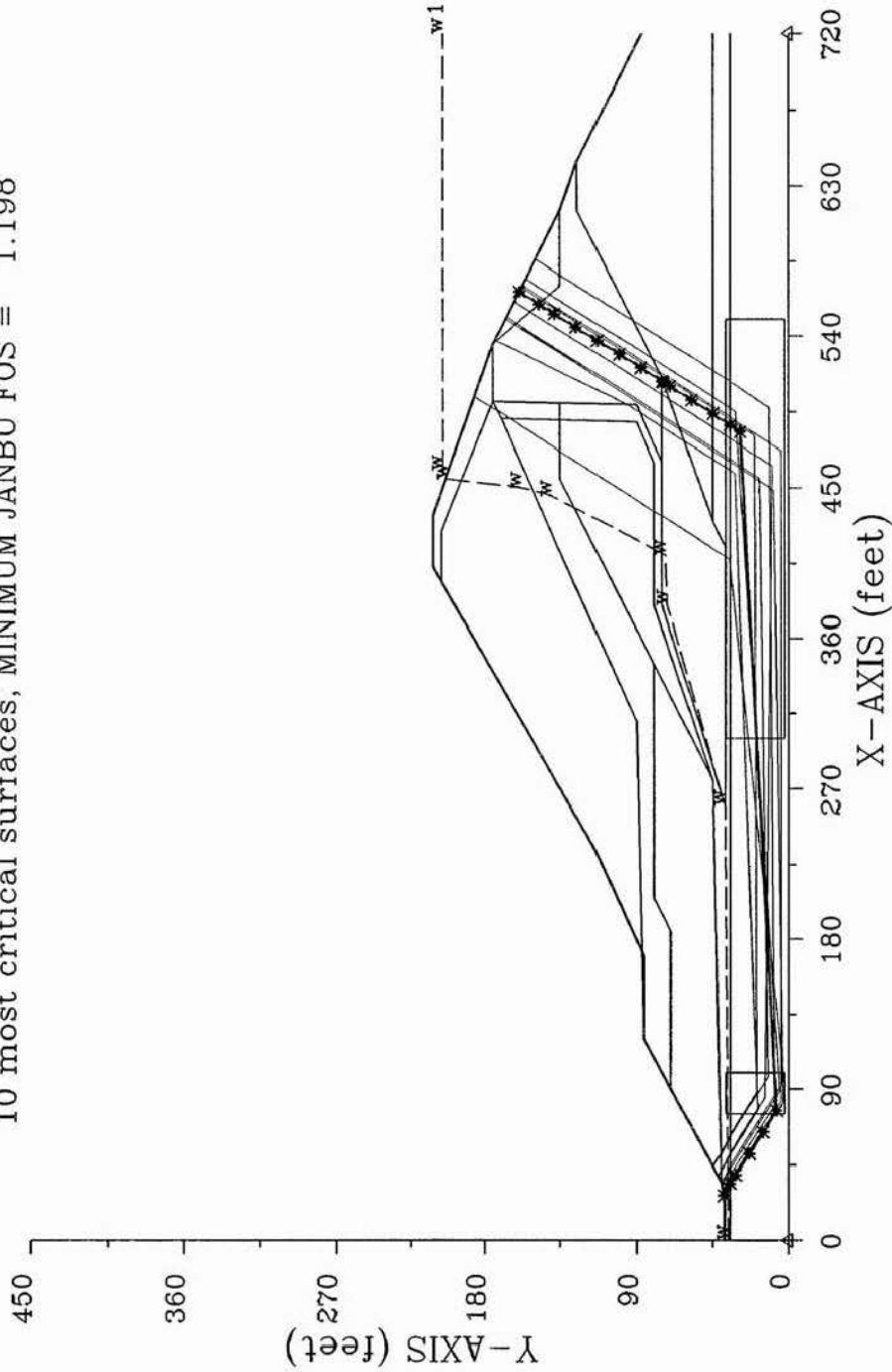

IMAGE REFERENCE: "FLY ASH RETENTION DAM, STAGE 3 RAISING ENGINEERING REPORT" PREPARED BY AEP SERVICE CORPORATION, MARCH 1993, PAGE 170

Drawing Copyright © 2009



111 Winners Circle, PO Box 5288, Albany, NY 12205-0288
 Main: (518) 433-4300 • www.chocomparia.com

STABILITY ANALYSIS - LONG TERM POND
 - SEISMIC CONDITION
 BIG SANDY POWER PLANT
 LOUISA, KENTUCKY

PROJECT NO.
 20085.7000
 DATE: 12/20/09
 FIGURE 1.20

VSP 12-30-92 12:47

STEADY SEEPAGE SURCHARGE POOL 709
 10 most critical surfaces, MINIMUM JANBU FOS = 1.388

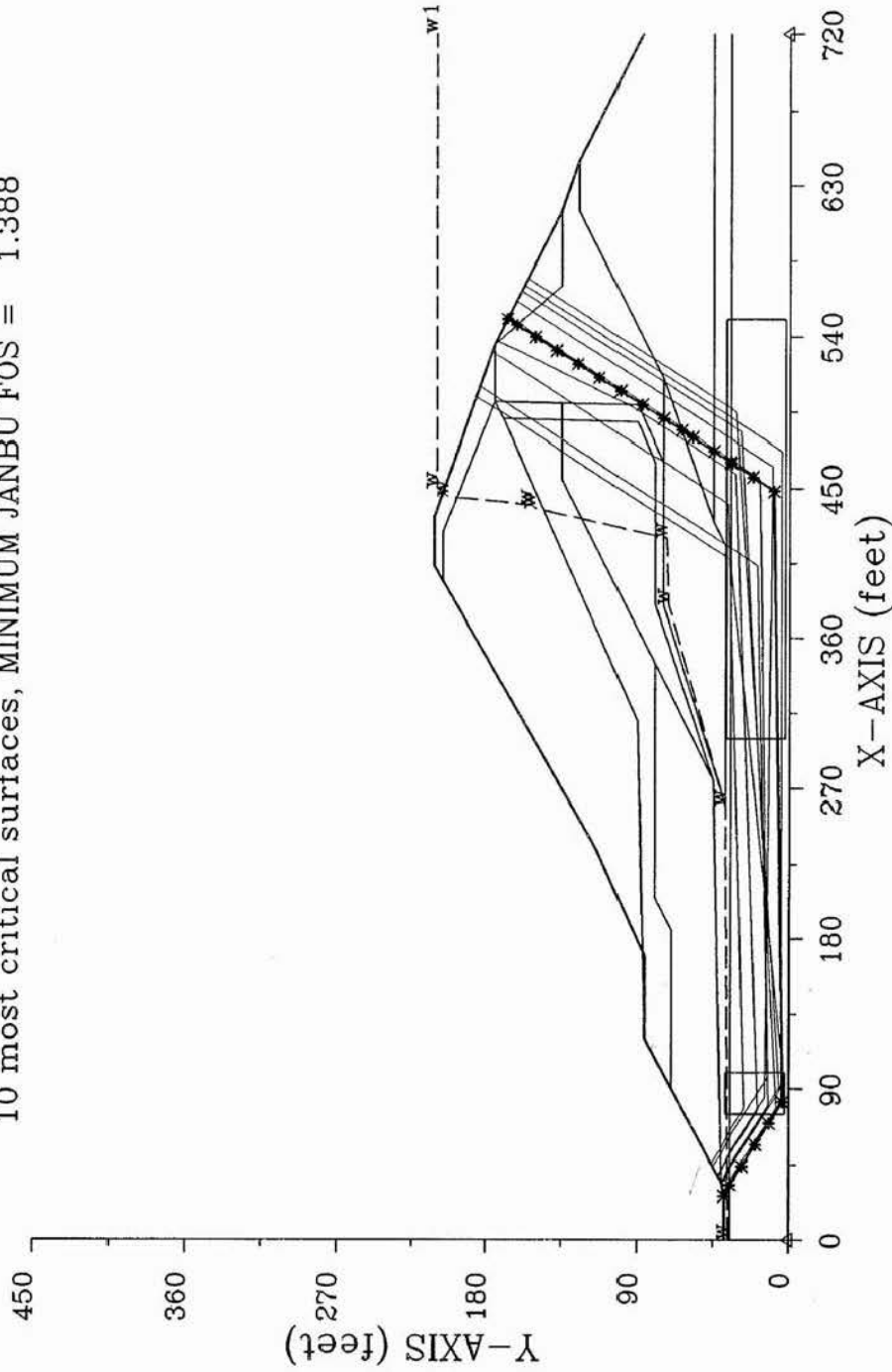

AEPBSP-001

IMAGE REFERENCE: "FLY ASH RETENTION DAM, STAGE 3 RAISING ENGINEERING REPORT" PREPARED BY AEP SERVICE CORPORATION, MARCH 1993, PAGE 171

Drawing Copyright © 2009



111 Winners Circle, PO Box 5288, Albany, NY 12205-0288
 Main (518) 433-4300 • www.chocomparia.com

STABILITY ANALYSIS – SURCHARGE POOL
– STATIC CONDITION
 BIG SANDY POWER PLANT
 LOUISA, KENTUCKY

PROJECT NO.
 20085.7000
 DATE: 12/20/09
 FIGURE 1.15

VF PE 12-30-92 12:50

STEADY SEEPAGE SURCHARGE POOL 709 EA
 10 most critical surfaces, MINIMUM JANBU FOS = 1.146

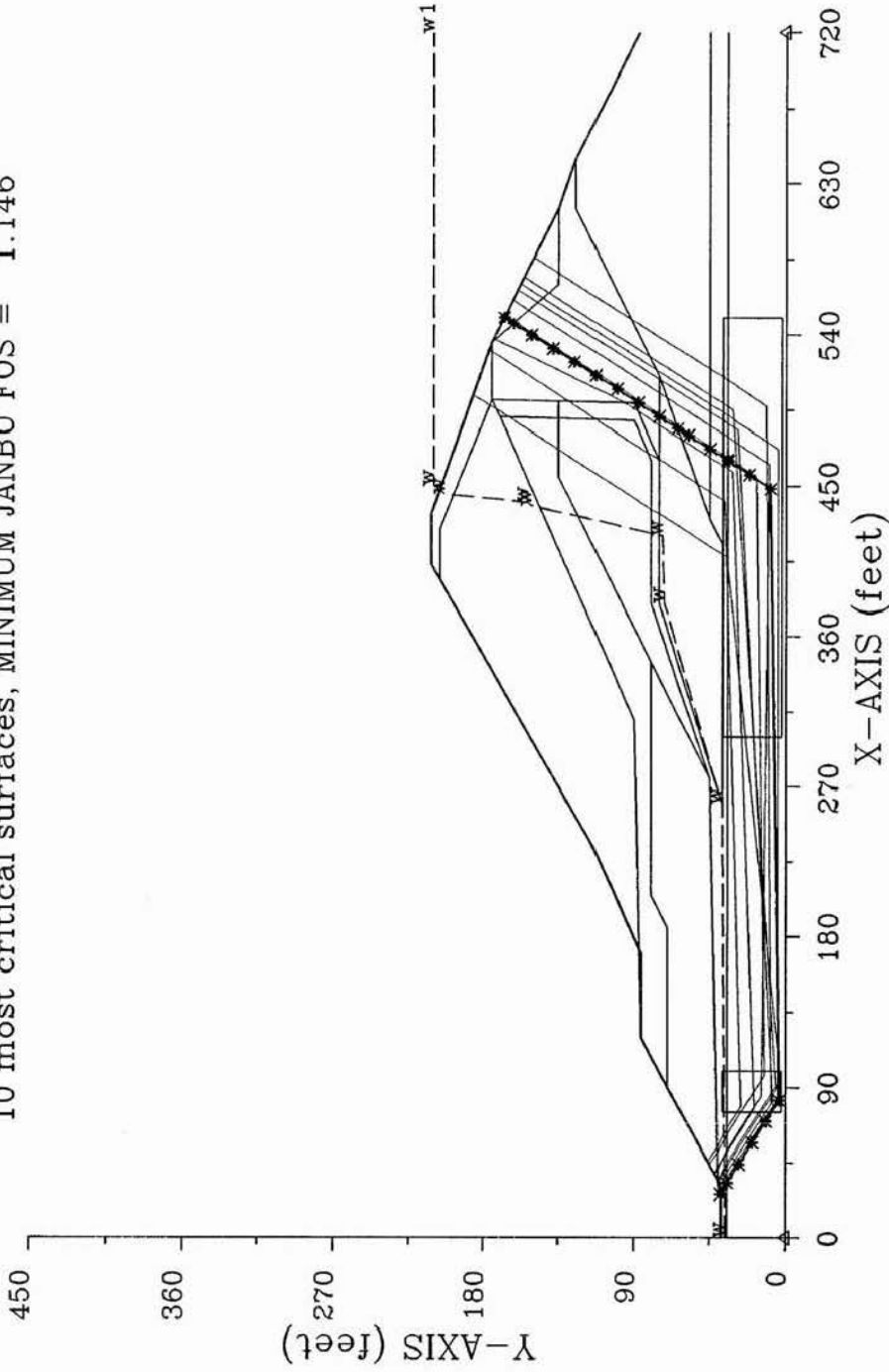

AEPBSP-00

IMAGE REFERENCE: "FLY ASH RETENTION DAM, STAGE 3 RAISING ENGINEERING REPORT" PREPARED BY AEP SERVICE CORPORATION, MARCH 1993, PAGE 172

Drawing Copyright © 2009



111 Winners Circle, PO Box 5268, Albany, NY 12205-0268
 Main (518) 433-4300 • www.chocomparia.com

STABILITY ANALYSIS – SURCHARGE POOL
– SEISMIC CONDITION
 BIG SANDY POWER PLANT
 LOUISA, KENTUCKY

| | |
|--|----------------|
| PROJECT NO. 20085.7000 | DATE: 12/20/09 |
| COMMISSION STAFF'S INITIAL SET OF DATA REQUESTS ORDER DATED SEPTEMBER 2, 2015 | ITEM NO. 4 |
| | PAGE 125 |
| FIGURE 172 | |

4.0 CONCLUSIONS/RECOMMENDATIONS

4.1 Acknowledgement of Management Unit Condition

I acknowledge that the **Fly Ash Pond** management unit referenced herein were personally inspected by me and was found to be in the following condition: **Satisfactory**. This indicates that no existing or potential management unit safety deficiencies are recognized and acceptable performance is expected under all applicable loading conditions.

I acknowledge that the **Bottom Ash Pond** management unit referenced herein were personally inspected by me and was found to be in the following condition: **Fair**. This indicates acceptable performance is expected under required loading conditions in accordance with applicable safety regulatory criteria; however some additional analyses should be performed and documented to verify that these criteria are met.

CHA presents the following recommendations for maintenance and updating of analyses to bring these facilities to satisfactory condition.

4.2 General Condition Monitoring and Maintenance

The following recommendations are based upon observations and review of data provided to CHA. Recommendations provided by the state, utility company, and other consultants should also be implemented.

4.2.1 Saddle Dam and Horseford Creek Dam

Visually, the upstream and downstream slopes of the Saddle and Horseford Creek Dams were found to be in satisfactory condition. A few areas were observed that warrant monitoring on a

routine basis to confirm that changes are not occurring or if periodic maintenance is required. These areas are as follows:

- An area of irregular grading was observed on the south end of the upstream slope. This area should be monitored to ensure that the irregularity is not the result of slope movement.
- Brush and trees have grown in the abutment area of the Saddle Dam and near the water's edge on the Horseford Creek Dam. Per the recommendation of KY Dam Safety, these trees should be cut. The resulting stumps should be monitored for decay.
- Vegetation should be kept clear from the toe drain outlets to permit observation of the flow.
- CHA recommends that the Horseford Creek Dam toe drains be located and cleared to facilitate monitoring for changed conditions.

4.2.2 Bottom Ash Complex Dikes

The slope of Bottom Ash Complex dikes were found to be in satisfactory condition. A few areas were observed that warrant monitoring on a routine basis to confirm that changes are not occurring or if periodic maintenance is required. These areas are as follows:

- Portions of the SBAP have recently be regraded and covered with grouted rip rap. We understand that this treatment is currently planned to extend to around the NBAP.
- Cut larger brush from the embankment where mowers cannot access the area.

4.3 Toe Drain Cleaning

The end of one underdrain pipe at the toe of the Horseford Creek Dam was observed to be partially blocked by gravel and cobbles and we understand that other pipes may be similarly

blocked. CHA recommends that the pipes be located and cleared so that the discharge can be observed and monitored.

4.4 Bottom Ash Complex Standing Water

Standing water was observed along the crest of the splitter dikes in the Bottom Ash Complex. Long term standing water can contribute to softening of the embankment toe and foundation soils. CHA recommends improving the drainage in this area to provide positive drainage of stormwater from the dike crests.

4.5 Seepage at the Fly Ash Pond

Calcium deposits were observed at the seepage drain pipe outlet within the old emergency spillway. Plant personnel indicated that deposit is likely from the limestone sand used in the drainage blanket and that the size of the deposit has stabilized since the end of construction. CHA recommends that the collected calcium deposit be removed and the discharge monitored for additional deposits. If the calcium continues to collect, an engineer should review the discharge conditions.

Seepage from the east abutment of the Horseford Creek Dam is milky from calcium deposits in the water from the limestone formation. CHA recommends that an engineer make an assessment of the impact of the deposits on the limestone underlying the dam.

4.6 Instrumentation

We understand that AEP reviews the instrumentation data from the Fly Ash Pond approximately every six months. However, the most recent survey data provided for the survey monitoring points is from October 21, 2008. CHA recommends that survey data be collected every 6 months to be consistent with the AEP data review. CHA noted significant scatter in the survey

data and potential heave at the toe of the Horseford Creek Dam. CHA therefore recommends a review of the survey methods and evaluation of this data given the history of past movement at this dam.

4.7 Rapid Drawdown Stability Analysis

A rapid drawdown analysis has not been performed for the Fly Ash Pond. Although the potential for this type of loading condition is low, it is standard dam safety practice to evaluate the condition for full understanding of the behavior of the upstream embankment should water need to be evacuated from the reservoir rapidly. There have also been documented case histories where other types of failure (such as a gate failure) have resulted in rapid drawdown conditions developing which have led to a domino effect and made the situation worse. Therefore, CHA recommends that a rapid drawdown analysis be performed for the Horseford Creek Dam and Saddle Dam.

4.8 Analysis for Bottom Ash Complex

We understand that geotechnical exploration program and analysis are being conducted for the Bottom Ash Complex. The report should include slope stability analysis for the load cases described herein and a hydraulic and hydrologic evaluation.

5.0 CLOSING

The information presented in this report is based on visual field observations, review of reports by others and this limited knowledge of the history of the Big Sandy Generating Station surface impoundments. The recommendations presented are based, in part, on project information available at the time of this report. No other warranty, expressed or implied is made. Should additional information or changes in field conditions occur the conclusions and recommendations provided in this report should be re-evaluated by an experienced engineer.

APPENDIX A

Completed EPA Coal Combustion Dam Inspection Checklist Forms

&

Completed EPA Coal Combustion Waste (CCW) Impoundment Inspection Forms



*Final Report
Assessment of Dam Safety of
Coal Combustion Surface Impoundments
American Electric Power
Big Sandy Generating Station
Louisa, Kentucky*



**Coal Combustion Waste (CCW)
Impoundment Inspection**

Impoundment NPDES Permit # _____ INSPECTOR _____
Date _____

Impoundment Name _____
Impoundment Company _____
EPA Region _____
State Agency (Field Office) Address _____

Name of Impoundment _____
(Report each impoundment on a separate form under the same Impoundment NPDES Permit number)

New _____ Update _____

| | | |
|--|-------|-------|
| | Yes | No |
| Is impoundment currently under construction? | _____ | _____ |
| Is water or ccw currently being pumped into the impoundment? | _____ | _____ |

IMPOUNDMENT FUNCTION: _____

Nearest Downstream Town : Name _____

Distance from the impoundment _____

Impoundment

Location: Longitude _____ Degrees _____ Minutes _____ Seconds
Latitude _____ Degrees _____ Minutes _____ Seconds
State _____ County _____

Does a state agency regulate this impoundment? YES _____ NO _____

If So Which State Agency? _____

CONFIGURATION:

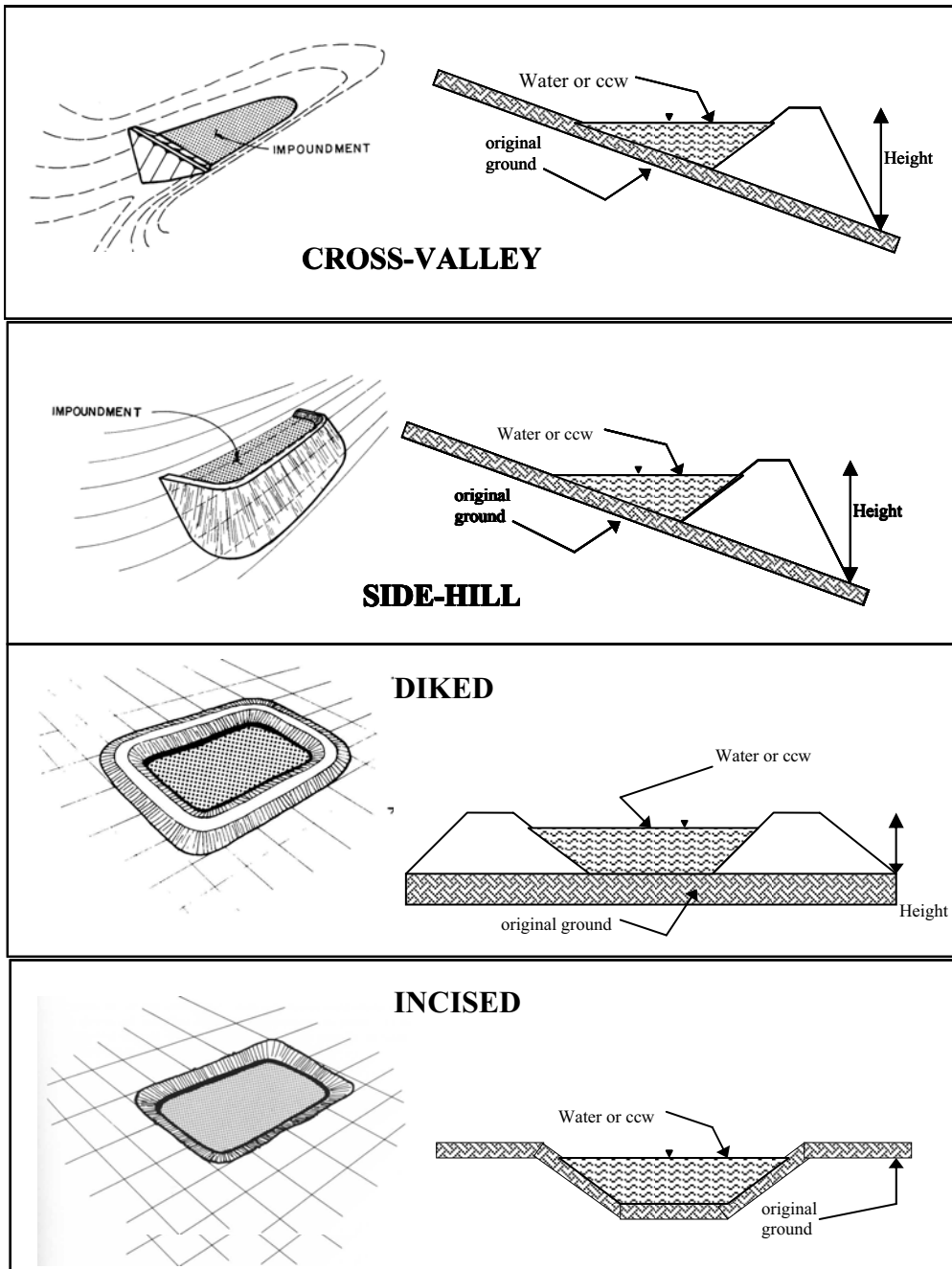

- _____ Cross-Valley
- _____ Side-Hill
- _____ Diked
- _____ Incised (form completion optional)
- _____ Combination Incised/Diked

Embankment Height _____ feet Embankment Material _____
 Pool Area _____ acres Liner _____
 Current Freeboard _____ feet Liner Permeability _____

TYPE OF OUTLET (Mark all that apply)

_____ **Open Channel Spillway**

- _____ Trapezoidal
- _____ Triangular
- _____ Rectangular
- _____ Irregular

TRAPEZOIDAL

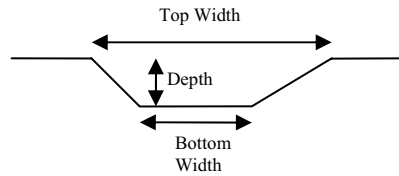

TRIANGULAR

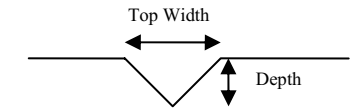

- _____ depth
- _____ bottom (or average) width
- _____ top width

RECTANGULAR

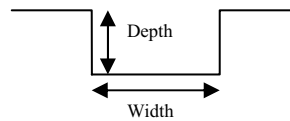

IRREGULAR

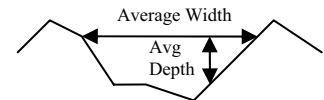

_____ **Outlet**

- _____ inside diameter

Material

- _____ corrugated metal
- _____ welded steel
- _____ concrete
- _____ plastic (hdpe, pvc, etc.)
- _____ other (specify) _____

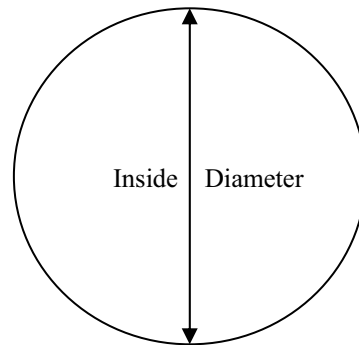

Is water flowing through the outlet? YES _____ NO _____

_____ **No Outlet**

_____ **Other Type of Outlet (specify)** _____

The Impoundment was Designed By _____

| | |
|--|--|
| Site Name: Big Sandy Generating Station | Date: 10-29-09 |
| Unit Name: Horseford Run Dam and Saddle Dam | Operator's Name: AEP |
| Unit I.D.: Horseford Run Dam | Hazard Potential Classification: High Significant Low |
| Inspector's Name: Katherine Adnams & Anthony Stellato, P.E. | |

Check the appropriate box below. Provide comments when appropriate. If not applicable or not available, record "N/A". Any unusual conditions or construction practices that should be noted in the comments section. For large diked embankments, separate checklists may be used for different embankment areas. If separate forms are used, identify approximate area that the form applies to in comments.

| | | Yes | No | | | Yes | No |
|--|--|-----|----|----------|---|-----|----|
| 1. Frequency of Company's Dam Inspections? | | | | See Note | | | |
| 2. Pool elevation (operator records)? | | | | 664 | | | |
| 3. Decant inlet elevation (operator records)? | | | | 664 | | | |
| 4. Open channel spillway elevation (operator records)? | | | | 706 | | | |
| 5. Lowest dam crest elevation (operator records)? | | | | 711 | | | |
| 6. If instrumentation is present, are readings recorded (operator records)? | | | | X | | | |
| 7. Is the embankment currently under construction? | | | | X | | | |
| 8. Foundation preparation (remove vegetation, stumps, topsoil in area where embankment fill will be placed)? | | | | NA | | | |
| 9. Trees growing on embankment? (If so, indicate largest diameter below) | | | | X | | | |
| 10. Cracks or scarps on crest? | | | | | X | | |
| 11. Is there significant settlement along the crest? | | | | | X | | |
| 12. Are decant trashracks clear and in place? | | | | X | | | |
| 13. Depressions or sinkholes in tailings surface or whirlpool in the pool area? | | | | | X | | |
| 14. Clogged spillways, groin or diversion ditches? | | | | | X | | |
| 15. Are spillway or ditch linings deteriorated? | | | | | X | | |
| 16. Are outlets of decant or underdrains blocked? | | | | X | | | |
| 17. Cracks or scarps on slopes? | | | | | X | | |
| 18. Sloughing or bulging on slopes? | | | | | | | X |
| 19. Major erosion or slope deterioration? | | | | | | | X |
| 20. Decant Pipes: | | | | | | | |
| Is water entering inlet, but not exiting outlet? | | | | | | | X |
| Is water exiting outlet, but not entering inlet? | | | | | | | X |
| Is water exiting outlet flowing clear? | | | | | | X | |
| 21. Seepage (specify location, if seepage carries fines, and approximate seepage rate below): | | | | | | | |
| From underdrain? | | | | | | X | |
| At isolated points on embankment slopes? | | | | | | | X |
| At natural hillside in the embankment area? | | | | | | | X |
| Over widespread areas? | | | | | | X | |
| From downstream foundation area? | | | | | | | X |
| "Boils" beneath stream or ponded water? | | | | | | | X |
| Around the outside of the decant pipe? | | | | | | | X |
| 22. Surface movements in valley bottom or on hillside? | | | | | | | X |
| 23. Water against downstream toe? | | | | | | | X |
| 24. Were Photos taken during the dam inspection? | | | | | | X | |

Major adverse changes in these items could cause instability and should be reported for further evaluation. Adverse conditions noted in these items should normally be described (extent, location, volume, etc.) in the space below and on the back of this sheet.

| <u>Inspection Issue #</u> | <u>Comments</u> | N/A = Not Applicable/Available |
|---------------------------|--|--------------------------------|
| 1. | Plant personnel make quarterly inspections, AEP Civil Group makes annual inspections. | |
| 7. | Phase 3 raising was substantially completed in the fall of 2009. Punch list being completed by the contractor. | |
| 9. | Occasional small trees noted in groin of the saddle dam and near the water's edge on the main dam. AEP indicated they had been sprayed with herbicide. KY Dam Safety representative requested they be cut as well. | |
| 21. | Toe drains at the Saddle Dam main toe and former emergency spillway plug have slight seepage (<5 gpm). Blanket drain area at toe of Main Dam and underdrain seepage along with some abutment drainage is collected at a V-notch weir. Observed at ~20gpm. Seepage clear except at former emergency spillway plug where calcareous minerals have sedimented in pipe and is making the seepage appear milky. | |
| 16. | The end of one underdrain pipe was partially blocked by gravel and cobbles. Flow was high enough that the appearance of boiling was observed until the end of the underdrain pipe was cleared. AEP personnel indicated there may be other underdrain pipe discharges also buried by the gravel in the same area. | |



U. S. Environmental Protection Agency

**Coal Combustion Waste (CCW)
 Impoundment Inspection**

Impoundment NPDES Permit # KY0000221 INSPECTOR Adnams/Stellato
 Date October 29, 2009

Impoundment Name Horseford Dam and Saddle Dam
 Impoundment Company AEP
 EPA Region 3
 State Agency (Field Office) Address 344 Christy Creek Road
Morehead, KY 40351

Name of Impoundment Horseford Dam and Saddle Dam
 (Report each impoundment on a separate form under the same Impoundment NPDES Permit number)

New _____ Update X

| | | |
|--|----------------------|-------|
| | Yes | No |
| Is impoundment currently under construction? | <u>X</u> | _____ |
| Is water or ccw currently being pumped into the impoundment? | _____ <u>X</u> _____ | _____ |

IMPOUNDMENT FUNCTION: Primarily Fly Ash disposal. Receives stormwater surge from Bottom Ash Complex

Nearest Downstream Town : Name Louisa, KY
 Distance from the impoundment 8 miles

Impoundment Location:
 Longitude 82 Degrees 37 Minutes 57 Seconds
 Latitude 38 Degrees 11 Minutes 12 Seconds
 State KY County Lawrence

Does a state agency regulate this impoundment? YES X NO _____

If So Which State Agency? KY Department of Environmental Protection - Dam Safety

HAZARD POTENTIAL (In the event the impoundment should fail, the following would occur):

 LESS THAN LOW HAZARD POTENTIAL: Failure or misoperation of the dam results in no probable loss of human life or economic or environmental losses.

 LOW HAZARD POTENTIAL: Dams assigned the low hazard potential classification are those where failure or misoperation results in no probable loss of human life and low economic and/or environmental losses. Losses are principally limited to the owner's property.

 SIGNIFICANT HAZARD POTENTIAL: Dams assigned the significant hazard potential classification are those dams where failure or misoperation results in no probable loss of human life but can cause economic loss, environmental damage, disruption of lifeline facilities, or can impact other concerns. Significant hazard potential classification dams are often located in predominantly rural or agricultural areas but could be located in areas with population and significant infrastructure.

X **HIGH HAZARD POTENTIAL:** Dams assigned the high hazard potential classification are those where failure or misoperation will probably cause loss of human life.

DESCRIBE REASONING FOR HAZARD RATING CHOSEN:

Homes immediately downstream of Horseford Run Dam are at risk of inundation in the event of a failure.

CONFIGURATION:

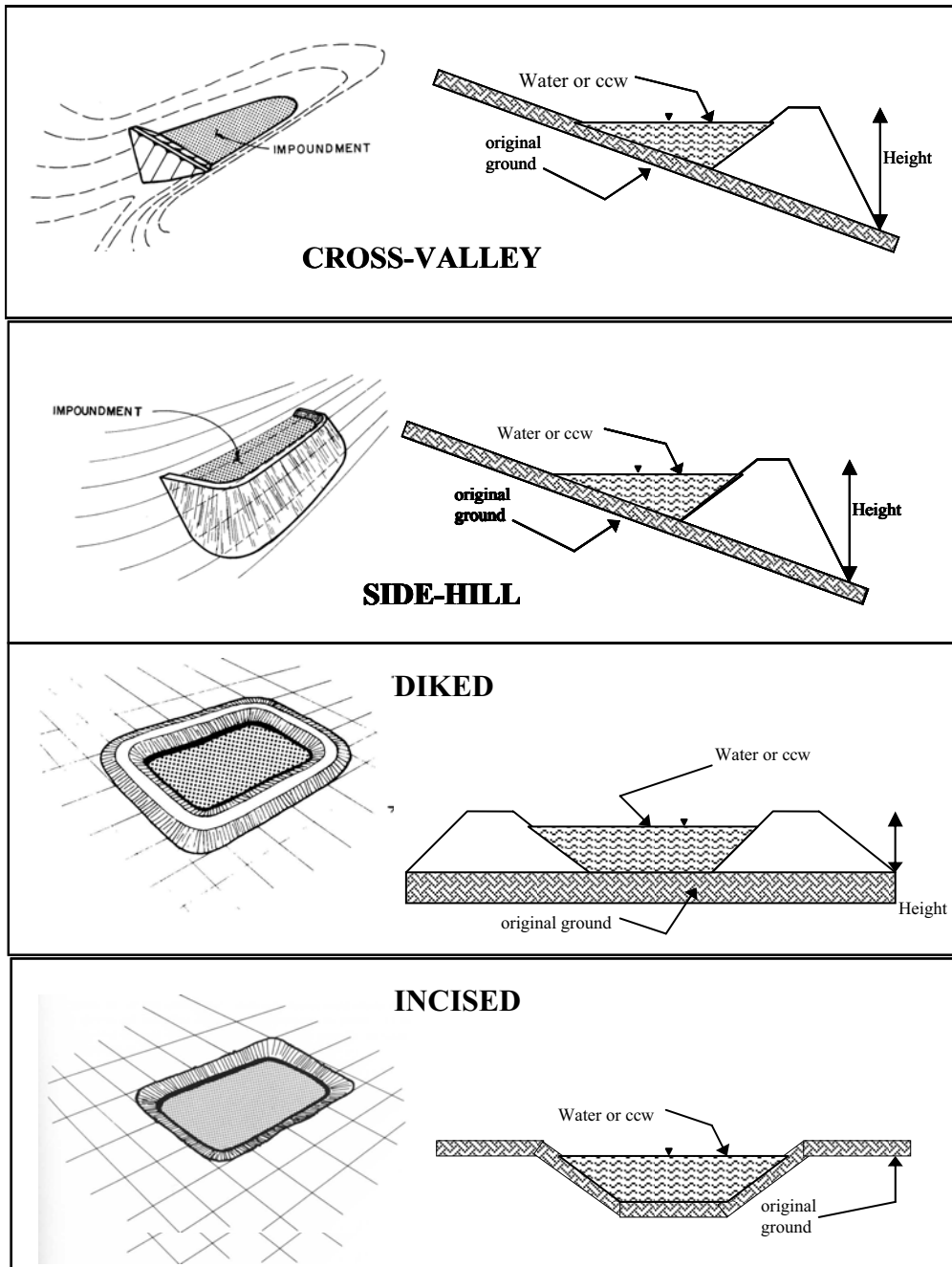

- Cross-Valley
- Side-Hill
- Diked
- Incised (form completion optional)
- Combination Incised/Diked

Embankment Height ~185 feet Embankment Material Zoned Embankment
 Pool Area ~113 (current) 176 (final) acres Liner None
 Current Freeboard 45 feet Liner Permeability Not Applicable

TYPE OF OUTLET (Mark all that apply)

 Open Channel Spillway

- Trapezoidal
- Triangular
- Rectangular
- Irregular

TRAPEZOIDAL

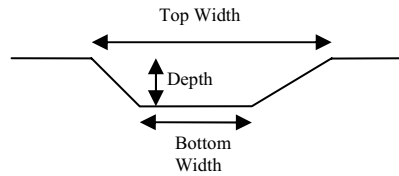

TRIANGULAR

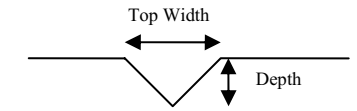

- depth
- bottom (or average) width
- top width

 X Emergency Spillway - El. 706
 Rectangular

RECTANGULAR

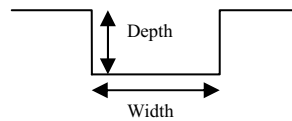

IRREGULAR

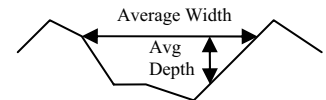

 X **Outlet**

 30 in. inside diameter (Primary)

Material

- corrugated metal
- welded steel
- X concrete
- plastic (hdpe, pvc, etc.)
- other (specify) _____

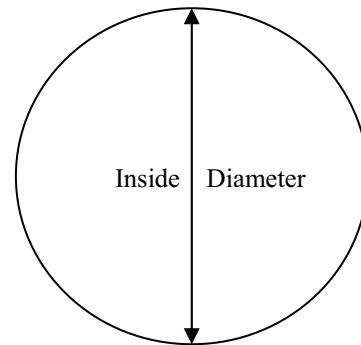

Is water flowing through the outlet? YES X NO _____
 (Primary)

 No Outlet

 Other Type of Outlet (specify) _____

The Impoundment was Designed By Final Raising by American Electric Power (AEP) Service Corporation

Has there ever been significant seepages at this site? YES _____ NO X

If So When? _____

IF So Please Describe: _____

Seepage at the Main Dam is routed through a V-notch wier. CHA observed flow at about 20 gpm. AEP indicated historic highs have been about 30 gpm. Seepage is clear.

Seepage at the Saddle Dam is clear at the toe drain pipe and minimal volume (<5 gpm). Seepage at the former Emergency Spillway plug is minimal (<5 gpm) but appears to be carrying calcareous minerals. AEP indicated that the deposits occurred shortly after construction and have reached an equilibrium.

