

COMMONWEALTH OF KENTUCKY
BEFORE THE PUBLIC SERVICE COMMISSION

In the Matter of:

APPLICATION OF KENTUCKY UTILITIES) CASE NO.
COMPANY FOR AN ADJUSTMENT OF ITS) 2014-00371
ELECTRIC RATES)

RESPONSE OF
KENTUCKY UTILITIES COMPANY
TO
LEXINGTON-FAYETTE URBAN COUNTY
GOVERNMENT'S REQUEST FOR INFORMATION
DATED JANUARY 7, 2015

FILED: JANUARY 23, 2015

VERIFICATION

COMMONWEALTH OF KENTUCKY)
) SS:
COUNTY OF JEFFERSON)

The undersigned, **Kent W. Blake**, being duly sworn, deposes and says that he is Chief Financial Officer for Kentucky Utilities Company and Louisville Gas and Electric Company and an employee of LG&E and KU Services Company, and that he has personal knowledge of the matters set forth in the responses for which he is identified as the witness, and the answers contained therein are true and correct to the best of his information, knowledge and belief.

K+W Blake

Kent W. Blake

Subscribed and sworn to before me, a Notary Public in and before said County and State, this 2nd day of January 2015.

Judy Schooler

Notary Public

(SEAL)

My Commission Expires:
JUDY SCHOOLER
Notary Public, State at Large, KY
My commission expires July 11, 2018

Notary ID # 512743

VERIFICATION

COMMONWEALTH OF KENTUCKY)
) SS:
COUNTY OF JEFFERSON)

The undersigned, **Dr. Martin J. Blake**, being duly sworn, deposes and states that he is a Principal of The Prime Group, LLC, that he has personal knowledge of the matters set forth in the responses for which he is identified as the witness, and the answers contained therein are true and correct to the best of his information, knowledge and belief.

Martin J. Blake
Dr. Martin J. Blake

Subscribed and sworn to before me, a Notary Public in and before said County and State, this 19th day of January 2015.

Judy Schuler (SEAL)
Notary Public

My Commission Expires:

JUDY SCHULER
Notary Public, State at Large, KY
My commission expires July 11, 2018
Notary ID # 512743

VERIFICATION

COMMONWEALTH OF KENTUCKY)
) SS:
COUNTY OF JEFFERSON)

The undersigned, **Robert M. Conroy**, being duly sworn, deposes and says that he is Director - Rates for Louisville Gas and Electric Company and Kentucky Utilities Company, an employee of LG&E and KU Services Company, and that he has personal knowledge of the matters set forth in the responses for which he is identified as the witness, and the answers contained therein are true and correct to the best of his information, knowledge and belief.

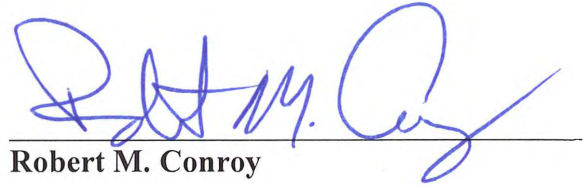
Robert M. Conroy

Subscribed and sworn to before me, a Notary Public in and before said County and State, this 20th day of January 2015.

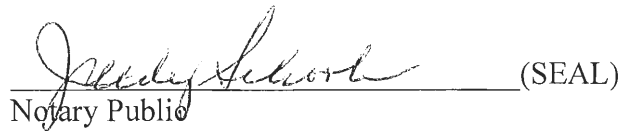

Notary Public (SEAL)

My Commission Expires:
JUDY SCHOOLER
Notary Public, State at Large, KY
~~My commission expires July 11, 2018~~
Notary ID # 512743

VERIFICATION

COMMONWEALTH OF KENTUCKY)
) SS:
COUNTY OF JEFFERSON)

The undersigned, **Christopher M. Garrett**, being duly sworn, deposes and says that he is Director – Accounting and Regulatory Reporting for Kentucky Utilities Company and Louisville Gas and Electric Company and an employee of LG&E and KU Services Company, that he has personal knowledge of the matters set forth in the responses for which he is identified as the witness, and the answers contained therein are true and correct to the best of his information, knowledge and belief.



Christopher M. Garrett

Subscribed and sworn to before me, a Notary Public in and before said County and State, this 19th day of January 2015.

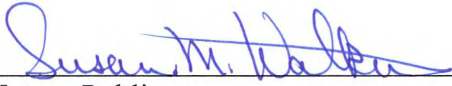

Notary Public (SEAL)

My Commission Expires:

SUSAN M. WATKINS

Notary Public, State at Large, KY
My Commission Expires Mar. 19, 2017
Notary ID # 485723

VERIFICATION

COMMONWEALTH OF KENTUCKY)
) SS:
COUNTY OF JEFFERSON)

The undersigned, **John P. Malloy**, being duly sworn, deposes and says that he is Vice President, Customer Services for Kentucky Utilities Company and Louisville Gas and Electric Company and an employee of LG&E and KU Services Company, and that he has personal knowledge of the matters set forth in the responses for which he is identified as the witness, and the answers contained therein are true and correct to the best of his information, knowledge and belief.

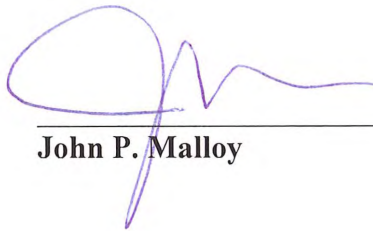

John P. Malloy

Subscribed and sworn to before me, a Notary Public in and before said County and State, this 20th day of January 2015.

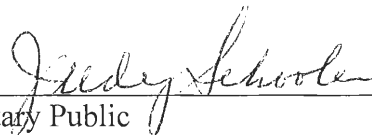

Notary Public (SEAL)

My Commission Expires:
JUDY SCHOOLER
Notary Public, State at Large, KY
My commission expires July 11, 2018
Notary ID # 512743

VERIFICATION

COMMONWEALTH OF KENTUCKY)
) SS:
COUNTY OF JEFFERSON)

The undersigned, **Edwin R. Staton**, being duly sworn, deposes and says that he is Vice President, State Regulation and Rates, for Kentucky Utilities Company and Louisville Gas and Electric Company and an employee of LG&E and KU Services Company, and that he has personal knowledge of the matters set forth in the responses for which he is identified as the witness, and the answers contained therein are true and correct to the best of his information, knowledge and belief.

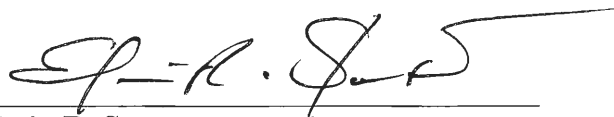

Edwin R. Staton

Subscribed and sworn to before me, a Notary Public in and before said County and State, this 19th day of January 2015.

 (SEAL)

Notary Public

My Commission Expires:

SUSAN M. WATKINS
Notary Public, State at Large, KY
My Commission Expires Mar. 10, 2017
Notary ID # 485723

VERIFICATION

COMMONWEALTH OF KENTUCKY)
) SS:
COUNTY OF JEFFERSON)

The undersigned, **Paul Gregory Thomas**, being duly sworn, deposes and says that he is Vice President, Electric Distribution, for Kentucky Utilities Company and Louisville Gas and Electric Company and an employee of LG&E and KU Services Company, and that he has personal knowledge of the matters set forth in the responses for which he is identified as the witness, and the answers contained therein are true and correct to the best of his information, knowledge and belief.

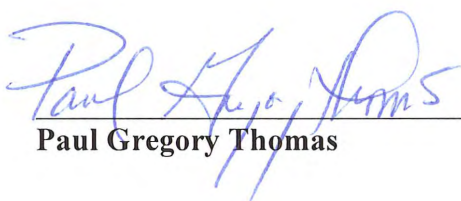

Paul Gregory Thomas

Subscribed and sworn to before me, a Notary Public in and before said County and State, this 28th day of January 2015.

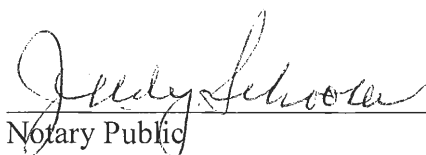

Notary Public (SEAL)

My Commission Expires:

JUDY SCHOOLER
Notary Public, State at Large, KY
My commission expires July 11, 2018
Notary ID # 512743

KENTUCKY UTILITIES COMPANY

CASE NO. 2014-00371

**Response to Lexington-Fayette Urban County
Government's Request for Information
Dated January 7, 2015**

Question No. 1

Responding Witness: Robert M. Conroy

Q-1. How many different types of customer rate classes does the LFUCG currently make payments to KU under? For each type of class, please provide the following information:

- (a) The type of customer rate class;
- (b) The number of LFUCG accounts in each such class;
- (c) The total amount paid by the LFUCG for each such class during the last 12 month period; and
- (d) The total net projected impact for each such class under the proposed rate increase.

A-1. a.- c: See below.

Customer Rate Class	Number of Accounts	2014 Revenue
General Service Single Phase	248	\$ 538,964.27
General Service Three Phase	125	\$ 658,401.95
Lighting Energy Service	1	\$ 24.83
Power Service - Secondary Pf Adj	2	\$ 275,173.11
Power Service Secondary	31	\$ 1,035,700.04
Residential Service	47	\$ 5,197.42
Residential Service - All Electric	11	\$ 11,941.12
Street Lights (combined for all types)	309	\$ 5,315,989.69
Time-of-Day Secondary Service	13	\$ 1,651,057.34
Time-of-Day Service - Primary	2	\$ 1,340,919.03
Traffic Energy Service	436	\$ 92,560.00
Traffic Energy Service - WiFi Receiver	272	\$ 25,325.92
	1,497	\$10,951,254.72

- d. KU has not performed the requested analysis on a customer rate class basis. The requested information on a rate schedule basis for KU can be found in Tab 65 Schedules M-2.1, 2.2, and 2.3 of the filing requirements.

KENTUCKY UTILITIES COMPANY

CASE NO. 2014-00371

**Response to Lexington-Fayette Urban County
Government's Request for Information
Dated January 7, 2015**

Question No. 2

Responding Witness: Robert M. Conroy

- Q-2. For each separate LFUCG account please provide a detailed analysis showing the impact of the proposed rate versus the existing rate using the most recent 12 month actual usage and billing data. Please also provide a detailed explanation of the formula that was used to obtain this information.
- A-2. KU has not performed the requested analysis on a customer-specific basis. The requested information on a rate schedule basis for KU can be found in Tab 65 Schedules M-2.1, 2.2, and 2.3 of the filing requirements.

KENTUCKY UTILITIES COMPANY

CASE NO. 2014-00371

**Response to Lexington-Fayette Urban County
Government's Request for Information
Dated January 7, 2015**

Question No. 3

Responding Witness: Edwin R. "Ed" Staton

- Q-3. Can KU's ratepayers expect any enhancement over the current existing level of service as a result of the proposed rate increase? If so, please provide a detailed response that includes the specific benefit or benefits to be provided to each particular customer rate class.
- (a) More specifically, will the LFUCG obtain any additional benefit or benefits (level of maintenance or otherwise) as a result of the proposed increase? If so, please provide a detailed response that includes the specific benefit or benefits to be provided to each particular customer rate class.

A-3. Response to 3 and 3(a):

It is essential that KU achieve and maintain a strong financial condition to allow it to continue to provide safe, reliable service to its customers. KU has made substantial investments in its utility infrastructure during the last several years and despite efforts to offset or absorb increased costs, revenues must be increased to reflect the cost of providing service and to continue to effectively meet its service obligation both now and in the future. As a result of the requested rate increase, KU expects to be able to continue to provide safe, reliable service to its customers at levels consistent with historical performance.

Please see the testimony of Paul Thompson for a detailed discussion of KU's investments in facilities and efforts to control costs since the last rate case.

KENTUCKY UTILITIES COMPANY

CASE NO. 2014-00371

**Response to Lexington-Fayette Urban County
Government's Request for Information
Dated January 7, 2015**

Question No. 4

Responding Witness: Edwin R. "Ed" Staton

- Q-4. Does KU have an estimate or general or specific information on how much revenue is derived from Fayette County customers? If so, please provide by customer class for each of the last 3 years as well as a comparison of the percentage of revenue that this constitutes in relation to all revenues.
- A-4. KU does not have a business reason to obtain or keep the requested customer information, and therefore cannot provide the requested response.

Each KU rate schedule applies equally to the entire 77-county KU service territory; KU does not have county-specific rates.

KENTUCKY UTILITIES COMPANY

CASE NO. 2014-00371

**Response to Lexington-Fayette Urban County
Government's Request for Information
Dated January 7, 2015**

Question No. 5

Responding Witness: Robert M. Conroy

- Q-5. How many additional customers (and of which particular customer rate class) does KU anticipate adding within Fayette County over the next 5 years? What is the anticipated level of additional revenue to KU as result of the addition of these customers?
- A-5. KU does not estimate additional customers or revenue by specific county.

KENTUCKY UTILITIES COMPANY

CASE NO. 2014-00371

**Response to Lexington-Fayette Urban County
Government's Request for Information
Dated January 7, 2015**

Question No. 6

Responding Witness: Robert M. Conroy

Q-6. Does the LFUCG's franchise fee apply to all tariffs for services provided in Fayette County? If not please identify each tariff for which the franchise fee does not apply.

A-6. The franchise fees apply to all tariffs with the exception of the following:

- Cable Television Attachment Charges
- Special Charges, which includes returned payment, meter test, disconnect/reconnect service, meter pulse, and meter data processing charges
- Curtailable Service Rider 10
- Curtailable Service Rider 30
- Small Capacity Cogeneration Qualifying Facilities
- Large Capacity Cogeneration Qualifying Facilities
- Net Metering
- Excess Facilities
- Redundant Capacity
- Supplemental/Stand-by Service
- Intermittent Load Rider
- Temporary/Seasonal Service Rider
- Green Energy Riders
- Economic Development Rider
- Late Payment Charges
- Line Extension
- Home Energy Assistance Program

In addition, pursuant to the franchise agreement with LFUCG, the franchise fee is not applied to those public street lights for which LFUCG is the customer.

KENTUCKY UTILITIES COMPANY

CASE NO. 2014-00371

**Response to Lexington-Fayette Urban County
Government's Request for Information
Dated January 7, 2015**

Question No. 7

Responding Witness: Paul Gregory "Greg" Thomas

Q-7. Please provide the total number of utility poles KU has in Fayette County and the number of these poles that are located in the public rights-of-way.

A-7. KU owns 62,436 poles in Fayette County.

KU does not track the number of poles located in the public rights-of-way.

KENTUCKY UTILITIES COMPANY

CASE NO. 2014-00371

**Response to Lexington-Fayette Urban County
Government's Request for Information
Dated January 7, 2015**

Question No. 8

Responding Witness: Robert M. Conroy / Dr. Martin J. Blake

Q-8. Does KU derive any rental or other income related to the use of or attachment to utility poles or other fixtures located within the public right-of-way? If so, please provide a detailed breakdown of the annual rents or other income received from any third parties attributable to these types of properties. If possible, further provide a breakdown within Fayette County, Kentucky.

a. Is this income considered revenue by KU; and if so, how is it allocated?

A-8. Yes. KU receives rental income from third party attachments to its poles, whether the poles are located within the public right-of-way or are located elsewhere. KU does not track pole attachment revenue by the location of the poles, and so does not have the detailed information requested.

a. Yes. Revenues received from pole attachments serve as a credit towards the cost of providing service to customers.

KENTUCKY UTILITIES COMPANY

CASE NO. 2014-00371

**Response to Lexington-Fayette Urban County
Government's Request for Information
Dated January 7, 2015**

Question No. 9

Responding Witness: Edwin R. "Ed" Staton

Q-9. Would KU be amenable to a proposal from LFUCG as to newly installed street lights which would provide for either: (a) lights purchased, owned and maintained by LFUCG, or (b) lights purchased and owned by LFUCG but maintained by KU?

A-9.

- (a) KU offers the Lighting Energy Services ("LE") tariff which allows LFUCG to purchase and to install the entire lighting unit; pole, fixture and accessories. Under that tariff, LFUCG would only be charged for the kWh consumed.
- (b) No. KU's standard practice is to not allow mixed-use or mixed-owned facilities between the Company and its customers. Obvious reasons for this include potential safety concerns and administrative burdens.

KENTUCKY UTILITIES COMPANY

CASE NO. 2014-00371

**Response to Lexington-Fayette Urban County
Government's Request for Information
Dated January 7, 2015**

Question No. 10

Responding Witness: Edwin R. "Ed" Staton

Q-10. Would KU be amenable to a proposal from LFUCG to acquire its existing street lights?

A-10. KU is always willing to discuss any needs, concerns or questions from its customers.

KENTUCKY UTILITIES COMPANY

CASE NO. 2014-00371

**Response to Lexington-Fayette Urban County
Government's Request for Information
Dated January 7, 2015**

Question No. 11

Responding Witness: Paul Gregory "Greg" Thomas

- Q-11. Please provide the number (quantity), rate type, type description, and location (by street address) of each street light located in Fayette County, Kentucky for which the LFUCG currently pays a monthly tariff.
- A-11. The number of lights by size, type, and description is shown in the table below through November, 2014. See the attachment for Street addresses applicable to each light.

# OF LTS	SIZE/TYPE	RATE CODE	FIXTURE
174	16000 GRANV STLT-A	360	GRANVILLE
25	16000 GRANV STLT-B	361	GRANVILLE
43	16000 GRANV STLT-C	362	GRANVILLE
5	16000 GRANV STLT-D	363	GRANVILLE
1	16000 GRANV STLT-E	364	GRANVILLE
5	16000 GRANV STLT-F	365	GRANVILLE
9	16000 GRANV STLT-G	366	GRANVILLE
17	16000 GRANV STLT-B3	367	GRANVILLE
1	16000 GRANV STLT-I	368	GRANVILLE
13	16000 GRANV STLT-A1	370	GRANVILLE
1	16000 GRANV STLT-E1	372	GRANVILLE
20	16000 GRANV STLT-A2	373	GRANVILLE
4	16000 GRANV STLT-B3	374	GRANVILLE
3	16000 GRANV STLT-G1	375	GRANVILLE
10	16000 GRANV STLT-B2	376	GRANVILLE
51	16000 GRANV STLT-A3	377	GRANVILLE

382 TOTAL - GRANVILLE

# OF LTS	SIZE/TYPE	RATE CODE	FIXTURE
23	9500 ACORN DEC	420	ACORN
677	10000 SOH MV	447	COBRA
314	20000 SOH MV	448	COBRA
22	10000 OOH MV	457	COBRA
407	10000 OUG MV	457	COBRA
548	20000 OUG MV	458	COBRA
246	20000 OOH MV	458	COBRA
656	4000 SOH HPS	461	COBRA
1,709	5800 SOH HPS	462	COBRA
966	9500 SOH HPS	463	COBRA
606	22000 SOH HPS	464	COBRA
132	50000 SOH HPS	465	COBRA
50	5800 CLN	467	COLONIAL
322	9500 CLN	468	COLONIAL
3,599	4000 OUG HPS	471	COBRA
35	4000 OOH HPS	471	COBRA
8,626	5800 OUG HPS	472	COBRA
125	5800 OOH HPS	472	COBRA
1,823	9500 OUG HPS	473	COBRA
35	9500 OOH HPS	473	COBRA
215	22000 OOH HPS	474	COBRA
2,688	22000 OUG HPS	474	COBRA
40	50000 OOH HPS	475	COBRA
164	50000 OUG HPS	475	COBRA
4,621	5800 CNT	476	CONTEMP.
459	9500 CNT	477	CONTEMP.
511	22000 CNT	478	CONTEMP.
78	50000 CNT	479	CONTEMP.
21	9500 DEC POL COL.	482	COLONIAL

29,718 TOTAL - STANDARD

OFFICE: 311		ROUTE: 564		ST_REF_NO: 0000000050		ABBINGTON HILL				
LUMENS	BULB TYPE	MULT SERIES	POLE TYPE	SHADE	ADDRESS NUMBER	REF	LOCATION	TAX DIST	DATE INST	DATE CHANGE
05800	S	M	OUG	III	01705	005		12	010897	1/1/0001
05800	S	M	OUG	II	01720	004		12	010897	1/1/0001
05800	S	M	OUG	II	01729	003		12	010897	1/1/0001
05800	S	M	OUG	II	01744	002		12	010897	1/1/0001
05800	S	M	OUG	II	01753	001		12	010897	1/1/0001

OFFICE: 311		ROUTE: 564		ST_REF_NO: 0000000100		ABBOTT ROAD				
LUMENS	BULB TYPE	MULT SERIES	POLE TYPE	SHADE	ADDRESS NUMBER	REF	LOCATION	TAX DIST	DATE INST	DATE CHANGE
05800	S	M	OUG	II	00000	001	SIDE OF 3062 BRECKENWOOD DR.	12	050888	9/9/2009
04000	S	M	OUG	II	00760	005	corrected address per audit	12	050888	10/11/2011
04000	S	M	OUG	II	00773	004		12	050888	1/1/0001
04000	S	M	OUG	II	00778	003		12	050888	1/1/0001
04000	S	M	OUG	II	00000	006	SIDE 595 ALBANY RD.	12	050888	1/1/0001
04000	S	M	OUG	II	00790	002		12	050888	1/1/0001

OFFICE: 311		ROUTE: 564		ST_REF_NO: 0000000200		ABDUL COURT				
LUMENS	BULB TYPE	MULT SERIES	POLE TYPE	SHADE	ADDRESS NUMBER	REF	LOCATION	TAX DIST	DATE INST	DATE CHANGE
04000	S	M	OUG	II	00000	021	SIDE OF 1156 BAY MEADOWS-PER AUDIT	12	031581	10/11/2011

OFFICE: 311		ROUTE: 564		ST_REF_NO: 0000000300		ABELIA DRIVE				
LUMENS	BULB TYPE	MULT SERIES	POLE TYPE	SHADE	ADDRESS NUMBER	REF	LOCATION	TAX DIST	DATE INST	DATE CHANGE
05800	S	M	OUG	II	00000	000	SIDE OF 938 LANE ALLEN RD	12	120165	10/11/2011
05800	S	M	OUG	II	00000	001	SIDE OF 901 HONEYSUCKLE RD.	12	120165	1/1/0001
05800	S	M	OUG	II	02012	000		12	120165	1/1/0001

OFFICE: 311		ROUTE: 564		ST_REF_NO: 0000000400		ABERDEEN DRIVE				
LUMENS	BULB TYPE	MULT SERIES	POLE TYPE	SHADE	ADDRESS NUMBER	REF	LOCATION	TAX DIST	DATE INST	DATE CHANGE
05800	S	M	OUG	II	00212	041		12	010886	9/9/2009
05800	S	M	OUG	II	00233	044		12	010886	9/4/2013
09500	S	M	OUG	II	00239	045		12	010886	9/9/2009
04000	S	M	OUG	II	00221	042		12	010886	1/1/0001

OFFICE: 311		ROUTE: 564		ST_REF_NO: 00000000400		ABERDEEN DRIVE		LUMENS	BULB TYPE	MULT SERIES	POLE TYPE	SHADE	ADDRESS NUMBER	REF	LOCATION	TAX DIST	DATE INST	DATE CHANGE
04000	S	M	OUG	II	00224	043										12	010886	1/1/0001
04000	S	M	OUG	II	00242	046										12	010886	1/1/0001
OFFICE: 311		ROUTE: 564		ST_REF_NO: 00000000450		ABINGER COURT		LUMENS	BULB TYPE	MULT SERIES	POLE TYPE	SHADE	ADDRESS NUMBER	REF	LOCATION	TAX DIST	DATE INST	DATE CHANGE
05800	S	M	CNT	II	02901	001										12	113005	1/1/0001
05800	S	M	CNT	III	02912	002										12	113005	1/1/0001
OFFICE: 311		ROUTE: 564		ST_REF_NO: 00000000500		ACADEMY ALLEY		LUMENS	BULB TYPE	MULT SERIES	POLE TYPE	SHADE	ADDRESS NUMBER	REF	LOCATION	TAX DIST	DATE INST	DATE CHANGE
05800	S	M	SOH	I	00000	002								1ST LT EAST OF LIME ON S SIDE	12	120869	10/11/2011	
05800	S	M	SOH	I	00000	003								2ND LT E. OF LIME ON S. SIDE	12	120869	10/11/2011	
05800	S	M	SOH	I	00000	004								3RD LT E. OF LIME ON S. SIDE	12	120869	10/11/2011	
05800	S	M	SOH	I	00000	005								4TH LT E. OF LIME ON S. SIDE	12	120869	10/11/2011	
05800	S	M	SOH	I	00000	006								5TH LT E. OF LIME ON S. SIDE	12	120869	10/11/2011	
05800	S	M	SOH	I	00000	007								6TH LT E. OF LIME ON S. SIDE	12	120869	10/11/2011	
OFFICE: 311		ROUTE: 564		ST_REF_NO: 00000000550		ACORN COURT		LUMENS	BULB TYPE	MULT SERIES	POLE TYPE	SHADE	ADDRESS NUMBER	REF	LOCATION	TAX DIST	DATE INST	DATE CHANGE
04000	S	M	OUG	II	02205	002										12	120889	1/1/0001
04000	S	M	OUG	V	02216	001										12	110892	1/1/0001
OFFICE: 311		ROUTE: 564		ST_REF_NO: 00000000555		ACORN FALLS DRIVE		LUMENS	BULB TYPE	MULT SERIES	POLE TYPE	SHADE	ADDRESS NUMBER	REF	LOCATION	TAX DIST	DATE INST	DATE CHANGE
05800	S	M	OUG	II	00169	001										12	083104	1/1/0001
05800	S	M	OUG	II	00176	002										12	083104	10/11/2011
05800	S	M	OUG	II	00193	003										12	083104	1/1/0001
05800	S	M	OUG	II	00200	004										12	083104	1/1/0001
05800	S	M	OUG	III	00209	005										12	083104	1/1/0001

OFFICE: 311

ROUTE: 564

ST_REF_NO: 0000000600 ADAIR ROAD

LUMENS	BULB TYPE	MULT SERIES	POLE TYPE	SHADE	ADDRESS NUMBER	REF	LOCATION	TAX DIST	DATE INST	DATE CHANGE
05800	S	M	OUG	III	00000	000	SIDE OF 1905 HART RD	12	041759	10/11/2011
05800	S	M	OUG	III	00443	000		12	072263	10/11/2011
05800	S	M	OUG	III	00451	000		12	072263	10/11/2011
05800	S	M	OUG	III	00412	000		12	030766	1/1/0001
05800	S	M	OUG	III	00419	000		12	030766	1/1/0001
05800	S	M	OUG	III	00430	000		12	060161	1/1/0001

OFFICE: 311

ROUTE: 564

ST_REF_NO: 0000000700 ADDIE STREET

LUMENS	BULB TYPE	MULT SERIES	POLE TYPE	SHADE	ADDRESS NUMBER	REF	LOCATION	TAX DIST	DATE INST	DATE CHANGE
04000	S	M	SOH	V	00439	009		12	100466	9/9/2009
05800	S	M	SOH	I	00459	008		12	100466	10/11/2011

OFFICE: 311

ROUTE: 564

ST_REF_NO: 0000000800 ADDISON AVENUE

LUMENS	BULB TYPE	MULT SERIES	POLE TYPE	SHADE	ADDRESS NUMBER	REF	LOCATION	TAX DIST	DATE INST	DATE CHANGE
09500	S	M	SOH	II	00502	031	upgraded 10/05	12	020886	10/11/2011
09500	S	M	SOH	II	00521	034	found light not on books-upgraded 10/05	12	092405	1/1/0001
09500	S	M	SOH	II	00514	033	upgraded 10/05	12	020886	1/1/0001
09500	S	M	SOH	II	00523	035	upgraded 10/05	12	020886	1/1/0001
09500	S	M	SOH	II	00506	032	upgraded 10/05	12	020886	1/1/0001

OFFICE: 311

ROUTE: 564

ST_REF_NO: 0000000810 ADDISON AVENUE (fka N Addison)

LUMENS	BULB TYPE	MULT SERIES	POLE TYPE	SHADE	ADDRESS NUMBER	REF	LOCATION	TAX DIST	DATE INST	DATE CHANGE
09500	S	M	SOH	II	00607	038	upgrade 10/05	12	020886	10/11/2011
09500	S	M	SOH	II	00613	039	upgraded 10/05	12	020886	10/11/2011
09500	S	M	SOH	II	00625	041	upgraded 10/05	12	020886	10/11/2011
09500	S	M	SOH	II	00629	042	upgraded 10/05	12	020886	10/11/2011
09500	S	M	SOH	II	00713	043	upgraded 10/05	12	020886	10/11/2011
09500	S	M	SOH	II	00725	044	upgraded 10/05	12	020886	10/11/2011
09500	S	M	SOH	II	00729	045	upgrade 10/05	12	020886	1/1/0001
09500	S	M	SOH	II	00745	046	upgrade 10/05	12	020886	1/1/0001
09500	S	M	SOH	II	00757	047	upgraded 10/05	12	020886	1/1/0001

OFFICE: 311		ROUTE: 564		ST_REF_NO: 0000000810		ADDISON AVENUE (fka N Addison)		LUMENS	BULB TYPE	MULT SERIES	POLE TYPE	SHADE	ADDRESS NUMBER	REF	LOCATION	TAX DIST	DATE INST	DATE CHANGE
09500	S	M	SOH	II	00520	065	upgraded 10/05	12	020886	1/1/0001								
09500	S	M	SOH	II	00601	037	upgrade 10/05	12	020886	1/1/0001								
09500	S	M	SOH	II	00617	040	upgraded 10/05	12	020886	1/1/0001								

OFFICE: 311		ROUTE: 564		ST_REF_NO: 0000000820		GOLF VIEW DRIVE (fka S Addison)		LUMENS	BULB TYPE	MULT SERIES	POLE TYPE	SHADE	ADDRESS NUMBER	REF	LOCATION	TAX DIST	DATE INST	DATE CHANGE
09500	S	M	SOH	II	00706	057	upgraded 10/05	12	020886	1/1/0001								
09500	S	M	SOH	II	00712	056	upgraded 10/05	12	020886	1/1/0001								
09500	S	M	SOH	II	00720	055	upgraded 10/05	12	020886	1/1/0001								
09500	S	M	SOH	II	00722	054	upgraded 10/05	12	020886	1/1/0001								
09500	S	M	SOH	II	00730	053	upgraded 10/05	12	020886	1/1/0001								
09500	S	M	SOH	II	00732	051	upgraded 10/05	12	020886	1/1/0001								
09500	S	M	SOH	II	00802	050	upgraded 10/05	12	020886	1/1/0001								
09500	S	M	SOH	II	00622	064	upgraded 10/05	12	020886	1/1/0001								
09500	S	M	SOH	II	00626	063	upgraded 10/05	12	020886	1/1/0001								
09500	S	M	SOH	II	00632	062	upgraded 10/05	12	020886	1/1/0001								
09500	S	M	SOH	II	00638	061	upgraded 10/05	12	020886	1/1/0001								
09500	S	M	SOH	II	00646	060	upgraded 10/05	12	020886	1/1/0001								
09500	S	M	SOH	II	00650	059	upgraded 10/05	12	020886	1/1/0001								
09500	S	M	SOH	II	00700	058	upgraded 10/05	12	020886	1/1/0001								

OFFICE: 311		ROUTE: 564		ST_REF_NO: 0000000950		ADWALTON ROAD		LUMENS	BULB TYPE	MULT SERIES	POLE TYPE	SHADE	ADDRESS NUMBER	REF	LOCATION	TAX DIST	DATE INST	DATE CHANGE
05800	S	M	CNT	II	00000	001	SIDE OF 2153 MARKET GARDEN LANE ON ADWALTON RD	12	100505	1/1/0001								
05800	S	M	CNT	II	03013	002		12	100505	10/11/2011								
05800	S	M	CNT	III	03029	003		12	100505	1/1/0001								

OFFICE: 311		ROUTE: 564		ST_REF_NO: 00000001000		AFFIMMED COURT		LUMENS	BULB TYPE	MULT SERIES	POLE TYPE	SHADE	ADDRESS NUMBER	REF	LOCATION	TAX DIST	DATE INST	DATE CHANGE
05800	S	M	OUG	II	02901	007		12	110884	9/9/2009								
04000	S	M	OUG	V	02908	008		12	110884	1/1/0001								

OFFICE: 311		ROUTE: 564		ST_REF_NO: 0000001120		AIRPORT ROAD		LUMENS	BULB TYPE	MULT SERIES	POLE TYPE	SHADE	ADDRESS NUMBER	REF	LOCATION	TAX DIST	DATE INST	DATE CHANGE
22000	S	M	OUG	III	00000	001	1ST LT W OF MAN-O-WAR,N SIDE	12	110891	10/11/2011								
22000	S	M	OUG	III	00000	002	2ND LT W OF MAN-O-WAR,S SIDE	12	110891	10/11/2011								
22000	S	M	OUG	III	00000	003	3RD LT W OF MAN-O-WAR,N SIDE	12	110891	10/11/2011								
09500	S	M	OUG	II	00000	004	4TH LT W OF MAN-O-WAR,S SIDE	12	110891	10/11/2011								
09500	S	M	OUG	II	00000	005	5TH LT W OF MAN-O-WAR,N SIDE	12	110891	10/11/2011								
09500	S	M	OUG	II	00000	006	6TH LT W OF MAN-O-WAR,S SIDE	12	110891	10/11/2011								
09500	S	M	OUG	II	00000	007	7TH LT W OF MAN-O-WAR,N SIDE	12	110891	10/11/2011								
09500	S	M	OUG	II	00000	008	8TH LT W OF MAN-O-WAR,S SIDE	12	110891	10/11/2011								
09500	S	M	OUG	II	00000	009	9TH LT W OF MAN-O-WAR,N SIDE	12	110891	10/11/2011								
OFFICE: 311		ROUTE: 564		ST_REF_NO: 0000001125		TERMINAL DRIVE		LUMENS	BULB TYPE	MULT SERIES	POLE TYPE	SHADE	ADDRESS NUMBER	REF	LOCATION	TAX DIST	DATE INST	DATE CHANGE
22000	S	M	OUG	III	00000	005	1ST LT. W. OF MAN-O-WAR IN MEDIAN, S SIDE	12	020891	10/11/2011								
22000	S	M	OUG	III	00000	006	1ST LT. W. OF MAN-O-WAR IN MEDIAN, N SIDE	12	020891	10/11/2011								
22000	S	M	OUG	III	00000	007	2ND LT. W. OF MAN-O-WAR IN MEDIAN, S SIDE	12	020891	10/11/2011								
22000	S	M	OUG	III	00000	008	2ND LT. W. OF MAN-O-WAR IN MEDIAN, N SIDE	12	020891	10/11/2011								
OFFICE: 311		ROUTE: 564		ST_REF_NO: 0000001200		AK SAR BEN PARK		LUMENS	BULB TYPE	MULT SERIES	POLE TYPE	SHADE	ADDRESS NUMBER	REF	LOCATION	TAX DIST	DATE INST	DATE CHANGE
22000	S	M	OUG	II	01268	137		12	041475	9/9/2009								
05800	S	M	OUG	II	00000	136	SIDE 3567 RIVER PARK DR. ON AK-SAR-BEN	12	041475	1/1/0001								
05800	S	M	OUG	II	01248	139		12	041475	1/1/0001								
05800	S	M	OUG	II	01265	138		12	041475	1/1/0001								
OFFICE: 311		ROUTE: 564		ST_REF_NO: 0000001300		ALABAMA AVENUE		LUMENS	BULB TYPE	MULT SERIES	POLE TYPE	SHADE	ADDRESS NUMBER	REF	LOCATION	TAX DIST	DATE INST	DATE CHANGE
04000	S	M	SOH	III	00000	005	SIDE REAR OF 648 N LIMESTONE	12	070894	10/11/2011								
05800	S	M	SOH	III	00000	001	SIDE 648 N. LIME-upgrade 1/08	12	070894	1/1/0001								
04000	S	M	SOH	III	00123	002		12	070894	1/1/0001								
04000	S	M	SOH	III	00135	006		12	070894	1/1/0001								
04000	S	M	SOH	III	00148	003		12	070894	1/1/0001								

OFFICE: 311

ROUTE: 564

ST_REF_NO: 00000001300

ALABAMA AVENUE

LUMENS	BULB TYPE	MULT SERIES	POLE TYPE	SHADE	ADDRESS NUMBER	REF	LOCATION	TAX DIST	DATE INST	DATE CHANGE
04000	S	M	SOH	III	00157	007		12	070894	1/1/0001
04000	S	M	SOH	III	00171	004		12	070894	1/1/0001

OFFICE: 311

ROUTE: 564

ST_REF_NO: 00000001400

ALBANY CIRCLE

LUMENS	BULB TYPE	MULT SERIES	POLE TYPE	SHADE	ADDRESS NUMBER	REF	LOCATION	TAX DIST	DATE INST	DATE CHANGE
05800	S	M	OUG	II	00000	011	SIDE OF 3104 MONTAVESTA	12	042067	1/1/0001
05800	S	M	OUG	V	00925	000		12	110172	1/1/0001

OFFICE: 311

ROUTE: 564

ST_REF_NO: 00000001500

ALBANY ROAD

LUMENS	BULB TYPE	MULT SERIES	POLE TYPE	SHADE	ADDRESS NUMBER	REF	LOCATION	TAX DIST	DATE INST	DATE CHANGE
05800	S	M	OUG	II	00210	035		12	051581	10/11/2011
05800	S	M	OUG	II	00226	033		12	110886	10/11/2011
05800	S	M	OUG	II	00250	031		12	110886	10/11/2011
05800	S	M	OUG	II	00530	017		12	110886	10/11/2011
05800	S	M	OUG	II	00840	006		12	110886	10/11/2011
05800	S	M	OUG	II	00848	005		12	110886	10/11/2011
05800	S	M	OUG	II	00202	036		12	051581	1/1/0001
05800	S	M	OUG	II	00219	034		12	051581	1/1/0001
05800	S	M	OUG	II	00229	032		12	110886	1/1/0001
05800	S	M	OUG	II	00257	030		12	110886	1/1/0001
05800	S	M	OUG	II	00266	029		12	110886	1/1/0001
05800	S	M	OUG	II	00277	028		12	110886	1/1/0001
05800	S	M	OUG	II	00300	027		12	110886	1/1/0001
05800	S	M	OUG	II	00313	026		12	110886	1/1/0001
05800	S	M	OUG	II	00320	025		12	110886	1/1/0001
05800	S	M	OUG	II	00329	024		12	110886	1/1/0001
05800	S	M	OUG	II	00336	023		12	110886	1/1/0001
05800	S	M	OUG	II	00345	022		12	110886	1/1/0001
05800	S	M	OUG	II	00352	021		12	110886	1/1/0001
05800	S	M	OUG	II	00361	020		12	110886	1/1/0001
05800	S	M	OUG	II	00364	019		12	110886	1/1/0001
05800	S	M	OUG	II	00501	018		12	110886	1/1/0001

OFFICE: 311

ROUTE: 564

ST_REF_NO: 0000001500 ALBANY ROAD

LUMENS	BULB TYPE	MULT SERIES	POLE TYPE	SHADE	ADDRESS NUMBER	REF	LOCATION	TAX DIST	DATE INST	DATE CHANGE
05800	S	M	OUG	II	00551	016		12	110886	1/1/0001
05800	S	M	OUG	II	00570	015		12	110886	1/1/0001
05800	S	M	OUG	II	00591	014		12	110886	1/1/0001
05800	S	M	OUG	II	00700	013		12	110886	1/1/0001
05800	S	M	OUG	II	00721	012		12	110886	1/1/0001
05800	S	M	OUG	II	00730	011		12	110886	1/1/0001
05800	S	M	OUG	II	00761	010		12	110886	1/1/0001
05800	S	M	OUG	II	00770	009		12	110886	1/1/0001
05800	S	M	OUG	II	00000	001	SIDE 3105 TATES CREEK RD.	12	110886	1/1/0001
05800	S	M	OUG	II	00000	002	SIDE 3105 TATES CREEK RD.	12	110886	1/1/0001
05800	S	M	OUG	II	00000	003	SIDE 3075 WINDEMERE RD.	12	110886	1/1/0001
05800	S	M	OUG	II	00000	012	SIDE OF 3200 TATES CREEK RD.	12	110172	1/1/0001
05800	S	M	OUG	II	00787	008		12	110886	1/1/0001
05800	S	M	OUG	II	00798	007		12	110886	1/1/0001
05800	S	M	OUG	II	00860	004		12	110886	1/1/0001
05800	S	M	OUG	II	00905	000		12	042067	1/1/0001

OFFICE: 311

ROUTE: 564

ST_REF_NO: 0000001600 ALBEMARLE ROAD

LUMENS	BULB TYPE	MULT SERIES	POLE TYPE	SHADE	ADDRESS NUMBER	REF	LOCATION	TAX DIST	DATE INST	DATE CHANGE
05800	S	M	OUG	II	00000	001	SIDE OF 848 CELIA LANE	12	100888	9/9/2009
04000	S	M	OUG	II	01709	002		12	100888	1/1/0001
04000	S	M	OUG	II	01720	003		12	100888	1/1/0001
04000	S	M	OUG	II	01729	004		12	100888	1/1/0001
04000	S	M	OUG	II	01741	005		12	100888	1/1/0001

OFFICE: 311

ROUTE: 564

ST_REF_NO: 0000001700 ALBERT LANE

LUMENS	BULB TYPE	MULT SERIES	POLE TYPE	SHADE	ADDRESS NUMBER	REF	LOCATION	TAX DIST	DATE INST	DATE CHANGE
05800	S	M	OUG	II	00000	047	SIDE OF 1117 WYNDHAM HILLS DRIVE	12	020897	10/11/2011
05800	S	M	OUG	II	01004	041		12	031581	9/9/2009
04000	S	M	OUG	II	01001	040		12	121581	1/1/0001
05800	S	M	OUG	II	01025	043		12	020897	1/1/0001
05800	S	M	OUG	II	01028	044		12	020897	1/1/0001

OFFICE: 311

ROUTE: 564

ST_REF_NO: 00000001700

ALBERT LANE

LUMENS	BULB TYPE	MULT SERIES	POLE TYPE	SHADE	ADDRESS NUMBER	REF	LOCATION	TAX DIST	DATE INST	DATE CHANGE
05800	S	M	OUG	II	01040	045		12	020897	1/1/0001
05800	S	M	OUG	II	01052	046		12	020897	1/1/0001

OFFICE: 311

ROUTE: 564

ST_REF_NO: 00000001780

ALDERBROOK WAY

LUMENS	BULB TYPE	MULT SERIES	POLE TYPE	SHADE	ADDRESS NUMBER	REF	LOCATION	TAX DIST	DATE INST	DATE CHANGE
05800	S	M	CNT	II	00000	003	SIDE OF 349 ALDERBROOK WAY	12	080102	1/1/0001
05800	S	M	CNT	II	00000	004	SIDE OF 476 ALDERBROOK WAY	12	052005	1/1/0001
05800	S	M	CNT	II	00000	006	SIDE OF 4097 ELORA LANE ON ALDERBROOK WAY	12	080102	1/1/0001
05800	S	M	CNT	II	00000	009	ACROSS FROM 541 ALDERBROOK WAY	12	030504	1/1/0001
05800	S	M	CNT	II	00000	010	SIDE OF 4377 RIVER OAK TRAIL ON ALDERBROOK WAY	12	030504	1/1/0001
05800	S	M	CNT	II	00000	012	SIDE OF 4300 CRESCENT SPRINGS CT	12	030504	10/11/2011
05800	S	M	CNT	II	00000	015	ACROSS FROM 440 ALDERBROOK WAY	12	030504	1/1/0001
05800	S	M	CNT	II	00341	001		12	080102	1/1/0001
05800	S	M	CNT	II	00352	002		12	080102	1/1/0001
05800	S	M	CNT	II	00384	005		12	080102	1/1/0001
05800	S	M	CNT	II	00400	007		12	080102	1/1/0001
05800	S	M	CNT	II	00449	001		12	052005	1/1/0001
05800	S	M	CNT	II	00461	002		12	052005	1/1/0001
05800	S	M	CNT	II	00473	003		12	052005	1/1/0001
05800	S	M	CNT	II	00505	005		12	052005	10/11/2011
05800	S	M	CNT	II	00509	006		12	052005	1/1/0001
05800	S	M	CNT	II	00521	007		12	052005	1/1/0001
05800	S	M	CNT	II	00529	008		12	030504	1/1/0001
05800	S	M	CNT	II	00565	011		12	030504	10/11/2011
05800	S	M	CNT	II	00589	013		12	030504	1/1/0001
05800	S	M	CNT	II	00597	014		12	030504	1/1/0001

OFFICE: 311

ROUTE: 564

ST_REF_NO: 00000001800

ALDERSHOT DRIVE

LUMENS	BULB TYPE	MULT SERIES	POLE TYPE	SHADE	ADDRESS NUMBER	REF	LOCATION	TAX DIST	DATE INST	DATE CHANGE
05800	S	M	OUG	II	00000	053	SIDE OF 633 CROMWELL WAY	12	110885	9/9/2009
05800	S	M	OUG	II	00000	079	SIDE OF 652 CARDIFF LANE	12	110885	9/9/2009
04000	S	M	OUG	V	03432	084		12	110885	10/11/2011

OFFICE: 311

ROUTE: 564

ST_REF_NO: 00000001800 ALDERSHOT DRIVE

LUMENS	BULB TYPE	MULT SERIES	POLE TYPE	SHADE	ADDRESS NUMBER	REF	LOCATION	TAX DIST	DATE INST	DATE CHANGE
04000	S	M	OUG	II	03441	083		12	110885	10/11/2011
04000	S	M	OUG	II	03473	055		12	110885	10/11/2011
04000	S	M	OUG	II	00000	054	OPP. 3485	12	110885	1/1/0001
04000	S	M	OUG	II	03456	080		12	110885	1/1/0001

OFFICE: 311

ROUTE: 564

ST_REF_NO: 00000001850 ALDRIDGE WAY

LUMENS	BULB TYPE	MULT SERIES	POLE TYPE	SHADE	ADDRESS NUMBER	REF	LOCATION	TAX DIST	DATE INST	DATE CHANGE
05800	S	M	OUG	II	00000	003	SIDE REAR OF 4801 BRENNEN DRIVE	12	061201	10/11/2011
05800	S	M	OUG	II	00000	008	SIDE REAR OF 1192 VINSON CT	12	061201	10/11/2011
05800	S	M	OUG	III	01113	001		12	033104	1/1/0001
05800	S	M	OUG	II	01120	002		12	061201	10/11/2011
05800	S	M	OUG	II	01145	004		12	061201	1/1/0001
05800	S	M	OUG	II	01156	005		12	061201	1/1/0001
05800	S	M	OUG	II	01173	006		12	061201	1/1/0001
05800	S	M	OUG	II	01181	007		12	061201	1/1/0001
05800	S	M	OUG	II	01209	009		12	061201	10/11/2011
05800	S	M	OUG	II	01220	010		12	061201	1/1/0001
05800	S	M	OUG	II	01229	011		12	061201	1/1/0001

OFFICE: 311

ROUTE: 564

ST_REF_NO: 00000001890 ALEXANDRIA COURT

LUMENS	BULB TYPE	MULT SERIES	POLE TYPE	SHADE	ADDRESS NUMBER	REF	LOCATION	TAX DIST	DATE INST	DATE CHANGE
05800	S	M	OUG	II	03229	000		12	060170	10/11/2011

OFFICE: 311

ROUTE: 564

ST_REF_NO: 00000001900 ALEXANDRIA DRIVE

LUMENS	BULB TYPE	MULT SERIES	POLE TYPE	SHADE	ADDRESS NUMBER	REF	LOCATION	TAX DIST	DATE INST	DATE CHANGE
20000	M		OUG	III	00000	024	opposite 1718	12	082065	1/1/0001
09500	S	M	OUG	II	00000	000	OPP 1298	12	021367	10/11/2011
22000	S	M	OUG	II	00000	003	OPP. 2353	12	010887	9/9/2009
22000	S	M	OUG	II	00000	020	SIDE OF 2285 VERSAILLES RD.	12	040890	10/11/2011
05800	S	M	OUG	II	00000	021	SIDE OF 3228 ALEXANDRIA CT. ON	12	040173	10/11/2011
22000	S	M	OUG	III	00000	025	DARIEN DR.	12	082065	9/9/2009

OFFICE: 311

ROUTE: 564

ST_REF_NO: 0000001900

ALEXANDRIA DRIVE

LUMENS	BULB TYPE	MULT SERIES	POLE TYPE	SHADE	ADDRESS NUMBER	REF	LOCATION	TAX DIST	DATE INST	DATE CHANGE
22000	S	M	OUG	III	00000	026	OPPOSITE OF DARIEN DR.	12	082065	9/9/2009
22000	S	M	OUG	III	00000	028	ALEX. AT ANTIETAM DR.	12	082065	9/9/2009
10000	M	M	OUG	II	00000	092	IN CURVE IN FRONT OF 957 LANE ALLEN RD	12	041477	10/11/2011
05800	S	M	OUG	III	00000	093	SIDE OF 1000 LANE ALLEN RD.	12	080164	10/11/2011
22000	S		CNT	II	00000	200	2ND LT S OF ROUNDABOUT, E SIDE ON ALEXANDRIA DRIVE	12	042310	5/25/2010
22000	S		CNT	II	00000	201	1ST LT S OF ROUNDABOUT, E SIDE ON ALEXANDRIA DR	12	042310	5/25/2010
22000	S		CNT	II	00000	202	1ST LT N OF ROUNDABOUT, E SIDE ON ALEXANDRIA DR	12	042310	5/25/2010
22000	S		CNT	II	00000	203	2ND LT N OF ROUNDABOUT, E SIDE ON ALEXANDRIA DR	12	042310	5/25/2010
09500	S	M	OUG	II	00000	900	1st LT N OF DEVONPORT, RIGHT SIDE	12	030874	9/9/2009
10000	M	M	OOH	III	00000	901	SIDE OF 2300 VERSAILLES RD	12	082065	9/9/2009
09500	S	M	OUG	III	00000	902	OPP 1536	12	082065	9/9/2009
09500	S	M	OUG	II	01159	000		12	040567	9/9/2009
05800	S	M	OUG	II	01226	000		12	021367	10/11/2011
05800	S	M	OUG	II	01235	000		12	062167	9/9/2009
05800	S	M	OUG	II	01247	000		12	080169	9/9/2009
22000	S	M	OUG	II	01389	000		12	090170	9/9/2009
22000	S	M	OUG	II	01400	000		12	030874	10/11/2011
22000	S	M	OUG	II	01425	023		12	080897	9/9/2009
22000	S	M	OUG	III	01548	000		12	082065	9/9/2009
10000	M	M	OUG	III	01565	000		12	082065	10/11/2011
09500	S	M	OUG	III	01568	000		12	082065	9/9/2009
09500	S	M	OUG	III	01573	000		12	082065	9/9/2009
22000	S	M	OUG	III	01601	000		12	082065	9/9/2009
09500	S	M	OUG	III	01606	000		12	082065	10/31/2011
09500	S	M	OUG	III	01619	000		12	082065	12/16/2011
10000	M	M	OUG	III	01667	000		12	082065	10/11/2011
09500	S	M	OUG	III	01678	000		12	082065	9/9/2009
22000	S	M	OUG	III	01685	000		12	082065	9/9/2009
22000	S	M	OUG	III	01750	000		12	082065	9/9/2009
22000	S	M	OUG	III	01768	000		12	082065	9/9/2009
09500	S	M	OUG	II	01879	077		12	041477	9/9/2009

OFFICE: 311

ROUTE: 564

ST_REF_NO: 0000001900

ALEXANDRIA DRIVE

LUMENS	BULB TYPE	MULT SERIES	POLE TYPE	SHADE	ADDRESS NUMBER	REF	LOCATION	TAX DIST	DATE INST	DATE CHANGE
09500	S	M	OUG	II	01882	078		12	041477	9/9/2009
22000	S	M	OUG	II	01887	079		12	041474	9/9/2009
09500	S	M	OUG	II	01894	080		12	041477	9/9/2009
10000	M	M	OUG	II	01900	082		12	041477	10/11/2011
10000	M	M	OUG	II	01916	084		12	041477	10/11/2011
09500	S	M	OUG	II	01924	086	bad fixture	12	041477	11/3/2008
09500	S	M	OUG	II	01937	088	bad fixture	12	041477	4/7/2010
09500	S	M	OUG	II	01944	089		12	041477	9/9/2009
22000	S	M	OUG	II	01956	091		12	041477	10/11/2011
05800	S	M	OUG	III	02076	000		12	090363	10/11/2011
05800	S	M	OUG	II	02148	016		12	060867	10/11/2011
05800	S	M	OUG	II	00000	015	SIDE OF 1198 KELSEY DR.	12	021367	1/1/0001
05800	S	M	OUG	II	01183	000		12	062167	1/1/0001
05800	S	M	OUG	II	01210	000		12	021367	1/1/0001
10000	M	M	OUG	II	00000	013	SIDE OF 2284 VERSAILLES RD.	12	040890	1/1/0001
10000	M	M	OUG	III	00000	017	NW CORNER OF CROSS KEYS AND ALEXANDRIA DR.	12	082065	1/1/0001
20000	M	M	OUG	III	00000	018	S.E. CORNER OF CROSS KEYS AT	12	082065	1/1/0001
22000	S	M	OUG	II	00000	019	SIDE OF 2301 VERSAILLES RD.	12	040890	1/1/0001
05800	S	M	OUG	II	01215	000		12	021367	1/1/0001
09500	S	M	OUG	II	01262	000		12	091367	1/1/0001
09500	S	M	OUG	II	01275	000		12	101067	1/1/0001
09500	S	M	OUG	II	01286	000		12	030868	1/1/0001
09500	S	M	OUG	II	01340	000		12	091874	1/1/0001
09500	S	M	OUG	II	01369	000		12	100170	1/1/0001
22000	S	M	OUG	II	01424	022		12	030874	1/1/0001
22000	S	M	OUG	II	01485	000		12	091874	1/1/0001
10000	M	M	OUG	III	01592	000		12	082065	1/1/0001
09500	S	M	OUG	III	01624	000		12	082065	1/1/0001
09500	S	M	OUG	III	01637	000		12	082065	1/1/0001
10000	M	M	OUG	III	01642	000		12	082065	1/1/0001
09500	S	M	OUG	III	01666	000		12	082065	1/1/0001
20000	M	M	OUG	III	01729	000		12	082065	1/1/0001
05800	S	M	OUG	III	00000	012	SIDE OF 2168 WINTERBERRY DRIVE	12	082065	1/1/0001

OFFICE: 311

ROUTE: 564

ST_REF_NO: 0000001900

ALEXANDRIA DRIVE

LUMENS	BULB TYPE	MULT SERIES	POLE TYPE	SHADE	ADDRESS NUMBER	REF	LOCATION	TAX DIST	DATE INST	DATE CHANGE
05800	S	M	OUG	III	00000	014	OPPOSITE 2120 ALEXANDRIA DR.	12	111565	1/1/0001
20000	M	M	OUG	III	00000	027	OPPOSITE 1867	12	082065	1/1/0001
10000	M	M	OUG	II	00000	090	OPP 1948 ALEX DR	12	041477	1/1/0001
20000	M	M	OUG	III	01801	000		12	082065	1/1/0001
20000	M	M	OUG	III	01867	000		12	082065	1/1/0001
10000	M	M	OUG	II	01899	081		12	041477	1/1/0001
10000	M	M	OUG	II	01909	083		12	041477	1/1/0001
10000	M	M	OUG	II	01921	085		12	041477	1/1/0001
10000	M	M	OUG	II	01933	087		12	041477	1/1/0001
05800	S	M	OUG	III	02008	000		12	070162	1/1/0001
05800	S	M	OUG	III	02017	000		12	120162	1/1/0001
05800	S	M	OUG	III	02024	000		12	070162	1/1/0001
05800	S	M	OUG	III	02033	000		12	070162	1/1/0001
05800	S	M	OUG	III	02048	000		12	102263	1/1/0001
05800	S	M	OUG	III	02060	000		12	110162	1/1/0001
05800	S	M	OUG	III	02069	000		12	090369	1/1/0001
05800	S	M	OUG	III	02093	000		12	090363	1/1/0001
05800	S	M	OUG	III	02104	000		12	090164	1/1/0001
05800	S	M	OUG	III	02132	000		12	082065	1/1/0001
05800	S	M	OUG	II	02205	000		12	122067	1/1/0001
05800	S	M	OUG	II	02214	000		12	022167	1/1/0001
05800	S	M	OUG	II	02229	000		12	022167	1/1/0001
05800	S	M	OUG	II	02255	000		12	080169	1/1/0001
05800	S	M	OUG	II	02266	000		12	080169	1/1/0001
05800	S	M	OUG	II	02281	000		12	022167	1/1/0001
09500	S	M	OUG	II	00000	001	SIDE 2515 HARRODSBURG RD.	12	010887	1/1/0001
09500	S	M	OUG	II	00000	002	SIDE 2515 HARRODSBURG RD.	12	010887	1/1/0001
09500	S	M	OUG	II	00000	004	OPP. 2353	12	010887	1/1/0001
09500	S	M	OUG	II	00000	006	OPP. 2343	12	010887	1/1/0001
09500	S	M	OUG	II	00000	008	OPP. 2333	12	010887	1/1/0001
09500	S	M	OUG	II	00000	010	OPP. 2323	12	010887	1/1/0001
09500	S	M	OUG	II	00000	112	OPP. 2323	12	010887	1/1/0001
05800	S	M	OUG	II	02290	000		12	070171	1/1/0001
05800	S	M	OUG	II	02309	000		12	060170	1/1/0001

OFFICE: 311		ROUTE: 564		ST_REF_NO: 00000001950		ALGONQUIN STREET		LUMENS	BULB TYPE	MULT SERIES	POLE TYPE	SHADE	ADDRESS NUMBER	REF	LOCATION	TAX DIST	DATE INST	DATE CHANGE
09500	S	M	SOH	II	00000	002	1ST LT. S. OF SHORT ST. ON EAST SIDE	12	030885	9/9/2009								

OFFICE: 311		ROUTE: 564		ST_REF_NO: 00000002000		ALICE DRIVE		LUMENS	BULB TYPE	MULT SERIES	POLE TYPE	SHADE	ADDRESS NUMBER	REF	LOCATION	TAX DIST	DATE INST	DATE CHANGE
04000	S	M	OUG	II	01924	000		12	051477	1/1/0001								
04000	S	M	OUG	II	01956	000		12	051477	1/1/0001								
04000	S	M	OUG	II	01963	000		12	051477	1/1/0001								
04000	S	M	OUG	II	01984	000		12	051477	1/1/0001								
04000	S	M	OUG	II	01987	000		12	051477	1/1/0001								

OFFICE: 311		ROUTE: 564		ST_REF_NO: 00000002100		ALIGAN WAY		LUMENS	BULB TYPE	MULT SERIES	POLE TYPE	SHADE	ADDRESS NUMBER	REF	LOCATION	TAX DIST	DATE INST	DATE CHANGE
05800	S	M	CNT	II	00000	004	SIDE OF 372 MEADOWCREST PARK	12	080102	10/11/2011								
05800	S	M	CNT	II	04469	001		12	080102	1/1/0001								
05800	S	M	CNT	II	04476	002		12	080102	1/1/0001								
05800	S	M	CNT	II	04489	003		12	080102	1/1/0001								
04000	S	M	OUG	II	00000	103	SIDE 301 WHITFIELD DR.	12	090886	1/1/0001								
04000	S	M	OUG	II	00000	105	SIDE 301 ANGELA CT.	12	090886	1/1/0001								
04000	S	M	OUG	II	00000	107	SIDE 245 SOUTHPOINT DR.	12	090886	1/1/0001								
04000	S	M	OUG	II	04505	104		12	090886	1/1/0001								
05800	S	M	OUG	II	04524	106	upgraded 2/08	12	090886	1/1/0001								

OFFICE: 311		ROUTE: 564		ST_REF_NO: 00000002105		ALLEGHENY WAY		LUMENS	BULB TYPE	MULT SERIES	POLE TYPE	SHADE	ADDRESS NUMBER	REF	LOCATION	TAX DIST	DATE INST	DATE CHANGE
05800	S		CNT	II	02121	030		12	062609	1/1/0001								
05800	S	M	CNT	II	00000	008	SIDE OF 2149 SOVEREIGN ON ALLEGHENY WAY	12	071001	1/1/0001								
05800	S	M	CNT	II	01965	009		12	050404	1/1/0001								
05800	S	M	CNT	II	01981	010		12	050404	1/1/0001								
05800	S	M	CNT	II	01997	012		12	050404	1/1/0001								
05800	S	M	CNT	II	02005	011		12	071001	1/1/0001								
05800	S	M	CNT	II	02017	013		12	082203	1/1/0001								

OFFICE: 311

ROUTE: 564

ST_REF_NO: 0000002105 ALLEGHENY WAY

LUMENS	BULB TYPE	MULT SERIES	POLE TYPE	SHADE	ADDRESS NUMBER	REF	LOCATION	TAX DIST	DATE INST	DATE CHANGE
05800	S	M	CNT	II	02028	014		12	082203	1/1/0001
05800	S	M	CNT	II	02037	015		12	082203	1/1/0001
05800	S	M	CNT	II	02064	016		12	082203	1/1/0001
05800	S	M	CNT	II	02076	017		12	082203	1/1/0001
05800	S	M	CNT	II	02096	018		12	082203	1/1/0001
05800	S	M	CNT	II	02109	013		12	071001	1/1/0001
05800	S	M	CNT	II	02137	006		12	071001	10/11/2011
05800	S	M	CNT	II	02148	005		12	071001	10/11/2011
05800	S	M	CNT	II	00000	004	SIDE REAR OF 1176 LACY LANE	12	120899	1/1/0001
05800	S	M	CNT	II	02176	003		12	120899	1/1/0001
05800	S	M	CNT	II	02185	002		12	120899	1/1/0001
05800	S	M	CNT	II	02197	001		12	120899	1/1/0001

OFFICE: 311

ROUTE: 564

ST_REF_NO: 0000002110 ALLANTE BROOK COURT

LUMENS	BULB TYPE	MULT SERIES	POLE TYPE	SHADE	ADDRESS NUMBER	REF	LOCATION	TAX DIST	DATE INST	DATE CHANGE
05800	S	M	OUG	II	03620	003		12	110894	10/11/2011
05800	S	M	OUG	II	00000	001	SIDE OF 3639	12	110894	1/1/0001
05800	S	M	OUG	IV	00000	004	OPP. 3607	12	110894	1/1/0001
05800	S	M	OUG	II	03633	002		12	110894	1/1/0001

OFFICE: 311

ROUTE: 564

ST_REF_NO: 0000002200 ALLEN COURT

LUMENS	BULB TYPE	MULT SERIES	POLE TYPE	SHADE	ADDRESS NUMBER	REF	LOCATION	TAX DIST	DATE INST	DATE CHANGE
04000	S	M	OUG	II	00000	078	SIDE OF 2307 ALLEN DR.	12	050884	1/1/0001
04000	S	M	OUG	II	00605	077		12	050884	1/1/0001

OFFICE: 311

ROUTE: 564

ST_REF_NO: 0000002300 ALLEN DRIVE

LUMENS	BULB TYPE	MULT SERIES	POLE TYPE	SHADE	ADDRESS NUMBER	REF	LOCATION	TAX DIST	DATE INST	DATE CHANGE
05800	S	M	OOH	II	00000	082	SIDE OF 601 FREEMAN DR.	12	050884	9/9/2009
05800	S	M	OUG	II	00000	084	SIDE OF 601 JUDY LANE	12	050884	9/9/2009
04000	S	M	OUG	II	02313	076		12	050884	10/11/2011
05800	S	M	OUG	II	00000	001	BESIDE 577 LISA DR	12	120667	1/1/0001

OFFICE: 311		ROUTE: 564		ST_REF_NO: 00000002300		ALLEN DRIVE		LUMENS	BULB TYPE	MULT SERIES	POLE TYPE	SHADE	ADDRESS NUMBER	REF	LOCATION	TAX DIST	DATE INST	DATE CHANGE
	04000	S	M	OUG	II	00000	081								SIDE OF 572 PARKSIDE DR.	12	050884	1/1/0001
	04000	S	M	OUG	II	00000	083								SIDE OF 582 FREEMAN DR.	12	050884	1/1/0001
	04000	S	M	OUG	II	00000	085								SIDE OF 588 JUDY LANE	12	050884	1/1/0001
	04000	S	M	OUG	II	02303	080									12	050884	1/1/0001
	04000	S	M	OUG	II	02306	079									12	050884	1/1/0001
	04000	S	M	OUG	II	02316	075									12	050884	1/1/0001
	05800	S	M	OUG	II	02324	000									12	040664	1/1/0001
	05800	S	M	OUG	II	02337	000									12	040664	1/1/0001
	05800	S	M	OUG	II	02346	000									12	040664	1/1/0001
	05800	S	M	OUG	II	02365	000									12	060663	1/1/0001
	05800	S	M	OUG	II	02374	000									12	060663	1/1/0001
	05800	S	M	OUG	II	02391	000									12	060663	1/1/0001
	05800	S	M	OUG	II	02398	000									12	060663	1/1/0001

OFFICE: 311

ROUTE: 564

OFFICE: 311		ROUTE: 564		ST_REF_NO: 00000002400		ALLENDALE DRIVE		LUMENS	BULB TYPE	MULT SERIES	POLE TYPE	SHADE	ADDRESS NUMBER	REF	LOCATION	TAX DIST	DATE INST	DATE CHANGE
	09500	S	M	OUG	II	00000	002								OPP. 719	12	050889	10/11/2011
	09500	S	M	OUG	II	00000	003								OPP 743	12	050889	10/11/2011
	04000	S	M	OUG	II	00762	005									12	050889	10/11/2011
	05800	S	M	OUG	II	00778	006									12	050889	6/7/2011
	04000	S	M	OUG	II	00790	007									12	050889	10/11/2011
	09500	S	M	OUG	II	00000	001								SIDE OF 1983 HARRODSBURG RD.	12	050889	1/1/0001
	04000	S	M	OUG	II	00755	004									12	050889	1/1/0001

OFFICE: 311

ROUTE: 564

OFFICE: 311		ROUTE: 564		ST_REF_NO: 00000002450		ALMOND WAY		LUMENS	BULB TYPE	MULT SERIES	POLE TYPE	SHADE	ADDRESS NUMBER	REF	LOCATION	TAX DIST	DATE INST	DATE CHANGE
	05800	S	M	CNT	II	00000	001								SIDE OF 2117 MANGROVE DR.	12	110898	1/1/0001

OFFICE: 311

ROUTE: 564

OFFICE: 311		ROUTE: 564		ST_REF_NO: 00000002470		ALPHARETTA COURT		LUMENS	BULB TYPE	MULT SERIES	POLE TYPE	SHADE	ADDRESS NUMBER	REF	LOCATION	TAX DIST	DATE INST	DATE CHANGE
	05800	S		CNT	III	01304	003									12	110509	1/1/0001

OFFICE: 311

ROUTE: 564

ST_REF_NO: 00000002470

ALPHARETTA COURT

LUMENS	BULB TYPE	MULT SERIES	POLE TYPE	SHADE	ADDRESS NUMBER	REF	LOCATION	TAX DIST	DATE INST	DATE CHANGE
05800	S	M	CNT	II	00000	001	SIDE OF 2265 SAVANNAH LANE	12	100899	10/11/2011
05800	S	M	CNT	II	01305	002		12	100899	1/1/0001

OFFICE: 311

ROUTE: 564

ST_REF_NO: 00000002500

ALPINE COURT

LUMENS	BULB TYPE	MULT SERIES	POLE TYPE	SHADE	ADDRESS NUMBER	REF	LOCATION	TAX DIST	DATE INST	DATE CHANGE
05800	S	M	OUG	II	00000	001	SIDE OF 369 REDDING RD ON	12	051478	1/1/0001
05800	S	M	OUG	II	03412	000		12	121478	1/1/0001
05800	S	M	OUG	II	03417	000		12	051478	1/1/0001
05800	S	M	OUG	II	03428	000		12	051478	1/1/0001

OFFICE: 311

ROUTE: 564

ST_REF_NO: 00000002600

ALSAB COURT

LUMENS	BULB TYPE	MULT SERIES	POLE TYPE	SHADE	ADDRESS NUMBER	REF	LOCATION	TAX DIST	DATE INST	DATE CHANGE
05800	S	M	OUG	II	00000	001	SIDE OF 2614 CHANT CT	12	060173	10/11/2011
05800	S	M	OUG	III	00000	005	SIDE OF 1002 AT END OF COURT	12	110898	10/11/2011
05800	S	M	OUG	II	00205	002		12	060173	10/11/2011
05800	S	M	OUG	II	00504	004		12	110898	10/11/2011
05800	S	M	OUG	II	00204	003		12	060173	1/1/0001

OFFICE: 311

ROUTE: 564

ST_REF_NO: 00000002700

ALTAMONT COURT

LUMENS	BULB TYPE	MULT SERIES	POLE TYPE	SHADE	ADDRESS NUMBER	REF	LOCATION	TAX DIST	DATE INST	DATE CHANGE
05800	S	M	OUG	II	00000	001	SIDE OF 147 LAKESHORE DR	12	020367	10/11/2011

OFFICE: 311

ROUTE: 564

ST_REF_NO: 00000002750

ALTHORPE WAY

LUMENS	BULB TYPE	MULT SERIES	POLE TYPE	SHADE	ADDRESS NUMBER	REF	LOCATION	TAX DIST	DATE INST	DATE CHANGE
05800	S	M	CNT	II	03121	003		12	110800	10/11/2011
05800	S	M	CNT	III	00000	005	OPP. 3116	12	110800	1/1/0001
05800	S	M	CNT	II	03113	004		12	110800	1/1/0001
05800	S	M	CNT	II	03129	002		12	110800	1/1/0001

OFFICE: 311

ROUTE: 564

ST_REF_NO: 0000002800

ALUMNI DRIVE

LUMENS	BULB TYPE	MULT SERIES	POLE TYPE	SHADE	ADDRESS NUMBER	REF	LOCATION	TAX DIST	DATE INST	DATE CHANGE
22000	S	M	OUG	III	00000	016	1ST LT. W. OF LAKELAND DR., S. SIDE	12	020887	10/11/2011
22000	S	M	OUG	III	00000	017	2ND LT. W. OF LAKELAND DR., S. SIDE	12	020887	10/11/2011
50000	S	M	OUG	III	00000	055	1ST LT. E. OF SUMMERSHADE CIRCLE, S. SIDE	12	120887	9/9/2009
09500	S	M	OUG	III	00000	060	1ST LT. W. OF CAMINO DR., S. SIDE	12	120887	9/9/2009
22000	S	M	OUG	III	00000	076	2ND LT. S. OF SHOAL LAKE DR, W. SIDE	12	070889	10/11/2011
22000	S	M	OUG	III	00000	079	1ST LT. N. OF SQUIRES RD BIKE PATH	12	070889	10/11/2011
22000	S	M	SOH	III	00000	082	1ST LT. S. OF SQUIRES RD BIKE PATH	12	050889	10/11/2011
22000	S	M	SOH	III	00000	084	2ND LT. S. OF SQUIRES RD BIKE PATH	12	050889	10/11/2011
22000	S	M	SOH	III	00000	086	3RD LT. S. OF SQUIRES RD BIKE PATH	12	050889	10/11/2011
22000	S	M	SOH	III	00000	088	4TH LT. S. OF SQUIRES RD BIKE PATH	12	050889	10/11/2011
22000	S	M	OUG	III	00000	089	1ST LT. N. OF BUCKHORN DR., W. SIDE	12	070889	10/11/2011
22000	S	M	OUG	III	00000	037	10TH LT. W. OF LAKESIDE DR., S. SIDE	12	020887	1/1/0001
22000	S	M	OUG	III	00000	038	3RD LT. E. OF CHINOE DR., S. SIDE	12	020887	1/1/0001
22000	S	M	OUG	III	00000	039	2ND LT. E. OF CHINOE DR., S. SIDE	12	020887	1/1/0001
22000	S	M	OUG	III	00000	040	2ND LT. E. OF CHINOE DR., N. SIDE	12	020887	1/1/0001
22000	S	M	OUG	III	00000	041	1ST LT. E. OF CHINOE DR., S. SIDE	12	020887	1/1/0001
22000	S	M	OUG	III	00000	042	1ST LT. E. OF CHINOE DR., N. SIDE	12	020887	1/1/0001
22000	S	M	OUG	III	00000	043	1ST LT. W. OF CHINOE DR., S. SIDE	12	020887	1/1/0001
22000	S	M	OUG	III	00000	044	1ST LT. W. OF CHINOE, N SIDE	12	060800	1/1/0001
22000	S	M	OUG	III	00000	045	2ND LT. W. OF CHINOE, S SIDE	12	060800	1/1/0001
22000	S	M	OUG	III	00000	046	2ND LT. W. OF CHINOE, N SIDE	12	060800	1/1/0001
22000	S	M	OUG	III	00000	047	1ST LT. E. OF TURKEY FOOT RD., S. SIDE	12	120887	1/1/0001
22000	S	M	OUG	III	00000	048	1ST LT. E. OF TURKEY FOOT RD., N SIDE	12	060800	1/1/0001
22000	S	M	OUG	III	00000	049	1ST LT. W. OF TURKEY FOOT RD., S. SIDE	12	120887	1/1/0001
22000	S	M	OUG	III	00000	050	1ST LT. W. OF TURKEY FOOT RD., N. SIDE	12	120887	1/1/0001
22000	S	M	OUG	III	00000	051	2ND LT. W. OF TURKEY FOOT RD., S. SIDE	12	120887	1/1/0001
22000	S	M	OUG	III	00000	052	2ND LT. W. OF TURKEY FOOT RD., N. SIDE	12	120887	1/1/0001
22000	S	M	OUG	III	00000	053	3RD LT. W. OF TURKEY FOOT RD., S. SIDE	12	120887	1/1/0001
22000	S	M	OUG	III	00000	054	2ND LT. E. OF SUMMERSHADE CIRCLE, N. SIDE	12	120887	1/1/0001
22000	S	M	OUG	III	00000	056	1ST LT. W. OF SUMMERSHADE CIRCLE, N. SIDE	12	120887	1/1/0001
22000	S	M	OUG	III	00000	057	1ST LT. W. OF SUMMERSHADE CIRCLE, S. SIDE	12	120887	1/1/0001
22000	S	M	OUG	III	00000	058	2ND LT. W. OF SUMMERSHADE CIRCLE, N. SIDE	12	120887	1/1/0001
22000	S	M	OUG	III	00000	059	1ST LT. E. OF CAMINO DR., S. SIDE	12	120887	1/1/0001
22000	S	M	OUG	III	00000	061	1ST LT. W. OF CAMINO DR., N. SIDE	12	120887	1/1/0001

OFFICE: 311

ROUTE: 564

ST_REF_NO: 0000002800

ALUMNI DRIVE

LUMENS	BULB TYPE	MULT SERIES	POLE TYPE	SHADE	ADDRESS NUMBER	REF	LOCATION	TAX DIST	DATE INST	DATE CHANGE
22000	S	M	OUG	III	00000	062	2ND LT. E. OF TATES CREEK RD., S. SIDE	12	120887	1/1/0001
22000	S	M	OUG	III	00000	063	2ND LT. E. OF TATES CREEK, NORTHSIDE	12	100895	1/1/0001
22000	S	M	OUG	III	00000	064	1ST LT. E. OF TATES CREEK, SOUTHSIDE	12	100895	1/1/0001
22000	S	M	SOH	III	00000	065	1ST LT. E. OF TATES CREEK RD., N. SIDE	12	120887	1/1/0001
22000	S	M	OUG	III	00000	020	2ND LT. W. OF EDGEWATER DR., S. SIDE	12	020887	1/1/0001
22000	S	M	OUG	III	00000	021	3RD LT. W. OF EDGEWATER DR., S. SIDE	12	020887	1/1/0001
22000	S	M	OUG	III	00000	022	4TH LT. W. OF EDGEWATER DR., S. SIDE	12	020887	1/1/0001
22000	S	M	OUG	III	00000	023	5TH LT. W. OF EDGEWATER DR., S. SIDE	12	020887	1/1/0001
22000	S	M	OUG	III	00000	024	6TH LT. W. OF EDGEWATER DR., S. SIDE	12	020887	1/1/0001
22000	S	M	OUG	III	00000	025	3RD LT. E. OF LAKESIDE DR., S. SIDE	12	020887	1/1/0001
22000	S	M	OUG	III	00000	026	2ND LT. E. OF LAKESIDE DR., S. SIDE	12	020887	1/1/0001
22000	S	M	OUG	III	00000	027	1ST LT. E. OF LAKESIDE DR., S. SIDE	12	020887	1/1/0001
22000	S	M	OUG	III	00000	028	1ST LT. W. OF LAKESIDE DR., S. SIDE	12	020887	1/1/0001
22000	S	M	OUG	III	00000	029	2ND LT. W. OF LAKESIDE DR., S. SIDE	12	020887	1/1/0001
22000	S	M	OUG	III	00000	030	3RD LT. W. OF LAKESIDE DR., S. SIDE	12	020887	1/1/0001
22000	S	M	OUG	III	00000	031	4TH LT. W. OF LAKESIDE DR., S. SIDE	12	020887	1/1/0001
22000	S	M	OUG	III	00000	032	5TH LT. W. OF LAKESIDE DR., S. SIDE	12	020887	1/1/0001
22000	S	M	OUG	III	00000	033	6TH LT. W. OF LAKESIDE DR., S. SIDE	12	020887	1/1/0001
22000	S	M	OUG	III	00000	034	7TH LT. W. OF LAKESIDE DR., S. SIDE	12	020887	1/1/0001
22000	S	M	OUG	III	00000	035	8TH LT. W. OF LAKESIDE DR., S. SIDE	12	020887	1/1/0001
22000	S	M	OUG	III	00000	036	9TH LT. W. OF LAKESIDE DR., S. SIDE	12	020887	1/1/0001
22000	S	M	OUG	III	00000	001	1ST LT. E. OF CHAUVIN DR., S. SIDE	12	040888	1/1/0001
22000	S	M	OUG	III	00000	002	2ND LT. E. OF CHAUVIN DR., N. SIDE	12	040888	1/1/0001
22000	S	M	OUG	III	00000	003	1ST LT. W. OF YELLOWSTONE PKWY., S. SIDE	12	040888	1/1/0001
22000	S	M	OUG	III	00000	004	1ST LT. W. OF YELLOWSTONE PARKWAY, N. SIDE	12	040888	1/1/0001
22000	S	M	OUG	III	00000	005	1ST LT. E. OF YELLOWSTONE PKWY., S. SIDE	12	040888	1/1/0001
22000	S	M	OUG	III	00000	006	1ST LT. E. OF YELLOWSTONE PKWY., N. SIDE	12	040888	1/1/0001
22000	S	M	OUG	III	00000	007	2ND LT. E. OF YELLOWSTONE PKWY., S. SIDE	12	040888	1/1/0001
22000	S	M	OUG	III	00000	008	2ND LT. E. OF YELLOWSTONE PKWY., N. SIDE	12	040888	1/1/0001
22000	S	M	OUG	III	00000	009	2ND LT. W. OF MAN O WAR BLVD., S. SIDE	12	040888	1/1/0001
22000	S	M	OUG	III	00000	010	2ND LT. W. OF MAN O WAR BLVD., N. SIDE	12	040888	1/1/0001
22000	S	M	OUG	III	00000	011	1ST LT. W. OF MAN O WAR BLVD., S. SIDE	12	040888	1/1/0001
22000	S	M	OUG	III	00000	012	1ST LT. W. OF MAN O WAR BLVD., N. SIDE	12	040888	1/1/0001
22000	S	M	OUG	III	00000	013	1ST LT. E. OF MAN O' WAR, S. SIDE	12	070889	1/1/0001

OFFICE: 311

ROUTE: 564

ST_REF_NO: 0000002800

ALUMNI DRIVE

LUMENS	BULB TYPE	MULT SERIES	POLE TYPE	SHADE	ADDRESS NUMBER	REF	LOCATION	TAX DIST	DATE INST	DATE CHANGE
22000	S	M	OUG	III	00000	014	1ST LT. E. OF MAN O' WAR, N. SIDE	12	070889	1/1/0001
22000	S	M	OUG	III	00000	015	2ND LT. E. OF MAN O' WAR, S. SIDE	12	070889	1/1/0001
22000	S	M	OUG	III	00000	018	1ST LT. E. OF EDGEWATER DR., S. SIDE	12	020887	1/1/0001
22000	S	M	OUG	III	00000	019	1ST LT. W. OF EDGEWATER, S. SIDE	12	020887	1/1/0001
22000	S	M	OUG	III	00000	066	2ND LT. S. OF MAN O' WAR, E. SIDE	12	070889	1/1/0001
22000	S	M	OUG	III	00000	067	3RD LT. S. OF MAN O' WAR, W. SIDE	12	070889	1/1/0001
22000	S	M	OUG	III	00000	068	3RD LT. S. OF MAN O' WAR, E. SIDE	12	070889	1/1/0001
22000	S	M	OUG	III	00000	069	4TH LT. S. OF MAN O' WAR, W. SIDE	12	070889	1/1/0001
22000	S	M	OUG	III	00000	070	4TH LT. S. OF MAN O' WAR, E. SIDE	12	070889	1/1/0001
22000	S	M	OUG	III	00000	071	5TH LT. S. OF MAN O' WAR, W. SIDE	12	070889	1/1/0001
22000	S	M	OUG	III	00000	072	6TH LT. S. OF MAN O' WAR, W. SIDE	12	070889	1/1/0001
22000	S	M	OUG	III	00000	073	1ST LT. S. OF SQUIRES RD., E. SIDE	12	070889	1/1/0001
22000	S	M	OUG	III	00000	074	1ST LT. S. OF SHOAL LAKE DR., W. SIDE	12	070889	1/1/0001
22000	S	M	OUG	III	00000	075	2ND LT. S. OF SQUIRES RD., E. SIDE	12	070889	1/1/0001
22000	S	M	OUG	III	00000	077	3RD LT. S. OF SQUIRES RD., E. SIDE	12	070889	1/1/0001
22000	S	M	OUG	III	00000	078	3RD LT. N. OF GRAFTON DR., W. SIDE	12	070889	1/1/0001
22000	S	M	OUG	III	00000	080	2ND LT. N. OF GRAFTON DR., W. SIDE	12	070889	1/1/0001
22000	S	M	OUG	III	00000	081	1ST LT. N. OF GRAFTON DR., W. SIDE	12	070889	1/1/0001
22000	S	M	OUG	III	00000	083	1ST LT. S. OF GRAFTON DR., W. SIDE	12	070889	1/1/0001
22000	S	M	OUG	III	00000	085	2ND LT. S. OF GRAFTON DR., W. SIDE	12	070889	1/1/0001
22000	S	M	OUG	III	00000	087	3RD LT. S. OF GRAFTON DR., W. SIDE	12	070889	1/1/0001
22000	S	M	SOH	III	00000	090	1ST LT. N. OF BUCKHORN DR., E. SIDE	12	050889	1/1/0001

OFFICE: 311

ROUTE: 564

ST_REF_NO: 0000002940

ALVERSTONE PLACE

LUMENS	BULB TYPE	MULT SERIES	POLE TYPE	SHADE	ADDRESS NUMBER	REF	LOCATION	TAX DIST	DATE INST	DATE CHANGE
05800	S	M	CNT	II	04500	001		12	080800	1/1/0001
05800	S	M	CNT	II	04509	002		12	080800	1/1/0001
05800	S	M	CNT	II	04520	003		12	080800	1/1/0001

OFFICE: 311

ROUTE: 564

ST_REF_NO: 0000003000

ALYDAR COURT

LUMENS	BULB TYPE	MULT SERIES	POLE TYPE	SHADE	ADDRESS NUMBER	REF	LOCATION	TAX DIST	DATE INST	DATE CHANGE
04000	S	M	OUG	II	02901	009		12	110884	1/1/0001

OFFICE: 311 ROUTE: 564										
ST_REF_NO: 00000003040 AMALFI LANE										
LUMENS	BULB TYPE	MULT SERIES	POLE TYPE	SHADE	ADDRESS NUMBER	REF	LOCATION	TAX DIST	DATE INST	DATE CHANGE
09500	S		CLN	II	00000	002	ACROSS FROM 808 AMALFI LANE	12	051609	1/1/0001
09500	S		CLN	II	00816	003		12	051609	1/1/0001
09500	S		CLN	II	00804	001		12	051609	5/16/2009
OFFICE: 311 ROUTE: 564										
ST_REF_NO: 00000003050 AMANDA COURT										
LUMENS	BULB TYPE	MULT SERIES	POLE TYPE	SHADE	ADDRESS NUMBER	REF	LOCATION	TAX DIST	DATE INST	DATE CHANGE
05800	S	M	OUG	II	00000	001	SIDE OF 4712 CARITA WOODS WAY	12	110899	1/1/0001
05800	S	M	OUG	II	00909	002		12	110899	1/1/0001
OFFICE: 311 ROUTE: 564										
ST_REF_NO: 00000003105 AMBERLEY DRIVE										
LUMENS	BULB TYPE	MULT SERIES	POLE TYPE	SHADE	ADDRESS NUMBER	REF	LOCATION	TAX DIST	DATE INST	DATE CHANGE
05800	S	M	CNT	II	00457	006		12	060800	10/11/2011
05800	S	M	CNT	II	00468	007		12	060800	10/11/2011
05800	S	M	CNT	II	00481	008		12	060800	10/11/2011
05800	S	M	CNT	II	00492	009		21	060800	10/11/2011
05800	S	M	CNT	III	00000	011	SIDE OF 533 AMBERLEY DRIVE	12	060800	1/1/0001
05800	S	M	CNT	II	00401	001		12	060800	1/1/0001
05800	S	M	CNT	II	00404	002		12	060800	1/1/0001
05800	S	M	CNT	II	00425	003		12	060800	1/1/0001
05800	S	M	CNT	II	00432	004		12	060800	1/1/0001
05800	S	M	CNT	II	00445	005		12	060800	1/1/0001
05800	S	M	CNT	II	00504	010		12	060800	1/1/0001
05800	S	M	CNT	II	00536	012		12	060800	1/1/0001
05800	S	M	CNT	II	00544	013		12	060800	1/1/0001
OFFICE: 311 ROUTE: 564										
ST_REF_NO: 00000003110 AMBERWOOD COURT										
LUMENS	BULB TYPE	MULT SERIES	POLE TYPE	SHADE	ADDRESS NUMBER	REF	LOCATION	TAX DIST	DATE INST	DATE CHANGE
05800	S	M	CNT	II	04109	005		12	100894	1/1/0001
05800	S	M	CNT	II	04117	004		12	100894	1/1/0001
05800	S	M	CNT	II	04125	003		12	100894	1/1/0001

OFFICE: 311

ROUTE: 564

ST_REF_NO: 0000003200

AMERICAN AVENUE

LUMENS	BULB TYPE	MULT SERIES	POLE TYPE	SHADE	ADDRESS NUMBER	REF	LOCATION	TAX DIST	DATE INST	DATE CHANGE
04000	S	M	SOH	II	00000	035	2ND LT EAST OF S BROADWAY, N SIDE	12	040886	10/11/2011
04000	S	M	SOH	II	00000	036	ACROSS FROM 351	12	040886	10/11/2011
04000	S	M	SOH	II	00000	046	OPP 104	12	040886	10/11/2011
04000	S	M	SOH	II	00000	047	OPP 102	12	040886	10/11/2011
09500	S	M	SOH	II	00136	044		12	040886	9/9/2009
05800	S	M	SOH	II	00170	042		12	040886	9/9/2009
04000	S	M	SOH	II	00258	041		12	040886	10/11/2011
04000	S	M	SOH	II	00264	040		12	040886	10/11/2011
04000	S	M	SOH	II	00000	034	SIDE OF 1214 S. BROADWAY	12	040886	1/1/0001
04000	S	M	SOH	II	00124	045		12	040886	1/1/0001
04000	S	M	SOH	II	00150	043		12	040886	1/1/0001
05800	S	M	SOH	II	00325	038	upgraded-bad fixture	12	040886	1/1/0001
04000	S	M	SOH	II	00340	037		12	040886	1/1/0001

OFFICE: 311

ROUTE: 564

ST_REF_NO: 0000003210

AMHERST DRIVE

LUMENS	BULB TYPE	MULT SERIES	POLE TYPE	SHADE	ADDRESS NUMBER	REF	LOCATION	TAX DIST	DATE INST	DATE CHANGE
05800	S	M	OUG	V	01309	003			110893	1/1/0001
05800	S	M	OUG	II	01312	002		12	110893	1/1/0001
05800	S	M	OUG	II	01329	001		12	110893	1/1/0001

OFFICE: 311

ROUTE: 564

ST_REF_NO: 0000003400

ANDERSON AVENUE

LUMENS	BULB TYPE	MULT SERIES	POLE TYPE	SHADE	ADDRESS NUMBER	REF	LOCATION	TAX DIST	DATE INST	DATE CHANGE
05800	S	M	SOH	I	00000	000	BACK CORNER OF SPEIGLE HEIGHTS PARK	12	050162	10/11/2011
09500	S	M	SOH	I	01137	001	upgraded 10/07	12	110731	10/11/2011
05800	S	M	SOH	I	01143	002		12	050162	10/11/2011
05800	S	M	SOH	II	01161	003	BET 1157&1161 ON	12	072058	10/11/2011
05800	S	M	SOH	I	01119	000		12	050162	1/1/0001

OFFICE: 311

ROUTE: 564

ST_REF_NO: 0000003500

ANDOVER ROAD

LUMENS	BULB TYPE	MULT SERIES	POLE TYPE	SHADE	ADDRESS NUMBER	REF	LOCATION	TAX DIST	DATE INST	DATE CHANGE
05800	S	M	OUG	II	00000	001	SIDE OF 1237 COOPER DR ON	12	030766	1/1/0001

OFFICE: 311		ROUTE: 564		ST_REF_NO: 00000003500		ANDOVER ROAD		LUMENS	BULB TYPE	MULT SERIES	POLE TYPE	SHADE	ADDRESS NUMBER	REF	LOCATION	TAX DIST	DATE INST	DATE CHANGE
	05800	S	M	OUG	II	00325	000									12	031466	1/1/0001
	05800	S	M	OUG	II	00340	000									12	031466	1/1/0001
	05800	S	M	OUG	II	00365	000									12	030766	1/1/0001
	05800	S	M	OUG	II	00380	000									12	020166	1/1/0001
	05800	S	M	OUG	II	00406	000									12	020166	1/1/0001
	05800	S	M	OUG	II	00415	000									12	020166	1/1/0001
	05800	S	M	OUG	II	00426	000									12	030166	1/1/0001
	05800	S	M	OUG	II	00435	000									12	030166	1/1/0001
OFFICE: 311		ROUTE: 564		ST_REF_NO: 00000003505		ANDOVER FOREST DRIVE		LUMENS	BULB TYPE	MULT SERIES	POLE TYPE	SHADE	ADDRESS NUMBER	REF	LOCATION	TAX DIST	DATE INST	DATE CHANGE
	05800	S	M	CNT	II	00000	008							SIDE OF 980 CHETFORD DR		12	120896	10/11/2011
	05800	S	M	CNT	II	00000	037							SIDE OF 3293 BRIGHTON PLACE DR		12	120896	10/11/2011
	05800	S	M	CNT	II	01036	010									12	120896	10/11/2011
	05800	S	M	CNT	II	01045	011									12	120896	10/11/2011
	05800	S	M	CNT	II	01128	100									12	120896	10/11/2011
	05800	S	M	CNT	II	01000	002									12	120896	1/1/0001
	05800	S	M	CNT	II	01001	001									12	120896	1/1/0001
	05800	S	M	CNT	II	01008	004									12	120896	1/1/0001
	05800	S	M	CNT	II	01009	003									12	120896	1/1/0001
	05800	S	M	CNT	II	01013	005									12	120896	1/1/0001
	05800	S	M	CNT	II	01016	006									12	120896	1/1/0001
	05800	S	M	CNT	II	01025	007									12	100898	1/1/0001
	05800	S	M	CNT	II	01033	009									12	120896	1/1/0001
	05800	S	M	CNT	II	01040	012									12	120896	1/1/0001
	05800	S	M	CNT	II	01052	014									12	120896	1/1/0001
	05800	S	M	CNT	II	01053	015									12	120896	1/1/0001
	05800	S	M	CNT	II	01056	016									12	120896	1/1/0001
	05800	S	M	CNT	II	01057	017									12	120896	1/1/0001
	05800	S	M	CNT	II	01064	018									12	120896	1/1/0001
	05800	S	M	CNT	II	01065	019									12	120896	1/1/0001
	05800	S	M	CNT	II	01073	021									12	120896	1/1/0001
	05800	S	M	CNT	II	01076	020									12	120896	1/1/0001

OFFICE: 311		ROUTE: 564		ST_REF_NO: 00000003505		ANDOVER FOREST DRIVE		LUMENS	BULB TYPE	MULT SERIES	POLE TYPE	SHADE	ADDRESS NUMBER	REF	LOCATION	TAX DIST	DATE INST	DATE CHANGE
	05800	S	M	CNT	II	01081	023									12	120896	1/1/0001
	05800	S	M	CNT	II	01088	022									12	120896	1/1/0001
	05800	S	M	CNT	II	01089	025									12	120896	1/1/0001
	05800	S	M	CNT	II	01092	024									12	120896	1/1/0001
	05800	S	M	CNT	II	01097	027									12	120896	1/1/0001
	05800	S	M	CNT	II	01100	026									12	120896	1/1/0001
	05800	S	M	CNT	II	01105	029									12	120896	1/1/0001
	05800	S	M	CNT	II	01112	028									12	120896	1/1/0001
	05800	S	M	CNT	II	01113	031									12	120896	1/1/0001
	05800	S	M	CNT	II	01120	030									12	120896	1/1/0001
	05800	S	M	CNT	II	01121	033									12	120896	1/1/0001
	05800	S	M	CNT	II	01125	035									12	120896	1/1/0001
	05800	S	M	CNT	II	01136	032									12	120896	1/1/0001
	05800	S	M	CNT	II	01148	034									12	120896	1/1/0001

OFFICE: 311		ROUTE: 564		ST_REF_NO: 00000003506		ANDOVER GREEN DRIVE		LUMENS	BULB TYPE	MULT SERIES	POLE TYPE	SHADE	ADDRESS NUMBER	REF	LOCATION	TAX DIST	DATE INST	DATE CHANGE
	05800	S	M	CNT	II	00900	001									12	100800	10/11/2011
	05800	S	M	CNT	II	00000	004								SIDE OF 945 ANDOVER WOODS LANE	12	100800	1/1/0001
	05800	S	M	CNT	II	00913	002									12	080800	1/1/0001
	05800	S	M	CNT	II	00924	003									12	100800	1/1/0001

OFFICE: 311		ROUTE: 564		ST_REF_NO: 00000003510		ANDOVER VILLAGE DRIVE		LUMENS	BULB TYPE	MULT SERIES	POLE TYPE	SHADE	ADDRESS NUMBER	REF	LOCATION	TAX DIST	DATE INST	DATE CHANGE
	05800	S	M	CNT	II	00000	001								1ST LT. S OF TODDS RD., EASTSIDE	12	120894	10/11/2011
	05800	S	M	CNT	II	00000	002								1ST LT. S OF TODDS RD., WESTSIDE	12	120894	10/11/2011
	05800	S	M	CNT	II	00000	014								OPP. 728	12	120894	1/1/0001
	05800	S	M	CNT	II	00000	015								1ST LT. W. OF MINT HILL LANE, NORTHSIDE	12	120894	1/1/0001
	05800	S	M	CNT	II	00701	017									12	120894	1/1/0001
	05800	S	M	CNT	II	00708	016									12	120894	1/1/0001
	05800	S	M	CNT	II	00745	013									12	120894	1/1/0001
	05800	S	M	CNT	II	00752	012									12	120894	1/1/0001

OFFICE: 311

ROUTE: 564

ST_REF_NO: 00000003510

ANDOVER VILLAGE DRIVE

LUMENS	BULB TYPE	MULT SERIES	POLE TYPE	SHADE	ADDRESS NUMBER	REF	LOCATION	TAX DIST	DATE INST	DATE CHANGE
05800	S	M	CNT	II	00761	011		12	120894	1/1/0001
05800	S	M	CNT	II	00773	010		12	120894	1/1/0001
05800	S	M	CNT	II	00777	009		12	120894	1/1/0001
05800	S	M	CNT	II	00788	008		12	120894	1/1/0001
05800	S	M	CNT	II	00793	007		12	120894	1/1/0001
05800	S	M	CNT	II	00805	006		12	120894	1/1/0001
05800	S	M	CNT	II	00809	004		12	120894	1/1/0001

OFFICE: 311

ROUTE: 564

ST_REF_NO: 00000003515

ANDOVER VILLAGE PLACE

LUMENS	BULB TYPE	MULT SERIES	POLE TYPE	SHADE	ADDRESS NUMBER	REF	LOCATION	TAX DIST	DATE INST	DATE CHANGE
05800	S		CNT	II	00001	001		12	112999	1/1/0001
05800	S		CNT	II	00002	002		12	112999	1/1/0001
05800	S		CNT	II	00003	003		12	112999	1/1/0001
05800	S		CNT	II	00004	004		12	112999	1/1/0001
05800	S		CNT	II	00005	005		12	112999	1/1/0001
05800	S		CNT	II	00006	006		12	112999	1/1/0001
05800	S		CNT	II	00007	007		12	112999	1/1/0001

OFFICE: 311

ROUTE: 564

ST_REF_NO: 00000003520

ANDOVER WOODS LANE

LUMENS	BULB TYPE	MULT SERIES	POLE TYPE	SHADE	ADDRESS NUMBER	REF	LOCATION	TAX DIST	DATE INST	DATE CHANGE
05800	S	M	CNT	II	00900	001		12	100800	1/1/0001
05800	S	M	CNT	II	00912	002		21	100800	1/1/0001
05800	S	M	CNT	II	00920	003		12	100800	1/1/0001
05800	S	M	CNT	II	00937	004		12	100800	1/1/0001
05800	S	M	CNT	II	00944	005		12	100800	1/1/0001

OFFICE: 311

ROUTE: 564

ST_REF_NO: 00000003600

ANDREA DRIVE

LUMENS	BULB TYPE	MULT SERIES	POLE TYPE	SHADE	ADDRESS NUMBER	REF	LOCATION	TAX DIST	DATE INST	DATE CHANGE
04000	S	M	OUG	II	00509	102		12	121583	10/11/2011
05800	S	M	OUG	II	00516	101		12	121583	9/9/2009
04000	S	M	OUG	II	00500	103		12	121583	1/1/0001

OFFICE: 311

ROUTE: 564

ST_REF_NO: 0000003600 ANDREA DRIVE

LUMENS	BULB TYPE	MULT SERIES	POLE TYPE	SHADE	ADDRESS NUMBER	REF	LOCATION	TAX DIST	DATE INST	DATE CHANGE
04000	S	M	OUG	II	00521	100		12	121583	1/1/0001

OFFICE: 311

ROUTE: 564

ST_REF_NO: 0000003675 ANGEL FALLS DRIVE

LUMENS	BULB TYPE	MULT SERIES	POLE TYPE	SHADE	ADDRESS NUMBER	REF	LOCATION	TAX DIST	DATE INST	DATE CHANGE
05800	S	M	CNT	III	00109	001		12	051706	1/1/0001
05800	S	M	CNT	II	00116	002		12	080102	1/1/0001
05800	S	M	CNT	II	00137	003		12	080102	1/1/0001
05800	S	M	CNT	II	00152	004		12	080102	1/1/0001
05800	S	M	CNT	II	00169	005		12	080102	1/1/0001
05800	S	M	CNT	II	00184	007		12	051706	1/1/0001
05800	S	M	CNT	II	00192	008		12	051706	1/1/0001

OFFICE: 311

ROUTE: 564

ST_REF_NO: 0000003690 ANGELA COURT

LUMENS	BULB TYPE	MULT SERIES	POLE TYPE	SHADE	ADDRESS NUMBER	REF	LOCATION	TAX DIST	DATE INST	DATE CHANGE
05800	S	M	OUG	II	00300	108		12	090886	9/9/2009
05800	S	M	OUG	II	00320	110		12	090886	9/9/2009
04000	S	M	OUG	V	00348	113		12	090886	10/11/2011
05800	S	M	OUG	II	00309	109	chg out bad fixture 2/08	12	090886	1/1/0001
04000	S	M	OUG	II	00332	111		12	090886	1/1/0001
04000	S	M	OUG	II	00340	112		12	090886	1/1/0001

OFFICE: 311

ROUTE: 564

ST_REF_NO: 0000003700 ANGLIANA AVENUE

LUMENS	BULB TYPE	MULT SERIES	POLE TYPE	SHADE	ADDRESS NUMBER	REF	LOCATION	TAX DIST	DATE INST	DATE CHANGE
10000	M	M	SOH	II	00000	010	OPP 498	12	011167	10/11/2011
10000	M	M	SOH	II	00000	012	opp 498	12	120166	9/19/2009
09500	S	M	SOH	II	00000	015	2ND POLE S OF HAMM ALLEY ON W SIDE	12	120166	9/9/2009
10000	M	M	SOH	II	00000	017	1ST POLE SOUTH OF HAM ALLEY, W SIDE	12	120166	10/11/2011
10000	M	M	SOH	II	00000	018	S.E. CORNER OF HAMM ALLEY	12	120166	10/11/2011
09500	S	M	SOH	II	00000	019	OPP 553	12	062167	9/9/2009
10000	M	M	SOH	II	00000	021	opp 845	12	062167	9/9/2009
10000	M	M	SOH	II	00422	004		12	120166	10/11/2011

OFFICE: 311

ROUTE: 564

ST_REF_NO: 0000003700

ANGLIANA AVENUE

LUMENS	BULB TYPE	MULT SERIES	POLE TYPE	SHADE	ADDRESS NUMBER	REF	LOCATION	TAX DIST	DATE INST	DATE CHANGE
10000	M	M	SOH	II	00422	005		12	011167	10/11/2011
10000	M	M	SOH	II	00466	007		12	011167	10/11/2011
10000	M	M	SOH	II	00472	008		12	120166	10/11/2011
10000	M	M	SOH	II	00498	009		12	011167	10/11/2011
09500	S	M	SOH	II	00537	016		12	120166	9/9/2009
05800	S	M	SOH	II	00553	020	1ST POLE N. OF HAMM ALLEY ON N. SIDE	12	080467	9/19/2009
09500	S	M	SOH	II	00574	023		12	062167	9/19/2009
10000	M	M	SOH	II	00845	022		12	062167	9/9/2009
10000	M	M	SOH	II	00850	025		12	120166	9/9/2009
10000	M	M	SOH	II	00861	026		12	120166	10/11/2011
10000	M	M	SOH	II	00000	013	7TH POLE W. OF S. BROADWAY ON S. SIDE	12	120166	1/1/0001
10000	M	M	SOH	II	00000	014	7TH POLE W. OF S. BROADWAY ON N. SIDE	12	120166	1/1/0001
22000	S	M	SOH	III	00000	028	SW CORNER OF SOUTH BROADWAY	12	110893	1/1/0001
09500	S	M	OUG	II	00000	029	1ST LT. W OF S. BROADWAY, N SIDE	12	070899	1/1/0001
09500	S	M	OUG	II	00000	030	2ND LT. W OF S. BROADWAY, N SIDE	12	070899	1/1/0001
09500	S	M	OUG	II	00000	031	3RD LT. W OF S. BROADWAY, N SIDE	12	070899	1/1/0001
09500	S	M	OUG	II	00000	032	4TH LT. S. OF BROADWAY, N SIDE	12	070899	1/1/0001
10000	M	M	SOH	II	00498	011		12	120166	1/1/0001
10000	M	M	SOH	II	00874	027		12	011167	1/1/0001

OFFICE: 311

ROUTE: 564

ST_REF_NO: 0000003735

ANGUS TRAIL

LUMENS	BULB TYPE	MULT SERIES	POLE TYPE	SHADE	ADDRESS NUMBER	REF	LOCATION	TAX DIST	DATE INST	DATE CHANGE
05800	S	M	CNT	II	01201	001		12	062808	1/1/0001
05800	S	M	CNT	II	01208	002		12	062808	1/1/0001
05800	S	M	CNT	II	01221	003		12	062808	1/1/0001
05800	S	M	CNT	II	01228	004		12	062808	1/1/0001
05800	S	M	CNT	II	01241	005		12	062808	1/1/0001
05800	S	M	CNT	II	01248	006		12	062808	1/1/0001
05800	S	M	CNT	II	01260	007		12	062808	1/1/0001

OFFICE: 311

ROUTE: 564

ST_REF_NO: 0000003900

ANNISTON DRIVE

LUMENS	BULB TYPE	MULT SERIES	POLE TYPE	SHADE	ADDRESS NUMBER	REF	LOCATION	TAX DIST	DATE INST	DATE CHANGE
05800	S	M	OUG	II	00000	003	1ST LT S OF BRYAN STATION RD, W SIDE	12	071063	10/11/2011
05800	S	M	OUG	II	00000	004	1ST LT S OF BRYAN STATION RD, E SIDE	12	071063	10/11/2011
05800	S	M	OUG	II	00000	005	2ND LT S OF BRYAN STATION RD, W SIDE	12	071063	10/11/2011
05800	S	M	OUG	II	00000	006	2ND LT S OF BRYAN STATION RD, E SIDE	12	071063	10/11/2011
05800	S	M	OUG	II	00463	000		12	041664	10/11/2011
05800	S	M	OUG	II	00630	000		12	010166	10/11/2011
05800	S	M	OOH	II	01488	000	ug to oh feed Dec 2011	12	120170	12/12/2011
05800	S	M	OUG	II	00405	000		12	041664	1/1/0001
05800	S	M	OUG	II	00416	000		12	041664	1/1/0001
05800	S	M	OUG	II	00429	000		12	010166	1/1/0001
05800	S	M	OUG	II	00438	000		12	062363	1/1/0001
05800	S	M	OUG	II	00449	000		12	062363	1/1/0001
05800	S	M	OUG	II	00454	000		12	062363	1/1/0001
05800	S	M	OUG	II	00470	000		12	042264	1/1/0001
05800	S	M	OUG	II	00483	000		12	061465	1/1/0001
05800	S	M	OUG	II	00000	001	SIDE OF 1998 BRYNELL DR. ON	12	061465	1/1/0001
05800	S	M	OUG	II	00000	002	SIDE OF 1919 MARIETTA DR. ON	12	090766	1/1/0001
05800	S	M	OUG	II	00500	000		12	042264	1/1/0001
05800	S	M	OUG	II	00517	000		12	041664	1/1/0001
05800	S	M	OUG	II	00524	000		12	041664	1/1/0001
05800	S	M	OUG	II	00545	000		12	041664	1/1/0001
05800	S	M	OUG	II	00568	000		12	041664	1/1/0001
05800	S	M	OUG	II	00571	000		12	042264	1/1/0001
05800	S	M	OUG	II	00617	000		12	042264	1/1/0001
05800	S	M	OUG	II	00641	000		12	041267	1/1/0001
05800	S	M	OUG	II	00656	000		12	010166	1/1/0001
05800	S	M	OUG	II	00669	000		12	010166	1/1/0001
05800	S	M	OUG	II	00684	000		12	010166	1/1/0001
05800	S	M	OUG	II	01436	000		12	090766	1/1/0001
05800	S	M	OUG	II	01449	000		12	090766	1/1/0001
05800	S	M	OUG	II	01464	000		12	090766	1/1/0001
05800	S	M	OUG	II	01477	000		12	090766	1/1/0001
05800	S	M	OUG	II	01497	000		12	090766	1/1/0001
05800	S	M	OUG	II	01500	000		12	040165	1/1/0001

OFFICE: 311

ROUTE: 564

ST_REF_NO: 00000003900

ANNISTON DRIVE

LUMENS	BULB TYPE	MULT SERIES	POLE TYPE	SHADE	ADDRESS NUMBER	REF	LOCATION	TAX DIST	DATE INST	DATE CHANGE
05800	S	M	OUG	II	01507	000		12	071064	1/1/0001
05800	S	M	OUG	II	01602	000		12	071064	1/1/0001
05800	S	M	OUG	II	01609	000		12	071064	1/1/0001

OFFICE: 311

ROUTE: 564

ST_REF_NO: 00000003910

ANNISTON COURT

LUMENS	BULB TYPE	MULT SERIES	POLE TYPE	SHADE	ADDRESS NUMBER	REF	LOCATION	TAX DIST	DATE INST	DATE CHANGE
05800	S	M	OUG	II	00000	001	SIDE OF 536 ANNISTON DR. ON	12	041664	1/1/0001

OFFICE: 311

ROUTE: 564

ST_REF_NO: 00000003950

ANSLEY COURT

LUMENS	BULB TYPE	MULT SERIES	POLE TYPE	SHADE	ADDRESS NUMBER	REF	LOCATION	TAX DIST	DATE INST	DATE CHANGE
05800	S	M	CNT	III	03709	002		12	020898	10/11/2011
05800	S	M	CNT	II	03700	001		12	020898	1/1/0001

OFFICE: 311

ROUTE: 564

ST_REF_NO: 00000004000

ANTIETAM ROAD

LUMENS	BULB TYPE	MULT SERIES	POLE TYPE	SHADE	ADDRESS NUMBER	REF	LOCATION	TAX DIST	DATE INST	DATE CHANGE
05800	S	M	OUG	II	00000	004	OPP. MANASSAS DR.	12	020889	9/9/2009
04000	S	M	OUG	II	00000	005	OPP. SIDE OF 1866 MANASSAS	12	020889	10/11/2011
04000	S	M	OUG	II	00000	001	SIDE OF 1848 TRAVELLER RD.	12	020889	1/1/0001
04000	S	M	OUG	II	00000	002	OPP. 1994	12	020889	1/1/0001
05800	S	M	OUG	II	00000	006	NW CORNER OF ALEXANDRIA upgraded 1/2008	12	020889	1/1/0001
04000	S	M	OUG	II	00000	007	SIDE OF 1874 ALEXANDRIA DR.	12	020889	1/1/0001
04000	S	M	OUG	II	00000	008	SIDE OF 1060 MAYWICK DR.	12	020889	1/1/0001
04000	S	M	OUG	II	01986	003		12	020889	1/1/0001

OFFICE: 311

ROUTE: 564

ST_REF_NO: 00000004150

ANTIQUE DRIVE

LUMENS	BULB TYPE	MULT SERIES	POLE TYPE	SHADE	ADDRESS NUMBER	REF	LOCATION	TAX DIST	DATE INST	DATE CHANGE
09500	S	M	SOH	II	00000	001	2ND LT E OF BURKE RD,S SIDE ON ANTIQUE RD	12	112403	1/1/0001
09500	S	M	SOH	II	00000	002	3RD LT E OF BURKE RD,S SIDE ON ANTIQUE RD	12	112403	1/1/0001
09500	S	M	SOH	II	00000	003	4TH LT E OF BURKE RD,S SIDE ON ANTIQUE RD	12	112403	1/1/0001
09500	S	M	SOH	II	00000	004	5TH LT E OF BURKE RD,S SIDE ON ANTIQUE RD	12	112403	1/1/0001
09500	S	M	SOH	II	00000	005	6TH LT E OF BURKE RD,S SIDE ON ANTIQUE RD	12	112403	1/1/0001

OFFICE: 311		ROUTE: 564		ST_REF_NO: 00000004150		ANTIQUE DRIVE		LUMENS	BULB TYPE	MULT SERIES	POLE TYPE	SHADE	ADDRESS NUMBER	REF	LOCATION	TAX DIST	DATE INST	DATE CHANGE
	09500	S	M	SOH	II	00000	006								7TH LT E OF BURKE RD,S SIDE ON ANTIQUE RD	12	112403	1/1/0001
	09500	S	M	SOH	II	00000	007								8TH LT E OF BURKE RD,S SIDE ON ANTIQUE RD	12	112403	1/1/0001
	09500	S	M	SOH	II	00000	999								1ST LT E OF BURKE RD,S SIDE ON ANTIQUE RD	12	112403	1/1/0001

OFFICE: 311		ROUTE: 564		ST_REF_NO: 00000004200		APACHE TRAIL		LUMENS	BULB TYPE	MULT SERIES	POLE TYPE	SHADE	ADDRESS NUMBER	REF	LOCATION	TAX DIST	DATE INST	DATE CHANGE
	05800	S	M	OUG	II	00825	008									12	050890	9/9/2009
	05800	S	M	OUG	II	00833	007									12	050890	9/9/2009
	04000	S	M	OUG	II	00000	002								SIDE OF 853	12	050890	1/1/0001
	04000	S	M	OUG	II	00840	006									12	050890	1/1/0001
	04000	S	M	OUG	II	00844	005									12	050890	1/1/0001
	04000	S	M	OUG	II	00849	004									12	050890	1/1/0001
	04000	S	M	OUG	II	00860	003									12	050890	1/1/0001
	04000	S	M	OUG	II	00880	001									12	050890	1/1/0001
	04000	S	M	OUG	II	00000	012								OPP. 800	12	050890	1/1/0001
	04000	S	M	OUG	II	00804	011									12	050890	1/1/0001
	04000	S	M	OUG	II	00813	010									12	050890	1/1/0001
	04000	S	M	OUG	II	00816	009									12	050890	1/1/0001

OFFICE: 311		ROUTE: 564		ST_REF_NO: 00000004210		APOSTOLIC WAY		LUMENS	BULB TYPE	MULT SERIES	POLE TYPE	SHADE	ADDRESS NUMBER	REF	LOCATION	TAX DIST	DATE INST	DATE CHANGE
	04000	S	M	SOH	II	00000	033								SIDE REAR OF 125 AMERICAN AVE.	12	050886	1/1/0001

OFFICE: 311		ROUTE: 564		ST_REF_NO: 00000004290		APPIAN CIRCLE		LUMENS	BULB TYPE	MULT SERIES	POLE TYPE	SHADE	ADDRESS NUMBER	REF	LOCATION	TAX DIST	DATE INST	DATE CHANGE
	04000	S	M	OUG	II	01200	001									12	030890	1/1/0001
	04000	S	M	OUG	V	01204	004									12	020891	1/1/0001
	04000	S	M	OUG	V	01217	002									12	030890	1/1/0001
	04000	S	M	OUG	II	01233	003									12	030890	1/1/0001

OFFICE: 311		ROUTE: 564		ST_REF_NO: 00000004295		APPIAN CROSSING		LUMENS	BULB TYPE	MULT SERIES	POLE TYPE	SHADE	ADDRESS NUMBER	REF	LOCATION	TAX DIST	DATE INST	DATE CHANGE
05800	S	M	OUG	II	00000	001	1ST LT NORTH OF APPIAN WAY ON APPIAN CROSSING	12	083001	1/1/0001								
05800	S	M	OUG	II	00000	002	2ND LT NORTH OF APPIAN WAY ON APPIAN CROSSING	12	083001	1/1/0001								
05800	S	M	OUG	II	00000	003	3RD LT N OF APPIAN WAY ON APPIAN CROSSING	12	083001	1/1/0001								
05800	S	M	OUG	II	00000	004	4TH LT N OF APPIAN WAY ON APPIAN CROSSING	12	083001	1/1/0001								
05800	S	M	OUG	II	00000	005	5TH LT N OF APPIAN WAY ON APPIAN CROSSING	12	083001	10/11/2011								

OFFICE: 311		ROUTE: 564		ST_REF_NO: 00000004300		APPIAN WAY		LUMENS	BULB TYPE	MULT SERIES	POLE TYPE	SHADE	ADDRESS NUMBER	REF	LOCATION	TAX DIST	DATE INST	DATE CHANGE
05800	S	M	OUG	II	00000	006	IN MEDIAN AT SIDE OF 1177 ARMSTRONG MILL	12	071562	10/11/2011								
05800	S	M	OUG	II	00000	008	IN MEDIAN AT SIDE OF 3595 OLYMPIA DRIVE	12	071562	10/11/2011								
05800	S	M	OUG	II	00000	009	IN MEDIAN AT SIDE OF 3600 OLYMPIA CIRCLE	12	071562	10/11/2011								
05800	S	M	OUG	II	00000	015	SIDE OF 1200 ARMSTRONG MILL RD	12	061580	10/11/2011								
05800	S	M	OUG	II	00000	033	IN MEDIAN AT SIDE OF 1190 VENETIAN WAY	12	041067	10/11/2011								
05800	S	M	OUG	II	00000	059	IN MEDIAN AT SIDE OF 1192 CENTRE PKWY	12	050868	10/11/2011								
05800	S	M	OUG	II	00000	060	IN MEDIAN AT SIDE OF 1200 CENTRE PKWY	12	050868	10/11/2011								
05800	S	M	OUG	II	03580	034	IN MEDIAN AT VENETIAN CIR.	12	041067	10/11/2011								
05800	S	M	OUG	II	03596	007	IN MEDIAN AT ARMSTRONG MILL	12	071562	10/11/2011								
05800	S	M	OUG	II	00000	031	IN MEDIAN ON APPIAN WAY SIDE OF 3598 OLYMPIA CIR.	12	041067	1/1/0001								
05800	S	M	OUG	II	00000	032	IN MEDIAN ON APPIAN WAY, SIDE OF 3601 OLYMPIA CIR.	12	041067	1/1/0001								
05800	S	M	OUG	II	00000	035	IN BACK OF 1194 OCTAVIAN CIR., IN MEDIAN	12	041067	1/1/0001								
05800	S	M	OUG	II	00000	036	IN BACK OF 1200 OCTAVIAN CIR. , IN MEDIAN	12	041067	1/1/0001								
05800	S	M	OUG	II	00000	037	IN FRONT 3559 , IN MEDIAN	12	041067	1/1/0001								
05800	S	M	OUG	II	00000	038	IN FRONT 3560 , IN MEDIAN	12	041067	1/1/0001								
05800	S	M	OUG	II	00000	041	OPP. 3685 APPIAN WAY	12	040892	1/1/0001								
05800	S	M	OUG	II	00000	054	SIDE 1079 TATESBROOK DR.	12	050886	1/1/0001								
05800	S	M	OUG	II	00000	055	SIDE OF 1088 TATESBROOK ON	12	011581	1/1/0001								
05800	S	M	OUG	II	00000	061	SIDE OF 1205 CENTRE PKWY.	12	120172	1/1/0001								
05800	S	M	OUG	II	00000	067	SIDE OF 1043 TRENT BLVD.	12	050886	1/1/0001								
05800	S	M	OUG	II	00000	068	SIDE 1050 TRENT BLVD.	12	050886	1/1/0001								
05800	S	M	OUG	II	00000	079	1ST LT. E. OF TATES CREEK, S. SIDE	12	030890	1/1/0001								

OFFICE: 311

ROUTE: 564

ST_REF_NO: 0000004300

APPIAN WAY

LUMENS	BULB TYPE	MULT SERIES	POLE TYPE	SHADE	ADDRESS NUMBER	REF	LOCATION	TAX DIST	DATE INST	DATE CHANGE
05800	S	M	OUG	II	00000	080	1ST LT. E. OF TATES CREEK, N. SIDE	12	030890	1/1/0001
05800	S	M	OUG	II	03605	016		12	061580	1/1/0001
05800	S	M	OUG	II	03616	017		12	061580	1/1/0001
05800	S	M	OUG	II	03617	018		12	061580	1/1/0001
05800	S	M	OUG	II	03625	020		12	061580	1/1/0001
05800	S	M	OUG	II	03632	019		12	061580	1/1/0001
05800	S	M	OUG	II	03645	036		12	111583	1/1/0001
05800	S	M	OUG	II	03664	037		12	030890	1/1/0001
05800	S	M	OUG	II	03680	039		12	030890	1/1/0001
05800	S	M	OUG	II	03712	063		12	071581	1/1/0001
05800	S	M	OUG	II	03724	064		12	050886	1/1/0001
05800	S	M	OUG	II	03724	066		12	050886	1/1/0001
05800	S	M	OUG	II	03725	065		12	050886	1/1/0001
05800	S	M	OUG	II	03744	075		12	050886	1/1/0001
05800	S	M	OUG	II	03751	074		12	050886	1/1/0001
05800	S	M	OUG	II	03751	076		12	050886	1/1/0001
05800	S	M	OUG	II	03751	078		12	030890	1/1/0001

OFFICE: 311

ROUTE: 564

ST_REF_NO: 0000004340

APPLECROSS DRIVE

LUMENS	BULB TYPE	MULT SERIES	POLE TYPE	SHADE	ADDRESS NUMBER	REF	LOCATION	TAX DIST	DATE INST	DATE CHANGE
05800	S	M	OUG	II	00000	006	SIDE OF 2300 BAILEYS ROW ON APPLECROSS DR	12	070908	1/1/0001
05800	S	M	OUG	II	00903	001		12	042508	1/1/0001
05800	S	M	OUG	II	00916	002		12	042508	10/11/2011
05800	S	M	OUG	II	00929	003		12	042508	1/1/0001
05800	S	M	OUG	II	00941	004		12	042508	1/1/0001
05800	S	M	OUG	II	00953	005		12	042508	1/1/0001
05800	S	M	OUG	II	00976	007		12	070908	1/1/0001
05800	S	M	OUG	II	00992	008		12	070908	1/1/0001
05800	S	M	OUG	II	01005	009		12	070908	1/1/0001
05800	S	M	OUG	II	01032	011		12	070908	1/1/0001
05800	S	M	OUG	II	01040	012		12	070908	1/1/0001

OFFICE: 311

ROUTE: 564

ST_REF_NO: 00000004345

APPLETREE LANE

LUMENS	BULB TYPE	MULT SERIES	POLE TYPE	SHADE	ADDRESS NUMBER	REF	LOCATION	TAX DIST	DATE INST	DATE CHANGE
05800	S	M	OUG	II	00000	126	SIDE 1652 STRADER RD-911 ST NAME CHANGE	12	110884	9/1/2011
05800	S	M	OUG	II	00000	127	SIDE 1657 WYATT PARKWAY-ST NAME WAS COLONIAL DR	12	110884	9/1/2011
04000	S	M	OUG	II	00000	128	SIDE 1662 WYATT PARKWAY	12	110884	9/1/2011
04000	S	M	OUG	II	00000	129	SIDE 1701 LINDY LANE	12	110884	9/1/2011
04000	S	M	OUG	II	00000	130	SIDE 1658 LINDY LANE	12	110884	9/1/2011
04000	S	M	OUG	II	00000	131	SIDE 1703 LIBERTY RD	12	110884	9/1/2011
04000	S	M	OUG	II	00000	132	SIDE OF 1668 LIBERTY RD	12	110884	9/1/2011
04000	S	M	OUG	II	00000	134	SIDE 1637 COURTNEY AVE.	12	110884	9/1/2011
04000	S	M	OUG	II	00616	133		12	110884	9/1/2011

OFFICE: 311

ROUTE: 564

ST_REF_NO: 00000004350

APPLE FOREST COURT

LUMENS	BULB TYPE	MULT SERIES	POLE TYPE	SHADE	ADDRESS NUMBER	REF	LOCATION	TAX DIST	DATE INST	DATE CHANGE
05800	S	M	CNT	III	00108	001		12	091001	1/1/0001

OFFICE: 311

ROUTE: 564

ST_REF_NO: 00000004400

APPOMATTOX ROAD

LUMENS	BULB TYPE	MULT SERIES	POLE TYPE	SHADE	ADDRESS NUMBER	REF	LOCATION	TAX DIST	DATE INST	DATE CHANGE
04000	S	M	OUG	II	00000	007	SIDE OF 989 DELLA DR	12	120888	10/11/2011
05800	S	M	OOH	II	00000	010	2ND LT. S. OF DELLA DR., W. SIDE	12	110888	9/9/2009
05800	S	M	OUG	II	00000	018	SIDE OF 998 MAYWICK DR.	12	110888	10/11/2011
04000	S	M	OUG	II	01720	003		12	120888	10/11/2011
04000	S	M	OUG	II	01725	004		12	120888	10/11/2011
04000	S	M	OUG	II	01744	005		12	120888	10/11/2011
05800	S	M	OUG	II	01749	006		12	120888	9/9/2009
04000	S	M	OUG	II	01700	001		12	120888	1/1/0001
04000	S	M	OUG	II	01705	002		12	120888	1/1/0001
05800	S	M	OUG	II	00000	008	SIDE OF 1000 DELLA DR.	12	120888	1/1/0001
05800	S	M	SOH	II	00000	009	SIDE OF 990 DELLA DR.	12	110888	1/1/0001
05800	S	M	OUG	II	00000	011	3RD LT. S. OF DELLA DR., W. SIDE	12	110888	1/1/0001
05800	S	M	OUG	II	00000	012	OPP. 1900	12	110888	1/1/0001
05800	S	M	OUG	II	00000	013	OPP. 1904	12	110888	1/1/0001
05800	S	M	OUG	II	00000	014	OPP. 1912	12	110888	1/1/0001
05800	S	M	OUG	II	00000	015	OPP. 1920	12	110888	1/1/0001

OFFICE: 311

ROUTE: 564

ST_REF_NO: 00000004400

APPOMATTOX ROAD

LUMENS	BULB TYPE	MULT SERIES	POLE TYPE	SHADE	ADDRESS NUMBER	REF	LOCATION	TAX DIST	DATE INST	DATE CHANGE
05800	S	M	OUG	II	00000	016	OPP. 1928	12	110888	1/1/0001
05800	S	M	OUG	II	00000	017	OPP. 1936	12	110888	1/1/0001
05800	S	M	OUG	II	00000	019	SIDE OF 1900 ALEXANDRIA DR.	12	110888	1/1/0001

OFFICE: 311

ROUTE: 564

ST_REF_NO: 00000004500

AQUEDUCT DRIVE

LUMENS	BULB TYPE	MULT SERIES	POLE TYPE	SHADE	ADDRESS NUMBER	REF	LOCATION	TAX DIST	DATE INST	DATE CHANGE
04000	S	M	OUG	II	03207	005		12	061580	10/11/2011
04000	S	M	OUG	II	03230	003		12	061580	10/11/2011
04000	S	M	OUG	II	03247	001		12	061580	10/11/2011
04000	S	M	OUG	II	00000	228	SIDE OF 3303 PIMLICO PKWY.	12	120172	1/1/0001
04000	S	M	OUG	II	03171	014		12	060886	1/1/0001
04000	S	M	OUG	II	03178	015		12	061580	1/1/0001
04000	S	M	OUG	II	03191	016		12	060886	1/1/0001
04000	S	M	OUG	II	03215	004		12	061580	1/1/0001
04000	S	M	OUG	II	03258	000		12	051074	1/1/0001
04000	S	M	OUG	II	03267	000		12	120172	1/1/0001
04000	S	M	OUG	II	03274	000		12	051074	1/1/0001
04000	S	M	OUG	II	03285	000		12	120172	1/1/0001

OFFICE: 311

ROUTE: 564

ST_REF_NO: 00000004510

ARBOR COURT

LUMENS	BULB TYPE	MULT SERIES	POLE TYPE	SHADE	ADDRESS NUMBER	REF	LOCATION	TAX DIST	DATE INST	DATE CHANGE
04000	S	M	OUG	II	03703	002		12	090892	10/11/2011
04000	S	M	OUG	V	03712	001		12	090892	1/1/0001

OFFICE: 311

ROUTE: 564

ST_REF_NO: 00000004520

ARBOR DRIVE

LUMENS	BULB TYPE	MULT SERIES	POLE TYPE	SHADE	ADDRESS NUMBER	REF	LOCATION	TAX DIST	DATE INST	DATE CHANGE
05800	S	M	OUG	III	03500	008		12	070899	10/11/2011
05800	S	M	OUG	II	03633	007		12	070899	10/11/2011
04000	S	M	OUG	II	03657	006		12	090892	10/11/2011
04000	S	M	OUG	II	03699	003		12	090892	10/11/2011
04000	S	M	OUG	II	03657	005		12	090892	1/1/0001

OFFICE: 311

ROUTE: 564

ST_REF_NO: 00000004520 ARBOR DRIVE

LUMENS	BULB TYPE	MULT SERIES	POLE TYPE	SHADE	ADDRESS NUMBER	REF	LOCATION	TAX DIST	DATE INST	DATE CHANGE
04000	S	M	OUG	II	03677	004		12	090892	1/1/0001

OFFICE: 311

ROUTE: 564

ST_REF_NO: 00000004570 ARBOR STATION COURT

LUMENS	BULB TYPE	MULT SERIES	POLE TYPE	SHADE	ADDRESS NUMBER	REF	LOCATION	TAX DIST	DATE INST	DATE CHANGE
05800	S	M	OUG	II	00900	001		12	120800	1/1/0001
05800	S	M	OUG	III	00908	002		12	120800	1/1/0001

OFFICE: 311

ROUTE: 564

ST_REF_NO: 00000004580 ARBOR STATION WAY

LUMENS	BULB TYPE	MULT SERIES	POLE TYPE	SHADE	ADDRESS NUMBER	REF	LOCATION	TAX DIST	DATE INST	DATE CHANGE
05800	S		OUG	III	01777	018		12	102809	1/1/0001
05800	S	M	OUG	II	00000	009	SIDE OF 1945 MARK AVENUE	12	012202	10/12/2011
05800	S	M	OUG	II	00000	014	SIDE OF 1853 SANDERSVILLE RD	12	012202	10/11/2011
05800	S	M	OUG	II	01796	017		12	012202	1/1/0001
05800	S	M	OUG	II	01808	016		12	012202	1/1/0001
05800	S	M	OUG	II	01816	015		12	012202	1/1/0001
05800	S	M	OUG	II	01840	013		12	012202	10/11/2011
05800	S	M	OUG	II	01861	012		12	012202	1/1/0001
05800	S	M	OUG	II	01868	011		12	012202	1/1/0001
05800	S	M	OUG	II	01881	010		12	012202	1/1/0001
05800	S	M	OUG	II	01909	008		12	012202	1/1/0001
05800	S	M	OUG	II	00000	007	SIDE OF 900 ARBOR STATION COURT	12	120800	1/1/0001
05800	S	M	OUG	II	01929	006		12	120800	1/1/0001
05800	S	M	OUG	II	01936	005		12	120800	1/1/0001
05800	S	M	OUG	II	01953	004		12	120800	1/1/0001
05800	S	M	OUG	II	01960	003		12	120800	1/1/0001
05800	S	M	OUG	II	01973	002		12	120800	1/1/0001
05800	S	M	OUG	II	01980	001		12	120800	1/1/0001

OFFICE: 311

ROUTE: 564

ST_REF_NO: 00000004600 ARCADIA PARK

LUMENS	BULB TYPE	MULT SERIES	POLE TYPE	SHADE	ADDRESS NUMBER	REF	LOCATION	TAX DIST	DATE INST	DATE CHANGE
05800	S	M	SOH	II	00207	000		12	121478	10/11/2011

OFFICE: 311

ROUTE: 564

ST_REF_NO: 00000004600 ARCADIA PARK

LUMENS	BULB TYPE	MULT SERIES	POLE TYPE	SHADE	ADDRESS NUMBER	REF	LOCATION	TAX DIST	DATE INST	DATE CHANGE
05800	S	M	SOH	II	00560	000		12	121478	10/11/2011
05800	S	M	SOH	II	00109	000		12	121478	1/1/0001
05800	S	M	SOH	II	00119	000		12	121478	1/1/0001

OFFICE: 311

ROUTE: 564

ST_REF_NO: 00000004700 ARCEME AVENUE

LUMENS	BULB TYPE	MULT SERIES	POLE TYPE	SHADE	ADDRESS NUMBER	REF	LOCATION	TAX DIST	DATE INST	DATE CHANGE
05800	S	M	SOH	II	00000	001	SIDE OF 928 N. LIMESTONE ST	12	120463	10/11/2011
05800	S	M	SOH	II	00148	000		12	120463	10/11/2011
05800	S	M	SOH	II	00161	000		12	120463	10/11/2011
05800	S	M	SOH	II	00000	002	SIDE OF 1003 BRYAN AVE. ON	12	120463	1/1/0001
05800	S	M	SOH	II	00123	000		12	120463	1/1/0001
05800	S	M	SOH	II	00186	000		12	120463	1/1/0001
05800	S	M	SOH	II	00215	000		12	120463	1/1/0001
05800	S	M	SOH	II	00228	000		12	120463	1/1/0001

OFFICE: 311

ROUTE: 564

ST_REF_NO: 00000004800 ARDEN PLACE

LUMENS	BULB TYPE	MULT SERIES	POLE TYPE	SHADE	ADDRESS NUMBER	REF	LOCATION	TAX DIST	DATE INST	DATE CHANGE
05800	S	M	OUG	II	00000	001	OPP. 3510 - IN COURT	12	091360	10/11/2011
05800	S	M	OUG	II	00000	002	OPP. 3516	12	091360	1/1/0001
05800	S	M	OUG	II	03503	000		12	060159	1/1/0001
05800	S	M	OUG	II	03506	000		12	091360	1/1/0001

OFFICE: 311

ROUTE: 564

ST_REF_NO: 00000004900 ARGONNE CIRCLE

LUMENS	BULB TYPE	MULT SERIES	POLE TYPE	SHADE	ADDRESS NUMBER	REF	LOCATION	TAX DIST	DATE INST	DATE CHANGE
09500	S	M	OUG	V	00255	000	upgraded ref 1, 254 and 266 to 9500 June 2005	12	080173	10/11/2011
09500	S	M	OUG	II	00000	001	SIDE OF 3463 LANSDOWNE DR. ON	12	010172	1/1/0001
09500	S	M	OUG	II	00266	000		12	080173	1/1/0001

OFFICE: 311

ROUTE: 564

ST_REF_NO: 00000005000 ARGYLE DRIVE

LUMENS	BULB TYPE	MULT SERIES	POLE TYPE	SHADE	ADDRESS NUMBER	REF	LOCATION	TAX DIST	DATE INST	DATE CHANGE
04000	S	M	OUG	II	00000	036	SIDE 2921 ARGYLE DR.	12	010886	1/1/0001

OFFICE: 311

ROUTE: 564

ST_REF_NO: 00000005000

ARGYLE DRIVE

LUMENS	BULB TYPE	MULT SERIES	POLE TYPE	SHADE	ADDRESS NUMBER	REF	LOCATION	TAX DIST	DATE INST	DATE CHANGE
04000	S	M	OUG	II	02903	033		12	010886	1/1/0001
04000	S	M	OUG	II	02911	034		12	010886	1/1/0001
04000	S	M	OUG	II	02920	035		12	010886	1/1/0001
04000	S	M	OUG	II	02944	037		12	010886	1/1/0001

OFFICE: 311

ROUTE: 564

ST_REF_NO: 00000005020

ARIA LANE

LUMENS	BULB TYPE	MULT SERIES	POLE TYPE	SHADE	ADDRESS NUMBER	REF	LOCATION	TAX DIST	DATE INST	DATE CHANGE
05800	S	M	OUG	II	00000	001	OPP. 3869	12	020897	1/1/0001
05800	S	M	OUG	II	00000	007	SIDE OF 3837 LANDRIDGE DRIVE	12	020897	1/1/0001
05800	S	M	OUG	III	03813	005		12	020897	1/1/0001
05800	S	M	OUG	II	03825	004		12	020897	1/1/0001
05800	S	M	OUG	III	03837	003		12	020897	1/1/0001
05800	S	M	OUG	II	03845	002		12	090898	1/1/0001
05800	S	M	OUG	II	03881	006		12	020897	1/1/0001

OFFICE: 311

ROUTE: 564

ST_REF_NO: 00000005090

ARISTIDES BLVD

LUMENS	BULB TYPE	MULT SERIES	POLE TYPE	SHADE	ADDRESS NUMBER	REF	LOCATION	TAX DIST	DATE INST	DATE CHANGE
22000	S	M	CNT	II	00000	001	1ST LT W OF NEWTOWN PK, N SIDE ON ARISTIDES BLVD	12	120401	1/1/0001
22000	S	M	CNT	II	00000	002	2ND LT W OF NEWTOWN PK, S SIDE ON ARISTIDES BLVD	12	120401	1/1/0001
22000	S	M	CNT	II	00000	003	2ND LT W OF NEWTOWN PK, N SIDE ON ARISTIDES BLVD	12	120401	1/1/0001
22000	S	M	CNT	II	00000	004	3RD LT W OF NEWTOWN PK, S SIDE ON ARISTIDES BLVD	12	120401	1/1/0001
22000	S	M	CNT	II	00000	005	3RD LT W OF NEWTOWN PK, N SIDE ON ARISTIDES BLVD	12	120401	1/1/0001
22000	S	M	CNT	II	00000	006	4TH LT W OF NEWTOWN PK, S SIDE ON ARISTIDES BLVD	12	120401	1/1/0001
22000	S	M	CNT	II	00000	007	4TH LT W OF NEWTOWN PK, N SIDE ON ARISTIDES BLVD	12	120401	1/1/0001
22000	S	M	CNT	II	00000	008	5TH LT W OF NEWTOWN PK, S SIDE ON ARISTIDES BLVD	12	120401	1/1/0001
22000	S	M	CNT	II	00000	009	5TH LT W OF NEWTOWN PK, N SIDE ON ARISTIDES BLVD	12	120401	1/1/0001

OFFICE: 311		ROUTE: 564		ST_REF_NO: 00000005090		ARISTIDES BLVD		LUMENS	BULB TYPE	MULT SERIES	POLE TYPE	SHADE	ADDRESS NUMBER	REF	LOCATION	TAX DIST	DATE INST	DATE CHANGE
22000	S	M	CNT	II	00000	010	6TH LT W OF NEWTOWN PK, S SIDE ON ARISTIDES BLVD	12	120401	1/1/0001								
22000	S	M	CNT	II	00000	011	6TH LT W OF NEWTOWN PK, N SIDE ON ARISTIDES BLVD	12	120401	1/1/0001								
22000	S	M	CNT	II	00000	012	7TH LT W OF NEWTOWN PK, S SIDE ON ARISTIDES BLVD	12	120401	1/1/0001								
22000	S	M	CNT	II	00000	013	7TH LT W OF NEWTOWN PK, N SIDE ON ARISTIDES BLVD	12	120401	1/1/0001								
22000	S	M	CNT	II	00000	999	1ST LT W OF NEWTOWN PK, S SIDE ON ARISTIDES BLVD	12	120401	1/1/0001								

OFFICE: 311		ROUTE: 564		ST_REF_NO: 00000005100		ARK ROYAL WAY		LUMENS	BULB TYPE	MULT SERIES	POLE TYPE	SHADE	ADDRESS NUMBER	REF	LOCATION	TAX DIST	DATE INST	DATE CHANGE
05800	S	M	OUG	II	02881	052		12	101173	10/11/2011								
04000	S	M	OUG	II	00000	055	SIDE OF 521 SEVERN WAY	12	062174	1/1/0001								
04000	S	M	OUG	II	02832	082		12	111583	1/1/0001								
04000	S	M	OUG	II	02840	083		12	111583	1/1/0001								
04000	S	M	OUG	II	02861	054		12	101173	1/1/0001								
04000	S	M	OUG	II	02868	053		12	101173	1/1/0001								
04000	S	M	OUG	II	00000	051	SIDE OF 423 WESTERFIELD WAY	12	101173	1/1/0001								
04000	S	M	OUG	II	02905	050		12	101173	1/1/0001								
04000	S	M	OUG	II	02912	049		12	101173	1/1/0001								
04000	S	M	OUG	II	02921	048		12	101173	1/1/0001								
04000	S	M	OUG	II	02932	047		12	062174	1/1/0001								
04000	S	M	OUG	II	02941	046		12	062174	1/1/0001								

OFFICE: 311		ROUTE: 564		ST_REF_NO: 00000005200		ARLINGTON AVENUE		LUMENS	BULB TYPE	MULT SERIES	POLE TYPE	SHADE	ADDRESS NUMBER	REF	LOCATION	TAX DIST	DATE INST	DATE CHANGE
05800	S	M	SOH	II	00000	001	SIDE OF 409 E. MAXWELL	12	010163	1/1/0001								
05800	S	M	SOH	II	00210	000		12	101579	1/1/0001								
05800	S	M	SOH	II	00217	000		12	010163	1/1/0001								
05800	S	M	SOH	II	00234	000		12	101579	1/1/0001								
05800	S	M	SOH	II	00249	000		12	010163	1/1/0001								

OFFICE: 311

ROUTE: 564

ST_REF_NO: 0000005400

ARMSTRONG MILL ROAD

LUMENS	BULB TYPE	MULT SERIES	POLE TYPE	SHADE	ADDRESS NUMBER	REF	LOCATION	TAX DIST	DATE INST	DATE CHANGE
05800	S	M	OUG	I	00000	001	SIDE OF 3601 APPIAN WAY ON SERVICE RD IN MEDIAN	12	061580	10/11/2011
09500	S	M	OUG	II	00000	002	SIDE OF 3601 APPIAN WAY IN MEDIAN	12	061580	9/9/2009
09500	S	M	OUG	II	00000	004	OPP. 1194 SERVICE RD. IN MEDIAN	12	061580	9/9/2009
09500	S	M	OUG	II	00000	008	OPP. 1174 SERVICE RD. IN MEDIAN	12	061580	9/9/2009
09500	S	M	OUG	II	00000	010	OPP. 1166 SERVICE RD. IN MEDIAN	12	061580	9/9/2009
09500	S	M	OUG	II	00000	012	OPP. 1158 SERVICE RD. IN MEDIAN	12	061580	9/9/2009
09500	S	M	OUG	II	00000	014	OPP. 1150 SERVICE RD. IN MEDIAN	12	061580	9/9/2009
09500	S	M	OUG	II	00000	015	1ST LT. E. OF TATES CREEK, N. SIDE	12	040890	9/9/2009
09500	S	M	OUG	II	00000	016	1 ST. LT. E. OF TATES CREEK ON S. SIDE	12	111580	9/9/2009
09500	S	M	OUG	II	00000	017	2ND LT. E. OF TATES CREEK, N. SIDE	12	040890	9/9/2009
09500	S	M	OUG	II	00000	018	2 ND. LT. E. OF TATES CREEK S. SIDE	12	111580	9/9/2009
09500	S	M	OUG	II	00000	020	OPP.1077	12	111580	9/9/2009
09500	S	M	OUG	II	00000	022	OPP. 1091	12	111580	9/9/2009
09500	S	M	OUG	II	00000	024	OPP. 1101	12	111580	9/9/2009
09500	S	M	OUG	II	00000	025	1st LT W OF GREENTREE, N SIDE	12	111580	7/11/2009
09500	S	M	OUG	II	00000	026	OPP. GREENTREE ROAD	12	030800	9/9/2009
09500	S	M	OUG	II	00000	027	1 ST. LT. E. OF GREETREEE ON N. SIDE	12	111580	9/9/2009
09500	S	M	OUG	III	00000	039	SIDE OF 3629 KEYSTONE CT ON ARMSTRONG MILL RD	12	090891	10/11/2011
09500	S	M	OUG	III	00000	040	2ND LT W OF KEYSTONE CT, SOUTHSIDE OF ARMSTRONG MILL	12	090891	10/11/2011
09500	S	M	OUG	II	00000	075	1ST LT E OF APPIAN WAY, S SIDE ON ARMSTRONG MILL	12	031505	9/9/2009
09500	S	M	OUG	II	00000	076	2ND LT E OF APPIAN WAY,S SIDE ON ARMSTRONG MILL	12	031505	1/1/0001
09500	S	M	OUG	II	00000	077	3RD LT E OF APPIAN WAY,S SIDE ON ARMSTRONG MILL	12	031505	1/1/0001
09500	S	M	OUG	II	00000	078	4TH LT E OF APPIAN WAY,S SIDE ON ARMSTRONG MILL	12	031505	1/1/0001
09500	S	M	OUG	II	00000	079	5TH LT E OF APPIAN WAY,S SIDE ON ARMSTRONG MILL	12	031505	1/1/0001
09500	S	M	OUG	II	00000	080	6TH LT E OF APPIAN WAY,S SIDE ON ARMSTRONG MILL	12	031505	1/1/0001
09500	S	M	OUG	II	00000	081	7TH LT E OF APPIAN WAY,S SIDE ON ARMSTRONG MILL	12	031505	1/1/0001
09500	S	M	OUG	II	00000	082	OPPOSITE CAULDER ROAD ON ARMSTRONG MILL	12	031505	1/1/0001

OFFICE: 311

ROUTE: 564

ST_REF_NO: 0000005400

ARMSTRONG MILL ROAD

LUMENS	BULB TYPE	MULT SERIES	POLE TYPE	SHADE	ADDRESS NUMBER	REF	LOCATION	TAX DIST	DATE INST	DATE CHANGE
09500	S	M	OUG	II	00000	083	1ST LT E OF CAULDER RD,S SIDE ON ARMSTRONG MILL	12	031505	1/1/0001
09500	S	M	OUG	II	00000	084	2ND LT E OF CAULDER RD,S SIDE ON ARMSTRONG MILL	12	031505	1/1/0001
09500	S	M	OUG	II	00000	085	1ST LT E OF CROSBY DR,S SIDE ON ARMSTRONG MILL	12	031505	1/1/0001
09500	S	M	OUG	II	00000	086	2ND LT E OF CROSBY DR,S SIDE ON ARMSTRONG MILL	12	031505	1/1/0001
09500	S	M	OUG	II	00000	087	3RD LT E OF CROSBY DR,S SIDE ON ARMSTRONG MILL	12	031505	1/1/0001
09500	S	M	OUG	II	00000	088	4TH LT E OF CROSBY DR,S SIDE ON ARMSTRONG MILL	12	031505	1/1/0001
09500	S	M	OUG	II	00000	089	5TH LT E OF CROSBY DR,S SIDE ON ARMSTRONG MILL	12	031505	1/1/0001
09500	S	M	OUG	II	00000	090	6TH LT E OF CROSBY DR,S SIDE ON ARMSTRONG MILL	12	031505	1/1/0001
09500	S	M	OUG	II	00000	091	1ST LT E OF GRACE DR,S SIDE ON ARMSTRONG MILL	12	031505	1/1/0001
09500	S	M	OUG	II	00000	092	2ND LT E OF GRACE DR,S SIDE ON ARMSTRONG MILL	12	031505	1/1/0001
09500	S	M	OUG	II	00000	093	3RD LT E OF GRACE DR,S SIDE ON ARMSTRONG MILL	12	031505	1/1/0001
09500	S	M	OUG	II	00000	094	4TH LT E OF GRACE DR,S SIDE ON ARMSTRONG MILL	12	031505	1/1/0001
09500	S	M	OUG	II	00000	095	5TH LT E OF GRACE DR,S SIDE ON ARMSTRONG MILL	12	031505	1/1/0001
09500	S	M	OUG	II	00000	096	1ST LT E OF RIVER PARK DR,S SIDE ON ARMSTRONG MILL	12	031505	1/1/0001
09500	S	M	OUG	II	00000	097	2ND LT E OF RIVER PARK DR,S SIDE ON ARMSTRONG MILL	12	031505	1/1/0001
09500	S	M	OUG	II	00000	098	3RD LT E OF RIVER PARK DR,S SIDE ON ARMSTRONG MILL	12	031505	1/1/0001
09500	S	M	OUG	II	00000	099	4TH LT E OF RIVER PARK, S SIDE ON ARMSTRONG MILL	12	031505	1/1/0001
09500	S	M	OUG	II	00000	100	5TH LT E OF RIVER PARK,S SIDE ON ARMSTRONG MILL	12	031505	1/1/0001
09500	S	M	OUG	II	01071	019		12	111580	9/9/2009
09500	S	M	OUG	II	01083	021		12	111580	9/9/2009
09500	S	M	OUG	II	01093	023		12	111580	9/9/2009
05800	S	M	OUG	II	01129	000	ON SERVICE ROAD	12	090166	10/11/2011

Street Light Listing run 1/11/2015 10:43:21 AM

Page 39 of 1254

OFFICE: 311

ROUTE: 564

ST_REF_NO: 0000005400

ARMSTRONG MILL ROAD

LUMENS	BULB TYPE	MULT SERIES	POLE TYPE	SHADE	ADDRESS NUMBER	REF	LOCATION	TAX DIST	DATE INST	DATE CHANGE
05800	S	M	OUG	II	01137	000	ON SERVICE ROAD	12	022262	10/11/2011
05800	S	M	OUG	II	01149	000	ON SERVICE ROAD	12	022262	10/11/2011
05800	S	M	OUG	II	01161	000	ON SERVICE ROAD	12	100164	10/11/2011
05800	S	M	OUG	II	01173	000	ON SERVICE ROAD	12	022262	10/11/2011
05800	S	M	OUG	I	00000	003	OPP. 1194 SERVICE RD. IN MEDIAN	12	061580	1/1/0001
05800	S	M	OUG	I	00000	005	OPP. 1182 SERVICE RD. IN MEDIAN	12	061580	1/1/0001
05800	S	M	OUG	II	00000	006	OPP. 1182 SERVICE RD. IN MEDIAN	12	061580	1/1/0001
05800	S	M	OUG	I	00000	007	OPP. 1174 SERVICE RD. IN MEDIAN	12	061580	1/1/0001
05800	S	M	OUG	I	00000	009	OPP. 1166 SERVICE RD. IN MEDIAN	12	061580	1/1/0001
05800	S	M	OUG	I	00000	011	OPP. 1158 SERVICE RD. IN MEDIAN	12	061580	1/1/0001
05800	S	M	OUG	I	00000	013	OPP. 1150 SERVICE RD. IN MEDIAN	12	061580	1/1/0001

OFFICE: 311

ROUTE: 564

ST_REF_NO: 0000005500

ARROWHEAD COURT

LUMENS	BULB TYPE	MULT SERIES	POLE TYPE	SHADE	ADDRESS NUMBER	REF	LOCATION	TAX DIST	DATE INST	DATE CHANGE
04000	S	M	OUG	II	00000	001	SIDE OF 3161 ARROWHEAD DR ON ARROWHEAD CT	12	120890	1/1/0001
04000	S	M	OUG	II	03169	002		12	100890	1/1/0001

OFFICE: 311

ROUTE: 564

ST_REF_NO: 0000005600

ARROWHEAD DRIVE

LUMENS	BULB TYPE	MULT SERIES	POLE TYPE	SHADE	ADDRESS NUMBER	REF	LOCATION	TAX DIST	DATE INST	DATE CHANGE
05800	S	M	OUG	II	00000	005	OPP 3012 ARROWHEAD	12	050890	10/11/2011
05800	S	M	OUG	II	00000	015	OPP 3052	12	050890	10/11/2011
05800	S	M	OUG	II	03001	001		12	050890	10/11/2011
05800	S	M	OUG	II	03005	004		12	050890	10/11/2011
05800	S	M	OUG	II	03013	006		12	050890	10/11/2011
05800	S	M	OUG	II	03020	007		12	050890	10/11/2011
05800	S	M	OUG	II	03021	008		12	050890	10/11/2011
05800	S	M	OUG	II	03025	009		12	050890	10/11/2011
05800	S	M	OUG	II	03032	010		12	050890	10/11/2011
05800	S	M	OUG	II	03037	011		12	050890	10/11/2011
05800	S	M	OUG	II	03040	012		12	050890	10/11/2011
05800	S	M	OUG	II	03045	013		12	050890	10/11/2011
05800	S	M	OUG	II	03052	014		12	050890	10/11/2011

OFFICE: 311		ROUTE: 564		ST_REF_NO: 00000005600		ARROWHEAD DRIVE				
LUMENS	BULB TYPE	MULT SERIES	POLE TYPE	SHADE	ADDRESS NUMBER	REF	LOCATION	TAX DIST	DATE INST	DATE CHANGE
05800	S	M	OUG	II	03056	023		12	050890	10/11/2011
05800	S	M	OUG	II	03121	023		12	010891	10/11/2011
05800	S	M	OUG	II	00000	002	SIDE OF 3098 HARRODSBURG RD.	12	050890	1/1/0001
05800	S	M	OUG	II	00000	003	SIDE OF 880 APACHE TRAIL	12	050890	1/1/0001
05800	S	M	OUG	II	00000	016	OPP. 3061	12	040894	1/1/0001
05800	S	M	OUG	II	00000	017	OPP. 3069	12	040894	1/1/0001
05800	S	M	OUG	II	03081	018		12	040894	1/1/0001
05800	S	M	OUG	II	03092	019		12	040892	1/1/0001
05800	S	M	OUG	II	03097	020		12	040894	1/1/0001
05800	S	M	OUG	II	03112	021		12	040894	1/1/0001
05800	S	M	OUG	II	03124	022		12	040894	1/1/0001
05800	S	M	OUG	II	03129	024		12	010891	1/1/0001
05800	S	M	OUG	II	03133	025		12	010891	1/1/0001
05800	S	M	OUG	II	03141	026		12	010891	1/1/0001
05800	S	M	OUG	II	03148	027		12	010891	1/1/0001
05800	S	M	OUG	II	03153	028		12	010891	1/1/0001
05800	S	M	OUG	II	03160	029		12	010891	1/1/0001
05800	S	M	OUG	II	03164	030		12	010891	1/1/0001
05800	S	M	OUG	II	03168	032		12	010891	1/1/0001
05800	S	M	OUG	II	03185	031		12	010891	1/1/0001

OFFICE: 311		ROUTE: 564		ST_REF_NO: 00000005660		ARTHUR WAY				
LUMENS	BULB TYPE	MULT SERIES	POLE TYPE	SHADE	ADDRESS NUMBER	REF	LOCATION	TAX DIST	DATE INST	DATE CHANGE
05800	S	M	OUG	II	02205	001		12	020801	10/11/2011
05800	S	M	OUG	III	02216	002		12	020801	1/1/0001

OFFICE: 311		ROUTE: 564		ST_REF_NO: 00000005700		ARUNDEL DRIVE				
LUMENS	BULB TYPE	MULT SERIES	POLE TYPE	SHADE	ADDRESS NUMBER	REF	LOCATION	TAX DIST	DATE INST	DATE CHANGE
05800	S	M	OUG	II	01840	000		12	032772	1/1/0001
05800	S	M	OUG	II	01851	000		12	010173	1/1/0001
05800	S	M	OUG	II	01860	000		12	081973	1/1/0001

OFFICE: 311

ROUTE: 564

ST_REF_NO: 00000005800

ARVICE COURT

LUMENS	BULB TYPE	MULT SERIES	POLE TYPE	SHADE	ADDRESS NUMBER	REF	LOCATION	TAX DIST	DATE INST	DATE CHANGE
04000	S	M	OUG	II	00000	093	SIDE 232 WHITFIELD DR.	12	090886	1/1/0001
04000	S	M	OUG	II	04508	092		12	090886	1/1/0001

OFFICE: 311

ROUTE: 564

ST_REF_NO: 00000005900

ASBURY LANE

LUMENS	BULB TYPE	MULT SERIES	POLE TYPE	SHADE	ADDRESS NUMBER	REF	LOCATION	TAX DIST	DATE INST	DATE CHANGE
05800	S	M	OUG	II	00000	001	IN MEDIAN AT ENTRANCE TO GREEN ACRES	12	110369	1/1/0001
05800	S	M	OUG	II	00000	002	IN MEDIAN AT ENTRANCE TO GREEN ACRES	12	110369	1/1/0001
05800	S	M	OUG	II	00000	003	IN MEDIAN AT ENTRANCE TO GREEN ACRES	12	110369	1/1/0001
05800	S	M	OUG	II	00000	004	IN MEDIAN AT ENTRANCE TO GREEN ACRES	12	110369	1/1/0001
05800	S	M	OUG	II	00000	012	SIDE OF 1598 KIRK CT.	12	010172	1/1/0001
05800	S	M	OUG	II	00000	044	SIDE OF 1490 VAN BUREN	12	030171	1/1/0001
05800	S	M	OUG	II	00413	000		12	010173	1/1/0001
05800	S	M	OUG	II	00420	000		12	110369	1/1/0001
05800	S	M	OUG	II	00425	000		12	010172	1/1/0001
05800	S	M	OUG	II	00436	000		12	060170	1/1/0001
05800	S	M	OUG	II	00437	000		12	010172	1/1/0001
05800	S	M	OUG	II	00448	000		12	060170	1/1/0001
05800	S	M	OUG	II	00453	000		12	010172	1/1/0001
05800	S	M	OUG	II	00468	000		12	060170	1/1/0001
05800	S	M	OUG	II	00469	000		12	110369	1/1/0001
05800	S	M	OUG	II	00485	000		12	110369	1/1/0001
05800	S	M	OUG	II	00488	000		12	110369	1/1/0001
05800	S	M	OUG	II	00499	000		12	060170	1/1/0001
05800	S	M	OUG	II	00504	000		12	010172	1/1/0001
05800	S	M	OUG	II	00509	000		12	010172	1/1/0001
05800	S	M	OUG	II	00520	000		12	010172	1/1/0001
05800	S	M	OUG	II	00529	000		12	010172	1/1/0001
05800	S	M	OUG	II	00545	000		12	010172	1/1/0001
05800	S	M	OUG	II	00552	000		12	010173	1/1/0001

OFFICE: 311

ROUTE: 564

ST_REF_NO: 0000006000 ASCOT PARK

LUMENS	BULB TYPE	MULT SERIES	POLE TYPE	SHADE	ADDRESS NUMBER	REF	LOCATION	TAX DIST	DATE INST	DATE CHANGE
05800	S	M	OUG	II	00000	132	SIDE OF 3587 RIVER PARK	12	041475	1/1/0001
05800	S	M	OUG	II	01248	135		12	041475	1/1/0001
05800	S	M	OUG	II	01261	134		12	041475	1/1/0001
05800	S	M	OUG	II	01272	133		12	041475	1/1/0001

OFFICE: 311

ROUTE: 564

ST_REF_NO: 0000006100 ASH STREET

LUMENS	BULB TYPE	MULT SERIES	POLE TYPE	SHADE	ADDRESS NUMBER	REF	LOCATION	TAX DIST	DATE INST	DATE CHANGE
05800	S	M	SOH	I	00000	003	SIDE OF 567 GEORGETOWN ST.	12	060366	10/11/2011
05800	S	M	SOH	I	00418	000		12	060366	10/11/2011
05800	S	M	SOH	I	00432	000		12	060366	10/11/2011
05800	S	M	SOH	I	00000	001	SIDE OF 572 GEORGETOWN	12	121262	1/1/0001
05800	S	M	SOH	I	00000	002	1ST LT FROM NEWTOWN RD.	12	121262	1/1/0001
05800	S	M	SOH	I	00000	004	SIDE OF 937 CHARLES AVE.	12	060366	1/1/0001
05800	S	M	SOH	I	00000	005	SIDE OF 944 CHARLES AVE.	12	060366	1/1/0001
05800	S	M	SOH	I	00000	006	OPP. 315 ASH ST.	12	060366	1/1/0001
05800	S	M	SOH	I	00000	007	SIDE OF 945 WHITNEY AVE.	12	060366	1/1/0001
05800	S	M	SOH	I	00442	000		12	060366	1/1/0001
05800	S	M	SOH	I	00456	000		12	060366	1/1/0001
05800	S	M	SOH	I	00466	000		12	060366	1/1/0001
05800	S	M	SOH	I	00470	000		12	060366	1/1/0001
05800	S	M	SOH	I	00518	000		12	121262	1/1/0001
05800	S	M	SOH	I	00540	000		12	121262	1/1/0001
05800	S	M	SOH	I	00550	000		12	121262	1/1/0001
05800	S	M	SOH	I	00560	000		12	121262	1/1/0001
05800	S	M	SOH	I	00572	000		12	121262	1/1/0001

OFFICE: 311

ROUTE: 564

ST_REF_NO: 0000006110 ASHBROOKE DRIVE

LUMENS	BULB TYPE	MULT SERIES	POLE TYPE	SHADE	ADDRESS NUMBER	REF	LOCATION	TAX DIST	DATE INST	DATE CHANGE
05800	S	M	CNT	II	02704	019		12	080895	10/11/2011
05800	S	M	CNT	II	02760	025		12	080896	10/11/2011
05800	S	M	CNT	II	02769	026		12	080896	10/11/2011
05800	S	M	CNT	II	02784	027		12	080896	10/11/2011

OFFICE: 311

ROUTE: 564

ST_REF_NO: 00000006110

ASHBROOKE DRIVE

LUMENS	BULB TYPE	MULT SERIES	POLE TYPE	SHADE	ADDRESS NUMBER	REF	LOCATION	TAX DIST	DATE INST	DATE CHANGE
05800	S	M	CNT	II	00000	023	SIDE OF 4933 WAYNE'S BLVD.	12	080896	1/1/0001
05800	S	M	CNT	II	00000	029	SIDE OF 2805	12	080896	1/1/0001
05800	S	M	CNT	II	00000	036	SIDE REAR OF 2717	12	080896	1/1/0001
05800	S	M	CNT	II	02628	011		12	080895	1/1/0001
05800	S	M	CNT	II	02633	012		12	080895	1/1/0001
05800	S	M	CNT	II	02640	013		12	080895	1/1/0001
05800	S	M	CNT	II	02653	014		12	080895	1/1/0001
05800	S	M	CNT	II	02660	015		12	080895	1/1/0001
05800	S	M	CNT	II	02669	016		12	080895	1/1/0001
05800	S	M	CNT	II	02676	017		12	080895	1/1/0001
05800	S	M	CNT	II	02684	018		12	080895	1/1/0001
05800	S	M	CNT	II	02709	020		12	080896	1/1/0001
05800	S	M	CNT	II	02720	021		12	080896	1/1/0001
05800	S	M	CNT	III	02736	022		12	080896	1/1/0001
05800	S	M	CNT	II	02753	024		12	050897	1/1/0001
05800	S	M	CNT	III	02792	028		12	080896	1/1/0001
05800	S	M	CNT	II	02812	030		12	080896	1/1/0001
05800	S	M	CNT	II	02828	031		12	080896	1/1/0001
05800	S	M	CNT	II	02837	032		12	080896	1/1/0001
05800	S	M	CNT	II	02844	033		12	080896	1/1/0001
05800	S	M	CNT	II	02853	034		12	080896	1/1/0001
05800	S	M	CNT	II	02860	035		12	080896	1/1/0001

OFFICE: 311

ROUTE: 564

ST_REF_NO: 00000006130

ASHBY COURT

LUMENS	BULB TYPE	MULT SERIES	POLE TYPE	SHADE	ADDRESS NUMBER	REF	LOCATION	TAX DIST	DATE INST	DATE CHANGE
05800	S	M	CNT	III	01001	001		12	090898	1/1/0001

OFFICE: 311

ROUTE: 564

ST_REF_NO: 00000006140

ASHBY GLEN PLACE

LUMENS	BULB TYPE	MULT SERIES	POLE TYPE	SHADE	ADDRESS NUMBER	REF	LOCATION	TAX DIST	DATE INST	DATE CHANGE
05800	S	M	OUG	II	00000	004	SIDE OF 2824	12	032503	10/11/2011
05800	S	M	OUG	II	02800	002		12	032503	10/11/2011
05800	S	M	OUG	II	02801	001		12	032503	1/1/0001

OFFICE: 311		ROUTE: 564		ST_REF_NO: 00000006140		ASHBY GLEN PLACE				
LUMENS	BULB TYPE	MULT SERIES	POLE TYPE	SHADE	ADDRESS NUMBER	REF	LOCATION	TAX DIST	DATE INST	DATE CHANGE
05800	S	M	OUG	II	02821	003		12	032503	1/1/0001
05800	S	M	OUG	II	02857	005		12	032503	10/11/2011
05800	S	M	OUG	II	02868	006		12	032503	10/11/2011

OFFICE: 311		ROUTE: 564		ST_REF_NO: 00000006400		ASHLAND, NORTH AVENUE				
LUMENS	BULB TYPE	MULT SERIES	POLE TYPE	SHADE	ADDRESS NUMBER	REF	LOCATION	TAX DIST	DATE INST	DATE CHANGE
04000	S	M	SOH	II	00000	001	1ST LT. E. OF AURORA ST.	12	101866	10/11/2011
04000	S	M	SOH	II	00000	002	2ND LT. E. OF AURORA AVE.	12	101866	10/11/2011
04000	S	M	SOH	II	00000	003	3RD LT. E. OF AURORA AVE.	12	101866	10/11/2011
04000	S	S	SOH	II	00000	004	1ST LT. E. OF CRAMER AVE.	12	101866	10/11/2011
04000	S	S	SOH	II	00000	005	2ND LT. E. OF CRAMER AVE.	12	101866	10/11/2011
10000	M	M	SOH	II	00000	007	SIDE OF 735 E MAIN	12	011167	10/11/2011
10000	M	M	SOH	II	00000	008	OPP 115	12	011167	10/11/2011
10000	M	M	SOH	II	00000	009	OPP 158	12	091267	10/11/2011
09500	S	M	SOH	II	00121	000	bad fixture	12	011167	3/2/2009
09500	S	M	SOH	II	00168	000	bad fixture-changed out 2/08	12	011167	10/11/2011
10000	M	S	SOH	II	00000	006	SIDE OF 801 E. MAIN	12	011167	1/1/0001
10000	M	M	SOH	II	00140	000		12	011167	1/1/0001
10000	M	M	SOH	II	00145	000		12	091267	1/1/0001
10000	M	M	SOH	II	00154	000		12	011167	1/1/0001
10000	M	M	SOH	II	00173	000		12	091267	1/1/0001
10000	M	M	SOH	II	00180	000		12	011167	1/1/0001
10000	M	M	SOH	II	00195	000		12	091267	1/1/0001

OFFICE: 311		ROUTE: 564		ST_REF_NO: 00000006410		ASHLAND, SOUTH AVENUE				
LUMENS	BULB TYPE	MULT SERIES	POLE TYPE	SHADE	ADDRESS NUMBER	REF	LOCATION	TAX DIST	DATE INST	DATE CHANGE
10000	M	M	SOH	II	00000	007	SIDE OF 732 EUCLID AVE	12	080268	10/11/2011
05800	S	M	SOH	III	00000	008	1ST LT. S. OF MAIN W. SIDE	12	081064	9/9/2009
05800	S	M	SOH	III	00000	009	NW CORNER OF ASHLAND & HIGH	12	081064	9/9/2009
09500	S	M	SOH	III	00107	000		12	081064	9/9/2009
09500	S	M	SOH	III	00117	000		12	081064	9/9/2011
09500	S	M	SOH	III	00125	000		12	081064	9/9/2009

OFFICE: 311

ROUTE: 564

ST_REF_NO: 00000006410

ASHLAND, SOUTH AVENUE

LUMENS	BULB TYPE	MULT SERIES	POLE TYPE	SHADE	ADDRESS NUMBER	REF	LOCATION	TAX DIST	DATE INST	DATE CHANGE
09500	S	M	SOH	III	00200	000		12	061564	10/11/2011
09500	S	M	SOH	III	00211	000		12	081064	4/9/2012
09500	S	M	SOH	III	00221	000		12	081064	10/11/2011
09500	S	M	SOH	III	00248	000		12	061564	10/11/2011
22000	S	M	SOH	III	00315	000	bad fixture	12	050162	7/19/2010
04000	S	M	SOH	I	00475	010		12	070767	10/11/2011
09500	S	M	SOH	III	294	000	replaced bad fixture 11/5/2008	12	061564	10/11/2011
05800	S	M	SOH	I	00000	011	SIDE OF 801 SUNSET	12	070767	1/1/0001
09500	S	M	SOH	III	00124	000		12	061564	1/1/0001
09500	S	M	SOH	III	00212	000		12	061564	1/1/0001
09500	S	M	SOH	III	00232	000		12	061564	1/1/0001
09500	S	M	SOH	III	00237	000		12	061564	1/1/0001
09500	S	M	SOH	III	00255	000		12	082464	1/1/0001
10000	M	M	SOH	III	00262	000		12	061564	1/1/0001
09500	S	M	SOH	III	00265	000		12	081064	1/1/0001
10000	M	M	SOH	III	00276	000		12	061564	1/1/0001
09500	S	M	SOH	III	00285	000		12	081064	1/1/0001
20000	M	M	SOH	III	00307	000		12	050162	1/1/0001
20000	M	M	SOH	III	00323	000		12	050162	1/1/0001
10000	M	M	SOH	II	00442	000		12	080268	1/1/0001
10000	M	M	SOH	II	00449	000		12	080268	1/1/0001
05800	S	M	SOH	I	00458	000		12	070767	1/1/0001
05800	S	M	SOH	I	00467	000		12	070767	1/1/0001
05800	S	M	SOH	I	00468	000		12	070767	1/1/0001
05800	S	M	SOH	I	00476	000		12	070767	1/1/0001
05800	S	M	SOH	I	00480	000		12	081867	1/1/0001
04000	S	M	SOH	I	00611	000		12	070767	1/1/0001
05800	S	M	SOH	I	00637	000		12	070767	1/1/0001

OFFICE: 311

ROUTE: 564

ST_REF_NO: 00000006470

ASHLAND TERRACE

LUMENS	BULB TYPE	MULT SERIES	POLE TYPE	SHADE	ADDRESS NUMBER	REF	LOCATION	TAX DIST	DATE INST	DATE CHANGE
05800	S	M	SOH	II	00454	100		12	033106	1/1/0001

OFFICE: 311		ROUTE: 564		ST_REF_NO: 00000006500		ASHLEY WAY		LUMENS	BULB TYPE	MULT SERIES	POLE TYPE	SHADE	ADDRESS NUMBER	REF	LOCATION	TAX DIST	DATE INST	DATE CHANGE
04000	S	M	OUG	II	00000	012	SIDE AT 2900 NEAL DR	12	071581	10/11/2011								
04000	S	M	OUG	II	00000	019	SIDE OF 2940 NEAL DR	12	011581	10/11/2011								
05800	S	M	OUG	II	00518	016		12	081581	9/9/2009								
04000	S	M	OUG	II	00533	015		12	071581	10/11/2011								
05800	S	M	OUG	II	00577	011		12	011581	9/9/2009								
04000	S	M	OUG	II	00505	017		12	011581	1/1/0001								
04000	S	M	OUG	II	00510	018		12	050886	1/1/0001								
05800	S	M	OUG	II	00542	014		12	011581	1/1/0001								
04000	S	M	OUG	II	00557	013		12	011581	1/1/0001								
04000	S	M	OUG	II	00590	010		12	111581	1/1/0001								

OFFICE: 311

ROUTE: 564

OFFICE: 311		ROUTE: 564		ST_REF_NO: 00000006505		ASHLEY OAKS DRIVE		LUMENS	BULB TYPE	MULT SERIES	POLE TYPE	SHADE	ADDRESS NUMBER	REF	LOCATION	TAX DIST	DATE INST	DATE CHANGE
05800	S		CNT	II	03009	002		12	030309	1/1/0001								
05800	S	M	CNT	II	03000	001		12	050603	1/1/0001								
05800	S	M	CNT	II	03024	003		12	050603	10/11/2011								
05800	S	M	CNT	II	03032	004		12	050603	1/1/0001								
05800	S	M	CNT	II	03045	005		12	050603	1/1/0001								

OFFICE: 311

ROUTE: 564

OFFICE: 311		ROUTE: 564		ST_REF_NO: 00000006510		ASHMOOR DRIVE		LUMENS	BULB TYPE	MULT SERIES	POLE TYPE	SHADE	ADDRESS NUMBER	REF	LOCATION	TAX DIST	DATE INST	DATE CHANGE
04000	S	M	OUG	II	00000	039	SIDE OF 4508 GRAVES DR	12	011579	10/11/2011								
04000	S	M	OUG	II	00309	010		12	011581	1/1/0001								
04000	S	M	OUG	II	00317	011		12	011579	1/1/0001								
05800	S	M	OUG	II	00332	012		12	011579	1/1/0001								
04000	S	M	OUG	II	00337	013		12	011579	1/1/0001								
04000	S	M	OUG	II	00348	026		12	011579	1/1/0001								
04000	S	M	OUG	II	00361	038		12	011581	1/1/0001								
05800	S	M	OUG	II	00381	040		12	011581	1/1/0001								
04000	S	M	OUG	V	00392	041		12	011581	1/1/0001								

OFFICE: 311

ROUTE: 564

ST_REF_NO: 00000006600 ASHTON DRIVE

LUMENS	BULB TYPE	MULT SERIES	POLE TYPE	SHADE	ADDRESS NUMBER	REF	LOCATION	TAX DIST	DATE INST	DATE CHANGE
05800	S	M	SOH	II	00000	010	SIDE OF 101 ASHTON DRIVE	12	032304	1/1/0001
05800	S	M	SOH	II	00000	011	ACROSS FROM 103 ASHTON DRIVE	12	032304	1/1/0001
05800	S	M	OOH	II	00000	153	SIDE 1260 WINCHESTER RD	12	110884	9/9/2009
05800	S	M	SOH	II	00120	012		12	032304	1/1/0001
05800	S	M	SOH	II	00141	013		12	032304	1/1/0001
04000	S	M	SOH	II	00149	160		12	120884	10/11/2011
04000	S	M	SOH	II	00110	155		12	010885	1/1/0001
04000	S	M	SOH	II	00124	157		12	010885	1/1/0001
04000	S	M	SOH	II	00133	158		12	120884	1/1/0001

OFFICE: 311

ROUTE: 564

ST_REF_NO: 00000006700 ASHWOOD DRIVE

LUMENS	BULB TYPE	MULT SERIES	POLE TYPE	SHADE	ADDRESS NUMBER	REF	LOCATION	TAX DIST	DATE INST	DATE CHANGE
05800	S	M	OUG	II	01637	000		12	090171	10/11/2011
05800	S	M	OUG	II	00000	001	SIDE OF 119 CHINOE RD	12	090171	1/1/0001
05800	S	M	OUG	II	01611	000		12	090171	1/1/0001
05800	S	M	OUG	II	01620	000		12	090171	1/1/0001
05800	S	M	OUG	II	01631	000		12	090171	1/1/0001
05800	S	M	OUG	II	01650	000		12	090171	1/1/0001

OFFICE: 311

ROUTE: 564

ST_REF_NO: 00000006780 ASPEN STREET

LUMENS	BULB TYPE	MULT SERIES	POLE TYPE	SHADE	ADDRESS NUMBER	REF	LOCATION	TAX DIST	DATE INST	DATE CHANGE
05800	S	M	CNT	II	01201	001		12	060897	1/1/0001
05800	S	M	CNT	III	01217	002		12	060897	1/1/0001
05800	S	M	CNT	II	01240	003		12	070899	1/1/0001

OFFICE: 311

ROUTE: 564

ST_REF_NO: 00000006900 ASTAIRE DRIVE

LUMENS	BULB TYPE	MULT SERIES	POLE TYPE	SHADE	ADDRESS NUMBER	REF	LOCATION	TAX DIST	DATE INST	DATE CHANGE
05800	S	M	OUG	II	01511	041		12	011475	10/11/2011
05800	S	M	OUG	II	00000	039	SIDE OF 602 HOLLOW CREEK	12	081475	1/1/0001
05800	S	M	OUG	II	00000	040	SIDE OF 634 HOLLOW CREEK RD. ON	12	061674	1/1/0001
05800	S	M	OUG	II	01526	042		12	051475	1/1/0001

OFFICE: 311		ROUTE: 564		ST_REF_NO: 00000006900		ASTAIRE DRIVE		LUMENS	BULB TYPE	MULT SERIES	POLE TYPE	SHADE	ADDRESS NUMBER	REF	LOCATION	TAX DIST	DATE INST	DATE CHANGE
05800	S	M	OUG	II	01547	043										12	051475	1/1/0001
05800	S	M	OUG	II	01553	000										12	061674	1/1/0001
05800	S	M	OUG	II	01578	000										12	061674	1/1/0001
05800	S	M	OUG	II	01591	000										12	061674	1/1/0001

OFFICE: 311		ROUTE: 564		ST_REF_NO: 00000006901		ASTAIRE COURT		LUMENS	BULB TYPE	MULT SERIES	POLE TYPE	SHADE	ADDRESS NUMBER	REF	LOCATION	TAX DIST	DATE INST	DATE CHANGE
05800	S	M	OUG	II	00000	047										12	061674	10/11/2011

OFFICE: 311		ROUTE: 564		ST_REF_NO: 00000006950		ASTARITA WAY		LUMENS	BULB TYPE	MULT SERIES	POLE TYPE	SHADE	ADDRESS NUMBER	REF	LOCATION	TAX DIST	DATE INST	DATE CHANGE
09500	S		CLN	II	02420	001										12	091109	1/1/0001
09500	S		CLN	II	02425	002										12	091109	1/1/0001
09500	S		CLN	II	02431	004										12	091109	1/1/0001
09500	S		CLN	II	02438	003										12	091109	1/1/0001
09500	S		CLN	II	02442	005										12	091109	1/1/0001
09500	S		CLN	II	02449	006										12	091109	1/1/0001
09500	S		CLN	II	02460	007										12	091109	1/1/0001
09500	S		CLN	II	02465	008										12	091109	1/1/0001
09500	S		CLN	II	02468	009										12	091109	1/1/0001
09500	S		CLN	II	02473	010										12	091109	1/1/0001
09500	S		CLN	II	02480	011										12	091109	1/1/0001
09500	S		CLN	II	02489	012										12	091109	1/1/0001

OFFICE: 311		ROUTE: 564		ST_REF_NO: 00000007000		ASTER ROAD		LUMENS	BULB TYPE	MULT SERIES	POLE TYPE	SHADE	ADDRESS NUMBER	REF	LOCATION	TAX DIST	DATE INST	DATE CHANGE
05800	S	M	OUG	II	00000	000										12	091064	10/11/2011
05800	S	M	OUG	II	00838	000										12	090164	1/1/0001
05800	S	M	OUG	II	00866	000										12	090164	1/1/0001
05800	S	M	OUG	II	00881	000										12	090164	1/1/0001

OFFICE: 311		ROUTE: 564		ST_REF_NO: 00000007100		ATOKAD PARK		LUMENS	BULB TYPE	MULT SERIES	POLE TYPE	SHADE	ADDRESS NUMBER	REF	LOCATION	TAX DIST	DATE INST	DATE CHANGE
05800	S	M	OUG	II	00000	122	SIDE OF 3527 RIVER PARK	12	041475	1/1/0001								
05800	S	M	OUG	II	01256	124		12	041475	1/1/0001								
05800	S	M	OUG	II	01269	123		12	041475	1/1/0001								

OFFICE: 311		ROUTE: 564		ST_REF_NO: 00000007200		ATHENIA DRIVE		LUMENS	BULB TYPE	MULT SERIES	POLE TYPE	SHADE	ADDRESS NUMBER	REF	LOCATION	TAX DIST	DATE INST	DATE CHANGE
05800	S	M	OUG	II	00000	027	OPP. 1131	12	120888	9/9/2009								
04000	S	M	OUG	II	01135	026		12	120888	10/11/2011								
05800	S	M	OUG	II	01175	021	replaced bad fixture	12	120888	10/22/2008								
05800	S	M	OUG	II	00000	028	CORNER OF GEORGIAN WAY AND ATHENIA DR.	12	101465	1/1/0001								
05800	S	M	OUG	II	00000	029	SIDE OF 2034 OLD NASSAU RD.	12	101465	1/1/0001								
05800	S	M	OUG	II	00000	031	SIDE OF 2044 FALLON DR.	12	101465	1/1/0001								
05800	S	M	OUG	II	00000	033	OPPOSITE 1127	12	101465	1/1/0001								
05800	S	M	OUG	II	01103	030		12	101465	1/1/0001								
05800	S	M	OUG	II	01119	032		12	080169	1/1/0001								
04000	S	M	OUG	II	01147	025		12	120888	1/1/0001								
04000	S	M	OUG	II	01154	024		12	120888	1/1/0001								
04000	S	M	OUG	II	01163	023		12	120888	1/1/0001								
04000	S	M	SOH	II	01166	022		12	120888	1/1/0001								

OFFICE: 311		ROUTE: 564		ST_REF_NO: 00000007300		ATHENS COURT		LUMENS	BULB TYPE	MULT SERIES	POLE TYPE	SHADE	ADDRESS NUMBER	REF	LOCATION	TAX DIST	DATE INST	DATE CHANGE
05800	S	M	OUG	II	01600	000		12	120263	1/1/0001								

OFFICE: 311		ROUTE: 564		ST_REF_NO: 00000007500		ATHENS-BOONESBORO ROAD		LUMENS	BULB TYPE	MULT SERIES	POLE TYPE	SHADE	ADDRESS NUMBER	REF	LOCATION	TAX DIST	DATE INST	DATE CHANGE
09500	S		OUG	II	00000	222	1ST LT W OF BLUE SKY PW(1ST)ON S SIDE OF ATHENS BB	12	030801	9/9/2009								
09500	S	M	SOH	III	06338	005		22	050885	10/11/2011								
09500	S	M	SOH	III	06346	006		22	050885	10/11/2011								
09500	S	M	SOH	III	06366	007		22	050885	10/11/2011								
09500	S	M	SOH	III	06422	009		22	050885	10/11/2011								

OFFICE: 311		ROUTE: 564		ST_REF_NO: 0000007500		ATHENS-BOONESBORO ROAD		LUMENS	BULB TYPE	MULT SERIES	POLE TYPE	SHADE	ADDRESS NUMBER	REF	LOCATION	TAX DIST	DATE INST	DATE CHANGE
09500	S	M	SOH	III	06434	010										22	050885	10/11/2011
09500	S	M	SOH	III	06450	011										22	050885	10/11/2011
09500	S	M	SOH	III	06476	012										22	050885	10/11/2011
09500	S	M	SOH	III	06496	013										22	050885	10/11/2011
09500	S	M	SOH	III	06496	014										22	050885	10/11/2011
09500	S	M	SOH	III	06496	015										22	050885	10/11/2011
09500	S	M	SOH	III	00000	001									1ST LT. W. OF ATHENS-WALNUT HILL ON SOUTHSIDE	22	050885	1/1/0001
09500	S	M	SOH	III	00000	002									OPP. ATHENS-WALNUT HILL ON NORTHSIDE	22	050885	1/1/0001
09500	S	M	SOH	III	00000	003									1ST LT. E. OF ATHENS-WALNUT ON SOUTHSIDE	22	050885	1/1/0001
09500	S	M	SOH	III	00000	004									2ND LT. E. OF ATHENS-WALNUT HILL ON SOUTHSIDE	22	050885	1/1/0001
09500	S		OUG	II	00000	221									2ND LT W OF BLUE SKY PW(1ST)ON S SIDE OF ATHENS BB	12	030801	1/1/0001
22000	S		OUG	II	00000	223									1ST LT E OF BLUE SKY(1ST)ON S SIDE OF ATHENS BB	12	030801	1/1/0001
09500	S		OUG	II	00000	224									2ND LT E OF BLUE SKY PW(1ST)ON S SIDE OF ATHENS BB	12	030801	1/1/0001
09500	S		OUG	II	00000	231									2ND LT W OF BLUE SKY PW(2ND)ON S SIDE OF ATHENS BB	12	030801	1/1/0001
22000	S		OUG	II	00000	232									1ST LT W OF BLUE SKY(2ND)ON S SIDE OF ATHENS BB	12	030801	1/1/0001
22000	S		OUG	II	00000	233									1ST LT E OF BLUE SKY PW(2ND)ON S SIDE OF ATHENS BB	12	030801	1/1/0001
09500	S		OUG	II	00000	234									2ND ST E OF BLUE SKY PW(2ND)ON S SIDE OF ATHENS BB	12	030801	1/1/0001
22000	S	M	OUG	II	00000	300									1ST LT. E OF WALNUT HILL CHILESBURG	12	050896	1/1/0001
22000	S	M	OUG	II	00000	301									1ST. LT. W OF WALNUT HILL CHILESBURG RD.	12	050896	1/1/0001

OFFICE: 311		ROUTE: 564		ST_REF_NO: 0000007600		ATHENS-WALNUT HILL ROAD		LUMENS	BULB TYPE	MULT SERIES	POLE TYPE	SHADE	ADDRESS NUMBER	REF	LOCATION	TAX DIST	DATE INST	DATE CHANGE
09500	S	M	SOH	III	00000	001									1ST LT. S. OF ATHENS-BOONESBORO ON EASTSIDE	22	050885	1/1/0001
09500	S	M	SOH	III	00000	002									2ND LT. S. OF ATHENS-BOONESBORO ON WESTSIDE	22	050885	1/1/0001
09500	S	M	SOH	III	00000	003									3RD LT. S. OF ATHENS-BOONESBORO ON EASTSIDE	22	050885	1/1/0001

OFFICE: 311

ROUTE: 564

ST_REF_NO: 00000007600

ATHENS-WALNUT HILL ROAD

LUMENS	BULB TYPE	MULT SERIES	POLE TYPE	SHADE	ADDRESS NUMBER	REF	LOCATION	TAX DIST	DATE INST	DATE CHANGE
09500	S	M	OUG	III	00000	004	4TH LT. S. OF ATHENS-BOONESBORO ON NORTHSIDE	22	050885	1/1/0001
09500	S	M	OUG	III	00000	005	5TH LT. S. OF ATHENS-BOONESBORO ON SOUTHSIDE	22	050885	1/1/0001
09500	S	M	OUG	III	00000	006	6TH LT. S. OF ATHENS-BOONESBORO ON NORTHSIDE	22	050885	1/1/0001
09500	S	M	OUG	III	00000	007	7TH LT. S. OF ATHENS-BOONESBORO ON SOUTHSIDE	22	050885	1/1/0001

OFFICE: 311

ROUTE: 564

ST_REF_NO: 00000007610

ATLANTA COURT

LUMENS	BULB TYPE	MULT SERIES	POLE TYPE	SHADE	ADDRESS NUMBER	REF	LOCATION	TAX DIST	DATE INST	DATE CHANGE
05800	S	M	OUG	II	01500	000		12	101861	1/1/0001
05800	S	M	OUG	II	01505	000		12	101861	1/1/0001

OFFICE: 311

ROUTE: 564

ST_REF_NO: 00000007700

ATLANTA DRIVE

LUMENS	BULB TYPE	MULT SERIES	POLE TYPE	SHADE	ADDRESS NUMBER	REF	LOCATION	TAX DIST	DATE INST	DATE CHANGE
05800	S	M	OUG	II	01607	000		12	070161	10/11/2011
05800	S	M	OUG	II	01600	000		12	070161	1/1/0001
05800	S	M	OUG	II	01608	000		12	070161	1/1/0001
05800	S	M	OUG	II	01615	000		12	070161	1/1/0001
05800	S	M	OUG	II	01616	000		12	120263	1/1/0001

OFFICE: 311

ROUTE: 564

ST_REF_NO: 00000007725

ATOMA DRIVE

LUMENS	BULB TYPE	MULT SERIES	POLE TYPE	SHADE	ADDRESS NUMBER	REF	LOCATION	TAX DIST	DATE INST	DATE CHANGE
09500	S	M	OUG	II	00000	001	1ST LT N OF SANDERSVILLE, E SIDE ON ATOMA DR	12	072607	1/1/0001
09500	S	M	OUG	II	00000	002	2ND LT N OF SANDERSVILLE, E SIDE ON ATOMA DR	12	072607	1/1/0001
09500	S	M	OUG	II	00000	003	3RD LT N OF SANDERSVILLE, E SIDE ON ATOMA DR	12	072607	1/1/0001
09500	S	M	OUG	II	00000	004	4TH LT N OF SANDERSVILLE, E SIDE ON ATOMA DR	12	072607	1/1/0001
09500	S	M	OUG	II	00000	005	5TH LT N OF SANDERSVILLE, E SIDE ON ATOMA DR	12	072607	1/1/0001
09500	S	M	OUG	II	00000	006	6TH LT N OF SANDERSVILLE, E SIDE ON ATOMA DR	12	072607	1/1/0001
05800	S	M	OUG	II	01660	004		12	121606	1/1/0001

OFFICE: 311 ROUTE: 564										
ST_REF_NO: 00000007725 ATOMA DRIVE										
LUMENS	BULB TYPE	MULT SERIES	POLE TYPE	SHADE	ADDRESS NUMBER	REF	LOCATION	TAX DIST	DATE INST	DATE CHANGE
05800	S	M	OUG	II	01673	003		12	021508	1/1/0001
05800	S	M	OUG	II	01684	002	SIDE OF 1677 KONNER WOODS	12	121606	10/11/2011
05800	S	M	OUG	II	01697	001		12	121606	1/1/0001
OFFICE: 311 ROUTE: 564										
ST_REF_NO: 00000007750 ATTINGHAM COURT										
LUMENS	BULB TYPE	MULT SERIES	POLE TYPE	SHADE	ADDRESS NUMBER	REF	LOCATION	TAX DIST	DATE INST	DATE CHANGE
09500	S		OUG	III	00600	003		12	052009	1/1/0001
05800	S	M	OUG	II	00629	002		12	060895	1/1/0001
05800	S	M	OUG	II	00640	001		12	060895	1/1/0001
OFFICE: 311 ROUTE: 564										
ST_REF_NO: 00000007800 AUBURN CIRCLE										
LUMENS	BULB TYPE	MULT SERIES	POLE TYPE	SHADE	ADDRESS NUMBER	REF	LOCATION	TAX DIST	DATE INST	DATE CHANGE
05800	S	M	OUG	II	00000	000	REAR CORNER OF 2301 EASTLAND PARKWAY	12	120169	10/11/2011
OFFICE: 311 ROUTE: 564										
ST_REF_NO: 00000007900 AUBURN COURT										
LUMENS	BULB TYPE	MULT SERIES	POLE TYPE	SHADE	ADDRESS NUMBER	REF	LOCATION	TAX DIST	DATE INST	DATE CHANGE
05800	S	M	OUG	II	01502	000		12	040165	1/1/0001
05800	S	M	OUG	II	01507	000		12	071064	1/1/0001
OFFICE: 311 ROUTE: 564										
ST_REF_NO: 00000008000 AUBURN DRIVE										
LUMENS	BULB TYPE	MULT SERIES	POLE TYPE	SHADE	ADDRESS NUMBER	REF	LOCATION	TAX DIST	DATE INST	DATE CHANGE
05800	S	M	OUG	II	01602	000		12	070161	10/11/2011
05800	S	M	OUG	II	01607	000		12	070161	10/11/2011
05800	S	M	OUG	II	01608	000		12	070161	1/1/0001
05800	S	M	OUG	II	01615	000		12	070161	1/1/0001
05800	S	M	OUG	II	01618	000		12	070161	1/1/0001
05800	S	M	OUG	II	01623	000		12	070161	1/1/0001

OFFICE: 311		ROUTE: 564		ST_REF_NO: 0000008100		AUDUBON AVENUE				
LUMENS	BULB TYPE	MULT SERIES	POLE TYPE	SHADE	ADDRESS NUMBER	REF	LOCATION	TAX DIST	DATE INST	DATE CHANGE
05800	S		SOH	II	00000	001	OPPOSITE 1302	12	090909	1/1/0001
05800	S	M	SOH	II	01423	000		12	051477	10/11/2011

OFFICE: 311		ROUTE: 564		ST_REF_NO: 0000008200		AUGUSTA COURT				
LUMENS	BULB TYPE	MULT SERIES	POLE TYPE	SHADE	ADDRESS NUMBER	REF	LOCATION	TAX DIST	DATE INST	DATE CHANGE
05800	S	M	OUG	II	01804	000		12	071064	1/1/0001
05800	S	M	OUG	II	01807	000		12	060162	1/1/0001

OFFICE: 311		ROUTE: 564		ST_REF_NO: 0000008300		AUGUSTA DRIVE				
LUMENS	BULB TYPE	MULT SERIES	POLE TYPE	SHADE	ADDRESS NUMBER	REF	LOCATION	TAX DIST	DATE INST	DATE CHANGE
05800	S	M	OUG	II	01823	000		12	060162	10/11/2011
05800	S	M	OUG	II	01828	000		12	060162	10/11/2011
05800	S	M	OUG	II	01843	000		12	060162	10/11/2011
05800	S	M	OUG	II	00000	153	SIDE OF 1470 VALDOSTA COURT	12	071367	1/1/0001
05800	S	M	OUG	II	01854	000		12	083173	1/1/0001
05800	S	M	OUG	II	01917	000		12	090766	1/1/0001
05800	S	M	OUG	II	01926	000		12	090766	1/1/0001
05800	S	M	OUG	II	01954	000		12	090766	1/1/0001
05800	S	M	OUG	II	00000	001	SIDE OF 1633 RALEIGH ROAD	12	081265	1/1/0001

OFFICE: 311		ROUTE: 564		ST_REF_NO: 0000008400		AURORA AVENUE				
LUMENS	BULB TYPE	MULT SERIES	POLE TYPE	SHADE	ADDRESS NUMBER	REF	LOCATION	TAX DIST	DATE INST	DATE CHANGE
04000	S	M	SOH	II	00000	000	1ST LT E OF WALTON, N SIDE	12	101166	10/11/2011
04000	S	M	SOH	II	00710	000		12	101166	10/11/2011
05800	S	M	SOH	II	00727	000		12	101166	9/9/2009
04000	S	M	SOH	II	00806	000		12	101166	10/11/2011
04000	S	M	SOH	II	00902	000		12	101166	10/11/2011
04000	S	M	SOH	II	00735	000		12	021579	1/1/0001
04000	S	M	SOH	II	00815	000		12	101166	1/1/0001
04000	S	M	SOH	II	00820	000		12	101166	1/1/0001
04000	S	M	SOH	II	00824	000		12	092466	1/1/0001

OFFICE: 311

ROUTE: 564

ST_REF_NO: 0000008400

AURORA AVENUE

LUMENS	BULB TYPE	MULT SERIES	POLE TYPE	SHADE	ADDRESS NUMBER	REF	LOCATION	TAX DIST	DATE INST	DATE CHANGE
04000	S	M	SOH	II	00915	000		12	101166	1/1/0001
04000	S	M	SOH	II	00924	000		12	101166	1/1/0001
04000	S	M	SOH	II	01002	025		12	050885	1/1/0001
04000	S	M	SOH	II	01009	026		12	050885	1/1/0001
04000	S	M	SOH	II	01015	027		12	050885	1/1/0001

OFFICE: 311

ROUTE: 564

ST_REF_NO: 0000008500

AUSTIN COURT

LUMENS	BULB TYPE	MULT SERIES	POLE TYPE	SHADE	ADDRESS NUMBER	REF	LOCATION	TAX DIST	DATE INST	DATE CHANGE
05800	S	M	OUG	II	01200	000		12	090170	1/1/0001
05800	S	M	OUG	II	01209	000		12	060171	1/1/0001

OFFICE: 311

ROUTE: 564

ST_REF_NO: 0000008610

AUTUMN RIDGE DRIVE

LUMENS	BULB TYPE	MULT SERIES	POLE TYPE	SHADE	ADDRESS NUMBER	REF	LOCATION	TAX DIST	DATE INST	DATE CHANGE
05800	S	M	CNT	II	00000	013	SIDE OF 3523 INDIAN SUMMER TRAIL	12	060894	10/11/2011
05800	S	M	CNT	II	01072	012		12	060894	10/11/2011
05800	S	M	CNT	II	01132	018		12	100896	10/11/2011
05800	S	M	CNT	II	00000	003	SIDE 3528 WILLOW SPRING	12	060894	1/1/0001
05800	S	M	CNT	II	00000	004	SIDE 3600 WILLOW SPRING	12	060894	1/1/0001
05800	S	M	CNT	II	00000	005	CORNER OF 3601 WILLOW SPRING	12	060894	1/1/0001
05800	S	M	CNT	II	00000	006	SIDE OF 3598 MICHAELS COVE	12	060894	1/1/0001
05800	S	M	CNT	II	00000	008	OPP. 1036	12	060894	1/1/0001
05800	S	M	CNT	II	01000	002		12	060894	1/1/0001
05800	S	M	CNT	II	01001	001		12	060894	1/1/0001
05800	S	M	CNT	II	01028	007		12	060894	1/1/0001
05800	S	M	CNT	II	01045	009		12	060894	1/1/0001
05800	S	M	CNT	II	01048	010		12	060894	1/1/0001
05800	S	M	CNT	II	01065	011		12	060894	1/1/0001
05800	S	M	CNT	II	01084	014		12	060894	1/1/0001
05800	S	M	CNT	II	01101	015		12	060894	1/1/0001
05800	S	M	CNT	II	01108	016		12	060894	1/1/0001
05800	S	M	CNT	II	01116	017		12	060894	1/1/0001
05800	S	M	CNT	II	01125	018		12	060894	1/1/0001

OFFICE: 311		ROUTE: 564		ST_REF_NO: 0000008800		AVON AVENUE		LUMENS	BULB TYPE	MULT SERIES	POLE TYPE	SHADE	ADDRESS NUMBER	REF	LOCATION	TAX DIST	DATE INST	DATE CHANGE
05800	S	M	SOH	II	00000	001	SIDE OF 935 BRYAN AVE.	12	120162	1/1/0001								
05800	S	M	SOH	II	00000	002	SIDE OF 918 N. LIME	12	120162	1/1/0001								
05800	S	M	SOH	II	00125	000		12	120162	1/1/0001								
05800	S	M	SOH	II	00140	000		12	120162	1/1/0001								
05800	S	M	SOH	II	00157	000		12	120162	1/1/0001								
05800	S	M	SOH	II	00164	000		12	120162	1/1/0001								
OFFICE: 311		ROUTE: 564		ST_REF_NO: 0000009050		AYLESBURY CIRCLE		LUMENS	BULB TYPE	MULT SERIES	POLE TYPE	SHADE	ADDRESS NUMBER	REF	LOCATION	TAX DIST	DATE INST	DATE CHANGE
05800	S	M	CNT	III	03101	003		12	020898	10/11/2011								
05800	S	M	CNT	II	03116	004		12	100504	10/11/2011								
05800	S	M	CNT	II	00000	001	SIDE OF 3176 BRIGHTON PLACE	12	020898	1/1/0001								
05800	S	M	CNT	II	03117	002		12	020898	1/1/0001								
OFFICE: 311		ROUTE: 564		ST_REF_NO: 0000009100		AYLESFORD PLACE		LUMENS	BULB TYPE	MULT SERIES	POLE TYPE	SHADE	ADDRESS NUMBER	REF	LOCATION	TAX DIST	DATE INST	DATE CHANGE
05800	S	M	SOH	I	00364	000		12	010868	10/11/2011								
05800	S	M	SOH	I	00370	000		12	010868	10/11/2011								
09500	S	M	SOH	I	00404	000		12	010868	10/11/2011								
09500	S	M	SOH	I	00424	000		12	010868	10/11/2011								
05800	S	M	SOH	I	00000	002	SIDE OF 416 E. MAXWELL ST.	12	010868	1/1/0001								
05800	S	M	SOH	I	00316	000		12	010868	1/1/0001								
05800	S	M	SOH	I	00324	000		12	010868	1/1/0001								
05800	S	M	SOH	I	00328	000		12	010868	1/1/0001								
05800	S	M	SOH	I	00332	000		12	010868	1/1/0001								
05800	S	M	SOH	I	00346	000		12	010868	1/1/0001								
05800	S	M	SOH	I	00348	000		12	010868	1/1/0001								
09500	S	M	SOH	I	00418	000		12	010868	1/1/0001								

OFFICE: 311

ROUTE: 564

ST_REF_NO: 0000009200 AZALEA DRIVE

LUMENS	BULB TYPE	MULT SERIES	POLE TYPE	SHADE	ADDRESS NUMBER	REF	LOCATION	TAX DIST	DATE INST	DATE CHANGE
05800	S	M	OUG	II	02113	000		12	090164	10/11/2011
05800	S	M	OUG	II	02100	000		12	090164	1/1/0001
05800	S	M	OUG	II	02128	000		12	090164	1/1/0001
05800	S	M	OUG	II	02141	000		12	090164	1/1/0001
05800	S	M	OUG	II	02156	000		12	090164	1/1/0001
05800	S	M	OUG	II	02169	000		12	090164	1/1/0001
05800	S	M	OUG	II	02177	000		12	060867	1/1/0001
05800	S	M	OUG	II	02201	000		12	060867	1/1/0001
05800	S	M	OUG	II	02212	000		12	122067	1/1/0001
05800	S	M	OUG	II	02221	000		12	042468	1/1/0001
05800	S	M	OUG	II	02228	000		12	040173	1/1/0001

OFFICE: 311

ROUTE: 564

ST_REF_NO: 0000009210 AZOV COURT

LUMENS	BULB TYPE	MULT SERIES	POLE TYPE	SHADE	ADDRESS NUMBER	REF	LOCATION	TAX DIST	DATE INST	DATE CHANGE
04000	S	M	OUG	II	00000	001	SIDE OF 681 DARDANELLES DR	12	110889	10/11/2011
04000	S	M	OUG	II	02900	002		12	110889	10/11/2011

OFFICE: 311

ROUTE: 564

ST_REF_NO: 0000009300 AZTEC COURT

LUMENS	BULB TYPE	MULT SERIES	POLE TYPE	SHADE	ADDRESS NUMBER	REF	LOCATION	TAX DIST	DATE INST	DATE CHANGE
04000	S	M	OUG	II	00000	018	SIDE OF 2824 MOUNT MCKINLEY WAY	12	091476	1/1/0001

OFFICE: 311

ROUTE: 564

ST_REF_NO: 0000009320 BABBLING BROOK WAY

LUMENS	BULB TYPE	MULT SERIES	POLE TYPE	SHADE	ADDRESS NUMBER	REF	LOCATION	TAX DIST	DATE INST	DATE CHANGE
05800	S	M	OUG	III	00000	001	SIDE OF 424 STONE CREEK DR	12	090896	10/11/2011

OFFICE: 311

ROUTE: 564

ST_REF_NO: 0000009400 BACKHAND COURT

LUMENS	BULB TYPE	MULT SERIES	POLE TYPE	SHADE	ADDRESS NUMBER	REF	LOCATION	TAX DIST	DATE INST	DATE CHANGE
04000	S	M	OUG	V	00413	034		12	121579	10/11/2011
04000	S	M	OUG	II	00401	033		12	121579	1/1/0001

OFFICE: 311

ROUTE: 564

ST_REF_NO: 0000009425

BACOPA PLACE

LUMENS	BULB TYPE	MULT SERIES	POLE TYPE	SHADE	ADDRESS NUMBER	REF	LOCATION	TAX DIST	DATE INST	DATE CHANGE
05800	S		CNT	II	00000	001	SIDE OF 969 JOUETT CREEK DR	12	070910	1/1/0001
05800	S		CNT	II	04012	002		12	070910	1/1/0001
05800	S		CNT	II	04025	003		12	070910	1/1/0001
05800	S		CNT	II	04044	005		12	070910	1/1/0001

OFFICE: 311

ROUTE: 564

ST_REF_NO: 0000009500

BAFFIN BAY ROAD

LUMENS	BULB TYPE	MULT SERIES	POLE TYPE	SHADE	ADDRESS NUMBER	REF	LOCATION	TAX DIST	DATE INST	DATE CHANGE
05800	S	M	OUG	II	00000	018	SIDE OF 193 MANITOBA LN	12	021579	9/9/2009
09500	S	M	OUG	II	04104	017		12	021579	9/9/2009

OFFICE: 311

ROUTE: 564

ST_REF_NO: 0000009730

BAILEYS ROW

LUMENS	BULB TYPE	MULT SERIES	POLE TYPE	SHADE	ADDRESS NUMBER	REF	LOCATION	TAX DIST	DATE INST	DATE CHANGE
05800	S	M	OUG	II	00000	001	SIDE OF 973 APPLECROSS DR ON BAILEYS ROW	12	070908	1/1/0001
05800	S	M	OUG	II	00000	003	SIDE OF 1301 HARRINGTON COURT ON BAILEYS ROW	12	070908	1/1/0001
05800	S	M	OUG	II	00000	006	SIDE OF 1300 GREENDALE ROAD ON BAILEYS ROW	12	070908	1/1/0001
05800	S	M	OUG	II	02312	002		12	070908	1/1/0001
05800	S	M	OUG	II	02345	004		12	070908	1/1/0001
05800	S	M	OUG	II	02352	005		12	070908	1/1/0001

OFFICE: 311

ROUTE: 564

ST_REF_NO: 0000009800

BAINBRIDGE COURT

LUMENS	BULB TYPE	MULT SERIES	POLE TYPE	SHADE	ADDRESS NUMBER	REF	LOCATION	TAX DIST	DATE INST	DATE CHANGE
04000	S	M	OUG	II	00000	014	SIDE OF 325 BAINBRIDGE DR	12	080886	10/11/2011
05800	S	M	OUG	II	00000	100	ACROSS FROM 408-W BAINBRIDGE COURT	12	102606	10/11/2011
05800	S	M	OUG	II	00000	101	SIDE OF 408-A BAINBRIDGE COURT	12	102606	10/11/2011
05800	S	M	OUG	II	00000	102	SIDE OF 408-T BAINBRIDGE COURT	12	102606	10/11/2011
05800	S	M	OUG	II	00000	103	SIDE OF 408-V BAINBRIDGE COURT	12	102606	10/11/2011
05800	S	M	OUG	II	00000	104	SIDE OF 408-BB BAINBRIDGE COURT	12	102606	10/11/2011
04000	S	M	OUG	II	00404	013		12	110885	10/11/2011
05800	S	M	OUG	V	00405	015		12	080886	9/9/2009

OFFICE: 311

ROUTE: 564

ST_REF_NO: 0000009900

BAINBRIDGE DRIVE

LUMENS	BULB TYPE	MULT SERIES	POLE TYPE	SHADE	ADDRESS NUMBER	REF	LOCATION	TAX DIST	DATE INST	DATE CHANGE
05800	S	M	OUG	II	00000	008	opp 309	12	110885	10/11/2011
05800	S	M	OUG	II	00000	009	OPP. 313	12	030895	10/11/2011
05800	S	M	OUG	II	00000	010	OPP. 325	12	030895	10/11/2011
05800	S	M	OUG	II	00000	029	SIDE 305 LINDENHURST DR.	12	110885	10/11/2011
05800	S	M	OUG	II	00305	007		12	040890	10/11/2011
05800	S	M	OUG	II	00404	012		12	110885	10/11/2011
05800	S	M	OUG	II	00000	004	OPP. 301	12	110885	1/1/0001
05800	S	M	OUG	II	00000	006	OPP. 305	12	110885	1/1/0001
05800	S	M	OUG	II	00000	011	OPP. 325	12	030895	1/1/0001
05800	S	M	OUG	II	00301	005		12	110885	1/1/0001

OFFICE: 311

ROUTE: 564

ST_REF_NO: 00000010000

BAIRD COURT

LUMENS	BULB TYPE	MULT SERIES	POLE TYPE	SHADE	ADDRESS NUMBER	REF	LOCATION	TAX DIST	DATE INST	DATE CHANGE
04000	S	M	OUG	II	03209	043		12	061580	1/1/0001

OFFICE: 311

ROUTE: 564

ST_REF_NO: 00000010100

BAKER COURT

LUMENS	BULB TYPE	MULT SERIES	POLE TYPE	SHADE	ADDRESS NUMBER	REF	LOCATION	TAX DIST	DATE INST	DATE CHANGE
10000	M	M	OUG	II	00000	001	1ST LT. FROM MERCER RD. ON BAKER, W. SIDE	12	061580	1/1/0001
10000	M	M	OUG	II	00000	002	2ND LT. FROM MERCER RD. ON BAKER, E. SIDE	12	061580	1/1/0001
10000	M	M	OUG	II	00000	003	3RD LT. FROM MERCER RD. ON BAKER, W. SIDE	12	061580	1/1/0001
10000	M	M	OUG	II	00000	004	4TH LT. FROM MERCER RD. ON BAKER, E. SIDE	12	061580	1/1/0001
10000	M	M	OUG	II	00000	005	5TH LT. FROM MERCER RD. ON BAKER, W. SIDE	12	061580	1/1/0001
10000	M	M	OUG	II	00000	006	6TH LT. FROM MERCER RD. ON BAKER, E. SIDE	12	061580	1/1/0001
10000	M	M	OUG	II	00000	007	7TH LT. FROM MERCER RD. ON BAKER, W. SIDE	12	061580	1/1/0001
10000	M	M	OUG	II	00000	008	8TH LT. FROM MERCER RD. ON BAKER, E. SIDE	12	061580	1/1/0001
10000	M	M	OUG	II	00000	009	9TH LT. FROM MERCER RD. ON BAKER, W. SIDE	12	061580	1/1/0001

OFFICE: 311

ROUTE: 564

ST_REF_NO: 00000010300

BAL HARBOR COURT

LUMENS	BULB TYPE	MULT SERIES	POLE TYPE	SHADE	ADDRESS NUMBER	REF	LOCATION	TAX DIST	DATE INST	DATE CHANGE
05800	S	M	OUG	V	01532	000		12	060172	1/1/0001
05800	S	M	OUG	II	01548	000		12	060172	1/1/0001

OFFICE: 311 ROUTE: 564										
ST_REF_NO: 00000010500 BALDWIN AVENUE										
LUMENS	BULB TYPE	MULT SERIES	POLE TYPE	SHADE	ADDRESS NUMBER	REF	LOCATION	TAX DIST	DATE INST	DATE CHANGE
05800	S	M	SOH	I	00000	000	side of 446 Park Ave	12	070172	9/9/2009
05800	S	M	SOH	I	00000	001	SIDE OF 440 PARK AVE.	12	071467	1/1/0001
05800	S	M	SOH	I	00618	000		12	011865	1/1/0001

OFFICE: 311 ROUTE: 564										
ST_REF_NO: 00000010600 BALFOUR DRIVE										
LUMENS	BULB TYPE	MULT SERIES	POLE TYPE	SHADE	ADDRESS NUMBER	REF	LOCATION	TAX DIST	DATE INST	DATE CHANGE
05800	S	M	OUG	II	01854	000		12	080173	9/9/2009
05800	S	M	OUG	II	01855	103		12	100897	9/9/2009
05800	S	M	OUG	II	01814	105		12	060888	1/1/0001
05800	S	M	OUG	II	01830	000		12	080173	1/1/0001
05800	S	M	OUG	II	01879	000		12	080173	1/1/0001
05800	S	M	OUG	II	01882	000		12	070172	1/1/0001
05800	S	M	OUG	II	01899	000		12	080173	1/1/0001

OFFICE: 311 ROUTE: 564										
ST_REF_NO: 00000010700 BALLARD STREET										
LUMENS	BULB TYPE	MULT SERIES	POLE TYPE	SHADE	ADDRESS NUMBER	REF	LOCATION	TAX DIST	DATE INST	DATE CHANGE
05800	S	M	SOH	I	00000	002	2nd LT W OF JEFFERSON ST, N SIDE	12	070166	9/9/2009
05800	S	M	SOH	I	00000	003	1st LT E OF OLD GEORGETOWN ST, N SIDE	12	070166	9/9/2009
05800	S	M	SOH	I	00000	001	SIDE OF 149 JEFFERSON	12	070166	1/1/0001

OFFICE: 311 ROUTE: 564										
ST_REF_NO: 00000010800 BALMORAL COURT										
LUMENS	BULB TYPE	MULT SERIES	POLE TYPE	SHADE	ADDRESS NUMBER	REF	LOCATION	TAX DIST	DATE INST	DATE CHANGE
05800	S	M	OUG	II	00513	149		12	081475	9/9/2009
05800	S	M	OUG	II	00500	148		12	081475	1/1/0001

OFFICE: 311 ROUTE: 564										
ST_REF_NO: 00000010880										
LUMENS	BULB TYPE	MULT SERIES	POLE TYPE	SHADE	ADDRESS NUMBER	REF	LOCATION	TAX DIST	DATE INST	DATE CHANGE
05800	S	M	OUG	II	00000	001	SIDE REAR OF 1122 ROCKBRIDGE RD.	12	060897	1/1/0001
05800	S	M	OUG	II	00000	002	SIDE OF 4600 RIVERMAN WAY	12	060897	1/1/0001
05800	S	M	OUG	II	04616	003		12	060897	1/1/0001
05800	S	M	OUG	II	04628	004		12	060897	1/1/0001

OFFICE: 311

ROUTE: 564

ST_REF_NO: 00000010900

BALSAM DRIVE

LUMENS	BULB TYPE	MULT SERIES	POLE TYPE	SHADE	ADDRESS NUMBER	REF	LOCATION	TAX DIST	DATE INST	DATE CHANGE
05800	S	M	OUG	II	00000	001	SIDE OF 1028 JUNIPER DR	12	070162	9/9/2009
05800	S	M	OUG	II	00000	009	SIDE OF 1025 JUNIPER	12	110162	1/1/0001
05800	S	M	OUG	II	01000	000		12	070162	1/1/0001
05800	S	M	OUG	II	01009	000		12	102263	1/1/0001
05800	S	M	OUG	II	01037	000		12	102263	1/1/0001

OFFICE: 311

ROUTE: 564

ST_REF_NO: 00000010950

BALTUSROL LANE

LUMENS	BULB TYPE	MULT SERIES	POLE TYPE	SHADE	ADDRESS NUMBER	REF	LOCATION	TAX DIST	DATE INST	DATE CHANGE
05800	S	M	CNT	II	02005	001		12	100901	1/1/0001
05800	S	M	CNT	II	02016	002		12	100901	1/1/0001

OFFICE: 311

ROUTE: 564

ST_REF_NO: 00000011000

BAMBERGER ROAD

LUMENS	BULB TYPE	MULT SERIES	POLE TYPE	SHADE	ADDRESS NUMBER	REF	LOCATION	TAX DIST	DATE INST	DATE CHANGE
05800	S	M	OUG	II	00440	000		12	123055	1/1/0001

OFFICE: 311

ROUTE: 564

ST_REF_NO: 00000011100

BAMBOO DRIVE

LUMENS	BULB TYPE	MULT SERIES	POLE TYPE	SHADE	ADDRESS NUMBER	REF	LOCATION	TAX DIST	DATE INST	DATE CHANGE
04000	S	M	OUG	II	00000	041	SIDE OF 3331 MANTILLA DR	12	031581	9/9/2009
04000	S	M	OUG	II	02044	042		12	031581	9/9/2009
04000	S	M	OUG	II	00000	108	SIDE 3354 RIDGECANE	12	100884	1/1/0001
04000	S	M	OUG	II	02001	032		12	031581	1/1/0001
04000	S	M	OUG	II	02008	046		12	031581	1/1/0001
04000	S	M	OUG	II	02021	045		12	031581	1/1/0001
04000	S	M	OUG	II	02028	044		12	031581	1/1/0001
04000	S	M	OUG	II	02041	043		12	031581	1/1/0001

OFFICE: 311

ROUTE: 564

ST_REF_NO: 00000011200

BANBURY COURT

LUMENS	BULB TYPE	MULT SERIES	POLE TYPE	SHADE	ADDRESS NUMBER	REF	LOCATION	TAX DIST	DATE INST	DATE CHANGE
05800	S	M	OUG	II	01706	000		12	111366	1/1/0001
05800	S	M	OUG	V	01722	000		12	041267	1/1/0001

OFFICE: 311		ROUTE: 564		ST_REF_NO: 00000011274		BANYAN COVE		LUMENS	BULB TYPE	MULT SERIES	POLE TYPE	SHADE	ADDRESS NUMBER	REF	LOCATION	TAX DIST	DATE INST	DATE CHANGE
05800	S		CNT	II	01101	001										12	062810	1/1/0001
05800	S		CNT	III	01112	002										12	062810	1/1/0001
OFFICE: 311		ROUTE: 564		ST_REF_NO: 00000011275		BANYAN PARK		LUMENS	BULB TYPE	MULT SERIES	POLE TYPE	SHADE	ADDRESS NUMBER	REF	LOCATION	TAX DIST	DATE INST	DATE CHANGE
05800	S		CNT	II	00000	001	ACROSS FROM 1036 JOUETT CR, ON BANYAN PARK									12	062810	1/1/0001
05800	S		CNT	II	00000	002	SIDE OF 1036 STONECROP DR, ON BANYAN PARK									12	062810	1/1/0001
05800	S		CNT	II	00000	003	SIDE OF 1037 STONECROP DR, ON BANYAN PARK									12	062810	1/1/0001
05800	S		CNT	II	04428	004										12	062810	1/1/0001
05800	S		CNT	II	04437	005										12	062810	1/1/0001
05800	S		CNT	II	04452	006										12	062810	1/1/0001
OFFICE: 311		ROUTE: 564		ST_REF_NO: 00000011400		BARK ALLEY		LUMENS	BULB TYPE	MULT SERIES	POLE TYPE	SHADE	ADDRESS NUMBER	REF	LOCATION	TAX DIST	DATE INST	DATE CHANGE
05800	S	M	SOH	I	00000	002	2ND LT S OF THIRD ST, E SIDE									12	020885	9/9/2009
05800	S	M	SOH	I	00000	003	2ST LT S OF THIRD ST, E SIDE									12	020885	9/9/2009
05800	S	M	SOH	I	00000	001	CORNER OF BARK ALLEY AND NEW ST.									12	020885	1/1/0001
OFFICE: 311		ROUTE: 564		ST_REF_NO: 00000011500		BARKLEY DRIVE		LUMENS	BULB TYPE	MULT SERIES	POLE TYPE	SHADE	ADDRESS NUMBER	REF	LOCATION	TAX DIST	DATE INST	DATE CHANGE
04000	S	M	OUG	II	00000	064	SIDE 474 BARKLEY									12	051166	9/9/2009
04000	S	M	OUG	II	00428	061										12	051166	9/9/2009
04000	S	M	OUG	II	00437	062										12	020167	9/9/2009
04000	S	M	OUG	II	00449	063										12	051166	9/9/2009
04000	S	M	OUG	II	00478	065										12	051166	1/1/0001
04000	S	M	OUG	II	00489	066										12	060766	1/1/0001
04000	S	M	OUG	II	00492	060										12	051166	1/1/0001

OFFICE: 311		ROUTE: 564		ST_REF_NO: 00000011600		BARKSDALE DRIVE		LUMENS	BULB TYPE	MULT SERIES	POLE TYPE	SHADE	ADDRESS NUMBER	REF	LOCATION	TAX DIST	DATE INST	DATE CHANGE
05800	S	M	OUG	II	01824	000		12	070172	9/9/2009								
05800	S	M	OUG	II	01860	000		12	070172	1/1/0001								
05800	S	M	OUG	II	01875	000		12	070172	1/1/0001								
05800	S	M	OUG	II	01888	000		12	070172	1/1/0001								
05800	S	M	OUG	II	00000	032	SIDE OF 1230 WINBURN ON	12	081475	1/1/0001								
05800	S	M	OUG	II	01775	000		12	061269	1/1/0001								
05800	S	M	OUG	II	01788	000		12	070172	1/1/0001								
05800	S	M	OUG	II	01799	036		12	100171	1/1/0001								
05800	S	M	OUG	II	01812	000		12	020970	1/1/0001								
05800	S	M	OUG	II	01823	000		12	070172	1/1/0001								

OFFICE: 311		ROUTE: 564		ST_REF_NO: 00000011680		BARNARD DRIVE		LUMENS	BULB TYPE	MULT SERIES	POLE TYPE	SHADE	ADDRESS NUMBER	REF	LOCATION	TAX DIST	DATE INST	DATE CHANGE
05800	S	M	CNT	II	00000	019	SIDE OF 3884	12	090898	9/9/2009								
05800	S	M	CNT	II	03841	004		12	090898	9/9/2009								
05800	S	M	CNT	II	03889	008		12	090898	9/9/2009								
05800	S	M	CNT	II	03948	014		12	090898	9/9/2009								
05800	S	M	CNT	II	03981	015		12	090898	9/9/2009								
05800	S	M	CNT	III	00000	001	OPP. 3805	12	090898	1/1/0001								
05800	S	M	CNT	II	00000	007	SIDE OF 1020 KIMBOLTON DRIVE	12	090898	1/1/0001								
05800	S	M	CNT	II	00000	009	OPP. 3901	12	090898	1/1/0001								
05800	S	M	CNT	II	03812	003		12	090898	1/1/0001								
05800	S	M	CNT	II	03813	002		12	090898	1/1/0001								
05800	S	M	CNT	II	03848	005		12	090898	1/1/0001								
05800	S	M	CNT	II	03861	006		12	090898	1/1/0001								
05800	S	M	CNT	II	03909	010		12	090898	1/1/0001								
05800	S	M	CNT	II	03921	011		12	090898	1/1/0001								
05800	S	M	CNT	II	03936	012		12	090898	1/1/0001								
05800	S	M	CNT	III	03953	013		12	090898	1/1/0001								
05800	S	M	CNT	II	03988	016		12	090898	1/1/0001								
05800	S	M	CNT	II	04005	017		12	090898	1/1/0001								
05800	S	M	CNT	II	04020	018		12	090898	1/1/0001								

OFFICE: 311		ROUTE: 564		ST_REF_NO: 00000011750		BARNWELL LANE		LUMENS	BULB TYPE	MULT SERIES	POLE TYPE	SHADE	ADDRESS NUMBER	REF	LOCATION	TAX DIST	DATE INST	DATE CHANGE
05800	S		CNT	II	00000	020	SIDE OF 3200 CASHIERS COURT	12	091109								1/1/0001	
05800	S		CNT	II	02261	021		12	091109								1/1/0001	
05800	S		CNT	II	02269	022		12	091109								1/1/0001	
05800	S		CNT	II	02285	023		12	091109								1/1/0001	
05800	S		CNT	II	02288	024		12	091109								1/1/0001	
05800	S		CNT	II	02300	025		12	091109								1/1/0001	
05800	S		CNT	II	02308	026		12	091109								1/1/0001	
05800	S	M	CNT	II	00000	002	SIDE OF 3249 SEBASTIAN LANE ON BARNWELL LANE	12	060105								1/1/0001	
05800	S	M	CNT	II	02201	001		12	060105								1/1/0001	
05800	S	M	CNT	II	02213	003		12	060105								1/1/0001	
05800	S	M	CNT	II	02232	004		12	060105								1/1/0001	
05800	S	M	CNT	II	02241	005		12	060105								9/9/2009	
05800	S	M	CNT	II	02245	006		12	060105								1/1/0001	

OFFICE: 311

ROUTE: 564

OFFICE: 311		ROUTE: 564		ST_REF_NO: 00000011800		BARR STREET		LUMENS	BULB TYPE	MULT SERIES	POLE TYPE	SHADE	ADDRESS NUMBER	REF	LOCATION	TAX DIST	DATE INST	DATE CHANGE
22000	S	M	SOH	III	00000	006	1ST LT W OF MARTIN LUTHER KING BLVD, N SIDE	12	102061									9/9/2009
16000	S	M	GRN	IV	00000	315	1ST LT E OF N LIMESTONE ST,S SIDE ON BARR ST	12	070101									1/1/0001
16000	S	M	GRN	IV	00000	316	2ND LT E OF N LIMESTONE,S SIDE ON BARR ST	12	070101									1/1/0001
16000	S	M	GRN	IV	00000	317	3RD LT E OF N LIMESTONE ST,S SIDE ON BARR ST	12	070101									1/1/0001
16000	S	M	GRN	IV	00000	318	4TH LT E OF N LIMESTONE ST,S SIDE ON BARR ST	12	070101									1/1/0001
16000	S	M	GRN	IV	00000	319	5TH LT E OF N LIMESTONEST, S SIDE ON BARR ST	12	070101									1/1/0001
16000	S	M	GRN	IV	00000	320	6TH LT E OF N LIMESTONE ST,S SIDE ON BARR ST	12	070101									1/1/0001
16000	S	M	GRN	IV	00000	321	7TH LT E OF N LIMESTONE ST,S SIDE ON BARR ST	12	070101									1/1/0001
16000	S	M	GRN	IV	00000	322	8TH LT E OF N LIMESTONE ST,S SIDE ON BARR ST	12	070101									1/1/0001
16000	S	M	GRN	IV	00000	323	9TH LT E OF N LIMESTONE ST, S SIDE ON BARR ST	12	070101									1/1/0001
16000	S	M	GRN	IV	00000	324	10TH LT E OF N LIMESTONE ST,S SIDE ON BARR ST	12	070101									1/1/0001
22000	S	M	SOH	III	00125	002		12	102061									9/9/2009
22000	S	M	SOH	III	00133	003		12	102061									1/1/0001
22000	S	M	SOH	III	00133	004		12	102061									1/1/0001
22000	S	M	SOH	III	00153	005		12	102061									1/1/0001

OFFICE: 311

ROUTE: 564

ST_REF_NO: 00000011900

BARREN RIVER COURT

LUMENS	BULB TYPE	MULT SERIES	POLE TYPE	SHADE	ADDRESS NUMBER	REF	LOCATION	TAX DIST	DATE INST	DATE CHANGE
04000	S	M	OUG	II	00000	052	SIDE OF 242 EAGLE CK DR	12	051478	1/1/0001
04000	S	M	OUG	II	03317	053		12	051478	1/1/0001

OFFICE: 311

ROUTE: 564

ST_REF_NO: 00000011950

BARRINGTON LANE

LUMENS	BULB TYPE	MULT SERIES	POLE TYPE	SHADE	ADDRESS NUMBER	REF	LOCATION	TAX DIST	DATE INST	DATE CHANGE
05800	S	M	CNT	II	00000	004	SIDE OF 3101 CAVERSHAM PARK ON BARRINGTON LN	12	051701	1/1/0001
05800	S	M	CNT	II	00000	010	3RD LT W OF SCOTTISH TRACE,N SIDE ON BARRINGTON LN	12	080806	1/1/0001
05800	S	M	CNT	II	00000	011	2ND LT W OF SCOTTISH TRACE,N SIDE ON BARRINGTON LN	12	080806	1/1/0001
05800	S	M	CNT	II	00000	012	SIDE OF 3197 SCOTTISH TRACE ON BARRINGTON LN	12	080806	1/1/0001
05800	S	M	CNT	II	02201	001		12	051701	1/1/0001
05800	S	M	CNT	II	02209	002		12	051701	1/1/0001
05800	S	M	CNT	II	02221	003		12	051701	1/1/0001

OFFICE: 311

ROUTE: 564

ST_REF_NO: 00000012000

BARRISTER COURT

LUMENS	BULB TYPE	MULT SERIES	POLE TYPE	SHADE	ADDRESS NUMBER	REF	LOCATION	TAX DIST	DATE INST	DATE CHANGE
04000	S	M	OUG	II	00000	008	SIDE OF 3351 SPANGLER DR	12	081476	1/1/0001
04000	S	M	OUG	II	00409	007		12	081476	1/1/0001

OFFICE: 311

ROUTE: 564

ST_REF_NO: 00000012010

BARRON ALLEY

LUMENS	BULB TYPE	MULT SERIES	POLE TYPE	SHADE	ADDRESS NUMBER	REF	LOCATION	TAX DIST	DATE INST	DATE CHANGE
05800	S	M	OOH	I	00000	003	3RD LT N OF SHORT ST	12	051667	1/1/0001
05800	S	M	OOH	I	00000	004	4TH LT N OF SHORT	12	051667	1/1/0001

OFFICE: 311

ROUTE: 564

ST_REF_NO: 00000012200

BARWICK DRIVE

LUMENS	BULB TYPE	MULT SERIES	POLE TYPE	SHADE	ADDRESS NUMBER	REF	LOCATION	TAX DIST	DATE INST	DATE CHANGE
05800	S	M	OUG	II	01800	001		12	062364	1/1/0001
05800	S	M	OUG	II	01803	002		12	082573	1/1/0001
05800	S	M	OUG	II	01806	003		12	082573	1/1/0001

OFFICE: 311

ROUTE: 564

ST_REF_NO: 00000012200

BARWICK DRIVE

LUMENS	BULB TYPE	MULT SERIES	POLE TYPE	SHADE	ADDRESS NUMBER	REF	LOCATION	TAX DIST	DATE INST	DATE CHANGE
05800	S	M	OUG	II	01811	005		12	042474	1/1/0001
05800	S	M	OUG	II	01814	004		12	121073	1/1/0001
05800	S	M	OUG	II	01818	006		12	121073	1/1/0001
05800	S	M	OUG	II	01825	007		12	082573	1/1/0001
05800	S	M	OUG	II	01826	008		12	050172	1/1/0001
05800	S	M	OUG	II	01831	009		12	082573	1/1/0001

OFFICE: 311

ROUTE: 564

ST_REF_NO: 00000012400

BASS COURT

LUMENS	BULB TYPE	MULT SERIES	POLE TYPE	SHADE	ADDRESS NUMBER	REF	LOCATION	TAX DIST	DATE INST	DATE CHANGE
05800	S	M	OUG	II	00000	000	SIDE OF 1321 DALE DR	12	041674	9/9/2009
05800	S	M	OUG	V	03660	000		12	050374	1/1/0001

OFFICE: 311

ROUTE: 564

ST_REF_NO: 00000012500

BASSETT AVENUE

LUMENS	BULB TYPE	MULT SERIES	POLE TYPE	SHADE	ADDRESS NUMBER	REF	LOCATION	TAX DIST	DATE INST	DATE CHANGE
04000	S	M	SOH	II	00216	103		12	020885	9/9/2009
05800	S	M	SOH	II	00223	104		12	020885	9/9/2009
04000	S	M	SOH	II	00312	109		12	040887	9/9/2009
04000	S	M	SOH	II	00368	113		12	020885	9/9/2009
04000	S	M	SOH	II	00000	097	SIDE 1421 RICHMOND RD.	12	020885	1/1/0001
04000	S	M	SOH	II	00122	098		12	020885	1/1/0001
04000	S	M	SOH	II	00141	099		12	020885	1/1/0001
04000	S	M	SOH	II	00157	100		12	040887	1/1/0001
04000	S	M	SOH	II	00174	101		12	020885	1/1/0001
04000	S	M	SOH	II	00201	102		12	040887	1/1/0001
04000	S	M	SOH	II	00240	105		12	040887	1/1/0001
04000	S	M	SOH	II	00256	106		12	020885	1/1/0001
04000	S	M	SOH	II	00272	107		12	020885	1/1/0001
04000	S	M	SOH	II	00287	108		12	020885	1/1/0001
04000	S	M	SOH	II	00325	110		12	020885	1/1/0001
04000	S	M	SOH	II	00340	111		12	020885	1/1/0001
04000	S	M	SOH	II	00353	112		12	020885	1/1/0001
04000	S	M	SOH	II	00383	114		12	020885	1/1/0001

OFFICE: 311		ROUTE: 564		ST_REF_NO: 00000012500		BASSETT AVENUE		LUMENS	BULB TYPE	MULT SERIES	POLE TYPE	SHADE	ADDRESS NUMBER	REF	LOCATION	TAX DIST	DATE INST	DATE CHANGE
	04000	S	M	SOH	II	00395	115									12	040887	1/1/0001
OFFICE: 311		ROUTE: 564		ST_REF_NO: 00000012600		BASSETT COURT		LUMENS	BULB TYPE	MULT SERIES	POLE TYPE	SHADE	ADDRESS NUMBER	REF	LOCATION	TAX DIST	DATE INST	DATE CHANGE
	05800	S	M	SOH	I	00000	001								SIDE OF 230 S LIMESTONE	12	100567	1/1/0001
	05800	S	M	SOH	I	00117	000									12	100567	1/1/0001
OFFICE: 311		ROUTE: 564		ST_REF_NO: 00000012700		BATHURST COURT		LUMENS	BULB TYPE	MULT SERIES	POLE TYPE	SHADE	ADDRESS NUMBER	REF	LOCATION	TAX DIST	DATE INST	DATE CHANGE
	04000	S	M	OUG	II	03489	037									12	110885	1/1/0001
OFFICE: 311		ROUTE: 564		ST_REF_NO: 00000012800		BAUMANN DRIVE		LUMENS	BULB TYPE	MULT SERIES	POLE TYPE	SHADE	ADDRESS NUMBER	REF	LOCATION	TAX DIST	DATE INST	DATE CHANGE
	05800	S	M	OOH	II	00000	053								1ST LT. E OF HARBISON, NORTHSIDE	12	080896	9/9/2009
	05800	S	M	OOH	II	00000	002								2ND LT. E OF HARBISON, NORTHSIDE	12	080896	1/1/0001
	05800	S	M	OOH	II	00000	003								3RD LT. E OF HARBISON, NORTHSIDE	12	080896	1/1/0001
	05800	S	M	OOH	II	00000	004								4TH LT. E OF HARBISON, NORTHSIDE	12	080896	1/1/0001
	05800	S	M	OOH	II	00000	005								1ST LT. E OF HARBISON, SOUTHSIDE	12	080896	1/1/0001
	05800	S	M	OOH	II	00000	006								2ND LT. E OF HARBISON, SOUTHSIDE	12	080896	1/1/0001
	05800	S	M	OOH	II	00000	007								3RD LT. E OF HARBISON, SOUTHSIDE	12	080896	1/1/0001
	05800	S	M	OOH	II	00000	008								4TH LT. E OF HARBISON, SOUTHSIDE	12	080896	1/1/0001
OFFICE: 311		ROUTE: 564		ST_REF_NO: 00000012880		BAY COLONY LANE		LUMENS	BULB TYPE	MULT SERIES	POLE TYPE	SHADE	ADDRESS NUMBER	REF	LOCATION	TAX DIST	DATE INST	DATE CHANGE
	05800	S	M	CNT	II	00000	001								SIDE OF 2993 MAJESTIC VIEW WLK ON BAY COLONY LANE	12	092507	1/1/0001
	05800	S	M	CNT	II	00000	002								SIDE OF 733 CORBIN WALK ON BAY COLONY LANE	12	092507	1/1/0001
	05800	S	M	CNT	II	00000	008								SIDE OF 3128 MAJESTIC VIEW WALK ON BAY COLONY LANE	12	092507	1/1/0001
	05800	S	M	CNT	II	02813	007									12	092507	1/1/0001
	05800	S	M	CNT	II	02824	006									12	092507	1/1/0001

OFFICE: 311

ROUTE: 564

ST_REF_NO: 00000012880

BAY COLONY LANE

LUMENS	BULB TYPE	MULT SERIES	POLE TYPE	SHADE	ADDRESS NUMBER	REF	LOCATION	TAX DIST	DATE INST	DATE CHANGE
05800	S	M	CNT	II	02836	005		12	092507	1/1/0001
05800	S	M	CNT	II	02841	004		12	092507	9/9/2009
05800	S	M	CNT	II	02861	003		12	092507	1/1/0001

OFFICE: 311

ROUTE: 564

ST_REF_NO: 00000012890

BAY CEDAR COVE

LUMENS	BULB TYPE	MULT SERIES	POLE TYPE	SHADE	ADDRESS NUMBER	REF	LOCATION	TAX DIST	DATE INST	DATE CHANGE
05800	S	M	CNT	II	02700	001		12	101905	1/1/0001
05800	S	M	CNT	II	02716	002		12	101905	1/1/0001
05800	S	M	CNT	III	02729	003		12	101905	9/9/2009

OFFICE: 311

ROUTE: 564

ST_REF_NO: 00000012900

BAY LEAF DRIVE

LUMENS	BULB TYPE	MULT SERIES	POLE TYPE	SHADE	ADDRESS NUMBER	REF	LOCATION	TAX DIST	DATE INST	DATE CHANGE
05800	S	M	OUG	II	00000	085	SIDE OF 3333 PEPPERHILL RD	12	011475	1/1/0001
05800	S	M	OUG	II	03406	000		12	091573	1/1/0001
05800	S	M	OUG	II	03414	158		12	111478	1/1/0001
05800	S	M	OUG	V	03417	157		12	011476	1/1/0001

OFFICE: 311

ROUTE: 564

ST_REF_NO: 00000013000

BAY MEADOWS COURT

LUMENS	BULB TYPE	MULT SERIES	POLE TYPE	SHADE	ADDRESS NUMBER	REF	LOCATION	TAX DIST	DATE INST	DATE CHANGE
04000	S	M	OUG	II	03801	022		12	021581	1/1/0001
05800	S	M	OUG	II	03816	023	upgraded 5/08 - bad fixture	12	011581	1/1/0001

OFFICE: 311

ROUTE: 564

ST_REF_NO: 00000013100

BAY MEADOWS DRIVE

LUMENS	BULB TYPE	MULT SERIES	POLE TYPE	SHADE	ADDRESS NUMBER	REF	LOCATION	TAX DIST	DATE INST	DATE CHANGE
05800	S	M	OUG	II	01113	017		12	011581	11/17/2012
05800	S	M	OUG	II	01125	018		12	021581	9/9/2009
05800	S	M	OUG	II	01153	020		12	120889	9/9/2009
04000	S	M	OUG	II	00000	016	SIDE OF 3809 HIDDEN SPRINGS	12	080884	1/1/0001
04000	S	M	OUG	II	01136	019		12	080884	1/1/0001
05800	S	M	OUG	II	01165	021		12	060894	1/1/0001
05800	S	M	OUG	II	01172	022		12	060894	1/1/0001

OFFICE: 311		ROUTE: 564		ST_REF_NO: 00000013100		BAY MEADOWS DRIVE		LUMENS	BULB TYPE	MULT SERIES	POLE TYPE	SHADE	ADDRESS NUMBER	REF	LOCATION	TAX DIST	DATE INST	DATE CHANGE
05800	S	M	OUG	II	01180	023										12	060894	1/1/0001
OFFICE: 311		ROUTE: 564		ST_REF_NO: 00000013150		BAY SPRINGS PARK		LUMENS	BULB TYPE	MULT SERIES	POLE TYPE	SHADE	ADDRESS NUMBER	REF	LOCATION	TAX DIST	DATE INST	DATE CHANGE
05800	S		CNT	II	00000	002	SIDE OF 3421 MATHERN TRL ON BAY SPRINGS PARK	12	020510							12	020510	1/1/0001
05800	S		CNT	II	00000	009	SIDE OF 3313 BAY SPRINGS PARK	12	020510							12	020510	1/1/0001
05800	S		CNT	II	00000	010	SIDE OF 3300 HIBERNIA PASS ON BAY SPRINGS PARK	12	020510							12	020510	1/1/0001
05800	S		CNT	II	00000	011	SIDE OF 3301 HIBERNIA PASS ON BAY SPRINGS PARK	12	020510							12	020510	1/1/0001
05800	S		CNT	II	00000	012	SIDE OF 3232 MATHERN TRL ON BAY SPRINGS PARK	12	020510							12	020510	1/1/0001
05800	S		CNT	II	00000	013	SIDE OF 3301 MATHERN TRL ON BAY SPRINGS PARK	12	020510							12	020510	1/1/0001
05800	S		CNT	II	00000	014	SIDE OF 3296 BLACKFORD PKW ON BAY SPRINGS PARK	12	020510							12	020510	1/1/0001
05800	S		CNT	II	03313	008		12	020510							12	020510	1/1/0001
05800	S		CNT	II	03341	007		12	020510							12	020510	1/1/0001
05800	S		CNT	II	03360	006		12	020510							12	020510	1/1/0001
05800	S		CNT	II	03377	005		12	020510							12	020510	1/1/0001
05800	S		CNT	II	03393	004		12	030911							12	030911	1/1/0001
05800	S		CNT	II	03404	003		12	020510							12	020510	1/1/0001
05800	S		CNT	II	03424	001		12	020510							12	020510	1/1/0001
OFFICE: 311		ROUTE: 564		ST_REF_NO: 00000013300		BAYBROOK ROAD		LUMENS	BULB TYPE	MULT SERIES	POLE TYPE	SHADE	ADDRESS NUMBER	REF	LOCATION	TAX DIST	DATE INST	DATE CHANGE
05800	S	M	SOH	II	00000	100	SIDE OF 50R PLANVIEW ON BAYBROOK RD	12	072007							12	072007	9/9/2009
05800	S	M	OUG	II	02804	022		12	100897							12	100897	9/9/2009
05800	S	M	OUG	II	02817	023		12	100897							12	100897	9/9/2009
05800	S	M	OUG	II	00000	024	SIDE OF 553 EUREKA SPRINGS DR.	12	010888							12	010888	1/1/0001
05800	S	M	SOH	II	00000	038	SIDE OF 493 MT. TABOR RD.	12	100897							12	100897	1/1/0001
05800	S	M	OUG	II	00000	039	SIDE OF 496 PLAINVIEW RD-upgraded 10/07	12	091167							12	091167	1/1/0001
05800	S	M	OUG	II	00000	040	SIDE OF 505 PLAINVIEW RD	12	040268							12	040268	1/1/0001

OFFICE: 311

ROUTE: 564

ST_REF_NO: 00000013300 BAYBROOK ROAD

LUMENS	BULB TYPE	MULT SERIES	POLE TYPE	SHADE	ADDRESS NUMBER	REF	LOCATION	TAX DIST	DATE INST	DATE CHANGE
05800	S	M	OUG	II	02749	020		12	121467	1/1/0001
05800	S	M	OUG	II	02758	019		12	110168	1/1/0001
05800	S	M	OUG	II	02769	041		12	122468	1/1/0001
05800	S	M	OUG	II	02801	021		12	100897	1/1/0001

OFFICE: 311

ROUTE: 564

ST_REF_NO: 00000013350 BAYLOR PLACE

LUMENS	BULB TYPE	MULT SERIES	POLE TYPE	SHADE	ADDRESS NUMBER	REF	LOCATION	TAX DIST	DATE INST	DATE CHANGE
05800	S	M	CNT	II	00000	003	SIDE REAR OF 480 JOSEPH BAY WAY	12	071407	9/9/2009
05800	S	M	CNT	II	00000	004	SIDE OF 480 JOSEPH BRYAN WAY ON BAYLOR PLACE	12	071407	1/1/0001
05800	S	M	CNT	II	00501	001		12	071407	1/1/0001
05800	S	M	CNT	II	00512	002		12	071407	1/1/0001

OFFICE: 311

ROUTE: 564

ST_REF_NO: 00000013400 BAYONNE DRIVE

LUMENS	BULB TYPE	MULT SERIES	POLE TYPE	SHADE	ADDRESS NUMBER	REF	LOCATION	TAX DIST	DATE INST	DATE CHANGE
05800	S	M	OUG	II	00000	034	SIDE OF 2339 PIERSON DR.	12	050170	1/1/0001

OFFICE: 311

ROUTE: 564

ST_REF_NO: 00000013500 BAYOU COURT

LUMENS	BULB TYPE	MULT SERIES	POLE TYPE	SHADE	ADDRESS NUMBER	REF	LOCATION	TAX DIST	DATE INST	DATE CHANGE
05800	S	M	OUG	II	00000	001	SIDE OF 1823 AUGUSTA DR.	12	060162	9/9/2009

OFFICE: 311

ROUTE: 564

ST_REF_NO: 00000013650 BEECHWOOD CIRCLE

LUMENS	BULB TYPE	MULT SERIES	POLE TYPE	SHADE	ADDRESS NUMBER	REF	LOCATION	TAX DIST	DATE INST	DATE CHANGE
05800	S	M	CNT	II	03609	001		12	040897	9/9/2009
05800	S	M	CNT	II	03624	002		12	040897	9/9/2009
05800	S	M	CNT	III	03637	003		12	040897	1/1/0001

OFFICE: 311

ROUTE: 564

ST_REF_NO: 00000013700 BEACON HILL ROAD

LUMENS	BULB TYPE	MULT SERIES	POLE TYPE	SHADE	ADDRESS NUMBER	REF	LOCATION	TAX DIST	DATE INST	DATE CHANGE
05800	S	M	OUG	II	00000	028	1ST LT S OF FURLONG DR, E SIDE	12	120888	9/9/2009

OFFICE: 311

ROUTE: 564

ST_REF_NO: 0000013700

BEACON HILL ROAD

LUMENS	BULB TYPE	MULT SERIES	POLE TYPE	SHADE	ADDRESS NUMBER	REF	LOCATION	TAX DIST	DATE INST	DATE CHANGE
05800	S	M	OUG	II	00000	029	2ND LT S OF FURLONG DR, E SIDE	12	120888	9/9/2009
05800	S	M	OUG	II	01817	026		12	120888	9/9/2009
05800	S	M	OUG	II	01941	035		12	110888	9/9/2009
05800	S	M	OUG	II	00000	008	SIDE OF 899 MASON HEADLEY RD.	12	050888	1/1/0001
05800	S	M	OUG	II	00000	009	SIDE OF 899 MASON HEADLEY RD.	12	050888	1/1/0001
05800	S	M	OUG	II	00000	010	SIDE OF 902 MASON HEADLEY RD.	12	020889	1/1/0001
05800	S	M	OUG	II	00000	012	SIDE OF 901 CELIA LANE	12	020889	1/1/0001
05800	S	M	OUG	II	01502	000		12	060766	1/1/0001
05800	S	M	OUG	II	01505	000		12	060766	1/1/0001
05800	S	M	OUG	II	01520	003		12	050888	1/1/0001
05800	S	M	OUG	II	01530	004		12	050888	1/1/0001
05800	S	M	OUG	II	01550	005		12	050888	1/1/0001
05800	S	M	OUG	II	01560	006		12	050888	1/1/0001
05800	S	M	OUG	II	01580	007		12	050888	1/1/0001
05800	S	M	OUG	II	01694	011		12	020889	1/1/0001
05800	S	M	OUG	II	01706	013		12	020889	1/1/0001
05800	S	M	OUG	II	01709	014		12	020889	1/1/0001
05800	S	M	OUG	II	00000	031	SIDE OF 901 HOLLY SPRINGS DR.	12	110888	1/1/0001
05800	S	M	OUG	II	00000	036	SIDE OF 895 MAYWICK DR.	12	110888	1/1/0001
05800	S	M	OUG	II	00000	038	SIDE OF 898 MAYWICK DR.	12	110888	1/1/0001
05800	S	M	OUG	II	00000	039	SIDE OF 900 MAYWICK DR.	12	110888	1/1/0001
05800	S	M	OUG	II	00000	040	SIDE OF 899 LANE ALLEN	12	110888	1/1/0001
05800	S	M	OUG	II	01722	015		12	020889	1/1/0001
05800	S	M	OUG	II	01729	016		12	020889	1/1/0001
05800	S	M	OUG	II	01742	017		12	020889	1/1/0001
05800	S	M	OUG	II	01749	018		12	020889	1/1/0001
05800	S	M	OUG	II	01762	019		12	020889	1/1/0001
05800	S	M	OUG	II	01770	020		12	020889	1/1/0001
05800	S	M	OUG	II	01773	021		12	020889	1/1/0001
05800	S	M	OUG	II	01781	022		12	020889	1/1/0001
05800	S	M	OUG	II	01794	023		12	020889	1/1/0001
05800	S	M	OUG	II	01802	024		12	020889	1/1/0001
05800	S	M	OUG	II	01814	025		12	120888	1/1/0001
05800	S	M	OUG	II	01916	027		12	120888	1/1/0001

Street Light Listing run 1/11/2015 10:43:21 AM

Page 71 of 1254

OFFICE: 311		ROUTE: 564		ST_REF_NO: 00000013700		BEACON HILL ROAD		LUMENS	BULB TYPE	MULT SERIES	POLE TYPE	SHADE	ADDRESS NUMBER	REF	LOCATION	TAX DIST	DATE INST	DATE CHANGE
	05800	S	M	OUG	II	01920	030									12	110888	1/1/0001
	05800	S	M	OUG	II	01929	033									12	110888	1/1/0001
	05800	S	M	OUG	II	01932	032									12	110888	1/1/0001
	05800	S	M	OUG	II	01944	034									12	110888	1/1/0001
	05800	S	M	OUG	II	01953	037									12	110888	1/1/0001
OFFICE: 311		ROUTE: 564		ST_REF_NO: 00000013750		BEASLEY STREET		LUMENS	BULB TYPE	MULT SERIES	POLE TYPE	SHADE	ADDRESS NUMBER	REF	LOCATION	TAX DIST	DATE INST	DATE CHANGE
	05800	S	M	OUG	II	00000	007							1ST LT. N. OF JINGLE BELL LANE, E.SIDE		12	030890	9/9/2009
	05800	S	M	OOH	II	00000	008							2ND LT. N. OF JINGLE BELL LANE, W.SIDE		12	030890	9/9/2009
	05800	S	M	OUG	II	00000	016							OPP. 961		12	030890	9/9/2009
	05800	S	M	OUG	II	00000	021							SIDE OF 2321 FORTUNE DR		12	030890	9/9/2009
	05800	S	M	OUG	II	00921	017									12	030890	9/9/2009
	05800	S	M	OUG	II	00970	012									12	030890	9/9/2009
	05800	S	M	OUG	II	00970	014									12	030890	9/9/2009
	05800	S	M	OUG	II	00000	009							3RD LT. N. OF JINGLE BELL LANE, E.SIDE		12	030890	1/1/0001
	05800	S	M	OUG	II	00000	010							4TH LT. N. OF JINGLE BELL LANE, W. SIDE		12	030890	1/1/0001
	05800	S	M	OUG	II	00921	019									12	030890	1/1/0001
OFFICE: 311		ROUTE: 564		ST_REF_NO: 00000013760		BEATEN PATH		LUMENS	BULB TYPE	MULT SERIES	POLE TYPE	SHADE	ADDRESS NUMBER	REF	LOCATION	TAX DIST	DATE INST	DATE CHANGE
	05800	S	M	CNT	II	03600	008									12	080108	1/1/0001
	05800	S	M	CNT	II	03605	007									12	080108	1/1/0001
	05800	S	M	CNT	II	03612	006									12	080108	1/1/0001
	05800	S	M	CNT	II	03633	005									12	080108	1/1/0001
	05800	S	M	CNT	II	03644	004									12	080108	1/1/0001
	05800	S	M	CNT	II	03661	003									12	080108	1/1/0001
	05800	S	M	CNT	II	03684	002									12	080108	1/1/0001
	05800	S	M	CNT	II	03693	001									12	080108	1/1/0001

OFFICE: 311

ROUTE: 564

ST_REF_NO: 00000013800

BEAUFORT DRIVE

LUMENS	BULB TYPE	MULT SERIES	POLE TYPE	SHADE	ADDRESS NUMBER	REF	LOCATION	TAX DIST	DATE INST	DATE CHANGE
05800	S	M	OUG	II	00000	006	SIDE OF 3624 RIVER PARK DR.	12	050867	1/1/0001
05800	S	M	OUG	II	01411	007		12	060171	1/1/0001
05800	S	M	OUG	II	01426	008		12	050867	1/1/0001
05800	S	M	OUG	II	01435	009		12	011568	1/1/0001
05800	S	M	OUG	II	01446	010		12	011568	1/1/0001

OFFICE: 311

ROUTE: 564

ST_REF_NO: 00000013900

BEAUMONT AVENUE

LUMENS	BULB TYPE	MULT SERIES	POLE TYPE	SHADE	ADDRESS NUMBER	REF	LOCATION	TAX DIST	DATE INST	DATE CHANGE
05800	S	M	SOH	I	00613	000	chg out bad fixture 2/08	12	070767	9/9/2009
04000	S	M	SOH	I	00000	001	SIDE OF 702 MELROSE AVE.	12	070767	1/1/0001
05800	S	M	SOH	I	00000	002	OPPOSITE 631	12	070767	1/1/0001
04000	S	M	SOH	V	00000	003	CORNER OF BEAUMONT AND TREMONT AVE.	12	020168	1/1/0001

OFFICE: 311

ROUTE: 564

ST_REF_NO: 00000014040

BEAUMONT CENTER CIRCLE

LUMENS	BULB TYPE	MULT SERIES	POLE TYPE	SHADE	ADDRESS NUMBER	REF	LOCATION	TAX DIST	DATE INST	DATE CHANGE
22000	S	M	CNT	II	00000	009	1ST LT S OF WALL STREET, OUTSIDE	12	020800	9/9/2009
22000	S	M	CNT	II	00000	010	1ST LT N OF WALL STREET, INSIDE	12	020800	9/9/2009
22000	S	M	CNT	II	00000	011	1ST LT N OF WALL STREET, OUTSIDE	12	020800	9/9/2009
22000	S	M	CNT	III	00000	012	2ND LT N OF WALL STREET, INSIDE	12	020800	9/9/2009
22000	S	M	CNT	II	00000	014	1ST LT N OF MONARCH STREET	12	020800	9/9/2009
22000	S	M	CNT	II	00000	016	2ND LT N OF MONARCH STREEET	12	020800	9/9/2009
22000	S	M	CNT	II	00000	018	SIDE OF 997 GOVERNOR'S LANE	12	020800	9/9/2009
22000	S	M	CNT	II	00000	019	OPP GOVERNOR'S LANE	12	020800	9/9/2009
22000	S	M	CNT	II	00000	039	2ND LT E OF SNAFFLE RD., INSIDE	12	020800	9/9/2009
22000	S	M	CNT	II	03141	013		12	020800	9/9/2009
22000	S	M	CNT	II	03151	015		12	020800	9/9/2009
22000	S	M	CNT	II	03155	017		12	020800	9/9/2009
22000	S	M	CNT	II	00000	001	1ST LT N OF BEAUMONT CRT. PKWY, OUTSIDE	12	020800	1/1/0001
22000	S	M	CNT	II	00000	002	1ST LT N OF BEAUMONT CTR. PKWY, INSIDE	12	020800	1/1/0001
22000	S	M	CNT	II	00000	003	2ND LT N OF BEAUMONT CTR. PKWY, OUTSIDE	12	020800	1/1/0001
22000	S	M	CNT	II	00000	004	2ND LT N OF BEAUMONT CTR. PKWY, INSIDE	12	020800	1/1/0001
22000	S	M	CNT	II	00000	005	1ST LT S OF LAKECREST CIRCLE, OUTSIDE	12	020800	1/1/0001

OFFICE: 311

ROUTE: 564

ST_REF_NO: 00000014040

BEAUMONT CENTER CIRCLE

LUMENS	BULB TYPE	MULT SERIES	POLE TYPE	SHADE	ADDRESS NUMBER	REF	LOCATION	TAX DIST	DATE INST	DATE CHANGE
22000	S	M	CNT	II	00000	006	1ST LT N OF LAKECREST CIRCLE, INSIDE	12	020800	1/1/0001
22000	S	M	CNT	II	00000	007	1ST LT N OF LAKECREST CIRCLE, OUTSIDE	12	020800	1/1/0001
22000	S	M	CNT	II	00000	008	2ND LT N OF LAKECREST CIRCLE, INSIDE	12	020800	1/1/0001
22000	S	M	CNT	II	00000	020	2ND LT N OF BEAUMONT CTR. LANE, INSIDE	12	020800	1/1/0001
22000	S	M	CNT	II	00000	021	2ND LT N OF BEAUMONT CTR. LANE, OUTSIDE	12	020800	1/1/0001
22000	S	M	CNT	II	00000	022	1ST LT N OF BEAUMONT CTR LANE, INSIDE	12	020800	1/1/0001
22000	S	M	CNT	II	00000	023	1ST LT N OF BEAUMONT CTR LANE, OUTSIDE	12	020800	1/1/0001
22000	S	M	CNT	II	00000	024	OPP BEAUMONT CTR LANE, INSIDE	12	020800	1/1/0001
22000	S	M	CNT	II	00000	025	BEAUMONT CTR. CIRCLE AT B. CTR. LANE, IN MEDIAN	12	020800	1/1/0001
22000	S	M	CNT	II	00000	027	1ST LT S OF BEAUMONT CTR LANE, OUTSIDE	12	020800	1/1/0001
22000	S	M	CNT	II	00000	028	2ND LT S OF BEAUMONT CTR LANE, INSIDE	12	020800	1/1/0001
22000	S	M	CNT	II	00000	029	2ND LT S OF BEAUMONT CTR LANE, OUTSIDE	12	020800	1/1/0001
22000	S	M	CNT	II	00000	030	3RD LT S OF BEAUMONT CTR LANE, INSIDE	12	020800	1/1/0001
22000	S	M	CNT	II	00000	031	4TH LT W OF SNAFFLE RD., OUTSIDE	12	020800	1/1/0001
22000	S	M	CNT	II	00000	032	3RD LT W OF SNAFFLE RD., INSIDE	12	020800	1/1/0001
22000	S	M	CNT	II	00000	033	3RD LT W OF SNAFFLE RD., OUTSIDE	12	020800	1/1/0001
22000	S	M	CNT	II	00000	034	2ND LT W OF SNAFFLE RD., INSIDE	12	020800	1/1/0001
22000	S	M	CNT	II	00000	035	2ND LT W OF SNAFFLE RD., OUTSIDE	12	020800	1/1/0001
22000	S	M	CNT	II	00000	036	1ST LT W OF SNAFFLE RD., INSIDE	12	020800	1/1/0001
22000	S	M	CNT	II	00000	037	1ST LT W OF SNAFFLE RD., OUTSIDE	12	020800	1/1/0001
22000	S	M	CNT	II	00000	038	1ST LT. E OF SNAFFLE RD., INSIDE	12	020800	1/1/0001
22000	S	M	CNT	II	00000	040	BEAUMONT CTR CIRCLE S OF B. CTR PKWY, IN MEDIAN	12	020800	1/1/0001
22000	S	M	CNT	II	00000	041	BEAUMONT CTR CIRCLE N OF B. CTR. PKWY, IN MEDIAN	12	020800	1/1/0001
22000	S	M	CNT	II	00000	026	1ST LT S OF BEAUMONT CTR LANE, INSIDE	12	020800	1/1/0001

OFFICE: 311

ROUTE: 564

ST_REF_NO: 00000014050

BEAUMONT CENTRE LANE

LUMENS	BULB TYPE	MULT SERIES	POLE TYPE	SHADE	ADDRESS NUMBER	REF	LOCATION	TAX DIST	DATE INST	DATE CHANGE
09500	S	M	CNT	II	00000	039	1ST LT W OF ROSWELL DR, S SIDE	12	110899	9/9/2009
09500	S	M	CNT	II	00000	053	8TH LT. W OF ROSWELL DR., NORTHSIDE	12	110899	9/9/2009
09500	S	M	CNT	II	00000	100	BEAUMONT CENTRE LN NEAR TRAIL CROSS LT @ ALLEGHENY	12	110805	1/1/0001

OFFICE: 311

ROUTE: 564

ST_REF_NO: 0000014050

BEAUMONT CENTRE LANE

LUMENS	BULB TYPE	MULT SERIES	POLE TYPE	SHADE	ADDRESS NUMBER	REF	LOCATION	TAX DIST	DATE INST	DATE CHANGE
09500	S	M	CNT	II	00000	001	1ST LT. W OF BEAUMONT CTR. CIRCLE, SSIDE	12	110899	1/1/0001
09500	S	M	CNT	II	00000	002	IN MEDIAN AT BEAUMONT CTR. CIRCLE	12	110899	1/1/0001
09500	S	M	CNT	II	00000	003	1ST LT. W OF BEAUMONT CTR. CIRCLE, NORHTSIDE	12	110899	1/1/0001
09500	S	M	CNT	II	00000	004	2ND LT. W OF BEAUMONT CTR. CIRCLE, NORTHSIDE	12	110899	1/1/0001
09500	S	M	CNT	II	00000	005	2ND LT. W OF BEAUMONT CTR. CIRCLE, SOUTHSIDE	12	110899	1/1/0001
09500	S	M	CNT	II	00000	006	3RD LT. W OF BEAUMONT CTR. CIRCLE, NORTHSIDE	12	110899	1/1/0001
09500	S	M	CNT	II	00000	007	1ST LT. W OF DUNNSTON LANE, SOUTHSIDE	12	110899	1/1/0001
09500	S	M	CNT	II	00000	008	1ST LT. W OF DUNNSTON LANE, NORTHSIDE	12	110899	1/1/0001
09500	S	M	CNT	II	00000	009	2ND LT. W OF DUNNSTON LANE, SOUTHSIDE	12	110899	1/1/0001
09500	S	M	CNT	II	00000	010	2ND LT. W OF DUNNSTON LANE, NORTHSIDE	12	110899	1/1/0001
09500	S	M	CNT	II	00000	011	3RD LT. W OF DUNNSTON LANE, SOUTHSIDE	12	110899	1/1/0001
09500	S	M	CNT	II	00000	012	3RD LT. W OF DUNNSTON LANE, NORTHSIDE	12	110899	1/1/0001
09500	S	M	CNT	II	00000	013	1ST LT. W OF OLD FIELD WAY, SOUTHSIDE	12	110899	1/1/0001
09500	S	M	CNT	II	00000	014	1ST LT. W OF OLD FIELD WAY, NORTHSIDE	12	110899	1/1/0001
09500	S	M	CNT	II	00000	015	2ND LT. W OF OLD FIELD WAY, SOUTHSIDE	21	110899	1/1/0001
09500	S	M	CNT	II	00000	016	2ND LT. W OF OLD FIELD WAY, NORTHSIDE	12	110899	1/1/0001
09500	S	M	CNT	II	00000	017	3RD LT. W OF OLD FIELD WAY, SOUTHSIDE	12	110899	1/1/0001
09500	S	M	CNT	II	00000	018	3RD LT. W OF OLD FIELD WAY, NORTHSIDE	12	110899	1/1/0001
09500	S	M	CNT	II	00000	019	4TH LT. W OF OLD FIELD WAY, SOUTHSIDE	12	110899	1/1/0001
09500	S	M	CNT	II	00000	020	4TH LT. W OF OLD FIELD WAY, NORTHSIDE	12	110899	1/1/0001
09500	S	M	CNT	II	00000	021	1ST LT. W OF SOVEREIGN LANE, SOUTHSIDE	12	110899	1/1/0001
09500	S	M	CNT	II	00000	022	1ST LT. W OF SOVEREIGN LANE, NORTHSIDE	12	110899	1/1/0001
09500	S	M	CNT	II	00000	023	2ND LT. W OF SOVEREIGN LANE, SOUTHSIDE	12	110899	1/1/0001
09500	S	M	CNT	II	00000	024	2ND LT. W OF SOVEREIGN LANE, NORTHSIDE	12	110899	1/1/0001
09500	S	M	CNT	II	00000	025	3RD LT. W OF SOVEREIGN LANE, SOUTHSIDE	12	110899	1/1/0001
09500	S	M	CNT	II	00000	026	3RD LT. W OF SOVEREIGN LANE, NORTHSIDE	12	110899	1/1/0001
09500	S	M	CNT	II	00000	027	1ST LT. W OF JEKYLL DR., SOUTHSIDE	12	110899	1/1/0001
09500	S	M	CNT	II	00000	028	1ST LT. W OF JEKYLL DR., NORTHSIDE	12	110899	1/1/0001
09500	S	M	CNT	II	00000	029	2ND LT. W OF JEKYLL DR., SOUTHSIDE	12	110899	1/1/0001
09500	S	M	CNT	II	00000	030	2ND LT. W OF JEKYLL DR., NORTHSIDE	12	110899	1/1/0001
09500	S	M	CNT	II	00000	031	3RD LT. W OF JEKYLL DR., SOUTHSIDE	12	110899	1/1/0001

OFFICE: 311

ROUTE: 564

ST_REF_NO: 0000014050

BEAUMONT CENTRE LANE

LUMENS	BULB TYPE	MULT SERIES	POLE TYPE	SHADE	ADDRESS NUMBER	REF	LOCATION	TAX DIST	DATE INST	DATE CHANGE
09500	S	M	CNT	II	00000	032	3RD LT. W OF JEKYL DR., NORTHSIDE	12	110899	1/1/0001
09500	S	M	CNT	II	00000	033	4TH LT. W OF JEKYL DR., SOUTHSIDE	12	110899	1/1/0001
09500	S	M	CNT	II	00000	034	4TH LT. W OF JEKYL DR., NORTHSIDE	12	110899	1/1/0001
09500	S	M	CNT	II	00000	035	5TH LT. W OF JEKYL DR., SOUTHSIDE	12	110899	1/1/0001
09500	S	M	CNT	II	00000	036	5TH LT. W OF JEKYL DR., NORTHSIDE	12	110899	1/1/0001
09500	S	M	CNT	II	00000	037	6TH LT. W OF JEKYL DR., SOUTHSIDE	12	110899	1/1/0001
09500	S	M	CNT	II	00000	040	1ST LT. W OF ROSWELL DR., NORTHSIDE	12	110899	1/1/0001
09500	S	M	CNT	II	00000	041	2ND LT. W OF ROSWELL DR., SOUTHSIDE	12	110899	1/1/0001
09500	S	M	CNT	II	00000	042	2ND LT. W OF ROSWELL DR., NORTHSIDE	12	110899	1/1/0001
09500	S	M	CNT	II	00000	044	3RD LT. W OF ROSWELL DR., NORTHSIDE	12	110899	1/1/0001
09500	S	M	CNT	II	00000	045	4TH LT. W OF ROSWELL DR., SOUTHSIDE	12	110899	1/1/0001
09500	S	M	CNT	II	00000	046	4TH LT. W OF ROSWELL DR., NORTHSIDE	12	110899	1/1/0001
09500	S	M	CNT	II	00000	047	5TH LT. W OF ROSWELL DR., SOUTHSIDE	12	110899	1/1/0001
09500	S	M	CNT	II	00000	048	5TH LT. W OF ROSWELL DR., NORTHSIDE	12	110899	1/1/0001
09500	S	M	CNT	II	00000	049	6TH LT. W OF ROSWELL DR., SOUTHSIDE	12	110899	1/1/0001
09500	S	M	CNT	II	00000	050	6TH LT. W OF ROSWELL DR., NORTHSIDE	12	110899	1/1/0001
09500	S	M	CNT	II	00000	051	7TH LT. W OF ROSWELL DR, SOUTHSIDE	12	110899	1/1/0001
09500	S	M	CNT	II	00000	052	7TH LT. W OF ROSWELL DR., NORTHSIDE	12	110899	1/1/0001
09500	S	M	CNT	II	00000	043	3RD LT. W OF ROSWELL DR., SOUTHSIDE	12	110899	1/1/0001

OFFICE: 311

ROUTE: 564

ST_REF_NO: 0000014070

BEAUMONT CENTRE PARKWAY

LUMENS	BULB TYPE	MULT SERIES	POLE TYPE	SHADE	ADDRESS NUMBER	REF	LOCATION	TAX DIST	DATE INST	DATE CHANGE
22000	S	M	CNT	II	00000	007	4th LT N OF HARRODSBURG RD, W SIDE	12	110899	9/9/2009
22000	S	M	CNT	II	00000	008	4th LT N OF HARRODSBURG RD, E SIDE	12	110899	9/9/2009
22000	S	M	CNT	II	00000	009	5th LT N OF HARRODSBURG RD, W SIDE	12	110899	9/9/2009
22000	S	M	CNT	II	00000	011	6TH LT N OF HARRODSBURG RD, W SIDE	12	110899	9/9/2009
22000	S	M	CNT	II	00000	005	3RD LT. N OF HARRODSBURG RD., EASTSIDE	12	110899	1/1/0001
22000	S	M	CNT	II	00000	006	3RD LT. N OF HARRODSBURG RD., WESTSIDE	12	110899	1/1/0001
22000	S	M	CNT	II	00000	010	5TH LT. N OF HARRODSBURG RD, EASTSIDE	12	110899	1/1/0001
22000	S	M	CNT	II	00000	012	6TH LT. N OF HARRODSBURG RD., EASTSIE	12	110899	1/1/0001
22000	S	M	CNT	II	00900	001		12	110899	1/1/0001
22000	S	M	CNT	II	00901	002		12	110899	1/1/0001
22000	S	M	CNT	II	00910	003		12	110899	1/1/0001

OFFICE: 311

ROUTE: 564

ST_REF_NO: 0000014070

BEAUMONT CENTRE PARKWAY

LUMENS	BULB TYPE	MULT SERIES	POLE TYPE	SHADE	ADDRESS NUMBER	REF	LOCATION	TAX DIST	DATE INST	DATE CHANGE
22000	S	M	CNT	II	00911	004		12	110899	1/1/0001

OFFICE: 311

ROUTE: 564

ST_REF_NO: 0000014100

BEAVER CREEK DRIVE

LUMENS	BULB TYPE	MULT SERIES	POLE TYPE	SHADE	ADDRESS NUMBER	REF	LOCATION	TAX DIST	DATE INST	DATE CHANGE
05800	S	M	OUG	II	00000	022	SIDE OF 394 WOODVIEW DR	12	030888	9/9/2009
05800	S	M	OUG	II	00000	041	SIDE OF 3300 GREEN RIVER CT	12	051478	9/9/2009
05800	S	M	OUG	II	00000	043	SIDE OF 3352 OTTER CREEK	12	051477	9/9/2009
05800	S	M	OUG	II	00000	045	SIDE OF 391 S EAGLE CREEK DR	12	051477	9/9/2009
05800	S	M	OUG	II	00000	065	1ST LT. E. OF MAN O WAR BLVD., N SIDE	12	100889	9/9/2009
05800	S	M	OUG	II	03187	119		12	011581	9/9/2009
09500	S	M	OUG	II	03289	063		12	011581	9/9/2009
05800	S	M	OUG	II	00000	021	SIDE OF 401 WOODVIEW DR.	12	091479	1/1/0001
05800	S	M	OUG	II	00000	037	SIDE OF 231 EAGLE CREEK DR.	12	051477	1/1/0001
05800	S	M	OUG	II	00000	038	SIDE OF 234 EAGLE CREEK DR.	12	051477	1/1/0001
05800	S	M	OUG	II	00000	103	SIDE OF 717 EUREKA SPRINGS DR.	12	111580	1/1/0001
05800	S	M	OUG	II	00000	104	SIDE OF 601 HIDDEN POINT DR.	12	111580	1/1/0001
05800	S	M	OUG	II	00000	117	SIDE OF 601 ELK LAKE DR.	12	011581	1/1/0001
05800	S	M	OUG	II	03158	108		12	110885	1/1/0001
05800	S	M	OUG	II	03174	118		12	011581	1/1/0001
05800	S	M	OUG	II	03203	132		12	050887	1/1/0001
05800	S	M	OUG	II	03288	064		12	010888	1/1/0001
05800	S	M	OUG	II	03313	039		12	051477	1/1/0001
05800	S	M	OUG	II	03316	040		12	051477	1/1/0001
05800	S	M	OUG	II	03332	042		12	051478	1/1/0001
05800	S	M	OUG	II	03344	044		12	051478	1/1/0001
05800	S	M	OUG	II	03368	023		12	090897	1/1/0001

OFFICE: 311

ROUTE: 564

ST_REF_NO: 0000014150

BEAVER PLACE RD

LUMENS	BULB TYPE	MULT SERIES	POLE TYPE	SHADE	ADDRESS NUMBER	REF	LOCATION	TAX DIST	DATE INST	DATE CHANGE
04000	S	M	OUG	II	03500	002		12	110891	9/9/2009
04000	S	M	OUG	II	00000	001	SIDE 310 RETRAC ON BEAVER PLACE RD	12	110891	1/1/0001
04000	S	M	OUG	V	03501	003		12	110891	1/1/0001

OFFICE: 311		ROUTE: 564		ST_REF_NO: 00000014209		BECK ALLEY		LUMENS	BULB TYPE	MULT SERIES	POLE TYPE	SHADE	ADDRESS NUMBER	REF	LOCATION	TAX DIST	DATE INST	DATE CHANGE
22000	S	M	CNT	II	00000	001	2ND LT. S. OF VINE ST., EASTSIDE	12	060892	1/1/0001								
22000	S	M	CNT	II	00000	002	1ST LT S OF VINE ST., EASTSIDE	12	060892	1/1/0001								

OFFICE: 311		ROUTE: 564		ST_REF_NO: 00000014210		BECKY PLACE		LUMENS	BULB TYPE	MULT SERIES	POLE TYPE	SHADE	ADDRESS NUMBER	REF	LOCATION	TAX DIST	DATE INST	DATE CHANGE
04000	S	M	OUG	V	00396	001		12	020888	9/9/2009								
04000	S	M	OUG	II	00000	003	SIDE OF 428 GROVES POINT WAY	12	020888	1/1/0001								
04000	S	M	OUG	II	00417	002		12	020888	1/1/0001								
04000	S	M	OUG	II	00441	004		12	020890	1/1/0001								
04000	S	M	OUG	II	00468	005		12	020888	1/1/0001								

OFFICE: 311		ROUTE: 564		ST_REF_NO: 00000014300		BEDINGER COURT		LUMENS	BULB TYPE	MULT SERIES	POLE TYPE	SHADE	ADDRESS NUMBER	REF	LOCATION	TAX DIST	DATE INST	DATE CHANGE
05800	S	M	OUG	II	01922	000		12	080173	1/1/0001								
05800	S	M	OUG	II	01935	000		12	080173	1/1/0001								

OFFICE: 311		ROUTE: 564		ST_REF_NO: 00000014400		BEECHMONT ROAD		LUMENS	BULB TYPE	MULT SERIES	POLE TYPE	SHADE	ADDRESS NUMBER	REF	LOCATION	TAX DIST	DATE INST	DATE CHANGE
05800	S	M	OUG	II	00000	000	SIDE OF 700 OLD DOBBIN ROAD	12	070863	9/9/2009								
05800	S	M	OUG	II	00601	000		12	070863	1/1/0001								
05800	S	M	OUG	II	00608	000		12	070863	1/1/0001								
05800	S	M	OUG	II	00617	000		12	070863	1/1/0001								
05800	S	M	OUG	II	00705	000		12	070863	1/1/0001								
05800	S	M	OUG	II	00708	000		12	041367	1/1/0001								
05800	S	M	OUG	II	00721	000		12	070863	1/1/0001								

OFFICE: 311		ROUTE: 564		ST_REF_NO: 00000014500		BELL COURT		LUMENS	BULB TYPE	MULT SERIES	POLE TYPE	SHADE	ADDRESS NUMBER	REF	LOCATION	TAX DIST	DATE INST	DATE CHANGE
05800	S	M	SOH	I	00000	001	SIDE OF 533 E. MAIN ST.	12	070162	1/1/0001								
05800	S	M	SOH	I	00000	002	SIDE OF 544 SAYRE AVE.	12	070162	1/1/0001								

OFFICE: 311		ROUTE: 564		ST_REF_NO: 00000014510		BELL, EAST COURT		LUMENS	BULB TYPE	MULT SERIES	POLE TYPE	SHADE	ADDRESS NUMBER	REF	LOCATION	TAX DIST	DATE INST	DATE CHANGE
04000	S	S	SOH	II	00000	001	OPPOSITE 132	12	070162	9/9/2009								
05800	S	S	SOH	II	00000	002	OPPOSITE 160	12	070162	9/9/2009								
04000	S	S	SOH	II	00000	003	SIDE OF 615 RUSSELL AVE.	12	070162	1/1/0001								
04000	S	S	SOH	II	00146	000		12	070162	1/1/0001								
04000	S	M	SOH	II	00216	000		12	070162	1/1/0001								
04000	S	M	SOH	II	00231	000		12	070162	1/1/0001								

OFFICE: 311		ROUTE: 564		ST_REF_NO: 00000014520		BELL, WEST COURT		LUMENS	BULB TYPE	MULT SERIES	POLE TYPE	SHADE	ADDRESS NUMBER	REF	LOCATION	TAX DIST	DATE INST	DATE CHANGE
04000	S	S	SOH	II	00149	000		12	070162	9/9/2009								
04000	S	M	SOH	II	00000	002	OPPOSITE 161	12	070162	1/1/0001								
04000	S	S	SOH	II	00000	003	OPPOSITE 137	12	070162	1/1/0001								

OFFICE: 311		ROUTE: 564		ST_REF_NO: 00000014525		BELL PLACE		LUMENS	BULB TYPE	MULT SERIES	POLE TYPE	SHADE	ADDRESS NUMBER	REF	LOCATION	TAX DIST	DATE INST	DATE CHANGE
05800	S	S	SOH	I	00000	001	SIDE OF 601 RUSSELL AVE.	12	070162	9/9/2009								
05800	S	S	SOH	I	00218	000		12	070162	9/9/2009								
05800	S	S	SOH	I	00256	000		12	070162	9/9/2009								
05800	S	M	SOH	I	00261	000		12	070162	9/9/2009								

OFFICE: 311		ROUTE: 564		ST_REF_NO: 00000014600		BELLAIRE AVENUE		LUMENS	BULB TYPE	MULT SERIES	POLE TYPE	SHADE	ADDRESS NUMBER	REF	LOCATION	TAX DIST	DATE INST	DATE CHANGE
05800	S	M	SOH	II	00000	003	OPP 734	12	121365	9/9/2009								
05800	S	M	SOH	II	00000	004	OPP 624	12	091566	9/9/2009								
05800	S	M	SOH	II	00000	001	SIDE OF 467 W. SIXTH ST.	12	091566	1/1/0001								
05800	S	M	SOH	V	00000	002	OPP. 744 AT END OF STREET	12	121365	1/1/0001								
05800	S	M	SOH	II	00640	000		12	091566	1/1/0001								
05800	S	M	SOH	II	00641	000		12	091566	1/1/0001								
05800	S	M	SOH	II	00704	000		12	091566	1/1/0001								

OFFICE: 311

ROUTE: 564

ST_REF_NO: 00000014650

BELLADONNA ROAD

LUMENS	BULB TYPE	MULT SERIES	POLE TYPE	SHADE	ADDRESS NUMBER	REF	LOCATION	TAX DIST	DATE INST	DATE CHANGE
05800	S	M	CNT	II	00000	005	SIDE OF 4316 JASMINE ROSE WAY ON BELLADONNA RD	12	110306	1/1/0001
05800	S	M	CNT	II	01004	001		12	110306	9/9/2009
05800	S	M	CNT	II	01013	002		12	110306	1/1/0001
05800	S	M	CNT	II	01036	003		12	110306	1/1/0001
05800	S	M	CNT	II	01052	004		12	110306	9/9/2009

OFFICE: 311

ROUTE: 564

ST_REF_NO: 00000014700

BELLCASTLE ROAD

LUMENS	BULB TYPE	MULT SERIES	POLE TYPE	SHADE	ADDRESS NUMBER	REF	LOCATION	TAX DIST	DATE INST	DATE CHANGE
05800	S	M	OUG	II	00000	001	SIDE OF 525 BRYANWOOD PKWY	12	060166	9/9/2009
05800	S	M	OUG	II	00653	000		12	102367	9/9/2009
05800	S	M	OUG	II	00663	178		12	081475	9/9/2009
05800	S	M	OUG	II	00000	177	SIDE OF 632 BERESFORD DR.	12	081475	1/1/0001
05800	S	M	OUG	II	00552	000		12	060166	1/1/0001
05800	S	M	OUG	II	00561	000		12	060166	1/1/0001
05800	S	M	OUG	II	00568	000		12	060166	1/1/0001
05800	S	M	OUG	II	00577	000		12	060166	1/1/0001
05800	S	M	OUG	II	00588	000		12	042067	1/1/0001
05800	S	M	OUG	II	00593	000		12	042067	1/1/0001
05800	S	M	OUG	II	00604	000		12	102367	1/1/0001
05800	S	M	OUG	II	00613	000		12	030970	1/1/0001
05800	S	M	OUG	II	00620	000		12	060269	1/1/0001
05800	S	M	OUG	II	00629	000		12	102367	1/1/0001
05800	S	M	OUG	II	00636	000		12	102367	1/1/0001

OFFICE: 311

ROUTE: 564

ST_REF_NO: 00000014780

BELLE HAVEN PLACE

LUMENS	BULB TYPE	MULT SERIES	POLE TYPE	SHADE	ADDRESS NUMBER	REF	LOCATION	TAX DIST	DATE INST	DATE CHANGE
05800	S		CNT	II	02845	006		12	111612	1/1/0001
05800	S		CNT	II	02860	007		12	111612	1/1/0001
05800	S	M	CNT	II	00000	009	SIDE OF 2925 MAJESTIC VIEW WALK ON BELLE HAVEN PL	12	092507	1/1/0001
05800	S	M	CNT	II	02800	001		12	092507	1/1/0001
05800	S	M	CNT	II	02809	002		12	092507	1/1/0001

OFFICE: 311

ROUTE: 564

ST_REF_NO: 00000014780

BELLE HAVEN PLACE

LUMENS	BULB TYPE	MULT SERIES	POLE TYPE	SHADE	ADDRESS NUMBER	REF	LOCATION	TAX DIST	DATE INST	DATE CHANGE
05800	S	M	CNT	II	02825	003		12	092507	1/1/0001
05800	S	M	CNT	II	02833	004		12	092507	1/1/0001
05800	S	M	CNT	II	02836	005		12	092507	1/1/0001
05800	S	M	CNT	II	02869	008		12	092507	1/1/0001

OFFICE: 311

ROUTE: 564

ST_REF_NO: 00000014800

BELLEAU WOOD DRIVE

LUMENS	BULB TYPE	MULT SERIES	POLE TYPE	SHADE	ADDRESS NUMBER	REF	LOCATION	TAX DIST	DATE INST	DATE CHANGE
05800	S	M	OUG	II	00000	006	SIDE OF 600 PEBBLE CREEK DR.	12	111580	1/1/0001
05800	S	M	OUG	II	00000	008	SIDE OF 3700 FOREST GREEN DR.	12	051581	1/1/0001
05800	S	M	OUG	II	00000	019	OPP. 3812	12	050890	1/1/0001
05800	S	M	OUG	II	03701	001		12	111580	1/1/0001
05800	S	M	SOH	II	03709	007		12	100884	1/1/0001
05800	S	M	OUG	II	03729	009		12	100884	1/1/0001
05800	S	M	OUG	II	03732	010		12	100884	1/1/0001
05800	S	M	OUG	II	03748	015		12	100884	1/1/0001
05800	S	M	OUG	II	03749	011		12	100884	1/1/0001
05800	S	M	OUG	II	03761	016		12	100884	1/1/0001
05800	S	M	OUG	II	03764	017		12	100884	1/1/0001
05800	S	M	OUG	II	03773	018		12	100884	1/1/0001
05800	S	M	OUG	II	03781	048		12	110885	1/1/0001
05800	S	M	OUG	II	03789	049		12	110885	1/1/0001
05800	S	M	OUG	II	03797	050		12	110885	1/1/0001
05800	S	M	OUG	II	03804	020		12	120887	1/1/0001
05800	S	M	OUG	II	03824	014		12	120887	1/1/0001
05800	S	M	OUG	II	00000	002	1ST LT. E. OF MAN'O WAR, S.SIDE	12	120887	1/1/0001
05800	S	M	OUG	II	00000	003	1ST LT. E. OF MAN O WAR, N. SIDE	12	050890	1/1/0001
05800	S	M	OUG	II	00000	005	OPP. 3852	12	050890	1/1/0001
05800	S	M	OUG	II	00000	013	OPP. 3832	12	050890	1/1/0001
05800	S	M	OUG	II	03844	012		12	120887	1/1/0001

OFFICE: 311

ROUTE: 564

ST_REF_NO: 00000014900

BELLECHASSE DRIVE

LUMENS	BULB TYPE	MULT SERIES	POLE TYPE	SHADE	ADDRESS NUMBER	REF	LOCATION	TAX DIST	DATE INST	DATE CHANGE
05800	S	M	OUG	II	00000	030	SIDE OF 580 BELLCastle RD	12	060166	1/1/0001
05800	S	M	OUG	II	01744	162		12	081475	1/1/0001
05800	S	M	OUG	II	01752	164		12	081475	1/1/0001
05800	S	M	OUG	II	01761	163		12	041476	1/1/0001
05800	S	M	OUG	II	01772	166		12	081475	1/1/0001
05800	S	M	OUG	II	01777	165		12	081475	1/1/0001

OFFICE: 311

ROUTE: 564

ST_REF_NO: 00000015000

BELLEFONTE DRIVE

LUMENS	BULB TYPE	MULT SERIES	POLE TYPE	SHADE	ADDRESS NUMBER	REF	LOCATION	TAX DIST	DATE INST	DATE CHANGE
05800	S	M	OUG	II	00000	020	OPP. 1887	12	080164	9/9/2009
05800	S	M	OUG	II	01882	001		12	091476	9/9/2009
05800	S	M	OUG	II	02029	033		12	110888	9/9/2009
05800	S	M	OUG	II	00000	003	OPP. 1913	12	091476	1/1/0001
05800	S	M	OUG	II	00000	004	OPP. 1921	12	091476	1/1/0001
05800	S	M	OUG	II	00000	010	OPP. JESSELIN DR.	12	050888	1/1/0001
05800	S	M	OUG	II	00000	012	SIDE 365 ALBANY RD.	12	050888	1/1/0001
05800	S	M	OUG	II	00000	013	SIDE 500 ALBANY RD.	12	050888	1/1/0001
05800	S	M	OUG	II	00000	014	SIDE OF 359 GREENBRIAR RD.	12	080888	1/1/0001
05800	S	M	OUG	II	00000	015	SIDE OF 359 GREENBRIAR RD.	12	080888	1/1/0001
05800	S	M	OUG	II	00000	022	SIDE OF 600 BEECHMONT RD.	12	070863	1/1/0001
05800	S	M	OUG	II	01835	029		12	070863	1/1/0001
05800	S	M	OUG	II	01843	028		12	070863	1/1/0001
05800	S	M	OUG	II	01851	027		12	070863	1/1/0001
05800	S	M	OUG	II	01858	026		12	070863	1/1/0001
05800	S	M	OUG	II	01867	023		12	070863	1/1/0001
05800	S	M	OUG	II	01883	021		12	070863	1/1/0001
05800	S	M	OUG	II	01895	019		12	070863	1/1/0001
05800	S	M	OUG	II	01909	002		12	091476	1/1/0001
05800	S	M	OUG	II	01929	005		12	091476	1/1/0001
05800	S	M	OUG	II	01937	009		12	050888	1/1/0001
05800	S	M	OUG	II	01938	011		12	050888	1/1/0001
05800	S	M	OUG	II	00000	006	SIDE OF 301 MELBOURNE WAY	12	080166	1/1/0001
05800	S	M	OUG	II	00000	016	SIDE OF 400 GREENBRIAR RD.	12	080888	1/1/0001

OFFICE: 311		ROUTE: 564		ST_REF_NO: 00000015000		BELLEFONTE DRIVE		LUMENS	BULB TYPE	MULT SERIES	POLE TYPE	SHADE	ADDRESS NUMBER	REF	LOCATION	TAX DIST	DATE INST	DATE CHANGE
05800	S	M	OUG	II	00000	017	SIDE OF 360 GREENBRIAR RD.	12	080888	1/1/0001								
05800	S	M	OUG	II	00000	018	SIDE (FRONT) OF 313 ZANDALE DR.	12	110888	1/1/0001								
05800	S	M	OUG	II	00000	030	SIDE OF 316 ZANDALE DR.	12	110888	1/1/0001								
05800	S	M	OUG	II	00000	034	SIDE OF 305 LOWRY LANE	12	110888	1/1/0001								
05800	S	M	OUG	II	00000	035	SIDE OF 262 LOWRY LANE	12	110888	1/1/0001								
05800	S	M	OUG	II	02021	031		12	110888	1/1/0001								
05800	S	M	OUG	II	02025	032		12	110888	1/1/0001								
05800	S	M	OUG	II	03289	003		12	080166	1/1/0001								
05800	S	M	OUG	II	03296	004		12	080166	1/1/0001								
05800	S	M	OUG	II	03301	005		12	051368	1/1/0001								
05800	S	M	OUG	II	03312	007		12	080166	1/1/0001								
05800	S	M	OUG	II	03317	008		12	080166	1/1/0001								
05800	S	M	OUG	II	03328	045		12	080166	1/1/0001								
05800	S	M	OUG	II	03337	046		12	080166	1/1/0001								
05800	S	M	OUG	II	03344	047		12	080166	1/1/0001								

OFFICE: 311		ROUTE: 564		ST_REF_NO: 00000015100		BELLMEADE ROAD		LUMENS	BULB TYPE	MULT SERIES	POLE TYPE	SHADE	ADDRESS NUMBER	REF	LOCATION	TAX DIST	DATE INST	DATE CHANGE
22000	S	M	OUG	II	00000	001	OPP. 3468	12	022674	9/9/2009								
05800	S	M	OUG	II	03440	000		12	080173	1/1/0001								
05800	S	M	OUG	II	03449	000		12	080173	1/1/0001								
05800	S	M	OUG	II	03460	000		12	022674	1/1/0001								

OFFICE: 311		ROUTE: 564		ST_REF_NO: 00000015140		BELMERE DRIVE		LUMENS	BULB TYPE	MULT SERIES	POLE TYPE	SHADE	ADDRESS NUMBER	REF	LOCATION	TAX DIST	DATE INST	DATE CHANGE
09500	S		CLN	II	00000	001	SIDE OF 2557 FLYING EBONY DR, ON BELMERE DRIVE	12	091109	1/1/0001								
09500	S		CLN	II	00000	009	SIDE OF 2477 FRANKS WAY, ON BELMERE WAY	12	091109	1/1/0001								
09500	S		CLN	II	00905	002		12	091109	1/1/0001								
09500	S		CLN	II	00912	003		12	091109	1/1/0001								
09500	S		CLN	II	00917	004		12	091109	1/1/0001								
09500	S		CLN	II	00932	005		12	091109	1/1/0001								
09500	S		CLN	II	00937	006		12	091109	1/1/0001								

OFFICE: 311

ROUTE: 564

ST_REF_NO: 00000015140 BELMERE DRIVE

LUMENS	BULB TYPE	MULT SERIES	POLE TYPE	SHADE	ADDRESS NUMBER	REF	LOCATION	TAX DIST	DATE INST	DATE CHANGE
09500	S		CLN	II	00948	007		12	091109	1/1/0001
09500	S		CLN	II	00957	008		12	091109	1/1/0001

OFFICE: 311

ROUTE: 564

ST_REF_NO: 00000015150 BELMONT DRIVE

LUMENS	BULB TYPE	MULT SERIES	POLE TYPE	SHADE	ADDRESS NUMBER	REF	LOCATION	TAX DIST	DATE INST	DATE CHANGE
05800	S	M	OUG	II	00000	014	SIDE OF 268 ELLIS PARK	12	070898	9/9/2009
05800	S	M	OUG	II	00000	018	SIDE OF 300 PREAKNESS DR ON BELMONT	12	5/3/01	1/1/0001
05800	S	M	OUG	II	02057	016		12	050301	9/9/2009
05800	S	M	OUG	II	02113	011		12	070898	9/9/2009
05800	S	M	OUG	II	02141	017		12	050301	9/9/2009
05800	S	M	OUG	II	02169	015		12	050301	9/9/2009
05800	S	M	OUG	II	02173	007		12	050301	9/9/2009
05800	S	M	OUG	II	02184	006		12	5/3/01	1/1/0001
05800	S	M	OUG	III	02216	002		12	090896	9/9/2009
05800	S	M	OUG	II	00000	003	SIDE REAR OF 2209	12	090896	1/1/0001
05800	S	M	OUG	II	00000	005	SIDE OF 332 PREAKNESS DRIVE	12	090896	1/1/0001
05800	S	M	OUG	II	02093	013		12	070898	1/1/0001
05800	S	M	OUG	II	02100	012		12	070898	1/1/0001
05800	S	M	OUG	II	02124	010		12	070898	1/1/0001
05800	S	M	OUG	II	02141	009		12	070898	1/1/0001
05800	S	M	OUG	II	02160	008		12	070898	1/1/0001
05800	S	M	OUG	II	02200	001		12	090896	1/1/0001
05800	S	M	OUG	II	02236	004		12	090896	1/1/0001

OFFICE: 311

ROUTE: 564

ST_REF_NO: 00000015155 BELMONT COURT

LUMENS	BULB TYPE	MULT SERIES	POLE TYPE	SHADE	ADDRESS NUMBER	REF	LOCATION	TAX DIST	DATE INST	DATE CHANGE
05800	S	M	OUG	II	00209	001		12	050301	1/1/0001

OFFICE: 311

ROUTE: 564

ST_REF_NO: 00000015200 BELT LINE AVENUE

LUMENS	BULB TYPE	MULT SERIES	POLE TYPE	SHADE	ADDRESS NUMBER	REF	LOCATION	TAX DIST	DATE INST	DATE CHANGE
09500	S	M	SOH	II	00000	010	SIDE OF 767 MAPLE AVENUE ON BELT LINE AVE	12	072806	1/1/0001

OFFICE: 311

ROUTE: 564

ST_REF_NO: 00000015200 BELT LINE AVENUE

LUMENS	BULB TYPE	MULT SERIES	POLE TYPE	SHADE	ADDRESS NUMBER	REF	LOCATION	TAX DIST	DATE INST	DATE CHANGE
09500	S	M	SOH	II	00138	011		12	072806	1/1/0001
09500	S	M	SOH	I	00000	278	OPP. ELSMERE ALLEY on IDOHO AVE upgraded 7/06	12	100466	1/1/0001
09500	S	M	SOH	I	00130	000	upgraded 7/06	12	040165	1/1/0001
09500	S	M	SOH	I	00148	000	upgraded 7/06	12	040165	1/1/0001

OFFICE: 311

ROUTE: 564

ST_REF_NO: 00000015300 BELVOIR DRIVE

LUMENS	BULB TYPE	MULT SERIES	POLE TYPE	SHADE	ADDRESS NUMBER	REF	LOCATION	TAX DIST	DATE INST	DATE CHANGE
04000	S	M	OUG	II	00000	001	SIDE OF 324 MALABU	12	050890	1/1/0001
04000	S	M	OUG	II	00000	003	SIDE OF 301 LEAWOOD	12	050890	1/1/0001
05800	S	M	OUG	II	00000	004	SIDE OF 266 LEAWOOD	12	050890	1/1/0001
04000	S	M	OUG	II	00000	008	OPP. 3468	12	050890	1/1/0001
04000	S	M	OUG	II	03413	002		12	050890	1/1/0001
04000	S	M	OUG	II	03432	005		12	050890	1/1/0001
04000	S	M	OUG	II	03445	006		12	050890	1/1/0001
04000	S	M	OUG	II	03448	007		12	050890	1/1/0001

OFFICE: 311

ROUTE: 564

ST_REF_NO: 00000015375 BENJAMIN LANE

LUMENS	BULB TYPE	MULT SERIES	POLE TYPE	SHADE	ADDRESS NUMBER	REF	LOCATION	TAX DIST	DATE INST	DATE CHANGE
05800	S	M	CNT	II	00000	001	SIDE OF 2164 SOVEREIGN LN	12	071001	9/9/2009
05800	S	M	CNT	II	01100	003		12	071001	1/1/0001
05800	S	M	CNT	II	01112	002		12	071001	9/9/2009

OFFICE: 311

ROUTE: 564

ST_REF_NO: 00000015400 BENNETT AVENUE

LUMENS	BULB TYPE	MULT SERIES	POLE TYPE	SHADE	ADDRESS NUMBER	REF	LOCATION	TAX DIST	DATE INST	DATE CHANGE
05800	S	M	SOH	I	00773	000		12	071367	9/9/2009
05800	S	M	SOH	I	00781	000		12	071367	9/9/2009
05800	S	M	OUG	II	00845	024		12	051101	1/1/0001
05800	S	M	SOH	I	00000	424	SIDE OF 1200 VERSAILLES ROAD	12	071367	1/1/0001
05800	S	M	SOH	I	00799	000		12	071367	1/1/0001
05800	S	M	SOH	I	00817	000		12	071367	1/1/0001
05800	S	M	SOH	I	00839	000		12	071367	1/1/0001

OFFICE: 311

ROUTE: 564

ST_REF_NO: 00000015400 BENNETT AVENUE

LUMENS	BULB TYPE	MULT SERIES	POLE TYPE	SHADE	ADDRESS NUMBER	REF	LOCATION	TAX DIST	DATE INST	DATE CHANGE
05800	S	M	SOH	I	00855	000		12	071367	1/1/0001
05800	S	M	SOH	I	00863	001		12	020800	1/1/0001

OFFICE: 311

ROUTE: 564

ST_REF_NO: 00000015500 BENT BOUGH PLACE

LUMENS	BULB TYPE	MULT SERIES	POLE TYPE	SHADE	ADDRESS NUMBER	REF	LOCATION	TAX DIST	DATE INST	DATE CHANGE
05800	S	M	OUG	V	00332	029		12	090884	9/9/2009
04000	S	M	OUG	II	00304	027		12	090884	1/1/0001
05800	S	M	OUG	II	00317	028		12	120898	1/1/0001
04000	S	M	OUG	V	00348	030		12	090884	1/1/0001

OFFICE: 311

ROUTE: 564

ST_REF_NO: 00000015550 BENTLEY WAY

LUMENS	BULB TYPE	MULT SERIES	POLE TYPE	SHADE	ADDRESS NUMBER	REF	LOCATION	TAX DIST	DATE INST	DATE CHANGE
05800	S	M	OUG	II	00000	001	SIDE OF 4037 KENESAW DR.	12	110899	1/1/0001
05800	S	M	OUG	II	04801	002		12	110899	1/1/0001

OFFICE: 311

ROUTE: 564

ST_REF_NO: 00000015600 BENTON COURT

LUMENS	BULB TYPE	MULT SERIES	POLE TYPE	SHADE	ADDRESS NUMBER	REF	LOCATION	TAX DIST	DATE INST	DATE CHANGE
05800	S	M	OUG	II	00610	000		12	120266	1/1/0001

OFFICE: 311

ROUTE: 564

ST_REF_NO: 00000015700 BENTON ROAD

LUMENS	BULB TYPE	MULT SERIES	POLE TYPE	SHADE	ADDRESS NUMBER	REF	LOCATION	TAX DIST	DATE INST	DATE CHANGE
05800	S	M	OUG	II	00000	001	OPP 554	12	040171	9/9/2009
05800	S	M	OUG	II	00000	076	SIDE OF 423 RADCLIFFE	12	031372	1/1/0001
05800	S	M	OUG	II	00000	082	SIDE OF 563 BENTON AT PARK	12	031372	1/1/0001
05800	S	M	OUG	II	00538	000		12	031372	1/1/0001
05800	S	M	OUG	II	00566	000		12	100169	1/1/0001
05800	S	M	OUG	II	00583	000		12	100169	1/1/0001
05800	S	M	OUG	II	00594	000		12	100169	1/1/0001
05800	S	M	OUG	II	00599	000		12	100169	1/1/0001

OFFICE: 311

ROUTE: 564

ST_REF_NO: 00000015800 BENWOOD DRIVE

LUMENS	BULB TYPE	MULT SERIES	POLE TYPE	SHADE	ADDRESS NUMBER	REF	LOCATION	TAX DIST	DATE INST	DATE CHANGE
05800	S	M	OUG	II	00000	011	SIDE OF 1720	12	091967	1/1/0001
05800	S	M	OUG	II	01701	010		12	061269	1/1/0001
05800	S	M	OUG	II	01721	012		12	091967	1/1/0001
05800	S	M	OUG	II	01732	013		12	061268	1/1/0001
05800	S	M	OUG	II	01741	014		12	040172	1/1/0001

OFFICE: 311

ROUTE: 564

ST_REF_NO: 00000016000 BERESFORD DRIVE

LUMENS	BULB TYPE	MULT SERIES	POLE TYPE	SHADE	ADDRESS NUMBER	REF	LOCATION	TAX DIST	DATE INST	DATE CHANGE
05800	S	M	OUG	II	00637	176		12	081475	9/9/2009
05800	S	M	OUG	II	00608	173		12	081475	1/1/0001
05800	S	M	OUG	II	00621	174		12	081475	1/1/0001
05800	S	M	OUG	II	00624	175		12	081475	1/1/0001

OFFICE: 311

ROUTE: 564

ST_REF_NO: 00000016100 BERMUDA AVENUE

LUMENS	BULB TYPE	MULT SERIES	POLE TYPE	SHADE	ADDRESS NUMBER	REF	LOCATION	TAX DIST	DATE INST	DATE CHANGE
05800	S	M	SOH	II	00103	056		12	121478	9/9/2009
05800	S	M	SOH	II	00111	057		12	060685	9/9/2009
05800	S	M	SOH	II	00119	058		12	121478	9/9/2009
05800	S	M	SOH	II	00000	055	SIDE 1416 N. LIMESTONE	12	060685	1/1/0001

OFFICE: 311

ROUTE: 564

ST_REF_NO: 00000016150 BERNARD ALLEY

LUMENS	BULB TYPE	MULT SERIES	POLE TYPE	SHADE	ADDRESS NUMBER	REF	LOCATION	TAX DIST	DATE INST	DATE CHANGE
05800	S	M	SOH	III	00000	001	1ST LT. W OF ELMTREE LANE	12	110899	1/1/0001
05800	S	M	SOH	III	00000	003	3RD LT. W OF ELMTREE LANE	12	110899	1/1/0001
05800	S	M	SOH	III	00000	002	2ND LT. W OF ELMTREE LANE	21	110899	1/1/0001

OFFICE: 311

ROUTE: 564

ST_REF_NO: 00000016200 BERRY LANE

LUMENS	BULB TYPE	MULT SERIES	POLE TYPE	SHADE	ADDRESS NUMBER	REF	LOCATION	TAX DIST	DATE INST	DATE CHANGE
05800	S	M	OUG	III	00741	000		12	100156	9/9/2009
05800	S	M	OUG	III	00660	000		12	072160	1/1/0001
05800	S	M	OUG	III	00677	000		12	082756	1/1/0001

OFFICE: 311		ROUTE: 564		ST_REF_NO: 00000016200		BERRY LANE		LUMENS	BULB TYPE	MULT SERIES	POLE TYPE	SHADE	ADDRESS NUMBER	REF	LOCATION	TAX DIST	DATE INST	DATE CHANGE
05800	S	M	OUG	III	00684	000										12	111056	1/1/0001
05800	S	M	OUG	III	00697	000										12	100156	1/1/0001
05800	S	M	OUG	III	00704	000										12	112056	1/1/0001
05800	S	M	OUG	III	00717	000										12	100156	1/1/0001
05800	S	M	OUG	III	00728	000										12	100156	1/1/0001

OFFICE: 311		ROUTE: 564		ST_REF_NO: 00000016225		BERRYMAN CT		LUMENS	BULB TYPE	MULT SERIES	POLE TYPE	SHADE	ADDRESS NUMBER	REF	LOCATION	TAX DIST	DATE INST	DATE CHANGE
05800	S	M	OUG	II	04125	003										12	090893	1/1/0001
04000	S	M	OUG	V	04100	006										12	080891	1/1/0001
04000	S	M	OUG	II	04109	005										12	080891	1/1/0001
04000	S	M	OUG	II	04120	004										12	080891	1/1/0001
04000	S	M	OUG	II	04144	002										12	080891	1/1/0001
04000	S	M	OUG	II	04156	001										12	100892	1/1/0001

OFFICE: 311		ROUTE: 564		ST_REF_NO: 00000016250		BERRY RIDGE CIRCLE		LUMENS	BULB TYPE	MULT SERIES	POLE TYPE	SHADE	ADDRESS NUMBER	REF	LOCATION	TAX DIST	DATE INST	DATE CHANGE
04000	S	M	OUG	II	03808	001										12	100890	1/1/0001

OFFICE: 311		ROUTE: 564		ST_REF_NO: 00000016275		BERRYWOOD DRIVE		LUMENS	BULB TYPE	MULT SERIES	POLE TYPE	SHADE	ADDRESS NUMBER	REF	LOCATION	TAX DIST	DATE INST	DATE CHANGE
05800	S	M	OUG	II	00000	001									SIDE OF 4640 FIELDMOOR DR.	12	110893	1/1/0001
05800	S	M	OUG	II	00000	003									SIDE OF 4693 HATHWAY DR.	12	110893	1/1/0001
05800	S	M	OUG	II	01213	002										12	110893	1/1/0001

OFFICE: 311		ROUTE: 564		ST_REF_NO: 00000016300		BERWIN COURT		LUMENS	BULB TYPE	MULT SERIES	POLE TYPE	SHADE	ADDRESS NUMBER	REF	LOCATION	TAX DIST	DATE INST	DATE CHANGE
04000	S	M	OUG	II	00000	061									SIDE OF 628 CROMWELL WAY	12	110885	9/9/2009
04000	S	M	OUG	II	03514	060										12	110885	1/1/0001
04000	S	M	OUG	V	03524	059										12	110885	1/1/0001

OFFICE: 311

ROUTE: 564

ST_REF_NO: 00000016400

BESHEAR COURT

LUMENS	BULB TYPE	MULT SERIES	POLE TYPE	SHADE	ADDRESS NUMBER	REF	LOCATION	TAX DIST	DATE INST	DATE CHANGE
05800	S	M	OUG	V	00600	030		12	041478	1/1/0001
05800	S	M	OUG	II	00616	031		12	041478	1/1/0001

OFFICE: 311

ROUTE: 564

ST_REF_NO: 00000016500

BETH LANE

LUMENS	BULB TYPE	MULT SERIES	POLE TYPE	SHADE	ADDRESS NUMBER	REF	LOCATION	TAX DIST	DATE INST	DATE CHANGE
05800	S	M	OUG	II	00645	003		12	080890	9/9/2009
04000	S	M	OUG	II	00653	004		12	080890	9/9/2009
04000	S	M	OUG	II	00673	006		12	080890	9/9/2009
04000	S	M	OUG	II	00000	007	OPP. 677 BETH LANE	12	080890	1/1/0001
04000	S	M	OUG	II	00632	001		12	080890	1/1/0001
04000	S	M	OUG	II	00637	002		12	080890	1/1/0001
04000	S	M	OUG	II	00661	005		12	080890	1/1/0001
04000	S	M	OUG	II	00676	008		12	080890	1/1/0001
04000	S	M	OUG	II	00690	009		12	080890	1/1/0001
04000	S	M	OUG	II	00694	010		12	080890	1/1/0001

OFFICE: 311

ROUTE: 564

ST_REF_NO: 00000017010

BETTY HOPE LANE

LUMENS	BULB TYPE	MULT SERIES	POLE TYPE	SHADE	ADDRESS NUMBER	REF	LOCATION	TAX DIST	DATE INST	DATE CHANGE
05800	S	M	SOH	II	00000	001	OPP. 133	12	121578	9/9/2009
05800	S	M	SOH	II	00000	002	OPP. 151	12	121578	1/1/0001
05800	S	M	SOH	II	00196	003		12	121578	1/1/0001

OFFICE: 311

ROUTE: 564

ST_REF_NO: 00000017100

BEULAH PARK DRIVE

LUMENS	BULB TYPE	MULT SERIES	POLE TYPE	SHADE	ADDRESS NUMBER	REF	LOCATION	TAX DIST	DATE INST	DATE CHANGE
05800	S	M	OUG	V	01261	121		12	041475	1/1/0001
05800	S	M	OUG	II	01273	120		12	041475	1/1/0001
05800	S	M	OUG	II	01284	119		12	041475	1/1/0001

OFFICE: 311

ROUTE: 564

ST_REF_NO: 00000017290

BIG BEAR LANE

LUMENS	BULB TYPE	MULT SERIES	POLE TYPE	SHADE	ADDRESS NUMBER	REF	LOCATION	TAX DIST	DATE INST	DATE CHANGE
05800	S	M	OUG	III	00504	007		12	020800	9/9/2009

OFFICE: 311		ROUTE: 564		ST_REF_NO: 00000017290		BIG BEAR LANE		LUMENS	BULB TYPE	MULT SERIES	POLE TYPE	SHADE	ADDRESS NUMBER	REF	LOCATION	TAX DIST	DATE INST	DATE CHANGE
05800	S	M	OUG	II	00517	006										12	020800	9/9/2009
05800	S	M	OUG	II	00534	005										12	020800	9/9/2009
05800	S	M	OUG	II	00548	004										12	020800	9/9/2009
05800	S	M	OUG	II	00629	003										12	020800	9/9/2009
05800	S	M	OUG	II	00000	001	SIDE OF 3634 WALDEN DRIVE									12	020800	1/1/0001
05800	S	M	OUG	II	00616	002										12	020800	1/1/0001
OFFICE: 311		ROUTE: 564		ST_REF_NO: 00000017300		BIG BEND COURT		LUMENS	BULB TYPE	MULT SERIES	POLE TYPE	SHADE	ADDRESS NUMBER	REF	LOCATION	TAX DIST	DATE INST	DATE CHANGE
05800	S	M	OUG	II	00000	016	SIDE OF 2816 MT. MCKINLEY WAY									12	041478	2/1/2012
04000	S	M	OUG	II	03309	017										12	091478	1/1/0001
OFFICE: 311		ROUTE: 564		ST_REF_NO: 00000017400		BIG RUN ROAD		LUMENS	BULB TYPE	MULT SERIES	POLE TYPE	SHADE	ADDRESS NUMBER	REF	LOCATION	TAX DIST	DATE INST	DATE CHANGE
09500	S	M	OUG	II	00000	001	SIDE OF 299 GOLD RUSH RD.									12	121475	9/9/2009
10000	M	M	OUG	II	00203	024										12	061580	9/9/2009
09500	S	M	OUG	II	00219	022										12	061580	12/12/2013
10000	M	M	OUG	II	00228	008										12	061580	9/9/2009
10000	M	M	OUG	II	00242	006										12	021475	9/9/2009
10000	M	M	OUG	II	00255	007										12	111478	9/9/2009
09500	S	M	OUG	II	00290	002										12	061580	9/9/2009
10000	M	M	OUG	II	00272	004										12	021475	1/1/0001
10000	M	M	OUG	II	00273	005										12	021475	1/1/0001
10000	M	M	OUG	II	00281	003										12	021475	1/1/0001
09500	S	M	OUG	II	00200	026										12	090891	1/1/0001
10000	M	M	OUG	II	00201	025										12	061580	1/1/0001
09500	S	M	OUG	II	00210	023										12	090891	1/1/0001
OFFICE: 311		ROUTE: 564		ST_REF_NO: 00000017550		BILTMORE PLACE		LUMENS	BULB TYPE	MULT SERIES	POLE TYPE	SHADE	ADDRESS NUMBER	REF	LOCATION	TAX DIST	DATE INST	DATE CHANGE
05800	S	M	CNT	II	00000	002	SIDE OF 4740 WINDSTAR WAY ON BILTMORE PL									12	110207	1/1/0001

OFFICE: 311		ROUTE: 564		ST_REF_NO: 00000017550		BILTMORE PLACE		LUMENS	BULB TYPE	MULT SERIES	POLE TYPE	SHADE	ADDRESS NUMBER	REF	LOCATION	TAX DIST	DATE INST	DATE CHANGE
05800	S	M	CNT	II	00000	005	SIDE OF 501 REVENNA LN ON BILTMORE PL	12	110207	1/1/0001								
05800	S	M	CNT	II	00000	006	REAR OF 4617 WINDSTAR WAY ON BILTMORE PL	12	110207	1/1/0001								
05800	S	M	CNT	II	00000	007	SIDE OF 4617 WINDSTAR WAY ON BILTMORE PL	12	110207	1/1/0001								
05800	S	M	CNT	II	00000	030	SIDE OF 573 SOUTHPONT DR ON BILTMORE PLACE	12	012608	1/1/0001								
09500	S	M	CNT	II	00000	100	SIDE OF 4732 WINDSTAR WY ON BILTMORE PL	12	110207	1/1/0001								
09500	S	M	CNT	II	00000	101	SIDE OF 572 SOUTHPONT DR ON BILTMORE PL	12	110207	1/1/0001								
05800	S	M	CNT	II	04409	032		12	012608	9/9/2009								
05800	S	M	CNT	II	04416	031		12	012608	1/1/0001								
05800	S	M	CNT	II	04517	003		12	110207	1/1/0001								
05800	S	M	CNT	II	04532	004		12	110207	1/1/0001								

OFFICE: 311

ROUTE: 564

OFFICE: 311		ROUTE: 564		ST_REF_NO: 00000017700		BILOXI COURT		LUMENS	BULB TYPE	MULT SERIES	POLE TYPE	SHADE	ADDRESS NUMBER	REF	LOCATION	TAX DIST	DATE INST	DATE CHANGE
05800	S	M	OUG	II	01702	000	AT END OF COURT	12	060162	9/9/2009								
05800	S	M	OUG	II	01706	000		12	060162	1/1/0001								
05800	S	M	OUG	II	01711	000		12	060162	1/1/0001								
05800	S	M	OUG	II	01718	000		12	060162	1/1/0001								
05800	S	M	OUG	II	01803	000		12	071064	1/1/0001								

OFFICE: 311

ROUTE: 564

OFFICE: 311		ROUTE: 564		ST_REF_NO: 00000017750		BINGHAM DRIVE		LUMENS	BULB TYPE	MULT SERIES	POLE TYPE	SHADE	ADDRESS NUMBER	REF	LOCATION	TAX DIST	DATE INST	DATE CHANGE
05800	S	M	OUG	II	03768	005		12	040897	9/9/2009								
05800	S	M	OUG	II	00000	004	SIDE OF 1200 KENNECOTT WAY	12	040897	1/1/0001								
05800	S	M	OUG	III	03761	006		12	040897	1/1/0001								
05800	S	M	OUG	II	03792	003			040897	1/1/0001								
05800	S	M	OUG	II	03800	001		12	040897	1/1/0001								
05800	S	M	OUG	III	03812	002		12	040897	1/1/0001								

OFFICE: 311

ROUTE: 564

OFFICE: 311		ROUTE: 564		ST_REF_NO: 00000017800		BIMINI ROAD		LUMENS	BULB TYPE	MULT SERIES	POLE TYPE	SHADE	ADDRESS NUMBER	REF	LOCATION	TAX DIST	DATE INST	DATE CHANGE
05800	S	M	OUG	II	00000	001	SIDE OF 630 TATESWOOD	12	070863	9/9/2009								

OFFICE: 311

ROUTE: 564

ST_REF_NO: 00000017800 Bimini Road

LUMENS	BULB TYPE	MULT SERIES	POLE TYPE	SHADE	ADDRESS NUMBER	REF	LOCATION	TAX DIST	DATE INST	DATE CHANGE
05800	S	M	OUG	II	00000	024	SIDE OF 617 BEECHMONT	12	070863	1/1/0001
05800	S	M	OUG	II	01809	000		12	070863	1/1/0001
05800	S	M	OUG	II	01816	000		12	070863	1/1/0001

OFFICE: 311

ROUTE: 564

ST_REF_NO: 00000017900 Birch Drive

LUMENS	BULB TYPE	MULT SERIES	POLE TYPE	SHADE	ADDRESS NUMBER	REF	LOCATION	TAX DIST	DATE INST	DATE CHANGE
04000	S	M	OUG	II	00000	033	SIDE OF 1958 MARK AVE	12	051477	9/9/2009
05800	S	M	OUG	II	01006	025		12	051477	9/9/2009
04000	S	M	OUG	II	00000	035	SIDE OF 1963 KNIGHT LANE	12	051477	1/1/0001
04000	S	M	OUG	II	01017	026		12	051477	1/1/0001
04000	S	M	OUG	II	01029	028		12	051477	1/1/0001
04000	S	M	OUG	II	01038	027		12	051477	1/1/0001
04000	S	M	OUG	II	01057	030		12	051477	1/1/0001
04000	S	M	OUG	II	01062	029		12	051477	1/1/0001
04000	S	M	OUG	II	01081	032		12	051477	1/1/0001
04000	S	M	OUG	II	01088	031		12	051477	1/1/0001
04000	S	M	OUG	II	01116	034		12	051477	1/1/0001

OFFICE: 311

ROUTE: 564

ST_REF_NO: 00000017970 Birch Tree Lane

LUMENS	BULB TYPE	MULT SERIES	POLE TYPE	SHADE	ADDRESS NUMBER	REF	LOCATION	TAX DIST	DATE INST	DATE CHANGE
05800	S	M	OUG	II	03001	001		12	050897	1/1/0001
05800	S	M	OUG	II	03012	002		12	050897	1/1/0001

OFFICE: 311

ROUTE: 564

ST_REF_NO: 00000017985 Birkdale Drive

LUMENS	BULB TYPE	MULT SERIES	POLE TYPE	SHADE	ADDRESS NUMBER	REF	LOCATION	TAX DIST	DATE INST	DATE CHANGE
05800	S	M	CNT	II	00000	003	SIDE OF 3216 POLO CLUB	12	100901	9/9/2009
05800	S	M	CNT	II	02160	001		12	100901	1/1/0001
05800	S	M	CNT	II	02177	002		12	100901	1/1/0001

OFFICE: 311		ROUTE: 564		ST_REF_NO: 00000017990		BIRKENHEAD COURT		LUMENS	BULB TYPE	MULT SERIES	POLE TYPE	SHADE	ADDRESS NUMBER	REF	LOCATION	TAX DIST	DATE INST	DATE CHANGE
04000	S	M	OUG	II	03414	117										12	110885	9/9/2009
04000	S	M	OUG	II	00000	116	SIDE OF 592 MERRIMAC DR.									12	110885	1/1/0001
04000	S	M	OUG	V	03405	118										12	110885	1/1/0001
04000	S	M	OUG	II	00000	067	SIDE OF 592 CROMWELL WAY									12	110885	1/1/0001
04000	S	M	OUG	II	03514	066										12	110885	1/1/0001

OFFICE: 311		ROUTE: 564		ST_REF_NO: 00000018000		BIRKENHEAD DRIVE		LUMENS	BULB TYPE	MULT SERIES	POLE TYPE	SHADE	ADDRESS NUMBER	REF	LOCATION	TAX DIST	DATE INST	DATE CHANGE
04000	S	M	OUG	II	03466	070										12	110885	9/9/2009
04000	S	M	OUG	II	03437	088										12	110885	1/1/0001
04000	S	M	OUG	II	03449	089										12	110885	1/1/0001
04000	S	M	OUG	II	03457	071										12	110885	1/1/0001
04000	S	M	OUG	II	03481	069										12	110885	1/1/0001
04000	S	M	OUG	II	03489	068										12	110885	1/1/0001

OFFICE: 311		ROUTE: 564		ST_REF_NO: 00000018050		BIRMINGHAM LANE		LUMENS	BULB TYPE	MULT SERIES	POLE TYPE	SHADE	ADDRESS NUMBER	REF	LOCATION	TAX DIST	DATE INST	DATE CHANGE
05800	S	M	CNT	III	01201	005										12	100899	9/9/2009
05800	S	M	CNT	II	01233	002										12	100899	9/9/2009
05800	S	M	CNT	II	01212	004										12	100899	1/1/0001
05800	S	M	CNT	II	01245	001										12	100899	1/1/0001

OFFICE: 311		ROUTE: 564		ST_REF_NO: 00000018100		BISHOP COURT		LUMENS	BULB TYPE	MULT SERIES	POLE TYPE	SHADE	ADDRESS NUMBER	REF	LOCATION	TAX DIST	DATE INST	DATE CHANGE
05800	S	M	OUG	II	00000	030	SIDE OF 550 RADCLIFFE RD									12	040166	1/1/0001

OFFICE: 311		ROUTE: 564		ST_REF_NO: 00000018200		BISHOP DRIVE		LUMENS	BULB TYPE	MULT SERIES	POLE TYPE	SHADE	ADDRESS NUMBER	REF	LOCATION	TAX DIST	DATE INST	DATE CHANGE
05800	S	M	OUG	II	00000	025	SIDE OF 659 BURGESS AVE									12	102367	9/9/2009
05800	S	M	OUG	II	00576	000										12	101267	9/9/2009
05800	S	M	OUG	II	00000	031	SIDE OF 209 RADCLIFFE RD.									12	070767	1/1/0001

OFFICE: 311

ROUTE: 564

ST_REF_NO: 00000018200

BISHOP DRIVE

LUMENS	BULB TYPE	MULT SERIES	POLE TYPE	SHADE	ADDRESS NUMBER	REF	LOCATION	TAX DIST	DATE INST	DATE CHANGE
05800	S	M	OUG	II	00000	036	SIDE OF 537 RADCLIFFE RD.	12	040166	1/1/0001
05800	S	M	OUG	II	00000	042	SIDE OF 1819 LINTON RD.	12	120266	1/1/0001
05800	S	M	OUG	II	00542	000		12	040166	1/1/0001
05800	S	M	OUG	II	00563	000		12	042067	1/1/0001
05800	S	M	OUG	II	00591	000		12	042067	1/1/0001
05800	S	M	OUG	II	00596	000		12	042067	1/1/0001
05800	S	M	OUG	II	00610	000		12	042067	1/1/0001
05800	S	M	OUG	II	00621	000		12	120266	1/1/0001
05800	S	M	OUG	II	00629	053		12	120266	1/1/0001
05800	S	M	OUG	II	00630	000		12	101267	1/1/0001
05800	S	M	OUG	II	00654	000		12	120167	1/1/0001
05800	S	M	OUG	II	00661	000		12	120266	1/1/0001
05800	S	M	OUG	II	00685	000		12	060468	1/1/0001
05800	S	M	OUG	II	00702	000		12	040171	1/1/0001
05800	S	M	OUG	II	00711	000		12	100169	1/1/0001
05800	S	M	OUG	II	00726	000		12	120167	1/1/0001
05800	S	M	OUG	II	00739	000		12	060468	1/1/0001

OFFICE: 311

ROUTE: 564

ST_REF_NO: 00000018300

BISKOFF COURT

LUMENS	BULB TYPE	MULT SERIES	POLE TYPE	SHADE	ADDRESS NUMBER	REF	LOCATION	TAX DIST	DATE INST	DATE CHANGE
05800	S	M	OUG	II	00000	049	SIDE OF 2319 PIERSON DR.	12	060870	1/1/0001
05800	S	M	OUG	II	00710	000		12	050969	1/1/0001

OFFICE: 311

ROUTE: 564

ST_REF_NO: 00000018350

BITTER SWEET WAY

LUMENS	BULB TYPE	MULT SERIES	POLE TYPE	SHADE	ADDRESS NUMBER	REF	LOCATION	TAX DIST	DATE INST	DATE CHANGE
05800	S	M	CNT	II	00000	004	OPPOSITE 209 BITTER SWEET WAY	12	080102	1/1/0001
05800	S	M	CNT	II	00176	001		12	030904	1/1/0001
05800	S	M	CNT	II	00193	002		12	030904	1/1/0001
05800	S	M	CNT	II	00201	003		12	080102	1/1/0001
05800	S	M	CNT	II	00221	005		12	080102	1/1/0001
05800	S	M	CNT	II	00232	006	updated street address field only	12	111504	2/6/2014
05800	S	M	CNT	II	00241	007		12	111504	1/1/0001

OFFICE: 311

ROUTE: 564

ST_REF_NO: 00000018350 BITTER SWEET WAY

LUMENS	BULB TYPE	MULT SERIES	POLE TYPE	SHADE	ADDRESS NUMBER	REF	LOCATION	TAX DIST	DATE INST	DATE CHANGE
05800	S	M	CNT	II	00253	008		12	111504	9/9/2009

OFFICE: 311

ROUTE: 564

ST_REF_NO: 00000018400 BIXBY WAY

LUMENS	BULB TYPE	MULT SERIES	POLE TYPE	SHADE	ADDRESS NUMBER	REF	LOCATION	TAX DIST	DATE INST	DATE CHANGE
05800	S	M	OUG	II	00000	053	SIDE OF 401 LAKESHORE ON BIXBY WAY	12	020367	9/9/2009
05800	S	M	OUG	II	00000	017	SIDE OF 2003 HART RD.ON BIXBY WAY W.	12	080171	1/1/0001
05800	S	M	OUG	II	00000	018	SIDE OF 1972 BLAIRMORE ON BIXBY WAY W.	12	020367	1/1/0001
05800	S	M	OUG	II	02010	041		12	020367	1/1/0001

OFFICE: 311

ROUTE: 564

ST_REF_NO: 00000018500 BIZZELL DRIVE

LUMENS	BULB TYPE	MULT SERIES	POLE TYPE	SHADE	ADDRESS NUMBER	REF	LOCATION	TAX DIST	DATE INST	DATE CHANGE
05800	S	M	OUG	II	00649	003		12	060867	9/9/2009
05800	S	M	OUG	II	00604	006		12	060867	1/1/0001
05800	S	M	OUG	II	00633	005		12	060867	1/1/0001
05800	S	M	OUG	II	00636	004		12	060867	1/1/0001
05800	S	M	OUG	II	00680	002		12	060867	1/1/0001
05800	S	M	OUG	II	00695	001		12	060867	1/1/0001

OFFICE: 311

ROUTE: 564

ST_REF_NO: 00000018600 BLACK ARROW COURT

LUMENS	BULB TYPE	MULT SERIES	POLE TYPE	SHADE	ADDRESS NUMBER	REF	LOCATION	TAX DIST	DATE INST	DATE CHANGE
04000	S	M	OUG	V	02883	039		12	041470	1/1/0001
04000	S	M	OUG	II	02895	038		12	120869	1/1/0001

OFFICE: 311

ROUTE: 564

ST_REF_NO: 00000018650 BLACKBERRY LANE

LUMENS	BULB TYPE	MULT SERIES	POLE TYPE	SHADE	ADDRESS NUMBER	REF	LOCATION	TAX DIST	DATE INST	DATE CHANGE
04000	S	M	OUG	II	03805	002		12	100890	1/1/0001
04000	S	M	OUG	II	03808	001		12	100890	1/1/0001

OFFICE: 311		ROUTE: 564		ST_REF_NO: 00000018700		BLACKBURN AVENUE		LUMENS	BULB TYPE	MULT SERIES	POLE TYPE	SHADE	ADDRESS NUMBER	REF	LOCATION	TAX DIST	DATE INST	DATE CHANGE
05800	S	M	SOH	II	00000	001	SIDE OF 550 W FOURTH ST	12	092366							12	092366	9/9/2009
05800	S	M	SOH	II	00349	000		12	092366							12	092366	9/9/2009
05800	S	M	SOH	II	00317	000		12	092366							12	092366	1/1/0001

OFFICE: 311		ROUTE: 564		ST_REF_NO: 00000018800		BLACKFORD Parkway		LUMENS	BULB TYPE	MULT SERIES	POLE TYPE	SHADE	ADDRESS NUMBER	REF	LOCATION	TAX DIST	DATE INST	DATE CHANGE
05800	S		CNT	II	00000	001	1st It e of MOW, south side on Blackford Pkwy	12	090608							12	090608	9/6/2008
05800	S		CNT	II	00000	003	2nd It E of MOW, S side on Blackford Pkwy	12	090608							12	090608	9/6/2008
05800	S		CNT	II	00000	005	3rd It E of MOW, S side on Blackford Pkwy	12	090608							12	090608	9/6/2008
05800	S		CNT	II	00000	007	4th It E of MOW, S side on Blackford Pkwy	12	090608							12	090608	9/6/2008
05800	S		CNT	II	00000	011	side of 3300 Feliciana Ln on Blackford Pkwy	12	090608							12	090608	9/6/2008
05800	S		CNT	II	02929	008		12	090608							12	090608	9/6/2008
05800	S		CNT	II	02965	012		12	090608							12	090608	9/6/2008
05800	S		CNT	II	03004	016		12	090608							12	090608	9/6/2008
05800	S		CNT	II	03013	017		12	090608							12	090608	9/6/2008
05800	S		CNT	II	03033	019		12	090608							12	090608	9/6/2008
05800	S		CNT	II	03060	022		12	090608							12	090608	9/6/2008

OFFICE: 311		ROUTE: 564		ST_REF_NO: 00000018805		BLACKFORD PASS		LUMENS	BULB TYPE	MULT SERIES	POLE TYPE	SHADE	ADDRESS NUMBER	REF	LOCATION	TAX DIST	DATE INST	DATE CHANGE
05800	S		CNT	II	03301	002		12	090608							12	090608	9/6/2008
05800	S		CNT	II	03305	004		12	090608							12	090608	9/6/2008

OFFICE: 311		ROUTE: 564		ST_REF_NO: 00000018830		BLACKHORSE LANE		LUMENS	BULB TYPE	MULT SERIES	POLE TYPE	SHADE	ADDRESS NUMBER	REF	LOCATION	TAX DIST	DATE INST	DATE CHANGE
05800	S	M	CNT	II	02040	004		12	100896							12	100896	9/9/2009
05800	S	M	CNT	III	02072	006		12	060899							12	060899	9/9/2009
05800	S	M	CNT	II	00000	001	SIDE REAR OF 3677 GLADMAN WAY	12	100896							12	100896	1/1/0001
05800	S	M	CNT	III	01980	007		12	100896							12	100896	1/1/0001
05800	S	M	CNT	II	02012	002		12	100896							12	100896	1/1/0001
05800	S	M	CNT	II	02025	003		12	100896							12	100896	1/1/0001

OFFICE: 311		ROUTE: 564		ST_REF_NO: 00000018830		BLACKHORSE LANE		LUMENS	BULB TYPE	MULT SERIES	POLE TYPE	SHADE	ADDRESS NUMBER	REF	LOCATION	TAX DIST	DATE INST	DATE CHANGE
	05800	S	M	CNT	II	02053	005									12	100896	1/1/0001
OFFICE: 311		ROUTE: 564		ST_REF_NO: 00000018850		BLACKMOOR CIRCLE		LUMENS	BULB TYPE	MULT SERIES	POLE TYPE	SHADE	ADDRESS NUMBER	REF	LOCATION	TAX DIST	DATE INST	DATE CHANGE
	05800	S	M	CNT	II	03000	001									12	051701	1/1/0001
	05800	S	M	CNT	III	03021	002									12	051701	1/1/0001
OFFICE: 311		ROUTE: 564		ST_REF_NO: 00000018855		BLACKMOOR PARK LANE		LUMENS	BULB TYPE	MULT SERIES	POLE TYPE	SHADE	ADDRESS NUMBER	REF	LOCATION	TAX DIST	DATE INST	DATE CHANGE
	05800	S	M	CNT	II	00000	007	OPPOSITE 2200 BLACKMOOR PARK LANE								12	051701	1/1/0001
	05800	S	M	CNT	II	02208	006									12	051701	1/1/0001
	05800	S	M	CNT	II	02221	005									12	041703	1/1/0001
	05800	S	M	CNT	II	02237	004									12	051701	1/1/0001
	05800	S	M	CNT	II	02249	003									12	051701	1/1/0001
	05800	S	M	CNT	II	02256	002									12	051701	1/1/0001
	05800	S	M	CNT	II	02264	001									12	051701	1/1/0001
OFFICE: 311		ROUTE: 564		ST_REF_NO: 00000018865		BLACKWATER LANE		LUMENS	BULB TYPE	MULT SERIES	POLE TYPE	SHADE	ADDRESS NUMBER	REF	LOCATION	TAX DIST	DATE INST	DATE CHANGE
	05800	S	M	CNT	II	00149	001									12	060304	1/1/0001
	05800	S	M	CNT	II	00164	002									12	060304	1/1/0001
	05800	S	M	CNT	II	00185	003									12	060304	1/1/0001
	05800	S	M	CNT	II	00196	004									12	060304	1/1/0001
	05800	S	M	CNT	II	00205	005									12	060304	1/1/0001
	05800	S	M	CNT	II	00224	006									12	060304	1/1/0001
	05800	S	M	CNT	II	00237	007									12	060304	1/1/0001
OFFICE: 311		ROUTE: 564		ST_REF_NO: 00000018890		BLAIRMORE COURT		LUMENS	BULB TYPE	MULT SERIES	POLE TYPE	SHADE	ADDRESS NUMBER	REF	LOCATION	TAX DIST	DATE INST	DATE CHANGE
	05800	S	M	OUG	II	01845	000									12	030169	1/1/0001
	05800	S	M	OUG	II	01852	000									12	070767	1/1/0001

OFFICE: 311		ROUTE: 564		ST_REF_NO: 00000018890		BLAIRMORE COURT		LUMENS	BULB TYPE	MULT SERIES	POLE TYPE	SHADE	ADDRESS NUMBER	REF	LOCATION	TAX DIST	DATE INST	DATE CHANGE
	05800	S	M	OUG	II	01861	000									12	020367	1/1/0001
	05800	S	M	OUG	II	01872	000									12	020367	1/1/0001
OFFICE: 311		ROUTE: 564		ST_REF_NO: 00000018900		BLAIRMORE ROAD		LUMENS	BULB TYPE	MULT SERIES	POLE TYPE	SHADE	ADDRESS NUMBER	REF	LOCATION	TAX DIST	DATE INST	DATE CHANGE
	05800	S	M	OUG	II	01873	019									12	070170	1/1/0001
	05800	S	M	OUG	II	01877	000									12	070767	1/1/0001
	05800	S	M	OUG	II	01888	000									12	070767	1/1/0001
	05800	S	M	OUG	II	01893	000									12	080172	1/1/0001
	05800	S	M	OUG	II	01904	000									12	020367	1/1/0001
	05800	S	M	OUG	II	01909	000									12	080172	1/1/0001
	05800	S	M	OUG	II	01920	000									12	020367	1/1/0001
	05800	S	M	OUG	II	01941	000									12	021369	1/1/0001
	05800	S	M	OUG	II	01952	000									12	070767	1/1/0001
	05800	S	M	OUG	II	01961	000									12	050668	1/1/0001
	05800	S	M	OUG	II	01968	000									12	070767	1/1/0001
	05800	S	M	OUG	II	02001	000									12	020367	1/1/0001
	05800	S	M	OUG	II	02008	000									12	040172	1/1/0001
	05800	S	M	OUG	II	02017	000									12	020367	1/1/0001
	05800	S	M	OUG	II	02024	000									12	020367	1/1/0001
	05800	S	M	OUG	II	02037	000									12	070767	1/1/0001
	05800	S	M	OUG	II	02044	000									12	020367	1/1/0001
	05800	S	M	OUG	II	01928	000									12	021369	1/1/0001
OFFICE: 311		ROUTE: 564		ST_REF_NO: 00000018910		BLANCHESTER ROAD		LUMENS	BULB TYPE	MULT SERIES	POLE TYPE	SHADE	ADDRESS NUMBER	REF	LOCATION	TAX DIST	DATE INST	DATE CHANGE
	04000	S	M	OUG	II	04500	014									12	011579	1/1/0001
	04000	S	M	OUG	II	04505	015									12	011579	1/1/0001

OFFICE: 311

ROUTE: 564

ST_REF_NO: 00000018917

BLAZER DRIVE

LUMENS	BULB TYPE	MULT SERIES	POLE TYPE	SHADE	ADDRESS NUMBER	REF	LOCATION	TAX DIST	DATE INST	DATE CHANGE
09500	S	M	OUG	II	00000	003	3RD LT S OF MAN O WAR, WEST SIDE ON BLAZER DRIVE	12	120101	1/1/0001
09500	S	M	OUG	II	00000	004	4TH LT S OF MAN O WAR, WEST SIDE ON BLAZER DRIVE	12	120101	1/1/0001
09500	S	M	OUG	II	00000	006	6TH LT S OF MAN O WAR, EAST SIDE ON BLAZER DRIVE	12	120101	1/1/0001
09500	S	M	OUG	II	00000	008	8TH LT S OF MAN O WAR, EAST SIDE ON BLAZER DRIVE	12	120101	1/1/0001
09500	S	M	OUG	II	00000	009	9TH LT S OF MAN O WAR, WEST SIDE ON BLAZER DRIVE	12	120101	1/1/0001
09500	S	M	OUG	II	00000	010	10TH LT S OF MAN O WAR, EAST SIDE ON BLAZER DRIVE	12	120101	1/1/0001
09500	S	M	OUG	II	00000	011	11TH LT S OF MAN O WAR, WEST SIDE ON BLAZER DRIVE	12	120101	1/1/0001
09500	S	M	OUG	II	00000	012	12TH LT S OF MAN O WAR, EAST SIDE ON BLAZER DRIVE	12	120101	1/1/0001
09500	S	M	OUG	II	00000	013	13TH LT S OF MAN O WAR, WEST SIDE ON BLAZER DRIVE	12	120101	1/1/0001
09500	S	M	OUG	II	00000	014	14TH LT S OF MAN O WAR, EAST SIDE ON BLAZER DRIVE	12	120101	1/1/0001
09500	S	M	OUG	II	00000	015	15TH LT S OF MAN O WAR, WEST SIDE ON BLAZER DRIVE	12	120101	1/1/0001
09500	S	M	OUG	II	00000	016	16TH LT S OF MAN O WAR, EAST SIDE ON BLAZER DRIVE	12	120101	1/1/0001
09500	S	M	OUG	II	00000	017	17TH LT S OF MAN O WAR, WEST SIDE ON BLAZER DRIVE	12	120101	1/1/0001
09500	S	M	OUG	II	00000	018	18TH LT S OF MAN O WAR, EAST SIDE ON BLAZER DRIVE	12	120101	1/1/0001
09500	S	M	OUG	II	00000	019	19TH LT S OF MAN O WAR, WEST SIDE ON BLAZER DRIVE	12	120101	1/1/0001
09500	S	M	OUG	II	03250	005		12	120101	1/1/0001
09500	S	M	OUG	II	03280	007		12	120101	1/1/0001

OFFICE: 311

ROUTE: 564

ST_REF_NO: 00000018919

BLED SOE PLACE

LUMENS	BULB TYPE	MULT SERIES	POLE TYPE	SHADE	ADDRESS NUMBER	REF	LOCATION	TAX DIST	DATE INST	DATE CHANGE
05800	S		CNT	II	03200	010		12	051510	1/1/0001
05800	S		CNT	II	03209	020		12	051510	1/1/0001
05800	S		CNT	II	00000	001	SIDE OF 2997 Mahala Ln on Bledsoe Place	12	090608	9/6/2008

OFFICE: 311

ROUTE: 564

ST_REF_NO: 00000018920

BLLENHEIM CT

LUMENS	BULB TYPE	MULT SERIES	POLE TYPE	SHADE	ADDRESS NUMBER	REF	LOCATION	TAX DIST	DATE INST	DATE CHANGE
05800	S	M	CNT	II	00805	001		12	060894	1/1/0001

OFFICE: 311

ROUTE: 564

ST_REF_NO: 00000018930

BLLENHEIM WAY

LUMENS	BULB TYPE	MULT SERIES	POLE TYPE	SHADE	ADDRESS NUMBER	REF	LOCATION	TAX DIST	DATE INST	DATE CHANGE
05800	S	M	CNT	II	00000	019	SIDE OF 3113 COMANCHE TRAIL	12	080894	1/1/0001
05800	S	M	CNT	II	00000	020	SIDE OF 3164 COTTONTAIL LANE	12	080897	1/1/0001
05800	S	M	CNT	III	03012	025		12	080897	1/1/0001
05800	S	M	CNT	III	03025	026		12	080897	1/1/0001
05800	S	M	CNT	II	03028	024		12	080897	1/1/0001
05800	S	M	CNT	II	03033	023		12	080897	1/1/0001
05800	S	M	CNT	II	03044	022		12	080897	1/1/0001
05800	S	M	CNT	II	03060	021		12	080897	1/1/0001
05800	S	M	CNT	II	03120	018		12	080894	1/1/0001
05800	S	M	CNT	II	03132	017		12	080894	1/1/0001
05800	S	M	CNT	II	03144	016		12	080894	1/1/0001
05800	S	M	CNT	II	03153	015		12	110895	1/1/0001
05800	S	M	CNT	II	03160	014		12	080894	1/1/0001
05800	S	M	CNT	II	03173	013		12	080894	1/1/0001
05800	S	M	CNT	II	03176	012		12	110895	1/1/0001
05800	S	M	CNT	II	03185	011		12	110895	1/1/0001
05800	S	M	CNT	II	03192	010		12	060894	1/1/0001
05800	S	M	CNT	II	03204	009		12	060894	1/1/0001
05800	S	M	CNT	II	03205	008		12	060894	1/1/0001
05800	S	M	CNT	II	03213	007		12	060894	1/1/0001
05800	S	M	CNT	II	03225	006		12	060894	1/1/0001
05800	S	M	CNT	II	03232	005		12	060894	1/1/0001
05800	S	M	CNT	II	03236	004		12	060894	1/1/0001
05800	S	M	CNT	II	03249	003		12	060894	1/1/0001
05800	S	M	CNT	II	03252	002		12	060894	1/1/0001
05800	S	M	CNT	II	03269	001		12	060894	1/1/0001

OFFICE: 311

ROUTE: 564

ST_REF_NO: 00000019000 BLUE ASH DRIVE

LUMENS	BULB TYPE	MULT SERIES	POLE TYPE	SHADE	ADDRESS NUMBER	REF	LOCATION	TAX DIST	DATE INST	DATE CHANGE
05800	S	M	OUG	II	00000	020	SIDE OF 1827 CLAYS MILL	12	080884	9/9/2009
05800	S	M	OUG	II	00620	019		12	080884	12/19/2013
04000	S	M	OUG	II	00625	018		12	080884	1/1/0001
04000	S	M	OUG	II	00630	017		12	080884	1/1/0001

OFFICE: 311

ROUTE: 564

ST_REF_NO: 00000019100 BLUEGRASS AVENUE

LUMENS	BULB TYPE	MULT SERIES	POLE TYPE	SHADE	ADDRESS NUMBER	REF	LOCATION	TAX DIST	DATE INST	DATE CHANGE
09500	S	M	SOH	II	00000	069	SIDE 1330 N. LIMESTONE	12	050885	1/1/0001
09500	S	M	SOH	II	00105	070		12	050885	1/1/0001
09500	S	M	SOH	II	00110	071		12	050885	1/1/0001
09500	S	M	SOH	II	00115	072		12	050885	1/1/0001
09500	S	M	SOH	II	00206	073		12	050885	1/1/0001
09500	S	M	SOH	II	00000	078	SIDE 1401 BRYAN AVE.	12	050885	1/1/0001
09500	S	M	SOH	II	00213	074		12	050885	1/1/0001
09500	S	M	SOH	II	00300	075		12	050885	1/1/0001
09500	S	M	SOH	II	00309	076		12	050885	1/1/0001
09500	S	M	SOH	II	00324	077		12	050885	1/1/0001

OFFICE: 311

ROUTE: 564

ST_REF_NO: 00000019250 BLUE HERON PLACE

LUMENS	BULB TYPE	MULT SERIES	POLE TYPE	SHADE	ADDRESS NUMBER	REF	LOCATION	TAX DIST	DATE INST	DATE CHANGE
05800	S	M	CNT	II	00000	007	SIDE OF 296 LONG BRANCH LN ON BLUE HERON LANE	12	103005	1/1/0001
05800	S	M	CNT	II	00105	001		12	103005	1/1/0001
05800	S	M	CNT	II	00121	002		12	103005	1/1/0001
05800	S	M	CNT	II	00128	003		12	080102	1/1/0001
05800	S	M	CNT	II	00149	004		12	080102	1/1/0001
05800	S	M	CNT	II	00165	005		12	103005	1/1/0001
05800	S	M	CNT	II	00176	006		12	103005	1/1/0001

OFFICE: 311

ROUTE: 564

ST_REF_NO: 00000019300 BLUE LICKS ROAD

LUMENS	BULB TYPE	MULT SERIES	POLE TYPE	SHADE	ADDRESS NUMBER	REF	LOCATION	TAX DIST	DATE INST	DATE CHANGE
05800	S	M	OUG	II	01762	006		12	110888	9/9/2009

OFFICE: 311		ROUTE: 564		ST_REF_NO: 00000019300		BLUE LICKS ROAD		LUMENS	BULB TYPE	MULT SERIES	POLE TYPE	SHADE	ADDRESS NUMBER	REF	LOCATION	TAX DIST	DATE INST	DATE CHANGE
04000	S	M	OUG	II	00000	001	SIDE OF 974 CELIA LANE	12	110888	1/1/0001								
04000	S	M	OUG	II	01710	002		12	110888	1/1/0001								
04000	S	M	OUG	II	01721	003		12	110888	1/1/0001								
04000	S	M	OUG	II	01734	004		12	110888	1/1/0001								
04000	S	M	OUG	II	01745	005		12	110888	1/1/0001								
04000	S	M	OUG	II	01769	007		12	110888	1/1/0001								
04000	S	M	OUG	II	00000	008	SIDE OF 979 DELLA DR.	12	110888	1/1/0001								

OFFICE: 311		ROUTE: 564		ST_REF_NO: 00000019400		BLUE RIDGE DRIVE		LUMENS	BULB TYPE	MULT SERIES	POLE TYPE	SHADE	ADDRESS NUMBER	REF	LOCATION	TAX DIST	DATE INST	DATE CHANGE
05800	S	M	OUG	II	00000	028	SIDE OF 456 LIN WAL DR.	12	091582	1/1/0001								
05800	S	M	OUG	II	00000	029	SIDE OF 505 LIN WAL DR.	12	091582	1/1/0001								
05800	S	M	OUG	II	00000	045	SIDE OF 501 DOVER RD.	12	061581	1/1/0001								
05800	S	M	OUG	II	01702	024		12	091582	1/1/0001								
05800	S	M	OUG	II	01711	025		12	091582	1/1/0001								
05800	S	M	OUG	II	01716	026		12	091582	1/1/0001								
05800	S	M	OUG	II	01723	027		12	091582	1/1/0001								
05800	S	M	OUG	II	01800	030		12	091582	1/1/0001								
05800	S	M	OUG	II	01809	031		12	091582	1/1/0001								
05800	S	M	OUG	II	01820	032		12	091582	1/1/0001								
05800	S	M	OUG	II	01829	033		12	091582	1/1/0001								

OFFICE: 311		ROUTE: 564		ST_REF_NO: 00000019600		BLUEBERRY LANE		LUMENS	BULB TYPE	MULT SERIES	POLE TYPE	SHADE	ADDRESS NUMBER	REF	LOCATION	TAX DIST	DATE INST	DATE CHANGE
05800	S	M	OUG	II	00302	007		12	070888	9/9/2009								
05800	S	M	OUG	II	00309	006		12	070888	9/9/2009								
04000	S	M	OUG	II	00000	001	SIDE 1921 BELLEFONTE	12	050888	1/1/0001								
04000	S	M	OUG	II	00322	005		12	070888	1/1/0001								
04000	S	M	OUG	II	00330	004		12	070888	1/1/0001								
04000	S	M	OUG	II	00337	003		12	070888	1/1/0001								
04000	S	M	OUG	II	00346	002		12	070888	1/1/0001								

OFFICE: 311

ROUTE: 564

ST_REF_NO: 00000019700

BLUEBIRD LANE

LUMENS	BULB TYPE	MULT SERIES	POLE TYPE	SHADE	ADDRESS NUMBER	REF	LOCATION	TAX DIST	DATE INST	DATE CHANGE
05800	S	M	OUG	II	01553	053		12	110884	9/9/2009
04000	S	M	OUG	II	00000	052	SIDE 1540 HERON LANE	12	110884	1/1/0001
04000	S	M	OUG	II	00000	055	SIDE 236 MOCKINGBIRD LANE	12	110884	1/1/0001
04000	S	M	OUG	II	01565	054		12	110884	1/1/0001
04000	S	M	OUG	II	01589	056		12	110884	1/1/0001

OFFICE: 311

ROUTE: 564

ST_REF_NO: 00000019900

BOARDWALK

LUMENS	BULB TYPE	MULT SERIES	POLE TYPE	SHADE	ADDRESS NUMBER	REF	LOCATION	TAX DIST	DATE INST	DATE CHANGE
22000	S	M	OUG	II	00000	015	3rd LT ON RIGHT FROM NEW CIRCLE RD	12	021477	9/9/2009
10000	M	M	OUG	II	00000	013	4TH LT. ON RIGHT FROM NEW CIRCLE RD.	12	051581	1/1/0001
10000	M	M	OUG	II	00000	014	OPPOSITE 1483	12	021477	1/1/0001
10000	M	M	OUG	II	01494	016		12	021477	1/1/0001
10000	M	M	OUG	II	01498	018		12	021477	1/1/0001
10000	M	M	OUG	II	01499	017		12	021477	1/1/0001
10000	M	M	OUG	II	01499	019		12	021477	1/1/0001
10000	M	M	OUG	II	00000	009	6TH LT. ON RIGHT FROM NEW CIRCLE RD.	12	051581	1/1/0001
10000	M	M	OUG	II	00000	010	1ST LT. N. OF PARK PLACE ON E. SIDE	12	021477	1/1/0001
10000	M	M	OUG	II	00000	011	5TH LT. ON RIGHT FROM NEW CIRCLE RD.	12	051581	1/1/0001
10000	M	M	OUG	II	00000	012	2ND LT. N. OF PARK PLACE ON E. SIDE	12	021477	1/1/0001

OFFICE: 311

ROUTE: 564

ST_REF_NO: 00000020000

BOB O LINK DRIVE

LUMENS	BULB TYPE	MULT SERIES	POLE TYPE	SHADE	ADDRESS NUMBER	REF	LOCATION	TAX DIST	DATE INST	DATE CHANGE
05800	S	M	OUG	II	00354	044		12	070904	1/1/0001
05800	S	M	OUG	II	00360	043		12	070904	1/1/0001
05800	S	M	OUG	II	00373	042		12	070904	1/1/0001
05800	S	M	OUG	II	00385	041		12	070904	1/1/0001
05800	S	M	OUG	II	00397	040		12	070904	1/1/0001
05800	S	M	OUG	II	00494	008		12	110884	9/9/2009
05800	S	M	OUG	II	00499	007		12	110884	3/19/2012
05800	S	M	OUG	II	00000	014	SIDE OF 1401 HARRODSBURG RD.	12	020890	1/1/0001
05800	S	M	OUG	II	00000	016	SIDE OF 651 SHAKER DR.	12	020890	1/1/0001
05800	S	M	OUG	II	00000	017	SIDE OF 675 SHAKER DR.	12	020890	1/1/0001

OFFICE: 311		ROUTE: 564		ST_REF_NO: 0000020000		BOB O LINK DRIVE		LUMENS	BULB TYPE	MULT SERIES	POLE TYPE	SHADE	ADDRESS NUMBER	REF	LOCATION	TAX DIST	DATE INST	DATE CHANGE
05800	S	M	OUG	II	00490	013										12	020890	1/1/0001
05800	S	M	OUG	II	00490	015										12	020890	1/1/0001
05800	S	M	OUG	II	00000	001	SIDE 1594 HARRODSBURG RD									12	110884	1/1/0001
04000	S	M	OUG	II	00462	012										12	110884	1/1/0001
04000	S	M	OUG	II	00471	011										12	110884	1/1/0001
04000	S	M	OUG	II	00476	010										12	110884	1/1/0001
04000	S	M	OUG	II	00487	009										12	110884	1/1/0001
05800	S	M	OUG	II	00554	006										12	110884	1/1/0001
05800	S	M	OUG	II	00563	005										12	110884	1/1/0001
05800	S	M	OUG	II	00576	004										12	110884	1/1/0001
05800	S	M	OUG	II	00579	003										12	110884	1/1/0001
05800	S	M	OUG	II	00586	002										12	110884	1/1/0001

OFFICE: 311

ROUTE: 564

OFFICE: 311		ROUTE: 564		ST_REF_NO: 0000020050		BOCA LANE		LUMENS	BULB TYPE	MULT SERIES	POLE TYPE	SHADE	ADDRESS NUMBER	REF	LOCATION	TAX DIST	DATE INST	DATE CHANGE
05800	S	M	CNT	II	04700	005										12	032404	1/1/0001
05800	S	M	CNT	II	04709	004										12	032404	1/1/0001
05800	S	M	CNT	II	04724	003										12	032404	1/1/0001
05800	S	M	CNT	II	04745	002										12	032404	1/1/0001
05800	S	M	CNT	II	04752	001										12	032404	1/1/0001

OFFICE: 311

ROUTE: 564

OFFICE: 311		ROUTE: 564		ST_REF_NO: 0000020200		BOILING SPRINGS DRIVE		LUMENS	BULB TYPE	MULT SERIES	POLE TYPE	SHADE	ADDRESS NUMBER	REF	LOCATION	TAX DIST	DATE INST	DATE CHANGE
05800	S	M	OUG	II	00364	118										12	121582	9/9/2009
05800	S	M	OUG	II	00000	112	OPPOSITE 284									12	121582	1/1/0001
05800	S	M	OUG	II	00276	111										12	121582	1/1/0001
04000	S	M	OUG	II	00304	113										12	121582	1/1/0001
04000	S	M	OUG	II	00317	114										12	121582	1/1/0001
04000	S	M	OUG	II	00332	115										12	121582	1/1/0001
04000	S	M	OUG	II	00345	116										12	011583	1/1/0001
04000	S	M	OUG	II	00356	117										12	121582	1/1/0001
05800	S	M	OUG	II	00000	102	SIDE OF 1553 LEESTOWN SERVICE RD. IN MEDIAN									12	121582	1/1/0001

OFFICE: 311		ROUTE: 564		ST_REF_NO: 00000020200		BOILING SPRINGS DRIVE				
LUMENS	BULB TYPE	MULT SERIES	POLE TYPE	SHADE	ADDRESS NUMBER	REF	LOCATION	TAX DIST	DATE INST	DATE CHANGE
05800	S	M	OUG	II	00000	103	SIDE OF 1554 MEADOWTHORPE IN MEDIAN	12	121582	1/1/0001
05800	S	M	OUG	II	00000	104	SIDE OF 1553 LESSTOWN SERVICE RD. IN MEDIAN	12	121582	1/1/0001
05800	S	M	OUG	II	00000	105	SIDE OF 1554 MEADOWTHORPE IN MEDIAN	12	121582	1/1/0001
05800	S	M	OUG	II	00208	106		12	121582	1/1/0001
05800	S	M	OUG	II	00220	107		12	121582	1/1/0001
05800	S	M	OUG	II	00237	108		12	121582	1/1/0001
05800	S	M	OUG	II	00250	109		12	121582	1/1/0001
05800	S	M	OUG	II	00265	110		12	121582	1/1/0001

OFFICE: 311		ROUTE: 564		ST_REF_NO: 00000020300		BOLD BIDDER DRIVE				
LUMENS	BULB TYPE	MULT SERIES	POLE TYPE	SHADE	ADDRESS NUMBER	REF	LOCATION	TAX DIST	DATE INST	DATE CHANGE
05800	S	M	OUG	II	00000	159	SIDE OF 1336 CANONERO DR.	12	071476	1/1/0001
05800	S	M	OUG	II	03501	155		12	051475	1/1/0001
05800	S	M	OUG	II	03508	156		12	031476	1/1/0001
05800	S	M	OUG	II	03517	157		12	031476	1/1/0001
05800	S	M	OUG	II	03524	158		12	071476	1/1/0001
05800	S	M	OUG	II	03544	160		12	071476	1/1/0001
05800	S	M	OUG	II	03545	161		12	031476	1/1/0001

OFFICE: 311		ROUTE: 564		ST_REF_NO: 00000020400		BOLIVAR STREET				
LUMENS	BULB TYPE	MULT SERIES	POLE TYPE	SHADE	ADDRESS NUMBER	REF	LOCATION	TAX DIST	DATE INST	DATE CHANGE
09500	S	M	SOH	II	00235	004	chg'd out bad fixture	12	010567	7/30/2009
10000	M	M	SOH	II	00000	005	OPP. 245	12	011667	1/1/0001
10000	M	M	SOH	II	00000	007	1ST. LT. E. OF BROADWAY, ON S. SIDE	12	011667	1/1/0001
10000	M	M	SOH	II	00000	008	1ST. LT. E. OF BROADWAY, ON N. SIDE	12	011667	1/1/0001
09500	S	M	SOH	II	00245	006	mv changeout	12	010567	1/1/0001
10000	M	M	SOH	II	00224	001		12	011667	1/1/0001
10000	M	M	SOH	II	00314	003		12	010567	1/1/0001

OFFICE: 311

ROUTE: 564

ST_REF_NO: 0000020410

BOLSER ALLEY

LUMENS	BULB TYPE	MULT SERIES	POLE TYPE	SHADE	ADDRESS NUMBER	REF	LOCATION	TAX DIST	DATE INST	DATE CHANGE
05800	S	M	SOH	II	00000	059	SIDE 1404 N. LIMESTONE	12	060685	1/1/0001
05800	S	M	SOH	II	00000	060	REAR OF 105 BLUEGRASS AVE.	12	060685	1/1/0001
05800	S	M	SOH	II	00000	061	REAR OF 114 BERMUDA AVE.	12	060685	1/1/0001
05800	S	M	SOH	II	00000	062	SIDE REAR 201 BLUEGRASS AVE.	12	060685	1/1/0001
05800	S	M	SOH	II	00000	063	OPP. REAR 209 BLUEGRASS AVE.	12	060685	1/1/0001
05800	S	M	SOH	II	00000	064	REAR 217 BLUEGRASS AVE.	12	060685	1/1/0001
05800	S	M	SOH	II	00000	065	SIDE 1402 HIGHLAWN AVE.	12	060685	1/1/0001
05800	S	M	SOH	II	00000	066	SIDE 1405 EDGELAWN	12	050885	1/1/0001
05800	S	M	SOH	II	00000	067	SIDE 1406 EDGELAWN	12	050885	1/1/0001

OFFICE: 311

ROUTE: 564

ST_REF_NO: 0000020500

BON AIR DRIVE

LUMENS	BULB TYPE	MULT SERIES	POLE TYPE	SHADE	ADDRESS NUMBER	REF	LOCATION	TAX DIST	DATE INST	DATE CHANGE
04000	S	M	OUG	II	01600	055		12	051581	1/1/0001
04000	S	M	OUG	II	01609	000		12	080966	1/1/0001
04000	S	M	OUG	II	01710	053		12	071478	1/1/0001
04000	S	M	OUG	II	00000	051	SIDE OF 245 HOLIDAY RD.	12	041582	1/1/0001
04000	S	M	OUG	II	01801	052		12	071478	1/1/0001

OFFICE: 311

ROUTE: 564

ST_REF_NO: 0000020600

BONANZA DRIVE

LUMENS	BULB TYPE	MULT SERIES	POLE TYPE	SHADE	ADDRESS NUMBER	REF	LOCATION	TAX DIST	DATE INST	DATE CHANGE
05800	S	M	OUG	V	03039	015		12	100892	7/19/2013
04000	S	M	OUG	II	00000	013	SIDE OF 2899 RIO DOSA	12	100892	1/1/0001
04000	S	M	OUG	II	03031	014		12	100892	1/1/0001
04000	S	M	OUG	II	03053	016		12	100892	1/1/0001
04000	S	M	OUG	II	03073	017		12	120886	1/1/0001
04000	S	M	OUG	II	03092	018		12	120886	1/1/0001
04000	S	M	OUG	IV	04005	019		12	100892	1/1/0001

OFFICE: 311

ROUTE: 564

ST_REF_NO: 0000020700

BONNIE BRAE DRIVE

LUMENS	BULB TYPE	MULT SERIES	POLE TYPE	SHADE	ADDRESS NUMBER	REF	LOCATION	TAX DIST	DATE INST	DATE CHANGE
05800	S	M	SOH	I	00000	540	SIDE OF 653 MAXWELTON CT.	12	062167	1/1/0001

OFFICE: 311		ROUTE: 564		ST_REF_NO: 00000020700		BONNIE BRAE DRIVE				
LUMENS	BULB TYPE	MULT SERIES	POLE TYPE	SHADE	ADDRESS NUMBER	REF	LOCATION	TAX DIST	DATE INST	DATE CHANGE
05800	S	M	SOH	I	00154	541		12	062167	1/1/0001
05800	S	M	SOH	I	00161	542		12	062167	1/1/0001
OFFICE: 311		ROUTE: 564		ST_REF_NO: 00000020800		BOOKER STREET				
LUMENS	BULB TYPE	MULT SERIES	POLE TYPE	SHADE	ADDRESS NUMBER	REF	LOCATION	TAX DIST	DATE INST	DATE CHANGE
05800	S	M	SOH	I	00000	218	1ST. LT. W. OF NEWTOWN PIKE	12	091566	1/1/0001
05800	S	M	SOH	I	00000	219	2ND. LT. W. OF NEWTOWN PIKE	12	092366	1/1/0001
OFFICE: 311		ROUTE: 564		ST_REF_NO: 00000020950		BOONE CREEK COURT				
LUMENS	BULB TYPE	MULT SERIES	POLE TYPE	SHADE	ADDRESS NUMBER	REF	LOCATION	TAX DIST	DATE INST	DATE CHANGE
05800	S	M	CNT	II	01000	001		12	102103	1/1/0001
05800	S	M	CNT	III	01008	002		12	102103	1/1/0001
OFFICE: 311		ROUTE: 564		ST_REF_NO: 00000020955		BOONE CREEK ROAD				
LUMENS	BULB TYPE	MULT SERIES	POLE TYPE	SHADE	ADDRESS NUMBER	REF	LOCATION	TAX DIST	DATE INST	DATE CHANGE
05800	S	M	CNT	II	04012	001		12	102103	1/1/0001
05800	S	M	CNT	II	04025	002		12	102103	1/1/0001
05800	S	M	CNT	II	04037	003		12	102103	1/1/0001
05800	S	M	CNT	II	04048	004		12	102103	1/1/0001
05800	S	M	CNT	II	04060	006		12	102103	1/1/0001
05800	S	M	CNT	II	04061	005		12	102103	1/1/0001
05800	S	M	CNT	II	04089	007		12	102103	1/1/0001
05800	S	M	CNT	II	04101	008		12	102103	1/1/0001
05800	S	M	CNT	II	04124	009		12	102103	1/1/0001
05800	S	M	CNT	II	04125	010		12	102103	1/1/0001
05800	S	M	CNT	II	04136	011		12	102103	1/1/0001
05800	S	M	CNT	II	04157	012		12	102103	1/1/0001
05800	S	M	CNT	II	04164	013		12	102103	1/1/0001
05800	S	M	CNT	II	04173	014		12	102103	1/1/0001

OFFICE: 311

ROUTE: 564

ST_REF_NO: 00000021000

BOONESBORO AVENUE

LUMENS	BULB TYPE	MULT SERIES	POLE TYPE	SHADE	ADDRESS NUMBER	REF	LOCATION	TAX DIST	DATE INST	DATE CHANGE
05800	S	S	SOH	I	00000	001	OPPOSITE 531	12	070162	1/1/0001
04000	S	S	SOH	I	00000	002	OPPOSITE 601	12	070162	1/1/0001
04000	S	S	SOH	I	00000	004	OPPOSITE 621	12	070162	1/1/0001
04000	S	S	SOH	I	00000	005	SIDE OF 193 WALTON AVE.	12	070162	1/1/0001
04000	S	S	SOH	I	00609	003		12	070162	1/1/0001

OFFICE: 311

ROUTE: 564

ST_REF_NO: 00000021100

BORDALLO DRIVE

LUMENS	BULB TYPE	MULT SERIES	POLE TYPE	SHADE	ADDRESS NUMBER	REF	LOCATION	TAX DIST	DATE INST	DATE CHANGE
05800	S	M	OUG	II	00000	024	SIDE OF 3845 LEE ADAMS	12	080884	7/13/2013
05800	S	M	OUG	II	00932	027		12	121583	9/9/2009
05800	S	M	OUG	II	00949	028		12	031581	9/9/2009
04000	S	M	OUG	II	00878	023		12	080884	1/1/0001
04000	S	M	OUG	II	00912	025		12	051581	1/1/0001
04000	S	M	OUG	II	00925	026		12	031581	1/1/0001
04000	S	M	OUG	II	00956	039		12	031581	1/1/0001

OFFICE: 311

ROUTE: 564

ST_REF_NO: 00000021200

BORDEAUX COURT

LUMENS	BULB TYPE	MULT SERIES	POLE TYPE	SHADE	ADDRESS NUMBER	REF	LOCATION	TAX DIST	DATE INST	DATE CHANGE
05800	S	M	OUG	V	01339	000		12	072363	1/1/0001

OFFICE: 311

ROUTE: 564

ST_REF_NO: 00000021300

BORDEAUX DRIVE

LUMENS	BULB TYPE	MULT SERIES	POLE TYPE	SHADE	ADDRESS NUMBER	REF	LOCATION	TAX DIST	DATE INST	DATE CHANGE
05800	S	M	OUG	II	00000	001	AT VERSAILLES RD.	12	072373	1/1/0001
05800	S	M	OUG	II	01329	000		12	072363	1/1/0001
05800	S	M	OUG	II	01344	000		12	072373	1/1/0001
05800	S	M	OUG	II	01355	000		12	072363	1/1/0001
05800	S	M	OUG	II	01368	000		12	072363	1/1/0001
05800	S	M	OUG	II	01387	000		12	072363	1/1/0001
05800	S	M	OUG	II	00000	021	SIDE OF 2401 SEINE RD.	12	072363	1/1/0001
05800	S	M	OUG	II	01235	000		12	052068	1/1/0001
05800	S	M	OUG	II	01246	000		12	041466	1/1/0001

OFFICE: 311		ROUTE: 564		ST_REF_NO: 0000021300		BORDEAUX DRIVE		LUMENS	BULB TYPE	MULT SERIES	POLE TYPE	SHADE	ADDRESS NUMBER	REF	LOCATION	TAX DIST	DATE INST	DATE CHANGE
05800	S	M	OUG	II	01255	000		12	041466	1/1/0001								
05800	S	M	OUG	II	01270	000		12	041466	1/1/0001								
05800	S	M	OUG	II	01283	000		12	041466	1/1/0001								
05800	S	M	OUG	II	01290	000		12	041466	1/1/0001								
05800	S	M	OUG	II	01300	000		12	080565	1/1/0001								
05800	S	M	OUG	II	01320	000		12	072363	1/1/0001								
OFFICE: 311		ROUTE: 564		ST_REF_NO: 0000021400		BOSTON ROAD		LUMENS	BULB TYPE	MULT SERIES	POLE TYPE	SHADE	ADDRESS NUMBER	REF	LOCATION	TAX DIST	DATE INST	DATE CHANGE
04000	S	M	OUG	II	00000	064	OPP. 4025 BOSTON RD	12	100890	9/9/2009								
05800	S	M	OUG	II	03345	008		12	061579	1/1/0001								
05800	S	M	OUG	II	03348	007		12	061579	1/1/0001								
05800	S	M	OUG	II	00000	057	SIDE 877 GREGORY WAY ON BOSTON RD	12	100890	1/1/0001								
05800	S	M	OUG	II	00000	059	SIDE 901 WYNDHAM HILLS DR ON BOSTON RD	12	100890	1/1/0001								
05800	S	M	OUG	II	04001	060		12	100890	1/1/0001								
05800	S	M	OUG	II	04004	061		12	100890	1/1/0001								
05800	S	M	OUG	II	04013	062		12	100890	1/1/0001								
05800	S	M	OUG	II	04016	063		12	100890	1/1/0001								
05800	S	M	OUG	II	00000	002	SIDE OF 498 RETRAC ROAD	12	111579	1/1/0001								
05800	S	M	OUG	II	00000	004	SIDE OF 476 CROMWELL WAY	12	111579	1/1/0001								
05800	S	M	OUG	II	00000	027	SIDE OF 501 MARBLEROCK WAY	12	100896	1/1/0001								
05800	S	M	OUG	II	00000	028	SIDE OF 492 MARBLEROCK ON BOSTON RD	12	110891	1/1/0001								
09500	S	M	OUG	II	00000	035	1ST LT SOUTH OF MAN O WAR ON WESTSIDE OF BOSTON RD	12	100890	1/1/0001								
09500	S	M	OUG	II	00000	036	1ST LT SOUTH OF MAN O WAR ON EASTSIDE OF BOSTON RD	12	100890	1/1/0001								
09500	S	M	OUG	II	00000	038	2ND LT SOUTH OF MAN O WAR ON EASTSIDE OF BOSTON RD	12	100890	1/1/0001								
09500	S	M	OUG	II	00000	040	3RD LT SOUTH OF MAN O WAR ON EASTSIDE OF BOSTON RD	12	100890	1/1/0001								
05800	S	M	OUG	II	00000	045	1ST LT. SOUTH OF MILLPOND ROAD, EASTSIDE	12	110895	1/1/0001								
05800	S	M	OUG	II	00000	047	OPP. 3873	12	100895	1/1/0001								
05800	S	M	OUG	II	03365	010		12	061579	1/1/0001								
05800	S	M	OUG	II	03372	009		12	061579	1/1/0001								

OFFICE: 311

ROUTE: 564

ST_REF_NO: 0000021400

BOSTON ROAD

LUMENS	BULB TYPE	MULT SERIES	POLE TYPE	SHADE	ADDRESS NUMBER	REF	LOCATION	TAX DIST	DATE INST	DATE CHANGE
05800	S	M	OUG	II	03381	067		12	100885	1/1/0001
05800	S	M	OUG	II	03388	011		12	061579	1/1/0001
05800	S	M	OUG	II	03397	013		12	061579	1/1/0001
05800	S	M	OUG	II	03404	068		12	100885	1/1/0001
05800	S	M	OUG	II	03416	014		12	061579	1/1/0001
05800	S	M	OUG	II	03421	015		12	061579	1/1/0001
05800	S	M	OUG	II	03432	016		12	061579	1/1/0001
05800	S	M	OUG	II	03437	019		12	100885	1/1/0001
05800	S	M	OUG	II	03448	020		12	100885	1/1/0001
05800	S	M	OUG	II	03453	021		12	100885	1/1/0001
05800	S	M	OUG	II	03461	022		12	100885	1/1/0001
05800	S	M	OUG	II	03473	023		12	100885	1/1/0001
05800	S	M	OUG	II	03482	024		12	100885	1/1/0001
05800	S	M	OUG	II	03491	025		12	100885	1/1/0001
05800	S	M	OUG	II	03506	026		12	100885	1/1/0001
05800	S	M	OUG	II	03513	001		12	111579	1/1/0001
05800	S	M	OUG	II	03525	003		12	111579	1/1/0001
05800	S	M	OUG	II	03549	029		12	010894	1/1/0001
05800	S	M	OUG	II	03552	030		12	110891	1/1/0001
05800	S	M	OUG	II	03568	032		12	010894	1/1/0001
05800	S	M	OUG	II	03569	031		12	110891	1/1/0001
05800	S	M	OUG	II	03584	034		12	01894	1/1/0001
05800	S	M	OUG	II	03585	033		12	010894	1/1/0001
05800	S	M	OUG	II	03887	048		12	100895	1/1/0001
05800	S	M	OUG	II	03900	049		12	100892	1/1/0001
05800	S	M	OUG	II	03912	050		12	100890	1/1/0001
05800	S	M	OUG	II	03917	051		12	100890	1/1/0001
05800	S	M	OUG	II	03932	052		12	100890	1/1/0001
05800	S	M	OUG	II	03933	053		12	100890	1/1/0001
05800	S	M	OUG	II	03948	054		12	100892	1/1/0001
05800	S	M	OUG	II	03953	055		12	100890	1/1/0001
05800	S	M	OUG	II	03968	056		12	100890	1/1/0001
05800	S	M	OUG	II	03988	058		12	100890	1/1/0001

OFFICE: 311		ROUTE: 564		ST_REF_NO: 00000021410		BOSTON COURT		LUMENS	BULB TYPE	MULT SERIES	POLE TYPE	SHADE	ADDRESS NUMBER	REF	LOCATION	TAX DIST	DATE INST	DATE CHANGE
	04000	S	M	OUG	II	03401	017									12	060685	1/1/0001
	04000	S	M	OUG	II	03404	018									12	061579	1/1/0001

OFFICE: 311		ROUTE: 564		ST_REF_NO: 00000021540		BOULDER COURT		LUMENS	BULB TYPE	MULT SERIES	POLE TYPE	SHADE	ADDRESS NUMBER	REF	LOCATION	TAX DIST	DATE INST	DATE CHANGE
	05800	S	M	CNT	II	00000	001								SIDE 1878 TIMBER CREEK DR.	12	100896	1/1/0001
	05800	S	M	CNT	II	03109	002									12	100896	1/1/0001
	05800	S	M	CNT	III	03124	003									12	100896	1/1/0001

OFFICE: 311		ROUTE: 564		ST_REF_NO: 00000021600		BOURBON AVENUE		LUMENS	BULB TYPE	MULT SERIES	POLE TYPE	SHADE	ADDRESS NUMBER	REF	LOCATION	TAX DIST	DATE INST	DATE CHANGE
	05800	S		SOH	II	00417	002									12	022813	1/1/0001
	05800	S		SOH	II	00441	003									12	022813	1/1/0001
	05800	S		SOH	II	00455	004									12	022813	1/1/0001
	05800	S		SOH	II	00465	005									12	022813	1/1/0001
	05800	S	M	SOH	II	00415	001									12	040165	2/25/2013
	05800	S	M	SOH	II	00449	000									12	040165	1/1/0001
	05800	S	M	SOH	II	00429	000									12	040165	1/1/0001

OFFICE: 311		ROUTE: 564		ST_REF_NO: 00000021700		BOWEN COURT		LUMENS	BULB TYPE	MULT SERIES	POLE TYPE	SHADE	ADDRESS NUMBER	REF	LOCATION	TAX DIST	DATE INST	DATE CHANGE
	05800	S	M	OUG	II	01875	000									12	030171	1/1/0001
	05800	S	M	OUG	II	01888	000									12	061269	1/1/0001
	05800	S	M	OUG	II	00000	028								SIDE OF 1259 WINBURN DR.	12	070172	1/1/0001

OFFICE: 311		ROUTE: 564		ST_REF_NO: 00000021750		BOWER LANE		LUMENS	BULB TYPE	MULT SERIES	POLE TYPE	SHADE	ADDRESS NUMBER	REF	LOCATION	TAX DIST	DATE INST	DATE CHANGE
	05800	S		CNT	II	00000	004								1ST LT S OF JOUETT CREEK DR, ON BOWER LANE	12	061710	1/1/0001
	05800	S		CNT	II	04512	003									12	061710	1/1/0001
	05800	S		CNT	II	04520	002									12	061710	1/1/0001
	05800	S		CNT	II	04524	001									12	061710	1/1/0001

OFFICE: 311

ROUTE: 564

ST_REF_NO: 00000021800 BOWIE DRIVE

LUMENS	BULB TYPE	MULT SERIES	POLE TYPE	SHADE	ADDRESS NUMBER	REF	LOCATION	TAX DIST	DATE INST	DATE CHANGE
04000	S	M	OUG	II	00000	009	OPPOSITE 3251	12	121581	1/1/0001
04000	S	M	OUG	II	03236	017		12	021583	1/1/0001
04000	S	M	OUG	II	03240	018		12	091582	1/1/0001
04000	S	M	OUG	II	03264	008		12	061580	1/1/0001
04000	S	M	OUG	II	03271	007		12	060886	1/1/0001
04000	S	M	OUG	V	03272	006		12	061580	1/1/0001
04000	S	M	OUG	II	03280	000		12	050974	1/1/0001
04000	S	M	OUG	II	03291	000		12	050974	1/1/0001

OFFICE: 311

ROUTE: 564

ST_REF_NO: 00000022000 BOWMANS MILL PIKE

LUMENS	BULB TYPE	MULT SERIES	POLE TYPE	SHADE	ADDRESS NUMBER	REF	LOCATION	TAX DIST	DATE INST	DATE CHANGE
09500	S		SOH	II	00000	103	1ST LT N OF 3001 BOWMANS MILL ROAD ON W SIDE	12	030801	9/9/2009
09500	S		SOH	II	03001	102		12	030801	9/9/2009
05800	S		SOH	II	00000	101	1ST LT E OF 3000 BOWMANS MILL ROAD ON N SIDE	12	030801	1/1/0001
05800	S		SOH	II	00000	104	1ST LT N OF 3000 BOWMANS MILL ROAD ON W SIDE	12	030801	1/1/0001

OFFICE: 311

ROUTE: 564

ST_REF_NO: 00000022100 BOXWOOD COURT

LUMENS	BULB TYPE	MULT SERIES	POLE TYPE	SHADE	ADDRESS NUMBER	REF	LOCATION	TAX DIST	DATE INST	DATE CHANGE
05800	S	M	OUG	II	01137	000		12	011966	1/1/0001

OFFICE: 311

ROUTE: 564

ST_REF_NO: 00000022200 BOXWOOD DRIVE

LUMENS	BULB TYPE	MULT SERIES	POLE TYPE	SHADE	ADDRESS NUMBER	REF	LOCATION	TAX DIST	DATE INST	DATE CHANGE
05800	S	M	OUG	II	00000	015	OPP. 1145	12	011966	1/1/0001
05800	S	M	OUG	II	01105	000		12	011966	1/1/0001
05800	S	M	OUG	II	01110	000		12	011966	1/1/0001
05800	S	M	OUG	II	01133	000		12	011966	1/1/0001
05800	S	M	OUG	II	01153	000		12	011966	1/1/0001
05800	S	M	OUG	II	01164	000		12	011966	1/1/0001

OFFICE: 311

ROUTE: 564

ST_REF_NO: 0000022300

BRADFORD CIRCLE

LUMENS	BULB TYPE	MULT SERIES	POLE TYPE	SHADE	ADDRESS NUMBER	REF	LOCATION	TAX DIST	DATE INST	DATE CHANGE
09500	S	M	OUG	II	00000	111	SIDE OF 245 BRADFORD DR. upgraded to 9500 1/2006	12	121583	1/1/0001

OFFICE: 311

ROUTE: 564

ST_REF_NO: 0000022400

BRADFORD DRIVE

LUMENS	BULB TYPE	MULT SERIES	POLE TYPE	SHADE	ADDRESS NUMBER	REF	LOCATION	TAX DIST	DATE INST	DATE CHANGE
04000	S	M	OUG	II	00000	085	SIDE OF 2530 SOUTHVIEW DR.	12	092368	1/1/0001
04000	S	M	OUG	II	00200	091		12	121583	1/1/0001
04000	S	M	OUG	II	00225	000		12	090968	1/1/0001
04000	S	M	OUG	II	00248	000		12	101468	1/1/0001
04000	S	M	OUG	II	00269	000		12	092368	1/1/0001
04000	S	M	OUG	II	00395	000		12	090968	1/1/0001

OFFICE: 311

ROUTE: 564

ST_REF_NO: 0000022425

BRADFORD COLONY DRIVE

LUMENS	BULB TYPE	MULT SERIES	POLE TYPE	SHADE	ADDRESS NUMBER	REF	LOCATION	TAX DIST	DATE INST	DATE CHANGE
05800	S	M	OUG	II	00000	004	SIDE OF 3928 SUFFOLK CIRCLE	12	120892	1/1/0001
05800	S	M	OUG	II	00304	001		12	120892	1/1/0001
05800	S	M	OUG	II	00321	002		12	120892	1/1/0001
05800	S	M	OUG	II	00352	003		12	120892	1/1/0001
05800	S	M	SOH	II	00000	006	SIDE REAR OF 3928 HARWICK CIRCLE	12	120892	1/1/0001
05800	S	M	OUG	II	00400	005		12	120892	1/1/0001

OFFICE: 311

ROUTE: 564

ST_REF_NO: 0000022500

BRADLEY COURT

LUMENS	BULB TYPE	MULT SERIES	POLE TYPE	SHADE	ADDRESS NUMBER	REF	LOCATION	TAX DIST	DATE INST	DATE CHANGE
05800	S	M	SOH	I	00000	057	SIDE OF 841 GEORGETOWN ST.	12	081869	1/1/0001
05800	S	M	SOH	I	00437	000		12	081869	1/1/0001
05800	S	M	SOH	I	00445	000		12	081869	1/1/0001
05800	S	M	SOH	I	00451	000		12	081869	1/1/0001
05800	S	M	SOH	I	00457	000		12	081869	1/1/0001
05800	S	M	SOH	I	00461	000		12	081869	1/1/0001

OFFICE: 311

ROUTE: 564

ST_REF_NO: 0000022510 BRADLEY LANE

LUMENS	BULB TYPE	MULT SERIES	POLE TYPE	SHADE	ADDRESS NUMBER	REF	LOCATION	TAX DIST	DATE INST	DATE CHANGE
05800	S	M	SOH	II	00000	001	SIDE OF 3296 OLD LEESTOWN RD.	12	071581	1/1/0001
05800	S	M	SOH	II	00147	000		12	071581	1/1/0001
05800	S	M	SOH	II	00150	000		12	071581	1/1/0001
05800	S	M	SOH	II	00175	004		12	121578	1/1/0001

OFFICE: 311

ROUTE: 564

ST_REF_NO: 0000022600 BRAEMER DRIVE

LUMENS	BULB TYPE	MULT SERIES	POLE TYPE	SHADE	ADDRESS NUMBER	REF	LOCATION	TAX DIST	DATE INST	DATE CHANGE
05800	S	M	OUG	II	00000	010	SIDE OF 2 LANSDOWNE ESTATES ON BRAEMER DRIVE	12	051005	1/1/0001
05800	S	M	OUG	II	00000	004	SIDE OF 701 BROOKHILL DR.	12	060897	1/1/0001
05800	S	M	OUG	II	00000	007	SIDE OF 742 BROOKHILL DRIVE	12	060897	1/1/0001
05800	S	M	OUG	II	00000	008	SIDE OF 730 BROOKHILL DR.	12	060897	1/1/0001
05800	S	M	OUG	II	00000	009	SIDE OF 743 BROOKHILL DR.	12	060897	1/1/0001
05800	S	M	OUG	II	03321	006		12	060897	1/1/0001
05800	S	M	OUG	II	03325	005		12	060897	1/1/0001
05800	S	M	OUG	II	03332	003		12	060897	1/1/0001
05800	S	M	OUG	II	03340	001		12	060897	1/1/0001
05800	S	M	SOH	II	03341	002		12	060897	1/1/0001

OFFICE: 311

ROUTE: 564

ST_REF_NO: 0000022650 BRAMBLEBERRY CIRCLE

LUMENS	BULB TYPE	MULT SERIES	POLE TYPE	SHADE	ADDRESS NUMBER	REF	LOCATION	TAX DIST	DATE INST	DATE CHANGE
04000	S	M	OUG	II	03909	001		12	100890	1/1/0001

OFFICE: 311

ROUTE: 564

ST_REF_NO: 0000022675 BRANCHWOOD PLACE

LUMENS	BULB TYPE	MULT SERIES	POLE TYPE	SHADE	ADDRESS NUMBER	REF	LOCATION	TAX DIST	DATE INST	DATE CHANGE
04000	S	M	OUG	II	03501	001		12	110891	1/1/0001
04000	S	M	OUG	II	03508	002		12	110891	1/1/0001

OFFICE: 311

ROUTE: 564

ST_REF_NO: 0000022700 BRANDON DRIVE

LUMENS	BULB TYPE	MULT SERIES	POLE TYPE	SHADE	ADDRESS NUMBER	REF	LOCATION	TAX DIST	DATE INST	DATE CHANGE
05800	S	M	OUG	II	00000	123	SIDE OF 3422 BRANDON DR.	12	071674	1/1/0001

OFFICE: 311		ROUTE: 564		ST_REF_NO: 0000022700		BRANDON DRIVE		LUMENS	BULB TYPE	MULT SERIES	POLE TYPE	SHADE	ADDRESS NUMBER	REF	LOCATION	TAX DIST	DATE INST	DATE CHANGE
05800	S	M	OUG	II	00000	126	SIDE OF 3430 MONTAVESTA RD.	12	071674	1/1/0001								
05800	S	M	OUG	II	03405	100		12	111478	1/1/0001								
05800	S	M	OUG	II	03410	122		12	071674	1/1/0001								
05800	S	M	OUG	II	03417	124		12	071674	1/1/0001								
05800	S	M	OUG	II	03430	125		12	071674	1/1/0001								
OFFICE: 311		ROUTE: 564		ST_REF_NO: 0000022950		BRAVINGTON CT		LUMENS	BULB TYPE	MULT SERIES	POLE TYPE	SHADE	ADDRESS NUMBER	REF	LOCATION	TAX DIST	DATE INST	DATE CHANGE
04000	S	M	OUG	II	00000	001	SIDE OF 741 BRAVINGTON WAY ON BRAVINGTON CT	12	050891	1/1/0001								
04000	S	M	OUG	V	03283	002		12	050891	1/1/0001								
OFFICE: 311		ROUTE: 564		ST_REF_NO: 0000023000		BRAVINGTON WAY		LUMENS	BULB TYPE	MULT SERIES	POLE TYPE	SHADE	ADDRESS NUMBER	REF	LOCATION	TAX DIST	DATE INST	DATE CHANGE
05800	S	M	OUG	II	00921	012		12	050891	6/18/2012								
04000	S	M	OUG	II	00000	008	OPP. 782 BRAVINGTON WAY	12	050891	1/1/0001								
04000	S	M	OUG	II	00000	014	OPP. 932 BRAVINGTON WAY	12	050891	1/1/0001								
04000	S	M	OUG	II	00730	001		12	050891	1/1/0001								
04000	S	M	OUG	II	00735	002		12	050891	1/1/0001								
04000	S	M	OUG	II	00746	003		12	050891	1/1/0001								
04000	S	M	OUG	II	00751	004		12	050891	1/1/0001								
04000	S	M	OUG	II	00762	005		12	050891	1/1/0001								
04000	S	M	OUG	II	00767	006		12	050891	1/1/0001								
04000	S	M	OUG	II	00774	007		12	050891	1/1/0001								
05800	S	M	OUG	II	00786	009	upgraded 2/08	12	050891	1/1/0001								
04000	S	M	OUG	II	00905	010		12	050891	1/1/0001								
04000	S	M	OUG	II	00913	011		12	050891	1/1/0001								
04000	S	M	OUG	II	00928	013		12	050891	1/1/0001								
05800	S	M	OUG	II	00940	015	chg out bad fixture 2/08	12	050891	1/1/0001								

OFFICE: 311

ROUTE: 564

ST_REF_NO: 00000023075

BRAXTON COURT

LUMENS	BULB TYPE	MULT SERIES	POLE TYPE	SHADE	ADDRESS NUMBER	REF	LOCATION	TAX DIST	DATE INST	DATE CHANGE
05800	S	M	OUG	III	04600	001		12	041602	1/1/0001
05800	S	M	OUG	II	04616	002		12	041602	1/1/0001

OFFICE: 311

ROUTE: 564

ST_REF_NO: 00000023080

BREAKWATER COURT

LUMENS	BULB TYPE	MULT SERIES	POLE TYPE	SHADE	ADDRESS NUMBER	REF	LOCATION	TAX DIST	DATE INST	DATE CHANGE
05800	S	M	CNT	III	04409	001		12	081501	1/1/0001

OFFICE: 311

ROUTE: 564

ST_REF_NO: 00000023100

BREATHITT AVENUE

LUMENS	BULB TYPE	MULT SERIES	POLE TYPE	SHADE	ADDRESS NUMBER	REF	LOCATION	TAX DIST	DATE INST	DATE CHANGE
05800	S	M	SOH	I	00000	019	SIDE OF 421 DOUGLAS AVE.	12	060269	1/1/0001
05800	S	M	SOH	I	00000	027	SIDE OF 408 PRICE RD.	12	060269	1/1/0001
05800	S	M	SOH	I	00745	000		12	060269	1/1/0001
05800	S	M	SOH	I	00763	000		12	060269	1/1/0001
05800	S	M	SOH	I	00775	000		12	060269	1/1/0001
05800	S	M	SOH	I	00777	000		12	060269	1/1/0001
05800	S	M	SOH	I	00787	000		12	060269	1/1/0001
05800	S	M	SOH	I	00797	000		12	060269	1/1/0001
05800	S	M	SOH	I	00805	000		12	060269	1/1/0001

OFFICE: 311

ROUTE: 564

ST_REF_NO: 00000023200

BRECKENRIDGE STREET

LUMENS	BULB TYPE	MULT SERIES	POLE TYPE	SHADE	ADDRESS NUMBER	REF	LOCATION	TAX DIST	DATE INST	DATE CHANGE
05800	S		CNT	II	00705	200		12	112210	1/1/0001
05800	S		CNT	II	00717	201		12	112210	1/1/0001
05800	S	M	SOH	II	00000	001	INTERSECTION OF SHROPSHIRE & BRECKINRIDGE	12	062520	1/1/0001
05800	S	M	SOH	III	00405	002		12	010865	1/1/0001
05800	S	M	SOH	III	00422	003		12	040891	1/1/0001
05800	S	M	SOH	II	00433	004		12	062520	1/1/0001
05800	S	M	SOH	III	00442	005		12	010865	1/1/0001
05800	S	M	SOH	III	00530	007		12	040891	1/1/0001
05800	S	M	SOH	III	00545	008		12	080891	1/1/0001
05800	S	M	SOH	II	00572	010		12	020761	1/1/0001

OFFICE: 311

ROUTE: 564

ST_REF_NO: 00000023200

BRECKENRIDGE STREET

LUMENS	BULB TYPE	MULT SERIES	POLE TYPE	SHADE	ADDRESS NUMBER	REF	LOCATION	TAX DIST	DATE INST	DATE CHANGE
05800	S	M	SOH	III	00601	006		12	040891	1/1/0001
05800	S	M	SOH	III	00625	011		12	040891	1/1/0001
05800	S	M	SOH	II	00629	012		12	062520	1/1/0001
05800	S	M	SOH	III	00637	013		12	040891	1/1/0001

OFFICE: 311

ROUTE: 564

ST_REF_NO: 00000023300

BRECKINWOOD DRIVE

LUMENS	BULB TYPE	MULT SERIES	POLE TYPE	SHADE	ADDRESS NUMBER	REF	LOCATION	TAX DIST	DATE INST	DATE CHANGE
05800	S	M	OUG	II	00000	006	SIDE OF 795 ALBANY RD.	12	050888	9/9/2009
04000	S	M	OUG	II	00000	001	SIDE OF 798 REBECCA RD.	12	050888	1/1/0001
04000	S	M	OUG	II	03013	002		12	050888	1/1/0001
05800	S	M	OUG	II	03034	003		12	050888	1/1/0001
04000	S	M	OUG	II	03054	004		12	050888	1/1/0001
04000	S	M	OUG	II	00000	016	SIDE OF 799 ZANDALE DR.	12	110888	1/1/0001
04000	S	M	OUG	II	03217	015		12	110888	1/1/0001
04000	S	M	OUG	II	00000	007	SIDE OF 840 ALBANY RD.	12	050888	1/1/0001
04000	S	M	OUG	II	00000	008	SIDE OF 799 ROBIN RD.	12	110888	1/1/0001
04000	S	M	OUG	II	00000	009	SIDE OF 852 ROBIN RD.	12	110888	1/1/0001
04000	S	M	OUG	II	00000	010	SIDE OF 799 SHERWOOD DR.	12	110888	1/1/0001
04000	S	M	OUG	II	00000	011	SIDE OF 798 SHERWOOD DR.	12	110888	1/1/0001
04000	S	M	OUG	II	00000	012	SIDE OF 799 HILDEEN RD.	12	110888	1/1/0001
04000	S	M	OUG	II	00000	013	SIDE OF 798 HILDEEN RD.	12	110888	1/1/0001
04000	S	M	OUG	II	03065	005		12	050888	1/1/0001
04000	S	M	OUG	II	03209	014		12	110888	1/1/0001

OFFICE: 311

ROUTE: 564

ST_REF_NO: 00000023320

BREEDERS COURT

LUMENS	BULB TYPE	MULT SERIES	POLE TYPE	SHADE	ADDRESS NUMBER	REF	LOCATION	TAX DIST	DATE INST	DATE CHANGE
04000	S	M	OUG	V	02308	001		12	120889	1/1/0001

OFFICE: 311

ROUTE: 564

ST_REF_NO: 00000023340

BRENNEN DRIVE

LUMENS	BULB TYPE	MULT SERIES	POLE TYPE	SHADE	ADDRESS NUMBER	REF	LOCATION	TAX DIST	DATE INST	DATE CHANGE
05800	S	M	OUG	II	00000	001	SIDE OF 1212 ALDRIDGE WAY	12	110899	1/1/0001

OFFICE: 311		ROUTE: 564		ST_REF_NO: 0000023340		BRENNEN DRIVE		LUMENS	BULB TYPE	MULT SERIES	POLE TYPE	SHADE	ADDRESS NUMBER	REF	LOCATION	TAX DIST	DATE INST	DATE CHANGE
05800	S	M	OUG	II	04804	006										12	110899	1/1/0001
05800	S	M	OUG	II	04816	005										12	110899	1/1/0001
05800	S	M	OUG	II	04825	004										12	110899	1/1/0001
05800	S	M	OUG	II	04840	003										12	110899	1/1/0001
05800	S	M	OUG	II	04849	002										12	110899	1/1/0001

OFFICE: 311		ROUTE: 564		ST_REF_NO: 0000023400		BRENTWOOD COURT		LUMENS	BULB TYPE	MULT SERIES	POLE TYPE	SHADE	ADDRESS NUMBER	REF	LOCATION	TAX DIST	DATE INST	DATE CHANGE
05800	S	M	OUG	II	00000	066	SIDE OF 945 NANDINO BLVD.									12	041475	1/1/0001
05800	S	M	OUG	II	01005	057										12	091477	1/1/0001
05800	S	M	OUG	II	01022	058										12	041475	1/1/0001
05800	S	M	OUG	II	01037	060										12	090171	1/1/0001
05800	S	M	OUG	II	01038	059										12	091477	1/1/0001
05800	S	M	OUG	II	01054	061										12	051480	1/1/0001
05800	S	M	OUG	II	01069	062										12	090171	1/1/0001
05800	S	M	OUG	V	01085	064										12	051480	1/1/0001
05800	S	M	OUG	II	01086	063										12	091477	1/1/0001
05800	S	M	OUG	V	01086	065										12	091477	1/1/0001

OFFICE: 311		ROUTE: 564		ST_REF_NO: 0000023490		BREVARD COURT		LUMENS	BULB TYPE	MULT SERIES	POLE TYPE	SHADE	ADDRESS NUMBER	REF	LOCATION	TAX DIST	DATE INST	DATE CHANGE
05800	S	M	CNT	II	02108	001										12	081704	1/1/0001

OFFICE: 311		ROUTE: 564		ST_REF_NO: 0000023500		BREWER DRIVE		LUMENS	BULB TYPE	MULT SERIES	POLE TYPE	SHADE	ADDRESS NUMBER	REF	LOCATION	TAX DIST	DATE INST	DATE CHANGE
05800	S	M	OUG	II	00000	001	OPPOSITE 1725									12	020367	1/1/0001
05800	S	M	OUG	II	00000	003	OPP. 1701									12	020367	1/1/0001
05800	S	M	OUG	II	00000	024	SIDE OF 516 LIN WAL DR.									12	040166	1/1/0001
05800	S	M	OUG	II	00000	029	SIDE OF 530 RADCLIFFE RD.									12	040166	1/1/0001
05800	S	M	OUG	II	01713	000										12	020367	1/1/0001
05800	S	M	OUG	II	01746	000										12	040166	1/1/0001

OFFICE: 311		ROUTE: 564		ST_REF_NO: 00000023500		BREWER DRIVE		LUMENS	BULB TYPE	MULT SERIES	POLE TYPE	SHADE	ADDRESS NUMBER	REF	LOCATION	TAX DIST	DATE INST	DATE CHANGE
05800	S	M	OUG	II	01757	000										12	040166	1/1/0001
05800	S	M	OUG	II	01785	000										12	040166	1/1/0001
05800	S	M	OUG	II	01790	027										12	040166	1/1/0001

OFFICE: 311		ROUTE: 564		ST_REF_NO: 00000023590		BRIANNA COURT		LUMENS	BULB TYPE	MULT SERIES	POLE TYPE	SHADE	ADDRESS NUMBER	REF	LOCATION	TAX DIST	DATE INST	DATE CHANGE
05800	S	M	CNT	II	01404	001										12	081704	1/1/0001
05800	S	M	CNT	III	01409	002										12	081704	1/1/0001

OFFICE: 311		ROUTE: 564		ST_REF_NO: 00000023600		BRIAR HILL PIKE		LUMENS	BULB TYPE	MULT SERIES	POLE TYPE	SHADE	ADDRESS NUMBER	REF	LOCATION	TAX DIST	DATE INST	DATE CHANGE
09500	S	M	SOH	II	00000	082									1ST LT. E OF ROYSTER ROAD, N SIDE	21	110800	9/9/2009
05800	S	M	SOH	II	00000	081									1ST LT. W OR ROYSTER ROAD, N SIDE	12	110800	1/1/0001
09500	S	M	SOH	III	00000	091									1ST LT. W OF N CLEVELAND RD., S SIDE	12	110800	1/1/0001
09500	S	M	SOH	III	00000	092									1ST LT. E OF N CLEVELAND RD., S SIDE	12	110800	1/1/0001
09500	S	M	SOH	II	00000	231									1ST LT. W OF HALEY ROAD, N SIDE	12	110800	1/1/0001
09500	S	M	SOH	II	00000	232									2ND LT. W OF HALEY ROAD, N SIDE	12	110800	1/1/0001
22000	S	M	OUG	III	00000	228									OPP. HALEY LANE	12	020801	1/1/0001

OFFICE: 311		ROUTE: 564		ST_REF_NO: 00000023710		BRIARPATCH WAY		LUMENS	BULB TYPE	MULT SERIES	POLE TYPE	SHADE	ADDRESS NUMBER	REF	LOCATION	TAX DIST	DATE INST	DATE CHANGE
05800	S	M	CNT	II	00000	003									SIDE OF 1008 VERO COURT	12	070896	1/1/0001
05800	S	M	CNT	II	03583	002										12	060894	1/1/0001
05800	S	M	CNT	II	03590	001										12	060894	1/1/0001

OFFICE: 311		ROUTE: 564		ST_REF_NO: 00000023790		BRIARWOOD CIRCLE		LUMENS	BULB TYPE	MULT SERIES	POLE TYPE	SHADE	ADDRESS NUMBER	REF	LOCATION	TAX DIST	DATE INST	DATE CHANGE
05800	S	M	OUG	II	00000	001									SIDE OF 1178 BRIARWOOD DR	12	100895	9/9/2009

OFFICE: 311

ROUTE: 564

ST_REF_NO: 0000023800

BRIARWOOD DRIVE

LUMENS	BULB TYPE	MULT SERIES	POLE TYPE	SHADE	ADDRESS NUMBER	REF	LOCATION	TAX DIST	DATE INST	DATE CHANGE
05800	S	M	OUG	II	00000	026	ENTRANCE TO BRIARWOOD DR IN MEDIAN	12	081869	1/1/0001
05800	S	M	OUG	II	00000	027	ENTRANCE TO BRIARWOOD DR IN MEDIAN	12	081869	1/1/0001
05800	S	M	OUG	II	01062	000		12	080170	1/1/0001
05800	S	M	OUG	II	01065	000		12	080170	1/1/0001
05800	S	M	OUG	II	01082	000		12	080170	1/1/0001
05800	S	M	OUG	II	01089	000		12	030171	1/1/0001
05800	S	M	OUG	II	01106	000		12	080170	1/1/0001
05800	S	M	OUG	II	01113	000		12	030171	1/1/0001
05800	S	M	OUG	II	01126	000		12	081869	1/1/0001
05800	S	M	OUG	II	01137	000		12	081869	1/1/0001
05800	S	M	OUG	II	01150	000		12	081869	1/1/0001
05800	S	M	OUG	II	01161	000		12	081869	1/1/0001
05800	S	M	OUG	II	01174	000		12	032772	1/1/0001
05800	S	M	OUG	II	01177	000		12	110369	1/1/0001

OFFICE: 311

ROUTE: 564

ST_REF_NO: 0000023801

BRICK HOUSE LANE

LUMENS	BULB TYPE	MULT SERIES	POLE TYPE	SHADE	ADDRESS NUMBER	REF	LOCATION	TAX DIST	DATE INST	DATE CHANGE
05800	S		CNT	II	01201	001		12	080508	1/1/0001
05800	S		CNT	II	01204	002		12	080508	1/1/0001
05800	S		CNT	II	01213	004		12	080508	1/1/0001
05800	S		CNT	II	01216	003		12	080508	1/1/0001
05800	S	M	CNT	II	00000	001	SIDE OF 3672 POLO CLUB BLVD, ON BRICK HOUSE LANE	12	080108	1/1/0001
05800	S	M	CNT	II	01064	010		12	080108	1/1/0001
05800	S	M	CNT	II	01073	009		12	080108	1/1/0001
05800	S	M	CNT	II	01092	008		12	080108	1/1/0001
05800	S	M	CNT	II	01112	007		12	080108	1/1/0001
05800	S	M	CNT	II	01125	006		12	080108	1/1/0001
05800	S	M	CNT	II	01129	004		12	080108	1/1/0001
05800	S	M	CNT	II	01140	005		12	080108	1/1/0001
05800	S	M	CNT	II	01168	003		12	080108	1/1/0001
05800	S	M	CNT	II	01188	002		12	080108	1/1/0001

OFFICE: 311		ROUTE: 564		ST_REF_NO: 0000023802		BRIDLE COURT		LUMENS	BULB TYPE	MULT SERIES	POLE TYPE	SHADE	ADDRESS NUMBER	REF	LOCATION	TAX DIST	DATE INST	DATE CHANGE
05800	S	M	CNT	II	02500	001										12	062205	1/1/0001
05800	S	M	CNT	II	02512	002										12	091001	1/1/0001
05800	S	M	CNT	II	02529	003										12	091001	1/1/0001

OFFICE: 311		ROUTE: 564		ST_REF_NO: 0000023810		BRIDGEMONT LANE		LUMENS	BULB TYPE	MULT SERIES	POLE TYPE	SHADE	ADDRESS NUMBER	REF	LOCATION	TAX DIST	DATE INST	DATE CHANGE
05800	S	M	CNT	II	00000	003	SIDE 4116									12	120894	1/1/0001
05800	S	M	CNT	II	04081	051										12	120894	1/1/0001
05800	S	M	CNT	II	04084	050										12	120894	1/1/0001
05800	S	M	CNT	II	04101	001										12	120894	1/1/0001
05800	S	M	CNT	II	04113	002										12	120894	1/1/0001
05800	S	M	CNT	II	04148	005										12	120894	1/1/0001
05800	S	M	CNT	II	04165	006										12	120894	1/1/0001
05800	S	M	CNT	II	04173	007										12	080896	1/1/0001
05800	S	M	CNT	II	04177	004										12	120894	1/1/0001
05800	S	M	CNT	II	04193	008										12	080896	1/1/0001
05800	S	M	CNT	III	04196	009										12	080896	1/1/0001

OFFICE: 311		ROUTE: 564		ST_REF_NO: 0000023900		BRIDGEPORT DRIVE		LUMENS	BULB TYPE	MULT SERIES	POLE TYPE	SHADE	ADDRESS NUMBER	REF	LOCATION	TAX DIST	DATE INST	DATE CHANGE
05800	S	M	OUG	II	02012	000										12	091573	1/1/0001
05800	S	M	OUG	II	02020	000										12	041774	1/1/0001
05800	S	M	OUG	II	02036	000										12	101674	1/1/0001
05800	S	M	OUG	II	02044	000										12	091573	1/1/0001
05800	S	M	OUG	II	02051	000										12	041774	1/1/0001
05800	S	M	OUG	II	02056	000										12	091573	1/1/0001
05800	S	M	OUG	II	02063	000										12	091573	1/1/0001
05800	S	M	OUG	II	00000	142	SIDE OF 532 LAKESHORE DR									12	091573	1/1/0001
05800	S	M	OUG	II	02076	000										12	091573	1/1/0001
05800	S	M	OUG	II	02088	000										12	101674	1/1/0001
05800	S	M	OUG	II	02091	000										12	101774	1/1/0001
05800	S	M	OUG	II	02105	000										12	091573	1/1/0001

OFFICE: 311

ROUTE: 564

ST_REF_NO: 00000023930

BRIDLINGTON ROAD

LUMENS	BULB TYPE	MULT SERIES	POLE TYPE	SHADE	ADDRESS NUMBER	REF	LOCATION	TAX DIST	DATE INST	DATE CHANGE
05800	S	M	CNT	II	00000	001	SIDE OF 1064 ANDOVER FOREST DRIVE	12	010897	1/1/0001
05800	S	M	CNT	II	03304	002		12	010897	1/1/0001
05800	S	M	CNT	II	03317	003		12	010897	1/1/0001
05800	S	M	CNT	II	03320	004		12	010897	1/1/0001

OFFICE: 311

ROUTE: 564

ST_REF_NO: 00000024000

BRIGADOON PARKWAY

LUMENS	BULB TYPE	MULT SERIES	POLE TYPE	SHADE	ADDRESS NUMBER	REF	LOCATION	TAX DIST	DATE INST	DATE CHANGE
05800	S	M	OUG	II	00100	001		12	110885	1/1/0001
05800	S	M	OUG	II	00103	002		12	110885	1/1/0001
05800	S	M	OUG	II	00106	003		12	110885	1/1/0001
05800	S	M	OUG	II	00111	004		12	110885	1/1/0001
05800	S	M	OUG	II	00112	005		12	110885	1/1/0001
05800	S	M	OUG	II	02907	006		12	110885	1/1/0001
05800	S	M	OUG	II	00000	015	SIDE 126 LOCH LOMOND	12	010886	1/1/0001
05800	S	M	OUG	II	00000	016	SIDE 199 WILSON DOWNING	12	010886	1/1/0001
05800	S	M	OUG	II	02908	007		12	110885	1/1/0001
05800	S	M	OUG	II	02912	008		12	110885	1/1/0001
05800	S	M	OUG	II	02915	009		12	110885	1/1/0001
05800	S	M	OUG	II	02920	010		12	110885	1/1/0001
05800	S	M	OUG	II	02923	011		12	110885	1/1/0001
05800	S	M	OUG	II	02927	012		12	110885	1/1/0001
05800	S	M	OUG	II	02931	013		12	110885	1/1/0001
05800	S	M	OUG	II	02936	014		12	010886	1/1/0001

OFFICE: 311

ROUTE: 564

ST_REF_NO: 00000024050

BRIGGS PLACE

LUMENS	BULB TYPE	MULT SERIES	POLE TYPE	SHADE	ADDRESS NUMBER	REF	LOCATION	TAX DIST	DATE INST	DATE CHANGE
05800	S	M	CNT	II	02904	001		12	060304	1/1/0001
05800	S	M	CNT	II	02920	002		12	060304	1/1/0001
05800	S	M	CNT	III	02936	003		12	060304	1/1/0001

OFFICE: 311

ROUTE: 564

ST_REF_NO: 00000024100

BRIGHT AVENUE

LUMENS	BULB TYPE	MULT SERIES	POLE TYPE	SHADE	ADDRESS NUMBER	REF	LOCATION	TAX DIST	DATE INST	DATE CHANGE
05800	S	M	SOH	I	00000	220	SIDE OF 498 GEORGETOWN ST	12	092366	1/1/0001
05800	S	M	SOH	I	00526	221		12	093266	1/1/0001
05800	S	M	SOH	I	00534	222		12	092366	1/1/0001

OFFICE: 311

ROUTE: 564

ST_REF_NO: 00000024150

BRINDLEY WAY

LUMENS	BULB TYPE	MULT SERIES	POLE TYPE	SHADE	ADDRESS NUMBER	REF	LOCATION	TAX DIST	DATE INST	DATE CHANGE
04000	S	M	OUG	II	00000	001	SIDE OF 1079 FOREST LAKE DR.	12	010890	1/1/0001

OFFICE: 311

ROUTE: 564

ST_REF_NO: 00000024160

BRIGHTON PLACE DRIVE

LUMENS	BULB TYPE	MULT SERIES	POLE TYPE	SHADE	ADDRESS NUMBER	REF	LOCATION	TAX DIST	DATE INST	DATE CHANGE
05800	S	M	CNT	II	00000	001	SIDE OF 1176 CHETFORD DRIVE	12	010897	1/1/0001
05800	S	M	CNT	II	00000	019	SIDE OF 3132 HELMSDALE PLACE	12	020898	1/1/0001
05800	S	M	CNT	III	03144	026		12	110800	1/1/0001
05800	S	M	CNT	II	03153	025		12	110800	1/1/0001
05800	S	M	CNT	II	03168	024		12	110800	1/1/0001
05800	S	M	CNT	II	03173	023		12	020898	1/1/0001
05800	S	M	CNT	II	03184	022		12	020898	1/1/0001
05800	S	M	CNT	II	03193	021		12	020898	1/1/0001
05800	S	M	CNT	II	03201	020		12	020898	1/1/0001
05800	S	M	CNT	II	03209	018		12	020898	1/1/0001
05800	S	M	CNT	II	03220	017		12	020898	1/1/0001
05800	S	M	CNT	II	03224	016		12	020898	1/1/0001
05800	S	M	CNT	II	03233	015		12	010897	1/1/0001
05800	S	M	CNT	II	03253	013		12	010897	1/1/0001
05800	S	M	CNT	II	03269	011		12	010897	1/1/0001
05800	S	M	CNT	II	03280	010		12	010897	1/1/0001
05800	S	M	CNT	II	03285	009		12	010897	1/1/0001
05800	S	M	CNT	II	03296	008		12	010897	1/1/0001
05800	S	M	CNT	II	03305	007		12	010897	1/1/0001
05800	S	M	CNT	III	03312	006		12	010897	1/1/0001
05800	S	M	CNT	II	03325	005		12	010897	1/1/0001
05800	S	M	CNT	II	03332	004		12	010897	1/1/0001

OFFICE: 311		ROUTE: 564		ST_REF_NO: 00000024160		BRIGHTON PLACE DRIVE				
LUMENS	BULB TYPE	MULT SERIES	POLE TYPE	SHADE	ADDRESS NUMBER	REF	LOCATION	TAX DIST	DATE INST	DATE CHANGE
05800	S	M	CNT	II	03341	003		12	010897	1/1/0001
05800	S	M	CNT	II	03352	002		12	010897	1/1/0001

OFFICE: 311		ROUTE: 564		ST_REF_NO: 00000024200		BRISTOL ROAD				
LUMENS	BULB TYPE	MULT SERIES	POLE TYPE	SHADE	ADDRESS NUMBER	REF	LOCATION	TAX DIST	DATE INST	DATE CHANGE
05800	S	M	OUG	III	00405	000		12	041759	1/1/0001
05800	S	M	OUG	III	00416	000		12	100160	1/1/0001
05800	S	M	OUG	III	00429	000		12	090159	1/1/0001
05800	S	M	OUG	III	00440	000		12	010160	1/1/0001

OFFICE: 311		ROUTE: 564		ST_REF_NO: 00000024210		BRITAIN PLACE				
LUMENS	BULB TYPE	MULT SERIES	POLE TYPE	SHADE	ADDRESS NUMBER	REF	LOCATION	TAX DIST	DATE INST	DATE CHANGE
05800	S	M	SOH	II	00000	001	75 FT. W OF BROWN AVE, NORTHSIDE	12	110894	1/1/0001
05800	S	M	SOH	II	01171	005		12	110894	1/1/0001
05800	S	M	SOH	II	01179	004		12	110894	1/1/0001
05800	S	M	SOH	II	01187	003		12	110894	1/1/0001
05800	S	M	SOH	II	01195	002		12	110894	1/1/0001

OFFICE: 311		ROUTE: 564		ST_REF_NO: 00000024300		BRITTANY LANE				
LUMENS	BULB TYPE	MULT SERIES	POLE TYPE	SHADE	ADDRESS NUMBER	REF	LOCATION	TAX DIST	DATE INST	DATE CHANGE
09500	S	M	OUG	II	00000	001	SIDE OF 236 SAVOY RD	12	120660	1/1/0001
09500	S	M	OUG	II	01601	000		12	120660	1/1/0001
09500	S	M	OUG	II	01608	000		12	010162	1/1/0001
09500	S	M	OUG	II	01625	000		12	120660	1/1/0001
09500	S	M	OUG	II	01636	000		12	120660	1/1/0001
09500	S	M	OUG	II	01653	000		12	120660	1/1/0001
09500	S	M	OUG	II	01660	000		12	120660	1/1/0001
09500	S	M	OUG	II	01677	000		12	120660	1/1/0001

OFFICE: 311

ROUTE: 564

ST_REF_NO: 00000024370

BROADMOOR PLACE

LUMENS	BULB TYPE	MULT SERIES	POLE TYPE	SHADE	ADDRESS NUMBER	REF	LOCATION	TAX DIST	DATE INST	DATE CHANGE
05800	S	M	CNT	II	00701	001		12	060896	1/1/0001
05800	S	M	CNT	III	00713	002		12	060896	1/1/0001

OFFICE: 311

ROUTE: 564

ST_REF_NO: 00000024380

BROADMOOR CIRCLE

LUMENS	BULB TYPE	MULT SERIES	POLE TYPE	SHADE	ADDRESS NUMBER	REF	LOCATION	TAX DIST	DATE INST	DATE CHANGE
05800	S	M	CNT	II	00804	001		12	120894	1/1/0001
05800	S	M	CNT	III	00833	003		12	120894	1/1/0001

OFFICE: 311

ROUTE: 564

ST_REF_NO: 00000024390

BROADMOOR DRIVE

LUMENS	BULB TYPE	MULT SERIES	POLE TYPE	SHADE	ADDRESS NUMBER	REF	LOCATION	TAX DIST	DATE INST	DATE CHANGE
05800	S	M	CNT	II	00000	006	REAR OF 700 BROADMOOR PLACE	12	060896	1/1/0001
05800	S	M	CNT	II	03701	001		12	120894	1/1/0001
05800	S	M	CNT	II	03709	002		12	120894	1/1/0001
05800	S	M	CNT	II	03716	003		12	120894	1/1/0001
05800	S	M	CNT	II	03729	004		12	120894	1/1/0001
05800	S	M	CNT	II	03740	005		12	120894	1/1/0001
05800	S	M	CNT	II	03764	007		12	060896	1/1/0001
05800	S	M	CNT	II	03769	008		12	060896	1/1/0001
05800	S	M	CNT	III	03784	009		12	060896	1/1/0001

OFFICE: 311

ROUTE: 564

ST_REF_NO: 00000024400

BROADVIEW DRIVE

LUMENS	BULB TYPE	MULT SERIES	POLE TYPE	SHADE	ADDRESS NUMBER	REF	LOCATION	TAX DIST	DATE INST	DATE CHANGE
05800	S	M	OUG	II	00262	001		12	100889	9/9/2009
04000	S	M	OUG	II	00000	006	SIDE 1429 N. LIMESTONE	12	100889	1/1/0001
04000	S	M	OUG	II	00209	005		12	100889	1/1/0001
04000	S	M	OUG	II	00222	004		12	100889	1/1/0001
04000	S	M	OUG	II	00233	003		12	100889	1/1/0001
04000	S	M	OUG	II	00250	002		12	100889	1/1/0001

OFFICE: 311

ROUTE: 564

ST_REF_NO: 0000024500

BROADWAY, NORTH

LUMENS	BULB TYPE	MULT SERIES	POLE TYPE	SHADE	ADDRESS NUMBER	REF	LOCATION	TAX DIST	DATE INST	DATE CHANGE
22000	S		SOH	II	00000	650	ACROSS FROM 777 N BROADWAY	12	011110	1/1/0001
50000	S		SOH	II	00000	700	NE CORNER OF N BROADWAY AT WITHERS AVE	12	082010	1/1/0001
22000	S	M	OOH	II	00000	067	SIDE OF 261 BROADVIEW DR.	12	012268	9/9/2009
22000	S	M	OOH	II	00000	069	2ND. LT. ON R. FROM BROADVIEW BY RR TRACK	12	012268	9/9/2009
09500	S	M	OOH	II	00000	070	1ST LT. PAST RR TRACK ON W. SIDE	12	012268	9/9/2009
22000	S	M	OUG	II	00000	075	1ST LT N OF NEW CIRCLE RD, E SIDE	12	050268	9/9/2009
20000	M	M	OUG	II	00000	077	2ND LT N OF NEW CIRCLE RD, E SIDE	12	050268	9/9/2009
22000	S	M	OOH	II	00000	079	3RD LT N OF NEW CIRCLE, E SIDE	12	050268	9/9/2009
22000	S	M	OUG	II	00000	089	OPP. 1737 - UPGRADED DUE TO BAD FIXTURE	12	090171	7/30/2009
22000	S	M	OUG	II	00000	096	SIDE OF 401 DOVER RD.	12	090171	9/24/2009
22000	S	M	OUG	II	00000	098	SIDE OF 400 SOUTH RIDGE DR.	12	090171	5/1/2013
22000	S	M	OUG	II	00000	102	FRONT OF 407 NORTH RIDGE-ch'd out bad fixture	12	090171	7/30/2009
22000	S	M	OUG	II	00000	104	SIDE OF 401 NORTH RIDGE DR.	12	090171	9/9/2009
22000	S	M	OOH	II	00000	112	FRONT OF PARKWAY BAPTIST CHURCH	12	090171	9/9/2009
22000	S	M	OUG	II	00000	115	OPPOSITE 1949-chg'd out bad fixture	12	090171	7/30/2009
22000	S	M	OUG	II	00000	119	OPPOSITE 1987-chg'd out bad fixture	12	090171	7/30/2009
22000	S	M	OUG	III	00000	126	OPPOSITE 2203	12	081477	9/9/2009
50000	S	M	OUG	III	00000	129	OPPOSITE OLD PARIS PIKE	12	081477	9/9/2009
22000	S	M	SOH	III	00000	133	OPPOSITE PARKSIDE DR	12	081477	9/9/2009
50000	S	M	SOH	II	00173	013		12	090160	9/9/2009
50000	S	M	SOH	II	00187	014		12	090160	9/9/2009
50000	S	M	SOH	II	00187	015		12	090160	5/14/2008
50000	S	M	SOH	II	00203	016		12	090160	5/14/2008
22000	S	M	SOH	II	00223	017		12	090160	5/14/2008
22000	S	M	SOH	II	00239	018		12	090160	5/14/2008
22000	S	M	SOH	II	00253	019		12	090160	5/14/2008
50000	S	M	SOH	II	00307	021		12	090160	5/14/2008
50000	S	M	SOH	II	00319	022		12	090160	5/14/2008
50000	S	M	SOH	II	00331	023		12	090160	5/14/2008
50000	S	M	SOH	II	00345	024		12	090160	5/14/2008
50000	S	M	SOH	II	00345	025		12	090160	5/14/2008
22000	S	M	SOH	II	00415	028		12	090160	5/14/2008
22000	S	M	SOH	II	00429	029		12	090160	5/14/2008
50000	S	M	SOH	II	00439	030		12	090160	5/14/2008

Street Light Listing run 1/11/2015 10:43:21 AM

Page 126 of 1254

OFFICE: 311

ROUTE: 564

ST_REF_NO: 0000024500

BROADWAY, NORTH

LUMENS	BULB TYPE	MULT SERIES	POLE TYPE	SHADE	ADDRESS NUMBER	REF	LOCATION	TAX DIST	DATE INST	DATE CHANGE
20000	M	M	SOH	II	00451	031		12	090160	9/9/2009
22000	S	M	SOH	II	00469	033	bad fixture	12	090160	10/28/2010
50000	S	M	SOH	II	00617	040		12	090160	9/9/2009
50000	S	M	SOH	II	00629	041		12	090160	9/9/2009
22000	S	M	SOH	II	00644	042		12	090160	9/9/2009
22000	S	M	SOH	II	00721	048	chg'd out bad fixture	12	090160	7/30/2009
09500	S	M	SOH	II	00728	047		12	090160	9/9/2009
22000	S	M	SOH	II	00777	050		12	090160	12/14/2009
09500	S	M	OOH	II	00900	051		12	050268	9/9/2009
22000	S	M	OOH	II	00916	053		12	050268	9/26/2008
22000	S	M	OUG	II	00917	052		12	050268	3/24/2011
22000	S	M	OUG	II	01005	054	bad fixture	12	050268	10/28/2010
22000	S	M	OOH	II	01020	055	bad fixture	12	050268	10/4/2010
22000	S	M	OUG	II	01105	056	chg'd out bad fixture	12	050268	7/30/2009
22000	S	M	OOH	II	01118	057		12	050268	9/9/2009
50000	S	M	SOH	II	01221	060	lfucg upgrade	12	012268	8/4/2010
22000	S	M	SOH	II	01420	063		12	012268	9/9/2009
22000	S	M	SOH	II	01479	066		12	012268	9/9/2009
22000	S	M	OOH	II	01499	068		12	012268	9/9/2009
22000	S	M	OUG	II	01704	083		12	050268	9/9/2009
22000	S	M	OUG	II	01705	084		12	050268	9/9/2009
22000	S	M	OUG	II	01737	090	car accident	12	090171	11/23/2009
22000	S	M	OUG	II	01749	092		12	090171	5/12/2009
50000	S	M	OUG	II	01951	116		12	090171	9/9/2009
22000	S	M	OUG	III	02141	121		12	081477	9/9/2009
22000	S	M	SOH	III	02314	131		12	081477	9/9/2009
20000	M	M	OUG	II	00000	099	OPP. THE SIDE OF 400 SOUTH RIDGE DR.	12	090171	1/1/0001
20000	M	M	OUG	II	00000	100	FRONT OF 401 SOUTH RIDGE	12	090171	1/1/0001
20000	M	M	OUG	II	00000	101	OPP. SOUTH RIDGE	12	090171	1/1/0001
20000	M	M	OUG	II	00000	103	OPP. 401 NORTH RIDGE	12	090171	1/1/0001
22000	S	M	OUG	II	00000	105	OPP. SIDE REAR OF 401 NORTH RIDGE	12	090171	1/1/0001
20000	M	M	OUG	II	00000	106	SIDE OF 404 LIN WAL DR.	12	090171	1/1/0001
20000	M	M	OUG	II	00000	107	OPP. LIN WAL DR.	12	090171	1/1/0001
20000	M	M	OUG	II	00000	108	SIDE OF 405 LIN WAL DR.	12	090171	1/1/0001

Street Light Listing run 1/11/2015 10:43:21 AM

Page 127 of 1254

OFFICE: 311

ROUTE: 564

ST_REF_NO: 0000024500

BROADWAY, NORTH

LUMENS	BULB TYPE	MULT SERIES	POLE TYPE	SHADE	ADDRESS NUMBER	REF	LOCATION	TAX DIST	DATE INST	DATE CHANGE
20000	M	M	OUG	II	00000	109	OPP. PARKWAY BAPTIST CHURCH	12	090171	1/1/0001
20000	M	M	OUG	II	00000	110	FRONT OF PARKWAY BAPTIST CHURCH	12	090171	1/1/0001
20000	M	M	OUG	II	00000	111	OPP. PARKWAY BAPTIST CHURCH	12	090171	1/1/0001
20000	M	M	OUG	II	00000	113	OPP. PARKWAY BAPTIST CHURCH	12	090171	1/1/0001
20000	M	M	OUG	II	00000	114	SW CORNER OF HAGGARD LANE	12	090171	1/1/0001
20000	M	M	OUG	II	00000	117	OPPOSITE 1951	12	090171	1/1/0001
20000	M	M	OUG	III	00000	120	OPPOSITE 2115	12	081477	1/1/0001
20000	M	M	OUG	III	00000	122	OPPOSITE 2149	12	081477	1/1/0001
20000	M	M	OUG	III	00000	124	OPPOSITE JUDY LANE	12	081477	1/1/0001
20000	M	M	OUG	III	00000	128	OPPOSITE 2251	12	081477	1/1/0001
50000	S	M	OUG	III	00000	130	SIDE OF 2200 N. BROADWAY ON OLD PARIS PIKE	12	081477	1/1/0001
20000	M	M	OUG	II	01955	118		12	090171	1/1/0001
20000	M	M	OUG	III	02149	123		12	081477	1/1/0001
20000	M	M	OUG	III	02203	125		12	081477	1/1/0001
20000	M	M	OUG	III	02251	127		12	081477	1/1/0001
20000	M	M	OUG	III	02299	132		12	081477	1/1/0001
20000	M	M	OUG	III	02301	134		12	081477	1/1/0001
20000	M	M	SOH	II	00000	059	OPP. 1300	12	012268	1/1/0001
50000	S	M	SOH	II	00000	062	OPP. PARIS AVE upgrade 4/08	12	012268	1/1/0001
50000	S	M	SOH	II	00000	064	SW CORNER OF NORTHLAND DR.upgrade 4/08	12	012268	1/1/0001
50000	S	M	SOH	II	00000	072	SIDE OF 206 NEW CIRCLE RD.upgrade 4/08	12	012268	1/1/0001
22000	S	M	OUG	II	00000	074	SIDE OF 1601-upgraded Nov 2007	12	050268	1/1/0001
50000	S	M	SOH	II	00451	032	upgrade 4/08	12	090160	1/1/0001
20000	M	M	SOH	II	00507	034		12	090160	1/1/0001
20000	M	M	SOH	II	00521	035		12	090160	1/1/0001
20000	M	M	SOH	II	00531	036		12	090160	1/1/0001
20000	M	M	SOH	II	00551	037		12	090160	1/1/0001
20000	M	M	SOH	II	00559	038		12	090160	1/1/0001
50000	S	M	SOH	II	00603	039	upgrade 4/08	12	090160	1/1/0001
20000	M	M	SOH	II	00657	043		12	090160	1/1/0001
50000	S	M	SOH	II	00670	044	upgrade 4/08	12	090160	1/1/0001
50000	S	M	SOH	II	00701	045	upgrade 4/08	12	090160	1/1/0001
20000	M	M	SOH	II	00711	046		12	090160	1/1/0001
20000	M	M	SOH	II	00760	049		12	090160	1/1/0001

Street Light Listing run 1/11/2015 10:43:21 AM

Page 128 of 1254

OFFICE: 311

ROUTE: 564

ST_REF_NO: 0000024500

BROADWAY, NORTH

LUMENS	BULB TYPE	MULT SERIES	POLE TYPE	SHADE	ADDRESS NUMBER	REF	LOCATION	TAX DIST	DATE INST	DATE CHANGE
22000	S	M	OUG	II	01201	058		12	050268	1/1/0001
20000	M	M	SOH	II	01412	061		12	012268	1/1/0001
22000	S	M	SOH	II	01450	065		12	012268	1/1/0001
20000	M	M	OUG	II	00000	086	BESIDE 1725	12	070268	1/1/0001
20000	M	M	OUG	II	00000	087	OPP. 1725	12	050268	1/1/0001
20000	M	M	OUG	II	00000	091	OPP. 1745	12	090171	1/1/0001
20000	M	M	OUG	II	00000	093	OPP. 1753	12	090171	1/1/0001
20000	M	M	OUG	II	00000	094	SIDE OF 400 DOVER RD.	12	090171	1/1/0001
20000	M	M	OUG	II	00000	095	OPP. DOVER RD.	12	090171	1/1/0001
20000	M	M	OUG	II	00000	097	OPP. THE SIDE OF 401 DOVER RD.	12	090171	1/1/0001
22000	S	M	OUG	II	01651	076	upgraded Nov 2007	12	050268	1/1/0001
20000	M	M	OUG	II	01675	078		12	050268	1/1/0001
22000	S	M	OUG	II	01687	080		12	050268	1/1/0001
20000	M	M	OOH	II	01700	081		12	050268	1/1/0001
22000	S	M	OUG	II	01701	082		12	050268	1/1/0001
20000	M	M	OUG	II	01712	085		12	050268	1/1/0001
20000	M	M	OUG	II	01731	088		12	090171	1/1/0001
50000	S	M	OUG	II	00000	002	SIDE 361 W. MAIN	12	060685	1/1/0001
50000	S	M	OOH	III	00000	005	S.E. CORNER OF SHORT & BROADWAY	12	102061	1/1/0001
50000	S	M	OOH	III	00000	006	S.W. CORNER OF SHORT & BROADWAY	12	102061	1/1/0001
50000	S	M	OOH	III	00000	007	N.E. CORNER OF SHORT & BROADWAY	12	102061	1/1/0001
50000	S	M	OOH	III	00000	008	N.W. CORNER OF SHORT & BROADWAY	12	102061	1/1/0001
50000	S	M	OUG	III	00118	003		12	050885	1/1/0001
20000	M	M	SOH	III	00142	009		12	102061	1/1/0001
20000	M	M	SOH	III	00149	010		12	102061	1/1/0001
20000	M	M	SOH	III	00152	011		12	102061	1/1/0001
20000	M	M	SOH	III	00159	012		12	102061	1/1/0001
50000	S	M	SOH	II	00263	020		12	090160	1/1/0001
50000	S	M	SOH	II	00345	026		12	090160	1/1/0001
50000	S	M	SOH	II	00401	027		12	090160	1/1/0001

OFFICE: 311

ROUTE: 564

ST_REF_NO: 0000024510

BROADWAY, SOUTH

LUMENS	BULB TYPE	MULT SERIES	POLE TYPE	SHADE	ADDRESS NUMBER	REF	LOCATION	TAX DIST	DATE INST	DATE CHANGE
20000	M		SOH	II	00000	047	NW CORNER OF S BROADWAY AND RED MILE RD	12	022613	1/1/0001
16000	S		GRN	IV	00000	081	1st LT S OF MAIN ST, W SIDE (TRIANGLE PARK)	12	120611	1/1/0001
16000	S		GRN	IV	00000	083	2nd LT S OF MAIN ST, W SIDE (TRIANGLE PARK)	12	120611	1/1/0001
16000	S		GRN	IV	00000	085	3rd LT S OF MAIN ST, W SIDE (TRIANGLE PARK)	12	120611	1/1/0001
22000	S		OUG	II	00000	500	2ND LT SOUTH OF PINE ST, W SIDE ON S BROADWAY	12	042409	1/1/0001
22000	S		OUG	II	00000	501	3RD LT SOUTH OF PINE ST, W SIDE ON S BROADWAY	12	042409	1/1/0001
22000	S		OUG	II	00000	502	2ND LT SOUTH OF PINE ST., EAST SIDE ON S. BROADWAY	12	101909	1/1/0001
50000	S		OUG	II	00000	503	1ST LT SOUTH OF CEDAR ST, W SIDE ON S BROADWAY	12	042409	1/1/0001
22000	S		OUG	II	00000	504	1ST LT SOUTH OF CEDAR ST., EST SIDE ON S. BROADWAY	12	101909	1/1/0001
22000	S		OUG	II	00000	505	2ND LT SOUTH OF CEDAR ST, W SIDE ON S BROADWAY	12	042409	1/1/0001
50000	S		SOH	II	00402	400		12	102008	1/1/0001
22000	S	M	OUG	III	00000	003	2ND LT. S. OF VINE, E. SIDE	12	070171	9/9/2009
22000	S	M	SOH	II	00000	016	SW CORNER OF S. BROADWAY AND PINE	12	110162	4/16/2009
22000	S	M	SOH	III	00000	022	OPP. 570 upgrade per city request	12	101862	10/16/2009
22000	S	M	SOH	III	00000	058	S. W. CORNER OF PYKE AND S. BROADWAY	12	020162	9/9/2009
22000	S	M	OOH	III	00000	064	OPPOSITE 1216	12	110761	9/9/2009
22000	S	M	OOH	III	00000	071	OPPOSITE PARKWAY DRIVE	12	110761	9/9/2009
50000	S	M	SOH	II	00000	300	SOUTHWEST CORNER OF S BROADWAY @ W HIGH ST	12	112905	1/1/0001
22000	S	M	SOH	II	00314	005		12	110162	10/6/2009
22000	S	M	OOH	II	00343	008		12	111362	9/9/2009
22000	S	M	SOH	II	00367	010		12	110162	9/9/2009
22000	S	M	SOH	II	00419	014		12	110162	9/9/2009
22000	S	M	SOH	II	00426	015		12	110162	9/9/2009
22000	S	M	OUG	III	00550	021	upgrade per city request	12	110162	4/16/2009
22000	S	M	SOH	III	00640	027		12	090884	9/9/2009
22000	S	M	SOH	III	00867	044		12	101862	9/9/2009
50000	S	M	SOH	III	00914	046		12	101862	9/9/2009
50000	S	M	SOH	III	01008	048		12	101862	9/9/2009
50000	S	M	SOH	III	01025	050		12	101862	9/9/2009

OFFICE: 311

ROUTE: 564

ST_REF_NO: 0000024510

BROADWAY, SOUTH

LUMENS	BULB TYPE	MULT SERIES	POLE TYPE	SHADE	ADDRESS NUMBER	REF	LOCATION	TAX DIST	DATE INST	DATE CHANGE
22000	S	M	SOH	III	01100	057		12	110761	11/24/2013
22000	S	M	OOH	III	01201	060		12	110761	9/9/2009
22000	S	M	OOH	III	01203	062		12	110761	9/9/2009
22000	S	M	SOH	III	01221	066		12	020162	9/9/2009
22000	S	M	OOH	III	01222	065		12	110761	9/9/2009
22000	S	M	OOH	III	01228	069		12	110761	9/9/2009
22000	S	M	OOH	III	01316	073		12	110761	9/9/2009
22000	S	M	OOH	III	01335	074		12	110761	9/9/2009
22000	S	M	OOH	III	01350	077		12	110761	9/9/2009
50000	S	M	OOH	III	01350	079		12	110761	9/9/2009
22000	S	M	SOH	III	01375	076		12	020162	9/9/2009
22000	S	M	OOH	III	01375	078		12	110761	9/9/2009
22000	S	M	OOH	III	01375	080		12	110761	9/9/2009
22000	S	M	SOH	III	00000	025	S BDWAY & CHAIR AVE, NW CORNER,upgrade 2/08	12	090884	1/1/0001
22000	S	M	SOH	III	00000	026	S BDWAY & CHAIR AVE, S.W. CORNER,upgrade 2/08	12	090884	1/1/0001
05800	S	M	SOH	III	00000	034	OPP. ANGLIANA AVE.	12	101862	1/1/0001
20000	M	M	SOH	III	00000	045	OPPOSITE 912	12	101862	1/1/0001
22000	S	M	OOH	II	00000	089	1ST LT. NORTH OF RR UNDERPASS, EASTSIDE	12	110893	1/1/0001
22000	S	M	OOH	II	00000	090	1ST LT. SOUTH OF RR UNDERPASS, WESTSIDE	12	110893	1/1/0001
22000	S	M	OOH	II	00000	091	1ST LT. SOUTH OF RR UNDERPASS, EASTSIDE	12	110893	1/1/0001
22000	S	M	OOH	II	00000	092	2ND LT. SOUTH OF RR UNDERPASS, WESTSIDE	12	110893	1/1/0001
22000	S	M	OOH	II	00000	093	2ND LT. SOUTH OF RR UNDERPASS, EASTSIDE	12	110893	1/1/0001
22000	S	M	OOH	II	00000	094	NW CORNER OF ANGLIANA AVE.	12	110893	1/1/0001
22000	S	M	OOH	II	00000	105	3RD LT. NORTH OF RR UNDERPASS, EASTSIDE	12	110893	1/1/0001
22000	S	M	OOH	II	00000	106	2ND LT. NORTH OF RR UNDERPASS, WESTSIDE	12	110893	1/1/0001
22000	S	M	OOH	II	00000	107	2ND LT. NORTH OF RR UNDERPASS, EASTSIDE	12	110893	1/1/0001
22000	S	M	OOH	II	00000	108	1ST LT. NORTH OF RR UNDERPASS, WESTSIDE	12	110893	1/1/0001
20000	M	M	SOH	III	00615	024		12	101862	1/1/0001
22000	S	M	SOH	II	00630	101		12	110893	1/1/0001
22000	S	M	OOH	II	00640	104		12	110893	1/1/0001
22000	S	M	SOH	II	00645	103		12	110893	1/1/0001
20000	M	M	SOH	III	00650	028		12	090884	1/1/0001
20000	M	M	SOH	III	00672	029		12	090884	1/1/0001
20000	M	M	SOH	III	00684	030		12	101862	1/1/0001

Street Light Listing run 1/11/2015 10:43:21 AM

Page 131 of 1254

OFFICE: 311

ROUTE: 564

ST_REF_NO: 0000024510

BROADWAY, SOUTH

LUMENS	BULB TYPE	MULT SERIES	POLE TYPE	SHADE	ADDRESS NUMBER	REF	LOCATION	TAX DIST	DATE INST	DATE CHANGE
22000	S	M	OOH	II	00808	095		12	110893	1/1/0001
22000	S	M	OOH	II	00812	097		12	110893	1/1/0001
22000	S	M	OOH	II	00847	096		12	110893	1/1/0001
22000	S	M	OOH	II	00847	098		12	110893	1/1/0001
22000	S	M	SOH	II	00855	099		12	110893	1/1/0001
22000	S	M	SOH	II	00855	100		12	110893	1/1/0001
20000	M	M	SOH	III	00862	043		12	101862	1/1/0001
20000	M	M	OOH	III	00000	072	S. W. CORNER OF PARKWAY AND S. BROADWAY	12	110761	1/1/0001
20000	M	M	OOH	III	01026	051		12	101862	1/1/0001
20000	M	M	SOH	III	01057	052		12	101862	1/1/0001
20000	M	M	OOH	III	01064	053		12	101862	1/1/0001
20000	M	M	SOH	III	01081	054		12	101862	1/1/0001
20000	M	M	SOH	III	01093	055		12	101862	1/1/0001
20000	M	M	SOH	III	01112	059		12	110761	1/1/0001
20000	M	M	OOH	III	01200	061		12	110761	1/1/0001
20000	M	M	SOH	III	01218	063		12	110761	1/1/0001
20000	M	M	OOH	III	01221	067		12	110761	1/1/0001
20000	M	M	OOH	III	01221	070		12	110761	1/1/0001
20000	M	M	OOH	III	01222	068		12	110761	1/1/0001
20000	M	M	SOH	III	00000	023	OPP. BOLIVAR ST	12	101862	1/1/0001
20000	M	M	SOH	II	00301	004		12	110162	1/1/0001
20000	M	M	SOH	II	00331	006		12	110162	1/1/0001
22000	S	M	SOH	II	00334	007	change out bad mv fixture 2/08	12	111362	1/1/0001
20000	M	M	SOH	II	00362	009		12	110162	1/1/0001
20000	M	M	SOH	II	00382	011		12	110162	1/1/0001
20000	M	M	SOH	II	00401	012		12	110162	1/1/0001
20000	M	M	OOH	II	00404	013		12	110162	1/1/0001
22000	S	M	SOH	II	00514	017	change out bad mv fixture 2/08	12	110162	1/1/0001
50000	S	M	CNT	III	00000	082	1ST LT. S. OF MAIN ST., EASTSIDE	12	010892	1/1/0001
50000	S	M	CNT	III	00000	084	2ND LT. S. OF MAIN ST., EASTSIDE	12	010892	1/1/0001
50000	S	M	CNT	III	00000	086	1ST LT. S. OF W. VINE ST., WESTSIDE	12	010892	1/1/0001
50000	S	M	CNT	III	00000	087	2NT LT. S. OF W. VINE ST., WESTSIDE	12	010892	1/1/0001
50000	S	M	CNT	III	00000	088	NW CORNER OF WEST HIGH ST.	12	010892	1/1/0001

OFFICE: 311		ROUTE: 564		ST_REF_NO: 00000024520		BROADWAY, NORTH PARK				
LUMENS	BULB TYPE	MULT SERIES	POLE TYPE	SHADE	ADDRESS NUMBER	REF	LOCATION	TAX DIST	DATE INST	DATE CHANGE
09500	S	M	SOH	II	00000	030	SIDE OF 1105 N BROADWAY ON N BROADWAY PARK	12	083105	1/1/0001
05800	S	M	OUG	II	00000	031	SIDE OF 1100 MCCLAIN DR ON N BROADWAY PARK	12	083105	1/1/0001
05800	S	M	OUG	II	00000	032	SIDE OF 1129 MCCLAIN DR ON N BROADWAY PARK	12	083105	1/1/0001
05800	S	M	SOH	II	00000	001	SIDE OF 1100 MCCLAIN DRIVE	12	120257	1/1/0001
04000	S	M	SOH	II	00000	008	SIDE 1021 N. LIMESTONE	12	060685	1/1/0001
04000	S	M	SOH	II	00107	007		12	121578	1/1/0001
04000	S	M	SOH	II	00111	006		12	060685	1/1/0001
04000	S	M	SOH	II	00117	005		12	121578	1/1/0001
04000	S	M	SOH	II	00125	004		12	060685	1/1/0001
04000	S	M	SOH	II	00131	003		12	121578	1/1/0001
04000	S	M	SOH	II	00139	002		12	060685	1/1/0001
04000	S	M	SOH	II	00145	001		12	121578	1/1/0001

OFFICE: 311		ROUTE: 564		ST_REF_NO: 00000024530		BROADWAY, SOUTH PARK				
LUMENS	BULB TYPE	MULT SERIES	POLE TYPE	SHADE	ADDRESS NUMBER	REF	LOCATION	TAX DIST	DATE INST	DATE CHANGE
05800	S	M	SOH	I	00000	001	1ST LIGHT EAST OF BROADWAY IN MEDIAN	12	110464	1/1/0001
05800	S	M	SOH	I	00339	000		12	110464	1/1/0001
05800	S	M	SOH	I	00349	000		12	110464	1/1/0001
05800	S	M	SOH	I	00360	000		12	110464	1/1/0001
05800	S	M	SOH	I	00369	000		12	110464	1/1/0001
05800	S	M	SOH	II	00379	000		12	072219	1/1/0001
05800	S	M	SOH	V	00000	002	END OF SOUTH BROADWAY PARK	12	120858	1/1/0001
05800	S	M	SOH	I	00309	000		12	110464	1/1/0001
05800	S	M	SOH	I	00325	000		12	110464	1/1/0001
05800	S	M	SOH	I	00330	000		12	110464	1/1/0001

OFFICE: 311		ROUTE: 564		ST_REF_NO: 00000024535		BROCK MCVEY DR				
LUMENS	BULB TYPE	MULT SERIES	POLE TYPE	SHADE	ADDRESS NUMBER	REF	LOCATION	TAX DIST	DATE INST	DATE CHANGE
09500	S		OUG	II	00000	001	1ST LT S OF TRADE CENTER, W SIDE OF BROCK MCVEY	12	030801	1/1/0001
09500	S		OUG	II	00000	002	1ST LT S OF TRADE CENTER, E SIDE OF BROCK MCVEY	12	030801	1/1/0001

OFFICE: 311

ROUTE: 564

ST_REF_NO: 00000024535

BROCK MCVEY DR

LUMENS	BULB TYPE	MULT SERIES	POLE TYPE	SHADE	ADDRESS NUMBER	REF	LOCATION	TAX DIST	DATE INST	DATE CHANGE
09500	S		OUG	II	00000	003	2ND LT S OF TRADE CENTER, W SIDE OF BROCK MCVEY	12	030801	1/1/0001
09500	S		OUG	II	01100	004		12	030801	1/1/0001
09500	S		OUG	II	01100	005		12	030801	1/1/0001
09500	S		OUG	II	01165	006		12	030801	1/1/0001
09500	S		OUG	II	01174	007		12	030801	1/1/0001
09500	S		OUG	II	01175	008		12	030801	1/1/0001
09500	S		OUG	II	01175	009		12	030801	1/1/0001
09500	S		OUG	II	01183	010		12	030801	1/1/0001
09500	S		OUG	II	01183	011		12	030801	1/1/0001

OFFICE: 311

ROUTE: 564

ST_REF_NO: 00000024575

BROOKDALE CIRCLE

LUMENS	BULB TYPE	MULT SERIES	POLE TYPE	SHADE	ADDRESS NUMBER	REF	LOCATION	TAX DIST	DATE INST	DATE CHANGE
04000	S	M	OUG	V	03801	002		12	100890	1/1/0001
04000	S	M	OUG	II	03816	001		12	100890	1/1/0001

OFFICE: 311

ROUTE: 564

ST_REF_NO: 00000024580

BROOKEWIND WAY

LUMENS	BULB TYPE	MULT SERIES	POLE TYPE	SHADE	ADDRESS NUMBER	REF	LOCATION	TAX DIST	DATE INST	DATE CHANGE
05800	S	M	CNT	II	00000	002	OPP. 3508	12	050899	1/1/0001
05800	S	M	CNT	II	00000	004	OPP. 3544	12	050899	1/1/0001
05800	S	M	CNT	II	00000	006	REAR OF 148 ELLEMOOR LANE	12	050899	1/1/0001
05800	S	M	CNT	II	03500	001		12	050899	1/1/0001
05800	S	M	CNT	II	03524	003		12	050899	1/1/0001
05800	S	M	CNT	II	03556	005		12	050899	1/1/0001
05800	S	M	CNT	II	03600	007		12	110899	1/1/0001
05800	S	M	CNT	II	03600	009		12	110899	1/1/0001
05800	S	M	CNT	II	03601	008		12	110899	1/1/0001

OFFICE: 311

ROUTE: 564

ST_REF_NO: 00000024590

BROOK FARM COURT

LUMENS	BULB TYPE	MULT SERIES	POLE TYPE	SHADE	ADDRESS NUMBER	REF	LOCATION	TAX DIST	DATE INST	DATE CHANGE
05800	S	M	OUG	III	00512	002		12	020800	1/1/0001
05800	S	M	OUG	II	00524	001		12	020800	1/1/0001

OFFICE: 311		ROUTE: 564		ST_REF_NO: 00000024600		BROOKFIELD DRIVE		LUMENS	BULB TYPE	MULT SERIES	POLE TYPE	SHADE	ADDRESS NUMBER	REF	LOCATION	TAX DIST	DATE INST	DATE CHANGE
	04000	S	M	OUG	II	01041	077									12	050886	1/1/0001
	04000	S	M	OUG	II	01052	078									12	050886	1/1/0001

OFFICE: 311		ROUTE: 564		ST_REF_NO: 00000024610		BROOKGLEN PLACE		LUMENS	BULB TYPE	MULT SERIES	POLE TYPE	SHADE	ADDRESS NUMBER	REF	LOCATION	TAX DIST	DATE INST	DATE CHANGE
	04000	S	M	OUG	II	00000	001								SIDE REAR 949 ROCKBRIDGE RD.	12	020895	1/1/0001

OFFICE: 311		ROUTE: 564		ST_REF_NO: 00000024620		BROOKGREEN LANE		LUMENS	BULB TYPE	MULT SERIES	POLE TYPE	SHADE	ADDRESS NUMBER	REF	LOCATION	TAX DIST	DATE INST	DATE CHANGE
	05800	S	M	CNT	II	00666	004									12	100897	1/1/0001
	05800	S	M	CNT	II	00686	002									12	100897	1/1/0001
	05800	S	M	CNT	II	00000	003								SIDE REAR OF 691 BROOKGREEN LANE	12	060896	1/1/0001
	05800	S	M	CNT	II	00603	009									12	060800	1/1/0001
	05800	S	M	CNT	II	00606	008									12	060800	1/1/0001
	05800	S	M	CNT	II	00627	007									12	060800	1/1/0001
	05800	S	M	CNT	II	00646	006									12	060800	1/1/0001
	05800	S	M	CNT	II	00655	005									12	060896	1/1/0001
	05800	S	M	CNT	II	00698	001									12	060896	1/1/0001

OFFICE: 311		ROUTE: 564		ST_REF_NO: 00000024700		BROOKHAVEN DRIVE		LUMENS	BULB TYPE	MULT SERIES	POLE TYPE	SHADE	ADDRESS NUMBER	REF	LOCATION	TAX DIST	DATE INST	DATE CHANGE
	05800	S	M	OUG	II	00000	001								SIDE OF 3432 LANSDOWNE DR.	12	040899	1/1/0001
	05800	S	M	OUG	II	00000	006								SIDE OF 704 MALABU DRIVE	12	040899	1/1/0001
	05800	S	M	OUG	II	03406	005									12	040899	1/1/0001
	05800	S	M	OUG	II	03419	004									12	040899	1/1/0001
	05800	S	M	OUG	II	03426	003									12	040899	1/1/0001
	05800	S	M	OUG	II	03429	002									12	040899	1/1/0001

OFFICE: 311		ROUTE: 564		ST_REF_NO: 00000024800		BROOKHILL CIRCLE		LUMENS	BULB TYPE	MULT SERIES	POLE TYPE	SHADE	ADDRESS NUMBER	REF	LOCATION	TAX DIST	DATE INST	DATE CHANGE
	04000	S	M	OUG	II	03302	319									12	020886	1/1/0001

OFFICE: 311

ROUTE: 564

ST_REF_NO: 00000024800 BROOKHILL CIRCLE

LUMENS	BULB TYPE	MULT SERIES	POLE TYPE	SHADE	ADDRESS NUMBER	REF	LOCATION	TAX DIST	DATE INST	DATE CHANGE
04000	S	M	OUG	II	03310	318		12	020886	1/1/0001
04000	S	M	OUG	II	03315	317		12	020886	1/1/0001

OFFICE: 311

ROUTE: 564

ST_REF_NO: 00000025000 BROOKMEADE DRIVE

LUMENS	BULB TYPE	MULT SERIES	POLE TYPE	SHADE	ADDRESS NUMBER	REF	LOCATION	TAX DIST	DATE INST	DATE CHANGE
05800	S	M	OUG	II	00000	011	SIDE OF 327 MANHATTAN DR.	12	091466	1/1/0001

OFFICE: 311

ROUTE: 564

ST_REF_NO: 00000025010 BROOKSIDE COURT

LUMENS	BULB TYPE	MULT SERIES	POLE TYPE	SHADE	ADDRESS NUMBER	REF	LOCATION	TAX DIST	DATE INST	DATE CHANGE
05800	S	M	OUG	II	00000	001	SIDE OF 4720 BROOKSIDE WAY	12	030895	1/1/0001

OFFICE: 311

ROUTE: 564

ST_REF_NO: 00000025020 BROOKSIDE WAY

LUMENS	BULB TYPE	MULT SERIES	POLE TYPE	SHADE	ADDRESS NUMBER	REF	LOCATION	TAX DIST	DATE INST	DATE CHANGE
05800	S	M	OUG	IV	04705	003		12	040895	1/1/0001
05800	S	M	OUG	II	04717	002		12	040895	1/1/0001
05800	S	M	OUG	II	04724	001		12	030895	1/1/0001

OFFICE: 311

ROUTE: 564

ST_REF_NO: 00000025060 BROOKRIDGE DRIVE

LUMENS	BULB TYPE	MULT SERIES	POLE TYPE	SHADE	ADDRESS NUMBER	REF	LOCATION	TAX DIST	DATE INST	DATE CHANGE
05800	S	M	CNT	II	00000	008	SIDE OF 601 POPLAR SPRINGS LN ON BROOKRIDGE DR	12	081501	1/1/0001
05800	S	M	CNT	II	04340	005		12	081501	1/1/0001
05800	S	M	CNT	II	04344	006		12	081501	1/1/0001
05800	S	M	CNT	II	04353	007		12	081501	1/1/0001
05800	S	M	CNT	II	04373	009		12	081501	1/1/0001
05800	S	M	CNT	II	04376	006		12	050404	1/1/0001
05800	S	M	CNT	II	04389	005		12	050404	1/1/0001
05800	S	M	CNT	II	04392	004		12	060205	1/1/0001
05800	S	M	CNT	II	04409	003		12	050404	1/1/0001
05800	S	M	CNT	II	04425	002		12	050404	1/1/0001
05800	S	M	CNT	II	04437	001		12	050404	1/1/0001

OFFICE: 311

ROUTE: 564

ST_REF_NO: 00000025060 BROOKRIDGE DRIVE

LUMENS	BULB TYPE	MULT SERIES	POLE TYPE	SHADE	ADDRESS NUMBER	REF	LOCATION	TAX DIST	DATE INST	DATE CHANGE
05800	S	M	CNT	II	00000	004	SIDE OF 600 ROLLING CREEK LANE	12	030899	1/1/0001
05800	S	M	CNT	III	04305	001		12	030899	1/1/0001
05800	S	M	CNT	II	04320	002		12	030899	1/1/0001
05800	S		CNT	II	04325	003		12	030899	1/1/0001

OFFICE: 311

ROUTE: 564

ST_REF_NO: 00000025100 BROOKS AVENUE

LUMENS	BULB TYPE	MULT SERIES	POLE TYPE	SHADE	ADDRESS NUMBER	REF	LOCATION	TAX DIST	DATE INST	DATE CHANGE
05800	S	M	SOH	I	00706	000		12	060269	1/1/0001

OFFICE: 311

ROUTE: 564

ST_REF_NO: 00000025160 BROOKSTONE COURT

LUMENS	BULB TYPE	MULT SERIES	POLE TYPE	SHADE	ADDRESS NUMBER	REF	LOCATION	TAX DIST	DATE INST	DATE CHANGE
05800	S	M	CNT	III	00708	001		12	100899	1/1/0001

OFFICE: 311

ROUTE: 564

ST_REF_NO: 00000025300 BROOKVIEW DRIVE

LUMENS	BULB TYPE	MULT SERIES	POLE TYPE	SHADE	ADDRESS NUMBER	REF	LOCATION	TAX DIST	DATE INST	DATE CHANGE
04000	S	M	OUG	II	00000	040	SIDE 311 STONEYBROOK DR.	12	060886	1/1/0001
04000	S	M	OUG	II	03501	031		12	060886	1/1/0001
04000	S	M	OUG	II	03508	032		12	060886	1/1/0001
04000	S	M	OUG	II	03513	033		12	060886	1/1/0001
04000	S	M	OUG	II	03519	034		12	060886	1/1/0001
04000	S	M	OUG	II	03524	035		12	060886	1/1/0001
04000	S	M	OUG	II	03531	036		12	060886	1/1/0001
04000	S	M	OUG	II	03539	037		12	060886	1/1/0001
04000	S	M	OUG	II	03550	038		12	060886	1/1/0001
04000	S	M	OUG	II	03566	039		12	060886	1/1/0001

OFFICE: 311

ROUTE: 564

ST_REF_NO: 00000025310 BROOKWATER COURT

LUMENS	BULB TYPE	MULT SERIES	POLE TYPE	SHADE	ADDRESS NUMBER	REF	LOCATION	TAX DIST	DATE INST	DATE CHANGE
05800	S	M	CNT	II	04000	001		21	120894	1/1/0001
05800	S	M	CNT	III	04009	002		12	120894	1/1/0001

OFFICE: 311		ROUTE: 564		ST_REF_NO: 00000025320		BROOKWATER LANE		LUMENS	BULB TYPE	MULT SERIES	POLE TYPE	SHADE	ADDRESS NUMBER	REF	LOCATION	TAX DIST	DATE INST	DATE CHANGE
05800	S	M	CNT	II	00000	003	SIDE REAR OF 4001 BROOKWATER CT.	12	120894	1/1/0001								
05800	S	M	CNT	II	00509	002		12	120894	1/1/0001								
05800	S	M	CNT	II	00525	004		12	120894	1/1/0001								
05800	S	M	CNT	II	00541	006		12	120894	1/1/0001								
05800	S	M	CNT	II	00544	005		12	120894	1/1/0001								

OFFICE: 311		ROUTE: 564		ST_REF_NO: 00000025400		BROWN AVENUE		LUMENS	BULB TYPE	MULT SERIES	POLE TYPE	SHADE	ADDRESS NUMBER	REF	LOCATION	TAX DIST	DATE INST	DATE CHANGE
05800	S	M	SOH	II	00109	145		12	100884	9/9/2009								
04000	S	M	SOH	II	00000	143	SIDE OF 1200 WINCHESTER RD.	12	100884	1/1/0001								
04000	S	M	SOH	II	00105	144		12	100884	1/1/0001								
04000	S	M	SOH	II	00119	147		12	100884	1/1/0001								
04000	S	M	SOH	II	00122	146		12	100884	1/1/0001								
04000	S	M	SOH	II	00130	148		12	100884	1/1/0001								
04000	S	M	SOH	II	00138	149		12	100884	1/1/0001								
04000	S	M	SOH	II	00144	150		12	100884	1/1/0001								
04000	S	M	SOH	II	00205	151		12	100884	1/1/0001								
04000	S	M	SOH	II	00211	152		12	100884	1/1/0001								

OFFICE: 311		ROUTE: 564		ST_REF_NO: 00000025500		BROWN COURT		LUMENS	BULB TYPE	MULT SERIES	POLE TYPE	SHADE	ADDRESS NUMBER	REF	LOCATION	TAX DIST	DATE INST	DATE CHANGE
05800	S	M	SOH	II	00538	000		12	010130	1/1/0001								

OFFICE: 311		ROUTE: 564		ST_REF_NO: 00000025700		BRUCE STREET		LUMENS	BULB TYPE	MULT SERIES	POLE TYPE	SHADE	ADDRESS NUMBER	REF	LOCATION	TAX DIST	DATE INST	DATE CHANGE
05800	S	M	SOH	II	00000	189	SIDE OF 468 W. 2ND. STREET	12	070566	1/1/0001								
05800	S	M	SOH	II	00139	000		12	070166	1/1/0001								
05800	S	M	SOH	II	00145	000		12	070566	1/1/0001								
05800	S	M	SOH	II	00150	000		12	070566	1/1/0001								
05800	S	M	SOH	II	00168	000		12	070566	1/1/0001								

OFFICE: 311		ROUTE: 564		ST_REF_NO: 0000025900		BRUNSWICK ROAD				
LUMENS	BULB TYPE	MULT SERIES	POLE TYPE	SHADE	ADDRESS NUMBER	REF	LOCATION	TAX DIST	DATE INST	DATE CHANGE
05800	S	M	OUG	II	00000	079	OPP. 3398	12	100885	10/2/2013
05800	S	M	OUG	II	03499	030		12	100885	9/9/2009
04000	S	M	OUG	II	03409	080		12	100885	1/1/0001
04000	S	M	OUG	II	03418	081		12	100885	1/1/0001
04000	S	M	OUG	II	03429	082		12	100885	1/1/0001
04000	S	M	OUG	II	03442	084		12	100885	1/1/0001
04000	S	M	OUG	II	03453	085		12	100885	1/1/0001
04000	S	M	OUG	II	03463	033		12	100885	1/1/0001
04000	S	M	OUG	II	03475	032		12	100885	1/1/0001
04000	S	M	OUG	II	03486	031		12	100885	1/1/0001

OFFICE: 311		ROUTE: 564		ST_REF_NO: 0000026000		BRUSH CREEK DRIVE				
LUMENS	BULB TYPE	MULT SERIES	POLE TYPE	SHADE	ADDRESS NUMBER	REF	LOCATION	TAX DIST	DATE INST	DATE CHANGE
04000	S	M	OUG	II	00000	206	SIDE OF 1104 CHINOE RD.	12	011581	1/1/0001
04000	S	M	OUG	II	03504	207		12	040888	1/1/0001

OFFICE: 311		ROUTE: 564		ST_REF_NO: 0000026200		BRYAN AVENUE				
LUMENS	BULB TYPE	MULT SERIES	POLE TYPE	SHADE	ADDRESS NUMBER	REF	LOCATION	TAX DIST	DATE INST	DATE CHANGE
09500	S	M	SOH	II	00000	006	OPP. 943	12	062167	9/9/2009
09500	S	M	SOH	II	00000	007	OPP. 833 - bad fixture	12	062167	9/14/2010
09500	S	M	SOH	II	00000	009	OPP. 1015	12	062167	9/9/2009
22000	S	M	SOH	II	00000	030	SIDE OF 304 NEW CIRCLE RD.	12	061477	9/9/2009
09500	S	M	SOH	II	00841	000	bad fixture	12	030167	11/18/2008
09500	S	M	SOH	II	00845	000		12	020167	9/9/2009
09500	S	M	SOH	II	01027	000	bad fixture	12	030167	11/18/2008
09500	S	M	SOH	II	01310	017		12	071367	9/9/2009
09500	S	M	SOH	II	01315	018		12	061477	9/9/2009
10000	M	M	SOH	II	01443	024		12	061477	6/14/1977
09500	S	M	SOH	II	01447	025	upgrade bad fixture 5/08	12	061477	9/9/2009
10000	M	M	SOH	II	00000	001	SIDE OF 780 N. LIME	12	022167	1/1/0001
10000	M	M	SOH	II	00000	002	150' S. OF E. LOUDON AVE., E. SIDE	12	030167	1/1/0001
09500	S	M	SOH	II	00000	003	SW CORNER OF LOUDON AVE.-upgraded 5/08 bad fix	12	022167	1/1/0001

OFFICE: 311

ROUTE: 564

ST_REF_NO: 00000026200

BRYAN AVENUE

LUMENS	BULB TYPE	MULT SERIES	POLE TYPE	SHADE	ADDRESS NUMBER	REF	LOCATION	TAX DIST	DATE INST	DATE CHANGE
10000	M	M	SOH	II	00000	004	NW CORNER OF LOUDON AVE.	12	022167	1/1/0001
10000	M	M	SOH	II	00000	008	OPP. 1003	12	062167	1/1/0001
10000	M	M	SOH	II	00000	011	SIDE OF 301 PARKVIEW AVE.	12	071367	1/1/0001
10000	M	M	SOH	II	00000	031	OPP. 995	12	062167	1/1/0001
10000	M	M	SOH	II	00000	032	OPP. OF 811	12	071367	1/1/0001
10000	M	M	SOH	II	00000	034	OPP. BURNETT AVE.	12	062167	1/1/0001
10000	M	M	SOH	II	00827	000		12	022167	1/1/0001
10000	M	M	SOH	II	00848	000		12	022167	1/1/0001
10000	M	M	SOH	II	00905	000		12	022167	1/1/0001
10000	M	M	SOH	II	00915	000		12	022167	1/1/0001
10000	M	M	SOH	II	00935	000		12	022167	1/1/0001
10000	M	M	SOH	II	01104	000		12	022167	1/1/0001
10000	M	M	SOH	II	01117	000		12	022167	1/1/0001
10000	M	M	SOH	II	00000	023	SIDE OF 400 MEADOW PARK	12	061477	1/1/0001
10000	M	M	SOH	II	00000	027	SIDE OF 400 EMERSON DR.	12	061477	1/1/0001
10000	M	M	SOH	II	00000	029	SIDE OF 274 NEW CIRCLE RD.	12	061477	1/1/0001
10000	M	M	SOH	II	01210	000		12	071367	1/1/0001
09500	S	M	SOH	II	01218	000		12	071367	1/1/0001
10000	M	M	SOH	II	01303	000		12	022167	1/1/0001
10000	M	M	SOH	II	01402	019		12	061477	1/1/0001
10000	M	M	SOH	II	01410	021		12	061477	1/1/0001
10000	M	M	SOH	II	01411	020		12	061477	1/1/0001
10000	M	M	SOH	II	01425	022		12	061477	1/1/0001
10000	M	M	SOH	II	01451	026		12	061477	1/1/0001
10000	M	M	SOH	II	01504	028		12	061477	1/1/0001

OFFICE: 311

ROUTE: 564

ST_REF_NO: 00000026300

BRYAN STATION PIKE

LUMENS	BULB TYPE	MULT SERIES	POLE TYPE	SHADE	ADDRESS NUMBER	REF	LOCATION	TAX DIST	DATE INST	DATE CHANGE
10000	M	M	OUG	III	00000	001	SIDE OF 307 E. NEW CIRCLE ROAD	12	110800	9/9/2009
10000	M	M	OUG	III	00000	002	2ND LT. E OF NEW CIRCLE ROAD, S SIDE	12	110800	9/9/2009
09500	S	M	OUG	III	00000	074	3RD LT. E OF PREAKNESS DRIVE, N SIDE	12	110800	9/9/2009
05800	S	M	OUG	III	00000	075	3RD LT. E OF PREAKNESS DR., S SIDE	12	110800	9/9/2009
05800	S	M	OUG	III	00000	076	1ST LT. W OF HUME ROAD, N SIDE	12	110800	9/9/2009

OFFICE: 311

ROUTE: 564

ST_REF_NO: 0000026300

BRYAN STATION PIKE

LUMENS	BULB TYPE	MULT SERIES	POLE TYPE	SHADE	ADDRESS NUMBER	REF	LOCATION	TAX DIST	DATE INST	DATE CHANGE
09500	S	M	SOH	II	00000	077	1st lt W of Hume Rd., S Side	12	110800	9/9/2009
05800	S	M	OUG	III	00000	078	opp Hume Rd.	12	110800	9/9/2009
05800	S	M	OUG	III	00000	079	1ST LT. E OF HUME ROAD, N SIDE	12	110800	9/9/2009
09500	S	M	SOH	II	00000	329	1ST LT. E OF BRIAR HILL RD., N SIDE	12	070899	9/9/2009
09500	S	M	SOH	III	00000	064	1ST LT. E OF I-75 BRIDGE, N SIDE	12	110800	1/1/0001
09500	S	M	OUG	III	00000	065	1ST LT. E OF I-75 BRIDGE, S SIDE	12	110800	1/1/0001
09500	S	M	OUG	III	00000	066	2ND LT. E OF I-75 BRIDGE, N SIDE	12	110800	1/1/0001
09500	S	M	OUG	III	00000	067	2ND LT. E OF I-75 BRIDGE, S SIDE	12	110800	1/1/0001
09500	S	M	OUG	III	00000	068	3RD LT. E OF I-75 BRIDGE, N SIDE	12	110800	1/1/0001
05800	S	M	OUG	I	00000	328	1ST LT. W OF BRIAR HILL RD., N SIDE	12	070899	1/1/0001
22000	S	M	OUG	III	00000	003	1ST LT. E OF NEW CIRCLE ROAD, N SIDE	12	110800	1/1/0001
22000	S	M	OUG	III	00000	004	3RD LT. E OF NEW CIRCLE ROAD, S SIDE	12	110800	1/1/0001
22000	S	M	OUG	III	00000	005	2ND LT. E OF NEW CIRCLE ROAD, N SIDE	12	110800	1/1/0001
22000	S	M	OUG	III	00000	006	4TH LT. E OF NEW CIRCLE ROAD, S SIDE	12	110800	1/1/0001
22000	S	M	OUG	III	00000	008	OPP. NORTHWOOD DRIVE	12	110800	1/1/0001
09500	S	M	OUG	III	00000	011	SIDE OF 388 ROOKWOOD PARKWAY	12	110800	1/1/0001
09500	S	M	OUG	III	00000	015	OPP. 1706	12	110800	1/1/0001
09500	S	M	OUG	III	00000	017	OPP. 1718	12	110800	1/1/0001
09500	S	M	OUG	III	00000	026	SIDE OF 402 MCKENNA COURT	12	110800	1/1/0001
09500	S	M	OUG	III	00000	027	SIDE OF 321 MARIEMONT DRIVE	12	110800	1/1/0001
09500	S	M	OUG	III	00000	029	SIDE OF 328 MARIEMONT DRIVE	12	110800	1/1/0001
09500	S	M	OUG	III	00000	031	SIDE OF 330 EASTIN ROAD	12	110800	1/1/0001
09500	S	M	OUG	III	00000	032	OPP. EASTIN ROAD	12	110800	1/1/0001
09500	S	M	OUG	III	00000	033	SIDE OF 331 EASTIN ROAD	12	110800	1/1/0001
09500	S	M	OUG	III	00000	035	SIDE 366 SIERRA DRIVE	12	110800	1/1/0001
09500	S	M	OUG	III	00000	037	OPP. 1824 BRYAN STATION RD. CORNER OF SIERRA DRIVE	21	110800	1/1/0001
09500	S	M	OUG	III	00000	039	OPP. ST. ANTHONY DRIVE	12	110800	1/1/0001
09500	S	M	OUG	III	00000	040	OPP. 1837	12	110800	1/1/0001
09500	S	M	OUG	III	00000	041	OPP. 1841	12	110800	1/1/0001
09500	S	M	OUG	III	00000	043	OPP. NORTHSIDE DRIVE	12	110800	1/1/0001
09500	S	M	OUG	III	00000	046	OPP. 1881	12	110800	1/1/0001
09500	S	M	OUG	III	00000	048	OPP. 1891	12	110800	1/1/0001
09500	S	M	OUG	III	00000	049	SIDE OF 396 HERMITAGE DRIVE	12	110800	1/1/0001

OFFICE: 311

ROUTE: 564

ST_REF_NO: 00000026300

BRYAN STATION PIKE

LUMENS	BULB TYPE	MULT SERIES	POLE TYPE	SHADE	ADDRESS NUMBER	REF	LOCATION	TAX DIST	DATE INST	DATE CHANGE
09500	S	M	OUG	III	00000	050	IN MEDIAN OF ANNISTON DRIVE	12	110800	1/1/0001
09500	S	M	OUG	III	00000	051	1ST LT. E OF ANNISTON DRIVE, N SIDE	12	110800	1/1/0001
09500	S	M	OUG	III	00000	052	1ST LT. E OF ANNISTON DRIVE, S SIDE	12	110800	1/1/0001
09500	S	M	OUG	III	00000	053	2ND LT. E OF ANNISTON DRIVE,S SIDE	12	110800	1/1/0001
09500	S	M	OUG	III	00000	054	2ND LT. E OF ANNISTON DRIVE, N SIDE	12	110800	1/1/0001
09500	S	M	OUG	III	00000	055	3RD LT. E OF ANNISTON DRIVE, S SIDE	12	110800	1/1/0001
09500	S	M	OUG	III	00000	056	3RD LT. E OF ANNISTON DRIVE, N SIDE	12	110800	1/1/0001
09500	S	M	OUG	III	00000	057	4TH LT. E OF ANNISTON DRIVE, S SIDE	12	110800	1/1/0001
09500	S	M	OUG	III	00000	058	4TH LT. E OF ANNISTON DRIVE, N SIDE	12	110800	1/1/0001
09500	S	M	OUG	III	00000	059	5TH LT. E OF ANNISTON DRIVE, S SIDE	12	110800	1/1/0001
09500	S	M	OUG	III	00000	060	5TH LT. E OF ANNISTON DRIVE, N SIDE	12	110800	1/1/0001
09500	S	M	OUG	III	00000	061	6TH LT. E OF ANNISTON DRIVE, S SIDE	12	110800	1/1/0001
09500	S	M	OUG	III	00000	062	6TH LT. E OF ANNISTON DRIVE, N SIDE	12	110800	1/1/0001
09500	S	M	OUG	III	00000	063	7TH LT. E OF ANNISTON DRIVE, S SIDE	21	110800	1/1/0001
09500	S	M	OUG	III	00000	069	OPP. PREAKNESS DRIVE, N SIDE	12	110800	1/1/0001
09500	S	M	OUG	III	00000	070	1ST LT. E OF PREAKNESS DRIVE, N SIDE	12	110800	1/1/0001
09500	S	M	OUG	III	00000	071	1ST LT. E OF PREAKNESS DRIVE, S SIDE	12	110800	1/1/0001
09500	S	M	OUG	III	00000	072	2ND LT. E OF PREAKNESS DRIVE, N SIDE	12	110800	1/1/0001
09500	S	M	OUG	III	00000	073	2ND LT. E OF PREAKNESS DRIVE, S SIDE	12	110800	1/1/0001
09500	S	M	SOH	II	00000	341	SE CORNER OF MUIR STATION ROAD	12	110800	1/1/0001
09500	S	M	OUG	III	01690	010		12	110800	1/1/0001
22000	S	M	OUG	III	01695	007		12	110800	1/1/0001
09500	S	M	OUG	III	01698	012		12	110800	1/1/0001
09500	S	M	OUG	III	01702	014		12	110800	1/1/0001
09500	S	M	OUG	III	01705	009		21	110800	1/1/0001
09500	S	M	OUG	III	01714	016		12	110800	1/1/0001
09500	S	M	OUG	III	01718	018		21	110800	1/1/0001
09500	S	M	OUG	III	01725	013		12	110800	1/1/0001
09500	S	M	OUG	III	01735	019		12	110800	1/1/0001
09500	S	M	OUG	III	01742	020		12	110800	1/1/0001
09500	S	M	OUG	III	01746	021		12	110800	1/1/0001
09500	S	M	OUG	III	01747	022		12	110800	1/1/0001
09500	S	M	OUG	III	01750	023		12	110800	1/1/0001
09500	S	M	OUG	III	01751	024		12	110800	1/1/0001

OFFICE: 311

ROUTE: 564

ST_REF_NO: 00000026300

BRYAN STATION PIKE

LUMENS	BULB TYPE	MULT SERIES	POLE TYPE	SHADE	ADDRESS NUMBER	REF	LOCATION	TAX DIST	DATE INST	DATE CHANGE
09500	S	M	OUG	III	01755	025		12	110800	1/1/0001
09500	S	M	OUG	III	01774	028		12	110800	1/1/0001
09500	S	M	OUG	III	01774	030		12	110800	1/1/0001
09500	S	M	OUG	III	01786	034		12	110800	1/1/0001
09500	S	M	OUG	III	01818	036		12	110800	1/1/0001
09500	S	M	OUG	III	01824	038		12	110800	1/1/0001
09500	S	M	OUG	III	01840	042		12	110800	1/1/0001
09500	S	M	OUG	III	01848	044		12	110800	1/1/0001
09500	S	M	OUG	III	01853	045		12	110800	1/1/0001
09500	S	M	OUG	III	01891	047		12	110800	1/1/0001

OFFICE: 311

ROUTE: 564

ST_REF_NO: 00000026600

BRYANT ROAD

LUMENS	BULB TYPE	MULT SERIES	POLE TYPE	SHADE	ADDRESS NUMBER	REF	LOCATION	TAX DIST	DATE INST	DATE CHANGE
09500	S	M	CNT	II	00000	001	1ST LT N OF PLEASANT RIDGE, W SIDE ON BRYANT RD	12	030307	1/1/0001
09500	S	M	CNT	II	00000	002	2ND LT N OF PLEASANT RIDGE, W SIDE ON BRYANT RD	12	030307	1/1/0001
09500	S	M	CNT	II	00000	003	3RD LT N OF PLEASANT RIDGE, W SIDE ON BRYANT RD	12	030307	1/1/0001
09500	S	M	CNT	II	00000	004	4TH LT N OF PLEASANT RIDGE, W SIDE ON BRYANT RD	12	030307	1/1/0001
09500	S	M	CNT	II	00000	005	5TH LT N OF PLEASANT RIDGE, W SIDE ON BRYANT RD	12	030307	1/1/0001
09500	S	M	CNT	II	00000	006	6TH LT N OF PLEASANT RIDGE, W SIDE ON BRYANT RD	12	030307	1/1/0001
09500	S	M	CNT	II	00000	007	1ST LT E OF PLAUDIT PL, N SIDE ON BRYANT RD	12	030307	1/1/0001
09500	S	M	CNT	II	00000	008	2ND LT E OF PLAUDIT PL, N SIDE ON BRYANT RD	12	030307	1/1/0001
09500	S	M	CNT	II	00000	009	3RD LT E OF PLAUDIT PL, N SIDE ON BRYANT RD	12	030307	1/1/0001
09500	S	M	CNT	II	00000	010	4TH LT E OF PLAUDIT PL, N SIDE ON BRYANT RD	12	030307	1/1/0001
09500	S	M	CNT	II	00000	011	5TH LT E OF PLAUDIT PL, N SIDE ON BRYANT RD	12	030307	1/1/0001
09500	S	M	CNT	II	00000	012	1ST LT E OF JUSTICE DR, N SIDE ON BRYANT RD	12	030307	1/1/0001
09500	S	M	CNT	II	00000	013	2ND LT E OF JUSTICE DR, N SIDE ON BRYANT RD	12	030307	1/1/0001
09500	S	M	CNT	II	00000	014	3RD LT E OF JUSTICE DR, N SIDE ON BRYANT RD	12	030307	1/1/0001
09500	S	M	CNT	II	00000	015	4TH LT E OF JUSTICE DR, N SIDE ON BRYANT RD	12	030307	1/1/0001
09500	S	M	CNT	II	00000	016	5TH LT E OF JUSTICE DR, N SIDE ON BRYANT RD	12	030307	1/1/0001

OFFICE: 311		ROUTE: 564		ST_REF_NO: 00000026600		BRYANT ROAD		LUMENS	BULB TYPE	MULT SERIES	POLE TYPE	SHADE	ADDRESS NUMBER	REF	LOCATION	TAX DIST	DATE INST	DATE CHANGE
09500	S	M	CNT	II	00000	017	6TH LT E OF JUSTICE DR, N SIDE ON BRYANT RD	12	030307	1/1/0001								
09500	S	M	CNT	II	00000	018	7TH LT E OF JUSTICE DR, N SIDE ON BRYANT RD	12	030307	1/1/0001								
09500	S	M	CNT	II	00000	019	8TH LT E OF JUSTICE DR, N SIDE ON BRYANT RD	12	030307	1/1/0001								

OFFICE: 311		ROUTE: 564		ST_REF_NO: 00000026700		BRYANWOOD PARKWAY		LUMENS	BULB TYPE	MULT SERIES	POLE TYPE	SHADE	ADDRESS NUMBER	REF	LOCATION	TAX DIST	DATE INST	DATE CHANGE
05800	S	M	OUG	II	00000	008	SIDE OF 1774 BRYAN STATION SERVICE RD., IN MEDIAN	12	050466	1/1/0001								
05800	S	M	OUG	II	00000	009	SIDE OF 1782 BRYAN STATION PIKE, IN MEDIAN	12	050466	1/1/0001								
05800	S	M	OUG	II	00000	010	OPP. 404 , IN MEDIAN	12	050466	1/1/0001								
05800	S	M	OUG	II	00000	011	OPP. 405 , IN MEDIAN	12	050466	1/1/0001								
05800	S	M	OUG	II	00412	000		12	050466	1/1/0001								
05800	S	M	OUG	II	00429	000		12	050466	1/1/0001								
05800	S	M	OUG	II	00500	000		12	060166	1/1/0001								
05800	S	M	OUG	II	00509	000		12	050466	1/1/0001								
05800	S	M	OUG	II	00517	000		12	050466	1/1/0001								
05800	S	M	OUG	II	00532	022		12	081475	1/1/0001								
05800	S	M	OUG	II	00537	161		12	081475	1/1/0001								
05800	S	M	OUG	II	00548	160		12	071476	1/1/0001								
05800	S	M	OUG	II	00557	159		12	081475	1/1/0001								
05800	S	M	OUG	II	00569	157		12	101478	1/1/0001								
05800	S	M	OUG	II	00572	158		12	121475	1/1/0001								
05800	S	M	OUG	II	00592	156		12	121475	1/1/0001								
05800	S	M	OUG	II	00600	167		12	081475	1/1/0001								
05800	S	M	OUG	II	00605	168		12	081475	1/1/0001								

OFFICE: 311		ROUTE: 564		ST_REF_NO: 00000026750		BRYCE POINT DRIVE		LUMENS	BULB TYPE	MULT SERIES	POLE TYPE	SHADE	ADDRESS NUMBER	REF	LOCATION	TAX DIST	DATE INST	DATE CHANGE
05800	S	M	CNT	II	01005	001		12	102103	1/1/0001								
05800	S	M	CNT	II	01021	002		12	102103	1/1/0001								
05800	S	M	CNT	III	01029	003		12	102103	1/1/0001								

OFFICE: 311

ROUTE: 564

ST_REF_NO: 00000026800

BRYNELL

LUMENS	BULB TYPE	MULT SERIES	POLE TYPE	SHADE	ADDRESS NUMBER	REF	LOCATION	TAX DIST	DATE INST	DATE CHANGE
05800	S	M	OUG	II	00000	024	SIDE OF 572 NORTHSIDE DRIVE	12	060164	1/1/0001
05800	S	M	OUG	II	00000	025	SIDE OF 601 ST. ANTHONY	12	060164	1/1/0001
05800	S	M	OUG	II	00000	026	SIDE OF 596 ST. ANTHONY	12	060164	1/1/0001
05800	S	M	OUG	II	00000	027	SIDE OF 617 HI CREST DRIVE	12	050164	1/1/0001
05800	S	M	OUG	II	00000	028	SIDE OF 616 HI CREST DRIVE	12	050164	1/1/0001
05800	S	M	OUG	II	00000	031	SIDE OF 601 BELLCASTLE	12	060166	1/1/0001
05800	S	M	OUG	II	00000	044	SIDE OF 601 NORTHSIDE DR.	12	111478	1/1/0001
05800	S	M	OUG	II	00000	063	OPPOSITE 1904, SIDE OF SCHOOL YARD	12	042264	1/1/0001
05800	S	M	OUG	II	00000	065	OPPOSITE 1932, SIDE OF SCHOOL YARD	12	042264	1/1/0001
05800	S	M	OUG	II	00000	171	SIDE OF 600 BERESFORD	12	041476	1/1/0001
05800	S	M	OUG	II	01752	169		12	071476	1/1/0001
05800	S	M	OUG	II	01761	000		12	071476	1/1/0001
05800	S	M	OUG	II	01777	032		12	081475	1/1/0001
05800	S	M	OUG	II	01916	064		12	042264	1/1/0001
05800	S	M	OUG	II	01940	000		12	061565	1/1/0001
05800	S	M	OUG	II	01949	000		12	042264	1/1/0001
05800	S	M	OUG	II	01960	000		12	042264	1/1/0001
05800	S	M	OUG	II	01975	000		12	061465	1/1/0001
05800	S	M	OUG	II	01988	000		12	042264	1/1/0001
05800	S	M	OUG	II	01999	000		12	042264	1/1/0001

OFFICE: 311

ROUTE: 564

ST_REF_NO: 00000026900

BUCHANAN STREET

LUMENS	BULB TYPE	MULT SERIES	POLE TYPE	SHADE	ADDRESS NUMBER	REF	LOCATION	TAX DIST	DATE INST	DATE CHANGE
05800	S	M	SOH	II	00000	001	1ST LT. S. OF MAIN	12	021163	1/1/0001
05800	S	M	SOH	II	00000	002	2ND LT. S. OF MAIN	12	021163	1/1/0001
05800	S	M	SOH	II	00000	003	3RD LT. S. OF MAIN	12	021163	1/1/0001

OFFICE: 311

ROUTE: 564

ST_REF_NO: 00000027000

BUCK LANE

LUMENS	BULB TYPE	MULT SERIES	POLE TYPE	SHADE	ADDRESS NUMBER	REF	LOCATION	TAX DIST	DATE INST	DATE CHANGE
05800	S	M	CNT	II	00000	001	SIDE OF 208 LUCILLE DR ON BUCK LANE	12	042605	1/1/0001
05800	S	M	CNT	II	00000	005	SIDE OF 2672 MICHELLE PARK ON BUCK LANE	12	042605	1/1/0001
09500	S	M	OUG	II	00000	014	SIDE OF 499 CONWAY COURT ON BUCK LANE	12	041101	1/1/0001

OFFICE: 311

ROUTE: 564

ST_REF_NO: 0000027000 BUCK LANE

LUMENS	BULB TYPE	MULT SERIES	POLE TYPE	SHADE	ADDRESS NUMBER	REF	LOCATION	TAX DIST	DATE INST	DATE CHANGE
09500	S	M	OUG	II	00000	015	OPPOSITE 2088 BUCK LANE	12	041101	1/1/0001
05800	S	M	CNT	II	00000	030	SIDE OF 2553 MICHELLE PARK ON BUCK LANE	12	062405	1/1/0001
05800	S	M	CNT	II	00000	043	SIDE OF 301 SPRING VALLEY LANE ON BUCK LANE	12	090602	1/1/0001
05800	S	M	CNT	II	00000	044	SIDE OF 301 DARENIA LANE ON BUCK LANE	12	090602	1/1/0001
09500	S	M	OUG	II	02001	001		12	041101	1/1/0001
09500	S	M	OUG	II	02001	002		12	041101	1/1/0001
09500	S	M	OUG	II	02001	003		12	041101	1/1/0001
09500	S	M	OUG	II	02029	004		12	041101	1/1/0001
09500	S	M	OUG	II	02037	006		12	041101	1/1/0001
09500	S	M	OUG	II	02044	008		12	041101	1/1/0001
09500	S	M	OUG	II	02044	009		12	041101	1/1/0001
09500	S	M	OUG	II	02060	012		12	041101	1/1/0001
09500	S	M	OUG	II	02088	016		12	041101	1/1/0001
05800	S	M	CNT	II	02500	040		12	090602	1/1/0001
05800	S	M	CNT	II	02513	041		12	090602	1/1/0001
05800	S	M	CNT	II	02528	042		12	090602	1/1/0001
05800	S	M	CNT	II	02549	006		12	042605	1/1/0001
05800	S	M	CNT	II	02573	034		12	062405	1/1/0001
05800	S	M	CNT	II	02601	004		12	042605	1/1/0001
05800	S	M	CNT	II	02613	003		12	042605	1/1/0001
05800	S	M	CNT	II	02637	002		12	042605	1/1/0001
09500	S	M	OUG	II	02029	005		12	011581	1/1/0001
09500	S	M	OUG	II	02037	007		12	050969	1/1/0001
09500	S	M	OUG	II	02044	010		12	061580	1/1/0001
09500	S	M	OUG	II	02061	011		12	061580	1/1/0001
09500	S	M	OUG	II	02061	013		12	061580	1/1/0001

OFFICE: 311

ROUTE: 564

ST_REF_NO: 0000027100 BUCKHORN DRIVE

LUMENS	BULB TYPE	MULT SERIES	POLE TYPE	SHADE	ADDRESS NUMBER	REF	LOCATION	TAX DIST	DATE INST	DATE CHANGE
05800	S	M	OUG	II	00000	045	SIDE OF 644 SQUIRES RD.	12	111478	1/1/0001
05800	S	M	OUG	II	00000	077	SIDE OF 1008 NICOLET CT.	12	061580	1/1/0001
05800	S	M	OUG	II	00000	078	OPP. 3261	12	011584	1/1/0001
05800	S	M	OUG	II	00000	115	OPP. 3320	12	050887	1/1/0001

OFFICE: 311		ROUTE: 564		ST_REF_NO: 0000027100		BUCKHORN DRIVE		LUMENS	BULB TYPE	MULT SERIES	POLE TYPE	SHADE	ADDRESS NUMBER	REF	LOCATION	TAX DIST	DATE INST	DATE CHANGE
05800	S	M	OUG	II	00000	116	SIDE OF 1260 FENWICK RD.	12	011581	1/1/0001								
05800	S	M	OUG	II	00000	117	SIDE 1261 FENWICK	12	110884	1/1/0001								
05800	S	M	OUG	II	03205	046		12	111478	1/1/0001								
05800	S	M	OUG	II	03212	047		12	111478	1/1/0001								
05800	S	M	OUG	II	03217	048		12	111579	1/1/0001								
05800	S	M	OUG	II	03220	072		12	010888	1/1/0001								
05800	S	M	OUG	II	03233	073		12	061580	1/1/0001								
05800	S	M	OUG	II	03236	074		12	010888	1/1/0001								
05800	S	M	OUG	II	03241	075		12	061580	1/1/0001								
05800	S	M	OUG	II	03248	076		12	010888	1/1/0001								
05800	S	M	OUG	II	03272	080		12	011581	1/1/0001								
05800	S	M	OUG	II	03273	079		12	061580	1/1/0001								
05800	S	M	OUG	II	03285	081		12	010888	1/1/0001								
05800	S	M	OUG	II	03288	082		12	111580	1/1/0001								
05800	S	M	OUG	II	03293	083		12	061580	1/1/0001								
05800	S	M	OUG	II	03300	092		12	050887	1/1/0001								
05800	S	M	OUG	II	03309	091		12	051581	1/1/0001								
05800	S	M	OUG	II	03312	090		12	050887	1/1/0001								
05800	S	M	OUG	II	03341	118		12	050887	1/1/0001								

OFFICE: 311		ROUTE: 564		ST_REF_NO: 0000027200		BUCKINGHAM LANE		LUMENS	BULB TYPE	MULT SERIES	POLE TYPE	SHADE	ADDRESS NUMBER	REF	LOCATION	TAX DIST	DATE INST	DATE CHANGE
04000	S	M	OUG	II	00000	010	SIDE 3128 ARROWHEAD DR. ON BUCKINGHAM LANE	12	100890	1/1/0001								
04000	S	M	OUG	II	00657	009		12	120890	1/1/0001								
04000	S	M	OUG	II	00000	008	OPP. 637 BUCKINGHAM LANE	12	120890	1/1/0001								
04000	S	M	OUG	II	00566	001		12	120890	1/1/0001								
04000	S	M	OUG	II	00569	002		12	120890	1/1/0001								
04000	S	M	OUG	II	00586	003		12	120890	1/1/0001								
04000	S	M	OUG	II	00593	004		12	120890	1/1/0001								
04000	S	M	OUG	II	00600	006		12	120890	1/1/0001								
04000	S	M	OUG	II	00601	005		12	120890	1/1/0001								
04000	S	M	OUG	II	00625	007		12	120890	1/1/0001								

OFFICE: 311

ROUTE: 564

ST_REF_NO: 00000027210

BUCKLAND PLACE

LUMENS	BULB TYPE	MULT SERIES	POLE TYPE	SHADE	ADDRESS NUMBER	REF	LOCATION	TAX DIST	DATE INST	DATE CHANGE
05800	S	M	OUG	II	04301	001		12	040894	1/1/0001
05800	S	M	OUG	II	04312	002		12	040894	1/1/0001
05800	S	M	OUG	II	04329	003		12	040894	1/1/0001

OFFICE: 311

ROUTE: 564

ST_REF_NO: 00000027230

BUCKNER COURT

LUMENS	BULB TYPE	MULT SERIES	POLE TYPE	SHADE	ADDRESS NUMBER	REF	LOCATION	TAX DIST	DATE INST	DATE CHANGE
05800	S	M	CNT	II	00000	001	SIDE OF 1780 CHANDLER LANE	12	120800	1/1/0001
05800	S	M	CNT	II	01708	002		12	120800	1/1/0001
05800	S	M	CNT	III	01728	003		12	120800	1/1/0001

OFFICE: 311

ROUTE: 564

ST_REF_NO: 00000027300

BUCOTO COURT

LUMENS	BULB TYPE	MULT SERIES	POLE TYPE	SHADE	ADDRESS NUMBER	REF	LOCATION	TAX DIST	DATE INST	DATE CHANGE
04000	S	M	SOH	I	00000	001	AT END OF COURT	12	120424	1/1/0001
04000	S	M	SOH	I	00000	497	SIDE OF 840 S. BROADWAY	12	100267	1/1/0001
04000	S	M	SOH	I	00367	000		12	100567	1/1/0001
04000	S	M	SOH	I	00378	000		12	100567	1/1/0001

OFFICE: 311

ROUTE: 564

ST_REF_NO: 00000027310

BUENA VISTA ROAD

LUMENS	BULB TYPE	MULT SERIES	POLE TYPE	SHADE	ADDRESS NUMBER	REF	LOCATION	TAX DIST	DATE INST	DATE CHANGE
05800	S	M	OUG	II	00000	002	SIDE OF 2280 EXECUTIVE DR.	12	120892	1/1/0001
05800	S	M	OUG	II	00000	009	SIDE 2291 ELKHORN	12	050886	1/1/0001
05800	S	M	OUG	II	00000	010	SIDE OF 2271 ELKHORN	12	081582	1/1/0001
05800	S	M	OUG	II	00000	014	OPP. 2341	12	110884	1/1/0001
05800	S	M	OUG	II	00000	015	OPP. 2351	12	110884	1/1/0001
05800	S	M	OUG	II	00000	016	OPP. 2351	12	110884	1/1/0001
05800	S	M	OUG	II	00000	017	OPP. 2351	12	110884	1/1/0001
05800	S	M	OUG	II	00000	018	REAR OF 2260 ELKHORN	12	120892	1/1/0001
05800	S	M	OUG	II	00000	019	2371 BUENA VISTA RD., SOUTHSIDE	12	120892	1/1/0001
05800	S	M	OUG	II	00000	020	2371 BUENA VISTA RD., NORTHSIDE	12	120892	1/1/0001
05800	S	M	OUG	II	00000	021	2381 BUENA VISTA RD., SOUTHSIDE	12	120892	1/1/0001
05800	S	M	OUG	II	00000	022	2381 BUENA VISTA RD., NORTHSIDE	12	120892	1/1/0001

OFFICE: 311

ROUTE: 564

ST_REF_NO: 0000027310

BUENA VISTA ROAD

LUMENS	BULB TYPE	MULT SERIES	POLE TYPE	SHADE	ADDRESS NUMBER	REF	LOCATION	TAX DIST	DATE INST	DATE CHANGE
05800	S	M	OUG	II	00000	023	2391 BUENA VISTA RD., SOUTHSIDE	12	120892	1/1/0001
05800	S	M	OUG	II	00000	024	2391 BUENA VISTA RD., NORTHSIDE	12	120892	1/1/0001
05800	S	M	OUG	II	00000	027	SIDE OF 2220 ELKHORN RD.	12	120892	1/1/0001
05800	S	M	OUG	II	02240	003		12	120892	1/1/0001
05800	S	M	OUG	II	02260	005		12	120889	1/1/0001
05800	S	M	OUG	II	02280	007		12	120889	1/1/0001
05800	S	M	OUG	II	02281	006		12	120889	1/1/0001
05800	S	M	OUG	II	02331	011		12	050886	1/1/0001
05800	S	M	OUG	II	02331	012		12	050886	1/1/0001
05800	S	M	OUG	II	02340	013		12	110884	1/1/0001
09500	S	M	OUG	II	02400	028		12	120892	1/1/0001
05800	S	M	OUG	II	02401	025		12	120892	1/1/0001
05800	S	M	OUG	II	02401	026		12	120892	1/1/0001

OFFICE: 311

ROUTE: 564

ST_REF_NO: 0000027390

BULL LEA ROAD

LUMENS	BULB TYPE	MULT SERIES	POLE TYPE	SHADE	ADDRESS NUMBER	REF	LOCATION	TAX DIST	DATE INST	DATE CHANGE
22000	S		OUG	II	00000	050	1ST LT S OF CITATION, E SIDE OF BULL LEA ROAD	12	011314	1/1/0001
22000	S		OUG	II	00000	051	1ST LT S OF CITATION, W SIDE OF BULL LEA ROAD	12	011314	1/1/0001
22000	S		OUG	II	00000	052	2ND LT S OF CITATION, E SIDE OF BULL LEA ROAD	12	011314	1/1/0001
22000	S		OUG	II	00000	053	2ND LT S OF CITATION, W SIDE OF BULL LEA ROAD	12	011314	1/1/0001
22000	S		OUG	II	00000	054	3RD LT S OF CITATION, E SIDE OF BULL LEA ROAD	12	011314	1/1/0001
22000	S		OUG	II	00000	055	3RD LT S OF CITATION, W SIDE OF BULL LEA ROAD	12	011314	1/1/0001
09500	S		OUG	II	00000	056	4TH LT S OF CITATION, E SIDE OF BULL LEA ROAD	12	011314	1/1/0001
09500	S		OUG	II	00000	057	4TH LT S OF CITATION, W SIDE OF BULL LEA ROAD	12	011314	1/1/0001
09500	S		OUG	II	00000	058	5TH LT S OF CITATION, E SIDE OF BULL LEA ROAD	12	011314	1/1/0001
22000	S	M	CNT	II	00000	001	2ST LT N OF CITATION BLVD, E SIDE ON BULL LEA ROAD	12	123101	1/1/0001
22000	S	M	CNT	II	00000	002	2ND LT N OF CITATION BLVD, W SIDE ON BULL LEA ROAD	12	123101	1/1/0001
22000	S	M	CNT	II	00000	003	2ND LT N OF CITATION BLVD, E SIDE ON BULL LEA ROAD	12	123101	1/1/0001
22000	S	M	CNT	II	00000	004	3RD LT N OF CITATION BLVD, W SIDE ON BULL LEA ROAD	12	123101	1/1/0001
22000	S	M	CNT	II	00000	005	3RD LT N OF CITATION BLVD, E SIDE ON BULL LEA ROAD	12	123101	1/1/0001

OFFICE: 311		ROUTE: 564		ST_REF_NO: 00000027390		BULL LEA ROAD		LUMENS	BULB TYPE	MULT SERIES	POLE TYPE	SHADE	ADDRESS NUMBER	REF	LOCATION	TAX DIST	DATE INST	DATE CHANGE
22000	S	M	CNT	II	00000	006	4TH LT N OF CITATION BLVD, W SIDE ON BULL LEA ROAD	12	123101	1/1/0001								
22000	S	M	CNT	II	00000	007	4TH LT N OF CITATION BLVD, E SIDE ON BULL LEA ROAD	12	123101	1/1/0001								
22000	S	M	CNT	II	00000	008	5TH LT N OF CITATION BLVD, W SIDE ON BULL LEA ROAD	12	123101	1/1/0001								
22000	S	M	CNT	II	00000	009	5TH LT N OF CITATION BLVD, E SIDE ON BULL LEA ROAD	12	123101	1/1/0001								
22000	S	M	CNT	II	00000	010	6TH LT N OF CITATION BLVD, W SIDE ON BULL LEA ROAD	12	123101	1/1/0001								
22000	S	M	CNT	II	00000	011	6TH LT N OF CITATION BLVD, E SIDE ON BULL LEA ROAD	12	123101	1/1/0001								
22000	S	M	CNT	II	00000	012	7TH LT N OF CITATION BLVD, W SIDE ON BULL LEA ROAD	12	123101	1/1/0001								
22000	S	M	CNT	II	00000	013	7TH LT N OF CITATION BLVD, E SIDE ON BULL LEA ROAD	12	123101	1/1/0001								
22000	S	M	CNT	II	00000	014	8TH LT N OF CITATION BLVD, W SIDE ON BULL LEA ROAD	12	123101	1/1/0001								
22000	S	M	CNT	II	00000	015	8TH LT N OF CITATION BLVD, E SIDE ON BULL LEA ROAD	12	123101	1/1/0001								
22000	S	M	CNT	II	00000	016	9TH LT N OF CITATION BLVD, W SIDE ON BULL LEA ROAD	12	123101	1/1/0001								
22000	S	M	CNT	II	00000	017	9TH LT N OF CITATION BLVD, E SIDE ON BULL LEA ROAD	12	123101	1/1/0001								
22000	S	M	CNT	II	00000	999	1ST LT N OF CITATION BLVD, W SIDE ON BULL LEA ROAD	12	123101	1/1/0001								
OFFICE: 311		ROUTE: 564		ST_REF_NO: 00000027400		BULLOCK PLACE		LUMENS	BULB TYPE	MULT SERIES	POLE TYPE	SHADE	ADDRESS NUMBER	REF	LOCATION	TAX DIST	DATE INST	DATE CHANGE
04000	S	S	SOH	II	00701	000		12	010162	1/1/0001								
04000	S	S	SOH	II	00704	000		12	010162	1/1/0001								
04000	S	M	SOH	II	00719	000		12	010162	1/1/0001								
04000	S	S	SOH	II	00732	000		12	010162	1/1/0001								

OFFICE: 311

ROUTE: 564

ST_REF_NO: 00000027500

BURBANK COURT

LUMENS	BULB TYPE	MULT SERIES	POLE TYPE	SHADE	ADDRESS NUMBER	REF	LOCATION	TAX DIST	DATE INST	DATE CHANGE
05800	S	M	OUG	II	00612	007		12	081583	9/9/2009
05800	S	M	OUG	V	00601	008	upgrade 1/08	12	081583	1/1/0001
04000	S	M	OUG	II	00624	006		12	081583	1/1/0001

OFFICE: 311

ROUTE: 564

ST_REF_NO: 00000027600

BURBANK DRIVE

LUMENS	BULB TYPE	MULT SERIES	POLE TYPE	SHADE	ADDRESS NUMBER	REF	LOCATION	TAX DIST	DATE INST	DATE CHANGE
09500	S	M	OUG	II	00000	003	SIDE OF 2400 HARRODSBURG RD.	12	081583	1/1/0001
09500	S	M	OUG	III	00000	005	SIDE OF 2401 TULSA	12	081583	1/1/0001
09500	S	M	OUG	II	00637	004		12	081583	1/1/0001

OFFICE: 311

ROUTE: 564

ST_REF_NO: 00000027675

BURGIN PASS

LUMENS	BULB TYPE	MULT SERIES	POLE TYPE	SHADE	ADDRESS NUMBER	REF	LOCATION	TAX DIST	DATE INST	DATE CHANGE
05800	S	M	CNT	II	00000	001	1ST LT E OF MARCUS DR,NORTH SIDE ON BURGIN PASS	12	070806	1/1/0001
05800	S	M	CNT	II	00000	002	2ND LIGHT E OF MARCUS DR,NORTH SIDE ON BURGIN PASS	12	070806	1/1/0001

OFFICE: 311

ROUTE: 564

ST_REF_NO: 00000027700

BURGOYNE COURT

LUMENS	BULB TYPE	MULT SERIES	POLE TYPE	SHADE	ADDRESS NUMBER	REF	LOCATION	TAX DIST	DATE INST	DATE CHANGE
09500	S	M	OUG	II	00717	000		12	031868	9/9/2009

OFFICE: 311

ROUTE: 564

ST_REF_NO: 00000027780

BURGESS AVENUE

LUMENS	BULB TYPE	MULT SERIES	POLE TYPE	SHADE	ADDRESS NUMBER	REF	LOCATION	TAX DIST	DATE INST	DATE CHANGE
05800	S		OUG	II	00000	002	SIDE OF 1796 MILLBANK RD ON BURGESS AVENUE	12	031909	1/1/0001
05800	S		OUG	II	00000	003	SIDE OF 1801 MILLBANK RD ON BURGESS AVENUE	12	031909	1/1/0001
05800	S		OUG	II	00000	010	SIDE OF 1668 MCCULLOUGH DR ON BURGESS AVENUE	12	031909	1/1/0001
05800	S		OUG	II	00705	001		12	031909	1/1/0001
05800	S		OUG	II	00724	004		12	031909	1/1/0001
05800	S		OUG	II	00737	005		12	031909	1/1/0001
05800	S		OUG	II	00756	006		12	031909	1/1/0001
05800	S		OUG	II	00765	007		12	031909	1/1/0001

OFFICE: 311

ROUTE: 564

ST_REF_NO: 00000027780

BURGESS AVENUE

LUMENS	BULB TYPE	MULT SERIES	POLE TYPE	SHADE	ADDRESS NUMBER	REF	LOCATION	TAX DIST	DATE INST	DATE CHANGE
05800	S		OUG	II	00780	008		12	031909	1/1/0001
05800	S		OUG	II	00797	009		12	031909	1/1/0001

OFFICE: 311

ROUTE: 564

ST_REF_NO: 00000027800

BURGOYNE DRIVE

LUMENS	BULB TYPE	MULT SERIES	POLE TYPE	SHADE	ADDRESS NUMBER	REF	LOCATION	TAX DIST	DATE INST	DATE CHANGE
05800	S	M	OUG	II	00000	035	SIDE OF 2378 PIERSON DR.	12	031868	1/1/0001
05800	S	M	OUG	II	00701	000		12	031868	1/1/0001

OFFICE: 311

ROUTE: 564

ST_REF_NO: 00000027900

BURKE ROAD

LUMENS	BULB TYPE	MULT SERIES	POLE TYPE	SHADE	ADDRESS NUMBER	REF	LOCATION	TAX DIST	DATE INST	DATE CHANGE
10000	M	M	OUG	II	00000	131	SIDE OF 1499 MEADOWTHORPE AVE.	12	121582	1/1/0001
09500	S	M	OUG	III	00000	154	SIDE OF 1519 LEESTOWN RD.	12	010887	1/1/0001
05800	S	M	OUG	II	00212	132		12	121582	1/1/0001
05800	S	M	OUG	II	00219	133		12	121582	1/1/0001
05800	S	M	OUG	II	00240	134		12	121582	1/1/0001
05800	S	M	OUG	II	00247	135		12	121582	1/1/0001
05800	S	M	OUG	II	00259	136		12	121582	1/1/0001
05800	S	M	OUG	II	00271	137		12	121582	1/1/0001
05800	S	M	OUG	II	00288	138		12	121582	1/1/0001

OFFICE: 311

ROUTE: 564

ST_REF_NO: 00000027980

BURKEWOOD DRIVE

LUMENS	BULB TYPE	MULT SERIES	POLE TYPE	SHADE	ADDRESS NUMBER	REF	LOCATION	TAX DIST	DATE INST	DATE CHANGE
05800	S	M	OUG	II	00000	002	SIDE OF 2196 HADDON DR.	12	110899	1/1/0001
05800	S	M	OUG	II	00000	007	SIDE OF 872	12	110899	1/1/0001
05800	S	M	OUG	II	00000	011	NE CORNER OF LIBERTY RD.	12	110899	1/1/0001
05800	S	M	OUG	II	00800	001		12	110899	1/1/0001
05800	S	M	OUG	II	00816	003		12	110899	1/1/0001
05800	S	M	OUG	II	00829	004		12	110899	1/1/0001
05800	S	M	OUG	II	00849	006		12	110899	1/1/0001
05800	S	M	OUG	II	00881	008		12	110899	1/1/0001
05800	S	M	OUG	II	00892	009		12	110899	1/1/0001

OFFICE: 311		ROUTE: 564		ST_REF_NO: 00000027980		BURKEWOOD DRIVE		LUMENS	BULB TYPE	MULT SERIES	POLE TYPE	SHADE	ADDRESS NUMBER	REF	LOCATION	TAX DIST	DATE INST	DATE CHANGE
	05800	S	M	OUG	II	00909	010									12	110899	1/1/0001
OFFICE: 311		ROUTE: 564		ST_REF_NO: 00000028100		BURLEY AVENUE		LUMENS	BULB TYPE	MULT SERIES	POLE TYPE	SHADE	ADDRESS NUMBER	REF	LOCATION	TAX DIST	DATE INST	DATE CHANGE
	05800	S	M	SOH	II	00106	027									12	040886	9/9/2009
	04000	S	M	SOH	II	00000	017	SIDE OF 1200 S. BROADWAY								12	040886	1/1/0001
	04000	S	M	SOH	II	00000	018	352 - 360								12	040886	1/1/0001
	04000	S	M	SOH	II	00100	028									12	040886	1/1/0001
	04000	S	M	SOH	II	00116	026									12	040886	1/1/0001
	04000	S	M	SOH	II	00124	025									12	040886	1/1/0001
	04000	S	M	SOH	II	00136	024									12	040886	1/1/0001
	04000	S	M	SOH	II	00149	023									12	050886	1/1/0001
	04000	S	M	SOH	II	00206	022									12	040886	1/1/0001
	04000	S	M	SOH	II	00310	021									12	040886	1/1/0001
	04000	S	M	SOH	II	00320	020									12	040886	1/1/0001
	04000	S	M	SOH	II	00340	019									12	040886	1/1/0001
OFFICE: 311		ROUTE: 564		ST_REF_NO: 00000028200		BURNETT AVENUE		LUMENS	BULB TYPE	MULT SERIES	POLE TYPE	SHADE	ADDRESS NUMBER	REF	LOCATION	TAX DIST	DATE INST	DATE CHANGE
	05800	S	M	SOH	I	00000	001	SIDE OF 908-910 N. LIMESTONE								12	081657	1/1/0001
	05800	S	M	SOH	I	00118	000									12	081657	1/1/0001
	05800	S	M	SOH	I	00126	000									12	081657	1/1/0001
	05800	S	M	SOH	I	00138	000									12	081657	1/1/0001
	05800	S	M	SOH	I	00152	000									12	081657	1/1/0001
	05800	S	M	SOH	I	00164	000									12	081657	1/1/0001
	05800	S	M	SOH	I	00172	000									12	081657	1/1/0001
OFFICE: 311		ROUTE: 564		ST_REF_NO: 00000028315		BURNS COURT		LUMENS	BULB TYPE	MULT SERIES	POLE TYPE	SHADE	ADDRESS NUMBER	REF	LOCATION	TAX DIST	DATE INST	DATE CHANGE
	05800	S	M	CNT	II	00000	001	SIDE OF 3389 MALONE DRIVE								12	110800	1/1/0001
	05800	S	M	CNT	II	02204	002									12	110800	1/1/0001

OFFICE: 311		ROUTE: 564		ST_REF_NO: 00000028315		BURNS COURT		TAX DIST	DATE INST	DATE CHANGE
LUMENS	BULB TYPE	MULT SERIES	POLE TYPE	SHADE	ADDRESS NUMBER	REF	LOCATION	TAX DIST	DATE INST	DATE CHANGE
05800	S	M	CNT	II	02216	003		12	110800	1/1/0001
OFFICE: 311		ROUTE: 564		ST_REF_NO: 00000028320		BURNT MILL ROAD		TAX DIST	DATE INST	DATE CHANGE
LUMENS	BULB TYPE	MULT SERIES	POLE TYPE	SHADE	ADDRESS NUMBER	REF	LOCATION	TAX DIST	DATE INST	DATE CHANGE
05800	S	M	CNT	II	00000	001	SIDE OF 148 WHITE OAK TRACE ON BURNT MILL ROAD	12	060304	1/1/0001
05800	S	M	CNT	II	02881	002		12	060304	1/1/0001
OFFICE: 311		ROUTE: 564		ST_REF_NO: 00000028325		BURRUS DRIVE		TAX DIST	DATE INST	DATE CHANGE
LUMENS	BULB TYPE	MULT SERIES	POLE TYPE	SHADE	ADDRESS NUMBER	REF	LOCATION	TAX DIST	DATE INST	DATE CHANGE
05800	S	M	OUG	II	02204	001		12	120892	1/1/0001
OFFICE: 311		ROUTE: 564		ST_REF_NO: 00000028400		BURT ROAD		TAX DIST	DATE INST	DATE CHANGE
LUMENS	BULB TYPE	MULT SERIES	POLE TYPE	SHADE	ADDRESS NUMBER	REF	LOCATION	TAX DIST	DATE INST	DATE CHANGE
22000	S	M	OUG	II	00000	005	SIDE OF 2275 NICHOLASVILLE RD.upgrade 4/08	12	050867	1/1/0001
22000	S	M	OUG	II	00000	006	OPP. 124 upgrade 4/08	12	050867	1/1/0001
50000	S	M	OUG	V	00145	007	upgrade 4/08	12	050867	1/1/0001
OFFICE: 311		ROUTE: 564		ST_REF_NO: 00000028500		BUTTERNUT HILL COURT		TAX DIST	DATE INST	DATE CHANGE
LUMENS	BULB TYPE	MULT SERIES	POLE TYPE	SHADE	ADDRESS NUMBER	REF	LOCATION	TAX DIST	DATE INST	DATE CHANGE
05800	S	M	OUG	II	00000	002	OPP. 2417	12	080169	1/1/0001
05800	S	M	OUG	II	02405	000		12	110369	1/1/0001
05800	S	M	OUG	V	02437	000		12	110369	1/1/0001
05800	S	M	OUG	II	02445	004		12	080169	1/1/0001
05800	S	M	OUG	II	02456	005		12	080169	1/1/0001
05800	S	M	OUG	II	02469	000		12	110369	1/1/0001
05800	S	M	OUG	V	02485	007		12	080169	1/1/0001

OFFICE: 311		ROUTE: 564		ST_REF_NO: 00000028550		BUTTONWOOD COURT		LUMENS	BULB TYPE	MULT SERIES	POLE TYPE	SHADE	ADDRESS NUMBER	REF	LOCATION	TAX DIST	DATE INST	DATE CHANGE
05800	S	M	OUG	II	00000	014	SIDE 4104 HEARTWOOD	12	060887	9/9/2009								
04000	S	M	OUG	II	01108	013		12	060887	1/1/0001								
04000	S	M	OUG	V	01125	015		12	060887	1/1/0001								

OFFICE: 311		ROUTE: 564		ST_REF_NO: 00000028600		BYARS ALLEY		LUMENS	BULB TYPE	MULT SERIES	POLE TYPE	SHADE	ADDRESS NUMBER	REF	LOCATION	TAX DIST	DATE INST	DATE CHANGE
05800	S	M	SOH	I	00000	445	OPP. 711	12	060867	1/1/0001								

OFFICE: 311		ROUTE: 564		ST_REF_NO: 00000028700		BYARS AVENUE		LUMENS	BULB TYPE	MULT SERIES	POLE TYPE	SHADE	ADDRESS NUMBER	REF	LOCATION	TAX DIST	DATE INST	DATE CHANGE
05800	S	M	SOH	II	00857	004		12	020887	9/9/2009								
05800	S	M	SOH	II	00901	000		12	110160	1/1/0001								
05800	S	M	SOH	II	00905	000		12	110160	1/1/0001								
05800	S	M	SOH	II	00911	000		12	110160	1/1/0001								

OFFICE: 311		ROUTE: 564		ST_REF_NO: 00000028710		BYWAY		LUMENS	BULB TYPE	MULT SERIES	POLE TYPE	SHADE	ADDRESS NUMBER	REF	LOCATION	TAX DIST	DATE INST	DATE CHANGE
05800	S	M	SOH	I	00000	001	IN BACK OF 258 MARKET ST.	12	020563	1/1/0001								
05800	S	M	SOH	I	00000	002	IN BACK OF 248 MARKET ST.	12	020563	1/1/0001								
05800	S	M	SOH	I	00000	003	BYWAY AT MECHANIC	12	020563	1/1/0001								
05800	S	M	SOH	II	00000	004	IN BACK OF 220 MARKET ST.	12	080960	1/1/0001								
05800	S	M	SOH	II	00000	005	IN BACK OF 200 MARKET ST.	12	080960	1/1/0001								
05800	S	M	SOH	I	00000	006	SIDE OF 205 WEST 2ND ST.	12	020563	1/1/0001								

OFFICE: 311		ROUTE: 564		ST_REF_NO: 00000028800		CABOT DRIVE		LUMENS	BULB TYPE	MULT SERIES	POLE TYPE	SHADE	ADDRESS NUMBER	REF	LOCATION	TAX DIST	DATE INST	DATE CHANGE
05800	S	M	OUG	II	02313	069	bad fixture	12	050884	8/15/2009								
04000	S	M	OUG	II	02314	070		12	050884	1/1/0001								
04000	S	M	OUG	II	00000	067	OPP. 2301	12	050884	1/1/0001								
05800	S	M	OUG	II	02304	068	chg out bad fixture 2/08	12	050884	1/1/0001								

OFFICE: 311

ROUTE: 564

ST_REF_NO: 0000028880 CADDIS LANE

LUMENS	BULB TYPE	MULT SERIES	POLE TYPE	SHADE	ADDRESS NUMBER	REF	LOCATION	TAX DIST	DATE INST	DATE CHANGE
05800	S	M	CNT	II	00000	002	SIDE OF 101 BLUE HERON PLACE ON CADDIS LANE	12	080102	1/1/0001
05800	S	M	CNT	II	03000	005		12	080102	1/1/0001
05800	S	M	CNT	II	03016	005		12	090605	1/1/0001
05800	S	M	CNT	II	03029	004		12	080102	1/1/0001
05800	S	M	CNT	II	03045	003		12	080102	1/1/0001
05800	S	M	CNT	II	03073	001		12	090605	1/1/0001

OFFICE: 311

ROUTE: 564

ST_REF_NO: 0000029000 CADEN LANE

LUMENS	BULB TYPE	MULT SERIES	POLE TYPE	SHADE	ADDRESS NUMBER	REF	LOCATION	TAX DIST	DATE INST	DATE CHANGE
05800	S		SOH	II	00000	002	OPP 779 CADEN LANE	12	030801	1/1/0001
05800	S		SOH	II	00000	003	OPP 757 CADEN LANE	12	030801	1/1/0001
05800	S		SOH	II	00000	004	4TH LT S OF LIBERTY RD ON E SIDE OF CADEN LANE	12	030801	1/1/0001
05800	S		SOH	II	00000	005	5TH LT S OF LIBERTY ROAD ON E SIDE OF CADEN LANE	12	030801	1/1/0001
05800	S		SOH	II	00000	006	5TH LT W OF TODDS ROAD ON N SIDE OF CADEN LANE	12	030801	1/1/0001
05800	S		SOH	II	00000	007	4TH LT W OF TODDS ROAD ON N SIDE OF CADEN LANE	12	030801	1/1/0001
05800	S		SOH	II	00646	009		12	030801	1/1/0001
05800	S		SOH	II	00646	010		12	030801	1/1/0001
05800	S		SOH	II	00662	008		12	030801	1/1/0001
05800	S	M	SOH	II	00784	001		12	040897	1/1/0001

OFFICE: 311

ROUTE: 564

ST_REF_NO: 0000029010 CADEN COURT

LUMENS	BULB TYPE	MULT SERIES	POLE TYPE	SHADE	ADDRESS NUMBER	REF	LOCATION	TAX DIST	DATE INST	DATE CHANGE
05800	S	M	SOH	I	00000	001	OPP. 505	12	031165	1/24/2012

OFFICE: 311

ROUTE: 564

ST_REF_NO: 0000029140 CAHILL DRIVE

LUMENS	BULB TYPE	MULT SERIES	POLE TYPE	SHADE	ADDRESS NUMBER	REF	LOCATION	TAX DIST	DATE INST	DATE CHANGE
09500	S	M	OUG	II	00400	002		12	090898	1/1/0001
09500	S	M	OUG	II	00401	001		12	090898	1/1/0001
09500	S	M	OUG	II	00409	003		12	090898	1/1/0001

OFFICE: 311

ROUTE: 564

ST_REF_NO: 00000029180

CALAIS PLACE

LUMENS	BULB TYPE	MULT SERIES	POLE TYPE	SHADE	ADDRESS NUMBER	REF	LOCATION	TAX DIST	DATE INST	DATE CHANGE
05800	S	M	CNT	II	00000	001	SIDE OF 973 HAMMOCK OAK LN ON CALAIS PLACE	12	052703	1/1/0001
05800	S	M	CNT	II	04313	004		12	052703	1/1/0001
05800	S	M	CNT	II	04317	003		12	052703	1/1/0001
05800	S	M	CNT	II	04329	002		12	052703	1/1/0001

OFFICE: 311

ROUTE: 564

ST_REF_NO: 00000029200

CALDWELL ALLEY

LUMENS	BULB TYPE	MULT SERIES	POLE TYPE	SHADE	ADDRESS NUMBER	REF	LOCATION	TAX DIST	DATE INST	DATE CHANGE
05800	S	M	SOH	I	00000	001	1ST LT. S. OF 5TH ST.	12	021666	1/1/0001
05800	S	M	SOH	I	00000	002	2ND. LT. N. OF 4TH ST.	12	021666	1/1/0001
05800	S	M	SOH	I	00000	275	1ST. LT. N. OF 4TH ST.	12	100266	1/1/0001

OFFICE: 311

ROUTE: 564

ST_REF_NO: 00000029210

CALEVARES DRIVE

LUMENS	BULB TYPE	MULT SERIES	POLE TYPE	SHADE	ADDRESS NUMBER	REF	LOCATION	TAX DIST	DATE INST	DATE CHANGE
05800	S	M	CNT	II	00000	032		12	100898	1/1/0001
05800	S	M	OUG	II	00000	041	SIDE OF 1976 TWAIN RIDGE	12	011581	1/1/0001
05800	S	M	OUG	II	04308	040		12	011581	1/1/0001
05800	S	M	OUG	II	04317	039		12	010885	1/1/0001
05800	S	M	OUG	II	04324	038		12	011581	1/1/0001
05800	S	M	OUG	II	04332	037		12	011581	1/1/0001
05800	S	M	OUG	II	04345	036		12	011581	1/1/0001
05800	S	M	OUG	II	04348	035		12	101581	1/1/0001
05800	S	M	OUG	II	04357	034		12	070886	1/1/0001
05800	S	M	OUG	II	04368	033		12	010885	1/1/0001

OFFICE: 311

ROUTE: 564

ST_REF_NO: 00000029250

CALHOUN CIRCLE

LUMENS	BULB TYPE	MULT SERIES	POLE TYPE	SHADE	ADDRESS NUMBER	REF	LOCATION	TAX DIST	DATE INST	DATE CHANGE
05800	S	M	CNT	II	00900	001		12	100899	1/1/0001
05800	S	M	CNT	III	00905	002		12	100899	1/1/0001

OFFICE: 311		ROUTE: 564		ST_REF_NO: 00000029290		CALI COURT		LUMENS	BULB TYPE	MULT SERIES	POLE TYPE	SHADE	ADDRESS NUMBER	REF	LOCATION	TAX DIST	DATE INST	DATE CHANGE
04000	S	M	OUG	II	00000	001	SIDE OF 712 JAEDUKE DR.	12	120887	1/1/0001								
04000	S	M	OUG	V	03713	002		12	120887	1/1/0001								
OFFICE: 311		ROUTE: 564		ST_REF_NO: 00000029320		CALL DRIVE		LUMENS	BULB TYPE	MULT SERIES	POLE TYPE	SHADE	ADDRESS NUMBER	REF	LOCATION	TAX DIST	DATE INST	DATE CHANGE
05800	S	M	OUG	II	02072	002		12	063003	1/1/0001								
05800	S	M	OUG	II	02089	003		12	060401	1/1/0001								
05800	S	M	OUG	II	02104	004		12	060401	1/1/0001								
05800	S	M	OUG	II	02121	005		12	060401	1/1/0001								
05800	S	M	OUG	II	02128	006		12	060401	1/1/0001								
05800	S	M	OUG	II	02148	007		12	060401	1/1/0001								
05800	S	M	OUG	II	02165	008		12	060401	1/1/0001								
05800	S	M	OUG	II	02257	001		12	060401	1/1/0001								
OFFICE: 311		ROUTE: 564		ST_REF_NO: 00000029340		CALLAWAY COURT		LUMENS	BULB TYPE	MULT SERIES	POLE TYPE	SHADE	ADDRESS NUMBER	REF	LOCATION	TAX DIST	DATE INST	DATE CHANGE
05800	S	M	CNT	II	04501	001		12	060800	1/1/0001								
05800	S	M	CNT	III	04508	002		12	060800	1/1/0001								
OFFICE: 311		ROUTE: 564		ST_REF_NO: 00000029400		CALUMET TERR		LUMENS	BULB TYPE	MULT SERIES	POLE TYPE	SHADE	ADDRESS NUMBER	REF	LOCATION	TAX DIST	DATE INST	DATE CHANGE
05800	S	M	OUG	II	02400	000		12	101964	1/1/0001								
05800	S	M	OUG	II	02413	000		12	100172	1/1/0001								
OFFICE: 311		ROUTE: 564		ST_REF_NO: 00000029420		CALYPSO BREEZE DRIVE		LUMENS	BULB TYPE	MULT SERIES	POLE TYPE	SHADE	ADDRESS NUMBER	REF	LOCATION	TAX DIST	DATE INST	DATE CHANGE
05800	S	M	CNT	II	00000	005	SIDE OF 868 CALYPSO BREEZE DR	12	080504	1/1/0001								
05800	S	M	CNT	II	00800	001		12	080504	1/1/0001								
05800	S	M	CNT	II	00813	002		12	080504	1/1/0001								
05800	S	M	CNT	II	00820	003		12	080504	1/1/0001								
05800	S	M	CNT	II	00833	004		12	080504	1/1/0001								

OFFICE: 311

ROUTE: 564

ST_REF_NO: 0000029420

CALYPSO BREEZE DRIVE

LUMENS	BULB TYPE	MULT SERIES	POLE TYPE	SHADE	ADDRESS NUMBER	REF	LOCATION	TAX DIST	DATE INST	DATE CHANGE
05800	S	M	CNT	III	00857	006		12	080504	1/1/0001
05800	S	M	CNT	II	00869	007		12	080504	1/1/0001
05800	S	M	CNT	II	00876	008		12	080504	1/1/0001
05800	S	M	CNT	II	00885	009		12	080404	1/1/0001
05800	S	M	CNT	II	00897	010		12	121505	1/1/0001
05800	S	M	CNT	II	00905	011		12	121505	1/1/0001
05800	S	M	CNT	III	00916	012		12	121505	1/1/0001

OFFICE: 311

ROUTE: 564

ST_REF_NO: 0000029500

CAMBRIDGE DRIVE

LUMENS	BULB TYPE	MULT SERIES	POLE TYPE	SHADE	ADDRESS NUMBER	REF	LOCATION	TAX DIST	DATE INST	DATE CHANGE
09500	S	M	OUG	II	00000	025	SIDE OF 1242 ALEXANDRIA DR.	12	102473	1/1/0001
09500	S	M	OUG	II	00000	079	SIDE OF 1261 VILLAGE DR.	12	030774	1/1/0001
09500	S	M	OUG	II	01901	001		12	080565	1/1/0001
09500	S	M	OUG	II	01908	002		12	080565	1/1/0001
09500	S	M	OUG	II	01917	003		12	080565	1/1/0001
09500	S	M	OUG	II	01932	004		12	080565	1/1/0001
09500	S	M	OUG	II	01941	005		12	080565	1/1/0001
09500	S	M	OUG	II	01952	006		12	090166	1/1/0001
09500	S	M	OUG	II	01961	007		12	060870	1/1/0001
09500	S	M	OUG	II	01972	008		12	060870	1/1/0001
09500	S	M	OUG	II	01989	009		12	080171	1/1/0001
09500	S	M	OUG	II	02000	010		12	060870	1/1/0001
09500	S	M	OUG	II	02013	011		12	011472	1/1/0001
09500	S	M	OUG	II	02020	046		12	041476	1/1/0001
09500	S	M	OUG	II	02036	044		12	111580	1/1/0001
09500	S	M	OUG	II	02045	043		12	111580	1/1/0001
09500	S	M	OUG	II	02045	045		12	111580	1/1/0001
09500	S	M	OUG	II	02051	000		12	100172	1/1/0001
09500	S	M	OUG	II	02064	081		12	030774	1/1/0001

OFFICE: 311

ROUTE: 564

ST_REF_NO: 00000029550

CAMRY COURT

LUMENS	BULB TYPE	MULT SERIES	POLE TYPE	SHADE	ADDRESS NUMBER	REF	LOCATION	TAX DIST	DATE INST	DATE CHANGE
09500	S	M	OUG	III	02200	001		12	110897	1/1/0001
09500	S	M	OUG	II	02209	001		12	110897	1/1/0001

OFFICE: 311

ROUTE: 564

ST_REF_NO: 00000029600

CAMDEN AVENUE

LUMENS	BULB TYPE	MULT SERIES	POLE TYPE	SHADE	ADDRESS NUMBER	REF	LOCATION	TAX DIST	DATE INST	DATE CHANGE
04000	S	M	SOH	II	01305	052		12	050886	1/1/0001
04000	S	M	SOH	II	01311	053		12	050886	1/1/0001
04000	S	M	SOH	II	01321	054		12	050886	1/1/0001

OFFICE: 311

ROUTE: 564

ST_REF_NO: 00000029700

CAMELLIA DRIVE

LUMENS	BULB TYPE	MULT SERIES	POLE TYPE	SHADE	ADDRESS NUMBER	REF	LOCATION	TAX DIST	DATE INST	DATE CHANGE
05800	S	M	OUG	II	00000	020	SIDE OF 2009 ALEXANDRIA DR.	12	102263	1/1/0001
05800	S	M	OUG	II	01008	000		12	070162	1/1/0001
05800	S	M	OUG	II	01021	000		12	110162	1/1/0001
05800	S	M	OUG	II	01037	000		12	070162	1/1/0001
05800	S	M	OUG	II	01044	000		12	110162	1/1/0001
05800	S	M	OUG	II	01057	000		12	070162	1/1/0001
05800	S	M	OUG	II	01081	000		12	070162	1/1/0001

OFFICE: 311

ROUTE: 564

ST_REF_NO: 00000029800

CAMELOT DRIVE

LUMENS	BULB TYPE	MULT SERIES	POLE TYPE	SHADE	ADDRESS NUMBER	REF	LOCATION	TAX DIST	DATE INST	DATE CHANGE
05800	S	M	OUG	II	00000	001	AT WILSON DOWNING IN MEDIAN	12	041167	1/1/0001
05800	S	M	OUG	II	00000	002	AT WILSON DOWNING IN MEDIAN	12	041167	1/1/0001
05800	S	M	OUG	II	00000	003	SIDE OF 3676 KING ARTHUR DR.	12	121268	1/1/0001
05800	S	M	OUG	II	00000	004	BESIDE 3797	12	061580	1/1/0001
05800	S	M	OUG	II	00000	005	BESIDE 399 GAWAINE DR.	12	061968	1/1/0001
05800	S	M	OUG	II	00000	006	OPP. 3812	12	061580	1/1/0001
05800	S	M	OUG	II	00000	020	SIDE OF 408 LENNEY CT.	12	041478	1/1/0001
05800	S	M	OUG	II	00000	022	SIDE OF 402 WHISPERING HILLS	12	081476	1/1/0001
05800	S	M	OUG	II	00000	050	SIDE OF 399 NOTTINGHAM RD.	12	080173	1/1/0001
05800	S	M	OUG	II	00000	059	SIDE OF 423 LANCELOT	12	051582	1/1/0001

OFFICE: 311		ROUTE: 564		ST_REF_NO: 00000029800		CAMELOT DRIVE		LUMENS	BULB TYPE	MULT SERIES	POLE TYPE	SHADE	ADDRESS NUMBER	REF	LOCATION	TAX DIST	DATE INST	DATE CHANGE
05800	S	M	OUG	II	00000	068	SIDE 3797 BELLEAU WOOD DR.	12	110885	1/1/0001								
05800	S	M	OUG	II	03501	000		12	060171	1/1/0001								
05800	S	M	OUG	II	03504	000		12	060171	1/1/0001								
05800	S	M	OUG	II	03528	000		12	120171	1/1/0001								
05800	S	M	OUG	II	03560	000		12	121268	1/1/0001								
05800	S	M	OUG	II	03701	000		12	101475	1/1/0001								
05800	S	M	OUG	II	03713	018		12	041478	1/1/0001								
05800	S	M	OUG	II	03720	019		12	041478	1/1/0001								
05800	S	M	OUG	II	03732	023		12	041478	1/1/0001								
05800	S	M	OUG	II	03745	024		12	041478	1/1/0001								
05800	S	M	OUG	II	03745	026		12	041478	1/1/0001								
05800	S	M	OUG	II	03748	025		12	041478	1/1/0001								
05800	S	M	OUG	II	03760	038		12	061580	1/1/0001								
05800	S	M	OUG	II	03772	040		12	061580	1/1/0001								
05800	S	M	OUG	II	03788	003		12	061580	1/1/0001								
05800	S	M	OUG	II	03808	005		12	041478	1/1/0001								
05800	S	M	OUG	II	03840	069		12	110885	1/1/0001								
05800	S	M	OUG	II	03840	070		12	120887	1/1/0001								
05800	S	M	OUG	II	03840	071		12	120887	1/1/0001								

OFFICE: 311

ROUTE: 564

OFFICE: 311		ROUTE: 564		ST_REF_NO: 00000029900		CAMERON COURT		LUMENS	BULB TYPE	MULT SERIES	POLE TYPE	SHADE	ADDRESS NUMBER	REF	LOCATION	TAX DIST	DATE INST	DATE CHANGE
05800	S	M	OUG	II	01713	000		12	030166	1/1/0001								
05800	S	M	OUG	II	01726	000		12	030166	1/1/0001								
05800	S	M	OUG	II	01733	000		12	030166	1/1/0001								

OFFICE: 311

ROUTE: 564

OFFICE: 311		ROUTE: 564		ST_REF_NO: 00000030000		CAMINO COURT		LUMENS	BULB TYPE	MULT SERIES	POLE TYPE	SHADE	ADDRESS NUMBER	REF	LOCATION	TAX DIST	DATE INST	DATE CHANGE
05800	S	M	OUG	II	00717	091		12	020890	2/1/2012								
04000	S	M	OUG	V	00601	116		12	090891	1/1/0001								
04000	S	M	OUG	II	00608	115		12	111580	1/1/0001								
04000	S	M	OUG	II	00700	089		12	061580	1/1/0001								

OFFICE: 311 **ROUTE:** 564

ST_REF_NO: 00000030000 CAMINO COURT

LUMENS	BULB TYPE	MULT SERIES	POLE TYPE	SHADE	ADDRESS NUMBER	REF	LOCATION	TAX DIST	DATE INST	DATE CHANGE
04000	S	M	OUG	II	00709	090		12	041581	1/1/0001

OFFICE: 311 **ROUTE:** 564

ST_REF_NO: 00000030220 CAMPBELL LANE

LUMENS	BULB TYPE	MULT SERIES	POLE TYPE	SHADE	ADDRESS NUMBER	REF	LOCATION	TAX DIST	DATE INST	DATE CHANGE
05800	S	M	SOH	II	00000	001	SIDE OF 2861 LIBERTY RD.	12	040898	1/1/0001

OFFICE: 311 **ROUTE:** 564

ST_REF_NO: 00000030300 CAMPBELL STREET

LUMENS	BULB TYPE	MULT SERIES	POLE TYPE	SHADE	ADDRESS NUMBER	REF	LOCATION	TAX DIST	DATE INST	DATE CHANGE
05800	S	M	SOH	I	00462	000		12	051165	1/1/0001
05800	S	M	SOH	I	00000	001	SIDE OF 231 W. 4TH. ST.	12	051165	1/1/0001
05800	S	M	SOH	I	00428	000		12	051165	1/1/0001
05800	S	M	SOH	I	00444	000		12	051165	1/1/0001

OFFICE: 311 **ROUTE:** 564

ST_REF_NO: 00000030400 CAMPERDOWN COURT

LUMENS	BULB TYPE	MULT SERIES	POLE TYPE	SHADE	ADDRESS NUMBER	REF	LOCATION	TAX DIST	DATE INST	DATE CHANGE
05800	S	M	OUG	II	02004	000		12	120165	1/1/0001
05800	S	M	OUG	II	02015	000		12	120165	1/1/0001

OFFICE: 311 **ROUTE:** 564

ST_REF_NO: 00000030500 CAMPSIE PLACE

LUMENS	BULB TYPE	MULT SERIES	POLE TYPE	SHADE	ADDRESS NUMBER	REF	LOCATION	TAX DIST	DATE INST	DATE CHANGE
05800	S	M	SOH	II	00000	010	REAR OF 250 CAMPSIE	12	062408	1/1/0001
05800	S	M	SOH	I	00000	001	OPP. 206	12	120170	1/1/0001
05800	S	M	SOH	I	00224	000		12	120170	1/1/0001
05800	S	M	SOH	I	00240	000		12	120170	1/1/0001
05800	S	M	SOH	I	00250	000		12	080162	1/1/0001
05800	S	M	SOH	I	00348	000		12	080162	1/1/0001

OFFICE: 311 **ROUTE:** 564

ST_REF_NO: 00000030600 CANDLELIGHT WAY

LUMENS	BULB TYPE	MULT SERIES	POLE TYPE	SHADE	ADDRESS NUMBER	REF	LOCATION	TAX DIST	DATE INST	DATE CHANGE
05800	S	M	OUG	II	02900	001		12	061580	1/1/0001

OFFICE: 311		ROUTE: 564		ST_REF_NO: 00000030600		CANDLELIGHT WAY		LUMENS	BULB TYPE	MULT SERIES	POLE TYPE	SHADE	ADDRESS NUMBER	REF	LOCATION	TAX DIST	DATE INST	DATE CHANGE
05800	S	M	OUG	II	02917	002										12	061580	1/1/0001
05800	S	M	OUG	II	02932	003										12	061580	1/1/0001
05800	S	M	OUG	II	02949	004										12	061580	1/1/0001
05800	S	M	OUG	II	02964	005										12	061580	1/1/0001
OFFICE: 311		ROUTE: 564		ST_REF_NO: 00000030700		CANE RUN ROAD		LUMENS	BULB TYPE	MULT SERIES	POLE TYPE	SHADE	ADDRESS NUMBER	REF	LOCATION	TAX DIST	DATE INST	DATE CHANGE
09500	S	M	OUG	II	00500	000	bad fixture									12	100769	11/13/2010
09500	S	M	OUG	II	00509	000	chg'd out bad fixture									12	100769	7/30/2009
09500	S	M	OUG	II	00524	000										12	100769	12/6/2011
09500	S	M	OUG	II	00581	012	bad fixture									12	071475	5/4/2011
10000	M	M	OUG	II	00000	002	OPP. 496									12	100769	1/1/0001
10000	M	M	SOH	II	00000	020	OPP. 577									12	091582	1/1/0001
10000	M	M	OUG	II	00516	000										12	100769	1/1/0001
10000	M	M	OUG	II	00517	000										12	100769	1/1/0001
10000	M	M	OUG	II	00529	000										12	100769	1/1/0001
10000	M	M	OUG	II	00536	000										12	100769	1/1/0001
10000	M	M	OUG	II	00541	000										12	100769	1/1/0001
10000	M	M	OUG	II	00548	000										12	100769	1/1/0001
10000	M	M	OUG	II	00553	015										12	091582	1/1/0001
10000	M	M	OUG	II	00556	016										12	091582	1/1/0001
10000	M	M	OUG	II	00561	017										12	091582	1/1/0001
10000	M	M	OUG	II	00564	018										12	091582	1/1/0001
10000	M	M	OUG	II	00573	019										12	091582	1/1/0001
10000	M	M	OUG	II	00000	021	5TH LT. W. OF BROADWAY, S. SIDE									12	091582	1/1/0001
10000	M	M	OUG	II	00450	000										12	100769	1/1/0001
10000	M	M	OUG	II	00000	022	4TH LT. W. OF BROADWAY, S. SIDE									12	091582	1/1/0001
10000	M	M	OUG	II	00000	023	4TH LT. W. OF BROADWAY, N. SIDE									12	091582	1/1/0001
10000	M	M	OUG	II	00000	024	3RD LT. W. OF BROADWAY, S. SIDE									12	091582	1/1/0001
10000	M	M	OUG	II	00000	025	3RD LT. W. OF BROADWAY, N. SIDE									12	091582	1/1/0001
10000	M	M	OUG	II	00000	026	2ND LT. W. OF BROADWAY, S. SIDE									12	091582	1/1/0001
10000	M	M	OUG	II	00000	027	2ND LT. W. OF BROADWAY, N. SIDE									12	091582	1/1/0001
10000	M	M	OUG	II	00000	028	SIDE OF 1687 N. BROADWAY									12	091582	1/1/0001

OFFICE: 311		ROUTE: 564		ST_REF_NO: 00000030800		CANONERO DRIVE		LUMENS	BULB TYPE	MULT SERIES	POLE TYPE	SHADE	ADDRESS NUMBER	REF	LOCATION	TAX DIST	DATE INST	DATE CHANGE
05800	S	M	OUG	II	01300	148										12	051475	1/1/0001
05800	S	M	OUG	II	01308	149										12	071476	1/1/0001
05800	S	M	OUG	II	01313	150										12	071476	1/1/0001
05800	S	M	OUG	II	01332	151										12	071476	1/1/0001
OFFICE: 311		ROUTE: 564		ST_REF_NO: 00000030810		CANONERO COURT		LUMENS	BULB TYPE	MULT SERIES	POLE TYPE	SHADE	ADDRESS NUMBER	REF	LOCATION	TAX DIST	DATE INST	DATE CHANGE
05800	S	M	OUG	II	01345	152										12	071476	1/1/0001
05800	S	M	OUG	II	01352	153										12	031476	1/1/0001
OFFICE: 311		ROUTE: 564		ST_REF_NO: 00000030900		CANTERBURY COURT		LUMENS	BULB TYPE	MULT SERIES	POLE TYPE	SHADE	ADDRESS NUMBER	REF	LOCATION	TAX DIST	DATE INST	DATE CHANGE
05800	S	M	OUG	V	01603	000										12	030166	1/1/0001
05800	S	M	OUG	II	01619	000										12	030166	1/1/0001
OFFICE: 311		ROUTE: 564		ST_REF_NO: 00000031000		CANTRILL COURT		LUMENS	BULB TYPE	MULT SERIES	POLE TYPE	SHADE	ADDRESS NUMBER	REF	LOCATION	TAX DIST	DATE INST	DATE CHANGE
05800	S	M	OUG	V	01605	000										12	040165	1/1/0001
OFFICE: 311		ROUTE: 564		ST_REF_NO: 00000031100		CANTRILL DRIVE		LUMENS	BULB TYPE	MULT SERIES	POLE TYPE	SHADE	ADDRESS NUMBER	REF	LOCATION	TAX DIST	DATE INST	DATE CHANGE
05800	S	M	OUG	II	00000	057										12	082573	1/1/0001
05800	S	M	OUG	II	01501	000										12	072474	1/1/0001
05800	S	M	OUG	II	01508	000										12	102466	1/1/0001
05800	S	M	OUG	II	01509	000										12	102466	1/1/0001
05800	S	M	OUG	II	01528	000										12	120263	1/1/0001
05800	S	M	OUG	II	01541	000										12	072474	1/1/0001
05800	S	M	OUG	II	01548	000										12	062364	1/1/0001
05800	S	M	OUG	II	01600	000										12	072474	1/1/0001
05800	S	M	OUG	II	01605	000										12	102466	1/1/0001
05800	S	M	OUG	II	01608	000										12	102466	1/1/0001

OFFICE: 311 ROUTE: 564										
ST_REF_NO: 00000031100 CANTRILL DRIVE										
LUMENS	BULB TYPE	MULT SERIES	POLE TYPE	SHADE	ADDRESS NUMBER	REF	LOCATION	TAX DIST	DATE INST	DATE CHANGE
05800	S	M	OUG	II	01613	000		12	120263	1/1/0001
05800	S	M	OUG	II	01617	000		12	082573	1/1/0001
05800	S	M	OUG	II	01704	000		12	040969	1/1/0001
05800	S	M	OUG	II	01708	000		12	080367	1/1/0001
05800	S	M	OUG	II	01800	000		12	062364	1/1/0001
05800	S	M	OUG	II	01805	000		12	082573	1/1/0001
05800	S	M	OUG	II	01806	000		12	102466	1/1/0001
05800	S	M	OUG	II	01832	000		12	050172	1/1/0001
05800	S	M	OUG	II	01815	000		12	040165	1/1/0001
05800	S	M	OUG	II	01816	000		12	062364	1/1/0001
05800	S	M	OUG	II	01817	000		12	082573	1/1/0001
05800	S	M	OUG	II	01826	000		12	082573	1/1/0001
05800	S	M	OUG	II	01829	000		12	060574	1/1/0001

OFFICE: 311

ROUTE: 564

ST_REF_NO: 00000031140 CANYON COURT										
LUMENS	BULB TYPE	MULT SERIES	POLE TYPE	SHADE	ADDRESS NUMBER	REF	LOCATION	TAX DIST	DATE INST	DATE CHANGE
05800	S	M	CNT	II	01105	001		12	020899	1/1/0001

OFFICE: 311

ROUTE: 564

ST_REF_NO: 00000031147 CAPSTONE DRIVE										
LUMENS	BULB TYPE	MULT SERIES	POLE TYPE	SHADE	ADDRESS NUMBER	REF	LOCATION	TAX DIST	DATE INST	DATE CHANGE
09500	S	M	OUG	II	00000	001	1ST LT W OF GEORGETOWN RD, S SIDE ON CAPSTONE DR	12	112207	1/1/0001
09500	S	M	OUG	II	00000	002	2ND LT W OF GEORGETOWN RD, S SIDE ON CAPSTONE DR	12	112207	1/1/0001
09500	S	M	OUG	II	00000	003	3RD LT W OF GEORGETOWN RD, S SIDE ON CAPSTONE DR	12	112207	1/1/0001
09500	S	M	OUG	II	00000	004	4TH LT W OF GEORGETOWN RD, S SIDE ON CAPSTONE DR	12	112207	1/1/0001
09500	S	M	OUG	II	00000	005	5TH LT W OF GEORGETOWN RD, S SIDE ON CAPSTONE DR	12	112207	1/1/0001
09500	S	M	OUG	II	00000	006	6TH LT W OF GEORGETOWN RD, S SIDE ON CAPSTONE DR	12	112207	1/1/0001
09500	S	M	OUG	II	00000	007	7TH LT W OF GEORGETOWN RD, S SIDE ON CAPSTONE DR	12	112207	1/1/0001

OFFICE: 311		ROUTE: 564		ST_REF_NO: 00000031147		CAPSTONE DRIVE		LUMENS	BULB TYPE	MULT SERIES	POLE TYPE	SHADE	ADDRESS NUMBER	REF	LOCATION	TAX DIST	DATE INST	DATE CHANGE
09500	S	M	OUG	II	00000	008	8TH LT W OF GEORGETOWN RD, S SIDE ON CAPSTONE DR	12	112207	1/1/0001								
09500	S	M	OUG	II	00000	009	9TH LT W OF GEORGETOWN RD, S SIDE ON CAPSTONE DR	12	112207	1/1/0001								
09500	S	M	OUG	II	00000	010	10TH LT W OF GEORGETOWN RD, S SIDE ON CAPSTONE DR	12	112207	1/1/0001								
09500	S	M	OUG	II	00000	011	11TH LT W OF GEORGETOWN RD, S SIDE ON CAPSTONE DR	12	112207	1/1/0001								
09500	S	M	OUG	II	00000	012	12TH LT W OF GEORGETOWN RD, S SIDE ON CAPSTONE DR	12	112207	1/1/0001								
09500	S	M	OUG	II	00000	013	13TH LT W OF GEORGETOWN RD, S SIDE ON CAPSTONE DR	12	112207	1/1/0001								
OFFICE: 311		ROUTE: 564		ST_REF_NO: 00000031150		CAPTIVA COURT		LUMENS	BULB TYPE	MULT SERIES	POLE TYPE	SHADE	ADDRESS NUMBER	REF	LOCATION	TAX DIST	DATE INST	DATE CHANGE
05800	S	M	CNT	II	03401	001		12	070896	1/1/0001								
05800	S	M	CNT	II	03420	002		12	070896	1/1/0001								
OFFICE: 311		ROUTE: 564		ST_REF_NO: 00000031200		CARDIFF LANE		LUMENS	BULB TYPE	MULT SERIES	POLE TYPE	SHADE	ADDRESS NUMBER	REF	LOCATION	TAX DIST	DATE INST	DATE CHANGE
04000	S	M	OUG	II	00645	076		12	110885	1/1/0001								
04000	S	M	OUG	II	00649	077		12	110885	1/1/0001								
04000	S	M	OUG	II	00617	074		12	110885	1/1/0001								
05800	S	M	OUG	II	00624	075		12	110885	1/1/0001								
OFFICE: 311		ROUTE: 564		ST_REF_NO: 00000031300		CARDIGAN COURT		LUMENS	BULB TYPE	MULT SERIES	POLE TYPE	SHADE	ADDRESS NUMBER	REF	LOCATION	TAX DIST	DATE INST	DATE CHANGE
05800	S	M	OUG	II	00000	056	SIDE REAR OF 3478 ALDERSHOT	12	040595	1/1/0001								
05800	S	M	OUG	IV	00625	058		12	040895	1/1/0001								
05800	S	M	OUG	II	00633	057		12	040895	1/1/0001								

OFFICE: 311

ROUTE: 564

ST_REF_NO: 0000031400

CARDINAL LANE

LUMENS	BULB TYPE	MULT SERIES	POLE TYPE	SHADE	ADDRESS NUMBER	REF	LOCATION	TAX DIST	DATE INST	DATE CHANGE
05800	S	M	OUG	II	00000	002	SIDE OF 705 SHERIDAN	12	101583	9/9/2009
05800	S	M	OUG	II	00660	003		12	101583	9/9/2009
04000	S	M	OUG	II	00000	001	SIDE OF 2340 HARRODSBURG RD.	12	101583	1/1/0001
04000	S	M	OUG	II	00000	013	SIDE OF 2303 CLAYS MILL RD.	12	101583	1/1/0001
04000	S	M	OUG	II	00605	012		12	101583	1/1/0001
05800	S	M	OUG	II	00610	011	chg out bad fixture 2/08	12	101583	1/1/0001
04000	S	M	OUG	II	00617	010		12	101583	1/1/0001
04000	S	M	OUG	II	00623	009		12	101583	1/1/0001
04000	S	M	OUG	II	00630	008		12	101583	1/1/0001
04000	S	M	OUG	II	00637	007		12	101583	1/1/0001
04000	S	M	OUG	II	00645	006		12	101583	1/1/0001
04000	S	M	OUG	II	00646	005		12	101583	1/1/0001
04000	S	M	OUG	II	00657	004		12	101583	1/1/0001

OFFICE: 311

ROUTE: 564

ST_REF_NO: 0000031450

CARDUCCI STREET

LUMENS	BULB TYPE	MULT SERIES	POLE TYPE	SHADE	ADDRESS NUMBER	REF	LOCATION	TAX DIST	DATE INST	DATE CHANGE
09500	S		CLN	III	00000	001	SIDE OF 2433 CORONEO LN ON CARDUCCI STREET	12	072213	1/1/0001
09500	S		CLN	III	00000	009	SIDE OF 2553 PASCOLI PL ON CARDUCCI STREET	12	072213	1/1/0001
09500	S		CLN	III	00000	010	2ND LT W OF SIR BARTON, S SIDE ON CARDUCCI STREET	12	072213	1/1/0001
09500	S		CLN	III	00000	011	2ND LT W OF SIR BARTON, N SIDE ON CARDUCCI STREET	12	072213	1/1/0001
09500	S		CLN	III	00000	012	1ST LT W OF SIR BARTON, S SIDE ON CARDUCCI STREET	12	072213	1/1/0001
09500	S		CLN	III	00000	013	1ST LT W OF SIR BARTON, N SIDE ON CARDUCCI STREET	12	072213	1/1/0001
09500	S		CLN	III	02509	002		12	072213	1/1/0001
09500	S		CLN	III	02512	003		12	072213	1/1/0001
09500	S		CLN	III	02529	004		12	072213	1/1/0001
09500	S		CLN	III	02536	005		12	072213	1/1/0001
09500	S		CLN	III	02549	006		12	072213	1/1/0001
09500	S		CLN	III	02552	007		12	072213	1/1/0001
09500	S		CLN	III	02564	008		12	072213	1/1/0001

OFFICE: 311 ROUTE: 564										
ST_REF_NO: 00000031560 CARITA WOODS WAY										
LUMENS	BULB TYPE	MULT SERIES	POLE TYPE	SHADE	ADDRESS NUMBER	REF	LOCATION	TAX DIST	DATE INST	DATE CHANGE
05800	S	M	OUG	II	00000	004	SIDE OF 900 AMANDA CT.	12	110899	1/1/0001
05800	S	M	OUG	II	04700	002		12	110899	1/1/0001
05800	S	M	OUG	II	04713	003		12	110899	1/1/0001

OFFICE: 311 ROUTE: 564										
ST_REF_NO: 00000031600 CARLA COURT										
LUMENS	BULB TYPE	MULT SERIES	POLE TYPE	SHADE	ADDRESS NUMBER	REF	LOCATION	TAX DIST	DATE INST	DATE CHANGE
05800	S	M	OUG	II	02109	000		12	120667	1/1/0001

OFFICE: 311 ROUTE: 564										
ST_REF_NO: 00000031700 CARLISLE AVENUE										
LUMENS	BULB TYPE	MULT SERIES	POLE TYPE	SHADE	ADDRESS NUMBER	REF	LOCATION	TAX DIST	DATE INST	DATE CHANGE
05800	S	M	SOH	II	00000	001	SIDE OF 1200 LIMESTONE	12	120463	1/1/0001
05800	S	M	SOH	II	00000	008	SIDE OF 1117 BRYAN AVE.	12	120463	1/1/0001
05800	S	M	OUG	II	00000	031	SIDE OF 1108 BRYAN AVE.	12	020171	1/1/0001
05800	S	M	SOH	II	00128	000		12	120463	1/1/0001
05800	S	M	SOH	II	00149	000		12	120463	1/1/0001
05800	S	M	SOH	II	00170	000		12	120463	1/1/0001
05800	S	M	SOH	II	00205	000		12	120463	1/1/0001
05800	S	M	SOH	II	00218	000		12	120463	1/1/0001
05800	S	M	SOH	II	00243	000		12	120463	1/1/0001
05800	S	M	OUG	II	00324	000		12	020171	1/1/0001
05800	S	M	OUG	II	00406	000		12	020171	1/1/0001
05800	S	M	SOH	II	00416	000		12	110173	1/1/0001
05800	S	M	OUG	II	00432	000		12	020171	1/1/0001
05800	S	M	OUG	II	00452	000		12	020171	1/1/0001
05800	S	M	OUG	II	00464	000		12	052456	1/1/0001

OFFICE: 311 ROUTE: 564										
ST_REF_NO: 00000031800 CARLSBAD COURT										
LUMENS	BULB TYPE	MULT SERIES	POLE TYPE	SHADE	ADDRESS NUMBER	REF	LOCATION	TAX DIST	DATE INST	DATE CHANGE
04000	S	M	OUG	II	00000	024	SIDE OF 2849 MT. MCKINLEY WAY	12	091476	1/1/0001
05800	S	M	OUG	V	03285	023	chg out bad fixture 2/08	12	101579	1/1/0001

OFFICE: 311

ROUTE: 564

ST_REF_NO: 0000031900

CARNEAL ROAD

LUMENS	BULB TYPE	MULT SERIES	POLE TYPE	SHADE	ADDRESS NUMBER	REF	LOCATION	TAX DIST	DATE INST	DATE CHANGE
09500	S	M	OUG	II	00000	082	SIDE OF 478 EMERSON upgrade 4/08	12	100164	1/1/0001
09500	S	M	OUG	II	00975	000	upgrade 4/08	12	031563	1/1/0001
09500	S	M	OUG	II	00998	000	upgrade 4/08	12	062855	1/1/0001
09500	S	M	OUG	II	01018	000	upgrade 4/08	12	100164	1/1/0001
09500	S	M	OUG	II	01035	000	upgrade 4/08	12	031563	1/1/0001
09500	S	M	OUG	II	01046	000	upgrade 4/08	12	100164	1/1/0001
09500	S	M	OUG	III	00000	010	SIDE OF 653 LOUDON AVE. upgrade 4/08	12	112056	1/1/0001
09500	S	M	OUG	II	00000	079	SIDE OF 1028 HIGHLAND PARK DR. upgrade 4/08	12	110863	1/1/0001
09500	S	M	OUG	II	00000	080	SIDE OF 1101 HIGHLAND PARK DR. upgrade 4/08	12	110863	1/1/0001
09500	S	M	OUG	III	00809	000	upgrade 4/08	12	112056	1/1/0001
09500	S	M	OUG	III	00826	000	upgrade 4/08	12	112056	1/1/0001
09500	S	M	OUG	III	00841	000	upgrade 4/08	12	112056	1/1/0001
09500	S	M	OUG	III	00858	000	upgrade 4/08	12	112056	1/1/0001
09500	S	M	OUG	II	00912	000	upgrade 4/08	12	062855	1/1/0001
09500	S	M	OUG	II	00936	000	upgrade 4/08	12	062855	1/1/0001
09500	S	M	OUG	II	00945	000	upgrade 4/08	12	031563	1/1/0001
09500	S	M	OUG	II	00970	000	upgrade 4/08	12	052456	1/1/0001

OFFICE: 311

ROUTE: 564

ST_REF_NO: 0000032000

CAROL LANE

LUMENS	BULB TYPE	MULT SERIES	POLE TYPE	SHADE	ADDRESS NUMBER	REF	LOCATION	TAX DIST	DATE INST	DATE CHANGE
04000	S	M	OUG	II	00000	001	SIDE OF 331 ZANDALE DR.	12	110888	1/1/0001
04000	S	M	OUG	II	02015	002		12	110888	1/1/0001

OFFICE: 311

ROUTE: 564

ST_REF_NO: 0000032095

CAROLINA LANE

LUMENS	BULB TYPE	MULT SERIES	POLE TYPE	SHADE	ADDRESS NUMBER	REF	LOCATION	TAX DIST	DATE INST	DATE CHANGE
05800	S	M	CNT	II	00000	011	SIDE OF 2169 CAROLINA LANE	12	081704	1/1/0001
05800	S	M	CNT	II	00000	012	SIDE OF 2100 SEDALIA LANE ON CAROLINA LANE	12	081704	1/1/0001
05800	S	M	CNT	III	02105	014		12	081704	1/1/0001
05800	S	M	CNT	III	02124	013		12	081704	1/1/0001
05800	S	M	CNT	III	02160	010		12	081704	1/1/0001
05800	S	M	CNT	II	02172	009		12	081704	1/1/0001
05800	S	M	CNT	II	02180	008		12	081704	1/1/0001

OFFICE: 311

ROUTE: 564

ST_REF_NO: 00000032095 CAROLINA LANE

LUMENS	BULB TYPE	MULT SERIES	POLE TYPE	SHADE	ADDRESS NUMBER	REF	LOCATION	TAX DIST	DATE INST	DATE CHANGE
05800	S	M	CNT	II	02197	007		12	081704	1/1/0001
05800	S	M	CNT	II	02204	006		12	081704	1/1/0001
05800	S	M	CNT	III	02220	005		12	081704	1/1/0001
05800	S	M	CNT	II	02228	004		12	081704	1/1/0001
05800	S	M	CNT	II	02237	003		12	081704	1/1/0001
05800	S	M	CNT	II	02241	002		12	081704	1/1/0001
05800	S	M	CNT	III	02256	001		12	071102	1/1/0001

OFFICE: 311

ROUTE: 564

ST_REF_NO: 00000032100 CAROLYN DRIVE

LUMENS	BULB TYPE	MULT SERIES	POLE TYPE	SHADE	ADDRESS NUMBER	REF	LOCATION	TAX DIST	DATE INST	DATE CHANGE
05800	S	M	OUG	II	00000	200	SIDE 440 HENRY CLAY	12	110884	12/21/2010
04000	S	M	OUG	II	00000	202	OPP. 1709	12	110884	1/1/0001
04000	S	M	OUG	II	00000	203	1801 & 1803	12	110884	1/1/0001
04000	S	M	OUG	II	00000	205	SIDE 472 HOLIDAY RD	12	110884	1/1/0001
04000	S	M	OUG	II	01617	201		12	110884	1/1/0001
04000	S	M	OUG	II	01814	204		12	110884	1/1/0001

OFFICE: 311

ROUTE: 564

ST_REF_NO: 00000032200 CARR COURT

LUMENS	BULB TYPE	MULT SERIES	POLE TYPE	SHADE	ADDRESS NUMBER	REF	LOCATION	TAX DIST	DATE INST	DATE CHANGE
05800	S	M	OUG	II	00491	150		12	081475	1/1/0001

OFFICE: 311

ROUTE: 564

ST_REF_NO: 00000032300 CARRIAGE LANE

LUMENS	BULB TYPE	MULT SERIES	POLE TYPE	SHADE	ADDRESS NUMBER	REF	LOCATION	TAX DIST	DATE INST	DATE CHANGE
05800	S	M	OUG	II	03336	043		12	041478	9/9/2009
05800	S	M	OUG	II	03181	013		12	061580	1/1/0001
05800	S	M	OUG	II	03189	003		12	061475	1/1/0001
05800	S	M	OUG	II	03200	000		12	031475	1/1/0001
05800	S	M	OUG	II	03209	000		12	031475	1/1/0001
05800	S	M	OUG	II	03216	006		12	021476	1/1/0001
05800	S	M	OUG	II	03225	007		12	061475	1/1/0001
05800	S	M	OUG	II	03236	008		12	061475	1/1/0001

OFFICE: 311		ROUTE: 564		ST_REF_NO: 00000032300		CARRIAGE LANE		LUMENS	BULB TYPE	MULT SERIES	POLE TYPE	SHADE	ADDRESS NUMBER	REF	LOCATION	TAX DIST	DATE INST	DATE CHANGE
	05800	S	M	OUG	II	03245	009									12	061475	1/1/0001
	05800	S	M	OUG	II	03257	032									12	041478	1/1/0001
	05800	S	M	OUG	II	03260	033									12	061580	1/1/0001
	05800	S	M	OUG	II	03277	034									12	101478	1/1/0001
	05800	S	M	OUG	II	03284	035									12	041478	1/1/0001
	05800	S	M	OUG	II	03289	036									12	041478	1/1/0001
	05800	S	M	OUG	II	03304	037									12	041478	1/1/0001
	05800	S	M	OUG	II	03305	040									12	061580	1/1/0001
	05800	S	M	OUG	II	03320	041									12	061580	1/1/0001
	05800	S	M	OUG	II	03325	042									12	101478	1/1/0001
	05800	S	M	OUG	II	03341	044									12	041478	1/1/0001
	05800	S	M	OUG	II	03352	045									12	041478	1/1/0001
	05800	S	M	OUG	II	03361	030									12	011579	1/1/0001
	05800	S	M	OUG	II	03372	031									12	061580	1/1/0001
	05800	S	M	OUG	II	03381	032									12	011581	1/1/0001
	05800	S	M	OUG	II	03384	033									12	011579	1/1/0001
OFFICE: 311		ROUTE: 564		ST_REF_NO: 00000032310		CARRIAGE LANE CIRCLE		LUMENS	BULB TYPE	MULT SERIES	POLE TYPE	SHADE	ADDRESS NUMBER	REF	LOCATION	TAX DIST	DATE INST	DATE CHANGE
	05800	S	M	OUG	II	03201	039									12	101478	1/1/0001
	05800	S	M	OUG	II	03399	034									12	120893	1/1/0001
OFFICE: 311		ROUTE: 564		ST_REF_NO: 00000032500		CARRIE CIRCLE		LUMENS	BULB TYPE	MULT SERIES	POLE TYPE	SHADE	ADDRESS NUMBER	REF	LOCATION	TAX DIST	DATE INST	DATE CHANGE
	09500	S	M	OUG	III	04505	001									12	062603	9/9/2009
OFFICE: 311		ROUTE: 564		ST_REF_NO: 00000032600		CARRIE COURT		LUMENS	BULB TYPE	MULT SERIES	POLE TYPE	SHADE	ADDRESS NUMBER	REF	LOCATION	TAX DIST	DATE INST	DATE CHANGE
	09500	S	M	OUG	II	00109	084									12	090886	9/9/2009
	04000	S	M	OUG	II	00000	087							SIDE 4525 PRINCE ALBERT WAY		12	090886	1/1/0001
	04000	S	M	OUG	II	00120	085									12	090886	1/1/0001

OFFICE: 311

ROUTE: 564

ST_REF_NO: 00000032600 CARRIE COURT

LUMENS	BULB TYPE	MULT SERIES	POLE TYPE	SHADE	ADDRESS NUMBER	REF	LOCATION	TAX DIST	DATE INST	DATE CHANGE
04000	S	M	OUG	II	00133	086		12	090886	1/1/0001

OFFICE: 311

ROUTE: 564

ST_REF_NO: 00000032640 CARRINGTON COURT

LUMENS	BULB TYPE	MULT SERIES	POLE TYPE	SHADE	ADDRESS NUMBER	REF	LOCATION	TAX DIST	DATE INST	DATE CHANGE
05800	S	M	CNT	II	02205	001		12	110800	1/1/0001
05800	S	M	CNT	II	02213	002		12	110800	1/1/0001

OFFICE: 311

ROUTE: 564

ST_REF_NO: 00000032700 CARSON COURT

LUMENS	BULB TYPE	MULT SERIES	POLE TYPE	SHADE	ADDRESS NUMBER	REF	LOCATION	TAX DIST	DATE INST	DATE CHANGE
05800	S	M	OUG	II	00000	015	SIDE OF 1178 ALEXANDRIA DR.	12	040467	1/1/0001

OFFICE: 311

ROUTE: 564

ST_REF_NO: 00000032710 CARSON DRIVE

LUMENS	BULB TYPE	MULT SERIES	POLE TYPE	SHADE	ADDRESS NUMBER	REF	LOCATION	TAX DIST	DATE INST	DATE CHANGE
05800	S	M	OUG	II	00000	008	SIDE OF 1199 ALEXANDRIA DR.	12	062167	1/1/0001
05800	S	M	OUG	II	00000	007	SIDE OF 1200 DEVONPORT DR.	12	062167	1/1/0001

OFFICE: 311

ROUTE: 564

ST_REF_NO: 00000032790 CATERA TRACE

LUMENS	BULB TYPE	MULT SERIES	POLE TYPE	SHADE	ADDRESS NUMBER	REF	LOCATION	TAX DIST	DATE INST	DATE CHANGE
05800	S	M	OUG	II	00201	001		12	090898	1/1/0001
05800	S	M	OUG	II	00212	002		12	090898	1/1/0001
05800	S	M	OUG	II	00229	003		12	090898	1/1/0001
05800	S	M	OUG	III	00244	004		12	090898	1/1/0001

OFFICE: 311

ROUTE: 564

ST_REF_NO: 00000032970 CARTER'S CLOSE

LUMENS	BULB TYPE	MULT SERIES	POLE TYPE	SHADE	ADDRESS NUMBER	REF	LOCATION	TAX DIST	DATE INST	DATE CHANGE
05800	S	M	OUG	III	01101	002		12	020897	1/1/0001
05800	S	M	OUG	II	01112	001		12	020897	1/1/0001

OFFICE: 311

ROUTE: 564

ST_REF_NO: 00000033000

CARVER ROAD

LUMENS	BULB TYPE	MULT SERIES	POLE TYPE	SHADE	ADDRESS NUMBER	REF	LOCATION	TAX DIST	DATE INST	DATE CHANGE
05800	S	M	OUG	II	00605	000		12	091774	1/1/0001
05800	S	M	OUG	II	00616	000		12	070173	1/1/0001
05800	S	M	OUG	II	00629	000		12	010173	1/1/0001
05800	S	M	OUG	II	00640	000		12	070173	1/1/0001
05800	S	M	OUG	II	00661	000		12	070173	1/1/0001

OFFICE: 311

ROUTE: 564

ST_REF_NO: 00000033150

CASHEL COURT

LUMENS	BULB TYPE	MULT SERIES	POLE TYPE	SHADE	ADDRESS NUMBER	REF	LOCATION	TAX DIST	DATE INST	DATE CHANGE
09500	S	M	OUG	II	02616	003		12	120898	9/9/2009
05800	S	M	OUG	II	02513	009		21	020800	1/1/0001
05800	S	M	OUG	II	02524	008		12	020800	1/1/0001
05800	S	M	OUG	II	02549	006		12	120898	1/1/0001
05800	S	M	OUG	II	02560	005		12	120898	1/1/0001
05800	S	M	OUG	II	02593	002		12	120898	1/1/0001
05800	S	M	OUG	III	02628	004		12	120898	1/1/0001

OFFICE: 311

ROUTE: 564

ST_REF_NO: 00000033160

CASHIERS COURT

LUMENS	BULB TYPE	MULT SERIES	POLE TYPE	SHADE	ADDRESS NUMBER	REF	LOCATION	TAX DIST	DATE INST	DATE CHANGE
05800	S		CNT	II	00000	003	AT END OF COURT	12	091109	1/1/0001
05800	S		CNT	II	03200	001		12	091109	1/1/0001
05800	S		CNT	III	03212	002		12	091109	1/1/0001

OFFICE: 311

ROUTE: 564

ST_REF_NO: 00000033200

CASSIDY AVENUE

LUMENS	BULB TYPE	MULT SERIES	POLE TYPE	SHADE	ADDRESS NUMBER	REF	LOCATION	TAX DIST	DATE INST	DATE CHANGE
05800	S	M	OUG	II	00000	052	SIDE OF 192 COCHRAN RD.	12	100265	1/1/0001
05800	S	M	OUG	II	00000	063	OPP. 201	12	010696	1/1/0001
05800	S	M	OUG	II	00000	064	OPP. 229	12	120165	1/1/0001
05800	S	M	OUG	II	00000	065	OPP. 261	12	120165	1/1/0001
05800	S	M	OUG	II	00000	066	OPP. 277	12	120165	1/1/0001
05800	S	M	OUG	II	00000	067	OPP. 299	12	120165	1/1/0001
05800	S	M	OUG	II	00115	000		12	100265	1/1/0001

OFFICE: 311

ROUTE: 564

ST_REF_NO: 0000033200

CASSIDY AVENUE

LUMENS	BULB TYPE	MULT SERIES	POLE TYPE	SHADE	ADDRESS NUMBER	REF	LOCATION	TAX DIST	DATE INST	DATE CHANGE
05800	S	M	OUG	II	00136	000		12	120165	1/1/0001
05800	S	M	OUG	II	00165	000		12	120165	1/1/0001
05800	S	M	OUG	II	00308	000		12	010166	1/1/0001
05800	S	M	OUG	II	00321	000		12	100265	1/1/0001
05800	S	M	OUG	II	00000	072	SIDE OF 1051 COOPER DR.	12	100165	1/1/0001
05800	S	M	OUG	II	00336	000		12	110165	1/1/0001
05800	S	M	OUG	II	00349	000		12	120165	1/1/0001

OFFICE: 311

ROUTE: 564

ST_REF_NO: 0000033300

CASTLETON, NORTH WAY

LUMENS	BULB TYPE	MULT SERIES	POLE TYPE	SHADE	ADDRESS NUMBER	REF	LOCATION	TAX DIST	DATE INST	DATE CHANGE
05800	S	M	OUG	II	03460	000		12	071562	1/1/0001
05800	S	M	OUG	II	03467	000		12	091564	1/1/0001
05800	S	M	OUG	II	03474	000		12	101964	1/1/0001
05800	S	M	OUG	II	03477	000		12	071562	1/1/0001
05800	S	M	OUG	II	03482	000		12	071562	1/1/0001
05800	S	M	OUG	II	03485	000		12	060161	1/1/0001
05800	S	M	OUG	II	03492	000		12	072264	1/1/0001
05800	S	M	OUG	II	00000	003	SIDE OF 1005 GAINESWAY DR	12	072264	1/1/0001
05800	S	M	OUG	II	03497	000		12	092060	1/1/0001

OFFICE: 311

ROUTE: 564

ST_REF_NO: 0000033310

CASTLETON, SOUTH WAY

LUMENS	BULB TYPE	MULT SERIES	POLE TYPE	SHADE	ADDRESS NUMBER	REF	LOCATION	TAX DIST	DATE INST	DATE CHANGE
05800	S	M	OUG	III	00000	001	SIDE OF 3512 NEWPORT DR.	12	092059	1/1/0001
05800	S	M	OUG	III	01000	000		12	092060	1/1/0001
05800	S	M	OUG	III	01005	000		12	020659	1/1/0001
05800	S	M	OUG	III	01009	000		12	071562	1/1/0001
05800	S	M	OUG	III	01018	000		12	092059	1/1/0001
05800	S	M	OUG	III	01026	000		12	010160	1/1/0001
05800	S	M	OUG	III	01031	000		12	040159	1/1/0001
05800	S	M	OUG	III	01034	000		12	022359	1/1/0001
05800	S	M	OUG	III	01040	000		12	030460	1/1/0001
05800	S	M	OUG	III	01041	000		12	010160	1/1/0001

OFFICE: 311		ROUTE: 564		ST_REF_NO: 00000033400		CASTLEWOOD DRIVE		LUMENS	BULB TYPE	MULT SERIES	POLE TYPE	SHADE	ADDRESS NUMBER	REF	LOCATION	TAX DIST	DATE INST	DATE CHANGE
10000	M	M	SOH	II	00192	000										12	030167	1/1/0001
05800	S	M	SOH	II	00206	001										12	011156	1/1/0001
05800	S	M	SOH	II	00210	002										12	011156	1/1/0001
05800	S	M	SOH	II	00214	003										12	011156	1/1/0001
05800	S	M	SOH	II	00220	004										12	011156	1/1/0001
05800	S	M	SOH	II	00226	005										12	011156	1/1/0001
05800	S	M	SOH	II	00232	006										12	011156	1/1/0001
05800	S	M	SOH	II	00238	007										12	011156	1/1/0001
09500	S	M	SOH	II	00264	008										12	011156	1/1/0001
05800	S	M	SOH	II	00278	009										12	012256	1/1/0001

OFFICE: 311

ROUTE: 564

OFFICE: 311		ROUTE: 564		ST_REF_NO: 00000033500		CATALPA ROAD		LUMENS	BULB TYPE	MULT SERIES	POLE TYPE	SHADE	ADDRESS NUMBER	REF	LOCATION	TAX DIST	DATE INST	DATE CHANGE
05800	S	M	OUG	II	00000	011	SIDE OF 1310 FINCASTLE RD.									12	102164	1/1/0001
05800	S	M	OUG	II	00206	000										12	102164	1/1/0001
05800	S	M	OUG	II	00214	000										12	011966	1/1/0001
05800	S	M	OUG	II	00226	000										12	102164	1/1/0001
05800	S	M	OUG	II	00231	000										12	040165	1/1/0001

OFFICE: 311

ROUTE: 564

OFFICE: 311		ROUTE: 564		ST_REF_NO: 00000033700		CATHY LANE		LUMENS	BULB TYPE	MULT SERIES	POLE TYPE	SHADE	ADDRESS NUMBER	REF	LOCATION	TAX DIST	DATE INST	DATE CHANGE
05800	S	M	OUG	II	00000	055	OPP. FROM THE SIDE OF 2001 MARK AVE.									12	051477	9/9/2009
04000	S	M	OUG	II	00000	052	SIDE OF 1121 BIRCH DR.									12	051477	1/1/0001
04000	S	M	OUG	II	01979	053										12	051477	1/1/0001
04000	S	M	OUG	II	01988	054										12	051477	1/1/0001

OFFICE: 311

ROUTE: 564

OFFICE: 311		ROUTE: 564		ST_REF_NO: 00000033900		CATSKILL COURT		LUMENS	BULB TYPE	MULT SERIES	POLE TYPE	SHADE	ADDRESS NUMBER	REF	LOCATION	TAX DIST	DATE INST	DATE CHANGE
05800	S	M	OUG	II	03201	006										12	011581	1/1/0001
05800	S	M	OUG	II	03217	007										12	071478	1/1/0001
05800	S	M	OUG	V	03229	008										12	111478	1/1/0001

OFFICE: 311		ROUTE: 564		ST_REF_NO: 00000034000		CAULDER ROAD		LUMENS	BULB TYPE	MULT SERIES	POLE TYPE	SHADE	ADDRESS NUMBER	REF	LOCATION	TAX DIST	DATE INST	DATE CHANGE
05800	S	M	OUG	II	00000	099	SIDE OF 1220 CENTRE PARKWAY	12	120172	1/1/0001								
05800	S	M	OUG	II	03544	000		12	032274	1/1/0001								
05800	S	M	OUG	II	03555	000		12	032274	1/1/0001								
05800	S	M	OUG	II	03564	000		12	032274	1/1/0001								
05800	S	M	OUG	II	03575	000		12	032274	1/1/0001								
05800	S	M	OUG	II	03584	000		12	120172	1/1/0001								
05800	S	M	OUG	II	03589	000		12	120172	1/1/0001								
05800	S	M	OUG	II	03595	000		12	032274	1/1/0001								

OFFICE: 311		ROUTE: 564		ST_REF_NO: 00000034090		CAVE COURT		LUMENS	BULB TYPE	MULT SERIES	POLE TYPE	SHADE	ADDRESS NUMBER	REF	LOCATION	TAX DIST	DATE INST	DATE CHANGE
05800	S	M	CNT	II	03500	001		12	042502	1/1/0001								

OFFICE: 311		ROUTE: 564		ST_REF_NO: 00000034100		CAVE HILL LANE		LUMENS	BULB TYPE	MULT SERIES	POLE TYPE	SHADE	ADDRESS NUMBER	REF	LOCATION	TAX DIST	DATE INST	DATE CHANGE
05800	S	M	OUG	II	00000	001	SIDE OF 3500 LYON DR.	12	110898	1/1/0001								

OFFICE: 311		ROUTE: 564		ST_REF_NO: 00000034110		CAVE HILL PLACE		LUMENS	BULB TYPE	MULT SERIES	POLE TYPE	SHADE	ADDRESS NUMBER	REF	LOCATION	TAX DIST	DATE INST	DATE CHANGE
05800	S	M	CNT	II	02236	008		12	042502	1/1/0001								
05800	S	M	CNT	II	03529	006		12	042502	1/1/0001								
05800	S	M	CNT	II	03530	005		12	042502	1/1/0001								
05800	S	M	CNT	II	03539	004		12	042502	1/1/0001								
05800	S	M	CNT	II	03547	003		12	042502	1/1/0001								
05800	S	M	CNT	II	03556	002		12	042502	1/1/0001								
05800	S	M	CNT	III	03562	001		12	042502	1/1/0001								
05800	S	M	CNT	II	03608	007		12	042502	1/1/0001								

OFFICE: 311		ROUTE: 564		ST_REF_NO: 0000034150		CAVERSHAM PARK LANE		LUMENS	BULB TYPE	MULT SERIES	POLE TYPE	SHADE	ADDRESS NUMBER	REF	LOCATION	TAX DIST	DATE INST	DATE CHANGE
05800	S	M	CNT	II	00000	003									SIDE OF 2200 BLACKMOOR PK LN ON CAVERSHAM PARK LN	12	041703	1/1/0001
05800	S	M	CNT	II	00000	009									SIDE REAR OF 2225 BARRINGTON LN ON CAVERSHAM PARK	12	051701	1/1/0001
05800	S	M	CNT	II	03097	010										12	051701	1/1/0001
05800	S	M	CNT	II	03117	008										12	051701	1/1/0001
05800	S	M	CNT	II	03129	007										12	051701	1/1/0001
05800	S	M	CNT	II	03141	006										12	051701	1/1/0001
05800	S	M	CNT	II	03156	005										12	041703	1/1/0001
05800	S	M	CNT	II	03169	004										12	051701	1/1/0001
05800	S	M	CNT	II	03189	002										12	041703	1/1/0001
05800	S	M	CNT	II	03205	001										12	041703	1/1/0001

OFFICE: 311		ROUTE: 564		ST_REF_NO: 0000034200		CAYWOOD CIRCLE		LUMENS	BULB TYPE	MULT SERIES	POLE TYPE	SHADE	ADDRESS NUMBER	REF	LOCATION	TAX DIST	DATE INST	DATE CHANGE
05800	S	M	OUG	II	02304	000										12	021367	1/1/0001
05800	S	M	OUG	V	02320	000										12	021367	1/1/0001

OFFICE: 311		ROUTE: 564		ST_REF_NO: 0000034300		CAYWOOD DRIVE		LUMENS	BULB TYPE	MULT SERIES	POLE TYPE	SHADE	ADDRESS NUMBER	REF	LOCATION	TAX DIST	DATE INST	DATE CHANGE
05800	S	M	OUG	II	01146	000										12	030874	1/1/0001
05800	S	M	OUG	II	01149	000										12	120171	1/1/0001
05800	S	M	OUG	II	01162	000										12	120171	1/1/0001
05800	S	M	OUG	II	01178	000										12	021367	1/1/0001
05800	S	M	OUG	II	01191	000										12	030868	1/1/0001
05800	S	M	OUG	II	01198	000										12	021367	1/1/0001

OFFICE: 311		ROUTE: 564		ST_REF_NO: 0000034400		CECIL WAY		LUMENS	BULB TYPE	MULT SERIES	POLE TYPE	SHADE	ADDRESS NUMBER	REF	LOCATION	TAX DIST	DATE INST	DATE CHANGE
05800	S	M	OUG	II	00000	001									SIDE OF 2901 JASON CT.	12	061582	1/1/0001
04000	S	M	OUG	II	00000	169									SIDE 2899 CLAYS MILL ON CECIL WAY	12	090884	1/1/0001
05800	S	M	OUG	II	00572	009										12	071581	1/1/0001

OFFICE: 311

ROUTE: 564

ST_REF_NO: 00000034400

CECIL WAY

LUMENS	BULB TYPE	MULT SERIES	POLE TYPE	SHADE	ADDRESS NUMBER	REF	LOCATION	TAX DIST	DATE INST	DATE CHANGE
05800	S	M	OUG	II	00573	004		12	071581	1/1/0001
05800	S	M	OUG	II	00584	003		12	071581	1/1/0001
05800	S	M	OUG	II	00589	002		12	061582	1/1/0001
04000	S	M	OUG	II	00604	168		12	090884	1/1/0001
04000	S	M	OUG	II	00609	167		12	090884	1/1/0001
04000	S	M	OUG	II	00616	166		12	090884	1/1/0001
04000	S	M	OUG	II	00621	165		12	090884	1/1/0001
04000	S	M	OUG	II	00627	164		12	090884	1/1/0001

OFFICE: 311

ROUTE: 564

ST_REF_NO: 00000034500

CEDAR STREET

LUMENS	BULB TYPE	MULT SERIES	POLE TYPE	SHADE	ADDRESS NUMBER	REF	LOCATION	TAX DIST	DATE INST	DATE CHANGE
09500	S	M	SOH	II	00000	004	OPP. 222	12	100768	9/9/2009
10000	M	M	SOH	II	00000	001	SIDE OF 534 S. BROADWAY	12	100768	1/1/0001
10000	M	M	SOH	II	00000	002	NE CORNER OF PLUNKETT AND CEDAR	12	100768	1/1/0001
10000	M	M	SOH	II	00000	003	SIDE OF 600 S. MILL ST.	12	100768	1/1/0001

OFFICE: 311

ROUTE: 564

ST_REF_NO: 00000034550

CEDAR MILL CIRCLE

LUMENS	BULB TYPE	MULT SERIES	POLE TYPE	SHADE	ADDRESS NUMBER	REF	LOCATION	TAX DIST	DATE INST	DATE CHANGE
05800	S	M	CNT	II	00000	001	SIDE OF 2632 MARBLE LANE ON CEDAR MILL CIRCLE	12	071902	1/1/0001
05800	S	M	CNT	II	00317	002		12	071902	1/1/0001
05800	S	M	CNT	III	00325	003		12	071902	1/1/0001

OFFICE: 311

ROUTE: 564

ST_REF_NO: 00000034600

CEDARCREST

LUMENS	BULB TYPE	MULT SERIES	POLE TYPE	SHADE	ADDRESS NUMBER	REF	LOCATION	TAX DIST	DATE INST	DATE CHANGE
04000	S	M	OUG	II	00000	011	SIDE 384 PLAINVIEW	12	100884	1/1/0001
05800	S	M	OUG	II	00000	068	SIDE OF 401 SHROUT CT.	12	061581	1/1/0001
04000	S	M	OUG	II	02909	078		12	100884	1/1/0001
04000	S	M	OUG	II	02916	074		12	100884	1/1/0001
05800	S	M	OUG	II	02933	075		12	091582	1/1/0001
05800	S	M	OUG	II	02957	069		12	011581	1/1/0001

OFFICE: 311							ROUTE: 564			
ST_REF_NO: 00000034620							CEDARVALE COURT			
LUMENS	BULB TYPE	MULT SERIES	POLE TYPE	SHADE	ADDRESS NUMBER	REF	LOCATION	TAX DIST	DATE INST	DATE CHANGE
05800	S	M	OUG	II	00401	076		12	091582	1/1/0001
05800	S	M	OUG	V	00416	077		12	091582	1/1/0001

OFFICE: 311							ROUTE: 564			
ST_REF_NO: 00000034700							CEDARWOOD DRIVE			
LUMENS	BULB TYPE	MULT SERIES	POLE TYPE	SHADE	ADDRESS NUMBER	REF	LOCATION	TAX DIST	DATE INST	DATE CHANGE
05800	S	M	OUG	II	00000	001	SIDE OF 1944 SANDERSVILLE RD ON CEDARWOOD	12	100802	1/1/0001
05800	S	M	OUG	II	00840	004		12	100802	1/1/0001
05800	S	M	OUG	II	00849	003		12	100802	1/1/0001
05800	S	M	OUG	II	00860	002		12	100802	1/1/0001
05800	S	M	OUG	II	00000	012	SIDE OF 1145 BOXWOOD DR.	12	011966	1/1/0001
05800	S	M	OUG	II	00804	010		12	011966	1/1/0001
05800	S	M	OUG	II	00817	011		12	011966	1/1/0001

OFFICE: 311							ROUTE: 564			
ST_REF_NO: 00000034800							CELIA LANE			
LUMENS	BULB TYPE	MULT SERIES	POLE TYPE	SHADE	ADDRESS NUMBER	REF	LOCATION	TAX DIST	DATE INST	DATE CHANGE
04000	S	M	OUG	II	00000	007	SIDE OF 1698 BEACON HILL RD.	12	100888	1/1/0001
04000	S	M	OUG	II	00000	008	OPP. 901	12	020889	1/1/0001
04000	S	M	OUG	II	00000	025	SIDE OF 1049 DELLA DR.	12	020889	1/1/0001
04000	S	M	OUG	II	00833	004		12	100888	1/1/0001
04000	S	M	OUG	II	00841	005		12	100888	1/1/0001
04000	S	M	OUG	II	00856	006		12	100888	1/1/0001
04000	S	M	OUG	II	00909	009		12	020889	1/1/0001
04000	S	M	OUG	II	00921	010		12	070889	1/1/0001
04000	S	M	OUG	II	00926	011		12	070889	1/1/0001
04000	S	M	OUG	II	00938	012		12	070889	1/1/0001
04000	S	M	OUG	II	00949	013		12	070889	1/1/0001
04000	S	M	OUG	II	00954	014		12	070889	1/1/0001
04000	S	M	OUG	II	00965	015		12	110888	1/1/0001
04000	S	M	OUG	II	00973	016		12	110888	1/1/0001
04000	S	M	OUG	II	00978	017		12	110888	1/1/0001
04000	S	M	OUG	II	00993	018		12	120888	1/1/0001
04000	S	M	OUG	II	01002	019		12	120888	1/1/0001

OFFICE: 311 ROUTE: 564										
ST_REF_NO: 00000034800 CELIA LANE										
LUMENS	BULB TYPE	MULT SERIES	POLE TYPE	SHADE	ADDRESS NUMBER	REF	LOCATION	TAX DIST	DATE INST	DATE CHANGE
04000	S	M	OUG	II	01007	020		12	020889	1/1/0001
04000	S	M	OUG	II	01012	021		12	020889	1/1/0001
04000	S	M	OUG	II	01015	022		12	020889	1/1/0001
04000	S	M	OUG	II	01022	023		12	020889	1/1/0001
04000	S	M	OUG	II	01023	024		12	020889	1/1/0001
04000	S	M	OUG	II	00800	001		12	100888	1/1/0001
04000	S	M	OUG	II	00813	002		12	100888	1/1/0001
04000	S	M	OUG	II	00824	003		12	100888	1/1/0001

OFFICE: 311 ROUTE: 564										
ST_REF_NO: 00000034900 CENTENNIAL LANE										
LUMENS	BULB TYPE	MULT SERIES	POLE TYPE	SHADE	ADDRESS NUMBER	REF	LOCATION	TAX DIST	DATE INST	DATE CHANGE
04000	S	M	OUG	II	00600	060		12	111478	1/1/0001
04000	S	M	OUG	II	00605	061		12	111478	1/1/0001
04000	S	M	OUG	II	00621	067		12	061580	1/1/0001
04000	S	M	OUG	II	00624	068		12	111478	1/1/0001
04000	S	M	OUG	II	00633	069		12	111478	1/1/0001

OFFICE: 311 ROUTE: 564										
ST_REF_NO: 00000035000 CENTRAL AVENUE										
LUMENS	BULB TYPE	MULT SERIES	POLE TYPE	SHADE	ADDRESS NUMBER	REF	LOCATION	TAX DIST	DATE INST	DATE CHANGE
05800	S	M	OOH	II	00000	024	SIDE OF 207 S. ASHLAND AVE.	12	102367	9/9/2009
09500	S	M	OOH	II	00611	017	bad fixture	12	102367	11/2/2009
09500	S	M	OOH	II	00727	025	bad fixture	12	102367	8/18/2010
10000	M	M	SOH	II	00000	010	SIDE OF 132 WOODLAND AVE.	12	011967	1/1/0001
10000	M	M	SOH	II	00521	011		12	011967	1/1/0001
05800	S	M	SOH	I	00000	002	BETWEEN S. ASHLAND & S. HANOVER	12	111568	1/1/0001
10000	M	M	SOH	II	00000	012	SIDE OF 131 KENTUCKY AVE.	12	011967	1/1/0001
10000	M	M	SOH	II	00000	013	SIDE OF 120 KENTUCKY AVE.	12	011967	1/1/0001
09500	S	M	SOH	II	00000	015	SIDE OF 147 PARK AVE.	12	011967	1/1/0001
10000	M	M	OOH	II	00000	016	SIDE OF 164 PARK AVE.	12	102367	1/1/0001
10000	M	M	OOH	II	00000	021	SIDE OF 135 CLAY AVE.	12	102367	1/1/0001
05800	S	M	SOH	I	00000	060	SIDE OF 200 S. ASHLAND AVE.	12	100168	1/1/0001
05800	S	M	SOH	I	00000	061	SIDE OF 141 S. HANOVER AVE.	12	100168	1/1/0001

OFFICE: 311

ROUTE: 564

ST_REF_NO: 00000035000

CENTRAL AVENUE

LUMENS	BULB TYPE	MULT SERIES	POLE TYPE	SHADE	ADDRESS NUMBER	REF	LOCATION	TAX DIST	DATE INST	DATE CHANGE
10000	M	M	SOH	II	00546	014		12	011967	1/1/0001
10000	M	M	OOH	II	00615	018		12	102367	1/1/0001
10000	M	M	OOH	II	00631	019		12	102367	1/1/0001
10000	M	M	OOH	II	00638	020		12	102367	1/1/0001
09500	S	M	OOH	II	00702	022		12	102367	1/1/0001
10000	M	M	OOH	II	00711	023		12	102367	1/1/0001

OFFICE: 311

ROUTE: 564

ST_REF_NO: 00000035100

CENTRE PARKWAY

LUMENS	BULB TYPE	MULT SERIES	POLE TYPE	SHADE	ADDRESS NUMBER	REF	LOCATION	TAX DIST	DATE INST	DATE CHANGE
05800	S	M	OUG	II	00000	051	OPPOSITE 1152	12	120869	1/1/0001
05800	S	M	OUG	II	00000	053	OPPOSITE 1172	12	032274	1/1/0001
05800	S	M	OUG	II	00000	055	OPPOSITE 1188	12	032274	1/1/0001
05800	S	M	OUG	II	00000	070	OPPOSITE 1110	12	032274	1/1/0001
05800	S	M	OUG	II	00000	080	OPPOSITE 1220	12	111478	1/1/0001
05800	S	M	OUG	II	00000	084	OPPOSITE 1252	12	111478	1/1/0001
05800	S	M	OUG	II	00000	107	OPPOSITE 1272	12	031476	1/1/0001
05800	S	M	OUG	II	00000	143	SIDE OF 1301 CANONERO DR	12	051475	1/1/0001
05800	S	M	OUG	II	00000	147	SIDE OF 3500 BOLD BIDDER DR	12	051475	1/1/0001
05800	S	M	OUG	II	00000	284	3RD LT. FROM PIMLICO PARKWAY	12	111583	1/1/0001
05800	S	M	OUG	II	00000	285	2ND LT. FROM PIMLICO PARKWAY	12	111583	1/1/0001
05800	S	M	OUG	II	00000	286	1ST LT. FROM PIMLICO PARKWAY	12	111583	1/1/0001
05800	S	M	OUG	II	01101	072		12	032274	1/1/0001
05800	S	M	OUG	II	01104	000		12	050169	1/1/0001
05800	S	M	OUG	II	01124	081		12	050169	1/1/0001
05800	S	M	OUG	II	01143	000		12	120869	1/1/0001
05800	S	M	OUG	II	01144	000		12	050169	1/1/0001
05800	S	M	OUG	II	01160	000		12	050169	1/1/0001
05800	S	M	OUG	II	01180	000		12	050169	1/1/0001
05800	S	M	OUG	II	01192	000		12	050768	1/1/0001
05800	S	M	OUG	II	01205	057		12	120172	1/1/0001
05800	S	M	OUG	II	01216	000		12	050179	1/1/0001
05800	S	M	OUG	II	01224	000		12	120172	1/1/0001
05800	S	M	OUG	II	01225	082		12	111478	1/1/0001

OFFICE: 311

ROUTE: 564

ST_REF_NO: 00000035100 CENTRE PARKWAY

LUMENS	BULB TYPE	MULT SERIES	POLE TYPE	SHADE	ADDRESS NUMBER	REF	LOCATION	TAX DIST	DATE INST	DATE CHANGE
05800	S	M	OUG	II	01240	083		12	120172	1/1/0001
05800	S	M	OUG	II	01260	085		12	040974	1/1/0001
05800	S	M	OUG	II	01280	108		12	041475	1/1/0001
05800	S	M	OUG	II	01301	140		12	051476	1/1/0001
05800	S	M	OUG	II	01301	153		12	031476	1/1/0001
05800	S	M	OUG	II	01317	142		12	051476	1/1/0001
05800	S	M	OUG	II	01332	145		12	051475	1/1/0001
05800	S	M	OUG	II	01333	144		12	091477	1/1/0001
05800	S	M	OUG	II	01349	146		12	011581	1/1/0001

OFFICE: 311

ROUTE: 564

ST_REF_NO: 00000035200 CENTURIAN ROAD

LUMENS	BULB TYPE	MULT SERIES	POLE TYPE	SHADE	ADDRESS NUMBER	REF	LOCATION	TAX DIST	DATE INST	DATE CHANGE
05800	S	M	OUG	II	00000	025	SIDE OF 3535 MILANO RD	12	090166	1/1/0001
05800	S	M	OUG	II	01100	000		12	050868	1/1/0001
05800	S	M	OUG	II	01113	000		12	090170	1/1/0001
05800	S	M	OUG	II	01118	000		12	080171	1/1/0001
05800	S	M	OUG	II	01129	027		12	090166	1/1/0001
05800	S	M	OUG	II	01140	026		12	090166	1/1/0001

OFFICE: 311

ROUTE: 564

ST_REF_NO: 00000035250 CEPHAS WAY

LUMENS	BULB TYPE	MULT SERIES	POLE TYPE	SHADE	ADDRESS NUMBER	REF	LOCATION	TAX DIST	DATE INST	DATE CHANGE
04000	S	M	OUG	V	03501	001		12	110891	1/1/0001
04000	S	M	OUG	II	03517	002		12	110891	1/1/0001
04000	S	M	OUG	II	03525	003		12	110891	1/1/0001
05800	S	M	OUG	II	03537	004	upgrade 4/08	12	110891	1/1/0001
05800	S	M	OUG	II	03540	005		12	100896	1/1/0001
04000	S	M	OUG	II	03548	006		12	110891	1/1/0001
05800	S	M	OUG	II	03577	007		12	100896	1/1/0001
04000	S	M	OUG	V	03593	008		12	110891	1/1/0001

OFFICE: 311		ROUTE: 564		ST_REF_NO: 00000035300		CERO CIRCLE		LUMENS	BULB TYPE	MULT SERIES	POLE TYPE	SHADE	ADDRESS NUMBER	REF	LOCATION	TAX DIST	DATE INST	DATE CHANGE
								04000	S	M	OUG	II	00000	092	SIDE 701 CAMINO DR.	12	020890	1/1/0001
OFFICE: 311		ROUTE: 564		ST_REF_NO: 00000035350		CHADBOURN DRIVE		LUMENS	BULB TYPE	MULT SERIES	POLE TYPE	SHADE	ADDRESS NUMBER	REF	LOCATION	TAX DIST	DATE INST	DATE CHANGE
								05800	S	M	CNT	II	00000	001	SIDE OF 1217 RAEFORD LANE ON CHADBOURN LANE	12	033006	1/1/0001
								05800	S	M	CNT	II	03105	002		12	033006	1/1/0001
OFFICE: 311		ROUTE: 564		ST_REF_NO: 00000035400		CHAIR AVENUE		LUMENS	BULB TYPE	MULT SERIES	POLE TYPE	SHADE	ADDRESS NUMBER	REF	LOCATION	TAX DIST	DATE INST	DATE CHANGE
								05800	S	M	SOH	I	00000	380	BESIDE OF 442	12	061566	1/1/0001
								05800	S	M	SOH	I	00000	381	BESIDE 468	12	061566	1/1/0001
								05800	S	M	SOH	II	00412	377		12	090884	1/1/0001
								05800	S	M	SOH	I	00422	378		12	061566	1/1/0001
OFFICE: 311		ROUTE: 564		ST_REF_NO: 00000035500		CHAMBERLAIN DRIVE		LUMENS	BULB TYPE	MULT SERIES	POLE TYPE	SHADE	ADDRESS NUMBER	REF	LOCATION	TAX DIST	DATE INST	DATE CHANGE
								05800	S	M	OUG	II	00300	090		12	020887	9/9/2009
								04000	S	M	OUG	II	00000	094	OPP. 361	12	020887	1/1/0001
								04000	S	M	OUG	II	00000	097	SIDE OF 3848 WEM DR.	12	020887	1/1/0001
								04000	S	M	OUG	II	00317	091		12	020887	1/1/0001
								04000	S	M	OUG	II	00328	092		12	020887	1/1/0001
								04000	S	M	OUG	II	00343	093		12	020887	1/1/0001
								04000	S	M	OUG	II	00372	095		12	020887	1/1/0001
								04000	S	M	OUG	II	00385	096		12	020887	1/1/0001
OFFICE: 311		ROUTE: 564		ST_REF_NO: 00000035525		CHAMBLEE LANE		LUMENS	BULB TYPE	MULT SERIES	POLE TYPE	SHADE	ADDRESS NUMBER	REF	LOCATION	TAX DIST	DATE INST	DATE CHANGE
								05800	S	M	CNT	II	00000	003	SIDE OF 1300 NORCROSS CT ON CHAMBLEE LANE	12	082603	1/1/0001
								05800	S	M	CNT	II	00000	012	SIDE OF 2196 ROSWELL DRIVE ON CHAMBLEE LANE	12	082603	1/1/0001

OFFICE: 311 ROUTE: 564										
ST_REF_NO: 00000035525 CHAMBLEE LANE										
LUMENS	BULB TYPE	MULT SERIES	POLE TYPE	SHADE	ADDRESS NUMBER	REF	LOCATION	TAX DIST	DATE INST	DATE CHANGE
05800	S	M	CNT	II	02213	011		12	082603	1/1/0001
05800	S	M	CNT	II	02216	010		12	082603	1/1/0001
05800	S	M	CNT	II	02249	007		12	071102	1/1/0001
05800	S	M	CNT	II	02260	006		12	071102	1/1/0001
05800	S	M	CNT	II	02273	005		12	071102	1/1/0001
05800	S	M	CNT	II	02285	004		12	082603	1/1/0001
05800	S	M	CNT	II	02293	002		12	120899	1/1/0001
05800	S	M	CNT	II	02296	001		12	120899	1/1/0001
OFFICE: 311 ROUTE: 564										
ST_REF_NO: 00000035550 CHANDLER LANE										
LUMENS	BULB TYPE	MULT SERIES	POLE TYPE	SHADE	ADDRESS NUMBER	REF	LOCATION	TAX DIST	DATE INST	DATE CHANGE
05800	S	M	CNT	II	00000	006	SIDE OF 701 WIDENER CT.	12	110897	1/1/0001
05800	S	M	CNT	II	00000	008	OPP. 1700	12	120800	1/1/0001
05800	S	M	CNT	II	01673	010		12	120800	1/1/0001
05800	S	M	CNT	II	01688	009		12	120800	1/1/0001
05800	S	M	CNT	II	01712	007		12	120800	1/1/0001
05800	S	M	CNT	II	01736	005		12	110897	1/1/0001
05800	S	M	CNT	II	01761	004		12	120800	1/1/0001
05800	S	M	CNT	II	01786	003		12	110897	1/1/0001
05800	S	M	CNT	II	01788	002		12	110897	1/1/0001
05800	S	M	CNT	II	01793	001		12	110897	1/1/0001
OFFICE: 311 ROUTE: 564										
ST_REF_NO: 00000035600 CHANNING WAY										
LUMENS	BULB TYPE	MULT SERIES	POLE TYPE	SHADE	ADDRESS NUMBER	REF	LOCATION	TAX DIST	DATE INST	DATE CHANGE
05800	S	M	OUG	II	00000	057	SIDE OF 440 PLAINVIEW RD	12	050170	1/1/0001
04000	S	M	OUG	II	00453	079		12	100884	1/1/0001
04000	S	M	OUG	II	00472	080		12	100884	1/1/0001
05800	S	M	OUG	II	00481	000		12	030171	1/1/0001

OFFICE: 311		ROUTE: 564		ST_REF_NO: 00000035700		CHANT COURT		LUMENS	BULB TYPE	MULT SERIES	POLE TYPE	SHADE	ADDRESS NUMBER	REF	LOCATION	TAX DIST	DATE INST	DATE CHANGE
05800	S	M	OUG	II	00000	006	BESIDE 2603	12	060173	1/1/0001								
05800	S	M	OUG	II	02608	005		12	060173	1/1/0001								
05800	S	M	OUG	V	02687	008		12	060173	1/1/0001								
05800	S	M	OUG	II	02694	007		12	060173	1/1/0001								

OFFICE: 311		ROUTE: 564		ST_REF_NO: 00000035800		CHANTILLY STREET		LUMENS	BULB TYPE	MULT SERIES	POLE TYPE	SHADE	ADDRESS NUMBER	REF	LOCATION	TAX DIST	DATE INST	DATE CHANGE
09500	S	M	OOH	II	00000	012	SIDE OF 1961 CAMBRIDGE DR	12	090166	1/1/0001								
09500	S	M	OUG	II	00000	095	SIDE OF 1926 DEAUVILLE DR	12	081363	1/1/0001								
09500	S	M	OUG	II	00119	000		12	120960	1/1/0001								
09500	S	M	OUG	II	00124	000		12	120960	1/1/0001								
09500	S	M	OUG	II	00129	000		12	100163	1/1/0001								
09500	S	M	OUG	II	00132	000		12	100160	1/1/0001								
09500	S	M	OUG	II	00139	000		12	092260	1/1/0001								
09500	S	M	OUG	II	00148	000		12	092260	1/1/0001								
09500	S	M	OUG	II	00151	000		12	100163	1/1/0001								
09500	S	M	OUG	II	00158	000		12	121659	1/1/0001								

OFFICE: 311		ROUTE: 564		ST_REF_NO: 00000035900		CHAPMAN COURT		LUMENS	BULB TYPE	MULT SERIES	POLE TYPE	SHADE	ADDRESS NUMBER	REF	LOCATION	TAX DIST	DATE INST	DATE CHANGE
04000	S	M	OUG	V	00401	016		12	081477	1/1/0001								
04000	S	M	OUG	II	00413	015		12	051478	1/1/0001								

OFFICE: 311		ROUTE: 564		ST_REF_NO: 00000036000		CHARLBURY ROAD		LUMENS	BULB TYPE	MULT SERIES	POLE TYPE	SHADE	ADDRESS NUMBER	REF	LOCATION	TAX DIST	DATE INST	DATE CHANGE
05800	S	M	OUG	II	00000	003	SIDE OF 689 BISHOP DR.	12	060468	1/1/0001								
05800	S	M	OUG	II	00000	006	SIDE OF 1872 CHARLBURY CT.	12	100169	1/1/0001								
05800	S	M	OUG	II	00602	000		12	060468	1/1/0001								
05800	S	M	OUG	II	00626	000		12	120266	1/1/0001								
05800	S	M	OUG	II	00639	000		12	120266	1/1/0001								
05800	S	M	OUG	II	00658	000		12	120266	1/1/0001								

OFFICE: 311

ROUTE: 564

ST_REF_NO: 00000036000 CHARLBURY ROAD

LUMENS	BULB TYPE	MULT SERIES	POLE TYPE	SHADE	ADDRESS NUMBER	REF	LOCATION	TAX DIST	DATE INST	DATE CHANGE
05800	S	M	OUG	II	00663	000		12	120266	1/1/0001

OFFICE: 311

ROUTE: 564

ST_REF_NO: 00000036010 CHARLBURY COURT

LUMENS	BULB TYPE	MULT SERIES	POLE TYPE	SHADE	ADDRESS NUMBER	REF	LOCATION	TAX DIST	DATE INST	DATE CHANGE
05800	S	M	OUG	II	00000	008	SIDE OF 623 CHARLBURY RD.	12	040171	1/1/0001
05800	S	M	OUG	II	01884	000		12	070767	1/1/0001

OFFICE: 311

ROUTE: 564

ST_REF_NO: 00000036100 CHARLES AVENUE

LUMENS	BULB TYPE	MULT SERIES	POLE TYPE	SHADE	ADDRESS NUMBER	REF	LOCATION	TAX DIST	DATE INST	DATE CHANGE
05800	S	M	SOH	I	00749	012		12	060266	1/1/0001
05800	S	M	SOH	II	00759	010		12	060266	1/1/0001
05800	S	M	SOH	I	00808	009		12	060266	1/1/0001
05800	S	M	SOH	I	00824	008		12	060266	1/1/0001
05800	S	M	SOH	I	00830	007		12	060266	1/1/0001
05800	S	M	SOH	I	00840	006		12	060266	1/1/0001
05800	S	M	SOH	I	00858	005		12	060266	1/1/0001
05800	S	M	SOH	I	00902	004		12	060266	1/1/0001
05800	S	M	SOH	I	00915	002		12	060266	1/1/0001
05800	S	M	SOH	I	00925	001		12	060266	1/1/0001
05800	S	M	SOH	II	00937	003		12	110891	1/1/0001
05800	S	M	SOH	I	00000	016	OPPOSITE 710	12	060266	1/1/0001
05800	S	M	SOH	I	00000	017	OPPOSITE 700	12	060266	1/1/0001
05800	S	M	SOH	I	00731	015		12	060266	1/1/0001
05800	S	M	SOH	I	00734	013		12	060266	1/1/0001

OFFICE: 311

ROUTE: 564

ST_REF_NO: 00000036200 CHARLESTON COURT

LUMENS	BULB TYPE	MULT SERIES	POLE TYPE	SHADE	ADDRESS NUMBER	REF	LOCATION	TAX DIST	DATE INST	DATE CHANGE
05800	S	M	OUG	II	01703	000		12	101861	1/1/0001
05800	S	M	OUG	II	01712	000		12	101861	1/1/0001
05800	S	M	OUG	II	01717	000		12	101861	1/1/0001

OFFICE: 311

ROUTE: 564

ST_REF_NO: 00000036210

CHARLESTON DRIVE

LUMENS	BULB TYPE	MULT SERIES	POLE TYPE	SHADE	ADDRESS NUMBER	REF	LOCATION	TAX DIST	DATE INST	DATE CHANGE
05800	S	M	OUG	II	01800	000		12	071064	1/1/0001
05800	S	M	OUG	II	01807	000		12	071064	1/1/0001

OFFICE: 311

ROUTE: 564

ST_REF_NO: 00000036220

CHARLESTON GARDENS BLVD

LUMENS	BULB TYPE	MULT SERIES	POLE TYPE	SHADE	ADDRESS NUMBER	REF	LOCATION	TAX DIST	DATE INST	DATE CHANGE
05800	S	M	CNT	II	00000	001	SIDE OF 5096 MIDDLETON PL ON CHARLESTON GRDNS BLVD	12	050603	1/1/0001
05800	S	M	CNT	II	00000	002	SIDE OF 5100 MIDDLETON PL ON CHARLESTON GRDNS BLVD	12	050603	1/1/0001
05800	S	M	CNT	II	03009	003		12	050603	1/1/0001
05800	S	M	CNT	II	03020	011		12	042407	1/1/0001
05800	S	M	CNT	II	03029	010		12	042407	1/1/0001
05800	S	M	CNT	II	03032	005		12	050603	1/1/0001

OFFICE: 311

ROUTE: 564

ST_REF_NO: 00000036340

CHARWOOD COURT

LUMENS	BULB TYPE	MULT SERIES	POLE TYPE	SHADE	ADDRESS NUMBER	REF	LOCATION	TAX DIST	DATE INST	DATE CHANGE
04000	S	M	OUG	II	00000	001	SIDE OF 870 CHARWOOD DR.	12	020888	1/1/0001
04000	S	M	OUG	II	04617	002		12	020888	1/1/0001

OFFICE: 311

ROUTE: 564

ST_REF_NO: 00000036350

CHARWOOD DRIVE

LUMENS	BULB TYPE	MULT SERIES	POLE TYPE	SHADE	ADDRESS NUMBER	REF	LOCATION	TAX DIST	DATE INST	DATE CHANGE
05800	S	M	OUG	II	00000	004	SIDE OF 900 CHERRYWOOD	12	060887	9/9/2009
05800	S	M	OUG	V	00854	014		12	110889	9/9/2009
09500	S	M	OUG	II	00918	008		12	060887	9/9/2009
04000	S	M	OUG	II	00830	017		12	020895	1/1/0001
04000	S	M	OUG	II	00850	015		12	110889	1/1/0001
04000	S	M	OUG	II	00855	016		12	110889	1/1/0001
04000	S	M	OUG	II	00871	013		12	110889	1/1/0001
04000	S	M	OUG	II	00882	011		12	020888	1/1/0001
04000	S	M	OUG	II	00883	012		12	020888	1/1/0001
04000	S	M	OUG	II	00898	010		12	020888	1/1/0001
04000	S	M	OUG	II	00911	009		12	020888	1/1/0001

OFFICE: 311

ROUTE: 564

ST_REF_NO: 00000036350 CHARWOOD DRIVE

LUMENS	BULB TYPE	MULT SERIES	POLE TYPE	SHADE	ADDRESS NUMBER	REF	LOCATION	TAX DIST	DATE INST	DATE CHANGE
04000	S	M	OUG	II	00931	007		12	060887	1/1/0001
05800	S	M	OUG	II	00942	006	upgraded Aug 2007 due to car accident	12	110888	1/1/0001
04000	S	M	OUG	II	00950	005		12	060887	1/1/0001
04000	S	M	OUG	II	00975	003		12	060887	1/1/0001
04000	S	M	OUG	II	00986	002		12	060887	1/1/0001

OFFICE: 311

ROUTE: 564

ST_REF_NO: 00000036358 CHAS CIRCLE

LUMENS	BULB TYPE	MULT SERIES	POLE TYPE	SHADE	ADDRESS NUMBER	REF	LOCATION	TAX DIST	DATE INST	DATE CHANGE
05800	S	M	CNT	II	04300	001		12	020403	1/1/0001
05800	S	M	CNT	III	04304	002		12	020403	1/1/0001

OFFICE: 311

ROUTE: 564

ST_REF_NO: 00000036360 CHAS DRIVE

LUMENS	BULB TYPE	MULT SERIES	POLE TYPE	SHADE	ADDRESS NUMBER	REF	LOCATION	TAX DIST	DATE INST	DATE CHANGE
05800	S	M	CNT	II	00000	001	SIDE OF 1085 DUVAL STREET ON CHAS DRIVE	12	020403	1/1/0001
05800	S	M	CNT	II	00983	003		12	020403	1/1/0001
05800	S	M	CNT	II	00991	002		12	020403	1/1/0001

OFFICE: 311

ROUTE: 564

ST_REF_NO: 00000036370 CHASE PLACE

LUMENS	BULB TYPE	MULT SERIES	POLE TYPE	SHADE	ADDRESS NUMBER	REF	LOCATION	TAX DIST	DATE INST	DATE CHANGE
05800	S	M	OUG	II	00301	001		12	100896	1/1/0001
05800	S	M	OUG	II	00340	002		12	100896	1/1/0001
05800	S	M	OUG	II	00356	003		12	100896	1/1/0001
05800	S	M	OUG	II	00393	004		12	100896	1/1/0001

OFFICE: 311

ROUTE: 564

ST_REF_NO: 00000036380 CHASEMORE

LUMENS	BULB TYPE	MULT SERIES	POLE TYPE	SHADE	ADDRESS NUMBER	REF	LOCATION	TAX DIST	DATE INST	DATE CHANGE
05800	S	M	OUG	III	02205	001		12	110899	1/1/0001

OFFICE: 311

ROUTE: 564

ST_REF_NO: 00000036390

CHASEWOOD WAY

LUMENS	BULB TYPE	MULT SERIES	POLE TYPE	SHADE	ADDRESS NUMBER	REF	LOCATION	TAX DIST	DATE INST	DATE CHANGE
05800	S	M	CNT	II	00000	002	SIDE OF 3012 MERIDITH CIRCLE	12	100899	1/1/0001
05800	S	M	CNT	II	01004	001		12	100899	1/1/0001
05800	S	M	CNT	II	01020	003		12	100899	1/1/0001
05800	S	M	CNT	III	01033	004		12	100899	1/1/0001
05800	S	M	CNT	II	01060	005		12	100899	1/1/0001
05800	S	M	CNT	II	01065	006		12	100899	1/1/0001
05800	S	M	CNT	II	01080	007		12	100899	1/1/0001
05800	S	M	CNT	II	01089	008		12	100899	1/1/0001

OFFICE: 311

ROUTE: 564

ST_REF_NO: 00000036400

CHATHAM DRIVE

LUMENS	BULB TYPE	MULT SERIES	POLE TYPE	SHADE	ADDRESS NUMBER	REF	LOCATION	TAX DIST	DATE INST	DATE CHANGE
04000	S	M	OUG	II	03105	010		12	050891	1/1/0001
04000	S	M	OUG	II	03116	009		12	100890	1/1/0001
04000	S	M	OUG	II	03125	008		12	100890	1/1/0001
04000	S	M	OUG	II	03132	007		12	100890	1/1/0001
04000	S	M	OUG	II	03141	006		12	100890	1/1/0001
04000	S	M	OUG	II	03148	005		12	100890	1/1/0001
04000	S	M	OUG	II	03153	004		12	100890	1/1/0001
04000	S	M	OUG	II	03164	003		12	100890	1/1/0001
04000	S	M	OUG	II	03169	002		12	100890	1/1/0001
04000	S	M	OUG	II	03172	001		12	100890	1/1/0001

OFFICE: 311

ROUTE: 564

ST_REF_NO: 00000036500

CHATSWORTH DRIVE

LUMENS	BULB TYPE	MULT SERIES	POLE TYPE	SHADE	ADDRESS NUMBER	REF	LOCATION	TAX DIST	DATE INST	DATE CHANGE
05800	S	M	OUG	II	01816	000		12	071973	1/1/0001
05800	S	M	OUG	II	01833	000		12	071973	1/1/0001
05800	S	M	OUG	II	01842	000		12	071973	1/1/0001
05800	S	M	OUG	V	01860	000		12	081973	1/1/0001

OFFICE: 311

ROUTE: 564

ST_REF_NO: 00000036700

CHAUVIN LANE

LUMENS	BULB TYPE	MULT SERIES	POLE TYPE	SHADE	ADDRESS NUMBER	REF	LOCATION	TAX DIST	DATE INST	DATE CHANGE
05800	S	M	OUG	II	00000	056	SIDE OF 2371-upgrade per city request	12	021580	5/12/2010
05800	S	M	OUG	II	00000	060	SIDE OF 2398-upgrade per city request	12	021580	5/12/2010
05800	S	M	OUG	II	02362	058	upgrade per city request	12	021580	5/12/2010
05800	S	M	OUG	II	02375	059	upgrade per city request	12	021580	5/12/2010
05800	S	M	OUG	V	02391	061	upgrade per city request	12	021580	5/12/2010
05800	S	M	OUG	II	02398	062	upgrade per city request	12	021580	5/12/2010

OFFICE: 311

ROUTE: 564

ST_REF_NO: 00000036800

CHEAPSIDE

LUMENS	BULB TYPE	MULT SERIES	POLE TYPE	SHADE	ADDRESS NUMBER	REF	LOCATION	TAX DIST	DATE INST	DATE CHANGE
09500	S		SOH	II	00000	001	FACING CHEAPSIDE PARK ON EXISTING ST LT POLES	12	100908	1/1/0001
09500	S		SOH	II	00000	002	FACING CHEAPSIDE PARK ON EXISTING ST LT POLES	12	100908	1/1/0001

OFFICE: 311

ROUTE: 564

ST_REF_NO: 00000036840

CHECKERBERRY DRIVE

LUMENS	BULB TYPE	MULT SERIES	POLE TYPE	SHADE	ADDRESS NUMBER	REF	LOCATION	TAX DIST	DATE INST	DATE CHANGE
05800	S	M	OUG	II	02448	011		12	101201	1/1/0001
05800	S	M	OUG	II	02461	010		12	101201	1/1/0001
05800	S	M	OUG	II	02476	009		12	101201	1/1/0001
05800	S	M	OUG	II	00000	003	SIDE OF 601 SHIRETOWN RD.	12	110899	1/1/0001
05800	S	M	OUG	II	00000	004	SIDE OF 600 HUGGING BEAR DR.	12	110899	1/1/0001
05800	S	M	OUG	II	00000	008	SIDE REAR OF 649 GRAFTONS MILL LANE	12	110899	1/1/0001
05800	S	M	OUG	II	02508	007		12	110899	1/1/0001
05800	S	M	OUG	II	02521	006		12	110899	1/1/0001
05800	S	M	OUG	II	02544	005		12	110899	1/1/0001
05800	S	M	OUG	II	02585	002		12	110899	1/1/0001
05800	S	M	OUG	II	02600	001		12	110899	1/1/0001

OFFICE: 311

ROUTE: 564

ST_REF_NO: 00000036900

CHEDDINGTON LANE

LUMENS	BULB TYPE	MULT SERIES	POLE TYPE	SHADE	ADDRESS NUMBER	REF	LOCATION	TAX DIST	DATE INST	DATE CHANGE
04000	S	M	OUG	II	03500	223		12	040888	1/1/0001
04000	S	M	OUG	II	03513	224		12	011581	1/1/0001

OFFICE: 311		ROUTE: 564		ST_REF_NO: 00000036900		CHEDDINGTON LANE				
LUMENS	BULB TYPE	MULT SERIES	POLE TYPE	SHADE	ADDRESS NUMBER	REF	LOCATION	TAX DIST	DATE INST	DATE CHANGE
04000	S	M	OUG	II	03516	225		12	040888	1/1/0001
04000	S	M	OUG	V	03533	226		12	041582	1/1/0001

OFFICE: 311		ROUTE: 564		ST_REF_NO: 00000037000		CHELAN DRIVE				
LUMENS	BULB TYPE	MULT SERIES	POLE TYPE	SHADE	ADDRESS NUMBER	REF	LOCATION	TAX DIST	DATE INST	DATE CHANGE
04000	S	M	SOH	II	00000	144	SIDE 241 ROSEMONT	12	100884	1/1/0001
04000	S	M	SOH	II	00105	145		12	100884	1/1/0001
04000	S	M	SOH	II	00111	146		12	100884	1/1/0001

OFFICE: 311		ROUTE: 564		ST_REF_NO: 00000037100		CHELMSFORD DRIVE				
LUMENS	BULB TYPE	MULT SERIES	POLE TYPE	SHADE	ADDRESS NUMBER	REF	LOCATION	TAX DIST	DATE INST	DATE CHANGE
05800	S	M	OUG	II	00000	096	SIDE OF 663 WARRINGTON DR.	12	111366	1/1/0001
05800	S	M	OUG	II	01716	000		12	032772	1/1/0001
05800	S	M	OUG	II	01725	000		12	041267	1/1/0001
05800	S	M	OUG	V	01740	179		12	071476	1/1/0001

OFFICE: 311		ROUTE: 564		ST_REF_NO: 00000037200		CHELSEA DRIVE				
LUMENS	BULB TYPE	MULT SERIES	POLE TYPE	SHADE	ADDRESS NUMBER	REF	LOCATION	TAX DIST	DATE INST	DATE CHANGE
05800	S	M	OUG	II	03140	007		12	100890	9/9/2009
05800	S	M	OUG	II	03101	001		12	060890	1/1/0001
04000	S	M	OUG	II	03105	002		12	060890	1/1/0001
04000	S	M	OUG	II	03112	003		12	060890	1/1/0001
04000	S	M	OUG	II	03117	004		12	100890	1/1/0001
04000	S	M	OUG	II	03124	005		12	100890	1/1/0001
04000	S	M	OUG	II	03133	006		12	100890	1/1/0001
04000	S	M	OUG	II	03149	008		12	100890	1/1/0001
04000	S	M	OUG	II	03156	009		12	100890	1/1/0001
04000	S	M	OUG	II	03157	010		12	100890	1/1/0001
04000	S	M	OUG	II	03172	011		12	100890	1/1/0001

OFFICE: 311

ROUTE: 564

ST_REF_NO: 00000037209

CHELSEA WOODS COURT

LUMENS	BULB TYPE	MULT SERIES	POLE TYPE	SHADE	ADDRESS NUMBER	REF	LOCATION	TAX DIST	DATE INST	DATE CHANGE
04000	S	M	OUG	II	02709	003		12	120889	1/1/0001
04000	S	M	OUG	II	02728	002		12	120889	1/1/0001
04000	S	M	OUG	II	02748	001		12	120889	1/1/0001

OFFICE: 311

ROUTE: 564

ST_REF_NO: 00000037210

CHELSEA WOODS DRIVE

LUMENS	BULB TYPE	MULT SERIES	POLE TYPE	SHADE	ADDRESS NUMBER	REF	LOCATION	TAX DIST	DATE INST	DATE CHANGE
04000	S	M	OUG	II	00000	001	400 CHELSEA WOODS DR. IN MEDIAN	12	120889	1/1/0001
04000	S	M	OUG	II	00000	002	400 CHELSEA WOODS DR. IN MEDIAN	12	120889	1/1/0001
04000	S	M	OUG	II	00000	003	SIDE OF 2745 CHELSEA WOODS CT.	12	120889	1/1/0001
04000	S	M	OUG	V	00421	004		12	120889	1/1/0001
04000	S	M	OUG	II	00444	005		12	120889	1/1/0001
04000	S	M	OUG	II	00449	006		12	120889	1/1/0001
04000	S	M	OUG	V	00465	007		12	120889	1/1/0001
04000	S	M	OUG	V	00499	008		12	120889	1/1/0001

OFFICE: 311

ROUTE: 564

ST_REF_NO: 00000037250

CHELTENHAM DRIVE

LUMENS	BULB TYPE	MULT SERIES	POLE TYPE	SHADE	ADDRESS NUMBER	REF	LOCATION	TAX DIST	DATE INST	DATE CHANGE
05800	S	M	CNT	II	00000	006	SIDE OF 1005 CHETFORD DRIVE	12	010897	1/1/0001
05800	S	M	CNT	II	03301	001		12	010897	1/1/0001
05800	S	M	CNT	II	03305	003		12	010897	1/1/0001
05800	S	M	CNT	II	03308	002		12	010897	1/1/0001
05800	S	M	CNT	III	03328	004		12	010897	1/1/0001
05800	S	M	CNT	II	03336	005		12	010897	1/1/0001

OFFICE: 311

ROUTE: 564

ST_REF_NO: 00000037300

CHENAULT ROAD

LUMENS	BULB TYPE	MULT SERIES	POLE TYPE	SHADE	ADDRESS NUMBER	REF	LOCATION	TAX DIST	DATE INST	DATE CHANGE
05800	S	M	OUG	V	00000	034	IN MEDIAN, OPP. 239	12	040467	1/1/0001
05800	S	M	OUG	V	00000	035	IN MEDIAN, OPP. 240	12	090170	1/1/0001
05800	S	M	OOH	II	00125	000		12	100265	1/1/0001
05800	S	M	OUG	II	00138	000		12	100165	1/1/0001
05800	S	M	OUG	II	00143	000		12	030897	1/1/0001

OFFICE: 311		ROUTE: 564		ST_REF_NO: 00000037300		CHENAULT ROAD				
LUMENS	BULB TYPE	MULT SERIES	POLE TYPE	SHADE	ADDRESS NUMBER	REF	LOCATION	TAX DIST	DATE INST	DATE CHANGE
05800	S	M	OUG	II	00154	000		12	101478	1/1/0001
05800	S	M	SOH	II	00161	000		12	090865	1/1/0001
05800	S	M	OUG	II	00212	000		12	110165	1/1/0001
05800	S	M	OUG	II	00219	000		12	040467	1/1/0001
05800	S	M	OUG	II	00228	000		12	110165	1/1/0001
05800	S	M	OUG	II	00234	000		12	121465	1/1/0001

OFFICE: 311		ROUTE: 564		ST_REF_NO: 00000037375		CHERAW COURT				
LUMENS	BULB TYPE	MULT SERIES	POLE TYPE	SHADE	ADDRESS NUMBER	REF	LOCATION	TAX DIST	DATE INST	DATE CHANGE
09500	S	M	OUG	III	02112	001		12	082602	9/9/2009

OFFICE: 311		ROUTE: 564		ST_REF_NO: 00000037400		CHERBOURG COURT				
LUMENS	BULB TYPE	MULT SERIES	POLE TYPE	SHADE	ADDRESS NUMBER	REF	LOCATION	TAX DIST	DATE INST	DATE CHANGE
05800	S	M	OUG	II	00000	052	SIDE OF 1236 CHERBOURG RD	12	080169	1/1/0001
05800	S	M	OUG	V	01256	053		12	041466	1/1/0001

OFFICE: 311		ROUTE: 564		ST_REF_NO: 00000037500		CHERBOURG ROAD				
LUMENS	BULB TYPE	MULT SERIES	POLE TYPE	SHADE	ADDRESS NUMBER	REF	LOCATION	TAX DIST	DATE INST	DATE CHANGE
05800	S	M	OUG	II	00000	028	SIDE OF 2417 LA ROCHELLE	12	101964	1/1/0001
05800	S	M	OUG	II	00000	047	SIDE OF 1220 NICE DR.	12	100967	1/1/0001
05800	S	M	OUG	II	01232	048		12	041466	1/1/0001
05800	S	M	OUG	II	01265	049		12	080169	1/1/0001
05800	S	M	OUG	II	01276	050		12	062167	1/1/0001
05800	S	M	OUG	II	01288	051		12	050969	1/1/0001

OFFICE: 311		ROUTE: 564		ST_REF_NO: 00000037700		CHERRY COURT				
LUMENS	BULB TYPE	MULT SERIES	POLE TYPE	SHADE	ADDRESS NUMBER	REF	LOCATION	TAX DIST	DATE INST	DATE CHANGE
05800	S	M	OUG	II	01900	000		12	062363	1/1/0001
05800	S	M	OUG	II	01921	000		12	062363	1/1/0001

OFFICE: 311

ROUTE: 564

ST_REF_NO: 00000037705

CHERRY MEADOW PATH

LUMENS	BULB TYPE	MULT SERIES	POLE TYPE	SHADE	ADDRESS NUMBER	REF	LOCATION	TAX DIST	DATE INST	DATE CHANGE
05800	S		CNT	II	00000	050	SIDE OF 3100 BLACKFORD PWKY, ON CHERRY MEADOW PATH	12	051510	1/1/0001
05800	S		CNT	II	03109	051		12	051510	1/1/0001
05800	S		CNT	II	03116	052		12	051510	1/1/0001
05800	S		CNT	II	03145	053		12	051510	1/1/0001
05800	S		CNT	II	03148	100		12	051510	1/1/0001
05800	S		CNT	II	03224	030		12	051510	1/1/0001
05800	S		CNT	II	03231	001		12	051510	1/1/0001
05800	S		CNT	II	03237	002		12	051510	1/1/0001
05800	S	M	CNT	II	03121	012		12	092506	1/1/0001
05800	S	M	CNT	II	03133	011		12	092506	1/1/0001
05800	S	M	CNT	II	03165	008		12	102606	1/1/0001
05800	S	M	CNT	II	03172	007		12	102606	1/1/0001
05800	S	M	CNT	II	03177	006		12	102606	1/1/0001
05800	S	M	CNT	II	03200	005		12	102606	1/1/0001
05800	S	M	CNT	II	03205	004		12	102606	1/1/0001
05800	S	M	CNT	II	03212	003		12	102606	1/1/0001

OFFICE: 311

ROUTE: 564

ST_REF_NO: 00000037710

CHERRYWOOD DRIVE

LUMENS	BULB TYPE	MULT SERIES	POLE TYPE	SHADE	ADDRESS NUMBER	REF	LOCATION	TAX DIST	DATE INST	DATE CHANGE
05800	S	M	OUG	II	00929	002		12	060887	9/9/2009
04000	S	M	OUG	II	00901	001		12	060887	1/1/0001
04000	S	M	OUG	II	00924	003		12	060887	1/1/0001
04000	S	M	OUG	II	00940	004		12	060887	1/1/0001
04000	S	M	OUG	V	00945	005		12	060887	1/1/0001

OFFICE: 311

ROUTE: 564

ST_REF_NO: 00000037800

CHERYL LANE

LUMENS	BULB TYPE	MULT SERIES	POLE TYPE	SHADE	ADDRESS NUMBER	REF	LOCATION	TAX DIST	DATE INST	DATE CHANGE
05800	S	M	OUG	II	00000	001	SIDE OF 1883 HARRODSBURG RD.	12	100889	9/9/2009
09500	S	M	OUG	II	00740	005		12	100889	9/9/2009
05800	S	M	OUG	II	00749	006		12	100889	9/9/2009
05800	S	M	OUG	II	00788	010		12	100889	9/9/2009
05800	S	M	OUG	II	00803	011		12	100889	9/9/2009

OFFICE: 311		ROUTE: 564		ST_REF_NO: 00000037800		CHERYL LANE		LUMENS	BULB TYPE	MULT SERIES	POLE TYPE	SHADE	ADDRESS NUMBER	REF	LOCATION	TAX DIST	DATE INST	DATE CHANGE
	04000	S	M	OUG	II	00000	019	SIDE OF 1802 BEACON HILL RD.	12	020889	1/1/0001							
	04000	S	M	OUG	II	00703	002		12	100889	1/1/0001							
	04000	S	M	OUG	II	00716	003		12	100889	1/1/0001							
	05800	S	M	OUG	II	00725	004		12	100889	1/1/0001							
	04000	S	M	OUG	II	00768	007		12	100889	1/1/0001							
	04000	S	M	OUG	II	00777	008		12	100889	1/1/0001							
	04000	S	M	OUG	II	00814	012		12	100889	1/1/0001							
	04000	S	M	OUG	II	00827	013		12	100889	1/1/0001							
	04000	S	M	OUG	II	00838	014		12	100889	1/1/0001							
	04000	S	M	OUG	II	00851	015		12	100889	1/1/0001							
	04000	S	M	OUG	II	00862	016		12	100889	1/1/0001							
	04000	S	M	OUG	II	00875	017		12	100889	1/1/0001							
	04000	S	M	OUG	II	00887	018		12	100889	1/1/0001							

OFFICE: 311

ROUTE: 564

OFFICE: 311		ROUTE: 564		ST_REF_NO: 00000037850		CHESAPEAKE COURT		LUMENS	BULB TYPE	MULT SERIES	POLE TYPE	SHADE	ADDRESS NUMBER	REF	LOCATION	TAX DIST	DATE INST	DATE CHANGE
	05800	S	M	CNT	III	02200	001		12	060105	1/1/0001							

OFFICE: 311

ROUTE: 564

OFFICE: 311		ROUTE: 564		ST_REF_NO: 00000037900		CHESTERFIELD CIRCLE		LUMENS	BULB TYPE	MULT SERIES	POLE TYPE	SHADE	ADDRESS NUMBER	REF	LOCATION	TAX DIST	DATE INST	DATE CHANGE
	05800	S		OUG	II	00000	086	SIDE OF 3253 YELLOWSTONE PKWY	12	061580	1/1/0001							
	05800	S		OUG	V	03201	087		12	111580	1/1/0001							

OFFICE: 311

ROUTE: 564

OFFICE: 311		ROUTE: 564		ST_REF_NO: 00000038000		CHESTNUT STREET		LUMENS	BULB TYPE	MULT SERIES	POLE TYPE	SHADE	ADDRESS NUMBER	REF	LOCATION	TAX DIST	DATE INST	DATE CHANGE
	05800	S	M	SOH	II	00000	010	SIDE OF 398 E. FIFTH ST.-chg ref details only	12	080165	12/8/2014							
	05800	S	M	SOH	II	00000	112	side of 406 E Sixth St-chg ref details only	12	080165	12/8/2014							
	05800	S	M	SOH	II	00405	105	chg ref number only	12	080165	12/8/2014							
	05800	S	M	SOH	II	00421	106	chg ref number only	12	080165	12/8/2014							
	05800	S	M	SOH	II	00439	107	chg ref number only	12	080165	12/8/2014							
	05800	S	M	SOH	II	00452	108	chg ref number only	12	080165	12/8/2014							

OFFICE: 311

ROUTE: 564

ST_REF_NO: 00000038000

CHESTNUT STREET

LUMENS	BULB TYPE	MULT SERIES	POLE TYPE	SHADE	ADDRESS NUMBER	REF	LOCATION	TAX DIST	DATE INST	DATE CHANGE
05800	S	M	SOH	II	00521	109	chg ref number only	12	080165	12/8/2014
05800	S	M	SOH	II	00540	110	chg ref number only	12	080165	12/8/2014
05800	S	M	SOH	II	00557	111	chg ref number only	12	080165	12/8/2014
05800	S	M	SOH	II	00000	011	SIDE OF 401 E. FIFTH ST.	12	080165	1/1/0001
05800	S	M	SOH	II	00607	000		12	080165	1/1/0001
05800	S	M	SOH	II	00632	000		12	080165	1/1/0001
05800	S	M	SOH	II	00633	000		12	080165	1/1/0001
05800	S	M	SOH	II	00640	000		12	080165	1/1/0001
05800	S	M	SOH	II	00655	000		12	080165	1/1/0001
05800	S	M	SOH	II	00000	001	SIDE OF 367 E. THIRD ST.	12	080165	1/1/0001
05800	S	M	SOH	II	00321	000		12	080165	1/1/0001
05800	S	M	SOH	II	00336	000		12	080165	1/1/0001
05800	S	M	SOH	II	00351	000		12	080165	1/1/0001
05800	S	M	SOH	II	00364	000		12	080165	1/1/0001

OFFICE: 311

ROUTE: 564

ST_REF_NO: 00000038010

CHESTNUT HILL LANE

LUMENS	BULB TYPE	MULT SERIES	POLE TYPE	SHADE	ADDRESS NUMBER	REF	LOCATION	TAX DIST	DATE INST	DATE CHANGE
05800	S	M	CNT	II	00000	001	SIDE OF 593 FOREST HILL DR.	12	120894	1/1/0001
05800	S	M	CNT	III	03400	007		12	120894	1/1/0001
05800	S	M	CNT	II	03409	006		12	120894	1/1/0001
05800	S	M	CNT	II	03420	005		12	120894	1/1/0001
05800	S	M	CNT	II	03425	004		12	120894	1/1/0001
05800	S	M	CNT	II	03442	003		12	120894	1/1/0001
05800	S	M	CNT	II	03445	002		12	120894	1/1/0001

OFFICE: 311

ROUTE: 564

ST_REF_NO: 00000038020

CHESTNUT OAK WAY

LUMENS	BULB TYPE	MULT SERIES	POLE TYPE	SHADE	ADDRESS NUMBER	REF	LOCATION	TAX DIST	DATE INST	DATE CHANGE
05800	S	M	OUG	II	00000	003	SIDE OF 560 GLEN ARVIN AVE, ON CHESTNUT OAK WAY	12	081903	1/1/0001
05800	S	M	OUG	II	00601	001		12	081903	1/1/0001
05800	S	M	OUG	II	00604	002		12	081903	1/1/0001

OFFICE: 311

ROUTE: 564

ST_REF_NO: 00000038060

CHESTNUT RIDGE DRIVE

LUMENS	BULB TYPE	MULT SERIES	POLE TYPE	SHADE	ADDRESS NUMBER	REF	LOCATION	TAX DIST	DATE INST	DATE CHANGE
05800	S	M	CNT	II	00000	001	SIDE OF 2600 WHITEBERRY DR ON CHESTNUT RIDGE DR	12	091001	1/1/0001
05800	S	M	CNT	II	00000	002	SIDE OF 2601 WHITEBERRY DR ON CHESTNUT RIDGE DR	12	091001	1/1/0001
05800	S	M	CNT	II	00000	006	SIDE OF 2798 WHITEBERRY DR ON CHESTNUT RIDGE DR	12	091001	1/1/0001
05800	S	M	CNT	II	00000	009	SIDE OF 2796 TRAILWOOD LN ON CHESTNUT RIDGE DR	12	091001	1/1/0001
05800	S	M	CNT	II	00125	003		12	091001	1/1/0001
05800	S	M	CNT	II	00137	004		12	091001	1/1/0001
05800	S	M	CNT	II	00153	005		12	091001	1/1/0001
05800	S	M	CNT	II	00177	007		12	091001	1/1/0001
05800	S	M	CNT	II	00193	008		12	091001	1/1/0001
05800	S	M	CNT	II	00217	010		12	091001	1/1/0001
05800	S	M	CNT	II	00257	012		12	122004	1/1/0001
05800	S	M	CNT	II	00260	011		12	091001	1/1/0001
05800	S	M	CNT	II	00272	013		12	122004	1/1/0001
05800	S	M	CNT	II	00292	014		12	091001	1/1/0001

OFFICE: 311

ROUTE: 564

ST_REF_NO: 00000038070

CHETFORD DRIVE

LUMENS	BULB TYPE	MULT SERIES	POLE TYPE	SHADE	ADDRESS NUMBER	REF	LOCATION	TAX DIST	DATE INST	DATE CHANGE
05800	S	M	CNT	II	00000	005	SIDE OF 3344 CHELTINGHAM CIRCLE	12	030897	1/1/0001
05800	S	M	CNT	II	00981	001		12	030897	1/1/0001
05800	S	M	CNT	II	00988	002		12	030897	1/1/0001
05800	S	M	CNT	II	00989	003		12	030897	1/1/0001
05800	S	M	CNT	II	01000	004		12	030897	1/1/0001
05800	S	M	CNT	II	01024	006		12	030897	1/1/0001
05800	S	M	CNT	III	01032	007		12	030897	1/1/0001
05800	S	M	CNT	II	01041	008		12	030897	1/1/0001
05800	S	M	CNT	II	01048	009		12	030897	1/1/0001
05800	S	M	CNT	II	01053	010		12	030897	1/1/0001
05800	S	M	CNT	III	01064	011		12	030897	1/1/0001
05800	S	M	CNT	II	01072	012		12	030897	1/1/0001
05800	S	M	CNT	II	01080	013		12	030897	1/1/0001

OFFICE: 311		ROUTE: 564		ST_REF_NO: 00000038070		CHETFORD DRIVE				
LUMENS	BULB TYPE	MULT SERIES	POLE TYPE	SHADE	ADDRESS NUMBER	REF	LOCATION	TAX DIST	DATE INST	DATE CHANGE
05800	S	M	CNT	II	01081	014		12	030897	1/1/0001
05800	S	M	CNT	II	01085	015		12	030897	1/1/0001
05800	S	M	CNT	II	01108	016		12	030897	1/1/0001
05800	S	M	CNT	II	01113	017		12	030897	1/1/0001
05800	S	M	CNT	II	01120	018		12	030897	1/1/0001
05800	S	M	CNT	II	01129	019		12	030897	1/1/0001
05800	S	M	CNT	II	01140	020		12	030897	1/1/0001
05800	S	M	CNT	II	01149	021		12	030897	1/1/0001
05800	S	M	CNT	II	01156	022		12	030897	1/1/0001
05800	S	M	CNT	II	01165	023		12	030897	1/1/0001

OFFICE: 311

ROUTE: 564

OFFICE: 311		ROUTE: 564		ST_REF_NO: 00000038100		CHEVY CHASE TERRACE				
LUMENS	BULB TYPE	MULT SERIES	POLE TYPE	SHADE	ADDRESS NUMBER	REF	LOCATION	TAX DIST	DATE INST	DATE CHANGE
05800	S	M	SOH	I	00000	001	SIDE REAR 859 E. HIGH ON CHEVY CHASE TERRACE	12	091477	2/6/2014

OFFICE: 311

ROUTE: 564

OFFICE: 311		ROUTE: 564		ST_REF_NO: 00000038200		CHICKASAW COURT				
LUMENS	BULB TYPE	MULT SERIES	POLE TYPE	SHADE	ADDRESS NUMBER	REF	LOCATION	TAX DIST	DATE INST	DATE CHANGE
05800	S	M	OUG	II	01701	000		12	071064	1/1/0001
05800	S	M	OUG	II	01706	000		12	071064	1/1/0001

OFFICE: 311

ROUTE: 564

OFFICE: 311		ROUTE: 564		ST_REF_NO: 00000038300		CHILES AVENUE				
LUMENS	BULB TYPE	MULT SERIES	POLE TYPE	SHADE	ADDRESS NUMBER	REF	LOCATION	TAX DIST	DATE INST	DATE CHANGE
05800	S	M	SOH	I	00709	000		12	050969	1/1/0001
05800	S	M	SOH	I	00717	000		12	050969	1/1/0001
05800	S	M	SOH	I	00731	000		12	050969	1/1/0001
05800	S	M	SOH	I	00741	000		12	050969	1/1/0001
05800	S	M	SOH	I	00749	000		12	050969	1/1/0001
05800	S	M	SOH	I	00771	000		12	050969	1/1/0001
05800	S	M	SOH	I	00787	000		12	050969	1/1/0001
05800	S	M	SOH	I	00803	000		12	050969	1/1/0001

OFFICE: 311

ROUTE: 564

ST_REF_NO: 00000038303

CHILESBURG ROAD

LUMENS	BULB TYPE	MULT SERIES	POLE TYPE	SHADE	ADDRESS NUMBER	REF	LOCATION	TAX DIST	DATE INST	DATE CHANGE
09500	S	M	OUG	II	00000	001	IN ISLAND AT HAYS BOULEVARD	12	020305	1/1/0001
09500	S	M	OUG	II	00000	002	1ST LT W OF HAYES BLVD, N SIDE ON CHILESBURG RD	12	020305	1/1/0001
09500	S	M	OUG	II	00000	003	2ND LT W OF HAYS BLVD, N SIDE ON CHILESBURG RD	12	020305	1/1/0001
09500	S	M	OUG	II	00000	004	3RD LT W OF HAYS BLVD, N SIDE ON CHILESBURG RD	12	020305	1/1/0001

OFFICE: 311

ROUTE: 564

ST_REF_NO: 00000038305

CHIMNEY POINT LANE

LUMENS	BULB TYPE	MULT SERIES	POLE TYPE	SHADE	ADDRESS NUMBER	REF	LOCATION	TAX DIST	DATE INST	DATE CHANGE
05800	S	M	OUG	II	00000	001	REAR OF 781 GRAFTONS MILL LANE	12	110899	1/1/0001
05800	S	M	OUG	II	02408	004		12	110899	1/1/0001
05800	S	M	OUG	II	02416	003		12	110899	1/1/0001
05800	S	M	OUG	II	02432	002		12	110899	1/1/0001

OFFICE: 311

ROUTE: 564

ST_REF_NO: 00000038310

CHINABERRY COURT

LUMENS	BULB TYPE	MULT SERIES	POLE TYPE	SHADE	ADDRESS NUMBER	REF	LOCATION	TAX DIST	DATE INST	DATE CHANGE
05800	S	M	CNT	III	04005	001		12	100894	1/1/0001

OFFICE: 311

ROUTE: 564

ST_REF_NO: 00000038400

CHINOE ROAD

LUMENS	BULB TYPE	MULT SERIES	POLE TYPE	SHADE	ADDRESS NUMBER	REF	LOCATION	TAX DIST	DATE INST	DATE CHANGE
05800	S	M	OOH	II	00000	013	96 CHINOE RD., IN MEDIAN	12	020889	9/9/2009
05800	S	M	OOH	II	00000	014	97 CHINOE RD., IN MEDIAN	12	020889	9/9/2009
05800	S	M	OUG	II	00000	260	CORNER OF MORELAND DRIVE AND CHINOE RD	12	123101	1/1/0001
05800	S	M	OUG	III	00230	000		12	110955	12/3/2012
09500	S	M	OUG	III	00240	000		12	110955	9/9/2009
05800	S	M	OUG	II	00416	050		12	081582	9/9/2009
05800	S	M	OUG	II	00746	250		12	123101	1/1/0001
05800	S	M	OUG	II	00763	251		12	123101	1/1/0001
05800	S	M	OUG	II	00767	252		12	123101	1/1/0001
05800	S	M	OUG	II	00774	253		12	123101	1/1/0001
05800	S	M	OUG	II	00783	254		12	123101	1/1/0001

OFFICE: 311

ROUTE: 564

ST_REF_NO: 0000038400

CHINOE ROAD

LUMENS	BULB TYPE	MULT SERIES	POLE TYPE	SHADE	ADDRESS NUMBER	REF	LOCATION	TAX DIST	DATE INST	DATE CHANGE
05800	S	M	OUG	II	00786	255		12	123101	1/1/0001
05800	S	M	OUG	II	00801	256		12	123101	1/1/0001
05800	S	M	OUG	II	00802	257		12	123101	1/1/0001
05800	S	M	OUG	II	00813	258		12	123101	1/1/0001
05800	S	M	OUG	II	00818	259		12	123101	1/1/0001
09500	S	M	OUG	II	00834	261		12	123101	9/9/2009
05800	S	M	OUG	II	00000	011	SIDE OF 1800 E. MAIN ST., IN MEDIAN	12	020889	1/1/0001
05800	S	M	OUG	II	00000	012	SIDE OF 1800 E. MAIN ST., IN MEDIAN	12	020889	1/1/0001
04000	S	M	OUG	III	00116	000		12	100957	1/1/0001
04000	S	M	OUG	III	00124	000		12	100957	1/1/0001
04000	S	M	OUG	III	00200	000		12	110955	1/1/0001
04000	S	M	OUG	III	00222	000		12	110955	1/1/0001
05800	S	M	OUG	II	00309	000		12	040165	1/1/0001
05800	S	M	OUG	II	00331	000		12	040165	1/1/0001
05800	S	M	OUG	II	00000	061	SIDE OF 1395 LAKEWOOD DR	12	122164	1/1/0001
05800	S	M	OUG	II	00000	062	SIDE OF 1410 LAKEWOOD DR	12	010665	1/1/0001
05800	S	M	OUG	II	00404	000		12	122164	1/1/0001
05800	S	M	OUG	II	00409	000		12	070566	1/1/0001
05800	S	M	OUG	II	00425	000		12	122164	1/1/0001
05800	S	M	OUG	II	00502	000		12	122164	1/1/0001
05800	S	M	OUG	II	00524	000		12	122164	1/1/0001
05800	S	M	OUG	II	00536	000		12	020166	1/1/0001
05800	S	M	OUG	II	00539	000		12	122164	1/1/0001
05800	S	M	OUG	II	00602	000		12	040165	1/1/0001
05800	S	M	OUG	II	00613	000		12	122164	1/1/0001
05800	S	M	OUG	II	00640	000		12	122164	1/1/0001
05800	S	M	OUG	II	00719	186		12	091477	1/1/0001
05800	S	M	OUG	II	00738	187		12	091477	1/1/0001
05800	S	M	OUG	II	00900	002		12	011475	1/1/0001
05800	S	M	OUG	II	00901	001		12	011475	1/1/0001
05800	S	M	OUG	II	00905	003		12	011475	1/1/0001
05800	S	M	OUG	II	00909	004		12	011475	1/1/0001
04000	S	M	OUG	V	00912	010		12	051476	1/1/0001
05800	S	M	OUG	II	00000	001	OPP. MOUNT DR.	12	030888	1/1/0001

OFFICE: 311

ROUTE: 564

ST_REF_NO: 00000038400

CHINOE ROAD

LUMENS	BULB TYPE	MULT SERIES	POLE TYPE	SHADE	ADDRESS NUMBER	REF	LOCATION	TAX DIST	DATE INST	DATE CHANGE
05800	S	M	OUG	II	00000	003	OPP. 945	12	030888	1/1/0001
05800	S	M	OUG	II	00000	007	SIDE OF 977 WARRENTON CIRCLE	12	030888	1/1/0001
05800	S	M	OUG	II	00000	008	SIDE 3185 PEPPERHILL ON CHINOE	12	090884	1/1/0001
05800	S	M	OUG	II	00000	009	OPP. 3100 BLOCK OF PEPPERHILL ON CHINOE	12	090884	1/1/0001
05800	S	M	OUG	II	00000	010	SIDE OF 3180 PEPPERHILL RD.	12	030888	1/1/0001
05800	S	M	OUG	II	00000	017	OPP. 997	12	110885	1/1/0001
05800	S	M	OUG	II	00000	018	OPP. 1005	12	030888	1/1/0001
05800	S	M	OUG	II	00000	019	OPP. 1013	12	030888	1/1/0001
05800	S	M	OUG	II	00000	020	OPP. 1021	12	110885	1/1/0001
05800	S	M	OUG	II	00000	196	CHINOE AT NEW CIRCLE	12	070890	1/1/0001
05800	S	M	OUG	II	00000	201	OPP. 1112	12	040888	1/1/0001
05800	S	M	OUG	II	00000	216	OPP. 1061	12	110885	1/1/0001
05800	S	M	OUG	II	00000	218	OPP. 1045	12	110885	1/1/0001
05800	S	M	OUG	II	00921	006		12	051476	1/1/0001
05800	S	M	OUG	II	00924	005		12	011475	1/1/0001
05800	S	M	OUG	II	00936	007		12	051476	1/1/0001
05800	S	M	OUG	II	00937	008		12	051478	1/1/0001
05800	S	M	OUG	II	00949	004		12	030888	1/1/0001
05800	S	M	OUG	II	00957	005		12	111580	1/1/0001
05800	S	M	OUG	II	00961	006		12	111580	1/1/0001
05800	S	M	OUG	II	01029	221		12	110885	1/1/0001
05800	S	M	OUG	II	01032	220		12	111580	1/1/0001
05800	S	M	OUG	II	01041	219		12	110885	1/1/0001
05800	S	M	OUG	II	01053	217		12	110885	1/1/0001
05800	S	M	OUG	II	01069	215		12	111580	1/1/0001
05800	S	M	OUG	II	01073	214		12	111580	1/1/0001
05800	S	M	OUG	II	01080	213		12	111580	1/1/0001
05800	S	M	OUG	II	01089	205		12	111580	1/1/0001
05800	S	M	OUG	II	01096	204		12	111580	1/1/0001
05800	S	M	OUG	II	01105	203		12	111580	1/1/0001
05800	S	M	OUG	II	01108	202		12	011581	1/1/0001
05800	S	M	OUG	II	01120	200		12	070890	1/1/0001
05800	S	M	OUG	II	01121	199		12	041581	1/1/0001
05800	S	M	OUG	II	01132	198		12	070890	1/1/0001

OFFICE: 311 ROUTE: 564										
ST_REF_NO: 00000038400 CHINOE ROAD										
LUMENS	BULB TYPE	MULT SERIES	POLE TYPE	SHADE	ADDRESS NUMBER	REF	LOCATION	TAX DIST	DATE INST	DATE CHANGE
05800	S	M	OUG	II	01137	197		12	040888	1/1/0001
OFFICE: 311 ROUTE: 564										
ST_REF_NO: 00000038405 CHINOE PLACE										
LUMENS	BULB TYPE	MULT SERIES	POLE TYPE	SHADE	ADDRESS NUMBER	REF	LOCATION	TAX DIST	DATE INST	DATE CHANGE
05800	S	M	OUG	II	00937	009		12	011475	1/1/0001
OFFICE: 311 ROUTE: 564										
ST_REF_NO: 00000038410 CHINQUAPIN LANE										
LUMENS	BULB TYPE	MULT SERIES	POLE TYPE	SHADE	ADDRESS NUMBER	REF	LOCATION	TAX DIST	DATE INST	DATE CHANGE
05800	S	M	OUG	II	00000	001	1ST LT. NORTH OF PARKERS MILL	12	090893	1/1/0001
05800	S	M	OUG	II	00000	002	OPP. 2405	12	090893	1/1/0001
05800	S	M	OUG	II	00000	003	OPP. 2417	12	090893	1/1/0001
OFFICE: 311 ROUTE: 564										
ST_REF_NO: 00000038500 CHIPPENDALE CIRCLE										
LUMENS	BULB TYPE	MULT SERIES	POLE TYPE	SHADE	ADDRESS NUMBER	REF	LOCATION	TAX DIST	DATE INST	DATE CHANGE
04000	S	M	OUG	II	00000	017	OPP. 200 CHIPPEN DALE CIRCLE	12	100890	1/1/0001
04000	S	M	OUG	II	00000	019	OPP. 224 CHIPPEN DALE CIRCLE	12	100890	1/1/0001
04000	S	M	OUG	II	00212	018		12	100887	1/1/0001
04000	S	M	OUG	II	00228	020		12	100887	1/1/0001
04000	S	M	OUG	V	00104	013		12	100887	1/1/0001
05800	S	M	OUG	II	00300	022	chg out bad fixture 2/08	12	100884	1/1/0001
04000	S	M	OUG	II	00301	021		12	100887	1/1/0001
04000	S	M	OUG	II	00315	023		12	100884	1/1/0001
OFFICE: 311 ROUTE: 564										
ST_REF_NO: 00000038600 CHRIS DRIVE										
LUMENS	BULB TYPE	MULT SERIES	POLE TYPE	SHADE	ADDRESS NUMBER	REF	LOCATION	TAX DIST	DATE INST	DATE CHANGE
05800	S	M	OUG	II	00000	079	SIDE OF 1021 PENNEBAKER DR	12	100171	1/1/0001
05800	S	M	OUG	II	00000	106	SIDE OF 1016 VALLEY FARM DR	12	081475	1/1/0001
05800	S	M	OUG	II	01913	000		12	050774	1/1/0001
05800	S	M	OUG	II	01924	000		12	080173	1/1/0001
05800	S	M	OUG	II	01933	109		12	051475	1/1/0001

OFFICE: 311

ROUTE: 564

ST_REF_NO: 00000039000

CHURCH STREET

LUMENS	BULB TYPE	MULT SERIES	POLE TYPE	SHADE	ADDRESS NUMBER	REF	LOCATION	TAX DIST	DATE INST	DATE CHANGE
22000	S	M	SOH	III	00000	004	1ST LT W OF MILL, S SIDE	12	102061	9/9/2009
20000	M	M	SOH	III	00000	001	SIDE OF 154 NORTH BROADWAY	12	102061	1/1/0001
20000	M	M	SOH	III	00000	002	OPP SKILLMAN ALLEY	12	102061	1/1/0001
20000	M	M	SOH	III	00331	003		12	102161	1/1/0001
20000	M	M	SOH	III	00000	005	SIDE OF 160 NORTH MILL ST	12	102061	1/1/0001
20000	M	M	SOH	III	00000	006	1ST LT EAST OF MILL ON SOUTH SIDE	12	102061	1/1/0001
20000	M	M	SOH	III	00000	007	SIDE OF 155 MARKET ST	12	102061	1/1/0001
20000	M	M	SOH	III	00000	008	SIDE OF 154 MARKET ST	12	102061	1/1/0001
20000	M	M	SOH	III	00000	009	1ST LT EAST OF MARKET ST NORTH SIDE	12	102061	1/1/0001
20000	M	M	SOH	III	00000	010	SIDE OF 153 UPPER ST	12	102061	1/1/0001
20000	M	M	SOH	III	00000	011	SIDE OF 154 UPPER	12	102061	1/1/0001
20000	M	M	SOH	III	00000	012	OPP 145	12	102061	1/1/0001
20000	M	M	SOH	III	00000	014	SIDE OF 157 LIMESTONE	12	102061	1/1/0001
20000	M	M	SOH	III	00125	013		12	102061	1/1/0001

OFFICE: 311

ROUTE: 564

ST_REF_NO: 00000039100

CHURCHILL DRIVE

LUMENS	BULB TYPE	MULT SERIES	POLE TYPE	SHADE	ADDRESS NUMBER	REF	LOCATION	TAX DIST	DATE INST	DATE CHANGE
05800	S	M	OUG	II	00000	009	OPP 1016	12	051165	1/1/0001
05800	S	M	OUG	II	00000	008	OPP 1010	12	051165	1/1/0001

OFFICE: 311

ROUTE: 564

ST_REF_NO: 00000039200

CHYLEEN COURT

LUMENS	BULB TYPE	MULT SERIES	POLE TYPE	SHADE	ADDRESS NUMBER	REF	LOCATION	TAX DIST	DATE INST	DATE CHANGE
05800	S	M	OUG	II	00000	001	SIDE OF 658 EDEN RD	12	110766	1/1/0001
05800	S	M	OUG	II	00000	002	SIDE OF 649 EDEN RD	12	110766	1/1/0001
04000	S	M	OUG	II	00000	025	SIDE OF 2207 CHYLEEN DR.	12	050884	1/1/0001

OFFICE: 311

ROUTE: 564

ST_REF_NO: 00000039300

CHYLEEN DRIVE

LUMENS	BULB TYPE	MULT SERIES	POLE TYPE	SHADE	ADDRESS NUMBER	REF	LOCATION	TAX DIST	DATE INST	DATE CHANGE
05800	S	M	OUG	II	02204	024		12	050884	9/9/2009
04000	S	M	OUG	II	02211	026		12	050884	1/1/0001

OFFICE: 311

ROUTE: 564

ST_REF_NO: 00000039310

CIMARRON COURT

LUMENS	BULB TYPE	MULT SERIES	POLE TYPE	SHADE	ADDRESS NUMBER	REF	LOCATION	TAX DIST	DATE INST	DATE CHANGE
05800	S	M	CNT	III	04104	001		12	100894	1/1/0001

OFFICE: 311

ROUTE: 564

ST_REF_NO: 00000039400

CINDY BLAIR WAY

LUMENS	BULB TYPE	MULT SERIES	POLE TYPE	SHADE	ADDRESS NUMBER	REF	LOCATION	TAX DIST	DATE INST	DATE CHANGE
05800	S	M	OUG	II	00685	010		12	120890	9/9/2009
05800	S	M	OUG	II	00747	017		12	120890	9/9/2009
05800	S	M	OUG	II	00750	018		12	120890	9/9/2009
04000	S	M	OUG	II	00000	012	OPP. 696 CINDY BLAIR WAY	12	120890	1/1/0001
04000	S	M	OUG	II	00000	016	OPP. 739 CINDY BLAIR WAY	12	120890	1/1/0001
04000	S	M	OUG	II	00693	011		12	120890	1/1/0001
04000	S	M	OUG	II	00710	013		12	120890	1/1/0001
04000	S	M	OUG	II	00723	014		12	120890	1/1/0001
04000	S	M	OUG	II	00731	015		12	120890	1/1/0001
04000	S	M	OUG	II	00759	019		12	120890	1/1/0001
04000	S	M	OUG	II	00766	020		12	120890	1/1/0001
04000	S	M	OUG	II	00774	021		12	120890	1/1/0001
04000	S	M	OUG	II	00779	022		12	120891	1/1/0001
05800	S	M	OUG	II	00640	002		12	120890	1/1/0001
05800	S	M	OUG	II	00640	004		12	120890	1/1/0001
05800	S	M	OUG	II	00641	001		12	120890	1/1/0001
05800	S	M	OUG	II	00641	003		12	120890	1/1/0001
05800	S	M	OUG	II	00644	005		12	120890	1/1/0001
05800	S	M	OUG	II	00653	006		12	120890	1/1/0001
04000	S	M	OUG	II	00656	007		12	120890	1/1/0001
04000	S	M	OUG	II	00664	008		12	120890	1/1/0001
04000	S	M	OUG	II	00669	009		12	120890	1/1/0001

OFFICE: 311

ROUTE: 564

ST_REF_NO: 00000039600

CIRCLE DRIVE

LUMENS	BULB TYPE	MULT SERIES	POLE TYPE	SHADE	ADDRESS NUMBER	REF	LOCATION	TAX DIST	DATE INST	DATE CHANGE
05800	S	M	OUG	II	02206	005		12	050884	1/1/0001
04000	S	M	OUG	II	02211	004		12	050884	1/1/0001
04000	S	M	OUG	II	02223	003		12	050884	1/1/0001

OFFICE: 311		ROUTE: 564		ST_REF_NO: 00000039600		CIRCLE DRIVE				
LUMENS	BULB TYPE	MULT SERIES	POLE TYPE	SHADE	ADDRESS NUMBER	REF	LOCATION	TAX DIST	DATE INST	DATE CHANGE
04000	S	M	OUG	II	02234	001		12	050884	1/1/0001
04000	S	M	OUG	II	02235	002		12	050884	1/1/0001
OFFICE: 311		ROUTE: 564		ST_REF_NO: 00000039700		CISCO ROAD				
LUMENS	BULB TYPE	MULT SERIES	POLE TYPE	SHADE	ADDRESS NUMBER	REF	LOCATION	TAX DIST	DATE INST	DATE CHANGE
04000	S	M	SOH	II	00000	001	SIDE 1330 VERSAILLES RD.	12	030886	1/1/0001
04000	S	M	SOH	II	00104	002		12	030886	1/1/0001
04000	S	M	SOH	II	00110	003		12	030886	1/1/0001
04000	S	M	SOH	II	00114	004		12	030886	1/1/0001
04000	S	M	SOH	II	00118	005		12	030886	1/1/0001
04000	S	M	SOH	II	00124	006		12	030886	1/1/0001
OFFICE: 311		ROUTE: 564		ST_REF_NO: 00000039720		CITATION BLVD.				
LUMENS	BULB TYPE	MULT SERIES	POLE TYPE	SHADE	ADDRESS NUMBER	REF	LOCATION	TAX DIST	DATE INST	DATE CHANGE
50000	S		OUG	II	00000	400	1ST LT E OF NEWTOWN PK, S SIDE OF CITATION	12	100113	1/1/0001
22000	S		OUG	II	00000	401	1ST LT E OF NEWTOWN PK, N SIDE OF CITATION BLVD	12	100113	1/1/0001
22000	S		OUG	II	00000	402	2ND LT E OF NEWTOWN PK, S SIDE OF CITATION	12	100113	1/1/0001
22000	S		OUG	II	00000	403	2ND LT E OF NEWTOWN PK, N SIDE OF CITATION BLVD	12	100113	1/1/0001
22000	S		OUG	II	00000	404	3RD LT E OF NEWTOWN PK, S SIDE OF CITATION BLVD	12	100113	1/1/0001
22000	S		OUG	II	00000	405	3RD LT E OF NEWTOWN PK, N SIDE OF CITATION BLVD	12	100113	1/1/0001
22000	S		OUG	II	00000	406	4TH LT E OF NEWTOWN PK, S SIDE OF CITATION BLVD	12	100113	1/1/0001
22000	S		OUG	II	00000	407	4TH LT E OF NEWTOWN PK, N SIDE OF CITATION BLVD	12	100113	1/1/0001
22000	S		OUG	II	00000	408	5TH LT E OF NEWTOWN PK, S SIDE OF CITATION BLVD	12	100113	1/1/0001
22000	S		OUG	II	00000	409	5TH LT E OF NEWTOWN PK, N SIDE OF CITATION BLVD	12	100113	1/1/0001
22000	S		OUG	II	00000	410	6TH LT E OF NEWTOWN PK, S SIDE OF CITATION BLVD	12	100113	1/1/0001

OFFICE: 311

ROUTE: 564

ST_REF_NO: 00000039720

CITATION BLVD.

LUMENS	BULB TYPE	MULT SERIES	POLE TYPE	SHADE	ADDRESS NUMBER	REF	LOCATION	TAX DIST	DATE INST	DATE CHANGE
22000	S		OUG	II	00000	411	6TH LT E OF NEWTOWN PK, N SIDE OF CITATION BLVD	12	100113	1/1/0001
22000	S		OUG	II	00000	412	7TH LT E OF NEWTOWN PK, S SIDE OF CITATION BLVD	12	100113	1/1/0001
22000	S		OUG	II	00000	413	7TH LT E OF NEWTOWN PK, N SIDE OF CITATION BLVD	12	100113	1/1/0001
09500	S		OUG	II	00000	414	8TH LT E OF NEWTOWN PK, N SIDE OF CITATION BLVD	12	100113	1/1/0001
09500	S		OUG	II	00000	415	9TH LT E OF NEWTOWN PK, S SIDE OF CITATION BLVD	12	100113	1/1/0001
09500	S		OUG	II	00000	416	10TH LT E OF NEWTOWN PK, S SIDE OF CITATION BLVD	12	100113	1/1/0001
09500	S		OUG	II	00000	417	11TH LT E OF NEWTOWN PK, S SIDE OF CITATION BLVD	12	100113	1/1/0001
22000	S	M	OUG	II	00000	201	10TH LT W OF GEORGETOWN RD, NORTH SIDE ON CITATION	12	062308	1/1/0001
22000	S	M	OUG	II	00000	202	1ST LT E OF JAGGIE FOX, SOUTH SIDE ON CITATION	12	060808	1/1/0001
22000	S	M	OUG	II	00000	203	9TH LT W OF GEORGETOWN RD, NORTH SIDE ON CITATION	12	062308	1/1/0001
22000	S	M	OUG	II	00000	204	2ND LT E OF JAGGIE FOX, SOUTH SIDE ON CITATION	12	060808	1/1/0001
22000	S	M	OUG	II	00000	205	8TH LT W OF GEORGETOWN RD, NORTH SIDE ON CITATION	12	062308	1/1/0001
22000	S	M	OUG	II	00000	206	3RD LT E OF JAGGIE FOX, SOUTH SIDE ON CITATION	12	060808	1/1/0001
22000	S	M	OUG	II	00000	207	7TH LT W OF GEORGETOWN RD, NORTH SIDE ON CITATION	12	062308	1/1/0001
22000	S	M	OUG	II	00000	208	4TH LT E OF JAGGIE FOX, SOUTH SIDE ON CITATION	12	060808	1/1/0001
22000	S	M	OUG	II	00000	209	6TH LT W OF GEORGETOWN RD, NORTH SIDE ON CITATION	12	062308	1/1/0001
22000	S	M	OUG	II	00000	210	5TH LT E OF JAGGIE FOX, SOUTH SIDE ON CITATION	12	060808	1/1/0001
22000	S	M	OUG	II	00000	211	5TH LT W OF GEORGETOWN RD, NORTH SIDE ON CITATION	12	062308	1/1/0001
22000	S	M	OUG	II	00000	212	6TH LT E OF JAGGIE FOX, SOUTH SIDE ON CITATION	12	060808	1/1/0001
22000	S	M	OUG	II	00000	213	4TH LT W OF GEORGETOWN RD, NORTH SIDE ON CITATION	12	062308	1/1/0001

OFFICE: 311

ROUTE: 564

ST_REF_NO: 00000039720

CITATION BLVD.

LUMENS	BULB TYPE	MULT SERIES	POLE TYPE	SHADE	ADDRESS NUMBER	REF	LOCATION	TAX DIST	DATE INST	DATE CHANGE
22000	S	M	OUG	II	00000	214	7TH LT E OF JAGGIE FOX, SOUTH SIDE ON CITATION	12	060808	1/1/0001
22000	S	M	OUG	II	00000	215	3RD LT W OF GEORGETOWN RD, NORTH SIDE ON CITATION	12	062308	1/1/0001
22000	S	M	OUG	II	00000	216	8TH LT E OF JAGGIE FOX , SOUTH SIDE ON CITATION	12	060808	1/1/0001
22000	S	M	OUG	II	00000	217	2ND LT W OF GEORGETOWN RD, NORTH SIDE ON CITATION	12	062308	1/1/0001
22000	S	M	OUG	II	00000	218	9TH LT E OF JAGGIE FOX, SOUTH SIDE ON CITATION	12	060808	1/1/0001
22000	S	M	OUG	II	00000	219	1ST LT W OF GEORGETOWN RD, NORTH SIDE ON CITATION	12	062308	1/1/0001
22000	S	M	OUG	II	00000	225	12TH LT W OF REMINGTON WAY, NORTH SIDE ON CITATION	12	062308	1/1/0001
22000	S	M	OUG	II	00000	227	11TH LT W OF REMINGTON WAY, NORTH SIDE ON CITATION	12	062308	1/1/0001
22000	S	M	OUG	II	00000	228	1ST LT E OF GEORGETOWN RD, SOUTH SIDE ON CITATION	12	060808	1/1/0001
22000	S	M	OUG	II	00000	229	10TH LT W OF REMINGTON WAY, NORTH SIDE ON CITATION	12	062308	1/1/0001
22000	S	M	OUG	II	00000	230	2ND LT E OF GEORGETOWN RD, SOUTH SIDE ON CITATION	12	060808	1/1/0001
22000	S	M	OUG	II	00000	231	9TH LT W OF REMINGTON WAY, NORTH SIDE ON CITATION	12	062308	1/1/0001
22000	S	M	OUG	II	00000	232	3RD LT E OF GEORGETOWN RD, SOUTH SIDE ON CITATION	12	060808	1/1/0001
22000	S	M	OUG	II	00000	233	8TH LT W OF REMINGTON WAY, NORTH SIDE ON CITATION	12	062308	1/1/0001
22000	S	M	OUG	II	00000	234	4TH LT E OF GEORGETOWN, SOUTH SIDE ON CITATION	12	060808	1/1/0001
22000	S	M	OUG	II	00000	235	7TH LT W OF REMINGTON WAY, NORTH SIDE ON CITATION	12	062308	1/1/0001
22000	S	M	OUG	II	00000	236	5TH LT E OF GEORGETOWN RD, SOUTH SIDE ON CITATION	12	060808	1/1/0001
22000	S	M	OUG	II	00000	237	6TH LT W OF REMINGTON WAY, NORTH SIDE ON CITATION	12	062308	1/1/0001
22000	S	M	OUG	II	00000	238	6TH LT E OF GEORGETOWN RD, SOUTH SIDE ON CITATION	12	060808	1/1/0001
22000	S	M	OUG	II	00000	239	5TH LT W OF REMINGTON WAY, NORTH SIDE ON CITATION	12	062308	1/1/0001

Street Light Listing run 1/11/2015 10:43:21 AM

Page 207 of 1254

OFFICE: 311

ROUTE: 564

ST_REF_NO: 00000039720

CITATION BLVD.

LUMENS	BULB TYPE	MULT SERIES	POLE TYPE	SHADE	ADDRESS NUMBER	REF	LOCATION	TAX DIST	DATE INST	DATE CHANGE
22000	S	M	OUG	II	00000	240	7TH LT E OF GEORGETOWN RD, SOUTH SIDE ON CITATION	12	060808	1/1/0001
22000	S	M	OUG	II	00000	241	4TH LT W OF REMINGTON WAY, NORTH SIDE ON CITATION	12	062308	1/1/0001
22000	S	M	OUG	II	00000	242	8TH LT E OF GEORGETOWN RD, SOUTH SIDE ON CITATION	12	060808	1/1/0001
22000	S	M	OUG	II	00000	243	3RD LT W OF REMINGTON WAY, NORTH SIDE ON CITATION	12	062308	1/1/0001
22000	S	M	OUG	II	00000	244	9TH LT E OF GEORGETOWN RD, SOUTH SIDE ON CITATION	12	060808	1/1/0001
22000	S	M	OUG	II	00000	245	2ND LT W OF REMINGTON WAY, NORTH SIDE ON CITATION	12	062308	1/1/0001
22000	S	M	OUG	II	00000	246	10TH LT E OF GEORGETOWN RD, SOUTH SIDE ON CITATION	12	060808	1/1/0001
22000	S	M	OUG	II	00000	247	1ST LT W OF REMINGTON WAY, NORTH SIDE ON CITATION	12	062308	1/1/0001
22000	S	M	OUG	II	00000	248	11TH LT E OF GEORGETOWN RD, SOUTH SIDE ON CITATION	12	060808	1/1/0001
22000	S	M	OUG	II	00000	249	1ST LT E OF REMINGTON WAY, NORTH SIDE ON CITATION	12	062308	1/1/0001
22000	S	M	OUG	II	00000	250	1ST LT E OF REMINGTON WAY, SOUTH SIDE ON CITATION	12	060808	1/1/0001
22000	S	M	OUG	II	00000	251	2ND LT E OF REMINGTON WAY,NORTH SIDE ON CITATION	12	062308	1/1/0001
22000	S	M	OUG	II	00000	252	2ND LT E OF REMINGTON WAY, SOUTH SIDE ON CITATION	12	060808	1/1/0001
22000	S	M	OUG	II	00000	253	3RD LT E OF REMINGTON WAY, NORTH SIDE ON CITATION	12	062308	1/1/0001
22000	S	M	OUG	II	00000	254	3RD LT E OF REMINGTON WAY, SOUTH SIDE ON CITATION	12	060808	1/1/0001
22000	S	M	OUG	II	00000	255	4TH LT E OF REMINGTON WAY, NORTH SIDE ON CITATION	12	062308	1/1/0001
22000	S	M	OUG	II	00000	256	4TH LT E OF REMINGTON WY, SOUTH SIDE ON CITATION	12	060808	1/1/0001
22000	S	M	OUG	II	00000	257	5TH LT E OF REMINGTON WAY, NORTH SIDE ON CITATION	12	062308	1/1/0001
22000	S	M	OUG	II	00000	258	5TH LT E OF REMINGTON WY, SOUTH SIDE ON CITATION	12	060808	1/1/0001
22000	S	M	OUG	II	00000	259	6TH LT E OF REMINGTON WAY, NORTH SIDE ON CITATION	12	062308	1/1/0001

OFFICE: 311

ROUTE: 564

ST_REF_NO: 00000039720

CITATION BLVD.

LUMENS	BULB TYPE	MULT SERIES	POLE TYPE	SHADE	ADDRESS NUMBER	REF	LOCATION	TAX DIST	DATE INST	DATE CHANGE
22000	S	M	OUG	II	00000	260	6TH LT E OF REMINGTON WY, SOUTH SIDE ON CITATION	12	060808	1/1/0001
22000	S	M	OUG	II	00000	261	7TH LT E OF REMINGTON WAY, NORTH SIDE ON CITATION	12	062308	1/1/0001
22000	S	M	OUG	II	00000	262	7TH LT E OF REMINGTON WY, SOUTH SIDE ON CITATION	12	060808	1/1/0001
22000	S	M	OUG	II	00000	263	8TH LT E OF REMINGTON WAY, NORTH SIDE ON CITATION	12	062308	1/1/0001
22000	S	M	OUG	II	00000	264	8TH LT E OF REMINGTON WY, SOUTH SIDE ON CITATION	12	060808	1/1/0001
22000	S	M	OUG	II	00000	265	9TH LT E OF REMINGTON WAY, NORTH SIDE ON CITATION	12	062308	1/1/0001
22000	S	M	OUG	II	00000	266	9TH LT E OF REMINGTON WY, SOUTH SIDE ON CITATION	12	060808	1/1/0001
22000	S	M	OUG	II	00000	348	22ND LT W OF NEWTOWN PK, S SIDE ON CITATION BLVD	12	011702	1/1/0001
22000	S	M	OUG	II	00000	349	21ST LT W OF NEWTOWN PK, N SIDE ON CITATION BLVD	12	011702	1/1/0001
22000	S	M	OUG	II	00000	350	20TH LT W OF NEWTOWN PK, S SIDE ON CITATION BLVD	12	011702	1/1/0001
22000	S	M	OUG	II	00000	351	19TH LT W OF NEWTOWN PK, N SIDE ON CITATION BLVD	12	011702	1/1/0001
22000	S	M	OUG	II	00000	352	18TH LT W OF NEWTOWN PK, S SIDE ON CITATION BLVD	12	011702	1/1/0001
22000	S	M	OUG	II	00000	353	17TH LT W OF NEWTOWN PK, N SIDE ON CITATION BLVD	12	011702	1/1/0001
22000	S	M	OUG	II	00000	354	16TH LT W OF NEWTOWN PK, S SIDE ON CITATION BLVD	12	011702	1/1/0001
22000	S	M	OUG	II	00000	355	15TH LT W OF NEWTOWN PK, N SIDE ON CITATION BLVD	12	011702	1/1/0001
22000	S	M	OUG	II	00000	356	14TH LT W OF NEWTOWN PK, S SIDE ON CITATION BLVD	12	011702	1/1/0001
22000	S	M	OUG	II	00000	357	13TH LT W OF NEWTOWN PK, N SIDE ON CITATION BLVD	12	011702	1/1/0001
22000	S	M	OUG	II	00000	358	12TH LT W OF NEWTOWN PK, S SIDE ON CITATION BLVD	12	011702	1/1/0001
22000	S	M	OUG	II	00000	359	11TH LT W OF NEWTOWN PK, N SIDE ON CITATION BLVD	12	011702	1/1/0001
22000	S	M	OUG	II	00000	360	10TH LT W OF NEWTOWN PK, S SIDE ON CITATION BLVD	12	011702	1/1/0001

OFFICE: 311		ROUTE: 564		ST_REF_NO: 00000039720		CITATION BLVD.				
LUMENS	BULB TYPE	MULT SERIES	POLE TYPE	SHADE	ADDRESS NUMBER	REF	LOCATION	TAX DIST	DATE INST	DATE CHANGE
22000	S	M	OUG	II	00000	361	9TH LT W OF NEWTOWN PK, N SIDE ON CITATION BLVD	12	011702	1/1/0001
22000	S	M	OUG	II	00000	362	8TH LT W OF NEWTOWN PK, S SIDE ON CITATION BLVD	12	011702	1/1/0001
22000	S	M	OUG	II	00000	363	7TH LT W OF NEWTOWN PK, N SIDE ON CITATION BLVD	12	011702	1/1/0001
22000	S	M	OUG	II	00000	364	6TH LT W OF NEWTOWN PK, S SIDE ON CITATION BLVD	12	011702	1/1/0001
22000	S	M	OUG	II	00000	365	5TH LT W OF NEWTOWN PK, N SIDE ON CITATION BLVD	12	011702	1/1/0001
22000	S	M	OUG	II	00000	366	4TH LT W OF NEWTOWN PK, S SIDE ON CITATION BLVD	12	011702	1/1/0001
22000	S	M	OUG	II	00000	367	3RD LT W OF NEWTOWN PK, N SIDE ON CITATION BLVD	12	011702	1/1/0001
22000	S	M	OUG	II	00000	368	2ND LT W OF NEWTOWN PK, S SIDE ON CITATION BLVD	12	011702	1/1/0001
50000	S	M	OUG	III	00000	369	1ST LT W OF NEWTOWN PK, N SIDE ON CITATION BLVD	12	011702	1/1/0001

OFFICE: 311		ROUTE: 564		ST_REF_NO: 00000039800		CLAIBORNE WAY				
LUMENS	BULB TYPE	MULT SERIES	POLE TYPE	SHADE	ADDRESS NUMBER	REF	LOCATION	TAX DIST	DATE INST	DATE CHANGE
05800	S	M	OUG	II	01000	000		12	080159	1/1/0001
05800	S	M	OUG	II	01007	000		12	050160	1/1/0001
05800	S	M	OUG	II	01013	000		12	080159	1/1/0001
05800	S	M	OUG	II	01014	000		12	080159	1/1/0001
05800	S	M	OUG	II	01023	000		12	080159	1/1/0001
05800	S	M	OUG	II	01028	000		12	091564	1/1/0001
05800	S	M	OUG	II	01033	000		12	010160	1/1/0001
05800	S	M	OUG	II	01038	000		12	091564	1/1/0001

OFFICE: 311		ROUTE: 564		ST_REF_NO: 00000039900		CLAIR ROAD				
LUMENS	BULB TYPE	MULT SERIES	POLE TYPE	SHADE	ADDRESS NUMBER	REF	LOCATION	TAX DIST	DATE INST	DATE CHANGE
04000	S	M	OUG	II	00000	001	OPP. 3086	12	110889	1/1/0001
05800	S	M	OUG	II	00000	038	SIDE OF 3001 MONTAVESTA	12	030171	1/1/0001
05800	S	M	OUG	II	00000	039	SIDE OF 2994 MONTAVESTA	12	090170	1/1/0001

OFFICE: 311		ROUTE: 564		ST_REF_NO: 00000039900		CLAIR ROAD		LUMENS	BULB TYPE	MULT SERIES	POLE TYPE	SHADE	ADDRESS NUMBER	REF	LOCATION	TAX DIST	DATE INST	DATE CHANGE
05800	S	M	OUG	II	03109	000										12	030171	1/1/0001

OFFICE: 311		ROUTE: 564		ST_REF_NO: 00000039910		CLAREDON DRIVE		LUMENS	BULB TYPE	MULT SERIES	POLE TYPE	SHADE	ADDRESS NUMBER	REF	LOCATION	TAX DIST	DATE INST	DATE CHANGE
05800	S	M	OUG	II	00000	021	SIDE OF 1222 TRENT BLVD									12	101477	1/1/0001
05800	S	M	OUG	V	03677	019										12	101477	1/1/0001
05800	S	M	OUG	II	03688	020										12	101477	1/1/0001
05800	S	M	OUG	II	03712	022										12	101477	1/1/0001

OFFICE: 311		ROUTE: 564		ST_REF_NO: 00000040100		CLARIDGE DRIVE		LUMENS	BULB TYPE	MULT SERIES	POLE TYPE	SHADE	ADDRESS NUMBER	REF	LOCATION	TAX DIST	DATE INST	DATE CHANGE
05800	S	M	OUG	V	01086	001										12	020889	9/9/2009
05800	S	M	OUG	II	01104	004										12	020889	9/9/2009
04000	S	M	OUG	II	00000	002	SIDE OF 1816 DARIEN DR.									12	020889	1/1/0001
04000	S	M	OUG	II	00000	003	SIDE OF 1829 DARIEN DR.									12	020889	1/1/0001
04000	S	M	OUG	II	00000	009	SIDE 1812 WILLIAMSBURG RD.									12	020889	1/1/0001
04000	S	M	OUG	II	01124	006										12	020889	1/1/0001
04000	S	M	OUG	II	01125	005										12	020889	1/1/0001
04000	S	M	OUG	II	01145	007										12	020889	1/1/0001
04000	S	M	OUG	II	01148	008										12	020889	1/1/0001

OFFICE: 311		ROUTE: 564		ST_REF_NO: 00000040300		CLARKSDALE COURT		LUMENS	BULB TYPE	MULT SERIES	POLE TYPE	SHADE	ADDRESS NUMBER	REF	LOCATION	TAX DIST	DATE INST	DATE CHANGE
05800	S	M	OUG	V	01501	000										12	040165	1/1/0001
05800	S	M	OUG	II	01506	000										12	060162	1/1/0001
05800	S	M	OUG	II	01511	000										12	060162	1/1/0001
05800	S	M	OUG	II	01514	000										12	090866	1/1/0001

OFFICE: 311		ROUTE: 564		ST_REF_NO: 00000040370		CLAYVIS COURT		LUMENS	BULB TYPE	MULT SERIES	POLE TYPE	SHADE	ADDRESS NUMBER	REF	LOCATION	TAX DIST	DATE INST	DATE CHANGE
05800	S	M	CNT	II	00705	004										12	080102	1/1/0001

OFFICE: 311

ROUTE: 564

ST_REF_NO: 00000040370

CLAYVIS COURT

LUMENS	BULB TYPE	MULT SERIES	POLE TYPE	SHADE	ADDRESS NUMBER	REF	LOCATION	TAX DIST	DATE INST	DATE CHANGE
05800	S	M	CNT	II	00729	003		12	020899	1/1/0001
05800	S	M	CNT	II	00736	002		12	020899	1/1/0001
05800	S	M	CNT	III	00749	001		12	020899	1/1/0001

OFFICE: 311

ROUTE: 564

ST_REF_NO: 00000040400

CLAY AVENUE

LUMENS	BULB TYPE	MULT SERIES	POLE TYPE	SHADE	ADDRESS NUMBER	REF	LOCATION	TAX DIST	DATE INST	DATE CHANGE
09500	S	M	SOH	III	00000	001	SIDE OF 656 EAST MAIN ST	12	010868	9/9/2009
22000	S	M	SOH	III	00000	009	OPPOSITE 222	12	010868	9/9/2009
09500	S	M	SOH	III	00000	017	SIDE OF 645 EAST HIGH ST. (field verified)	12	010868	1/8/1968
10000	M	M	SOH	III	00000	276	OPPOSITE 276 - just added reference, no change in billing	12	010868	1/7/2014
05800	S	M	SOH	III	00114	002		12	010868	9/9/2009
09500	S	M	SOH	III	00119	000		12	010868	9/9/2009
09500	S	M	SOH	III	00000	006	SIDE OF 702 CENTRAL AVE-upgrade 2/08	12	010868	1/1/0001
10000	M	M	SOH	III	00000	011	OPPOSITE 242	12	010868	1/1/0001
09500	S	M	SOH	III	00000	013	OPPOSITE 260-chg out bad mv fixture 2/08	12	010868	1/1/0001
05800	S	M	SOH	I	00000	634	SIDE OF 639 EUCLID AVE	12	050867	1/1/0001
05800	S	M	SOH	I	00000	637	SIDE OF 656 EAST HIGH ST	12	050867	1/1/0001
05800	S	M	SOH	I	00000	638	SIDE OF 656 EAST HIGH ST	12	050867	1/1/0001
10000	M	M	SOH	III	00126	000		12	010868	1/1/0001
10000	M	M	SOH	III	00135	000		12	010868	1/1/0001
10000	M	M	SOH	III	00211	007		12	010868	1/1/0001
10000	M	M	SOH	III	00218	000		12	010868	1/1/0001
10000	M	M	SOH	III	00236	000		12	010868	1/1/0001
10000	M	M	SOH	III	00248	000		12	010868	1/1/0001
10000	M	M	SOH	III	00268	000		12	010868	1/1/0001
10000	M	M	SOH	III	00282	000		12	010868	1/1/0001
05800	S	M	SOH	I	00317	000		12	050867	1/1/0001
05800	S	M	SOH	I	00327	000		12	050867	1/1/0001

OFFICE: 311

ROUTE: 564

ST_REF_NO: 00000040600

CLAYMONT DRIVE

LUMENS	BULB TYPE	MULT SERIES	POLE TYPE	SHADE	ADDRESS NUMBER	REF	LOCATION	TAX DIST	DATE INST	DATE CHANGE
04000	S	M	OUG	II	00000	101	SIDE OF 560 CLAYMONT DR.	12	092368	1/1/0001

OFFICE: 311

ROUTE: 564

ST_REF_NO: 00000040600

CLAYMONT DRIVE

LUMENS	BULB TYPE	MULT SERIES	POLE TYPE	SHADE	ADDRESS NUMBER	REF	LOCATION	TAX DIST	DATE INST	DATE CHANGE
04000	S	M	OUG	II	00000	104	SIDE OF 502 HILL'N'DALE RD.	12	090968	1/1/0001
04000	S	M	OUG	II	00544	103		12	101468	1/1/0001
04000	S	M	OUG	II	00556	102		12	090170	1/1/0001
04000	S	M	OUG	II	00565	100		12	120869	1/1/0001
04000	S	M	OUG	II	00576	099		12	120869	1/1/0001

OFFICE: 311

ROUTE: 564

ST_REF_NO: 00000040800

CLAYS MILL ROAD

LUMENS	BULB TYPE	MULT SERIES	POLE TYPE	SHADE	ADDRESS NUMBER	REF	LOCATION	TAX DIST	DATE INST	DATE CHANGE
50000	S		OUG	II	00000	114	1ST LT E OF HIGBEE MILL RD, N SIDE ON CLAYS MILL RD	12	061812	1/1/0001
22000	S		OUG	II	00000	115	1ST LT E OF HIGBEE MILL RD, S SIDE OF CLAYS MILL RD	12	061812	1/1/0001
22000	S		OUG	II	00000	116	2ND LT E OF HIGBEE MILL RD, N SIDE OF CLAYS MILL RD	12	061812	1/1/0001
22000	S		OUG	II	00000	117	2ND LT E OF HIGBEE MILL RD, S SIDE OF CLAYS MILL RD	12	061812	1/1/0001
22000	S		OUG	II	00000	118	3RD LT E OF HIGBEE MILL RD, N SIDE OF CLAYS MILL RD	12	061812	1/1/0001
22000	S		OUG	II	00000	119	1ST LT E OF GRAVIS CT, S SIDE OF CLAYS MILL RD	12	061812	1/1/0001
22000	S		OUG	II	00000	120	1ST LT E OF GRAVIS CT, N SIDE OF CLAYS MILL RD	12	061812	1/1/0001
22000	S		OUG	II	00000	121	2ND LT E OF GRAVIS CT, S SIDE OF CLAYS MILL RD	12	061812	1/1/0001
50000	S		OUG	II	00000	122	2ND LT E OF GRAVIS CT, N SIDE OF CLAYS MILL RD	12	061812	1/1/0001
22000	S		OUG	II	00000	134	ACROSS FROM 3409 CLAYS MILL RD	12	071012	1/1/0001
22000	S		OUG	II	00000	137	SIDE OF 641 CINDY BLAIR WAY ON CLAYS MILL RD	12	071012	1/1/0001
22000	S		OUG	II	00000	140	ACROSS FROM 3375 CLAYS MILL RD	12	071012	1/1/0001
22000	S		OUG	II	00000	142	ACROSS FROM 3347 CLAYS MILL RD	12	071012	1/1/0001
50000	S		OUG	II	00000	143	SIDE OF 3344 KEITHSHIRE WAY ON CLAYS MILL RD	12	071012	1/1/0001
50000	S		OUG	II	00000	144	1ST LT N OF KEITHSHIRE WAY, EAST SIDE OF CLAYS MILL RD	12	071012	1/1/0001
22000	S		OUG	II	03347	141		12	071012	1/1/0001
22000	S		OUG	II	03379	139		12	071012	1/1/0001
22000	S		OUG	II	03405	135		12	071012	1/1/0001
22000	S		OUG	II	03413	138		12	071012	1/1/0001
22000	S		OUG	II	03417	133		12	071012	1/1/0001
22000	S		OUG	II	03418	131		12	062612	1/1/0001

OFFICE: 311

ROUTE: 564

ST_REF_NO: 0000040800

CLAYS MILL ROAD

LUMENS	BULB TYPE	MULT SERIES	POLE TYPE	SHADE	ADDRESS NUMBER	REF	LOCATION	TAX DIST	DATE INST	DATE CHANGE
22000	S		OUG	II	03425	132		12	071012	1/1/0001
22000	S		OUG	II	03426	129		12	062612	1/1/0001
50000	S		OUG	II	03433	136		12	071012	1/1/0001
22000	S		OUG	II	03437	130		12	062612	1/1/0001
22000	S		OUG	II	03444	127		12	062612	1/1/0001
22000	S		OUG	II	03449	128		12	062612	1/1/0001
22000	S		OUG	II	03461	126		12	062612	1/1/0001
22000	S		OUG	II	03464	125		12	062612	1/1/0001
22000	S		OUG	II	03473	124		12	062612	1/1/0001
50000	S		OUG	II	03478	123		12	062612	1/1/0001
22000	S	M	SOH	III	00000	092	OPP SIDE OF 3028 NEAL DR	12	071583	9/9/2009
22000	S	M	SOH	III	00000	188	SIDE OF 397 CECIL WAY	12	071583	7/15/1983
22000	S	M	SOH	III	00000	190	OPP 2901	12	071583	9/9/2009
22000	S	M	OOH	II	00000	267	2ND LT. S. OF HIGBEE MILL RD., EASTSIDE	12	060685	9/9/2009
22000	S	M	SOH	III	01939	208		12	041583	9/9/2009
22000	S	M	SOH	III	02065	197		12	041583	9/9/2009
22000	S	M	SOH	III	02100	196		12	041583	9/9/2009
22000	S	M	SOH	III	02119	193		12	041583	9/9/2009
22000	S	M	SOH	III	02209	191		12	041583	9/9/2009
50000	S	M	SOH	III	02249	185		12	051583	9/9/2009
50000	S	M	SOH	III	02250	180		12	051583	9/9/2009
50000	S	M	SOH	III	02250	182		12	051583	9/9/2009
50000	S	M	SOH	III	02250	184		12	051583	9/9/2009
50000	S	M	SOH	III	02305	183		12	051583	9/9/2009
50000	S	M	SOH	III	02319	177		12	051583	9/9/2009
22000	S	M	SOH	III	02319	179		12	051583	9/9/2009
22000	S	M	SOH	III	02319	181		12	051583	9/9/2009
50000	S	M	SOH	III	02501	172		12	051583	9/9/2009
50000	S	M	SOH	III	02501	174		12	051583	9/9/2009
50000	S	M	SOH	III	02501	175		12	051583	9/9/2009
09500	S	M	SOH	III	02817	150		12	030800	9/9/2009
50000	S	M	SOH	III	02857	153		12	030800	9/9/2009
22000	S	M	SOH	II	00000	007	OPP. 1804	12	040884	1/1/0001
22000	S	M	SOH	II	00000	009	OPP. 1708	12	040884	1/1/0001

OFFICE: 311

ROUTE: 564

ST_REF_NO: 0000040800

CLAYS MILL ROAD

LUMENS	BULB TYPE	MULT SERIES	POLE TYPE	SHADE	ADDRESS NUMBER	REF	LOCATION	TAX DIST	DATE INST	DATE CHANGE
22000	S	M	SOH	II	00000	011	OPP. 1700	12	040884	1/1/0001
20000	M	M	SOH	III	00000	202	SIDE OF 556 ROSEMONT GARDEN	12	041583	1/1/0001
20000	M	M	SOH	III	00000	204	SIDE OF 600 LANE ALLEN RD.	12	041583	1/1/0001
20000	M	M	SOH	III	00000	205	BESIDE 1920	12	041583	1/1/0001
22000	S	M	SOH	II	01600	016		12	040884	1/1/0001
22000	S	M	SOH	II	01604	015		12	040884	1/1/0001
22000	S	M	SOH	II	01612	013		12	040884	1/1/0001
22000	S	M	SOH	II	01616	012		12	040884	1/1/0001
22000	S	M	SOH	II	01701	014		12	110892	1/1/0001
22000	S	M	SOH	II	01704	010		12	040884	1/1/0001
22000	S	M	SOH	II	01800	008		12	040884	1/1/0001
22000	S	M	SOH	II	01808	006		12	040884	1/1/0001
22000	S	M	SOH	II	01815	005		12	040884	1/1/0001
22000	S	M	SOH	II	01824	004		12	040884	1/1/0001
22000	S	M	SOH	II	01827	003		12	040884	1/1/0001
22000	S	M	SOH	II	01831	002		12	040884	1/1/0001
22000	S	M	SOH	II	01839	001		12	040884	1/1/0001
20000	M	M	SOH	III	01856	211		12	041583	1/1/0001
20000	M	M	SOH	III	01869	212		12	041583	1/1/0001
20000	M	M	SOH	III	01894	209		12	041583	1/1/0001
20000	M	M	SOH	III	01900	207		12	041583	1/1/0001
20000	M	M	SOH	III	01909	210		12	041583	1/1/0001
20000	M	M	SOH	III	01995	206		12	041583	1/1/0001
20000	M	M	SOH	III	02021	203		12	041583	1/1/0001
20000	M	M	SOH	III	02033	201		12	041583	1/1/0001
20000	M	M	SOH	III	02038	200		12	041583	1/1/0001
22000	S	M	SOH	III	02049	199	changed out bad mv fix 5/08	12	041583	1/1/0001
20000	M	M	SOH	III	02050	198		12	041583	1/1/0001
22000	S	M	SOH	III	00000	086	OPP. 2916	12	071583	1/1/0001
22000	S	M	SOH	III	00000	088	OPP. 2924	12	071583	1/1/0001
22000	S	M	SOH	III	00000	090	OPP. 2934	12	071583	1/1/0001
22000	S	M	SOH	III	00000	094	OPP. 3000	12	071583	1/1/0001
22000	S	M	SOH	III	00000	095	SIDE OF 521 ANDREA DR.	12	071583	1/1/0001
22000	S	M	SOH	III	00000	096	OPP. THE SIDE OF 521 ANDREA DR.	12	071583	1/1/0001

OFFICE: 311

ROUTE: 564

ST_REF_NO: 0000040800

CLAYS MILL ROAD

LUMENS	BULB TYPE	MULT SERIES	POLE TYPE	SHADE	ADDRESS NUMBER	REF	LOCATION	TAX DIST	DATE INST	DATE CHANGE
50000	S	M	SOH	III	00000	157	OPP. 2799	12	030800	1/1/0001
20000	M	M	SOH	III	00000	171	SIDE OF 565 HILL'N'DALE RD.	12	051583	1/1/0001
20000	M	M	SOH	III	00000	173	SIDE OF 568 FAIRFIELD DR.	12	051583	1/1/0001
20000	M	M	SOH	III	00000	176	SIDE OF 571 FAIRFIELD DR.	12	051583	1/1/0001
20000	M	M	SOH	III	00000	178	SIDE OF 545 HOLLY HILL DR.	12	051583	1/1/0001
20000	M	M	SOH	III	00000	187	SIDE OF 601 STRATFORD DR.	12	041583	1/1/0001
20000	M	M	SOH	III	00000	189	SIDE OF 600 SHERIDAN DR.	12	041583	1/1/0001
22000	S	M	SOH	III	00000	192	OPP. 2909	12	071583	1/1/0001
22000	S	M	SOH	III	02105	195	changed out bad mv fixture 5/08	12	041583	1/1/0001
20000	M	M	SOH	III	02116	194		12	041583	1/1/0001
20000	M	M	SOH	III	02200	192		12	041583	1/1/0001
20000	M	M	SOH	III	02216	190		12	041583	1/1/0001
20000	M	M	SOH	III	02228	188		12	041583	1/1/0001
22000	S	M	SOH	III	02236	186		12	041583	1/1/0001
22000	S	M	SOH	III	02601	170		12	071583	1/1/0001
22000	S	M	SOH	III	02601	171		12	071583	1/1/0001
22000	S	M	SOH	III	02622	173		12	071583	1/1/0001
50000	S	M	SOH	III	02623	156		12	030800	1/1/0001
50000	S	M	SOH	III	02700	155		12	030800	1/1/0001
50000	S	M	SOH	III	02779	158		12	030800	1/1/0001
50000	S	M	SOH	III	02790	151		12	030800	1/1/0001
22000	S	M	SOH	III	02791	176		12	071583	1/1/0001
50000	S	M	SOH	III	02794	152		12	030800	1/1/0001
22000	S	M	SOH	II	02801	178		12	020890	1/1/0001
50000	S	M	SOH	III	02802	154		12	030800	1/1/0001
22000	S	M	SOH	III	02810	186		12	071583	1/1/0001
22000	S	M	SOH	III	02873	185		12	071583	1/1/0001
22000	S	M	SOH	III	02893	187		12	071583	1/1/0001
22000	S	M	SOH	III	02901	189		12	071583	1/1/0001
22000	S	M	SOH	III	02907	191		12	071583	1/1/0001
22000	S	M	SOH	III	02911	193		12	071583	1/1/0001
22000	S	M	SOH	III	02914	085		12	071583	1/1/0001
22000	S	M	SOH	III	02920	087		12	071583	1/1/0001
22000	S	M	SOH	III	02924	089		12	071583	1/1/0001

OFFICE: 311

ROUTE: 564

ST_REF_NO: 0000040800

CLAYS MILL ROAD

LUMENS	BULB TYPE	MULT SERIES	POLE TYPE	SHADE	ADDRESS NUMBER	REF	LOCATION	TAX DIST	DATE INST	DATE CHANGE
22000	S	M	SOH	III	03000	093		12	071583	1/1/0001
22000	S	M	SOH	III	00000	001	OPP. 3367 CLAYS MILL RD.	12	020884	1/1/0001
22000	S	M	SOH	III	00000	002	OPP. 3371 CLAYS MILL RD.	12	020884	1/1/0001
22000	S	M	SOH	III	00000	003	OPP. 3379 CLAYS MILL RD.	12	020884	1/1/0001
22000	S	M	SOH	III	00000	004	OPP. 3383 CLAYS MILL RD.	12	020884	1/1/0001
22000	S	M	SOH	III	00000	020	SIDE OF 616 WELLINGTON WAY ON CLAYS MILL	12	110891	1/1/0001
22000	S	M	SOH	III	00000	021	REAR SIDE OF 629 BETH LANE ON CLAYS MILL	12	110891	1/1/0001
22000	S	M	SOH	III	00000	022	FRONT SIDE OF 629 BETH LANE ON CLAYS MILL	12	110891	1/1/0001
22000	S	M	SOH	III	00000	023	SIDE OF 632 BETH LANE ON CLAYS MILL	12	110891	1/1/0001
22000	S	M	SOH	III	00000	097	SIDE OF 520 ANDREA DR.	12	071583	1/1/0001
22000	S	M	SOH	III	00000	098	OPP. THE SIDE OF 520 ANDREA DR	12	071583	1/1/0001
22000	S	M	SOH	III	00000	099	OPP. STONE RD.	12	071583	1/1/0001
22000	S	M	SOH	II	00000	213	1ST LT. N. OF DELZAN PLACE, E. SIDE	12	090885	1/1/0001
22000	S	M	SOH	II	00000	214	OPP. DELZAN PLACE	12	090885	1/1/0001
22000	S	M	SOH	II	00000	229	OPP. 3391	12	090885	1/1/0001
22000	S	M	SOH	III	00000	272	3RD LT. S. OF NEW CIRCLE RD.	12	050893	1/1/0001
22000	S	M	SOH	III	00000	273	4TH LT. S. OF NEW CIRCLE RD.	12	050893	1/1/0001
22000	S	M	SOH	III	00000	274	5TH LT. S. OF NEW CIRCLE RD.	12	050893	1/1/0001
22000	S	M	SOH	III	00000	275	6TH LT. S. OF NEW CIRCLE RD.	12	050893	1/1/0001
22000	S	M	SOH	III	00000	276	7TH LT. S. OF NEW CIRCLE RD.	12	050893	1/1/0001
22000	S	M	SOH	III	00000	277	1ST LT. S. OF W. REYNOLDS RD.	12	050893	1/1/0001
22000	S	M	SOH	III	00000	278	2ND LT. S. OF W. REYNOLDS RD.	12	050893	1/1/0001
22000	S	M	SOH	III	00000	279	3RD LT. S. OF W. REYNOLDS RD.	12	050893	1/1/0001
22000	S	M	SOH	III	03231	024		12	110891	1/1/0001
22000	S	M	SOH	III	03233	025		12	110891	1/1/0001
22000	S	M	SOH	II	03334	215		12	090885	1/1/0001
22000	S	M	SOH	II	03340	217		12	090885	1/1/0001
50000	S	M	SOH	III	03341	026		12	110891	1/1/0001
22000	S	M	SOH	II	03353	216		12	090885	1/1/0001
22000	S	M	OUG	II	00000	265	1ST LT. S. OF HIGBEE MILL RD., EASTSIDE	12	060685	1/1/0001
22000	S	M	OUG	III	00000	281	SIDE OF 1301 TRACE BLVD.	12	070893	1/1/0001
22000	S	M	OUG	III	00000	282	SIDE OF 1300 TRACE BLVD.	12	070893	1/1/0001
22000	S	M	OUG	II	00000	305	3RD LT. S OF MAN-O-WAR BLVD., EASTSIDE	12	060899	1/1/0001
22000	S	M	OUG	II	00000	306	1ST LT. S OF TWAIN RIDGE DR., WSIDE	12	030899	1/1/0001

OFFICE: 311

ROUTE: 564

ST_REF_NO: 00000040800

CLAYS MILL ROAD

LUMENS	BULB TYPE	MULT SERIES	POLE TYPE	SHADE	ADDRESS NUMBER	REF	LOCATION	TAX DIST	DATE INST	DATE CHANGE
22000	S	M	OUG	II	00000	307	1ST LT. S OF SPRING RUN RD., ESIDE	12	030899	1/1/0001
22000	S	M	OUG	II	00000	308	2ND LT. S OF TWAIN RIDGE DR., WSIDE	12	030899	1/1/0001
22000	S	M	OUG	II	00000	309	2ND LT. S OF SPRING RUN RD., ESIDE	12	030899	1/1/0001
22000	S	M	OUG	II	00000	310	3RD LT. S OF TWIAN RIDGE DR., WSIDE	12	030899	1/1/0001
22000	S	M	OUG	II	00000	311	1ST LT. S OF WYNDHAM HILLS DR., ESIDE	12	030899	1/1/0001
22000	S	M	OUG	II	00000	312	1ST LT. S OF COPPER RUN BLVD., WSIDE	12	030899	1/1/0001
22000	S	M	OUG	II	00000	313	2ND LT. S OF WYNDHAM HILLS DR., ESIDE	12	030899	1/1/0001
22000	S	M	OUG	II	00000	314	2ND LT. S OF COPPER RUN BLVD., WSIDE	12	030899	1/1/0001
22000	S	M	OUG	II	00000	315	3RD LT. S OF WYNDHAM HILLS DR., ESIDE	12	030899	1/1/0001
22000	S	M	OUG	II	00000	316	3RD LT. S OF COPPER RUN BLVD., WSIDE	12	030899	1/1/0001
22000	S	M	OUG	II	00000	317	4TH LT. S OF WYNDHAM HILLS DR., ESIDE	12	030899	1/1/0001
22000	S	M	OUG	II	00000	318	4RH LT. S OF COPPER RUN BLVD., WSIDE	12	030899	1/1/0001
22000	S	M	OUG	II	00000	319	5TH LT. S OF WYNDHAM HILLS DR., ESIDE	12	030899	1/1/0001
22000	S	M	OUG	II	00000	320	OPP. WEBER WAY, WSIDE	12	030899	1/1/0001
22000	S	M	OUG	II	00000	321	1ST LT. S OF WEBER WAY, ESIDE	12	030899	1/1/0001

OFFICE: 311

ROUTE: 564

ST_REF_NO: 00000040900

CLAYTON AVENUE

LUMENS	BULB TYPE	MULT SERIES	POLE TYPE	SHADE	ADDRESS NUMBER	REF	LOCATION	TAX DIST	DATE INST	DATE CHANGE
04000	S	M	OUG	II	00000	173	SIDE OF 700 HENRY CLAY BLVD	12	110884	1/1/0001
04000	S	M	SOH	II	01609	174		12	010885	1/1/0001
04000	S	M	OUG	II	01625	175		12	110884	1/1/0001
04000	S	M	OUG	II	01641	176		12	110884	1/1/0001

OFFICE: 311

ROUTE: 564

ST_REF_NO: 00000041100

CLEARVIEW DRIVE

LUMENS	BULB TYPE	MULT SERIES	POLE TYPE	SHADE	ADDRESS NUMBER	REF	LOCATION	TAX DIST	DATE INST	DATE CHANGE
04000	S	M	OUG	II	00000	041	SIDE OF 2571 MILLBROOK	12	121583	1/1/0001
04000	S	M	OUG	II	00000	048	SIDE OF 362 HILL 'N DALE	12	111583	1/1/0001
04000	S	M	OUG	II	00000	049	SIDE OF 293 PASADENA	12	111583	1/1/0001
04000	S	M	OUG	II	00239	042		12	121583	1/1/0001
05800	S	M	OUG	II	00259	044	upgraded to 5800 hps 5/08	12	121583	1/1/0001
04000	S	M	OUG	II	00262	043		12	121583	1/1/0001
04000	S	M	OUG	II	00286	045		12	121583	1/1/0001

OFFICE: 311							ROUTE: 564			
ST_REF_NO: 00000041100							CLEARVIEW DRIVE			
LUMENS	BULB TYPE	MULT SERIES	POLE TYPE	SHADE	ADDRESS NUMBER	REF	LOCATION	TAX DIST	DATE INST	DATE CHANGE
04000	S	M	OUG	II	00287	046		12	121583	1/1/0001
04000	S	M	OUG	II	00298	047		12	121583	1/1/0001
OFFICE: 311							ROUTE: 564			
ST_REF_NO: 00000041105							CLEARWATER WAY			
LUMENS	BULB TYPE	MULT SERIES	POLE TYPE	SHADE	ADDRESS NUMBER	REF	LOCATION	TAX DIST	DATE INST	DATE CHANGE
09500	S	M	CNT	II	00000	202	1ST LT E OF SOUTHPOINT DR, S SIDE ON CLEARWATER WA	12	081301	1/1/0001
09500	S	M	CNT	II	00000	203	2ND LT E OF SOUTHPOINT DR, S SIDE ON CLEARWATER WA	12	081301	1/1/0001
09500	S	M	CNT	II	00000	204	3RD LT E OF SOUTHPOINT DR, S SIDE ON CLEARWATER WA	12	081301	1/1/0001
09500	S	M	CNT	II	00000	205	4TH LT E OF SOUTHPOINT DR, S SIDE ON CLEARWATER WA	12	081301	1/1/0001
09500	S	M	CNT	II	00000	206	5TH LT E OF SOUTHPOINT DR, S SIDE ON CLEARWATER WA	12	081301	1/1/0001
09500	S	M	CNT	II	00000	207	6TH LT E OF SOUTHPOINT DR, S SIDE ON CLEARWATER WA	12	081301	1/1/0001
09500	S	M	CNT	II	00000	208	7TH LT E OF SOUTHPOINT DR, S SIDE ON CLEARWATER WA	12	081301	1/1/0001
05800	S	M	CNT	II	00000	001	1ST LT. S. OF MAN-O-WAR, WESTSIDE	12	120894	1/1/0001
05800	S	M	CNT	II	00000	002	1ST LT. S. OF MAN-O-WAR, EASTSIDE	12	120894	1/1/0001
05800	S	M	CNT	II	00000	003	2ND LT. S. OF MAN-O-WAR, WESTSIDE	12	120894	1/1/0001
05800	S	M	CNT	II	00000	004	2ND LT. S. OF MAN-O-WAR, EASTSIDE	12	120894	1/1/0001
05800	S	M	CNT	II	00000	005	3RD LT. S. OF MAN-O-WAR, WESTSIDE	12	120894	1/1/0001
05800	S	M	CNT	II	00000	006	3RD LT. S. OF MAN-O-WAR, EASTSIDE	12	120894	1/1/0001
05800	S	M	CNT	II	00000	007	4TH LT. S. OF MAN-O-WAR, EASTSIDE	12	120894	1/1/0001
05800	S	M	CNT	II	00000	008	SIDE OF 4057 WHITEWATER WAY	12	120894	1/1/0001
05800	S	M	CNT	II	00000	010	SIDE OF 524 WOODSTREAM CT.	12	120894	1/1/0001
05800	S	M	CNT	II	00000	011	SIDE OF 4093 BRIDGEMONT LANE	12	120894	1/1/0001
05800	S	M	CNT	II	00000	012	SIDE OF 4100 BRIDGEMONT LANE	12	120894	1/1/0001
05800	S	M	CNT	II	00000	013	OPP. 4049	12	120894	1/1/0001
05800	S	M	CNT	II	00000	014	OPP. 4057	12	120894	1/1/0001
05800	S	M	CNT	II	00000	015	OPP. 4201 RIDGEWATER	12	120894	1/1/0001
05800	S	M	CNT	II	00000	017	OPP. 4085	12	120894	1/1/0001
09500	S	M	CNT	III	00000	028	OPP. 4170 CLEARWATER	12	020899	1/1/0001

OFFICE: 311

ROUTE: 564

ST_REF_NO: 0000041105

CLEARWATER WAY

LUMENS	BULB TYPE	MULT SERIES	POLE TYPE	SHADE	ADDRESS NUMBER	REF	LOCATION	TAX DIST	DATE INST	DATE CHANGE
09500	S	M	CNT	III	00000	031	SIDE OF 4492 JOSIAH WAY	12	020899	1/1/0001
09500	S	M	CNT	II	00000	043	10TH LT. E OF SOUTHPOINT DR., SOUTHSIDE	12	070898	1/1/0001
09500	S	M	CNT	II	00000	044	11TH LT. E OF SOUTHPOINT DR., SOUTHSIDE	12	070898	1/1/0001
09500	S	M	CNT	II	00000	045	12TH LT. E OF SOUTHPOINT DR., SOUTHSIDE	12	070898	1/1/0001
09500	S	M	CNT	II	00000	046	13TH LT. E OF SOUTHPOINT DR., SOUTHSIDE	12	070898	1/1/0001
09500	S	M	CNT	II	00000	047	14TH LT. E OF SOUTHPOINT DR., SOUTHSIDE	12	070898	1/1/0001
09500	S	M	CNT	II	00000	048	15TH LT. E OF SOUTHPOINT DR., SOUTHSIDE	12	070898	1/1/0001
09500	S	M	CNT	II	00000	049	16TH LT. E OF SOUTHPOINT DR., SOUTHSIDE	12	070898	1/1/0001
09500	S	M	CNT	II	00000	101	1ST LT. W OF TATES CREEK RD., S SIDE	12	040800	1/1/0001
09500	S	M	CNT	II	00000	102	2ND LT. W OF TATES CREEK RD., N SIDE	12	040800	1/1/0001
09500	S	M	CNT	II	00000	103	2ND LT. W OF TATES CREEK RD., S SIDE	12	040800	1/1/0001
09500	S	M	CNT	II	00000	104	3RD LT. W OF TATES CREEK RD., N SIDE	12	040800	1/1/0001
09500	S	M	CNT	II	00000	105	3RD LT. W OF TATES CREEK RD., S SIDE	12	040800	1/1/0001
09500	S	M	CNT	II	00000	106	4TH LT. W OF TATES CREEK RD., N SIDE	12	040800	1/1/0001
09500	S	M	CNT	II	00000	107	4TH LT. W OF TATES CREEK RD., S SIDE	12	040800	1/1/0001
09500	S	M	CNT	II	00000	108	5TH LT. W OF TATES CREEK RD, N SIDE	12	040800	1/1/0001
09500	S	M	CNT	II	00000	109	1ST LT. W OF SARON DRIVE, S SIDE	12	040800	1/1/0001
09500	S	M	CNT	II	00000	110	1ST LT. W OF SARON DRIVE, S SIDE	12	040800	1/1/0001
09500	S	M	CNT	II	00000	112	1ST LT. W OF TATES CREEK RD., N SIDE	12	040800	1/1/0001
05800	S	M	CNT	II	04012	009		12	120894	1/1/0001
05800	S	M	CNT	II	04077	016		12	120894	1/1/0001
05800	S	M	CNT	II	04093	018		12	120894	1/1/0001
05800	S	M	CNT	II	04105	020		12	080895	1/1/0001
05800	S	M	CNT	II	04120	021		12	080895	1/1/0001
05800	S	M	CNT	II	04129	022		12	080895	1/1/0001
05800	S	M	CNT	II	04140	023		12	080895	1/1/0001
09500	S	M	CNT	II	04148	031		12	100899	1/1/0001
09500	S	M	CNT	II	04153	030		12	100899	1/1/0001
09500	S	M	CNT	II	04165	029		12	100899	1/1/0001
09500	S	M	CNT	III	04181	030		12	020899	1/1/0001
09500	S	M	CNT	III	04182	029		12	020899	1/1/0001
09500	S	M	CNT	III	04201	032		12	020899	1/1/0001
09500	S	M	CNT	III	04210	033		12	020899	1/1/0001

OFFICE: 311

ROUTE: 564

ST_REF_NO: 00000041110 CLEARWATER COURT

LUMENS	BULB TYPE	MULT SERIES	POLE TYPE	SHADE	ADDRESS NUMBER	REF	LOCATION	TAX DIST	DATE INST	DATE CHANGE
05800	S	M	CNT	II	00604	001		12	080895	1/1/0001

OFFICE: 311

ROUTE: 564

ST_REF_NO: 00000041200 CLEARWOOD COURT

LUMENS	BULB TYPE	MULT SERIES	POLE TYPE	SHADE	ADDRESS NUMBER	REF	LOCATION	TAX DIST	DATE INST	DATE CHANGE
05800	S	M	OUG	II	00000	116	SIDE OF 428 LARKWOOD DR.	12	062774	1/1/0001
05800	S	M	OUG	II	00382	117		12	062774	1/1/0001

OFFICE: 311

ROUTE: 564

ST_REF_NO: 00000041210 CLEMENS COURT

LUMENS	BULB TYPE	MULT SERIES	POLE TYPE	SHADE	ADDRESS NUMBER	REF	LOCATION	TAX DIST	DATE INST	DATE CHANGE
04000	S	M	OUG	II	02004	020		12	121579	1/1/0001
05800	S	M	OUG	V	02016	021	upgrade 1/08	12	121579	1/1/0001

OFFICE: 311

ROUTE: 564

ST_REF_NO: 00000041220 CLEMENS DRIVE

LUMENS	BULB TYPE	MULT SERIES	POLE TYPE	SHADE	ADDRESS NUMBER	REF	LOCATION	TAX DIST	DATE INST	DATE CHANGE
05800	S	M	OUG	II	00000	023	SIDE OF 1992 TWAIN RIDGE DRIVE	12	011581	9/9/2009
05800	S	M	OUG	II	04204	006		12	010885	9/9/2009
04000	S	M	OUG	II	04328	027		12	010885	9/9/2009
05800	S	M	OUG	II	4352	010		12	121579	9/9/2009
05800	S	M	SOH	II	00000	002	2 ND. LT. S. OF HIGBEE MILL, E. SIDE	12	011580	1/1/0001
05800	S	M	SOH	II	00000	003	3 RD. LT. S. OF HIGBEE MILL, W. SIDE	12	011580	1/1/0001
05800	S	M	SOH	II	00000	004	4 TH. LT. S. OF HIGBEE MILL, E. SIDE	12	011580	1/1/0001
05800	S	M	SOH	II	00000	005	5 TH. LT. S. OF HIGBEE MILL, W. SIDE	12	011580	1/1/0001
04000	S	M	OUG	II	00000	009	SIDE OF 2000 LANGHORNE DR.	12	121579	1/1/0001
04000	S	M	OUG	II	00000	022	SIDE OF 2001 TWAIN RIDGE DR.	12	011581	1/1/0001
05800	S	M	OUG	II	04225	007		12	121579	1/1/0001
04000	S	M	OUG	II	04232	008		12	121579	1/1/0001
04000	S	M	OUG	II	04264	011		12	121579	1/1/0001
04000	S	M	OUG	II	00000	032	SIDE OF 4353 CALEVARES	12	070886	1/1/0001
04000	S	M	OUG	II	04289	024		12	010885	1/1/0001
04000	S	M	OUG	II	04309	026		12	061581	1/1/0001
04000	S	M	OUG	II	04312	025		12	011581	1/1/0001

OFFICE: 311		ROUTE: 564		ST_REF_NO: 00000041220		CLEMENS DRIVE		LUMENS	BULB TYPE	MULT SERIES	POLE TYPE	SHADE	ADDRESS NUMBER	REF	LOCATION	TAX DIST	DATE INST	DATE CHANGE
	05800	S	M	OUG	II	04333	028									12	011581	1/1/0001
	04000	S	M	OUG	II	04348	029									12	010885	1/1/0001
	04000	S	M	OUG	II	04357	030									12	010885	1/1/0001
	04000	S	M	OUG	II	04368	031									12	101581	1/1/0001

OFFICE: 311		ROUTE: 564		ST_REF_NO: 00000041300		CLEVELAND AVENUE		LUMENS	BULB TYPE	MULT SERIES	POLE TYPE	SHADE	ADDRESS NUMBER	REF	LOCATION	TAX DIST	DATE INST	DATE CHANGE
	05800	S	M	SOH	II	00000	001								SIDE OF 184 CARLISLE AVE.	12	120463	1/1/0001
	05800	S	M	SOH	II	00000	003								SIDE OF 201 DEVONIA AVE.	12	120463	1/1/0001
	05800	S	M	SOH	II	00000	004								SIDE OF 180 DEVONIA AVE.	12	120463	1/1/0001
	05800	S	M	SOH	II	00000	005								SIDE OF 201 ARCEME AVE.	12	120463	1/1/0001
	05800	S	M	SOH	II	01105	002									12	120463	1/1/0001

OFFICE: 311		ROUTE: 564		ST_REF_NO: 00000041400		CLEVELAND PIKE		LUMENS	BULB TYPE	MULT SERIES	POLE TYPE	SHADE	ADDRESS NUMBER	REF	LOCATION	TAX DIST	DATE INST	DATE CHANGE
	09500	S	M	SOH	II	00000	093								1ST LT. S OF BRIAR HILL RD., E SIDE	12	110800	1/1/0001
	09500	S	M	SOH	III	00000	001								1ST LT. N. OF ATHENS-BOONESBORO ON EASTSIDE	22	050885	1/1/0001

OFFICE: 311		ROUTE: 564		ST_REF_NO: 00000041440		CLIFFMORE		LUMENS	BULB TYPE	MULT SERIES	POLE TYPE	SHADE	ADDRESS NUMBER	REF	LOCATION	TAX DIST	DATE INST	DATE CHANGE
	05800	S	M	OUG	III	02205	001									12	110899	1/1/0001

OFFICE: 311		ROUTE: 564		ST_REF_NO: 00000041445		CLIFFORD CIRCLE		LUMENS	BULB TYPE	MULT SERIES	POLE TYPE	SHADE	ADDRESS NUMBER	REF	LOCATION	TAX DIST	DATE INST	DATE CHANGE
	05800	S	M	OUG	III	04800	005									12	061201	1/1/0001
	05800	S	M	OUG	II	04816	004									12	061201	1/1/0001
	05800	S	M	OUG	II	04833	003									12	061201	1/1/0001
	05800	S	M	OUG	II	04840	002									12	061201	1/1/0001
	05800	S	M	OUG	II	04849	001									12	061201	1/1/0001

OFFICE: 311

ROUTE: 564

ST_REF_NO: 00000041700 CLINTON ROAD

LUMENS	BULB TYPE	MULT SERIES	POLE TYPE	SHADE	ADDRESS NUMBER	REF	LOCATION	TAX DIST	DATE INST	DATE CHANGE
05800	S	M	OUG	III	00201	000		12	081156	1/1/0001
05800	S	M	OUG	III	00209	000		12	081156	1/1/0001
05800	S	M	OUG	III	00221	000		12	081156	1/1/0001
05800	S	M	OUG	III	00305	006		12	081156	1/1/0001
05800	S	M	OUG	III	00315	000		12	081156	1/1/0001
05800	S	M	OUG	III	00405	013		12	081156	1/1/0001
05800	S	M	OUG	III	00419	000		12	052057	1/1/0001
05800	S	M	OUG	III	00501	000		12	052257	1/1/0001
05800	S	M	OUG	III	00517	000		12	052057	1/1/0001
05800	S	M	OUG	III	00529	000		12	091757	1/1/0001

OFFICE: 311

ROUTE: 564

ST_REF_NO: 00000041905 CLOONEY PASS

LUMENS	BULB TYPE	MULT SERIES	POLE TYPE	SHADE	ADDRESS NUMBER	REF	LOCATION	TAX DIST	DATE INST	DATE CHANGE
05800	S	M	CNT	II	00000	001	SIDE OF 564 VONBRYAN TRACE ON CLOONEY PASS	12	070806	1/1/0001
05800	S	M	CNT	II	04517	002		12	070806	1/1/0001

OFFICE: 311

ROUTE: 564

ST_REF_NO: 00000041910 CLOVELLY COURT

LUMENS	BULB TYPE	MULT SERIES	POLE TYPE	SHADE	ADDRESS NUMBER	REF	LOCATION	TAX DIST	DATE INST	DATE CHANGE
05800	S	M	OUG	II	01108	001		12	060894	1/1/0001

OFFICE: 311

ROUTE: 564

ST_REF_NO: 00000042050 CLOVER VALLEY DRIVE

LUMENS	BULB TYPE	MULT SERIES	POLE TYPE	SHADE	ADDRESS NUMBER	REF	LOCATION	TAX DIST	DATE INST	DATE CHANGE
05800	S	M	CNT	II	00000	005	SIDE OF 2757 TRAILWOOD LN ON CLOVER VALLEY DR	12	091001	1/1/0001
05800	S	M	CNT	II	00000	006	SIDE OF 2756 TRAILWOOD LN ON CLOVER VALLEY DR	12	091001	1/1/0001
05800	S	M	CNT	II	00000	007	SIDE OF 2761 STONEY DR ON CLOVER VALLEY DR	12	091001	1/1/0001
05800	S	M	CNT	II	00101	001		12	091001	1/1/0001
05800	S	M	CNT	II	00120	002		12	091001	1/1/0001
05800	S	M	CNT	II	00129	003		12	091001	1/1/0001
05800	S	M	CNT	II	00148	004		12	091001	1/1/0001

OFFICE: 311		ROUTE: 564		ST_REF_NO: 00000042050		CLOVER VALLEY DRIVE				
LUMENS	BULB TYPE	MULT SERIES	POLE TYPE	SHADE	ADDRESS NUMBER	REF	LOCATION	TAX DIST	DATE INST	DATE CHANGE
05800	S	M	CNT	II	00232	008		12	091001	1/1/0001
05800	S	M	CNT	II	00248	009		12	091001	1/1/0001
05800	S	M	CNT	III	00264	010		12	091001	1/1/0001

OFFICE: 311		ROUTE: 564		ST_REF_NO: 00000042100		CLOVERDALE DRIVE				
LUMENS	BULB TYPE	MULT SERIES	POLE TYPE	SHADE	ADDRESS NUMBER	REF	LOCATION	TAX DIST	DATE INST	DATE CHANGE
04000	S	M	OUG	II	00000	001	SIDE OF 716 KIRKLAND DR.	12	110888	1/1/0001
04000	S	M	OUG	II	00000	003	SIDE OF 737 MALABU DR.	12	110888	1/1/0001
04000	S	M	OUG	II	03364	002		12	110888	1/1/0001

OFFICE: 311		ROUTE: 564		ST_REF_NO: 00000042170		CLUBHOUSE DRIVE				
LUMENS	BULB TYPE	MULT SERIES	POLE TYPE	SHADE	ADDRESS NUMBER	REF	LOCATION	TAX DIST	DATE INST	DATE CHANGE
05800	S	M	CNT	II	00000	001	SIDE OF 1336 TRACE BLVD.	12	020896	1/1/0001
05800	S	M	CNT	II	00000	002	SIDE OF 1336 TRACE BLVD.	12	020896	1/1/0001
05800	S	M	CNT	II	04512	003		12	080896	1/1/0001
05800	S	M	CNT	II	04521	004		12	080896	1/1/0001
05800	S	M	CNT	II	04536	005		12	080896	1/1/0001
05800	S	M	CNT	II	04545	006		12	020896	1/1/0001
05800	S	M	CNT	II	04556	007		12	020896	1/1/0001
05800	S	M	CNT	II	04564	008		12	020896	1/1/0001

OFFICE: 311		ROUTE: 564		ST_REF_NO: 00000042200		CLYDE STREET				
LUMENS	BULB TYPE	MULT SERIES	POLE TYPE	SHADE	ADDRESS NUMBER	REF	LOCATION	TAX DIST	DATE INST	DATE CHANGE
05800	S	M	SOH	II	00000	001	SIDE OF 1208 LEESTOWN RD.	12	082465	1/1/0001
05800	S	M	SOH	II	00102	002		12	082465	1/1/0001
05800	S	M	SOH	II	00108	003		12	082465	1/1/0001
05800	S	M	SOH	II	00116	004		12	082465	1/1/0001
05800	S	M	SOH	II	00122	005		12	082465	1/1/0001
05800	S	M	SOH	II	00128	006		12	082465	1/1/0001
05800	S	M	SOH	II	00134	007		12	082465	1/1/0001
05800	S	M	SOH	II	00138	008		12	082465	1/1/0001

OFFICE: 311

ROUTE: 564

ST_REF_NO: 00000042200 CLYDE STREET

LUMENS	BULB TYPE	MULT SERIES	POLE TYPE	SHADE	ADDRESS NUMBER	REF	LOCATION	TAX DIST	DATE INST	DATE CHANGE
05800	S	M	SOH	II	00204	009		12	082465	1/1/0001
05800	S	M	SOH	V	00210	010		12	082465	1/1/0001

OFFICE: 311

ROUTE: 564

ST_REF_NO: 00000042205 COBBLEBROOK COURT

LUMENS	BULB TYPE	MULT SERIES	POLE TYPE	SHADE	ADDRESS NUMBER	REF	LOCATION	TAX DIST	DATE INST	DATE CHANGE
05800	S	M	OUG	V	00109	003		12	080893	1/1/0001

OFFICE: 311

ROUTE: 564

ST_REF_NO: 00000042210 COBBLESTONE COURT

LUMENS	BULB TYPE	MULT SERIES	POLE TYPE	SHADE	ADDRESS NUMBER	REF	LOCATION	TAX DIST	DATE INST	DATE CHANGE
05800	S	M	OUG	V	00100	002		12	060893	1/1/0001
05800	S	M	OUG	IV	00116	001		12	060893	1/1/0001

OFFICE: 311

ROUTE: 564

ST_REF_NO: 00000042220 COBBLESTONE KNOLL DRIVE

LUMENS	BULB TYPE	MULT SERIES	POLE TYPE	SHADE	ADDRESS NUMBER	REF	LOCATION	TAX DIST	DATE INST	DATE CHANGE
05800	S	M	OUG	IV	00000	002	SIDE OF 120 COBBLESTONE CT.	12	060893	1/1/0001
05800	S	M	OUG	IV	00000	004	SIDE OF 112 COBBLEBROOK CT.	12	060893	1/1/0001
05800	S	M	OUG	III	04309	006		12	060893	1/1/0001
05800	S	M	OUG	IV	04324	005		12	060893	1/1/0001
05800	S	M	OUG	IV	04356	003		12	060893	1/1/0001
05800	S	M	OUG	IV	04384	001		12	060893	1/1/0001

OFFICE: 311

ROUTE: 564

ST_REF_NO: 00000042300 COBURN BOULEVARD

LUMENS	BULB TYPE	MULT SERIES	POLE TYPE	SHADE	ADDRESS NUMBER	REF	LOCATION	TAX DIST	DATE INST	DATE CHANGE
05800	S	M	OUG	II	00000	004	SIDE OF 118 ST. PHILLIP DR.	12	121579	1/1/0001
05800	S	M	OUG	II	00000	005	OPP. 2035	12	021479	1/1/0001
05800	S	M	OUG	II	00000	006	OPP. 2053	12	021479	1/1/0001
05800	S	M	OUG	II	00000	007	OPP. 2111	12	021479	1/1/0001
05800	S	M	OUG	II	00000	008	OPP. 2125	12	021479	1/1/0001
05800	S	M	OUG	II	00000	009	OPP. 2129	12	021479	1/1/0001
05800	S	M	OUG	II	00000	010	OPP. 2137	12	021479	1/1/0001
05800	S	M	OUG	II	02206	001		12	121579	1/1/0001

OFFICE: 311		ROUTE: 564		ST_REF_NO: 00000042300		COBURN BOULEVARD				
LUMENS	BULB TYPE	MULT SERIES	POLE TYPE	SHADE	ADDRESS NUMBER	REF	LOCATION	TAX DIST	DATE INST	DATE CHANGE
05800	S	M	OUG	II	02209	002		12	121579	1/1/0001
05800	S	M	OUG	II	02232	003		12	121579	1/1/0001

OFFICE: 311		ROUTE: 564		ST_REF_NO: 00000042400		COBYVILLE COURT				
LUMENS	BULB TYPE	MULT SERIES	POLE TYPE	SHADE	ADDRESS NUMBER	REF	LOCATION	TAX DIST	DATE INST	DATE CHANGE
05800	S	M	OUG	II	01910	113		12	051475	1/1/0001
05800	S	M	OUG	II	01925	000		12	100874	1/1/0001
05800	S	M	OUG	II	01934	000		12	080173	1/1/0001

OFFICE: 311		ROUTE: 564		ST_REF_NO: 00000042500		COCHRAN ROAD				
LUMENS	BULB TYPE	MULT SERIES	POLE TYPE	SHADE	ADDRESS NUMBER	REF	LOCATION	TAX DIST	DATE INST	DATE CHANGE
05800	S	M	OUG	I	00000	001	OPP. 435	12	091564	1/1/0001
05800	S	M	OUG	I	00000	002	OPP. 429	12	091564	1/1/0001
05800	S	M	OUG	I	00000	003	OPP. 421 upgraded 10/07	12	091564	1/1/0001
05800	S	M	OUG	I	00000	004	OPP. 413	12	091564	1/1/0001
05800	S	M	OUG	I	00000	005	OPP. 405	12	091564	1/1/0001
05800	S	M	OUG	II	00000	008	SIDE OF 901 TATES CREEK RD.	12	100165	1/1/0001
05800	S	M	OUG	V	00000	012	IN ISLAND , OPP. 160	12	100265	1/1/0001
05800	S	M	OUG	II	00000	024	SIDE OF 175 ROMANY RD.	12	090165	1/1/0001
05800	S	M	OUG	II	00104	000		12	100165	1/1/0001
05800	S	M	OUG	II	00108	000		12	100165	1/1/0001
05800	S	M	OUG	II	00180	000		12	100265	1/1/0001
05800	S	M	OUG	II	00209	000		12	100265	1/1/0001
05800	S	M	OUG	II	00210	000		12	121665	1/1/0001
05800	S	M	OUG	II	00235	000		12	121665	1/1/0001
05800	S	M	OUG	II	00252	000		12	120165	1/1/0001
05800	S	M	OUG	II	00263	000		12	120165	1/1/0001
05800	S	M	OUG	II	00310	000		12	110766	1/1/0001
05800	S	M	OUG	II	00329	000		12	110165	1/1/0001
05800	S	M	OUG	II	00338	000		12	092765	1/1/0001
05800	S	M	OUG	II	00357	000		12	092765	1/1/0001
05800	S	M	OUG	II	00376	000		12	092765	1/1/0001

OFFICE: 311

ROUTE: 564

ST_REF_NO: 00000042500

COCHRAN ROAD

LUMENS	BULB TYPE	MULT SERIES	POLE TYPE	SHADE	ADDRESS NUMBER	REF	LOCATION	TAX DIST	DATE INST	DATE CHANGE
05800	S	M	OUG	II	00000	094	SIDE OF 435 DUDLEY RD.	12	110164	1/1/0001
05800	S	M	OUG	II	00000	096	SIDE OF 425 CHINOE RD.	12	122164	1/1/0001
05800	S	M	OOH	II	00000	097	SIDE OF 501 CHINOE RD.	12	122164	1/1/0001
05800	S	M	OUG	II	00000	098	SIDE OF 500 CHINOE RD.	12	020165	1/1/0001
05800	S	M	OUG	II	00000	099	SIDE OF 501 CULPEPPER RD.	12	020165	1/1/0001
05800	S	M	SOH	II	00000	100	SIDE OF 446 CULPEPPER RD.	12	110164	1/1/0001
05800	S	M	OUG	II	01398	093		12	122164	1/1/0001

OFFICE: 311

ROUTE: 564

ST_REF_NO: 00000042600

CODELL DRIVE

LUMENS	BULB TYPE	MULT SERIES	POLE TYPE	SHADE	ADDRESS NUMBER	REF	LOCATION	TAX DIST	DATE INST	DATE CHANGE
09500	S	M	OOH	II	00000	035	2ND LT. W OF TODDS RD., SSIDE	12	110898	9/9/2009
09500	S	M	OUG	II	00000	017	SIDE OF 2345 PALUMBO DRIVE	12	030896	1/1/0001
09500	S	M	OUG	II	00000	019	SIDE OF 2345 PALUMBO DR.	12	080171	1/1/0001
09500	S	M	OUG	II	00000	115	SIDE OF 2364 PALUMBO DR.	12	110369	1/1/0001
09500	S	M	OUG	II	00000	118	SIDE OF 2345 PALUMBO DR.	12	021581	1/1/0001
09500	S	M	OUG	V	00522	000		12	021475	1/1/0001
09500	S	M	OUG	II	00000	009	OPP. 208	12	090170	1/1/0001
09500	S	M	OUG	II	00000	011	OPP. 220	12	090170	1/1/0001
09500	S	M	OUG	II	00000	013	OPP. 236	12	090170	1/1/0001
09500	S	M	OUG	II	00000	015	OPP. BUTTERNUT HILL CT.	12	090170	1/1/0001
09500	S	M	OUG	II	00000	016		12	110369	1/1/0001
09500	S	M	OUG	II	00000	018	SIDE OF 2400 WOODHILL DR.	12	070172	1/1/0001
09500	S	M	OUG	II	00000	021	2ND LT. N OF WOODHILL DR., WSIDE	12	110898	1/1/0001
09500	S	M	OUG	II	00000	023	3RD LT. N OF WOODHILL DR., WSIDE	12	110898	1/1/0001
09500	S	M	OUG	II	00000	025	4TH LT. N OF WOODHILL DR., WSIDE	12	110898	1/1/0001
09500	S	M	OUG	II	00000	027	OPP. MIRAHILL DR.	12	110898	1/1/0001
09500	S	M	OUG	II	00000	029	1ST LT. N OF WOODHILL DR., WSIDE	12	110898	1/1/0001
09500	S	M	OUG	II	00000	030	1ST LT. S OF WOODHILL DR., WSIDE	12	110898	1/1/0001
09500	S	M	OUG	II	00000	031	4TH LT. W OF TODDS RD., SSIDE	12	110898	1/1/0001
09500	S	M	OUG	II	00000	032	4TH LT. W OF TODDS RD., NSIDE	12	110898	1/1/0001
09500	S	M	OUG	II	00000	033	3RD LT. W OF TODDS RD., SSIDE	12	110898	1/1/0001
09500	S	M	OUG	II	00000	034	3RD LT. W OF TODDS RD., NSIDE	12	110898	1/1/0001
09500	S	M	OUG	II	00000	036	2ND LT. W OF TODDS RD., NSIDE	12	110898	1/1/0001

OFFICE: 311		ROUTE: 564		ST_REF_NO: 00000042600		CODELL DRIVE		LUMENS	BULB TYPE	MULT SERIES	POLE TYPE	SHADE	ADDRESS NUMBER	REF	LOCATION	TAX DIST	DATE INST	DATE CHANGE
09500	S	M	OUG	II	00000	037	1ST LT. W OF TODDS RD., SSIDE	12	110898	1/1/0001								
09500	S	M	OUG	II	00000	038	1ST LT. W OF TODDS RD., NSIDE	12	110898	1/1/0001								
09500	S	M	OUG	II	00000	050	1ST LT. S OF TODDS RD., WESTSIDE	12	100800	1/1/0001								
09500	S	M	OUG	II	00000	051	1ST LT. S OF TODDS RD., EASTSIDE	12	100800	1/1/0001								
09500	S	M	OUG	II	00000	052	2ND LT. S OF TODDS RD., WESTSIDE	12	100800	1/1/0001								
09500	S	M	OUG	II	00000	053	SIDE OF 200 MOUSAS WAY	12	100800	1/1/0001								
09500	S	M	OUG	II	00000	054	3RD LT. S OF TODDS RD., WESTSIDE	12	100800	1/1/0001								
09500	S	M	OUG	III	00000	055	4TH LT. S OF TODDS RD., WESTSIDE	12	100800	1/1/0001								
09500	S	M	OUG	II	00200	008		12	090170	1/1/0001								
09500	S	M	OUG	II	00216	010		12	090170	1/1/0001								
09500	S	M	OOH	II	00228	000		12	090170	1/1/0001								
09500	S	M	OUG	II	00248	000		12	110369	1/1/0001								
09500	S	M	OUG	II	00320	020		12	041581	1/1/0001								
09500	S	M	OUG	II	00340	022		12	041581	1/1/0001								
09500	S	M	OUG	II	00370	000		12	020474	1/1/0001								
09500	S	M	OUG	II	00400	000		12	080172	1/1/0001								
09500	S	M	OUG	II	00422	028		12	041581	1/1/0001								
09500	S	M	OUG	II	00429	016		12	051475	1/1/0001								

OFFICE: 311		ROUTE: 564		ST_REF_NO: 00000042650		COFFEE TREE LANE		LUMENS	BULB TYPE	MULT SERIES	POLE TYPE	SHADE	ADDRESS NUMBER	REF	LOCATION	TAX DIST	DATE INST	DATE CHANGE
05800	S	M	OUG	II	00000	001	SIDE OF 529 GLEN ARVIN AVE, ON COFFEE TREE LN	12	081903	1/1/0001								
05800	S	M	OUG	II	00000	003	SIDE OF 528 DOUGLAS AVE, ON COFFEE TREE LN	12	081903	1/1/0001								
09500	S	M	OUG	II	00664	002		12	081903	9/9/2009								
05800	S	M	OUG	II	00685	004		12	081903	1/1/0001								
09500	S	M	OUG	II	00693	005		12	081903	9/9/2009								
09500	S	M	OUG	II	00696	006		12	081903	9/9/2009								

OFFICE: 311		ROUTE: 564		ST_REF_NO: 00000042800		COLCHESTER DRIVE		LUMENS	BULB TYPE	MULT SERIES	POLE TYPE	SHADE	ADDRESS NUMBER	REF	LOCATION	TAX DIST	DATE INST	DATE CHANGE
05800	S	M	OUG	II	00000	021	SIDE OF 1286 WINBURN DR.	12	061269	1/1/0001								
05800	S	M	OUG	II	01862	000		12	070172	1/1/0001								

OFFICE: 311		ROUTE: 564		ST_REF_NO: 00000042800		COLCHESTER DRIVE		LUMENS	BULB TYPE	MULT SERIES	POLE TYPE	SHADE	ADDRESS NUMBER	REF	LOCATION	TAX DIST	DATE INST	DATE CHANGE
	05800	S	M	OUG	II	01882	020									12	061269	1/1/0001
	05800	S	M	OUG	V	01897	000									12	101970	1/1/0001

OFFICE: 311		ROUTE: 564		ST_REF_NO: 00000042900		COLD HARBOR DRIVE		LUMENS	BULB TYPE	MULT SERIES	POLE TYPE	SHADE	ADDRESS NUMBER	REF	LOCATION	TAX DIST	DATE INST	DATE CHANGE
	04000	S	M	OUG	II	00000	001								SIDE OF 800 MASON HEADLEY RD.	12	100888	1/1/0001
	04000	S	M	OUG	II	00000	002								OPP. 1704	12	100888	1/1/0001
	04000	S	M	OUG	II	00000	003								OPP. 1712	12	100888	1/1/0001
	04000	S	M	OUG	II	00000	008								SIDE OF 821 LAUREL HILL RD.	12	100888	1/1/0001
	04000	S	M	OUG	II	01724	004									12	100888	1/1/0001
	04000	S	M	OUG	II	01733	005									12	100888	1/1/0001
	04000	S	M	OUG	II	01744	006									12	100888	1/1/0001
	04000	S	M	OUG	II	01757	007									12	100888	1/1/0001

OFFICE: 311		ROUTE: 564		ST_REF_NO: 00000043100		COLDSTREAM DRIVE		LUMENS	BULB TYPE	MULT SERIES	POLE TYPE	SHADE	ADDRESS NUMBER	REF	LOCATION	TAX DIST	DATE INST	DATE CHANGE
	05800	S	M	OUG	II	03303	000									12	052068	1/1/0001
	05800	S	M	OUG	II	03310	000									12	080172	1/1/0001
	05800	S	M	OUG	II	03323	000									12	042067	1/1/0001
	05800	S	M	OUG	II	03338	000									12	042067	1/1/0001
	05800	S	M	OUG	II	03347	000									12	042067	1/1/0001
	05800	S	M	OUG	II	03354	000									12	042067	1/1/0001
	05800	S	M	OUG	II	03367	000									12	062267	1/1/0001

OFFICE: 311		ROUTE: 564		ST_REF_NO: 00000043110		COLDSTREAM COURT		LUMENS	BULB TYPE	MULT SERIES	POLE TYPE	SHADE	ADDRESS NUMBER	REF	LOCATION	TAX DIST	DATE INST	DATE CHANGE
	09500	S	M	OUG	II	03422	000									12	042067	9/9/2009
	05800	S	M	OUG	II	00000	176								SIDE OF 1280 GAINESWAY DR.upgraded 10/07	12	042067	1/1/0001
	05800	S	M	OUG	II	03411	000									12	042067	1/1/0001

OFFICE: 311		ROUTE: 564		ST_REF_NO: 00000043400		COLESBURY CIRCLE		LUMENS	BULB TYPE	MULT SERIES	POLE TYPE	SHADE	ADDRESS NUMBER	REF	LOCATION	TAX DIST	DATE INST	DATE CHANGE
09500	S	M	OUG	II	00000	001	1ST LT. N OF NEW CIRCLE RD., W SIDE	12	070899	1/1/0001								
09500	S	M	OUG	II	00000	002	1ST LT. N OF NEW CIRCLE RD., E SIDE	12	070899	1/1/0001								
09500	S	M	OUG	II	00000	003	2ND LT. N OF NEW CIRCLE RD., E SIDE	12	070899	1/1/0001								
09500	S	M	OUG	II	00000	004	3RD LT. N OF NEW CIRCLE RD., E SIDE	12	070899	1/1/0001								
09500	S	M	OUG	II	01512	005		12	070899	1/1/0001								
09500	S	M	OUG	II	01515	006		12	070899	1/1/0001								
OFFICE: 311		ROUTE: 564		ST_REF_NO: 00000043500		COLFAX STREET		LUMENS	BULB TYPE	MULT SERIES	POLE TYPE	SHADE	ADDRESS NUMBER	REF	LOCATION	TAX DIST	DATE INST	DATE CHANGE
05800	S	M	SOH	I	00000	001	SIDE OF 521 SOUTH LIME	12	061578	1/1/0001								
05800	S	M	SOH	I	00125	002		12	061578	1/1/0001								
05800	S	M	SOH	I	00131	003		12	061578	1/1/0001								
05800	S	M	SOH	I	00141	004		12	061578	1/1/0001								
05800	S	M	SOH	I	00151	005		12	061578	1/1/0001								
05800	S	M	SOH	I	00167	006		12	061578	1/1/0001								
05800	S	M	SOH	I	00171	007		12	061578	1/1/0001								
05800	S	M	SOH	I	00185	008		12	061578	1/1/0001								
OFFICE: 311		ROUTE: 564		ST_REF_NO: 00000043700		COLLIER COURT		LUMENS	BULB TYPE	MULT SERIES	POLE TYPE	SHADE	ADDRESS NUMBER	REF	LOCATION	TAX DIST	DATE INST	DATE CHANGE
05800	S	M	OUG	II	00000	151	SIDE OF 1759 HARROGATE RD.	12	121475	1/1/0001								
05800	S	M	OUG	II	00513	152		12	041476	1/1/0001								
05800	S	M	OUG	II	00520	153		12	111476	1/1/0001								
OFFICE: 311		ROUTE: 564		ST_REF_NO: 00000043720		COLLINSWOOD DRIVE		LUMENS	BULB TYPE	MULT SERIES	POLE TYPE	SHADE	ADDRESS NUMBER	REF	LOCATION	TAX DIST	DATE INST	DATE CHANGE
05800	S	M	OUG	II	00000	001	SIDE OF 1094 WOODSONG WAY	12	080800	9/9/2009								
05800	S	M	OUG	II	00000	005	OPP. 4669	12	010890	9/9/2009								
05800	S	M	OUG	II	04652	009		12	060897	9/9/2009								
05800	S	M	OUG	II	04689	003		12	010890	9/9/2009								
04000	S	M	OUG	II	00000	006	OPP. 4665	12	010890	1/1/0001								

OFFICE: 311		ROUTE: 564		ST_REF_NO: 00000043720		COLLINSWOOD DRIVE				
LUMENS	BULB TYPE	MULT SERIES	POLE TYPE	SHADE	ADDRESS NUMBER	REF	LOCATION	TAX DIST	DATE INST	DATE CHANGE
05800	S	M	OUG	II	04652	008		12	060897	1/1/0001
05800	S	M	OUG	II	04656	007		12	060897	1/1/0001
04000	S	M	OUG	II	00000	002	NW CORNER OF COLLINSWOOD AND WOODSONG DR.	12	010890	1/1/0001
05800	S	M	OUG	II	04681	004		12	100893	1/1/0001

OFFICE: 311

ROUTE: 564

OFFICE: 311		ROUTE: 564		ST_REF_NO: 00000043900		COLONY BOULEVARD				
LUMENS	BULB TYPE	MULT SERIES	POLE TYPE	SHADE	ADDRESS NUMBER	REF	LOCATION	TAX DIST	DATE INST	DATE CHANGE
05800	S	M	OOH	I	00000	007	2ND. LT. S. OF COCHRAN RD., E. SIDE	12	091564	9/9/2009
05800	S	M	OUG	II	00304	000		12	090165	9/1/1965
05800	S	M	OUG	II	00309	074		12	42601	1/1/0001
05800	S	M	OUG	II	00329	000		12	090865	9/8/1965
05800	S	M	OUG	I	00000	006	1ST. LT. S. OF COCHRAN RD., E. SIDE	12	091564	1/1/0001
05800	S	M	OUG	II	00000	079	SIDE OF 1096 COOPER DR.	12	100165	1/1/0001
05800	S	M	SOH	II	00000	080	SIDE OF 1161 INDIAN MOUND RD.	12	090865	1/1/0001
05800	S	M	OOH	II	00000	081	SIDE OF 1093 LAKEWOOD DR.	12	100165	1/1/0001
05800	S	M	OUG	II	00345	000		12	100165	1/1/0001
05800	S	M	OUG	II	00356	000		12	090865	1/1/0001
05800	S	M	OUG	II	00377	000		12	100265	1/1/0001

OFFICE: 311

ROUTE: 564

OFFICE: 311		ROUTE: 564		ST_REF_NO: 00000043950		COLORADO ROAD				
LUMENS	BULB TYPE	MULT SERIES	POLE TYPE	SHADE	ADDRESS NUMBER	REF	LOCATION	TAX DIST	DATE INST	DATE CHANGE
05800	S	M	CNT	II	00000	051	SIDE OF 1396 PLEASANT RIDGE ON COLORADO RD	12	051601	1/1/0001
05800	S	M	CNT	II	00000	052	SIDE OF 3412 PUEBLO CT ON COLORADO RD	12	051601	1/1/0001
05800	S	M	CNT	II	00000	012	SIDE REAR OF 1393 PLEASANT RIDGE DR.	12	070899	1/1/0001
05800	S	M	CNT	II	01165	011		12	070899	1/1/0001
05800	S	M	CNT	II	01181	010		12	020899	1/1/0001
05800	S	M	CNT	II	01192	009		12	020899	1/1/0001
05800	S	M	CNT	II	01213	008		12	020899	1/1/0001
05800	S	M	CNT	II	01228	007		12	060897	1/1/0001
05800	S	M	CNT	II	01237	006		12	060897	1/1/0001
05800	S	M	CNT	II	01252	005		12	060897	1/1/0001
05800	S	M	CNT	II	01269	004		12	060897	1/1/0001

Street Light Listing run 1/11/2015 10:43:21 AM

Page 231 of 1254

OFFICE: 311

ROUTE: 564

ST_REF_NO: 00000043950 COLORADO ROAD

LUMENS	BULB TYPE	MULT SERIES	POLE TYPE	SHADE	ADDRESS NUMBER	REF	LOCATION	TAX DIST	DATE INST	DATE CHANGE
05800	S	M	CNT	II	01276	003		12	060897	1/1/0001
05800	S	M	CNT	II	01289	002		12	060897	1/1/0001
05800	S	M	CNT	III	01312	001		12	100896	1/1/0001

OFFICE: 311

ROUTE: 564

ST_REF_NO: 00000044000 COLRAIN COURT

LUMENS	BULB TYPE	MULT SERIES	POLE TYPE	SHADE	ADDRESS NUMBER	REF	LOCATION	TAX DIST	DATE INST	DATE CHANGE
05800	S	M	OUG	V	02674	000		12	061269	1/1/0001
05800	S	M	OUG	II	02686	000		12	041068	1/1/0001

OFFICE: 311

ROUTE: 564

ST_REF_NO: 00000044100 COLTNECK LANE

LUMENS	BULB TYPE	MULT SERIES	POLE TYPE	SHADE	ADDRESS NUMBER	REF	LOCATION	TAX DIST	DATE INST	DATE CHANGE
05800	S	M	OUG	II	00000	240	2ND LIGHT E OF COLTNECK CT ON COLTNECK LN	12	071001	1/1/0001
05800	S	M	OUG	II	00000	241	3RD LIGHT E OF COLTNECK CT ON COLTNECK LN	12	071001	1/1/0001
05800	S	M	OUG	II	00000	242	4TH LIGHT E OF COLTNECK CT ON COLTNECK LN	12	071001	1/1/0001
05800	S	M	OUG	II	00000	243	5TH LIGHT E OF COLTNECK CT ON COLTNECK LN	12	071001	1/1/0001
04000	S	M	OUG	II	00000	250	SIDE OF 3537 IN ISLAND	12	051582	1/1/0001
04000	S	M	OUG	II	00000	251	SIDE OF 3537 IN ISLAND	12	051582	1/1/0001
05800	S	M	OUG	II	03501	227		12	011581	1/1/0001
05800	S	M	OUG	II	03504	228		12	111580	1/1/0001
05800	S	M	OUG	II	03509	229		12	080884	1/1/0001
05800	S	M	OUG	II	03516	230		12	011581	1/1/0001
05800	S	M	OUG	II	03525	236		12	080884	1/1/0001
05800	S	M	OUG	II	03528	237		12	041582	1/1/0001
05800	S	M	OUG	II	03536	239		12	011581	1/1/0001
05800	S	M	OUG	II	03537	238		12	051582	1/1/0001

OFFICE: 311

ROUTE: 564

ST_REF_NO: 00000044200 COLUMBIA AVENUE

LUMENS	BULB TYPE	MULT SERIES	POLE TYPE	SHADE	ADDRESS NUMBER	REF	LOCATION	TAX DIST	DATE INST	DATE CHANGE
22000	S	M	CNT	II	00000	001	SIDE OF 474 ROSE ST. lfucg upgrade	12	110897	12/6/2010
22000	S	M	CNT	II	00000	002	2ND LT. E OF ROSE ST., NORTHSIDE - lfucg upgrade	12	110897	12/6/2010
22000	S	M	CNT	II	00000	007	SIDE OF 450 PENNSYLVANIA AVE. lfucg upgrade	12	110897	12/6/2010

OFFICE: 311

ROUTE: 564

ST_REF_NO: 0000044200

COLUMBIA AVENUE

LUMENS	BULB TYPE	MULT SERIES	POLE TYPE	SHADE	ADDRESS NUMBER	REF	LOCATION	TAX DIST	DATE INST	DATE CHANGE
22000	S	M	CNT	II	00000	015	SIDE OF 575 WOODLAND AVE. lfucg upgrade	12	110897	12/6/2011
22000	S	M	SOH	I	00000	017	SIDE OF 600 WOODLAND AVE. lfucg upgrade	12	011967	12/6/2010
22000	S	M	CNT	II	00319	003	lfucg upgrade	12	110897	12/6/2010
22000	S	M	CNT	II	00327	005	lfucg upgrade	12	110897	12/6/2010
22000	S	M	CNT	II	00329	004	lfucg upgrade	12	110897	12/6/2010
22000	S	M	CNT	II	00345	006	lfucg upgrade	12	110897	12/6/2010
22000	S	M	CNT	II	00409	008	lfucg upgrade	12	110897	12/6/2010
22000	S	M	CNT	II	00415	009	lfucg upgrade	12	110897	12/6/2010
22000	S	M	CNT	II	00425	010	lfucg upgrade	12	110897	12/6/2010
22000	S	M	CNT	II	00429	011	lfucg upgrade	12	110897	12/6/2010
22000	S	M	CNT	II	00429	012	lfucg upgrade	12	110897	12/9/2010
22000	S	M	CNT	II	00445	013	lfucg upgrade	12	110897	12/6/2010
22000	S	M	CNT	II	00451	014	lfucg upgrade	12	110897	12/6/2010
22000	S	M	SOH	I	00454	016	lfucg upgrade	12	011967	12/6/2010
09500	S	M	SOH	I	00000	018	OPP. 507	12	020167	1/1/0001
09500	S	M	SOH	I	00508	019		12	020167	1/1/0001
09500	S	M	SOH	I	00538	021		12	020167	1/1/0001
09500	S	M	SOH	I	00542	022		12	022167	1/1/0001
09500	S	M	SOH	I	00548	023		12	022167	1/1/0001
09500	S	M	SOH	I	00556	024		12	020167	1/1/0001
09500	S	M	SOH	I	00568	025		12	022167	1/1/0001
05800	S	M	SOH	I	00600	026		12	022167	1/1/0001
05800	S	M	SOH	I	00612	027		12	022167	1/1/0001
05800	S	M	SOH	I	00618	028		12	022167	1/1/0001
05800	S	M	SOH	I	00622	029		12	022167	1/1/0001

OFFICE: 311

ROUTE: 564

ST_REF_NO: 0000044290

COMANCHE CIRCLE

LUMENS	BULB TYPE	MULT SERIES	POLE TYPE	SHADE	ADDRESS NUMBER	REF	LOCATION	TAX DIST	DATE INST	DATE CHANGE
05800	S	M	CNT	III	00808	002		12	110895	1/1/0001
05800	S	M	CNT	II	00813	001		12	110895	1/1/0001

OFFICE: 311		ROUTE: 564		ST_REF_NO: 00000044300		COMANCHE TRAIL		LUMENS	BULB TYPE	MULT SERIES	POLE TYPE	SHADE	ADDRESS NUMBER	REF	LOCATION	TAX DIST	DATE INST	DATE CHANGE
05800	S	M	CNT	II	00000	060	SIDE OF 3116 BLENHEIM WAY ON COMANCHE TRAIL	12	100404	1/1/0001								
05800	S	M	CNT	II	00000	001	SIDE 1915 FORT HARRODS DRIVE	12	110895	1/1/0001								
05800	S	M	CNT	II	00000	006	SIDE REAR OF 129 BLENHEIM WAY	12	080894	1/1/0001								
04000	S	M	OUG	II	00000	008	SIDE OF 836 APACHE TRAIL	12	110895	1/1/0001								
05800	S	M	CNT	II	03105	007		12	080894	1/1/0001								
05800	S	M	CNT	II	03121	005		12	080894	1/1/0001								
05800	S	M	CNT	II	03132	004		12	110895	1/1/0001								
05800	S	M	CNT	II	03140	003		12	080894	1/1/0001								
05800	S	M	CNT	II	03145	002		12	080894	1/1/0001								
OFFICE: 311		ROUTE: 564		ST_REF_NO: 00000044400		COMBS STREET		LUMENS	BULB TYPE	MULT SERIES	POLE TYPE	SHADE	ADDRESS NUMBER	REF	LOCATION	TAX DIST	DATE INST	DATE CHANGE
05800	S	M	SOH	I	00717	000		12	120169	1/1/0001								
05800	S	M	SOH	I	00741	000		12	120169	1/1/0001								
OFFICE: 311		ROUTE: 564		ST_REF_NO: 00000044600		COMMERCIAL DRIVE		LUMENS	BULB TYPE	MULT SERIES	POLE TYPE	SHADE	ADDRESS NUMBER	REF	LOCATION	TAX DIST	DATE INST	DATE CHANGE
05800	S	M	OUG	II	00000	026	OPPOSITE FROM SIDE OF 1267 EASTLAND DR.	12	111478	1/1/0001								
05800	S	M	OUG	II	00000	028	OPPOSITE 1157	12	111478	1/1/0001								
05800	S	M	OUG	II	00000	029	OPPOSITE 1141	12	111478	1/1/0001								
05800	S	M	OUG	II	00000	031	OPPOSITE 1113	12	111478	1/1/0001								
05800	S	M	OUG	II	01127	030		12	062364	1/1/0001								
05800	S	M	OUG	II	01171	027		12	050167	1/1/0001								
OFFICE: 311		ROUTE: 564		ST_REF_NO: 00000044900		COMPTON DRIVE		LUMENS	BULB TYPE	MULT SERIES	POLE TYPE	SHADE	ADDRESS NUMBER	REF	LOCATION	TAX DIST	DATE INST	DATE CHANGE
05800	S	M	OUG	II	00550	000		12	050170	1/1/0001								
05800	S	M	OUG	II	00557	000		12	050170	1/1/0001								
05800	S	M	OUG	II	00572	013		12	071674	1/1/0001								

OFFICE: 311		ROUTE: 564		ST_REF_NO: 00000045000		CONCORD DRIVE		LUMENS	BULB TYPE	MULT SERIES	POLE TYPE	SHADE	ADDRESS NUMBER	REF	LOCATION	TAX DIST	DATE INST	DATE CHANGE
	05800	S	M	OUG	II	00000	033								SIDE OF 1429 PINE MEADOW RD.	12	060766	1/1/0001
OFFICE: 311		ROUTE: 564		ST_REF_NO: 00000045100		CONFEDERATE COURT		LUMENS	BULB TYPE	MULT SERIES	POLE TYPE	SHADE	ADDRESS NUMBER	REF	LOCATION	TAX DIST	DATE INST	DATE CHANGE
	04000	S	M	OUG	II	00000	057								SIDE OF 756 LONGWOOD RD.	12	021580	1/1/0001
	04000	S	M	OUG	II	01308	056									12	021580	1/1/0001
OFFICE: 311		ROUTE: 564		ST_REF_NO: 00000045300		CONLEY STREET		LUMENS	BULB TYPE	MULT SERIES	POLE TYPE	SHADE	ADDRESS NUMBER	REF	LOCATION	TAX DIST	DATE INST	DATE CHANGE
	05800	S	M	SOH	I	00000	014								OPPOSITE 429	12	020466	1/1/0001
OFFICE: 311		ROUTE: 564		ST_REF_NO: 00000045400		CONN TERRACE		LUMENS	BULB TYPE	MULT SERIES	POLE TYPE	SHADE	ADDRESS NUMBER	REF	LOCATION	TAX DIST	DATE INST	DATE CHANGE
	09500	S	M	SOH	II	00000	010								SIDE OF 1033 SOUTH LIMESTONE ON CONN TERR	12	022604	1/1/0001
	09500	S	M	SOH	I	00104	000								upgraded all lts on Conn Terr to 9500 cobra 7/07	12	010855	1/1/0001
	09500	S	M	SOH	II	00110	011									12	022604	1/1/0001
	09500	S	M	SOH	I	00114	000									12	010855	1/1/0001
	09500	S	M	SOH	II	00120	012									12	022604	1/1/0001
	09500	S	M	SOH	I	00200	000									12	010855	1/1/0001
	09500	S	M	SOH	I	00208	000									12	011061	1/1/0001
	09500	S	M	SOH	I	00216	000									12	011061	1/1/0001
	09500	S	M	SOH	I	00228	000									12	011061	1/1/0001
	09500	S	M	SOH	I	00240	000									12	010855	1/1/0001
OFFICE: 311		ROUTE: 564		ST_REF_NO: 00000045430		CONSTANTINE AVE		LUMENS	BULB TYPE	MULT SERIES	POLE TYPE	SHADE	ADDRESS NUMBER	REF	LOCATION	TAX DIST	DATE INST	DATE CHANGE
	05800	S		CNT	II	00000	004								SIDE OF 2873 MAHALA LN, ON CONSTANTINE AVE	12	051510	1/1/0001
	05800	S		CNT	II	02969	003									12	051510	1/1/0001
	05800	S		CNT	II	02980	002									12	051510	1/1/0001
	05800	S		CNT	II	02997	001									12	051510	1/1/0001

OFFICE: 311		ROUTE: 564		ST_REF_NO: 00000045450		CONSTITUTION STREET		LUMENS	BULB TYPE	MULT SERIES	POLE TYPE	SHADE	ADDRESS NUMBER	REF	LOCATION	TAX DIST	DATE INST	DATE CHANGE
05800	S	M	SOH	II	00000	013	1ST LT. E. OF LIMESTONE ST., S. SIDE	12	020167	1/1/0001								
05800	S	M	SOH	II	00111	012		12	091367	1/1/0001								
05800	S	M	SOH	II	00124	011		12	020167	1/1/0001								
05800	S	M	SOH	II	00133	010		12	091367	1/1/0001								
05800	S	M	SOH	II	00140	009		12	020167	1/1/0001								
05800	S	M	SOH	II	00155	008		12	091367	1/1/0001								
05800	S	M	SOH	II	00160	007		12	020167	1/1/0001								
OFFICE: 311		ROUTE: 564		ST_REF_NO: 00000045470		CONTESSA COURT		LUMENS	BULB TYPE	MULT SERIES	POLE TYPE	SHADE	ADDRESS NUMBER	REF	LOCATION	TAX DIST	DATE INST	DATE CHANGE
05800	S	M	CNT	II	04308	001		12	050905	1/1/0001								
05800	S	M	CNT	III	04313	002		12	050905	1/1/0001								
OFFICE: 311		ROUTE: 564		ST_REF_NO: 00000045500		CONTRACT STREET		LUMENS	BULB TYPE	MULT SERIES	POLE TYPE	SHADE	ADDRESS NUMBER	REF	LOCATION	TAX DIST	DATE INST	DATE CHANGE
05800	S	M	SOH	II	00000	007	SIDE OF 705 LOUDON AVE.	12	011582	9/9/2009								
05800	S	M	OUG	II	00000	014	SIDE OF 997 FLOYD DRIVE ON CONTRACT STREET	12	122701	1/1/0001								
05800	S	M	OUG	II	00000	016	ACROSS FROM 1047 CONTRACT STREET	12	122701	1/1/0001								
05800	S	M	OUG	II	00900	026		12	122701	1/1/0001								
05800	S	M	OUG	II	00916	025		12	122701	1/1/0001								
05800	S	M	OUG	II	00917	024		12	122701	1/1/0001								
05800	S	M	OUG	II	00933	023		12	122701	1/1/0001								
05800	S	M	OUG	II	00949	022		12	122701	1/1/0001								
05800	S	M	OUG	II	00950	018		12	122701	1/1/0001								
05800	S	M	OUG	II	00965	021		12	122701	1/1/0001								
05800	S	M	OUG	II	00981	020		12	122701	1/1/0001								
05800	S	M	OUG	II	00997	019		12	122701	1/1/0001								
05800	S	M	OUG	II	01031	017		12	122701	1/1/0001								
05800	S	M	OUG	II	01447	015		12	122701	1/1/0001								
05800	S	M	OUG	II	00802	008		12	011582	1/1/0001								
05800	S	M	OUG	II	00850	010		12	011582	1/1/0001								

OFFICE: 311

ROUTE: 564

ST_REF_NO: 00000045565 CONWAY COURT

LUMENS	BULB TYPE	MULT SERIES	POLE TYPE	SHADE	ADDRESS NUMBER	REF	LOCATION	TAX DIST	DATE INST	DATE CHANGE
05800	S	M	OUG	II	00000	002	OPPOSITE 499 CONWAY COURT	12	030901	1/1/0001
05800	S	M	OUG	II	00000	003	OPPOSITE 470 CONWAY COURT	12	030901	1/1/0001
05800	S	M	OUG	II	00450	005		12	030901	1/1/0001
05800	S	M	OUG	II	00451	004		12	030901	1/1/0001
05800	S	M	OUG	II	00499	001		12	030901	1/1/0001

OFFICE: 311

ROUTE: 564

ST_REF_NO: 00000045569 CONYERS COURT

LUMENS	BULB TYPE	MULT SERIES	POLE TYPE	SHADE	ADDRESS NUMBER	REF	LOCATION	TAX DIST	DATE INST	DATE CHANGE
05800	S	M	CNT	III	01308	001		12	071102	1/1/0001

OFFICE: 311

ROUTE: 564

ST_REF_NO: 00000045600 COOL WATER COURT

LUMENS	BULB TYPE	MULT SERIES	POLE TYPE	SHADE	ADDRESS NUMBER	REF	LOCATION	TAX DIST	DATE INST	DATE CHANGE
05800	S	M	OUG	II	01016	104		12	011581	9/9/2009
04000	S	M	OUG	II	00000	103	SIDE OF 3232 COOL WATER DR.	12	041581	1/1/0001
04000	S	M	OUG	V	01025	105		12	090884	1/1/0001

OFFICE: 311

ROUTE: 564

ST_REF_NO: 00000045610 COOL WATER DRIVE

LUMENS	BULB TYPE	MULT SERIES	POLE TYPE	SHADE	ADDRESS NUMBER	REF	LOCATION	TAX DIST	DATE INST	DATE CHANGE
04000	S	M	OUG	II	03204	109		12	011584	1/1/0001
04000	S	M	OUG	II	03212	108		12	011584	1/1/0001
04000	S	M	OUG	II	03224	107		12	010888	1/1/0001
04000	S	M	OUG	II	03225	106		12	011584	1/1/0001

OFFICE: 311

ROUTE: 564

ST_REF_NO: 00000045700 COOLIDGE STREET

LUMENS	BULB TYPE	MULT SERIES	POLE TYPE	SHADE	ADDRESS NUMBER	REF	LOCATION	TAX DIST	DATE INST	DATE CHANGE
05800	S	M	SOH	I	01133	000		12	050162	1/1/0001
05800	S	M	SOH	I	01153	000		12	050162	1/1/0001
05800	S	M	SOH	III	01165	003		12	020898	1/1/0001

OFFICE: 311

ROUTE: 564

ST_REF_NO: 00000045900

COOPER DRIVE

LUMENS	BULB TYPE	MULT SERIES	POLE TYPE	SHADE	ADDRESS NUMBER	REF	LOCATION	TAX DIST	DATE INST	DATE CHANGE
22000	S		OUG	II	00000	001	1ST LT ON N SIDE FROM NICHOLASVILLE RD-REINSTALLED AFTER CONSTR	12	100108	1/1/0001
22000	S		OUG	II	00000	003	2ND LT ON N SIDE FROM NICHOLASVILLE RD-REINSTALLED AFTER CONSTR	12	100108	1/1/0001
22000	S		OUG	II	00000	005	3RD LT ON N SIDE FROM NICHOLASVILLE RD-REINSTALLED AFTER CONST	12	100108	1/1/0001
22000	S	M	SOH	II	00000	012	6TH LT. EAST OF NICHOLASVILLE RD., S SIDE	12	100573	9/9/2009
20000	M	M	OOH	II	00000	014	7TH LT. EAST OF NICHOLASVILLE RD., S SIDE	12	100573	9/9/2009
22000	S	M	OUG	II	00000	020	3RD LT EAST OF UNIVERSITY DR, S SIDE	12	100573	9/9/2009
22000	S	M	OUG	II	00000	051	4TH LT E OF UNIVERSITY DR, S SIDE ON COOPER DRIVE	12	112707	1/1/0001
20000	M	M	OUG	II	00000	002	1ST LIGHT ON S SIDE FROM NICHOLASVILLE RD	12	100573	1/1/0001
20000	M	M	OUG	II	00000	004	2ND LT. ON S. SIDE FROM NICHOLASVILLE RD.	12	100573	1/1/0001
20000	M	M	OUG	II	00000	006	3RD LT. ON S. SIDE FROM NICHOLASVILLE RD.	12	100573	1/1/0001
20000	M	M	OUG	II	00000	007	4TH LT. ON N. SIDE FROM NICHOLASVILLE RD.	12	100573	1/1/0001
22000	S	M	OUG	II	00000	008	4TH LT. ON S. SIDE FROM NICHOLASVILLE RD.	12	100573	1/1/0001
20000	M	M	OUG	II	00000	009	5TH LT. ON N. SIDE FROM NICHOLASVILLE RD.	12	100573	1/1/0001
20000	M	M	OUG	II	00000	010	5TH LT. ON S. SIDE FROM NICHOLASVILLE RD.	12	100573	1/1/0001
20000	M	M	OUG	II	00000	011	6TH LT. ON N. SIDE FROM NICHOLASVILLE RD.	12	100573	1/1/0001
20000	M	M	OUG	II	00000	015	8TH LT. ON N. SIDE FROM NICHOLASVILLE RD.	12	100573	1/1/0001
20000	M	M	OUG	II	00000	016	8TH LT. ON S. SIDE FROM NICHOLASVILLE RD.	12	100573	1/1/0001
20000	M	M	OUG	II	00000	017	9TH LT. ON N. SIDE FROM NICHOLASVILLE RD.	12	100573	1/1/0001
20000	M	M	OUG	II	00000	018	9TH LT. ON S. SIDE FROM NICHOLASVILLE RD.	12	100573	1/1/0001
20000	M	M	OUG	II	00000	019	10TH LT. ON N. SIDE FROM NICHOLASVILLE RD.	12	100573	1/1/0001
22000	S	M	OOH	II	00000	021	11TH LT. FROM NICHOLASVILLE RD., N. SIDE	12	051864	1/1/0001
22000	S	M	OOH	II	00000	022	11TH LT. FROM NICHOLASVILLE RD., S. SIDE	12	051864	1/1/0001
22000	S	M	OOH	II	00000	023	12TH LT. FROM NICHOLASVILLE RD., N. SIDE	12	051864	1/1/0001
22000	S	M	OOH	II	00000	024	12TH LT. FROM NICHOLASVILLE RD., S. SIDE	12	051864	1/1/0001
22000	S	M	OOH	II	00000	025	13TH LT. FROM NICHOLASVILLE RD., N. SIDE	12	051864	1/1/0001
22000	S	M	OOH	II	00000	026	13TH LT. FROM NICHOLASVILLE RD., S. SIDE	12	051864	1/1/0001
22000	S	M	OOH	II	00000	027	14TH LT. FROM NICHOLASVILLE RD., N. SIDE	12	051864	1/1/0001
22000	S	M	OOH	II	00000	028	14TH LT. FROM NICHOLASVILLE RD., S. SIDE	12	051864	1/1/0001
22000	S	M	OOH	II	00000	029	15TH LT. FROM NICHOLASVILLE RD., N. SIDE	12	051864	1/1/0001
22000	S	M	OOH	II	00000	030	15TH LT. FROM NICHOLASVILLE RD., S. SIDE	12	051864	1/1/0001

OFFICE: 311

ROUTE: 564

ST_REF_NO: 0000045900

COOPER DRIVE

LUMENS	BULB TYPE	MULT SERIES	POLE TYPE	SHADE	ADDRESS NUMBER	REF	LOCATION	TAX DIST	DATE INST	DATE CHANGE
22000	S	M	OOH	II	00000	031	16TH LT. FROM NICHOLASVILLE RD., N. SIDE	12	051864	1/1/0001
22000	S	M	OOH	II	00000	032	OPP. 619	12	051864	1/1/0001
22000	S	M	OUG	II	00000	037	SIDE OF 1200 SUMMIT DR.	12	120864	1/1/0001
22000	S	M	OUG	II	00000	040	SIDE OF 1492 TATES CREEK PK.	12	110664	1/1/0001
05800	S	M	OUG	II	00000	041	SIDE OF 1491 TATES CREEK PK.	12	100165	1/1/0001
22000	S	M	OUG	II	00635	033		12	110664	1/1/0001
22000	S	M	OUG	II	00662	034		12	010665	1/1/0001
22000	S	M	OUG	II	00705	035		12	120864	1/1/0001
22000	S	M	OUG	II	00714	036		12	110664	1/1/0001
22000	S	M	OUG	II	00767	038		12	110664	1/1/0001
22000	S	M	OUG	II	00820	039		12	110664	1/1/0001
05800	S	M	OUG	II	00000	042	SIDE OF 601 CHINOE RD.	12	040165	1/1/0001
05800	S	M	OUG	II	00000	043	SIDE OF 542 CHINOE RD.	12	021565	1/1/0001
05800	S	M	OUG	II	00990	000		12	100165	1/1/0001
05800	S	M	OUG	II	01001	000		12	100165	1/1/0001
05800	S	M	OUG	II	01028	000		12	020166	1/1/0001
05800	S	M	OUG	II	01043	000		12	100165	1/1/0001
05800	S	M	OUG	II	01060	000		12	100165	1/1/0001
05800	S	M	OUG	II	01071	000		12	110165	1/1/0001
05800	S	M	OUG	II	01089	000		12	052551	1/1/0001
05800	S	M	OUG	II	01090	000		12	110165	1/1/0001
05800	S	M	OUG	II	01104	000		12	100165	1/1/0001
05800	S	M	OUG	II	01111	000		12	100265	1/1/0001
05800	S	M	OUG	II	01118	000		12	100265	1/1/0001
05800	S	M	OUG	II	01129	000		12	100265	1/1/0001
05800	S	M	OUG	II	01136	000		12	100265	1/1/0001
05800	S	M	OUG	II	01157	000		12	052551	1/1/0001
05800	S	M	OUG	II	01202	000		12	100265	1/1/0001
05800	S	M	OUG	II	01211	000		12	010166	1/1/0001
05800	S	M	OUG	II	01222	000		12	110165	1/1/0001
05800	S	M	OUG	II	01229	000		12	030767	1/1/0001
05800	S	M	OUG	II	01242	000		12	020166	1/1/0001
05800	S	M	OUG	II	01245	000		12	030166	1/1/0001
05800	S	M	OUG	II	01300	000		12	021565	1/1/0001

OFFICE: 311		ROUTE: 564		ST_REF_NO: 00000045900		COOPER DRIVE		LUMENS	BULB TYPE	MULT SERIES	POLE TYPE	SHADE	ADDRESS NUMBER	REF	LOCATION	TAX DIST	DATE INST	DATE CHANGE
	05800	S	M	OUG	II	01301	000									12	010665	1/1/0001
	05800	S	M	OUG	II	01309	000									12	020165	1/1/0001
	05800	S	M	OUG	II	01312	000									12	020166	1/1/0001
	05800	S	M	OUG	II	01325	000									12	020165	1/1/0001
	05800	S	M	OUG	II	01328	000									12	020165	1/1/0001
	05800	S	M	OUG	II	01337	000									12	020367	1/1/0001
	05800	S	M	OUG	II	01344	000									12	020165	1/1/0001
	05800	S	M	OUG	II	01352	000									12	020367	1/1/0001
	05800	S	M	OUG	II	01361	000									12	020367	1/1/0001
	05800	S	M	OUG	II	01364	000									12	020367	1/1/0001

OFFICE: 311

ROUTE: 564

OFFICE: 311		ROUTE: 564		ST_REF_NO: 00000045905		COPPER CREEK DRIVE		LUMENS	BULB TYPE	MULT SERIES	POLE TYPE	SHADE	ADDRESS NUMBER	REF	LOCATION	TAX DIST	DATE INST	DATE CHANGE
	05800	S	M	CNT	II	01341	002									12	100896	1/1/0001
	05800	S	M	CNT	II	00000	001								SIDE REAR 440 COPPERFIELD DR.	12	100896	1/1/0001
	05800	S	M	CNT	II	01312	005									12	100896	1/1/0001
	05800	S	M	CNT	II	01321	004									12	100896	1/1/0001
	05800	S	M	CNT	II	01336	003									12	100896	1/1/0001
	05800	S	M	CNT	II	01365	007									12	100896	1/1/0001
	05800	S	M	CNT	II	01368	008									12	100896	1/1/0001
	05800	S	M	CNT	II	01381	009									12	100896	1/1/0001
	05800	S	M	CNT	II	01392	010									12	100896	1/1/0001
	05800	S	M	CNT	II	01405	011									12	100896	1/1/0001
	05800	S	M	CNT	II	01412	012									12	100896	1/1/0001

OFFICE: 311

ROUTE: 564

OFFICE: 311		ROUTE: 564		ST_REF_NO: 00000045910		COPPERFIELD DRIVE		LUMENS	BULB TYPE	MULT SERIES	POLE TYPE	SHADE	ADDRESS NUMBER	REF	LOCATION	TAX DIST	DATE INST	DATE CHANGE
	09500	S	M	OUG	II	00000	101								CORNER OF COPPERFIELD DR AND OLD HIGBEE MILL RD	12	072805	1/1/0001
	05800	S	M	OUG	II	00000	102								SIDE OF 1424 SCARLETT WAY ON COPPERFIELD DRIVE	12	072805	1/1/0001
	05800	S	M	OUG	II	00000	006								SIDE OF 1868 HAVERWOOD PARK	12	040894	1/1/0001
	05800	S	M	OUG	II	00000	007								REAR OF 4336 BUCKLAND PLACE	12	040894	1/1/0001

OFFICE: 311

ROUTE: 564

ST_REF_NO: 00000045910

COPPERFIELD DRIVE

LUMENS	BULB TYPE	MULT SERIES	POLE TYPE	SHADE	ADDRESS NUMBER	REF	LOCATION	TAX DIST	DATE INST	DATE CHANGE
05800	S	M	OUG	II	00000	008	REAR OF 4309 STONEYHURST PLACE	12	040894	1/1/0001
05800	S	M	OUG	II	00000	011	REAR OF 4237 CANTERBURY GREEN WAY	12	110896	1/1/0001
05800	S	M	OUG	II	00000	012	REAR OF 4236 HAMPTON RIDGE	12	110896	1/1/0001
05800	S	M	OUG	II	00000	013	REAR OF 4213 CANTERBURY GREEN WAY	12	110896	1/1/0001
05800	S	M	OUG	II	00000	014	REAR OF 4208 HAMPTON RIDGE	12	110896	1/1/0001
05800	S	M	OUG	II	00000	031	SE CORNER OF TWAIN RIDGE DR.	12	040894	1/1/0001
05800	S	M	OUG	II	00000	032	REAR OF 4256 HAMPTON RIDGE	12	040894	1/1/0001
05800	S	M	OUG	II	00000	033	REAR OF 1709 KENNING PLACE	12	040894	1/1/0001
05800	S	M	CNT	II	04412	002		12	100896	1/1/0001
05800	S	M	CNT	II	04420	001		12	100896	1/1/0001
05800	S	M	OUG	II	00000	009	REAR OF 1701 KENNING PLACE	12	040894	1/1/0001

OFFICE: 311

ROUTE: 564

ST_REF_NO: 00000045920

COPPERFIELD COURT

LUMENS	BULB TYPE	MULT SERIES	POLE TYPE	SHADE	ADDRESS NUMBER	REF	LOCATION	TAX DIST	DATE INST	DATE CHANGE
05800	S	M	CNT	II	01308	006		12	100896	1/1/0001
05800	S	M	CNT	II	01317	005		12	100896	1/1/0001
05800	S	M	CNT	II	01328	004		12	100896	1/1/0001
05800	S	M	CNT	II	01345	003		12	100896	1/1/0001
05800	S	M	CNT	II	01348	002		12	100896	1/1/0001
05800	S	M	CNT	II	01361	001		12	050896	1/1/0001
05800	S	M	CNT	II	01368	007		12	100896	1/1/0001
05800	S	M	CNT	II	01384	009		12	100896	1/1/0001
05800	S	M	CNT	II	01385	008		12	100896	1/1/0001
05800	S	M	CNT	II	01401	010		12	100896	1/1/0001
05800	S	M	CNT	II	01417	011		12	100896	1/1/0001
05800	S	M	CNT	II	01420	012		12	100896	1/1/0001
05800	S	M	CNT	II	01437	013		12	100896	1/1/0001
05800	S	M	CNT	II	01440	014		12	100896	1/1/0001

OFFICE: 311

ROUTE: 564

ST_REF_NO: 00000045930

COPPER GLEN COURT

LUMENS	BULB TYPE	MULT SERIES	POLE TYPE	SHADE	ADDRESS NUMBER	REF	LOCATION	TAX DIST	DATE INST	DATE CHANGE
05800	S	M	CNT	III	04504	001		12	050896	1/1/0001

OFFICE: 311

ROUTE: 564

ST_REF_NO: 00000045935

COPPER GLEN DRIVE

LUMENS	BULB TYPE	MULT SERIES	POLE TYPE	SHADE	ADDRESS NUMBER	REF	LOCATION	TAX DIST	DATE INST	DATE CHANGE
05800	S	M	CNT	II	01409	003		12	080896	1/1/0001
05800	S	M	CNT	II	01416	002		12	080896	1/1/0001
05800	S	M	CNT	II	01432	001		12	080896	1/1/0001
05800	S	M	CNT	II	01433	005		12	080896	1/1/0001
05800	S	M	CNT	II	01444	006		12	080896	1/1/0001
05800	S	M	CNT	II	01452	007		12	080896	1/1/0001
05800	S	M	CNT	II	01457	008		12	080896	1/1/0001
05800	S	M	CNT	II	01468	009		12	080896	1/1/0001

OFFICE: 311

ROUTE: 564

ST_REF_NO: 00000045940

COPPER KNOLL CIRCLE

LUMENS	BULB TYPE	MULT SERIES	POLE TYPE	SHADE	ADDRESS NUMBER	REF	LOCATION	TAX DIST	DATE INST	DATE CHANGE
05800	S	M	CNT	II	04500	002		12	080896	1/1/0001
05800	S	M	CNT	II	04517	001		12	080896	1/1/0001

OFFICE: 311

ROUTE: 564

ST_REF_NO: 00000045945

COPPER RIDGE COURT

LUMENS	BULB TYPE	MULT SERIES	POLE TYPE	SHADE	ADDRESS NUMBER	REF	LOCATION	TAX DIST	DATE INST	DATE CHANGE
05800	S	M	CNT	II	00000	001	SIDE REAR 1460 COPPER GLEN DR.	12	080896	1/1/0001

OFFICE: 311

ROUTE: 564

ST_REF_NO: 00000045947

COPPER RUN BLVD

LUMENS	BULB TYPE	MULT SERIES	POLE TYPE	SHADE	ADDRESS NUMBER	REF	LOCATION	TAX DIST	DATE INST	DATE CHANGE
05800	S	M	CNT	II	01300	001		12	020896	1/1/0001
05800	S	M	CNT	II	01301	002		12	020896	1/1/0001
05800	S	M	CNT	II	01304	003		12	020896	1/1/0001
05800	S	M	CNT	II	01305	004		12	020896	1/1/0001
05800	S	M	CNT	II	01308	005		12	020896	1/1/0001
05800	S	M	CNT	II	01313	006		12	020896	1/1/0001
05800	S	M	CNT	II	01320	007		12	020896	1/1/0001
05800	S	M	CNT	II	01333	008		12	020896	1/1/0001
05800	S	M	CNT	II	01336	009		12	020896	1/1/0001
05800	S	M	CNT	II	01349	010		12	020896	1/1/0001
05800	S	M	CNT	II	01352	011		12	020896	1/1/0001

OFFICE: 311		ROUTE: 564		ST_REF_NO: 00000045947		COPPER RUN BLVD		LUMENS	BULB TYPE	MULT SERIES	POLE TYPE	SHADE	ADDRESS NUMBER	REF	LOCATION	TAX DIST	DATE INST	DATE CHANGE
	05800	S	M	CNT	II	01357	012									12	020896	1/1/0001
	05800	S	M	CNT	II	01364	013									12	020896	1/1/0001
	05800	S	M	CNT	II	01377	014									12	020896	1/1/0001
	05800	S	M	CNT	II	01384	015									12	020896	1/1/0001
	05800	S	M	CNT	II	01392	016									12	020896	1/1/0001
	05800	S	M	CNT	II	01393	017									12	020896	1/1/0001
	05800	S	M	CNT	II	01396	018									12	020896	1/1/0001
	05800	S	M	CNT	II	01409	019									12	020896	1/1/0001
	05800	S	M	CNT	II	01412	020									12	020896	1/1/0001
	05800	S	M	CNT	II	01424	022									12	020896	1/1/0001
	05800	S	M	CNT	II	01425	021									12	020896	1/1/0001
	05800	S	M	CNT	II	01432	023									12	100898	1/1/0001
	05800	S	M	CNT	II	01441	024									12	100898	1/1/0001
	05800	S	M	CNT	III	01453	025									12	100898	1/1/0001
	05800	S	M	CNT	II	01469	026									12	100898	1/1/0001
	05800	S	M	CNT	II	01488	027									12	100898	1/1/0001
	05800	S	M	CNT	III	01500	028									12	100898	1/1/0001

OFFICE: 311		ROUTE: 564		ST_REF_NO: 00000045950		COPPER SPRINGS DRIVE		LUMENS	BULB TYPE	MULT SERIES	POLE TYPE	SHADE	ADDRESS NUMBER	REF	LOCATION	TAX DIST	DATE INST	DATE CHANGE
	05800	S	M	CNT	II	00000	001									12	080896	1/1/0001
	05800	S	M	CNT	II	00000	002									12	050896	1/1/0001

OFFICE: 311		ROUTE: 564		ST_REF_NO: 00000045970		COPPER WOODS CIRCLE		LUMENS	BULB TYPE	MULT SERIES	POLE TYPE	SHADE	ADDRESS NUMBER	REF	LOCATION	TAX DIST	DATE INST	DATE CHANGE
	05800	S	M	CNT	II	04408	001									12	020896	1/1/0001

OFFICE: 311		ROUTE: 564		ST_REF_NO: 00000045980		CORBIN WALK		LUMENS	BULB TYPE	MULT SERIES	POLE TYPE	SHADE	ADDRESS NUMBER	REF	LOCATION	TAX DIST	DATE INST	DATE CHANGE
	05800	S	M	CNT	II	00700	001									12	092507	1/1/0001
	05800	S	M	CNT	II	00700	001									12	092507	1/1/0001

OFFICE: 311

ROUTE: 564

ST_REF_NO: 00000045980

CORBIN WALK

LUMENS	BULB TYPE	MULT SERIES	POLE TYPE	SHADE	ADDRESS NUMBER	REF	LOCATION	TAX DIST	DATE INST	DATE CHANGE
05800	S	M	CNT	II	00708	002		12	092507	1/1/0001
05800	S	M	CNT	II	00708	002		12	092507	1/1/0001
05800	S	M	CNT	II	00725	003		12	092507	1/1/0001
05800	S	M	CNT	II	00725	003		12	092507	1/1/0001
05800	S	M	CNT	II	00732	004		12	092507	1/1/0001
05800	S	M	CNT	II	00732	004		12	092507	1/1/0001

OFFICE: 311

ROUTE: 564

ST_REF_NO: 00000045985

CORDELE LANE

LUMENS	BULB TYPE	MULT SERIES	POLE TYPE	SHADE	ADDRESS NUMBER	REF	LOCATION	TAX DIST	DATE INST	DATE CHANGE
05800	S	M	CNT	II	01305	001		12	081704	1/1/0001
05800	S	M	CNT	II	01309	002		12	081704	1/1/0001
05800	S	M	CNT	III	01320	003		12	081704	1/1/0001

OFFICE: 311

ROUTE: 564

ST_REF_NO: 00000045990

CORIANDER LANE

LUMENS	BULB TYPE	MULT SERIES	POLE TYPE	SHADE	ADDRESS NUMBER	REF	LOCATION	TAX DIST	DATE INST	DATE CHANGE
05800	S	M	OUG	III	02012	001		12	060401	1/1/0001
05800	S	M	OUG	II	02025	002		12	063003	1/1/0001
05800	S	M	OUG	II	02036	003		12	060401	1/1/0001
05800	S	M	OUG	II	02053	004		12	060401	1/1/0001
05800	S	M	OUG	II	02068	005		12	060401	1/1/0001
05800	S	M	OUG	II	02089	006		12	060401	1/1/0001
05800	S	M	OUG	III	02109	007		12	063003	1/1/0001

OFFICE: 311

ROUTE: 564

ST_REF_NO: 00000046100

CORNWALL DRIVE

LUMENS	BULB TYPE	MULT SERIES	POLE TYPE	SHADE	ADDRESS NUMBER	REF	LOCATION	TAX DIST	DATE INST	DATE CHANGE
05800	S	M	OUG	II	00000	017	SIDE OF 696 CINDY BLAIR WAY ON CORNWALL DR.	12	120890	1/1/0001
05800	S	M	OUG	II	00000	030	SIDE OF 3416 LANNETTE LANE ON CORNWALL DR	12	050891	1/1/0001
05800	S	M	OUG	II	00000	034	OPP. 3500 CORNWALL	12	050891	1/1/0001
05800	S	M	OUG	II	00000	036	OPP. 3509	12	020891	1/1/0001
05800	S	M	OUG	II	00000	041		12	020891	1/1/0001
05800	S	M	OUG	II	03256	013		12	120890	1/1/0001

OFFICE: 311

ROUTE: 564

ST_REF_NO: 0000046100

CORNWALL DRIVE

LUMENS	BULB TYPE	MULT SERIES	POLE TYPE	SHADE	ADDRESS NUMBER	REF	LOCATION	TAX DIST	DATE INST	DATE CHANGE
05800	S	M	OUG	II	03260	014		12	120890	1/1/0001
05800	S	M	OUG	II	03267	016		12	120890	1/1/0001
05800	S	M	OUG	II	03268	015		12	120890	1/1/0001
05800	S	M	OUG	II	03284	018		12	120890	1/1/0001
05800	S	M	OUG	II	03291	019		12	050891	1/1/0001
05800	S	M	OUG	II	03296	020		12	050891	1/1/0001
05800	S	M	OUG	II	03296	021		12	050891	1/1/0001
05800	S	M	OUG	II	03307	022		12	050891	1/1/0001
05800	S	M	OUG	II	03308	023		12	050891	1/1/0001
05800	S	M	OUG	II	03311	024		12	050891	1/1/0001
05800	S	M	OUG	II	03315	025		12	050891	1/1/0001
05800	S	M	OUG	II	03400	026		12	050891	1/1/0001
05800	S	M	OUG	II	03404	027		12	050891	1/1/0001
05800	S	M	OUG	II	03407	028		12	050891	1/1/0001
05800	S	M	OUG	II	03416	029		12	050891	1/1/0001
05800	S	M	OUG	II	03427	031		12	050891	1/1/0001
05800	S	M	OUG	II	03435	032		12	050891	1/1/0001
05800	S	M	OUG	II	03436	033		12	050891	1/1/0001
05800	S	M	OUG	II	03504	035		12	020891	1/1/0001
05800	S	M	OUG	II	03517	037		12	020891	1/1/0001
05800	S	M	OUG	II	03524	038		12	020891	1/1/0001
05800	S	M	OUG	II	03529	039		12	020891	1/1/0001
05800	S	M	OUG	II	03536	040		12	020891	1/1/0001
05800	S	M	OUG	II	03553	042		12	020891	1/1/0001
05800	S	M	OUG	II	03556	043		12	020891	1/1/0001
05800	S	M	OUG	II	03561	045		12	020891	1/1/0001
05800	S	M	OUG	II	03565	044		12	020891	1/1/0001
05800	S	M	OUG	II	03577	046		12	020891	1/1/0001
05800	S	M	OUG	II	00000	003	OPP. 697 BETH LANE ON CORNWALL DR.	12	100890	1/1/0001
05800	S	M	OUG	II	00000	004	OPP. 694 BETH LANE ON CORNWALL DR.	12	100890	1/1/0001
05800	S	M	OUG	II	00000	008	OPP. 3228 CORNWALL DR	12	100890	1/1/0001
05800	S	M	OUG	II	00000	010	OPP. 3240 CORNWALL DR	12	100890	1/1/0001
05800	S	M	OUG	II	00000	012	OPP. 3252 CORNWALL DR.	12	120890	1/1/0001
05800	S	M	OUG	II	03201	001		12	100890	1/1/0001

OFFICE: 311

ROUTE: 564

ST_REF_NO: 00000046100

CORNWALL DRIVE

LUMENS	BULB TYPE	MULT SERIES	POLE TYPE	SHADE	ADDRESS NUMBER	REF	LOCATION	TAX DIST	DATE INST	DATE CHANGE
05800	S	M	OUG	II	03201	002		12	100890	1/1/0001
05800	S	M	OUG	II	03213	005		12	100890	1/1/0001
05800	S	M	OUG	II	03213	006		12	100890	1/1/0001
05800	S	M	OUG	II	03220	007		12	100890	1/1/0001
05800	S	M	OUG	II	03232	009		12	100890	1/1/0001
05800	S	M	OUG	II	03244	011		12	100890	1/1/0001

OFFICE: 311

ROUTE: 564

ST_REF_NO: 00000046105

CORONA DRIVE

LUMENS	BULB TYPE	MULT SERIES	POLE TYPE	SHADE	ADDRESS NUMBER	REF	LOCATION	TAX DIST	DATE INST	DATE CHANGE
05800	S	M	CNT	II	00000	012	REAR OF 1336 TRACE BLVD.	12	020896	1/1/0001
05800	S	M	CNT	II	01293	010		12	080896	1/1/0001
05800	S	M	CNT	II	01300	009		12	020896	1/1/0001
05800	S	M	CNT	II	01313	008		12	020896	1/1/0001
05800	S	M	CNT	II	01320	007		12	020896	1/1/0001
05800	S	M	CNT	II	01333	006		12	080896	1/1/0001
05800	S	M	CNT	II	01336	005		12	080896	1/1/0001
05800	S	M	CNT	II	01352	004		12	020896	1/1/0001
05800	S	M	CNT	II	01361	003		12	020896	1/1/0001
05800	S	M	CNT	II	01377	002		12	020896	1/1/0001
05800	S	M	CNT	II	01388	001		12	080896	1/1/0001
05800	S	M	CNT	II	01400	011		12	050896	1/1/0001
05800	S	M	CNT	II	01413	013		12	050896	1/1/0001
05800	S	M	CNT	II	01429	014		12	080896	1/1/0001
05800	S	M	CNT	II	01432	015		12	050896	1/1/0001
05800	S	M	CNT	II	01441	016		12	080896	1/1/0001
05800	S	M	CNT	II	01452	017		12	050896	1/1/0001
05800	S	M	CNT	II	01465	018		12	080896	1/1/0001
05800	S	M	CNT	II	01476	019		12	080896	1/1/0001

OFFICE: 311

ROUTE: 564

ST_REF_NO: 00000046150

CORONADO RIDGE DRIVE

LUMENS	BULB TYPE	MULT SERIES	POLE TYPE	SHADE	ADDRESS NUMBER	REF	LOCATION	TAX DIST	DATE INST	DATE CHANGE
05800	S	M	OUG	II	00000	001	SIDE OF 2285 SPRINTER TRAIL DR ON CORONADO RIDGE	12	101403	1/1/0001

OFFICE: 311		ROUTE: 564		ST_REF_NO: 00000046150		CORONADO RIDGE DRIVE				
LUMENS	BULB TYPE	MULT SERIES	POLE TYPE	SHADE	ADDRESS NUMBER	REF	LOCATION	TAX DIST	DATE INST	DATE CHANGE
05800	S	M	OUG	II	02605	006		12	101403	1/1/0001
05800	S	M	OUG	II	02633	005		12	101403	1/1/0001
05800	S	M	OUG	II	02644	004		12	101403	1/1/0001
05800	S	M	OUG	II	02661	003		12	101403	1/1/0001
05800	S	M	OUG	II	02676	002		12	101403	1/1/0001

OFFICE: 311		ROUTE: 564		ST_REF_NO: 00000046160		CORONEO LANE				
LUMENS	BULB TYPE	MULT SERIES	POLE TYPE	SHADE	ADDRESS NUMBER	REF	LOCATION	TAX DIST	DATE INST	DATE CHANGE
09500	S		CLN	III	00000	003	SIDE OF 2400 GEPPA CT ON CORONEO LANE	12	072213	1/1/0001
09500	S		CLN	III	00000	005	SIDE OF 2404 ROSSINI PL ON CORONEO LANE	12	072213	1/1/0001
09500	S		CLN	III	02400	009		12	072213	1/1/0001
09500	S		CLN	III	02405	008		12	072213	1/1/0001
09500	S		CLN	III	02424	007		12	072213	1/1/0001
09500	S		CLN	III	02433	006		12	072213	1/1/0001
09500	S		CLN	III	02453	004		12	072213	1/1/0001
09500	S		CLN	III	02473	002		12	072213	1/1/0001
09500	S		CLN	III	02484	001		12	072213	1/1/0001

OFFICE: 311		ROUTE: 564		ST_REF_NO: 00000046200		CORPORATE DRIVE				
LUMENS	BULB TYPE	MULT SERIES	POLE TYPE	SHADE	ADDRESS NUMBER	REF	LOCATION	TAX DIST	DATE INST	DATE CHANGE
05800	S		OUG	II	00000	112	side of 3050 Harrodsburg Rd	12	051480	1/1/0001
05800	S		OUG	II	00000	113	side of 3050 Harrodsburg Rd	12	051480	1/1/0001
05800	S		OUG	II	00771	110		12	051480	1/1/0001
05800	S		OUG	II	00771	111		12	051480	1/1/0001
50000	S	M	OUG	II	00861	006		12	061581	9/9/2009
09500	S	M	OUG	II	00000	001	SIDE OF 3060 HARRODSBURG RD.,	12	120896	1/1/0001
09500	S	M	OUG	II	00000	002	SIDE OF 3050 HARRODSBURG RD.,	12	120896	1/1/0001
09500	S	M	OUG	II	00000	003	SIDE REAR OF 3060 HARRODSBURG RD.,	12	120896	1/1/0001
09500	S	M	OUG	II	00000	007	OPPOSITE 851	12	111580	1/1/0001
09500	S	M	OUG	II	00000	009	OPPOSITE 831	12	111580	1/1/0001
09500	S	M	OUG	II	00000	010	OPPOSITE 831	12	111580	1/1/0001
09500	S	M	OUG	II	00000	011	OPPOSITE 831	12	111580	1/1/0001

OFFICE: 311

ROUTE: 564

ST_REF_NO: 00000046200

CORPORATE DRIVE

LUMENS	BULB TYPE	MULT SERIES	POLE TYPE	SHADE	ADDRESS NUMBER	REF	LOCATION	TAX DIST	DATE INST	DATE CHANGE
09500	S	M	SOH	II	00000	012	OPPOSITE 800	12	051480	1/1/0001
05800	S	M	OUG	II	00000	022	OPPOSITE 771	12	051480	1/1/0001
05800	S	M	OUG	II	00000	023	OPPOSITE 771	12	051480	1/1/0001
05800	S	M	OUG	II	00781	021		12	051480	1/1/0001
05800	S	M	OUG	II	00791	019		12	051480	1/1/0001
05800	S	M	OUG	II	00791	020		12	051480	1/1/0001
09500	S	M	OUG	II	00800	013		12	111580	1/1/0001
05800	S	M	OUG	II	00801	016		12	051480	1/1/0001
05800	S	M	OUG	II	00801	017		12	051480	1/1/0001
05800	S	M	OUG	II	00801	018		12	051480	1/1/0001
05800	S	M	OUG	II	00811	015		12	121583	1/1/0001
05800	S	M	OUG	II	00821	014		12	121583	1/1/0001
09500	S	M	OUG	II	00841	008		12	020884	1/1/0001
09500	S	M	OUG	II	00870	005		12	020884	1/1/0001
09500	S	M	OUG	II	00881	004		12	120896	1/1/0001

OFFICE: 311

ROUTE: 564

ST_REF_NO: 00000046300

CORRAL STREET

LUMENS	BULB TYPE	MULT SERIES	POLE TYPE	SHADE	ADDRESS NUMBER	REF	LOCATION	TAX DIST	DATE INST	DATE CHANGE
22000	S	M	OOH	II	00000	001	SIDE OF 156 N MARTIN LUTHER KING BLVD	12	110167	9/9/2009
10000	M	M	OOH	II	00000	002	SIDE OF 166 N MARTIN LUTHER KING BLVD (COLUMBIA GAS BUILDING)	12	110167	9/9/2009
09500	S	M	OOH	II	00000	007	SIDE OF 163 SPURCE STREET-upgrade 1/08	12	110167	9/9/2009
10000	M	M	OOH	II	00000	009	SIDE OF 169 DEWEESE ST.	12	110167	9/9/2009
05800	S	M	SOH	I	00000	020	1ST LT E OF RACE, S SIDE	12	030168	9/9/2009
05800	S	M	SOH	I	00000	021	2ND LT N OF MIDLAND AVENUE, E SIDE	12	020669	9/9/2009
05800	S	M	SOH	I	00000	022	1ST LT N OF MIDLAND, W SIDE	12	030168	9/9/2009
05800	S	M	SOH	II	00000	025	OPP OLDE HURST PL	12	020269	9/9/2009
10000	M	M	OOH	II	00211	004		12	110167	9/9/2009
09500	S	M	OOH	II	00220	003		12	110167	9/9/2009
09500	S	M	OOH	II	00221	006		12	110167	9/9/2009
05800	S	M	SOH	I	00313	011		12	030168	9/9/2009
05800	S	M	SOH	I	00327	012		12	030168	9/9/2009
05800	S	M	SOH	I	00355	014		12	030168	9/9/2009

OFFICE: 311

ROUTE: 564

ST_REF_NO: 00000046300

CORRAL STREET

LUMENS	BULB TYPE	MULT SERIES	POLE TYPE	SHADE	ADDRESS NUMBER	REF	LOCATION	TAX DIST	DATE INST	DATE CHANGE
05800	S	M	SOH	I	00400	017		12	030168	9/9/2009
05800	S	M	SOH	I	00411	018		12	020669	9/9/2009
10000	M	M	OOH	II	00000	005	S.E. CORNER OF CLARK ST.	12	110167	1/1/0001
10000	M	M	OOH	II	00000	008	SIDE OF 180 SPRUCE ST.	12	110167	1/1/0001
05800	S	M	SOH	I	00339	013		12	030168	1/1/0001
05800	S	M	SOH	I	00365	015		12	020669	1/1/0001
05800	S	M	SOH	I	00377	016		12	020669	1/1/0001

OFFICE: 311

ROUTE: 564

ST_REF_NO: 00000046310

CORAL CREEK CIRCLE

LUMENS	BULB TYPE	MULT SERIES	POLE TYPE	SHADE	ADDRESS NUMBER	REF	LOCATION	TAX DIST	DATE INST	DATE CHANGE
05800	S	M	OUG	II	00000	001	SIDE 4803 HARTLAND PARKWAY	12	080893	1/1/0001
05800	S	M	OUG	II	00000	002	SIDE 4821 CORAL CREEK CIRCLE	12	080893	1/1/0001
05800	S	M	OUG	IV	00000	005	OPP. 4836 (IN ISLAND)	12	080893	1/1/0001
05800	S	M	OUG	IV	00000	006	OPP. 4837 (IN ISLAND)	12	080893	1/1/0001
05800	S	M	OUG	II	04824	003		12	080893	1/1/0001
05800	S	M	OUG	II	04825	004		12	080893	1/1/0001

OFFICE: 311

ROUTE: 564

ST_REF_NO: 00000046360

CORNERSTONE DRIVE

LUMENS	BULB TYPE	MULT SERIES	POLE TYPE	SHADE	ADDRESS NUMBER	REF	LOCATION	TAX DIST	DATE INST	DATE CHANGE
05800	S	M	OUG	II	00000	007	2ND LT N OF STONEWOOD DR, E SIDE ON CORNERSTONE DR	12	063003	1/1/0001
05800	S	M	OUG	II	00000	008	1ST N OF CRUSADERS WAY, W SIDE ON CORNERSTONE DR	12	063003	9/9/2009
09500	S	M	OUG	II	00000	009	1ST LT S OF KNIGHTSBRIDGE, ON CORNERSTONE DR	12	063003	9/9/2009
09500	S	M	OUG	II	00000	010	1ST LT S OF FORTUNE DR, E SIDE ON CORNERSTONE DR	12	063003	9/9/2009
05800	S	M	OUG	III	02221	007		12	020801	9/9/2009
05800	S	M	OUG	II	00000	005	SIDE OF 2096 STONEWOOD LANE	12	020801	1/1/0001
05800	S	M	OUG	II	02113	004		12	020801	1/1/0001
05800	S	M	OUG	II	02208	006		12	020801	1/1/0001

OFFICE: 311

ROUTE: 564

ST_REF_NO: 00000046400

COSTIGAN DRIVE

LUMENS	BULB TYPE	MULT SERIES	POLE TYPE	SHADE	ADDRESS NUMBER	REF	LOCATION	TAX DIST	DATE INST	DATE CHANGE
05800	S	M	OUG	II	00000	091	SIDE OF 1065 PENNEBAKER DR.	12	051475	1/1/0001
05800	S	M	OUG	II	01663	000		12	050874	1/1/0001
05800	S	M	OUG	II	01674	000		12	050774	1/1/0001
05800	S	M	OUG	II	01687	130		12	051475	1/1/0001
05800	S	M	OUG	II	01713	000		12	080173	1/1/0001
05800	S	M	OUG	II	01724	000		12	080173	1/1/0001
05800	S	M	OUG	II	01737	000		12	080173	1/1/0001
05800	S	M	OUG	II	01748	000		12	080173	1/1/0001
05800	S	M	OUG	II	01765	000		12	080173	1/1/0001
05800	S	M	OUG	II	01776	000		12	080173	1/1/0001
05800	S	M	OUG	II	01792	000		12	070172	1/1/0001
05800	S	M	OUG	II	01820	000		12	070172	1/1/0001
05800	S	M	OUG	II	01821	000		12	100171	1/1/0001
05800	S	M	OUG	II	01836	000		12	100171	1/1/0001
05800	S	M	OUG	II	01849	000		12	070172	1/1/0001
05800	S	M	OUG	II	01860	000		12	100171	1/1/0001
05800	S	M	OUG	II	01877	000		12	100171	1/1/0001
05800	S	M	OUG	II	01888	000		12	100171	1/1/0001

OFFICE: 311

ROUTE: 564

ST_REF_NO: 00000046530

COTTAGE CIRCLE

LUMENS	BULB TYPE	MULT SERIES	POLE TYPE	SHADE	ADDRESS NUMBER	REF	LOCATION	TAX DIST	DATE INST	DATE CHANGE
05800	S	M	OUG	II	00000	001	SIDE OF 3600	12	120896	1/1/0001
05800	S	M	OUG	II	00000	002	SIDE OF 3725	12	120896	1/1/0001
05800	S	M	OUG	II	00000	007	SIDE REAR OF 3701	12	120896	1/1/0001
05800	S	M	OUG	II	03608	010		12	120896	1/1/0001
05800	S	M	OUG	II	03620	009		12	120896	1/1/0001
05800	S	M	OUG	II	03700	005		12	120896	1/1/0001
05800	S	M	OUG	II	03717	004		12	120896	1/1/0001
05800	S	M	OUG	II	03728	003		12	120896	1/1/0001
05800	S	M	OUG	II	03752	008		12	120896	1/1/0001
05800	S	M	OUG	II	03784	006		12	120896	1/1/0001

OFFICE: 311

ROUTE: 564

ST_REF_NO: 00000046560 COTTONTAIL LANE

LUMENS	BULB TYPE	MULT SERIES	POLE TYPE	SHADE	ADDRESS NUMBER	REF	LOCATION	TAX DIST	DATE INST	DATE CHANGE
05800	S	M	CNT	II	03109	005		12	080897	1/1/0001
05800	S	M	CNT	II	03133	033		12	080897	1/1/0001
05800	S	M	CNT	II	03153	002		12	080897	1/1/0001
05800	S	M	CNT	II	03165	001		12	080897	1/1/0001

OFFICE: 311

ROUTE: 564

ST_REF_NO: 00000046600 COTTONWOOD DRIVE

LUMENS	BULB TYPE	MULT SERIES	POLE TYPE	SHADE	ADDRESS NUMBER	REF	LOCATION	TAX DIST	DATE INST	DATE CHANGE
05800	S	M	OUG	II	00000	032	side of 4276 Forsythe on Cottonwood Drive	12	021580	11/6/2008
05800	S	M	OUG	II	01929	028		12	021580	9/9/2009
04000	S	M	OUG	II	01968	031		12	021580	9/9/2009
04000	S	M	OUG	II	01900	025		12	021580	1/1/0001
04000	S	M	OUG	II	01909	026		12	021580	1/1/0001
04000	S	M	OUG	II	01920	027		12	021580	1/1/0001
04000	S	M	OUG	II	01948	029		12	021580	1/1/0001
04000	S	M	OUG	II	01961	030		12	021580	1/1/0001

OFFICE: 311

ROUTE: 564

ST_REF_NO: 00000046650 COUNTRY HILLS CIRCLE

LUMENS	BULB TYPE	MULT SERIES	POLE TYPE	SHADE	ADDRESS NUMBER	REF	LOCATION	TAX DIST	DATE INST	DATE CHANGE
05800	S	M	OUG	III	00000	001	SIDE REAR OF 684 MORGAN HILLS DR.	12	020899	1/1/0001

OFFICE: 311

ROUTE: 564

ST_REF_NO: 00000046700 COURCHELLE COURT

LUMENS	BULB TYPE	MULT SERIES	POLE TYPE	SHADE	ADDRESS NUMBER	REF	LOCATION	TAX DIST	DATE INST	DATE CHANGE
05800	S	M	OUG	II	02901	004		12	061580	1/1/0001

OFFICE: 311

ROUTE: 564

ST_REF_NO: 00000046800 COURTLAND DRIVE

LUMENS	BULB TYPE	MULT SERIES	POLE TYPE	SHADE	ADDRESS NUMBER	REF	LOCATION	TAX DIST	DATE INST	DATE CHANGE
05800	S	M	OUG	II	01801	000		12	081265	1/1/0001
05800	S	M	OUG	II	01814	000		12	100466	1/1/0001
05800	S	M	OUG	II	01829	000		12	081265	1/1/0001
05800	S	M	OUG	II	01840	000		12	100466	1/1/0001
05800	S	M	OUG	II	01861	000		12	081265	1/1/0001

OFFICE: 311

ROUTE: 564

ST_REF_NO: 00000046800

COURTLAND DRIVE

LUMENS	BULB TYPE	MULT SERIES	POLE TYPE	SHADE	ADDRESS NUMBER	REF	LOCATION	TAX DIST	DATE INST	DATE CHANGE
05800	S	M	OUG	II	01885	000		12	081265	1/1/0001

OFFICE: 311

ROUTE: 564

ST_REF_NO: 00000046900

COURTNEY AVENUE

LUMENS	BULB TYPE	MULT SERIES	POLE TYPE	SHADE	ADDRESS NUMBER	REF	LOCATION	TAX DIST	DATE INST	DATE CHANGE
05800	S		OUG	II	01745	200		12	101808	1/1/0001
05800	S		OUG	II	01765	201		12	101808	1/1/0001
05800	S		OUG	II	01780	202		12	101808	1/1/0001
05800	S		OUG	II	01793	203		12	101808	1/1/0001
05800	S		OUG	II	01816	204		12	101808	1/1/0001
05800	S	M	OUG	II	01604	178		12	110884	9/9/2009
04000	S	M	OUG	II	01731	183		12	110884	9/9/2009
04000	S	M	OUG	II	00000	177	SIDE OF 532 HENRY CLAY BLVD	12	110884	1/1/0001
04000	S	M	OUG	II	01621	179		12	110884	1/1/0001
04000	S	M	OUG	II	01636	180		12	110884	1/1/0001
04000	S	M	OUG	II	01703	181		12	110884	1/1/0001
04000	S	M	OUG	II	01720	182		12	110884	1/1/0001
04000	S	M	OUG	II	01738	184		12	110884	1/1/0001

OFFICE: 311

ROUTE: 564

ST_REF_NO: 00000047000

COVE LAKE DRIVE

LUMENS	BULB TYPE	MULT SERIES	POLE TYPE	SHADE	ADDRESS NUMBER	REF	LOCATION	TAX DIST	DATE INST	DATE CHANGE
05800	S	M	OUG	II	00000	015	OPP 3360	12	100897	9/9/2009
05800	S	M	OUG	II	03316	010		12	051478	9/9/2009
04000	S	M	OUG	II	03375	017		12	010888	9/9/2009
04000	S	M	OUG	II	00000	009	OPPOSITE 3310	12	051581	1/1/0001
04000	S	M	OUG	II	00000	011	OPPOSITE 3326	12	051581	1/1/0001
04000	S	M	OUG	II	00000	013	OPPOSITE 3342	12	051581	1/1/0001
04000	S	M	OUG	II	03300	008		12	051478	1/1/0001
04000	S	M	OUG	II	03332	012		12	051478	1/1/0001
04000	S	M	OUG	II	03354	014		12	051581	1/1/0001
04000	S	M	OUG	II	03368	016		12	051478	1/1/0001
04000	S	M	OUG	II	03384	038		12	030888	1/1/0001

OFFICE: 311

ROUTE: 564

ST_REF_NO: 00000047100 COVENTRY COURT

LUMENS	BULB TYPE	MULT SERIES	POLE TYPE	SHADE	ADDRESS NUMBER	REF	LOCATION	TAX DIST	DATE INST	DATE CHANGE
04000	S	M	OUG	II	00000	081	SIDE 2930 SOUTHVIEW DR	12	040884	1/1/0001
05800	S	M	OUG	V	00400	084		12	070899	1/1/0001
04000	S	M	OUG	II	00421	083		12	040884	1/1/0001
04000	S	M	OUG	II	00430	082		12	040884	1/1/0001

OFFICE: 311

ROUTE: 564

ST_REF_NO: 00000047200 COX STREET

LUMENS	BULB TYPE	MULT SERIES	POLE TYPE	SHADE	ADDRESS NUMBER	REF	LOCATION	TAX DIST	DATE INST	DATE CHANGE
22000	S	M	SOH	II	00000	004	3RD LT. S. OF W. MAIN ST., EASTSIDE	12	010893	9/9/2009
04000	S	M	SOH	II	00000	008	1ST LT. S. OF MANCHESTER ST., E. SIDE	12	020886	9/9/2009
04000	S	M	SOH	II	00000	009	2ND LT S OF MANCHESTER ST, W SIDE	12	020886	9/9/2009
04000	S	M	SOH	II	00000	011	4TH LT S OF MANCHESTER, W SIDE	12	020893	9/9/2009
04000	S	M	SOH	II	00000	012	SIDE OF 859 W HIGH STREET	12	020893	9/9/2009
04000	S	M	SOH	II	00240	010	3RD LT S OF MANCHESTER ST, E SIDE	12	020893	9/9/2009

OFFICE: 311

ROUTE: 564

ST_REF_NO: 00000047220 COYS LANE

LUMENS	BULB TYPE	MULT SERIES	POLE TYPE	SHADE	ADDRESS NUMBER	REF	LOCATION	TAX DIST	DATE INST	DATE CHANGE
22000	S	M	OUG	II	00000	001	1ST LT E OF RICHMOND RD, NORTH SIDE ON COYS LANE	12	032105	1/1/0001
09500	S	M	OUG	II	00000	002	2ND LT E OF RICHMOND RD, NORTH SIDE ON COYS LANE	12	032105	1/1/0001

OFFICE: 311

ROUTE: 564

ST_REF_NO: 00000047280 CRAB APPLE COURT

LUMENS	BULB TYPE	MULT SERIES	POLE TYPE	SHADE	ADDRESS NUMBER	REF	LOCATION	TAX DIST	DATE INST	DATE CHANGE
05800	S	M	OUG	III	03001	001		12	050897	1/1/0001

OFFICE: 311

ROUTE: 564

ST_REF_NO: 00000047500 CRAMER AVENUE

LUMENS	BULB TYPE	MULT SERIES	POLE TYPE	SHADE	ADDRESS NUMBER	REF	LOCATION	TAX DIST	DATE INST	DATE CHANGE
05800	S	S	SOH	I	00000	001	SIDE OF 214 WALTON AVE.	12	020367	1/1/0001
05800	S	S	SOH	I	00000	005	OPPOSITE 733	12	020367	1/1/0001
05800	S	S	SOH	I	00712	002		12	020367	1/1/0001
05800	S	M	SOH	I	00720	003		12	020367	1/1/0001

OFFICE: 311		ROUTE: 564		ST_REF_NO: 00000047500		CRAMER AVENUE		LUMENS	BULB TYPE	MULT SERIES	POLE TYPE	SHADE	ADDRESS NUMBER	REF	LOCATION	TAX DIST	DATE INST	DATE CHANGE
	05800	S	S	SOH	I	00726	004									12	020367	1/1/0001
	05800	S	S	SOH	I	00000	006								SIDE OF 198 N. ASHLAND AVE.	12	020367	1/1/0001
	05800	S	M	SOH	I	00000	009								OPPOSITE 827	12	030167	1/1/0001
	05800	S	M	SOH	I	00000	010								OPPOSITE 901	12	030167	1/1/0001
	05800	S	M	SOH	I	00000	013								OPPOSITE 921	12	030167	1/1/0001
	05800	S	M	SOH	I	00000	014								OPPOSITE 925	12	030167	1/1/0001
	05800	S	M	SOH	II	00000	028								SIDE 192 RICHMOND AVE.	12	050885	1/1/0001
	05800	S	M	SOH	II	00000	030								SIDE 148 VICTORY AVE.	12	050885	1/1/0001
	05800	S	M	SOH	I	00808	007									12	030167	1/1/0001
	05800	S	M	SOH	I	00812	008									12	030167	1/1/0001
	05800	S	M	SOH	I	00911	012									12	080367	1/1/0001
	05800	S	M	SOH	I	00912	011									12	030167	1/1/0001
	05800	S	M	SOH	I	00931	015									12	080367	1/1/0001
	05800	S	M	SOH	II	01015	029									12	050885	1/1/0001
OFFICE: 311		ROUTE: 564		ST_REF_NO: 00000047550		CRANBROOK COURT		LUMENS	BULB TYPE	MULT SERIES	POLE TYPE	SHADE	ADDRESS NUMBER	REF	LOCATION	TAX DIST	DATE INST	DATE CHANGE
	05800	S	M	CNT	II	00000	001								SIDE OF 969 TANBARK ROAD	12	080897	1/1/0001
	05800	S	M	CNT	III	04504	022									12	080897	1/1/0001
	05800	S	M	CNT	II	04529	003									12	080897	1/1/0001
	05800	S	M	CNT	III	04544	004									12	080897	1/1/0001
OFFICE: 311		ROUTE: 564		ST_REF_NO: 00000047600		CRATER LAKE COURT		LUMENS	BULB TYPE	MULT SERIES	POLE TYPE	SHADE	ADDRESS NUMBER	REF	LOCATION	TAX DIST	DATE INST	DATE CHANGE
	04000	S	M	OUG	V	03289	019									12	091476	1/1/0001
	04000	S	M	OUG	II	03292	020									12	041478	1/1/0001
OFFICE: 311		ROUTE: 564		ST_REF_NO: 00000047785		CREEK PATH LANE		LUMENS	BULB TYPE	MULT SERIES	POLE TYPE	SHADE	ADDRESS NUMBER	REF	LOCATION	TAX DIST	DATE INST	DATE CHANGE
	05800	S		CNT	II	00000	001								SIDE OF 2620 KEARNEY RIDGE BLVD ON CREEK PATH	12	041109	1/1/0001

OFFICE: 311

ROUTE: 564

ST_REF_NO: 00000047785 CREEK PATH LANE

LUMENS	BULB TYPE	MULT SERIES	POLE TYPE	SHADE	ADDRESS NUMBER	REF	LOCATION	TAX DIST	DATE INST	DATE CHANGE
05800	S		CNT	II	00000	007	SIDE OF 2956 SULLIVANS TRACE, ON CREEK PATH LANE	12	041109	1/1/0001
05800	S		CNT	II	03264	004		12	041109	1/1/0001
05800	S		CNT	II	03272	002		12	041109	1/1/0001
05800	S		CNT	II	03281	003		12	041109	1/1/0001

OFFICE: 311

ROUTE: 564

ST_REF_NO: 00000047790 CREEK VALLEY WAY

LUMENS	BULB TYPE	MULT SERIES	POLE TYPE	SHADE	ADDRESS NUMBER	REF	LOCATION	TAX DIST	DATE INST	DATE CHANGE
05800	S		CNT	II	04304	002		12	100899	1/1/0001
05800	S	M	CNT	II	04321	003		12	100899	9/9/2009
05800	S	M	CNT	II	04328	004		12	100899	9/9/2009
05800	S	M	CNT	II	04356	006		12	100899	9/9/2009
05800	S	M	CNT	II	04301	001		12	100899	1/1/0001
05800	S	M	CNT	II	04341	005		12	100899	1/1/0001

OFFICE: 311

ROUTE: 564

ST_REF_NO: 00000047800 CREEKWOOD DRIVE

LUMENS	BULB TYPE	MULT SERIES	POLE TYPE	SHADE	ADDRESS NUMBER	REF	LOCATION	TAX DIST	DATE INST	DATE CHANGE
05800	S	M	OUG	II	00000	002	OPP. 3504	12	070896	1/1/0001
05800	S	M	OUG	II	00000	003	3516-A	12	070896	1/1/0001
05800	S	M	OUG	II	00000	004	2ND LT. E OF CHINOE, NORTHSIDE	12	070896	1/1/0001
05800	S	M	OUG	II	00000	006	3RD LT. E OF CHINOE, NORTHSIDE	12	070896	1/1/0001
05800	S	M	OUG	II	03500	001		12	070896	1/1/0001
05800	S	M	OUG	II	03522	005		12	070896	1/1/0001

OFFICE: 311

ROUTE: 564

ST_REF_NO: 00000047810 CREEL COURT

LUMENS	BULB TYPE	MULT SERIES	POLE TYPE	SHADE	ADDRESS NUMBER	REF	LOCATION	TAX DIST	DATE INST	DATE CHANGE
05800	S	M	OUG	II	03609	001		12	100894	1/1/0001
05800	S	M	OUG	II	03617	002		12	100894	1/1/0001
05800	S	M	OUG	II	03629	003		12	100894	1/1/0001

OFFICE: 311		ROUTE: 564		ST_REF_NO: 00000047900		CRESCENT AVENUE		LUMENS	BULB TYPE	MULT SERIES	POLE TYPE	SHADE	ADDRESS NUMBER	REF	LOCATION	TAX DIST	DATE INST	DATE CHANGE
09500	S	M	SOH	II	00000	001	ACROSS FROM 1041 CRESCENT AVENUE-UPGRD 2007	12	031904	1/1/0001								
09500	S	M	SOH	II	00000	003	SIDE OF 224 STATE STREET ON CRESCENT AVENUE	12	031904	1/1/0001								
09500	S	M	SOH	II	00000	004	SIDE OF 223 UNIVERSITY AVENUE ON CRESCENT AVENUE	12	031904	1/1/0001								
09500	S	M	SOH	II	00000	005	ACROSS FROM 1207 CRESCENT AVENUE	12	031904	1/1/0001								
09500	S	M	SOH	II	00000	006	SIDE OF 225 WALLER AVENUE ON CRESCENT AVENUE	12	031904	1/1/0001								
09500	S	M	SOH	II	01047	002	UPGRADED ALL LIGHTS ON CRESCENT TO 9500 6/07	12	031904	1/1/0001								

OFFICE: 311

ROUTE: 564

ST_REF_NO: 00000047910

CREEKSIDE COURT

LUMENS	BULB TYPE	MULT SERIES	POLE TYPE	SHADE	ADDRESS NUMBER	REF	LOCATION	TAX DIST	DATE INST	DATE CHANGE
09500	S	M	SOH	III	00000	001	OPP. 213B	12	010893	1/1/0001
09500	S	M	SOH	III	00000	002	OPP. 221	12	010893	1/1/0001
09500	S	M	SOH	III	00000	003	OPP. 229	12	010893	1/1/0001
09500	S	M	OUG	II	00000	005	SIDE OF 2124 DEAUVILLE DRIVE	12	040899	1/1/0001
09500	S	M	OUG	III	00241	004		12	040899	1/1/0001

OFFICE: 311

ROUTE: 564

ST_REF_NO: 00000047920

CREEKWATER CIRCLE

LUMENS	BULB TYPE	MULT SERIES	POLE TYPE	SHADE	ADDRESS NUMBER	REF	LOCATION	TAX DIST	DATE INST	DATE CHANGE
05800	S	M	CNT	III	00000	001	SIDE REAR OF 4164 WATERTRACE DR.	12	080895	1/1/0001

OFFICE: 311

ROUTE: 564

ST_REF_NO: 00000047960

CRESCENT SPRINGS COURT

LUMENS	BULB TYPE	MULT SERIES	POLE TYPE	SHADE	ADDRESS NUMBER	REF	LOCATION	TAX DIST	DATE INST	DATE CHANGE
05800	S	M	CNT	II	04301	001		12	030904	1/1/0001
05800	S	M	CNT	II	04308	002		12	030904	1/1/0001
05800	S	M	CNT	III	04321	003		12	030904	1/1/0001

OFFICE: 311		ROUTE: 564		ST_REF_NO: 00000047963		CRESCENZIO WAY				
LUMENS	BULB TYPE	MULT SERIES	POLE TYPE	SHADE	ADDRESS NUMBER	REF	LOCATION	TAX DIST	DATE INST	DATE CHANGE
05800	S		CNT	II	00000	002	SIDE OF 697 ESTRELLA DR ON CRESCENZIO WAY	12	080610	1/1/0001
05800	S		CNT	II	02469	003		12	080610	1/1/0001
05800	S		CNT	II	02497	001		12	080610	1/1/0001

OFFICE: 311		ROUTE: 564		ST_REF_NO: 00000048000		CRESTWOOD DRIVE				
LUMENS	BULB TYPE	MULT SERIES	POLE TYPE	SHADE	ADDRESS NUMBER	REF	LOCATION	TAX DIST	DATE INST	DATE CHANGE
04000	S	M	OUG	II	00000	033	SIDE OF 205 ZANDALE DR.	12	110888	1/1/0001
04000	S	M	OUG	II	00000	034	SIDE OF 132 GREENBRIAR RD.	12	080888	1/1/0001
04000	S	M	OUG	II	00000	035	SIDE OF 133 GREENBRIAR RD.	12	080888	1/1/0001
04000	S	M	SOH	II	00000	036	SIDE OF 201 GREENBRIAR RD.	12	110888	1/1/0001
05800	S	M	OUG	II	00150	038		12	051581	1/1/0001
05800	S	M	OUG	II	00150	039		12	051581	1/1/0001
05800	S	M	OUG	II	00158	037		12	051581	1/1/0001

OFFICE: 311		ROUTE: 564		ST_REF_NO: 00000048010		CREWE COURT				
LUMENS	BULB TYPE	MULT SERIES	POLE TYPE	SHADE	ADDRESS NUMBER	REF	LOCATION	TAX DIST	DATE INST	DATE CHANGE
04000	S	M	OUG	II	00000	137	SIDE OF 556 MERRIMAC DR.	12	110885	1/1/0001
04000	S	M	OUG	V	00525	139		12	110885	1/1/0001
04000	S	M	OUG	II	00538	138		12	110885	1/1/0001

OFFICE: 311		ROUTE: 564		ST_REF_NO: 00000048100		CRICKLEWOOD DRIVE				
LUMENS	BULB TYPE	MULT SERIES	POLE TYPE	SHADE	ADDRESS NUMBER	REF	LOCATION	TAX DIST	DATE INST	DATE CHANGE
05800	S	M	OUG	II	00000	120	SIDE OF 611 SHAFTSBURY RD.	12	010173	1/1/0001
05800	S	M	OUG	II	00500	000		12	030166	1/1/0001
05800	S	M	OUG	II	00515	000		12	041267	1/1/0001
05800	S	M	OUG	II	00525	000		12	041768	1/1/0001
05800	S	M	OUG	V	00531	000		12	041768	1/1/0001
05800	S	M	OUG	II	00536	000		12	010170	1/1/0001
05800	S	M	OUG	II	00543	000		12	041768	1/1/0001
05800	S	M	OUG	II	00563	000		12	090368	1/1/0001
05800	S	M	OUG	II	00576	000		12	100169	1/1/0001

OFFICE: 311

ROUTE: 564

ST_REF_NO: 00000048100

CRICKLEWOOD DRIVE

LUMENS	BULB TYPE	MULT SERIES	POLE TYPE	SHADE	ADDRESS NUMBER	REF	LOCATION	TAX DIST	DATE INST	DATE CHANGE
05800	S	M	OUG	II	00587	000		12	041768	1/1/0001
05800	S	M	OUG	II	00596	126		12	071476	1/1/0001
05800	S	M	OUG	II	00603	000		12	041768	1/1/0001
05800	S	M	OUG	II	00000	128	SIDE OF 1733 CHELMSFORD DR.	12	120170	1/1/0001

OFFICE: 311

ROUTE: 564

ST_REF_NO: 00000048200

CRILLON DRIVE

LUMENS	BULB TYPE	MULT SERIES	POLE TYPE	SHADE	ADDRESS NUMBER	REF	LOCATION	TAX DIST	DATE INST	DATE CHANGE
04000	S	M	OUG	II	00305	037		12	080166	9/9/2009
05800	S	M	OUG	II	00000	006	SIDE OF 3305 BELLEFONTE DR.	12	040969	1/1/0001
05800	S	M	OUG	II	00000	036	SIDE OF 2448 HEATHER WAY	12	080166	1/1/0001
05800	S	M	OUG	II	00316	038		12	080166	1/1/0001
05800	S	M	OUG	II	00325	039		12	080166	1/1/0001

OFFICE: 311

ROUTE: 564

ST_REF_NO: 00000048300

CRIMSON KING COURT

LUMENS	BULB TYPE	MULT SERIES	POLE TYPE	SHADE	ADDRESS NUMBER	REF	LOCATION	TAX DIST	DATE INST	DATE CHANGE
05800	S	M	OUG	II	00000	179	SIDE OF 1312 GAINESWAY DR.	12	051074	1/1/0001
05800	S	M	OUG	II	03413	000		12	052068	1/1/0001
05800	S	M	OUG	II	03420	000		12	042067	1/1/0001

OFFICE: 311

ROUTE: 564

ST_REF_NO: 00000048320

CRIMSON CREEK

LUMENS	BULB TYPE	MULT SERIES	POLE TYPE	SHADE	ADDRESS NUMBER	REF	LOCATION	TAX DIST	DATE INST	DATE CHANGE
05800	S	M	CNT	III	01009	008		12	050897	1/1/0001
05800	S	M	CNT	II	01021	007		12	050897	1/1/0001
05800	S	M	CNT	II	01033	006		12	050897	1/1/0001
05800	S	M	CNT	II	01041	005		12	050897	1/1/0001
05800	S	M	CNT	II	01053	004		12	050897	1/1/0001
05800	S	M	CNT	II	01069	003		12	050897	1/1/0001
05800	S	M	CNT	II	01080	002		12	050897	1/1/0001
05800	S	M	CNT	III	01081	001		12	050897	1/1/0001

OFFICE: 311

ROUTE: 564

ST_REF_NO: 00000048350

CROMWELL CT

LUMENS	BULB TYPE	MULT SERIES	POLE TYPE	SHADE	ADDRESS NUMBER	REF	LOCATION	TAX DIST	DATE INST	DATE CHANGE
05800	S	M	OUG	II	00709	001		12	050891	9/9/2009
04000	S	M	OUG	V	00717	002		12	050891	1/1/0001

OFFICE: 311

ROUTE: 564

ST_REF_NO: 00000048400

CROMWELL WAY

LUMENS	BULB TYPE	MULT SERIES	POLE TYPE	SHADE	ADDRESS NUMBER	REF	LOCATION	TAX DIST	DATE INST	DATE CHANGE
05800	S	M	OUG	II	00000	009	SIDE OF 3531 WINTHROP	12	110891	9/9/2009
05800	S	M	OUG	II	00433	020		12	111579	9/9/2009
05800	S	M	OUG	II	00444	019		12	111579	9/9/2009
05800	S	M	OUG	II	00464	017		12	111579	9/9/2009
05800	S	M	OUG	II	00477	016		12	111579	9/9/2009
05800	S	M	OOH	II	00642	052		12	110885	9/9/2009
22000	S	M	OUG	II	00732	066		12	050891	9/9/2009
05800	S	M	OUG	II	00000	059	SIDE OF 3500 CORNWALL DR ON CROMWELL WAY	12	050891	1/1/0001
05800	S	M	OUG	II	00000	060	OPP. 700 CROMWELL WAY	12	050891	1/1/0001
05800	S	M	OUG	II	00000	065	SIDE OF 3492 LANNETTE LANE ON CROMWELL WAY	12	050891	1/1/0001
05800	S	M	OUG	II	00622	047		12	110885	1/1/0001
05800	S	M	OUG	II	00627	048		12	110885	1/1/0001
05800	S	M	OUG	II	00630	049		12	110885	1/1/0001
05800	S	M	OUG	II	00634	050		12	110885	1/1/0001
05800	S	M	OUG	II	00637	051		12	110885	1/1/0001
05800	S	M	OUG	II	00665	053		12	050891	1/1/0001
05800	S	M	OUG	II	00669	054		12	050891	1/1/0001
05800	S	M	OUG	II	00672	055		12	050891	1/1/0001
05800	S	M	OUG	II	00681	056		12	050891	1/1/0001
05800	S	M	OUG	II	00684	057		12	050891	1/1/0001
05800	S	M	OUG	II	00689	058		12	050891	1/1/0001
05800	S	M	OUG	II	00705	061		12	050891	1/1/0001
05800	S	M	OUG	II	00708	062		12	050891	1/1/0001
05800	S	M	OUG	II	00720	064		12	050891	1/1/0001
05800	S	M	OUG	II	00721	063		12	050891	1/1/0001
05800	S	M	OUG	II	00000	043	SIDE OF 3494 IPSWICH CT.	12	110885	1/1/0001
05800	S	M	OUG	II	00612	044		12	110885	1/1/0001

OFFICE: 311

ROUTE: 564

ST_REF_NO: 0000048400

CROMWELL WAY

LUMENS	BULB TYPE	MULT SERIES	POLE TYPE	SHADE	ADDRESS NUMBER	REF	LOCATION	TAX DIST	DATE INST	DATE CHANGE
05800	S	M	OUG	II	00615	045		12	110885	1/1/0001
05800	S	M	OUG	II	00620	046		12	110885	1/1/0001
04000	S	M	OUG	II	00000	003	SIDE 3501 PEPPERWOOD PLACE ON CROMWELL	12	110891	1/1/0001
04000	S	M	OUG	II	00000	007	SIDE OF 3500 WINDRUSH CIRCLE	12	040894	1/1/0001
05800	S	M	OUG	II	00000	027	SIDE OF 540 MERRIMAC DR.	12	110885	1/1/0001
05800	S	M	OUG	II	00000	029	SIDE OF 3494 BATHURST CT.	12	110885	1/1/0001
04000	S	M	OUG	II	00293	002		12	110891	1/1/0001
04000	S	M	OUG	II	00296	001		12	110891	1/1/0001
04000	S	M	OUG	II	00325	004		12	110891	1/1/0001
04000	S	M	OUG	II	00352	005		12	110891	1/1/0001
04000	S	M	OUG	II	00357	006		12	110891	1/1/0001
04000	S	M	OUG	II	00380	008		12	110891	1/1/0001
04000	S	M	OUG	II	00396	010		12	110891	1/1/0001
04000	S	M	OUG	II	00413	011		12	110891	1/1/0001
04000	S	M	OUG	II	00416	012		12	110891	1/1/0001
04000	S	M	OUG	II	00457	018		12	111579	1/1/0001
05800	S	M	OUG	II	00484	015		12	111579	1/1/0001
05800	S	M	OUG	II	00493	014		12	111579	1/1/0001
05800	S	M	OUG	II	00500	013		12	111579	1/1/0001
05800	S	M	OUG	II	00509	021		12	110885	1/1/0001
05800	S	M	OUG	II	00520	022		12	110885	1/1/0001
05800	S	M	OUG	II	00528	023		12	110885	1/1/0001
05800	S	M	OUG	II	00536	024		12	110885	1/1/0001
05800	S	M	OUG	II	00537	025		12	110885	1/1/0001
05800	S	M	OUG	II	00545	026		12	110885	1/1/0001
05800	S	M	OUG	II	00560	028		12	110885	1/1/0001
05800	S	M	OUG	II	00576	030		12	110885	1/1/0001
05800	S	M	OUG	II	00581	031		12	110885	1/1/0001
05800	S	M	OUG	II	00588	032		12	110885	1/1/0001
05800	S	M	OUG	II	00593	041		12	110885	1/1/0001
05800	S	M	OUG	II	00600	042		12	110885	1/1/0001

OFFICE: 311

ROUTE: 564

ST_REF_NO: 0000048410

CROSBY COURT

LUMENS	BULB TYPE	MULT SERIES	POLE TYPE	SHADE	ADDRESS NUMBER	REF	LOCATION	TAX DIST	DATE INST	DATE CHANGE
05800	S	M	OUG	II	00000	008	SIDE OF 3633 CROSBY DR.	12	120170	1/1/0001
05800	S	M	OUG	V	01208	000		12	060867	1/1/0001

OFFICE: 311

ROUTE: 564

ST_REF_NO: 0000048500

CROSBY DRIVE

LUMENS	BULB TYPE	MULT SERIES	POLE TYPE	SHADE	ADDRESS NUMBER	REF	LOCATION	TAX DIST	DATE INST	DATE CHANGE
05800	S	M	OUG	III	03753	024		12	070893	1/1/0001
05800	S	M	OUG	II	00000	007	SIDE OF 3693 NILES DR.	12	080173	1/1/0001
05800	S	M	OUG	II	00000	049	SIDE OF 1292 DALE DR.	12	041674	1/1/0001
05800	S	M	OUG	II	03601	012		12	041067	1/1/0001
05800	S	M	OUG	II	03608	011		12	060171	1/1/0001
05800	S	M	OUG	II	03617	008		12	040168	1/1/0001
05800	S	M	OUG	II	03628	009		12	090170	1/1/0001
05800	S	M	OUG	II	03641	010		12	050969	1/1/0001
05800	S	M	OUG	II	03644	006		12	080173	1/1/0001
05800	S	M	OUG	II	03656	046		12	121475	1/1/0001
05800	S	M	OUG	II	03665	047		12	121475	1/1/0001
05800	S	M	OUG	II	03676	048		12	041674	1/1/0001
05800	S	M	OUG	II	03688	050		12	081477	1/1/0001
05800	S	M	OUG	II	00000	013	1ST LT. S. OF MAN-OF-WAR BLVD., EASTSIDE	12	050893	1/1/0001
05800	S	M	OUG	II	00000	014	SIDE OF 1185 TANBARK RD., W. SIDE	12	060887	1/1/0001
05800	S	M	OUG	II	00000	015	2ND LT. S OF MAN-O-WAR BLVD., EASTSIDE	12	050893	1/1/0001
05800	S	M	OUG	II	00000	017	OPP. 3921	12	050893	1/1/0001
05800	S	M	OUG	II	00000	019	OPP. 3941	12	050893	1/1/0001
05800	S	M	SOH	II	00000	022	OPP. 3965	12	050893	1/1/0001
05800	S	M	OUG	II	00000	023	4TH LT. N. OF MAN O WAR , E. SIDE	12	120889	1/1/0001
05800	S	M	OUG	II	00000	025	OPP. 3761	12	120889	1/1/0001
05800	S	M	OUG	II	00000	027	2ND LT. N. OF MAN O WAR, E. SIDE	12	120889	1/1/0001
05800	S	M	OUG	II	00000	028	1ST LT. N. OF MAN O WAR, W. SIDE	12	120889	1/1/0001
05800	S	M	OUG	II	00000	029	NE CORNER OF MAN O WAR BLVD AND CROSBY	12	120889	1/1/0001
05800	S	M	OUG	II	03704	002		12	081477	1/1/0001
05800	S	M	OUG	II	03705	001		12	081477	1/1/0001
05800	S	M	OUG	II	03725	003		12	081477	1/1/0001
05800	S	M	OUG	II	03728	004		12	081477	1/1/0001

OFFICE: 311

ROUTE: 564

ST_REF_NO: 00000048500 CROSBY DRIVE

LUMENS	BULB TYPE	MULT SERIES	POLE TYPE	SHADE	ADDRESS NUMBER	REF	LOCATION	TAX DIST	DATE INST	DATE CHANGE
05800	S	M	OUG	II	03737	005		12	081477	1/1/0001
05800	S	M	OUG	II	03769	026		12	060894	1/1/0001
05800	S	M	OUG	II	03913	016		12	060887	1/1/0001
05800	S	M	OUG	II	03929	018		12	100888	1/1/0001
05800	S	M	OUG	II	03949	020		12	100888	1/1/0001
05800	S	M	OUG	II	03957	021		12	100888	1/1/0001

OFFICE: 311

ROUTE: 564

ST_REF_NO: 00000048600 CROSS LANE

LUMENS	BULB TYPE	MULT SERIES	POLE TYPE	SHADE	ADDRESS NUMBER	REF	LOCATION	TAX DIST	DATE INST	DATE CHANGE
05800	S	M	OOH	II	00000	047	SIDE OF 200 CHENAULT RD.	12	120165	1/1/0001
05800	S	M	OUG	II	00323	000		12	120165	1/1/0001

OFFICE: 311

ROUTE: 564

ST_REF_NO: 00000048700 CROSS STREET

LUMENS	BULB TYPE	MULT SERIES	POLE TYPE	SHADE	ADDRESS NUMBER	REF	LOCATION	TAX DIST	DATE INST	DATE CHANGE
05800	S	M	SOH	II	00000	001	1ST. LT. S. OF W. MAXWELL, W. SIDE	12	022168	1/1/0001

OFFICE: 311

ROUTE: 564

ST_REF_NO: 00000048750 CROSS CREEK TRACE

LUMENS	BULB TYPE	MULT SERIES	POLE TYPE	SHADE	ADDRESS NUMBER	REF	LOCATION	TAX DIST	DATE INST	DATE CHANGE
05800	S	M	CNT	II	02308	002		12	120404	1/1/0001
05800	S	M	CNT	II	02321	003		12	102606	1/1/0001
05800	S	M	CNT	II	02328	004		12	102606	1/1/0001
05800	S	M	CNT	II	02337	005		12	102606	1/1/0001

OFFICE: 311

ROUTE: 564

ST_REF_NO: 00000048800 CROSS KEYS ROAD

LUMENS	BULB TYPE	MULT SERIES	POLE TYPE	SHADE	ADDRESS NUMBER	REF	LOCATION	TAX DIST	DATE INST	DATE CHANGE
05800	S	M	OUG	II	00000	027	SIDE OF 1701 TRAVELLER RD.	12	020889	1/1/0001
05800	S	M	OUG	II	00000	028	SIDE OF 1700 TRAVELLER RD.	12	020889	1/1/0001
05800	S	M	OUG	II	00000	029	SIDE OF 1701 ALEXANDRIA DR.	12	020889	1/1/0001
05800	S	M	OUG	II	00000	030	SIDE OF 1701 ALEXANDRIA DR.	12	020889	1/1/0001
05800	S	M	OUG	II	00000	032	OPP. 1081	12	022167	1/1/0001
05800	S	M	OUG	II	00000	033	SIDE OF 1674 MAYWICK DR.	12	022167	1/1/0001

OFFICE: 311

ROUTE: 564

ST_REF_NO: 00000048800

CROSS KEYS ROAD

LUMENS	BULB TYPE	MULT SERIES	POLE TYPE	SHADE	ADDRESS NUMBER	REF	LOCATION	TAX DIST	DATE INST	DATE CHANGE
05800	S	M	OUG	II	00000	034	OPP. 1049	12	090166	1/1/0001
05800	S	M	OUG	II	01025	037		12	052068	1/1/0001
05800	S	M	OUG	II	01032	036		12	052068	1/1/0001
05800	S	M	OUG	II	01043	035		12	090166	1/1/0001
05800	S	M	OUG	II	01081	031		12	090166	1/1/0001

OFFICE: 311

ROUTE: 564

ST_REF_NO: 00000048900

CROSSFIELD PLACE

LUMENS	BULB TYPE	MULT SERIES	POLE TYPE	SHADE	ADDRESS NUMBER	REF	LOCATION	TAX DIST	DATE INST	DATE CHANGE
05800	S	M	OUG	V	00208	022		12	011581	1/1/0001

OFFICE: 311

ROUTE: 564

ST_REF_NO: 00000048905

CROSSMAN COURT

LUMENS	BULB TYPE	MULT SERIES	POLE TYPE	SHADE	ADDRESS NUMBER	REF	LOCATION	TAX DIST	DATE INST	DATE CHANGE
09500	S	M	OUG	III	01197	001		12	120899	1/1/0001

OFFICE: 311

ROUTE: 564

ST_REF_NO: 00000048910

CROWN CIRCLE

LUMENS	BULB TYPE	MULT SERIES	POLE TYPE	SHADE	ADDRESS NUMBER	REF	LOCATION	TAX DIST	DATE INST	DATE CHANGE
05800	S	M	OUG	II	01205	001		12	060893	1/1/0001
05800	S	M	OUG	IV	01217	002		12	060893	1/1/0001

OFFICE: 311

ROUTE: 564

ST_REF_NO: 00000049000

CROWN CREST ROAD

LUMENS	BULB TYPE	MULT SERIES	POLE TYPE	SHADE	ADDRESS NUMBER	REF	LOCATION	TAX DIST	DATE INST	DATE CHANGE
05800	S	M	OUG	II	00000	150	SIDE OF 3346	12	062267	1/1/0001
05800	S	M	OUG	II	03301	000		12	110171	1/1/0001
05800	S	M	OUG	II	03312	000		12	090266	1/1/0001
05800	S	M	OUG	II	03321	000		12	090266	1/1/0001
05800	S	M	OUG	II	03345	000		12	090266	1/1/0001
05800	S	M	OUG	II	03356	000		12	090266	1/1/0001

OFFICE: 311		ROUTE: 564		ST_REF_NO: 00000049100		CROYDEN COURT				
LUMENS	BULB TYPE	MULT SERIES	POLE TYPE	SHADE	ADDRESS NUMBER	REF	LOCATION	TAX DIST	DATE INST	DATE CHANGE
05800	S	M	OUG	II	00000	017	SIDE OF 428 ROOKWOOD PKWY	12	060164	1/1/0001

OFFICE: 311		ROUTE: 564		ST_REF_NO: 00000049300		CRUTCHER COURT				
LUMENS	BULB TYPE	MULT SERIES	POLE TYPE	SHADE	ADDRESS NUMBER	REF	LOCATION	TAX DIST	DATE INST	DATE CHANGE
04000	S	M	OUG	II	00000	001	SIDE OF 3920 FOREST GREEN	12	120887	1/1/0001
04000	S	M	OUG	V	03713	002		12	050890	1/1/0001

OFFICE: 311		ROUTE: 564		ST_REF_NO: 00000049400		CRYSTAL COURT				
LUMENS	BULB TYPE	MULT SERIES	POLE TYPE	SHADE	ADDRESS NUMBER	REF	LOCATION	TAX DIST	DATE INST	DATE CHANGE
05800	S	M	OUG	II	01001	101		12	061580	1/1/0001

OFFICE: 311		ROUTE: 564		ST_REF_NO: 00000049430		CRYSTAL FALLS ROAD				
LUMENS	BULB TYPE	MULT SERIES	POLE TYPE	SHADE	ADDRESS NUMBER	REF	LOCATION	TAX DIST	DATE INST	DATE CHANGE
05800	S	M	OUG	III	02609	008		12	091001	1/1/0001
05800	S	M	OUG	II	02628	007		12	091001	1/1/0001
05800	S	M	OUG	II	02713	020		12	042605	1/1/0001
05800	S	M	OUG	II	02637	006		12	100899	1/1/0001
05800	S	M	OUG	II	02660	005		12	100899	1/1/0001
05800	S	M	OUG	II	02669	004		12	100899	1/1/0001
05800	S	M	OUG	II	02696	003		12	100899	1/1/0001
05800	S	M	OUG	II	02707	002		12	100899	1/1/0001
05800	S	M	OUG	III	02728	001		12	100899	1/1/0001

OFFICE: 311		ROUTE: 564		ST_REF_NO: 00000049490		CULLMAN LANE				
LUMENS	BULB TYPE	MULT SERIES	POLE TYPE	SHADE	ADDRESS NUMBER	REF	LOCATION	TAX DIST	DATE INST	DATE CHANGE
05800	S	M	CNT	II	00000	001	SIDE OF 3236 RIDGECANE DRIVE ON CULLMAN	12	072203	1/1/0001

OFFICE: 311		ROUTE: 564		ST_REF_NO: 00000049500		CULPEPPER ROAD				
LUMENS	BULB TYPE	MULT SERIES	POLE TYPE	SHADE	ADDRESS NUMBER	REF	LOCATION	TAX DIST	DATE INST	DATE CHANGE
05800	S	M	OUG	II	00200	000		12	110955	1/1/0001

OFFICE: 311

ROUTE: 564

ST_REF_NO: 00000049500

CULPEPPER ROAD

LUMENS	BULB TYPE	MULT SERIES	POLE TYPE	SHADE	ADDRESS NUMBER	REF	LOCATION	TAX DIST	DATE INST	DATE CHANGE
05800	S	M	OUG	II	00209	000		12	110955	1/1/0001
05800	S	M	OUG	II	00216	000		12	060164	1/1/0001
05800	S	M	OUG	II	00229	000		12	110955	1/1/0001
05800	S	M	OUG	II	00304	000		12	020165	1/1/0001
05800	S	M	OUG	II	00317	064		12	081582	1/1/0001
05800	S	M	OUG	II	00400	000		12	020165	1/1/0001
05800	S	M	OUG	II	00413	000		12	020166	1/1/0001
05800	S	M	OUG	II	00430	000		12	020166	1/1/0001
05800	S	M	OUG	II	00441	000		12	020165	1/1/0001
05800	S	M	OUG	II	00500	000		12	020165	1/1/0001
05800	S	M	OUG	II	00513	000		12	020165	1/1/0001
05800	S	M	OUG	II	00528	000		12	040165	1/1/0001
05800	S	M	OUG	II	00537	000		12	090171	1/1/0001
05800	S	M	OUG	II	00548	000		12	040165	1/1/0001
05800	S	M	OUG	II	00557	000		12	021565	1/1/0001

OFFICE: 311

ROUTE: 564

ST_REF_NO: 00000049590

CULZEAN COURT

LUMENS	BULB TYPE	MULT SERIES	POLE TYPE	SHADE	ADDRESS NUMBER	REF	LOCATION	TAX DIST	DATE INST	DATE CHANGE
05800	S	M	CNT	III	01009	001		12	090898	1/1/0001

OFFICE: 311

ROUTE: 564

ST_REF_NO: 00000049600

CUMBERLAND ROAD

LUMENS	BULB TYPE	MULT SERIES	POLE TYPE	SHADE	ADDRESS NUMBER	REF	LOCATION	TAX DIST	DATE INST	DATE CHANGE
04000	S	M	OUG	II	00708	003		12	120890	1/1/0001
04000	S	M	OUG	II	00717	002		12	120890	1/1/0001
04000	S	M	OUG	II	00724	001		12	120890	1/1/0001
04000	S	M	OUG	II	00701	004		12	120890	1/1/0001

OFFICE: 311

ROUTE: 564

ST_REF_NO: 00000049700

CUMMINS COURT

LUMENS	BULB TYPE	MULT SERIES	POLE TYPE	SHADE	ADDRESS NUMBER	REF	LOCATION	TAX DIST	DATE INST	DATE CHANGE
09500	S	M	OUG	II	00000	053	SIDE OF 1301 VILLAGE DR	12	060870	1/1/0001
09500	S	M	OUG	II	02035	054		12	060870	1/1/0001

OFFICE: 311		ROUTE: 564		ST_REF_NO: 00000049850		CUNNINGHAM LANE		LUMENS	BULB TYPE	MULT SERIES	POLE TYPE	SHADE	ADDRESS NUMBER	REF	LOCATION	TAX DIST	DATE INST	DATE CHANGE
	05800	S		CNT	II	00417	002									12	080610	1/1/0001
	05800	S		CNT	II	00457	004									12	080610	1/1/0001
OFFICE: 311		ROUTE: 564		ST_REF_NO: 00000050100		CURLEY AVENUE		LUMENS	BULB TYPE	MULT SERIES	POLE TYPE	SHADE	ADDRESS NUMBER	REF	LOCATION	TAX DIST	DATE INST	DATE CHANGE
	04000	S	M	SOH	II	00140	000									12	110266	1/1/0001
	04000	S	M	SOH	II	00152	000									12	110266	1/1/0001
OFFICE: 311		ROUTE: 564		ST_REF_NO: 00000050200		CURRY AVENUE		LUMENS	BULB TYPE	MULT SERIES	POLE TYPE	SHADE	ADDRESS NUMBER	REF	LOCATION	TAX DIST	DATE INST	DATE CHANGE
	05800	S	M	SOH	II	00426	000									12	040893	1/1/0001
	05800	S	M	SOH	II	00432	000									12	080171	1/1/0001
	05800	S	M	SOH	II	00446	000									12	080171	1/1/0001
	05800	S	M	SOH	II	00464	000									12	080171	1/1/0001
	05800	S	M	SOH	II	00478	000									12	080171	1/1/0001
	05800	S	M	SOH	II	00490	000									12	080171	1/1/0001
OFFICE: 311		ROUTE: 564		ST_REF_NO: 00000050300		CURTIN DRIVE		LUMENS	BULB TYPE	MULT SERIES	POLE TYPE	SHADE	ADDRESS NUMBER	REF	LOCATION	TAX DIST	DATE INST	DATE CHANGE
	05800	S	M	OUG	II	00000	032	SIDE OF 276 MELBOURNE WAY								12	080166	1/1/0001
	05800	S	M	OUG	II	00303	000									12	080166	1/1/0001
	05800	S	M	OUG	II	00318	000									12	080166	1/1/0001
	05800	S	M	OUG	II	00327	000									12	080166	1/1/0001
	05800	S	M	OUG	II	00338	000									12	051967	1/1/0001
	05800	S	M	OUG	II	00347	000									12	120869	1/1/0001
	05800	S	M	OUG	II	00350	000									12	070767	1/1/0001
OFFICE: 311		ROUTE: 564		ST_REF_NO: 00000050400		CURTIS COURT		LUMENS	BULB TYPE	MULT SERIES	POLE TYPE	SHADE	ADDRESS NUMBER	REF	LOCATION	TAX DIST	DATE INST	DATE CHANGE
	05800	S	M	OUG	II	01800	000									12	072474	1/1/0001

OFFICE: 311		ROUTE: 564		ST_REF_NO: 0000050403		CURTISWOOD DRIVE		LUMENS	BULB TYPE	MULT SERIES	POLE TYPE	SHADE	ADDRESS NUMBER	REF	LOCATION	TAX DIST	DATE INST	DATE CHANGE
05800	S	M	OUG	II	02105	001		12	063003	1/1/0001								
05800	S	M	OUG	II	02113	007		12	063003	1/1/0001								
05800	S	M	OUG	II	02116	002		12	063003	1/1/0001								
05800	S	M	OUG	II	02133	003		12	063003	1/1/0001								
05800	S	M	OUG	II	02165	005		12	063003	1/1/0001								
05800	S	M	OUG	II	02225	008		12	063003	1/1/0001								
OFFICE: 311		ROUTE: 564		ST_REF_NO: 0000050410		CUSTER DRIVE		LUMENS	BULB TYPE	MULT SERIES	POLE TYPE	SHADE	ADDRESS NUMBER	REF	LOCATION	TAX DIST	DATE INST	DATE CHANGE
05800	S	M	OUG	II	03118	093		12	060890	1/1/0001								
05800	S	M	OUG	II	03127	094		12	060890	1/1/0001								
05800	S	M	OUG	II	03131	092		12	060890	1/1/0001								
05800	S	M	OUG	II	03138	091		12	111580	1/1/0001								
05800	S	M	OUG	II	03150	076		12	030895	1/1/0001								
05800	S	M	OUG	II	03151	077		12	060890	1/1/0001								
05800	S	M	OUG	II	03167	075		12	060890	1/1/0001								
05800	S	M	OUG	II	03174	071		12	060890	1/1/0001								
05800	S	M	OUG	II	03199	029		12	091477	1/1/0001								
05800	S	M	OUG	II	03202	028		12	060890	1/1/0001								
OFFICE: 311		ROUTE: 564		ST_REF_NO: 0000050420		CYPRESS CREEK CIRCLE		LUMENS	BULB TYPE	MULT SERIES	POLE TYPE	SHADE	ADDRESS NUMBER	REF	LOCATION	TAX DIST	DATE INST	DATE CHANGE
05800	S	M	OUG	IV	04701	007		12	080893	1/1/0001								
05800	S	M	OUG	II	04712	006		12	080893	1/1/0001								
05800	S	M	OUG	II	04720	005		12	080893	1/1/0001								
05800	S	M	OUG	II	04729	004		12	080893	1/1/0001								
05800	S	M	OUG	II	04732	003		12	080893	1/1/0001								
05800	S	M	OUG	II	04745	002		12	080893	1/1/0001								
05800	S	M	OUG	II	04748	001		12	080893	1/1/0001								

OFFICE: 311		ROUTE: 564		ST_REF_NO: 00000050425		CYPRESS POINT WAY		LUMENS	BULB TYPE	MULT SERIES	POLE TYPE	SHADE	ADDRESS NUMBER	REF	LOCATION	TAX DIST	DATE INST	DATE CHANGE
05800	S	M	OUG	II	00888	002										12	120893	1/1/0001
05800	S	M	OUG	II	00891	003										12	120893	1/1/0001
05800	S	M	OUG	II	00899	001										12	120893	1/1/0001

OFFICE: 311		ROUTE: 564		ST_REF_NO: 00000050500		CYPRESS DRIVE		LUMENS	BULB TYPE	MULT SERIES	POLE TYPE	SHADE	ADDRESS NUMBER	REF	LOCATION	TAX DIST	DATE INST	DATE CHANGE
05800	S	M	OUG	II	00000	000									SIDE OF 2164	12	090164	9/9/2009
09500	S	M	OUG	II	00000	126									SIDE OF 2157 LARKSPUR	12	090164	9/9/2009
05800	S	M	SOH	II	00000	127									OPPOSITE TAMARACK	12	050166	9/9/2009
05800	S	M	OUG	II	00000	113									SIDE OF 2106 GARDEN SPRINGS	12	080164	1/1/0001
05800	S	M	OUG	II	00000	133									SIDE OF 2100 VIOLET RD.	12	090164	1/1/0001
05800	S	M	OUG	II	02124	000										12	080164	1/1/0001
05800	S	M	OUG	II	02137	000										12	090164	1/1/0001
05800	S	M	OUG	II	02152	000										12	090164	1/1/0001
05800	S	M	OUG	II	02163	000										12	090164	1/1/0001

OFFICE: 311		ROUTE: 564		ST_REF_NO: 00000050595		D-HUFF		LUMENS	BULB TYPE	MULT SERIES	POLE TYPE	SHADE	ADDRESS NUMBER	REF	LOCATION	TAX DIST	DATE INST	DATE CHANGE
05800	S	M	CNT	III	02605	002										12	080896	1/1/0001
05800	S	M	CNT	II	02612	001										12	080896	1/1/0001
05800	S	M	CNT	II	02625	003										12	080896	1/1/0001
05800	S	M	CNT	II	02632	004										12	080896	1/1/0001
05800	S	M	CNT	II	02664	006										12	080896	1/1/0001
05800	S	M	CNT	II	02673	007										12	080896	1/1/0001

OFFICE: 311		ROUTE: 564		ST_REF_NO: 00000050600		DABNEY DRIVE		LUMENS	BULB TYPE	MULT SERIES	POLE TYPE	SHADE	ADDRESS NUMBER	REF	LOCATION	TAX DIST	DATE INST	DATE CHANGE
09500	S	M	CNT	II	00000	033									2ND LT. W OF FOREST HILL DR., N SIDE	12	120899	1/1/0001
09500	S	M	CNT	II	00000	034									SIDE OF 3397 TYLER CT.	12	120899	1/1/0001
09500	S	M	CNT	II	00000	036									1ST LT. E OF MAPLELEAF DR., S SIDE	12	120899	1/1/0001
09500	S	M	CNT	II	00000	037									1ST LT. W OF MAPLELEAF DR., S SIDE	12	120899	1/1/0001

OFFICE: 311		ROUTE: 564		ST_REF_NO: 00000050600		DABNEY DRIVE				
LUMENS	BULB TYPE	MULT SERIES	POLE TYPE	SHADE	ADDRESS NUMBER	REF	LOCATION	TAX DIST	DATE INST	DATE CHANGE
09500	S	M	CNT	II	00402	035		12	110800	1/1/0001
09500	S	M	CNT	II	00512	032		12	120899	1/1/0001
09500	S	M	CNT	II	00000	031	1ST LT. W OF FOREST HILL DR., N SIDE	12	120899	1/1/0001

OFFICE: 311		ROUTE: 564		ST_REF_NO: 00000050675		DAISY HILL LANE				
LUMENS	BULB TYPE	MULT SERIES	POLE TYPE	SHADE	ADDRESS NUMBER	REF	LOCATION	TAX DIST	DATE INST	DATE CHANGE
04000	S	M	OUG	II	04012	001		12	100890	1/1/0001
04000	S	M	OUG	II	04021	002		12	100890	1/1/0001

OFFICE: 311		ROUTE: 564		ST_REF_NO: 00000050700		DAKOTA STREET				
LUMENS	BULB TYPE	MULT SERIES	POLE TYPE	SHADE	ADDRESS NUMBER	REF	LOCATION	TAX DIST	DATE INST	DATE CHANGE
05800	S	M	SOH	II	00709	000		12	040165	9/9/2009
05800	S	M	SOH	II	00731	000		12	040165	9/9/2009
05800	S	M	SOH	II	00751	000		12	040165	9/9/2009
05800	S	M	SOH	II	00769	295		12	090966	9/9/2009

OFFICE: 311		ROUTE: 564		ST_REF_NO: 00000050800		DALE DRIVE				
LUMENS	BULB TYPE	MULT SERIES	POLE TYPE	SHADE	ADDRESS NUMBER	REF	LOCATION	TAX DIST	DATE INST	DATE CHANGE
05800	S	M	OUG	II	00000	061	SIDE OF 1271 TRENT BLVD	12	111478	9/9/2009
05800	S	M	OUG	II	01361	060		12	121475	9/9/2009
05800	S	M	OUG	II	00000	055	SIDE OF 3677 CROSBY DR.	12	041674	1/1/0001
05800	S	M	OUG	II	01269	053		12	041674	1/1/0001
05800	S	M	OUG	II	01280	054		12	041674	1/1/0001
05800	S	M	OUG	II	01304	056		12	041674	1/1/0001
05800	S	M	OUG	II	01321	057		12	041674	1/1/0001
05800	S	M	OUG	II	01329	058		12	071475	1/1/0001
05800	S	M	OUG	II	01344	059		12	041774	1/1/0001
05800	S	M	OUG	II	01404	062		12	041674	1/1/0001
05800	S	M	OUG	II	01417	063		12	041674	1/1/0001
05800	S	M	OUG	II	01428	000		12	021475	1/1/0001
05800	S	M	OUG	II	01441	000		12	021475	1/1/0001

OFFICE: 311

ROUTE: 564

ST_REF_NO: 0000050900

DALE HOLLOW DRIVE

LUMENS	BULB TYPE	MULT SERIES	POLE TYPE	SHADE	ADDRESS NUMBER	REF	LOCATION	TAX DIST	DATE INST	DATE CHANGE
04000	S	M	OUG	II	03036	038		12	041478	1/1/0001
04000	S	M	OUG	II	03045	039		12	041478	1/1/0001
04000	S	M	OUG	II	03056	040		12	041478	1/1/0001
04000	S	M	OUG	II	03069	041		12	041478	1/1/0001
04000	S	M	OUG	II	03080	042		12	041478	1/1/0001
04000	S	M	OUG	II	03092	043		12	041478	1/1/0001
04000	S	M	OUG	II	03108	044		12	111580	1/1/0001
04000	S	M	OUG	II	03120	028		12	041478	1/1/0001
04000	S	M	OUG	II	03125	027		12	041478	1/1/0001
04000	S	M	OUG	II	03140	026		12	041478	1/1/0001
04000	S	M	OUG	II	03149	025		12	041478	1/1/0001
05800	S	M	OUG	II	00000	019	SIDE OF 633 SQUIRES RD.	12	041478	1/1/0001
04000	S	M	OUG	II	03012	035		12	041478	1/1/0001
04000	S	M	OUG	II	03013	029		12	111580	1/1/0001
05800	S	M	OUG	II	03020	036		12	111478	1/1/0001
05800	S	M	OUG	II	03029	037		12	111478	1/1/0001
04000	S	M	OUG	II	03164	024		12	041478	1/1/0001
04000	S	M	OUG	II	03169	023		12	041478	1/1/0001
04000	S	M	OUG	II	03180	022		12	041478	1/1/0001
05800	S	M	OUG	II	03189	021		12	041478	1/1/0001
05800	S	M	OUG	II	03196	020		12	100894	1/1/0001

OFFICE: 311

ROUTE: 564

ST_REF_NO: 0000051000

DALLAS AVENUE

LUMENS	BULB TYPE	MULT SERIES	POLE TYPE	SHADE	ADDRESS NUMBER	REF	LOCATION	TAX DIST	DATE INST	DATE CHANGE
04000	S	M	SOH	II	00000	026	OPP. 420 DALLAS AVE.	12	010885	9/9/2009
05800	S	M	SOH	II	00400	024		12	120884	9/9/2009
04000	S	M	SOH	II	00428	027		12	120884	9/9/2009
04000	S	M	SOH	II	00000	025	OPP. 410	12	120884	1/1/0001
04000	S	M	SOH	II	00000	028	SIDE 944 LIBERTY RD.	12	010885	1/1/0001

OFFICE: 311		ROUTE: 564		ST_REF_NO: 0000051100		DALNA DRIVE		LUMENS	BULB TYPE	MULT SERIES	POLE TYPE	SHADE	ADDRESS NUMBER	REF	LOCATION	TAX DIST	DATE INST	DATE CHANGE
05800	S	M	OUG	II	00000	113	SIDE OF 1817 JOAN DR.	12	082573	1/1/0001								
05800	S	M	OUG	II	01801	117		12	082573	1/1/0001								
05800	S	M	OUG	II	01808	116		12	082573	1/1/0001								
05800	S	M	OUG	II	01824	115		12	092066	1/1/0001								
05800	S	M	OUG	II	01829	000		12	092066	1/1/0001								

OFFICE: 311		ROUTE: 564		ST_REF_NO: 0000051200		DALTON COURT		LUMENS	BULB TYPE	MULT SERIES	POLE TYPE	SHADE	ADDRESS NUMBER	REF	LOCATION	TAX DIST	DATE INST	DATE CHANGE
05800	S	M	OUG	V	01883	000		12	071367	9/9/2009								
05800	S	M	OUG	II	00000	173	SIDE OF 1450 ETAWAH DR.	12	090766	1/1/0001								
05800	S	M	OUG	V	01803	000		12	050374	1/1/0001								
05800	S	M	OUG	II	01843	174		12	090766	1/1/0001								
05800	S	M	OUG	II	01860	175		12	090766	1/1/0001								

OFFICE: 311		ROUTE: 564		ST_REF_NO: 0000051300		DAMEL COURT		LUMENS	BULB TYPE	MULT SERIES	POLE TYPE	SHADE	ADDRESS NUMBER	REF	LOCATION	TAX DIST	DATE INST	DATE CHANGE
05800	S	M	OUG	II	00000	013	SIDE OF 2452 PIERSON DR.	12	120167	1/1/0001								
05800	S	M	OUG	V	00718	015		12	120167	1/1/0001								
05800	S	M	OUG	II	00730	000		12	050969	1/1/0001								

OFFICE: 311		ROUTE: 564		ST_REF_NO: 0000051350		DANA COURT		LUMENS	BULB TYPE	MULT SERIES	POLE TYPE	SHADE	ADDRESS NUMBER	REF	LOCATION	TAX DIST	DATE INST	DATE CHANGE
05800	S	M	OUG	IV	03901	002		12	100892	1/1/0001								
04000	S	M	OUG	II	03909	001		12	100890	1/1/0001								

OFFICE: 311		ROUTE: 564		ST_REF_NO: 0000051400		DANADA DRIVE		LUMENS	BULB TYPE	MULT SERIES	POLE TYPE	SHADE	ADDRESS NUMBER	REF	LOCATION	TAX DIST	DATE INST	DATE CHANGE
05800	S	M	OUG	II	03504	000		12	060159	9/9/2009								
05800	S	M	OUG	II	03503	000		12	080159	1/1/0001								
05800	S	M	OUG	II	03513	000		12	060159	1/1/0001								
05800	S	M	OUG	II	03514	000		12	060159	1/1/0001								

OFFICE: 311

ROUTE: 564

ST_REF_NO: 0000051400 DANADA DRIVE

LUMENS	BULB TYPE	MULT SERIES	POLE TYPE	SHADE	ADDRESS NUMBER	REF	LOCATION	TAX DIST	DATE INST	DATE CHANGE
05800	S	M	OUG	II	03523	000		12	060159	1/1/0001

OFFICE: 311

ROUTE: 564

ST_REF_NO: 0000051423 DANBY WOODS CIRCLE

LUMENS	BULB TYPE	MULT SERIES	POLE TYPE	SHADE	ADDRESS NUMBER	REF	LOCATION	TAX DIST	DATE INST	DATE CHANGE
05800	S		OUG	II	00000	020	SIDE OF 2444 TREELINE WAY, ON DANBY WOODS DRIVE	12	081310	1/1/0001
05800	S	M	OUG	III	02401	002		12	101201	9/9/2009
05800	S	M	OUG	II	02425	001		12	101201	1/1/0001

OFFICE: 311

ROUTE: 564

ST_REF_NO: 0000051425 DANBY WOODS DRIVE

LUMENS	BULB TYPE	MULT SERIES	POLE TYPE	SHADE	ADDRESS NUMBER	REF	LOCATION	TAX DIST	DATE INST	DATE CHANGE
05800	S	M	OUG	II	00000	006	SIDE OF 661	12	101201	9/9/2009
05800	S	M	OUG	II	00609	001		12	101201	9/9/2009
05800	S	M	OUG	II	00620	002		12	101201	1/1/0001
05800	S	M	OUG	II	00632	003		12	101201	1/1/0001
05800	S	M	OUG	II	00649	004		12	101201	9/9/2009
05800	S	M	OUG	II	00664	005		12	101201	9/9/2009
05800	S	M	OUG	II	00709	007		12	101201	1/1/0001

OFFICE: 311

ROUTE: 564

ST_REF_NO: 0000051440 DANFORTH DRIVE

LUMENS	BULB TYPE	MULT SERIES	POLE TYPE	SHADE	ADDRESS NUMBER	REF	LOCATION	TAX DIST	DATE INST	DATE CHANGE
09500	S	M	OUG	II	02268	006		12	110897	9/9/2009
09500	S	M	OUG	II	02284	004		12	110897	9/9/2009
09500	S	M	OUG	II	02292	002		12	110897	9/9/2009
09500	S	M	OUG	II	00000	001	SIDE OF 1692 JAGGIE FOX DR.	12	110897	1/1/0001
09500	S	M	OUG	II	02269	005		12	110897	1/1/0001
09500	S	M	OUG	II	02285	003		12	110897	1/1/0001

OFFICE: 311

ROUTE: 564

ST_REF_NO: 0000051500 DANIEL COURT

LUMENS	BULB TYPE	MULT SERIES	POLE TYPE	SHADE	ADDRESS NUMBER	REF	LOCATION	TAX DIST	DATE INST	DATE CHANGE
09500	S	M	OUG	II	02032	000		12	100172	1/1/0001

OFFICE: 311 ROUTE: 564							ST_REF_NO: 00000051500 DANIEL COURT			
LUMENS	BULB TYPE	MULT SERIES	POLE TYPE	SHADE	ADDRESS NUMBER	REF	LOCATION	TAX DIST	DATE INST	DATE CHANGE
09500	S	M	OUG	II	02033	000		12	100172	1/1/0001
09500	S	M	OUG	II	02048	000		12	100172	1/1/0001

OFFICE: 311 ROUTE: 564							ST_REF_NO: 00000051600 DANTZLER COURT			
LUMENS	BULB TYPE	MULT SERIES	POLE TYPE	SHADE	ADDRESS NUMBER	REF	LOCATION	TAX DIST	DATE INST	DATE CHANGE
05800	S	M	SOH	II	00000	004	IN ISLAND ACROSS FROM 305 DANTZLER CT	12	102904	1/1/0001
05800	S	M	SOH	II	00000	005	IN ISLAND ACROSS FROM 305 DANTZLER CT	12	102904	1/1/0001
05800	S	M	SOH	II	00000	006	ACROSS FROM 317 DANTZLER CT	12	102904	1/1/0001
05800	S	M	SOH	II	00206	001		12	102904	1/1/0001
05800	S	M	SOH	II	00216	002		12	102904	1/1/0001
05800	S	M	SOH	II	00228	003		12	102904	1/1/0001
05800	S	M	SOH	II	00329	007		12	102904	1/1/0001

OFFICE: 311 ROUTE: 564							ST_REF_NO: 00000051700 DARBY CREEK ROAD			
LUMENS	BULB TYPE	MULT SERIES	POLE TYPE	SHADE	ADDRESS NUMBER	REF	LOCATION	TAX DIST	DATE INST	DATE CHANGE
09500	S	M	OUG	II	00404	006		12	110884	9/9/2009
05800	S	M	OUG	II	00409	005		12	110884	9/9/2009
05800	S	M	OUG	II	00414	008		12	020890	1/1/0001
05800	S	M	OUG	II	00449	009		12	020890	1/1/0001
05800	S	M	OUG	II	00453	007		12	020890	1/1/0001
05800	S	M	OUG	II	00498	010		12	020890	1/1/0001
05800	S	M	OUG	II	00000	002	SIDE 2900 AFFIRMED CT	12	110884	1/1/0001
05800	S	M	OUG	II	00000	004	SIDE 2900 ALYDAR CT	12	110884	1/1/0001
05800	S	M	SOH	II	00301	001		12	111580	1/1/0001
05800	S	M	OUG	II	00361	003		12	110884	1/1/0001

OFFICE: 311 ROUTE: 564							ST_REF_NO: 00000051701 DARDA COURT			
LUMENS	BULB TYPE	MULT SERIES	POLE TYPE	SHADE	ADDRESS NUMBER	REF	LOCATION	TAX DIST	DATE INST	DATE CHANGE
04000	S	M	OUG	II	00000	001	SIDE OF 943 FAIRHAVEN DR	12	020887	9/9/2009
04000	S	M	OUG	II	00929	003		12	020887	9/9/2009
05800	S	M	OUG	II	00941	004		12	020887	9/9/2009

OFFICE: 311

ROUTE: 564

ST_REF_NO: 0000051701

DARDA COURT

LUMENS	BULB TYPE	MULT SERIES	POLE TYPE	SHADE	ADDRESS NUMBER	REF	LOCATION	TAX DIST	DATE INST	DATE CHANGE
04000	S	M	OUG	II	00904	002		12	020887	1/1/0001
04000	S	M	OUG	II	00948	005		12	020887	1/1/0001
04000	S	M	OUG	II	00965	006		12	020887	1/1/0001

OFFICE: 311

ROUTE: 564

ST_REF_NO: 0000051705

DARDANELLES DRIVE

LUMENS	BULB TYPE	MULT SERIES	POLE TYPE	SHADE	ADDRESS NUMBER	REF	LOCATION	TAX DIST	DATE INST	DATE CHANGE
04000	S	M	OUG	II	00000	004	SIDE OF 2932 WACO ROAD	12	110889	9/9/2009
05800	S	M	OUG	II	00673	007		12	110889	9/9/2009
04000	S	M	OUG	II	00684	006		12	110889	9/9/2009
05800	S	M	OUG	II	00693	005	upgrade due to damage from tree limbs	12	020895	9/1/2008
05800	S	M	OUG	II	00716	003		12	110889	9/9/2009
05800	S	M	OUG	II	00732	002		12	110889	9/9/2009
04000	S	M	OUG	II	00000	009	SIDE OF 649 GALATA DR.	12	020895	1/1/0001
04000	S	M	OUG	II	00608	012		12	110889	1/1/0001
04000	S	M	OUG	II	00621	011		12	110889	1/1/0001
04000	S	M	OUG	II	00632	010		12	110889	1/1/0001
04000	S	M	OUG	II	00656	008		12	110889	1/1/0001
04000	S	M	OUG	V	00744	001		12	110889	1/1/0001

OFFICE: 311

ROUTE: 564

ST_REF_NO: 0000051708

DARENIA LANE

LUMENS	BULB TYPE	MULT SERIES	POLE TYPE	SHADE	ADDRESS NUMBER	REF	LOCATION	TAX DIST	DATE INST	DATE CHANGE
05800	S	M	CNT	II	00200	001		12	090602	1/1/0001
05800	S	M	CNT	II	00216	002		12	090602	9/9/2009
05800	S	M	CNT	II	00237	003		12	090602	9/9/2009
05800	S	M	CNT	II	00244	004		12	090602	1/1/0001
05800	S	M	CNT	II	00261	005		12	090602	1/1/0001
05800	S	M	CNT	II	00276	006		12	090602	1/1/0001
05800	S	M	CNT	II	00320	008		12	090602	1/1/0001
05800	S	M	CNT	II	00333	009		12	090602	1/1/0001
05800	S	M	CNT	III	00340	010		12	090602	9/9/2009

OFFICE: 311		ROUTE: 564		ST_REF_NO: 0000051710		DARLEY DRIVE				
LUMENS	BULB TYPE	MULT SERIES	POLE TYPE	SHADE	ADDRESS NUMBER	REF	LOCATION	TAX DIST	DATE INST	DATE CHANGE
09500	S	M	OUG	II	00000	000	SIDE OF 1300 HIGHLAND PARK DR	12	110863	9/9/2009
09500	S	M	OUG	II	00800	089		12	110863	9/9/2009
09500	S	M	OUG	II	00837	000	upgraded 2/08	12	060163	9/9/2009
09500	S	M	OUG	II	00844	000	upgraded 2/08	12	100164	9/9/2009
09500	S	M	OUG	II	00908	000	upgraded 2/08	12	110863	9/9/2009
09500	S	M	OUG	II	00000	093	SIDE OF 550 EMERSON DR.upgraded 2/08	12	110863	1/1/0001
09500	S	M	OUG	II	01048	000	upgraded 2/08	12	031563	1/1/0001
09500	S	M	OUG	II	01067	000	upgraded 2/08	12	031563	1/1/0001
09500	S	M	OUG	II	00000	048	SIDE OF 1223 HIGHLAND PARK DR. upgrade 2/08	12	100164	1/1/0001
09500	S	M	OUG	II	00812	000	upgraded 2/08	12	041763	1/1/0001
09500	S	M	OUG	II	00860	000	moved from 865 st sewer proj 2005/upgrade 2/08	12	041763	1/1/0001
09500	S	M	OUG	II	00917	000	upgraded 2/08	12	051165	1/1/0001
09500	S	M	OUG	II	00922	000	upgraded 2/08	12	080173	1/1/0001
09500	S	M	OUG	II	00933	000	upgraded 2/08	12	050163	1/1/0001
09500	S	M	OUG	II	00938	000	upgraded 2/08	12	110863	1/1/0001
09500	S	M	OUG	II	01009	000	upgraded 2/08	12	050163	1/1/0001
09500	S	M	OUG	II	01016	000	upgraded 2/08	12	031563	1/1/0001
09500	S	M	OUG	II	01031	000	upgraded 2/08	12	041763	1/1/0001

OFFICE: 311		ROUTE: 564		ST_REF_NO: 0000051750		DARLINGTON CIRCLE				
LUMENS	BULB TYPE	MULT SERIES	POLE TYPE	SHADE	ADDRESS NUMBER	REF	LOCATION	TAX DIST	DATE INST	DATE CHANGE
05800	S	M	CNT	II	00000	001	SIDE OF 3232 BRIGHTON PL DR	12	020898	9/9/2009
05800	S	M	CNT	III	03200	003		12	020898	1/1/0001

OFFICE: 311		ROUTE: 564		ST_REF_NO: 0000051800		DARIEN DRIVE				
LUMENS	BULB TYPE	MULT SERIES	POLE TYPE	SHADE	ADDRESS NUMBER	REF	LOCATION	TAX DIST	DATE INST	DATE CHANGE
05800	S	M	OUG	II	00000	001	SIDE OF 1073 LANE ALLEN RD.	12	020889	9/9/2009
05800	S	M	OUG	II	00000	006	SIDE OF 1101 CLARIDGE DR	12	020889	9/9/2009
05800	S	M	OUG	II	01808	007		12	020889	1/1/0001
05800	S	M	OUG	II	01824	005		12	020889	1/1/0001
05800	S	M	OUG	II	01836	003		12	020889	1/1/0001
05800	S	M	OUG	II	01837	004		12	020889	1/1/0001

OFFICE: 311

ROUTE: 564

ST_REF_NO: 0000051800

DARIEN DRIVE

LUMENS	BULB TYPE	MULT SERIES	POLE TYPE	SHADE	ADDRESS NUMBER	REF	LOCATION	TAX DIST	DATE INST	DATE CHANGE
05800	S	M	OUG	II	01849	002		12	020889	1/1/0001
05800	S	M	OUG	II	00000	009	SIDE OF 1801 TRAVELLER RD.	12	020889	1/1/0001
05800	S	M	OUG	II	00000	010	SIDE OF 1800 TRAVELLER RD.	12	020889	1/1/0001
05800	S	M	SOH	II	00000	011	SIDE OF 1800 TRAVELLER RD.	12	020889	1/1/0001
05800	S	M	OUG	II	01805	008		12	020889	1/1/0001

OFFICE: 311

ROUTE: 564

ST_REF_NO: 0000051900

DARTMOOR COURT

LUMENS	BULB TYPE	MULT SERIES	POLE TYPE	SHADE	ADDRESS NUMBER	REF	LOCATION	TAX DIST	DATE INST	DATE CHANGE
05800	S	M	OUG	II	00685	000		12	080367	9/9/2009
05800	S	M	OUG	II	00000	088	SIDE OF 656 DARTMOOR DR.	12	111366	1/1/0001
05800	S	M	OUG	II	00700	000		12	032772	1/1/0001

OFFICE: 311

ROUTE: 564

ST_REF_NO: 0000052000

DARTMOOR DRIVE

LUMENS	BULB TYPE	MULT SERIES	POLE TYPE	SHADE	ADDRESS NUMBER	REF	LOCATION	TAX DIST	DATE INST	DATE CHANGE
05800	S	M	OUG	II	00000	082	SIDE OF 568 SHAFTSBURY RD.	12	080367	1/1/0001
05800	S	M	OUG	II	00613	000		12	111366	1/1/0001
05800	S	M	OUG	II	00620	000		12	111366	1/1/0001
05800	S	M	OUG	II	00637	000		12	111366	1/1/0001
05800	S	M	OUG	II	00648	000		12	111366	1/1/0001
05800	S	M	OUG	II	00661	000		12	111366	1/1/0001

OFFICE: 311

ROUTE: 564

ST_REF_NO: 0000052100

DARTMOUTH DRIVE

LUMENS	BULB TYPE	MULT SERIES	POLE TYPE	SHADE	ADDRESS NUMBER	REF	LOCATION	TAX DIST	DATE INST	DATE CHANGE
04000	S	M	OUG	II	00000	040	SIDE 3041 STANFORD DR.	12	060886	1/1/0001

OFFICE: 311

ROUTE: 564

ST_REF_NO: 0000052200

DAVID DRIVE

LUMENS	BULB TYPE	MULT SERIES	POLE TYPE	SHADE	ADDRESS NUMBER	REF	LOCATION	TAX DIST	DATE INST	DATE CHANGE
04000	S	M	OUG	II	00000	001	SIDE OF 2036 DELLWOOD DR.	12	110888	1/1/0001
04000	S	M	OUG	II	00000	003	SIDE OF 2049 HEATHER WAY	12	110888	1/1/0001
04000	S	M	OUG	II	00209	002		12	110888	1/1/0001

OFFICE: 311		ROUTE: 564		ST_REF_NO: 00000052300		DAVIDSON COURT		LUMENS	BULB TYPE	MULT SERIES	POLE TYPE	SHADE	ADDRESS NUMBER	REF	LOCATION	TAX DIST	DATE INST	DATE CHANGE
	05800	S	M	SOH	II	00000	258								SIDE OF 635 N. BROADWAY	12	091566	1/1/0001
	05800	S	M	SOH	II	00426	257									12	091566	1/1/0001

OFFICE: 311		ROUTE: 564		ST_REF_NO: 00000052395		DAY LILY DRIVE		LUMENS	BULB TYPE	MULT SERIES	POLE TYPE	SHADE	ADDRESS NUMBER	REF	LOCATION	TAX DIST	DATE INST	DATE CHANGE
	05800	S		CNT	II	00000	002								SIDE OF 2776 GOLDENROD LN ON DAY LILY DR	12	102908	1/1/0001
	05800	S		CNT	II	01401	001									12	102908	1/1/0001
	05800	S		CNT	II	01421	003									12	102908	1/1/0001
	05800	S		CNT	II	01441	004									12	102908	1/1/0001
	05800	S		CNT	II	01453	005									12	102908	1/1/0001
	05800	S		CNT	II	01468	006									12	102908	1/1/0001
	05800	S		CNT	II	01485	007									12	102908	1/1/0001

OFFICE: 311		ROUTE: 564		ST_REF_NO: 00000052400		DAYTON AVENUE		LUMENS	BULB TYPE	MULT SERIES	POLE TYPE	SHADE	ADDRESS NUMBER	REF	LOCATION	TAX DIST	DATE INST	DATE CHANGE
	05800	S	M	SOH	I	00000	009								OPP 910	12	080174	9/9/2009
	05800	S	M	SOH	I	00000	010								SIDE OF 824 WINCHESTER RD	12	080274	9/9/2009
	05800	S	M	SOH	I	00927	006									12	080174	9/9/2009
	05800	S	M	SOH	I	00917	008									12	080174	1/1/0001
	05800	S	M	SOH	I	00923	007									12	080174	1/1/0001
	05800	S	M	SOH	I	00933	005									12	080174	1/1/0001
	05800	S	M	SOH	I	00939	004									12	080174	1/1/0001
	05800	S	M	SOH	I	00947	003									12	088174	1/1/0001
	05800	S	M	SOH	I	00953	002									12	080274	1/1/0001

OFFICE: 311		ROUTE: 564		ST_REF_NO: 00000052450		DAWSON SPRINGS WAY		LUMENS	BULB TYPE	MULT SERIES	POLE TYPE	SHADE	ADDRESS NUMBER	REF	LOCATION	TAX DIST	DATE INST	DATE CHANGE
	05800	S		OUG	II	00000	050								SIDE OF 617 SAUNDERS SPRINGS WAY ON DAWSON SPRINGS	12	042011	1/1/0001
	05800	S		OUG	II	00709	002									12	042011	1/1/0001
	05800	S		OUG	II	00725	003									12	042011	1/1/0001
	05800	S		OUG	II	00737	004									12	042011	1/1/0001

OFFICE: 311

ROUTE: 564

ST_REF_NO: 0000052450

DAWSON SPRINGS WAY

LUMENS	BULB TYPE	MULT SERIES	POLE TYPE	SHADE	ADDRESS NUMBER	REF	LOCATION	TAX DIST	DATE INST	DATE CHANGE
05800	S		OUG	II	00745	005		12	042011	1/1/0001
05800	S		OUG	II	00756	006		12	042011	1/1/0001
05800	S		OUG	II	00764	007		12	042011	1/1/0001
05800	S		OUG	II	00912	052		12	042011	1/1/0001
05800	S		OUG	II	00916	051		12	042011	1/1/0001

OFFICE: 311

ROUTE: 564

ST_REF_NO: 0000052510

DEANSIDE DRIVE

LUMENS	BULB TYPE	MULT SERIES	POLE TYPE	SHADE	ADDRESS NUMBER	REF	LOCATION	TAX DIST	DATE INST	DATE CHANGE
05800	S	M	CNT	II	00000	001	SIDE REAR OF 2649 IDLEWOOD DR.	12	080896	1/1/0001

OFFICE: 311

ROUTE: 564

ST_REF_NO: 0000052520

DEARMAN COURT

LUMENS	BULB TYPE	MULT SERIES	POLE TYPE	SHADE	ADDRESS NUMBER	REF	LOCATION	TAX DIST	DATE INST	DATE CHANGE
05800	S	M	CNT	III	03709	002		12	120898	9/9/2009
05800	S	M	CNT	II	00000	001	SIDE OF 608 WINTER HILL LANE	12	120898	1/1/0001

OFFICE: 311

ROUTE: 564

ST_REF_NO: 0000052540

DEATON PLACE

LUMENS	BULB TYPE	MULT SERIES	POLE TYPE	SHADE	ADDRESS NUMBER	REF	LOCATION	TAX DIST	DATE INST	DATE CHANGE
05800	S	M	OUG	II	00509	001		12	060898	1/1/0001
05800	S	M	OUG	III	00524	003		12	060898	1/1/0001
05800	S	M	OUG	III	00545	002		12	060898	1/1/0001

OFFICE: 311

ROUTE: 564

ST_REF_NO: 0000052600

DEAUVILLE DRIVE

LUMENS	BULB TYPE	MULT SERIES	POLE TYPE	SHADE	ADDRESS NUMBER	REF	LOCATION	TAX DIST	DATE INST	DATE CHANGE
09500	S	M	OUG	II	00000	001	OPPOSITE OF 2031	12	120960	9/9/2009
09500	S	M	OUG	II	00000	002	OPPOSITE OF 2059	12	122065	9/9/2009
09500	S	M	OUG	II	00000	003	SIDE OF 1917 OXFORD CIR	12	090159	9/9/2009
09500	S	M	OUG	II	01913	000		12	060161	9/9/2009
09500	S	M	OUG	II	02092	000		12	122065	9/9/2009
09500	S	M	OUG	II	00000	083	OPP. 2095	12	020890	1/1/0001
09500	S	M	OUG	II	02091	082		12	071475	1/1/0001
09500	S	M	OUG	II	02107	084		12	071475	1/1/0001

OFFICE: 311

ROUTE: 564

ST_REF_NO: 00000052600

DEAUVILLE DRIVE

LUMENS	BULB TYPE	MULT SERIES	POLE TYPE	SHADE	ADDRESS NUMBER	REF	LOCATION	TAX DIST	DATE INST	DATE CHANGE
09500	S	M	OUG	II	02124	085		12	070894	1/1/0001
09500	S	M	OUG	II	02131	086		12	071475	1/1/0001
09500	S	M	OUG	II	02139	087		12	071475	1/1/0001
09500	S	M	OUG	II	02164	088		12	070894	1/1/0001
09500	S	M	OUG	II	01904	000		12	120960	1/1/0001
09500	S	M	OUG	II	01916	000		12	060161	1/1/0001
09500	S	M	OUG	II	01923	000		12	080565	1/1/0001
09500	S	M	OUG	II	01926	000		12	081363	1/1/0001
09500	S	M	OUG	II	02008	000		12	120960	1/1/0001
09500	S	M	OUG	II	02019	000		12	120960	1/1/0001
09500	S	M	OUG	II	02047	000		12	110761	1/1/0001
09500	S	M	OUG	II	02071	000		12	110761	1/1/0001

OFFICE: 311

ROUTE: 564

ST_REF_NO: 00000052700

DECATUR COURT

LUMENS	BULB TYPE	MULT SERIES	POLE TYPE	SHADE	ADDRESS NUMBER	REF	LOCATION	TAX DIST	DATE INST	DATE CHANGE
05800	S	M	OUG	II	01504	000		12	090164	1/1/0001

OFFICE: 311

ROUTE: 564

ST_REF_NO: 00000052750

DECLARATION COURT

LUMENS	BULB TYPE	MULT SERIES	POLE TYPE	SHADE	ADDRESS NUMBER	REF	LOCATION	TAX DIST	DATE INST	DATE CHANGE
05800	S	M	OUG	III	00652	001		12	050897	1/1/0001

OFFICE: 311

ROUTE: 564

ST_REF_NO: 00000052910

DEEP GLEN COURT

LUMENS	BULB TYPE	MULT SERIES	POLE TYPE	SHADE	ADDRESS NUMBER	REF	LOCATION	TAX DIST	DATE INST	DATE CHANGE
05800	S	M	OUG	II	00000	003	SIDE OF 536 GLENBROOK	12	042264	9/9/2009
05800	S	M	OUG	II	00000	001	SIDE OF 542 GLENBROOK DR.	12	080800	1/1/0001
05800	S	M	OUG	III	01900	005		12	080800	1/1/0001
05800	S	M	OUG	II	01912	002		12	080800	1/1/0001
05800	S	M	OUG	II	01913	000		12	062363	1/1/0001

OFFICE: 311

ROUTE: 564

ST_REF_NO: 0000052920

DEER CROSSING WAY

LUMENS	BULB TYPE	MULT SERIES	POLE TYPE	SHADE	ADDRESS NUMBER	REF	LOCATION	TAX DIST	DATE INST	DATE CHANGE
05800	S	M	CNT	II	00000	001	SIDE OF 3628 PLEASANT RUN	12	110894	9/9/2009
05800	S	M	CNT	II	00916	101		12	070895	9/9/2009
05800	S	M	CNT	II	00980	108		12	070895	9/9/2009
05800	S	M	CNT	II	01036	002		12	110894	9/9/2009
05800	S	M	CNT	III	00929	102		12	070895	1/1/0001
05800	S	M	CNT	II	00941	103		12	070895	1/1/0001
05800	S	M	CNT	II	00944	104		12	070895	1/1/0001
05800	S	M	CNT	II	00952	105		12	070895	1/1/0001
05800	S	M	CNT	II	00972	107		12	070895	1/1/0001
05800	S	M	CNT	II	01005	109		12	070895	1/1/0001
05800	S	M	CNT	III	01021	003		12	110894	1/1/0001
05800	S	M	CNT	II	01028	004		12	110894	1/1/0001
05800	S	M	CNT	II	01049	050		12	110894	1/1/0001
05800	S	M	CNT	II	01060	051		12	110894	1/1/0001
05800	S	M	CNT	II	01064	052		12	060895	1/1/0001
05800	S	M	CNT	II	01076	053		12	060895	1/1/0001
05800	S	M	CNT	II	01089	054		12	060895	1/1/0001
05800	S	M	CNT	II	01093	055		12	060895	1/1/0001

OFFICE: 311

ROUTE: 564

ST_REF_NO: 0000053005

DEERFIELD LANE

LUMENS	BULB TYPE	MULT SERIES	POLE TYPE	SHADE	ADDRESS NUMBER	REF	LOCATION	TAX DIST	DATE INST	DATE CHANGE
05800	S	M	CNT	II	00280	009		12	020801	9/9/2009
05800	S	M	CNT	II	00000	001	SIDE OF 384 MEADOW VALLEY ROAD	12	020801	1/1/0001
05800	S	M	CNT	II	00269	011		12	020801	1/1/0001
05800	S	M	CNT	II	00273	010		12	020801	1/1/0001
05800	S	M	CNT	II	00293	008		12	020801	1/1/0001
05800	S	M	CNT	II	00304	007		12	020801	1/1/0001
05800	S	M	CNT	II	00313	006		12	020801	1/1/0001
05800	S	M	CNT	II	00324	005		12	020801	1/1/0001
05800	S	M	CNT	II	00329	004		12	020801	1/1/0001
05800	S	M	CNT	II	00340	003		12	020801	1/1/0001
05800	S	M	CNT	II	00349	002		12	020801	1/1/0001

OFFICE: 311		ROUTE: 564		ST_REF_NO: 0000053008		DEERHAVEN LANE		TAX DIST	DATE INST	DATE CHANGE
LUMENS	BULB TYPE	MULT SERIES	POLE TYPE	SHADE	ADDRESS NUMBER	REF	LOCATION			
09500	S	M	SOH	II	00000	009	1ST LT E OF WARGRAVE WALK, S SIDE ON DEERHAVEN LN	12	011007	1/1/0001
09500	S	M	SOH	II	00000	010	2ND LT E OF WARGRAVE WALK, S SIDE ON DEERHAVEN LN	12	011007	1/1/0001
09500	S	M	SOH	II	00000	011	3RD LT E OF WARGRAVE WALK, S SIDE ON DEERHAVEN LN	12	011007	1/1/0001
05800	S	M	CNT	III	01112	001		12	091106	9/9/2009
05800	S	M	CNT	II	01124	002		12	091106	1/1/0001
05800	S	M	CNT	II	01136	003		12	091106	9/9/2009
05800	S	M	CNT	II	01148	004		12	091106	9/9/2009
05800	S	M	CNT	II	01168	005		12	091106	1/1/0001
05800	S	M	CNT	II	01176	006		12	091106	1/1/0001
OFFICE: 311		ROUTE: 564		ST_REF_NO: 0000053010		DEERING COURT		TAX DIST	DATE INST	DATE CHANGE
LUMENS	BULB TYPE	MULT SERIES	POLE TYPE	SHADE	ADDRESS NUMBER	REF	LOCATION			
04000	S	M	OUG	II	00000	095	SIDE 216 WHITFIELD DR.	12	090886	1/1/0001
04000	S	M	OUG	V	04513	094		12	090886	1/1/0001
OFFICE: 311		ROUTE: 564		ST_REF_NO: 0000053200		DELAWARE AVENUE		TAX DIST	DATE INST	DATE CHANGE
LUMENS	BULB TYPE	MULT SERIES	POLE TYPE	SHADE	ADDRESS NUMBER	REF	LOCATION			
09500	S	M	SOH	II	00000	001	SIDE 780 WINCHESTER RD	12	010885	9/9/2009
09500	S	M	SOH	II	00000	011	OPPOSITE 955	12	110884	9/9/2009
09500	S	M	SOH	II	00000	012	1ST LT N OF DALLAS AVE, W SIDE	12	110884	9/9/2009
09500	S	M	SOH	II	00000	014	OPP. 1101	12	110884	9/9/2009
09500	S	M	SOH	II	00000	016	OPP 1123	12	110884	9/9/2009
09500	S	M	SOH	II	00000	017	OPP 1411	12	110884	9/9/2009
09500	S	M	SOH	II	00902	002		12	110884	9/9/2009
09500	S	M	SOH	II	00940	007		12	010885	9/9/2009
09500	S	M	SOH	II	00946	008		12	110884	9/9/2009
09500	S	M	SOH	II	00968	010		12	110884	9/9/2009
09500	S	M	SOH	II	00976	009		12	110884	9/9/2009
09500	S	M	SOH	II	01426	018		12	110884	9/9/2009
09500	S	M	SOH	II	01560	019		12	110884	9/9/2009

OFFICE: 311

ROUTE: 564

ST_REF_NO: 0000053200

DELAWARE AVENUE

LUMENS	BULB TYPE	MULT SERIES	POLE TYPE	SHADE	ADDRESS NUMBER	REF	LOCATION	TAX DIST	DATE INST	DATE CHANGE
09500	S	M	SOH	II	01586	021		12	110884	9/9/2009
09500	S	M	SOH	II	01592	022		12	110884	9/9/2009
09500	S	M	SOH	II	00908	003		12	010885	1/1/0001
09500	S	M	SOH	II	00912	004		12	110884	1/1/0001
09500	S	M	SOH	II	00918	005		12	010885	1/1/0001
09500	S	M	SOH	II	00924	006		12	110884	1/1/0001
09500	S	M	SOH	II	01000	013		12	110884	1/1/0001
09500	S	M	SOH	II	01110	015		12	110884	1/1/0001
09500	S	M	SOH	II	01584	020		12	110884	1/1/0001
09500	S	M	SOH	II	01592	023		12	110884	1/1/0001

OFFICE: 311

ROUTE: 564

ST_REF_NO: 0000053300

DELCAMP AVENUE

LUMENS	BULB TYPE	MULT SERIES	POLE TYPE	SHADE	ADDRESS NUMBER	REF	LOCATION	TAX DIST	DATE INST	DATE CHANGE
05800	S	M	SOH	II	00000	233	OPP. 453	12	092366	9/9/2009
05800	S	M	SOH	II	00000	232	SIDE OF 650 BELLAIRE AVE.	12	092366	1/1/0001
05800	S	M	SOH	II	00000	234	OPP. 445	12	092366	1/1/0001
05800	S	M	SOH	II	00000	235	SIDE OF 676 HEADLEY AVE.	12	101579	1/1/0001
05800	S	M	SOH	II	00000	238	SIDE OF 671 N. BROADWAY	12	092366	1/1/0001
05800	S	M	SOH	II	00406	000		12	092366	1/1/0001
05800	S	M	SOH	II	00412	000		12	092366	1/1/0001

OFFICE: 311

ROUTE: 564

ST_REF_NO: 0000053400

DELLA DRIVE

LUMENS	BULB TYPE	MULT SERIES	POLE TYPE	SHADE	ADDRESS NUMBER	REF	LOCATION	TAX DIST	DATE INST	DATE CHANGE
04000	S	M	OUG	II	00000	024	SIDE OF 1778 BEACON HILL RD.	12	020889	9/9/2009
05800	S	M	OUG	II	00000	048	SIDE OF 1028 CELIA LN	12	020889	9/9/2009
05800	S	M	OUG	II	00735	005		12	090889	9/9/2009
05800	S	M	OUG	II	00832	016		12	090889	9/9/2009
05800	S	M	OUG	II	00876	020		12	090889	9/9/2009
04000	S	M	OUG	II	00970	034		12	110888	9/9/2009
04000	S	M	OUG	II	01019	042		12	020889	9/9/2009
05800	S	M	OUG	II	00000	050	SIDE OF 1029 CELIA LANE	12	020889	1/1/0001
05800	S	M	OUG	II	00000	051	SIDE OF 1101 THE LANE	12	020889	1/1/0001

OFFICE: 311

ROUTE: 564

ST_REF_NO: 0000053400

DELLA DRIVE

LUMENS	BULB TYPE	MULT SERIES	POLE TYPE	SHADE	ADDRESS NUMBER	REF	LOCATION	TAX DIST	DATE INST	DATE CHANGE
05800	S	M	OUG	II	00000	052	SIDE OF 1090 THE LANE	12	020889	1/1/0001
05800	S	M	OUG	II	00000	068	SIDE OF 1900 SEVEN PINES DR.	12	101674	1/1/0001
05800	S	M	OUG	II	01001	037		12	120888	1/1/0001
05800	S	M	SOH	II	01003	038		12	110888	1/1/0001
05800	S	M	OUG	II	01008	039		12	020889	1/1/0001
05800	S	M	OUG	II	01011	040		12	020889	1/1/0001
05800	S	M	OUG	II	01018	041		12	020889	1/1/0001
05800	S	M	OUG	II	01028	043		12	020889	1/1/0001
05800	S	M	OUG	II	01033	044		12	020889	1/1/0001
05800	S	M	OUG	II	01038	045		12	020889	1/1/0001
05800	S	M	OUG	II	01041	046		12	020889	1/1/0001
05800	S	M	OUG	II	01046	047		12	020889	1/1/0001
05800	S	M	OUG	II	01054	049		12	020889	1/1/0001
05800	S	M	OUG	II	00000	001	SIDE OF 1763 HARRODSBURG RD.	12	090889	1/1/0001
05800	S	M	OUG	II	00000	025	SIDE OF 1769 BEACON HILL RD.	12	020889	1/1/0001
05800	S	M	OUG	II	00000	026	SIDE OF 1802 NORMAND ROAD	12	120800	1/1/0001
05800	S	M	OUG	II	00000	027	SIDE OF 1773 NORMANDY	12	030889	1/1/0001
05800	S	M	OUG	II	00000	028	SIDE OF 1801 NORMANDY	12	120800	1/1/0001
05800	S	M	OUG	II	00000	029	SIDE OF 1778 YORKTOWN	12	030889	1/1/0001
05800	S	M	OUG	II	00000	030	SIDE 1801 YORKTOWN	12	050889	1/1/0001
05800	S	M	OUG	II	00000	031	SIDE 1800 GETTYSBURG RD.	12	050889	1/1/0001
05800	S	M	OUG	II	00000	032	SIDE 1801 GETTYSBURG RD.	12	050889	1/1/0001
05800	S	M	OUG	II	00702	002		12	090889	1/1/0001
05800	S	M	OUG	II	00711	003		12	090889	1/1/0001
05800	S	M	OUG	II	00722	004		12	090889	1/1/0001
05800	S	M	OUG	II	00742	006		12	090889	1/1/0001
05800	S	M	OUG	II	00751	007		12	090889	1/1/0001
05800	S	M	OUG	II	00760	008		12	090889	1/1/0001
05800	S	M	OUG	II	00771	009		12	090889	1/1/0001
05800	S	M	OUG	II	00780	010		12	090889	1/1/0001
05800	S	M	OUG	II	00787	011		12	090889	1/1/0001
05800	S	M	OUG	II	00796	012		12	090889	1/1/0001
05800	S	M	OUG	II	00805	013		12	090889	1/1/0001
05800	S	M	OUG	II	00816	014		12	090889	1/1/0001

OFFICE: 311

ROUTE: 564

ST_REF_NO: 0000053400 DELLA DRIVE

LUMENS	BULB TYPE	MULT SERIES	POLE TYPE	SHADE	ADDRESS NUMBER	REF	LOCATION	TAX DIST	DATE INST	DATE CHANGE
05800	S	M	OUG	II	00825	015		12	090889	1/1/0001
05800	S	M	OUG	II	00845	017		12	090889	1/1/0001
05800	S	M	OUG	II	00856	018		12	090889	1/1/0001
05800	S	M	OUG	II	00865	019		12	090889	1/1/0001
05800	S	M	OUG	II	00885	021		12	090889	1/1/0001
05800	S	M	OUG	II	00892	022		12	090889	1/1/0001
04000	S	M	OUG	II	00899	023		12	020889	1/1/0001
05800	S	M	OUG	II	00965	033		12	110888	1/1/0001
05800	S	M	OUG	II	00981	035		12	110888	1/1/0001
05800	S	M	OUG	II	00990	036		12	120888	1/1/0001

OFFICE: 311

ROUTE: 564

ST_REF_NO: 0000053500 DELLWOOD DRIVE

LUMENS	BULB TYPE	MULT SERIES	POLE TYPE	SHADE	ADDRESS NUMBER	REF	LOCATION	TAX DIST	DATE INST	DATE CHANGE
04000	S	M	OUG	II	02028	003		12	110888	9/9/2009
04000	S	M	OUG	II	02005	005		12	110888	1/1/0001
04000	S	M	OUG	II	02020	004		12	110888	1/1/0001
04000	S	M	OUG	II	02040	002		12	110888	1/1/0001
04000	S	M	OUG	II	02053	001		12	110888	1/1/0001

OFFICE: 311

ROUTE: 564

ST_REF_NO: 0000053600 DELMAR AVENUE

LUMENS	BULB TYPE	MULT SERIES	POLE TYPE	SHADE	ADDRESS NUMBER	REF	LOCATION	TAX DIST	DATE INST	DATE CHANGE
05800	S	M	SOH	II	00246	000		12	070162	9/9/2009
05800	S	M	SOH	II	00000	001	SIDE OF 525 RUSSELL AVE.	12	070162	1/1/0001
05800	S	M	SOH	II	00239	000		12	070162	1/1/0001
05800	S	M	SOH	II	00253	000		12	070162	1/1/0001

OFFICE: 311

ROUTE: 564

ST_REF_NO: 0000053700 DELMONT COURT

LUMENS	BULB TYPE	MULT SERIES	POLE TYPE	SHADE	ADDRESS NUMBER	REF	LOCATION	TAX DIST	DATE INST	DATE CHANGE
05800	S	M	OUG	II	00154	000		12	010162	1/1/0001

OFFICE: 311

ROUTE: 564

ST_REF_NO: 00000053800

DELMONT DRIVE

LUMENS	BULB TYPE	MULT SERIES	POLE TYPE	SHADE	ADDRESS NUMBER	REF	LOCATION	TAX DIST	DATE INST	DATE CHANGE
09500	S		SOH	II	00000	100	1ST LT N OF VERSAILLES RD, E SIDE ON DELMONT DR	12	011411	1/1/0001
05800	S	M	SOH	I	00130	006		12	071477	9/9/2009
09500	S	M	OUG	II	00164	000		12	110761	9/9/2009
09500	S	M	SOH	I	00000	001	SIDE OF 1417 VERSAILLES RD.	12	071477	1/1/0001
09500	S	M	SOH	I	00104	002		12	071477	1/1/0001
09500	S	M	SOH	I	00108	003		12	071477	1/1/0001
09500	S	M	SOH	II	00114	004		12	071477	1/1/0001
09500	S	M	SOH	I	00124	005		12	071477	1/1/0001
09500	S	M	OUG	II	00134	000		12	010162	1/1/0001
09500	S	M	OUG	II	00146	000		12	100163	1/1/0001
09500	S	M	OUG	II	00149	000		12	100163	1/1/0001
09500	S	M	OUG	II	00161	000		12	110761	1/1/0001

OFFICE: 311

ROUTE: 564

ST_REF_NO: 00000053950

DELTINO COURT

LUMENS	BULB TYPE	MULT SERIES	POLE TYPE	SHADE	ADDRESS NUMBER	REF	LOCATION	TAX DIST	DATE INST	DATE CHANGE
05800	S	M	CNT	II	00601	001		12	110207	1/1/0001
05800	S	M	CNT	III	00613	002		12	110207	1/1/0001

OFFICE: 311

ROUTE: 564

ST_REF_NO: 00000054000

DELZAN PLACE

LUMENS	BULB TYPE	MULT SERIES	POLE TYPE	SHADE	ADDRESS NUMBER	REF	LOCATION	TAX DIST	DATE INST	DATE CHANGE
09500	S	M	OUG	II	00000	001	SIDE 3334 CLAYS MILL RD.	12	080885	1/1/0001
09500	S	M	OUG	II	00000	007	OPP. 593	12	080885	1/1/0001
09500	S	M	OUG	II	00000	009	OPP. 581	12	080885	1/1/0001
09500	S	M	OUG	II	00000	011	OPP. 569	12	080885	1/1/0001
09500	S	M	OUG	II	00573	010		12	080885	1/1/0001
09500	S	M	OUG	II	00585	008		12	080885	1/1/0001
09500	S	M	OUG	II	00597	006		12	080885	1/1/0001
09500	S	M	OUG	II	00617	004		12	080885	1/1/0001
09500	S	M	OUG	II	00625	003		12	080885	1/1/0001
09500	S	M	OUG	II	00641	002		12	080885	1/1/0001

OFFICE: 311

ROUTE: 564

ST_REF_NO: 0000054050

DENALI PASS DRIVE

LUMENS	BULB TYPE	MULT SERIES	POLE TYPE	SHADE	ADDRESS NUMBER	REF	LOCATION	TAX DIST	DATE INST	DATE CHANGE
05800	S	M	CNT	II	00000	001	SIDE OF 909 JOUETT CREEK DR ON DENALI PASS DR	12	102103	1/1/0001
05800	S	M	CNT	II	00000	002	SIDE OF 4004 BOONE CREEK DR ON DENALI PASS DR	12	102103	1/1/0001

OFFICE: 311

ROUTE: 564

ST_REF_NO: 0000054055

DENBURN COURT

LUMENS	BULB TYPE	MULT SERIES	POLE TYPE	SHADE	ADDRESS NUMBER	REF	LOCATION	TAX DIST	DATE INST	DATE CHANGE
05800	S	M	CNT	III	02508	002		12	042506	1/1/0001
05800	S	M	CNT	II	02517	001		12	042506	1/1/0001

OFFICE: 311

ROUTE: 564

ST_REF_NO: 0000054100

DENNIS DRIVE

LUMENS	BULB TYPE	MULT SERIES	POLE TYPE	SHADE	ADDRESS NUMBER	REF	LOCATION	TAX DIST	DATE INST	DATE CHANGE
05800	S	M	OUG	II	00000	002	SIDE OF 2417 NICHOLASVILLE RD	12	100884	9/9/2009
10000	M	M	OUG	II	00000	008	SIDE OF 2432 REGENCY RD	12	120891	9/9/2009
10000	M	M	OUG	II	00000	009	SIDE OF 2416 REGENCY RD	12	100887	9/9/2009
05800	S	M	OUG	II	00000	010	OPP 112	12	103002	9/9/2009
05800	S	M	OUG	II	00000	011	ACROSS FROM 120 DENNIS DRIVE	12	103002	1/1/0001
05800	S	M	OUG	II	00098	001	SIDE OF 2421 NICHOLASVILLE RD.	12	100884	9/9/2009
05800	S	M	OUG	II	00163	013		12	103002	1/1/0001
05800	S	M	OUG	II	00170	012		12	103002	9/9/2009
05800	S	M	OUG	II	00175	014		12	103002	1/1/0001
05800	S	M	OUG	II	00104	003		12	100884	1/1/0001
05800	S	M	OUG	II	00109	004		12	100884	1/1/0001

OFFICE: 311

ROUTE: 564

ST_REF_NO: 0000054200

DENVER LANE

LUMENS	BULB TYPE	MULT SERIES	POLE TYPE	SHADE	ADDRESS NUMBER	REF	LOCATION	TAX DIST	DATE INST	DATE CHANGE
04000	S	M	OUG	II	00498	066		12	100885	9/9/2009
04000	S	M	OUG	II	00475	064		12	100885	1/1/0001
04000	S	M	OUG	II	00482	065		12	100885	1/1/0001

OFFICE: 311

ROUTE: 564

ST_REF_NO: 0000054300

DEPORRES AVENUE

LUMENS	BULB TYPE	MULT SERIES	POLE TYPE	SHADE	ADDRESS NUMBER	REF	LOCATION	TAX DIST	DATE INST	DATE CHANGE
05800	S	M	OUG	III	00980	000		12	121258	9/9/2009
05800	S	M	OUG	III	00960	000		12	021157	1/1/0001
05800	S	M	OUG	III	00969	000		12	121258	1/1/0001
05800	S	M	OUG	III	00989	000		12	121258	1/1/0001
05800	S	M	OUG	III	00904	000		12	123055	1/1/0001
05800	S	M	OUG	III	00917	000		12	123055	1/1/0001
05800	S	M	OUG	II	00928	000		12	030896	1/1/0001
05800	S	M	OUG	III	00941	000		12	021157	1/1/0001

OFFICE: 311

ROUTE: 564

ST_REF_NO: 0000054400

DERBY DRIVE

LUMENS	BULB TYPE	MULT SERIES	POLE TYPE	SHADE	ADDRESS NUMBER	REF	LOCATION	TAX DIST	DATE INST	DATE CHANGE
05800	S		OUG	II	00251	050		12	022511	1/1/0001
05800	S		OUG	II	00260	052		12	022511	1/1/0001
05800	S		OUG	II	00292	051		12	022511	1/1/0001
09500	S	M	OUG	II	00268	024	upgrade per city request	12	080171	9/12/2009
09500	S	M	OUG	II	00300	022	upgrade per city request	12	080171	9/22/2009
09500	S	M	OUG	II	00311	021	upgraded per city request	12	080171	9/12/2009
05800	S	M	OUG	II	00000	019	SIDE OF 2094 RAMBLER RD.	12	100268	1/1/0001
05800	S	M	OUG	II	00000	023	SIDE OF 299 DERBY DR.	12	080171	1/1/0001
05800	S	M	OUG	II	00000	026	SIDE OF 2098 REGENCY RD.	12	080171	1/1/0001
05800	S	M	OUG	V	00200	007		12	080171	1/1/0001
05800	S	M	OUG	II	00255	025		12	080171	1/1/0001

OFFICE: 311

ROUTE: 564

ST_REF_NO: 0000054410

DERBY LANDING CIRCLE

LUMENS	BULB TYPE	MULT SERIES	POLE TYPE	SHADE	ADDRESS NUMBER	REF	LOCATION	TAX DIST	DATE INST	DATE CHANGE
05800	S	M	CNT	II	03401	001		12	081904	1/1/0001
05800	S	M	CNT	II	03409	002		12	081904	1/1/0001
05800	S	M	CNT	II	03412	004		12	081904	1/1/0001
05800	S	M	CNT	III	03421	003		12	081904	1/1/0001
05800	S	M	CNT	III	03453	005		12	081904	1/1/0001
05800	S	M	CNT	III	03456	006		12	081904	1/1/0001

OFFICE: 311		ROUTE: 564		ST_REF_NO: 0000054500		DEROODE STREET		LUMENS	BULB TYPE	MULT SERIES	POLE TYPE	SHADE	ADDRESS NUMBER	REF	LOCATION	TAX DIST	DATE INST	DATE CHANGE
05800	S	M	SOH	II	00000	007	1ST LT W OF PATTERSON, N SIDE	12	030886	9/9/2009								
05800	S	M	SOH	II	00000	008	2ND LT W OF PATTERSON, N SIDE	12	030886	9/9/2009								
05800	S	M	SOH	II	00000	009	3RD LT W OF PATTERSON, N SIDE	12	030886	9/9/2009								
05800	S	M	SOH	II	00000	014	NE CORNER OF DEROODE AND MCKINLEY	12	030886	9/9/2009								
05800	S	M	SOH	II	00000	015	OPP. 706	12	030886	9/9/2009								
05800	S	M	SOH	II	00000	021	OPP 767	12	030886	9/9/2009								
05800	S	M	SOH	II	00000	022	4TH LT S OF W HIGH VIADUCT, E SIDE	12	030886	9/9/2009								
05800	S	M	SOH	II	00000	023	3RD LT S OF W HIGH VIADUCT, W SIDE	12	030886	9/9/2009								
05800	S	M	SOH	II	00000	025	1ST LT S OF W HIGH ST VIADUCT, W SIDE	12	030886	9/9/2009								
05800	S	M	SOH	II	00000	027	2ND LT. S. OF VALLEY AVE., W. SIDE	12	030886	9/9/2009								
05800	S	M	SOH	II	00000	028	1ST LT. S. OF VALLEY AVE., E. SIDE	12	030886	9/9/2009								
05800	S	M	SOH	II	00434	003		12	030886	9/9/2009								
05800	S	M	SOH	II	00607	012		12	030886	9/9/2009								
05800	S	M	SOH	II	00848	024	2ND LT S OF W HIGH VIADUCT, W SIDE	12	030886	9/9/2009								
05800	S	M	SOH	II	00000	001	SIDE 603 S. BROADWAY	12	030886	1/1/0001								
05800	S	M	SOH	II	00000	004	2ND LT. E. OF PATTERSON, S. SIDE	12	030886	1/1/0001								
05800	S	M	SOH	II	00000	005	1ST LT. E. OF PATTERSON, S. SIDE	12	030886	1/1/0001								
05800	S	M	SOH	II	00000	006	1ST LT. E. OF PATTERSON, N. SIDE	12	030886	1/1/0001								
05800	S	M	SOH	II	00000	013	OPP. 616	12	030886	1/1/0001								
05800	S	M	SOH	II	00000	020	OPP. 753	12	030886	1/1/0001								
05800	S	M	SOH	II	00000	026	UNDER W. HIGH VIADUCT	12	030886	1/1/0001								
05800	S	M	SOH	II	00418	002		12	030886	1/1/0001								
05800	S	M	SOH	II	00536	010		12	030886	1/1/0001								
05800	S	M	SOH	II	00603	011		12	030886	1/1/0001								
05800	S	M	SOH	II	00712	016		12	030886	1/1/0001								
05800	S	M	SOH	II	00716	017		12	030886	1/1/0001								
05800	S	M	SOH	II	00730	018		12	030886	1/1/0001								
05800	S	M	SOH	II	00740	019		12	030886	1/1/0001								
OFFICE: 311		ROUTE: 564		ST_REF_NO: 0000054600		DES COGNETS LANE		LUMENS	BULB TYPE	MULT SERIES	POLE TYPE	SHADE	ADDRESS NUMBER	REF	LOCATION	TAX DIST	DATE INST	DATE CHANGE
04000	S	M	OUG	II	00000	231	SIDE OF 3508 COLTNECK LANE	12	011581	9/9/2009								
04000	S	M	OUG	II	02004	232		12	111580	9/9/2009								

OFFICE: 311		ROUTE: 564		ST_REF_NO: 00000054600		DES COGNETS LANE		LUMENS	BULB TYPE	MULT SERIES	POLE TYPE	SHADE	ADDRESS NUMBER	REF	LOCATION	TAX DIST	DATE INST	DATE CHANGE
04000	S	M	OUG	V	02016	234										12	011581	9/9/2009
04000	S	M	OUG	II	02017	233										12	041582	9/9/2009

OFFICE: 311		ROUTE: 564		ST_REF_NO: 00000054650		DESDEMONA WAY		LUMENS	BULB TYPE	MULT SERIES	POLE TYPE	SHADE	ADDRESS NUMBER	REF	LOCATION	TAX DIST	DATE INST	DATE CHANGE
05800	S	M	CNT	II	00000	001									SIDE OF 2092 TWAIN RIDGE DR ON DESDEMONA WAY	12	080505	1/1/0001
05800	S	M	CNT	II	04213	002										12	080505	1/1/0001
05800	S	M	CNT	II	04224	003										12	080505	1/1/0001
05800	S	M	CNT	II	04233	004										12	080505	1/1/0001
05800	S	M	CNT	II	04244	005										12	080505	1/1/0001
05800	S	M	CNT	II	04253	006										12	080505	1/1/0001
05800	S	M	CNT	II	04268	007										12	080505	1/1/0001
05800	S	M	CNT	II	04276	008										12	080505	9/9/2009
05800	S	M	CNT	II	04293	009										12	080505	1/1/0001

OFFICE: 311		ROUTE: 564		ST_REF_NO: 00000054700		DESHA ROAD		LUMENS	BULB TYPE	MULT SERIES	POLE TYPE	SHADE	ADDRESS NUMBER	REF	LOCATION	TAX DIST	DATE INST	DATE CHANGE
05800	S	M	SOH	I	00109	000										12	061168	9/9/2009
05800	S	M	SOH	I	00201	000										12	061168	9/9/2009
05800	S	M	SOH	I	00215	000										12	061168	9/9/2009
05800	S	M	SOH	I	00307	000										12	061168	9/9/2009
05800	S	M	SOH	I	00322	000										12	061168	9/9/2009
05800	S	M	SOH	I	00335	000										12	061168	9/9/2009
05800	S	M	OUG	II	00000	029									OPP. 121	12	101468	1/1/0001
05800	S	M	SOH	I	00112	000										12	061168	1/1/0001
05800	S	M	SOH	I	00118	000										12	061168	1/1/0001
05800	S	M	SOH	I	00233	000										12	061168	1/1/0001
05800	S	M	SOH	I	00239	000										12	061168	1/1/0001
05800	S	M	SOH	I	00316	000										12	061168	1/1/0001

OFFICE: 311

ROUTE: 564

ST_REF_NO: 00000054720

DESTIN COURT

LUMENS	BULB TYPE	MULT SERIES	POLE TYPE	SHADE	ADDRESS NUMBER	REF	LOCATION	TAX DIST	DATE INST	DATE CHANGE
05800	S	M	CNT	II	03400	002		12	070896	1/1/0001
05800	S	M	CNT	II	03409	001		12	070896	1/1/0001

OFFICE: 311

ROUTE: 564

ST_REF_NO: 00000054800

DETROIT AVENUE

LUMENS	BULB TYPE	MULT SERIES	POLE TYPE	SHADE	ADDRESS NUMBER	REF	LOCATION	TAX DIST	DATE INST	DATE CHANGE
05800	S	M	SOH	I	00933	000		12	011478	9/9/2009
05800	S	M	SOH	I	00954	000		12	011478	9/9/2009
05800	S	M	SOH	II	00000	001	SIDE OF 901 WINCHESTER RD.	12	110160	1/1/0001
05800	S	M	SOH	II	00000	002	SIDE OF 901 WINCHESTER RD.	12	110160	1/1/0001
05800	S	M	SOH	I	00000	003	SIDE OF 840 WINCHESTER RD.	12	011478	1/1/0001
05800	S	M	SOH	I	00922	000		12	011478	1/1/0001
05800	S	M	SOH	I	00940	000		12	011478	1/1/0001
05800	S	M	SOH	I	00951	000		12	011478	1/1/0001
05800	S	M	SOH	I	00963	000		12	011478	1/1/0001

OFFICE: 311

ROUTE: 564

ST_REF_NO: 00000055000

DEVINE AVENUE

LUMENS	BULB TYPE	MULT SERIES	POLE TYPE	SHADE	ADDRESS NUMBER	REF	LOCATION	TAX DIST	DATE INST	DATE CHANGE
04000	S	M	SOH	II	00107	002		12	030886	9/9/2009
04000	S	M	SOH	II	00000	001	SIDE 104 CISCO RD.	12	030886	1/1/0001

OFFICE: 311

ROUTE: 564

ST_REF_NO: 00000055100

DEVONIA AVENUE

LUMENS	BULB TYPE	MULT SERIES	POLE TYPE	SHADE	ADDRESS NUMBER	REF	LOCATION	TAX DIST	DATE INST	DATE CHANGE
05800	S	M	SOH	II	00120	002		12	120463	9/9/2009
05800	S	M	SOH	II	00000	001	SIDE OF 1104 N. LIMESTONE	12	120463	1/1/0001
05800	S	M	SOH	II	00141	003		12	120463	1/1/0001
05800	S	M	SOH	II	00154	004		12	120463	1/1/0001
05800	S	M	SOH	II	00173	005		12	120463	1/1/0001
05800	S	M	SOH	II	00210	006		12	120463	1/1/0001
05800	S	M	SOH	II	00233	007		12	120463	1/1/0001
05800	S	M	SOH	II	00242	008		12	120463	1/1/0001

OFFICE: 311							ROUTE: 564			
ST_REF_NO: 0000055200							DEVONPORT CIRCLE			
LUMENS	BULB TYPE	MULT SERIES	POLE TYPE	SHADE	ADDRESS NUMBER	REF	LOCATION	TAX DIST	DATE INST	DATE CHANGE
05800	S	M	OUG	V	01163	000		12	062167	1/1/0001
05800	S	M	OUG	II	01179	005		12	021367	1/1/0001

OFFICE: 311							ROUTE: 564			
ST_REF_NO: 0000055300							DEVONPORT DRIVE			
LUMENS	BULB TYPE	MULT SERIES	POLE TYPE	SHADE	ADDRESS NUMBER	REF	LOCATION	TAX DIST	DATE INST	DATE CHANGE
09500	S	M	OUG	II	00000	011	SIDE OF 1429 VILLAGE DR.	12	030774	9/9/2009
10000	M	M	OUG	II	00000	077	SIDE OF 1400 ALEXANDRIA DR	12	111580	9/9/2009
05800	S	M	OUG	II	00000	078	SIDE OF 1400 ALEXANDRIA DR	12	030874	9/9/2009
09500	S	M	OUG	II	02220	013		12	080171	9/9/2009
05800	S	M	OUG	II	00000	003	SIDE OF 1236 BORDEAUX DR.	12	021367	1/1/0001
05800	S	M	OUG	II	00000	035	SIDE OF 1425 ALEXANDRIA DR.	12	030874	1/1/0001
05800	S	M	OUG	II	01192	004		12	021367	1/1/0001
05800	S	M	OUG	II	01215	000		12	041466	1/1/0001
05800	S	M	OUG	II	01220	002		12	021367	1/1/0001
05800	S	M	OUG	II	01247	000		12	100172	1/1/0001
05800	S	M	OUG	II	01248	066		12	021367	1/1/0001
05800	S	M	OUG	II	01276	000		12	041466	1/1/0001
05800	S	M	OUG	II	01283	063		12	021367	1/1/0001
05800	S	M	OUG	II	01296	000		12	041466	1/1/0001
05800	S	M	OUG	II	01309	000		12	062167	1/1/0001
05800	S	M	OUG	II	01328	000		12	060870	1/1/0001
05800	S	M	OUG	II	01329	000		12	060870	1/1/0001
05800	S	M	OUG	II	01344	000		12	060870	1/1/0001
05800	S	M	OUG	II	01364	000		12	091874	1/1/0001
05800	S	M	OUG	II	01365	000		12	030874	1/1/0001
10000	M	M	OUG	II	02223	010		12	090170	1/1/0001
10000	M	M	OUG	II	02223	012		12	090170	1/1/0001
10000	M	M	OUG	II	02223	014		12	030874	1/1/0001

OFFICE: 311							ROUTE: 564			
ST_REF_NO: 0000055400							DEVONSHIRE AVENUE			
LUMENS	BULB TYPE	MULT SERIES	POLE TYPE	SHADE	ADDRESS NUMBER	REF	LOCATION	TAX DIST	DATE INST	DATE CHANGE
04000	S	M	SOH	II	00000	009	SIDE 512 PYKE RD.	12	020886	1/1/0001

OFFICE: 311

ROUTE: 564

ST_REF_NO: 0000055400 DEVONSHIRE AVENUE

LUMENS	BULB TYPE	MULT SERIES	POLE TYPE	SHADE	ADDRESS NUMBER	REF	LOCATION	TAX DIST	DATE INST	DATE CHANGE
04000	S	M	SOH	II	00000	011	SIDE FRONT OF 515 GIBSON AVE.	12	020886	1/1/0001

OFFICE: 311

ROUTE: 564

ST_REF_NO: 0000055500 DEW COURT

LUMENS	BULB TYPE	MULT SERIES	POLE TYPE	SHADE	ADDRESS NUMBER	REF	LOCATION	TAX DIST	DATE INST	DATE CHANGE
04000	S	M	OUG	II	00000	114	SIDE OF 3217 COOL WATER ON DEW CT.	12	011584	1/1/0001
04000	S	M	OUG	II	01001	115		12	010888	1/1/0001

OFFICE: 311

ROUTE: 564

ST_REF_NO: 0000055600 DEWEESE STREET

LUMENS	BULB TYPE	MULT SERIES	POLE TYPE	SHADE	ADDRESS NUMBER	REF	LOCATION	TAX DIST	DATE INST	DATE CHANGE
50000	S	M	SOH	III	00000	005	1ST LT. N. OF SHORT ST., W. SIDE	12	061563	9/9/2009
22000	S	M	SOH	II	00148	000		12	050867	4/3/2012
22000	S	M	OUG	II	00169	000		12	091967	9/9/2009
20000	M	M	SOH	III	00000	001	1ST LT. N. OF MAIN ST., W. SIDE	12	061563	1/1/0001
20000	M	M	OUG	III	00000	002	1ST LT. N. OF MAIN ST., E. SIDE	12	061563	1/1/0001
20000	M	M	SOH	III	00000	003	2ND LT. N. OF MAIN ST., W. SIDE	12	061563	1/1/0001
20000	M	M	SOH	III	00000	004	SE CORNER OF SHORT AND DEWEESE ST.	12	061563	1/1/0001
20000	M	M	SOH	III	00134	006		12	061563	1/1/0001
20000	M	M	SOH	II	00141	000		12	091967	1/1/0001
20000	M	M	SOH	II	00158	000		12	110894	1/1/0001

OFFICE: 311

ROUTE: 564

ST_REF_NO: 0000055700 DEWEY DRIVE

LUMENS	BULB TYPE	MULT SERIES	POLE TYPE	SHADE	ADDRESS NUMBER	REF	LOCATION	TAX DIST	DATE INST	DATE CHANGE
04000	S	M	OUG	V	03163	006		12	081477	1/1/0001
04000	S	M	OUG	II	03171	005		12	081477	1/1/0001
04000	S	M	OUG	II	03182	004		12	081477	1/1/0001
04000	S	M	OUG	II	03191	002		12	081477	1/1/0001
04000	S	M	OUG	II	03198	001		12	081477	1/1/0001

OFFICE: 311

ROUTE: 564

ST_REF_NO: 0000055710 DIAZ ALLEY

LUMENS	BULB TYPE	MULT SERIES	POLE TYPE	SHADE	ADDRESS NUMBER	REF	LOCATION	TAX DIST	DATE INST	DATE CHANGE
05800	S	M	SOH	I	00000	001	1ST LT. N. OF EASTLAND PKWY, W SIDE	12	012069	9/9/2009

OFFICE: 311

ROUTE: 564

ST_REF_NO: 0000055710

DIAZ ALLEY

LUMENS	BULB TYPE	MULT SERIES	POLE TYPE	SHADE	ADDRESS NUMBER	REF	LOCATION	TAX DIST	DATE INST	DATE CHANGE
05800	S	M	SOH	I	00000	002	2ND LT. N. OF EASTLAND PKWY, W SIDE	12	012069	9/9/2009
05800	S	M	SOH	I	00000	003	3RD LT. N. OF EASTLAND PKWY, W SIDE		012069	9/9/2009
05800	S	M	SOH	I	00000	004	2ND LT. N. OF COMMERCIAL DR	12	012069	9/9/2009
05800	S	M	SOH	I	00000	005	1ST LT. N. OF COMMERCIAL DR.,E. SIDE	12	012069	1/1/0001

OFFICE: 311

ROUTE: 564

ST_REF_NO: 0000055800

DICKSONIA CIRCLE

LUMENS	BULB TYPE	MULT SERIES	POLE TYPE	SHADE	ADDRESS NUMBER	REF	LOCATION	TAX DIST	DATE INST	DATE CHANGE
05800	S	M	OUG	V	00601	039	changed out bad fixture	12	051582	7/30/2009
05800	S	M	OUG	II	00613	038		12	100884	9/8/2011

OFFICE: 311

ROUTE: 564

ST_REF_NO: 0000055900

DICKSONIA COURT

LUMENS	BULB TYPE	MULT SERIES	POLE TYPE	SHADE	ADDRESS NUMBER	REF	LOCATION	TAX DIST	DATE INST	DATE CHANGE
04000	S	M	OUG	II	00000	043	SIDE 3752 DICKSONIA DRIVE	12	100884	1/1/0001
04000	S	M	OUG	V	00716	044		12	100884	1/1/0001

OFFICE: 311

ROUTE: 564

ST_REF_NO: 0000056000

DICKSONIA DRIVE

LUMENS	BULB TYPE	MULT SERIES	POLE TYPE	SHADE	ADDRESS NUMBER	REF	LOCATION	TAX DIST	DATE INST	DATE CHANGE
04000	S	M	OUG	II	00000	036	SIDE OF 612 DICKSONIA	12	051582	9/9/2009
04000	S	M	OUG	II	00000	051	SIDE OF 3997 FOREST GREEN DR	12	110885	9/9/2009
04000	S	M	OUG	II	03708	035		12	100884	9/9/2009
04000	S	M	OUG	II	03788	054		12	110885	9/9/2009
04000	S	M	OUG	II	03812	052		12	110885	9/9/2009
04000	S	M	OUG	II	03701	034		12	100884	1/1/0001
04000	S	M	OUG	II	03736	037		12	100884	1/1/0001
04000	S	M	OUG	II	03748	040		12	121582	1/1/0001
04000	S	M	OUG	II	03760	041		12	100884	1/1/0001
04000	S	M	OUG	II	03765	042		12	100884	1/1/0001
04000	S	M	OUG	II	03793	053		12	110885	1/1/0001

OFFICE: 311		ROUTE: 564		ST_REF_NO: 00000056100		DINSMORE DRIVE		LUMENS	BULB TYPE	MULT SERIES	POLE TYPE	SHADE	ADDRESS NUMBER	REF	LOCATION	TAX DIST	DATE INST	DATE CHANGE
05800	S	M	OUG	II	00000	081	OPP. 2216	12	020367	1/1/0001								
05800	S	M	OUG	II	00000	083	OPP. 2248	12	020367	1/1/0001								
05800	S	M	OUG	II	02200	080		12	020367	1/1/0001								
05800	S	M	OUG	II	02232	082		12	020367	1/1/0001								

OFFICE: 311		ROUTE: 564		ST_REF_NO: 00000056110		DIX DRIVE		LUMENS	BULB TYPE	MULT SERIES	POLE TYPE	SHADE	ADDRESS NUMBER	REF	LOCATION	TAX DIST	DATE INST	DATE CHANGE
05800	S	M	OUG	II	00000	071	SIDE OF 3745 NIAGARA DR.	12	091574	1/1/0001								
05800	S	M	OUG	II	01358	079		12	111478	1/1/0001								
05800	S	M	OUG	II	01375	078		12	091574	1/1/0001								
05800	S	M	OUG	II	01386	000		12	071475	1/1/0001								

OFFICE: 311		ROUTE: 564		ST_REF_NO: 00000056200		DIXIANA DRIVE		LUMENS	BULB TYPE	MULT SERIES	POLE TYPE	SHADE	ADDRESS NUMBER	REF	LOCATION	TAX DIST	DATE INST	DATE CHANGE
05800	S	M	OUG	II	00000	074	SIDE OF 3411 GREENTREE RD.	12	071562	1/1/0001								
05800	S	M	OUG	II	03421	000		12	071562	1/1/0001								
05800	S	M	OUG	II	03428	000		12	071562	1/1/0001								
05800	S	M	OUG	II	03441	000		12	071562	1/1/0001								
05800	S	M	OUG	II	03452	000		12	071562	1/1/0001								
05800	S	M	OUG	II	03465	000		12	071562	1/1/0001								
05800	S	M	OUG	II	03476	000		12	071562	1/1/0001								

OFFICE: 311		ROUTE: 564		ST_REF_NO: 00000056300		DIXIE COURT		LUMENS	BULB TYPE	MULT SERIES	POLE TYPE	SHADE	ADDRESS NUMBER	REF	LOCATION	TAX DIST	DATE INST	DATE CHANGE
09500	S	M	SOH	I	00000	001	SIDE OF 443 COLUMBIA AVE.	12	060162	1/1/0001								
09500	S	M	SOH	I	00002	000		12	060162	1/1/0001								
09500	S	M	SOH	I	00010	000		12	060162	1/1/0001								

OFFICE: 311		ROUTE: 564		ST_REF_NO: 00000056310		DIXON ALLEY		LUMENS	BULB TYPE	MULT SERIES	POLE TYPE	SHADE	ADDRESS NUMBER	REF	LOCATION	TAX DIST	DATE INST	DATE CHANGE
05800	S	M	SOH	I	00000	001	SIDE OF 321 JEFFERSON ST.	12	021666	1/1/0001								

OFFICE: 311

ROUTE: 564

ST_REF_NO: 00000056410

DOE MEADOW COURT

LUMENS	BULB TYPE	MULT SERIES	POLE TYPE	SHADE	ADDRESS NUMBER	REF	LOCATION	TAX DIST	DATE INST	DATE CHANGE
05800	S	M	CNT	II	00000	001	SIDE OF 3612 PHEASANT RUN	12	110894	9/9/2009
05800	S	M	CNT	III	01001	002		12	110894	9/9/2009

OFFICE: 311

ROUTE: 564

ST_REF_NO: 00000056500

DOGWOOD DRIVE

LUMENS	BULB TYPE	MULT SERIES	POLE TYPE	SHADE	ADDRESS NUMBER	REF	LOCATION	TAX DIST	DATE INST	DATE CHANGE
05800	S	M	OUG	II	00000	049	SIDE OF 880 TEAROSE DR.	12	090363	1/1/0001
05800	S	M	OUG	II	02013	000		12	102263	1/1/0001
05800	S	M	OUG	II	02028	000		12	090363	1/1/0001
05800	S	M	OUG	II	02041	000		12	090363	1/1/0001
05800	S	M	OUG	II	02056	000		12	090363	1/1/0001
05800	S	M	OUG	II	02069	000		12	090363	1/1/0001
05800	S	M	OUG	II	02080	000		12	090164	1/1/0001

OFFICE: 311

ROUTE: 564

ST_REF_NO: 00000056680

ARUM PARK

LUMENS	BULB TYPE	MULT SERIES	POLE TYPE	SHADE	ADDRESS NUMBER	REF	LOCATION	TAX DIST	DATE INST	DATE CHANGE
05800	S		CNT	II	04513	001		12	062810	1/1/0001
05800	S		CNT	II	04525	002		12	062810	1/1/0001

OFFICE: 311

ROUTE: 564

ST_REF_NO: 00000056700

DOMINICAN DRIVE

LUMENS	BULB TYPE	MULT SERIES	POLE TYPE	SHADE	ADDRESS NUMBER	REF	LOCATION	TAX DIST	DATE INST	DATE CHANGE
05800	S	M	OUG	II	00449	000		12	070566	1/1/0001
05800	S	M	OUG	II	00462	000		12	070566	1/1/0001
05800	S	M	OUG	II	00481	000		12	070566	1/1/0001
05800	S	M	OUG	II	00496	000		12	070566	1/1/0001

OFFICE: 311

ROUTE: 564

ST_REF_NO: 00000056800

DON ANNA DRIVE

LUMENS	BULB TYPE	MULT SERIES	POLE TYPE	SHADE	ADDRESS NUMBER	REF	LOCATION	TAX DIST	DATE INST	DATE CHANGE
05800	S	M	OUG	II	00000	005	SIDE OF 980 DE PORRES AVE.	12	080169	9/9/2009
05800	S	M	OUG	II	00000	006	BETWEEN LIMA DR. AND DE PORRES AVE., S. SIDE	12	081875	1/1/0001

OFFICE: 311 **ROUTE: 564**
ST_REF_NO: 00000056900 DONABROOK COURT

LUMENS	BULB TYPE	MULT SERIES	POLE TYPE	SHADE	ADDRESS NUMBER	REF	LOCATION	TAX DIST	DATE INST	DATE CHANGE
09500	S	M	OUG	II	00173	048		12	010886	1/1/0001
09500	S	M	OUG	II	00181	049	upgraded to 9500 June 2005	12	010886	1/1/0001

OFFICE: 311 **ROUTE: 564**
ST_REF_NO: 00000057000 DONCASTER COURT

LUMENS	BULB TYPE	MULT SERIES	POLE TYPE	SHADE	ADDRESS NUMBER	REF	LOCATION	TAX DIST	DATE INST	DATE CHANGE
05800	S	M	OUG	II	00000	112	SIDE OF 1746 HARROGATE RD.	12	081869	1/1/0001
05800	S	M	OUG	II	00487	000		12	100169	1/1/0001

OFFICE: 311 **ROUTE: 564**
ST_REF_NO: 00000057100 DONCO COURT

LUMENS	BULB TYPE	MULT SERIES	POLE TYPE	SHADE	ADDRESS NUMBER	REF	LOCATION	TAX DIST	DATE INST	DATE CHANGE
04000	S	M	OUG	II	01843	000		12	120170	9/9/2009
05800	S	M	OUG	V	01827	000		12	120169	1/1/0001

OFFICE: 311 **ROUTE: 564**
ST_REF_NO: 00000057200 DONLEY AVENUE

LUMENS	BULB TYPE	MULT SERIES	POLE TYPE	SHADE	ADDRESS NUMBER	REF	LOCATION	TAX DIST	DATE INST	DATE CHANGE
05800	S	M	SOH	I	00000	001	SIDE OF 135 YORK ST	12	111866	9/9/2009

OFFICE: 311 **ROUTE: 564**
ST_REF_NO: 00000057280 DORCHESTER PLACE

LUMENS	BULB TYPE	MULT SERIES	POLE TYPE	SHADE	ADDRESS NUMBER	REF	LOCATION	TAX DIST	DATE INST	DATE CHANGE
05800	S	M	CNT	II	00000	001	SIDE OF 568 VINCENT WAY ON DORCHESTER PLACE	12	030602	1/1/0001
05800	S	M	CNT	II	00000	003	SIDE OF 529 HADLOW STREET ON DORCHESTER PLACE	12	030602	1/1/0001
05800	S	M	CNT	II	00000	004	SIDE OF 520 HADLOW STREET ON DORCHESTER PLACE	12	030602	1/1/0001
09500	S	M	CNT	II	00000	030	ACROSS FROM 3292 DORCHESTER PLACE	12	090506	1/1/0001
05800	S	M	CNT	II	00000	032	REAR OF 3272 MARSTON PL ON DORCHESTER PLACE	12	090506	1/1/0001
09500	S	M	CNT	II	03268	033		12	090506	1/1/0001
05800	S	M	CNT	II	03284	031		12	090506	1/1/0001
05800	S	M	CNT	II	03308	002		12	030602	9/9/2009

OFFICE: 311		ROUTE: 564		ST_REF_NO: 00000057300		DORSET DRIVE		LUMENS	BULB TYPE	MULT SERIES	POLE TYPE	SHADE	ADDRESS NUMBER	REF	LOCATION	TAX DIST	DATE INST	DATE CHANGE
	09500	S	M	OUG	II	02068	000									12	101162	9/9/2009
	09500	S	M	OUG	II	02053	000									12	081363	1/1/0001
	09500	S	M	OUG	II	02077	000									12	101162	1/1/0001
	09500	S	M	OUG	II	02005	000									12	120960	1/1/0001
	09500	S	M	OUG	II	02016	000									12	120960	1/1/0001
	09500	S	M	OUG	II	02029	000									12	120960	1/1/0001
	09500	S	M	OUG	II	02044	000									12	120960	1/1/0001

OFFICE: 311		ROUTE: 564		ST_REF_NO: 00000057305		DOTHAN COURT		LUMENS	BULB TYPE	MULT SERIES	POLE TYPE	SHADE	ADDRESS NUMBER	REF	LOCATION	TAX DIST	DATE INST	DATE CHANGE
	05800	S	M	OUG	V	04485	005									12	020888	1/1/0001
	05800	S	M	OUG	II	04497	004									12	020888	1/1/0001

OFFICE: 311		ROUTE: 564		ST_REF_NO: 00000057310		DOTHAN DRIVE		LUMENS	BULB TYPE	MULT SERIES	POLE TYPE	SHADE	ADDRESS NUMBER	REF	LOCATION	TAX DIST	DATE INST	DATE CHANGE
	04000	S	M	OUG	II	00000	001									12	020887	9/9/2009
	04000	S	M	OUG	II	04504	003									12	020887	1/1/0001
	04000	S	M	OUG	II	04513	002									12	020887	1/1/0001

OFFICE: 311		ROUTE: 564		ST_REF_NO: 00000057400		DOUGLAS AVENUE		LUMENS	BULB TYPE	MULT SERIES	POLE TYPE	SHADE	ADDRESS NUMBER	REF	LOCATION	TAX DIST	DATE INST	DATE CHANGE
	05800	S		OUG	II	00569	009									12	090909	1/1/0001
	05800	S		OUG	II	00580	010									12	090909	1/1/0001
	09500	S	M	OUG	II	00000	001									12	081903	9/9/2009
	05800	S	M	SOH	II	00000	002									12	050969	9/9/2009
	05800	S	M	OUG	II	00000	005									12	081903	1/1/0001
	09500	S	M	OUG	II	00000	011									12	081903	9/9/2009
	05800	S	M	SOH	II	00467	000									12	050969	9/9/2009
	05800	S	M	OUG	II	00520	004									12	081903	1/1/0001
	05800	S	M	OUG	II	00537	006									12	081903	1/1/0001
	05800	S	M	OUG	II	00545	007									12	081903	1/1/0001

OFFICE: 311

ROUTE: 564

ST_REF_NO: 0000057400

DOUGLAS AVENUE

LUMENS	BULB TYPE	MULT SERIES	POLE TYPE	SHADE	ADDRESS NUMBER	REF	LOCATION	TAX DIST	DATE INST	DATE CHANGE
05800	S	M	OUG	II	00556	008		12	081903	1/1/0001
05800	S	M	SOH	II	00412	000		12	050969	1/1/0001
05800	S	M	SOH	II	00417	000		12	050969	1/1/0001
05800	S	M	SOH	II	00426	000		12	050969	1/1/0001
05800	S	M	SOH	II	00433	000		12	050969	1/1/0001
05800	S	M	SOH	II	00440	000		12	050969	1/1/0001
05800	S	M	SOH	II	00449	000		12	050969	1/1/0001
05800	S	M	SOH	II	00452	000		12	050969	1/1/0001

OFFICE: 311

ROUTE: 564

ST_REF_NO: 0000057410

DOUGLAS LOOP

LUMENS	BULB TYPE	MULT SERIES	POLE TYPE	SHADE	ADDRESS NUMBER	REF	LOCATION	TAX DIST	DATE INST	DATE CHANGE
05800	S		OUG	II	00513	002		12	090909	1/1/0001
05800	S		OUG	II	00517	003		12	090909	1/1/0001

OFFICE: 311

ROUTE: 564

ST_REF_NO: 0000057450

DOVE CREEK COURT

LUMENS	BULB TYPE	MULT SERIES	POLE TYPE	SHADE	ADDRESS NUMBER	REF	LOCATION	TAX DIST	DATE INST	DATE CHANGE
05800	S	M	OUG	II	03804	001		12	060895	1/1/0001

OFFICE: 311

ROUTE: 564

ST_REF_NO: 0000057500

DOVE RUN ROAD

LUMENS	BULB TYPE	MULT SERIES	POLE TYPE	SHADE	ADDRESS NUMBER	REF	LOCATION	TAX DIST	DATE INST	DATE CHANGE
09500	S	M	OUG	II	00000	059	OPPOSITE 1065	12	121073	9/9/2009
09500	S	M	OUG	II	00000	064	SIDE OF 3368 TATES CREEK RD. IN MEDIAN	12	121073	9/9/2009
09500	S	M	OUG	II	00000	065	SIDE OF 3368 TATES CREEK RD. IN MEDIAN	12	121073	9/9/2009
09500	S	M	OUG	II	00000	066	SIDE OF 3368 TATES CREEK RD. IN MEDIAN	12	121073	9/9/2009
09500	S	M	OUG	II	01025	062		12	081475	9/9/2009
10000	M	M	OUG	II	00000	057	OPPOSITE 1081	12	121073	1/1/0001
10000	M	M	OUG	II	00000	061	OPPOSITE 1025	12	121073	1/1/0001
10000	M	M	OUG	II	00000	063	SIDE OF 3368 TATES CREEK RD. IN MEDIAN	12	121073	1/1/0001
10000	M	M	OUG	II	01055	060		12	121073	1/1/0001

OFFICE: 311

ROUTE: 564

ST_REF_NO: 00000057600

DOVER ROAD

LUMENS	BULB TYPE	MULT SERIES	POLE TYPE	SHADE	ADDRESS NUMBER	REF	LOCATION	TAX DIST	DATE INST	DATE CHANGE
04000	S	M	OUG	II	00000	009	SIDE OF 1678 RUSSELL CAVE PIKE	12	060465	9/9/2009
05800	S	M	OUG	II	00532	001	opp 533	12	010270	9/9/2009
05800	S	M	OUG	II	00000	022	SIDE OF 1756 HAWTHORNE LANE	12	041478	1/1/0001
05800	S	M	OUG	II	00000	024	SIDE OF 1761 HAWTHORNE LANE	12	111580	1/1/0001
05800	S	M	OUG	II	00000	027	SIDE OF 1732 PALMYRA AVE.	12	111580	1/1/0001
05800	S	M	OUG	II	00445	023		12	111580	1/1/0001
05800	S	M	OUG	II	00461	025		12	041478	1/1/0001
05800	S	M	OUG	II	00505	026		12	041478	1/1/0001
05800	S	M	OUG	II	00525	028		12	111580	1/1/0001
05800	S	M	OUG	II	00541	000		12	010270	1/1/0001
05800	S	M	OUG	II	00548	000		12	021464	1/1/0001
05800	S	M	OUG	II	00557	000		12	060465	1/1/0001
05800	S	M	OUG	II	00560	000		12	021464	1/1/0001
05800	S	M	OUG	II	00573	000		12	021464	1/1/0001
05800	S	M	OUG	II	00580	000		12	010264	1/1/0001
05800	S	M	OUG	II	00401	021		12	041478	1/1/0001

OFFICE: 311

ROUTE: 564

ST_REF_NO: 00000057650

DOVERHILL CIRCLE

LUMENS	BULB TYPE	MULT SERIES	POLE TYPE	SHADE	ADDRESS NUMBER	REF	LOCATION	TAX DIST	DATE INST	DATE CHANGE
05800	S	M	CNT	II	00000	001	SIDE OF 644 WINTER HILL LANE	12	020898	1/1/0001
05800	S	M	CNT	III	03705	002		12	020898	1/1/0001

OFFICE: 311

ROUTE: 564

ST_REF_NO: 00000057700

DOWNING COURT

LUMENS	BULB TYPE	MULT SERIES	POLE TYPE	SHADE	ADDRESS NUMBER	REF	LOCATION	TAX DIST	DATE INST	DATE CHANGE
04000	S	M	OUG	II	00000	011	SIDE OF 3363 SPANGLER DR.	12	051478	1/1/0001
04000	S	M	OUG	II	00409	010		12	051478	1/1/0001

OFFICE: 311

ROUTE: 564

ST_REF_NO: 00000057800

DOWNING PLACE

LUMENS	BULB TYPE	MULT SERIES	POLE TYPE	SHADE	ADDRESS NUMBER	REF	LOCATION	TAX DIST	DATE INST	DATE CHANGE
05800	S	M	OUG	II	03305	012		12	081476	1/1/0001
05800	S	M	OUG	II	03320	013		12	081476	1/1/0001

OFFICE: 311

ROUTE: 564

ST_REF_NO: 0000057800 DOWNING PLACE

LUMENS	BULB TYPE	MULT SERIES	POLE TYPE	SHADE	ADDRESS NUMBER	REF	LOCATION	TAX DIST	DATE INST	DATE CHANGE
05800	S	M	OUG	II	03329	014		12	081477	1/1/0001
05800	S	M	OUG	II	03344	024		12	051582	1/1/0001
05800	S	M	OUG	II	03357	025		12	110893	1/1/0001
05800	S	M	OUG	II	03369	026		12	051582	1/1/0001

OFFICE: 311

ROUTE: 564

ST_REF_NO: 0000057900 DOWNS AVENUE

LUMENS	BULB TYPE	MULT SERIES	POLE TYPE	SHADE	ADDRESS NUMBER	REF	LOCATION	TAX DIST	DATE INST	DATE CHANGE
04000	S	M	SOH	II	00720	211		12	120884	9/9/2009
04000	S	M	SOH	II	00000	210	SIDE 2000 LIBERTY RD.	12	120884	1/1/0001

OFFICE: 311

ROUTE: 564

ST_REF_NO: 0000057950 DOWNY PARK

LUMENS	BULB TYPE	MULT SERIES	POLE TYPE	SHADE	ADDRESS NUMBER	REF	LOCATION	TAX DIST	DATE INST	DATE CHANGE
05800	S		CNT	II	04000	004		12	070910	1/1/0001
05800	S		CNT	II	04005	001		12	070910	1/1/0001
05800	S		CNT	II	04012	003		12	070910	1/1/0001
05800	S		CNT	II	04013	002		12	070910	1/1/0001

OFFICE: 311

ROUTE: 564

ST_REF_NO: 0000058135 DRAYTON PLACE

LUMENS	BULB TYPE	MULT SERIES	POLE TYPE	SHADE	ADDRESS NUMBER	REF	LOCATION	TAX DIST	DATE INST	DATE CHANGE
05800	S	M	CNT	II	00000	008	ACROSS FROM 3301 DRAYTON PLACE	12	030602	1/1/0001
05800	S	M	CNT	II	03236	013		12	030602	9/9/2009
05800	S	M	CNT	II	03252	012		12	030602	1/1/0001
05800	S	M	CNT	II	03260	011		12	030602	1/1/0001
05800	S	M	CNT	II	03272	010		12	030602	1/1/0001
05800	S	M	CNT	II	03280	009		12	030602	1/1/0001
05800	S	M	CNT	II	03312	007		12	030602	9/9/2009
05800	S	M	CNT	II	03329	006		12	030602	1/1/0001
05800	S	M	CNT	II	03340	005		12	030602	1/1/0001
05800	S	M	CNT	II	03357	004		12	030602	1/1/0001

OFFICE: 311		ROUTE: 564		ST_REF_NO: 0000058150		DRESSAGE WAY				
LUMENS	BULB TYPE	MULT SERIES	POLE TYPE	SHADE	ADDRESS NUMBER	REF	LOCATION	TAX DIST	DATE INST	DATE CHANGE
05800	S	M	CNT	II	00000	005	SIDE OF 1305 SADDLE CLUB WAY	12	062205	9/9/2009
05800	S	M	CNT	II	02501	001		12	091001	1/1/0001
05800	S	M	CNT	II	02509	002		12	091001	1/1/0001
05800	S	M	CNT	III	02524	003		12	020800	9/9/2009
05800	S	M	CNT	II	02532	004		12	062205	1/1/0001
OFFICE: 311		ROUTE: 564		ST_REF_NO: 0000058160		DREXAL PASS				
LUMENS	BULB TYPE	MULT SERIES	POLE TYPE	SHADE	ADDRESS NUMBER	REF	LOCATION	TAX DIST	DATE INST	DATE CHANGE
05800	S		CNT	II	00000	001	SIDE OF 2964 MAHALA LN, ON DREXAL PASS	12	051510	1/1/0001
05800	S		CNT	II	03001	004		12	051510	1/1/0001
05800	S		CNT	II	03025	003		12	051510	1/1/0001
05800	S		CNT	II	03036	002		12	051510	1/1/0001
OFFICE: 311		ROUTE: 564		ST_REF_NO: 0000058195		DRIFTER WAY				
LUMENS	BULB TYPE	MULT SERIES	POLE TYPE	SHADE	ADDRESS NUMBER	REF	LOCATION	TAX DIST	DATE INST	DATE CHANGE
05800	S	M	CNT	II	00600	001		12	062907	1/1/0001
05800	S	M	CNT	II	00609	002		12	062907	1/1/0001
OFFICE: 311		ROUTE: 564		ST_REF_NO: 0000058200		DRIFTWOOD PLACE				
LUMENS	BULB TYPE	MULT SERIES	POLE TYPE	SHADE	ADDRESS NUMBER	REF	LOCATION	TAX DIST	DATE INST	DATE CHANGE
05800	S	M	OUG	II	00300	025		12	051581	1/1/0001
05800	S	M	OUG	II	00313	024		12	120898	1/1/0001
OFFICE: 311		ROUTE: 564		ST_REF_NO: 0000058300		DRISCOLL STREET				
LUMENS	BULB TYPE	MULT SERIES	POLE TYPE	SHADE	ADDRESS NUMBER	REF	LOCATION	TAX DIST	DATE INST	DATE CHANGE
05800	S	M	SOH	I	00000	007	OPP 260	12	100466	9/9/2009
05800	S	M	SOH	I	00000	008	2nd LIGHT S OF MANCHESTER ST	12	100466	9/9/2009
05800	S	M	SOH	I	00000	009	3RD LIGHT S OF MANCHESTER ST	12	100466	9/9/2009
05800	S	M	SOH	I	00272	006		12	100466	9/9/2009
05800	S	M	SOH	I	00000	003	1ST LT. S. OF MANCHESTER ST.	12	100466	1/1/0001
05800	S	M	SOH	I	00000	005	OPP 246	12	100466	1/1/0001

OFFICE: 311		ROUTE: 564		ST_REF_NO: 0000058350		DRUMMOND DRIVE				
LUMENS	BULB TYPE	MULT SERIES	POLE TYPE	SHADE	ADDRESS NUMBER	REF	LOCATION	TAX DIST	DATE INST	DATE CHANGE
05800	S		CNT	II	00000	014	SIDE OF 2549 MILSOM LANE ON DRUMMOND DR	12	070210	1/1/0001
05800	S		CNT	II	00000	015	SIDE OF 2548 MILSOM LANE ON DRUMMOND DR	12	070210	1/1/0001
05800	S	M	CNT	II	00000	003	SIDE OF 2517 GLASCOW LANE ON DRUMMOND LANE	12	041706	1/1/0001
05800	S	M	CNT	II	00000	004	SIDE OF 2517 BENBURN CT ON DRUMMOND LANE	12	041706	1/1/0001
05800	S	M	CNT	II	00000	008	SIDE OF 2617 MORAY PLACE ON DRUMMOND LANE	12	041706	1/1/0001
05800	S	M	CNT	II	00000	010	SIDE OF 2500 MORAY PLACE ON DRUMMOND LANE	12	041706	1/1/0001
05800	S	M	CNT	II	02033	013		12	041706	1/1/0001
05800	S	M	CNT	II	02049	011		12	041706	1/1/0001
05800	S	M	CNT	II	02081	009		12	041706	1/1/0001
05800	S	M	CNT	II	02109	007		12	041706	1/1/0001
05800	S	M	CNT	II	02116	006		12	041706	1/1/0001
05800	S	M	CNT	II	02137	005		12	041706	1/1/0001
05800	S	M	CNT	II	02173	002		12	041706	1/1/0001
05800	S	M	CNT	III	02193	001		12	041706	9/9/2009
OFFICE: 311		ROUTE: 564		ST_REF_NO: 0000058600		DUDLEY ROAD				
LUMENS	BULB TYPE	MULT SERIES	POLE TYPE	SHADE	ADDRESS NUMBER	REF	LOCATION	TAX DIST	DATE INST	DATE CHANGE
05800	S	M	OUG	II	00000	037	SIDE OF 1500 FONTAINE RD.	12	010665	1/1/0001
05800	S	M	OUG	II	00309	038		12	010665	1/1/0001
05800	S	M	OUG	II	00326	039		12	050365	1/1/0001
05800	S	M	OUG	II	00341	040		12	050365	1/1/0001
05800	S	M	OUG	II	00400	041		12	010665	1/1/0001
05800	S	M	OUG	II	00421	042		12	110164	1/1/0001
05800	S	M	OUG	II	00424	043		12	110164	1/1/0001
05800	S	M	OUG	II	00435	044		12	110164	1/1/0001
OFFICE: 311		ROUTE: 564		ST_REF_NO: 0000058675		DUFANE POINTE				
LUMENS	BULB TYPE	MULT SERIES	POLE TYPE	SHADE	ADDRESS NUMBER	REF	LOCATION	TAX DIST	DATE INST	DATE CHANGE
05800	S	M	CNT	III	00000	001	SIDE OF 3733 WARGRAVE WALK ON DUFANE POINTE	12	091106	1/1/0001
05800	S	M	CNT	II	00000	002	SIDE OF 3736 POLO CLUB BLVD ON DUFANE POINTE	12	091106	1/1/0001

OFFICE: 311		ROUTE: 564		ST_REF_NO: 00000058700		DUFFY COURT		LUMENS	BULB TYPE	MULT SERIES	POLE TYPE	SHADE	ADDRESS NUMBER	REF	LOCATION	TAX DIST	DATE INST	DATE CHANGE
	04000	S	M	OUG	II	03801	042									12	061580	1/1/0001
	04000	S	M	OUG	V	03809	043									12	061580	1/1/0001

OFFICE: 311		ROUTE: 564		ST_REF_NO: 00000058800		DUKE ROAD		LUMENS	BULB TYPE	MULT SERIES	POLE TYPE	SHADE	ADDRESS NUMBER	REF	LOCATION	TAX DIST	DATE INST	DATE CHANGE
	05800	S	M	OUG	II	00307	000									12	121558	9/9/2009
	05800	S	M	OUG	II	00000	001	OPP 372 DUKE RD								12	120158	1/1/0001
	05800	S	M	OUG	II	00320	000									12	120158	1/1/0001
	05800	S	M	OUG	II	00331	000									12	121558	1/1/0001
	05800	S	M	OUG	II	00358	000									12	120158	1/1/0001

OFFICE: 311		ROUTE: 564		ST_REF_NO: 00000058900		DUNAWAY STREET		LUMENS	BULB TYPE	MULT SERIES	POLE TYPE	SHADE	ADDRESS NUMBER	REF	LOCATION	TAX DIST	DATE INST	DATE CHANGE
	05800	S	M	SOH	I	00000	001	1 ST. LT. S. OF MAXWELL ST., E. SIDE								12	031165	1/1/0001
	05800	S	M	SOH	I	00000	002	1 ST. LT. S. OF PINE ST., E. SIDE								12	031165	1/1/0001

OFFICE: 311		ROUTE: 564		ST_REF_NO: 00000059100		DUNBARTON LANE		LUMENS	BULB TYPE	MULT SERIES	POLE TYPE	SHADE	ADDRESS NUMBER	REF	LOCATION	TAX DIST	DATE INST	DATE CHANGE
	04000	S	M	OUG	V	01099	212									12	110885	9/9/2009
	05800	S	M	OUG	II	01140	208									12	110885	6/25/2013
	04000	S	M	OUG	II	01109	211									12	110885	1/1/0001
	04000	S	M	OUG	II	01120	210									12	111580	1/1/0001
	04000	S	M	OUG	II	01148	235									12	111580	1/1/0001

OFFICE: 311		ROUTE: 564		ST_REF_NO: 00000059190		DUNCAN AVENUE		LUMENS	BULB TYPE	MULT SERIES	POLE TYPE	SHADE	ADDRESS NUMBER	REF	LOCATION	TAX DIST	DATE INST	DATE CHANGE
	05800	S	M	SOH	II	01083	023									12	050898	9/9/2009
	05800	S	M	SOH	II	00000	024	SIDE OF 501 PYKE RD.								12	050898	1/1/0001
	04000	S	M	SOH	II	00000	025	SIDE FRONT OF 502 PYKE RD.								12	020886	1/1/0001
	05800	S	M	SOH	II	00000	026	SIDE OF 502 PYKE RD.								12	050898	1/1/0001
	05800	S	M	SOH	II	01055	021									12	050898	1/1/0001

OFFICE: 311

ROUTE: 564

ST_REF_NO: 00000059190 DUNCAN AVENUE

LUMENS	BULB TYPE	MULT SERIES	POLE TYPE	SHADE	ADDRESS NUMBER	REF	LOCATION	TAX DIST	DATE INST	DATE CHANGE
05800	S	M	SOH	II	01075	022		12	050898	1/1/0001
04000	S	M	SOH	II	00000	027	SIDE FRONT OF 502 GIBSON AVE.	12	020886	1/1/0001

OFFICE: 311

ROUTE: 564

ST_REF_NO: 00000059200 DUNCAN MACHINERY DR

LUMENS	BULB TYPE	MULT SERIES	POLE TYPE	SHADE	ADDRESS NUMBER	REF	LOCATION	TAX DIST	DATE INST	DATE CHANGE
22000	S	M	SOH	II	00000	001	1 ST. LT. W. OF OLD FRANKFORT RD., S. SIDE	12	121578	9/9/2009
10000	M	M	SOH	II	00000	002	2 ND. LT. W. OF OLD FRANKFORT RD., S. SIDE	12	121578	1/1/0001
10000	M	M	SOH	II	00000	003	SIDE OF 704 WERNE DR.	12	121578	1/1/0001
10000	M	M	SOH	II	00000	004	N. SIDE BETWEEN WERNE & WESTLAND DR.	12	121578	1/1/0001

OFFICE: 311

ROUTE: 564

ST_REF_NO: 00000059300 DUNDEE DRIVE

LUMENS	BULB TYPE	MULT SERIES	POLE TYPE	SHADE	ADDRESS NUMBER	REF	LOCATION	TAX DIST	DATE INST	DATE CHANGE
04000	S	M	OUG	II	00000	064	SIDE 3512 NICHOLASVILLE ROAD	12	010886	9/9/2009
04000	S	M	OUG	II	00000	063	SIDE 3512 NICHOLASVILLE RD.	12	010886	1/1/0001
04000	S	M	OUG	II	00107	065		12	010886	1/1/0001
04000	S	M	OUG	II	00110	066		12	010886	1/1/0001
04000	S	M	OUG	II	00117	067		12	010886	1/1/0001
04000	S	M	OUG	II	00121	068		12	010886	1/1/0001

OFFICE: 311

ROUTE: 564

ST_REF_NO: 00000059400 DUNES CIRCLE

LUMENS	BULB TYPE	MULT SERIES	POLE TYPE	SHADE	ADDRESS NUMBER	REF	LOCATION	TAX DIST	DATE INST	DATE CHANGE
05800	S	M	OUG	V	00711	000		12	050969	9/9/2009

OFFICE: 311

ROUTE: 564

ST_REF_NO: 00000059450 DUNHILL LANE

LUMENS	BULB TYPE	MULT SERIES	POLE TYPE	SHADE	ADDRESS NUMBER	REF	LOCATION	TAX DIST	DATE INST	DATE CHANGE
05800	S	M	CNT	II	02200	001		12	120404	1/1/0001
05800	S	M	CNT	II	02205	002		12	120404	9/9/2009
05800	S	M	CNT	II	02212	003		12	120404	9/9/2009
05800	S	M	CNT	III	02225	004		12	120404	1/1/0001
05800	S	M	CNT	II	02236	005		12	120404	9/9/2009
05800	S	M	CNT	II	02241	006		12	120404	9/9/2009

OFFICE: 311

ROUTE: 564

ST_REF_NO: 0000059450 DUNHILL LANE

LUMENS	BULB TYPE	MULT SERIES	POLE TYPE	SHADE	ADDRESS NUMBER	REF	LOCATION	TAX DIST	DATE INST	DATE CHANGE
05800	S	M	CNT	II	02252	007		12	120404	1/1/0001

OFFICE: 311

ROUTE: 564

ST_REF_NO: 0000059500 DUNKIRK COURT

LUMENS	BULB TYPE	MULT SERIES	POLE TYPE	SHADE	ADDRESS NUMBER	REF	LOCATION	TAX DIST	DATE INST	DATE CHANGE
09500	S	M	OUG	II	00000	004	SIDE OF 1950 DUNKIRK DR.	12	090166	1/1/0001
09500	S	M	OUG	II	01938	000		12	122065	1/1/0001
09500	S	M	OUG	II	01957	012		12	010891	1/1/0001
09500	S	M	OUG	II	01981	011		12	010891	1/1/0001
09500	S	M	OUG	II	02009	010		12	010891	1/1/0001

OFFICE: 311

ROUTE: 564

ST_REF_NO: 0000059600 DUNKIRK DRIVE

LUMENS	BULB TYPE	MULT SERIES	POLE TYPE	SHADE	ADDRESS NUMBER	REF	LOCATION	TAX DIST	DATE INST	DATE CHANGE
09500	S	M	OUG	II	00000	113	OPP. 1893	12	110761	9/9/2009
09500	S	M	OUG	II	01878	000		12	120461	9/9/2009
09500	S	M	OUG	II	01935	032		12	122065	9/9/2009
09500	S	M	OUG	II	00000	146	SIDE OF 169 NEWCASTLE ST.	12	081363	1/1/0001
09500	S	M	OUG	II	01871	000		12	110761	1/1/0001
09500	S	M	OUG	II	01885	000		12	060161	1/1/0001
09500	S	M	OUG	II	01899	000		12	101162	1/1/0001
09500	S	M	OUG	II	01902	000		12	101162	1/1/0001
09500	S	M	OUG	II	01910	000		12	101162	1/1/0001
09500	S	M	OUG	II	01911	000		12	090166	1/1/0001
09500	S	M	OUG	II	01923	000		12	090166	1/1/0001
09500	S	M	OUG	II	01928	000		12	101162	1/1/0001
09500	S	M	OUG	II	01950	000		12	122065	1/1/0001
09500	S	M	OUG	II	01974	000		12	122065	1/1/0001
09500	S	M	OUG	II	02008	000		12	090166	1/1/0001
09500	S	M	OUG	II	02029	008		12	120893	1/1/0001
09500	S	M	OUG	II	02032	000		12	122065	1/1/0001
09500	S	M	OUG	II	01839	000		12	100163	1/1/0001
09500	S	M	OUG	II	01845	000		12	100163	1/1/0001
09500	S	M	OUG	II	01850	000		12	120461	1/1/0001

OFFICE: 311		ROUTE: 564		ST_REF_NO: 00000059600		DUNKIRK DRIVE		LUMENS	BULB TYPE	MULT SERIES	POLE TYPE	SHADE	ADDRESS NUMBER	REF	LOCATION	TAX DIST	DATE INST	DATE CHANGE
	09500	S	M	OUG	II	01859	000									12	100163	1/1/0001
	09500	S	M	OUG	II	01864	000									12	100163	1/1/0001

OFFICE: 311		ROUTE: 564		ST_REF_NO: 00000059670		DUNSWOOD PLACE		LUMENS	BULB TYPE	MULT SERIES	POLE TYPE	SHADE	ADDRESS NUMBER	REF	LOCATION	TAX DIST	DATE INST	DATE CHANGE
	05800	S	M	OUG	II	03752	005									12	010897	9/9/2009
	05800	S	M	OUG	II	03708	002									12	010897	1/1/0001
	05800	S	M	OUG	II	00000	001								SIDE OF 1704 ABBINGTON HILL	12	010897	1/1/0001
	05800	S	M	OUG	II	03720	003									12	010897	1/1/0001
	05800	S	M	OUG	II	03732	004									12	010897	1/1/0001

OFFICE: 311		ROUTE: 564		ST_REF_NO: 00000059690		DUNNSTON LANE		LUMENS	BULB TYPE	MULT SERIES	POLE TYPE	SHADE	ADDRESS NUMBER	REF	LOCATION	TAX DIST	DATE INST	DATE CHANGE
	05800	S	M	CNT	II	03000	001									12	100899	1/1/0001
	05800	S	M	CNT	II	03001	002									12	100899	1/1/0001

OFFICE: 311		ROUTE: 564		ST_REF_NO: 00000059700		DUNTREATH DRIVE		LUMENS	BULB TYPE	MULT SERIES	POLE TYPE	SHADE	ADDRESS NUMBER	REF	LOCATION	TAX DIST	DATE INST	DATE CHANGE
	05800	S	M	OUG	II	00000	001								1ST LT. E. OF MASON HEADLEY, N. SIDE	12	050888	1/1/0001
	04000	S	M	OUG	II	00000	002								2ND LT. E. OF MASON HEADLEY, N. SIDE	12	050888	1/1/0001
	04000	S	M	OUG	II	00000	003								3RD LT. E. OF MASON HEADLEY, N. SIDE	12	050888	1/1/0001
	04000	S	M	OUG	II	00000	004								SIDE OF 965 WOLF RUN RD.	12	050888	1/1/0001
	04000	S	M	OUG	II	01623	008									12	050888	1/1/0001
	04000	S	M	OUG	II	01631	007									12	050888	1/1/0001
	04000	S	M	OUG	II	01639	006									12	050888	1/1/0001
	04000	S	M	OUG	II	01647	005									12	050888	1/1/0001

OFFICE: 311		ROUTE: 564		ST_REF_NO: 00000059800		DURHAM COURT		LUMENS	BULB TYPE	MULT SERIES	POLE TYPE	SHADE	ADDRESS NUMBER	REF	LOCATION	TAX DIST	DATE INST	DATE CHANGE
	05800	S	M	OUG	II	01504	000									12	090766	1/1/0001

OFFICE: 311

ROUTE: 564

ST_REF_NO: 00000059805

DURANGO DRIVE

LUMENS	BULB TYPE	MULT SERIES	POLE TYPE	SHADE	ADDRESS NUMBER	REF	LOCATION	TAX DIST	DATE INST	DATE CHANGE
09500	S	M	CNT	II	03201	001		12	060800	1/1/0001
09500	S	M	CNT	II	03212	002		12	060800	1/1/0001
09500	S	M	CNT	III	03221	003		12	060800	1/1/0001

OFFICE: 311

ROUTE: 564

ST_REF_NO: 00000059835

DUVAL STREET

LUMENS	BULB TYPE	MULT SERIES	POLE TYPE	SHADE	ADDRESS NUMBER	REF	LOCATION	TAX DIST	DATE INST	DATE CHANGE
05800	S	M	CNT	II	00000	001	1ST LT E OF SARON DR, S SIDE ON DUVAL STREET	12	120902	1/1/0001
05800	S	M	CNT	II	00000	002	2ND LT E OF SARON DR,S SIDE ON DUVAL STREET	12	120902	1/1/0001
05800	S	M	CNT	II	00000	003	3RD LT E OF SARON DR,S SIDE ON DUVAL STREET	12	120902	1/1/0001
05800	S	M	CNT	II	00000	004	4TH LT E OF SARON DR,S SIDE ON DUVAL STREET	12	120902	1/1/0001
05800	S	M	CNT	II	00000	005	5TH LT E OF SARON DR,S SIDE ON DUVAL STREET	12	120902	1/1/0001
05800	S	M	CNT	II	00000	006	6TH LT E OF SARON DR,S SIDE ON DUVAL STREET	12	120902	1/1/0001
05800	S	M	CNT	II	00000	007	7TH LT E OF SARON DR,N SIDE ON DUVAL STREET	12	120902	1/1/0001
05800	S	M	CNT	II	00000	008	8TH LT E OF SARON DR,N SIDE ON DUVAL STREET	12	120902	1/1/0001
05800	S	M	CNT	II	00000	009	9TH LT E OF SARON DR,S SIDE ON DUVAL STREET	12	120902	1/1/0001

OFFICE: 311

ROUTE: 564

ST_REF_NO: 00000059850

DYLAN PLACE

LUMENS	BULB TYPE	MULT SERIES	POLE TYPE	SHADE	ADDRESS NUMBER	REF	LOCATION	TAX DIST	DATE INST	DATE CHANGE
04000	S	M	OUG	II	03899	001	CHANGED HSE NUMBER ONLY	12	090891	2/17/2014
04000	S	M	OUG	II	03883	002		12	090891	1/1/0001

OFFICE: 311

ROUTE: 564

ST_REF_NO: 00000059900

EAGLE CREEK DRIVE

LUMENS	BULB TYPE	MULT SERIES	POLE TYPE	SHADE	ADDRESS NUMBER	REF	LOCATION	TAX DIST	DATE INST	DATE CHANGE
04000	S	M	OUG	II	00339	031	CHANGED HOUSE NUMBER ONLY	12	051477	2/17/2014
05800	S	M	OUG	V	00392	036	PER AUDIT	12	051477	2/17/2014
05800	S	M	OUG	II	00000	004	2 ND. LT. N. OF COVE LAKE DR., E. SIDE	12	051581	1/1/0001
05800	S	M	OUG	II	00000	006	1 ST. LT. N. OF COVE LAKE DR., E. SIDE	12	051581	1/1/0001
04000	S	M	OUG	II	00000	035	SIDE OF 3345 BEAVER CREEK DR.	12	051477	1/1/0001
05800	S	M	OUG	II	00167	005		12	010888	1/1/0001
05800	S	M	OUG	II	00197	007		12	010888	1/1/0001
05800	S	M	OUG	II	00207	018		12	051478	1/1/0001

OFFICE: 311		ROUTE: 564		ST_REF_NO: 00000059900		EAGLE CREEK DRIVE		TAX DIST	DATE INST	DATE CHANGE
LUMENS	BULB TYPE	MULT SERIES	POLE TYPE	SHADE	ADDRESS NUMBER	REF	LOCATION			
05800	S	M	OUG	II	00214	019		12	051477	1/1/0001
05800	S	M	OUG	II	00223	020		12	051477	1/1/0001
05800	S	M	OUG	II	00226	021		12	051477	1/1/0001
04000	S	M	OUG	II	00238	022		12	051477	1/1/0001
04000	S	M	OUG	II	00255	023		12	051477	1/1/0001
04000	S	M	OUG	II	00267	024		12	051477	1/1/0001
04000	S	M	OUG	II	00270	025		12	051477	1/1/0001
04000	S	M	OUG	II	00286	027		12	051477	1/1/0001
04000	S	M	OUG	II	00291	026		12	051477	1/1/0001
04000	S	M	OUG	V	00311	028		12	051477	1/1/0001
04000	S	M	OUG	II	00319	029		12	051477	1/1/0001
04000	S	M	OUG	II	00328	030		12	051477	1/1/0001
04000	S	M	OUG	II	00355	032		12	051477	1/1/0001
04000	S	M	OUG	II	00356	033		12	111478	1/1/0001
04000	S	M	OUG	II	00379	034		12	051477	1/1/0001
05800	S	M	OUG	II	00101	003		12	121581	1/1/0001
OFFICE: 311		ROUTE: 564		ST_REF_NO: 00000059910		EAGLE CREEK, NORTH DRIVE		TAX DIST	DATE INST	DATE CHANGE
LUMENS	BULB TYPE	MULT SERIES	POLE TYPE	SHADE	ADDRESS NUMBER	REF	LOCATION			
10000	M	M	OUG	III	00000	001	1ST LT. E. OF RICHMOND RD, S SIDE.-chg'd description only	12	031581	2/17/2014
10000	M	M	OUG	III	00000	002	2ND LT. E. OF RICHMOND RD, N SIDE (chg'd descr only)	12	031583	2/17/2014
10000	M	M	OUG	III	00000	003	1ST LT. E. OF RICHMOND RD, S SIDE (chg'd descr only)	12	031583	2/17/2014
10000	M	M	OUG	III	00000	005	1ST LT W OF EAGLE VIEW LANE, S SIDE-CHG'D DESCR ONLY	12	031583	2/17/2014
10000	M	M	OUG	III	00000	006	1ST LT E OF EAGLE VIEW LANE, N SIDE-ch'd description only	12	031583	2/17/2014
10000	M	M	OUG	III	00000	007	2ND LT E OF EAGLE VIEW LN, N SIDE-chg'd descr only	12	031583	2/17/2014
10000	M	M	OUG	III	00000	008	3RD LT E OF EAGLE VIEW LN, S SIDE-chg'd descr only	12	031583	2/17/2014
09500	S	M	OUG	II	00000	010	ACROSS FROM 151 N. EAGLE CREEK DRIVE	12	121701	1/1/0001
09500	S	M	OUG	II	00000	011	4TH LT W OF BLAZER DR, N SIDE ON N EAGLE CREEK DR	12	121701	1/1/0001

OFFICE: 311 ROUTE: 564										
ST_REF_NO: 00000059910 EAGLE CREEK, NORTH DRIVE										
LUMENS	BULB TYPE	MULT SERIES	POLE TYPE	SHADE	ADDRESS NUMBER	REF	LOCATION	TAX DIST	DATE INST	DATE CHANGE
09500	S	M	OUG	II	00000	012	3RD LT W OF BLAZER DR,S SIDE ON N EAGLE CREEK DR	12	121701	1/1/0001
09500	S	M	OUG	II	00000	013	2ND LT W OF BLAZER DR,N SIDE ON N EAGLE CREEK DR	12	121701	1/1/0001
09500	S	M	OUG	II	00000	014	1ST LT W OF BLAZER DR,S SIDE ON N EAGLE CREEK DR	12	121701	1/1/0001
10000	M	M	OUG	III	00141	009	chg'd addr only-audit	12	031583	2/17/2014
10000	M	M	OUG	II	00131	004		12	010897	1/1/0001

OFFICE: 311 ROUTE: 564										
ST_REF_NO: 00000059915 EAGLE POINT COURT										
LUMENS	BULB TYPE	MULT SERIES	POLE TYPE	SHADE	ADDRESS NUMBER	REF	LOCATION	TAX DIST	DATE INST	DATE CHANGE
05800	S	M	CNT	III	03204	001		12	010897	1/1/0001

OFFICE: 311 ROUTE: 564										
ST_REF_NO: 00000059920 EAGLE VIEW LANE										
LUMENS	BULB TYPE	MULT SERIES	POLE TYPE	SHADE	ADDRESS NUMBER	REF	LOCATION	TAX DIST	DATE INST	DATE CHANGE
05800	S	M	OUG	II	00000	002	OPP. 3275	12	120893	1/1/0001
05800	S	M	OUG	II	03275	001		12	120893	1/1/0001

OFFICE: 311 ROUTE: 564										
ST_REF_NO: 00000060010 EASTBROOK DRIVE										
LUMENS	BULB TYPE	MULT SERIES	POLE TYPE	SHADE	ADDRESS NUMBER	REF	LOCATION	TAX DIST	DATE INST	DATE CHANGE
05800	S	M	SOH	IV	00000	001	CORNER OF MT. TABOR RD.	12	060893	1/1/0001
05800	S	M	OOH	III	00000	002	OPP. FOUR PINES ENTRANCE ON EASTBROOK DR.	12	060893	1/1/0001
05800	S	M	SOH	III	00000	003	3RD LT. OFF OLD MT. TABOR RD.	12	060893	1/1/0001
05800	S	M	OOH	III	00000	004	OPP. EASTBROOK CT.	12	060893	1/1/0001

OFFICE: 311 ROUTE: 564										
ST_REF_NO: 00000060200 EAST HILLS COURT										
LUMENS	BULB TYPE	MULT SERIES	POLE TYPE	SHADE	ADDRESS NUMBER	REF	LOCATION	TAX DIST	DATE INST	DATE CHANGE
05800	S	M	OUG	II	00000	037	SIDE OF 2816 EAST HILLS DR.-audit	12	101478	2/17/2014
04000	S	M	OUG	V	00613	038		12	101478	1/1/0001

OFFICE: 311

ROUTE: 564

ST_REF_NO: 0000060300

EAST HILLS DRIVE

LUMENS	BULB TYPE	MULT SERIES	POLE TYPE	SHADE	ADDRESS NUMBER	REF	LOCATION	TAX DIST	DATE INST	DATE CHANGE
05800	S	M	OUG	II	00000	008	SIDE OF 420 WOODVIEW DR.	12	091579	1/1/0001
05800	S	M	OUG	II	00000	010	SIDE OF 433 SQUIRES CIRCLE	12	091579	1/1/0001
05800	S	M	OUG	II	02801	032		12	101478	1/1/0001
05800	S	M	OUG	II	02808	033		12	101478	1/1/0001
05800	S	M	OUG	II	02813	034		12	101478	1/1/0001
05800	S	M	OUG	II	02824	035		12	101478	1/1/0001
05800	S	M	OUG	II	02905	064		12	111579	1/1/0001
05800	S	M	OUG	II	02916	065		12	111579	1/1/0001
05800	S	M	OUG	II	02925	066		12	111579	1/1/0001
05800	S	M	OUG	II	02936	067		12	111579	1/1/0001
05800	S	M	OUG	II	02941	088		12	111579	1/1/0001
05800	S	M	OUG	II	02953	089		12	111579	1/1/0001

OFFICE: 311

ROUTE: 564

ST_REF_NO: 0000060320

EAST LEESWAY

LUMENS	BULB TYPE	MULT SERIES	POLE TYPE	SHADE	ADDRESS NUMBER	REF	LOCATION	TAX DIST	DATE INST	DATE CHANGE
05800	S	M	OUG	II	00000	005	SIDE OF 117	12	010897	1/1/0001
05800	S	M	OUG	II	00102	001		12	010897	1/1/0001
05800	S	M	OUG	II	00107	002		12	010897	1/1/0001
05800	S	M	OUG	II	00112	003		12	010897	1/1/0001
05800	S	M	OUG	II	00120	004		12	010897	1/1/0001
05800	S	M	OUG	II	00129	006		12	010897	1/1/0001
05800	S	M	OUG	II	00138	007		12	010897	1/1/0001

OFFICE: 311

ROUTE: 564

ST_REF_NO: 0000060450

EAST VINE

LUMENS	BULB TYPE	MULT SERIES	POLE TYPE	SHADE	ADDRESS NUMBER	REF	LOCATION	TAX DIST	DATE INST	DATE CHANGE
16000	S	M	GRN	IV	00000	231	1ST LT E OF S LIMESTONE ST,N SIDE ON E VINE ST	12	070101	1/1/0001
16000	S	M	GRN	IV	00000	232	1ST LT E OF S LIMESTONE ST,S SIDE ON E VINE ST	12	070101	1/1/0001
16000	S	M	GRN	IV	00000	233	2ND LT E OF S LIMESTONE ST,N SIDE ON E VINE ST	12	070101	1/1/0001
16000	S	M	GRN	IV	00000	234	2ND LT E OF S LIMESTONE ST,S SIDE ON E VINE ST	12	070101	1/1/0001
16000	S	M	GRN	IV	00000	235	3RD LT E OF S LIMESTONE ST,N SIDE ON E VINE ST	12	070101	1/1/0001
16000	S	M	GRN	IV	00000	236	3RD LT E OF S LIMESTONE ST,S SIDE ON E VINE ST	12	070101	1/1/0001

OFFICE: 311

ROUTE: 564

ST_REF_NO: 0000060450

EAST VINE

LUMENS	BULB TYPE	MULT SERIES	POLE TYPE	SHADE	ADDRESS NUMBER	REF	LOCATION	TAX DIST	DATE INST	DATE CHANGE
16000	S	M	GRN	IV	00000	237	4TH LT E OF S LIMESTONE ST,N SIDE ON E VINE ST	12	070101	1/1/0001
16000	S	M	GRN	IV	00000	238	4TH LT E OF S LIMESTONE ST,S SIDE ON E VINE ST	12	070101	1/1/0001
16000	S	M	GRN	IV	00000	239	5TH LT E OF S LIMESTONE ST,N SIDE ON E VINE ST	12	070101	1/1/0001
16000	S	M	GRN	IV	00000	240	5TH LT E OF S LIMESTONE ST,S SIDE ON E VINE ST	12	070101	1/1/0001
16000	S	M	GRN	IV	00000	241	6TH LT E OF S LIMESTONE ST,N SIDE ON E VINE ST	12	070101	1/1/0001
16000	S	M	GRN	IV	00000	242	6TH LT E OF S LIMESTONE ST,S SIDE ON E VINE ST	12	070101	1/1/0001
16000	S	M	GRN	IV	00000	243	7TH LT E OF S LIMESTONE ST,N SIDE ON E VINE ST	12	070101	1/1/0001
16000	S	M	GRN	IV	00000	244	8TH LT E OF S LIMESTONE ST,N SIDE ON E VINE ST	12	070101	1/1/0001
16000	S	M	GRN	IV	00000	245	9TH LT E OF S LIMESTONE,N SIDE ON E VINE ST	12	070101	1/1/0001
16000	S	M	GRN	IV	00000	246	10TH LT E OF S LIMESTONE ST,N SIDE ON E VINE ST	12	070101	1/1/0001
16000	S	M	GRN	IV	00000	247	11TH LT E OF S LIMESTONE ST,N SIDE ON E VINE ST	12	070101	1/1/0001
16000	S	M	GRN	IV	00000	248	1ST LT E OF MLK OVERPASS,N SIDE ON E VINE ST	12	070101	1/1/0001
16000	S	M	GRN	IV	00000	249	2ND LT E OF MLK OVERPASS,N SIDE ON E VINE ST	12	070101	1/1/0001
16000	S	M	GRN	IV	00000	250	3RD LT E OF MLK OVERPASS,N SIDE ON E VINE ST	12	070101	1/1/0001
16000	S	M	GRN	IV	00000	251	4TH LT E OF MLK OVERPASS,N SIDE ON E VINE ST	12	070101	1/1/0001
16000	S	M	GRN	IV	00000	253	5TH LT E OF MLK OVERPASS,N SIDE ON E VINE ST	12	070101	1/1/0001
16000	S	M	GRN	IV	00000	254	1ST LT E OF MLK OVERPASS,S SIDE ON E VINE ST	12	070101	1/1/0001
16000	S	M	GRN	IV	00000	255	6TH LT E OF MLK OVERPASS,N SIDE ON E VINE ST	12	070101	1/1/0001
16000	S	M	GRN	IV	00000	256	2ND LT E OF MLK OVERPASS,S SIDE ON E VINE ST	12	070101	1/1/0001
16000	S	M	GRN	IV	00000	257	7TH LT E OF MLK OVERPASS,N SIDE ON E VINE ST	12	070101	1/1/0001
16000	S	M	GRN	IV	00000	258	3RD LT E OF MLK OVERPASS,S SIDE ON E VINE ST	12	070101	1/1/0001
16000	S	M	GRN	IV	00000	259	8TH LT E OF MLK OVERPASS,N SIDE ON E VINE ST	12	070101	1/1/0001
16000	S	M	GRN	IV	00000	260	4TH LT E OF MLK OVERPASS,S SIDE ON E VINE ST	12	070101	1/1/0001
16000	S	M	GRN	IV	00000	261	9TH LT E OF MLK OVERPASS,N SIDE ON E VINE ST	12	070101	1/1/0001
16000	S	M	GRN	IV	00000	262	5TH LT E OF MLK OVERPASS,S SIDE ON E VINE ST	12	070101	1/1/0001
16000	S	M	GRN	IV	00000	263	1ST LT E OF QUALITY ST,N SIDE ON E VINE ST	12	070101	1/1/0001
16000	S	M	GRN	IV	00000	264	1ST LT E OF QUALITY ST,S SIDE ON E VINE ST	12	070101	1/1/0001
16000	S	M	GRN	IV	00000	265	2ND LT E OF QUALITY ST,N SIDE ON E VINE ST	12	070101	1/1/0001
16000	S	M	GRN	IV	00000	266	2ND LT E OF QUALITY ST,S SIDE ON E VINE ST	12	070101	1/1/0001
16000	S	M	GRN	IV	00000	267	3RD LT E OF QUALITY ST,N SIDE ON E VINE ST	12	070101	1/1/0001
16000	S	M	GRN	IV	00000	268	3RD LT E OF QUALITY ST,S SIDE ON E VINE ST	12	070101	1/1/0001
16000	S	M	GRN	IV	00000	269	4TH LT E OF QUALITY ST,N SIDE ON E VINE ST	12	070101	1/1/0001
16000	S	M	GRN	IV	00000	270	4TH LT E OF QUALITY ST,S SIDE ON E VINE ST	12	070101	1/1/0001

Street Light Listing run 1/11/2015 10:43:21 AM

Page 311 of 1254

OFFICE: 311

ROUTE: 564

ST_REF_NO: 0000060450

EAST VINE

LUMENS	BULB TYPE	MULT SERIES	POLE TYPE	SHADE	ADDRESS NUMBER	REF	LOCATION	TAX DIST	DATE INST	DATE CHANGE
16000	S	M	GRN	IV	00000	271	5TH LT E OF QUALITY ST,N SIDE ON E VINE ST	12	070101	1/1/0001
16000	S	M	GRN	IV	00000	272	5TH LT E OF QUALITY ST,S SIDE ON E VINE ST	12	070101	1/1/0001
16000	S	M	GRN	IV	00000	273	6TH LT E OF QUALITY ST,N SIDE ON E VINE ST	12	070101	1/1/0001
16000	S	M	GRN	IV	00000	274	6TH LT E OF QUALITY ST,S SIDE ON E VINE ST	12	070101	1/1/0001
16000	S	M	GRN	IV	00000	275	7TH LT E OF QUALITY ST,N SIDE ON E VINE ST	12	070101	1/1/0001
16000	S	M	GRN	IV	00000	276	7TH LT E OF QUALITY ST,S SIDE ON E VINE ST	12	070101	1/1/0001
16000	S	M	GRN	IV	00000	277	1ST LT E OF ROSE ST,N SIDE ON E VINE ST	12	070101	1/1/0001
16000	S	M	GRN	IV	00000	278	1ST LT E OF ROSE ST,S SIDE ON E VINE ST	12	070101	1/1/0001
16000	S	M	GRN	IV	00000	279	2ND LT E OF ROSE ST,N SIDE ON E VINE ST	12	070101	1/1/0001
16000	S	M	GRN	IV	00000	280	2ND LT E OF ROSE ST,S SIDE ON E VINE ST	12	070101	1/1/0001
16000	S	M	GRN	IV	00000	281	3RD LT E OF ROSE ST,N SIDE ON E VINE ST	12	070101	1/1/0001
16000	S	M	GRN	IV	00000	282	3RD LT E OF ROSE ST,S SIDE ON E VINE ST	12	070101	1/1/0001
16000	S	M	GRN	IV	00000	283	4TH LT E OF ROSE ST,N SIDE ON E VINE ST	12	070101	1/1/0001
16000	S	M	GRN	IV	00000	284	4TH LT E OF ROSE ST,S SIDE ON E VINE ST	12	070101	1/1/0001
16000	S	M	GRN	IV	00000	285	5TH LT E OF ROSE ST,N SIDE ON E VINE ST	12	070101	1/1/0001
16000	S	M	GRN	IV	00000	286	5TH LT E OF ROSE ST,S SIDE ON E VINE ST	12	070101	1/1/0001
16000	S	M	GRN	IV	00000	287	6TH LT E OF ROSE ST,N SIDE ON E VINE ST	12	070101	1/1/0001
16000	S	M	GRN	IV	00000	288	6TH LT E OF ROSE ST,S SIDE ON E VINE ST	12	070101	1/1/0001
16000	S	M	GRN	IV	00000	289	7TH LT E OF ROSE ST,N SIDE ON E VINE ST	12	070101	1/1/0001
16000	S	M	GRN	IV	00000	290	7TH LT E OF ROSE ST,S SIDE ON E VINE ST	12	070101	1/1/0001
16000	S	M	GRN	IV	00000	291	8TH LT E OF ROSE ST,N SIDE ON E VINE ST	12	070101	1/1/0001
16000	S	M	GRN	IV	00000	292	8TH LT E OF ROSE ST,S SIDE ON E VINE ST	12	070101	1/1/0001
16000	S	M	GRN	IV	00000	293	1ST LT E OF GRAND BLVD,N SIDE ON E VINE ST	12	070101	1/1/0001
16000	S	M	GRN	IV	00000	294	1ST LT E OF GRAND BLVD,S SIDE ON E VINE ST	12	070101	1/1/0001
16000	S	M	GRN	IV	00000	295	2ND LT E OF GRAND BLVD,N SIDE ON E VINE ST	12	070101	1/1/0001
16000	S	M	GRN	IV	00000	296	2ND LT E OF GRAND BLVD,S SIDE ON E VINE ST	12	070101	1/1/0001
16000	S	M	GRN	IV	00000	297	3RD LT E OF GRAND BLVD, N SIDE ON E VINE ST	12	070101	1/1/0001
16000	S	M	GRN	IV	00000	298	3RD LT E OF GRAND BLVD,S SIDE ON E VINE ST	12	070101	1/1/0001
16000	S	M	GRN	IV	00000	299	4TH LT E OF GRAND BLVD,N SIDE ON E VINE ST	12	070101	1/1/0001
16000	S	M	GRN	IV	00000	300	4TH LT E OF GRAND BLVD,S SIDE ON E VINE ST	12	070101	1/1/0001
16000	S	M	GRN	IV	00000	301	5TH LT E OF GRAND BLVD,N SIDE ON E VINE ST	12	070101	1/1/0001
16000	S	M	GRN	IV	00000	302	5TH LT E OF GRAND BLVD,S SIDE ON E VINE ST	12	070101	1/1/0001

OFFICE: 311

ROUTE: 564

ST_REF_NO: 0000060500

EASTERN, NORTH AVENUE

LUMENS	BULB TYPE	MULT SERIES	POLE TYPE	SHADE	ADDRESS NUMBER	REF	LOCATION	TAX DIST	DATE INST	DATE CHANGE
22000	S	M	OOH	III	00000	002	2ND LT. N. OF MAIN ST., W. SIDE	12	061563	1/1/0001
22000	S	M	SOH	III	00000	005	OPP. WILSON ST.	12	061563	1/1/0001
05800	S	M	SOH	II	00000	014	OPP. 186	12	110266	1/1/0001
05800	S	M	SOH	II	00000	017	SIDE OF 376 E. THIRD ST.	12	110266	1/1/0001
22000	S	M	OOH	III	00137	004		12	061563	1/1/0001
04000	S	M	SOH	II	00167	013		12	110266	1/1/0001
05800	S	M	SOH	II	00209	015		12	110266	1/1/0001
05800	S	M	SOH	II	00221	016		12	110266	1/1/0001

OFFICE: 311

ROUTE: 564

ST_REF_NO: 0000060510

EASTERN, SOUTH AVENUE

LUMENS	BULB TYPE	MULT SERIES	POLE TYPE	SHADE	ADDRESS NUMBER	REF	LOCATION	TAX DIST	DATE INST	DATE CHANGE
05800	S	M	SOH	II	00000	547	1ST LT. N. OF E. HIGH ST., ON W. SIDE	12	062167	1/1/0001
05800	S	M	SOH	II	00000	548	2ND LT. N. OF E. HIGH ST., E. SIDE	12	062167	1/1/0001

OFFICE: 311

ROUTE: 564

ST_REF_NO: 0000060700

EASTLAND DRIVE

LUMENS	BULB TYPE	MULT SERIES	POLE TYPE	SHADE	ADDRESS NUMBER	REF	LOCATION	TAX DIST	DATE INST	DATE CHANGE
05800	S	M	OOH	II	00000	001	1ST LT WEST OF NEW CIRCLE RD	12	081477	1/1/0001
05800	S	M	OUG	II	00000	002	2ND LT WEST OF NEW CIRCLE RD	12	081477	1/1/0001
05800	S	M	OUG	II	00000	007	1ST LT WEST OF COMMERCIAL DR	12	081762	1/1/0001
05800	S	M	OUG	II	00000	008	2ND LT WEST OF COMMERCIAL DR	12	081762	1/1/0001
05800	S	M	OUG	II	00000	009	3RD LT WEST OF COMMERCIAL DR	12	081762	1/1/0001
05800	S	M	OUG	II	00000	010	4TH LT WEST OF COMMERCIAL DR	12	081762	1/1/0001
05800	S	M	SOH	II	00000	012	OPP DIAZ ALLEY	12	011662	1/1/0001
05800	S	M	SOH	II	00000	013	SE CORNER OF INDUSTRY RD & EASTLAND DR	12	011662	1/1/0001
05800	S	M	SOH	II	00000	014	SW CORNER OF INDUSTRY RD & EASTLAND DR	12	011662	1/1/0001
05800	S	M	SOH	II	00000	016	1ST LT WEST OF GOODWIN DR	12	011662	1/1/0001
05800	S	M	SOH	II	00000	025	SIDE OF 625 LOUDEN AVE.	12	011662	1/1/0001
05800	S	M	SOH	II	01006	024		12	011662	1/1/0001
05800	S	M	SOH	II	01044	022		12	011662	1/1/0001
05800	S	M	SOH	II	01056	020		12	011662	1/1/0001
05800	S	M	SOH	II	01076	019		12	011662	1/1/0001
05800	S	M	SOH	II	01090	017		12	011662	1/1/0001

OFFICE: 311

ROUTE: 564

ST_REF_NO: 0000060700

EASTLAND DRIVE

LUMENS	BULB TYPE	MULT SERIES	POLE TYPE	SHADE	ADDRESS NUMBER	REF	LOCATION	TAX DIST	DATE INST	DATE CHANGE
05800	S	M	SOH	II	01142	015		12	011662	1/1/0001
05800	S	M	OUG	II	01225	011		12	081762	1/1/0001
05800	S	M	OUG	II	01267	006		12	081762	1/1/0001
05800	S	M	OUG	II	01275	005		12	081762	1/1/0001
05800	S	M	OOH	II	01331	003		12	081477	1/1/0001
05800	S	M	OUG	II	01331	004		12	081762	1/1/0001

OFFICE: 311

ROUTE: 564

ST_REF_NO: 0000060800

EASTLAND PARKWAY

LUMENS	BULB TYPE	MULT SERIES	POLE TYPE	SHADE	ADDRESS NUMBER	REF	LOCATION	TAX DIST	DATE INST	DATE CHANGE
05800	S	M	OUG	II	00000	050	SIDE OF 1592 MEADE CT.-audit	12	120263	2/17/2014
09500	S	M	OUG	II	00000	077	1ST LT E OF CONTINENTAL SQUARE, S SIDE-audit	12	091466	2/17/2014
09500	S	M	OOH	II	00000	105	OPP. DALNA DR.-audit	12	011167	2/17/2014
09500	S	M	OUG	II	02031	116	SIDE OF 2040 GAINESVILLE CT.-audit	12	090866	2/17/2014
05800	S	M	OUG	II	00000	090	SIDE OF 1601 ANNISTON DR.	12	071064	1/1/0001
05800	S	M	OUG	II	00000	109	SIDE OF 1504 TAMPA CT.	12	090866	1/1/0001
05800	S	M	OUG	II	00000	110	SIDE OF 2001 MOBILE CT.	12	090866	1/1/0001
05800	S	M	OUG	II	00000	111	SIDE OF 2000 MOBILE CT.	12	090866	1/1/0001
05800	S	M	OUG	II	00000	113	SIDE OF 2020 MEMPHIS CT.	12	090866	1/1/0001
05800	S	M	OUG	II	02010	112		12	090866	1/1/0001
05800	S	M	OUG	II	00000	036	OPP. CLARKSDALE CT.	12	062364	1/1/0001
05800	S	M	OUG	II	00000	037	SIDE OF 1548 CANTRILL DR.,AT CREEK	12	062364	1/1/0001
05800	S	M	OUG	II	00000	038	SIDE OF 1601 CANTRILL DR.	12	102466	1/1/0001
05800	S	M	OUG	II	00000	039	SIDE OF 1548 CANTRILL DR.	12	062364	1/1/0001
05800	S	M	OUG	II	00000	040	SIDE OF 1600 CANTRILL DR.	12	050267	1/1/0001
05800	S	M	OUG	II	00000	041	SIDE OF 1501 CANTRILL DR.	12	050167	1/1/0001
05800	S	M	OUG	II	00000	042	SIDE OF 1600 CANTRILL CT.	12	050267	1/1/0001
05800	S	M	OUG	II	00000	043	SIDE OF 1500 CANTRILL DR.	12	062364	1/1/0001
05800	S	M	OUG	II	00000	044	SIDE OF 1601 MARTHA CT.	12	050167	1/1/0001
05800	S	M	OUG	II	00000	045	SIDE OF 1598 MARTHA CT.	12	062364	1/1/0001
05800	S	M	OUG	II	00000	046	SIDE OF 1601 JENNIFER DR.	12	050167	1/1/0001
05800	S	M	OUG	II	00000	055	SIDE OF 1515 CLARKSDALE CT.	12	071064	1/1/0001
05800	S	M	OUG	II	00000	056	SIDE OF 1600 FORT SUMTER DR.	12	060162	1/1/0001
10000	M	M	OUG	II	00000	076	SIDE OF 1501 YATES CRESCENT	12	091466	1/1/0001

OFFICE: 311

ROUTE: 564

ST_REF_NO: 0000060800

EASTLAND PARKWAY

LUMENS	BULB TYPE	MULT SERIES	POLE TYPE	SHADE	ADDRESS NUMBER	REF	LOCATION	TAX DIST	DATE INST	DATE CHANGE
05800	S	M	OUG	II	00000	080	SIDE OF 1513 FORT SUMTER CT.	12	090164	1/1/0001
05800	S	M	OUG	II	00000	121	OPP. SIDE OF 1832 CANTRILL DR.	12	011167	1/1/0001
05800	S	M	OUG	II	00000	122	SIDE OF 1833 CANTRILL DR.	12	011167	1/1/0001
05800	S	M	OUG	II	00000	123	SIDE OPP. REAR OF 1833 CANTRILL DR.	12	011167	1/1/0001
05800	S	M	OUG	II	00000	124	SIDE OF 1801 CANTRILL DR.	12	092066	1/1/0001
05800	S	M	OUG	II	00000	125	OPP. THE SIDE OF 1800 CANTRILL DR.	12	092066	1/1/0001
05800	S	M	OUG	II	00000	126	SIDE REAR OF 1800 CANTRILL DR.	12	092066	1/1/0001
05800	S	M	OUG	II	00000	127	OPP. BARWICK DR.	12	011167	1/1/0001
05800	S	M	OUG	II	00000	128	SIDE OF 1831 BARWICK DR.	12	082573	1/1/0001
05800	S	M	OUG	II	00000	129	OPP. SIDE OF 1803 CURTIS CT.	12	011167	1/1/0001
05800	S	M	OUG	II	00000	130	SIDE OF 1800 CURTIS CT.	12	072474	1/1/0001
05800	S	M	OUG	II	00000	132	OPP. BARWICK DR.	12	092066	1/1/0001
05800	S	M	OUG	II	00000	133	SIDE OF 1800 BARWICK DR.	12	092066	1/1/0001
09500	S	M	SOH	II	00000	201	1ST LT. E OF NEW CIRCLE RD., SOUTHSIDE	12	100800	1/1/0001
09500	S	M	OUG	II	00000	202	SIDE OF 781 NEW CIRCLE RD. ON EASTLAND PKWY	12	100800	1/1/0001
09500	S	M	OUG	II	00000	203	2ND LT. E OF NEW CIRCLE RD., SOUTHSIDE	12	100800	1/1/0001
09500	S	M	OUG	II	00000	204	3RD LT. E OF NEW CIRCLE RD., SOUTHSIDE	12	100800	1/1/0001
09500	S	M	OUG	II	00000	205	4TH LT. E OF NEW CIRCLE RD., SOUTHSIDE	12	100800	1/1/0001
09500	S	M	OUG	II	00000	207	5TH LT. E OF NEW CIRCLE RD., SOUTHSIDE	12	100800	1/1/0001
09500	S	M	OUG	II	00000	208	1ST LT. W OF CONTINENTAL SQUARE, NORTHSIDE	12	100800	1/1/0001
09500	S	M	OUG	II	00000	209	6TH LT. E OF NEW CIRCLE RD., SOUTHSIDE	12	100800	1/1/0001
09500	S	M	OUG	II	01541	206		12	100800	1/1/0001
05800	S	M	OUG	II	00000	001	SIDE OF 1600 RALEIGH RD.	12	071064	1/1/0001
05800	S	M	OUG	II	00000	002	SIDE OF 1507 RALEIGH RD.	12	090866	1/1/0001
05800	S	M	OUG	II	00000	004	1ST LT. E. OF AUBURN, S. SIDE	12	090866	1/1/0001
05800	S	M	OUG	II	00000	057	SIDE OF 1622 RALEIGH RD.	12	120263	1/1/0001
05800	S	M	OUG	II	00000	058	SIDE OF 1627 RALEIGH RD.	12	071064	1/1/0001
05800	S	M	OUG	II	00000	059	SIDE OF 1600 ATLANTA DR.	12	060162	1/1/0001
05800	S	M	OUG	II	00000	060	SIDE OF 1505 ATLANTA CT.	12	101861	1/1/0001
05800	S	M	OUG	II	00000	061	SIDE OF 1600 AUBURN DR.	12	071064	1/1/0001
05800	S	M	OUG	II	00000	062	SIDE OF 1507 AUBURN CT.	12	071064	1/1/0001
05800	S	M	OUG	II	00000	063	SIDE OF 1705 FT. SUMPTER	12	060162	1/1/0001
05800	S	M	OUG	II	00000	064	OPP. 1622 AUBURN DR.	12	090866	1/1/0001

OFFICE: 311

ROUTE: 564

ST_REF_NO: 0000060800

EASTLAND PARKWAY

LUMENS	BULB TYPE	MULT SERIES	POLE TYPE	SHADE	ADDRESS NUMBER	REF	LOCATION	TAX DIST	DATE INST	DATE CHANGE
05800	S	M	OUG	II	00000	065	SIDE OF 1623 AUBURN DR.	12	060162	1/1/0001
05800	S	M	OUG	II	00000	082	SIDE OF 1800 BILOXI CT.	12	071064	1/1/0001
05800	S	M	OUG	II	00000	083	SIDE OF 1717 BILOXI CT.	12	071064	1/1/0001
05800	S	M	OUG	II	00000	084	SIDE OF 2000 NEW ORLEANS DR.	12	040165	1/1/0001
05800	S	M	OUG	II	00000	085	SIDE OF 1717 NEW ORLEANS CT.	12	040165	1/1/0001
05800	S	M	OUG	II	00000	089	SIDE OF 1506 ANNISTON DR.	12	071064	1/1/0001
05800	S	M	OUG	II	00000	097	SIDE OF 1601 ATHENS CT.	12	120263	1/1/0001
05800	S	M	OUG	II	00000	098	SIDE OF 1503 DECATUR CT.	12	071064	1/1/0001
05800	S	M	OUG	II	00000	099	SIDE OF 1801 GAYLE DR.	12	020167	1/1/0001
05800	S	M	OUG	II	00000	100	SIDE OF 1669 GAYLE DR.	12	020167	1/1/0001
05800	S	M	OUG	II	00000	101	SIDE OF 1800 GAYLE DR.	12	020167	1/1/0001
05800	S	M	OUG	II	00000	102	SIDE OF 1668 GAYLE DR.	12	011167	1/1/0001
05800	S	M	OUG	II	00000	103	SIDE OF 1899 GAYLE DR.	12	020167	1/1/0001
05800	S	M	OUG	II	00000	104	OPP. SIDE OF 1801 DALNA DR.	12	011167	1/1/0001
05800	S	M	OUG	II	00000	106	SIDE OF 1800 DALNA DR.	12	020167	1/1/0001
05800	S	M	OUG	II	00000	107	OPP. SIDE OF 1801 JOAN DR.	12	011167	1/1/0001
05800	S	M	OUG	II	00000	108	SIDE OF 1800 JOAN DR.	12	020167	1/1/0001
05800	S	M	OUG	II	00000	115	SIDE OF 2041 GAINESVILLE CT.	12	090866	1/1/0001
05800	S	M	OUG	II	00000	117	SIDE OF 1711 KNOXVILLE CT.	12	090866	1/1/0001
05800	S	M	OUG	II	00000	118	SIDE OF 2063 NEW ORLEANS DR.	12	090866	1/1/0001
05800	S	M	OUG	II	00000	159	SIDE OF 1601 RALEIGH RD.	12	120263	1/1/0001
05800	S	M	OUG	II	00000	168	SIDE OF 1709 CHICKASAW CT.	12	101861	1/1/0001
05800	S	M	OUG	II	00000	170	SIDE OF 1719 SARASOTA CT.	12	070161	1/1/0001
05800	S	M	OUG	II	00000	171	SIDE OF 1800 CHARLESTON CT.	12	071064	1/1/0001
05800	S	M	OUG	II	00000	172	SIDE OF 1719 CHARLESTON CT.	12	070161	1/1/0001
05800	S	M	OUG	II	01881	005		12	090866	1/1/0001
05800	S	M	OUG	II	01940	006		12	090866	1/1/0001
05800	S	M	OUG	II	01940	008		12	090866	1/1/0001
05800	S	M	OUG	II	01945	007		12	090866	1/1/0001
05800	S	M	OUG	II	02020	114		12	090866	1/1/0001
05800	S	M	OUG	II	02275	066		12	090866	1/1/0001
05800	S	M	OUG	II	02275	067		12	090866	1/1/0001

OFFICE: 311

ROUTE: 564

ST_REF_NO: 0000060830

EASTMONT ROAD

LUMENS	BULB TYPE	MULT SERIES	POLE TYPE	SHADE	ADDRESS NUMBER	REF	LOCATION	TAX DIST	DATE INST	DATE CHANGE
05800	S	M	OUG	II	00000	001	SIDE OF 2186 STONEWOOD LANE	12	110897	1/1/0001
05800	S	M	OUG	II	00000	002	SIDE OF 2117 WALSH CT.	12	110897	1/1/0001
05800	S	M	OUG	II	00844	005		12	020801	1/1/0001
05800	S	M	OUG	II	00861	004		12	020801	1/1/0001
05800	S	M	OUG	II	00876	003		12	020801	1/1/0001

OFFICE: 311

ROUTE: 564

ST_REF_NO: 0000060900

EASTOVER DRIVE

LUMENS	BULB TYPE	MULT SERIES	POLE TYPE	SHADE	ADDRESS NUMBER	REF	LOCATION	TAX DIST	DATE INST	DATE CHANGE
05800	S	M	OUG	II	00132	059		12	070767	1/1/0001
05800	S	M	OUG	II	00145	060		12	070767	1/1/0001
05800	S	M	OUG	II	00168	061		12	070767	1/1/0001
05800	S	M	OUG	II	00000	062	SIDE OF 1001 E. COOPER DR.	12	070767	1/1/0001

OFFICE: 311

ROUTE: 564

ST_REF_NO: 0000061000

EASTWAY DRIVE

LUMENS	BULB TYPE	MULT SERIES	POLE TYPE	SHADE	ADDRESS NUMBER	REF	LOCATION	TAX DIST	DATE INST	DATE CHANGE
05800	S		OUG	II	02481	051		12	031511	1/1/0001
05800	S		OUG	II	02489	052		12	031511	1/1/0001
05800	S		OUG	II	02497	053		12	031511	1/1/0001
05800	S		OUG	II	02504	054		12	031511	1/1/0001
05800	S	M	OUG	II	02308	000	audit	12	040466	2/17/2014
05800	S	M	OUG	II	02436	000	audit	12	040466	2/17/2014
04000	S	M	OUG	II	00000	007	SIDE OF 301 HOLLY HILL DR.	12	040466	1/1/0001
04000	S	M	OUG	II	02108	000		12	040466	1/1/0001
04000	S	M	OUG	II	02205	000		12	040466	1/1/0001
04000	S	M	OUG	II	02225	000		12	040466	1/1/0001
04000	S	M	SOH	II	02412	000		12	030766	1/1/0001
04000	S	M	OUG	II	02425	000		12	040466	1/1/0001
04000	S	M	OUG	II	02449	000		12	060766	1/1/0001
04000	S	M	OUG	II	02456	000		12	040766	1/1/0001

OFFICE: 311

ROUTE: 564

ST_REF_NO: 0000061100

EDDIE STREET

LUMENS	BULB TYPE	MULT SERIES	POLE TYPE	SHADE	ADDRESS NUMBER	REF	LOCATION	TAX DIST	DATE INST	DATE CHANGE
05800	S	M	SOH	I	00000	157	SIDE OF 726 N. LIMESTONE ST.	12	111366	1/1/0001
05800	S	M	SOH	I	00117	156		12	111366	1/1/0001
05800	S	M	SOH	I	00139	155		12	111366	1/1/0001
05800	S	M	SOH	I	00000	151	SIDE OF 707 MAPLE AVE.	12	111366	1/1/0001
05800	S	M	SOH	I	00165	154		12	111366	1/1/0001
05800	S	M	SOH	I	00181	153		12	111366	1/1/0001

OFFICE: 311

ROUTE: 564

ST_REF_NO: 0000061110

EDEN CIRCLE

LUMENS	BULB TYPE	MULT SERIES	POLE TYPE	SHADE	ADDRESS NUMBER	REF	LOCATION	TAX DIST	DATE INST	DATE CHANGE
05800	S	M	OUG	II	00725	000		12	032067	1/1/0001

OFFICE: 311

ROUTE: 564

ST_REF_NO: 0000061200

EDEN COURT

LUMENS	BULB TYPE	MULT SERIES	POLE TYPE	SHADE	ADDRESS NUMBER	REF	LOCATION	TAX DIST	DATE INST	DATE CHANGE
05800	S	M	OUG	II	00744	000		12	070767	1/1/0001
05800	S	M	OUG	II	00747	000		12	070767	1/1/0001
05800	S	M	OUG	II	00703	000		12	032067	1/1/0001
05800	S	M	OUG	II	00716	000		12	032067	1/1/0001
05800	S	M	OUG	II	00731	000		12	042067	1/1/0001

OFFICE: 311

ROUTE: 564

ST_REF_NO: 0000061300

EDEN ROAD

LUMENS	BULB TYPE	MULT SERIES	POLE TYPE	SHADE	ADDRESS NUMBER	REF	LOCATION	TAX DIST	DATE INST	DATE CHANGE
05800	S	M	OUG	II	00000	008	SIDE OF 638 CHYLEEN CT.	12	110766	1/1/0001
05800	S	M	OUG	II	00602	000		12	110766	1/1/0001
05800	S	M	OUG	II	00607	000		12	020367	1/1/0001
05800	S	M	OUG	II	00616	000		12	070767	1/1/0001
05800	S	M	OUG	II	00637	000		12	110766	1/1/0001
05800	S	M	OUG	II	00646	000		12	110766	1/1/0001
05800	S	M	OUG	II	00670	000		12	042067	1/1/0001
05800	S	M	OUG	II	00684	000		12	032067	1/1/0001
05800	S	M	OUG	II	00689	000		12	032067	1/1/0001
05800	S	M	OUG	II	00696	000		12	032067	1/1/0001

OFFICE: 311		ROUTE: 564		ST_REF_NO: 0000061400		EDGELAWN AVENUE		LUMENS	BULB TYPE	MULT SERIES	POLE TYPE	SHADE	ADDRESS NUMBER	REF	LOCATION	TAX DIST	DATE INST	DATE CHANGE
05800	S	M	SOH	III	01437	130										12	013002	1/1/0001
05800	S	M	SOH	II	00000	118	SIDE 319 BLUE GRASS									12	060685	1/1/0001
05800	S	M	SOH	II	01403	119										12	060685	1/1/0001
05800	S	M	SOH	II	01413	120										12	060685	1/1/0001
05800	S	M	SOH	II	01417	121										12	060685	1/1/0001
05800	S	M	SOH	II	01429	122										12	060685	1/1/0001
05800	S	M	SOH	II	01433	123										12	060685	1/1/0001

OFFICE: 311		ROUTE: 564		ST_REF_NO: 0000061500		EDGEMOOR DRIVE		LUMENS	BULB TYPE	MULT SERIES	POLE TYPE	SHADE	ADDRESS NUMBER	REF	LOCATION	TAX DIST	DATE INST	DATE CHANGE
04000	S	M	SOH	II	00103	002	audit									12	080888	2/17/2014
05800	S	M	OUG	II	00145	007	chd'd addr per audit									12	080888	7/30/2009
04000	S	M	SOH	II	00000	001	SIDE OF 1950 S. LIMESTONE									12	080888	1/1/0001
04000	S	M	OUG	II	00000	011	SIDE OF 209 GLENDOVER RD.									12	070888	1/1/0001
04000	S	M	SOH	II	00112	003										12	080888	1/1/0001
04000	S	M	SOH	II	00120	004										12	080888	1/1/0001
04000	S	M	OUG	II	00128	005										12	080888	1/1/0001
04000	S	M	OUG	II	00136	006										12	080888	1/1/0001
04000	S	M	OUG	II	00155	008										12	080888	1/1/0001
04000	S	M	SOH	II	00159	009										12	080888	1/1/0001
04000	S	M	OUG	II	00169	010										12	080888	1/1/0001

OFFICE: 311		ROUTE: 564		ST_REF_NO: 0000061690		EDGEWATER COURT		LUMENS	BULB TYPE	MULT SERIES	POLE TYPE	SHADE	ADDRESS NUMBER	REF	LOCATION	TAX DIST	DATE INST	DATE CHANGE
09500	S	M	SOH	II	00000	023	SIDE OF 999 EDGEWATER DR. audit									12	031477	2/17/2014
09500	S	M	SOH	II	00000	028	4TH WOOD POLE W. OF EDGEWATER DR.,N. SIDE									12	110887	2/17/2014
05800	S	M	SOH	II	02015	026	audit									12	031477	2/17/2014
04000	S	M	SOH	II	00000	024	SIDE OF 998 EDGEWATER DR.									12	031477	1/1/0001
04000	S	M	SOH	II	02018	027										12	020892	1/1/0001
09500	S	M	SOH	II	02073	025										12	032477	1/1/0001

OFFICE: 311		ROUTE: 564		ST_REF_NO: 0000061700		EDGEWATER DRIVE		LUMENS	BULB TYPE	MULT SERIES	POLE TYPE	SHADE	ADDRESS NUMBER	REF	LOCATION	TAX DIST	DATE INST	DATE CHANGE
05800	S	M	OUG	II	00902	021		12	020890	1/1/0001								
05800	S	M	OUG	II	00903	022		12	091477	1/1/0001								
05800	S	M	OUG	II	00911	000		12	060172	1/1/0001								
05800	S	M	OUG	II	00916	000		12	100172	1/1/0001								
05800	S	M	OUG	II	00923	000		12	060172	1/1/0001								
05800	S	M	OUG	II	00928	000		12	040170	1/1/0001								
05800	S	M	OUG	II	00935	000		12	060172	1/1/0001								
05800	S	M	OUG	II	00940	000		12	030171	1/1/0001								
05800	S	M	OUG	II	00951	000		12	030171	1/1/0001								
05800	S	M	OUG	II	00958	000		12	100172	1/1/0001								
05800	S	M	OUG	II	00971	000		12	050171	1/1/0001								
05800	S	M	OUG	II	00980	000		12	040172	1/1/0001								
05800	S	M	OUG	II	00986	000		12	011874	1/1/0001								
05800	S	M	OUG	II	00987	000		12	100172	1/1/0001								
05800	S	M	OUG	II	00998	000		12	040170	1/1/0001								

OFFICE: 311		ROUTE: 564		ST_REF_NO: 0000061805		EDGEWOOD CT		LUMENS	BULB TYPE	MULT SERIES	POLE TYPE	SHADE	ADDRESS NUMBER	REF	LOCATION	TAX DIST	DATE INST	DATE CHANGE
04000	S	M	OUG	II	00000	002	SIDE OF 857 EDGEWOOD DR ON EDGEWOOD CT	12	050891	1/1/0001								
04000	S	M	OUG	II	00900	001		12	050891	1/1/0001								

OFFICE: 311		ROUTE: 564		ST_REF_NO: 0000061810		EDGEWOOD DRIVE		LUMENS	BULB TYPE	MULT SERIES	POLE TYPE	SHADE	ADDRESS NUMBER	REF	LOCATION	TAX DIST	DATE INST	DATE CHANGE
04000	S	M	OUG	V	00800	008		12	020888	1/1/0001								
04000	S	M	OUG	II	00812	007		12	020888	1/1/0001								
04000	S	M	OUG	II	00829	006		12	020888	1/1/0001								
04000	S	M	OUG	II	00836	005		12	110888	1/1/0001								
04000	S	M	OUG	II	00849	004		12	050891	1/1/0001								
04000	S	M	OUG	II	00856	003		12	050891	1/1/0001								
04000	S	M	OUG	II	00869	002		12	020888	1/1/0001								
04000	S	M	OUG	II	00880	001		12	060887	1/1/0001								

OFFICE: 311

ROUTE: 564

ST_REF_NO: 00000061890 EDINBURGH COURT

LUMENS	BULB TYPE	MULT SERIES	POLE TYPE	SHADE	ADDRESS NUMBER	REF	LOCATION	TAX DIST	DATE INST	DATE CHANGE
05800	S	M	OUG	II	00000	032	SIDE 2912 EDINBURGH DR. audit	12	010886	2/17/2014

OFFICE: 311

ROUTE: 564

ST_REF_NO: 00000061900 EDINBURGH DRIVE

LUMENS	BULB TYPE	MULT SERIES	POLE TYPE	SHADE	ADDRESS NUMBER	REF	LOCATION	TAX DIST	DATE INST	DATE CHANGE
05800	S	M	OUG	II	00000	029	SIDE 2922 EDINBURGH CT. audit	12	010886	2/17/2014
05800	S	M	OUG	II	02904	026	audit	12	010886	2/17/2014
05800	S	M	OUG	II	02906	027		12	010886	1/1/0001
04000	S	M	OUG	II	00000	031	SIDE 205 INVERNESS DR.	12	010886	1/1/0001
04000	S	M	OUG	II	02911	028		12	010886	1/1/0001
04000	S	M	OUG	II	02929	030		12	010886	1/1/0001

OFFICE: 311

ROUTE: 564

ST_REF_NO: 00000062000 EDMOND AVENUE

LUMENS	BULB TYPE	MULT SERIES	POLE TYPE	SHADE	ADDRESS NUMBER	REF	LOCATION	TAX DIST	DATE INST	DATE CHANGE
05800	S	M	SOH	I	00000	001	AT THE END OF EDMOND STREET	12	011865	1/1/0001
05800	S	M	SOH	II	00000	002	SIDE OF 258 PERRY STREET	12	011865	1/1/0001

OFFICE: 311

ROUTE: 564

ST_REF_NO: 00000062100 EDWARDS AVENUE

LUMENS	BULB TYPE	MULT SERIES	POLE TYPE	SHADE	ADDRESS NUMBER	REF	LOCATION	TAX DIST	DATE INST	DATE CHANGE
04000	S	M	SOH	II	00000	029	SIDE OF 330 BURLEY AVE.	12	050886	1/1/0001
04000	S	M	SOH	II	00000	030	SIDE 341 AMERICAN AVE.	12	050886	1/1/0001

OFFICE: 311

ROUTE: 564

ST_REF_NO: 00000062200 EFFIE ROAD

LUMENS	BULB TYPE	MULT SERIES	POLE TYPE	SHADE	ADDRESS NUMBER	REF	LOCATION	TAX DIST	DATE INST	DATE CHANGE
05800	S	M	OUG	II	00000	095	OPPOSITE 952	12	070566	1/1/0001
05800	S	M	OUG	II	00946	000		12	050159	1/1/0001
05800	S	M	OUG	II	00960	000		12	012160	1/1/0001
05800	S	M	OUG	III	00934	000		12	021157	1/1/0001
05800	S	M	OUG	III	00941	000		12	021157	1/1/0001

OFFICE: 311

ROUTE: 564

ST_REF_NO: 0000062210

EL PASEO PLACE

LUMENS	BULB TYPE	MULT SERIES	POLE TYPE	SHADE	ADDRESS NUMBER	REF	LOCATION	TAX DIST	DATE INST	DATE CHANGE
04000	S	M	OUG	II	00000	121	SIDE 624 EUREKA SPRINGS	12	110886	1/1/0001
04000	S	M	OUG	V	00500	125		12	110885	1/1/0001
04000	S	M	OUG	II	00521	124		12	110886	1/1/0001
04000	S	M	OUG	II	00544	123		12	110886	1/1/0001
04000	S	M	OUG	II	00561	122		12	110886	1/1/0001

OFFICE: 311

ROUTE: 564

ST_REF_NO: 0000062300

ELAINE DRIVE

LUMENS	BULB TYPE	MULT SERIES	POLE TYPE	SHADE	ADDRESS NUMBER	REF	LOCATION	TAX DIST	DATE INST	DATE CHANGE
05800	S	M	OUG	II	00000	001	1ST LT. E. OF BROADWAY, S. SIDE	12	120167	1/1/0001
05800	S	M	OOH	II	00000	002	2ND LT. E. OF BROADWAY, S. SIDE	12	120167	1/1/0001
05800	S	M	OOH	II	00000	003	1ST. LT. E. OF BROADWAY, N. SIDE	12	120167	1/1/0001
05800	S	M	OOH	II	00000	004	3RD. LT. E. OF BROADWAY, S. SIDE	12	120167	1/1/0001
05800	S	M	OOH	II	00000	005	2ND LT. E. OF BROADWAY, N. SIDE	12	120167	1/1/0001
05800	S	M	OOH	II	00000	006	4TH. LT. E. OF BROADWAY, S. SIDE	12	120167	1/1/0001

OFFICE: 311

ROUTE: 564

ST_REF_NO: 0000062400

ELAM PARK

LUMENS	BULB TYPE	MULT SERIES	POLE TYPE	SHADE	ADDRESS NUMBER	REF	LOCATION	TAX DIST	DATE INST	DATE CHANGE
05800	S	M	SOH	II	00000	148	OPP 126	12	100884	1/1/0001
05800	S	M	SOH	II	00103	000		12	121578	1/1/0001
05800	S	M	SOH	II	00107	000		12	121578	1/1/0001
05800	S	M	SOH	II	00113	000		12	121578	1/1/0001
05800	S	M	SOH	II	00121	000		12	121578	1/1/0001
05800	S	M	OOH	II	00131	000		12	100884	1/1/0001
05800	S	M	SOH	II	00135	000		12	121578	1/1/0001
05800	S	M	SOH	III	00137	008		12	060898	1/1/0001

OFFICE: 311

ROUTE: 564

ST_REF_NO: 0000062500

ELDEMERE ROAD

LUMENS	BULB TYPE	MULT SERIES	POLE TYPE	SHADE	ADDRESS NUMBER	REF	LOCATION	TAX DIST	DATE INST	DATE CHANGE
05800	S	M	OUG	III	00000	001	BETWEEN BERRY LANE & PROVIDENCE RD.	12	100156	1/1/0001
05800	S	M	OUG	III	00000	002	BETWEEN MT. VERNON AND BERRY LANE	12	100156	1/1/0001
05800	S	M	OUG	III	00000	003	BETWEEN PROVIDENCE AND W. COOPER DR.	12	111056	1/1/0001

OFFICE: 311		ROUTE: 564		ST_REF_NO: 0000062500		ELDEMERE ROAD				
LUMENS	BULB TYPE	MULT SERIES	POLE TYPE	SHADE	ADDRESS NUMBER	REF	LOCATION	TAX DIST	DATE INST	DATE CHANGE
05800	S	M	OUG	II	00000	037	SIDE OF 810 COOPER DR.	12	121465	1/1/0001
05800	S	M	OUG	III	01115	000		12	072757	1/1/0001
05800	S	M	OUG	II	01219	000		12	121465	1/1/0001
05800	S	M	OUG	II	01232	000		12	121465	1/1/0001
05800	S	M	OUG	II	01245	000		12	121465	1/1/0001
05800	S	M	OUG	II	01248	000		12	121465	1/1/0001

OFFICE: 311		ROUTE: 564		ST_REF_NO: 0000062600		ELDERBERRY COURT				
LUMENS	BULB TYPE	MULT SERIES	POLE TYPE	SHADE	ADDRESS NUMBER	REF	LOCATION	TAX DIST	DATE INST	DATE CHANGE
05800	S	M	OUG	II	00000	102	SIDE OF 380 CODELL DR.	12	020474	1/1/0001

OFFICE: 311		ROUTE: 564		ST_REF_NO: 0000062800		ELIZABETH STREET				
LUMENS	BULB TYPE	MULT SERIES	POLE TYPE	SHADE	ADDRESS NUMBER	REF	LOCATION	TAX DIST	DATE INST	DATE CHANGE
05800	S		SOH	II	00000	031	ACROSS FROM 1603 ELIZABETH STREET	12	081810	1/1/0001
05800	S		SOH	II	01459	030		12	081810	1/1/0001
05800	S		SOH	II	01610	032		12	081810	1/1/0001
05800	S	M	SOH	II	00000	007	SIDE OF 146 WALLER AVENUE ON ELIZABETH	12	102301	1/1/0001
05800	S	M	SOH	II	00000	009	SIDE OF 195 FOREST PARK ROAD ON ELIZABETH STREET	12	102301	1/1/0001
05800	S	M	SOH	II	00000	013	SIDE OF 125 WESTWOOD DRIVE ON ELIZABETH	12	102301	1/1/0001
05800	S	M	SOH	II	00000	014	ACROSS FROM 1436 ELIZABETH STREET	12	102301	1/1/0001
09500	S	M	SOH	II	00000	017	SIDE OF 144 STATE STREET ON ELIZABETH STREET	12	031004	1/1/0001
09500	S	M	SOH	II	00000	018	ACROSS FROM 202 STATE STREET ON ELIZABETH STREET	12	031004	1/1/0001
09500	S	M	SOH	II	00000	019	SIDE OF 141 UNIVERSITY AVENUE ON ELIZABETH STREET	12	031004	1/1/0001
09500	S	M	SOH	II	00000	020	SIDE OF 138 UNIVERSITY AVE ON ELIZABETH	12	031605	1/1/0001
09500	S	M	SOH	II	00000	021	SIDE OF 137 WALLER AVE ON ELIZABETH	12	031605	1/1/0001
05800	S	M	SOH	II	01350	008		12	102301	1/1/0001
05800	S	M	SOH	II	01405	010		12	102301	1/1/0001
05800	S	M	SOH	II	01409	011		12	102301	1/1/0001
05800	S	M	SOH	II	01413	012		12	102301	1/1/0001
05800	S	M	SOH	II	01507	015		12	102301	1/1/0001

OFFICE: 311

ROUTE: 564

ST_REF_NO: 0000062800

ELIZABETH STREET

LUMENS	BULB TYPE	MULT SERIES	POLE TYPE	SHADE	ADDRESS NUMBER	REF	LOCATION	TAX DIST	DATE INST	DATE CHANGE
05800	S	M	SOH	II	01511	016		12	102301	1/1/0001
09500	S	M	SOH	I	00000	001	SIDE OF 143 STATE ST.	12	050863	1/1/0001
09500	S	M	SOH	I	00000	002	SIDE OF 154 TRANSCRIPT AVE.	12	050863	1/1/0001
09500	S	M	SOH	I	00000	003	SIDE OF 201 CONN TERRACE	12	050863	1/1/0001
09500	S	M	SOH	I	00000	004	SIDE OF 200 CONN TERRACE	12	050863	1/1/0001
05800	S	M	SOH	III	01417	006		12	100899	1/1/0001
04000	S	M	SOH	I	00000	005	SIDE OF 201 LACKAWANA RD.	12	100162	1/1/0001

OFFICE: 311

ROUTE: 564

ST_REF_NO: 0000062890

ELKHORN ROAD

LUMENS	BULB TYPE	MULT SERIES	POLE TYPE	SHADE	ADDRESS NUMBER	REF	LOCATION	TAX DIST	DATE INST	DATE CHANGE
09500	S	M	OUG	II	02220	029		12	120892	1/1/0001
09500	S	M	OUG	II	02230	031		12	120892	1/1/0001
09500	S	M	OUG	II	02231	030		12	120892	1/1/0001
09500	S	M	OUG	II	02241	032		12	120892	1/1/0001
09500	S	M	OUG	II	02241	033		12	120892	1/1/0001
09500	S	M	OUG	II	02241	034		12	120892	1/1/0001
09500	S	M	OUG	II	02250	007		12	081582	1/1/0001
09500	S	M	OUG	II	02251	008		12	120892	1/1/0001
09500	S	M	OUG	II	02261	006		12	120892	1/1/0001
09500	S	M	OUG	II	02270	005		12	050886	1/1/0001
09500	S	M	OUG	II	02271	004		12	081582	1/1/0001
09500	S	M	OUG	II	02291	001		12	050886	1/1/0001
09500	S	M	OUG	II	02291	002		12	050886	1/1/0001

OFFICE: 311

ROUTE: 564

ST_REF_NO: 0000062895

ELK LAKE COURT

LUMENS	BULB TYPE	MULT SERIES	POLE TYPE	SHADE	ADDRESS NUMBER	REF	LOCATION	TAX DIST	DATE INST	DATE CHANGE
04000	S	M	OUG	II	00000	116	SIDE OF 604 ELK LAKE DRIVE	12	101581	1/1/0001

OFFICE: 311

ROUTE: 564

ST_REF_NO: 0000062900

ELK LAKE DRIVE

LUMENS	BULB TYPE	MULT SERIES	POLE TYPE	SHADE	ADDRESS NUMBER	REF	LOCATION	TAX DIST	DATE INST	DATE CHANGE
05800	S	M	OUG	II	00613	115	bad fixture	12	011581	3/2/2009

OFFICE: 311

ROUTE: 564

ST_REF_NO: 0000062900 ELK LAKE DRIVE

LUMENS	BULB TYPE	MULT SERIES	POLE TYPE	SHADE	ADDRESS NUMBER	REF	LOCATION	TAX DIST	DATE INST	DATE CHANGE
05800	S	M	OUG	V	00664	101	audit	12	111580	2/17/2014
04000	S	M	OUG	II	00000	114	SIDE OF 3183 BEAVER CREEK DR.	12	011581	1/1/0001
04000	S	M	OUG	II	00000	126	SIDE 498 GRAYSON LAKE	12	110885	1/1/0001
04000	S	M	SOH	II	00560	127		12	050887	1/1/0001
04000	S	M	OUG	II	00580	113		12	050887	1/1/0001
04000	S	M	OUG	II	00616	107		12	111580	1/1/0001
04000	S	M	OUG	II	00633	106		12	111580	1/1/0001
04000	S	M	OUG	II	00644	105		12	111580	1/1/0001
04000	S	M	OUG	II	00661	102		12	111580	1/1/0001
04000	S	M	OUG	II	00676	100		12	111580	1/1/0001
04000	S	M	OUG	II	00689	099		12	111580	1/1/0001

OFFICE: 311

ROUTE: 564

ST_REF_NO: 0000063100 ELKIN ALLEY

LUMENS	BULB TYPE	MULT SERIES	POLE TYPE	SHADE	ADDRESS NUMBER	REF	LOCATION	TAX DIST	DATE INST	DATE CHANGE
05800	S	M	SOH	I	00000	001	BETWEEN WARREN CT. AND BASSETT CT.	12	082967	1/1/0001

OFFICE: 311

ROUTE: 564

ST_REF_NO: 0000063230 ELLA RAE COURT

LUMENS	BULB TYPE	MULT SERIES	POLE TYPE	SHADE	ADDRESS NUMBER	REF	LOCATION	TAX DIST	DATE INST	DATE CHANGE
05800	S	M	CNT	II	00000	001	OPPOSITE 2749 ELLA RAE COURT	12	072401	1/1/0001
05800	S	M	CNT	II	02716	003		12	072401	1/1/0001
05800	S	M	CNT	II	02733	002		12	072401	1/1/0001

OFFICE: 311

ROUTE: 564

ST_REF_NO: 0000063235 ELLA RAE LANE

LUMENS	BULB TYPE	MULT SERIES	POLE TYPE	SHADE	ADDRESS NUMBER	REF	LOCATION	TAX DIST	DATE INST	DATE CHANGE
05800	S	M	CNT	II	00000	001	SIDE OF 2773 MABLE LANE ON ELLA RAE LANE	12	072401	1/1/0001
05800	S	M	CNT	II	00000	007	SIDE OF 2753 JACQUELYN DR ON ELLA RAE LANE	12	072401	1/1/0001
05800	S	M	CNT	II	00000	010	SIDE OF 440 LUCILLE DR ON ELLA RAE LANE	12	072401	1/1/0001
05800	S	M	CNT	II	00321	003		12	072401	1/1/0001
05800	S	M	CNT	II	00332	004		12	072401	1/1/0001
05800	S	M	CNT	II	00349	005		12	072401	1/1/0001
05800	S	M	CNT	II	00360	006		12	072401	1/1/0001

OFFICE: 311 ROUTE: 564							ST_REF_NO: 0000063235 ELLA RAE LANE			
LUMENS	BULB TYPE	MULT SERIES	POLE TYPE	SHADE	ADDRESS NUMBER	REF	LOCATION	TAX DIST	DATE INST	DATE CHANGE
05800	S	M	CNT	II	00409	008		12	072401	1/1/0001
05800	S	M	CNT	II	00424	009		12	072401	1/1/0001

OFFICE: 311 ROUTE: 564							ST_REF_NO: 0000063240 ELLEMOOR COURT			
LUMENS	BULB TYPE	MULT SERIES	POLE TYPE	SHADE	ADDRESS NUMBER	REF	LOCATION	TAX DIST	DATE INST	DATE CHANGE
05800	S	M	CNT	III	03509	001		12	050899	1/1/0001

OFFICE: 311 ROUTE: 564							ST_REF_NO: 0000063250 ELLEMOOR LANE			
LUMENS	BULB TYPE	MULT SERIES	POLE TYPE	SHADE	ADDRESS NUMBER	REF	LOCATION	TAX DIST	DATE INST	DATE CHANGE
05800	S	M	CNT	II	00000	008	SIDE 3512 ELLEMOOR CT.	12	050899	1/1/0001
05800	S	M	CNT	III	00101	004		12	050899	1/1/0001
05800	S	M	CNT	II	00121	003		12	050899	1/1/0001
05800	S	M	CNT	II	00132	002		12	050899	1/1/0001
05800	S	M	CNT	II	00145	001		12	050899	1/1/0001
05800	S	M	CNT	II	00196	007		12	050899	1/1/0001
05800	S	M	CNT	II	00217	009		12	050899	1/1/0001
05800	S	M	CNT	II	00181	006		12	050899	1/1/0001
05800	S	M	CNT	II	00164	005		12	050899	1/1/0001

OFFICE: 311 ROUTE: 564							ST_REF_NO: 0000063260 ELLEN COURT			
LUMENS	BULB TYPE	MULT SERIES	POLE TYPE	SHADE	ADDRESS NUMBER	REF	LOCATION	TAX DIST	DATE INST	DATE CHANGE
05800	S	M	CNT	III	03008	001		12	113005	1/1/0001

OFFICE: 311 ROUTE: 564							ST_REF_NO: 0000063305 ELLERSLIE PARK BLVD			
LUMENS	BULB TYPE	MULT SERIES	POLE TYPE	SHADE	ADDRESS NUMBER	REF	LOCATION	TAX DIST	DATE INST	DATE CHANGE
09500	S		CLN	II	00000	001	1ST LT S OF RICHMOND RD, W SIDE ON ELLERSLIE PARK BLVD	12	041511	1/1/0001
09500	S		CLN	II	00000	002	1ST LT S OF RICHMOND RD, E SIDE ON ELLERSLIE PARK BLVD	12	041511	1/1/0001
09500	S		CLN	II	00000	003	2ND LT S OF RICHMOND RD, W SIDE ON ELLERSLIE PARK BLVD	12	041511	1/1/0001

OFFICE: 311

ROUTE: 564

ST_REF_NO: 0000063305

ELLERSLIE PARK BLVD

LUMENS	BULB TYPE	MULT SERIES	POLE TYPE	SHADE	ADDRESS NUMBER	REF	LOCATION	TAX DIST	DATE INST	DATE CHANGE
09500	S		CLN	II	00000	004	2ND LT S OF RICHMOND RD, E SIDE ON ELLERSLIE PARK BLVD	12	041511	1/1/0001
09500	S		CLN	II	00000	005	3RD LT S OF RICHMOND RD, W SIDE ON ELLERSLIE PARK BLVD	12	041511	1/1/0001
09500	S		CLN	II	00169	006		12	041511	1/1/0001
09500	S		CLN	II	00181	007		12	041511	1/1/0001
09500	S		CLN	II	00197	008		12	041511	1/1/0001
09500	S		CLN	II	00200	009		12	041511	1/1/0001
09500	S		CLN	II	00217	010		12	041511	1/1/0001

OFFICE: 311

ROUTE: 564

ST_REF_NO: 0000063350

ELLIS PARK DRIVE

LUMENS	BULB TYPE	MULT SERIES	POLE TYPE	SHADE	ADDRESS NUMBER	REF	LOCATION	TAX DIST	DATE INST	DATE CHANGE
05800	S	M	OUG	II	00208	005		12	090800	1/1/0001
05800	S	M	OUG	II	00216	004		12	090800	1/1/0001
05800	S	M	OUG	II	00241	003		12	090800	1/1/0001
05800	S	M	OUG	II	00252	002		12	090800	1/1/0001
05800	S	M	OUG	II	00273	001		12	090800	1/1/0001

OFFICE: 311

ROUTE: 564

ST_REF_NO: 0000063400

ELM STREET

LUMENS	BULB TYPE	MULT SERIES	POLE TYPE	SHADE	ADDRESS NUMBER	REF	LOCATION	TAX DIST	DATE INST	DATE CHANGE
05800	S	M	SOH	II	00000	010	1ST LT E OF CHARLES AVE, N SIDE ON ELM STREET	12	020405	1/1/0001
05800	S	M	SOH	II	00427	011		12	020405	1/1/0001
05800	S	M	SOH	II	00443	012		12	020405	1/1/0001
05800	S	M	SOH	II	00000	008	SIDE OF 501 GEORGETOWN ST.	12	060266	1/1/0001
05800	S	M	SOH	II	00413	000		12	011865	1/1/0001
05800	S	M	SOH	II	00437	000		12	011865	1/1/0001

OFFICE: 311

ROUTE: 564

ST_REF_NO: 0000063600

ELM TREE LANE

LUMENS	BULB TYPE	MULT SERIES	POLE TYPE	SHADE	ADDRESS NUMBER	REF	LOCATION	TAX DIST	DATE INST	DATE CHANGE
09500	S	M	SOH	II	00545	000		12	020966	12/13/2013
05800	S	M	SOH	II	00501	000		12	060893	1/1/0001

OFFICE: 311		ROUTE: 564		ST_REF_NO: 00000063600		ELM TREE LANE		LUMENS	BULB TYPE	MULT SERIES	POLE TYPE	SHADE	ADDRESS NUMBER	REF	LOCATION	TAX DIST	DATE INST	DATE CHANGE
05800	S	M	SOH	II	00515	000										12	011865	1/1/0001
05800	S	M	SOH	II	00524	000										12	020966	1/1/0001
05800	S	M	SOH	II	00552	000										12	020966	1/1/0001
05800	S	M	SOH	I	00609	000										12	020966	1/1/0001
05800	S	M	SOH	I	00635	000										12	020966	1/1/0001
05800	S	M	SOH	I	00661	000										12	020966	1/1/0001

OFFICE: 311		ROUTE: 564		ST_REF_NO: 00000063610		ELMENDORF LANE		LUMENS	BULB TYPE	MULT SERIES	POLE TYPE	SHADE	ADDRESS NUMBER	REF	LOCATION	TAX DIST	DATE INST	DATE CHANGE
05800	S	M	OUG	II	01012	000										12	091564	1/1/0001

OFFICE: 311		ROUTE: 564		ST_REF_NO: 00000063620		ELMENDORF PLACE		LUMENS	BULB TYPE	MULT SERIES	POLE TYPE	SHADE	ADDRESS NUMBER	REF	LOCATION	TAX DIST	DATE INST	DATE CHANGE
05800	S	M	OUG	II	01007	000										12	071562	1/1/0001
05800	S	M	OUG	II	01019	000										12	071562	1/1/0001

OFFICE: 311		ROUTE: 564		ST_REF_NO: 00000063630		ELMENDORF CIRCLE		LUMENS	BULB TYPE	MULT SERIES	POLE TYPE	SHADE	ADDRESS NUMBER	REF	LOCATION	TAX DIST	DATE INST	DATE CHANGE
05800	S	M	OUG	II	00000	001									SIDE OF 1039 ELMENDORF DR.	12	091564	1/1/0001

OFFICE: 311		ROUTE: 564		ST_REF_NO: 00000063640		ELMENDORF WAY		LUMENS	BULB TYPE	MULT SERIES	POLE TYPE	SHADE	ADDRESS NUMBER	REF	LOCATION	TAX DIST	DATE INST	DATE CHANGE
05800	S	M	OUG	II	01051	000										12	071562	1/1/0001

OFFICE: 311		ROUTE: 564		ST_REF_NO: 00000063700		ELMENDORF DRIVE		LUMENS	BULB TYPE	MULT SERIES	POLE TYPE	SHADE	ADDRESS NUMBER	REF	LOCATION	TAX DIST	DATE INST	DATE CHANGE
05800	S	M	OUG	II	00000	101									SIDE OF 1024 GAINESWAY DR.	12	091564	1/1/0001
05800	S	M	OUG	II	01005	000										12	072264	1/1/0001
05800	S	M	OUG	II	01024	000										12	090166	1/1/0001
05800	S	M	OUG	II	00000	080									SIDE OF 3477 DIXIANA DR.	12	071562	1/1/0001

OFFICE: 311		ROUTE: 564		ST_REF_NO: 00000063700		ELMENDORF DRIVE				
LUMENS	BULB TYPE	MULT SERIES	POLE TYPE	SHADE	ADDRESS NUMBER	REF	LOCATION	TAX DIST	DATE INST	DATE CHANGE
05800	S	M	OUG	II	01027	000		12	071562	1/1/0001
05800	S	M	OUG	II	01039	000		12	091564	1/1/0001
05800	S	M	OUG	II	01046	000		12	090266	1/1/0001

OFFICE: 311		ROUTE: 564		ST_REF_NO: 00000063800		ELMHURST COURT				
LUMENS	BULB TYPE	MULT SERIES	POLE TYPE	SHADE	ADDRESS NUMBER	REF	LOCATION	TAX DIST	DATE INST	DATE CHANGE
05800	S	M	OUG	II	00000	167	SIDE OF 3342 COLDSTREAM DR.	12	042067	1/1/0001
05800	S	M	OUG	II	03270	000		12	120667	1/1/0001

OFFICE: 311		ROUTE: 564		ST_REF_NO: 00000063825		ELORA LANE				
LUMENS	BULB TYPE	MULT SERIES	POLE TYPE	SHADE	ADDRESS NUMBER	REF	LOCATION	TAX DIST	DATE INST	DATE CHANGE
05800	S	M	CNT	II	04076	003		12	080102	1/1/0001
05800	S	M	CNT	II	04089	002		12	080102	1/1/0001
05800	S	M	CNT	II	04096	001		12	080102	1/1/0001

OFFICE: 311		ROUTE: 564		ST_REF_NO: 00000063880		ELSMERE "A" ALLEY				
LUMENS	BULB TYPE	MULT SERIES	POLE TYPE	SHADE	ADDRESS NUMBER	REF	LOCATION	TAX DIST	DATE INST	DATE CHANGE
05800	S	M	SOH	I	00000	001	BEHIND 606 N. BROADWAY	12	030562	1/1/0001
05800	S	M	SOH	I	00000	002	BEHIND 616 N. BROADWAY	12	030562	1/1/0001
05800	S	M	SOH	I	00000	003	BEHIND 644 N. BROADWAY	12	030562	1/1/0001
05800	S	M	SOH	I	00000	004	BEHIND 658 N. BROADWAY	12	120162	1/1/0001

OFFICE: 311		ROUTE: 564		ST_REF_NO: 00000063890		ELSMERE "B" ALLEY				
LUMENS	BULB TYPE	MULT SERIES	POLE TYPE	SHADE	ADDRESS NUMBER	REF	LOCATION	TAX DIST	DATE INST	DATE CHANGE
05800	S	M	SOH	I	00000	001	BEHIND 606 ELSMERE PARK	12	030562	1/1/0001
05800	S	M	SOH	I	00000	002	BEHIND 612 ELSMERE PARK	12	030562	1/1/0001
05800	S	M	SOH	I	00000	003	BEHIND 638 ELSMERE PARK	12	030562	1/1/0001
05800	S	M	SOH	I	00000	004	BEHIND 644 ELSMERE PARK	12	030562	1/1/0001
05800	S	M	SOH	I	00000	005	BEHIND 666 ELSMERE PARK	12	030562	1/1/0001
05800	S	M	SOH	I	00000	284	BEHIND 709 N. UPPER ST.	12	101866	1/1/0001
05800	S	M	SOH	I	00000	285	BEHIND 725 N. UPPER ST.	12	101866	1/1/0001

OFFICE: 311		ROUTE: 564		ST_REF_NO: 00000063890		ELSMERE "B" ALLEY				
LUMENS	BULB TYPE	MULT SERIES	POLE TYPE	SHADE	ADDRESS NUMBER	REF	LOCATION	TAX DIST	DATE INST	DATE CHANGE
05800	S	M	SOH	I	00000	286	BEHIND 747 N. UPPER ST.	12	101866	1/1/0001
05800	S	M	SOH	I	00000	287	BEHIND 757 N. UPPER ST.	12	101866	1/1/0001

OFFICE: 311		ROUTE: 564		ST_REF_NO: 00000063900		ELMWOOD DRIVE				
LUMENS	BULB TYPE	MULT SERIES	POLE TYPE	SHADE	ADDRESS NUMBER	REF	LOCATION	TAX DIST	DATE INST	DATE CHANGE
05800	S	M	OUG	II	00000	011	SIDE OF 2424 WANDA WAY	12	060468	1/1/0001
05800	S	M	OUG	II	00177	000		12	070767	1/1/0001
05800	S	M	OUG	II	00197	000		12	070767	1/1/0001
05800	S	M	SOH	I	00209	000		12	081674	1/1/0001
05800	S	M	SOH	I	00225	000		12	081674	1/1/0001
05800	S	M	SOH	I	00237	000		12	081674	1/1/0001
05800	S	M	SOH	I	00249	000		12	081674	1/1/0001
05800	S	M	SOH	I	00261	000		12	081674	1/1/0001
05800	S	M	SOH	I	00269	000		12	081674	1/1/0001
05800	S	M	SOH	I	00277	000		12	081674	1/1/0001
05800	S	M	SOH	I	00289	000		12	081674	1/1/0001
05800	S	M	SOH	I	00293	000		12	081674	1/1/0001

OFFICE: 311		ROUTE: 564		ST_REF_NO: 00000064000		ELSMERE PARK				
LUMENS	BULB TYPE	MULT SERIES	POLE TYPE	SHADE	ADDRESS NUMBER	REF	LOCATION	TAX DIST	DATE INST	DATE CHANGE
05800	S	M	SOH	II	00000	001	NW CORNER OF ELSMERE ALLEY 'A'	12	020161	1/1/0001
05800	S	M	SOH	II	00000	002	SIDE OF 645	12	101965	1/1/0001
05800	S	M	SOH	II	00612	000		12	020161	1/1/0001
05800	S	M	SOH	II	00628	000		12	020161	1/1/0001
05800	S	M	SOH	II	00640	000		12	020161	1/1/0001
05800	S	M	SOH	II	00646	000		12	020161	1/1/0001
05800	S	M	SOH	II	00674	000		12	020161	1/1/0001

OFFICE: 311		ROUTE: 564		ST_REF_NO: 00000064100		ELSTON DRIVE				
LUMENS	BULB TYPE	MULT SERIES	POLE TYPE	SHADE	ADDRESS NUMBER	REF	LOCATION	TAX DIST	DATE INST	DATE CHANGE
05800	S	M	OUG	II	00000	001	SIDE OF 501 SCOTTSDALE CIRCLE	12	100896	1/1/0001

OFFICE: 311		ROUTE: 564		ST_REF_NO: 0000064100		ELSTON DRIVE		LUMENS	BULB TYPE	MULT SERIES	POLE TYPE	SHADE	ADDRESS NUMBER	REF	LOCATION	TAX DIST	DATE INST	DATE CHANGE
05800	S	M	OUG	II	00000	013	SIDE OF 501 HOLLOW CREEK RD	12	090172	1/1/0001								
05800	S	M	OUG	II	00000	019	SIDE OF 436 ASBURY LANE	12	060170	1/1/0001								
05800	S	M	OUG	II	00000	056	SIDE OF 452 KILPATRICK CT.	12	010172	1/1/0001								
05800	S	M	OUG	II	01587	000		12	030171	1/1/0001								
OFFICE: 311		ROUTE: 564		ST_REF_NO: 0000064149		ELVERTON COURT		LUMENS	BULB TYPE	MULT SERIES	POLE TYPE	SHADE	ADDRESS NUMBER	REF	LOCATION	TAX DIST	DATE INST	DATE CHANGE
05800	S		OUG	II	00701	001		12	080710	1/1/0001								
05800	S		OUG	II	00708	002		12	080710	1/1/0001								
OFFICE: 311		ROUTE: 564		ST_REF_NO: 0000064150		ELVERTON ROAD		LUMENS	BULB TYPE	MULT SERIES	POLE TYPE	SHADE	ADDRESS NUMBER	REF	LOCATION	TAX DIST	DATE INST	DATE CHANGE
05800	S		OUG	II	00000	001	SIDE OF 1752 MILLBANK RD., ON ELVERTON ROAD	12	080710	1/1/0001								
05800	S		OUG	II	01705	005		12	080710	1/1/0001								
05800	S		OUG	II	01709	004		12	080710	1/1/0001								
05800	S		OUG	II	01724	003		12	080710	1/1/0001								
05800	S		OUG	II	01737	002		12	080710	1/1/0001								
OFFICE: 311		ROUTE: 564		ST_REF_NO: 0000064200		EMBRY AVENUE		LUMENS	BULB TYPE	MULT SERIES	POLE TYPE	SHADE	ADDRESS NUMBER	REF	LOCATION	TAX DIST	DATE INST	DATE CHANGE
05800	S	M	SOH	I	00000	433	SIDE OF 804 BENNETT AVE.	12	071467	1/1/0001								
05800	S	M	SOH	I	01221	000		12	071467	1/1/0001								
05800	S	M	SOH	I	01233	000		12	071467	1/1/0001								
05800	S	M	SOH	I	01241	000		12	071467	1/1/0001								
05800	S	M	SOH	I	01249	000		12	071467	1/1/0001								
OFFICE: 311		ROUTE: 564		ST_REF_NO: 0000064250		EMERALD CIRCLE		LUMENS	BULB TYPE	MULT SERIES	POLE TYPE	SHADE	ADDRESS NUMBER	REF	LOCATION	TAX DIST	DATE INST	DATE CHANGE
04000	S	M	OUG	II	03509	001		12	110891	1/1/0001								

OFFICE: 311

ROUTE: 564

ST_REF_NO: 0000064300

EMERSON DRIVE

LUMENS	BULB TYPE	MULT SERIES	POLE TYPE	SHADE	ADDRESS NUMBER	REF	LOCATION	TAX DIST	DATE INST	DATE CHANGE
05800	S	M	OUG	II	00000	111	SIDE OF 1091 MEADOW LANE	12	110863	1/1/0001
05800	S	M	OUG	II	00000	112	SIDE OF 1100 MEADOW LANE	12	110863	1/1/0001
05800	S	M	OUG	II	00400	000		12	100164	1/1/0001
05800	S	M	OUG	II	00409	000		12	040163	1/1/0001
05800	S	M	OUG	II	00430	000		12	100164	1/1/0001
05800	S	M	OUG	II	00441	000		12	040163	1/1/0001
05800	S	M	OUG	II	00458	000		12	032172	1/1/0001
05800	S	M	OUG	II	00473	000		12	100164	1/1/0001
05800	S	M	OUG	II	00506	054		12	061580	1/1/0001
05800	S	M	OUG	II	00527	000		12	050163	1/1/0001
05800	S	M	OUG	II	00538	000		12	040163	1/1/0001
05800	S	M	OUG	II	00550	057		12	061580	1/1/0001
05800	S	M	OUG	II	00607	058		12	101476	1/1/0001
05800	S	M	OUG	II	00623	059		12	101476	1/1/0001
05800	S	M	OUG	II	00642	060		12	111478	1/1/0001
05800	S	M	OUG	II	00670	000		12	041763	1/1/0001

OFFICE: 311

ROUTE: 564

ST_REF_NO: 0000064380

EMERSON WOODS WAY

LUMENS	BULB TYPE	MULT SERIES	POLE TYPE	SHADE	ADDRESS NUMBER	REF	LOCATION	TAX DIST	DATE INST	DATE CHANGE
05800	S	M	OUG	II	00000	002	OPP. 3380	12	020800	1/1/0001
05800	S	M	OUG	II	00000	004	REAR OF 528 BROOK FARM COURT	12	020800	1/1/0001
05800	S	M	OUG	II	00000	006	SIDE OF 528 LIDIAN COURT	12	020800	1/1/0001
05800	S	M	OUG	II	03304	007		12	020800	1/1/0001
05800	S	M	OUG	II	03328	005		12	020800	1/1/0001
05800	S	M	OUG	II	03360	003		12	020800	1/1/0001
05800	S	M	OUG	II	03388	001		12	020800	1/1/0001

OFFICE: 311

ROUTE: 564

ST_REF_NO: 0000064400

EMERY COURT

LUMENS	BULB TYPE	MULT SERIES	POLE TYPE	SHADE	ADDRESS NUMBER	REF	LOCATION	TAX DIST	DATE INST	DATE CHANGE
04000	S	M	OUG	II	00000	185	SIDE OF 1716 COURTNEY AVE	12	110884	1/1/0001
04000	S	M	OUG	V	00572	187		12	110884	1/1/0001
04000	S	M	OUG	II	00592	186		12	110884	1/1/0001

OFFICE: 311							ROUTE: 564			
ST_REF_NO: 0000064450							EMILIE LANE			
LUMENS	BULB TYPE	MULT SERIES	POLE TYPE	SHADE	ADDRESS NUMBER	REF	LOCATION	TAX DIST	DATE INST	DATE CHANGE
05800	S	M	CNT	II	00200	003		12	052607	1/1/0001
05800	S	M	CNT	II	00217	002		12	052607	1/1/0001
05800	S	M	CNT	II	00225	001		12	052607	1/1/0001

OFFICE: 311							ROUTE: 564			
ST_REF_NO: 0000064550							EMMETT CREEK LANE			
LUMENS	BULB TYPE	MULT SERIES	POLE TYPE	SHADE	ADDRESS NUMBER	REF	LOCATION	TAX DIST	DATE INST	DATE CHANGE
05800	S	M	CNT	II	00632	016		12	100899	1/1/0001
05800	S	M	CNT	II	00637	015		12	100899	1/1/0001
05800	S	M	CNT	II	00652	014		12	100899	1/1/0001
05800	S	M	CNT	II	00657	013		12	100899	1/1/0001
05800	S	M	CNT	II	00669	012		12	100899	1/1/0001
05800	S	M	CNT	II	00680	011		12	100899	1/1/0001
05800	S	M	CNT	II	00696	009		12	100899	1/1/0001
05800	S	M	CNT	II	00697	010		12	100899	1/1/0001
05800	S	M	CNT	II	00721	008		12	100899	1/1/0001
05800	S	M	CNT	II	00000	004	SIDE OF 4437 JOSIAH WAY	12	080897	1/1/0001
05800	S	M	CNT	II	00604	019		12	030899	1/1/0001
05800	S	M	CNT	II	00609	018		12	030899	1/1/0001
05800	S	M	CNT	II	00617	017		12	030899	1/1/0001
05800	S	M	CNT	II	00732	007		12	080897	1/1/0001
05800	S	M	CNT	II	00741	006		12	080897	1/1/0001
05800	S	M	CNT	II	00752	005		12	080897	1/1/0001
05800	S	M	CNT	II	00768	003		12	08097	1/1/0001
05800	S	M	CNT	II	00785	002		12	080897	1/1/0001
05800	S	M	CNT	II	00792	001		12	080897	1/1/0001

OFFICE: 311							ROUTE: 564			
ST_REF_NO: 0000064600							ENDON DRIVE			
LUMENS	BULB TYPE	MULT SERIES	POLE TYPE	SHADE	ADDRESS NUMBER	REF	LOCATION	TAX DIST	DATE INST	DATE CHANGE
05800	S	M	OUG	II	01841	003	audit-corrected hse number only	12	030888	7/14/2011
05800	S	M	OUG	II	01821	000		12	060164	1/1/0001
04000	S	M	OUG	II	01832	002		12	030888	1/1/0001
04000	S	M	OUG	II	01856	004		12	030888	1/1/0001

OFFICE: 311		ROUTE: 564		ST_REF_NO: 0000064605		ENGLISH OAK CIRCLE		LUMENS	BULB TYPE	MULT SERIES	POLE TYPE	SHADE	ADDRESS NUMBER	REF	LOCATION	TAX DIST	DATE INST	DATE CHANGE
05800	S	M	CNT	II	03913	001										12	110895	1/1/0001
OFFICE: 311		ROUTE: 564		ST_REF_NO: 0000064700		ENGMAN AVENUE		LUMENS	BULB TYPE	MULT SERIES	POLE TYPE	SHADE	ADDRESS NUMBER	REF	LOCATION	TAX DIST	DATE INST	DATE CHANGE
05800	S	M	SOH	I	00000	001	SIDE OF 530 WALNUT ST.									12	120162	1/1/0001
05800	S	M	SOH	I	00000	002	OPPOSITE 222									12	120162	1/1/0001
05800	S	M	SOH	I	00000	003	OPPOSITE 230									12	120162	1/1/0001
05800	S	M	SOH	I	00000	004	OPPOSITE 242									12	120162	1/1/0001
05800	S	M	SOH	I	00214	000										12	120162	1/1/0001
05800	S	M	SOH	I	00256	000										12	120162	1/1/0001
OFFICE: 311		ROUTE: 564		ST_REF_NO: 0000064705		ENSTAD COURT		LUMENS	BULB TYPE	MULT SERIES	POLE TYPE	SHADE	ADDRESS NUMBER	REF	LOCATION	TAX DIST	DATE INST	DATE CHANGE
04000	S	M	OUG	II	00800	001										12	100890	1/1/0001
OFFICE: 311		ROUTE: 564		ST_REF_NO: 0000064710		ENTERPRISE DRIVE		LUMENS	BULB TYPE	MULT SERIES	POLE TYPE	SHADE	ADDRESS NUMBER	REF	LOCATION	TAX DIST	DATE INST	DATE CHANGE
09500	S	M	OUG	II	00000	021	2ND LT W OF ENTERPRISE CT, S SIDE ON ENTERPRISE PK									12	062002	1/1/0001
09500	S	M	OUG	II	00000	022	3RD LT W OF ENTERPRISE CT, S SIDE ON ENTERPRISE PK									12	062002	1/1/0001
09500	S	M	OUG	II	00000	023	4TH LT W OF ENTERPRISE CT, S SIDE ON ENTERPRISE PK									12	062002	1/1/0001
09500	S	M	OUG	II	00000	025	6TH LT W OF ENTERPRISE CT, S SIDE ON ENTERPRISE PK									12	062002	1/1/0001
09500	S	M	OUG	II	00000	027	7TH LT W OF ENTERPRISE CT, S SIDE ON ENTERPRISE PK									12	062002	1/1/0001
09500	S	M	OUG	II	00990	024										12	062002	1/1/0001
09500	S	M	OUG	II	01020	026										12	062002	1/1/0001
50000	S	M	OUG	II	00000	002	1ST LT. OFF OLD FRANKFORT ROAD, EASTSIDE									12	060895	1/1/0001
09500	S	M	OUG	II	00000	019	OPP 800									12	050895	1/1/0001
09500	S	M	OUG	II	00000	020	END OF ENTERPRISE DRIVE,, CUL-DE-SAC									12	020800	1/1/0001
09500	S	M	OUG	II	00730	008										12	060895	1/1/0001

OFFICE: 311 ROUTE: 564										
ST_REF_NO: 0000064710 ENTERPRISE DRIVE										
LUMENS	BULB TYPE	MULT SERIES	POLE TYPE	SHADE	ADDRESS NUMBER	REF	LOCATION	TAX DIST	DATE INST	DATE CHANGE
09500	S	M	OUG	II	00731	005		12	050895	1/1/0001
09500	S	M	OUG	II	00731	007		12	050895	1/1/0001
09500	S	M	OUG	II	00750	010		12	060895	1/1/0001
09500	S	M	OUG	II	00751	009		12	060895	1/1/0001
09500	S	M	OUG	II	00760	012		12	060895	1/1/0001
09500	S	M	SOH	II	00761	011		12	050895	1/1/0001
09500	S	M	OUG	II	00771	013		12	050895	1/1/0001
09500	S	M	OUG	II	00780	016		12	050895	1/1/0001
09500	S	M	OUG	II	00790	018		12	050895	1/1/0001
09500	S	M	OUG	II	00791	015		12	050895	1/1/0001
OFFICE: 311 ROUTE: 564										
ST_REF_NO: 0000064720 ENTERPRISE CIRCLE										
LUMENS	BULB TYPE	MULT SERIES	POLE TYPE	SHADE	ADDRESS NUMBER	REF	LOCATION	TAX DIST	DATE INST	DATE CHANGE
09500	S	M	OUG	II	00000	001	SIDE 730 ENTERPRISE DR.	12	060895	1/1/0001
09500	S	M	OUG	II	02041	005		12	060895	1/1/0001
09500	S	M	OUG	II	02051	004		12	060895	1/1/0001
09500	S	M	OUG	II	02071	003		12	060895	1/1/0001
OFFICE: 311 ROUTE: 564										
ST_REF_NO: 0000064725 ENTERPRISE COURT										
LUMENS	BULB TYPE	MULT SERIES	POLE TYPE	SHADE	ADDRESS NUMBER	REF	LOCATION	TAX DIST	DATE INST	DATE CHANGE
09500	S	M	OUG	II	00000	002	SIDE 750 ENTERPRISE DRIVE	12	060895	1/1/0001
OFFICE: 311 ROUTE: 564										
ST_REF_NO: 0000064740 EQUINE COURT										
LUMENS	BULB TYPE	MULT SERIES	POLE TYPE	SHADE	ADDRESS NUMBER	REF	LOCATION	TAX DIST	DATE INST	DATE CHANGE
05800	S	M	CNT	III	01208	002		12	062205	1/1/0001
05800	S	M	CNT	II	01212	001		12	062205	1/1/0001
OFFICE: 311 ROUTE: 564										
ST_REF_NO: 0000064750 ERIC COURT										
LUMENS	BULB TYPE	MULT SERIES	POLE TYPE	SHADE	ADDRESS NUMBER	REF	LOCATION	TAX DIST	DATE INST	DATE CHANGE
05800	S	M	CNT	III	00000	001	SIDE REAR OF 401 FOREST HILL DR.	12	040897	1/1/0001

OFFICE: 311		ROUTE: 564		ST_REF_NO: 0000064800		ERIE ROAD		LUMENS	BULB TYPE	MULT SERIES	POLE TYPE	SHADE	ADDRESS NUMBER	REF	LOCATION	TAX DIST	DATE INST	DATE CHANGE
05800	S	M	OUG	II	00459	000										12	070566	1/1/0001
05800	S	M	OUG	II	00477	000										12	012160	1/1/0001
05800	S	M	OUG	II	00480	000										12	012160	1/1/0001
05800	S	M	OUG	II	00485	000										12	012160	1/1/0001
05800	S	M	OUG	II	00494	000										12	050159	1/1/0001
05800	S	M	OUG	II	00499	000										12	050159	1/1/0001

OFFICE: 311		ROUTE: 564		ST_REF_NO: 0000064900		ERMINE COURT		LUMENS	BULB TYPE	MULT SERIES	POLE TYPE	SHADE	ADDRESS NUMBER	REF	LOCATION	TAX DIST	DATE INST	DATE CHANGE
04000	S	M	OUG	II	02000	018										12	031581	1/1/0001
04000	S	M	OUG	II	02009	019										12	031581	1/1/0001
04000	S	M	OUG	II	02016	056										12	031581	1/1/0001

OFFICE: 311		ROUTE: 564		ST_REF_NO: 0000065010		ESCONDIDA WAY		LUMENS	BULB TYPE	MULT SERIES	POLE TYPE	SHADE	ADDRESS NUMBER	REF	LOCATION	TAX DIST	DATE INST	DATE CHANGE
05800	S	M	OUG	III	02200	197										12	040895	1/1/0001
05800	S	M	OUG	III	02204	196										12	040895	1/1/0001

OFFICE: 311		ROUTE: 564		ST_REF_NO: 0000065100		ESPLANADE		LUMENS	BULB TYPE	MULT SERIES	POLE TYPE	SHADE	ADDRESS NUMBER	REF	LOCATION	TAX DIST	DATE INST	DATE CHANGE
09500	S	M	ACD	III	00000	001									SIDE 233 E. MAIN ST.	12	050898	1/1/0001
09500	S	M	ACD	III	00000	002									SIDE 201 E. MAIN ST.,	12	050898	1/1/0001
09500	S	M	ACD	III	00000	004									OPP. 104	12	050898	1/1/0001
09500	S	M	ACD	III	00000	006									OPP. 108	12	050898	1/1/0001
09500	S	M	ACD	III	00000	008									OPP. 170	12	050898	1/1/0001
09500	S	M	ACD	III	00000	009									NE CORNER OF E. SHORT ST.	12	050898	1/1/0001
09500	S	M	ACD	III	00104	003										12	050898	1/1/0001
09500	S	M	ACD	III	00108	005										12	050898	1/1/0001
09500	S	M	ACD	III	00170	007										12	050898	1/1/0001
09500	S	M	ACD	III	00170	010										12	050898	1/1/0001

OFFICE: 311		ROUTE: 564		ST_REF_NO: 0000065250		ESTRELLA DRIVE				
LUMENS	BULB TYPE	MULT SERIES	POLE TYPE	SHADE	ADDRESS NUMBER	REF	LOCATION	TAX DIST	DATE INST	DATE CHANGE
05800	S		CNT	II	00628	006		12	080610	1/1/0001
05800	S		CNT	II	00644	005		12	080610	1/1/0001
05800	S		CNT	II	00657	004		12	080610	1/1/0001
05800	S		CNT	II	00672	003		12	080610	1/1/0001
05800	S		CNT	II	00689	002		12	080610	1/1/0001

OFFICE: 311		ROUTE: 564		ST_REF_NO: 0000065300		ETAWAH DRIVE				
LUMENS	BULB TYPE	MULT SERIES	POLE TYPE	SHADE	ADDRESS NUMBER	REF	LOCATION	TAX DIST	DATE INST	DATE CHANGE
05800	S	M	OUG	II	00000	168	SIDE OF 1850 MARIETTA DR.	12	090766	1/1/0001
05800	S	M	OUG	II	01450	000		12	090766	1/1/0001
05800	S	M	OUG	II	01484	000		12	090766	1/1/0001

OFFICE: 311		ROUTE: 564		ST_REF_NO: 0000065500		EUCLID AVENUE				
LUMENS	BULB TYPE	MULT SERIES	POLE TYPE	SHADE	ADDRESS NUMBER	REF	LOCATION	TAX DIST	DATE INST	DATE CHANGE
22000	S	M	OOH	II	00000	013	OPP. S MARTIN LUTHER KING BLVD-audit	12	090167	2/17/2014
20000	M	M	OOH	II	00000	014	1ST LT. E. OF S MARTIN LUTHER KING BLVD, N SIDE-audit	12	090167	2/17/2014
22000	S	M	OOH	II	00000	015	1ST LT. E. OF S MARTIN LUTHER KING BLVD-audit	12	090167	2/17/2014
22000	S	M	OOH	II	00000	018	1ST LT. E. OF LEXINGTON AVE., N. SIDE	12	090167	12/21/2009
22000	S	M	OOH	II	00000	019	1 ST. LT. E. OF LEXINGTON AVE., S. SIDE-car accident	12	090167	12/30/2010
22000	S	M	OOH	II	00000	021	2ND LT. E. OF LEXINGTON AVE., S. SIDE-chg'd bad fixture	12	090167	7/30/2009
22000	S	M	OOH	II	00000	022	3RD LT. E. OF LEXINGTON AVE., N. SIDE	12	090167	3/24/2011
22000	S	M	OOH	II	00000	023	3RD LT. E. OF LEXINGTON AVE., S. SIDE-chg'd bad fixture	12	090167	7/28/2009
22000	S	M	OOH	II	00000	024	4TH LT. E. OF LEXINGTON AVE., N. SIDE-chg'd bad fixture	12	090167	7/30/2009
22000	S	M	OOH	II	00000	028	6TH LT. E. OF LEXINGTON AVE., N. SIDE	12	090167	2/18/2014
50000	S	M	SOH	III	00000	040	1ST LT E OF WOODLAND, N SIDE	12	091861	10/20/2009
22000	S	S	SOH	III	00000	042	opp 512	12	091861	7/30/2009
22000	S	S	SOH	III	00000	044	SIDE OF 391 OLDHAM AVE-chg'd bad fixture	12	091861	7/30/2009
22000	S	S	SOH	III	00000	047	SIDE OF 378 PARK AVE.	12	101861	11/28/2012
22000	S	M	OOH	III	00000	063	EUCLID AT HIGH	12	101861	2/18/2014

OFFICE: 311

ROUTE: 564

ST_REF_NO: 0000065500

EUCLID AVENUE

LUMENS	BULB TYPE	MULT SERIES	POLE TYPE	SHADE	ADDRESS NUMBER	REF	LOCATION	TAX DIST	DATE INST	DATE CHANGE
22000	S	M	SOH	III	00430	035	changed out bad fixture	12	091861	7/30/2009
22000	S	M	SOH	III	00466	039	upgrade per SS	12	091861	10/20/2009
22000	S	S	SOH	III	00546	045	bad fixture	12	091861	2/5/2010
20000	M	M	OOH	III	00829	059	audit	12	101861	2/18/2014
20000	M	M	OUG	III	00836	062	audit	12	101861	2/18/2014
22000	S	S	SOH	III	00506	041	mv changeout	12	101861	1/1/0001
20000	M	M	SOH	III	00530	043		12	091861	1/1/0001
22000	S	M	SOH	III	00551	046	mv changeout	12	091861	1/1/0001
20000	M	S	SOH	III	00630	048		12	091861	1/1/0001
20000	M	M	SOH	III	00635	049		12	091861	1/1/0001
20000	M	S	SOH	III	00644	050		12	091861	1/1/0001
20000	M	M	SOH	III	00714	052		12	091861	1/1/0001
20000	M	S	SOH	III	00719	051		12	091861	1/1/0001
20000	M	S	SOH	III	00722	054		12	091861	1/1/0001
20000	M	M	SOH	III	00727	053		12	091861	1/1/0001
20000	M	M	OOH	III	00804	056		12	101861	1/1/0001
20000	M	M	OOH	III	00805	055		12	101861	1/1/0001
20000	M	M	OOH	III	00815	057		12	101861	1/1/0001
20000	M	M	OOH	III	00824	058		12	101861	1/1/0001
22000	S	M	OOH	III	00835	061		12	101861	1/1/0001
20000	M	M	OOH	II	00000	005	1ST LT. E. OF LIMESTONE, S. SIDE	12	090167	1/1/0001
20000	M	M	OOH	II	00000	006	1ST LT. E. OF LIMESTONE, N. SIDE	12	090167	1/1/0001
22000	S	M	OOH	II	00000	007	2ND LT. E. OF LIMESTONE, S. SIDE-upgrade 8/08	12	090167	1/1/0001
20000	M	M	OOH	II	00000	008	2ND LT. E. OF LIMESTONE, N. SIDE	12	090167	1/1/0001
22000	S	M	OOH	II	00000	009	3RD LT. E. OF LIMESTONE, S. SIDE-upgrade 8/08	12	090167	1/1/0001
20000	M	M	OOH	II	00000	011	4TH LT. E. OF LIMESTONE, S. SIDE	12	090167	1/1/0001
20000	M	M	OOH	II	00000	016	2ND LT. E. OF HARRISON AVE, N. SIDE	12	090167	1/1/0001
20000	M	M	OOH	II	00000	017	2ND LT. E. OF HARRISON AVE., S. SIDE	12	090167	1/1/0001
20000	M	M	OOH	II	00000	020	2ND LT. E. OF LEXINGTON AVE., N. SIDE	12	090167	1/1/0001
20000	M	M	OOH	II	00000	025	4TH LT. E. OF LEXINGTON AVE., S. SIDE	12	090167	1/1/0001
20000	M	M	OOH	II	00000	026	5TH LT. E. OF LEXINGTON AVE., N. SIDE	12	090167	1/1/0001
20000	M	M	OOH	II	00000	027	5TH LT. E. OF LEXINGTON AVE., S. SIDE	12	090167	1/1/0001
20000	M	M	OOH	II	00000	029	SW CORNER OF ROSE & EUCLID	12	090167	1/1/0001
20000	M	M	SOH	III	00000	032	SIDE OF 373 LINDEN WALK	12	091861	1/1/0001

OFFICE: 311

ROUTE: 564

ST_REF_NO: 0000065500

EUCLID AVENUE

LUMENS	BULB TYPE	MULT SERIES	POLE TYPE	SHADE	ADDRESS NUMBER	REF	LOCATION	TAX DIST	DATE INST	DATE CHANGE
20000	M	M	SOH	III	00000	033	SIDE OF 404 LINDEN WALK	12	091861	1/1/0001
20000	M	M	SOH	III	00000	034	SIDE OF 375 AYLESFORD PLACE	12	091861	1/1/0001
20000	M	M	SOH	III	00000	036	SIDE OF 375 TRANSYLVANIA PARK	12	091861	1/1/0001
20000	M	M	SOH	III	00000	037	EUCLID & TRANSYLVANIA	12	091861	1/1/0001
20000	M	M	SOH	III	00302	031		12	091861	1/1/0001
20000	M	M	SOH	III	00305	030		12	091861	1/1/0001
20000	M	M	SOH	III	00461	038		12	091861	1/1/0001

OFFICE: 311

ROUTE: 564

ST_REF_NO: 0000065600

EUREKA SPRINGS DRIVE

LUMENS	BULB TYPE	MULT SERIES	POLE TYPE	SHADE	ADDRESS NUMBER	REF	LOCATION	TAX DIST	DATE INST	DATE CHANGE
09500	S	M	OUG	II	00575	013	audit	12	021476	2/18/2014
09500	S	M	OUG	II	00609	008	bad fixture	12	081476	3/2/2009
09500	S	M	OUG	II	00000	006	SIDE OF 501 DEATON PLACE	12	090898	1/1/0001
09500	S	M	OUG	II	00000	010	OPP. 593	12	110886	1/1/0001
09500	S	M	OUG	II	00000	012	OPP. 581	12	110886	1/1/0001
09500	S	M	OUG	II	00000	014	OPP. 569	12	110886	1/1/0001
09500	S	M	OUG	II	00000	026	SIDE 583 EL PASEO	12	110886	1/1/0001
10000	M	M	OUG	II	00000	030	SIDE OF 2800 EAST HILLS DR.	12	011581	1/1/0001
10000	M	M	OUG	II	00000	090	SIDE OF 692 ELK LAKE DR.	12	111580	1/1/0001
09500	S	M	OUG	II	00000	091	SIDE REAR OF 700 ORLEANS CIRCLE	12	090898	1/1/0001
10000	M	M	OUG	II	00000	092	SIDE OF 689 ELK LAKE DR.	12	111580	1/1/0001
09500	S	M	OUG	II	00000	093	REAR OF 788 ORLEANS CIRCLE	12	090898	1/1/0001
10000	M	M	OUG	II	00000	096	SIDE OF 3155 BEAVER CREEK DR.	12	111580	1/1/0001
09500	S	M	OUG	II	00000	097	OPP. BEAVER CREEK	12	010888	1/1/0001
09500	S	M	OUG	II	00000	100	OPP. 737 EUREKA SPRINGS	12	090898	1/1/0001
09500	S	M	OUG	II	00000	102	OPP. DEATON PLACE	12	090898	1/1/0001
09500	S	M	OUG	II	00506	001		12	090898	1/1/0001
09500	S	M	OUG	II	00533	005		12	090898	1/1/0001
09500	S	M	OUG	II	00540	004		12	090898	1/1/0001
09500	S	M	OUG	II	00541	003		12	090898	1/1/0001
09500	S	M	OUG	II	00550	002		12	090898	1/1/0001
10000	M	M	OUG	II	00561	015		12	081476	1/1/0001
09500	S	M	OUG	II	00580	009		12	110886	1/1/0001

OFFICE: 311 ROUTE: 564										
ST_REF_NO: 00000065600 EUREKA SPRINGS DRIVE										
LUMENS	BULB TYPE	MULT SERIES	POLE TYPE	SHADE	ADDRESS NUMBER	REF	LOCATION	TAX DIST	DATE INST	DATE CHANGE
10000	M	M	OUG	II	00589	011		12	021476	1/1/0001
09500	S	M	OUG	II	00600	007		12	110886	1/1/0001
10000	M	M	OUG	II	00621	025		12	101478	1/1/0001
10000	M	M	OUG	II	00633	027		12	101478	1/1/0001
09500	S	M	OUG	II	00636	028		12	110886	1/1/0001
09500	S	M	OUG	II	00644	029		12	110886	1/1/0001
09500	S	M	OUG	II	00660	031		12	090898	1/1/0001
10000	M	M	OUG	II	00693	094		12	111580	1/1/0001
09500	S	M	OUG	II	00700	099		12	090898	1/1/0001
09500	S	M	OUG	II	00710	095		12	010888	1/1/0001
09500	S	M	OUG	II	00721	098		12	010888	1/1/0001
09500	S	M	OUG	II	00746	101		12	090898	1/1/0001

OFFICE: 311 ROUTE: 564

ST_REF_NO: 00000065700 EVANS STREET										
LUMENS	BULB TYPE	MULT SERIES	POLE TYPE	SHADE	ADDRESS NUMBER	REF	LOCATION	TAX DIST	DATE INST	DATE CHANGE
05800	S	M	SOH	I	00000	001	1ST. LT. N. OF THIRD ST., W. SIDE	12	111468	1/1/0001

OFFICE: 311 ROUTE: 564

ST_REF_NO: 00000065835 EVEREST COURT										
LUMENS	BULB TYPE	MULT SERIES	POLE TYPE	SHADE	ADDRESS NUMBER	REF	LOCATION	TAX DIST	DATE INST	DATE CHANGE
05800	S	M	CNT	III	00705	001		12	061501	1/1/0001

OFFICE: 311 ROUTE: 564

ST_REF_NO: 00000065837 EVERETTS DALE										
LUMENS	BULB TYPE	MULT SERIES	POLE TYPE	SHADE	ADDRESS NUMBER	REF	LOCATION	TAX DIST	DATE INST	DATE CHANGE
05800	S		OUG	II	00000	007	SIDE OF 753 SPRUCEWOOD DR, ON EVERETT'S DALE	12	080409	1/1/0001
05800	S		OUG	II	03797	006		12	080409	1/1/0001
05800	S	M	OUG	II	03805	005		12	030206	1/1/0001
05800	S	M	OUG	II	03816	004		12	030206	1/1/0001
05800	S	M	OUG	II	03833	003		12	030206	1/1/0001
05800	S	M	OUG	II	03840	002		12	030206	1/1/0001
05800	S	M	OUG	II	03845	001		12	030206	1/1/0001

OFFICE: 311		ROUTE: 564		ST_REF_NO: 0000065840		EVERGREEN DRIVE				
LUMENS	BULB TYPE	MULT SERIES	POLE TYPE	SHADE	ADDRESS NUMBER	REF	LOCATION	TAX DIST	DATE INST	DATE CHANGE
05800	S	M	CNT	II	04201	005		12	110898	1/1/0001
05800	S	M	CNT	II	04212	004		12	110898	1/1/0001
05800	S	M	CNT	II	04221	003		12	110898	1/1/0001
05800	S	M	CNT	II	04232	002		12	110898	1/1/0001
05800	S	M	CNT	II	04240	001		12	110898	1/1/0001

OFFICE: 311		ROUTE: 564		ST_REF_NO: 0000065890		EXECUTIVE DRIVE				
LUMENS	BULB TYPE	MULT SERIES	POLE TYPE	SHADE	ADDRESS NUMBER	REF	LOCATION	TAX DIST	DATE INST	DATE CHANGE
09500	S		OUG	II	02240	010		12	110608	1/1/0001
09500	S		OUG	II	02260	008		12	110608	1/1/0001
05800	S	M	OUG	II	00000	051	OPPOSITE 2112 EXECUTIVE DRIVE	12	060401	1/1/0001
05800	S	M	OUG	II	00000	052	SIDE OF 2120 WILKES WAY ON EXECUTIVE DRIVE	12	060401	1/1/0001
05800	S	M	OUG	II	00000	053	SIDE REAR OF 2097 CALL DRIVE ON EXECUTIVE DRIVE	12	060401	1/1/0001
09500	S	M	OUG	II	02233	011		12	100887	1/1/0001
09500	S	M	OUG	II	02249	009		12	100887	1/1/0001
09500	S	M	OUG	II	02265	007		12	120892	1/1/0001
09500	S	M	OUG	II	02273	006		12	100887	1/1/0001
09500	S	M	OUG	II	02280	004		12	120892	1/1/0001
09500	S	M	OUG	II	02285	005		12	120892	1/1/0001
09500	S	M	OUG	II	02297	001		12	100887	1/1/0001
09500	S	M	OUG	II	02297	003		12	100887	1/1/0001

OFFICE: 311		ROUTE: 564		ST_REF_NO: 0000065900		EXPO COURT				
LUMENS	BULB TYPE	MULT SERIES	POLE TYPE	SHADE	ADDRESS NUMBER	REF	LOCATION	TAX DIST	DATE INST	DATE CHANGE
05800	S	M	OUG	V	04000	005	audit	12	021579	2/18/2014
04000	S	M	OUG	II	00000	001	SIDE OF 4108 VICTORIA WAY	12	021579	1/1/0001
04000	S	M	OUG	II	04012	004		12	021579	1/1/0001
04000	S	M	OUG	II	04013	003		12	021579	1/1/0001
04000	S	M	OUG	II	04040	002		12	021579	1/1/0001

OFFICE: 311

ROUTE: 564

ST_REF_NO: 0000065910

EXPORT STREET

LUMENS	BULB TYPE	MULT SERIES	POLE TYPE	SHADE	ADDRESS NUMBER	REF	LOCATION	TAX DIST	DATE INST	DATE CHANGE
09500	S	M	CNT	II	00000	001	1ST LT. S OF VIRGINIA AVE., W SIDE	12	070899	1/1/0001
09500	S	M	CNT	II	00000	002	1ST LT. S OF VIRGINIA AVE., E SIDE	12	070899	1/1/0001
09500	S	M	CNT	II	00000	003	2ND LT. S OF VIRGINIA AVE., W SIDE	12	070899	1/1/0001
09500	S	M	CNT	II	00000	004	2ND LT. S OF VIRGINIA AVE., E SIDE	12	070899	1/1/0001
09500	S	M	CNT	II	00000	005	3RD LT. S OF VIRGINIA AVE., W SIDE	12	070899	1/1/0001
09500	S	M	CNT	II	00000	006	3RD LT. S OF VIRGINIA AVE., E SIDE	12	070899	1/1/0001
09500	S	M	CNT	II	00000	007	4TH LT. S OF VIRGINIA AVE., W SIDE	12	070899	1/1/0001
09500	S	M	CNT	II	00000	008	4TH LT. S OF VIRGINIA AVE., E SIDE	12	070899	1/1/0001
09500	S	M	CNT	II	00000	009	5TH LT. S OF VIRGINIA AVE., W SIDE	12	070899	1/1/0001
09500	S	M	CNT	II	00000	010	5TH LT. S OF VIRGINIA AVE., E SIDE	12	070899	1/1/0001
09500	S	M	CNT	II	00000	011	6TH LT. S OF VIRGINIA AVE., W SIDE	12	070899	1/1/0001

OFFICE: 311

ROUTE: 564

ST_REF_NO: 0000066000

FAIR OAKS DRIVE

LUMENS	BULB TYPE	MULT SERIES	POLE TYPE	SHADE	ADDRESS NUMBER	REF	LOCATION	TAX DIST	DATE INST	DATE CHANGE
05800	S	M	OUG	II	00000	053	SIDE OF 1529 PORT ROYAL DR.	12	101674	1/1/0001
05800	S	M	OUG	II	01971	054		12	101674	1/1/0001
05800	S	M	OUG	II	01982	055		12	101674	1/1/0001
05800	S	M	OUG	II	01983	056		12	101674	1/1/0001
05800	S	M	OUG	II	01994	057		12	101674	1/1/0001
05800	S	M	OUG	II	01995	058		12	101674	1/1/0001

OFFICE: 311

ROUTE: 564

ST_REF_NO: 0000066100

FAIRCREST DRIVE

LUMENS	BULB TYPE	MULT SERIES	POLE TYPE	SHADE	ADDRESS NUMBER	REF	LOCATION	TAX DIST	DATE INST	DATE CHANGE
05800	S	M	CNT	II	00000	101	SIDE OF 797 LAUREL HILL RD ON FAIRCREST DR	12	011703	1/1/0001
04000	S	M	OUG	II	00000	001	SIDE OF 800 LAUREL HILL RD.	12	100888	1/1/0001
04000	S	M	OUG	II	00000	002	SIDE OF 795 DELLA DR.	12	090889	1/1/0001
04000	S	M	OUG	II	00000	003	SIDE OF 800 DELLA DR.	12	100889	1/1/0001
04000	S	M	OUG	II	00000	004	SIDE OF 789 CHERYL LANE	12	100889	1/1/0001
04000	S	M	OUG	II	00000	005	SIDE OF 792 CHERYL LANE	12	100889	1/1/0001
04000	S	M	OUG	II	00000	006	SIDE OF 817 LYNN DR.	12	100889	1/1/0001
04000	S	M	OUG	II	00000	007	SIDE OF 812 LYNN DR.	12	100889	1/1/0001
04000	S	M	OUG	II	00000	008	SIDE OF 797 FURLONG DR.	12	100889	1/1/0001

OFFICE: 311		ROUTE: 564		ST_REF_NO: 0000066100		FAIRCREST DRIVE				
LUMENS	BULB TYPE	MULT SERIES	POLE TYPE	SHADE	ADDRESS NUMBER	REF	LOCATION	TAX DIST	DATE INST	DATE CHANGE
04000	S	M	OUG	II	00000	009	SIDE OF 802 FURLONG DR.	12	100889	1/1/0001
05800	S	M	CNT	II	00000	011	SIDE OF 1836 HEADLEY GREEN	12	060899	1/1/0001
05800	S	M	CNT	II	00000	012	SIDE OF 1796 CHANDLER LANE	12	110897	1/1/0001
05800	S	M	CNT	II	00000	013	SIDE OF 800 KEENE WOOD DR.	12	110897	1/1/0001
05800	S	M	CNT	II	00000	014	4TH LT. W OF MASON HEADLEY RD.	12	110897	1/1/0001
05800	S	M	CNT	II	00000	015	3RD LT. W OF MASON HEADLEY RD.	12	110897	1/1/0001
05800	S	M	CNT	II	00000	016	2ND LT. W OF MASON HEADLEY RD.	12	110897	1/1/0001
05800	S	M	CNT	II	00000	017	1ST LT W OF MASON HEADLEY RD.	12	110897	1/1/0001
OFFICE: 311		ROUTE: 564		ST_REF_NO: 0000066175		FAIRFAX LANE				
LUMENS	BULB TYPE	MULT SERIES	POLE TYPE	SHADE	ADDRESS NUMBER	REF	LOCATION	TAX DIST	DATE INST	DATE CHANGE
05800	S		CNT	II	00000	001	SIDE OF 3304 FELICIANA LN, ON FAIRFAX LN	12	020510	1/1/0001
05800	S		CNT	II	00000	002	ACROSS FROM 2901 FAIRFAX LANE	12	020510	1/1/0001
05800	S		CNT	II	00000	003	ACROSS FROM 2909 FAIRFAX LANE	12	020510	1/1/0001
05800	S		CNT	II	00000	004	ACROSS FROM 2917 FAIRFAX LANE	12	020510	1/1/0001
OFFICE: 311		ROUTE: 564		ST_REF_NO: 0000066200		FAIRFIELD DRIVE				
LUMENS	BULB TYPE	MULT SERIES	POLE TYPE	SHADE	ADDRESS NUMBER	REF	LOCATION	TAX DIST	DATE INST	DATE CHANGE
04000	S	M	OUG	II	00000	081	OPPOSITE 441	12	092368	1/1/0001
04000	S	M	OUG	II	00402	084		12	090968	1/1/0001
04000	S	M	OUG	II	00414	083		12	090968	1/1/0001
04000	S	M	OUG	II	00429	082		12	101468	1/1/0001
04000	S	M	OUG	II	00511	080		12	050172	1/1/0001
04000	S	M	OUG	II	00524	079		12	092368	1/1/0001
04000	S	M	OUG	II	00535	078		12	112068	1/1/0001
04000	S	M	OUG	II	00548	077		12	120869	1/1/0001
04000	S	M	OUG	II	00559	076		12	120869	1/1/0001
04000	S	M	OUG	II	00568	075		12	090969	1/1/0001

OFFICE: 311		ROUTE: 564		ST_REF_NO: 0000066205		FAIRGROUNDS DRIVE				
LUMENS	BULB TYPE	MULT SERIES	POLE TYPE	SHADE	ADDRESS NUMBER	REF	LOCATION	TAX DIST	DATE INST	DATE CHANGE
05800	S		OUG	III	00216	006		12	092010	1/1/0001
05800	S		OUG	II	00229	005		12	092010	1/1/0001
05800	S	M	OUG	II	00245	040		12	072407	1/1/0001
05800	S	M	OUG	II	00000	001	SIDE OF 2100 BELMONT DR.	12	090800	1/1/0001
05800	S	M	OUG	II	00000	003	SIDE OF 2000 FAIRGROUNDS CT.	12	090800	1/1/0001
05800	S	M	OUG	II	00272	002		12	090800	1/1/0001

OFFICE: 311		ROUTE: 564		ST_REF_NO: 0000066206		FAIRGROUNDS COURT				
LUMENS	BULB TYPE	MULT SERIES	POLE TYPE	SHADE	ADDRESS NUMBER	REF	LOCATION	TAX DIST	DATE INST	DATE CHANGE
05800	S	M	OUG	II	00201	001		12	090800	1/1/0001

OFFICE: 311		ROUTE: 564		ST_REF_NO: 0000066210		FAIRHAVEN DRIVE				
LUMENS	BULB TYPE	MULT SERIES	POLE TYPE	SHADE	ADDRESS NUMBER	REF	LOCATION	TAX DIST	DATE INST	DATE CHANGE
05800	S	M	OUG	II	00962	004		12	020887	8/7/2011
04000	S	M	OUG	II	00000	008	SIDE OF 4492 SARON	12	020888	1/1/0001
04000	S	M	OUG	II	00875	012		12	020888	1/1/0001
04000	S	M	OUG	II	00890	011		12	020888	1/1/0001
04000	S	M	OUG	II	00899	010		12	110889	1/1/0001
04000	S	M	OUG	II	00911	009		12	110889	1/1/0001
04000	S	M	OUG	II	00922	007		12	020887	1/1/0001
04000	S	M	OUG	II	00934	006		12	020887	1/1/0001
04000	S	M	OUG	II	00946	005		12	020887	1/1/0001
04000	S	M	OUG	II	00971	003		12	020887	1/1/0001
04000	S	M	OUG	II	00986	002		12	020887	1/1/0001
05800	S	M	OUG	III	00995	001		12	070899	1/1/0001

OFFICE: 311		ROUTE: 564		ST_REF_NO: 0000066300		FAIRLAWN AVENUE				
LUMENS	BULB TYPE	MULT SERIES	POLE TYPE	SHADE	ADDRESS NUMBER	REF	LOCATION	TAX DIST	DATE INST	DATE CHANGE
04000	S	M	SOH	II	00000	017	SIDE 1300 N. BROADWAY	12	060685	1/1/0001
04000	S	M	SOH	II	00000	022	SIDE 1201 N. LIMESTONE	12	060685	1/1/0001
04000	S	M	SOH	II	00106	021		12	060685	1/1/0001

OFFICE: 311

ROUTE: 564

ST_REF_NO: 00000066300 FAIRLAWN AVENUE

LUMENS	BULB TYPE	MULT SERIES	POLE TYPE	SHADE	ADDRESS NUMBER	REF	LOCATION	TAX DIST	DATE INST	DATE CHANGE
04000	S	M	SOH	II	00129	020		12	060685	1/1/0001
04000	S	M	SOH	II	00136	019		12	060685	1/1/0001
04000	S	M	SOH	II	00141	018		12	060685	1/1/0001

OFFICE: 311

ROUTE: 564

ST_REF_NO: 00000066400 FAIRLEAF PLACE

LUMENS	BULB TYPE	MULT SERIES	POLE TYPE	SHADE	ADDRESS NUMBER	REF	LOCATION	TAX DIST	DATE INST	DATE CHANGE
05800	S	M	OUG	V	00201	008		12	111580	1/1/0001

OFFICE: 311

ROUTE: 564

ST_REF_NO: 00000066500 FAIRMAN ROAD

LUMENS	BULB TYPE	MULT SERIES	POLE TYPE	SHADE	ADDRESS NUMBER	REF	LOCATION	TAX DIST	DATE INST	DATE CHANGE
10000	M	M	SOH	II	00000	001	1ST LT. N. OF MERCER RD.	12	031581	1/1/0001
10000	M	M	SOH	II	00000	002	2ND LT. N. OF MERCER RD.	12	031581	1/1/0001
10000	M	M	SOH	II	00000	003	3RD LT. N. OF MERCER RD.	12	031581	1/1/0001
10000	M	M	SOH	II	00000	004	4TH LT. N. OF MERCER RD.	12	031581	1/1/0001
10000	M	M	SOH	II	00000	005	5TH LT. N. OF MERCER RD.	12	031581	1/1/0001
10000	M	M	SOH	II	00000	006	6TH LT. N. OF MERCER RD.	12	031581	1/1/0001
10000	M	M	SOH	II	00000	007	7TH LT. N. OF MERCER RD.	12	031581	1/1/0001
10000	M	M	SOH	II	00000	008	8TH LT. N. OF MERCER RD.	12	031581	1/1/0001
10000	M	M	SOH	II	00000	009	9TH LT. N. OF MERCER RD.	12	031581	1/1/0001
10000	M	M	SOH	II	00000	010	10TH LT. N. OF MERCER RD.	12	031581	1/1/0001
10000	M	M	SOH	II	00000	011	11TH LT. N. OF MERCER RD.	12	031581	1/1/0001

OFFICE: 311

ROUTE: 564

ST_REF_NO: 00000066600 FAIRMONT COURT

LUMENS	BULB TYPE	MULT SERIES	POLE TYPE	SHADE	ADDRESS NUMBER	REF	LOCATION	TAX DIST	DATE INST	DATE CHANGE
05800	S	M	OUG	II	00000	074	SIDE OF 164 LAKESHORE DR.	12	030672	1/1/0001
05800	S	M	OUG	II	02074	075		12	090169	1/1/0001

OFFICE: 311

ROUTE: 564

ST_REF_NO: 00000066670 FAIR RIDGE DRIVE

LUMENS	BULB TYPE	MULT SERIES	POLE TYPE	SHADE	ADDRESS NUMBER	REF	LOCATION	TAX DIST	DATE INST	DATE CHANGE
05800	S	M	CNT	II	00000	001	SIDE OF 3688 PARK POINTE DR.	12	050899	1/1/0001
05800	S	M	CNT	II	03608	005		12	050899	1/1/0001

OFFICE: 311		ROUTE: 564		ST_REF_NO: 0000066670		FAIR RIDGE DRIVE				
LUMENS	BULB TYPE	MULT SERIES	POLE TYPE	SHADE	ADDRESS NUMBER	REF	LOCATION	TAX DIST	DATE INST	DATE CHANGE
05800	S	M	CNT	II	03621	004		12	050899	1/1/0001
05800	S	M	CNT	II	03632	003		12	050899	1/1/0001
05800	S	M	CNT	II	03641	002		12	050899	1/1/0001

OFFICE: 311		ROUTE: 564		ST_REF_NO: 0000066700		FAIRWAY DRIVE				
LUMENS	BULB TYPE	MULT SERIES	POLE TYPE	SHADE	ADDRESS NUMBER	REF	LOCATION	TAX DIST	DATE INST	DATE CHANGE
04000	S	M	OUG	II	00000	001	SIDE OF 1805 RICHMOND RD.	12	071367	1/1/0001
04000	S	M	OUG	II	00000	002	SIDE OF 1745 RICHMOND RD.	12	071367	1/1/0001
04000	S	M	OUG	II	00000	018	SIDE OF 1717 RICHMOND RD.	12	080966	1/1/0001
05800	S	M	OUG	II	00000	022	OPP. 1611	12	071478	1/1/0001
04000	S	M	OUG	II	00120	003		12	071367	1/1/0001
04000	S	M	OUG	II	01603	023		12	061269	1/1/0001
04000	S	M	OUG	II	01709	021		12	071478	1/1/0001
04000	S	M	OUG	II	01732	020		12	071367	1/1/0001
04000	S	M	OUG	II	01811	005		12	041582	1/1/0001

OFFICE: 311		ROUTE: 564		ST_REF_NO: 0000066705		FAIRWOOD LN				
LUMENS	BULB TYPE	MULT SERIES	POLE TYPE	SHADE	ADDRESS NUMBER	REF	LOCATION	TAX DIST	DATE INST	DATE CHANGE
04000	S		OUG	II	00120	019		12	080966	1/1/0001
04000	S		OUG	II	00121	004		12	071367	1/1/0001
05800	S		OUG	II	00000	016	SIDE OF 1617 RICHMOND RD,	12	080966	2/27/2013

OFFICE: 311		ROUTE: 564		ST_REF_NO: 0000066800		FALLON ROAD				
LUMENS	BULB TYPE	MULT SERIES	POLE TYPE	SHADE	ADDRESS NUMBER	REF	LOCATION	TAX DIST	DATE INST	DATE CHANGE
05800	S	M	OUG	II	00000	041	OPP. 2093	12	040566	1/1/0001
05800	S	M	OUG	II	02044	000		12	040566	1/1/0001
05800	S	M	OUG	II	02052	000		12	060766	1/1/0001
05800	S	M	OUG	II	02056	000		12	060766	1/1/0001
05800	S	M	OUG	II	02065	000		12	040566	1/1/0001
05800	S	M	OUG	II	02072	000		12	040566	1/1/0001
05800	S	M	OUG	II	02077	000		12	040566	1/1/0001

OFFICE: 311		ROUTE: 564		ST_REF_NO: 0000066810		FAMILY CIRCLE		LUMENS	BULB TYPE	MULT SERIES	POLE TYPE	SHADE	ADDRESS NUMBER	REF	LOCATION	TAX DIST	DATE INST	DATE CHANGE
09500	S	M	OUG	II	00000	003	SIDE OF 1114 NEW CIRCLE RD.	12	040886	1/1/0001								
09500	S	M	OUG	II	02000	006		12	120886	1/1/0001								
09500	S	M	OUG	II	02009	004		12	120886	1/1/0001								
09500	S	M	SOH	II	02015	002		12	040886	1/1/0001								
09500	S	M	OUG	II	02017	001		12	040886	1/1/0001								

OFFICE: 311		ROUTE: 564		ST_REF_NO: 0000067000		FARRA COURT		LUMENS	BULB TYPE	MULT SERIES	POLE TYPE	SHADE	ADDRESS NUMBER	REF	LOCATION	TAX DIST	DATE INST	DATE CHANGE
05800	S	M	OUG	II	00804	000		12	100169	1/1/0001								

OFFICE: 311		ROUTE: 564		ST_REF_NO: 0000067100		FAVELL COURT		LUMENS	BULB TYPE	MULT SERIES	POLE TYPE	SHADE	ADDRESS NUMBER	REF	LOCATION	TAX DIST	DATE INST	DATE CHANGE
04000	S	M	OUG	V	01972	064		12	091579	1/1/0001								
04000	S	M	OUG	II	01984	065		12	101579	1/1/0001								
05800	S	M	OUG	II	01993	066		12	091579	1/1/0001								

OFFICE: 311		ROUTE: 564		ST_REF_NO: 0000067150		FAWN CIRCLE		LUMENS	BULB TYPE	MULT SERIES	POLE TYPE	SHADE	ADDRESS NUMBER	REF	LOCATION	TAX DIST	DATE INST	DATE CHANGE
05800	S	M	CNT	III	00505	001		12	071902	1/1/0001								

OFFICE: 311		ROUTE: 564		ST_REF_NO: 0000067200		FAYE COURT		LUMENS	BULB TYPE	MULT SERIES	POLE TYPE	SHADE	ADDRESS NUMBER	REF	LOCATION	TAX DIST	DATE INST	DATE CHANGE
05800	S	M	OUG	II	02101	024		12	050169	1/1/0001								

OFFICE: 311		ROUTE: 564		ST_REF_NO: 0000067300		FAYETTE PARK		LUMENS	BULB TYPE	MULT SERIES	POLE TYPE	SHADE	ADDRESS NUMBER	REF	LOCATION	TAX DIST	DATE INST	DATE CHANGE
05800	S	M	SOH	I	00000	001	SIDE OF 521 N. BROADWAY	12	021369	1/1/0001								
05800	S	M	SOH	V	00000	002	OPP. 414, IN ISLAND	12	021369	1/1/0001								

OFFICE: 311		ROUTE: 564		ST_REF_NO: 0000067330		FEDERAL DRIVE		LUMENS	BULB TYPE	MULT SERIES	POLE TYPE	SHADE	ADDRESS NUMBER	REF	LOCATION	TAX DIST	DATE INST	DATE CHANGE
05800	S	M	CNT	II	00000	004	SIDE OF 1052 KIAWAH DR ON FEDERAL DRIVE	12	121505	1/1/0001								
05800	S	M	CNT	II	00000	005	SIDE OF 1061 KIAWAH DR ON FEDERAL DRIVE	12	121505	1/1/0001								
05800	S	M	CNT	II	00000	006	SIDE OF 1001 FIRETHORN PL ON FEDERAL DRIVE	12	121505	1/1/0001								
05800	S	M	CNT	II	05096	003		12	110800	1/1/0001								
05800	S	M	CNT	II	05100	002		12	110800	1/1/0001								
05800	S	M	CNT	II	05101	001		12	110800	1/1/0001								
OFFICE: 311		ROUTE: 564		ST_REF_NO: 0000067375		FELICIANA LANE		LUMENS	BULB TYPE	MULT SERIES	POLE TYPE	SHADE	ADDRESS NUMBER	REF	LOCATION	TAX DIST	DATE INST	DATE CHANGE
05800	S		CNT	II	00000	002	SIDE OF 2901 FAIFAX LANE ON FELICIANA LN	12	090608	9/6/2008								
05800	S		CNT	II	03304	001		12	090608	9/6/2008								
OFFICE: 311		ROUTE: 564		ST_REF_NO: 0000067400		FELIX STREET		LUMENS	BULB TYPE	MULT SERIES	POLE TYPE	SHADE	ADDRESS NUMBER	REF	LOCATION	TAX DIST	DATE INST	DATE CHANGE
22000	S	M	SOH	I	00000	001	1ST LT. N. OF MAIN ST., W. SIDE	12	011569	1/1/0001								
22000	S	M	SOH	I	00000	002	2ND LT. N. OF MAIN ST., W. SIDE	12	011569	1/1/0001								
OFFICE: 311		ROUTE: 564		ST_REF_NO: 0000067500		FELTNER COURT		LUMENS	BULB TYPE	MULT SERIES	POLE TYPE	SHADE	ADDRESS NUMBER	REF	LOCATION	TAX DIST	DATE INST	DATE CHANGE
05800	S	M	OUG	V	01897	023		12	120887	1/1/0001								
05800	S	M	OUG	II	00000	025	SIDE OF 1279 WINBURN DR.	12	020970	1/1/0001								
05800	S	M	OUG	II	01883	000		12	030896	1/1/0001								
OFFICE: 311		ROUTE: 564		ST_REF_NO: 0000067600		FENWICK ROAD		LUMENS	BULB TYPE	MULT SERIES	POLE TYPE	SHADE	ADDRESS NUMBER	REF	LOCATION	TAX DIST	DATE INST	DATE CHANGE
05800	S	M	OUG	II	00000	124	SIDE OF 3325 TAHOE RD. upgrade 6/08	12	011581	1/1/0001								
04000	S	M	OUG	II	01213	123		12	110884	1/1/0001								
04000	S	M	OUG	II	01225	122		12	110884	1/1/0001								
04000	S	M	OUG	II	01240	121		12	110884	1/1/0001								
04000	S	M	OUG	II	01253	120		12	110884	1/1/0001								
04000	S	M	OUG	II	01260	119		12	011581	1/1/0001								

OFFICE: 311		ROUTE: 564		ST_REF_NO: 00000067600		FENWICK ROAD		LUMENS	BULB TYPE	MULT SERIES	POLE TYPE	SHADE	ADDRESS NUMBER	REF	LOCATION	TAX DIST	DATE INST	DATE CHANGE
	04000	S	M	OUG	II	01301	125									12	010888	1/1/0001
	04000	S	M	OUG	II	01316	126									12	010888	1/1/0001
	04000	S	M	OUG	V	01321	127									12	010888	1/1/0001

OFFICE: 311		ROUTE: 564		ST_REF_NO: 00000067800		FERGUSON STREET		LUMENS	BULB TYPE	MULT SERIES	POLE TYPE	SHADE	ADDRESS NUMBER	REF	LOCATION	TAX DIST	DATE INST	DATE CHANGE
	09500	S	M	SOH	I	00000	001								OPP. 452-upgraded 10/07	12	050162	1/1/0001
	05800	S	M	SOH	I	00000	003								BETWEEN 417 AND 425	12	050162	1/1/0001
	09500	S	M	SOH	I	00000	004								SIDE OF 1141 COOLIDGE ST.	12	050162	1/1/0001
	05800	S	M	SOH	I	00000	005								OPP. 316	12	050162	1/1/0001
	05800	S	M	SOH	I	00000	006								BETWEEN 307 AND 311	12	050162	1/1/0001
	05800	S	M	SOH	I	00441	002									12	050162	1/1/0001

OFFICE: 311		ROUTE: 564		ST_REF_NO: 00000067900		FERN AVENUE		LUMENS	BULB TYPE	MULT SERIES	POLE TYPE	SHADE	ADDRESS NUMBER	REF	LOCATION	TAX DIST	DATE INST	DATE CHANGE
	04000	S	M	SOH	II	00000	014								SIDE 137 BURLEY AVE.	12	050886	1/1/0001
	04000	S	M	SOH	II	01101	058									12	050886	1/1/0001
	04000	S	M	SOH	II	01109	013									12	050886	1/1/0001

OFFICE: 311		ROUTE: 564		ST_REF_NO: 00000067975		FERNWOOD COURT		LUMENS	BULB TYPE	MULT SERIES	POLE TYPE	SHADE	ADDRESS NUMBER	REF	LOCATION	TAX DIST	DATE INST	DATE CHANGE
	05800	S	M	CNT	II	00709	001									12	110895	1/1/0001

OFFICE: 311		ROUTE: 564		ST_REF_NO: 00000067980		FERNDALE PASS		LUMENS	BULB TYPE	MULT SERIES	POLE TYPE	SHADE	ADDRESS NUMBER	REF	LOCATION	TAX DIST	DATE INST	DATE CHANGE
	05800	S		CNT	II	00000	010								SIDE OF 201 DARENIA LN, ON FERNDALE PASS	12	030609	1/1/0001
	05800	S		CNT	II	00193	008									12	030609	1/1/0001
	05800	S	M	CNT	II	00000	002								SIDE OF 2601 SHANNON TRACE ON FERNDALE PASS	12	042605	1/1/0001
	05800	S	M	CNT	II	00253	004									12	042605	1/1/0001
	05800	S	M	CNT	II	00264	003									12	042605	1/1/0001

OFFICE: 311		ROUTE: 564		ST_REF_NO: 0000067980		FERNDALE PASS		LUMENS	BULB TYPE	MULT SERIES	POLE TYPE	SHADE	ADDRESS NUMBER	REF	LOCATION	TAX DIST	DATE INST	DATE CHANGE
05800	S	M	CNT	II	00292	001										12	042605	1/1/0001
OFFICE: 311		ROUTE: 564		ST_REF_NO: 0000067990		FIDDLER CREEK WAY		LUMENS	BULB TYPE	MULT SERIES	POLE TYPE	SHADE	ADDRESS NUMBER	REF	LOCATION	TAX DIST	DATE INST	DATE CHANGE
05800	S	M	CNT	II	00000	006	SIDE OF 4301 CONTESSA CT ON FIDDLER CREEK WAY	12	050905	1/1/0001								
05800	S	M	CNT	II	00000	008	SIDE OF 900 MARBELLA LANE ON FIDDLER CREEK WAY	12	050905	1/1/0001								
05800	S	M	CNT	II	00000	010	SIDE OF 900 HAMMOCK OAK LANE ON FIDDLER CREEK WAY	12	050905	1/1/0001								
05800	S	M	CNT	II	00000	011	SIDE OF 4300 CLEARWATER WAY ON FIDDLER CREEK WAY	12	050905	1/1/0001								
05800	S	M	CNT	II	00909	009		12	050905	1/1/0001								
05800	S	M	CNT	II	00936	007		12	050905	1/1/0001								
05800	S	M	CNT	II	00953	005		12	050905	1/1/0001								
05800	S	M	CNT	II	00965	004		12	052703	1/1/0001								
05800	S	M	CNT	II	00972	003		12	052703	1/1/0001								
05800	S	M	CNT	II	00985	002		12	050905	1/1/0001								
05800	S	M	CNT	II	01005	012		12	020403	1/1/0001								
05800	S	M	CNT	II	01015	013		12	020403	1/1/0001								
OFFICE: 311		ROUTE: 564		ST_REF_NO: 0000068010		FIELDMOOR DRIVE		LUMENS	BULB TYPE	MULT SERIES	POLE TYPE	SHADE	ADDRESS NUMBER	REF	LOCATION	TAX DIST	DATE INST	DATE CHANGE
05800	S	M	OUG	II	00000	005	SIDE OF 1200 ROCKBRIDGE RD.	12	110893	1/1/0001								
05800	S	M	OUG	II	00000	006	SIDE OF 1199 ROCKBRIDGE RD.	12	110893	1/1/0001								
05800	S	M	CNT	II	04589	007		12	080897	1/1/0001								
05800	S	M	OUG	II	04613	004		12	110893	1/1/0001								
05800	S	M	OUG	II	04628	003		12	110893	1/1/0001								
05800	S	M	OUG	II	04637	002		12	110893	1/1/0001								
05800	S	M	OUG	III	04648	001		12	110893	1/1/0001								

OFFICE: 311		ROUTE: 564		ST_REF_NO: 0000068050		FIELDSTONE PLACE		LUMENS	BULB TYPE	MULT SERIES	POLE TYPE	SHADE	ADDRESS NUMBER	REF	LOCATION	TAX DIST	DATE INST	DATE CHANGE
05800	S	M	OUG	II	04312	001		12	010897	1/1/0001								

OFFICE: 311		ROUTE: 564		ST_REF_NO: 0000068070		FIELDSTONE WAY		LUMENS	BULB TYPE	MULT SERIES	POLE TYPE	SHADE	ADDRESS NUMBER	REF	LOCATION	TAX DIST	DATE INST	DATE CHANGE
09500	S	M	CNT	II	00000	001	1ST LT. E OF BEAUMONT CTR. PARKWAY, SOUTHSIDE	12	110899	1/1/0001								
09500	S	M	CNT	II	00000	003	2ND LT. E OF BEAUMONT CTR. PARKWAY, SOUTHSIDE	12	110899	1/1/0001								
09500	S	M	CNT	II	00000	004	2ND LT. E OF BEAUMONT CTR. PARKWAY, NORTHSIDE	12	110899	1/1/0001								
09500	S	M	CNT	II	00000	005	1ST LT. W OF BEAUMONT CTR. PARKWAY, SOUTHSIDE	12	110899	1/1/0001								
09500	S	M	CNT	II	00000	006	1ST LT. W OF BEAUONT CTR. PARKWAY, NORTHSIDE	12	110899	1/1/0001								
09500	S	M	CNT	II	00000	007	2ND LT. W OF BEAUMONT CTR. PARKWAY, SOUTHSIDE	12	110899	1/1/0001								
09500	S	M	CNT	II	00000	008	2ND LT. W OF BEAUMONT CTR. PARKWAY, NORTHSIDE	12	110899	1/1/0001								
09500	S	M	CNT	II	00000	009	3RD LT. W OF BEAUMONT CTR. PARKWAY, NORTHSIDE	12	110899	1/1/0001								
09500	S	M	CNT	II	00000	011	5TH LT. W OF BEAUMONT CTR. PARKWAY, NORTHSIDE	12	110899	1/1/0001								
09500	S	M	CNT	II	03080	012		12	110899	1/1/0001								
09500	S	M	CNT	II	00000	002	1ST LT. E OF BEAUMONT CTR. PARKWAY, NORTHSIDE	12	110899	1/1/0001								

OFFICE: 311		ROUTE: 564		ST_REF_NO: 0000068100		FIFTH STREET COURT		LUMENS	BULB TYPE	MULT SERIES	POLE TYPE	SHADE	ADDRESS NUMBER	REF	LOCATION	TAX DIST	DATE INST	DATE CHANGE
05800	S	M	SOH	V	00463	000		12	040165	1/1/0001								

OFFICE: 311		ROUTE: 564		ST_REF_NO: 0000068110		FIFTH, EAST STREET		LUMENS	BULB TYPE	MULT SERIES	POLE TYPE	SHADE	ADDRESS NUMBER	REF	LOCATION	TAX DIST	DATE INST	DATE CHANGE
05800	S		CNT	II	00000	050	SIDE OF 481 SHROPSHIRE AVE, ON E FIFTH STREET	12	080610	1/1/0001								
05800	S		CNT	II	00000	053	ACROSS FROM 480 JULIA WAY ON E FIFTH ST	12	080610	1/1/0001								

OFFICE: 311		ROUTE: 564		ST_REF_NO: 0000068110		FIFTH, EAST STREET		LUMENS	BULB TYPE	MULT SERIES	POLE TYPE	SHADE	ADDRESS NUMBER	REF	LOCATION	TAX DIST	DATE INST	DATE CHANGE
05800	S		CNT	II	00000	054	ACROSS FROM 564 E FIFTH STREET	12	080610								1/1/0001	
05800	S		CNT	II	00000	055	ACROSS FROM 473 CUNNINGHAM LN ON E FIFTH ST	12	080610								1/1/0001	
05800	S		CNT	II	00000	056	SIDE OF 381 NELSON AVE, ON E FIFTH STREET	12	080610								1/1/0001	
05800	S		CNT	II	00532	051		12	080610								1/1/0001	
05800	S		CNT	II	00548	052		12	080610								1/1/0001	
09500	S	M	SOH	II	00227	009		12	080668								12/14/2011	
09500	S	M	SOH	II	00232	010	changed out bad fixture	12	080668								9/30/2008	
09500	S	M	SOH	II	00442	018		12	080668								2/23/2012	
09500	S	M	SOH	II	00000	001	1ST. LT. E. OF LIMESTONE, N. SIDE upgrade 5/08	12	080668								1/1/0001	
09500	S	M	SOH	II	00000	002	1ST. LT. E. OF LIMESTONE, S. SIDE AT ANZA ALLEY	12	080668								1/1/0001	
10000	M	M	SOH	II	00000	003	2ND. LT. E. OF LIMESTONE, N. SIDE	12	080668								1/1/0001	
10000	M	M	SOH	II	00000	004	SIDE OF 470 JOHNSON AVE.	12	080668								1/1/0001	
10000	M	M	SOH	II	00000	005	OPPOSITE 144	12	080668								1/1/0001	
10000	M	M	SOH	II	00000	006	SIDE OF 473 WALNUT ST.	12	080668								1/1/0001	
10000	M	M	SOH	II	00000	011	SIDE OF 501 ELM TREE LANE	12	100268								1/1/0001	
10000	M	M	SOH	II	00000	015	SIDE OF 503 CHESTNUT ST.	12	080668								1/1/0001	
10000	M	M	SOH	II	00201	007		12	100268								1/1/0001	
10000	M	M	SOH	II	00218	008		12	080668								1/1/0001	
09500	S	M	SOH	II	00270	012	change out bad mv fixture 2/08	12	080668								1/1/0001	
10000	M	M	SOH	II	00285	013		12	080668								1/1/0001	
10000	M	M	SOH	II	00318	014		12	080668								1/1/0001	
10000	M	M	SOH	II	00412	016		12	080668								1/1/0001	
10000	M	M	SOH	II	00429	017		12	080668								1/1/0001	
05800	S	M	OUG	II	00501	030		12	020168								1/1/0001	
OFFICE: 311		ROUTE: 564		ST_REF_NO: 0000068120		FIFTH, WEST STREET		LUMENS	BULB TYPE	MULT SERIES	POLE TYPE	SHADE	ADDRESS NUMBER	REF	LOCATION	TAX DIST	DATE INST	DATE CHANGE
09500	S	M	SOH	II	00000	002	1ST. LT. W. OF VON ALLEY, N. SIDE	12	080668								11/7/2012	
09500	S	M	SOH	II	00000	008	OPPOSITE 556	12	100268								2/23/2012	
09500	S	M	SOH	II	00302	104		12	050168								2/15/2012	
09500	S	M	SOH	II	00519	006	chg'd out bad fixture	12	080668								7/30/2009	
10000	M	M	SOH	II	00000	001	1ST. LT. W. OF N. BROADWAY, S. SIDE	12	080668								1/1/0001	

OFFICE: 311

ROUTE: 564

ST_REF_NO: 0000068120

FIFTH, WEST STREET

LUMENS	BULB TYPE	MULT SERIES	POLE TYPE	SHADE	ADDRESS NUMBER	REF	LOCATION	TAX DIST	DATE INST	DATE CHANGE
10000	M	M	SOH	II	00000	003	1ST. LT. E. OF BOURBON AVE., S. SIDE	12	080668	1/1/0001
10000	M	M	SOH	II	00000	004	1ST. LT. E. OF BOURBON AVE., N. SIDE	12	100268	1/1/0001
10000	M	M	SOH	II	00000	005	OPPOSITE 503	12	080668	1/1/0001
10000	M	M	SOH	II	00000	101	SIDE OF 500 N. BROADWAY	12	050168	1/1/0001
10000	M	M	SOH	II	00330	102		12	050168	1/1/0001
22000	S	M	SOH	II	00536	007		12	080668	1/1/0001
05800	S	M	SOH	I	00604	000		12	040165	1/1/0001
05800	S	M	SOH	I	00614	000		12	022129	1/1/0001
10000	M	M	SOH	II	00000	105	1ST. LT. E. OF TONER ST., N. SIDE	12	050168	1/1/0001
10000	M	M	SOH	II	00000	107	OPPOSITE 206	12	050168	1/1/0001
10000	M	M	SOH	II	00000	110	SIDE OF 465 N. LIMESTONE ST.	12	050168	1/1/0001
10000	M	M	SOH	II	00119	109		12	050168	1/1/0001
10000	M	M	SOH	II	00130	108		12	050168	1/1/0001
10000	M	M	SOH	II	00216	106		12	050168	1/1/0001
10000	M	M	SOH	II	00319	103		12	050168	1/1/0001

OFFICE: 311

ROUTE: 564

ST_REF_NO: 0000068300

FINCASTLE ROAD

LUMENS	BULB TYPE	MULT SERIES	POLE TYPE	SHADE	ADDRESS NUMBER	REF	LOCATION	TAX DIST	DATE INST	DATE CHANGE
05800	S	M	OUG	III	00000	001	OPPOSITE 1707	12	081156	1/1/0001
05800	S	M	OUG	II	00000	003	SIDE OF 200 CHINOE RD.upgraded to 10/07	12	060164	1/1/0001
05800	S	M	OUG	II	00000	005	OPP. 1302	12	050365	1/1/0001
05800	S	M	SOH	I	00000	062	SIDE OF 138 S. HANOVER AVE.	12	100168	1/1/0001
05800	S	M	OUG	I	00000	064	OPP. 1020	12	100168	1/1/0001
05800	S	M	OUG	I	00000	067	OPP. 1115 IN ISLAND	12	100168	1/1/0001
05800	S	M	OUG	I	00000	068	OPP. 1116 IN ISLAND	12	100168	1/1/0001
05800	S	M	OUG	I	00000	069	OPP. 1201	12	100168	1/1/0001
05800	S	M	OUG	II	00000	122	OPP. 1308	12	050365	1/1/0001
05800	S	M	OUG	II	00000	123	OPP. 1400	12	050365	1/1/0001
05800	S	M	OUG	II	00000	124	OPP. 1416 IN ISLAND	12	040165	1/1/0001
05800	S	M	OUG	II	00000	125	S.W. CORNER OF FINCASTLE & WOODSPOINT, IN ISLAND	12	102164	1/1/0001
05800	S	M	OUG	II	00000	126	N.E. CORNER OF FINCASTLE & WOODSPOINT, IN ISLAND	12	102164	1/1/0001
05800	S	M	OUG	II	00000	127	OPP. 1601 IN ISLAND	12	010166	1/1/0001

OFFICE: 311		ROUTE: 564		ST_REF_NO: 0000068300		FINCASTLE ROAD		LUMENS	BULB TYPE	MULT SERIES	POLE TYPE	SHADE	ADDRESS NUMBER	REF	LOCATION	TAX DIST	DATE INST	DATE CHANGE
	05800	S	M	SOH	I	01010	063									12	100168	1/1/0001
	05800	S	M	OUG	I	01100	065									12	100168	1/1/0001
	05800	S	M	OUG	I	01106	066									12	100168	1/1/0001
	05800	S	M	SOH	II	01230	120									12	110164	1/1/0001
	05800	S	M	OUG	II	01604	000									12	090171	1/1/0001
	05800	S	M	OUG	II	01621	000									12	090171	1/1/0001
	05800	S	M	OUG	II	01630	000									12	090171	1/1/0001
	05800	S	M	OUG	II	01701	000									12	060164	1/1/0001

OFFICE: 311		ROUTE: 564		ST_REF_NO: 0000068410		FIREBROOK BLVD.		LUMENS	BULB TYPE	MULT SERIES	POLE TYPE	SHADE	ADDRESS NUMBER	REF	LOCATION	TAX DIST	DATE INST	DATE CHANGE
	05800	S	M	CNT	II	04793	052									12	060894	1/1/0001
	05800	S	M	CNT	II	04797	051									12	060894	1/1/0001
	05800	S	M	CNT	II	04801	001									12	060894	1/1/0001
	05800	S	M	CNT	II	04813	004									12	050897	1/1/0001
	05800	S	M	CNT	II	04825	006									12	050897	1/1/0001
	05800	S	M	CNT	II	04833	008									12	080896	1/1/0001
	05800	S	M	CNT	II	04841	009									12	080896	1/1/0001
	05800	S	M	CNT	III	04856	010									12	080896	1/1/0001
	05800	S	M	CNT	II	04857	012									12	080896	1/1/0001
	05800	S	M	CNT	II	04864	011									12	080896	1/1/0001
	05800	S	M	CNT	II	04873	014									12	080896	1/1/0001
	05800	S	M	CNT	II	04876	013									12	080896	1/1/0001
	05800	S	M	CNT	II	04885	016									12	100898	1/1/0001
	05800	S	M	CNT	II	04892	015									12	080896	1/1/0001
	05800	S	M	CNT	II	04893	018									12	100898	1/1/0001
	05800	S	M	CNT	II	04908	017									12	100898	1/1/0001

OFFICE: 311		ROUTE: 564		ST_REF_NO: 0000068420		FIRESIDE CIRCLE		LUMENS	BULB TYPE	MULT SERIES	POLE TYPE	SHADE	ADDRESS NUMBER	REF	LOCATION	TAX DIST	DATE INST	DATE CHANGE
	05800	S	M	CNT	II	02652	005									12	100898	1/1/0001

OFFICE: 311

ROUTE: 564

ST_REF_NO: 0000068450

FIRE THORN PLACE

LUMENS	BULB TYPE	MULT SERIES	POLE TYPE	SHADE	ADDRESS NUMBER	REF	LOCATION	TAX DIST	DATE INST	DATE CHANGE
05800	S	M	CNT	II	00969	006		12	121505	1/1/0001
05800	S	M	CNT	II	00976	007		12	121505	1/1/0001
05800	S	M	CNT	II	00993	008		12	121505	1/1/0001
05800	S	M	CNT	II	01000	009		12	121505	1/1/0001
05800	S	M	CNT	III	01009	010		12	121505	1/1/0001
05800	S	M	CNT	III	00905	001		12	090800	1/1/0001
05800	S	M	CNT	II	00912	002		12	090800	1/1/0001
05800	S	M	CNT	II	00925	003		12	090800	1/1/0001
05800	S	M	CNT	II	00932	004		12	090800	1/1/0001
05800	S	M	CNT	II	00957	005		12	090800	1/1/0001

OFFICE: 311

ROUTE: 564

ST_REF_NO: 0000068460

FITZROY DRIVE

LUMENS	BULB TYPE	MULT SERIES	POLE TYPE	SHADE	ADDRESS NUMBER	REF	LOCATION	TAX DIST	DATE INST	DATE CHANGE
05800	S	M	CNT	II	00732	006		12	081401	1/1/0001
05800	S	M	CNT	II	00737	005		12	081401	1/1/0001
05800	S	M	CNT	II	00761	004		12	081401	1/1/0001
05800	S	M	CNT	II	00000	001	SIDE OF 4609 PALERMO PLACE	12	080800	1/1/0001
05800	S	M	CNT	II	00000	003	SIDE OF 4601 FITZROY CT.	12	080800	1/1/0001
05800	S	M	CNT	II	00789	002		12	080800	1/1/0001

OFFICE: 311

ROUTE: 564

ST_REF_NO: 0000068470

FITZROY COURT

LUMENS	BULB TYPE	MULT SERIES	POLE TYPE	SHADE	ADDRESS NUMBER	REF	LOCATION	TAX DIST	DATE INST	DATE CHANGE
05800	S	M	CNT	II	04600	007		12	080800	1/1/0001
05800	S	M	CNT	II	04601	009		12	080800	1/1/0001
05800	S	M	CNT	II	04616	008		12	080800	1/1/0001

OFFICE: 311

ROUTE: 564

ST_REF_NO: 0000068500

FLADS ALLEY

LUMENS	BULB TYPE	MULT SERIES	POLE TYPE	SHADE	ADDRESS NUMBER	REF	LOCATION	TAX DIST	DATE INST	DATE CHANGE
04000	S	M	SOH	I	00000	263	1 ST. LT. E. OF NORTH EASTERN AVE., N. SIDE	12	100266	1/1/0001
04000	S	M	SOH	II	00000	264	2 ND. LT. E. OF NORTH EASTERN AVE., N. SIDE	12	081866	1/1/0001

OFFICE: 311

ROUTE: 564

ST_REF_NO: 0000068700

FLEETWOOD DRIVE

LUMENS	BULB TYPE	MULT SERIES	POLE TYPE	SHADE	ADDRESS NUMBER	REF	LOCATION	TAX DIST	DATE INST	DATE CHANGE
05800	S	M	OUG	II	03402	131		12	071674	1/1/0001
05800	S	M	OUG	II	03409	159		12	091477	1/1/0001
05800	S	M	OUG	II	03414	160		12	011581	1/1/0001
05800	S	M	OUG	II	03425	161		12	041476	1/1/0001
05800	S	M	OUG	II	03430	162		12	081475	1/1/0001

OFFICE: 311

ROUTE: 564

ST_REF_NO: 0000068710

FLINTRIDGE CIRCLE

LUMENS	BULB TYPE	MULT SERIES	POLE TYPE	SHADE	ADDRESS NUMBER	REF	LOCATION	TAX DIST	DATE INST	DATE CHANGE
05800	S	M	OUG	II	03409	000		12	081866	1/1/0001

OFFICE: 311

ROUTE: 564

ST_REF_NO: 0000068800

FLINTRIDGE DRIVE

LUMENS	BULB TYPE	MULT SERIES	POLE TYPE	SHADE	ADDRESS NUMBER	REF	LOCATION	TAX DIST	DATE INST	DATE CHANGE
09500	S	M	OUG	II	03420	000	upgraded to 9500 hps cobra June 2005	12	051967	1/1/0001
09500	S	M	OUG	II	03429	000	upgraded to 9500 hps cobra June 2005	12	081866	1/1/0001
09500	S	M	OUG	V	03444	000	upgraded to 9500 hps cobra June 2005	12	010172	1/1/0001
09500	S	M	OUG	II	03453	000	upgraded to 9500 hps cobra June 2005	12	081866	1/1/0001
09500	S	M	OUG	V	03469	000	upgraded to 9500 hps cobra June 2005	12	042067	1/1/0001

OFFICE: 311

ROUTE: 564

ST_REF_NO: 0000068900

FLORAL PARK

LUMENS	BULB TYPE	MULT SERIES	POLE TYPE	SHADE	ADDRESS NUMBER	REF	LOCATION	TAX DIST	DATE INST	DATE CHANGE
05800	S	M	SOH	II	00000	001	SIDE OF 1410 ELIZABETH ST.	12	121578	1/1/0001
05800	S	M	SOH	II	00000	003	OPP. 220 IN MEDIAN	12	121578	1/1/0001
05800	S	M	SOH	II	00209	002		12	121578	1/1/0001

OFFICE: 311

ROUTE: 564

ST_REF_NO: 0000069100

FLORENCE AVENUE

LUMENS	BULB TYPE	MULT SERIES	POLE TYPE	SHADE	ADDRESS NUMBER	REF	LOCATION	TAX DIST	DATE INST	DATE CHANGE
05800	S	M	SOH	I	00000	028	SIDE OF 433 DOUGLAS AVE.	12	060269	1/1/0001
05800	S	M	SOH	I	00000	033	OPP. 758	12	060269	1/1/0001
05800	S	M	SOH	I	00000	037	SIDE OF 426 PRICE RD.	12	060269	1/1/0001
05800	S	M	SOH	I	00711	029		12	060269	1/1/0001
05800	S	M	SOH	I	00725	030		12	060269	1/1/0001

OFFICE: 311		ROUTE: 564		ST_REF_NO: 0000069100		FLORENCE AVENUE				
LUMENS	BULB TYPE	MULT SERIES	POLE TYPE	SHADE	ADDRESS NUMBER	REF	LOCATION	TAX DIST	DATE INST	DATE CHANGE
05800	S	M	SOH	I	00735	031		12	060269	1/1/0001
05800	S	M	SOH	I	00747	032		12	060269	1/1/0001
05800	S	M	SOH	I	00767	034		12	060269	1/1/0001
05800	S	M	SOH	I	00779	035		12	060269	1/1/0001
05800	S	M	SOH	I	00803	036		12	060269	1/1/0001

OFFICE: 311		ROUTE: 564		ST_REF_NO: 0000069200		FLORIDA STREET				
LUMENS	BULB TYPE	MULT SERIES	POLE TYPE	SHADE	ADDRESS NUMBER	REF	LOCATION	TAX DIST	DATE INST	DATE CHANGE
05800	S	M	SOH	II	00000	294	BESIDE 780 AT BELTLINE AVE.	12	090966	1/1/0001
05800	S	M	SOH	II	00706	288		12	090966	1/1/0001
05800	S	M	SOH	II	00734	290		12	090966	1/1/0001
05800	S	M	SOH	II	00756	292		12	090966	1/1/0001

OFFICE: 311		ROUTE: 564		ST_REF_NO: 0000069300		FLOYD DRIVE				
LUMENS	BULB TYPE	MULT SERIES	POLE TYPE	SHADE	ADDRESS NUMBER	REF	LOCATION	TAX DIST	DATE INST	DATE CHANGE
05800	S	M	OUG	II	00901	014		12	122701	1/1/0001
05800	S	M	OUG	II	00917	015		12	122701	1/1/0001
05800	S	M	OUG	II	00936	017		12	122701	1/1/0001
05800	S	M	OUG	II	00948	018		12	122701	1/1/0001
05800	S	M	OUG	II	00964	019		12	122701	1/1/0001
05800	S	M	OUG	II	00975	020		12	122701	1/1/0001
05800	S	M	OUG	II	00996	021		12	122701	1/1/0001
05800	S	M	OUG	II	01050	023		12	122701	1/1/0001
05800	S	M	OUG	II	01051	022		12	122701	1/1/0001
05800	S	M	OUG	II	0932M	016		12	122701	1/1/0001
05800	S	M	OOH	II	00000	007	7 TH. LT. S. OF NEW CIRCLE RD.	12	032067	1/1/0001
05800	S	M	SOH	II	00000	008	6 TH. LT FROM NEW CIRCLE RD ON NORTH SIDE 6/08	12	032067	1/1/0001
05800	S	M	OOH	II	00000	009	5 TH. LT. S. OF NEW CIRCLE RD.	12	032067	1/1/0001
05800	S	M	OOH	II	00000	010	4 TH. LT. S. OF NEW CIRCLE RD.	12	032067	1/1/0001
05800	S	M	OOH	II	00000	011	3 RD. LT. S. OF NEW CIRCLE RD.	12	032067	1/1/0001
05800	S	M	OOH	II	00000	012	2 ND. LT. S. OF NEW CIRCLE RD.	12	032067	1/1/0001
05800	S	M	OOH	II	00000	013	1 ST. LT. S. OF NEW CIRCLE RD.	12	080367	1/1/0001

OFFICE: 311

ROUTE: 564

ST_REF_NO: 0000069300

FLOYD DRIVE

LUMENS	BULB TYPE	MULT SERIES	POLE TYPE	SHADE	ADDRESS NUMBER	REF	LOCATION	TAX DIST	DATE INST	DATE CHANGE
05800	S	M	OUG	II	00831	001		12	061764	1/1/0001
05800	S	M	OUG	II	00831	002		12	061764	1/1/0001
05800	S	M	OUG	II	00852	003		12	061764	1/1/0001
05800	S	M	OUG	II	00871	004		12	071367	1/1/0001
05800	S	M	OUG	II	00872	005		12	071367	1/1/0001
05800	S	M	OUG	II	00881	006		12	071367	1/1/0001

OFFICE: 311

ROUTE: 564

ST_REF_NO: 0000069320

FLYING EBONY DRIVE

LUMENS	BULB TYPE	MULT SERIES	POLE TYPE	SHADE	ADDRESS NUMBER	REF	LOCATION	TAX DIST	DATE INST	DATE CHANGE
09500	S		CLN	II	00000	001	SIDE OF 2340 ROCKMINSTER RD, ON FLYING EBONY	12	092609	1/1/0001
09500	S		CLN	II	00000	002	ACROSS FROM 2421 FLYING EBONY DRIVE	12	092609	1/1/0001
09500	S		CLN	II	00000	004	ACROSS FROM 2437 FLYING EBONY DR	12	092609	1/1/0001
09500	S		CLN	II	00000	006	ACROSS FROM 2453 FLYING EBONY DR	12	092609	1/1/0001
09500	S		CLN	II	00000	007	1ST LT S OF STAR GAZE, E SIDE ON FLYING EBONY	12	092609	1/1/0001
09500	S		CLN	II	00000	008	2ND LT S OF STAR GAZE, W SIDE ON FLYING EBONY	12	092609	1/1/0001
09500	S		CLN	II	00000	010	ACROSS FROM 2489 FLYING EBONY DR	12	092609	1/1/0001
09500	S		CLN	II	00000	011	SIDE OF 2489 FLYING EBONY DR	12	092609	1/1/0001
09500	S		CLN	II	00000	012	ACROSS FROM 2513 FLYING EBONY DR	12	092609	1/1/0001
09500	S		CLN	II	00000	014	ACROSS FROM 2525 FLYING EBONY DR	12	092609	1/1/0001
09500	S		CLN	II	00000	016	ACROSS FROM 2537 FLYING EBONY DR	12	092609	1/1/0001
09500	S		CLN	II	00000	018	ACROSS FROM 2549 FLYING EBONY DR	12	092609	1/1/0001
09500	S		CLN	II	00000	020	ACROSS FROM 2565 FLYING EBONY DR	12	092609	1/1/0001
09500	S		CLN	II	00000	022	ACROSS FROM 2589 FLYING EBONY DR	12	092609	1/1/0001
09500	S		CLN	II	02429	003		12	092609	1/1/0001
09500	S		CLN	II	02445	005		12	092609	1/1/0001
09500	S		CLN	II	02489	009		12	092609	1/1/0001
09500	S		CLN	II	02517	013		12	092609	1/1/0001
09500	S		CLN	II	02533	015		12	092609	1/1/0001
09500	S		CLN	II	02545	017		12	092609	1/1/0001
09500	S		CLN	II	02557	019		12	092609	1/1/0001
09500	S		CLN	II	02583	021		12	092609	1/1/0001

OFFICE: 311 ROUTE: 564										
ST_REF_NO: 00000069320 FLYING EBONY DRIVE										
LUMENS	BULB TYPE	MULT SERIES	POLE TYPE	SHADE	ADDRESS NUMBER	REF	LOCATION	TAX DIST	DATE INST	DATE CHANGE
09500	S		CLN	II	02597	023		12	092609	1/1/0001
OFFICE: 311 ROUTE: 564										
ST_REF_NO: 00000069400 FOG COURT										
LUMENS	BULB TYPE	MULT SERIES	POLE TYPE	SHADE	ADDRESS NUMBER	REF	LOCATION	TAX DIST	DATE INST	DATE CHANGE
04000	S	M	OUG	II	00000	113	SIDE 3216 COOL WATER ON FOG COURT	12	090884	1/1/0001
OFFICE: 311 ROUTE: 564										
ST_REF_NO: 00000069500 FOGO COURT										
LUMENS	BULB TYPE	MULT SERIES	POLE TYPE	SHADE	ADDRESS NUMBER	REF	LOCATION	TAX DIST	DATE INST	DATE CHANGE
04000	S	M	OUG	II	00000	134	SIDE OF 560 MERRIMAC DR.	12	110885	1/1/0001
04000	S	M	OUG	II	00533	136		12	110885	1/1/0001
04000	S	M	OUG	II	00542	135		12	110885	1/1/0001
OFFICE: 311 ROUTE: 564										
ST_REF_NO: 00000069510 FOLEY'S CROSSING										
LUMENS	BULB TYPE	MULT SERIES	POLE TYPE	SHADE	ADDRESS NUMBER	REF	LOCATION	TAX DIST	DATE INST	DATE CHANGE
05800	S	M	OUG	II	00000	001	SIDE REAR OF 1053 ALBERT LANE	12	020897	1/1/0001
OFFICE: 311 ROUTE: 564										
ST_REF_NO: 00000069520 FOLEY'S RETREAT										
LUMENS	BULB TYPE	MULT SERIES	POLE TYPE	SHADE	ADDRESS NUMBER	REF	LOCATION	TAX DIST	DATE INST	DATE CHANGE
05800	S	M	OUG	II	01105	001		12	020897	1/1/0001
05800	S	M	OUG	II	01120	002		12	020897	1/1/0001
05800	S	M	OUG	II	01125	003		12	020897	1/1/0001
OFFICE: 311 ROUTE: 564										
ST_REF_NO: 00000069530 FOLEYS TRAIL										
LUMENS	BULB TYPE	MULT SERIES	POLE TYPE	SHADE	ADDRESS NUMBER	REF	LOCATION	TAX DIST	DATE INST	DATE CHANGE
05800	S	M	OUG	II	00000	001	SIDE OF 1130 SPRING RUN RD ON FOLEYS TRAIL	12	072707	1/1/0001
05800	S	M	OUG	II	00000	003	REAR OF 1124 HARLAN CR ON FOLEYS TRAIL	12	072707	1/1/0001
05800	S	M	OUG	II	00000	004	REAR OF 1136 HARLAN CR ON FOLEYS TRAIL	12	072707	1/1/0001
05800	S	M	OUG	II	00000	005	ACROSS FROM 3872 FOLEYS TRAIL	12	072707	1/1/0001
05800	S	M	OUG	II	03832	002		12	072707	1/1/0001
05800	S	M	OUG	II	00000	001	SIDE OF 1081 MOYLAN LANE	12	020897	1/1/0001

OFFICE: 311		ROUTE: 564		ST_REF_NO: 00000069530		FOLEYS TRAIL				
LUMENS	BULB TYPE	MULT SERIES	POLE TYPE	SHADE	ADDRESS NUMBER	REF	LOCATION	TAX DIST	DATE INST	DATE CHANGE
05800	S	M	OUG	II	03828	003		12	020897	1/1/0001
05800	S	M	OUG	II	03893	002		12	020897	1/1/0001

OFFICE: 311		ROUTE: 564		ST_REF_NO: 00000069600		FOLKSTONE DRIVE				
LUMENS	BULB TYPE	MULT SERIES	POLE TYPE	SHADE	ADDRESS NUMBER	REF	LOCATION	TAX DIST	DATE INST	DATE CHANGE
05800	S	M	OUG	II	00000	027	SIDE OF 575 PLAINVIEW RD.	12	050170	1/1/0001
05800	S	M	OUG	II	00000	034	SIDE OF 2749 BAYBROOK DR.	12	121467	1/1/0001
05800	S	M	OUG	II	00000	037	SIDE OF 457 PLAINVIEW RD.	12	110168	1/1/0001
05800	S	M	OUG	II	00510	000		12	050170	1/1/0001
05800	S	M	OUG	II	00525	000		12	050170	1/1/0001
05800	S	M	OUG	II	00557	000		12	080169	1/1/0001
05800	S	M	OUG	II	00572	000		12	110168	1/1/0001
05800	S	M	OUG	II	00581	000		12	110168	1/1/0001
05800	S	M	OUG	II	00592	000		12	110168	1/1/0001
05800	S	M	OUG	II	00601	000		12	071674	1/1/0001
05800	S	M	OUG	II	00612	000		12	061968	1/1/0001

OFFICE: 311		ROUTE: 564		ST_REF_NO: 00000069700		FONTAINE CIRCLE				
LUMENS	BULB TYPE	MULT SERIES	POLE TYPE	SHADE	ADDRESS NUMBER	REF	LOCATION	TAX DIST	DATE INST	DATE CHANGE
05800	S	M	OUG	II	00000	047	SIDE OF 2017 FONTAINE RD. ON FONTAINE CIRCLE	12	120667	1/1/0001
05800	S	M	OUG	II	00000	051	SIDE OF 2029 FONTAINE RD. ON FONTAINE CIRCLE	12	051967	1/1/0001
05800	S	M	OUG	II	00217	000		12	120667	1/1/0001
05800	S	M	OUG	II	00240	000		12	120667	1/1/0001
05800	S	M	OUG	II	00265	000		12	122067	1/1/0001

OFFICE: 311		ROUTE: 564		ST_REF_NO: 00000069800		FONTAINE ROAD				
LUMENS	BULB TYPE	MULT SERIES	POLE TYPE	SHADE	ADDRESS NUMBER	REF	LOCATION	TAX DIST	DATE INST	DATE CHANGE
22000	S	M	OUG	II	00000	076	OPP. 2069 upgraded per city request	12	020367	9/24/2009
09500	S	M	SOH	II	01003	083		12	061968	1/18/2010
22000	S	M	OUG	II	02053	052	upgraded per city request	12	090169	9/24/2009
05800	S	M	OOH	II	00000	001	SIDE OF 240 CHINOE RD.	12	060164	1/1/0001

OFFICE: 311

ROUTE: 564

ST_REF_NO: 0000069800

FONTAINE ROAD

LUMENS	BULB TYPE	MULT SERIES	POLE TYPE	SHADE	ADDRESS NUMBER	REF	LOCATION	TAX DIST	DATE INST	DATE CHANGE
05800	S	M	OUG	II	00000	002	SIDE OF 301 CULPEPPER RD.	12	060164	1/1/0001
05800	S	M	SOH	V	00000	003	SIDE OF 346 DESHA RD.	12	111568	1/1/0001
05800	S	M	OUG	III	00000	007	BETWEEN CULPEPPER & CLINTON RD., N. SIDE	12	081156	1/1/0001
05800	S	M	OUG	III	00000	008	SIDE OF 300 CLINTON RD.	12	081156	1/1/0001
05800	S	M	SOH	II	00000	086	OPP. 1020	12	100168	1/1/0001
05800	S	M	SOH	II	00000	088	SIDE OF 331 IRVINE RD.	12	061968	1/1/0001
05800	S	M	SOH	II	00000	089	SIDE OF 344 IRVINE RD.	12	061968	1/1/0001
05800	S	M	SOH	II	00000	091	SIDE OF 333 MCDOWELL RD.	12	061968	1/1/0001
05800	S	M	SOH	II	00000	092	SIDE OF 330 MCDOWELL RD.	12	061968	1/1/0001
05800	S	M	SOH	II	00000	110	OPP. 1316	12	110164	1/1/0001
09500	S	M	SOH	III	00000	113	OPP. 1364 FONTAINE RD., NW CORNER OF INTERSECTION	12	120892	1/1/0001
05800	S	M	OUG	II	00000	115	OPP. 1388 IN ISLAND	12	102164	1/1/0001
05800	S	M	OUG	II	00000	116	OPP. 1400 IN ISLAND	12	102164	1/1/0001
09500	S	M	SOH	III	00000	118	SIDE OF 240 WOODSPOINT ROAD	12	050896	1/1/0001
05800	S	M	SOH	II	01008	000		12	100168	1/1/0001
05800	S	M	SOH	II	01014	000		12	100168	1/1/0001
05800	S	M	SOH	II	01046	000		12	050374	1/1/0001
05800	S	M	SOH	II	01119	090		12	061968	1/1/0001
05800	S	M	SOH	II	01209	108		12	110164	1/1/0001
05800	S	M	OOH	II	01300	000		12	050365	1/1/0001
05800	S	M	OOH	II	01342	000		12	050365	1/1/0001
05800	S	M	SOH	II	01351	112		12	110164	1/1/0001
05800	S	M	SOH	II	01375	114		12	110164	1/1/0001
05800	S	M	OUG	II	01406	117		12	102164	1/1/0001
05800	S	M	OUG	II	01509	000		12	020166	1/1/0001
05800	S	M	OUG	II	01520	000		12	050365	1/1/0001
05800	S	M	OUG	III	01909	000		12	081156	1/1/0001
05800	S	M	OUG	III	01922	000		12	081156	1/1/0001
05800	S	M	OUG	II	01935	000		12	081156	1/1/0001
05800	S	M	OUG	II	01952	000		12	020861	1/1/0001
05800	S	M	OUG	II	02005	000		12	070767	1/1/0001
09500	S	M	OUG	II	02016	000		12	070767	1/1/0001
05800	S	M	OUG	II	00000	078	OPP. 2093	12	020367	1/1/0001

OFFICE: 311

ROUTE: 564

ST_REF_NO: 0000069800

FONTAINE ROAD

LUMENS	BULB TYPE	MULT SERIES	POLE TYPE	SHADE	ADDRESS NUMBER	REF	LOCATION	TAX DIST	DATE INST	DATE CHANGE
05800	S	M	OUG	II	00000	084	OPP. 2117	12	051967	1/1/0001
05800	S	M	OUG	II	00000	085	SIDE OF 2150 RICHMOND RD.	12	090169	1/1/0001
05800	S	M	OUG	II	00000	186	2ND. LT. S. OF RICHMOND RD., E. SIDE	12	051967	1/1/0001
05800	S	M	OUG	II	00000	187	FONTAINE & RICHMOND RD. IN ISLAND	12	020367	1/1/0001
05800	S	M	OUG	II	00000	188	FONTAINE & RICHMOND RD. IN ISLAND	12	020367	1/1/0001
05800	S	M	OUG	II	02025	000		12	120667	1/1/0001
09500	S	M	OUG	II	02032	000		12	051967	1/1/0001
05800	S	M	OUG	II	02044	000		12	080172	1/1/0001
05800	S	M	OUG	II	02085	000		12	051967	1/1/0001
05800	S	M	OUG	II	02109	000		12	120667	1/1/0001

OFFICE: 311

ROUTE: 564

ST_REF_NO: 0000069900

FORBES ROAD

LUMENS	BULB TYPE	MULT SERIES	POLE TYPE	SHADE	ADDRESS NUMBER	REF	LOCATION	TAX DIST	DATE INST	DATE CHANGE
50000	S	M	SOH	II	00000	046	16TH LT. S OF LEESTOWN RD., W SIDE	12	070899	12/21/2009
50000	S	M	SOH	II	00000	047	1ST LT. S OF OLD FRANKFORT PK., W SIDE	12	070899	12/21/2009
50000	S	M	OUG	II	00000	066	20TH LT. S OF OLD FRANKFORT PK., W SIDE	12	070899	11/4/2009
05800	S	M	OUG	II	00000	019	SIDE OF 301 LARCH LANE	12	121582	1/1/0001
05800	S	M	OUG	II	00000	020	SIDE OF 284 BOILING SPRINGS DR.	12	121582	1/1/0001
05800	S	M	OUG	II	00000	021	SIDE OF 300 BOILING SPRINGS DR.	12	121582	1/1/0001
05800	S	M	OUG	II	00000	023	SIDE OF 304 HILLSBORO AVE.	12	121582	1/1/0001
05800	S	M	OUG	II	00000	024	SIDE OF 293 HILLSBORO AVE.	12	121582	1/1/0001
05800	S	M	SOH	II	00000	025	SIDE OF 308 GLENDALE AVE.	12	091582	1/1/0001
05800	S	M	SOH	II	00000	026	SIDE OF 308 GLENDALE AVE.	12	091582	1/1/0001
05800	S	M	OUG	II	00000	027	SIDE OF 297 GLENDALE AVE.	12	121582	1/1/0001
05800	S	M	OUG	II	00000	028	SIDE OF 296 TAYLOR DR.	12	121582	1/1/0001
04000	S	M	OUG	II	00000	029	SIDE OF 297 TAYLOR DR.	12	121582	1/1/0001
04000	S	M	SOH	II	00000	030	SIDE OF 313 TAYLOR DR.	12	091582	1/1/0001
05800	S	M	OUG	II	01602	022		12	121582	1/1/0001
04000	S	M	OOH	II	00000	001	1 ST. LT. N. OF LEESTOWN RD., W. SIDE	12	051967	1/1/0001
05800	S	M	OUG	III	00000	002	2ND LT. N. OF LEESTOWN RD.	12	100887	1/1/0001
05800	S	M	OUG	II	00000	007	SIDE OF 1456 MEADOWTHORPE AVE.	12	121582	1/1/0001
05800	S	M	OUG	II	00000	009	SIDE OF 1450 MEADOWTHORPE AVE.	12	121582	1/1/0001
05800	S	M	OUG	II	00000	011	OPP. 1475	12	121582	1/1/0001

OFFICE: 311

ROUTE: 564

ST_REF_NO: 0000069900

FORBES ROAD

LUMENS	BULB TYPE	MULT SERIES	POLE TYPE	SHADE	ADDRESS NUMBER	REF	LOCATION	TAX DIST	DATE INST	DATE CHANGE
05800	S	M	OUG	II	00000	015	OPP. 1499	12	121582	1/1/0001
05800	S	M	OUG	II	00000	017	SIDE OF 291 BURKE RD.	12	121582	1/1/0001
22000	S	M	SOH	II	00000	032	2ND LT. S OF LEESTOWN RD., W SIDE	12	070899	1/1/0001
22000	S	M	OUG	II	00000	033	3RD LT. S OF LEESTOWN RD., W SIDE	12	070899	1/1/0001
22000	S	M	OUG	II	00000	034	4TH LT. S OF LEESTOWN RD., W SIDE	12	070899	1/1/0001
22000	S	M	OUG	II	00000	035	5TH LT. S OF LEESTOWN RD., W SIDE	12	070899	1/1/0001
22000	S	M	OUG	II	00000	036	6TH LT. S OF LEESTOWN RD., W SIDE	12	070899	1/1/0001
22000	S	M	OUG	II	00000	037	7TH LT. S OF LEESTOWN RD., E SIDE	12	070899	1/1/0001
22000	S	M	OUG	II	00000	038	8TH LT. S OF LEESTOWN RD., E SIDE	12	070899	1/1/0001
22000	S	M	OUG	II	00000	039	9TH LT. S OF LEESTOWN RD., E SIDE	12	070899	1/1/0001
22000	S	M	OUG	II	00000	040	10TH LT. S OF LEESTOWN RD., E SIDE	12	070899	1/1/0001
22000	S	M	SOH	II	00000	041	11TH LT. S OF LEESTOWN RD., W SIDE	12	070899	1/1/0001
22000	S	M	OUG	II	00000	042	12TH LT. S OF LEESTOWN RD., E SIDE	12	070899	1/1/0001
22000	S	M	OUG	II	00000	043	13TH LT. S OF LEESTOWN RD., E SIDE	12	070899	1/1/0001
22000	S	M	SOH	II	00000	044	14TH LT. S OF LEESTOWN RD., W SIDE	12	070899	1/1/0001
22000	S	M	OUG	II	00000	045	15TH LT. S OF LEESTOWN RD., E SIDE	12	070899	1/1/0001
22000	S	M	SOH	II	00000	048	2ND LT. S OF OLD FRANKFORT PK., W SIDE	12	070899	1/1/0001
22000	S	M	OUG	II	00000	049	3RD LT. S OF OLD FRANKFORT PK., W SIDE	12	070899	1/1/0001
22000	S	M	OUG	II	00000	050	4TH LT. S OF OLD FRANKFORT PK., W SIDE	12	070899	1/1/0001
22000	S	M	OUG	II	00000	051	5TH LT. S OF OLD FRANKFORT PK., W SIDE	12	070899	1/1/0001
22000	S	M	SOH	II	00000	052	6TH LT. S OF OLD FRANKFORT PK., W SIDE	12	070899	1/1/0001
22000	S	M	SOH	II	00000	053	7TH LT. S OF OLD FRANKFORT PK., W SIDE	12	070899	1/1/0001
22000	S	M	SOH	II	00000	054	8TH LT. S OF OLD FRANKFORT PK., W SIDE	12	070899	1/1/0001
22000	S	M	SOH	II	00000	055	9TH LT. S OF OLD FRANKFORT PK., W SIDE	12	070899	1/1/0001
22000	S	M	SOH	II	00000	056	10TH LT. S OF OLD FRANKFORT PK., W SIDE	12	070899	1/1/0001
22000	S	M	OUG	II	00000	057	11TH LT. S OF OLD FRANKFORT PK., W SIDE	12	070899	1/1/0001
22000	S	M	OUG	II	00000	058		12	070899	1/1/0001
22000	S	M	OUG	II	00000	059	13TH LT. S OF OLD FRANKFORT PK., E SIDE	12	070899	1/1/0001
22000	S	M	OUG	II	00000	060	14TH LT. S OF OLD FRANKFORT PK., W SIDE	12	070899	1/1/0001
22000	S	M	OUG	II	00000	061	15TH LT. S OF OLD FRANKFORT PK., E SIDE	12	070899	1/1/0001
22000	S	M	OUG	II	00000	062	16TH LT. S OF OLD FRANKFORT PK., W SIDE	12	070899	1/1/0001
22000	S	M	OUG	II	00000	063	17TH LT. S OF OLD FRANKFORT PK., E SIDE	12	070899	1/1/0001
22000	S	M	OUG	II	00000	064	18TH LT. S OF OLD FRANKFORT PK., W SIDE	12	070899	1/1/0001
22000	S	M	OUG	II	00000	065	19TH LT. S OF OLD FRANKFORT PK., E SIDE	12	070899	1/1/0001

OFFICE: 311		ROUTE: 564		ST_REF_NO: 00000069900		FORBES ROAD		LUMENS	BULB TYPE	MULT SERIES	POLE TYPE	SHADE	ADDRESS NUMBER	REF	LOCATION	TAX DIST	DATE INST	DATE CHANGE
	05800	S	M	OUG	II	01409	003	upgraded 6/08	12	051967	1/1/0001							
	05800	S	M	OUG	III	01409	004		12	100887	1/1/0001							
	05800	S	M	OUG	III	01435	005		12	100887	1/1/0001							
	04000	S	M	OUG	II	01443	006		12	051967	1/1/0001							
	05800	S	M	OUG	II	01455	008		12	121582	1/1/0001							
	05800	S	M	OUG	II	01467	010		12	121582	1/1/0001							
	05800	S	M	OUG	II	01483	012		12	121582	1/1/0001							
	05800	S	M	OUG	II	01490	013		12	121582	1/1/0001							
	05800	S	M	OUG	II	01495	014		12	121582	1/1/0001							
	05800	S	M	OUG	II	01501	016		12	121582	1/1/0001							
	05800	S	M	OUG	II	01507	018		12	021583	1/1/0001							
OFFICE: 311		ROUTE: 564		ST_REF_NO: 00000070100		FORD PLACE		LUMENS	BULB TYPE	MULT SERIES	POLE TYPE	SHADE	ADDRESS NUMBER	REF	LOCATION	TAX DIST	DATE INST	DATE CHANGE
	05800	S	M	SOH	I	00000	001	SIDE OF 348 E. THIRD ST.	12	120165	1/1/0001							
	05800	S	M	SOH	II	00226	002		12	120165	1/1/0001							
OFFICE: 311		ROUTE: 564		ST_REF_NO: 00000070400		FORDSON COURT		LUMENS	BULB TYPE	MULT SERIES	POLE TYPE	SHADE	ADDRESS NUMBER	REF	LOCATION	TAX DIST	DATE INST	DATE CHANGE
	05800	S	M	OUG	II	00000	112	SIDE OF 633 ANNISTON DR.	12	010166	1/1/0001							
	05800	S	M	OUG	V	02012	113		12	010166	1/1/0001							
OFFICE: 311		ROUTE: 564		ST_REF_NO: 00000070500		FOREMAN AVENUE		LUMENS	BULB TYPE	MULT SERIES	POLE TYPE	SHADE	ADDRESS NUMBER	REF	LOCATION	TAX DIST	DATE INST	DATE CHANGE
	22000	S	M	SOH	III	00000	505	SW CORNER OF SOUTH BROADWAY	12	110893	1/1/0001							
OFFICE: 311		ROUTE: 564		ST_REF_NO: 00000070600		FOREST AVENUE		LUMENS	BULB TYPE	MULT SERIES	POLE TYPE	SHADE	ADDRESS NUMBER	REF	LOCATION	TAX DIST	DATE INST	DATE CHANGE
	05800	S	M	SOH	I	00000	001	1ST. LT. ON SIDE OF 505 E. MAIN ST.	12	070162	1/1/0001							
	05800	S	M	SOH	I	00000	002	2ND. LT. ON SIDE OF 505 E. MAIN	12	070162	1/1/0001							
	05800	S	M	SOH	I	00121	000		12	070162	1/1/0001							

OFFICE: 311		ROUTE: 564		ST_REF_NO: 00000070600		FOREST AVENUE				
LUMENS	BULB TYPE	MULT SERIES	POLE TYPE	SHADE	ADDRESS NUMBER	REF	LOCATION	TAX DIST	DATE INST	DATE CHANGE
05800	S	M	SOH	I	00131	000		12	070162	1/1/0001
05800	S	M	SOH	I	00133	000		12	070162	1/1/0001
05800	S	M	SOH	I	00141	000		12	070162	1/1/0001
05800	S	M	SOH	I	00149	000		12	070162	1/1/0001
05800	S	M	SOH	I	00159	000		12	070162	1/1/0001
05800	S	S	SOH	I	00173	000		12	070162	1/1/0001

OFFICE: 311		ROUTE: 564		ST_REF_NO: 00000070630		FOREST COVE LANE				
LUMENS	BULB TYPE	MULT SERIES	POLE TYPE	SHADE	ADDRESS NUMBER	REF	LOCATION	TAX DIST	DATE INST	DATE CHANGE
05800	S	M	CNT	II	00000	003	SIDE OF 3528	12	070899	1/1/0001
05800	S	M	CNT	II	03501	006		12	070899	1/1/0001
05800	S	M	CNT	II	03520	005		12	070899	1/1/0001
05800	S	M	CNT	II	03537	004		12	070899	1/1/0001
05800	S	M	CNT	II	03573	002		12	070899	1/1/0001
05800	S	M	CNT	II	03584	001		12	070899	1/1/0001

OFFICE: 311		ROUTE: 564		ST_REF_NO: 00000070700		FOREST GREEN DRIVE				
LUMENS	BULB TYPE	MULT SERIES	POLE TYPE	SHADE	ADDRESS NUMBER	REF	LOCATION	TAX DIST	DATE INST	DATE CHANGE
05800	S	M	OUG	II	00000	028	SIDE OF 3700 DICKSONIA DR.	12	121582	1/1/0001
05800	S	M	OUG	II	00000	029	OPP. 3741	12	050890	1/1/0001
05800	S	M	OUG	II	00000	030	OPP. 3741	12	050890	1/1/0001
05800	S	M	OUG	II	03701	012		12	051581	1/1/0001
05800	S	M	OUG	II	03708	013		12	100884	1/1/0001
05800	S	M	OUG	II	03717	014		12	100884	1/1/0001
05800	S	M	OUG	II	03728	027		12	100884	1/1/0001
05800	S	M	OUG	II	03749	031		12	100884	1/1/0001
05800	S	M	OUG	II	04004	065		12	110885	1/1/0001
05800	S	M	OUG	II	04005	066		12	110885	1/1/0001
05800	S	M	OUG	II	04013	067		12	110885	1/1/0001
05800	S	M	OUG	II	00000	032	OPP. 3761	12	050890	1/1/0001
05800	S	M	OUG	II	00000	045	OPP. 3781	12	050890	1/1/0001
05800	S	M	OUG	II	00000	047	OPP. 3801	12	050890	1/1/0001

OFFICE: 311

ROUTE: 564

ST_REF_NO: 0000070700

FOREST GREEN DRIVE

LUMENS	BULB TYPE	MULT SERIES	POLE TYPE	SHADE	ADDRESS NUMBER	REF	LOCATION	TAX DIST	DATE INST	DATE CHANGE
05800	S	M	OUG	II	00000	060	SIDE OF 752 TROY TRAIL	12	120887	1/1/0001
05800	S	M	OUG	II	00000	062	OPP. 3809	12	050890	1/1/0001
05800	S	M	OUG	II	00000	063	OPP. 3809	12	050890	1/1/0001
05800	S	M	OUG	II	00000	064	OPP. 3996	12	050890	1/1/0001
05800	S	M	OUG	II	03769	033		12	100884	1/1/0001
05800	S	M	OUG	II	03789	046		12	100884	1/1/0001
05800	S	M	OUG	II	03813	061		12	120887	1/1/0001
05800	S	M	OUG	II	03828	074		12	120887	1/1/0001
05800	S	M	OUG	II	03841	073		12	110885	1/1/0001
05800	S	M	SOH	II	03848	072		12	120887	1/1/0001
05800	S	M	OUG	II	03860	015		12	120887	1/1/0001
05800	S	M	OUG	II	03872	016		12	120887	1/1/0001
04000	S	M	OUG	II	03877	018		12	120887	1/1/0001
05800	S	M	OUG	II	03884	017		12	120887	1/1/0001
04000	S	M	OUG	II	03900	019		12	120887	1/1/0001
04000	S	M	OUG	II	03912	020		12	120887	1/1/0001
04000	S	M	OUG	II	03920	021		12	120887	1/1/0001
04000	S	M	OUG	II	03944	023		12	120887	1/1/0001
04000	S	M	OUG	II	03960	024		12	120887	1/1/0001
04000	S	M	OUG	II	03973	026		12	120887	1/1/0001
04000	S	M	OUG	II	03976	025		12	120887	1/1/0001

OFFICE: 311

ROUTE: 564

ST_REF_NO: 0000070705

FOREST HILL COURT

LUMENS	BULB TYPE	MULT SERIES	POLE TYPE	SHADE	ADDRESS NUMBER	REF	LOCATION	TAX DIST	DATE INST	DATE CHANGE
05800	S	M	CNT	II	00000	001	SIDE OF 309 FOREST HILL DRIVE	12	040897	1/1/0001
05800	S	M	CNT	III	03212	002		12	040897	1/1/0001

OFFICE: 311

ROUTE: 564

ST_REF_NO: 0000070710

FOREST HILL DRIVE

LUMENS	BULB TYPE	MULT SERIES	POLE TYPE	SHADE	ADDRESS NUMBER	REF	LOCATION	TAX DIST	DATE INST	DATE CHANGE
05800	S	M	CNT	II	00000	001	SIDE 700 ANDOVER VILLAGE DR.	12	12894	1/1/0001
05800	S	M	CNT	II	00000	002	OPP. 608	12	120894	1/1/0001
05800	S	M	CNT	II	00000	027	SIDE OF 3570 HUNTERS GREEN WAY	12	100897	1/1/0001

OFFICE: 311

ROUTE: 564

ST_REF_NO: 0000070710

FOREST HILL DRIVE

LUMENS	BULB TYPE	MULT SERIES	POLE TYPE	SHADE	ADDRESS NUMBER	REF	LOCATION	TAX DIST	DATE INST	DATE CHANGE
05800	S	M	CNT	II	00000	030	SIDE OF 3116 VALLEY HAVEN COURT	12	020800	1/1/0001
05800	S	M	CNT	II	00000	033	SIDE OF 3113 MEADOWLAND COURT	12	020800	1/1/0001
05800	S	M	CNT	II	00000	050	SIDE 693 ANDOVER VILLAGE DR.	12	120894	1/1/0001
05800	S	M	CNT	II	00200	007		12	040897	1/1/0001
05800	S	M	CNT	II	00204	008		12	040897	1/1/0001
05800	S	M	CNT	II	00216	009			040897	1/1/0001
05800	S	M	CNT	II	00228	010		12	040897	1/1/0001
05800	S	M	CNT	II	00245	011		12	040897	1/1/0001
05800	S	M	CNT	II	00252	012		12	040897	1/1/0001
05800	S	M	CNT	II	00264	013		12	040897	1/1/0001
05800	S	M	CNT	II	00281	014		12	040897	1/1/0001
05800	S	M	CNT	II	00300	015		12	040897	1/1/0001
05800	S	M	CNT	II	00301	016		12	040897	1/1/0001
05800	S	M	CNT	II	00321	018		12	100897	1/1/0001
05800	S	M	CNT	II	00324	017		12	040897	1/1/0001
05800	S	M	CNT	II	00393	019		12	040897	1/1/0001
05800	S	M	CNT	II	00397	020		12	040897	1/1/0001
05800	S	M	CNT	II	00408	021		12	040897	1/1/0001
05800	S	M	CNT	II	00409	022		12	020800	1/1/0001
05800	S	M	CNT	II	00429	032		12	020800	1/1/0001
05800	S	M	CNT	II	00505	031		12	020800	1/1/0001
05800	S	M	CNT	II	00520	029		12	020800	1/1/0001
05800	S	M	CNT	II	00529	028		12	020800	1/1/0001
05800	S	M	CNT	II	00552	025		12	100897	1/1/0001
05800	S	M	CNT	II	00553	026		12	100897	1/1/0001
05800	S	M	CNT	II	00572	023		12	100897	1/1/0001
05800	S	M	CNT	II	00573	024		12	100897	1/1/0001
05800	S	M	CNT	II	00593	006		12	120894	1/1/0001
05800	S	M	CNT	II	00600	003		12	120894	1/1/0001
05800	S	M	CNT	II	00605	004		12	120894	1/1/0001

OFFICE: 311		ROUTE: 564		ST_REF_NO: 0000070740		FOREST LAKE CIRCLE		LUMENS	BULB TYPE	MULT SERIES	POLE TYPE	SHADE	ADDRESS NUMBER	REF	LOCATION	TAX DIST	DATE INST	DATE CHANGE
05800	S	M	CNT	II	00000	053	3RD LT. W OF TODDS RD., NORTHSIDE	12	060899	1/1/0001								
05800	S	M	CNT	II	00000	055	2ND LT. W OF TODDS RD., NORTHSIDE	12	060899	1/1/0001								
05800	S	M	CNT	II	00000	056	2ND LT. W OF TODDS RD., SOUTHSIDE	12	060899	1/1/0001								
05800	S	M	CNT	II	00000	057	1ST LT. W OF TODDS RD., NORTHSIDE	12	060899	1/1/0001								
05800	S	M	CNT	II	00000	058	1ST LT. W OF TODDS RD., SOUTHSIDE	12	060899	1/1/0001								
05800	S	M	CNT	II	00628	051		12	060899	1/1/0001								
05800	S	M	CNT	II	00644	052		12	060899	1/1/0001								
05800	S	M	CNT	II	00668	054		12	060899	1/1/0001								
05800	S		OUG	II	04601	002		12	040895	1/1/0001								
05800	S	M	OUG	II	04616	001		12	040895	1/1/0001								
OFFICE: 311		ROUTE: 564		ST_REF_NO: 0000070750		FOREST LAKE DRIVE		LUMENS	BULB TYPE	MULT SERIES	POLE TYPE	SHADE	ADDRESS NUMBER	REF	LOCATION	TAX DIST	DATE INST	DATE CHANGE
05800	S	M	OUG	II	00000	025	ACROSS FROM 918 FOREST LAKE DRIVE	12	041602	1/1/0001								
05800	S	M	OUG	II	00805	028		12	041602	1/1/0001								
05800	S	M	OUG	II	00820	027		12	041602	1/1/0001								
05800	S	M	OUG	II	00824	026		12	041602	1/1/0001								
05800	S	M	OUG	II	00934	024		12	041602	1/1/0001								
05800	S	M	OUG	II	00000	001	1099 IN MEDIAN	12	010890	1/1/0001								
05800	S	M	OUG	II	00000	002	1099 IN MEDIAN	12	010890	1/1/0001								
05800	S	M	OUG	II	00000	003	1099 IN MEDIAN	12	010890	1/1/0001								
05800	S	M	OUG	II	00000	004	1099 IN MEDIAN	12	010890	1/1/0001								
05800	S	M	OUG	II	00000	005	SE CORNER OF FOREST LAKE AND WOODSONG DR.	12	010890	1/1/0001								
04000	S	M	OUG	II	00000	007	OPP. BRINDLEY WAY	12	010890	1/1/0001								
05800	S	M	OUG	II	00000	015	SIDE 4617 FOREST LAKE CIRCLE	12	030895	1/1/0001								
05800	S	M	OUG	II	00000	022	SIDE OF 4696 CARITA WOODS WAY	12	110899	1/1/0001								
05800	S	M	OUG	II	00942	023		12	110899	1/1/0001								
05800	S	M	OUG	II	00958	021		12	060897	1/1/0001								
05800	S	M	OUG	II	00966	020		12	060897	1/1/0001								
05800	S	M	OUG	II	00983	019		12	060897	1/1/0001								
05800	S	M	OUG	II	00986	018		12	060897	1/1/0001								
05800	S	M	OUG	II	00998	017		12	060897	1/1/0001								

OFFICE: 311		ROUTE: 564		ST_REF_NO: 00000070750		FOREST LAKE DRIVE		LUMENS	BULB TYPE	MULT SERIES	POLE TYPE	SHADE	ADDRESS NUMBER	REF	LOCATION	TAX DIST	DATE INST	DATE CHANGE
	05800	S	M	OUG	II	01006	016									12	030895	1/1/0001
	05800	S	M	OUG	II	01030	014									12	040895	1/1/0001
	05800	S	M	OUG	II	01035	013									12	100893	1/1/0001
	05800	S	M	OUG	II	01042	012									12	100893	1/1/0001
	05800	S	M	OUG	II	01047	011									12	100893	1/1/0001
	05800	S	M	OUG	II	01054	010									12	100893	1/1/0001
	05800	S	M	OUG	II	01059	009									12	100893	1/1/0001
	05800	S	M	OUG	II	01067	008									12	100893	1/1/0001
	05800	S	M	OUG	II	01086	006									12	010890	1/1/0001

OFFICE: 311		ROUTE: 564		ST_REF_NO: 00000070800		FOREST PARK ROAD		LUMENS	BULB TYPE	MULT SERIES	POLE TYPE	SHADE	ADDRESS NUMBER	REF	LOCATION	TAX DIST	DATE INST	DATE CHANGE
	05800	S	M	SOH	II	00000	001									12	121578	1/1/0001
	05800	S	M	SOH	II	00000	003									12	121578	1/1/0001
	05800	S	M	SOH	II	00000	005									12	121578	1/1/0001
	05800	S	M	SOH	II	00000	006									12	121578	1/1/0001
	05800	S	M	SOH	II	00000	007									12	121578	1/1/0001
	05800	S	M	SOH	II	00000	008									12	121578	1/1/0001
	05800	S	M	SOH	II	00000	009									12	121578	1/1/0001
	05800	S	M	SOH	II	00181	004									12	121578	1/1/0001
	05800	S	M	SOH	II	01410	002									12	051477	1/1/0001

OFFICE: 311		ROUTE: 564		ST_REF_NO: 00000070850		FOREST VIEW COURT		LUMENS	BULB TYPE	MULT SERIES	POLE TYPE	SHADE	ADDRESS NUMBER	REF	LOCATION	TAX DIST	DATE INST	DATE CHANGE
	05800	S	M	OUG	III	04705	001									12	060897	1/1/0001

OFFICE: 311		ROUTE: 564		ST_REF_NO: 00000070900		FORHAND COURT		LUMENS	BULB TYPE	MULT SERIES	POLE TYPE	SHADE	ADDRESS NUMBER	REF	LOCATION	TAX DIST	DATE INST	DATE CHANGE
	04000	S	M	OUG	II	00401	031									12	121579	1/1/0001
	04000	S	M	OUG	V	00412	032									12	121579	1/1/0001

OFFICE: 311 ROUTE: 564							ST_REF_NO: 0000071000 FORSTON AVENUE			
LUMENS	BULB TYPE	MULT SERIES	POLE TYPE	SHADE	ADDRESS NUMBER	REF	LOCATION	TAX DIST	DATE INST	DATE CHANGE
04000	S	M	SOH	II	00105	161		12	010885	1/1/0001
04000	S	M	SOH	II	00113	162		12	120884	1/1/0001

OFFICE: 311 ROUTE: 564							ST_REF_NO: 0000071090 FORSYTHE COURT			
LUMENS	BULB TYPE	MULT SERIES	POLE TYPE	SHADE	ADDRESS NUMBER	REF	LOCATION	TAX DIST	DATE INST	DATE CHANGE
04000	S	M	OUG	II	03800	033		12	021580	1/1/0001
04000	S	M	OUG	V	03812	034		12	021580	1/1/0001

OFFICE: 311 ROUTE: 564							ST_REF_NO: 0000071100 FORSYTHE DRIVE			
LUMENS	BULB TYPE	MULT SERIES	POLE TYPE	SHADE	ADDRESS NUMBER	REF	LOCATION	TAX DIST	DATE INST	DATE CHANGE
05800	S	M	OUG	II	00000	018	SIDE OF 1980 COTTONWOOD DR.	12	021580	1/14/2013
05800	S	M	OUG	II	04068	015		12	091579	9/5/2013
05800	S	M	OUG	II	04168	050	bad fixture	12	091579	10/13/2010
04000	S	M	OUG	II	00000	022	SIDE OF 3717 GLADMAN WAY	12	091579	1/1/0001
05800	S	M	OUG	IV	03868	075		12	070893	1/1/0001
05800	S	M	OUG	II	03876	074		12	070893	1/1/0001
04000	S	M	OUG	II	03884	073		12	080891	1/1/0001
05800	S	M	OUG	II	03901	072		12	070893	1/1/0001
05800	S	M	OUG	II	03916	071		12	070893	1/1/0001
05800	S	M	OUG	II	03924	070		12	070893	1/1/0001
05800	S	M	OUG	II	03936	069		12	070893	1/1/0001
04000	S	M	OUG	II	03949	068		12	080891	1/1/0001
04000	S	M	OUG	II	03957	067		12	100892	1/1/0001
05800	S	M	OUG	II	03980	066		12	100898	1/1/0001
04000	S	M	OUG	II	03996	064		12	080891	1/1/0001
05800	S	M	OUG	II	03997	065		12	030895	1/1/0001
04000	S	M	OUG	II	04008	063		12	080891	1/1/0001
04000	S	M	OUG	II	04012	062		12	080891	1/1/0001
05800	S	M	OUG	II	04033	061		12	030895	1/1/0001
04000	S	M	OUG	II	04049	014		12	100892	1/1/0001
04000	S	M	OUG	II	04052	060		12	080891	1/1/0001
04000	S	M	OUG	II	04073	016		12	091579	1/1/0001

OFFICE: 311

ROUTE: 564

ST_REF_NO: 0000071100

FORSYTHE DRIVE

LUMENS	BULB TYPE	MULT SERIES	POLE TYPE	SHADE	ADDRESS NUMBER	REF	LOCATION	TAX DIST	DATE INST	DATE CHANGE
04000	S	M	OUG	II	04088	017		12	091579	1/1/0001
04000	S	M	OUG	II	04093	018		12	091579	1/1/0001
04000	S	M	OUG	II	04100	019		12	091579	1/1/0001
04000	S	M	OUG	II	04117	020		12	091579	1/1/0001
04000	S	M	OUG	II	04120	021		12	091579	1/1/0001
04000	S	M	OUG	II	04140	023		12	091579	1/1/0001
04000	S	M	OUG	II	04157	049		12	091579	1/1/0001
04000	S	M	OUG	II	04177	051		12	111580	1/1/0001
04000	S	M	OUG	II	04192	052		12	091579	1/1/0001
04000	S	M	OUG	II	04204	043		12	021580	1/1/0001
04000	S	M	OUG	II	04237	023		12	021580	1/1/0001
04000	S	M	OUG	II	04240	022		12	021580	1/1/0001
04000	S	M	OUG	II	04261	021		12	021580	1/1/0001
04000	S	M	OUG	II	04268	020		12	021580	1/1/0001
04000	S	M	OUG	II	04285	019		12	021580	1/1/0001
04000	S	M	OUG	II	04309	012		12	021580	1/1/0001
04000	S	M	OUG	II	04316	011		12	021580	1/1/0001

OFFICE: 311

ROUTE: 564

ST_REF_NO: 0000071150

FORTUNE DRIVE

LUMENS	BULB TYPE	MULT SERIES	POLE TYPE	SHADE	ADDRESS NUMBER	REF	LOCATION	TAX DIST	DATE INST	DATE CHANGE
09500	S	M	OUG	II	00000	004	1ST LT S OF BEASLEY ST, W SIDE ON FORTUNE DR	12	040502	1/1/0001
09500	S	M	OUG	II	00000	005	3RD LT S OF BEASLEY ST, W SIDE ON FORTUNE DR	12	040502	1/1/0001
09500	S	M	OUG	II	00000	007	1ST LT S OF FORTUNE CT, W SIDE ON FORTUNE DR	12	040502	1/1/0001
09500	S	M	OUG	II	00000	008	2ND LT S OF FORTUNE CT, E SIDE ON FORTUNE DR	12	040502	1/1/0001
09500	S	M	OUG	II	00000	009	3RD LT S OF FORTUNE CT, W SIDE ON FORTUNE DR	12	040502	1/1/0001
09500	S	M	OUG	II	00000	010	4TH LT S OF FORTUNE CT, E SIDE ON FORTUNE DR	12	040502	1/1/0001
09500	S	M	OUG	II	00000	011	5TH LT S OF FORTUNE CT, W SIDE ON FORTUNE DR	12	040502	1/1/0001
09500	S	M	OUG	II	00000	012	6TH LT S OF FORTUNE CT, W SIDE ON FORTUNE DR	12	040502	1/1/0001

OFFICE: 311

ROUTE: 564

ST_REF_NO: 0000071150

FORTUNE DRIVE

LUMENS	BULB TYPE	MULT SERIES	POLE TYPE	SHADE	ADDRESS NUMBER	REF	LOCATION	TAX DIST	DATE INST	DATE CHANGE
09500	S	M	OUG	II	00000	013	7TH LT S OF FORTUNE CT, W SIDE ON FORTUNE DR	12	040502	1/1/0001
09500	S	M	OUG	II	00000	014	8TH LT S OF FORTUNE CT, E SIDE ON FORTUNE DR	12	040502	1/1/0001
09500	S	M	OUG	II	00000	037	9TH LT E OF TRADE CENTER DR, N SIDE ON FORTUNE DR	12	040502	1/1/0001
09500	S	M	OUG	II	00000	038	10TH LT E OF TRADE CENTER DR, S SIDE ON FORTUNE DR	12	040502	1/1/0001
09500	S	M	OUG	II	00000	039	11TH LT E OF TRADE CENTER DR, N SIDE ON FORTUNE DR	12	040502	1/1/0001
09500	S	M	OUG	II	00000	040	12TH LT E OF TRADE CENTER DR, S SIDE ON FORTUNE DR	12	040502	1/1/0001
09500	S	M	OUG	II	00000	041	2ND LT N OF CORNERSTONE DR, E SIDE ON FORTUNE DR	12	040502	1/1/0001
09500	S	M	OUG	II	00000	042	1ST LT N OF CORNERSTONE DR, W SIDE ON FORTUNE DR	12	040502	1/1/0001
09500	S	M	OUG	II	00000	043	4TH LT N OF HADDON DR, E SIDE ON FORTUNE DR	12	040502	1/1/0001
09500	S	M	OUG	II	00000	044	3RD LT N OF HADDON DR, W SIDE ON FORTUNE DR	12	040502	1/1/0001
09500	S	M	OUG	II	00000	045	2ND LT N OF HADDON DR, E SIDE ON FORTUNE DR	12	040502	1/1/0001
09500	S	M	OUG	II	00000	046	1ST LT N OF HADDON DR, W SIDE ON FORTUNE DR	12	040502	1/1/0001
09500	S	M	OUG	II	00000	047	2ND LT N OF FORTUNE HILL LN, E SIDE ON FORTUNE DR	12	040502	1/1/0001
09500	S	M	OUG	II	00000	048	1ST LT N OF FORTUNE HILL LN, W SIDE ON FORTUNE DR	12	040502	1/1/0001
09500	S	M	OUG	II	00000	049	2ND LT N OF LIBERTY RD, E SIDE ON FORTUNE DR	12	040502	1/1/0001
22000	S	M	OUG	II	00000	050	1ST LT N OF LIBERTY RD, W SIDE ON FORTUNE DR	12	040502	1/1/0001
05800	S	M	OUG	II	00000	001	1ST LT. S. OF WINCHESTER RD, W. SIDE	12	030890	1/1/0001
09500	S		OUG	II	00000	030	SIDE OF 2150 TRADE CENTER DRIVE ON FORTUNE DRIVE	12	030801	1/1/0001
09500	S		OUG	II	00000	032	SIDE OF 2150 TRADE CENTER DRIVE ON FORTUNE DRIVE	12	030801	1/1/0001
05800	S	M	OUG	II	02301	002		12	030890	1/1/0001
05800	S	M	OUG	II	02321	004		12	030890	1/1/0001
09500	S		OUG	II	02400	031		12	030801	1/1/0001
09500	S		OUG	II	02432	033		12	030801	1/1/0001
09500	S		OUG	II	02432	035		12	030801	1/1/0001
09500	S		OUG	II	02432	036		12	030801	1/1/0001

OFFICE: 311 ROUTE: 564										
ST_REF_NO: 0000071150 FORTUNE DRIVE										
LUMENS	BULB TYPE	MULT SERIES	POLE TYPE	SHADE	ADDRESS NUMBER	REF	LOCATION	TAX DIST	DATE INST	DATE CHANGE
09500	S		OUG	II	02432	037		12	030801	1/1/0001
09500	S		OUG	II	02433	034		12	030801	1/1/0001

OFFICE: 311 ROUTE: 564										
ST_REF_NO: 0000071390 FOUR WYNDS TRAIL										
LUMENS	BULB TYPE	MULT SERIES	POLE TYPE	SHADE	ADDRESS NUMBER	REF	LOCATION	TAX DIST	DATE INST	DATE CHANGE
05800	S	M	CNT	II	00000	003	SIDE OF 4585 FIELDMOOR DR.	12	080897	1/1/0001
05800	S	M	CNT	II	00000	006	SIDE OF 4533 PENTALLA POINTE	12	080897	1/1/0001
05800	S	M	CNT	III	01104	011		12	080897	1/1/0001
05800	S	M	CNT	II	01120	010		12	080897	1/1/0001
05800	S	M	CNT	II	01128	009		12	080897	1/1/0001
05800	S	M	CNT	II	01144	008		12	080897	1/1/0001
05800	S	M	CNT	II	01156	007		12	080897	1/1/0001
05800	S	M	CNT	II	01180	005		12	080897	1/1/0001
05800	S	M	CNT	II	01197	004		12	080897	1/1/0001
05800	S	M	CNT	II	01212	002		12	080897	1/1/0001
05800	S	M	CNT	III	01233	001		12	080897	1/1/0001

OFFICE: 311 ROUTE: 564										
ST_REF_NO: 0000071400 FOURTH, EAST STREET										
LUMENS	BULB TYPE	MULT SERIES	POLE TYPE	SHADE	ADDRESS NUMBER	REF	LOCATION	TAX DIST	DATE INST	DATE CHANGE
05800	S		CNT	II	00500	100		12	080610	1/1/0001
05800	S		CNT	II	00521	101		12	080610	1/1/0001
05800	S		CNT	II	00540	102		12	080610	1/1/0001
09500	S	M	SOH	II	00000	019	SIDE OF 400 CHESTNUT ST.	12	110168	10/10/2011
09500	S	M	SOH	II	00421	021		12	110168	5/22/2009
10000	M	M	SOH	II	00000	001	OPP. FROM SIDE OF 400 N. LIMESTONE	12	101468	1/1/0001
10000	M	M	SOH	II	00000	002	OPP. 117	12	101468	1/1/0001
10000	M	M	SOH	II	00000	006	SIDE OF 367 WALNUT ST.	12	101468	1/1/0001
10000	M	M	SOH	II	00000	008	OPP. 203	12	101468	1/1/0001
10000	M	M	SOH	II	00000	009	OPP. 218 AT KLEISER ALLEY	12	101468	1/1/0001
10000	M	M	SOH	II	00000	016	SIDE OF 371 OHIO ST.	12	101468	1/1/0001
10000	M	M	SOH	II	00000	018	OPP. 317	12	110168	1/1/0001
10000	M	M	SOH	II	00000	023	SIDE OF 401 RACE ST.	12	110168	1/1/0001

OFFICE: 311

ROUTE: 564

ST_REF_NO: 0000071400

FOURTH, EAST STREET

LUMENS	BULB TYPE	MULT SERIES	POLE TYPE	SHADE	ADDRESS NUMBER	REF	LOCATION	TAX DIST	DATE INST	DATE CHANGE
10000	M	M	SOH	II	00123	003		12	101468	1/1/0001
10000	M	M	SOH	II	00132	004		12	101468	1/1/0001
10000	M	M	SOH	II	00149	005		12	030171	1/1/0001
10000	M	M	SOH	II	00203	007		12	101468	1/1/0001
10000	M	M	SOH	II	00232	010		12	101468	1/1/0001
10000	M	M	SOH	II	00239	011		12	101468	1/1/0001
10000	M	M	SOH	II	00248	012		12	101468	1/1/0001
10000	M	M	SOH	II	00268	014		12	101468	1/1/0001
10000	M	M	SOH	II	00275	015		12	101468	1/1/0001
10000	M	M	SOH	II	00309	017		12	101468	1/1/0001
10000	M	M	SOH	II	00410	020		12	110168	1/1/0001
10000	M	M	SOH	II	00430	022		12	110168	1/1/0001

OFFICE: 311

ROUTE: 564

ST_REF_NO: 0000071410

FOURTH, WEST STREET

LUMENS	BULB TYPE	MULT SERIES	POLE TYPE	SHADE	ADDRESS NUMBER	REF	LOCATION	TAX DIST	DATE INST	DATE CHANGE
22000	S		OUG	II	00000	002	1ST LIGHT EAST OF NEWTOWN PIKE, NORTH SIDE	12	120513	1/1/0001
10000	M	M	SOH	II	00000	008	OPP 555	12	031165	9/1/2013
10000	M	M	SOH	II	00000	010	OPP 551	12	031165	9/1/2013
10000	M	M	SOH	II	00000	012	OPP 523	12	031165	9/1/2013
10000	M	M	SOH	II	00000	014	OPP 505	12	030165	9/1/2013
09500	S	M	SOH	II	00000	105	OPP. 457 bad fixture	12	020167	11/3/2008
10000	M	M	SOH	II	00000	001	1 ST. LT. E. OF NEWTOWN RD., S. SIDE	12	030165	1/1/0001
10000	M	M	SOH	II	00000	003	2 ND. LT. E. OF NEWTOWN RD., S. SIDE	12	030165	1/1/0001
10000	M	M	SOH	II	00000	007	S.W. CORNER OF FOURTH & HICKORY ST.	12	030165	1/1/0001
10000	M	M	SOH	II	00000	009	S. SIDE BETWEEN BLACKBURN & HENRY ST.	12	031165	1/1/0001
10000	M	M	SOH	II	00000	011	S.E. CORNER OF FOURTH & BLACKBURN ST.	12	030165	1/1/0001
22000	S	M	SOH	II	00000	015	S.W. CORNER OF FOURTH & JEFFERSON ST.	12	030165	1/1/0001
20000	M	M	OOH	III	00000	028	1 ST. LT. E. OF NEWTOWN RD., N. SIDE	12	070165	1/1/0001
50000	S	M	SOH	II	00000	101	SIDE OF 372 JEFFERSON ST.	12	020167	1/1/0001
10000	M	M	SOH	II	00000	103	OPP. SMITH ST.	12	020167	1/1/0001
22000	S	M	SOH	II	00000	106	OPP. 449 W. FOURTH ST.	12	080892	1/1/0001
22000	S	M	SOH	II	00000	107	OPP. 439	12	020167	1/1/0001
22000	S	M	SOH	II	00000	109	OPP. 421	12	020167	1/1/0001

OFFICE: 311

ROUTE: 564

ST_REF_NO: 0000071410

FOURTH, WEST STREET

LUMENS	BULB TYPE	MULT SERIES	POLE TYPE	SHADE	ADDRESS NUMBER	REF	LOCATION	TAX DIST	DATE INST	DATE CHANGE
22000	S	M	SOH	II	00000	110	OPP. 413	12	062167	1/1/0001
22000	S	M	SOH	II	00000	111	SIDE OF 373 N. BROADWAY	12	020167	1/1/0001
50000	S	M	SOH	II	00000	112	SIDE OF 401 N. BROADWAY	12	020167	1/1/0001
50000	S	M	SOH	II	00000	201	SIDE OF 400 N. BROADWAY	12	021368	1/1/0001
22000	S	M	SOH	II	00321	203		12	021368	1/1/0001
22000	S	M	SOH	II	00333	202		12	021368	1/1/0001
22000	S	M	SOH	II	00429	108		12	062167	1/1/0001
10000	M	M	SOH	II	00465	104		12	062167	1/1/0001
22000	S	M	SOH	II	00485	102	upgraded to 22,000 cobra Jan 2007	12	020167	1/1/0001
10000	M	M	SOH	II	00516	013		12	030165	1/1/0001
10000	M	M	SOH	II	00614	005		12	030165	1/1/0001
22000	S	M	SOH	II	00000	204	OPP. 301	12	021367	1/1/0001
50000	S	M	SOH	II	00000	207	SIDE OF 401 N. UPPER ST.	12	021368	1/1/0001
10000	M	M	SOH	II	00000	209	OPP. 110	12	021368	1/1/0001
10000	M	M	SOH	II	00000	210	SIDE OF 371 N. LIMESTONE ST.	12	021368	1/1/0001
10000	M	M	SOH	II	00126	208		12	021368	1/1/0001
22000	S	M	SOH	II	00217	206		12	021368	1/1/0001
22000	S	M	SOH	II	00225	205		12	021368	1/1/0001

OFFICE: 311

ROUTE: 564

ST_REF_NO: 0000071415

FOX FIRE COURT

LUMENS	BULB TYPE	MULT SERIES	POLE TYPE	SHADE	ADDRESS NUMBER	REF	LOCATION	TAX DIST	DATE INST	DATE CHANGE
05800	S	M	OUG	V	03908	001		12	100892	1/1/0001

OFFICE: 311

ROUTE: 564

ST_REF_NO: 0000071420

FOX HARBOUR DRIVE

LUMENS	BULB TYPE	MULT SERIES	POLE TYPE	SHADE	ADDRESS NUMBER	REF	LOCATION	TAX DIST	DATE INST	DATE CHANGE
05800	S	M	OUG	II	00300	001		12	100892	1/1/0001
05800	S	M	OUG	II	00317	002		12	110892	1/1/0001
05800	S	M	OUG	II	00324	004		12	100892	1/1/0001
05800	S	M	OUG	II	00329	003		12	110892	1/1/0001
05800	S	M	OUG	II	00340	006		12	100892	1/1/0001
05800	S	M	OUG	II	00353	005		12	110892	1/1/0001
05800	S	M	OUG	II	00377	007		12	110892	1/1/0001

OFFICE: 311

ROUTE: 564

ST_REF_NO: 0000071420

FOX HARBOUR DRIVE

LUMENS	BULB TYPE	MULT SERIES	POLE TYPE	SHADE	ADDRESS NUMBER	REF	LOCATION	TAX DIST	DATE INST	DATE CHANGE
05800	S	M	OUG	II	00385	008		12	110892	1/1/0001
05800	S	M	OUG	II	00388	010		12	110892	1/1/0001
05800	S	M	OUG	II	00397	009		12	110892	1/1/0001
05800	S	M	OUG	II	00400	011		12	100892	1/1/0001
05800	S	M	OUG	II	00428	013		12	100892	1/1/0001
05800	S	M	OUG	II	00441	012		12	110892	1/1/0001
05800	S	M	OUG	II	00460	015		12	110892	1/1/0001
05800	S	M	OUG	II	00461	014		12	110892	1/1/0001
05800	S	M	OUG	II	00468	016		12	110892	1/1/0001

OFFICE: 311

ROUTE: 564

ST_REF_NO: 0000071425

FOX HUNT CIRCLE

LUMENS	BULB TYPE	MULT SERIES	POLE TYPE	SHADE	ADDRESS NUMBER	REF	LOCATION	TAX DIST	DATE INST	DATE CHANGE
05800	S	M	OUG	V	03905	001		12	100892	1/1/0001

OFFICE: 311

ROUTE: 564

ST_REF_NO: 0000071600

FOX RUN ROAD

LUMENS	BULB TYPE	MULT SERIES	POLE TYPE	SHADE	ADDRESS NUMBER	REF	LOCATION	TAX DIST	DATE INST	DATE CHANGE
04000	S	M	OUG	II	00000	037	SIDE OF 1182 MEREWOOD DR.	12	111478	1/1/0001
04000	S	M	OUG	II	03613	036		12	111478	1/1/0001
04000	S	M	OUG	II	03620	035		12	111478	1/1/0001

OFFICE: 311

ROUTE: 564

ST_REF_NO: 0000071605

FOXBRIDGE CIRCLE

LUMENS	BULB TYPE	MULT SERIES	POLE TYPE	SHADE	ADDRESS NUMBER	REF	LOCATION	TAX DIST	DATE INST	DATE CHANGE
04000	S	M	OUG	II	00000	001	SIDE OF 976 ROCKBRIDGE RD.	12	020895	1/1/0001
04000	S	M	OUG	II	04609	002		12	020895	1/1/0001

OFFICE: 311

ROUTE: 564

ST_REF_NO: 0000071610

FOXCHASE COURT

LUMENS	BULB TYPE	MULT SERIES	POLE TYPE	SHADE	ADDRESS NUMBER	REF	LOCATION	TAX DIST	DATE INST	DATE CHANGE
04000	S	M	OUG	II	03209	008		12	080886	1/1/0001
04000	S	M	OUG	II	03212	009		12	070885	1/1/0001

OFFICE: 311		ROUTE: 564		ST_REF_NO: 00000071700		FOXCROFT COURT		LUMENS	BULB TYPE	MULT SERIES	POLE TYPE	SHADE	ADDRESS NUMBER	REF	LOCATION	TAX DIST	DATE INST	DATE CHANGE
	05800	S	M	OUG	II	00809	000									12	070767	1/1/0001
	05800	S	M	OUG	II	00816	000									12	120266	1/1/0001
	05800	S	M	OUG	II	00836	000									12	060870	1/1/0001
OFFICE: 311		ROUTE: 564		ST_REF_NO: 00000071800		FOX E BASIN ROAD		LUMENS	BULB TYPE	MULT SERIES	POLE TYPE	SHADE	ADDRESS NUMBER	REF	LOCATION	TAX DIST	DATE INST	DATE CHANGE
	05800	S	M	SOH	II	00000	068								SIDE OF 4020	12	030895	1/1/0001
	05800	S	M	OUG	II	04020	067									12	030895	1/1/0001
	05800	S	M	OUG	II	04037	066									12	030895	1/1/0001
	05800	S	M	OUG	IV	04058	065									12	030895	1/1/0001
	05800	S	M	OUG	II	04074	064									12	030895	1/1/0001
	05800	S	M	OUG	II	04089	063									12	030895	1/1/0001
OFFICE: 311		ROUTE: 564		ST_REF_NO: 00000071900		FOXTALE COURT		LUMENS	BULB TYPE	MULT SERIES	POLE TYPE	SHADE	ADDRESS NUMBER	REF	LOCATION	TAX DIST	DATE INST	DATE CHANGE
	05800	S	M	OUG	II	00000	165								SIDE OF 3326 COLDSTREAM DR.	12	042067	1/1/0001
	05800	S	M	OUG	II	03272	166									12	042067	1/1/0001
OFFICE: 311		ROUTE: 564		ST_REF_NO: 00000071910		FRALEY COURT		LUMENS	BULB TYPE	MULT SERIES	POLE TYPE	SHADE	ADDRESS NUMBER	REF	LOCATION	TAX DIST	DATE INST	DATE CHANGE
	05800	S	M	OUG	III	00000	001								SIDE REAR OF 3969 FORSYTHE DR.	12	030895	1/1/0001
OFFICE: 311		ROUTE: 564		ST_REF_NO: 00000072000		FRANCIS AVENUE		LUMENS	BULB TYPE	MULT SERIES	POLE TYPE	SHADE	ADDRESS NUMBER	REF	LOCATION	TAX DIST	DATE INST	DATE CHANGE
	05800	S		SOH	II	00000	001								SIDE OF 300 BURLEY AVENUE	12	101212	1/1/0001
	04000	S	M	SOH	II	00000	032								SIDE OF 297 AMERICAN AVE.	12	050886	1/1/0001

OFFICE: 311		ROUTE: 564		ST_REF_NO: 00000072095		FRANKFORT COURT				
LUMENS	BULB TYPE	MULT SERIES	POLE TYPE	SHADE	ADDRESS NUMBER	REF	LOCATION	TAX DIST	DATE INST	DATE CHANGE
05800	S	M	CNT	II	00000	075	1ST LT W OF OLD FRANKFORT CIR S SIDE OF F-FORT CT	12	071001	1/1/0001
05800	S	M	CNT	II	00000	076	2ND LT W OF OLD FRANKFORT CIR S SIDE OF F-FORT CT	12	071001	1/1/0001
05800	S	M	CNT	II	00000	077	3RD LT W OF OLD FRANKFORT CIR S SIDE OF F-FORT CT	12	071001	1/1/0001

OFFICE: 311		ROUTE: 564		ST_REF_NO: 00000072300		FRANKLIN AVENUE				
LUMENS	BULB TYPE	MULT SERIES	POLE TYPE	SHADE	ADDRESS NUMBER	REF	LOCATION	TAX DIST	DATE INST	DATE CHANGE
04000	S	S	SOH	II	00000	001	SIDE OF 155 N. ASHLAND AVE.	12	111463	1/1/0001
05800	S	M	SOH	II	00000	002	FRANKLIN & ASHLAND, NW CORNER	12	111463	1/1/0001
04000	S	S	SOH	II	00702	000		12	111463	1/1/0001
04000	S	S	SOH	II	00707	000		12	111463	1/1/0001
04000	S	S	SOH	II	00715	000		12	111463	1/1/0001
04000	S	S	SOH	II	00722	000		12	111463	1/1/0001

OFFICE: 311		ROUTE: 564		ST_REF_NO: 00000072325		FRANKS WAY				
LUMENS	BULB TYPE	MULT SERIES	POLE TYPE	SHADE	ADDRESS NUMBER	REF	LOCATION	TAX DIST	DATE INST	DATE CHANGE
09500	S		CLN	II	02404	001		12	091109	1/1/0001
09500	S		CLN	II	02420	003		12	091109	1/1/0001
09500	S		CLN	II	02436	005		12	091109	1/1/0001
09500	S		CLN	II	02437	006		12	091109	1/1/0001
09500	S		CLN	II	02453	008		12	091109	1/1/0001
09500	S		CLN	II	02481	012		12	091109	1/1/0001
09500	S		CLN	II	00000	009	SIDE OF 972 STAR GAZE ON FRANKS WAY	12	091109	9/11/2009
09500	S		CLN	II	00000	013	SIDE OF 957 VILLAGE GREEN ON FRANKS WAY	12	091109	9/11/2009
09500	S		CLN	II	02413	002		12	091109	9/11/2009
09500	S		CLN	II	02425	004		12	091109	9/11/2009
09500	S		CLN	II	02444	007		12	091109	9/11/2009
09500	S		CLN	II	02465	010		12	091109	9/11/2009
09500	S		CLN	II	02472	011		12	091109	9/11/2009

OFFICE: 311		ROUTE: 564		ST_REF_NO: 00000072400		FRASERDALE DRIVE				
LUMENS	BULB TYPE	MULT SERIES	POLE TYPE	SHADE	ADDRESS NUMBER	REF	LOCATION	TAX DIST	DATE INST	DATE CHANGE
04000	S	M	OUG	II	03374	124		12	110885	1/1/0001
04000	S	M	OUG	II	03386	123		12	110885	1/1/0001
04000	S	M	OUG	II	03397	122		12	110885	1/1/0001
04000	S	M	OUG	II	03409	121		12	110885	1/1/0001
04000	S	M	OUG	II	03422	120		12	110885	1/1/0001
04000	S	M	OUG	II	03429	119		12	110885	1/1/0001
05800	S	M	OUG	II	03442	104		12	110893	1/1/0001
05800	S	M	OUG	II	03453	105			110893	1/1/0001
05800	S	M	OUG	II	03458	106		12	110893	1/1/0001

OFFICE: 311		ROUTE: 564		ST_REF_NO: 00000072500		FREDERICK STREET				
LUMENS	BULB TYPE	MULT SERIES	POLE TYPE	SHADE	ADDRESS NUMBER	REF	LOCATION	TAX DIST	DATE INST	DATE CHANGE
09500	S	M	SOH	II	00000	066	SIDE REAR OF 701 GOLFBVIEW-upgraded 10/05	12	020886	1/1/0001
09500	S	M	SOH	II	00000	067	SIDE FRONT 700 GOLFBVIEW-upgraded 10/05	12	020886	1/1/0001
09500	S	M	SOH	III	00000	068	END OF FREDERICK STREET BEHIND GUARDRAIL-upgr 2005	12	120897	1/1/0001

OFFICE: 311		ROUTE: 564		ST_REF_NO: 00000072600		FREDERICKSBURG DRIVE				
LUMENS	BULB TYPE	MULT SERIES	POLE TYPE	SHADE	ADDRESS NUMBER	REF	LOCATION	TAX DIST	DATE INST	DATE CHANGE
04000	S	M	OUG	II	00000	001	SIDE OF 1957 VICKSBURG RD.	12	100888	1/1/0001
04000	S	M	OUG	II	00000	007	SIDE OF 1920 APPOMATTOX RD.	12	100888	1/1/0001
04000	S	M	OUG	II	00960	002		12	100888	1/1/0001
04000	S	M	OUG	II	00973	003		12	100888	1/1/0001
04000	S	M	OUG	II	00982	004		12	100888	1/1/0001
04000	S	M	OUG	II	00989	005		12	100888	1/1/0001
04000	S	M	OUG	II	00994	006		12	100888	1/1/0001

OFFICE: 311		ROUTE: 564		ST_REF_NO: 00000072610		FREELAND COURT				
LUMENS	BULB TYPE	MULT SERIES	POLE TYPE	SHADE	ADDRESS NUMBER	REF	LOCATION	TAX DIST	DATE INST	DATE CHANGE
05800	S	M	SOH	II	00000	188	SIDE OF 3425 PEPPERHILL RD.	12	101476	1/1/0001
05800	S	M	OUG	II	03429	175		12	111478	1/1/0001
05800	S	M	OUG	II	03436	176		12	101476	1/1/0001

OFFICE: 311		ROUTE: 564		ST_REF_NO: 0000072700		FREELAND DRIVE		LUMENS	BULB TYPE	MULT SERIES	POLE TYPE	SHADE	ADDRESS NUMBER	REF	LOCATION	TAX DIST	DATE INST	DATE CHANGE
05800	S	M	OUG	II	00000	187	SIDE OF 3414 PEPPERHILL .	12	011581	1/1/0001								
05800	S	M	OUG	II	03401	185		12	091476	1/1/0001								
05800	S	M	OUG	II	03408	186		12	091476	1/1/0001								

OFFICE: 311		ROUTE: 564		ST_REF_NO: 0000072800		FREEMAN DRIVE		LUMENS	BULB TYPE	MULT SERIES	POLE TYPE	SHADE	ADDRESS NUMBER	REF	LOCATION	TAX DIST	DATE INST	DATE CHANGE
05800	S	M	OUG	II	00000	041	SIDE OF 2219 CIRCLE DR.	12	050884	1/1/0001								
05800	S	M	OUG	II	00506	040		12	050884	1/1/0001								
05800	S	M	OUG	II	00519	039		12	050884	1/1/0001								
05800	S	M	OUG	II	00530	038		12	050884	1/1/0001								
05800	S	M	OUG	II	00543	037		12	050884	1/1/0001								
05800	S	M	OUG	II	00550	036		12	050884	1/1/0001								
05800	S	M	OUG	II	00557	035		12	050884	1/1/0001								
05800	S	M	OUG	II	00562	034		12	050884	1/1/0001								
05800	S	M	OUG	II	00569	033		12	050884	1/1/0001								
05800	S	M	OUG	II	00574	032		12	050884	1/1/0001								
05800	S	M	OUG	II	00581	031		12	050884	1/1/0001								
05800	S	M	OUG	II	00600	030		12	050884	1/1/0001								
05800	S	M	OUG	II	00603	029		12	050884	1/1/0001								
05800	S	M	OUG	II	00610	028		12	050884	1/1/0001								
05800	S	M	OUG	II	00613	027		12	050884	1/1/0001								

OFFICE: 311		ROUTE: 564		ST_REF_NO: 0000073100		FT HARRODS DRIVE		LUMENS	BULB TYPE	MULT SERIES	POLE TYPE	SHADE	ADDRESS NUMBER	REF	LOCATION	TAX DIST	DATE INST	DATE CHANGE
05800	S	M	OUG	II	00000	005	SIDE OF 3359 SNAFFLE RD.	12	031581	1/1/0001								
05800	S	M	OUG	II	00000	073	SIDE OF 3301 GONDOLA DR.	12	081582	1/1/0001								
05800	S	M	OUG	II	00000	074	SIDE OF 3298 GONDOLA DR.	12	081582	1/1/0001								
04000	S	M	OUG	II	00000	087	SIDE OF 3316 FT. HARRODS CT.	12	090891	1/1/0001								
04000	S	M	OUG	II	00000	089	SIDE OF 3297 LYON DR.	12	090891	1/1/0001								
05800	S	M	OUG	II	00000	091	OPP. 2160	12	081582	1/1/0001								
09500	S	M	OUG	III	00000	094	NE CORNER OF CAVE HILL LANE	12	110800	1/1/0001								
09500	S	M	OUG	III	00000	095	3RD LT E OF MAN O WAR ON SOUTHSIDE OF FT HARRODS	12	050891	1/1/0001								

OFFICE: 311

ROUTE: 564

ST_REF_NO: 0000073100

FT HARRODS DRIVE

LUMENS	BULB TYPE	MULT SERIES	POLE TYPE	SHADE	ADDRESS NUMBER	REF	LOCATION	TAX DIST	DATE INST	DATE CHANGE
09500	S	M	OUG	III	00000	096	3RD LT E OF MAN O WAR ON NORTHSIDE OF FT HARRODS	12	050891	1/1/0001
09500	S	M	OUG	III	00000	097	2ND LT E OF MAN O WAR N SOUTHSIDE OF FT HARRODS	12	050891	1/1/0001
09500	S	M	OUG	III	00000	098	2ND LT E OF MAN O WAR ON NORTHSIDE OF FT HARRODS	12	050891	1/1/0001
09500	S	M	OUG	III	00000	099	1ST LT E OF MAN O WAR ON SOUTHSIDE OF FT HARRODS	12	050891	1/1/0001
09500	S	M	OUG	III	00000	100	1ST LT E OF MAN O WAR ON NORTHSIDE OF FT HARRODS	12	050891	1/1/0001
09500	S	M	OUG	III	00000	101	1ST LT W OF MAN O WAR ON SOUTHSIDE OF FT HARRODS	12	050891	1/1/0001
09500	S	M	OUG	III	00000	102	2ND LT W OF MAN O WAR ON SOUTHSIDE OF FT HARRODS	12	050891	1/1/0001
05800	S	M	CNT	II	00000	201	1ST LT. E. OF HARRODSBURG RD., NORTHSIDE	12	080894	1/1/0001
05800	S	M	CNT	II	00000	202	1ST LT. E. OF HARRODSBURG RD., SOUTHSIDE	12	080894	1/1/0001
05800	S	M	CNT	II	00000	203	2ND LT. E. OF HARRODSBURG RD., NORTHSIDE	12	080894	1/1/0001
05800	S	M	CNT	II	00000	204	2ND LT. E. OF HARRODSBURG RD., SOUTHSIDE	12	080894	1/1/0001
05800	S	M	CNT	II	00000	205	3RD LT. E. OF HARRODSBURG RD., NORTHSIDE	12	080894	1/1/0001
05800	S	M	CNT	II	00000	210	OPP. COMANCHE TRAIL	12	080894	1/1/0001
05800	S	M	OUG	II	02000	002		12	031581	1/1/0001
05800	S	M	OUG	II	02001	001		12	031581	1/1/0001
05800	S	M	OUG	II	02009	003		12	031581	1/1/0001
05800	S	M	OUG	II	02012	004		12	031481	1/1/0001
05800	S	M	OUG	II	02028	006		12	031581	1/1/0001
05800	S	M	OUG	II	02033	007		12	081582	1/1/0001
05800	S	M	OUG	II	02044	008		12	031581	1/1/0001
05800	S	M	OUG	II	02049	055		12	031581	1/1/0001
05800	S	M	OUG	II	02056	054		12	031581	1/1/0001
05800	S	M	OUG	II	02068	068		12	011584	1/1/0001
05800	S	M	OUG	II	02069	053		12	031581	1/1/0001
05800	S	M	OUG	II	02081	067		12	081582	1/1/0001
05800	S	M	OUG	II	02084	066		12	081582	1/1/0001
04000	S	M	OUG	II	02109	083		12	090891	1/1/0001
04000	S	M	OUG	II	02133	085		12	090891	1/1/0001
05800	S	M	OUG	II	02140	084		12	081582	1/1/0001

OFFICE: 311

ROUTE: 564

ST_REF_NO: 0000073100

FT HARRODS DRIVE

LUMENS	BULB TYPE	MULT SERIES	POLE TYPE	SHADE	ADDRESS NUMBER	REF	LOCATION	TAX DIST	DATE INST	DATE CHANGE
05800	S	M	OUG	II	02140	086		12	081582	1/1/0001
05800	S	M	OUG	II	02140	088		12	081582	1/1/0001
05800	S	M	OUG	II	02160	090		12	081582	1/1/0001
05800	S	M	OUG	II	02160	092		12	081582	1/1/0001
05800	S	M	OUG	II	02160	093		12	081582	1/1/0001
05800	S	M	CNT	II	00000	206	OPP. REAR OF 836 PALOMINO LANE	12	060899	1/1/0001
05800	S	M	CNT	II	00000	207	REAR OF 828 PALOMINO LANE	12	060899	1/1/0001
05800	S	M	CNT	II	00000	208	OPP. REAR OF 816 PALOMINO LANE	12	060899	1/1/0001
05800	S	M	CNT	II	00000	209	REAR OF 808 PALOMINO LANE	12	060899	1/1/0001
05800	S	M	CNT	II	00000	212	SIDE REAR 793 WELLINGTON WAY	12	110895	1/1/0001
05800	S	M	CNT	III	01883	214		12	110895	1/1/0001
05800	S	M	CNT	II	01895	213		12	110895	1/1/0001
05800	S	M	CNT	II	01911	211		12	110895	1/1/0001

OFFICE: 311

ROUTE: 564

ST_REF_NO: 0000073300

FT SUMTER COURT

LUMENS	BULB TYPE	MULT SERIES	POLE TYPE	SHADE	ADDRESS NUMBER	REF	LOCATION	TAX DIST	DATE INST	DATE CHANGE
05800	S	M	OUG	II	01504	000		12	071064	1/1/0001
05800	S	M	OUG	II	01509	000		12	060162	1/1/0001
05800	S	M	OUG	II	01514	000		12	021565	1/1/0001

OFFICE: 311

ROUTE: 564

ST_REF_NO: 0000073400

FT SUMTER DRIVE

LUMENS	BULB TYPE	MULT SERIES	POLE TYPE	SHADE	ADDRESS NUMBER	REF	LOCATION	TAX DIST	DATE INST	DATE CHANGE
05800	S	M	OUG	II	01601	000		12	071064	1/1/0001
05800	S	M	OUG	II	01604	000		12	060162	1/1/0001
05800	S	M	OUG	II	01609	000		12	071064	1/1/0001
05800	S	M	OUG	II	01612	000		12	071064	1/1/0001
05800	S	M	OUG	II	01617	000		12	021565	1/1/0001
05800	S	M	OUG	II	01700	000		12	120264	1/1/0001
05800	S	M	OUG	II	01705	000		12	101861	1/1/0001

OFFICE: 311

ROUTE: 564

ST_REF_NO: 0000073490

FURLANI COURT

LUMENS	BULB TYPE	MULT SERIES	POLE TYPE	SHADE	ADDRESS NUMBER	REF	LOCATION	TAX DIST	DATE INST	DATE CHANGE
05800	S	M	CNT	II	02207	002		12	042502	1/1/0001
05800	S	M	CNT	II	02211	001		12	042502	1/1/0001

OFFICE: 311

ROUTE: 564

ST_REF_NO: 0000073500

FURLONG DRIVE

LUMENS	BULB TYPE	MULT SERIES	POLE TYPE	SHADE	ADDRESS NUMBER	REF	LOCATION	TAX DIST	DATE INST	DATE CHANGE
05800	S	M	OUG	II	00793	010	3rd party damage	12	100889	12/24/2012
04000	S	M	OUG	II	00801	009		12	100889	1/1/0001
04000	S	M	OUG	II	00814	008		12	100889	1/1/0001
04000	S	M	OUG	II	00829	007		12	100889	1/1/0001
04000	S	M	OUG	II	00838	006		12	100889	1/1/0001
04000	S	M	OUG	II	00853	005		12	100889	1/1/0001
04000	S	M	OUG	II	00865	004		12	100889	1/1/0001
04000	S	M	OUG	II	00877	003		12	100889	1/1/0001
04000	S	M	SOH	II	00882	002		12	120888	1/1/0001
04000	S	M	OUG	II	00894	001		12	120888	1/1/0001

OFFICE: 311

ROUTE: 564

ST_REF_NO: 0000073510

GABBARD ALLEY

LUMENS	BULB TYPE	MULT SERIES	POLE TYPE	SHADE	ADDRESS NUMBER	REF	LOCATION	TAX DIST	DATE INST	DATE CHANGE
04000	S	M	SOH	V	00000	001	BEHIND 238 ROSE ST.	12	091576	1/1/0001
04000	S	M	SOH	V	00000	002	BEHIND 321 GROSVENOR AVE.	12	091576	1/1/0001
04000	S	M	SOH	V	00000	003	BEHIND 344 E. HIGH ST.	12	091576	1/1/0001
04000	S	M	SOH	II	00000	004	REAR OF 326 E. HIGH	12	030887	1/1/0001
04000	S	M	SOH	II	00000	005	REAR OF 316 E. HIGH	12	030887	1/1/0001

OFFICE: 311

ROUTE: 564

ST_REF_NO: 0000073600

GAIDRY ROAD

LUMENS	BULB TYPE	MULT SERIES	POLE TYPE	SHADE	ADDRESS NUMBER	REF	LOCATION	TAX DIST	DATE INST	DATE CHANGE
05800	S	M	OUG	II	00000	030	SIDE OF 1705 JENNIFER RD.	12	072474	1/1/0001
05800	S	M	OUG	II	00000	064	SIDE OF 1704 CANTRILL DR.	12	040969	1/1/0001
05800	S	M	OUG	II	01507	134		12	081581	1/1/0001
05800	S	M	OUG	II	01515	000		12	082573	1/1/0001
05800	S	M	OUG	II	01526	000		12	082573	1/1/0001

OFFICE: 311

ROUTE: 564

ST_REF_NO: 0000073700

GAINESVILLE COURT

LUMENS	BULB TYPE	MULT SERIES	POLE TYPE	SHADE	ADDRESS NUMBER	REF	LOCATION	TAX DIST	DATE INST	DATE CHANGE
05800	S	M	OUG	II	02040	129		12	090866	1/1/0001
05800	S	M	OUG	II	02045	130		12	090866	1/1/0001

OFFICE: 311

ROUTE: 564

ST_REF_NO: 0000073710

GAINESWAY COURT

LUMENS	BULB TYPE	MULT SERIES	POLE TYPE	SHADE	ADDRESS NUMBER	REF	LOCATION	TAX DIST	DATE INST	DATE CHANGE
05800	S	M	OUG	II	01126	000		12	101964	1/1/0001

OFFICE: 311

ROUTE: 564

ST_REF_NO: 0000073800

GAINESWAY DRIVE

LUMENS	BULB TYPE	MULT SERIES	POLE TYPE	SHADE	ADDRESS NUMBER	REF	LOCATION	TAX DIST	DATE INST	DATE CHANGE
05800	S	M	OUG	III	00000	098	SIDE OF 1001 CLAIRBORNE WAY	12	071562	1/1/0001
05800	S	M	OUG	II	00000	100	SIDE OF 1001 ELMENDORF DR.	12	072264	1/1/0001
05800	S	M	OUG	II	01015	000		12	060161	1/1/0001
05800	S	M	OUG	II	01025	000		12	101964	1/1/0001
05800	S	M	OUG	II	01032	031		12	090266	1/1/0001
05800	S	M	OUG	II	01034	000		12	091564	1/1/0001
05800	S	M	OUG	II	01039	000		12	090266	1/1/0001
05800	S	M	OUG	II	01102	000		12	091564	1/1/0001
05800	S	M	OUG	II	01109	000		12	091564	1/1/0001
05800	S	M	OUG	II	01112	000		12	090266	1/1/0001
05800	S	M	OUG	II	01119	000		12	090266	1/1/0001
05800	S	M	OUG	II	01123	000		12	091564	1/1/0001
05800	S	M	OUG	II	01129	000		12	090266	1/1/0001
05800	S	M	OUG	II	01136	000		12	110171	1/1/0001
05800	S	M	OUG	II	01137	012		12	120667	1/1/0001
05800	S	M	OUG	II	01200	000		12	091564	1/1/0001
05800	S	M	OUG	II	01215	000		12	042067	1/1/0001
05800	S	M	OUG	II	01228	000		12	090266	1/1/0001
05800	S	M	OUG	II	01235	000		12	110171	1/1/0001
05800	S	M	OUG	II	00000	001	IN MEDIAN AT TATES CREEK RD.	12	020659	1/1/0001
05800	S	M	OUG	II	00000	002	IN MEDIAN AT TATES CREEK RD.	12	020659	1/1/0001
05800	S	M	OUG	II	00000	003	IN MEDIAN AT CASTLETON WAY	12	020659	1/1/0001
05800	S	M	OUG	II	00000	004	IN MEDIAN AT CASTLETON WAY	12	020659	1/1/0001

OFFICE: 311		ROUTE: 564		ST_REF_NO: 00000073800		GAINESWAY DRIVE		LUMENS	BULB TYPE	MULT SERIES	POLE TYPE	SHADE	ADDRESS NUMBER	REF	LOCATION	TAX DIST	DATE INST	DATE CHANGE
05800	S	M	OUG	II	00000	005	SIDE OF 3360 HIGH HOPE RD.	12	041470	1/1/0001								
05800	S	M	OUG	II	00000	024	SIDE OF 1001 CASTLETON WAY SOUTH	12	060161	1/1/0001								
05800	S	M	OUG	II	00000	183	SIDE OF 3370 COLDSTREAM DR.	12	120667	1/1/0001								
05800	S	M	OUG	II	00000	256	SIDE OF 3394 PIMLICO PKWY.	12	031475	1/1/0001								
05800	S	M	OUG	II	01007	000		12	072264	1/1/0001								
05800	S	M	OUG	II	01010	000		12	060161	1/1/0001								
05800	S	M	OUG	II	01252	000		12	090266	1/1/0001								
05800	S	M	OUG	II	01272	000		12	042067	1/1/0001								
05800	S	M	OUG	II	01288	000		12	052068	1/1/0001								
05800	S	M	OUG	II	01299	000		12	062267	1/1/0001								
05800	S	M	OUG	II	01300	000		12	072374	1/1/0001								
OFFICE: 311		ROUTE: 564		ST_REF_NO: 00000073900		GALAHAD DRIVE		LUMENS	BULB TYPE	MULT SERIES	POLE TYPE	SHADE	ADDRESS NUMBER	REF	LOCATION	TAX DIST	DATE INST	DATE CHANGE
05800	S	M	OUG	II	00000	028	SIDE OF 360 LANCELOT LANE	12	081869	1/1/0001								
05800	S	M	OUG	II	03512	027		12	080173	1/1/0001								
05800	S	M	OUG	II	03521	000		12	060171	1/1/0001								
05800	S	M	OUG	II	03532	000		12	081869	1/1/0001								
05800	S	M	OUG	II	03545	000		12	061968	1/1/0001								
05800	S	M	OUG	II	03556	000		12	121268	1/1/0001								
05800	S	M	OUG	II	03572	000		12	041067	1/1/0001								
05800	S	M	OUG	II	03573	000		12	060171	1/1/0001								
OFFICE: 311		ROUTE: 564		ST_REF_NO: 00000073950		GALATA DRIVE		LUMENS	BULB TYPE	MULT SERIES	POLE TYPE	SHADE	ADDRESS NUMBER	REF	LOCATION	TAX DIST	DATE INST	DATE CHANGE
04000	S	M	OUG	II	00000	005	SIDE OF 640 DARDANELLES DR.	12	020895	1/1/0001								
04000	S	M	OUG	II	00601	001		12	020895	1/1/0001								
04000	S	M	OUG	II	00608	002		12	110889	1/1/0001								
04000	S	M	OUG	II	00621	003		12	110889	1/1/0001								
04000	S	M	OUG	II	00632	004		12	110889	1/1/0001								
04000	S	M	OUG	II	00656	006		12	110889	1/1/0001								

OFFICE: 311		ROUTE: 564		ST_REF_NO: 0000074000		GALAXIE DRIVE		LUMENS	BULB TYPE	MULT SERIES	POLE TYPE	SHADE	ADDRESS NUMBER	REF	LOCATION	TAX DIST	DATE INST	DATE CHANGE
04000	S	M	OUG	II	00000	035	SIDE OF 924 TURKEY FOOT RD.	12	081477	1/1/0001								
04000	S	M	OUG	II	00000	042	SIDE OF 901 WISHBONE CIRCLE	12	081477	1/1/0001								
04000	S	M	OUG	II	00604	036		12	111478	1/1/0001								
04000	S	M	OUG	II	00616	043		12	081477	1/1/0001								
04000	S	M	OUG	II	00625	044		12	111478	1/1/0001								
04000	S	M	OUG	II	00628	045		12	111478	1/1/0001								
OFFICE: 311		ROUTE: 564		ST_REF_NO: 0000074110		GAR COURT		LUMENS	BULB TYPE	MULT SERIES	POLE TYPE	SHADE	ADDRESS NUMBER	REF	LOCATION	TAX DIST	DATE INST	DATE CHANGE
05800	S	M	OUG	V	03804	092		12	111583	1/1/0001								
05800	S	M	OUG	V	03809	093		12	121582	1/1/0001								
OFFICE: 311		ROUTE: 564		ST_REF_NO: 0000074200		GARDEN ROAD		LUMENS	BULB TYPE	MULT SERIES	POLE TYPE	SHADE	ADDRESS NUMBER	REF	LOCATION	TAX DIST	DATE INST	DATE CHANGE
05800	S	M	OUG	II	00000	090	OPP. 306	12	022167	1/1/0001								
05800	S	M	OUG	II	00000	094	SIDE OF 1219 COOPER DR.	12	030766	1/1/0001								
05800	S	M	OUG	II	00335	000		12	011856	1/1/0001								
05800	S	M	OUG	II	00348	000		12	010166	1/1/0001								
05800	S	M	OUG	II	00371	093		12	022167	1/1/0001								
OFFICE: 311		ROUTE: 564		ST_REF_NO: 0000074300		GARDEN SPRINGS DRIVE		LUMENS	BULB TYPE	MULT SERIES	POLE TYPE	SHADE	ADDRESS NUMBER	REF	LOCATION	TAX DIST	DATE INST	DATE CHANGE
05800	S	M	OUG	III	00000	098	REAR OF 2081 DOGWOOD DR.	12	090363	1/1/0001								
05800	S	M	OUG	III	00000	102	SIDE OF 2088 ALEXANDRIA DR.	12	090164	1/1/0001								
05800	S	M	OUG	II	00000	195	OPP. 2071 GARDEN SPRINGS	12	012474	1/1/0001								
05800	S	M	OUG	II	00000	196	OPP. 2053 GARDEN SPRINGS	12	012474	1/1/0001								
05800	S	M	OUG	II	00000	197	OPP. 2037 GARDEN SPRINGS	12	041476	1/1/0001								
05800	S	M	OUG	II	00000	198	OPP. 2013 GARDEN SPRINGS	12	041476	1/1/0001								
05800	S	M	OUG	III	02009	000		12	090266	1/1/0001								
05800	S	M	OUG	III	02025	000		12	090164	1/1/0001								
05800	S	M	OUG	III	02041	000		12	102263	1/1/0001								

OFFICE: 311

ROUTE: 564

ST_REF_NO: 0000074300

GARDEN SPRINGS DRIVE

LUMENS	BULB TYPE	MULT SERIES	POLE TYPE	SHADE	ADDRESS NUMBER	REF	LOCATION	TAX DIST	DATE INST	DATE CHANGE
05800	S	M	OUG	III	02063	000		12	080164	1/1/0001
05800	S	M	OUG	III	02079	000		12	102263	1/1/0001
05800	S	M	OUG	III	02086	000		12	080164	1/1/0001
05800	S	M	OUG	III	02099	000		12	102263	1/1/0001
05800	S	M	OUG	III	02100	000		12	090164	1/1/0001
05800	S	M	OUG	III	02115	000		12	090164	1/1/0001
05800	S	M	OUG	II	02124	000		12	080164	1/1/0001
05800	S	M	OUG	III	02148	000		12	090363	1/1/0001
05800	S	M	OUG	III	02151	104		12	090164	1/1/0001
05800	S	M	OUG	III	02172	000		12	090363	1/1/0001
05800	S	M	OUG	III	02185	100		12	090164	1/1/0001
05800	S	M	OUG	III	02192	000		12	090363	1/1/0001

OFFICE: 311

ROUTE: 564

ST_REF_NO: 0000074400

GARRETT AVENUE

LUMENS	BULB TYPE	MULT SERIES	POLE TYPE	SHADE	ADDRESS NUMBER	REF	LOCATION	TAX DIST	DATE INST	DATE CHANGE
09500	S	M	OUG	II	00000	001	SIDE OF 216 SAVOY RD.	12	060161	1/1/0001
09500	S	M	SOH	II	00000	002	SIDE OF 1517 VERSAILLES RD.	12	021478	1/1/0001
09500	S	M	SOH	II	00000	003	SIDE OF 1703 VERSAILLES RD.	12	021478	1/1/0001
09500	S	M	SOH	II	00106	006		12	021478	1/1/0001
09500	S	M	SOH	II	00113	007		12	021478	1/1/0001
09500	S	M	SOH	II	00121	004		12	021478	1/1/0001
09500	S	M	SOH	II	00125	005		12	021478	1/1/0001
09500	S	M	SOH	II	00135	008		12	021478	1/1/0001
09500	S	M	SOH	II	00139	009		12	021478	1/1/0001
09500	S	M	OUG	II	00200	000		12	060161	1/1/0001
09500	S	M	OUG	II	00205	000		12	010162	1/1/0001
09500	S	M	OUG	II	00220	000		12	120960	1/1/0001
09500	S	M	OUG	II	00233	000		12	050160	1/1/0001

OFFICE: 311

ROUTE: 564

ST_REF_NO: 0000074500

GARRISON STREET

LUMENS	BULB TYPE	MULT SERIES	POLE TYPE	SHADE	ADDRESS NUMBER	REF	LOCATION	TAX DIST	DATE INST	DATE CHANGE
09500	S	M	SOH	II	00000	048	SIDE FRONT OF 757 ADDISON AVE-upgraded 10/05	12	020886	1/1/0001

OFFICE: 311

ROUTE: 564

ST_REF_NO: 0000074500

GARRISON STREET

LUMENS	BULB TYPE	MULT SERIES	POLE TYPE	SHADE	ADDRESS NUMBER	REF	LOCATION	TAX DIST	DATE INST	DATE CHANGE
09500	S	M	SOH	II	00000	049	OPP. 1206-upgraded 10/05	12	020886	1/1/0001
09500	S	M	SOH	II	00000	052	SIDE FRONT OF 732 GOLFVIEW-upgraded 10/05	12	020886	1/1/0001
09500	S	M	SOH	III	00000	053	END OF GARRISON AVE. BEHIND GUARDRAIL-upgr 2005	12	120897	1/1/0001

OFFICE: 311

ROUTE: 564

ST_REF_NO: 0000074690

GATEHOUSE PLACE

LUMENS	BULB TYPE	MULT SERIES	POLE TYPE	SHADE	ADDRESS NUMBER	REF	LOCATION	TAX DIST	DATE INST	DATE CHANGE
04000	S	M	OUG	V	00704	004		12	100887	1/1/0001
04000	S	M	OUG	II	00736	003		12	100887	1/1/0001
04000	S	M	OUG	II	00752	002		12	100887	1/1/0001
04000	S	M	OUG	II	00761	001		12	100887	1/1/0001

OFFICE: 311

ROUTE: 564

ST_REF_NO: 0000074760

GATEWAY PARK CIRCLE

LUMENS	BULB TYPE	MULT SERIES	POLE TYPE	SHADE	ADDRESS NUMBER	REF	LOCATION	TAX DIST	DATE INST	DATE CHANGE
05800	S	M	CNT	II	00000	001	SIDE OF 2865 GATEWAY PARK LANE	12	030898	1/1/0001
05800	S	M	CNT	II	00000	003	SIDE OF 201 MEADOW VALLEY RD.	12	030898	1/1/0001
05800	S	M	CNT	II	00000	004	SIDE OF 200 MEADOW VALLEY RD.	12	030898	1/1/0001
05800	S	M	CNT	II	00217	002		12	030898	1/1/0001
05800	S	M	CNT	II	00240	005		12	030898	1/1/0001
05800	S	M	CNT	III	00261	006		12	110899	1/1/0001

OFFICE: 311

ROUTE: 564

ST_REF_NO: 0000074770

GATEWAY PARK LANE

LUMENS	BULB TYPE	MULT SERIES	POLE TYPE	SHADE	ADDRESS NUMBER	REF	LOCATION	TAX DIST	DATE INST	DATE CHANGE
05800	S	M	CNT	II	00000	003	SIDE OF 192 MASTERSON STATION DR.	12	030898	1/1/0001
05800	S	M	CNT	II	00000	010	SIDE REAR 2809	12	110899	1/1/0001
05800	S	M	CNT	III	02744	012		12	110899	1/1/0001
05800	S	M	CNT	II	02764	011		12	110899	1/1/0001
05800	S	M	CNT	II	02821	008		12	030898	1/1/0001
05800	S	M	CNT	II	02836	007		12	030898	1/1/0001
05800	S	M	CNT	II	02849	006		12	060898	1/1/0001
05800	S	M	CNT	II	02864	005			060898	1/1/0001
05800	S	M	CNT	II	02885	004		12	030898	1/1/0001

OFFICE: 311

ROUTE: 564

ST_REF_NO: 0000074770

GATEWAY PARK LANE

LUMENS	BULB TYPE	MULT SERIES	POLE TYPE	SHADE	ADDRESS NUMBER	REF	LOCATION	TAX DIST	DATE INST	DATE CHANGE
05800	S	M	CNT	II	02901	002		12	030898	1/1/0001
05800	S	M	CNT	II	02904	009		12	110899	1/1/0001
05800	S	M	CNT	II	02917	001		12	030898	1/1/0001

OFFICE: 311

ROUTE: 564

ST_REF_NO: 0000074800

GATEWOOD COURT

LUMENS	BULB TYPE	MULT SERIES	POLE TYPE	SHADE	ADDRESS NUMBER	REF	LOCATION	TAX DIST	DATE INST	DATE CHANGE
05800	S	M	OUG	II	00000	008	SIDE OF 3574 LAREDO DR.	12	081582	1/1/0001
04000	S	M	OUG	V	03401	011		12	120889	1/1/0001
05800	S	M	OUG	II	03409	010		12	111580	1/1/0001

OFFICE: 311

ROUTE: 564

ST_REF_NO: 0000074950

GAULEY LANE

LUMENS	BULB TYPE	MULT SERIES	POLE TYPE	SHADE	ADDRESS NUMBER	REF	LOCATION	TAX DIST	DATE INST	DATE CHANGE
05800	S	M	CNT	II	00000	001	SIDE OF 405 MCCONNELLS TRACE ON GAULEY LANE	12	103005	1/1/0001
05800	S	M	CNT	II	00000	003	SIDE OF 3072 TRAILWOOD LANE ON GAULEY LANE	12	103005	1/1/0001
05800	S	M	CNT	II	00213	002		12	103005	1/1/0001
05800	S	M	CNT	II	00241	004		12	103005	1/1/0001

OFFICE: 311

ROUTE: 564

ST_REF_NO: 0000075000

GAWAINE DRIVE

LUMENS	BULB TYPE	MULT SERIES	POLE TYPE	SHADE	ADDRESS NUMBER	REF	LOCATION	TAX DIST	DATE INST	DATE CHANGE
05800	S	M	OUG	II	00000	016	SIDE OF 3561 CAMELOT DR.	12	081869	1/1/0001
05800	S	M	OUG	II	00000	020	SIDE OF 3568 GALAHAD DR.	12	121268	1/1/0001
05800	S	M	OUG	II	00363	000		12	081869	1/1/0001
05800	S	M	OUG	II	00370	000		12	081869	1/1/0001
05800	S	M	OUG	II	00387	000		12	091267	1/1/0001

OFFICE: 311

ROUTE: 564

ST_REF_NO: 0000075100

GAY, NORTH PLACE

LUMENS	BULB TYPE	MULT SERIES	POLE TYPE	SHADE	ADDRESS NUMBER	REF	LOCATION	TAX DIST	DATE INST	DATE CHANGE
05800	S	M	OUG	II	00000	113	SIDE OF 1066 MEADOW LANE	12	100164	1/1/0001
05800	S	M	OUG	II	00610	000		12	031563	1/1/0001
05800	S	M	OUG	II	00634	000		12	062267	1/1/0001

OFFICE: 311

ROUTE: 564

ST_REF_NO: 0000075100

GAY, NORTH PLACE

LUMENS	BULB TYPE	MULT SERIES	POLE TYPE	SHADE	ADDRESS NUMBER	REF	LOCATION	TAX DIST	DATE INST	DATE CHANGE
05800	S	M	OUG	II	00663	000		12	050163	1/1/0001

OFFICE: 311

ROUTE: 564

ST_REF_NO: 0000075110

GAY, SOUTH PLACE

LUMENS	BULB TYPE	MULT SERIES	POLE TYPE	SHADE	ADDRESS NUMBER	REF	LOCATION	TAX DIST	DATE INST	DATE CHANGE
05800	S	M	OUG	II	00000	114	SIDE OF 1034 MEADOW LANE	12	100164	1/1/0001
05800	S	M	OUG	II	00611	063		12	100164	1/1/0001
05800	S	M	OUG	II	00618	000		12	031563	1/1/0001
05800	S	M	OUG	II	00635	065		12	111478	1/1/0001
05800	S	M	OUG	II	00642	000		12	110863	1/1/0001

OFFICE: 311

ROUTE: 564

ST_REF_NO: 0000075290

GAYE CIRCLE

LUMENS	BULB TYPE	MULT SERIES	POLE TYPE	SHADE	ADDRESS NUMBER	REF	LOCATION	TAX DIST	DATE INST	DATE CHANGE
05800	S	M	OUG	II	00000	087	SIDE OF 1825 GAYLE DR.	12	030468	1/1/0001

OFFICE: 311

ROUTE: 564

ST_REF_NO: 0000075300

GAYLE DRIVE

LUMENS	BULB TYPE	MULT SERIES	POLE TYPE	SHADE	ADDRESS NUMBER	REF	LOCATION	TAX DIST	DATE INST	DATE CHANGE
05800	S	M	OUG	II	01600	000		12	050167	1/1/0001
05800	S	M	OUG	II	01609	000		12	011073	1/1/0001
05800	S	M	OUG	II	01616	000		12	092366	1/1/0001
05800	S	M	OUG	II	01633	000		12	050172	1/1/0001
05800	S	M	OUG	II	01644	000		12	092066	1/1/0001
05800	S	M	OUG	II	01649	000		12	071367	1/1/0001
05800	S	M	OUG	II	01664	000		12	111067	1/1/0001
05800	S	M	OUG	II	01669	000		12	071467	1/1/0001
05800	S	M	OUG	II	01801	000		12	120170	1/1/0001
05800	S	M	OUG	II	01808	000		12	082573	1/1/0001
05800	S	M	OUG	II	01821	000		12	102466	1/1/0001
05800	S	M	OUG	II	01849	000		12	102466	1/1/0001
05800	S	M	OUG	II	01860	000		12	102466	1/1/0001
05800	S	M	OUG	II	01869	000		12	102466	1/1/0001
05800	S	M	OUG	II	01878	000		12	102466	1/1/0001

OFFICE: 311							ROUTE: 564			
ST_REF_NO: 00000075300							GAYLE DRIVE			
LUMENS	BULB TYPE	MULT SERIES	POLE TYPE	SHADE	ADDRESS NUMBER	REF	LOCATION	TAX DIST	DATE INST	DATE CHANGE
05800	S	M	OUG	II	01895	000		12	080169	1/1/0001
05800	S	M	OUG	II	01898	000		12	120169	1/1/0001
OFFICE: 311							ROUTE: 564			
ST_REF_NO: 00000075400							GAZETTE AVENUE			
LUMENS	BULB TYPE	MULT SERIES	POLE TYPE	SHADE	ADDRESS NUMBER	REF	LOCATION	TAX DIST	DATE INST	DATE CHANGE
09500	S	M	SOH	I	00000	001	SIDE OF 909 S.LIMESTONE	12	021161	1/1/0001
09500	S	M	SOH	I	00114	000		12	021161	1/1/0001
09500	S	M	SOH	I	00128	000		12	021161	1/1/0001
09500	S	M	SOH	I	00130	000		12	021161	1/1/0001
09500	S	M	SOH	I	00142	000		12	021161	1/1/0001
09500	S	M	SOH	I	00152	000		12	021161	1/1/0001
09500	S	M	SOH	I	00164	000		12	021161	1/1/0001
09500	S	M	SOH	I	00175	000	light moved from 178 to 175 1/2 Gazette Feb 2003	12	021161	1/1/0001
OFFICE: 311							ROUTE: 564			
ST_REF_NO: 00000075500							GE DRIVE			
LUMENS	BULB TYPE	MULT SERIES	POLE TYPE	SHADE	ADDRESS NUMBER	REF	LOCATION	TAX DIST	DATE INST	DATE CHANGE
04000	S	M	SOH	II	00000	153	SIDE 209 ROSEMONT	12	100884	1/1/0001
04000	S	M	SOH	II	00000	155	OPP. 105	12	100884	1/1/0001
04000	S	M	SOH	II	00101	154		12	100884	1/1/0001
04000	S	M	SOH	II	00109	156		12	100884	1/1/0001
OFFICE: 311							ROUTE: 564			
ST_REF_NO: 00000075700							GEORGETOWN PLACE			
LUMENS	BULB TYPE	MULT SERIES	POLE TYPE	SHADE	ADDRESS NUMBER	REF	LOCATION	TAX DIST	DATE INST	DATE CHANGE
05800	S	M	SOH	I	00000	001	1ST. LT. E. OF GEORGETOWN ST.,S. SIDE	12	121262	1/1/0001
05800	S	M	SOH	I	00000	002	2ND. LT. E. OF GEORGETOWN ST., S. SIDE	12	121262	1/1/0001
05800	S	M	SOH	I	00000	005	SIDE OF 520 ASH ST.	12	121262	1/1/0001
05800	S	M	SOH	I	00531	000		12	121262	1/1/0001
05800	S	M	SOH	I	00536	000		12	121262	1/1/0001

OFFICE: 311

ROUTE: 564

ST_REF_NO: 0000075800

GEORGETOWN ROAD

LUMENS	BULB TYPE	MULT SERIES	POLE TYPE	SHADE	ADDRESS NUMBER	REF	LOCATION	TAX DIST	DATE INST	DATE CHANGE
22000	S		OUG	II	00000	068	OPP BRIARWOOD DRIVE	12	090909	1/1/0001
22000	S		OUG	II	00000	138	10TH LT S OF SPURR ROAD, E SIDE	12	090909	1/1/0001
22000	S	M	OUG	II	00000	400	4th It N of Capstone, east side on Georgetown	12	041008	1/1/0001
22000	S	M	OUG	II	00000	401	4th It N of Capstone, west side on Georgetown	12	041008	1/1/0001
22000	S	M	OUG	II	00000	402	5th It N of Capstone, east side on Georgetown	12	041008	1/1/0001
22000	S	M	OUG	II	00000	403	5th It N of Capstone, west side on Georgetown	12	041008	1/1/0001
22000	S	M	OUG	II	00000	404	6th It N of Capstone, east side on Georgetown	12	041008	1/1/0001
22000	S	M	OUG	II	00000	405	6th It N of Capstone, west side on Georgetown	12	041008	1/1/0001
22000	S	M	OUG	II	00000	406	7th It N of Capstone, east side on Georgetown	12	041008	1/1/0001
22000	S	M	OUG	II	00000	407	7th It N of Capstone, west side on Georgetown	12	041008	1/1/0001
22000	S	M	OUG	II	00000	408	8th It N of Capstone, east side on Georgetown	12	041008	1/1/0001
22000	S	M	OUG	II	00000	409	8th It N of Capstone, west side on Georgetown	12	041008	1/1/0001
22000	S	M	OUG	II	00000	410	9th It N of Capstone, east side on Georgetown	12	041008	1/1/0001
22000	S	M	OUG	II	00000	411	9th It N of Capstone, west side on Georgetown	12	041008	1/1/0001
22000	S	M	OUG	II	00000	412	10th It N of Capstone, east side on Georgetown	12	041008	1/1/0001
22000	S	M	OUG	II	00000	413	10th It N of Capstone, west side on Georgetown	12	041008	1/1/0001
22000	S	M	OUG	II	00000	414	1st It N of Citation Blvd, east side on Georgetown	12	041008	1/1/0001
22000	S	M	OUG	II	00000	415	1st It N of Citation Blvd, west side on Georgetown	12	041008	1/1/0001
22000	S	M	OUG	II	00000	416	2nd It N of Citation Blvd, east side on Georgetown	12	041008	1/1/0001
22000	S	M	OUG	II	00000	417	2nd It N of Citation Blvd, west side on Georgetown	12	041008	1/1/0001
22000	S	M	OUG	II	00000	418	3rd It N of Citation Blvd, east side on Georgetown	12	041008	1/1/0001
22000	S	M	OUG	II	00000	419	3rd It N of Citation Blvd, west side on Georgetown	12	041008	1/1/0001
22000	S	M	OUG	II	00000	420	4th It N of Citation Blvd, east side on Georgetown	12	041008	1/1/0001
22000	S	M	OUG	II	00000	421	4th It N of Citation Blvd, west side on Georgetown	12	041008	1/1/0001
22000	S	M	OUG	II	00000	422	5th It N of Citation Blvd, east side on Georgetown	12	041008	1/1/0001
22000	S	M	OUG	II	00000	423	5th It N of Citation Blvd, west side on Georgetown	12	041008	1/1/0001
22000	S	M	OUG	II	00000	424	6th It N of Citation Blvd, east side on Georgetown	12	041008	1/1/0001
22000	S	M	OUG	II	00000	425	6th It N of Citation Blvd, west side on Georgetown	12	041008	1/1/0001
22000	S	M	OUG	II	00000	426	7th It N of Citation Blvd, east side on Georgetown	12	041008	1/1/0001
22000	S	M	OUG	II	00000	427	7th It N of Citation Blvd, west side on Georgetown	12	041008	1/1/0001
22000	S	M	OUG	II	00000	428	8th It N of Citation Blvd, east side on Georgetown	12	041008	1/1/0001
22000	S	M	OUG	II	00000	099	4TH LT. N OF SANDERSVILLE, EASTSIDE	12	030896	1/1/0001
22000	S	M	OUG	II	00000	100	4TH LT. N OF SANDERSVILLE, WESTSIDE	12	030896	1/1/0001
22000	S	M	OUG	II	00000	101	5TH LT. N OF SANDERSVILLE, EASTSIDE	12	030896	1/1/0001

OFFICE: 311

ROUTE: 564

ST_REF_NO: 0000075800

GEORGETOWN ROAD

LUMENS	BULB TYPE	MULT SERIES	POLE TYPE	SHADE	ADDRESS NUMBER	REF	LOCATION	TAX DIST	DATE INST	DATE CHANGE
22000	S	M	OUG	II	00000	102	5TH LT. N OF SANDERSVILLE, WESTSIDE	12	030896	1/1/0001
22000	S	M	OUG	II	00000	103	6TH LT. N OF SANDERSVILLE, EASTSIDE	12	030896	1/1/0001
22000	S	M	OUG	II	00000	104	6TH LT. N OF SANDERSVILLE, WESTSIDE	12	030896	1/1/0001
22000	S	M	OUG	II	00000	105	7TH LT. N OF SANDERSVILLE, EASTSIDE	12	030896	1/1/0001
22000	S	M	OUG	II	00000	106	7TH LT. N OF SANDERSVILLE, WESTSIDE	12	030896	1/1/0001
22000	S	M	OUG	II	00000	107	8TH LT. N OF SANDERSVILLE, EASTSIDE	12	030896	1/1/0001
22000	S	M	OUG	II	00000	108	8TH LT. N OF SANDERSVILLE, WESTSIDE	12	030896	1/1/0001
22000	S	M	OUG	II	00000	109	9TH LT. N OF SANDERSVILLE, EASTSIDE	12	030896	1/1/0001
22000	S	M	OUG	II	00000	110	9TH LT. N SANDERSVILLE, WESTSIDE	12	030896	1/1/0001
22000	S	M	OUG	II	00000	111	10TH LT. N OF SANDERSVILLE, EASTSIDE	12	030896	1/1/0001
22000	S	M	OUG	II	00000	112	10TH LT. N OF SANDERSVILLE, WESTSIDE	12	030896	1/1/0001
22000	S	M	OUG	II	00000	113	11TH LT. N OF SANDERSVILLE, EASTSIDE	12	030896	1/1/0001
22000	S	M	OUG	II	00000	114	11TH LT. N OF SANDERSVILLE, WESTSIDE	12	030896	1/1/0001
22000	S	M	OUG	II	00000	115	12TH LT. N OF SANDERSVILLE, EASTSIDE	12	030896	1/1/0001
22000	S	M	OUG	II	00000	116	12TH LT. N OF SANDERSVILLE, WESTSIDE	12	030896	1/1/0001
22000	S	M	OUG	II	00000	117	13TH LT. N OF SANDERSVILLE, EASTSIDE	12	030896	1/1/0001
22000	S	M	OUG	II	00000	118	13TH LT. N OF SANDERSVILLE, WESTSIDE	12	030896	1/1/0001
22000	S	M	OUG	II	00000	119	14TH LT. N OF SANDERSVILLE, EASTSIDE	12	030896	1/1/0001
22000	S	M	OUG	II	00000	120	14TH LT. N OF SANDERSVILLE, WESTSIDE	12	030896	1/1/0001
22000	S	M	OUG	II	00000	140	9TH LT. S OF SPURR RD., EASTSIDE	12	040896	1/1/0001
22000	S	M	OUG	II	00000	141	9TH LT. S OF SPURR RD., WESTSIDE	12	040896	1/1/0001
22000	S	M	OUG	II	00000	142	8TH LT. S OF SPURR RD., EASTSIDE	12	040896	1/1/0001
22000	S	M	OUG	II	00000	143	8TH LT. S OF SPURR RD., WESTSIDE	12	040896	1/1/0001
22000	S	M	OUG	II	00000	144	7TH LT. S OF SPURR RD., EASTSIDE	12	040896	1/1/0001
22000	S	M	OUG	II	00000	145	7TH LT. S OF SPURR RD., WESTSIDE	12	040896	1/1/0001
22000	S	M	OUG	II	00000	146	6TH LT. S OF SPURR RD., EASTSIDE	12	040896	1/1/0001
22000	S	M	OUG	II	00000	147	6TH LT. S OF SPURR RD., WESTSIDE	12	040896	1/1/0001
22000	S	M	OUG	II	00000	148	5TH LT. S OF SPURR RD., EASTSIDE	12	040896	1/1/0001
22000	S	M	OUG	II	00000	149	5TH LT. S OF SPURR RD., WESTSIDE	12	040896	1/1/0001
22000	S	M	OUG	II	00000	150	4TH LT. S OF SPURR RD., EASTSIDE	12	040896	1/1/0001
22000	S	M	OUG	II	00000	151	4TH LT.S OF SPURR RD., WESTSIDE	12	040896	1/1/0001
22000	S	M	OUG	II	00000	152	3RD LT. S OF SPURR RD., EASTSIDE	12	040896	1/1/0001
22000	S	M	OUG	II	00000	153	3RD LT. S OF SPURR RD., WESTSIDE	12	040896	1/1/0001
22000	S	M	OUG	II	00000	154	2ND LT. S OF SPURR RD., EASTSIDE	12	040896	1/1/0001

OFFICE: 311

ROUTE: 564

ST_REF_NO: 0000075800

GEORGETOWN ROAD

LUMENS	BULB TYPE	MULT SERIES	POLE TYPE	SHADE	ADDRESS NUMBER	REF	LOCATION	TAX DIST	DATE INST	DATE CHANGE
22000	S	M	OUG	II	00000	155	2ND LT. S OF SPURR RD., WESTSIDE	12	040896	1/1/0001
22000	S	M	OUG	II	00000	156	1ST LT. S OF SPURR RD., EASTSIDE	12	040896	1/1/0001
22000	S	M	OUG	II	00000	157	1ST LT. S OF SPURR RD., WESTSIDE	12	040896	1/1/0001
22000	S	M	OUG	II	00000	158	1ST LT. N OF SPURR RD., EASTSIDE	12	040896	1/1/0001
22000	S	M	OUG	II	00000	159	1ST LT. N OF SPURR RD., WESTSIDE	12	040896	1/1/0001
22000	S	M	OUG	II	00000	160	2ND LT. N OF SPURR RD., EASTSIDE	12	040896	1/1/0001
22000	S	M	OUG	II	00000	161	2ND LT. N OF SPURR RD., WESTSIDE	12	040896	1/1/0001
22000	S	M	OUG	II	00000	162	3RD LT. N OF SPURR RD., EASTSIDE	12	040896	1/1/0001
22000	S	M	OUG	II	00000	163	3RD LT. N OF SPURR RD., WESTSIDE	12	040896	1/1/0001
09500	S	M	SOH	III	00000	202	4TH LT. S. OF SPURR RD., WESTSIDE	12	030896	1/1/0001
09500	S	M	SOH	III	00000	203	3RD LT. S. OF SPURR RD., WESTSIDE	12	030896	1/1/0001
09500	S	M	SOH	III	00000	204	2ND LT. S. OF SPURR RD., WESTSIDE	12	030896	1/1/0001
22000	S	M	OUG	II	00000	039	2ND LT. S OF MERCER RD., EASTSIDE	12	120895	1/1/0001
22000	S	M	OUG	II	00000	040	2ND LT. S OF MERCER RD., WESTSIDE	12	120895	1/1/0001
22000	S	M	OUG	II	00000	041	1ST LT. S OF MERCER RD., EASTSIDE	12	120895	1/1/0001
22000	S	M	OUG	II	00000	042	1ST LT. S. OF MERCER RD., WESTSIDE	12	100895	1/1/0001
22000	S	M	OUG	II	00000	043	OPP. MERCER ROAD	12	120895	1/1/0001
22000	S	M	OUG	II	00000	044	1ST LT. N OF MERCER RD., WESTSIDE	12	120895	1/1/0001
22000	S	M	OUG	II	00000	045	1ST LT. N OF MERCER RD., EASTSIDE	12	120895	1/1/0001
22000	S	M	OUG	II	00000	046	2ND LT. N. OF MERCER RD., WESTSIDE	12	100895	1/1/0001
22000	S	M	OUG	II	00000	047	2ND LT. N OF MERCER RD., EASTSIDE	12	120895	1/1/0001
22000	S	M	OUG	II	00000	048	3RD LT. N. OF MERCER ROAD, WESTSIDE	12	100895	1/1/0001
22000	S	M	OUG	II	00000	049	3RD LT. N OF MERCER RD., EASTSIDE	12	120895	1/1/0001
22000	S	M	OUG	II	00000	050	4TH LT. N. OF MERCER ROAD, WESTSIDE	12	100895	1/1/0001
22000	S	M	OUG	III	00000	051	1ST LT. N OF NANDINO BLVD., EASTSIDE	12	120895	1/1/0001
22000	S	M	OUG	II	00000	052	1ST LT. N. OF NANDINO, WESTSIDE	12	100895	1/1/0001
22000	S	M	OUG	II	00000	053	2ND LT. N OF NANDINO BLVD., EASTSIDE	12	120895	1/1/0001
22000	S	M	OUG	II	00000	054	2ND LT. N. OF NANDINO, WESTSIDE	12	100895	1/1/0001
22000	S	M	OUG	II	00000	055	3RD LT. N OF NANDINO BLVD., EASTSIDE	12	120895	1/1/0001
22000	S	M	OUG	II	00000	056	3RD LT. N. OF NANDINO, WESTSIDE	12	100895	1/1/0001
22000	S	M	OUG	II	00000	057	4TH LT. N OF NANDINO BLVD., EASTSIDE	12	120895	1/1/0001
22000	S	M	OUG	II	00000	058	4TH LT. N. OF NANDINO, WESTSIDE	12	100895	1/1/0001
22000	S	M	OUG	II	00000	059	5TH LT. N OF NANDINO BLVD., EASTSIDE	12	120895	1/1/0001
22000	S	M	OUG	II	00000	060	5TH LT. N. OF NANDINO, WESTSIDE	12	100895	1/1/0001

OFFICE: 311

ROUTE: 564

ST_REF_NO: 0000075800

GEORGETOWN ROAD

LUMENS	BULB TYPE	MULT SERIES	POLE TYPE	SHADE	ADDRESS NUMBER	REF	LOCATION	TAX DIST	DATE INST	DATE CHANGE
22000	S	M	OUG	II	00000	061	6TH LT. N OF NANDINO BLVD., EASTSIDE	12	120895	1/1/0001
22000	S	M	OUG	II	00000	062	6TH LT. N. OF NANDINO, WESTSIDE	12	100895	1/1/0001
22000	S	M	OUG	II	00000	063	7TH LT. N OF NANDINO BLVD., EASTSIDE	12	120895	1/1/0001
22000	S	M	OUG	II	00000	064	7TH LT. N. OF NANDINO, WESTSIDE	12	100895	1/1/0001
22000	S	M	OUG	II	00000	065	8TH LT. N OF NANDINO BLVD., EASTSIDE	12	120895	1/1/0001
22000	S	M	OUG	II	00000	066	8TH LT. N. OF NANDINO, WESTSIDE	12	100895	1/1/0001
50000	S	M	OUG	III	00000	067	IN MEDIAN AT BRIARWOOD DRIVE	12	120895	1/1/0001
22000	S	M	OUG	II	00000	069	1ST LT. N OF BRIARWOOD, EASTSIDE	12	120895	1/1/0001
22000	S	M	OUG	II	00000	070	1ST LT. N OF BRIARWOOD DR., WESTSIDE	12	030896	1/1/0001
22000	S	M	OUG	II	00000	071	2ND LT. N OF BRIARWOOD, EASTSIDE	12	120895	1/1/0001
22000	S	M	OUG	II	00000	072	2ND LT. N OF BRIARWOOD DR., WESTSIDE	12	030896	1/1/0001
22000	S	M	OUG	II	00000	073	3RD LT. N OF BRIARWOOD, EASTSIDE	12	120895	1/1/0001
22000	S	M	OUG	II	00000	074	3RD LT. N OF BRIARWOOD DR., WESTSIDE	12	030896	1/1/0001
22000	S	M	OUG	II	00000	075	1ST LT. N OF OAKWOOD, EASTSIDE	12	120895	1/1/0001
22000	S	M	OUG	II	00000	076	1ST LT. N OF OAKWOOD DR., WESTSIDE	12	030896	1/1/0001
22000	S	M	OUG	II	00000	077	2ND LT. N OF OAKWOOD, EASTSIDE	12	120895	1/1/0001
22000	S	M	OUG	II	00000	078	2ND LT. N OF OAKWOOD DR., WESTSIDE	12	030896	1/1/0001
22000	S	M	OUG	II	00000	079	3RD LT. N OF OAKWOOD, EASTSIDE	12	030896	1/1/0001
22000	S	M	OUG	II	00000	080	3RD LT. N OF OAKWOOD DR., WESTSIDE	12	030896	1/1/0001
22000	S	M	OUG	II	00000	081	4TH LT. N OF OAKWOOD, EASTSIDE	12	030896	1/1/0001
22000	S	M	OUG	II	00000	082	4TH LT. N OF OAKWOOD DR., WESTSIDE	12	030896	1/1/0001
22000	S	M	OUG	II	00000	083	5TH LT. N OF OAKWOOD, EASTSIDE	12	030896	1/1/0001
22000	S	M	OUG	II	00000	084	5TH LT. N OF OAKWOOD DR., WESTSIDE	12	030896	1/1/0001
22000	S	M	OUG	II	00000	085	6TH LT. N OF OAKWOOD, EASTSIDE	12	030896	1/1/0001
22000	S	M	OUG	II	00000	086	6TH LT. N OF OAKWOOD DR., WESTSIDE	12	030896	1/1/0001
22000	S	M	SOH	II	00000	087	7TH LT. N OF OAKWOOD, E SIDE	12	040800	1/1/0001
22000	S	M	OUG	II	00000	088	7TH LT. N OF OAKWOOD DR., WESTSIDE	12	030896	1/1/0001
22000	S	M	SOH	II	00000	089	8TH LT. N OF OAKWOOD, E SIDE	12	040800	1/1/0001
22000	S	M	OUG	II	00000	090	8TH LT. N OF OAKWOOD DR., WESTSIDE	12	030896	1/1/0001
22000	S	M	SOH	II	00000	091	9TH LT. N OF OAKWOOD, E SIDE	12	040800	1/1/0001
22000	S	M	OUG	II	00000	092	9TH LT. N OF OAKWOOD DR., WESTSIDE	12	030896	1/1/0001
22000	S	M	SOH	II	00000	093	1ST LT. N OF SANDERSVILLE, E SIDE	12	040800	1/1/0001
22000	S	M	OUG	II	00000	094	1ST LT. N OF SANDERSVILLE, WESTSIDE	12	030896	1/1/0001
22000	S	M	OUG	II	00000	095	2ND LT. N OF SANDERSVILLE, EASTSIDE	12	030896	1/1/0001

OFFICE: 311

ROUTE: 564

ST_REF_NO: 0000075800

GEORGETOWN ROAD

LUMENS	BULB TYPE	MULT SERIES	POLE TYPE	SHADE	ADDRESS NUMBER	REF	LOCATION	TAX DIST	DATE INST	DATE CHANGE
22000	S	M	OUG	II	00000	096	2ND LT. N OF SANDERSVILLE, WESTSIDE	12	030896	1/1/0001
22000	S	M	OUG	II	00000	097	3RD LT. N OF SANDERSVILLE, EASTSIDE	12	030896	1/1/0001
22000	S	M	OUG	II	00000	098	3RD LT. N OF SANDERSVILLE, WESTSIDE	12	030896	1/1/0001
22000	S	M	SOH	II	00000	200	1ST LT. S OF BEREA RD., WESTSIDE	12	040896	1/1/0001
22000	S	M	SOH	II	00000	201	1ST LT. N OF BEREA RD., WESTSIDE	12	040896	1/1/0001
22000	S	M	SOH	II	00000	250	1ST LT. S OF KEARNEY RD., WESTSIDE	12	040896	1/1/0001
22000	S	M	SOH	II	00000	251	OPP. KEARNEY RD., EASTSIDE	12	040896	1/1/0001
22000	S	M	SOH	II	00000	252	1ST LT. N OF KEARNEY RD., WESTSIDE	12	040896	1/1/0001

OFFICE: 311

ROUTE: 564

ST_REF_NO: 0000075900

GEORGETOWN STREET

LUMENS	BULB TYPE	MULT SERIES	POLE TYPE	SHADE	ADDRESS NUMBER	REF	LOCATION	TAX DIST	DATE INST	DATE CHANGE
22000	S		OUG	II	00000	029	1ST LT WEST OF NEWTOWN PIKE, SOUTH SIDE	12	120513	1/1/0001
22000	S	M	SOH	II	00000	013	OPP. 545 - changed out bad fixture	12	081867	9/14/2004
22000	S	M	SOH	II	00000	031	OPP. PRICE RD.	12	04/01/	4/4/2013
09500	S	M	SOH	II	00133	103		12	051368	6/15/2011
20000	M	M	SOH	II	00000	034	OPP. 909	12	040171	1/1/0001
20000	M	M	SOH	II	00901	032		12	040171	1/1/0001
20000	M	M	SOH	II	00901	033		12	040171	1/1/0001
50000	S	M	SOH	II	00909	035		12	040171	1/1/0001
50000	S	M	SOH	II	00917	037		12	040171	1/1/0001
20000	M	M	SOH	II	00918	036		12	040171	1/1/0001
20000	M	M	SOH	II	00925	038		12	040171	1/1/0001
22000	S	M	SOH	II	00000	006	1ST LT. S OF BRADLEY CT., W SIDE	12	030800	1/1/0001
50000	S	M	SOH	II	00000	009	OPP. ELM STREET	12	081867	1/1/0001
50000	S	M	SOH	II	00000	012	NW CORNER OF GEORGETOWN & MICHIGAN ST.	12	020167	1/1/0001
50000	S	M	SOH	II	00000	016	1ST LT. N. OF ASH ST., W. SIDE	12	030167	1/1/0001
20000	M	M	SOH	II	00000	017	1ST LT. N. OF ASH ST., E. SIDE	12	020167	1/1/0001
20000	M	M	SOH	II	00000	018	2ND LT. N. OF ASH ST., W. SIDE	12	030167	1/1/0001
50000	S	M	SOH	II	00000	019	OPP. GLEN ARVIN AVE.	12	030167	1/1/0001
50000	S	M	SOH	II	00000	021	SE CORNER OF GEORGETOWN & WHITE ST.	12	020167	1/1/0001
20000	M	M	SOH	II	00000	023	OPP. 691	12	030167	1/1/0001
20000	M	M	SOH	II	00000	025	OPP. 729 AT HOWARD ST.	12	030167	1/1/0001
22000	S	M	SOH	II	00000	026	OPP. 737 AT DOUGLAS PARK	12	040171	1/1/0001

OFFICE: 311

ROUTE: 564

ST_REF_NO: 0000075900

GEORGETOWN STREET

LUMENS	BULB TYPE	MULT SERIES	POLE TYPE	SHADE	ADDRESS NUMBER	REF	LOCATION	TAX DIST	DATE INST	DATE CHANGE
50000	S	M	SOH	II	00000	027	OPP. 825 AT SCHOOL ENTRANCE	12	040171	1/1/0001
20000	M	M	SOH	II	00000	030	OPP. 863	12	040171	1/1/0001
20000	M	M	SOH	II	00000	129	OPP. 851	12	040171	1/1/0001
20000	M	M	SOH	II	00430	005		12	081867	1/1/0001
20000	M	M	SOH	II	00439	006		12	081867	1/1/0001
20000	M	M	SOH	II	00460	007		12	081867	1/1/0001
20000	M	M	SOH	II	00467	008		12	020167	1/1/0001
50000	S	M	SOH	II	00507	010		12	020167	1/1/0001
50000	S	M	SOH	II	00524	011		12	081867	1/1/0001
20000	M	M	SOH	II	00549	014		12	030167	1/1/0001
20000	M	M	SOH	II	00562	015		12	081867	1/1/0001
20000	M	M	SOH	II	00651	020		12	020167	1/1/0001
50000	S	M	SOH	II	00681	022		12	030167	1/1/0001
50000	S	M	SOH	II	00697	024		12	030167	1/1/0001
50000	S	M	SOH	II	00841	028		12	040171	1/1/0001
10000	M	M	SOH	II	00000	101	SIDE OF 701 W. MAIN ST.	12	051368	1/1/0001
10000	M	M	SOH	II	00000	108	OPP. 197	12	051368	1/1/0001
10000	M	M	SOH	II	00116	102		12	051368	1/1/0001
10000	M	M	SOH	II	00146	104		12	051368	1/1/0001
10000	M	M	SOH	II	00159	105		12	051368	1/1/0001
10000	M	M	SOH	II	00180	106		12	051368	1/1/0001
10000	M	M	SOH	II	00185	107		12	051368	1/1/0001
10000	M	M	SOH	II	00203	109		12	051368	1/1/0001
10000	M	M	SOH	II	00218	110		12	051368	1/1/0001
10000	M	M	SOH	II	00227	111		12	051368	1/1/0001
20000	M	M	SOH	II	00377	002		12	081867	1/1/0001
20000	M	M	SOH	II	00410	003		12	081867	1/1/0001
20000	M	M	SOH	II	00419	004		12	081867	1/1/0001

OFFICE: 311

ROUTE: 564

ST_REF_NO: 0000076000

GEORGIAN WAY

LUMENS	BULB TYPE	MULT SERIES	POLE TYPE	SHADE	ADDRESS NUMBER	REF	LOCATION	TAX DIST	DATE INST	DATE CHANGE
05800	S	M	OUG	II	00000	001	1ST. LT. S. OF LANE ALLEN, E. SIDE	12	100164	1/1/0001
05800	S	M	OUG	II	00000	002	2ND. LT. S. OF LANE ALLEN, E. SIDE	12	100164	1/1/0001

OFFICE: 311

ROUTE: 564

ST_REF_NO: 0000076000

GEORGIAN WAY

LUMENS	BULB TYPE	MULT SERIES	POLE TYPE	SHADE	ADDRESS NUMBER	REF	LOCATION	TAX DIST	DATE INST	DATE CHANGE
05800	S	M	OUG	II	00000	003	OPP. 2059	12	100164	1/1/0001
05800	S	M	OUG	II	00000	004	OPP. 2067	12	100164	1/1/0001
05800	S	M	OUG	II	00000	005	OPP. 2075	12	100164	1/1/0001
05800	S	M	OUG	II	00000	006	OPP. 2083	12	100164	1/1/0001
05800	S	M	OUG	II	00000	007	OPP. 2091	12	100164	1/1/0001
05800	S	M	OUG	II	00000	008	OPP. 2099	12	100164	1/1/0001
05800	S	M	OUG	II	00000	009	OPP. 2107	12	100164	1/1/0001
05800	S	M	OUG	II	00000	010	OPP. 2115	12	081265	1/1/0001
05800	S	M	OUG	II	00000	011	OPP. 2123	12	081265	1/1/0001
05800	S	M	OUG	II	00000	012	SIDE OF 1053 PINE BLOOM DR.	12	081265	1/1/0001
05800	S	M	OUG	II	00000	013	SIDE OF 1048 PINE BLOOM DR.	12	081265	1/1/0001
05800	S	M	OUG	II	00000	014	CORNER OF LANE ALLEN	12	101465	1/1/0001
05800	S	M	OUG	II	00000	015	IN FRONT OF CHURCH	12	101465	1/1/0001
05800	S	M	OUG	II	00000	016	CORNER OF ATHENIA DR.	12	101465	1/1/0001
05800	S	M	OUG	II	00000	072	OPP. WILLIAMSBURG RD.	12	081265	1/1/0001
05800	S	M	OUG	II	02063	017		12	101465	1/1/0001
05800	S	M	OUG	II	02067	018		12	101465	1/1/0001
05800	S	M	OUG	II	02079	019		12	101465	1/1/0001
05800	S	M	OUG	II	02087	020		12	101465	1/1/0001
05800	S	M	OUG	II	02095	021		12	101465	1/1/0001
05800	S	M	OUG	II	02103	022		12	101465	1/1/0001
05800	S	M	OUG	II	02111	023		12	030767	1/1/0001
05800	S	M	OUG	II	02119	024		12	101465	1/1/0001
05800	S	M	OUG	II	02127	025		12	061475	1/1/0001
05800	S	M	OUG	II	02135	026		12	081265	1/1/0001
05800	S	M	OUG	II	02139	027		12	030767	1/1/0001

OFFICE: 311

ROUTE: 564

ST_REF_NO: 0000076050

GEPPA COURT

LUMENS	BULB TYPE	MULT SERIES	POLE TYPE	SHADE	ADDRESS NUMBER	REF	LOCATION	TAX DIST	DATE INST	DATE CHANGE
09500	S		CLN	III	00000	001	SIDE OF 2476 CORONEO LN ON GEPPA COURT	12	072213	1/1/0001
09500	S		CLN	III	02409	002		12	072213	1/1/0001
09500	S		CLN	III	02417	003		12	072213	1/1/0001

OFFICE: 311

ROUTE: 564

ST_REF_NO: 0000076100

GERALD DRIVE

LUMENS	BULB TYPE	MULT SERIES	POLE TYPE	SHADE	ADDRESS NUMBER	REF	LOCATION	TAX DIST	DATE INST	DATE CHANGE
05800	S	M	OUG	II	00000	041	SIDE OF 1148 WINBURN DR.	12	090893	1/1/0001
05800	S	M	OUG	II	01713	049		12	100897	1/1/0001
05800	S	M	OUG	V	01737	044		12	090893	1/1/0001
05800	S	M	OUG	II	01761	043		12	100897	1/1/0001
05800	S	M	OUG	II	01784	042		12	090893	1/1/0001
05800	S	M	OUG	II	01804	000		12	061269	1/1/0001
05800	S	M	OUG	II	01825	000		12	100774	1/1/0001
05800	S	M	OUG	II	01840	051		12	091477	1/1/0001
05800	S	M	OUG	II	01865	052		12	101478	1/1/0001
05800	S	M	OUG	II	00000	053	OPP. 1901	12	101570	1/1/0001
05800	S	M	OUG	II	00000	047	OPP. 1697	12	120887	1/1/0001
04000	S	M	OUG	II	00000	048	SIDE OF 1775 MCCULLOUGH DR.	12	120887	1/1/0001
05800	S	M	OUG	II	01720	045		12	100897	1/1/0001

OFFICE: 311

ROUTE: 564

ST_REF_NO: 0000076130

GERARDI ROAD

LUMENS	BULB TYPE	MULT SERIES	POLE TYPE	SHADE	ADDRESS NUMBER	REF	LOCATION	TAX DIST	DATE INST	DATE CHANGE
05800	S	M	OUG	II	00812	001		12	120897	1/1/0001
05800	S	M	OUG	II	00828	002		12	120897	1/1/0001
05800	S	M	OUG	II	00844	003		12	120897	1/1/0001
05800	S	M	OUG	II	00857	004		12	120897	1/1/0001
05800	S	M	OUG	III	00868	006		12	120897	1/1/0001
05800	S	M	OUG	III	00877	005		12	120897	1/1/0001
05800	S	M	OUG	II	00884	007		12	120897	1/1/0001
05800	S	M	OUG	III	00901	008		12	120897	1/1/0001
05800	S	M	OUG	III	00908	009				1/1/0001
05800	S	M	OUG	II	00928	010		12	120897	1/1/0001
05800	S	M	OUG	III	00937	011		12	120897	1/1/0001
05800	S	M	OUG	III	00944	012		12	120897	1/1/0001

OFFICE: 311

ROUTE: 564

ST_REF_NO: 0000076150

GERMANN CT

LUMENS	BULB TYPE	MULT SERIES	POLE TYPE	SHADE	ADDRESS NUMBER	REF	LOCATION	TAX DIST	DATE INST	DATE CHANGE
04000	S	M	OUG	II	03505	001		12	110891	1/1/0001

OFFICE: 311							ROUTE: 564			
ST_REF_NO: 00000076150							GERMANN CT			
LUMENS	BULB TYPE	MULT SERIES	POLE TYPE	SHADE	ADDRESS NUMBER	REF	LOCATION	TAX DIST	DATE INST	DATE CHANGE
04000	S	M	OUG	II	03517	002		12	110891	1/1/0001
05800	S	M	OUG	II	03529	003	upgraded 6/08	12	110891	1/1/0001

OFFICE: 311							ROUTE: 564			
ST_REF_NO: 00000076200							GETTYSBURG ROAD			
LUMENS	BULB TYPE	MULT SERIES	POLE TYPE	SHADE	ADDRESS NUMBER	REF	LOCATION	TAX DIST	DATE INST	DATE CHANGE
04000	S	M	OUG	II	00000	001	SIDE 946 MASON HEADLEY RD.	12	070889	1/1/0001
04000	S	M	OUG	II	00000	002	SIDE OF 957 CELIA LANE	12	110888	1/1/0001
04000	S	M	OUG	II	00000	003	SIDE 950 CELIA LANE	12	070889	1/1/0001
04000	S	M	OUG	II	01709	004		12	070889	1/1/0001
04000	S	M	OUG	II	01718	005		12	070889	1/1/0001
04000	S	M	OUG	II	01727	006		12	070889	1/1/0001
04000	S	M	OUG	II	01742	007		12	070889	1/1/0001
04000	S	M	OUG	II	01753	008		12	070889	1/1/0001
04000	S	M	OUG	II	01762	009		12	070889	1/1/0001
04000	S	M	OUG	II	01777	010		12	050889	1/1/0001
04000	S	M	OUG	II	01800	011		12	050889	1/1/0001
04000	S	M	OUG	II	01812	012		12	050889	1/1/0001
04000	S	M	OUG	II	01820	013		12	050889	1/1/0001

OFFICE: 311							ROUTE: 564			
ST_REF_NO: 00000076300							GHENT ROAD			
LUMENS	BULB TYPE	MULT SERIES	POLE TYPE	SHADE	ADDRESS NUMBER	REF	LOCATION	TAX DIST	DATE INST	DATE CHANGE
05800	S	M	OUG	II	00000	093	SIDE OF 321 DESHA RD.	12	101468	1/1/0001

OFFICE: 311							ROUTE: 564			
ST_REF_NO: 00000076400							GIBSON AVENUE			
LUMENS	BULB TYPE	MULT SERIES	POLE TYPE	SHADE	ADDRESS NUMBER	REF	LOCATION	TAX DIST	DATE INST	DATE CHANGE
04000	S	M	SOH	II	00511	012		12	020886	1/1/0001
04000	S	M	SOH	II	00000	017	OPP. 406	12	020886	1/1/0001
04000	S	M	SOH	II	00000	018	SIDE 1203 S. BROADWAY	12	020886	1/1/0001
04000	S	M	SOH	II	00411	016		12	020886	1/1/0001
04000	S	M	SOH	II	00417	015		12	020886	1/1/0001
04000	S	M	SOH	II	00429	014		12	020886	1/1/0001

OFFICE: 311

ROUTE: 564

ST_REF_NO: 00000076400 GIBSON AVENUE

LUMENS	BULB TYPE	MULT SERIES	POLE TYPE	SHADE	ADDRESS NUMBER	REF	LOCATION	TAX DIST	DATE INST	DATE CHANGE
04000	S	M	SOH	II	00503	013		12	020886	1/1/0001

OFFICE: 311

ROUTE: 564

ST_REF_NO: 00000076405 GILLMOSS LANE

LUMENS	BULB TYPE	MULT SERIES	POLE TYPE	SHADE	ADDRESS NUMBER	REF	LOCATION	TAX DIST	DATE INST	DATE CHANGE
05800	S	M	CNT	II	00000	003	ACROSS FROM 4513 GILLMOSS LANE	12	062907	1/1/0001
05800	S	M	CNT	II	04501	001		12	062907	1/1/0001
05800	S	M	CNT	II	04509	002		12	062907	1/1/0001

OFFICE: 311

ROUTE: 564

ST_REF_NO: 00000076410 GINGERMILL COURT

LUMENS	BULB TYPE	MULT SERIES	POLE TYPE	SHADE	ADDRESS NUMBER	REF	LOCATION	TAX DIST	DATE INST	DATE CHANGE
05800	S	M	CNT	III	03600	001		12	120894	1/1/0001

OFFICE: 311

ROUTE: 564

ST_REF_NO: 00000076420 GINGERMILL LANE

LUMENS	BULB TYPE	MULT SERIES	POLE TYPE	SHADE	ADDRESS NUMBER	REF	LOCATION	TAX DIST	DATE INST	DATE CHANGE
05800	S	M	CNT	II	00000	001	SIDE 608 FOREST HILL DR.	12	120894	1/1/0001
05800	S	M	CNT	II	00598	011		12	120894	1/1/0001
05800	S	M	CNT	II	00599	013		12	120894	1/1/0001
05800	S	M	CNT	II	00610	010		12	120894	1/1/0001
05800	S	M	CNT	II	00634	008		12	120894	1/1/0001
05800	S	M	CNT	II	00635	009		12	120894	1/1/0001
05800	S	M	CNT	II	00650	006		12	120894	1/1/0001
05800	S	M	CNT	II	00698	002		12	120894	1/1/0001
05800	S	M	CNT	II	00000	014	OPP. 587	12	120894	1/1/0001
05800	S	M	CNT	II	00655	007		12	120894	1/1/0001
05800	S	M	CNT	II	00670	004		12	120894	1/1/0001
05800	S	M	CNT	II	00675	005		12	120894	1/1/0001
05800	S	M	CNT	II	00695	003		12	120894	1/1/0001

OFFICE: 311

ROUTE: 564

ST_REF_NO: 00000076450 GILLESPIES GLEN

LUMENS	BULB TYPE	MULT SERIES	POLE TYPE	SHADE	ADDRESS NUMBER	REF	LOCATION	TAX DIST	DATE INST	DATE CHANGE
05800	S	M	OUG	II	03804	001		12	100896	1/1/0001

OFFICE: 311

ROUTE: 564

ST_REF_NO: 00000076450

GILLESPIES GLEN

LUMENS	BULB TYPE	MULT SERIES	POLE TYPE	SHADE	ADDRESS NUMBER	REF	LOCATION	TAX DIST	DATE INST	DATE CHANGE
05800	S	M	OUG	II	03813	002		12	100896	1/1/0001
05800	S	M	OUG	II	03828	003		12	100896	1/1/0001

OFFICE: 311

ROUTE: 564

ST_REF_NO: 00000076470

GILMORE TRACE

LUMENS	BULB TYPE	MULT SERIES	POLE TYPE	SHADE	ADDRESS NUMBER	REF	LOCATION	TAX DIST	DATE INST	DATE CHANGE
05800	S	M	CNT	II	00000	001	SIDE OF 3129 SANDERSVILLE RD ON GILMORE TRACE	12	113005	1/1/0001
05800	S	M	CNT	II	00000	007	SIDE OF 2969 PRICHARD DR ON GILMORE TRACE	12	113005	1/1/0001
05800	S	M	CNT	III	03009	006		12	113005	1/1/0001
05800	S	M	CNT	II	03116	005		12	113005	1/1/0001
05800	S	M	CNT	II	03133	004		12	113005	1/1/0001
05800	S	M	CNT	II	03145	003		12	113005	1/1/0001
05800	S	M	CNT	II	03153	002		12	113005	1/1/0001

OFFICE: 311

ROUTE: 564

ST_REF_NO: 00000076500

GINGER TREE CIRCLE

LUMENS	BULB TYPE	MULT SERIES	POLE TYPE	SHADE	ADDRESS NUMBER	REF	LOCATION	TAX DIST	DATE INST	DATE CHANGE
05800	S	M	OUG	II	03402	117		12	011475	1/1/0001
05800	S	M	OUG	II	03405	118		12	071674	1/1/0001
05800	S	M	OUG	II	03418	119		12	011475	1/1/0001
05800	S	M	OUG	II	03421	120		12	071674	1/1/0001
05800	S	M	OUG	V	03433	121		12	011581	1/1/0001

OFFICE: 311

ROUTE: 564

ST_REF_NO: 00000076600

GIVEN AVENUE

LUMENS	BULB TYPE	MULT SERIES	POLE TYPE	SHADE	ADDRESS NUMBER	REF	LOCATION	TAX DIST	DATE INST	DATE CHANGE
05800	S	M	SOH	I	00000	355	SIDE OF 829 NATIONAL AVE upgrade 6/08	12	101866	1/1/0001
04000	S	M	SOH	I	00305	357		12	101866	1/1/0001
04000	S	M	SOH	I	00309	358		12	101866	1/1/0001
04000	S	M	SOH	I	00313	359		12	101866	1/1/0001
04000	S	M	SOH	I	00320	361		12	101866	1/1/0001

OFFICE: 311		ROUTE: 564		ST_REF_NO: 00000076700		GLACIER CIRCLE		LUMENS	BULB TYPE	MULT SERIES	POLE TYPE	SHADE	ADDRESS NUMBER	REF	LOCATION	TAX DIST	DATE INST	DATE CHANGE
	04000	S	M	OUG	II	00000	022	SIDE OF 2829 MT. MCKINLEY WAY		12	091476	1/1/0001						
	04000	S	M	OUG	V	03281	021			12	041478	1/1/0001						

OFFICE: 311		ROUTE: 564		ST_REF_NO: 00000076750		Glade Lane		LUMENS	BULB TYPE	MULT SERIES	POLE TYPE	SHADE	ADDRESS NUMBER	REF	LOCATION	TAX DIST	DATE INST	DATE CHANGE
	05800	S	M	CNT	II	00000	001	SIDE OF 2100 MAURA TRACE ON GLADE LN		12	101402	1/1/0001						
	05800	S	M	CNT	II	00000	008	SIDE OF 2053 GLADE LANE		12	101402	1/1/0001						
	05800	S	M	CNT	II	02009	003			12	101402	1/1/0001						
	05800	S	M	CNT	II	02012	004			12	101402	1/1/0001						
	05800	S	M	CNT	II	02037	005			12	101402	1/1/0001						
	05800	S	M	CNT	II	02041	006			12	101402	1/1/0001						
	05800	S	M	CNT	II	02053	007			12	101402	1/1/0001						
	05800	S	M	CNT	II	02061	009			12	101402	1/1/0001						
	05800	S	M	CNT	II	02081	010			12	101402	1/1/0001						
	05800	S	M	CNT	II	02084	011			12	101402	1/1/0001						
	05800	S	M	CNT	II	02105	002			12	101402	1/1/0001						

OFFICE: 311		ROUTE: 564		ST_REF_NO: 00000076800		GLADMAN WAY		LUMENS	BULB TYPE	MULT SERIES	POLE TYPE	SHADE	ADDRESS NUMBER	REF	LOCATION	TAX DIST	DATE INST	DATE CHANGE
	05800	S	M	OUG	II	00000	008	SIDE OF 4317 FORSYTHE DR.		12	021580	1/1/0001						
	05800	S	M	SOH	II	00000	063	SIDE REAR OF 1992 ST. STEPHENS GREEN		12	100896	1/1/0001						
	05800	S	M	CNT	II	00000	065	SIDE REAR OF 2000 BLACKHORSE LANE		12	100896	1/1/0001						
	05800	S	M	CNT	II	00000	066	SIDE REAR OF 1993 BLACKHORSE LANE		12	100896	1/1/0001						
	05800	S	M	CNT	II	00000	068	SIDE OF 1993 MT. JOY PLACE		12	100896	1/1/0001						
	05800	S	M	CNT	II	03641	071			12	060899	1/1/0001						
	05800	S	M	CNT	II	03648	070			12	060899	1/1/0001						
	05800	S	M	CNT	II	03657	069			12	060899	1/1/0001						
	05800	S	M	CNT	II	03673	067			12	100896	1/1/0001						
	05800	S	M	CNT	II	03688	064			12	100896	1/1/0001						
	05800	S	M	OUG	II	03708	062			12	091579	1/1/0001						
	05800	S	M	OUG	II	03709	061			12	091579	1/1/0001						
	05800	S	M	OUG	II	03716	036			12	091579	1/1/0001						

OFFICE: 311

ROUTE: 564

ST_REF_NO: 0000076800

GLADMAN WAY

LUMENS	BULB TYPE	MULT SERIES	POLE TYPE	SHADE	ADDRESS NUMBER	REF	LOCATION	TAX DIST	DATE INST	DATE CHANGE
05800	S	M	OUG	II	03801	035		12	091579	1/1/0001
05800	S	M	OUG	II	03808	034		12	091579	1/1/0001
05800	S	M	OUG	II	03813	033		12	091579	1/1/0001
05800	S	M	OUG	II	03820	032		12	091579	1/1/0001
05800	S	M	OUG	II	03829	031		12	091579	1/1/0001
05800	S	M	OUG	II	03841	030		12	091579	1/1/0001
05800	S	M	OUG	II	03844	029		12	091579	1/1/0001
05800	S	M	OUG	II	03853	028		12	091579	1/1/0001
05800	S	M	OUG	II	03860	043		12	091579	1/1/0001
05800	S	M	OUG	II	03868	041		12	091579	1/1/0001
05800	S	M	OUG	II	03869	042		12	091579	1/1/0001
05800	S	M	OUG	II	03885	001		12	111579	1/1/0001
05800	S	M	OUG	II	03892	002		12	111579	1/1/0001
05800	S	M	OUG	II	03901	003		12	111579	1/1/0001
05800	S	M	OUG	II	03908	004		12	111579	1/1/0001
05800	S	M	OUG	II	03917	005		12	111579	1/1/0001
05800	S	M	OUG	II	03924	006		12	111579	1/1/0001
05800	S	M	OUG	II	03933	007		12	021580	1/1/0001
05800	S	M	OUG	II	03945	009		12	021580	1/1/0001

OFFICE: 311

ROUTE: 564

ST_REF_NO: 0000076950

GLASCOW LANE

LUMENS	BULB TYPE	MULT SERIES	POLE TYPE	SHADE	ADDRESS NUMBER	REF	LOCATION	TAX DIST	DATE INST	DATE CHANGE
05800	S	M	CNT	II	00000	003	SIDE OF 2161 DRUMMOND DR ON GLASCOW LANE	12	042506	1/1/0001
05800	S	M	CNT	II	02501	001		12	042506	1/1/0001
05800	S	M	CNT	II	02516	002		12	042506	1/1/0001

OFFICE: 311

ROUTE: 564

ST_REF_NO: 0000077000

GLASS ALLEY

LUMENS	BULB TYPE	MULT SERIES	POLE TYPE	SHADE	ADDRESS NUMBER	REF	LOCATION	TAX DIST	DATE INST	DATE CHANGE
04000	S	M	SOH	III	00000	002	OPP. REAR OF 160 ALABAMA AVE. (LFUCG PARK)	12	070894	9/9/2009
04000	S	M	SOH	III	00000	003	OPP. REAR PF 134 ALABAMA AVE.	12	070894	9/9/2009
04000	S	M	SOH	V	00000	299	SIDE OF 630 WALNUT ST.	12	090966	1/1/0001

OFFICE: 311

ROUTE: 564

ST_REF_NO: 0000077100

GLASS AVENUE

LUMENS	BULB TYPE	MULT SERIES	POLE TYPE	SHADE	ADDRESS NUMBER	REF	LOCATION	TAX DIST	DATE INST	DATE CHANGE
04000	S	M	SOH	II	00000	138	OPP. 101	12	020885	1/1/0001
05800	S	M	SOH	II	00078	135	upgrade-bad fixture	12	100884	1/1/0001
04000	S	M	SOH	II	00088	136		12	100884	1/1/0001
04000	S	M	SOH	II	00092	137		12	100884	1/1/0001
04000	S	M	SOH	II	00110	139		12	020885	1/1/0001
04000	S	M	SOH	II	00115	140		12	100884	1/1/0001

OFFICE: 311

ROUTE: 564

ST_REF_NO: 0000077300

GLEN ARVIN AVENUE

LUMENS	BULB TYPE	MULT SERIES	POLE TYPE	SHADE	ADDRESS NUMBER	REF	LOCATION	TAX DIST	DATE INST	DATE CHANGE
05800	S	M	OUG	II	00000	001	SIDE OF 500 GEORGETOWN RD, ON GLEN ARVIN AVE	12	081903	1/1/0001
05800	S	M	OUG	II	00000	002	ACROSS FROM 575 GLEN ARVIN AVENUE	12	081903	1/1/0001
05800	S	M	OUG	II	00000	003	ACROSS FROM 509 GLEN ARVIN AVENUE	12	081903	1/1/0001
05800	S	M	OUG	II	00000	004	ACROSS FROM 521 GLEN ARVIN AVENUE	12	081903	1/1/0001
05800	S	M	OUG	II	00000	005	SIDE OF 529 GLEN ARVIN AVENUE	12	081903	1/1/0001
05800	S	M	OUG	II	00000	009	SIDE OF 616 CHESTNUT OAK WAY ON GLEN ARVIN AVE	12	081903	1/1/0001
05800	S	M	OUG	II	00516	006		12	081903	1/1/0001
05800	S	M	OUG	II	00532	007		12	081903	1/1/0001
05800	S	M	OUG	II	00541	011		12	081903	1/1/0001
05800	S	M	OUG	II	00553	008		12	081903	1/1/0001
05800	S	M	OUG	II	00572	010		12	081903	1/1/0001
05800	S	M	SOH	I	00000	369	1ST. LT. W. OF GEORGETOWN ST.	12	100666	1/1/0001
05800	S	M	SOH	I	00000	370	2ND. LT. W. OF GEORGETOWN ST.	12	100666	1/1/0001
05800	S	M	SOH	I	00373	000		12	021568	1/1/0001
05800	S	M	SOH	I	00385	000		12	021568	1/1/0001
05800	S	M	SOH	I	00407	376		12	100666	1/1/0001
05800	S	M	SOH	I	00415	375		12	100666	1/1/0001
05800	S	M	SOH	I	00421	374		12	100666	1/1/0001
05800	S	M	SOH	I	00436	373		12	100666	1/1/0001
05800	S	M	SOH	I	00442	372		12	100666	1/1/0001
05800	S	M	SOH	I	00448	371		12	100666	1/1/0001

OFFICE: 311		ROUTE: 564		ST_REF_NO: 00000077310		GLEN ABBEY CIRCLE		LUMENS	BULB TYPE	MULT SERIES	POLE TYPE	SHADE	ADDRESS NUMBER	REF	LOCATION	TAX DIST	DATE INST	DATE CHANGE
	05800	S	M	CNT	II	00000	001								SIDE 765 ANDOVER VILLAGE DR.	12	120894	1/1/0001
	05800	S	M	CNT	II	00833	002									12	120894	1/1/0001
	05800	S	M	CNT	II	00840	003									12	120894	1/1/0001
	05800	S	M	CNT	II	00857	004									12	120894	1/1/0001

OFFICE: 311		ROUTE: 564		ST_REF_NO: 00000077320		GLEN ABBEY DRIVE		LUMENS	BULB TYPE	MULT SERIES	POLE TYPE	SHADE	ADDRESS NUMBER	REF	LOCATION	TAX DIST	DATE INST	DATE CHANGE
	05800	S	M	CNT	II	00000	001								SIDE OF 760 ANDOVER VILLAGE DR.	12	120894	1/1/0001
	05800	S	M	CNT	II	00000	005								SIDE OF 701 WINTER HILL LANE	12	120897	1/1/0001

OFFICE: 311		ROUTE: 564		ST_REF_NO: 00000077390		GLENBROOK CIRCLE		LUMENS	BULB TYPE	MULT SERIES	POLE TYPE	SHADE	ADDRESS NUMBER	REF	LOCATION	TAX DIST	DATE INST	DATE CHANGE
	05800	S	M	OUG	V	00525	049									12	062363	1/1/0001

OFFICE: 311		ROUTE: 564		ST_REF_NO: 00000077400		GLENBROOK COURT		LUMENS	BULB TYPE	MULT SERIES	POLE TYPE	SHADE	ADDRESS NUMBER	REF	LOCATION	TAX DIST	DATE INST	DATE CHANGE
	05800	S	M	OUG	II	00557	055									12	042264	1/1/0001

OFFICE: 311		ROUTE: 564		ST_REF_NO: 00000077500		GLENBROOK DRIVE		LUMENS	BULB TYPE	MULT SERIES	POLE TYPE	SHADE	ADDRESS NUMBER	REF	LOCATION	TAX DIST	DATE INST	DATE CHANGE
	05800	S	M	OUG	II	00000	047								SIDE OF 486 ANNISTON DR.	12	041664	1/1/0001
	05800	S	M	OUG	II	00000	048								SIDE OF 513 GLENBROOK CIRCLE	12	062363	1/1/0001
	05800	S	M	OUG	II	00000	056								SIDE OF 1975 BRYNELL	12	042165	1/1/0001
	05800	S	M	OUG	II	00536	050									12	042264	1/1/0001
	05800	S	M	OUG	II	00545	053									12	042264	1/1/0001
	05800	S	M	OUG	II	00566	054									12	042264	1/1/0001

OFFICE: 311		ROUTE: 564		ST_REF_NO: 00000077600		GLENDALE AVENUE		LUMENS	BULB TYPE	MULT SERIES	POLE TYPE	SHADE	ADDRESS NUMBER	REF	LOCATION	TAX DIST	DATE INST	DATE CHANGE
	04000	S	M	OUG	II	00259	081									12	121582	1/1/0001

OFFICE: 311

ROUTE: 564

ST_REF_NO: 00000077600

GLENDALE AVENUE

LUMENS	BULB TYPE	MULT SERIES	POLE TYPE	SHADE	ADDRESS NUMBER	REF	LOCATION	TAX DIST	DATE INST	DATE CHANGE
04000	S	M	OUG	II	00272	082		12	121582	1/1/0001
04000	S	M	OUG	II	00285	083		12	121582	1/1/0001
04000	S	M	OUG	II	00292	084		12	121582	1/1/0001
04000	S	M	OUG	II	00312	085		12	121582	1/1/0001
04000	S	M	OUG	II	00325	086		12	121582	1/1/0001
04000	S	M	OUG	II	00336	087		12	121582	1/1/0001
04000	S	M	OUG	II	00349	088		12	121582	1/1/0001
04000	S	M	OUG	II	00216	078		12	121582	1/1/0001
04000	S	M	OUG	II	00229	079		12	121582	1/1/0001
04000	S	M	OUG	II	00246	080		12	121582	1/1/0001

OFFICE: 311

ROUTE: 564

ST_REF_NO: 00000077700

GLENDORA COURT

LUMENS	BULB TYPE	MULT SERIES	POLE TYPE	SHADE	ADDRESS NUMBER	REF	LOCATION	TAX DIST	DATE INST	DATE CHANGE
05800	S	M	OUG	II	00477	148		12	070899	1/1/0001
05800	S	M	OUG	II	00495	147		12	081475	1/1/0001

OFFICE: 311

ROUTE: 564

ST_REF_NO: 00000077780

GLENDOVER CIRCLE

LUMENS	BULB TYPE	MULT SERIES	POLE TYPE	SHADE	ADDRESS NUMBER	REF	LOCATION	TAX DIST	DATE INST	DATE CHANGE
05800	S	M	OUG	II	00834	008		12	032067	1/1/0001

OFFICE: 311

ROUTE: 564

ST_REF_NO: 00000077790

GLENDOVER COURT

LUMENS	BULB TYPE	MULT SERIES	POLE TYPE	SHADE	ADDRESS NUMBER	REF	LOCATION	TAX DIST	DATE INST	DATE CHANGE
05800	S	M	OUG	II	00000	007	SIDE OF 802 GLENDOVER RD.	12	032067	1/1/0001

OFFICE: 311

ROUTE: 564

ST_REF_NO: 00000077800

GLENDOVER ROAD

LUMENS	BULB TYPE	MULT SERIES	POLE TYPE	SHADE	ADDRESS NUMBER	REF	LOCATION	TAX DIST	DATE INST	DATE CHANGE
05800	S	M	OUG	II	00000	006	side of 858 - change addr only per audit	12	032067	8/5/2009
05800	S	M	OUG	II	00000	009	2nd lt E of Bellefonte, S side	12	050888	8/5/2009
05800	S	M	OUG	II	00301	018		12	070888	7/29/2009
05800	S	M	OUG	II	00318	016	bad fixture	12	070888	7/29/2009
05800	S	M	OUG	II	00736	008	3rd lt E of Bellefonte, S Side-chg addr only per audit	12	050888	8/5/2009

OFFICE: 311		ROUTE: 564		ST_REF_NO: 0000077800		GLENDOVER ROAD		TAX DIST	DATE INST	DATE CHANGE
LUMENS	BULB TYPE	MULT SERIES	POLE TYPE	SHADE	ADDRESS NUMBER	REF	LOCATION			
05800	S	M	OUG	II	00789	000	chg addr only per audit	12	032067	8/5/2009
05800	S	M	OUG	II	00000	010	1ST LT. E. OF BELLEFONTE, S. SIDE	12	050888	1/1/0001
05800	S	M	OUG	II	00000	011	1ST LT. E. OF BELLEFONTE, N. SIDE	12	050888	1/1/0001
04000	S	M	OUG	II	00000	020	SIDE OF 183 EDGEMOOR DR.	12	070888	1/1/0001
04000	S	M	OUG	II	00201	022		12	070888	1/1/0001
04000	S	M	OUG	II	00210	021		12	070888	1/1/0001
05800	S	M	OUG	II	00223	049		12	040884	1/1/0001
05800	S	M	OUG	II	00231	050		12	040884	1/1/0001
04000	S	M	OUG	II	00242	019		12	070888	1/1/0001
04000	S	M	OUG	II	00310	017		12	070888	1/1/0001
04000	S	M	OUG	II	00326	015		12	070888	1/1/0001
04000	S	M	OUG	II	00341	014		12	070888	1/1/0001
04000	S	M	OUG	II	00346	013		12	070888	1/1/0001
04000	S	M	OUG	II	00361	012		12	050888	1/1/0001
05800	S	M	OUG	II	00740	007		12	081477	1/1/0001
05800	S	M	OUG	II	00749	006		12	081477	1/1/0001
05800	S	M	OUG	II	00778	000		12	032067	1/1/0001
05800	S	M	OUG	II	00810	000		12	032067	1/1/0001
05800	S	M	OUG	II	00839	000		12	032067	1/1/0001
05800	S	M	OUG	V	00851	000		12	032067	1/1/0001
OFFICE: 311		ROUTE: 564		ST_REF_NO: 0000077900		GLENEAGLES DRIVE		TAX DIST	DATE INST	DATE CHANGE
LUMENS	BULB TYPE	MULT SERIES	POLE TYPE	SHADE	ADDRESS NUMBER	REF	LOCATION			
05800	S	M	OUG	II	00000	019	SIDE OF 409 ROOKWOOD	12	050164	1/1/0001
05800	S	M	OUG	II	00000	026	SIDE OF 465 ROOKWOOD	12	060164	1/1/0001
05800	S	M	OUG	II	01709	000		12	050164	1/1/0001
05800	S	M	OUG	II	01712	000		12	050164	1/1/0001
05800	S	M	OUG	II	01736	000		12	050164	1/1/0001
05800	S	M	OUG	II	01737	000		12	050164	1/1/0001
05800	S	M	OUG	II	01763	000		12	050164	1/1/0001
05800	S	M	OUG	II	01780	000		12	060465	1/1/0001

OFFICE: 311

ROUTE: 564

ST_REF_NO: 00000078000 GLENGARRY WAY

LUMENS	BULB TYPE	MULT SERIES	POLE TYPE	SHADE	ADDRESS NUMBER	REF	LOCATION	TAX DIST	DATE INST	DATE CHANGE
05800	S	M	OUG	II	00000	026	SIDE OF 2096 SPRING STATION DR.	12	041267	1/1/0001
05800	S	M	OUG	II	01902	000		12	011066	1/1/0001
05800	S	M	OUG	II	01909	000		12	091167	1/1/0001
05800	S	M	OUG	II	01937	000		12	011066	1/1/0001
05800	S	M	OUG	II	01942	000		12	011066	1/1/0001

OFFICE: 311

ROUTE: 564

ST_REF_NO: 00000078050 GLENGARTH PARK

LUMENS	BULB TYPE	MULT SERIES	POLE TYPE	SHADE	ADDRESS NUMBER	REF	LOCATION	TAX DIST	DATE INST	DATE CHANGE
05800	S	M	CNT	II	03100	001		12	092506	1/1/0001
05800	S	M	CNT	III	03113	002		12	092506	1/1/0001

OFFICE: 311

ROUTE: 564

ST_REF_NO: 00000078200 GLENN PLACE

LUMENS	BULB TYPE	MULT SERIES	POLE TYPE	SHADE	ADDRESS NUMBER	REF	LOCATION	TAX DIST	DATE INST	DATE CHANGE
05800	S	M	SOH	I	00000	001	SIDE OF 903 BRYAN AVE.	12	041057	1/1/0001
05800	S	M	SOH	I	00000	007	SIDE OF 900 N. LIMESTONE ST.	12	041057	1/1/0001
05800	S	M	SOH	I	00113	000		12	041057	1/1/0001
05800	S	M	SOH	I	00127	000		12	041057	1/1/0001
05800	S	M	SOH	I	00139	000		12	041057	1/1/0001
05800	S	M	SOH	I	00153	000		12	041057	1/1/0001
05800	S	M	SOH	I	00163	000		12	041057	1/1/0001

OFFICE: 311

ROUTE: 564

ST_REF_NO: 00000078210 GLEN RIDGE CIRCLE

LUMENS	BULB TYPE	MULT SERIES	POLE TYPE	SHADE	ADDRESS NUMBER	REF	LOCATION	TAX DIST	DATE INST	DATE CHANGE
04000	S	M	OUG	V	03101	112		12	061580	1/1/0001
04000	S	M	OUG	II	00000	098	SIDE OF 3179 PIMLICO PKWY	12	060890	1/1/0001

OFFICE: 311

ROUTE: 564

ST_REF_NO: 00000078220 GLENVIEW DRIVE

LUMENS	BULB TYPE	MULT SERIES	POLE TYPE	SHADE	ADDRESS NUMBER	REF	LOCATION	TAX DIST	DATE INST	DATE CHANGE
05800	S	M	CNT	II	00000	010	SIDE OF 4508 GLENVIEW CT.	12	080896	1/1/0001
05800	S	M	CNT	II	01308	014		12	080896	1/1/0001
05800	S	M	CNT	II	01320	013		12	080896	1/1/0001

OFFICE: 311		ROUTE: 564		ST_REF_NO: 00000078220		GLENVIEW DRIVE		LUMENS	BULB TYPE	MULT SERIES	POLE TYPE	SHADE	ADDRESS NUMBER	REF	LOCATION	TAX DIST	DATE INST	DATE CHANGE
05800	S	M	CNT	II	01325	012										12	050896	1/1/0001
05800	S	M	CNT	II	01340	011										12	080896	1/1/0001
05800	S	M	CNT	II	01360	009										12	080896	1/1/0001
05800	S	M	CNT	II	01369	008										12	080896	1/1/0001
05800	S	M	CNT	II	01376	007										12	080896	1/1/0001
05800	S	M	CNT	II	01385	006										12	080896	1/1/0001
05800	S	M	CNT	II	01401	001										12	080896	1/1/0001
05800	S	M	CNT	II	01405	002										12	080896	1/1/0001
05800	S	M	CNT	II	01413	003										12	080896	1/1/0001
05800	S	M	CNT	II	01428	004										12	080896	1/1/0001
05800	S	M	CNT	II	01429	005										12	080896	1/1/0001

OFFICE: 311

ROUTE: 564

OFFICE: 311		ROUTE: 564		ST_REF_NO: 00000078230		GLENVIEW COURT		LUMENS	BULB TYPE	MULT SERIES	POLE TYPE	SHADE	ADDRESS NUMBER	REF	LOCATION	TAX DIST	DATE INST	DATE CHANGE
05800	S	M	CNT	II	04504	001										12	080896	1/1/0001

OFFICE: 311

ROUTE: 564

OFFICE: 311		ROUTE: 564		ST_REF_NO: 00000078250		GLENWOOD DRIVE		LUMENS	BULB TYPE	MULT SERIES	POLE TYPE	SHADE	ADDRESS NUMBER	REF	LOCATION	TAX DIST	DATE INST	DATE CHANGE
05800	S	M	CNT	II	00000	001									SIDE OF 1863 TIMBER CREEK DR.	12	100896	1/1/0001
05800	S	M	CNT	II	00000	008									SIDE OF 1300 COLORADO RD.	12	100896	1/1/0001
05800	S	M	CNT	II	00000	009									SIDE OF 1293 RED STONE DR.	12	100896	1/1/0001
05800	S	M	CNT	III	03069	003										12	100896	1/1/0001
05800	S	M	CNT	II	03089	002										12	100896	1/1/0001
05800	S	M	CNT	II	03108	004										12	100896	1/1/0001
05800	S	M	CNT	II	03113	005										12	100896	1/1/0001
05800	S	M	CNT	II	03124	006										12	100896	1/1/0001
05800	S	M	CNT	II	03137	007										12	100896	1/1/0001
05800	S	M	CNT	III	03176	010										12	100896	1/1/0001

OFFICE: 311

ROUTE: 564

ST_REF_NO: 0000078300

GLOVER AVENUE

LUMENS	BULB TYPE	MULT SERIES	POLE TYPE	SHADE	ADDRESS NUMBER	REF	LOCATION	TAX DIST	DATE INST	DATE CHANGE
09500	S	M	SOH	II	00000	001	OPP. 1606	12	121578	1/1/0001
09500	S	M	SOH	II	00000	002	SIDE 128 GARRETT AVE.	12	030886	1/1/0001
09500	S	M	SOH	II	00000	003	OPP. 1608 GLOVER AVE.	12	030886	1/1/0001
09500	S	M	SOH	II	00000	004	SIDE 121 WOODFORD DR.	12	030886	1/1/0001
09500	S	M	SOH	II	00000	005	NE CORNER OF WOODFORD DR.	12	030886	1/1/0001
09500	S	M	SOH	II	00000	007	2ND LT. E. OF WOODFORD, S. SIDE	12	030886	1/1/0001
09500	S	M	SOH	II	01524	008		12	121578	1/1/0001
09500	S	M	SOH	II	01532	006		12	121578	1/1/0001

OFFICE: 311

ROUTE: 564

ST_REF_NO: 0000078400

GOLD RUSH ROAD

LUMENS	BULB TYPE	MULT SERIES	POLE TYPE	SHADE	ADDRESS NUMBER	REF	LOCATION	TAX DIST	DATE INST	DATE CHANGE
09500	S	M	OUG	II	00282	013	chg'd out bad fixture	12	121475	7/30/2009
10000	M	M	OUG	II	00000	009	SIDE OF 281 BIG RUN RD.	12	021475	1/1/0001
10000	M	M	OUG	II	00000	011	SIDE OF 282	12	121475	1/1/0001
10000	M	M	OUG	II	00219	019		12	061580	1/1/0001
10000	M	M	OUG	II	00223	018		12	121478	1/1/0001
10000	M	M	OUG	II	00231	016		12	061580	1/1/0001
10000	M	M	OUG	II	00236	017		12	111478	1/1/0001
10000	M	M	OUG	II	00265	012		12	061580	1/1/0001
10000	M	M	OUG	II	00275	014		12	061580	1/1/0001
10000	M	M	OUG	II	00295	010		12	111478	1/1/0001
10000	M	M	OUG	V	00201	021		12	061580	1/1/0001
09500	S	M	OUG	V	00208	020		12	090891	1/1/0001

OFFICE: 311

ROUTE: 564

ST_REF_NO: 0000078495

GOLDEN BELL PLACE

LUMENS	BULB TYPE	MULT SERIES	POLE TYPE	SHADE	ADDRESS NUMBER	REF	LOCATION	TAX DIST	DATE INST	DATE CHANGE
05800	S	M	CNT	III	00876	003		12	081404	1/1/0001
05800	S	M	CNT	II	00885	002		12	081404	1/1/0001
05800	S	M	CNT	II	00897	001		12	033007	1/1/0001
05800	S	M	CNT	II	00908	001		12	072803	1/1/0001

OFFICE: 311		ROUTE: 564		ST_REF_NO: 00000078500		GOLDEN GATE PARK		LUMENS	BULB TYPE	MULT SERIES	POLE TYPE	SHADE	ADDRESS NUMBER	REF	LOCATION	TAX DIST	DATE INST	DATE CHANGE
05800	S	M	OUG	V	01257	127										12	041475	1/1/0001
05800	S	M	OUG	II	01269	126										12	041475	1/1/0001
05800	S	M	OUG	II	01280	125										12	041475	1/1/0001

OFFICE: 311		ROUTE: 564		ST_REF_NO: 00000078525		GOLDENROD LANE		LUMENS	BULB TYPE	MULT SERIES	POLE TYPE	SHADE	ADDRESS NUMBER	REF	LOCATION	TAX DIST	DATE INST	DATE CHANGE
05800	S		CNT	II	02700	007										12	102908	1/1/0001
05800	S		CNT	II	02708	006										12	102908	1/1/0001
05800	S		CNT	II	02724	005										12	102908	1/1/0001
05800	S		CNT	II	02732	004										12	102908	1/1/0001
05800	S		CNT	II	02748	003										12	102908	1/1/0001
05800	S		CNT	II	02761	002										12	102908	1/1/0001
05800	S		CNT	II	02776	001										12	102908	1/1/0001

OFFICE: 311		ROUTE: 564		ST_REF_NO: 00000078600		GOLF COURSE CIRCLE		LUMENS	BULB TYPE	MULT SERIES	POLE TYPE	SHADE	ADDRESS NUMBER	REF	LOCATION	TAX DIST	DATE INST	DATE CHANGE
05800	S	M	OUG	II	00000	010									SIDE OF 3217 CARRIAGE LANE	12	061475	1/1/0001
05800	S	M	OUG	V	01304	012										12	081477	1/1/0001
05800	S	M	OUG	II	01308	011										12	021476	1/1/0001

OFFICE: 311		ROUTE: 564		ST_REF_NO: 00000078700		GONDOLA DRIVE		LUMENS	BULB TYPE	MULT SERIES	POLE TYPE	SHADE	ADDRESS NUMBER	REF	LOCATION	TAX DIST	DATE INST	DATE CHANGE
04000	S	M	OUG	II	03235	109										12	100884	1/1/0001
04000	S	M	OUG	II	03247	110										12	100884	1/1/0001
04000	S	M	OUG	II	03255	111										12	100884	1/1/0001
04000	S	M	OUG	II	03267	114										12	100884	1/1/0001
04000	S	M	OUG	II	03283	099										12	011584	1/1/0001
04000	S	M	OUG	II	03286	098										12	011584	1/1/0001
04000	S	M	OUG	II	03299	079										12	081582	1/1/0001
04000	S	M	OUG	II	03300	078										12	081582	1/1/0001
04000	S	M	OUG	II	03305	077										12	011584	1/1/0001

OFFICE: 311

ROUTE: 564

ST_REF_NO: 00000078700

GONDOLA DRIVE

LUMENS	BULB TYPE	MULT SERIES	POLE TYPE	SHADE	ADDRESS NUMBER	REF	LOCATION	TAX DIST	DATE INST	DATE CHANGE
04000	S	M	OUG	II	03316	076		12	111581	1/1/0001
04000	S	M	OUG	II	03325	075		12	111581	1/1/0001

OFFICE: 311

ROUTE: 564

ST_REF_NO: 00000078800

GOODLOE STREET

LUMENS	BULB TYPE	MULT SERIES	POLE TYPE	SHADE	ADDRESS NUMBER	REF	LOCATION	TAX DIST	DATE INST	DATE CHANGE
09500	S		OUG	II	00000	100	1ST LT W OF MIDLAND AVE, S SIDE ON GOODLOE STREET	12	081413	1/1/0001
05800	S	M	SOH	I	00000	028	GOODLOE AND MIDLAND AVE.	12	021535	1/1/0001
05800	S	M	SOH	I	00550	027		12	110266	1/1/0001
05800	S	M	SOH	I	00000	026	GOODLOE AT WARNOCK ST.	12	110266	1/1/0001
05800	S	M	SOH	I	00504	024		12	110266	1/1/0001
05800	S	M	SOH	I	00516	025		12	110266	1/1/0001

OFFICE: 311

ROUTE: 564

ST_REF_NO: 00000078900

GOODRICH AVENUE

LUMENS	BULB TYPE	MULT SERIES	POLE TYPE	SHADE	ADDRESS NUMBER	REF	LOCATION	TAX DIST	DATE INST	DATE CHANGE
04000	S	M	SOH	I	00000	001	SIDE OF 1915 NICHOLASVILLE RD.	12	100162	1/1/0001
04000	S	M	SOH	I	00000	002	OPP. 166, IN MEDIAN	12	100162	1/1/0001
04000	S	M	SOH	I	00098	000		12	100162	1/1/0001
04000	S	M	SOH	I	00104	000		12	100162	1/1/0001
04000	S	M	SOH	I	00110	000		12	100162	1/1/0001
04000	S	M	SOH	I	00114	000		12	100162	1/1/0001
04000	S	M	SOH	I	00120	000		12	100162	1/1/0001
04000	S	M	SOH	I	00126	000		12	100162	1/1/0001
04000	S	M	SOH	I	00134	000		12	100162	1/1/0001
04000	S	M	SOH	I	00142	000		12	100162	1/1/0001
04000	S	M	SOH	I	00146	000		12	100162	1/1/0001
04000	S	M	SOH	I	00152	000		12	100162	1/1/0001
04000	S	M	SOH	I	00158	000		12	100162	1/1/0001
04000	S	M	SOH	I	00163	000		12	100262	1/1/0001
04000	S	M	SOH	I	00169	000		12	100162	1/1/0001

OFFICE: 311

ROUTE: 564

ST_REF_NO: 00000079000

GOODWIN DRIVE

LUMENS	BULB TYPE	MULT SERIES	POLE TYPE	SHADE	ADDRESS NUMBER	REF	LOCATION	TAX DIST	DATE INST	DATE CHANGE
05800	S	M	OUG	II	00000	001	NW CORNER OF EASTLAND DR.	12	050167	1/1/0001
05800	S	M	OUG	II	00000	002	OPP. 1075	12	050167	1/1/0001
05800	S	M	OUG	II	00000	003	OPP. 1071	12	111478	1/1/0001
05800	S	M	OUG	II	00000	004	OPP. 1053	12	111478	1/1/0001
05800	S	M	OUG	II	00000	005	FRONT OF KY. ORNAMENTAL IRON	12	050167	1/1/0001
05800	S	M	OUG	II	00000	006	W. OF INDUSTRY RD.	12	050167	1/1/0001
05800	S	M	OUG	II	00000	007	REAR OF 1027 INDUSTRY RD.	12	071581	1/1/0001
05800	S	M	OUG	II	00000	008	OPP. REAR OF 1019 INDUSTRY RD.	12	071581	1/1/0001
05800	S	M	OUG	II	00000	009	REAR OF 1013 INDUSTRY RD.	12	081674	1/1/0001

OFFICE: 311

ROUTE: 564

ST_REF_NO: 00000079050

GOOSEBERRY CIRCLE

LUMENS	BULB TYPE	MULT SERIES	POLE TYPE	SHADE	ADDRESS NUMBER	REF	LOCATION	TAX DIST	DATE INST	DATE CHANGE
05800	S	M	CNT	II	02408	001		12	092506	1/1/0001
05800	S	M	CNT	II	02421	002		12	092506	1/1/0001
05800	S	M	CNT	II	02436	003		12	092506	1/1/0001

OFFICE: 311

ROUTE: 564

ST_REF_NO: 00000079200

GRACE DRIVE

LUMENS	BULB TYPE	MULT SERIES	POLE TYPE	SHADE	ADDRESS NUMBER	REF	LOCATION	TAX DIST	DATE INST	DATE CHANGE
05800	S	M	OUG	II	03600	000		12	080173	1/1/0001
05800	S	M	OUG	II	03613	000		12	080173	1/1/0001
05800	S	M	OUG	II	03628	000		12	080173	1/1/0001
05800	S	M	OUG	V	03636	000		12	080173	1/1/0001

OFFICE: 311

ROUTE: 564

ST_REF_NO: 00000079210

GRACELAWN LANE

LUMENS	BULB TYPE	MULT SERIES	POLE TYPE	SHADE	ADDRESS NUMBER	REF	LOCATION	TAX DIST	DATE INST	DATE CHANGE
09500	S	M	SOH	II	00000	200	SIDE REAR OF 1445 HIGHLAWN AVE ON GRACELAWN AVE	12	120705	1/1/0001

OFFICE: 311

ROUTE: 564

ST_REF_NO: 00000079400

GRAFTON COURT

LUMENS	BULB TYPE	MULT SERIES	POLE TYPE	SHADE	ADDRESS NUMBER	REF	LOCATION	TAX DIST	DATE INST	DATE CHANGE
05800	S	M	OUG	II	00000	072	SIDE OF 3241 VALHALLA DR.	12	011581	1/1/0001

OFFICE: 311

ROUTE: 564

ST_REF_NO: 00000079400

GRAFTON COURT

LUMENS	BULB TYPE	MULT SERIES	POLE TYPE	SHADE	ADDRESS NUMBER	REF	LOCATION	TAX DIST	DATE INST	DATE CHANGE
05800	S	M	OUG	II	00000	073	REAR OF 1224 KALONE WAY	12	011581	1/1/0001
05800	S	M	OUG	II	00000	074	REAR OF 1220 KALONE WAY	12	011581	1/1/0001
04000	S	M	OUG	II	01317	075		12	111580	1/1/0001
04000	S	M	OUG	II	01328	076		12	111580	1/1/0001
04000	S	M	OUG	II	01361	077		12	111580	1/1/0001

OFFICE: 311

ROUTE: 564

ST_REF_NO: 00000079450

GRAFTONS MILL LANE

LUMENS	BULB TYPE	MULT SERIES	POLE TYPE	SHADE	ADDRESS NUMBER	REF	LOCATION	TAX DIST	DATE INST	DATE CHANGE
05800	S	M	OUG	II	00668	011		12	101201	1/1/0001
05800	S	M	OUG	II	00000	004	SIDE OF 2500 ISLAND POND RD.	12	110899	1/1/0001
05800	S	M	OUG	II	00649	012		12	110899	1/1/0001
05800	S	M	OUG	II	00673	010		12	110899	1/1/0001
05800	S	M	OUG	II	00692	009		12	110899	1/1/0001
05800	S	M	OUG	II	00701	008		12	110899	1/1/0001
05800	S	M	OUG	II	00724	007		12	110899	1/1/0001
05800	S	M	OUG	II	00733	006		12	110899	1/1/0001
05800	S	M	OUG	II	00752	005		12	110899	1/1/0001
05800	S	M	OUG	II	00781	003		12	110899	1/1/0001
05800	S	M	OUG	II	00792	002		12	110899	1/1/0001
05800	S	M	OUG	II	00797	001		12	110899	1/1/0001

OFFICE: 311

ROUTE: 564

ST_REF_NO: 00000079600

GRAIG COURT

LUMENS	BULB TYPE	MULT SERIES	POLE TYPE	SHADE	ADDRESS NUMBER	REF	LOCATION	TAX DIST	DATE INST	DATE CHANGE
04000	S	M	OUG	II	02885	045		12	100173	1/1/0001
04000	S	M	OUG	II	00000	044	SIDE OF 413 WESTERFIELD WAY	12	100173	1/1/0001

OFFICE: 311

ROUTE: 564

ST_REF_NO: 00000079700

GRANARD AVENUE

LUMENS	BULB TYPE	MULT SERIES	POLE TYPE	SHADE	ADDRESS NUMBER	REF	LOCATION	TAX DIST	DATE INST	DATE CHANGE
05800	S	M	OOH	II	00000	001	SIDE OF 721 N. BROADWAY	12	110168	1/1/0001
05800	S	M	OUG	II	00000	003	SIDE OF 720 HEADLEY AVENUE	12	100895	1/1/0001
05800	S	M	OUG	II	00413	002		12	110168	1/1/0001

OFFICE: 311		ROUTE: 564		ST_REF_NO: 00000079725		GRANDSTAND DRIVE		LUMENS	BULB TYPE	MULT SERIES	POLE TYPE	SHADE	ADDRESS NUMBER	REF	LOCATION	TAX DIST	DATE INST	DATE CHANGE
05800	S		CNT	II	00000	001	SIDE OF 719 THOROUGHbred WAY, ON GRANDSTAND DR	12	112210							12	112210	1/1/0001
05800	S		CNT	II	00516	002		12	112210							12	112210	1/1/0001
OFFICE: 311		ROUTE: 564		ST_REF_NO: 00000079750		GRANDVILLE CT		LUMENS	BULB TYPE	MULT SERIES	POLE TYPE	SHADE	ADDRESS NUMBER	REF	LOCATION	TAX DIST	DATE INST	DATE CHANGE
04000	S	M	OUG	II	00902	001		12	050891							12	050891	1/1/0001
04000	S	M	OUG	V	00910	002		12	050891							12	050891	1/1/0001
OFFICE: 311		ROUTE: 564		ST_REF_NO: 00000079800		GRANITE CIRCLE		LUMENS	BULB TYPE	MULT SERIES	POLE TYPE	SHADE	ADDRESS NUMBER	REF	LOCATION	TAX DIST	DATE INST	DATE CHANGE
04000	S	M	OUG	II	00000	029	SIDE 3516 ROCKYHILL TERRACE	12	060886							12	060886	1/1/0001
OFFICE: 311		ROUTE: 564		ST_REF_NO: 00000079890		GRANT COURT		LUMENS	BULB TYPE	MULT SERIES	POLE TYPE	SHADE	ADDRESS NUMBER	REF	LOCATION	TAX DIST	DATE INST	DATE CHANGE
05800	S	M	OUG	II	00000	026	SIDE OF 1630 GRANT DR.	12	061674							12	061674	1/1/0001
OFFICE: 311		ROUTE: 564		ST_REF_NO: 00000079900		GRANT DRIVE		LUMENS	BULB TYPE	MULT SERIES	POLE TYPE	SHADE	ADDRESS NUMBER	REF	LOCATION	TAX DIST	DATE INST	DATE CHANGE
05800	S	M	OUG	II	00000	021	SIDE OF 1531	12	030173							12	030173	1/1/0001
05800	S	M	OUG	II	00000	023	SIDE OF 1594	12	061674							12	061674	1/1/0001
05800	S	M	OUG	II	00000	032	SIDE OF 594 HOLLOW CREEK RD.	12	061674							12	061674	1/1/0001
05800	S	M	OUG	II	01495	000		12	030173							12	030173	1/1/0001
05800	S	M	OUG	II	01502	000		12	030173							12	030173	1/1/0001
05800	S	M	OUG	II	01519	000		12	030173							12	030173	1/1/0001
05800	S	M	OUG	II	01530	000		12	030173							12	030173	1/1/0001
05800	S	M	OUG	II	01558	000		12	061674							12	061674	1/1/0001
05800	S	M	OUG	II	01591	000		12	030173							12	030173	1/1/0001
05800	S	M	OUG	II	01602	000		12	061674							12	061674	1/1/0001
05800	S	M	OUG	II	01627	000		12	030173							12	030173	1/1/0001

OFFICE: 311 ROUTE: 564										
ST_REF_NO: 0000080000 GRANTCHESTER ROAD										
LUMENS	BULB TYPE	MULT SERIES	POLE TYPE	SHADE	ADDRESS NUMBER	REF	LOCATION	TAX DIST	DATE INST	DATE CHANGE
05800	S	M	OUG	II	00000	013	OPP. 564	12	010264	1/1/0001
05800	S	M	OUG	II	00000	050	OPP. 500 IN ISLAND	12	071581	1/1/0001
05800	S	M	OUG	II	00000	051	SIDE OF 1700 PALMYRA AVE.	12	071581	1/1/0001
05800	S	M	OUG	II	00514	020		12	041478	1/1/0001
05800	S	M	OUG	II	00533	017		12	010264	1/1/0001
05800	S	M	OUG	II	00534	016		12	010264	1/1/0001
05800	S	M	OUG	II	00549	015		12	010264	1/1/0001
05800	S	M	OUG	II	00554	014		12	010264	1/1/0001
05800	S	M	OUG	II	00576	012		12	010264	1/1/0001
OFFICE: 311 ROUTE: 564										
ST_REF_NO: 0000080050 GRANTHAM WAY										
LUMENS	BULB TYPE	MULT SERIES	POLE TYPE	SHADE	ADDRESS NUMBER	REF	LOCATION	TAX DIST	DATE INST	DATE CHANGE
05800	S	M	CNT	III	03100	004		12	020898	1/1/0001
05800	S	M	CNT	II	03112	003		12	020898	1/1/0001
05800	S	M	CNT	II	03124	001		12	020898	1/1/0001
05800	S	M	CNT	II	03125	002		12	020898	1/1/0001
OFFICE: 311 ROUTE: 564										
ST_REF_NO: 0000080100 GRASMERE DRIVE										
LUMENS	BULB TYPE	MULT SERIES	POLE TYPE	SHADE	ADDRESS NUMBER	REF	LOCATION	TAX DIST	DATE INST	DATE CHANGE
05800	S	M	OUG	II	03416	008	upgrade due to bad fixture	12	101583	10/22/2008
04000	S	M	OUG	II	00000	022	OPP. 3301 GRASMERE DR.	12	050891	1/1/0001
04000	S	M	OUG	II	00000	050	OPP. 3504	12	021580	1/1/0001
04000	S	M	OUG	II	03308	021		12	050891	1/1/0001
04000	S	M	OUG	II	03315	020		12	050891	1/1/0001
04000	S	M	OUG	II	03318	019		12	050891	1/1/0001
04000	S	M	OUG	II	03327	018		12	050891	1/1/0001
04000	S	M	OUG	II	03336	017		12	050891	1/1/0001
04000	S	M	OUG	II	03345	016		12	050891	1/1/0001
04000	S	M	OUG	II	03352	015		12	050891	1/1/0001
04000	S	M	OUG	II	03365	014		12	050891	1/1/0001
04000	S	M	OUG	II	03368	013		12	050891	1/1/0001
04000	S	M	OUG	II	03377	012		12	050891	1/1/0001

OFFICE: 311		ROUTE: 564		ST_REF_NO: 0000080100		GRASMERE DRIVE		TAX DIST	DATE INST	DATE CHANGE
LUMENS	BULB TYPE	MULT SERIES	POLE TYPE	SHADE	ADDRESS NUMBER	REF	LOCATION			
04000	S	M	OUG	II	03388	011		12	050891	1/1/0001
04000	S	M	OUG	II	03401	010		12	050891	1/1/0001
04000	S	M	OUG	II	03409	009		12	101583	1/1/0001
04000	S	M	OUG	II	03425	075		12	091579	1/1/0001
04000	S	M	OUG	II	03436	074		12	091579	1/1/0001
04000	S	M	OUG	II	03445	073		12	021580	1/1/0001
04000	S	M	OUG	II	03456	072		12	091579	1/1/0001
04000	S	M	OUG	II	03465	071		12	091579	1/1/0001
04000	S	M	OUG	II	03476	070		12	091579	1/1/0001
04000	S	M	OUG	II	03485	052		12	021580	1/1/0001
04000	S	M	OUG	II	03492	051		12	021580	1/1/0001
OFFICE: 311		ROUTE: 564		ST_REF_NO: 0000080200		GRASSY CREEK DRIVE		TAX DIST	DATE INST	DATE CHANGE
LUMENS	BULB TYPE	MULT SERIES	POLE TYPE	SHADE	ADDRESS NUMBER	REF	LOCATION			
05800	S	M	OUG	II	00000	064	SIDE REAR OF 3796 MCGARRY DRIVE	12	050897	1/1/0001
05800	S	M	OUG	II	00000	068	OPP. 3840	12	050897	1/1/0001
05800	S	M	SOH	II	03800	005		12	120889	1/1/0001
05800	S	M	OUG	II	03809	006		12	011581	1/1/0001
05800	S	M	OUG	II	03812	007		12	120889	1/1/0001
05800	S	M	OUG	II	03821	008		12	120889	1/1/0001
05800	S	M	OUG	II	03824	009		12	051581	1/1/0001
05800	S	M	OUG	II	03829	010		12	011583	1/1/0001
05800	S	M	OUG	II	03852	067		12	050897	1/1/0001
05800	S	M	OUG	II	03861	066		12	050897	1/1/0001
05800	S	M	OUG	II	03872	065		12	050897	1/1/0001
05800	S	M	OUG	II	00000	058	SIDE OF 3800 LEE ADAMS LANE ON GRASSY CREEK	12	090891	1/1/0001
05800	S	M	OUG	II	00000	060	SIDE OF 3801 LEE ADAMS LANE	12	011583	1/1/0001
05800	S	M	OUG	II	00000	062	SIDE OF 3801 JOSHUA CIRCLE	12	051581	1/1/0001
05800	S	M	OUG	II	03888	063		12	121583	1/1/0001
05800	S	M	OUG	II	03908	061		12	121583	1/1/0001
05800	S	M	OUG	II	03924	059		12	021583	1/1/0001
05800	S	M	OUG	II	03948	057		12	100895	1/1/0001

OFFICE: 311

ROUTE: 564

ST_REF_NO: 0000080205 GRAVISS COURT

LUMENS	BULB TYPE	MULT SERIES	POLE TYPE	SHADE	ADDRESS NUMBER	REF	LOCATION	TAX DIST	DATE INST	DATE CHANGE
05800	S	M	CNT	II	00000	001	1ST LT. OFF CLAYS MILLRD., SOUTHSIDE	12	020899	1/1/0001
05800	S	M	CNT	II	00651	002		12	020899	1/1/0001
05800	S	M	CNT	II	00659	004		12	020899	1/1/0001
05800	S	M	CNT	II	00660	003		12	020899	1/1/0001
05800	S	M	CNT	III	00675	005		12	020899	1/1/0001

OFFICE: 311

ROUTE: 564

ST_REF_NO: 0000080210 GRAVES DRIVE

LUMENS	BULB TYPE	MULT SERIES	POLE TYPE	SHADE	ADDRESS NUMBER	REF	LOCATION	TAX DIST	DATE INST	DATE CHANGE
04000	S	M	OUG	II	04501	037		12	011579	1/1/0001
04000	S	M	OUG	II	04509	036		12	011579	1/1/0001
04000	S	M	OUG	II	04512	035		12	011579	1/1/0001

OFFICE: 311

ROUTE: 564

ST_REF_NO: 0000080220 GRAY COURT

LUMENS	BULB TYPE	MULT SERIES	POLE TYPE	SHADE	ADDRESS NUMBER	REF	LOCATION	TAX DIST	DATE INST	DATE CHANGE
05800	S	M	OUG	II	01300	055	upgrade due to bad fixture	12	021580	10/14/2008
04000	S	M	OUG	II	01313	054		12	021580	1/1/0001
04000	S	M	OUG	V	01320	053		12	021580	1/1/0001

OFFICE: 311

ROUTE: 564

ST_REF_NO: 0000080230 GRAY HAWK ROAD

LUMENS	BULB TYPE	MULT SERIES	POLE TYPE	SHADE	ADDRESS NUMBER	REF	LOCATION	TAX DIST	DATE INST	DATE CHANGE
05800	S	M	OUG	II	01312	108	bad fixture	12	111580	8/9/2009
04000	S	M	OUG	II	00000	112	SIDE OF 1109 TURKEY FOOT ON GRAY HAWK	12	011584	1/1/0001
04000	S	M	OUG	II	01300	106		12	041581	1/1/0001
05800	S	M	OUG	II	01300	107		12	060892	1/1/0001
04000	S	M	OUG	II	01321	109		12	111580	1/1/0001
05800	S	M	OUG	II	01329	110		12	060892	1/1/0001
04000	S	M	OUG	II	01337	111		12	011584	1/1/0001

OFFICE: 311

ROUTE: 564

ST_REF_NO: 0000080235 GRAYSON LAKE COURT

LUMENS	BULB TYPE	MULT SERIES	POLE TYPE	SHADE	ADDRESS NUMBER	REF	LOCATION	TAX DIST	DATE INST	DATE CHANGE
04000	S	M	OUG	II	00209	135		12	110885	1/1/0001

OFFICE: 311

ROUTE: 564

ST_REF_NO: 0000080240

GRAYSON LAKE DRIVE

LUMENS	BULB TYPE	MULT SERIES	POLE TYPE	SHADE	ADDRESS NUMBER	REF	LOCATION	TAX DIST	DATE INST	DATE CHANGE
05800	S	M	OUG	V	00474	130		12	110885	9/14/2013
04000	S	M	OUG	II	00443	134		12	110885	1/1/0001
04000	S	M	OUG	II	00450	133		12	110885	1/1/0001
04000	S	M	OUG	II	00467	131		12	110885	1/1/0001
04000	S	M	OUG	II	00486	129		12	110885	1/1/0001
04000	S	M	OUG	II	00499	128		12	050887	1/1/0001

OFFICE: 311

ROUTE: 564

ST_REF_NO: 0000080260

GREATSTONE POINT

LUMENS	BULB TYPE	MULT SERIES	POLE TYPE	SHADE	ADDRESS NUMBER	REF	LOCATION	TAX DIST	DATE INST	DATE CHANGE
09500	S	M	CNT	II	00000	001	SIDE OF 2416	12	010897	1/1/0001
09500	S	M	CNT	II	00000	002	OPP. 2416	12	010897	1/1/0001
09500	S	M	CNT	III	02402	004		12	010897	1/1/0001
09500	S	M	CNT	II	02410	003		12	010897	1/1/0001

OFFICE: 311

ROUTE: 564

ST_REF_NO: 0000080300

GREEN HILLS ROAD

LUMENS	BULB TYPE	MULT SERIES	POLE TYPE	SHADE	ADDRESS NUMBER	REF	LOCATION	TAX DIST	DATE INST	DATE CHANGE
05800	S	M	OUG	II	00000	029	SIDE OF 1609 JENNIFER DR.	12	031581	1/1/0001
05800	S	M	OUG	II	00000	063	SIDE OF 1700 CANTRILL DR.	12	082573	1/1/0001
05800	S	M	OUG	II	01508	141		12	082573	1/1/0001
05800	S	M	OUG	II	01513	142		12	082573	1/1/0001
05800	S	M	OUG	II	01524	143		12	082573	1/1/0001
05800	S	M	OUG	II	01529	000		12	072474	1/1/0001

OFFICE: 311

ROUTE: 564

ST_REF_NO: 0000080400

GREEN RIVER COURT

LUMENS	BULB TYPE	MULT SERIES	POLE TYPE	SHADE	ADDRESS NUMBER	REF	LOCATION	TAX DIST	DATE INST	DATE CHANGE
04000	S	M	OUG	II	03300	046		12	051478	1/1/0001
04000	S	M	OUG	II	03313	047		12	051478	1/1/0001
04000	S	M	OUG	V	03325	048		12	051478	1/1/0001

OFFICE: 311		ROUTE: 564		ST_REF_NO: 0000080500		GREENBO ROAD		LUMENS	BULB TYPE	MULT SERIES	POLE TYPE	SHADE	ADDRESS NUMBER	REF	LOCATION	TAX DIST	DATE INST	DATE CHANGE
04000	S	M	OUG	II	03170	007										12	081477	1/1/0001
04000	S	M	OUG	II	00000	010	SIDE OF 613 SQUIRES RD.									12	081477	1/1/0001
04000	S	M	OUG	II	03173	008										12	081477	1/1/0001
04000	S	M	OUG	II	03186	009										12	081477	1/1/0001

OFFICE: 311		ROUTE: 564		ST_REF_NO: 0000080600		GREENBRIAR ROAD		LUMENS	BULB TYPE	MULT SERIES	POLE TYPE	SHADE	ADDRESS NUMBER	REF	LOCATION	TAX DIST	DATE INST	DATE CHANGE
05800	S	M	OUG	II	00216	007										12	080888	9/14/2013
04000	S	M	OUG	II	00100	001										12	080888	1/1/0001
04000	S	M	OUG	II	00112	002										12	080888	1/1/0001
04000	S	M	OUG	II	00125	003										12	080888	1/1/0001
04000	S	M	OUG	II	00128	004										12	080888	1/1/0001
04000	S	M	OUG	II	00201	005										12	080888	1/1/0001
04000	S	M	OUG	II	00213	006										12	080888	1/1/0001
04000	S	M	OUG	II	00233	008										12	080888	1/1/0001
04000	S	M	OUG	II	00236	009										12	080888	1/1/0001
04000	S	M	OUG	II	00253	010										12	080888	1/1/0001
04000	S	M	OUG	II	00300	011										12	080888	1/1/0001
04000	S	M	OUG	II	00309	012										12	080888	1/1/0001
04000	S	M	OUG	II	00317	013										12	080888	1/1/0001
04000	S	M	OUG	II	00329	014										12	080888	1/1/0001
04000	S	M	OUG	II	00336	015										12	080888	1/1/0001
04000	S	M	OUG	II	00347	016										12	080888	1/1/0001
04000	S	M	OUG	II	00356	017										12	080888	1/1/0001
04000	S	M	OUG	II	00401	018										12	080888	1/1/0001
04000	S	M	OUG	II	00408	019										12	080888	1/1/0001
04000	S	M	OUG	II	00419	020										12	080888	1/1/0001
04000	S	M	OUG	II	00428	021										12	080888	1/1/0001

OFFICE: 311		ROUTE: 564		ST_REF_NO: 0000080700		GREENDALE PIKE		LUMENS	BULB TYPE	MULT SERIES	POLE TYPE	SHADE	ADDRESS NUMBER	REF	LOCATION	TAX DIST	DATE INST	DATE CHANGE
09500	S	M	OUG	II	00000	001	1ST LT E OF LEESTOWN RD, NORTH SIDE ON GREENDALE									12	012802	1/1/0001

OFFICE: 311

ROUTE: 564

ST_REF_NO: 0000080700

GREENDALE PIKE

LUMENS	BULB TYPE	MULT SERIES	POLE TYPE	SHADE	ADDRESS NUMBER	REF	LOCATION	TAX DIST	DATE INST	DATE CHANGE
09500	S	M	OUG	II	00000	002	2ND LT E OF LEESTOWN RD, NORTH SIDE ON GREENDALE	12	012802	1/1/0001
09500	S	M	OUG	II	00000	003	3RD LT E OF LEESTOWN RD, NORTH SIDE ON GREENDALE	12	012802	1/1/0001
09500	S	M	OUG	II	00000	004	4TH LT E OF LEESTOWN RD, NORTH SIDE ON GREENDALE	12	012802	1/1/0001
09500	S	M	OUG	II	00000	005	5TH LT E OF LEESTOWN RD, NORTH SIDE ON GREENDALE	12	012802	1/1/0001
09500	S	M	OUG	II	00000	006	6TH LT E OF LEESTOWN RD, NORTH SIDE ON GREENDALE	12	012802	1/1/0001
09500	S	M	OUG	II	00000	007	7TH LT E OF LEESTOWN RD, NORTH SIDE ON GREENDALE	12	012802	1/1/0001
09500	S	M	OUG	II	00000	008	8TH LT E OF LEESTOWN RD, NORTH SIDE ON GREENDALE	12	012802	1/1/0001
09500	S	M	OUG	II	00000	009	9TH LT E OF LEESTOWN RD, NORTH SIDE ON GREENDALE	12	012802	1/1/0001
09500	S	M	OUG	II	00000	010	10TH LT E OF LEESTOWN RD, NORTH SIDE ON GREENDALE	12	012802	1/1/0001
09500	S	M	OUG	II	00000	011	11TH LT E OF MERCER RD, S SIDE ON GREENDALE	12	012802	1/1/0001
09500	S	M	OUG	II	00000	012	2ND LT E OF MERCER RD, S SIDE ON GREENDALE	12	012802	1/1/0001
09500	S	M	OUG	II	00000	013	3RD LT E OF MERCER RD, S SIDE ON GREENDALE	12	012802	1/1/0001
09500	S	M	OUG	II	00000	014	4TH LT E OF MERCER RD, N SIDE ON GREENDALE	12	012802	1/1/0001
09500	S	M	OUG	II	00000	015	5TH LT E OF MERCER RD, N SIDE ON GREENDALE RD	12	012802	1/1/0001
09500	S	M	OUG	II	00000	016	6TH LT E OF MERCER RD, N SIDE ON GREENDALE RD	12	012802	1/1/0001

OFFICE: 311

ROUTE: 564

ST_REF_NO: 0000080800

GREENFIELD DRIVE

LUMENS	BULB TYPE	MULT SERIES	POLE TYPE	SHADE	ADDRESS NUMBER	REF	LOCATION	TAX DIST	DATE INST	DATE CHANGE
04000	S	M	OUG	II	00000	021	SIDE 3765 BELLEAU WOOD	12	100884	1/1/0001
05800	S	M	OUG	II	00000	022	OPP. 601	12	050890	1/1/0001
05800	S	M	OUG	II	00000	023	OPP. 597	12	050890	1/1/0001
05800	S	M	OUG	II	00000	025	OPP. 577	12	050890	1/1/0001
05800	S	M	OUG	II	00569	026		12	100884	1/1/0001
05800	S	M	OUG	II	00589	024		12	100884	1/1/0001

OFFICE: 311

ROUTE: 564

ST_REF_NO: 0000080890

GREENLAWN COURT

LUMENS	BULB TYPE	MULT SERIES	POLE TYPE	SHADE	ADDRESS NUMBER	REF	LOCATION	TAX DIST	DATE INST	DATE CHANGE
04000	S	M	OUG	II	00000	019	SIDE 3559 GREENLAWN DR.	12	060886	1/1/0001
04000	S	M	OUG	II	00414	018		12	060886	1/1/0001

OFFICE: 311

ROUTE: 564

ST_REF_NO: 0000080900

GREENLAWN DRIVE

LUMENS	BULB TYPE	MULT SERIES	POLE TYPE	SHADE	ADDRESS NUMBER	REF	LOCATION	TAX DIST	DATE INST	DATE CHANGE
05800	S	M	OUG	II	00000	014	SIDE 337 STONEYBROOK DR.	12	060886	11/17/2008
04000	S	M	OUG	II	00000	001	SIDE 3500 LANSDOWNE DR.	12	060886	1/1/0001
04000	S	M	OUG	II	00000	003	OPP. 3426	12	060886	1/1/0001
04000	S	M	OUG	II	00000	012	OPP. 3536	12	060886	1/1/0001
04000	S	M	OUG	II	03420	002		12	060886	1/1/0001
04000	S	M	OUG	II	03432	004		12	060886	1/1/0001
04000	S	M	OUG	II	03445	005		12	060886	1/1/0001
04000	S	M	OUG	II	03460	006		12	060886	1/1/0001
04000	S	M	OUG	II	03475	007		12	060886	1/1/0001
04000	S	M	OUG	II	03484	008		12	060886	1/1/0001
04000	S	M	OUG	II	03503	009		12	060886	1/1/0001
04000	S	M	OUG	II	03508	010		12	060886	1/1/0001
04000	S	M	OUG	II	03524	011		12	060886	1/1/0001
04000	S	M	OUG	II	03558	013		12	060886	1/1/0001

OFFICE: 311

ROUTE: 564

ST_REF_NO: 0000081000

GREENLEAF COURT

LUMENS	BULB TYPE	MULT SERIES	POLE TYPE	SHADE	ADDRESS NUMBER	REF	LOCATION	TAX DIST	DATE INST	DATE CHANGE
05800	S	M	OUG	II	00000	081	SIDE OF 1961 GREENLEAF DR.	12	042264	1/1/0001

OFFICE: 311

ROUTE: 564

ST_REF_NO: 0000081100

GREENLEAF DRIVE

LUMENS	BULB TYPE	MULT SERIES	POLE TYPE	SHADE	ADDRESS NUMBER	REF	LOCATION	TAX DIST	DATE INST	DATE CHANGE
05800	S	M	OUG	II	01902	000		12	010166	1/1/0001
05800	S	M	OUG	II	01921	000		12	010166	1/1/0001
05800	S	M	OUG	II	01932	083		12	042264	1/1/0001
05800	S	M	OUG	II	01951	000		12	060468	1/1/0001
05800	S	M	OUG	II	01956	080		12	042264	1/1/0001

OFFICE: 311		ROUTE: 564		ST_REF_NO: 0000081100		GREENLEAF DRIVE		LUMENS	BULB TYPE	MULT SERIES	POLE TYPE	SHADE	ADDRESS NUMBER	REF	LOCATION	TAX DIST	DATE INST	DATE CHANGE
05800	S	M	OUG	II	01969	079										12	042264	1/1/0001
05800	S	M	OUG	II	01984	078										12	042264	1/1/0001
05800	S	M	OUG	II	01997	000										12	061465	1/1/0001

OFFICE: 311		ROUTE: 564		ST_REF_NO: 0000081120		GREEN PARK COURT		LUMENS	BULB TYPE	MULT SERIES	POLE TYPE	SHADE	ADDRESS NUMBER	REF	LOCATION	TAX DIST	DATE INST	DATE CHANGE
05800	S	M	CNT	II	00000	003	SIDE OF 3696 PARK POINTE DR.									12	050899	1/1/0001
05800	S	M	CNT	III	03604	006										12	100899	1/1/0001
05800	S	M	CNT	II	03621	005										12	100899	1/1/0001
05800	S	M	CNT	II	03633	005										12	050899	1/1/0001
05800	S	M	CNT	II	03640	004										12	100899	1/1/0001
05800	S	M	CNT	II	03669	001										12	050899	1/1/0001

OFFICE: 311		ROUTE: 564		ST_REF_NO: 0000081150		GREEN PINE COURT.		LUMENS	BULB TYPE	MULT SERIES	POLE TYPE	SHADE	ADDRESS NUMBER	REF	LOCATION	TAX DIST	DATE INST	DATE CHANGE
05800	S	M	OUG	III	02900	001										12	050897	1/1/0001

OFFICE: 311		ROUTE: 564		ST_REF_NO: 0000081200		GREENRIDGE COURT		LUMENS	BULB TYPE	MULT SERIES	POLE TYPE	SHADE	ADDRESS NUMBER	REF	LOCATION	TAX DIST	DATE INST	DATE CHANGE
04000	S	M	OUG	II	00600	019										12	100884	1/1/0001
04000	S	M	OUG	II	00613	020										12	091582	1/1/0001

OFFICE: 311		ROUTE: 564		ST_REF_NO: 0000081300		GREENTREE COURT		LUMENS	BULB TYPE	MULT SERIES	POLE TYPE	SHADE	ADDRESS NUMBER	REF	LOCATION	TAX DIST	DATE INST	DATE CHANGE
05800	S	M	OUG	II	00000	094	SIDE OF 3387 GREENTREE RD.									12	031769	1/1/0001
05800	S	M	OUG	II	01108	000										12	120170	1/1/0001
05800	S	M	OUG	II	01115	000										12	041470	1/1/0001
05800	S	M	OUG	II	01128	000										12	030970	1/1/0001

OFFICE: 311

ROUTE: 564

ST_REF_NO: 0000081400

GREENTREE ROAD

LUMENS	BULB TYPE	MULT SERIES	POLE TYPE	SHADE	ADDRESS NUMBER	REF	LOCATION	TAX DIST	DATE INST	DATE CHANGE
05800	S	M	OUG	II	00000	188	SIDE OF 1209 GAINESWAY DR.	12	052068	1/1/0001
05800	S	M	OUG	V	03378	000		12	110171	1/1/0001
05800	S	M	OUG	II	03379	000		12	110171	1/1/0001
05800	S	M	OUG	II	03384	000		12	052068	1/1/0001
05800	S	M	OUG	V	03390	000		12	080172	1/1/0001
05800	S	M	OUG	II	03395	000		12	052068	1/1/0001
05800	S	M	OUG	II	03406	000		12	022262	1/1/0001
05800	S	M	OUG	II	03423	000		12	090266	1/1/0001
05800	S	M	OUG	III	00000	055	SIDE OF 1039 CLAIRBORNE WAY	12	060161	1/1/0001
05800	S	M	OUG	II	03430	000		12	022262	1/1/0001
05800	S	M	OUG	II	03439	000		12	022262	1/1/0001
05800	S	M	OUG	II	03458	000		12	092060	1/1/0001
05800	S	M	OUG	II	03459	000		12	091360	1/1/0001
05800	S	M	OUG	II	03474	000		12	091360	1/1/0001
05800	S	M	OUG	II	03483	000		12	091360	1/1/0001
05800	S	M	OUG	II	03488	000		12	091360	1/1/0001
05800	S	M	OUG	III	03504	000		12	080159	1/1/0001
05800	S	M	OUG	III	03507	000		12	092059	1/1/0001
05800	S	M	OUG	III	03512	000		12	092059	1/1/0001
05800	S	M	OUG	III	03517	000		12	080159	1/1/0001
05800	S	M	OUG	III	03524	000		12	010160	1/1/0001
05800	S	M	OUG	III	03527	000		12	080159	1/1/0001
05800	S	M	OUG	III	03534	000		12	092059	1/1/0001
05800	S	M	OUG	III	03535	000		12	092059	1/1/0001
05800	S	M	OUG	III	03542	000		12	072264	1/1/0001

OFFICE: 311

ROUTE: 564

ST_REF_NO: 0000081425

GREEN VALLEY DRIVE

LUMENS	BULB TYPE	MULT SERIES	POLE TYPE	SHADE	ADDRESS NUMBER	REF	LOCATION	TAX DIST	DATE INST	DATE CHANGE
05800	S	M	CNT	II	00000	011	SIDE OF 549 SKYVIEW LN ON GREEN VALLEY DR	12	101905	1/1/0001
05800	S	M	CNT	II	00000	012	SIDE OF 2700 MILL WOOD COVE ON GREEN VALLEY DR	12	101905	1/1/0001
05800	S	M	CNT	II	00000	016	SIDE OF 2700 GREEN VALLEY CT ON GREEN VALLEY DR	12	101905	1/1/0001

OFFICE: 311

ROUTE: 564

ST_REF_NO: 0000081425

GREEN VALLEY DRIVE

LUMENS	BULB TYPE	MULT SERIES	POLE TYPE	SHADE	ADDRESS NUMBER	REF	LOCATION	TAX DIST	DATE INST	DATE CHANGE
05800	S	M	CNT	II	00000	018	SIDE OF 2700 WIGGINTON POINT ON GREEN VALLEY DR	12	101905	1/1/0001
05800	S	M	CNT	II	00000	019	SIDE OF 2701 WIGGINTON POINT ON GREEN VALLEY DR	12	101905	1/1/0001
05800	S	M	CNT	III	00508	001		12	011304	1/1/0001
05800	S	M	CNT	II	00521	002		12	011304	1/1/0001
05800	S	M	CNT	II	00528	003		12	011304	1/1/0001
05800	S	M	CNT	II	00545	004		12	011304	1/1/0001
05800	S	M	CNT	II	00568	013		12	101905	1/1/0001
05800	S	M	CNT	II	00581	014		12	101905	1/1/0001
05800	S	M	CNT	II	00600	015		12	101905	1/1/0001
05800	S	M	CNT	II	00632	017		12	101905	1/1/0001

OFFICE: 311

ROUTE: 564

ST_REF_NO: 0000081430

GREEN VALLEY COURT

LUMENS	BULB TYPE	MULT SERIES	POLE TYPE	SHADE	ADDRESS NUMBER	REF	LOCATION	TAX DIST	DATE INST	DATE CHANGE
05800	S	M	CNT	II	02700	001		12	101905	1/1/0001
05800	S	M	CNT	II	02713	002		12	101905	1/1/0001
05800	S	M	CNT	II	02728	003		12	101905	1/1/0001

OFFICE: 311

ROUTE: 564

ST_REF_NO: 0000081440

GREENVILLE TERRACE

LUMENS	BULB TYPE	MULT SERIES	POLE TYPE	SHADE	ADDRESS NUMBER	REF	LOCATION	TAX DIST	DATE INST	DATE CHANGE
05800	S	M	CNT	II	05000	001		12	091503	1/1/0001
05800	S	M	CNT	II	05009	002		12	091503	1/1/0001
05800	S	M	CNT	II	05016	003		12	091503	1/1/0001
05800	S	M	CNT	II	05021	004		12	091503	1/1/0001
05800	S	M	CNT	III	05029	005		12	091503	1/1/0001

OFFICE: 311

ROUTE: 564

ST_REF_NO: 0000081455

GREENWAY COURT

LUMENS	BULB TYPE	MULT SERIES	POLE TYPE	SHADE	ADDRESS NUMBER	REF	LOCATION	TAX DIST	DATE INST	DATE CHANGE
05800	S	M	CNT	II	02816	002		12	072401	1/1/0001
05800	S	M	CNT	III	02825	001		12	072401	1/1/0001

OFFICE: 311

ROUTE: 564

ST_REF_NO: 0000081460 GREENWAY LANE

LUMENS	BULB TYPE	MULT SERIES	POLE TYPE	SHADE	ADDRESS NUMBER	REF	LOCATION	TAX DIST	DATE INST	DATE CHANGE
05800	S	M	CNT	II	00132	004		12	072401	1/1/0001
05800	S	M	CNT	II	00149	003		12	072401	1/1/0001
05800	S	M	CNT	II	00168	002		12	072401	1/1/0001
05800	S	M	CNT	II	00000	001	SIDE OF 2844 GATEWAY PARK LANE	12	030898	1/1/0001

OFFICE: 311

ROUTE: 564

ST_REF_NO: 0000081500 GREENWICH PIKE

LUMENS	BULB TYPE	MULT SERIES	POLE TYPE	SHADE	ADDRESS NUMBER	REF	LOCATION	TAX DIST	DATE INST	DATE CHANGE
05800	S	M	OUG	II	00000	041	SE CORNER OF FERGUSON ROAD	12	110800	1/1/0001
05800	S	M	OUG	II	00000	042	NW CORNER OF FERGUSON ROAD	12	110800	1/1/0001

OFFICE: 311

ROUTE: 564

ST_REF_NO: 0000081600 GREENWOOD AVENUE

LUMENS	BULB TYPE	MULT SERIES	POLE TYPE	SHADE	ADDRESS NUMBER	REF	LOCATION	TAX DIST	DATE INST	DATE CHANGE
05800	S	M	SOH	I	00000	050	SIDE OF 460 PRICE RD.	12	100769	1/1/0001
05800	S	M	SOH	I	00000	056	SIDE OF 851 GEORGETOWN RD.	12	100769	1/1/0001
05800	S	M	SOH	I	00441	052		12	100769	1/1/0001
05800	S	M	SOH	I	00443	053	upgraded 10/07	12	100769	1/1/0001
05800	S	M	SOH	I	00455	054	upgraded 10/07	12	100769	1/1/0001
05800	S	M	SOH	I	00465	055	upgraded 10/07	12	100769	1/1/0001
05800	S	M	SOH	I	00787	051		12	100769	1/1/0001

OFFICE: 311

ROUTE: 564

ST_REF_NO: 0000081700 GREGORY WAY

LUMENS	BULB TYPE	MULT SERIES	POLE TYPE	SHADE	ADDRESS NUMBER	REF	LOCATION	TAX DIST	DATE INST	DATE CHANGE
04000	S	M	OUG	II	00000	002	SIDE OF 3877 LEE ADAMS WAY	12	031581	1/1/0001
04000	S	M	OUG	II	00876	008		12	100892	1/1/0001
04000	S	M	OUG	II	00889	001		12	031581	1/1/0001
04000	S	M	OUG	II	00913	003		12	081582	1/1/0001
04000	S	M	OUG	II	00924	004		12	031581	1/1/0001
04000	S	M	OUG	II	00937	005		12	021583	1/1/0001
04000	S	M	OUG	II	00952	006		12	081582	1/1/0001
04000	S	M	OUG	II	00965	007		12	061581	1/1/0001

OFFICE: 311		ROUTE: 564		ST_REF_NO: 00000081710		GREVEY COURT		LUMENS	BULB TYPE	MULT SERIES	POLE TYPE	SHADE	ADDRESS NUMBER	REF	LOCATION	TAX DIST	DATE INST	DATE CHANGE
	05800	S	M	OUG	II	00000	137								SIDE OF 1257 WARD DR.	12	100374	1/1/0001
	05800	S	M	OUG	V	01245	138									12	100774	1/1/0001

OFFICE: 311		ROUTE: 564		ST_REF_NO: 00000081760		GREY OAK LANE		LUMENS	BULB TYPE	MULT SERIES	POLE TYPE	SHADE	ADDRESS NUMBER	REF	LOCATION	TAX DIST	DATE INST	DATE CHANGE
	05800	S	M	CNT	II	04504	001									12	060205	1/1/0001
	05800	S	M	CNT	II	04508	002									12	060205	1/1/0001

OFFICE: 311		ROUTE: 564		ST_REF_NO: 00000081800		GRIBBIN DRIVE		LUMENS	BULB TYPE	MULT SERIES	POLE TYPE	SHADE	ADDRESS NUMBER	REF	LOCATION	TAX DIST	DATE INST	DATE CHANGE
	05800	S	M	SOH	II	00000	006								REAR OF 2800 RICHMOND RD.	12	100884	1/1/0001
	05800	S	M	SOH	II	00000	007								REAR OF 2800 RICHMOND RD.	12	100884	1/1/0001
	05800	S	M	SOH	II	00000	008								REAR OF 3800 RICHMOND RD.	12	100884	1/1/0001
	05800	S	M	OUG	II	00000	009								SIDE OF 201 PATCHEN DR.	12	060574	1/1/0001
	05800	S	M	OUG	II	00000	010								SIDE OF 185 PATCHEN DR.	12	031476	1/1/0001
	05800	S	M	OUG	II	00000	011								SIDE OF 201 PATCHEN DR.	12	060574	1/1/0001
	05800	S	M	OUG	II	00000	012								SIDE OF 180 PATCHEN DR.	12	031476	1/1/0001
	05800	S	M	OUG	II	00000	013								SIDE OF 200 PATCHEN DR.	12	060574	1/1/0001

OFFICE: 311		ROUTE: 564		ST_REF_NO: 00000081810		GRIBBON DRIVE		LUMENS	BULB TYPE	MULT SERIES	POLE TYPE	SHADE	ADDRESS NUMBER	REF	LOCATION	TAX DIST	DATE INST	DATE CHANGE
	09500	S	M	OUG	II	00000	014								SIDE OF 200 PLEASANT PONTE DR.	12	080895	1/1/0001
	09500	S	M	OUG	II	00000	016								REAR OF 500 PLEASANT POINTE DR.	12	080895	1/1/0001
	09500	S	M	OUG	II	00000	017								REAR OF 2909 NALLY COURT	12	080895	1/1/0001
	09500	S	M	OUG	II	00000	018								SIDE OF 373 PLEASANT POINTE DRIVE	12	080895	1/1/0001
	09500	S	M	OUG	II	00000	019								SIDE OF 372 PLEASANT POINTE DRIVE	12	080895	1/1/0001

OFFICE: 311		ROUTE: 564		ST_REF_NO: 00000082100		GRINSTEAD STREET		LUMENS	BULB TYPE	MULT SERIES	POLE TYPE	SHADE	ADDRESS NUMBER	REF	LOCATION	TAX DIST	DATE INST	DATE CHANGE
	05800	S	M	SOH	I	00566	000									12	120257	1/1/0001
	05800	S	M	SOH	I	00000	001								1ST LT. E. OF RACE ST., S. SIDE	12	120257	1/1/0001

OFFICE: 311

ROUTE: 564

ST_REF_NO: 0000082100

GRINSTEAD STREET

LUMENS	BULB TYPE	MULT SERIES	POLE TYPE	SHADE	ADDRESS NUMBER	REF	LOCATION	TAX DIST	DATE INST	DATE CHANGE
05800	S	M	SOH	I	00000	002	BEHIND 513 E. THIRD ST.	12	120666	1/1/0001
05800	S	M	SOH	I	00542	000		12	020920	1/1/0001

OFFICE: 311

ROUTE: 564

ST_REF_NO: 0000082300

GROSVENOR AVENUE

LUMENS	BULB TYPE	MULT SERIES	POLE TYPE	SHADE	ADDRESS NUMBER	REF	LOCATION	TAX DIST	DATE INST	DATE CHANGE
05800	S	M	SOH	I	00306	000		12	010163	1/1/0001
05800	S	M	SOH	I	00322	000		12	010163	1/1/0001
05800	S	M	SOH	I	00326	000		12	010163	1/1/0001
05800	S	M	SOH	I	00342	000		12	010163	1/1/0001

OFFICE: 311

ROUTE: 564

ST_REF_NO: 0000082400

GROVE LANE

LUMENS	BULB TYPE	MULT SERIES	POLE TYPE	SHADE	ADDRESS NUMBER	REF	LOCATION	TAX DIST	DATE INST	DATE CHANGE
05800	S	M	OUG	V	00500	007	upgrade due to bad fixture	12	110885	10/1/2008
05800	S	M	OUG	II	00508	008	upgrade due to bad fixture	12	071581	10/1/2008
04000	S	M	OUG	II	00513	009		12	111580	1/1/0001
04000	S	M	OUG	II	00528	010		12	110885	1/1/0001

OFFICE: 311

ROUTE: 564

ST_REF_NO: 0000082520

GROVES POINT WAY

LUMENS	BULB TYPE	MULT SERIES	POLE TYPE	SHADE	ADDRESS NUMBER	REF	LOCATION	TAX DIST	DATE INST	DATE CHANGE
04000	S	M	OUG	II	00000	001	SIDE OF 428 PATCHEN DR.	12	020888	1/1/0001
04000	S	M	OUG	II	00416	002		12	020888	1/1/0001
04000	S	M	OUG	II	00429	003		12	020888	1/1/0001
04000	S	M	OUG	II	00437	004		12	020888	1/1/0001

OFFICE: 311

ROUTE: 564

ST_REF_NO: 0000082595

GUILFORD LANE

LUMENS	BULB TYPE	MULT SERIES	POLE TYPE	SHADE	ADDRESS NUMBER	REF	LOCATION	TAX DIST	DATE INST	DATE CHANGE
05800	S	M	CNT	II	00000	010	SIDE OF 1401 TUSCANY LANE ON GUILFORD LANE	12	112805	1/1/0001
05800	S	M	CNT	II	02204	001		12	081704	1/1/0001
05800	S	M	CNT	II	02208	002		12	081704	1/1/0001
05800	S	M	CNT	II	02213	003		12	081704	1/1/0001
05800	S	M	CNT	II	02220	004		12	112805	1/1/0001

OFFICE: 311		ROUTE: 564		ST_REF_NO: 0000082595		GUILFORD LANE				
LUMENS	BULB TYPE	MULT SERIES	POLE TYPE	SHADE	ADDRESS NUMBER	REF	LOCATION	TAX DIST	DATE INST	DATE CHANGE
05800	S	M	CNT	III	02245	005		12	081704	1/1/0001
05800	S	M	CNT	II	02249	006		12	081704	1/1/0001
05800	S	M	CNT	II	02260	007		12	112805	1/1/0001
05800	S	M	CNT	II	02264	008		12	112805	1/1/0001
05800	S	M	CNT	II	02272	009		12	112805	1/1/0001
05800	S	M	CNT	II	02284	011		12	112805	1/1/0001

OFFICE: 311		ROUTE: 564		ST_REF_NO: 0000082600		GUNBOW COURT				
LUMENS	BULB TYPE	MULT SERIES	POLE TYPE	SHADE	ADDRESS NUMBER	REF	LOCATION	TAX DIST	DATE INST	DATE CHANGE
05800	S	M	OUG	II	00000	154	SIDE OF 1329 CANONERO DR.	12	071476	1/1/0001

OFFICE: 311		ROUTE: 564		ST_REF_NO: 0000082610		GUMTREE LANE				
LUMENS	BULB TYPE	MULT SERIES	POLE TYPE	SHADE	ADDRESS NUMBER	REF	LOCATION	TAX DIST	DATE INST	DATE CHANGE
05800	S	M	CNT	II	04301	001		12	100894	1/1/0001
05800	S	M	CNT	II	04308	002		12	100894	1/1/0001
05800	S	M	CNT	II	04317	003		12	100894	1/1/0001
05800	S	M	CNT	II	04328	004		12	100894	1/1/0001
05800	S	M	CNT	II	04341	005		12	100894	1/1/0001
05800	S	M	CNT	II	04352	006		12	100894	1/1/0001

OFFICE: 311		ROUTE: 564		ST_REF_NO: 0000082700		GUNN STREET				
LUMENS	BULB TYPE	MULT SERIES	POLE TYPE	SHADE	ADDRESS NUMBER	REF	LOCATION	TAX DIST	DATE INST	DATE CHANGE
09500	S		SOH	II	00000	020	1ST LT E OF ELM TREE LN, S SIDE ON GUNN ST	12	082609	1/1/0001
05800	S	M	SOH	I	00000	009	OPP. 306	12	110266	1/1/0001
05800	S	M	SOH	I	00000	011	OPP. 416	12	110266	1/1/0001
05800	S	M	SOH	I	00319	010		12	110266	1/1/0001
05800	S	M	SOH	I	00403	007		12	040165	1/1/0001

OFFICE: 311		ROUTE: 564		ST_REF_NO: 0000082710		GULFSTREAM DRIVE				
LUMENS	BULB TYPE	MULT SERIES	POLE TYPE	SHADE	ADDRESS NUMBER	REF	LOCATION	TAX DIST	DATE INST	DATE CHANGE
05800	S	M	CNT	II	00000	001	NW CORNER OF ALEXANDIRA DR.	12	030895	1/1/0001

OFFICE: 311

ROUTE: 564

ST_REF_NO: 00000082710

GULFSTREAM DRIVE

LUMENS	BULB TYPE	MULT SERIES	POLE TYPE	SHADE	ADDRESS NUMBER	REF	LOCATION	TAX DIST	DATE INST	DATE CHANGE
05800	S	M	CNT	II	00000	002	SIDE REAR OF 2312 ALEXANDRIA DR.	12	030895	1/1/0001
05800	S	M	CNT	II	02209	005		12	040895	1/1/0001
05800	S	M	CNT	II	02216	004		12	040895	1/1/0001
05800	S	M	CNT	II	02233	003		12	040895	1/1/0001

OFFICE: 311

ROUTE: 564

ST_REF_NO: 00000082725

GUNPOWDER DRIVE

LUMENS	BULB TYPE	MULT SERIES	POLE TYPE	SHADE	ADDRESS NUMBER	REF	LOCATION	TAX DIST	DATE INST	DATE CHANGE
09500	S		CLN	II	00801	005		12	051609	1/1/0001
09500	S		CLN	II	00808	004		12	051609	1/1/0001
09500	S		CLN	II	00813	003		12	051609	1/1/0001
09500	S		CLN	II	00820	002		12	051609	1/1/0001
09500	S		CLN	II	00825	001		12	051609	5/16/2009

OFFICE: 311

ROUTE: 564

ST_REF_NO: 00000082800

GWINN COURT

LUMENS	BULB TYPE	MULT SERIES	POLE TYPE	SHADE	ADDRESS NUMBER	REF	LOCATION	TAX DIST	DATE INST	DATE CHANGE
04000	S	M	OUG	II	00404	009		12	081477	1/1/0001

OFFICE: 311

ROUTE: 564

ST_REF_NO: 00000082890

HABERSHAM COURT

LUMENS	BULB TYPE	MULT SERIES	POLE TYPE	SHADE	ADDRESS NUMBER	REF	LOCATION	TAX DIST	DATE INST	DATE CHANGE
05800	S	M	OUG	II	00202	098	upgrade per city request	12	020887	5/12/2010
05800	S	M	OUG	V	00218	099	upgrade per city request	12	020887	5/12/2010

OFFICE: 311

ROUTE: 564

ST_REF_NO: 00000082900

HABERSHAM DRIVE

LUMENS	BULB TYPE	MULT SERIES	POLE TYPE	SHADE	ADDRESS NUMBER	REF	LOCATION	TAX DIST	DATE INST	DATE CHANGE
09500	S		OUG	II	00000	070	1st LT N OF MOW BLVD, E SIDE ON HABERSHAM DR	12	040313	1/1/0001
04000	S	M	OUG	II	00000	032	SIDE OF 228 TIVERTON WAY	12	020887	1/1/0001
05800	S	M	OUG	II	00000	033	SIDE OF 201 KENLOCK DR.	12	020887	1/1/0001
05800	S	M	OUG	II	00000	035	SIDE OF 203 HABERSHAM CT.	12	020887	1/1/0001
05800	S	M	OUG	II	00000	039	SIDE OF 295 TANGLEY WAY	12	020887	1/1/0001
05800	S	M	OUG	II	00000	040	SIDE OF 294 TANGLEY WAY	12	020887	1/1/0001

OFFICE: 311

ROUTE: 564

ST_REF_NO: 0000082900

HABERSHAM DRIVE

LUMENS	BULB TYPE	MULT SERIES	POLE TYPE	SHADE	ADDRESS NUMBER	REF	LOCATION	TAX DIST	DATE INST	DATE CHANGE
05800	S	M	OUG	II	00000	042	OPP. 3878 HABERSHAM DRIVE	12	100892	1/1/0001
05800	S	M	OUG	II	03818	034		12	020887	1/1/0001
05800	S	M	OUG	II	03834	036		12	020887	1/1/0001
05800	S	M	OUG	II	03841	037		12	020887	1/1/0001
05800	S	M	OUG	II	03854	038		12	020887	1/1/0001
05800	S	M	OUG	II	03870	041		12	100892	1/1/0001

OFFICE: 311

ROUTE: 564

ST_REF_NO: 0000083000

HACKER COURT

LUMENS	BULB TYPE	MULT SERIES	POLE TYPE	SHADE	ADDRESS NUMBER	REF	LOCATION	TAX DIST	DATE INST	DATE CHANGE
04000	S	M	OUG	II	03701	031		12	061580	1/1/0001
04000	S	M	OUG	II	03708	032		12	061580	1/1/0001
04000	S	M	OUG	II	03717	033		12	061580	1/1/0001

OFFICE: 311

ROUTE: 564

ST_REF_NO: 0000083120

HADDON DRIVE

LUMENS	BULB TYPE	MULT SERIES	POLE TYPE	SHADE	ADDRESS NUMBER	REF	LOCATION	TAX DIST	DATE INST	DATE CHANGE
05800	S	M	OUG	II	00000	007	2ND LT N OF STONEWOOD DR, E SIDE ON HADDON DR	12	063003	1/1/0001
05800	S	M	OUG	II	00000	008	3RD LT N OF STONEWOOD DR, W SIDE ON HADDON DR	12	063003	1/1/0001
05800	S	M	OUG	II	00000	009	4TH LT N OF STONEWOOD DR, E SIDE ON HADDON DR	12	063003	1/1/0001
05800	S	M	OUG	II	00000	010	5TH LT N OF STONEWOOD DR, W SIDE ON HADDON DR	12	063003	1/1/0001
05800	S	M	OUG	II	00000	006	SIDE OF 2021 STONEWOOD LANE	12	020801	1/1/0001
05800	S	M	OUG	II	02157	005		12	020801	1/1/0001
05800	S	M	OUG	II	02164	004		12	020801	1/1/0001
05800	S	M	OUG	II	02187	003		12	020801	1/1/0001
05800	S	M	OUG	II	02197	002		12	020801	1/1/0001

OFFICE: 311

ROUTE: 564

ST_REF_NO: 0000083180

HADLOW STREET

LUMENS	BULB TYPE	MULT SERIES	POLE TYPE	SHADE	ADDRESS NUMBER	REF	LOCATION	TAX DIST	DATE INST	DATE CHANGE
05800	S	M	CNT	II	00000	050	SIDE OF 617 HADLOW STREET	12	030602	1/1/0001
05800	S	M	CNT	II	00521	008		12	030602	1/1/0001

OFFICE: 311		ROUTE: 564		ST_REF_NO: 0000083180		HADLOW STREET				
LUMENS	BULB TYPE	MULT SERIES	POLE TYPE	SHADE	ADDRESS NUMBER	REF	LOCATION	TAX DIST	DATE INST	DATE CHANGE
05800	S	M	CNT	II	00528	007		12	030602	1/1/0001
05800	S	M	CNT	II	00533	004		12	030602	1/1/0001
05800	S	M	CNT	II	00545	006		12	030602	1/1/0001
05800	S	M	CNT	II	00560	005		12	030602	1/1/0001
05800	S	M	CNT	II	00592	003		12	030602	1/1/0001
05800	S	M	CNT	II	00620	002		12	030602	1/1/0001
05800	S	M	CNT	II	00629	001		12	030602	1/1/0001

OFFICE: 311		ROUTE: 564		ST_REF_NO: 0000083200		HAGERMAN COURT				
LUMENS	BULB TYPE	MULT SERIES	POLE TYPE	SHADE	ADDRESS NUMBER	REF	LOCATION	TAX DIST	DATE INST	DATE CHANGE
04000	S	M	SOH	I	00000	523	1ST LT. S. OF E. HIGH ST., W. SIDE	12	100267	1/1/0001
04000	S	M	SOH	I	00000	526	OPP. FROM SIDE OF 126	12	062167	1/1/0001
04000	S	M	SOH	I	00000	527	SIDE OF 231 E. MAXWELL ST.	12	062167	1/1/0001
04000	S	M	SOH	I	00109	524		12	100267	1/1/0001
04000	S	M	SOH	I	00121	525		12	100267	1/1/0001

OFFICE: 311		ROUTE: 564		ST_REF_NO: 0000083280		HAGGAN PLACE				
LUMENS	BULB TYPE	MULT SERIES	POLE TYPE	SHADE	ADDRESS NUMBER	REF	LOCATION	TAX DIST	DATE INST	DATE CHANGE
05800	S	M	CNT	II	00701	001		12	120800	1/1/0001
05800	S	M	CNT	II	00708	002		12	120800	1/1/0001
05800	S	M	CNT	II	00721	003		12	120800	1/1/0001

OFFICE: 311		ROUTE: 564		ST_REF_NO: 0000083300		HAGGARD LANE				
LUMENS	BULB TYPE	MULT SERIES	POLE TYPE	SHADE	ADDRESS NUMBER	REF	LOCATION	TAX DIST	DATE INST	DATE CHANGE
22000	S	M	OUG	II	00000	006	SIDE OF 1828 BLUE RIDGE DR.	12	030171	9/18/2011
20000	M	M	OUG	II	00000	001	SIDE OF 1949 N. BROADWAY	12	030171	1/1/0001
20000	M	M	SOH	II	00000	002	OPP. SIDE REAR OF 1949 N. BROADWAY	12	030171	1/1/0001
20000	M	M	OUG	II	00000	004	OPP. 431	12	030171	1/1/0001
20000	M	M	OUG	II	00000	007	OPP. SIDE REAR 1829 BLUE RIDGE DR.	12	030171	1/1/0001
20000	M	M	OUG	II	00000	008	REAR OF 1785 BREWER DR.	12	030171	1/1/0001
22000	S	M	OUG	II	00000	009	OPP. REAR 1797 BREWER-upgrade 1/08 DTS	12	030171	1/1/0001

OFFICE: 311

ROUTE: 564

ST_REF_NO: 0000083300 Haggard Lane

LUMENS	BULB TYPE	MULT SERIES	POLE TYPE	SHADE	ADDRESS NUMBER	REF	LOCATION	TAX DIST	DATE INST	DATE CHANGE
20000	M	M	OUG	II	00425	003		12	030171	1/1/0001
20000	M	M	OUG	II	00443	005		12	030171	1/1/0001

OFFICE: 311

ROUTE: 564

ST_REF_NO: 0000083400 Haley Road

LUMENS	BULB TYPE	MULT SERIES	POLE TYPE	SHADE	ADDRESS NUMBER	REF	LOCATION	TAX DIST	DATE INST	DATE CHANGE
05800	S	M	OUG	II	00000	081	1ST LT S OF WILLOW LN ON W SIDE OF HALEY RD	12	051101	1/1/0001
05800	S	M	OUG	II	00000	082	1ST LT N OF WILLOW LN ON W SIDE OF HALEY RD	12	051101	1/1/0001
09500	S	M	SOH	II	00000	101	4TH LT. S OF BRIAR HILL RD., E SIDE	21	110800	1/1/0001
09500	S	M	SOH	II	00000	102	3RD LT. S OF BRIAR HILL RD., E SIDE	12	110800	1/1/0001
09500	S	M	SOH	II	00000	103	2ND LT. S OF BRIAR HILL ROAD, E SIDE	12	110800	1/1/0001
09500	S	M	SOH	II	00000	104	1ST LT. S OF BRIAR HILL ROAD, E SIDE	12	110800	1/1/0001

OFFICE: 311

ROUTE: 564

ST_REF_NO: 0000083450 Halford Place

LUMENS	BULB TYPE	MULT SERIES	POLE TYPE	SHADE	ADDRESS NUMBER	REF	LOCATION	TAX DIST	DATE INST	DATE CHANGE
05800	S		CNT	II	00000	001	SIDE OF 2649 ROCKAWAY PLACE ON HALFORD PLACE	12	080610	1/1/0001
05800	S		CNT	II	00000	002	SIDE OF 2665 ROCKAWAY PLACE ON HALFORD PLACE	12	080610	1/1/0001
05800	S		CNT	II	00000	003	SIDE OF 2400 ROCKAWAY PLACE ON HALFORD PLACE	12	080610	1/1/0001

OFFICE: 311

ROUTE: 564

ST_REF_NO: 0000083500 Halifax Court

LUMENS	BULB TYPE	MULT SERIES	POLE TYPE	SHADE	ADDRESS NUMBER	REF	LOCATION	TAX DIST	DATE INST	DATE CHANGE
04000	S	M	OUG	II	00000	037	SIDE 565 HALIFAX DR.	12	100885	1/1/0001

OFFICE: 311

ROUTE: 564

ST_REF_NO: 0000083600 Halifax Drive

LUMENS	BULB TYPE	MULT SERIES	POLE TYPE	SHADE	ADDRESS NUMBER	REF	LOCATION	TAX DIST	DATE INST	DATE CHANGE
04000	S	M	OUG	II	00000	035	SIDE 3436 STILLWATER RD.	12	100885	1/1/0001
04000	S	M	OUG	II	00000	103	SIDE 3406 WALLINGFORD DR.	12	100885	1/1/0001
04000	S	M	OUG	II	00562	036		12	100885	1/1/0001
04000	S	M	OUG	II	00579	105		12	100885	1/1/0001
04000	S	M	OUG	II	00590	104		12	100885	1/1/0001

OFFICE: 311 ROUTE: 564										
ST_REF_NO: 0000083600 HALIFAX DRIVE										
LUMENS	BULB TYPE	MULT SERIES	POLE TYPE	SHADE	ADDRESS NUMBER	REF	LOCATION	TAX DIST	DATE INST	DATE CHANGE
04000	S	M	OUG	II	00607	102		12	100885	1/1/0001
04000	S	M	OUG	II	00616	145		12	100885	1/1/0001
04000	S	M	OUG	II	00627	144		12	100885	1/1/0001
04000	S	M	OUG	II	00640	143		12	100885	1/1/0001
04000	S	M	OUG	II	00651	142		12	100885	1/1/0001
04000	S	M	OUG	II	00660	141		12	100885	1/1/0001
04000	S	M	OUG	II	00675	140		12	100885	1/1/0001
04000	S	M	OUG	II	00688	139		12	100885	1/1/0001
04000	S	M	OUG	II	00699	138		12	100885	1/1/0001
04000	S	M	OUG	II	00541	027		12	100885	1/1/0001

OFFICE: 311 ROUTE: 564

ST_REF_NO: 0000083710 HALLS ALLEY										
LUMENS	BULB TYPE	MULT SERIES	POLE TYPE	SHADE	ADDRESS NUMBER	REF	LOCATION	TAX DIST	DATE INST	DATE CHANGE
05800	S	M	SOH	II	00000	001	OPP. FROM SIDE OF 514 CHESTNUT ST.	12	091582	1/1/0001

OFFICE: 311 ROUTE: 564

ST_REF_NO: 0000083800 HALLS LANE										
LUMENS	BULB TYPE	MULT SERIES	POLE TYPE	SHADE	ADDRESS NUMBER	REF	LOCATION	TAX DIST	DATE INST	DATE CHANGE
05800	S	M	SOH	II	00000	002	1ST LT S OF CHESTNUT ST,WEST SIDE ON HALLS LANE	12	090803	1/1/0001
05800	S	M	SOH	II	00000	003	3RD LT S OF CHESTNUT ST,NORTH SIDE ON HALLS LANE	12	090803	1/1/0001
09500	S	M	SOH	II	00000	001	1ST LT. N. OF VERSAILLES RD., E. SIDE	12	121578	1/1/0001
09500	S	M	SOH	II	00000	999	2ND LT. N. OF VERSAILLES ROAD ON EASTSIDE	12	070891	1/1/0001
09500	S	M	SOH	II	00102	003		12	121578	1/1/0001
09500	S	M	SOH	II	00110	004		12	121578	1/1/0001
09500	S	M	SOH	II	00116	005		12	121578	1/1/0001
09500	S	M	SOH	II	00122	006		12	121578	1/1/0001
09500	S	M	SOH	II	00126	007		12	121578	1/1/0001

OFFICE: 311 ROUTE: 564

ST_REF_NO: 0000083900 HALSTEAD COURT										
LUMENS	BULB TYPE	MULT SERIES	POLE TYPE	SHADE	ADDRESS NUMBER	REF	LOCATION	TAX DIST	DATE INST	DATE CHANGE
05800	S	M	OUG	II	00000	020	SIDE OF 448 ASBURY LANE	12	060170	1/1/0001

OFFICE: 311

ROUTE: 564

ST_REF_NO: 0000083900

HALSTEAD COURT

LUMENS	BULB TYPE	MULT SERIES	POLE TYPE	SHADE	ADDRESS NUMBER	REF	LOCATION	TAX DIST	DATE INST	DATE CHANGE
05800	S	M	OUG	V	01575	040		12	010172	1/1/0001
05800	S	M	OUG	II	01587	000		12	100170	1/1/0001

OFFICE: 311

ROUTE: 564

ST_REF_NO: 0000084000

HAMBRICK AVENUE

LUMENS	BULB TYPE	MULT SERIES	POLE TYPE	SHADE	ADDRESS NUMBER	REF	LOCATION	TAX DIST	DATE INST	DATE CHANGE
04000	S	S	SOH	II	00700	000		12	111463	1/1/0001
04000	S	M	SOH	II	00717	000		12	111463	1/1/0001
04000	S	M	SOH	II	00000	001	NW CORNER OF HAMBRICK AND ASHLAND	12	111463	1/1/0001
04000	S	M	SOH	II	00726	000		12	111463	1/1/0001

OFFICE: 311

ROUTE: 564

ST_REF_NO: 0000084100

HAMILTON PARK

LUMENS	BULB TYPE	MULT SERIES	POLE TYPE	SHADE	ADDRESS NUMBER	REF	LOCATION	TAX DIST	DATE INST	DATE CHANGE
09500	S		SOH	II	00155	050		12	092409	1/1/0001
22000	S	M	SOH	II	00000	002	CORNER OF VERSAILLES RD. & HAMILTON PARK	12	121578	12/3/2009
09500	S	M	OUG	II	00000	001	SIDE OF 204 LONDONDERRY DR.	12	050160	1/1/0001
09500	S	M	SOH	II	00109	003		12	121578	1/1/0001
09500	S	M	SOH	II	00114	004		12	030886	1/1/0001
09500	S	M	SOH	II	00117	005		12	121578	1/1/0001
09500	S	M	SOH	II	00125	006		12	030886	1/1/0001
09500	S	M	SOH	II	00133	007		12	121578	1/1/0001
09500	S	M	SOH	II	00136	008		12	030886	1/1/0001
09500	S	M	SOH	II	00147	009		12	121578	1/1/0001
09500	S	M	SOH	II	00148	010		12	030886	1/1/0001
09500	S	M	OUG	II	00159	000		12	010162	1/1/0001
09500	S	M	OUG	II	00201	000		12	120960	1/1/0001
09500	S	M	OUG	II	00212	000		12	120660	1/1/0001

OFFICE: 311

ROUTE: 564

ST_REF_NO: 0000084190

HAMM ALLEY

LUMENS	BULB TYPE	MULT SERIES	POLE TYPE	SHADE	ADDRESS NUMBER	REF	LOCATION	TAX DIST	DATE INST	DATE CHANGE
05800	S	M	SOH	II	00000	001	200' N. OF ANGLIANA AVE.	12	100769	1/1/0001

OFFICE: 311		ROUTE: 564		ST_REF_NO: 0000084198		HAMMOCK OAK LANE		TAX DIST	DATE INST	DATE CHANGE
LUMENS	BULB TYPE	MULT SERIES	POLE TYPE	SHADE	ADDRESS NUMBER	REF	LOCATION			
05800	S	M	CNT	II	00901	001		12	050905	1/1/0001
05800	S	M	CNT	II	00912	002		12	050905	1/1/0001
05800	S	M	CNT	II	00925	003		12	050905	1/1/0001
05800	S	M	CNT	II	00932	004		12	050905	1/1/0001
05800	S	M	CNT	II	00941	005		12	050905	1/1/0001
05800	S	M	CNT	II	00960	006		12	050905	1/1/0001
05800	S	M	CNT	II	00961	007		12	052703	1/1/0001
05800	S	M	CNT	II	00976	008		12	050905	1/1/0001
OFFICE: 311		ROUTE: 564		ST_REF_NO: 0000084200		HAMMOND AVENUE		TAX DIST	DATE INST	DATE CHANGE
LUMENS	BULB TYPE	MULT SERIES	POLE TYPE	SHADE	ADDRESS NUMBER	REF	LOCATION			
05800	S	M	SOH	I	00000	438	OPP. 1248	12	071367	1/1/0001
05800	S	M	SOH	I	00000	439	OPP. 1236	12	071367	1/1/0001
05800	S	M	SOH	I	00000	440	OPP. 1226	12	071367	1/1/0001
05800	S	M	SOH	I	01208	441		12	071367	1/1/0001
OFFICE: 311		ROUTE: 564		ST_REF_NO: 0000084400		HAMPTON COURT		TAX DIST	DATE INST	DATE CHANGE
LUMENS	BULB TYPE	MULT SERIES	POLE TYPE	SHADE	ADDRESS NUMBER	REF	LOCATION			
04000	S	M	OUG	I	00000	001	1ST LT. E. OF 455 3RD ST.	12	111583	1/1/0001
04000	S	M	OUG	I	00000	002	2ND LT. SIDE OF 455 3RD ST.	12	111583	1/1/0001
04000	S	M	SOH	I	00000	003	OPP. 25, IN MEDIAN	12	111583	1/1/0001
04000	S	M	SOH	I	00000	004	OPP. 310, IN MEDIAN	12	111583	1/1/0001
04000	S	M	SOH	I	00000	005	OPP. 75, IN MEDIAN	12	111583	1/1/0001
04000	S	M	SOH	I	00000	006	OPP. 324, IN MEDIAN	12	111583	1/1/0001
04000	S	M	SOH	I	00000	007	OPP. 101, IN MEDIAN	12	111583	1/1/0001
04000	S	M	SOH	I	00000	008	OPP. 334, IN MEDIAN	12	111583	1/1/0001
04000	S	M	SOH	I	00000	009	OPP. 105, IN MEDIAN	12	111583	1/1/0001
04000	S	M	SOH	I	00000	010	OPP. 360, IN MEDIAN	12	111583	1/1/0001

OFFICE: 311		ROUTE: 564		ST_REF_NO: 0000084490		HANCOCK LANE		LUMENS	BULB TYPE	MULT SERIES	POLE TYPE	SHADE	ADDRESS NUMBER	REF	LOCATION	TAX DIST	DATE INST	DATE CHANGE
05800	S	M	CNT	II	00000	001	SIDE OF 2097 ALLEGHENY ON HANCOCK LANE		12	071001	1/1/0001							
05800	S	M	CNT	II	01112	002			12	071001	1/1/0001							

OFFICE: 311		ROUTE: 564		ST_REF_NO: 0000084603		HANNA PLACE		LUMENS	BULB TYPE	MULT SERIES	POLE TYPE	SHADE	ADDRESS NUMBER	REF	LOCATION	TAX DIST	DATE INST	DATE CHANGE
05800	S	M	CNT	III	00613	002			12	120203	1/1/0001							
05800	S	M	CNT	II	00628	001			12	120203	1/1/0001							
05800	S	M	OUG	II	02802	001			12	080800	1/1/0001							
05800	S	M	OUG	II	02814	002			12	080800	1/1/0001							
05800	S	M	OUG	II	02831	003			12	080800	1/1/0001							
05800	S	M	OUG	III	02848	004			12	080800	1/1/0001							

OFFICE: 311		ROUTE: 564		ST_REF_NO: 0000084604		HANNAH TODD PLACE		LUMENS	BULB TYPE	MULT SERIES	POLE TYPE	SHADE	ADDRESS NUMBER	REF	LOCATION	TAX DIST	DATE INST	DATE CHANGE
05800	S	M	CNT	II	00208	012			12	050808	1/1/0001							
05800	S	M	CNT	II	00224	001			12	050808	1/1/0001							
05800	S	M	CNT	II	00228	002			12	050808	1/1/0001							
05800	S	M	CNT	II	00240	003			12	050808	1/1/0001							
05800	S	M	CNT	II	00256	004			12	050808	1/1/0001							
05800	S	M	CNT	II	00264	005			12	050808	1/1/0001							
05800	S	M	CNT	II	00280	006			12	050808	1/1/0001							
05800	S	M	CNT	II	00288	007			12	050808	1/1/0001							

OFFICE: 311		ROUTE: 564		ST_REF_NO: 0000084605		HANNIBAL COURT		LUMENS	BULB TYPE	MULT SERIES	POLE TYPE	SHADE	ADDRESS NUMBER	REF	LOCATION	TAX DIST	DATE INST	DATE CHANGE
04000	S	M	OUG	II	02000	012			12	121579	1/1/0001							
04000	S	M	OUG	V	02013	013			12	121579	1/1/0001							

OFFICE: 311		ROUTE: 564		ST_REF_NO: 0000084610		HANOVER EXT. AVENUE		LUMENS	BULB TYPE	MULT SERIES	POLE TYPE	SHADE	ADDRESS NUMBER	REF	LOCATION	TAX DIST	DATE INST	DATE CHANGE
04000	S	M	SOH	II	00319	315			12	100666	1/1/0001							

OFFICE: 311

ROUTE: 564

ST_REF_NO: 0000084610

HANOVER EXT. AVENUE

LUMENS	BULB TYPE	MULT SERIES	POLE TYPE	SHADE	ADDRESS NUMBER	REF	LOCATION	TAX DIST	DATE INST	DATE CHANGE
04000	S	M	SOH	II	00327	316		12	100666	1/1/0001
04000	S	M	SOH	II	00309	314		12	100666	1/1/0001

OFFICE: 311

ROUTE: 564

ST_REF_NO: 0000084700

HANOVER, NORTH AVENUE

LUMENS	BULB TYPE	MULT SERIES	POLE TYPE	SHADE	ADDRESS NUMBER	REF	LOCATION	TAX DIST	DATE INST	DATE CHANGE
05800	S		SOH	II	00191	100		12	120808	1/1/0001
04000	S	S	SOH	II	00000	325	SIDE OF 829 CRAMER AVE.	12	100666	1/1/0001
04000	S	S	SOH	II	00000	326	SIDE OF 824 AURORA AVE.	12	100666	1/1/0001
04000	S	M	SOH	II	00106	317		12	100666	1/1/0001
04000	S	S	SOH	II	00125	318		12	100666	1/1/0001
04000	S	M	SOH	II	00144	319		12	100666	1/1/0001
04000	S	S	SOH	II	00159	320		12	100666	1/1/0001
04000	S	M	SOH	II	00172	321		12	100666	1/1/0001
04000	S	S	SOH	II	00187	322		12	100666	1/1/0001
04000	S	M	SOH	II	00196	323		12	100666	1/1/0001

OFFICE: 311

ROUTE: 564

ST_REF_NO: 0000084710

HANOVER, SOUTH AVENUE

LUMENS	BULB TYPE	MULT SERIES	POLE TYPE	SHADE	ADDRESS NUMBER	REF	LOCATION	TAX DIST	DATE INST	DATE CHANGE
05800	S	M	OUG	I	00000	002	IN FRONT OF 101, IN MEDIAN	12	071868	1/1/0001
05800	S	M	OUG	I	00000	003	IN FRONT OF 120, IN MEDIAN	12	071868	1/1/0001
05800	S	M	OUG	I	00000	004	IN FRONT OF 123, IN MEDIAN	12	071868	1/1/0001
05800	S	M	OUG	I	00000	005	IN FRONT OF 128, IN MEDIAN	12	071868	1/1/0001
05800	S	M	OUG	I	00000	006	IN FRONT OF 141, IN MEDIAN	12	071868	1/1/0001
05800	S	M	SOH	I	00000	007	AT HANOVER AND FINCASTLE, IN ISLAND	12	071868	1/1/0001
05800	S	M	OUG	I	00000	008	IN FRONT OF 201, IN MEDIAN	12	071868	1/1/0001
05800	S	M	OUG	I	00000	009	IN FRONT OF 210, IN MEDIAN	12	071868	1/1/0001
05800	S	M	OUG	I	00000	010	IN FRONT OF 219, IN MEDIAN	12	071868	1/1/0001
05800	S	M	OUG	I	00000	011	IN FRONT OF 224, IN MEDIAN	12	071868	1/1/0001
05800	S	M	OUG	I	00000	012	IN FRONT OF 229, IN MEDIAN	12	071868	1/1/0001
05800	S	M	OUG	I	00000	013	IN FRONT OF 232, IN MEDIAN	12	071868	1/1/0001
05800	S	M	OUG	I	00000	014	IN FRONT OF 241, IN MEDIAN	12	071868	1/1/0001
05800	S	M	OUG	I	00000	016	AT HANOVER AND SLASHES, IN ISLAND	12	071868	1/1/0001

OFFICE: 311		ROUTE: 564		ST_REF_NO: 0000084710		HANOVER, SOUTH AVENUE				
LUMENS	BULB TYPE	MULT SERIES	POLE TYPE	SHADE	ADDRESS NUMBER	REF	LOCATION	TAX DIST	DATE INST	DATE CHANGE
05800	S	M	OUG	I	00000	017	IN FRONT OF 249, IN MEDIAN	12	071868	1/1/0001
05800	S	M	OUG	I	00000	018	IN FRONT OF 248, IN MEDIAN	12	071868	1/1/0001
05800	S	M	OUG	I	00000	019	IN FRONT OF 261, IN MEDIAN	12	071868	1/1/0001
05800	S	M	OUG	I	00000	020	IN FRONT OF 272, IN MEDIAN	12	071868	1/1/0001
05800	S	M	OUG	I	00000	021	ON FRONT OF 269, IN MEDIAN	12	071868	1/1/0001
05800	S	M	OUG	I	00000	022	IN FRONT OF 308, IN MEDIAN	12	071868	1/1/0001
05800	S	M	OUG	I	00000	023	IN FRONT OF 301, IN MEDIAN	12	071868	1/1/0001
05800	S	M	SOH	I	00000	024	IN FRONT OF 314, IN MEDIAN	12	071868	1/1/0001
05800	S	M	SOH	I	00000	025	IN FRONT OF 309, IN MEDIAN	12	071868	1/1/0001
05800	S	M	SOH	I	00100	001		12	071868	1/1/0001
05800	S	M	OUG	I	00247	015		12	071868	1/1/0001

OFFICE: 311

ROUTE: 564

OFFICE: 311		ROUTE: 564		ST_REF_NO: 0000084800		HAPGOOD LANE				
LUMENS	BULB TYPE	MULT SERIES	POLE TYPE	SHADE	ADDRESS NUMBER	REF	LOCATION	TAX DIST	DATE INST	DATE CHANGE
04000	S	M	OUG	II	03800	048		12	091579	1/1/0001
04000	S	M	OUG	II	03813	047		12	091579	1/1/0001
04000	S	M	OUG	II	03820	046		12	091579	1/1/0001
04000	S	M	OUG	II	03836	044		12	091579	1/1/0001
04000	S	M	OUG	II	03837	045		12	091579	1/1/0001

OFFICE: 311

ROUTE: 564

OFFICE: 311		ROUTE: 564		ST_REF_NO: 0000085000		HARBISON ROAD				
LUMENS	BULB TYPE	MULT SERIES	POLE TYPE	SHADE	ADDRESS NUMBER	REF	LOCATION	TAX DIST	DATE INST	DATE CHANGE
05800	S	M	OOH	II	00000	001	1ST LT. N. OF MERCER RD., W. SIDE	12	010165	1/1/0001
05800	S	M	OOH	II	00000	002	1ST LT. N. OF MERCER RD., E. SIDE	12	010165	1/1/0001
05800	S	M	OOH	II	00000	003	2ND LT. N. OF MERCER RD., W. SIDE	12	010165	1/1/0001
05800	S	M	OOH	II	00000	004	2ND LT. N. OF MERCER RD., E. SIDE	12	010165	1/1/0001
05800	S	M	OOH	II	00000	005	3RD LT. N. OF MERCER RD., W. SIDE	12	010165	1/1/0001
05800	S	M	OOH	II	00000	006	3RD LT. N. OF MERCER RD., E. SIDE	12	010165	1/1/0001
05800	S	M	OOH	II	00000	007	4TH LT. N. OF MERCER RD., W. SIDE	12	010165	1/1/0001
05800	S	M	OOH	II	00000	008	4TH LT. N. OF MERCER RD., E. SIDE	12	010165	1/1/0001
05800	S	M	OOH	II	00000	009	5TH LT. N. OF MERCER RD., W. SIDE	12	010165	1/1/0001
05800	S	M	OOH	II	00000	010	5TH LT. N. OF MERCER RD.,E. SIDE	12	010165	1/1/0001

OFFICE: 311		ROUTE: 564		ST_REF_NO: 0000085000		HARBISON ROAD				
LUMENS	BULB TYPE	MULT SERIES	POLE TYPE	SHADE	ADDRESS NUMBER	REF	LOCATION	TAX DIST	DATE INST	DATE CHANGE
05800	S	M	OOH	II	00000	011	6TH LT. N. OF MERCER RD., E. SIDE	12	010165	1/1/0001
05800	S	M	OOH	II	00000	012	6TH LT. N. OF MERCER RD., W. SIDE	12	010165	1/1/0001
05800	S	M	OOH	II	00000	013	7TH LT. N. OF MERCER RD., E. SIDE	12	010165	1/1/0001
OFFICE: 311		ROUTE: 564		ST_REF_NO: 0000085150		HARKEN CT				
LUMENS	BULB TYPE	MULT SERIES	POLE TYPE	SHADE	ADDRESS NUMBER	REF	LOCATION	TAX DIST	DATE INST	DATE CHANGE
04000	S	M	SOH	I	00000	001	SIDE 523 TONER ON HARKEN CT	12	050891	1/1/0001
04000	S	M	SOH	I	00105	002		12	050891	1/1/0001
OFFICE: 311		ROUTE: 564		ST_REF_NO: 0000085170		HARLAN CIRCLE				
LUMENS	BULB TYPE	MULT SERIES	POLE TYPE	SHADE	ADDRESS NUMBER	REF	LOCATION	TAX DIST	DATE INST	DATE CHANGE
05800	S	M	OUG	II	01101	001		12	072707	1/1/0001
05800	S	M	OUG	II	01109	002		12	072707	1/1/0001
05800	S	M	OUG	II	01129	003		12	072707	1/1/0001
05800	S	M	OUG	II	01141	004		12	072707	1/1/0001
OFFICE: 311		ROUTE: 564		ST_REF_NO: 0000085200		HARMONY COURT				
LUMENS	BULB TYPE	MULT SERIES	POLE TYPE	SHADE	ADDRESS NUMBER	REF	LOCATION	TAX DIST	DATE INST	DATE CHANGE
05800	S	M	OUG	II	02084	000		12	101774	1/1/0001
05800	S	M	OUG	II	02091	139		12	091477	1/1/0001
OFFICE: 311		ROUTE: 564		ST_REF_NO: 0000085400		HARPER COURT				
LUMENS	BULB TYPE	MULT SERIES	POLE TYPE	SHADE	ADDRESS NUMBER	REF	LOCATION	TAX DIST	DATE INST	DATE CHANGE
05800	S	M	OUG	II	00000	023	SIDE OF 540 LIN WAL DR.	12	040166	1/1/0001
OFFICE: 311		ROUTE: 564		ST_REF_NO: 0000085500		HARR CIRCLE				
LUMENS	BULB TYPE	MULT SERIES	POLE TYPE	SHADE	ADDRESS NUMBER	REF	LOCATION	TAX DIST	DATE INST	DATE CHANGE
05800	S	M	OUG	II	00000	048	SIDE OF 2326 PIERSON DR.	12	100171	1/1/0001

OFFICE: 311

ROUTE: 564

ST_REF_NO: 0000085503

HARRINGTON COURT

LUMENS	BULB TYPE	MULT SERIES	POLE TYPE	SHADE	ADDRESS NUMBER	REF	LOCATION	TAX DIST	DATE INST	DATE CHANGE
05800	S	M	OUG	II	01300	001		12	070908	1/1/0001
05800	S	M	OUG	II	01309	002		12	070908	1/1/0001
05800	S	M	OUG	II	01321	003		12	070908	1/1/0001

OFFICE: 311

ROUTE: 564

ST_REF_NO: 0000085510

HARRIS COURT

LUMENS	BULB TYPE	MULT SERIES	POLE TYPE	SHADE	ADDRESS NUMBER	REF	LOCATION	TAX DIST	DATE INST	DATE CHANGE
05800	S	M	OUG	II	00000	139	SIDE OF 903 Ward Dr	12	041476	9/9/2009

OFFICE: 311

ROUTE: 564

ST_REF_NO: 0000085700

HARRODSBURG ROAD

LUMENS	BULB TYPE	MULT SERIES	POLE TYPE	SHADE	ADDRESS NUMBER	REF	LOCATION	TAX DIST	DATE INST	DATE CHANGE
22000	S		OUG	II	02452	111		12	100311	1/1/0001
22000	S	M	OOH	III	00000	015	OPPOSITE 1642	12	110761	9/9/2009
22000	S	M	SOH	II	00000	019	OPPOSITE 1642	12	110761	7/19/2013
22000	S	M	OOH	III	00000	029	OPPOSITE DELLA DR.	12	110761	9/9/2009
22000	S	M	OOH	III	00000	037	SIDE OF 631 BLUE ASH DRIVE	12	110761	9/9/2009
22000	S	M	SOH	III	00000	050	IN ISLAND, SW CORNER OF LANE ALLEN & HARRODSBURG	12	110761	9/9/2009
20000	M	M	OUG	II	00000	066	OPP SPRINGRIDGE DR	12	101475	9/9/2009
22000	S	M	OUG	II	00000	096	OPPOSITE BURBANK DR.	12	111475	9/9/2009
20000	M	M	OUG	II	00000	100	OPPOSITE 2400	12	111475	9/9/2009
20000	M	M	OUG	II	00000	106	OPP. 2444	12	110884	9/9/2009
22000	S	M	OUG	II	00000	109	OPPOSITE PASADENA DR. - bad fixture	12	110884	10/6/2010
50000	S	M	OUG	III	00000	135	1ST LT W OF CORPORATE DR ON S SIDE OF HARRODSBURG	12	042601	1/1/0001
22000	S	M	OUG	III	00000	136	1ST LT W OF CORPORATE DR ON N SIDE OF HARRODSBURG	12	042601	1/1/0001
22000	S	M	OUG	III	00000	137	2ND LT W OF CORPORATE DR ON S SIDE OF HARRODSBURG	12	042601	1/1/0001
22000	S	M	OUG	III	00000	138	2ND LT W OF CORPORATE DR ON N SIDE OF HARRODSBURG	12	042601	1/1/0001
22000	S	M	OUG	III	00000	139	3RD LT W OF CORPORATE DR ON S SIDE OF HARRODSBURG	12	042601	1/1/0001
22000	S	M	OUG	III	00000	140	3RD LT W OF CORPORATE DR ON N SIDE OF HARRODSBURG	12	042601	1/1/0001

OFFICE: 311

ROUTE: 564

ST_REF_NO: 0000085700

HARRODSBURG ROAD

LUMENS	BULB TYPE	MULT SERIES	POLE TYPE	SHADE	ADDRESS NUMBER	REF	LOCATION	TAX DIST	DATE INST	DATE CHANGE
22000	S	M	OUG	III	00000	141	4TH LT W OF CORPORATE DR ON S SIDE OF HARRODSBURG	12	042601	1/1/0001
22000	S	M	OUG	III	00000	142	4TH LT W OF CORPORATE DR ON N SIDE OF HARRODSBURG	12	042601	1/1/0001
22000	S	M	OUG	III	00000	143	5TH LT W OF CORPORATE DR ON S SIDE OF HARRODSBURG	12	042601	1/1/0001
22000	S	M	OUG	III	00000	144	5TH LT W OF CORPORATE DR ON N SIDE OF HARRODSBURG	12	042601	1/1/0001
22000	S	M	OUG	III	00000	145	6TH LT W OF CORPORATE DR ON S SIDE OF HARRODSBURG	12	042601	1/1/0001
50000	S	M	OUG	III	00000	146	OPPOSITE ARROWHEAD DR ON N SIDE OF HARRODSBURG	12	042601	1/1/0001
50000	S	M	OUG	III	00000	147	1ST LT W OF ARROWHEAD DR ON S SIDE OF HARRODSBURG	12	042601	1/1/0001
22000	S	M	OUG	III	00000	148	1ST LT W OF ARROWHEAD ON N SIDE OF HARRODSBURG	12	042601	1/1/0001
22000	S	M	OUG	III	00000	149	2ND LT W OF ARROWHEAD ON S SIDE OF HARRODSBURG	12	042601	1/1/0001
22000	S	M	OUG	III	00000	150	2ND LT W OF ARROWHEAD ON N SIDE OF HARRODSBURG	12	042601	1/1/0001
22000	S	M	OUG	III	00000	151	3RD LT W OF ARROWHEAD ON S SIDE OF HARRODSBURG	12	042601	1/1/0001
22000	S	M	OUG	III	00000	152	3RD LT W OF ARROWHEAD ON N SIDE OF HARRODSBURG	12	042601	1/1/0001
22000	S	M	OUG	III	00000	153	4TH LT W OF ARROWHEAD ON S SIDE OF HARRODSBURG	12	042601	1/1/0001
22000	S	M	OUG	III	00000	154	4TH LT W OF ARROWHEAD ON N SIDE OF HARRODSBURG	12	042601	1/1/0001
22000	S	M	OUG	III	00000	155	5TH LT W OF ARROWHEAD ON S SIDE OF HARRODSBURG	12	042601	1/1/0001
22000	S	M	OUG	III	00000	156	5TH LT W OF ARROWHEAD DR ON N SIDE OF HARRODSBURG	12	042601	1/1/0001
22000	S	M	OUG	III	00000	157	6TH LT W OF ARROWHEAD ON S SIDE OF HARRODSBURG	12	042601	1/1/0001
22000	S	M	OUG	III	00000	158	6TH LT W OF ARROWHEAD ON N SIDE OF HARRODSBURG	12	042601	1/1/0001
22000	S	M	OUG	III	00000	159	7TH LT W OF ARROWHEAD ON S SIDE OF HARRODSBURG	12	042601	1/1/0001
22000	S	M	OUG	III	00000	160	7TH LT W OF ARROWHEAD ON N SIDE OF HARRODSBURG	12	042601	1/1/0001

OFFICE: 311

ROUTE: 564

ST_REF_NO: 0000085700

HARRODSBURG ROAD

LUMENS	BULB TYPE	MULT SERIES	POLE TYPE	SHADE	ADDRESS NUMBER	REF	LOCATION	TAX DIST	DATE INST	DATE CHANGE
22000	S	M	OUG	III	00000	161	8TH LT W OF ARROWHEAD ON S SIDE OF HARRODSBURG	12	042601	1/1/0001
22000	S	M	OUG	III	00000	162	8TH LT W OF ARROWHEAD DR ON N SIDE OF HARRODSBURG	12	042601	1/1/0001
50000	S	M	OUG	III	00000	163	9TH LT W OF ARROWHEAD ON S SIDE OF HARRODSBURG	12	042601	1/1/0001
50000	S	M	OUG	III	00000	164	1ST LT W OF FT HARRODS ON N SIDE OF HARRODSBURG	12	042601	9/9/2009
22000	S	M	OUG	III	00000	165	1ST LT W OF FT HARRODS ON S SIDE OF HARRODSBURG	12	042601	1/1/0001
22000	S	M	OUG	III	00000	166	2ND LT W OF FT HARRODS ON N SIDE OF HARRODSBURG	12	042601	1/1/0001
22000	S	M	OUG	III	00000	167	2ND LT W OF FT HARRODS ON S SIDE OF HARRODSBURG	12	042601	1/1/0001
22000	S	M	OUG	III	00000	168	3RD LT W OF FT HARRODS ON N SIDE OF HARRODSBURG	12	042601	1/1/0001
22000	S	M	OUG	III	00000	169	3RD LT W OF FT HARRODS ON S SIDE OF HARRODSBURG	12	042601	1/1/0001
22000	S	M	OUG	III	00000	170	4TH LT W OF FT HARRODS ON N SIDE OF HARRODSBURG	12	042601	1/1/0001
22000	S	M	OUG	III	00000	171	OPPOSITE CAVE HILL LN ON S SIDE OF HARRODSBURG	12	042601	1/1/0001
22000	S	M	OUG	II	00000	172	1ST LT W OF CAVE HILL LN, N SIDE OF HARRODSBURG RD	12	071202	9/9/2009
22000	S	M	OUG	III	00000	173	1ST LT W OF CAVE HILL LN ON S SIDE OF HARRODSBURG	12	042601	1/1/0001
22000	S	M	OUG	II	00000	174	2ND LT W OF CAVE HILL LN, N SIDE ON HARRODSBURG RD	12	071202	9/9/2009
50000	S	M	OUG	III	00000	175	2ND LT W OF CAVE HILL LN ON S SIDE OF HARRODSBURG	12	042601	1/1/0001
50000	S	M	OUG	III	00000	176	3RD LT W OF CAVE HILL LN ON N SIDE OF HARRODSBURG	12	042601	1/1/0001
22000	S	M	OUG	III	00000	177	3RD LT W OF CAVE HILL LN ON S SIDE OF HARRODSBURG	12	042601	1/1/0001
22000	S	M	OUG	III	00000	178	4TH LT W OF CAVE HILL LN ON N SIDE OF HARRODSBURG	12	042601	1/1/0001
22000	S	M	OUG	III	00000	179	4TH LT W OF CAVE HILL LN ON S SIDE OF HARRODSBURG	12	042601	1/1/0001
22000	S	M	OUG	III	00000	180	5TH LT W OF CAVE HILL LN ON N SIDE OF HARRODSBURG	12	042601	1/1/0001

Street Light Listing run 1/11/2015 10:43:21 AM

Page 444 of 1254

OFFICE: 311

ROUTE: 564

ST_REF_NO: 0000085700

HARRODSBURG ROAD

LUMENS	BULB TYPE	MULT SERIES	POLE TYPE	SHADE	ADDRESS NUMBER	REF	LOCATION	TAX DIST	DATE INST	DATE CHANGE
22000	S	M	OUG	III	00000	181	5TH LT W OF CAVE HILL LN ON S SIDE OF HARRODSBURG	12	042601	1/1/0001
22000	S	M	OUG	III	00000	182	6TH LT W OF CAVE HILL LN ON N SIDE OF HARRODSBURG	12	042601	1/1/0001
22000	S	M	OUG	III	00000	183	6TH LT W OF CAVE HILL LN ON S SIDE OF HARRODSBURG	12	042601	1/1/0001
22000	S	M	OUG	III	00000	184	7TH LT W OF CAVE HILL LN ON N SIDE OF HARRODSBURG	12	042601	1/1/0001
22000	S	M	OUG	III	00000	185	7TH LT W OF CAVE HILL LN ON S SIDE OF HARRODSBURG	12	042601	1/1/0001
22000	S	M	OUG	III	00000	186	8TH LT W OF CAVE HILL LN ON N SIDE OF HARRODSBURG	12	042601	1/1/0001
22000	S	M	OUG	III	00000	187	8TH LT W OF CAVE HILL LN ON S SIDE OF HARRODSBURG	12	042601	1/1/0001
50000	S	M	OUG	III	00000	188	9TH LT W OF CAVE HILL LN ON N SIDE OF HARRODSBURG	12	042601	1/1/0001
50000	S	M	OUG	III	00000	189	9TH LT W OF CAVE HILL LN ON S SIDE OF HARRODSBURG	12	042601	1/1/0001
22000	S	M	OUG	III	00000	190	10TH LT W OF CAVE HILL LN ON N SIDE OF HARRODSBURG	12	042601	1/1/0001
22000	S	M	OUG	III	00000	191	10TH LT W OF CAVE HILL LN ON S SIDE OF HARRODSBURG	12	042601	1/1/0001
22000	S	M	OUG	III	00000	192	11TH LT W OF CAVE HILL LN ON N SIDE OF HARRODSBURG	12	042601	1/1/0001
22000	S	M	OUG	III	00000	193	11TH LT W OF CAVE HILL LN ON S SIDE OF HARRODSBURG	12	042601	1/1/0001
50000	S	M	OUG	III	00000	194	12TH LT W OF CAVE HILL LN ON N SIDE OF HARRODSBURG	12	042601	1/1/0001
50000	S	M	OUG	III	00000	195	1ST LT W OF WELLINGTON ON S SIDE OF HARRODSBURG	12	042601	1/1/0001
22000	S	M	OUG	III	00000	196	1ST LT W OF WELLINGTON ON N SIDE OF HARRODSBURG	12	042601	1/1/0001
22000	S	M	OUG	III	00000	197	2ND LT W OF WELLINGTON ON S SIDE OF HARRODSBURG	12	042601	1/1/0001
22000	S	M	OUG	III	00000	198	2ND LT W OF WELLINGTON ON N SIDE OF HARRODSBURG	12	042601	1/1/0001
22000	S	M	OUG	III	00000	199	3RD LT W OF WELLINGTON ON S SIDE OF HARRODSBURG	12	042601	1/1/0001
22000	S	M	OUG	III	00000	200	3RD LT W OF WELLINGTON ON N SIDE OF HARRODSBURG	12	042601	1/1/0001

OFFICE: 311

ROUTE: 564

ST_REF_NO: 0000085700

HARRODSBURG ROAD

LUMENS	BULB TYPE	MULT SERIES	POLE TYPE	SHADE	ADDRESS NUMBER	REF	LOCATION	TAX DIST	DATE INST	DATE CHANGE
22000	S	M	OUG	III	00000	201	4TH LT W OF WELLINGTON ON S SIDE OF HARRODSBURG	12	042601	1/1/0001
22000	S	M	OUG	III	00000	202	4TH LT W OF WELLINGTON ON N SIDE OF HARRODSBURG	12	042601	1/1/0001
22000	S	M	OUG	III	00000	203	5TH LT W OF WELLINGTON ON S SIDE OF HARRODSBURG	12	042601	1/1/0001
22000	S	M	OUG	III	00000	204	5TH LT W OF WELLINGTON ON N SIDE OF HARRODSBURG	12	042601	1/1/0001
22000	S	M	OUG	III	00000	205	6TH LT W OF WELLINGTON ON S SIDE OF HARRODSBURG	12	042601	1/1/0001
22000	S	M	OUG	III	00000	206	6TH LT W OF WELLINGTON ON N SIDE OF HARRODSBURG	12	042601	1/1/0001
22000	S	M	OUG	III	00000	207	7TH LT W OF WELLINGTON ON S SIDE OF HARRODSBURG	12	042601	1/1/0001
50000	S	M	OUG	III	00000	208	7TH LT W OF WELLINGTON ON N SIDE OF HARRODSBURG	12	042601	1/1/0001
50000	S	M	OUG	III	00000	209	8TH LT W OF WELLINGTON ON S SIDE OF HARRODSBURG	12	042601	1/1/0001
50000	S	M	OUG	III	00000	210	1ST LT W OF MAN O WAR ON N SIDE OF HARRODSBURG	12	042601	1/1/0001
22000	S	M	OUG	III	00000	211	1ST LT W OF MAN O WAR ON S SIDE OF HARRODSBURG	12	042601	1/1/0001
22000	S	M	OUG	III	00000	213	2ND LT W OF MAN O WAR ON S SIDE OF HARRODSBURG	12	042601	1/1/0001
22000	S	M	OUG	II	00000	300	2ND LT W OF MOW, N SIDE ON HARRODSBURG RD	12	041105	1/1/0001
22000	S	M	OUG	II	00000	302	3RD LT W OF MOW, NORTH SIDE ON HARRODSBURG RD	12	041406	1/1/0001
22000	S	M	OUG	II	00000	303	3RD LT W OF MOW, SOUTH SIDE ON HARRODSBURG RD	12	041406	1/1/0001
22000	S	M	OUG	II	00000	304	4TH LT W OF MOW, NORTH SIDE ON HARRODSBURG RD	12	041406	1/1/0001
22000	S	M	OUG	II	00000	305	4TH LT W OF MOW, SOUTH SIDE ON HARRODSBURG RD	12	041406	1/1/0001
22000	S	M	OUG	II	00000	306	5TH LT W OF MOW, NORTH SIDE ON HARRODSBURG RD	12	041406	1/1/0001
22000	S	M	OUG	II	00000	307	5TH LT W OF MOW, SOUTH SIDE ON HARRODSBURG RD	12	041406	1/1/0001
22000	S	M	OUG	II	00000	308	6TH LT W OF MOW, NORTH SIDE ON HARRODSBURG RD	12	041406	1/1/0001

OFFICE: 311

ROUTE: 564

ST_REF_NO: 0000085700

HARRODSBURG ROAD

LUMENS	BULB TYPE	MULT SERIES	POLE TYPE	SHADE	ADDRESS NUMBER	REF	LOCATION	TAX DIST	DATE INST	DATE CHANGE
22000	S	M	OUG	II	00000	309	6TH LT W OF MOW, SOUTH SIDE ON HARRODSBURG RD	12	041406	1/1/0001
22000	S	M	OUG	II	00000	310	7TH LT W OF MOW, NORTH SIDE ON HARRODSBURG RD	12	041406	1/1/0001
22000	S	M	OUG	II	00000	311	7TH LT W OF MOW, SOUTH SIDE ON HARRODSBURG RD	12	041406	1/1/0001
22000	S	M	OUG	II	00000	312	8TH LT W OF MOW, NORTH SIDE ON HARRODSBURG RD	12	041406	1/1/0001
22000	S	M	OUG	II	00000	313	8TH LT W OF MOW, SOUTH SIDE ON HARRODSBURG RD	12	041406	1/1/0001
22000	S	M	OUG	II	00000	314	9TH LT W OF MOW, NORTH SIDE ON HARRODSBURG RD	12	041406	1/1/0001
22000	S	M	OUG	II	00000	315	9TH LT W OF MOW, SOUTH SIDE ON HARRODSBURG RD	12	041406	1/1/0001
22000	S	M	OUG	II	00000	316	10TH LT W OF MOW, NORTH SIDE ON HARRODSBURG RD	12	041406	1/1/0001
22000	S	M	OUG	II	00000	317	10TH LT W OF MOW, SOUTH SIDE ON HARRODSBURG RD	12	041406	1/1/0001
22000	S	M	OUG	II	00000	318	11TH LT W OF MOW, NORTH SIDE ON HARRODSBURG RD	12	041406	1/1/0001
22000	S	M	OUG	II	00000	400	1ST LT E OF PALOMAR BLVD,N SIDE ON HARRODSBURG RD	12	041105	1/1/0001
22000	S	M	OUG	II	00000	401	1ST LT W OF PALOMAR BLVD,N SIDE ON HARRODSBURG RD	12	041105	1/1/0001
22000	S	M	OUG	II	00000	402	1ST LT W OF PALOMAR BLVD, S SIDE ON HARRODSBURG RD	12	041406	1/1/0001
22000	S	M	OUG	II	00000	403	2ND LT W OF PALOMAR BLVD, N SIDE ON HARRODSBURG RD	12	041406	1/1/0001
22000	S	M	OUG	II	00000	404	2ND LT W OF PALOMAR BLVD, S SIDE ON HARRODSBURG RD	12	041406	1/1/0001
22000	S	M	OUG	II	00000	405	3RD LT W OF PALOMAR BLVD, N SIDE ON HARRODSBURG RD	12	041406	1/1/0001
22000	S	M	OUG	II	00000	406	3RD LT W OF STEDMAN CT, SOUTH SIDE ON HARRODSBURG RD	12	041406	9/9/2009
22000	S	M	OUG	II	00000	407	4TH LT W OF PALOMAR BLVD, NORTH SIDE ON HARRODSBURG RD	12	041406	9/9/2009
22000	S	M	OUG	II	00000	408	4TH LT W OF STEDMAN CT, SOUTH SIDE ON HARRODSBURG RD	12	041406	9/9/2009
22000	S	M	OUG	II	00000	409	5TH LT W OF PALOMAR BLVD, NORTH SIDE ON HARRODSBURG RD	12	041406	9/9/2009

Street Light Listing run 1/11/2015 10:43:21 AM

Page 447 of 1254

OFFICE: 311

ROUTE: 564

ST_REF_NO: 0000085700

HARRODSBURG ROAD

LUMENS	BULB TYPE	MULT SERIES	POLE TYPE	SHADE	ADDRESS NUMBER	REF	LOCATION	TAX DIST	DATE INST	DATE CHANGE
22000	S	M	OUG	II	00000	410	5TH LT W OF STEDMAN CT, SOUTH SIDE ON HARRODSBURG RD	12	041406	9/9/2009
22000	S	M	OUG	II	00000	411	6TH LT W OF PALOMAR BLVD, NORTH SIDE ON HARRODSBURG RD	12	041406	9/9/2009
22000	S	M	OUG	II	00000	412	6TH LT W OF STEDMAN CT, SOUTH SIDE ON HARRODSBURG RD	12	041406	9/9/2009
22000	S	M	OUG	II	00000	500	2ND LT E OF HIGBEE MILL ,N SIDE ON HARRODSBURG RD	12	041105	1/1/0001
22000	S	M	OUG	II	00000	501	1ST LT E OF HIGBEE MILL, S SIDE ON HARRODSBURG RD	12	041105	1/1/0001
22000	S	M	OUG	II	00000	502	1ST LT E OF HIGBEE MILL, N SIDE ON HARRODSBURG RD	12	041105	9/9/2009
50000	S	M	OUG	II	00000	503	1ST LT W OF HIGBEE MILL,S SIDE ON HARRODSBURG RD	12	041105	1/1/0001
22000	S	M	OUG	II	00000	504	1ST LT W OF HIGBEE MILL,N SIDE ON HARRODSBURG RD	12	041105	1/1/0001
22000	S	M	OUG	II	00000	505	2ND LT W OF HIGBEE MILL,S SIDE ON HARRODSBURG	12	041105	1/1/0001
22000	S	M	OUG	II	00000	506	2ND LT W OF OLD HIGBEE MILL, N SIDE ON HARRODSBURG	12	041406	1/1/0001
22000	S	M	OUG	II	00000	507	3RD LT W OF OLD HIGBEE MILL, S SIDE ON HARRODSBURG	12	041406	1/1/0001
22000	S	M	OUG	II	00000	508	3RD LT W OF OLD HIGBEE MILL, N SIDE ON HARRODSBURG	12	041406	1/1/0001
22000	S	M	OUG	II	00000	509	4TH LT W OF OLD HIGBEE MILL, S SIDE ON HARRODSBURG	12	041406	1/1/0001
22000	S	M	OUG	II	00000	511	5TH LT W OF OLD HIGBEE MILL, S SIDE ON HARRODSBURG	12	041406	1/1/0001
22000	S	M	OUG	II	00000	513	6TH LT W OF OLD HIGBEE MILL, S SIDE ON HARRODSBURG	12	041406	1/1/0001
22000	S	M	OUG	II	00000	515	7TH LT W OF OLD HIGBEE MILL, S SIDE ON HARRODSBURG	12	041406	1/1/0001
22000	S	M	OUG	II	00000	519	2ND LT E OF MILITARY PK, SOUTH SIDE ON HARRODSBURG	12	041406	1/1/0001
22000	S	M	OUG	II	00000	600	2ND LT E OF MILITARY PK,N SIDE ON HARRODSBURG RD	12	041105	1/1/0001
22000	S	M	OOH	II	00000	601	1ST LT E OF MILITARY PK,S SIDE ON HARRODSBURG RD	12	041105	1/1/0001
50000	S	M	OUG	II	00000	602	1ST LT E OF MILITARY PK,N SIDE ON HARRODSBURG RD	12	041105	1/1/0001

OFFICE: 311

ROUTE: 564

ST_REF_NO: 0000085700

HARRODSBURG ROAD

LUMENS	BULB TYPE	MULT SERIES	POLE TYPE	SHADE	ADDRESS NUMBER	REF	LOCATION	TAX DIST	DATE INST	DATE CHANGE
22000	S	M	OOH	III	01400	001		12	110761	9/9/2009
20000	M	M	OUG	III	01400	004		12	110761	9/9/2009
22000	S	M	OOH	III	01401	002		12	110761	9/9/2009
20000	M	M	OUG	III	01401	005		12	110761	9/9/2009
50000	S	M	OOH	III	01590	007		12	110761	9/9/2009
22000	S	M	OOH	III	01600	010		12	110761	1/25/2013
22000	S	M	OOH	III	01642	018		12	110761	12/7/2012
22000	S	M	SOH	III	01700	024		12	110761	9/9/2009
22000	S	M	OOH	III	01700	026		12	110761	9/9/2009
22000	S	M	SOH	II	01759	028		12	111475	7/19/2013
22000	S	M	SOH	II	01771	030		12	111475	1/2/2013
22000	S	M	SOH	III	01784	031		12	110761	7/19/2013
22000	S	M	OOH	III	01784	033		12	110761	9/9/2009
22000	S	M	OOH	III	01787	032		12	110761	9/9/2009
22000	S	M	OOH	III	01887	034		12	110761	9/9/2009
50000	S	M	OOH	III	01913	038		12	040884	9/9/2009
22000	S	M	OOH	III	01927	040		12	110761	9/9/2009
22000	S	M	SOH	III	01946	041		12	110761	10/20/2009
22000	S	M	SOH	III	01962	044		12	110761	9/9/2009
22000	S	M	OOH	III	01975	042		12	110761	9/9/2009
22000	S	M	OOH	III	01975	043		12	110761	9/9/2009
22000	S	M	OOH	III	01987	046		12	110761	9/9/2009
22000	S	M	SOH	III	01998	045		12	110761	11/24/2013
20000	M	M	SOH	III	01998	048		12	110761	9/9/2009
22000	S	M	OOH	III	01999	049		12	110761	9/9/2009
22000	S	M	OOH	III	02000	051		12	110761	9/9/2009
22000	S	M	OOH	III	02020	053		12	110761	9/9/2009
22000	S	M	OOH	III	02020	057		12	110761	9/9/2009
22000	S	M	SOH	III	02021	054		12	110761	9/9/2009
20000	M	M	SOH	III	02026	056		12	110761	9/9/2009
22000	S	M	OUG	II	02090	059		12	101475	7/31/2010
22000	S	M	OUG	II	02098	061		12	101475	9/9/2009
20000	M	M	SOH	III	02099	058		12	110761	9/9/2009
22000	S	M	OUG	II	02101	060		12	101475	9/9/2009

OFFICE: 311

ROUTE: 564

ST_REF_NO: 0000085700

HARRODSBURG ROAD

LUMENS	BULB TYPE	MULT SERIES	POLE TYPE	SHADE	ADDRESS NUMBER	REF	LOCATION	TAX DIST	DATE INST	DATE CHANGE
22000	S	M	OUG	II	02104	063		12	101475	9/9/2009
20000	M	M	OUG	II	02181	062		12	101475	9/9/2009
20000	M	M	OUG	II	02195	064		12	101475	9/9/2009
50000	S	M	OUG	II	02198	065		12	101475	9/9/2009
50000	S	M	OUG	II	02212	067		12	101475	9/9/2009
22000	S	M	OUG	II	02217	068		12	101475	10/14/2013
50000	S	M	OUG	II	02224	069		12	101475	9/9/2009
22000	S	M	OUG	II	02265	071		12	101475	9/9/2009
20000	M	M	OUG	II	02315	074		12	101475	9/9/2009
50000	S	M	OUG	II	02316	075		12	101475	9/9/2009
22000	S	M	OUG	II	02336	082		12	101475	9/9/2009
22000	S	M	OUG	II	02355	083		12	111475	9/9/2009
50000	S	M	OUG	II	02355	089		12	111475	9/9/2009
50000	S	M	OUG	II	02356	090		12	111475	9/9/2009
22000	S	M	OUG	II	02356	094		12	111475	9/9/2009
22000	S	M	OUG	II	02400	099	change out bad mv fixture 2/08	12	111475	9/9/2009
50000	S	M	OUG	II	02424	103		12	111475	9/9/2009
22000	S	M	OUG	II	02424	105	change out bad mv fixture 2/08	12	111475	9/9/2009
22000	S	M	OUG	II	02444	107	upgraded 10/07	12	111475	10/1/2007
20000	M	M	OUG	II	02515	108		12	110884	9/9/2009
20000	M	M	OOH	III	00000	017	OPPOSITE 1642	12	110761	1/1/0001
20000	M	M	OOH	III	00000	036	S. W. CORNER OF LYNN AND HARRODSBURG RD.	12	110761	1/1/0001
20000	M	M	OOH	III	01642	020		12	110761	1/1/0001
20000	M	M	OOH	III	01733	021		12	110761	1/1/0001
20000	M	M	OOH	III	01733	022		12	110761	1/1/0001
20000	M	M	OOH	III	01733	023		12	110761	1/1/0001
22000	S	M	OOH	III	01733	025	change out bad mv fixture 2/08	12	110761	1/1/0001
22000	S	M	OOH	III	01733	027	change out bad mv fixture 2/08	12	110761	1/1/0001
20000	M	M	OOH	III	01784	035		12	110761	1/1/0001
20000	M	M	OOH	III	01910	039		12	110761	1/1/0001
20000	M	M	OOH	III	01997	047		12	110761	1/1/0001
20000	M	M	OOH	III	02001	052		12	110761	1/1/0001
20000	M	M	OOH	III	02020	055		12	110761	1/1/0001
22000	S	M	OUG	II	02300	072		12	101475	1/1/0001

Street Light Listing run 1/11/2015 10:43:21 AM

Page 450 of 1254

OFFICE: 311		ROUTE: 564		ST_REF_NO: 0000085700		HARRODSBURG ROAD				
LUMENS	BULB TYPE	MULT SERIES	POLE TYPE	SHADE	ADDRESS NUMBER	REF	LOCATION	TAX DIST	DATE INST	DATE CHANGE
20000	M	M	OUG	II	02315	077		12	101475	1/1/0001
22000	S	M	OUG	II	02324	078	upgraded bad fixture to 22,000 hps cobra 5/08	12	101475	1/1/0001
20000	M	M	OUG	II	02331	080		12	101475	1/1/0001
20000	M	M	OOH	III	00000	008	OPPOSITE 1590	12	110761	1/1/0001
20000	M	M	OOH	III	00000	009	OPPOSITE 1594	12	110761	1/1/0001
20000	M	M	OOH	III	00000	011	OPPOSITE 1608	12	110761	1/1/0001
20000	M	M	OOH	III	00000	013	OPPOSITE 1618	12	110761	1/1/0001
20000	M	M	OOH	III	01400	006		12	110761	1/1/0001
20000	M	M	OOH	III	01612	012		12	110761	1/1/0001
22000	S	M	OOH	III	01626	014		12	110761	1/1/0001
20000	M	M	OOH	III	01642	016		12	110761	1/1/0001
20000	M	M	OUG	II	00000	098	OPPOSITE 2400	12	111475	1/1/0001
20000	M	M	OUG	II	00000	102	OPPOSITE 2424	12	111475	1/1/0001
20000	M	M	OUG	II	00000	104	OPP. 2424	12	110884	1/1/0001
22000	S	M	OUG	II	02344	084		12	111475	1/1/0001
22000	S	M	OUG	II	02352	086		12	111475	1/1/0001
22000	S	M	OUG	II	02355	085		12	111475	1/1/0001
22000	S	M	OUG	II	02355	087		12	111475	1/1/0001
22000	S	M	OUG	II	02356	088		12	111475	1/1/0001
22000	S	M	OUG	II	02356	092		12	111475	1/1/0001
22000	S	M	OUG	II	02365	091		12	111475	1/1/0001
22000	S	M	OUG	II	02365	093		12	111475	1/1/0001
22000	S	M	OUG	II	02365	095		12	111475	1/1/0001
20000	M	M	OUG	II	02400	097		12	111475	1/1/0001
22000	S	M	OUG	II	02424	101	upgraded 10/07	12	111475	1/1/0001

OFFICE: 311

ROUTE: 564

ST_REF_NO: 0000085710

HARRODSBURG SERVICE ROAD

LUMENS	BULB TYPE	MULT SERIES	POLE TYPE	SHADE	ADDRESS NUMBER	REF	LOCATION	TAX DIST	DATE INST	DATE CHANGE
05800	S	M	OUG	II	00000	121	side of 3001 Arrowhead Drive	12	050890	9/9/2009
05800	S	M	OUG	II	03104	122	side of 3001 Arrowhead Dr	12	050890	9/9/2009
05800	S	M	OUG	II	02257	070		12	080169	1/1/0001
05800	S	M	OUG	II	02265	073		12	041476	1/1/0001
05800	S	M	OUG	II	02315	076		12	060170	1/1/0001

Street Light Listing run 1/11/2015 10:43:21 AM

Page 451 of 1254

OFFICE: 311

ROUTE: 564

ST_REF_NO: 0000085710

HARRODSBURG SERVICE ROAD

LUMENS	BULB TYPE	MULT SERIES	POLE TYPE	SHADE	ADDRESS NUMBER	REF	LOCATION	TAX DIST	DATE INST	DATE CHANGE
05800	S	M	OUG	II	02323	079		12	080164	1/1/0001
05800	S	M	OUG	II	02339	081		12	120165	1/1/0001
05800	S	M	OUG	II	03080	116		12	051480	1/1/0001
05800	S	M	OUG	II	03080	117		12	051480	1/1/0001
05800	S	M	OUG	II	03090	118		12	050890	1/1/0001
05800	S	M	OUG	II	03094	119		12	050890	1/1/0001
05800	S	M	OUG	II	03098	120		12	050890	1/1/0001
05800	S	M	OUG	II	03112	123		12	050890	1/1/0001
05800	S	M	OUG	II	03116	124		12	050890	1/1/0001
05800	S	M	OUG	II	03116	125		12	050890	1/1/0001
05800	S	M	OUG	II	03060	114		12	120896	1/1/0001
05800	S	M	OUG	II	03070	115		12	120896	1/1/0001

OFFICE: 311

ROUTE: 564

ST_REF_NO: 0000085730

HARRODS POINTE TRACE

LUMENS	BULB TYPE	MULT SERIES	POLE TYPE	SHADE	ADDRESS NUMBER	REF	LOCATION	TAX DIST	DATE INST	DATE CHANGE
05800	S	M	OUG	II	02255	024		12	100896	1/1/0001
05800	S	M	OUG	II	02258	023		12	100896	1/1/0001
05800	S	M	OUG	II	02271	022		12	100896	1/1/0001
05800	S	M	OUG	II	02278	021		12	100896	1/1/0001
05800	S	M	OUG	II	02286	020		12	100896	1/1/0001

OFFICE: 311

ROUTE: 564

ST_REF_NO: 0000085800

HARROGATE DRIVE

LUMENS	BULB TYPE	MULT SERIES	POLE TYPE	SHADE	ADDRESS NUMBER	REF	LOCATION	TAX DIST	DATE INST	DATE CHANGE
05800	S	M	OUG	II	00000	063	SIDE OF 1617 THIRLSTANE COURT	12	030166	1/1/0001
05800	S	M	OUG	II	00000	065	SIDE OF 1618 CANTERBURY CT.	12	030166	1/1/0001
05800	S	M	OUG	II	00000	067	SIDE OF 692 DARTMOOR CT.	12	021866	1/1/0001
05800	S	M	OUG	II	01621	066		12	021866	1/1/0001
05800	S	M	OUG	II	01645	064		12	030166	1/1/0001
05800	S	M	OUG	II	01665	062		12	021866	1/1/0001

OFFICE: 311

ROUTE: 564

ST_REF_NO: 0000085900

HARROGATE ROAD

LUMENS	BULB TYPE	MULT SERIES	POLE TYPE	SHADE	ADDRESS NUMBER	REF	LOCATION	TAX DIST	DATE INST	DATE CHANGE
05800	S	M	OUG	II	01758	143	side of 496 Carr Ct	12	081475	9/9/2009
05800	S	M	OUG	II	00000	019	SIDE OF 428 BRYANWOOD PKWY	12	050466	1/1/0001
05800	S	M	OUG	II	01670	061		12	021866	1/1/0001
05800	S	M	OUG	II	01685	060		12	030166	1/1/0001
05800	S	M	OUG	II	01698	059		12	021866	1/1/0001
05800	S	M	OUG	II	01701	058		12	021866	1/1/0001
05800	S	M	OUG	II	01710	057		12	030166	1/1/0001
05800	S	M	OUG	II	01719	000		12	100169	1/1/0001
05800	S	M	OUG	II	01730	055		12	030166	1/1/0001
05800	S	M	OUG	II	01743	000		12	081869	1/1/0001
05800	S	M	OUG	II	01754	000		12	120170	1/1/0001
05800	S	M	OUG	II	01778	145		12	081475	1/1/0001
05800	S	M	OUG	II	01787	146		12	081475	1/1/0001

OFFICE: 311

ROUTE: 564

ST_REF_NO: 0000086000

HARRY STREET

LUMENS	BULB TYPE	MULT SERIES	POLE TYPE	SHADE	ADDRESS NUMBER	REF	LOCATION	TAX DIST	DATE INST	DATE CHANGE
05800	S	M	SOH	II	00000	005	1ST. LT. N. OF 6TH ST., W. SIDE	12	050365	1/1/0001
05800	S	M	SOH	I	00000	006	2ND LT. N. OF 6TH ST., W. SIDE	12	050365	1/1/0001
05800	S	M	SOH	I	00000	007	1ST. LT. S. OF 7TH ST., W. SIDE	12	040165	1/1/0001
05800	S	M	SOH	I	00000	001	1ST. LT. N. OF 5TH ST., E. SIDE	12	040165	1/1/0001
05800	S	M	SOH	I	00000	004	1ST LT. S. OF E. 6TH, W. SIDE	12	040165	1/1/0001
05800	S	M	SOH	I	00530	002		12	040165	1/1/0001
05800	S	M	SOH	I	00552	003		12	040165	1/1/0001

OFFICE: 311

ROUTE: 564

ST_REF_NO: 0000086100

HART COURT

LUMENS	BULB TYPE	MULT SERIES	POLE TYPE	SHADE	ADDRESS NUMBER	REF	LOCATION	TAX DIST	DATE INST	DATE CHANGE
05800	S	M	OUG	II	02110	000		12	080172	1/1/0001
05800	S	M	OUG	II	02117	000		12	090169	1/1/0001
05800	S	M	OUG	II	02125	000		12	122067	1/1/0001

OFFICE: 311

ROUTE: 564

ST_REF_NO: 0000086200

HART ROAD

LUMENS	BULB TYPE	MULT SERIES	POLE TYPE	SHADE	ADDRESS NUMBER	REF	LOCATION	TAX DIST	DATE INST	DATE CHANGE
05800	S	M	OOH	II	00000	035	SIDE OF CASSIDY SCHOOL	12	120465	1/1/0001
05800	S	M	SOH	II	00000	036	15' W. OF CASSIDY AVE.	12	050154	1/1/0001
05800	S	M	OOH	II	00000	037	OPP. 203	12	120165	1/1/0001
05800	S	M	OUG	II	00000	039	SIDE OF 303 COCHRAN RD.	12	022167	1/1/0001
05800	S	M	OUG	II	00000	101	SIDE OF 401 RIDGEWAY RD.	12	110164	1/1/0001
05800	S	M	OUG	II	00000	102	SIDE OF 344 RIDGEWAY RD.	12	110164	1/1/0001
05800	S	M	OUG	II	00000	103	SIDE OF 401 DUDLEY RD.	12	110164	1/1/0001
05800	S	M	OUG	II	00000	104	SIDE OF 342 DUDLEY RD.	12	040165	1/1/0001
05800	S	M	OUG	II	00000	105	SIDE OF 401 CHINOE RD.	12	040165	1/1/0001
05800	S	M	OUG	II	00000	106	SIDE OF 332 CHINOE RD.	12	020165	1/1/0001
05800	S	M	SOH	III	00000	314	SIDE REAR OF 150 CASSIDY AVE.	12	030800	1/1/0001
05800	S	M	SOH	II	00207	000		12	020168	1/1/0001
05800	S	M	OUG	II	00311	000		12	120465	1/1/0001
05800	S	M	OUG	II	00342	000		12	090865	1/1/0001
05800	S	M	OUG	II	00421	000		12	010166	1/1/0001
05800	S	M	OUG	II	00442	000		12	090865	1/1/0001
05800	S	M	OUG	II	00479	000		12	090865	1/1/0001
05800	S	M	OUG	II	00490	000		12	092765	1/1/0001
05800	S	M	OUG	II	00501	000		12	090165	1/1/0001
05800	S	M	OUG	II	00000	089	SIDE OF 400 BRISTOL RD.	12	020367	1/1/0001
05800	S	M	OUG	III	00000	090	OPP. 1925	12	052360	1/1/0001
05800	S	M	OUG	III	00000	091	BETWEEN ADAIR & CLINTON	12	060258	1/1/0001
05800	S	M	OUG	III	00000	092	BETWEEN CULPEPPER & CLINTON	12	081156	1/1/0001
05800	S	M	OUG	II	00000	107	SIDE OF 401 CULPEPPER	12	020165	1/1/0001
05800	S	M	OUG	III	01913	000		12	050159	1/1/0001
05800	S	M	OUG	III	01933	000		12	050159	1/1/0001
05800	S	M	OUG	II	01948	000		12	070767	1/1/0001
05800	S	M	OUG	V	01953	000		12	040172	1/1/0001
05800	S	M	OUG	II	01964	000		12	051967	1/1/0001
05800	S	M	OUG	II	01969	000		12	020367	1/1/0001
05800	S	M	OUG	II	02007	000		12	120667	1/1/0001
05800	S	M	OUG	II	02016	000		12	070767	1/1/0001
05800	S	M	OUG	II	02023	000		12	090169	1/1/0001
05800	S	M	OUG	II	02030	000		12	080172	1/1/0001

Street Light Listing run 1/11/2015 10:43:21 AM

Page 454 of 1254

OFFICE: 311		ROUTE: 564		ST_REF_NO: 0000086200		HART ROAD		LUMENS	BULB TYPE	MULT SERIES	POLE TYPE	SHADE	ADDRESS NUMBER	REF	LOCATION	TAX DIST	DATE INST	DATE CHANGE
	05800	S	M	OUG	II	02101	000									12	030169	1/1/0001
OFFICE: 311		ROUTE: 564		ST_REF_NO: 0000086210		HARTFORD COURT		LUMENS	BULB TYPE	MULT SERIES	POLE TYPE	SHADE	ADDRESS NUMBER	REF	LOCATION	TAX DIST	DATE INST	DATE CHANGE
	04000	S	M	OUG	II	02005	051									12	070886	1/1/0001
	04000	S	M	OUG	II	02000	052									12	070886	1/1/0001
OFFICE: 311		ROUTE: 564		ST_REF_NO: 0000086250		HARTLAND PARKWAY		LUMENS	BULB TYPE	MULT SERIES	POLE TYPE	SHADE	ADDRESS NUMBER	REF	LOCATION	TAX DIST	DATE INST	DATE CHANGE
	05800	S	M	OUG	II	00000	001								NE CORNER OF TATES CREEK RD.	12	110893	1/1/0001
	05800	S	M	OUG	II	00000	005								SIDE OF 1108 RIDGELAND CT.	12	110893	1/1/0001
	05800	S	M	OUG	II	00000	006								SIDE OF 1101 LEDGEBROOK CT.	12	110893	1/1/0001
	05800	S	M	OUG	II	00000	072								4798-A	12	080893	1/1/0001
	05800	S	M	OUG	II	00000	074								SIDE REAR OF 4757	12	030895	1/1/0001
	05800	S	M	OUG	II	00000	075								OPP. 4747	12	030895	1/1/0001
	05800	S	M	OUG	II	00000	080								SIDE OF 4736 SPRING CREEK ON HARTLAND PKWY	12	080890	1/1/0001
	05800	S	M	OUG	II	00000	082								SIDE OF 1333 AMHERST DR.	12	110893	1/1/0001
	05800	S	M	OUG	II	00000	101								NE CORNER OF KENESAW DR.	12	030895	1/1/0001
	05800	S	M	OUG	II	04409	002									12	110893	1/1/0001
	05800	S	M	OUG	II	04416	003									12	110893	1/1/0001
	05800	S	M	OUG	II	04429	004									12	110893	1/1/0001
	05800	S	M	OUG	II	04444	007									12	110893	1/1/0001
	05800	S	M	OUG	II	04453	008									12	110893	1/1/0001
	05800	S	M	OUG	II	04468	009									12	110893	1/1/0001
	05800	S	M	OUG	II	04477	010									12	110893	1/1/0001
	05800	S	M	OUG	II	04492	011									12	010894	1/1/0001
	05800	S	M	OUG	II	04501	012									12	010894	1/1/0001
	05800	S	M	OUG	II	04516	013									12	010894	1/1/0001
	05800	S	M	OUG	II	04525	014									12	010894	1/1/0001
	05800	S	M	OUG	II	04548	015									12	010894	1/1/0001
	05800	S	M	OUG	II	04572	017									12	010894	1/1/0001
	05800	S	M	OUG	II	04593	016									12	010894	1/1/0001

OFFICE: 311

ROUTE: 564

ST_REF_NO: 0000086250

HARTLAND PARKWAY

LUMENS	BULB TYPE	MULT SERIES	POLE TYPE	SHADE	ADDRESS NUMBER	REF	LOCATION	TAX DIST	DATE INST	DATE CHANGE
05800	S	M	OUG	II	04617	018		12	010894	1/1/0001
05800	S	M	OUG	II	04625	019		12	010894	1/1/0001
05800	S	M	OUG	II	04641	020		12	010894	1/1/0001
05800	S	M	OUG	II	04661	084		12	110893	1/1/0001
05800	S	M	OUG	II	04668	083		12	110893	1/1/0001
05800	S	M	OUG	II	04688	081		12	110893	1/1/0001
05800	S	M	OUG	II	04704	079		12	080890	1/1/0001
05800	S	M	OUG	II	04709	078		12	080890	1/1/0001
05800	S	M	OUG	II	04724	077		12	080893	1/1/0001
05800	S	M	OUG	II	04725	102		12	040895	1/1/0001
05800	S	M	OUG	II	04735	076		12	030895	1/1/0001
05800	S	M	OUG	II	04781	073		12	080893	1/1/0001
05800	S	M	OUG	II	04795	071		12	080893	1/1/0001
05800	S	M	OUG	II	04802	070		12	080893	1/1/0001
05800	S	M	OUG	III	04814	205		12	040895	1/1/0001
05800	S	M	OUG	III	04818	204		12	040895	1/1/0001
05800	S	M	OUG	III	04826	203		21	040895	1/1/0001
05800	S	M	OUG	III	04830	202		12	040895	1/1/0001
05800	S	M	OUG	III	04834	201		12	040895	1/1/0001
05800	S	M	OUG	III	04842	200		12	040895	1/1/0001

OFFICE: 311

ROUTE: 564

ST_REF_NO: 0000086260

HARTLAND WOODS COURT

LUMENS	BULB TYPE	MULT SERIES	POLE TYPE	SHADE	ADDRESS NUMBER	REF	LOCATION	TAX DIST	DATE INST	DATE CHANGE
05800	S	M	OUG	IV	04805	007		12	060895	1/1/0001

OFFICE: 311

ROUTE: 564

ST_REF_NO: 0000086270

HARTLAND WOODS WAY

LUMENS	BULB TYPE	MULT SERIES	POLE TYPE	SHADE	ADDRESS NUMBER	REF	LOCATION	TAX DIST	DATE INST	DATE CHANGE
05800	S	M	OUG	II	00000	002	SIDE OF 1301 THE KINGS COURT	12	060895	1/1/0001
05800	S	M	OUG	II	00000	006	SIDE OF 1368	12	060895	1/1/0001
05800	S	M	OUG	IV	00000	007	SIDE OF 1421	12	060895	1/1/0001
05800	S	M	OUG	II	01304	001		12	060895	1/1/0001
05800	S	M	OUG	II	01328	003		12	060895	1/1/0001

OFFICE: 311

ROUTE: 564

ST_REF_NO: 0000086270

HARTLAND WOODS WAY

LUMENS	BULB TYPE	MULT SERIES	POLE TYPE	SHADE	ADDRESS NUMBER	REF	LOCATION	TAX DIST	DATE INST	DATE CHANGE
05800	S	M	OUG	II	01337	004		12	060895	1/1/0001
05800	S	M	OUG	II	01353	005		12	060895	1/1/0001

OFFICE: 311

ROUTE: 564

ST_REF_NO: 0000086380

HATTER LANE

LUMENS	BULB TYPE	MULT SERIES	POLE TYPE	SHADE	ADDRESS NUMBER	REF	LOCATION	TAX DIST	DATE INST	DATE CHANGE
05800	S		CNT	II	00000	003	3RD LT N OF LOUIE PL, E SIDE ON HATTER LANE	12	021909	1/1/0001
05800	S		CNT	II	00000	004	4TH LT N OF LOUIE PL, W SIDE ON HATTER LN	12	021909	1/1/0001
05800	S		CNT	II	00000	005	5TH LT N OF LOUIE PL, E SIDE ON HATTER LN	12	021909	1/1/0001
05800	S		CNT	II	00000	006	6TH LT N OF LOUIE PL, W SIDE ON HATTER LN	12	021909	1/1/0001
05800	S		CNT	II	00000	008	8TH LT N OF LOUIE PL, W SIDE ON HATTER LN	12	021909	1/1/0001

OFFICE: 311

ROUTE: 564

ST_REF_NO: 0000086400

HARVARD DRIVE

LUMENS	BULB TYPE	MULT SERIES	POLE TYPE	SHADE	ADDRESS NUMBER	REF	LOCATION	TAX DIST	DATE INST	DATE CHANGE
04000	S	M	OUG	II	00000	047	SIDE 302	12	060886	1/1/0001
04000	S	M	OUG	II	00000	100	SIDE OF 173 TIVERTON WAY	12	020887	1/1/0001
04000	S	M	OUG	II	00217	048		12	060886	1/1/0001
04000	S	M	OUG	II	00304	046		12	060886	1/1/0001
04000	S	M	OUG	II	00316	045		12	060886	1/1/0001
04000	S	M	OUG	II	00325	044		12	060886	1/1/0001
04000	S	M	OUG	II	00337	043		12	060886	1/1/0001
04000	S	M	OUG	II	00345	042		12	060886	1/1/0001
04000	S	M	OUG	II	00368	041		12	060886	1/1/0001

OFFICE: 311

ROUTE: 564

ST_REF_NO: 0000086425

HARVEST DR

LUMENS	BULB TYPE	MULT SERIES	POLE TYPE	SHADE	ADDRESS NUMBER	REF	LOCATION	TAX DIST	DATE INST	DATE CHANGE
04000	S	M	OUG	II	02001	001		12	080891	1/1/0001
05800	S	M	OUG	IV	02016	002		12	080893	1/1/0001
04000	S	M	OUG	II	02020	003		12	080891	1/1/0001
04000	S	M	OUG	II	02029	004		12	080891	1/1/0001

OFFICE: 311

ROUTE: 564

ST_REF_NO: 0000086450

HARWICK COURT

LUMENS	BULB TYPE	MULT SERIES	POLE TYPE	SHADE	ADDRESS NUMBER	REF	LOCATION	TAX DIST	DATE INST	DATE CHANGE
05800	S	M	OUG	IV	03901	002		12	120892	1/1/0001
05800	S	M	OUG	II	03925	001		12	120892	1/1/0001

OFFICE: 311

ROUTE: 564

ST_REF_NO: 0000086475

HASKELL CIRCLE

LUMENS	BULB TYPE	MULT SERIES	POLE TYPE	SHADE	ADDRESS NUMBER	REF	LOCATION	TAX DIST	DATE INST	DATE CHANGE
09500	S	M	CNT	II	00400	001		12	031201	1/1/0001
09500	S	M	CNT	II	00424	004		12	031201	1/1/0001
09500	S	M	CNT	II	00425	002		12	031201	1/1/0001
09500	S	M	CNT	II	00425	003		12	031201	1/1/0001

OFFICE: 311

ROUTE: 564

ST_REF_NO: 0000086500

HASKINS DRIVE

LUMENS	BULB TYPE	MULT SERIES	POLE TYPE	SHADE	ADDRESS NUMBER	REF	LOCATION	TAX DIST	DATE INST	DATE CHANGE
05800	S	M	OUG	II	00000	005	IN COURT	12	050952	1/5/2011
05800	S	M	OUG	II	00545	004		12	121475	1/1/0001
05800	S	M	OUG	II	00550	003		12	121475	1/1/0001
05800	S	M	OUG	II	00559	002		12	121475	1/1/0001
05800	S	M	OUG	II	00562	001		12	121475	1/1/0001

OFFICE: 311

ROUTE: 564

ST_REF_NO: 0000086600

HASTINGS COURT

LUMENS	BULB TYPE	MULT SERIES	POLE TYPE	SHADE	ADDRESS NUMBER	REF	LOCATION	TAX DIST	DATE INST	DATE CHANGE
05800	S	M	OUG	V	01601	000		12	032772	1/1/0001
05800	S	M	OUG	II	01616	000		12	021866	1/1/0001

OFFICE: 311

ROUTE: 564

ST_REF_NO: 0000086700

HATTERAS DRIVE

LUMENS	BULB TYPE	MULT SERIES	POLE TYPE	SHADE	ADDRESS NUMBER	REF	LOCATION	TAX DIST	DATE INST	DATE CHANGE
04000	S	M	OUG	II	00000	001	SIDE OF 812 CELIA LANE	12	100888	1/1/0001
04000	S	M	OUG	II	00000	006	SIDE OF 849 LAUREL HILL RD.	12	100888	1/1/0001
04000	S	M	OUG	II	01704	002		12	100888	1/1/0001
04000	S	M	OUG	II	01716	003		12	100888	1/1/0001
04000	S	M	OUG	II	01724	004		12	100888	1/1/0001
04000	S	M	OUG	II	01733	005		12	100888	1/1/0001

OFFICE: 311

ROUTE: 564

ST_REF_NO: 0000086710 HATHWAY DRIVE

LUMENS	BULB TYPE	MULT SERIES	POLE TYPE	SHADE	ADDRESS NUMBER	REF	LOCATION	TAX DIST	DATE INST	DATE CHANGE
05800	S	M	OUG	V	04657	005		12	110893	1/1/0001
05800	S	M	OUG	II	04660	004		12	110893	1/1/0001
05800	S	M	OUG	II	04677	003		12	110893	1/1/0001
05800	S	M	OUG	II	04684	002		12	110893	1/1/0001
05800	S	M	OUG	II	04696	001		12	110893	1/1/0001

OFFICE: 311

ROUTE: 564

ST_REF_NO: 0000086800 HAVELOCK CIRCLE

LUMENS	BULB TYPE	MULT SERIES	POLE TYPE	SHADE	ADDRESS NUMBER	REF	LOCATION	TAX DIST	DATE INST	DATE CHANGE
04000	S	M	OUG	II	00000	078	SIDE OF 641 CARDIFF LANE	12	110885	1/1/0001

OFFICE: 311

ROUTE: 564

ST_REF_NO: 0000086950 HAVEN COURT

LUMENS	BULB TYPE	MULT SERIES	POLE TYPE	SHADE	ADDRESS NUMBER	REF	LOCATION	TAX DIST	DATE INST	DATE CHANGE
05800	S	M	OUG	II	00204	001		12	020800	1/1/0001

OFFICE: 311

ROUTE: 564

ST_REF_NO: 0000086980 HAVERFORD DRIVE

LUMENS	BULB TYPE	MULT SERIES	POLE TYPE	SHADE	ADDRESS NUMBER	REF	LOCATION	TAX DIST	DATE INST	DATE CHANGE
05800	S	M	CNT	II	00000	001	SIDE OF 1064 CHETFORD DRIVE	12	010897	1/1/0001
05800	S	M	CNT	III	01117	002		12	010897	1/1/0001
05800	S	M	CNT	II	01125	003		12	010897	1/1/0001
05800	S	M	CNT	II	01141	004		12	010897	1/1/0001

OFFICE: 311

ROUTE: 564

ST_REF_NO: 0000087090 HAVERWOOD PARK

LUMENS	BULB TYPE	MULT SERIES	POLE TYPE	SHADE	ADDRESS NUMBER	REF	LOCATION	TAX DIST	DATE INST	DATE CHANGE
05800	S	M	OUG	II	00000	005	SIDE REAR OF 1813	12	010897	1/1/0001
05800	S	M	OUG	III	01808	006		12	010897	1/1/0001
05800	S	M	OUG	II	01809	007		12	010897	1/1/0001
05800	S	M	OUG	II	01836	004		12	010897	1/1/0001
05800	S	M	OUG	II	01848	003		12	010897	1/1/0001
05800	S	M	OUG	II	01857	002		12	010897	1/1/0001
05800	S	M	OUG	II	01868	001		12	010897	1/1/0001

OFFICE: 311		ROUTE: 564		ST_REF_NO: 0000087100		HAWKINS AVENUE				
LUMENS	BULB TYPE	MULT SERIES	POLE TYPE	SHADE	ADDRESS NUMBER	REF	LOCATION	TAX DIST	DATE INST	DATE CHANGE
05800	S	M	SOH	I	00000	013		12	121166	1/1/0001
05800	S	M	SOH	I	00451	058		12	120566	1/1/0001
05800	S	M	SOH	I	00000	054	SIDE OF 417 E. 4TH ST.	12	120566	1/1/0001
05800	S	M	SOH	I	00000	055	OPP. 414	12	120566	1/1/0001
05800	S	M	SOH	I	00427	013		12	120566	1/1/0001
05800	S	M	SOH	I	00439	057		12	120566	1/1/0001

OFFICE: 311		ROUTE: 564		ST_REF_NO: 0000087200		HAWTHORNE ROAD				
LUMENS	BULB TYPE	MULT SERIES	POLE TYPE	SHADE	ADDRESS NUMBER	REF	LOCATION	TAX DIST	DATE INST	DATE CHANGE
05800	S	M	OUG	II	00000	003	OPP. 1620	12	121363	1/1/0001
05800	S	M	OUG	II	00000	005	SIDE OF 500 CANE RUN RD.	12	121363	1/1/0001
05800	S	M	OUG	II	00000	029	SIDE OF 505 CANE RUN RD.	12	111580	1/1/0001
05800	S	M	OUG	II	01601	001		0	121363	1/1/0001
05800	S	M	OUG	II	01612	002		12	121363	1/1/0001
05800	S	M	OUG	II	01624	004		12	121363	1/1/0001
05800	S	M	OUG	II	00000	030	SIDE OF 500 GRANTCHESTER RD.	12	111580	1/1/0001
05800	S	M	OUG	II	01745	036		12	111580	1/1/0001
05800	S	M	OUG	II	01753	037		12	111580	1/1/0001
05800	S	M	OUG	II	01761	038		12	111580	1/1/0001
05800	S	M	OUG	II	01709	031		12	111580	1/1/0001
05800	S	M	OUG	II	01713	032		12	111580	1/1/0001
05800	S	M	OUG	II	01718	033		12	111580	1/1/0001
05800	S	M	OUG	II	01728	035		12	111580	1/1/0001
05800	S	M	OUG	II	01729	034		12	111580	1/1/0001

OFFICE: 311		ROUTE: 564		ST_REF_NO: 0000087280		HAYS BLVD				
LUMENS	BULB TYPE	MULT SERIES	POLE TYPE	SHADE	ADDRESS NUMBER	REF	LOCATION	TAX DIST	DATE INST	DATE CHANGE
22000	S		OUG	II	00000	100	1ST LT S OF JOUETT CR, W SIDE ON HAYS BLVD	12	061309	1/1/0001
22000	S		OUG	II	00000	101	11TH LT N OF SPERLING DR, E SIDE ON HAYS BLVD	12	061309	1/1/0001
22000	S		OUG	II	00000	102	2ND LT S OF JOUETT CR, W SIDE ON HAYS BLVD	12	061309	1/1/0001
22000	S		OUG	II	00000	103	10TH LT N OF SPERLING DR, E SIDE ON HAYS BLVD	12	061309	1/1/0001

OFFICE: 311

ROUTE: 564

ST_REF_NO: 0000087280

HAYS BLVD

LUMENS	BULB TYPE	MULT SERIES	POLE TYPE	SHADE	ADDRESS NUMBER	REF	LOCATION	TAX DIST	DATE INST	DATE CHANGE
22000	S		OUG	II	00000	104	3RD LT S OF JOUETT CR, W SIDE ON HAYS BLVD	12	061309	1/1/0001
22000	S		OUG	II	00000	105	9TH LT N OF SPERLING DR, E SIDE ON HAYS BLVD	12	061309	1/1/0001
22000	S		OUG	II	00000	106	4TH LT S OF JOUETT CR, W SIDE ON HAYES BLVD	12	061309	1/1/0001
22000	S		OUG	II	00000	107	8TH LT N OF SPERLING DR, E SIDE ON HAYS BLVD	12	061309	1/1/0001
22000	S		OUG	II	00000	108	5TH LT S OF JOUETT CR, W SIDE ON HAYS BLVD	12	061309	1/1/0001
22000	S		OUG	II	00000	109	7TH LT N OF SPERLING DR, E SIDE ON HAYS BLVD	12	061309	1/1/0001
22000	S		OUG	II	00000	110	6TH LT S OF JOUETT CR, W SIDE ON HAYS BLVD	12	061309	1/1/0001
22000	S		OUG	II	00000	111	6TH LT N OF SPERLING DR, E SIDE ON HAYS BLVD	12	061309	1/1/0001
22000	S		OUG	II	00000	112	1ST LT S OF GRASSER WAY, W SIDE ON HAYS BLVD	12	061309	1/1/0001
22000	S		OUG	II	00000	113	5TH LT N OF SPERLING DR, E SIDE ON HAYS BLVD	12	061309	1/1/0001
22000	S		OUG	II	00000	114	2ND LT S OF GRASSER WAY, W SIDE ON HAYS BLVD	12	061309	1/1/0001
22000	S		OUG	II	00000	115	4TH LT N OF SPERLING DR, E SIDE ON HAYS BLVD	12	061309	1/1/0001
22000	S		OUG	II	00000	116	3RD LT S OF GRASSER WAY, W SIDE ON HAYS BLVD	12	061309	1/1/0001
22000	S		OUG	II	00000	117	3RD LT N OF SPERLING DR, E SIDE ON HAYS BLVD	12	061309	1/1/0001
22000	S		OUG	II	00000	118	4TH LT S OF GRASSER WAY, W SIDE ON HAYS BLVD	12	061309	1/1/0001
22000	S		OUG	II	00000	119	2ND LT N OF SPERLING DR, E SIDE ON HAYS BLVD	12	061309	1/1/0001
22000	S		OUG	II	00000	120	5TH LT S OF GRASSER WAY, W SIDE ON HAYS BLVD	12	061309	1/1/0001
22000	S		OUG	II	00000	121	1ST LT N OF SPERLING DR, E SIDE ON HAYS BLVD	12	061309	1/1/0001
22000	S		OUG	II	00000	122	1ST LT W OF SPERLING DR, N SIDE ON HAYS BLVD	12	061309	1/1/0001
22000	S		OUG	II	00000	123	16TH LT E OF MARCUS TR, S SIDE ON HAYS BLVD	12	061309	1/1/0001
22000	S		OUG	II	00000	124	2ND LT W OF SPERLING DR, N SIDE ON HAYS BLVD	12	061309	1/1/0001
22000	S		OUG	II	00000	125	15TH LT E OF MARCUS TR, S SIDE ON HAYS BLVD	12	061309	1/1/0001
22000	S		OUG	II	00000	126	3RD LT W OF SPERLING DR, N SIDE ON HAYS BLVD	12	061309	1/1/0001
22000	S		OUG	II	00000	127	14TH LT E OF MARCUS TR, S SIDE ON HAYS BLVD	12	061309	1/1/0001
22000	S		OUG	II	00000	128	4TH LT W OF SPERLING DR, N SIDE ON HAYS BLVD	12	061309	1/1/0001
22000	S		OUG	II	00000	129	13TH LT E OF MARCUS TR, S SIDE ON HAYS BLVD	12	061309	1/1/0001
22000	S		OUG	II	00000	130	5TH LT W OF SPERLING DR, N SIDE ON HAYS BLVD	12	061309	1/1/0001
22000	S		OUG	II	00000	131	12TH LT E OF MARCUS TR, S SIDE ON HAYS BLVD	12	061309	1/1/0001
22000	S		OUG	II	00000	132	6TH LT W OF SPERLING DR, N SIDE ON HAYS BLVD	12	061309	1/1/0001
22000	S		OUG	II	00000	133	11TH LT E OF MARCUS TR, S SIDE ON HAYS BLVD	12	061309	1/1/0001
22000	S		OUG	II	00000	134	7TH LT W OF SPERLING DR, N SIDE ON HAYS BLVD	12	061309	1/1/0001

Street Light Listing run 1/11/2015 10:43:21 AM

Page 461 of 1254

OFFICE: 311

ROUTE: 564

ST_REF_NO: 0000087280

HAYS BLVD

LUMENS	BULB TYPE	MULT SERIES	POLE TYPE	SHADE	ADDRESS NUMBER	REF	LOCATION	TAX DIST	DATE INST	DATE CHANGE
22000	S		OUG	II	00000	135	10TH LT E OF MARCUS TR, S SIDE ON HAYS BLVD	12	061309	1/1/0001
22000	S		OUG	II	00000	136	8TH LT W OF SPERLING DR, N SIDE ON HAYS BLVD	12	061309	1/1/0001
22000	S		OUG	II	00000	137	9TH LT E OF MARCUS TR, S SIDE ONO HAYS BLVD	12	061309	1/1/0001
22000	S		OUG	II	00000	138	9TH LT W OF SPERLING DR, N SIDE ON HAYS BLVD	12	061309	1/1/0001
22000	S		OUG	II	00000	139	8TH LT E OF MARCUS TR, S SIDE ON HAYS BLVD	12	061309	1/1/0001
22000	S		OUG	II	00000	140	10TH LT W OF SPERLING DR, N SIDE ON HAYS BLVD	12	061309	1/1/0001
22000	S		OUG	II	00000	141	7TH LT E OF MARCUS TR, S SIDE ON HAYS BLVD	12	061309	1/1/0001
22000	S		OUG	II	00000	142	11TH LT W OF SPERLING DR, N SIDE ON HAYS BLVD	12	061309	1/1/0001
22000	S		OUG	II	00000	143	6TH LT E OF MARCUS TR, S SIDE ON HAYS BLVD	12	061309	1/1/0001
22000	S		OUG	II	00000	144	12TH LT W OF SPERLING DR, N SIDE ON HAYS BLVD	12	061309	1/1/0001
22000	S		OUG	II	00000	145	5TH LT E OF MARCUS TR, S SIDE ON HAYS BLVD	12	061309	1/1/0001
22000	S		OUG	II	00000	146	13TH LT W OF SPERLING DR, N SIDE ON HAYS BLVD	12	061309	1/1/0001
22000	S		OUG	II	00000	147	4TH LT E OF MARCUS TR, S SIDE ON HAYS BLVD	12	061309	1/1/0001
22000	S		OUG	II	00000	148	14TH LT W OF SPERLING DR, N SIDE ON HAYS BLVD	12	061309	1/1/0001
22000	S		OUG	II	00000	149	3RD LT E OF MARCUS TR, S SIDE ON HAYS BLVD	12	061309	1/1/0001
22000	S		OUG	II	00000	150	15TH LT W OF SPERLING DR, N SIDE ON HAYS BLVD	12	061309	1/1/0001
22000	S		OUG	II	00000	151	2ND LT E OF MARCUS TR, S SIDE ON HAYS BLVD	12	061309	1/1/0001
22000	S		OUG	II	00000	152	16TH LT W OF SPERLING DR, N SIDE ON HAYS BLVD	12	061309	1/1/0001
22000	S		OUG	II	00000	153	1ST LT E OF MARCUS TR, S SIDE ON HAYS BLVD	12	061309	1/1/0001
22000	S		OUG	II	00000	401	1st It E of Richmond Rd, S side on Hays Blvd	12	092208	1/1/0001
22000	S		OUG	II	00000	402	1st It E of Richmond Rd, N side on Hays Blvd	12	092208	1/1/0001
22000	S		OUG	II	00000	403	2nd It E of Richmond Rd., S side on Hays Blvd	12	092208	1/1/0001
22000	S		OUG	II	00000	404	2nd It E of Richmond Rd, N side on Hays Blvd	12	092208	1/1/0001
22000	S		OUG	II	00000	405	3rd It E of Richmond Rd, S side on Haus Blvd	12	092208	1/1/0001
22000	S		OUG	II	00000	406	3rd It E of Richmond Rd., N side on Hays Blvd	12	092208	1/1/0001
22000	S		OUG	II	00000	407	4th It E of Richmond Rd, S side on Hays Blvd	12	092208	1/1/0001
22000	S		OUG	II	00000	408	4th It E of Richmond Rd, N side on Hays Blvd	12	092208	1/1/0001
22000	S		OUG	II	00000	409	1st It E of Walnut Creek Dr, S side on Hays Blvd	12	092208	1/1/0001
22000	S		OUG	II	00000	410	1st It E of Walnut Creek Dr, N side on Hays Blvd	12	092208	1/1/0001

OFFICE: 311

ROUTE: 564

ST_REF_NO: 0000087280

HAYS BLVD

LUMENS	BULB TYPE	MULT SERIES	POLE TYPE	SHADE	ADDRESS NUMBER	REF	LOCATION	TAX DIST	DATE INST	DATE CHANGE
22000	S		OUG	II	00000	420	1st It E of Tradition Way, N side on Hays Blvd	12	092208	1/1/0001
22000	S		OUG	II	00000	427	side of 4468 Walnut creek Dr on Hays Blvd	12	092208	1/1/0001
22000	S		OUG	II	00000	431	2nd It W of Chilesburg, S side on Hays Blvd	12	092208	1/1/0001
22000	S		OUG	II	00000	433	1st It W of Chilesburg, S side on Hays Blvd	12	092208	1/1/0001
22000	S		OUG	II	00000	434	1st It W of Chilesburg, N side on Hays Blvd	12	092208	1/1/0001
22000	S		OUG	II	00156	411		12	092208	1/1/0001
22000	S		OUG	II	00157	412		12	092208	1/1/0001
22000	S		OUG	II	00164	413		12	092208	1/1/0001
22000	S		OUG	II	00165	414		12	092208	1/1/0001
22000	S		OUG	II	00172	415		12	092208	1/1/0001
22000	S		OUG	II	00177	416		12	092208	1/1/0001
22000	S		OUG	II	00188	417		12	092208	1/1/0001
22000	S		OUG	II	00197	418		12	092208	1/1/0001
22000	S		OUG	II	00200	419		12	092208	1/1/0001
22000	S		OUG	II	00212	421		12	092208	1/1/0001
22000	S		OUG	II	00213	422		12	092208	1/1/0001
22000	S		OUG	II	00225	424		12	092208	1/1/0001
22000	S		OUG	II	00228	423		12	092208	1/1/0001
22000	S		OUG	II	00232	425		12	092208	1/1/0001
22000	S		OUG	II	00233	426		12	092208	1/1/0001
22000	S		OUG	II	00245	428		12	092208	1/1/0001
22000	S		OUG	II	00252	429		12	092208	1/1/0001
22000	S		OUG	II	00257	430		12	092208	1/1/0001
22000	S		OUG	II	00269	432		12	092208	1/1/0001
50000	S	M	SOH	II	00000	001	1ST LT E OF RICHMOND RD, NORTH SIDE ON HAYS BLVD	12	050803	1/1/0001
50000	S	M	OOH	II	00000	002	1ST LT E OF RICHMOND RD, SOUTH SIDE ON HAYS BLVD	12	050803	1/1/0001
22000	S	M	OUG	II	00000	003	2ND LT S OF TODDS RD, W SIDE ON HAYS BLVD	12	021705	1/1/0001
22000	S	M	OUG	II	00000	004	2ND LT S OF TODDS RD, E SIDE ON HAYS BLVD	12	021705	1/1/0001
22000	S	M	OUG	II	00000	005	3RD LT S OF TODDS RD, W SIDE ON HAYS BLVD	12	021705	1/1/0001
22000	S	M	OUG	II	00000	006	3RD LT S OF TODDS RD, E SIDE ON HAYS BLVD	12	021705	1/1/0001
22000	S	M	OUG	II	00000	007	4TH LT S OF TODDS RD, W SIDE ON HAYS BLVD	12	021705	1/1/0001
22000	S	M	OUG	II	00000	008	4TH LT S OF TODDS RD, E SIDE ON HAYS BLVD	12	021705	1/1/0001
22000	S	M	OUG	II	00000	009	5TH LT S OF TODDS RD, W SIDE ON HAYS BLVD	12	021705	1/1/0001

Street Light Listing run 1/11/2015 10:43:21 AM

Page 463 of 1254

OFFICE: 311

ROUTE: 564

ST_REF_NO: 0000087280

HAYS BLVD

LUMENS	BULB TYPE	MULT SERIES	POLE TYPE	SHADE	ADDRESS NUMBER	REF	LOCATION	TAX DIST	DATE INST	DATE CHANGE
22000	S	M	OUG	II	00000	010	5TH LT S OF TODDS RD, E SIDE ON HAYS BLVD	12	021705	1/1/0001
22000	S	M	OUG	II	00000	011	6TH LT S OF TODDS RD, W SIDE ON HAYS BLVD	12	021705	1/1/0001
22000	S	M	OUG	II	00000	012	6TH LT S OF TODDS RD, E SIDE ON HAYS BLVD	12	021705	1/1/0001
22000	S	M	OUG	II	00000	013	7TH LT S OF TODDS RD, W SIDE ON HAYS BLVD	12	021705	1/1/0001
22000	S	M	OUG	II	00000	014	7TH LT S OF TODDS RD, E SIDE ON HAYS BLVD	12	021705	1/1/0001
22000	S	M	OUG	II	00000	015	8TH LT S OF TODDS RD, W SIDE ON HAYS BLVD	12	021705	1/1/0001
22000	S	M	OUG	II	00000	016	8TH LT S OF TODDS RD, E SIDE ON HAYS BLVD	12	021705	1/1/0001
50000	S	M	OUG	II	00000	017	9TH LT S OF TODDS RD, W SIDE ON HAYS BLVD	12	021705	1/1/0001
50000	S	M	OUG	II	00000	018	9TH LT S OF TODDS RD, E SIDE ON HAYS BLVD	12	021705	1/1/0001
50000	S	M	OUG	II	00000	019	1ST LT S OF TODDS RD, W SIDE ON HAYS BLVD	12	021705	1/1/0001
50000	S	M	OUG	II	00000	020	1ST LT S OF TODDS RD, E SIDE ON HAYS BLVD	12	021705	1/1/0001
22000	S	M	OUG	II	00000	206	SIDE OF 4401 LEVI TODD BLVD ON HAYS BLVD	12	053106	1/1/0001
22000	S	M	OUG	II	00000	211	SIDE OF 4397 STUART HALL BLVD ON HAYS BLVD	12	010707	1/1/0001
22000	S	M	OUG	II	00000	300	1ST LIGHT EAST OF CHILESBURG RD SOUTH SIDE OF HAYS	12	010707	1/1/0001
22000	S	M	OUG	II	00000	302	2ND LIGHT EAST OF CHILESBURG RD SOUTH SIDE ON HAYS	12	010707	1/1/0001
22000	S	M	OUG	II	00312	200		12	053106	1/1/0001
22000	S	M	OUG	II	00320	202		12	053106	1/1/0001
22000	S	M	OUG	II	00332	204		12	053106	1/1/0001
22000	S	M	OUG	II	00337	205		12	010707	1/1/0001
22000	S	M	OUG	II	00356	208		12	053106	1/1/0001
22000	S	M	OUG	II	00357	207		12	010707	1/1/0001
22000	S	M	OUG	II	00368	210		12	053106	1/1/0001
22000	S	M	OUG	II	00373	209		12	010707	1/1/0001
22000	S	M	OUG	II	00380	212		12	053106	1/1/0001
22000	S	M	OUG	II	00385	213		12	010707	1/1/0001
22000	S	M	OUG	II	00388	214		12	053106	1/1/0001
22000	S	M	OUG	II	00397	215		12	010707	1/1/0001
22000	S	M	OUG	II	00400	216		12	053106	1/1/0001
22000	S	M	OUG	II	00409	217		12	010707	1/1/0001
22000	S	M	OUG	II	00412	218		12	053106	1/1/0001

OFFICE: 311

ROUTE: 564

ST_REF_NO: 0000087300 HAYMAN AVENUE

LUMENS	BULB TYPE	MULT SERIES	POLE TYPE	SHADE	ADDRESS NUMBER	REF	LOCATION	TAX DIST	DATE INST	DATE CHANGE
05800	S	M	SOH	II	00000	001	BESIDE 428	12	061566	1/1/0001
05800	S	M	SOH	II	00000	002	3RD LT. W. OF S. BROADWAY, S. SIDE	12	080171	1/1/0001
05800	S	M	SOH	II	00410	003		12	090884	1/1/0001

OFFICE: 311

ROUTE: 564

ST_REF_NO: 0000087400 HAZEL AVENUE

LUMENS	BULB TYPE	MULT SERIES	POLE TYPE	SHADE	ADDRESS NUMBER	REF	LOCATION	TAX DIST	DATE INST	DATE CHANGE
05800	S	M	SOH	II	00000	003	SIDE OF 301 RICHMOND AVENUE ON HAZEL AVENUE	12	060105	1/1/0001
05800	S	M	SOH	II	00107	004		12	060105	1/1/0001
09500	S	M	SOH	II	00099	023	upgraded to 9500 hps cobra June 2005	12	020884	1/1/0001
09500	S	M	SOH	II	00109	024	upgraded to 9500 hps cobra June 2005	12	020884	1/1/0001

OFFICE: 311

ROUTE: 564

ST_REF_NO: 0000087450 HAZELMOOR PLACE

LUMENS	BULB TYPE	MULT SERIES	POLE TYPE	SHADE	ADDRESS NUMBER	REF	LOCATION	TAX DIST	DATE INST	DATE CHANGE
05800	S	M	OUG	II	01705	001		12	010897	1/1/0001
05800	S	M	OUG	II	01713	002		12	010897	1/1/0001

OFFICE: 311

ROUTE: 564

ST_REF_NO: 0000087500 HEADLEY AVENUE

LUMENS	BULB TYPE	MULT SERIES	POLE TYPE	SHADE	ADDRESS NUMBER	REF	LOCATION	TAX DIST	DATE INST	DATE CHANGE
05800	S	M	SOH	I	00000	242	SIDE OF 421 DELCAMP AVE.	12	100266	1/1/0001
05800	S	M	SOH	II	00617	247		12	100266	1/1/0001
05800	S	M	SOH	II	00621	246		12	100266	1/1/0001
05800	S	M	SOH	II	00635	245		12	100266	1/1/0001
05800	S	M	SOH	II	00647	244		12	100266	1/1/0001
05800	S	M	SOH	II	00665	243		12	100266	1/1/0001
05800	S	M	SOH	V	00673	000		12	121582	1/1/0001
05800	S	M	SOH	I	00710	241		12	100266	1/1/0001
05800	S	M	SOH	I	00716	240		12	100266	1/1/0001
05800	S	M	SOH	I	00720	239		12	100266	1/1/0001
05800	S	M	SOH	V	00722	248		12	100886	1/1/0001

OFFICE: 311

ROUTE: 564

ST_REF_NO: 00000087520

HEARTSBROOK LANE

LUMENS	BULB TYPE	MULT SERIES	POLE TYPE	SHADE	ADDRESS NUMBER	REF	LOCATION	TAX DIST	DATE INST	DATE CHANGE
05800	S	M	OUG	II	00701	001		12	090898	1/1/0001
05800	S	M	OUG	II	00704	002		12	090898	1/1/0001
05800	S	M	OUG	II	00716	003		12	090898	1/1/0001
05800	S	M	OUG	II	00725	004		12	090898	1/1/0001
05800	S	M	OUG	II	00732	005		12	090898	1/1/0001
05800	S	M	OUG	II	00741	006		12	090898	1/1/0001
05800	S	M	OUG	II	00748	007		12	090898	1/1/0001
05800	S	M	OUG	II	00757	008		12	090898	1/1/0001
05800	S	M	OUG	II	00764	009		12	090898	1/1/0001

OFFICE: 311

ROUTE: 564

ST_REF_NO: 00000087530

HEADLEY GREEN

LUMENS	BULB TYPE	MULT SERIES	POLE TYPE	SHADE	ADDRESS NUMBER	REF	LOCATION	TAX DIST	DATE INST	DATE CHANGE
05800	S	M	CNT	III	00000	008	SIDE OF 1724	12	060899	1/1/0001
05800	S	M	CNT	II	00000	010	SIDE OF 1716	12	060899	1/1/0001
05800	S	M	CNT	III	01709	011		12	060899	1/1/0001
05800	S	M	CNT	II	01737	009		12	060899	1/1/0001
05800	S	M	CNT	II	01769	007		12	060899	1/1/0001
05800	S	M	CNT	II	01776	006		12	060899	1/1/0001
05800	S	M	CNT	II	01785	001		12	110897	1/1/0001
05800	S	M	CNT	II	01797	002		12	110897	1/1/0001
05800	S	M	CNT	II	01808	003		12	110897	1/1/0001
05800	S	M	CNT	III	01825	004		12	060899	1/1/0001
05800	S	M	CNT	II	01837	005		12	060899	1/1/0001

OFFICE: 311

ROUTE: 564

ST_REF_NO: 00000087580

HEALY LANE

LUMENS	BULB TYPE	MULT SERIES	POLE TYPE	SHADE	ADDRESS NUMBER	REF	LOCATION	TAX DIST	DATE INST	DATE CHANGE
09500	S		CLN	II	02401	001		12	091109	1/1/0001
09500	S		CLN	II	02408	002		12	091109	1/1/0001
09500	S		CLN	II	02413	003		12	091109	1/1/0001
09500	S		CLN	II	02424	004		12	091109	1/1/0001

OFFICE: 311

ROUTE: 564

ST_REF_NO: 0000087600

HEARTWOOD ROAD

LUMENS	BULB TYPE	MULT SERIES	POLE TYPE	SHADE	ADDRESS NUMBER	REF	LOCATION	TAX DIST	DATE INST	DATE CHANGE
05800	S	M	OUG	II	04100	010	upgrade due to bad fixture	12	060887	10/1/2008
04000	S	M	OUG	II	00000	016	SIDE 4149	12	060887	1/1/0001
04000	S	M	OUG	II	00000	017	SIDE 4144	12	060887	1/1/0001
04000	S	M	OUG	II	04105	011		12	060887	1/1/0001
04000	S	M	OUG	II	04112	012		12	060887	1/1/0001
04000	S	M	OUG	II	04121	013		12	060887	1/1/0001
04000	S	M	OUG	II	04128	014		12	060887	1/1/0001
04000	S	M	OUG	II	04141	015		12	060887	1/1/0001
04000	S	M	OUG	II	04169	018		12	060887	1/1/0001
04000	S	M	OUG	II	04184	019		12	060887	1/1/0001
04000	S	M	OUG	II	04189	020		12	060887	1/1/0001

OFFICE: 311

ROUTE: 564

ST_REF_NO: 0000087700

HEATHER COURT

LUMENS	BULB TYPE	MULT SERIES	POLE TYPE	SHADE	ADDRESS NUMBER	REF	LOCATION	TAX DIST	DATE INST	DATE CHANGE
05800	S	M	OUG	II	00000	041	SIDE OF 2480 HEATHER WAY	12	080166	1/1/0001

OFFICE: 311

ROUTE: 564

ST_REF_NO: 0000087800

HEATHER WAY

LUMENS	BULB TYPE	MULT SERIES	POLE TYPE	SHADE	ADDRESS NUMBER	REF	LOCATION	TAX DIST	DATE INST	DATE CHANGE
05800	S	M	OUG	II	02460	026		12	080166	8/12/2013
04000	S	M	OUG	II	00000	005	OPP. 2028	12	081477	1/1/0001
04000	S	M	OUG	II	00000	006	SIDE OF 256 ZANDALE DR.	12	081477	1/1/0001
04000	S	M	OUG	II	00000	011	SIDE OF 301 ALBANY RD.	12	081477	1/1/0001
04000	S	M	OUG	II	00000	012	SIDE OF 226 JESSLIN DR.	12	081477	1/1/0001
04000	S	M	OUG	II	00000	013	SIDE OF 303 JESSLIN DR.	12	081477	1/1/0001
04000	S	M	OUG	II	00000	015	SIDE OF 301 BLUEBERRY	12	081477	1/1/0001
04000	S	M	OUG	II	00000	016	SIDE OF 246 GLENDOVER	12	081477	1/1/0001
04000	S	M	OUG	II	00000	079	SIDE OF 252 GREENBRIAR RD.	12	081477	1/1/0001
04000	S	M	OUG	II	00000	080	SIDE OF 301 GREENBRIAR RD.	12	081477	1/1/0001
04000	S	M	OUG	II	00000	081	SIDE OF 274 ALBANY RD.	12	081477	1/1/0001
04000	S	M	OUG	II	01927	014		12	081477	1/1/0001
04000	S	M	OUG	II	01998	000		12	081477	1/1/0001
04000	S	M	OUG	II	02036	004		12	081477	1/1/0001

OFFICE: 311		ROUTE: 564		ST_REF_NO: 0000087800		HEATHER WAY				
LUMENS	BULB TYPE	MULT SERIES	POLE TYPE	SHADE	ADDRESS NUMBER	REF	LOCATION	TAX DIST	DATE INST	DATE CHANGE
04000	S	M	OUG	II	02045	003		12	081477	1/1/0001
04000	S	M	OUG	II	02053	002		12	081477	1/1/0001
04000	S	M	OUG	II	00000	044	SIDE OF 3325 BELLEFONTE	12	080166	1/1/0001
04000	S	M	OUG	II	02064	001		12	081477	1/1/0001
04000	S	M	OUG	II	02337	051		12	080166	1/1/0001
04000	S	M	OUG	II	02346	052		12	080166	1/1/0001
04000	S	M	OUG	II	02359	053		12	080166	1/1/0001
04000	S	M	OUG	II	02378	054		12	080166	1/1/0001
04000	S	M	OUG	II	02383	055		12	090172	1/1/0001
04000	S	M	OUG	II	02394	056		12	080166	1/1/0001
04000	S	M	OUG	II	02403	057		12	080166	1/1/0001
04000	S	M	OUG	II	02406	058		12	080166	1/1/0001
04000	S	M	OUG	II	02419	022		12	080166	1/1/0001
04000	S	M	OUG	II	02432	023		12	080166	1/1/0001
05800	S	M	OUG	II	02439	024		12	080166	1/1/0001
04000	S	M	OUG	II	02451	025		12	080166	1/1/0001
04000	S	M	OUG	II	02479	040		12	080166	1/1/0001
04000	S	M	OUG	II	02488	000		12	070767	1/1/0001
OFFICE: 311		ROUTE: 564		ST_REF_NO: 0000087845		HEATHLAND PLACE				
LUMENS	BULB TYPE	MULT SERIES	POLE TYPE	SHADE	ADDRESS NUMBER	REF	LOCATION	TAX DIST	DATE INST	DATE CHANGE
05800	S	M	OUG	III	02104	001		12	082602	1/1/0001
05800	S	M	OUG	III	02209	002		12	082602	1/1/0001
OFFICE: 311		ROUTE: 564		ST_REF_NO: 0000087850		HEATHMOOR COURT				
LUMENS	BULB TYPE	MULT SERIES	POLE TYPE	SHADE	ADDRESS NUMBER	REF	LOCATION	TAX DIST	DATE INST	DATE CHANGE
05800	S	M	OUG	II	04208	002		12	110896	1/1/0001
05800	S	M	OUG	III	04221	001		12	110896	1/1/0001

OFFICE: 311

ROUTE: 564

ST_REF_NO: 00000087900 HEATON COURT

LUMENS	BULB TYPE	MULT SERIES	POLE TYPE	SHADE	ADDRESS NUMBER	REF	LOCATION	TAX DIST	DATE INST	DATE CHANGE
05800	S	M	OUG	II	02405	000		12	120170	1/1/0001

OFFICE: 311

ROUTE: 564

ST_REF_NO: 00000088090 HEDGEWOOD COURT

LUMENS	BULB TYPE	MULT SERIES	POLE TYPE	SHADE	ADDRESS NUMBER	REF	LOCATION	TAX DIST	DATE INST	DATE CHANGE
05800	S	M	OUG	V	00243	107		12	011674	1/1/0001
05800	S	M	OUG	II	00268	106		12	020474	1/1/0001
05800	S	M	OUG	II	00279	105		12	011674	1/1/0001
05800	S	M	OUG	II	00292	104		12	020474	1/1/0001

OFFICE: 311

ROUTE: 564

ST_REF_NO: 00000088100 HEDGEWOOD DRIVE

LUMENS	BULB TYPE	MULT SERIES	POLE TYPE	SHADE	ADDRESS NUMBER	REF	LOCATION	TAX DIST	DATE INST	DATE CHANGE
05800	S	M	OUG	II	00000	095	SIDE OF 374 LARKWOOD DR.	12	080172	1/1/0001
05800	S	M	OUG	II	00000	099	SIDE OF 2505 WOODHILL DR.	12	080172	1/1/0001
05800	S	M	OUG	II	00404	096		12	080172	1/1/0001
05800	S	M	OUG	II	00417	097		12	080172	1/1/0001
05800	S	M	OUG	II	00432	098		12	080172	1/1/0001

OFFICE: 311

ROUTE: 564

ST_REF_NO: 00000088200 HEIMBAUGH LANE

LUMENS	BULB TYPE	MULT SERIES	POLE TYPE	SHADE	ADDRESS NUMBER	REF	LOCATION	TAX DIST	DATE INST	DATE CHANGE
04000	S	M	OUG	II	00000	053	SIDE OF 4180 FORSYTHE DR.	12	091579	1/1/0001
04000	S	M	OUG	II	00000	059	SIDE OF 3860 GLADMAN WAY	12	091579	1/1/0001
04000	S	M	OUG	II	03808	054		12	091579	1/1/0001
04000	S	M	OUG	II	03821	055		12	091579	1/1/0001
04000	S	M	OUG	II	03832	056		12	091579	1/1/0001
04000	S	M	OUG	II	03837	057		12	091579	1/1/0001
04000	S	M	OUG	II	03852	058		12	091579	1/1/0001

OFFICE: 311

ROUTE: 564

ST_REF_NO: 00000088300 HELM STREET

LUMENS	BULB TYPE	MULT SERIES	POLE TYPE	SHADE	ADDRESS NUMBER	REF	LOCATION	TAX DIST	DATE INST	DATE CHANGE
05800	S	M	SOH	II	00000	013	1ST LT SOUTH OF WINCHESTER RD ON HELM STREET	12	032304	1/1/0001

OFFICE: 311		ROUTE: 564		ST_REF_NO: 0000088300		HELM STREET		LUMENS	BULB TYPE	MULT SERIES	POLE TYPE	SHADE	ADDRESS NUMBER	REF	LOCATION	TAX DIST	DATE INST	DATE CHANGE
05800	S	M	SOH	II	00104	010		12	032304	1/1/0001								
05800	S	M	SOH	II	00106	012		12	032304	1/1/0001								
OFFICE: 311		ROUTE: 564		ST_REF_NO: 0000088330		HELMSDALE PLACE		LUMENS	BULB TYPE	MULT SERIES	POLE TYPE	SHADE	ADDRESS NUMBER	REF	LOCATION	TAX DIST	DATE INST	DATE CHANGE
05800	S	M	CNT	II	03100	001		12	020898	1/1/0001								
05800	S	M	CNT	II	03105	002		12	020898	1/1/0001								
05800	S	M	CNT	II	03108	003		12	020898	1/1/0001								
05800	S	M	CNT	II	03121	004		12	020898	1/1/0001								
05800	S	M	CNT	II	03124	005		12	020898	1/1/0001								
05800	S	M	CNT	II	03137	006		12	020898	1/1/0001								
OFFICE: 311		ROUTE: 564		ST_REF_NO: 0000088332		HEMINGWAY LANE		LUMENS	BULB TYPE	MULT SERIES	POLE TYPE	SHADE	ADDRESS NUMBER	REF	LOCATION	TAX DIST	DATE INST	DATE CHANGE
05800	S	M	CNT	II	00000	010	ACROSS FROM 3140 HEMINGWAY LANE	12	033006	1/1/0001								
05800	S	M	CNT	II	00000	017	ACROSS FROM 2981 HEMINGWAY LANE	12	033006	1/1/0001								
05800	S	M	CNT	II	02961	018		12	033006	1/1/0001								
05800	S	M	CNT	II	02989	016		12	033006	1/1/0001								
05800	S	M	CNT	II	02993	015		12	033006	1/1/0001								
05800	S	M	CNT	II	03100	014		12	033006	1/1/0001								
05800	S	M	CNT	II	03112	013		12	033006	1/1/0001								
05800	S	M	CNT	II	03117	012		12	040707	1/1/0001								
05800	S	M	CNT	II	03132	011		12	040707	1/1/0001								
05800	S	M	CNT	II	03144	009		12	033006	1/1/0001								
05800	S	M	CNT	II	03161	008		12	033006	1/1/0001								
05800	S	M	CNT	II	03168	007		12	033006	1/1/0001								
05800	S	M	CNT	II	03181	006		12	033006	1/1/0001								
05800	S	M	CNT	II	03184	005		12	033006	1/1/0001								
05800	S	M	CNT	II	03193	004		12	033006	1/1/0001								
05800	S	M	CNT	II	03204	003		12	033006	1/1/0001								
05800	S	M	CNT	II	03212	002		12	033006	1/1/0001								
05800	S	M	CNT	III	03217	001		12	033006	1/1/0001								

OFFICE: 311

ROUTE: 564

ST_REF_NO: 0000088335 HENDERSON DRIVE

LUMENS	BULB TYPE	MULT SERIES	POLE TYPE	SHADE	ADDRESS NUMBER	REF	LOCATION	TAX DIST	DATE INST	DATE CHANGE
05800	S	M	CNT	II	00000	002	SIDE OF 558 VERMILLION PEAK PASS ON HENDERSON DR	12	031704	1/1/0001
05800	S	M	CNT	II	00000	003	2ND LT S OF VERMILLION PEAK PASS ON HENDERSON DR	12	031704	1/1/0001
05800	S	M	CNT	II	00000	004	SIDE OF 4701 MIAMI CIRCLE ON HENDERSON DR	12	031704	1/1/0001
05800	S	M	CNT	II	00000	005	SIDE OF 4700 MIAMI CIRCLE ON HENDERSON DR	12	031704	1/1/0001
05800	S	M	CNT	II	00000	007	SIDE OF 4737 POMPANO LANE ON HENDERSON DR	12	031704	1/1/0001
05800	S	M	CNT	III	00801	001		12	031704	1/1/0001
05800	S	M	CNT	II	00849	006		12	031704	1/1/0001
05800	S	M	CNT	II	00873	008		12	031704	1/1/0001
05800	S	M	CNT	II	00885	009		12	031704	1/1/0001

OFFICE: 311

ROUTE: 564

ST_REF_NO: 0000088400 HENRY STREET

LUMENS	BULB TYPE	MULT SERIES	POLE TYPE	SHADE	ADDRESS NUMBER	REF	LOCATION	TAX DIST	DATE INST	DATE CHANGE
09500	S	M	SOH	II	00000	210	SIDE OF 561 W. 3RD ST.	12	070166	2/23/2011
09500	S	M	SOH	II	00326	211		12	070166	2/23/2011
09500	S	M	SOH	II	00340	212		12	070166	2/23/2011
09500	S	M	SOH	II	00358	213		12	070166	2/23/2011

OFFICE: 311

ROUTE: 564

ST_REF_NO: 0000088500 HENRY CLAY BOULEVARD

LUMENS	BULB TYPE	MULT SERIES	POLE TYPE	SHADE	ADDRESS NUMBER	REF	LOCATION	TAX DIST	DATE INST	DATE CHANGE
05800	S	M	OUG	II	00000	100	1ST LT S OF DELAWARE ON HENRY CLAY BLVD	12	090401	1/1/0001
05800	S	M	OUG	II	00000	144	ACROSS FROM 451 HENRY CLAY BLVD	12	090401	1/1/0001
05800	S	M	OUG	II	00000	145	ACROSS FROM 443 HENRY CLAY BLVD	12	090401	1/1/0001
05800	S	M	OUG	II	00501	099		12	090401	1/1/0001
09500	S	M	OUG	II	00000	092	SIDE 1601 LIBERTY RD	12	110884	1/1/0001
09500	S	M	OUG	II	00807	091		12	110884	1/1/0001
09500	S	M	OUG	II	00812	090		12	110884	1/1/0001
09500	S	M	OUG	II	00823	089		12	110884	1/1/0001
09500	S	M	OUG	II	00836	088		12	110884	1/1/0001
09500	S	M	OUG	II	00847	087		12	110884	1/1/0001
09500	S	M	OUG	II	00856	086		12	110884	1/1/0001
09500	S	M	OUG	II	00867	085		12	110884	1/1/0001

OFFICE: 311

ROUTE: 564

ST_REF_NO: 0000088500

HENRY CLAY BOULEVARD

LUMENS	BULB TYPE	MULT SERIES	POLE TYPE	SHADE	ADDRESS NUMBER	REF	LOCATION	TAX DIST	DATE INST	DATE CHANGE
04000	S	M	OUG	II	00000	024	SIDE OF 1603 FAIRWAY DR.	12	061269	1/1/0001
04000	S	M	OUG	II	00229	025		12	080966	1/1/0001
04000	S	M	OUG	II	00242	026		12	051581	1/1/0001
04000	S	M	OUG	II	00249	027		12	051581	1/1/0001
04000	S	M	OUG	II	00312	028		12	080966	1/1/0001
04000	S	M	OUG	II	00324	029		12	120884	1/1/0001
04000	S	M	OUG	II	00000	032	OPP. 369	12	032568	1/1/0001
04000	S	M	OUG	II	00340	030		12	032568	1/1/0001
04000	S	M	OUG	II	00353	031		12	032568	1/1/0001
05800	S	M	SOH	II	00377	146		12	120898	1/1/0001
05800	S	M	SOH	II	00400	135		12	050885	1/1/0001
05800	S	M	OUG	II	00404	136		12	110884	1/1/0001
05800	S	M	OUG	II	00408	137		12	110884	1/1/0001
05800	S	M	OUG	II	00418	139		12	110884	1/1/0001
05800	S	M	OUG	II	00423	138		12	110884	1/1/0001
05800	S	M	OUG	II	00430	141		12	110884	1/1/0001
05800	S	M	OUG	II	00433	140		12	110884	1/1/0001
05800	S	M	OUG	II	00440	143		12	110884	1/1/0001
05800	S	M	OUG	II	00443	142		12	110884	1/1/0001
09500	S	M	SOH	II	00501	099		12	010885	1/1/0001
09500	S	M	OUG	II	00520	098		12	110884	1/1/0001
09500	S	M	OUG	II	00532	097		12	110884	1/1/0001
09500	S	M	OUG	II	00609	096		12	110884	1/1/0001
09500	S	M	OUG	II	00700	095		12	110884	1/1/0001
09500	S	M	OUG	II	00717	094		12	110884	1/1/0001
09500	S	M	SOH	II	00720	093		12	010885	1/1/0001

OFFICE: 311

ROUTE: 564

ST_REF_NO: 0000088600

HENTON ROAD

LUMENS	BULB TYPE	MULT SERIES	POLE TYPE	SHADE	ADDRESS NUMBER	REF	LOCATION	TAX DIST	DATE INST	DATE CHANGE
04000	S	M	SOH	II	00000	001	SIDE OF 110 THOMPSON RD.	12	070886	1/1/0001
04000	S	M	SOH	II	00000	002	OPP. 119	12	070886	1/1/0001
04000	S	M	SOH	II	00126	003		12	070886	1/1/0001
04000	S	M	SOH	II	00132	004		12	070886	1/1/0001

OFFICE: 311

ROUTE: 564

ST_REF_NO: 00000088600 HENTON ROAD

LUMENS	BULB TYPE	MULT SERIES	POLE TYPE	SHADE	ADDRESS NUMBER	REF	LOCATION	TAX DIST	DATE INST	DATE CHANGE
04000	S	M	SOH	II	00140	005		12	070886	1/1/0001
04000	S	M	SOH	II	00148	006		12	070886	1/1/0001

OFFICE: 311

ROUTE: 564

ST_REF_NO: 00000088700 HERLIHY AVENUE

LUMENS	BULB TYPE	MULT SERIES	POLE TYPE	SHADE	ADDRESS NUMBER	REF	LOCATION	TAX DIST	DATE INST	DATE CHANGE
05800	S	M	SOH	V	00000	001	SIDE REAR OF 200 COX ST.	12	102473	1/1/0001
05800	S	M	SOH	V	00000	002	OPP. 822	12	102473	1/1/0001
05800	S	M	SOH	II	00000	003	OPP. 816	12	072058	1/1/0001

OFFICE: 311

ROUTE: 564

ST_REF_NO: 00000088800 HERMITAGE DRIVE

LUMENS	BULB TYPE	MULT SERIES	POLE TYPE	SHADE	ADDRESS NUMBER	REF	LOCATION	TAX DIST	DATE INST	DATE CHANGE
09500	S	M	OUG	II	00357	004		12	011066	6/20/2013
05800	S	M	OUG	II	00000	001	SIDE OF 1906 WICKLAND DR.	12	011066	1/1/0001
05800	S	M	OUG	II	00344	005		12	011066	1/1/0001
05800	S	M	OUG	II	00372	003		12	011066	1/1/0001
05800	S	M	OUG	II	00381	002		12	011066	1/1/0001
05800	S	M	OUG	II	00396	006		12	091167	1/1/0001

OFFICE: 311

ROUTE: 564

ST_REF_NO: 00000088900 HERON LANE

LUMENS	BULB TYPE	MULT SERIES	POLE TYPE	SHADE	ADDRESS NUMBER	REF	LOCATION	TAX DIST	DATE INST	DATE CHANGE
04000	S	M	OUG	II	00000	048	SIDE 265 MOCKINGBIRD LANE	12	110884	1/1/0001
04000	S	M	OUG	II	01539	051		12	110884	1/1/0001
04000	S	M	OUG	II	01551	050		12	110884	1/1/0001
04000	S	M	OUG	II	01567	049		12	110884	1/1/0001

OFFICE: 311

ROUTE: 564

ST_REF_NO: 00000089000 HIALEIAH COURT

LUMENS	BULB TYPE	MULT SERIES	POLE TYPE	SHADE	ADDRESS NUMBER	REF	LOCATION	TAX DIST	DATE INST	DATE CHANGE
05800	S	M	OUG	II	00000	095	SIDE OF 3589 CAULDER RD.	12	120172	1/1/0001
05800	S	M	OUG	II	01237	096		12	120172	1/1/0001
05800	S	M	OUG	II	01248	097		12	120172	1/1/0001
05800	S	M	OUG	II	01261	098		12	120172	1/1/0001

OFFICE: 311		ROUTE: 564		ST_REF_NO: 00000089050		HIBERNIA PASS		LUMENS	BULB TYPE	MULT SERIES	POLE TYPE	SHADE	ADDRESS NUMBER	REF	LOCATION	TAX DIST	DATE INST	DATE CHANGE
05800	S		CNT	II	03301	006										12	020510	1/1/0001
05800	S		CNT	II	03316	005										12	020510	1/1/0001
05800	S		CNT	II	03348	003										12	020510	1/1/0001
05800	S		CNT	II	03376	001										12	020510	1/1/0001
OFFICE: 311		ROUTE: 564		ST_REF_NO: 00000089100		HICKORY STREET		LUMENS	BULB TYPE	MULT SERIES	POLE TYPE	SHADE	ADDRESS NUMBER	REF	LOCATION	TAX DIST	DATE INST	DATE CHANGE
05800	S	M	SOH	II	00318	000										12	060266	1/1/0001
05800	S	M	SOH	II	00332	000										12	011865	1/1/0001
OFFICE: 311		ROUTE: 564		ST_REF_NO: 00000089130		HICKORY BRANCH COURT		LUMENS	BULB TYPE	MULT SERIES	POLE TYPE	SHADE	ADDRESS NUMBER	REF	LOCATION	TAX DIST	DATE INST	DATE CHANGE
05800	S	M	OUG	III	00000	001	REAR OF 2275 HARRODS POINTE TRACE									12	100896	1/1/0001
OFFICE: 311		ROUTE: 564		ST_REF_NO: 00000089150		HICKORY CREEK DRIVE		LUMENS	BULB TYPE	MULT SERIES	POLE TYPE	SHADE	ADDRESS NUMBER	REF	LOCATION	TAX DIST	DATE INST	DATE CHANGE
05800	S	M	OUG	II	00000	001	OPP. 4600 HICKORY CREEK DR.									12	080890	12/14/2009
04000	S	M	OUG	II	04613	002										12	080890	1/1/0001
04000	S	M	OUG	II	04624	004										12	080890	1/1/0001
04000	S	M	OUG	II	04625	003										12	080890	1/1/0001
04000	S	M	OUG	II	04645	005										12	080890	1/1/0001
05800	S	M	OUG	II	04648	006										12	080893	1/1/0001
OFFICE: 311		ROUTE: 564		ST_REF_NO: 00000089175		HICKORY CREEK CIRCLE		LUMENS	BULB TYPE	MULT SERIES	POLE TYPE	SHADE	ADDRESS NUMBER	REF	LOCATION	TAX DIST	DATE INST	DATE CHANGE
04000	S	M	OUG	II	00000	001	SIDE OF 4616 HICKORY CREEK DR ON HICKORY CREEK CIR									12	080890	1/1/0001

OFFICE: 311		ROUTE: 564		ST_REF_NO: 0000089200		HICREST DRIVE		LUMENS	BULB TYPE	MULT SERIES	POLE TYPE	SHADE	ADDRESS NUMBER	REF	LOCATION	TAX DIST	DATE INST	DATE CHANGE
05800	S	M	OUG	II	00000	033	SIDE OF 1801 COURTLAND DR.	12	081265	1/1/0001								
05800	S	M	OUG	II	00512	000		12	060164	1/1/0001								
05800	S	M	OUG	II	00521	000		12	050164	1/1/0001								
05800	S	M	OUG	II	00536	000		12	050164	1/1/0001								
05800	S	M	OUG	II	00549	000		12	050164	1/1/0001								
05800	S	M	OUG	II	00560	000		12	050164	1/1/0001								
05800	S	M	OUG	II	00573	000		12	050164	1/1/0001								
05800	S	M	OUG	II	00588	000		12	050164	1/1/0001								
05800	S	M	OUG	II	00601	000		12	050164	1/1/0001								
05800	S	M	OUG	II	00612	000		12	050164	1/1/0001								
05800	S	M	OUG	II	00620	000		12	050164	1/1/0001								
05800	S	M	OUG	II	00629	000		12	050164	1/1/0001								
05800	S	M	OUG	II	00644	000		12	050164	1/1/0001								
05800	S	M	OUG	II	00655	000		12	050164	1/1/0001								
05800	S	M	OUG	II	00668	000		12	050164	1/1/0001								
05800	S	M	OUG	II	00684	000		12	060164	1/1/0001								
05800	S	M	OUG	II	00712	000		12	081265	1/1/0001								
05800	S	M	OUG	II	00723	000		12	100466	1/1/0001								
OFFICE: 311		ROUTE: 564		ST_REF_NO: 0000089250		HIDDEN CAVE CIRCLE		LUMENS	BULB TYPE	MULT SERIES	POLE TYPE	SHADE	ADDRESS NUMBER	REF	LOCATION	TAX DIST	DATE INST	DATE CHANGE
05800	S	M	CNT	II	03515	001		12	042502	1/1/0001								
05800	S	M	CNT	II	03525	002		12	042502	1/1/0001								
OFFICE: 311		ROUTE: 564		ST_REF_NO: 0000089300		HIDDEN POINT DRIVE		LUMENS	BULB TYPE	MULT SERIES	POLE TYPE	SHADE	ADDRESS NUMBER	REF	LOCATION	TAX DIST	DATE INST	DATE CHANGE
04000	S	M	OUG	II	00604	109		12	011581	1/1/0001								
04000	S	M	OUG	II	00624	110		12	011581	1/1/0001								
04000	S	M	OUG	II	00637	111		12	111580	1/1/0001								
04000	S	M	OUG	V	00657	112		12	011581	1/1/0001								

OFFICE: 311		ROUTE: 564		ST_REF_NO: 0000089400		HIDDEN SPRINGS DRIVE		LUMENS	BULB TYPE	MULT SERIES	POLE TYPE	SHADE	ADDRESS NUMBER	REF	LOCATION	TAX DIST	DATE INST	DATE CHANGE
05800	S	M	OUG	II	03884	031	upgrade due to bad fixture	12	071581	9/1/2008								
04000	S	M	OUG	II	03801	012		12	011583	1/1/0001								
04000	S	M	OUG	II	03804	013		12	011581	1/1/0001								
04000	S	M	OUG	II	03821	014		12	080884	1/1/0001								
04000	S	M	OUG	II	03832	015		12	080884	1/1/0001								
04000	S	M	OUG	II	03848	028		12	071581	1/1/0001								
04000	S	M	OUG	II	03853	029		12	071581	1/1/0001								
04000	S	M	OUG	II	03865	030		12	021581	1/1/0001								
04000	S	M	OUG	II	03893	032		12	101581	1/1/0001								
04000	S	M	OUG	V	03901	033		12	021582	1/1/0001								
04000	S	M	OUG	II	03904	034		12	071581	1/1/0001								
04000	S	M	OUG	II	03925	035		12	071581	1/1/0001								
04000	S	M	OUG	II	03928	036		12	071581	1/1/0001								
04000	S	M	OUG	II	03949	037		12	071581	1/1/0001								

OFFICE: 311		ROUTE: 564		ST_REF_NO: 0000089402		HIDDEN STREAM DRIVE		LUMENS	BULB TYPE	MULT SERIES	POLE TYPE	SHADE	ADDRESS NUMBER	REF	LOCATION	TAX DIST	DATE INST	DATE CHANGE
05800	S	M	OUG	II	00813	006		12	100802	1/1/0001								
05800	S	M	OUG	II	00836	005		12	100802	1/1/0001								
05800	S	M	OUG	II	00845	004		12	100802	1/1/0001								
05800	S	M	OUG	II	00860	003		12	100802	1/1/0001								
05800	S	M	OUG	II	00876	002		12	100802	1/1/0001								
05800	S	M	OUG	II	00885	001		12	100802	1/1/0001								

OFFICE: 311		ROUTE: 564		ST_REF_NO: 0000089410		HIDDEN WOODS COURT		LUMENS	BULB TYPE	MULT SERIES	POLE TYPE	SHADE	ADDRESS NUMBER	REF	LOCATION	TAX DIST	DATE INST	DATE CHANGE
04000	S	M	OUG	II	00000	009	SIDE 4497 PRINCE ALBERT WAY	12	090886	1/1/0001								
04000	S	M	OUG	V	00105	015		12	090886	1/1/0001								
04000	S	M	OUG	II	00116	014		12	090886	1/1/0001								

OFFICE: 311		ROUTE: 564		ST_REF_NO: 0000089500		HIGBEE MILL ROAD		LUMENS	BULB TYPE	MULT SERIES	POLE TYPE	SHADE	ADDRESS NUMBER	REF	LOCATION	TAX DIST	DATE INST	DATE CHANGE
04000	S	M	OUG	II	00000	018	2ND LT W OF CLAYS MILL, NORTHSIDE OF HIGBEE MILL	12	050891	1/1/0001								
04000	S	M	OUG	II	00000	019	3RD LT W OF CLAYS MILL, NORTHSIDE OF HIGBEE MILL	12	050891	1/1/0001								
04000	S	M	OUG	II	00000	020	4TH LT E OF CORNWALL ON NORTHSIDE OF HIGBEE MILL	12	050891	1/1/0001								
04000	S	M	OUG	II	00000	021	3RD LT E OF CORNWALL ON NORTHSIDE OF HIGBEE MILL	12	050891	1/1/0001								
04000	S	M	OUG	II	00000	022	2ND LT E OF CORNWALL ON NORTHSIDE OF HIGBEE MILL	12	050891	1/1/0001								
04000	S	M	OUG	II	00000	023	1ST LT E OF CORNWALL ON NORTHSIDE OF HIGBEE MILL	12	050891	1/1/0001								
04000	S	M	OUG	II	00000	015	1ST LT. E. OF CLAYS MILL ON N. SIDE	12	060685	1/1/0001								
04000	S	M	OOH	II	00000	016	1ST LT. W. OF CLAYS MILL ON S. SIDE	12	060685	1/1/0001								
04000	S	M	OUG	II	00000	017	1ST LT. W. OF CLAYS MILL ON N. SIDE	12	060685	1/1/0001								
05800	S	M	SOH	II	01080	002	SIDE OF 3801 GRASSY CR ON HIGBEE MILL (7/06)	12	011581	1/1/0001								
05800	S	M	SOH	II	01104	001	SIDE OF 3801 WINDING BROOK CT upgrade/moved 7/06	12	021581	1/1/0001								
05800	S	M	OUG	II	00000	005	SIDE OF 3800 GRASSY CREEK DR.	12	100898	1/1/0001								
05800	S	M	OUG	II	00000	008		12	100898	1/1/0001								
05800	S	M	CNT	II	00000	026	2ND LT. S OF MILLPOND RD., WESTSIDE	12	050899	1/1/0001								
05800	S	M	SOH	III	00940	010		12	100898	1/1/0001								
05800	S	M	OOH	II	00948	009		12	100898	1/1/0001								
05800	S	M	SOH	II	00968	007		12	100898	1/1/0001								
05800	S	M	SOH	II	00980	006		12	100898	1/1/0001								
09500	S	M	OUG	IV	00000	001	1ST LT. E. OF NICHOLASVILLE RD., NORTHSIDE	12	060893	1/1/0001								
09500	S	M	OUG	IV	00000	002	2ND LT. E. OF NICHOLASVILLE RD., NORTHSIDE	12	060893	1/1/0001								
09500	S	M	OUG	IV	00000	003	SIDE OF 4377 COBBLESTONE KNOLL DR.	12	060893	1/1/0001								
09500	S	M	OUG	IV	00000	004	4TH LT. E. OF NICHOLASVILLE RD., NORTHSIDE	12	060893	1/1/0001								
05800	S	M	CNT	II	00000	025	1ST LT. S OF MILLPOND RD., WESTSIDE	12	050899	1/1/0001								
OFFICE: 311		ROUTE: 564		ST_REF_NO: 0000089510		HIGBEE WOODS COURT		LUMENS	BULB TYPE	MULT SERIES	POLE TYPE	SHADE	ADDRESS NUMBER	REF	LOCATION	TAX DIST	DATE INST	DATE CHANGE
05800	S	M	OUG	II	03701	003		12	120892	1/1/0001								
05800	S	M	OUG	II	03716	004		12	120892	1/1/0001								

OFFICE: 311		ROUTE: 564		ST_REF_NO: 00000089510		HIGBEE WOODS COURT		TAX DIST	DATE INST	DATE CHANGE
LUMENS	BULB TYPE	MULT SERIES	POLE TYPE	SHADE	ADDRESS NUMBER	REF	LOCATION			
05800	S	M	OUG	II	03717	002		12	120892	1/1/0001
05800	S	M	OUG	II	03721	001		12	120892	1/1/0001
OFFICE: 311		ROUTE: 564		ST_REF_NO: 00000089650		HIGGENS COURT		TAX DIST	DATE INST	DATE CHANGE
LUMENS	BULB TYPE	MULT SERIES	POLE TYPE	SHADE	ADDRESS NUMBER	REF	LOCATION			
05800	S	M	CNT	II	03305	001		12	080897	1/1/0001
05800	S	M	CNT	III	03316	002		12	080897	1/1/0001
OFFICE: 311		ROUTE: 564		ST_REF_NO: 00000089700		HIGH, EAST STREET		TAX DIST	DATE INST	DATE CHANGE
LUMENS	BULB TYPE	MULT SERIES	POLE TYPE	SHADE	ADDRESS NUMBER	REF	LOCATION			
10000	M	S	SOH	II	00000	003	SIDE OF 298 SOUTH ASHLAND AVE.-CHG'D REF DESCRIPTION ONLY	12	050664	1/20/2014
22000	S	S	SOH	III	00000	010	1ST LT E OF MLK BLVD, S SIDE-AUDIT CORRECTION	12	021464	1/21/2014
50000	S	M	SOH	III	00000	013	2ND LT W OF MLK BLVD, S SIDE-AUDIT CORRECTION	12	121063	1/21/2014
50000	S	M	SOH	III	00000	014	3RD LT W OF MLK BLVD, S SIDE-AUDIT CORRECTION	12	121063	1/21/2014
50000	S	M	SOH	III	00000	016	OPP 101 E HIGH STREET - AUDIT CORRECTION	12	121063	1/20/2014
10000	M	M	OOH	IV	00000	160	OPP. 850-AUDIT CORRECTION	12	111157	1/20/2014
50000	S	M	SOH	III	00121	015	AUDIT CORRECTION	12	021464	1/21/2014
22000	S	M	OOH	III	00152	011		12	041064	11/30/2011
22000	S	S	SOH	III	00180	009	2ND LT E OF MLK BLVD, S SIDE	12	121063	7/28/2011
22000	S	S	SOH	III	00209	007	AUDIT CORRECTION	12	021464	1/21/2014
22000	S	S	SOH	III	00210	006	AUDIT CORRECTION	12	121063	1/21/2014
22000	S	S	SOH	III	00227	005	AUDIT CORRECTION	12	021464	1/21/2014
22000	S	S	SOH	III	00251	003	audit correction	12	021464	1/21/2014
22000	S	S	SOH	III	00258	002	audit correction	12	121063	1/21/2014
09500	S	S	SOH	III	00312	036	audit correction	12	050664	1/21/2014
09500	S	S	SOH	II	00322	035	audit correction	12	050664	1/21/2014
10000	M	M	SOH	II	00331	034	changed hse address only-audit correction	12	100164	1/21/2014
09500	S	S	SOH	II	00342	033	audit correction	12	050664	1/21/2014
09500	S	S	SOH	II	00401	032	bad fixture	12	100164	3/16/2009
10000	M	S	SOH	II	00610	013	CHG'D ADDRESS ONLY	12	101064	1/20/2014

Street Light Listing run 1/11/2015 10:43:21 AM

Page 478 of 1254

OFFICE: 311

ROUTE: 564

ST_REF_NO: 0000089700

HIGH, EAST STREET

LUMENS	BULB TYPE	MULT SERIES	POLE TYPE	SHADE	ADDRESS NUMBER	REF	LOCATION	TAX DIST	DATE INST	DATE CHANGE
09500	S	M	SOH	II	00636	010	upgrade due to bad fixture	12	050664	10/8/2008
09500	S	M	SOH	II	00645	009	AUDIT CORRECTION	12	100164	1/20/2014
22000	S	M	SOH	III	00865	163		12	110165	4/22/2009
22000	S	M	OOH	IV	00866	161	AUDIT CORRECTION	12	111157	1/20/2014
22000	S	M	OOH	II	00866	164		12	022167	3/24/2011
50000	S	S	OOH	III	00881	165	bad fixture	12	110165	11/25/2009
10000	M	M	SOH	II	00000	005	SIDE OF 293 S. ASHLAND AVE.	12	050664	1/1/0001
10000	M	M	SOH	II	00000	015	OPP. 600	12	100164	1/1/0001
10000	M	S	SOH	II	00000	017	OPP. OLDHAM AVE.	12	100164	1/1/0001
10000	M	S	SOH	II	00000	019	N.E. CORNER OF KENTUCKY AVE.	12	050664	1/1/0001
10000	M	S	SOH	II	00000	020	SW CORNER OF KENTUCKY AVE.	12	050664	1/1/0001
10000	M	M	SOH	II	00000	024	1ST LT. W. OF WOODLAND, N. SIDE	12	050664	1/1/0001
22000	S	S	OOH	III	00000	175	IN FRONT OF MORTON JR. HIGH SCHOOL	12	101165	1/1/0001
10000	M	M	SOH	II	00482	025		12	050664	1/1/0001
10000	M	M	SOH	II	00501	023		12	050664	1/1/0001
10000	M	S	SOH	II	00504	022		12	050664	1/1/0001
10000	M	S	SOH	II	00521	021		12	050664	1/1/0001
10000	M	M	SOH	II	00552	018		12	050664	1/1/0001
10000	M	M	SOH	II	00560	016		12	050664	1/1/0001
09500	S	M	SOH	II	00604	014		12	050664	1/1/0001
10000	M	S	SOH	II	00626	012		12	050664	1/1/0001
10000	M	M	SOH	II	00629	011		12	050664	1/1/0001
10000	M	S	SOH	II	00702	008		12	050664	1/1/0001
10000	M	M	SOH	II	00710	007		12	100898	1/1/0001
10000	M	M	SOH	II	00720	006		12	050664	1/1/0001
10000	M	S	SOH	II	00742	004		12	050664	1/1/0001
10000	M	M	SOH	II	00807	001		12	050664	1/1/0001
10000	M	S	SOH	II	00836	002		12	050664	1/1/0001
20000	M	S	SOH	III	00898	166		12	110165	1/1/0001
22000	S	M	SOH	III	00000	008	SW CORNER OF E. HIGH AND LEXINGTON	12	021464	1/1/0001
22000	S	M	CNT	II	00000	012	1ST LT W OF M.L.K BLVD, NORTHSIDE	12	060892	1/1/0001
10000	M	M	SOH	II	00000	031	SIDE OF 200 ARLINGTON AVE.	12	050664	1/1/0001
22000	S	M	CNT	II	00000	039	2ND LT E OF M.L.K. BLVD, NORTHSIDE	12	060892	1/1/0001
22000	S	M	CNT	II	00000	041	1ST LT E OF M.L.K. BLVD, NORTHSIDE	12	060892	1/1/0001

Street Light Listing run 1/11/2015 10:43:21 AM

Page 479 of 1254

OFFICE: 311		ROUTE: 564		ST_REF_NO: 0000089700		HIGH, EAST STREET		LUMENS	BULB TYPE	MULT SERIES	POLE TYPE	SHADE	ADDRESS NUMBER	REF	LOCATION	TAX DIST	DATE INST	DATE CHANGE
20000	M	M	SOH	III	00283	001		12	021464	1/1/0001								
10000	M	M	SOH	II	00425	030		12	050664	1/1/0001								
10000	M	M	SOH	II	00434	029		12	050664	1/1/0001								
10000	M	M	SOH	II	00449	028		12	050664	1/1/0001								
10000	M	M	SOH	II	00462	027		12	050664	1/1/0001								
10000	M	M	SOH	II	00465	026		12	050664	1/1/0001								
OFFICE: 311		ROUTE: 564		ST_REF_NO: 0000089710		HIGH, WEST STREET		LUMENS	BULB TYPE	MULT SERIES	POLE TYPE	SHADE	ADDRESS NUMBER	REF	LOCATION	TAX DIST	DATE INST	DATE CHANGE
50000	S		CNT	II	00000	670	1ST LT E OF OLIVER LEWIS WAY, N SIDE ON W HIGH ST	12	031511	1/1/0001								
22000	S		CNT	II	00000	671	2NT LT E OF OLIVER LEWIS WAY, N SIDE ON W HIGH ST	12	031511	1/1/0001								
22000	S		CNT	II	00000	672	REAR OF ISLAND BETWEEN W HIGH AND W MAXWELL	12	031511	1/1/0001								
22000	S	M	OUG	III	00000	037	4TH LT. W. OF PINE ST., N. SIDE	12	061583	1/18/2011								
22000	S	M	OUG	III	00000	041	6TH LT. W. OF PINE ST., N. SIDE	12	061583	11/5/2013								
50000	S	M	OUG	III	00000	055	3RD LT. E. OF ANGLIANA AVE., S. SIDE upgrade 5/08	12	061583	11/10/2009								
50000	S	M	OOH	II	00000	123	OPP. 218	12	100172	1/14/2013								
50000	S	M	OUG	III	01090	057		12	061583	11/10/2009								
20000	M	M	OUG	III	00000	061	1ST LT. W. OF ANGLIANA AVE., S. SIDE	12	061583	1/1/0001								
22000	S	M	OUG	III	00000	066	1ST LT. E. OF PORTER PLACE, N. SIDE upgrade 5/08	12	061583	1/1/0001								
20000	M	M	OUG	III	00000	067	1ST LT. W. OF PORTER PLACE, S. SIDE	12	061583	1/1/0001								
20000	M	M	OUG	III	01091	058		12	061583	1/1/0001								
20000	M	M	OUG	III	01091	060		12	061583	1/1/0001								
20000	M	M	OUG	III	01098	059		12	061583	1/1/0001								
20000	M	M	OOH	III	01109	064		12	061583	1/1/0001								
20000	M	M	OUG	III	01112	063		12	061583	1/1/0001								
20000	M	M	OUG	III	01115	062		12	061583	1/1/0001								
20000	M	M	OUG	III	01130	065		12	061583	1/1/0001								
20000	M	M	OUG	III	01135	068		12	061583	1/1/0001								
20000	M	M	OUG	III	01150	069		12	061583	1/1/0001								
20000	M	M	OUG	III	01155	070		12	061583	1/1/0001								
20000	M	M	OUG	III	01175	071		12	061583	1/1/0001								

OFFICE: 311

ROUTE: 564

ST_REF_NO: 0000089710

HIGH, WEST STREET

LUMENS	BULB TYPE	MULT SERIES	POLE TYPE	SHADE	ADDRESS NUMBER	REF	LOCATION	TAX DIST	DATE INST	DATE CHANGE
20000	M	M	OUG	III	01202	072		12	061583	1/1/0001
20000	M	M	OUG	III	01205	073		12	061583	1/1/0001
20000	M	M	OUG	III	01232	074		12	061583	1/1/0001
20000	M	M	OUG	III	01236	076		12	061583	1/1/0001
20000	M	M	OUG	III	01247	075		12	061583	1/1/0001
10000	M	M	SOH	II	00000	001	1ST LT. W. OF S. BROADWAY, S. SIDE	12	011477	1/1/0001
22000	S	M	OOH	II	00000	008	SW CORNER OF PATTERSON AND W. HIGH	12	040885	1/1/0001
22000	S	M	SOH	II	00000	009	NW CORNER OF MANCHESTER ST. AND W. HIGH	12	030885	1/1/0001
22000	S	M	SOH	II	00000	010	OPP. 630	12	030885	1/1/0001
10000	M	M	SOH	II	00000	016	SIDE OF 303 MADISON PLACE	12	110164	1/1/0001
20000	M	M	OUG	III	00000	032	2ND LT. W. OF PINE ST., S.SIDE	12	061583	1/1/0001
20000	M	M	OUG	III	00000	033	2ND LT. W. OF PINE ST., N. SIDE	12	061583	1/1/0001
20000	M	M	OUG	III	00000	034	3RD LT. W. OF PINE ST., S.SIDE	12	061583	1/1/0001
20000	M	M	OUG	III	00000	035	3RD LT. W. OF PINE ST., N. SIDE	12	061583	1/1/0001
20000	M	M	OUG	III	00000	036	4TH LT. W. OF PINE ST., S. SIDE	12	061583	1/1/0001
20000	M	M	OUG	III	00000	038	5TH LT. W. OF PINE ST., S. SIDE	12	061583	1/1/0001
20000	M	M	OUG	III	00000	039	5TH LT. W. OF PINE ST., N. SIDE	12	061583	1/1/0001
20000	M	M	OUG	III	00000	040	6TH LT. W. OF PINE ST., S. SIDE	12	061583	1/1/0001
20000	M	M	OUG	III	00000	042	7TH LT. W. OF PINE ST., S. SIDE	12	061583	1/1/0001
22000	S	M	OUG	III	00000	043	7TH LT. W. OF PINE ST., N. SIDE upgrade 5/08	12	061583	1/1/0001
20000	M	M	OUG	III	00000	044	8TH LT. W. OF PINE ST., S. SIDE	12	061583	1/1/0001
20000	M	M	OUG	III	00000	045	8TH LT. W. OF PINE ST., N. SIDE	12	061583	1/1/0001
20000	M	M	OUG	III	00000	046	6TH LT. E. OF ANGLIANA AVE., S. SIDE	12	061583	1/1/0001
20000	M	M	OUG	III	00000	047	6TH LT. E. OF ANGLIANA AVE., S. SIDE	12	061583	1/1/0001
20000	M	M	OUG	III	00000	048	6TH LT. E. OF ANGLIANA AVE., N. SIDE	12	061583	1/1/0001
20000	M	M	OUG	III	00000	049	5TH LT. E. OF ANGLIANA AVE., S. SIDE	12	061583	1/1/0001
20000	M	M	OUG	III	00000	050	5TH LT. E. OF ANGLIANA AVE., S. SIDE	12	061583	1/1/0001
20000	M	M	OUG	III	00000	051	5TH LT. E. OF ANGLIANA AVE., N. SIDE	12	061583	1/1/0001
20000	M	M	OUG	III	00000	052	4TH LT. E. OF ANGLIANA AVE., S. SIDE	12	061583	1/1/0001
20000	M	M	OUG	III	00000	053	4TH LT. E. OF ANGLIANA AVE., S. SIDE	12	061583	1/1/0001
20000	M	M	OUG	III	00000	054	4TH LT. E. OF ANGLIANA AVE., N. SIDE	12	061583	1/1/0001
20000	M	M	OUG	III	00000	056	3RD LT. E. OF ANGLIANA, N. SIDE	12	061583	1/1/0001
22000	S	M	SOH	II	00416	002		12	011477	1/1/0001
22000	S	M	SOH	II	00628	011		12	110164	1/1/0001

OFFICE: 311

ROUTE: 564

ST_REF_NO: 0000089710

HIGH, WEST STREET

LUMENS	BULB TYPE	MULT SERIES	POLE TYPE	SHADE	ADDRESS NUMBER	REF	LOCATION	TAX DIST	DATE INST	DATE CHANGE
22000	S	M	SOH	II	00703	012		12	051864	1/1/0001
22000	S	M	SOH	II	00716	013		12	051864	1/1/0001
22000	S	M	SOH	II	00724	014		12	110164	1/1/0001
22000	S	M	SOH	II	00733	015		12	051864	1/1/0001
22000	S	M	SOH	II	00819	017		12	051864	1/1/0001
22000	S	M	SOH	II	00828	018		12	110164	1/1/0001
22000	S	M	SOH	II	00841	019		12	051864	1/1/0001
22000	S	M	SOH	II	00854	020		12	110164	1/1/0001
22000	S	M	SOH	II	00859	021		12	021582	1/1/0001
20000	M	M	SOH	II	00000	003	1ST. LT. E. OF S. BROADWAY, N. SIDE	12	070171	1/1/0001
20000	M	M	OUG	III	00000	004	OPPOSITE 304	12	021582	1/1/0001
50000	S	M	CNT	III	00000	126	1ST LT. W. OF S. BROADWAY, NORTHSIDE	12	010892	1/1/0001
50000	S	M	CNT	III	00000	127	2ND LT. W. OF S. BROADWAY, NORTHSIDE	12	010892	1/1/0001
50000	S	M	CNT	III	00000	128	3RD LT. W. OF S. BROADWAY, NORTHSIDE	12	010892	1/1/0001
50000	S	M	CNT	III	00000	129	4TH LT. W. OF S. BROADWAY, NORTHSIDE	12	010892	1/1/0001
50000	S	M	CNT	III	00000	130	5TH LT. W. OF S. BROADWAY, NORTHSIDE	12	010892	1/1/0001
50000	S	M	CNT	III	00000	131	4TH LT. E. OF PATTERSON, NORTHSIDE	12	010892	1/1/0001
50000	S	M	CNT	III	00000	132	3RD LT. E. OF PATTERSON, NORTHSIDE	12	010892	1/1/0001
50000	S	M	CNT	III	00000	133	2ND LT. E. OF PATTERSON, NORTHSIDE	12	010892	1/1/0001
50000	S	M	CNT	III	00000	134	1ST LT. E. OF PATTERSON, NORTHSIDE	12	010892	1/1/0001
20000	M	M	SOH	III	00300	026		12	121063	1/1/0001
20000	M	M	SOH	II	00316	000		12	070171	1/1/0001
20000	M	M	SOH	III	00000	017	NW CORNER OF LIME	12	021464	1/1/0001
22000	S	M	SOH	III	00000	021	N.E. CORNER OF S. UPPER	12	021464	1/1/0001
20000	M	M	OOH	II	00000	125	OPP. 236	12	100172	1/1/0001
20000	M	M	SOH	III	00108	018		12	121063	1/1/0001
20000	M	M	SOH	III	00120	020		12	121063	1/1/0001
20000	M	M	SOH	III	00121	019		12	021464	1/1/0001
20000	M	M	SOH	III	00200	022		12	121063	1/1/0001
20000	M	M	SOH	III	00220	024		12	121063	1/1/0001

OFFICE: 311

ROUTE: 564

ST_REF_NO: 0000089900

HIGH HOPE ROAD

LUMENS	BULB TYPE	MULT SERIES	POLE TYPE	SHADE	ADDRESS NUMBER	REF	LOCATION	TAX DIST	DATE INST	DATE CHANGE
05800	S	M	OUG	II	00000	140	SIDE OF 3296 SUTHERLAND DR.	12	120667	1/1/0001
05800	S	M	OUG	II	03309	141		12	042067	1/1/0001
05800	S	M	OUG	II	03324	018		12	090266	1/1/0001
05800	S	M	OUG	II	03337	000		12	120170	1/1/0001
05800	S	M	OUG	II	03348	000		12	031768	1/1/0001
05800	S	M	OUG	II	03355	021		12	090266	1/1/0001
05800	S	M	OUG	II	00000	022	SIDE OF 1264 GAINESWAY DR.	12	090266	1/1/0001

OFFICE: 311

ROUTE: 564

ST_REF_NO: 0000090000

HIGH RIDGE DRIVE

LUMENS	BULB TYPE	MULT SERIES	POLE TYPE	SHADE	ADDRESS NUMBER	REF	LOCATION	TAX DIST	DATE INST	DATE CHANGE
04000	S	M	OUG	II	00000	104	OPP. 3108	12	060890	1/1/0001
04000	S	M	OUG	V	03100	105		12	061580	1/1/0001
04000	S	M	OUG	II	03120	103		12	060890	1/1/0001
04000	S	M	OUG	II	03133	102		12	041581	1/1/0001
04000	S	M	OUG	II	03144	101		12	060890	1/1/0001
04000	S	M	OUG	II	03151	100		12	060890	1/1/0001
04000	S	M	OUG	II	03166	099		12	060890	1/1/0001

OFFICE: 311

ROUTE: 564

ST_REF_NO: 0000090090

HIGHLAND DRIVE

LUMENS	BULB TYPE	MULT SERIES	POLE TYPE	SHADE	ADDRESS NUMBER	REF	LOCATION	TAX DIST	DATE INST	DATE CHANGE
05800	S	M	SOH	II	00000	001	BETWEEN HILLCREST & SHELBY	12	110160	1/1/0001
05800	S	M	SOH	II	00000	002	HIGHLAND & SHELBY	12	110160	1/1/0001
05800	S	M	SOH	II	00000	003	BETWEEN SHELBY & BYARS	12	110160	1/1/0001
05800	S	M	SOH	II	00000	004	HIGHLAND & BYARS	12	110160	1/1/0001
05800	S	M	SOH	II	00000	005	BEHIND 902 BYARS	12	110160	1/1/0001
05800	S	M	SOH	II	00000	006	SIDE OF 300 HILLCREST AVE.	12	110160	1/1/0001

OFFICE: 311

ROUTE: 564

ST_REF_NO: 0000090100

HIGHLAND PARK DRIVE

LUMENS	BULB TYPE	MULT SERIES	POLE TYPE	SHADE	ADDRESS NUMBER	REF	LOCATION	TAX DIST	DATE INST	DATE CHANGE
09500	S		OUG	II	01014	000		12	122310	1/1/0001
09500	S		OUG	II	01026	000		12	122310	1/1/0001

OFFICE: 311

ROUTE: 564

ST_REF_NO: 0000090100

HIGHLAND PARK DRIVE

LUMENS	BULB TYPE	MULT SERIES	POLE TYPE	SHADE	ADDRESS NUMBER	REF	LOCATION	TAX DIST	DATE INST	DATE CHANGE
09500	S		OUG	II	01318	000		12	122310	1/1/0001
09500	S	M	OUG	II	00000	101	HIGHLAND PARK DR. & MARCELLUS	12	110863	12/23/2010
09500	S	M	SOH	I	00953	007		12	020171	12/23/2010
09500	S	M	SOH	I	00959	008		12	020171	12/23/2010
09500	S	M	SOH	I	00963	009		12	020171	12/23/2010
09500	S	M	SOH	III	01002	000		12	123055	12/23/2010
09500	S	M	SOH	III	01113	000		12	122255	12/23/2010
09500	S	M	OUG	II	01215	000		12	100164	12/23/2010
09500	S	M	OUG	II	01300	000		12	110863	12/23/2010
09500	S	M	OUG	II	00000	002	OPP. 920	12	020171	1/1/0001
09500	S	M	OUG	II	00000	003	OPP. 928	12	020171	1/1/0001
09500	S	M	OUG	II	00000	004	OPP. 936	12	020171	1/1/0001
09500	S	M	OUG	II	00000	005	OPP. 940	12	020171	1/1/0001
09500	S	M	OUG	II	00000	006	OPP. 944	12	020171	1/1/0001
09500	S	M	SOH	II	00914	001		12	020171	1/1/0001

OFFICE: 311

ROUTE: 564

ST_REF_NO: 0000090200

HIGHLAWN AVENUE

LUMENS	BULB TYPE	MULT SERIES	POLE TYPE	SHADE	ADDRESS NUMBER	REF	LOCATION	TAX DIST	DATE INST	DATE CHANGE
05800	S	M	SOH	II	00000	106	SIDE 300 LOCUST AVE.	12	050885	1/1/0001
05800	S	M	SOH	II	00000	107	SIDE 301 LOCUST AVE.	12	050885	1/1/0001
05800	S	M	SOH	II	00000	108	SIDE REAR 300 BLUEGRASS AVE.	12	050885	1/1/0001
05800	S	M	SOH	II	00000	109	SIDE 300 BLUEGRASS AVE.	12	050885	1/1/0001
05800	S	M	SOH	II	00000	110	SIDE 301 BLUEGRASS AVE.	12	050885	1/1/0001
05800	S	M	SOH	II	01404	111		12	050885	1/1/0001
05800	S	M	SOH	II	01410	112		12	050885	1/1/0001
05800	S	M	SOH	II	01416	113		12	060685	1/1/0001
05800	S	M	SOH	II	01420	114		12	060685	1/1/0001
05800	S	M	SOH	II	01430	115		12	060685	1/1/0001
05800	S	M	SOH	II	01445	116		12	060685	1/1/0001
05800	S	M	SOH	II	01449	117		12	060685	1/1/0001

OFFICE: 311

ROUTE: 564

ST_REF_NO: 00000090300 HIGHTOWER ROAD

LUMENS	BULB TYPE	MULT SERIES	POLE TYPE	SHADE	ADDRESS NUMBER	REF	LOCATION	TAX DIST	DATE INST	DATE CHANGE
05800	S	M	OUG	II	00000	029	SIDE OF 288 HIGHTOWER RD.	12	010171	1/1/0001
05800	S	M	OUG	II	00000	035	SIDE OF 333 REDDING RD.	12	010172	1/1/0001
05800	S	M	OUG	V	00280	000		12	051967	1/1/0001
05800	S	M	OUG	II	00293	000		12	081866	1/1/0001
05800	S	M	OUG	II	00304	000		12	042368	1/1/0001
05800	S	M	OUG	II	00309	000		12	022674	1/1/0001
05800	S	M	OUG	II	00325	043		12	010172	1/1/0001
05800	S	M	OUG	II	00336	000		12	080173	1/1/0001

OFFICE: 311

ROUTE: 564

ST_REF_NO: 00000090400 HILDEEN ROAD

LUMENS	BULB TYPE	MULT SERIES	POLE TYPE	SHADE	ADDRESS NUMBER	REF	LOCATION	TAX DIST	DATE INST	DATE CHANGE
05800	S		OUG	II	00763	002		12	102111	1/1/0001
05800	S		OUG	II	00766	001		12	102111	1/1/0001
05800	S		OUG	II	00770	003		12	102111	1/1/0001
05800	S		OUG	II	00775	004		12	102111	1/1/0001
05800	S		OUG	II	00796	005		12	102111	1/1/0001
05800	S		OUG	II	00799	007		12	102111	1/1/0001
05800	S		OUG	II	00800	006		12	102111	1/1/0001
05800	S		OUG	II	00801	008		12	102111	1/1/0001
05800	S		OUG	II	00805	009		12	102111	1/1/0001
05800	S		OUG	II	00812	010		12	102111	1/1/0001

OFFICE: 311

ROUTE: 564

ST_REF_NO: 00000090500 HILL COURT

LUMENS	BULB TYPE	MULT SERIES	POLE TYPE	SHADE	ADDRESS NUMBER	REF	LOCATION	TAX DIST	DATE INST	DATE CHANGE
04000	S	M	OUG	V	00367	039		12	121583	1/1/0001
04000	S	M	OUG	II	00391	038		12	121583	1/1/0001

OFFICE: 311

ROUTE: 564

ST_REF_NO: 00000090600 HILL STREET

LUMENS	BULB TYPE	MULT SERIES	POLE TYPE	SHADE	ADDRESS NUMBER	REF	LOCATION	TAX DIST	DATE INST	DATE CHANGE
04000	S	M	SOH	II	01403	039		12	060885	1/1/0001
04000	S	M	SOH	II	01409	040		12	060885	1/1/0001

OFFICE: 311

ROUTE: 564

ST_REF_NO: 0000090700

HILL-N DALE ROAD

LUMENS	BULB TYPE	MULT SERIES	POLE TYPE	SHADE	ADDRESS NUMBER	REF	LOCATION	TAX DIST	DATE INST	DATE CHANGE
04000	S	M	OUG	II	00000	026	SIDE OF 2601 SOUTHVIEW ON HILL 'N DALE	12	121583	1/1/0001
04000	S	M	OUG	II	00000	027	SIDE OF 2602 SOUTHVIEW ON HILL 'N DALE	12	121583	1/1/0001
04000	S	M	OUG	II	00000	028	SIDE OF 395 HILL CT.	12	121583	1/1/0001
04000	S	M	OUG	II	00000	030	SIDE OF 299 CLEARVIEW	12	121583	1/1/0001
05800	S	M	OUG	II	00000	037	SIDE OF 2596 MILLBROOK-upgrade 1/08	12	121583	1/1/0001
04000	S	M	OUG	II	00000	042	SIDE OF 2460 TULSA	12	101583	1/1/0001
05800	S	M	OUG	II	00000	047	SIDE OF 2390 TUCSON	12	101583	1/1/0001
05800	S	M	SOH	II	00000	048	OPP. 648	12	091583	1/1/0001
05800	S	M	SOH	II	00000	049	OPP. THE SIDE OF 2401 TOPEKA	12	091583	1/1/0001
05800	S	M	SOH	II	00000	050	OPP. THE SIDE OF 2400 TOPEKA	12	091583	1/1/0001
05800	S	M	SOH	II	00000	051	OPP. THE SIDE OF 2400 TOPEKA	12	091583	1/1/0001
05800	S	M	SOH	II	00000	052	OPP. 630	12	091583	1/1/0001
05800	S	M	SOH	II	00000	053	OPP. THE SIDE OF 2401 YUMA COURT	12	091583	1/1/0001
05800	S	M	SOH	II	00000	054	OPP. THE SIDE OF 2400 YUMA COURT	12	091583	1/1/0001
05800	S	M	SOH	II	00000	057	SIDE OF 2501 CLAYS MILL	12	091583	1/1/0001
05800	S	M	SOH	II	00000	058	SIDE OF 2501 CLAYS MILL	12	091583	1/1/0001
04000	S	M	OUG	II	00000	093	SIDE OF 581 CLAYMONT DR.	12	121583	1/1/0001
05800	S	M	OUG	II	00000	100	SIDE OF 581 CLAYMONT DR.	12	050896	1/1/0001
04000	S	M	OUG	II	00230	036		12	121583	1/1/0001
04000	S	M	OUG	II	00249	035		12	121583	1/1/0001
04000	S	M	OUG	II	00261	034		12	121583	1/1/0001
04000	S	M	OUG	II	00270	033		12	121583	1/1/0001
04000	S	M	OUG	II	00285	032		12	121583	1/1/0001
04000	S	M	OUG	II	00298	031		12	121583	1/1/0001
04000	S	M	OUG	II	00378	029		12	121583	1/1/0001
04000	S	M	OUG	II	00489	098		12	121583	1/1/0001
04000	S	M	OUG	II	00506	097		12	121583	1/1/0001
04000	S	M	OUG	II	00517	096		12	121583	1/1/0001
04000	S	M	OUG	II	00522	095		12	121583	1/1/0001
05800	S	M	SOH	II	00601	055		12	091583	1/1/0001
05800	S	M	SOH	II	00601	056		12	091583	1/1/0001
04000	S	M	OUG	II	00662	046		12	101583	1/1/0001
04000	S	M	OUG	II	00674	045		12	101583	1/1/0001
04000	S	M	OUG	II	00686	044		12	101583	1/1/0001

OFFICE: 311		ROUTE: 564		ST_REF_NO: 00000090700		HILL-N DALE ROAD		LUMENS	BULB TYPE	MULT SERIES	POLE TYPE	SHADE	ADDRESS NUMBER	REF	LOCATION	TAX DIST	DATE INST	DATE CHANGE
	04000	S	M	OUG	II	00691	043									12	101583	1/1/0001

OFFICE: 311		ROUTE: 564		ST_REF_NO: 00000090800		HILLCREST AVENUE		LUMENS	BULB TYPE	MULT SERIES	POLE TYPE	SHADE	ADDRESS NUMBER	REF	LOCATION	TAX DIST	DATE INST	DATE CHANGE
	05800	S	M	SOH	II	00000	001								HILLCREST & WINCHESTER RD.	12	110160	1/1/0001
	05800	S	M	SOH	II	00000	003								OPP. 105	12	110160	1/1/0001
	05800	S	M	SOH	II	00104	002									12	110160	1/1/0001
	05800	S	M	SOH	II	00204	004									12	110160	1/1/0001
	05800	S	M	SOH	II	00210	005									12	110160	1/1/0001
	05800	S	M	SOH	II	00220	006									12	110160	1/1/0001
	05800	S	M	SOH	II	00300	007									12	110160	1/1/0001
	05800	S	M	SOH	II	00326	008									12	110160	1/1/0001
	05800	S	M	SOH	II	00332	009									12	110160	1/1/0001

OFFICE: 311		ROUTE: 564		ST_REF_NO: 00000090890		HILL RISE COURT		LUMENS	BULB TYPE	MULT SERIES	POLE TYPE	SHADE	ADDRESS NUMBER	REF	LOCATION	TAX DIST	DATE INST	DATE CHANGE
	05800	S	M	OUG	II	00000	013								SIDE OF 1700 HILL RISE DR	12	110171	1/1/0001
	05800	S	M	OUG	V	00000	014								END OF HILL RISE COURT, SOUTH	12	110171	1/1/0001
	05800	S	M	OUG	II	00000	011								SIDE OF 1695 HILL RISE DR.	12	110171	1/1/0001
	05800	S	M	OUG	II	00000	015								SIDE OF 722 TERRACE VIEW DR.	12	020895	1/1/0001
	05800	S	M	OUG	V	00708	012									12	020895	1/1/0001

OFFICE: 311		ROUTE: 564		ST_REF_NO: 00000090895		HILL RISE, SOUTH COURT		LUMENS	BULB TYPE	MULT SERIES	POLE TYPE	SHADE	ADDRESS NUMBER	REF	LOCATION	TAX DIST	DATE INST	DATE CHANGE
	05800	S	M	OUG	III	00000	020								3RD LT FROM HEARTSBROOK LANE ON HILL RISE COURT	12	052002	1/1/0001

OFFICE: 311		ROUTE: 564		ST_REF_NO: 00000090900		HILLRISE DRIVE		LUMENS	BULB TYPE	MULT SERIES	POLE TYPE	SHADE	ADDRESS NUMBER	REF	LOCATION	TAX DIST	DATE INST	DATE CHANGE
	05800	S	M	OUG	III	00000	016								OPP. 721	12	020895	1/1/0001
	05800	S	M	OUG	II	00000	017								SIDE OF 726 WHITNEY WOODS PLACE	12	090898	1/1/0001

OFFICE: 311

ROUTE: 564

ST_REF_NO: 0000090900

HILLRISE DRIVE

LUMENS	BULB TYPE	MULT SERIES	POLE TYPE	SHADE	ADDRESS NUMBER	REF	LOCATION	TAX DIST	DATE INST	DATE CHANGE
05800	S	M	OUG	II	00000	018	SIDE OF 733 WHITNEY WOODS PLACE	12	090898	1/1/0001
05800	S	M	OUG	II	01593	015		12	090898	1/1/0001
05800	S	M	OUG	II	01596	014		12	090897	1/1/0001
05800	S	M	OUG	II	01601	013		12	090898	1/1/0001
05800	S	M	OUG	II	01608	012		12	090898	1/1/0001
05800	S	M	OUG	II	01609	011		12	090898	1/1/0001
05800	S	M	OUG	II	01696	010		12	110171	1/1/0001
05800	S	M	OUG	II	01701	009		12	110171	1/1/0001

OFFICE: 311

ROUTE: 564

ST_REF_NO: 0000091000

HILLSBORO AVENUE

LUMENS	BULB TYPE	MULT SERIES	POLE TYPE	SHADE	ADDRESS NUMBER	REF	LOCATION	TAX DIST	DATE INST	DATE CHANGE
05800	S	M	OUG	II	00240	091		12	121582	11/21/2012
04000	S	M	OUG	II	00000	101	OPP. 361	12	121582	1/1/0001
04000	S	M	OUG	II	00277	094		12	121582	1/1/0001
04000	S	M	OUG	II	00288	095		12	121582	1/1/0001
04000	S	M	OUG	II	00305	096		12	121582	1/1/0001
04000	S	M	OUG	II	00316	097		12	121582	1/1/0001
04000	S	M	OUG	II	00329	098		12	121582	1/1/0001
04000	S	M	OUG	II	00340	099		12	121582	1/1/0001
04000	S	M	OUG	II	00353	100		12	121582	1/1/0001
04000	S	M	OUG	II	00212	089		12	121582	1/1/0001
04000	S	M	OUG	II	00225	090		12	121582	1/1/0001
04000	S	M	OUG	II	00249	092		12	121582	1/1/0001
04000	S	M	OUG	II	00264	093		12	121582	1/1/0001

OFFICE: 311

ROUTE: 564

ST_REF_NO: 0000091050

HILLSIDE DRIVE

LUMENS	BULB TYPE	MULT SERIES	POLE TYPE	SHADE	ADDRESS NUMBER	REF	LOCATION	TAX DIST	DATE INST	DATE CHANGE
04000	S	M	OUG	II	03900	001		12	100890	1/1/0001
04000	S	M	OUG	II	03913	002		12	100890	1/1/0001
04000	S	M	OUG	II	03933	004		12	100890	1/1/0001
04000	S	M	OUG	II	03936	003		12	100890	1/1/0001
04000	S	M	OUG	II	03948	005		12	100890	1/1/0001

OFFICE: 311

ROUTE: 564

ST_REF_NO: 00000091050

HILLSIDE DRIVE

LUMENS	BULB TYPE	MULT SERIES	POLE TYPE	SHADE	ADDRESS NUMBER	REF	LOCATION	TAX DIST	DATE INST	DATE CHANGE
04000	S	M	OUG	II	03960	006		12	100890	1/1/0001
04000	S	M	OUG	II	03964	018		12	100890	1/1/0001
04000	S	M	OUG	II	03973	007		12	100890	1/1/0001
04000	S	M	OUG	II	03988	008		12	100890	1/1/0001
04000	S	M	OUG	II	03997	009		12	100890	1/1/0001
04000	S	M	OUG	II	04004	010		12	100890	1/1/0001
04000	S	M	OUG	II	04017	011		12	100890	1/1/0001
04000	S	M	OUG	II	04020	012		12	100890	1/1/0001
04000	S	M	OUG	II	04041	013		12	100890	1/1/0001
04000	S	M	OUG	II	04057	014		12	100890	1/1/0001
04000	S	M	OUG	II	04069	015		12	100890	1/1/0001
04000	S	M	OUG	II	04084	016		12	100890	1/1/0001
04000	S	M	OUG	V	04096	017		12	100890	1/1/0001

OFFICE: 311

ROUTE: 564

ST_REF_NO: 00000091100

HILLTOP AVENUE

LUMENS	BULB TYPE	MULT SERIES	POLE TYPE	SHADE	ADDRESS NUMBER	REF	LOCATION	TAX DIST	DATE INST	DATE CHANGE
09500	S	M	SOH	III	00000	001	4TH LT. W. OF PENNSYLVANIA AVE., N. SIDE	12	110889	1/1/0001
09500	S	M	SOH	III	00000	002	3RD LT. W. OF PENNSYLVANIA AVE., N. SIDE	12	110889	1/1/0001
09500	S	M	SOH	III	00000	003	2ND LT. W. OF PENNSYLVANIA AVE., N. SIDE	12	110889	1/1/0001
09500	S	M	SOH	III	00000	004	1ST LT. W. OF PENNSYLVANIA AVE., N. SIDE	12	110889	1/1/0001
09500	S	M	SOH	III	00000	005	1ST LT. E. OF PENNSYLVANIA AVE., N. SIDE	12	110889	1/1/0001
09500	S	M	SOH	III	00000	006	2ND LT. E. OF PENNSYLVANIA AVE., N. SIDE	12	110889	1/1/0001
09500	S	M	SOH	III	00000	007	3RD LT. E. OF PENNSYLVANIA AVE., N. SIDE	12	110889	1/1/0001
09500	S	M	SOH	III	00000	008	4TH LT. E. OF PENNSYLVANIA AVE., N. SIDE	12	110889	1/1/0001
09500	S	M	SOH	III	00000	009	1ST LT. W. OF WOODLAND AVE., N. SIDE	12	110889	1/1/0001

OFFICE: 311

ROUTE: 564

ST_REF_NO: 00000091160

HILL VIEW DRIVE

LUMENS	BULB TYPE	MULT SERIES	POLE TYPE	SHADE	ADDRESS NUMBER	REF	LOCATION	TAX DIST	DATE INST	DATE CHANGE
05800	S	M	OUG	II	01596	014		12	090898	1/1/0001
05800	S	M	OUG	II	01601	013		12	090898	1/1/0001

OFFICE: 311

ROUTE: 564

ST_REF_NO: 00000091170

HILL VIEW PLACE

LUMENS	BULB TYPE	MULT SERIES	POLE TYPE	SHADE	ADDRESS NUMBER	REF	LOCATION	TAX DIST	DATE INST	DATE CHANGE
05800	S	M	OUG	II	00000	020	ACROSS FROM 1589 HILL VIEW PLACE	12	052002	1/1/0001
05800	S	M	OUG	II	00000	021	3RD LT N OF HEARTSBROOK LN ON HILL VIEW PLACE	12	052002	1/1/0001
05800	S	M	OUG	II	00000	011	REAR OF 1608 HILL RISE DR.	12	090898	1/1/0001
05800	S	M	OUG	II	01682	010		12	090898	1/1/0001

OFFICE: 311

ROUTE: 564

ST_REF_NO: 00000091200

HILTONIA PARK

LUMENS	BULB TYPE	MULT SERIES	POLE TYPE	SHADE	ADDRESS NUMBER	REF	LOCATION	TAX DIST	DATE INST	DATE CHANGE
22000	S	M	SOH	II	00000	005	ON 1ST WOOD POLE IN MEDIAN FRM NVILLE RD	12	112403	11/24/2003
09500	S	M	SOH	II	00000	008	ON 3RD WOOD POLE IN MEDIAN FRM NVILLE RD,N SIDE	12	112403	1/1/0001
09500	S	M	SOH	II	00000	009	ON 4TH WOOD POLE IN MEDIAN FRM NVILLE RD,S SIDE	12	112403	1/1/0001
04000	S	M	SOH	II	00000	001	OPP. 102	12	121578	1/1/0001
05800	S	M	SOH	II	00000	002	IN MEDIAN, OPP. 110	12	121578	1/1/0001
05800	S	M	SOH	II	00000	003	IN MEDIAN, OPP. 120	12	121578	1/1/0001
05800	S	M	SOH	II	00000	004	IN MEDIAN, OPP. 124	12	121578	1/1/0001

OFFICE: 311

ROUTE: 564

ST_REF_NO: 00000091300

HISLE WAY

LUMENS	BULB TYPE	MULT SERIES	POLE TYPE	SHADE	ADDRESS NUMBER	REF	LOCATION	TAX DIST	DATE INST	DATE CHANGE
04000	S	M	OUG	II	00000	001	1ST LT. FROM KILKENNY ON HISLE WAY	12	060884	1/1/0001
04000	S	M	OUG	II	00000	003	3RD LT. FROM KILKENNY ON HISLE WAY	12	060884	1/1/0001
04000	S	M	OUG	II	00000	004	4TH LT. FROM KILKENNY ON HISLE WAY	12	060884	1/1/0001
05800	S	M	OUG	II	00000	005	5TH LT. FROM KILKENNY ON HISLE WAY	12	060884	1/1/0001
04000	S	M	OUG	II	01813	002		12	100885	1/1/0001

OFFICE: 311

ROUTE: 564

ST_REF_NO: 00000091375

HOBBS WAY

LUMENS	BULB TYPE	MULT SERIES	POLE TYPE	SHADE	ADDRESS NUMBER	REF	LOCATION	TAX DIST	DATE INST	DATE CHANGE
05800	S	M	OUG	II	00000	002	SIDE OF 914 FOREST LAKE DRIVE ON HOBBS WAY	12	041602	1/1/0001
05800	S	M	OUG	II	04708	003		12	041602	1/1/0001

OFFICE: 311

ROUTE: 564

ST_REF_NO: 00000091500

HOLBROOK COURT

LUMENS	BULB TYPE	MULT SERIES	POLE TYPE	SHADE	ADDRESS NUMBER	REF	LOCATION	TAX DIST	DATE INST	DATE CHANGE
05800	S	M	SOH	II	00252	000		12	010161	1/1/0001
05800	S	M	SOH	II	00262	000		12	010161	1/1/0001

OFFICE: 311

ROUTE: 564

ST_REF_NO: 00000091600

HOLIDAY ROAD

LUMENS	BULB TYPE	MULT SERIES	POLE TYPE	SHADE	ADDRESS NUMBER	REF	LOCATION	TAX DIST	DATE INST	DATE CHANGE
05800	S	M	OUG	II	00000	195	SIDE 1814 CAROLYN DR - bad fixture	12	110884	5/27/2010
05800	S	M	OUG	II	00305	010	bad fixture	12	021583	9/18/2007
05800	S	M	OUG	II	00430	196		12	110884	11/19/2013
04000	S	M	OUG	II	00000	006	SIDE OF 1811 FAIRWAY DR.	12	041582	1/1/0001
04000	S	M	OUG	II	00221	007		12	041582	1/1/0001
04000	S	M	OUG	II	00239	008		12	041582	1/1/0001
04000	S	M	OUG	II	00250	000		12	030766	1/1/0001
04000	S	M	OUG	II	00312	011		12	021583	1/1/0001
04000	S	M	OUG	II	00316	012		12	120884	1/1/0001
04000	S	M	OUG	II	00322	000		12	030766	1/1/0001
04000	S	M	OUG	II	00325	014		12	071478	1/1/0001
04000	S	M	OUG	II	00400	153		12	120884	1/1/0001
04000	S	M	OUG	II	00405	154		12	120884	1/1/0001
04000	S	M	OUG	II	00410	155		12	120884	1/1/0001
04000	S	M	OUG	II	00415	199		12	110884	1/1/0001
04000	S	M	OUG	II	00420	198		12	110884	1/1/0001
04000	S	M	OUG	II	00425	197		12	110884	1/1/0001

OFFICE: 311

ROUTE: 564

ST_REF_NO: 00000091690

HOLLOW CREEK COURT

LUMENS	BULB TYPE	MULT SERIES	POLE TYPE	SHADE	ADDRESS NUMBER	REF	LOCATION	TAX DIST	DATE INST	DATE CHANGE
05800	S	M	OUG	II	00000	031	SIDE OF 573 HOLLOW CREEK RD.	12	061674	1/1/0001

OFFICE: 311

ROUTE: 564

ST_REF_NO: 00000091700

HOLLOW CREEK ROAD

LUMENS	BULB TYPE	MULT SERIES	POLE TYPE	SHADE	ADDRESS NUMBER	REF	LOCATION	TAX DIST	DATE INST	DATE CHANGE
05800	S	M	OUG	II	00000	005	OPP. 433	12	060269	1/1/0001
05800	S	M	OUG	II	00000	029	SIDE OF 1639 GRANT DR.	12	011475	1/1/0001

OFFICE: 311

ROUTE: 564

ST_REF_NO: 00000091700

HOLLOW CREEK ROAD

LUMENS	BULB TYPE	MULT SERIES	POLE TYPE	SHADE	ADDRESS NUMBER	REF	LOCATION	TAX DIST	DATE INST	DATE CHANGE
05800	S	M	OUG	II	00400	000		12	102367	1/1/0001
05800	S	M	OUG	II	00405	000		12	090172	1/1/0001
05800	S	M	OUG	II	00408	000		12	102367	1/1/0001
05800	S	M	OUG	II	00425	000		12	090172	1/1/0001
05800	S	M	OUG	II	00445	000		12	090172	1/1/0001
05800	S	M	OUG	II	00448	000		12	070170	1/1/0001
05800	S	M	OUG	II	00461	000		12	090172	1/1/0001
05800	S	M	OUG	II	00500	000		12	040171	1/1/0001
05800	S	M	OUG	II	00505	000		12	061674	1/1/0001
05800	S	M	OUG	II	00522	000		12	070170	1/1/0001
05800	S	M	OUG	II	00525	000		12	030173	1/1/0001
05800	S	M	OUG	II	00533	000		12	030173	1/1/0001
05800	S	M	OUG	II	00534	000		12	031372	1/1/0001
05800	S	M	OUG	II	00549	000		12	030173	1/1/0001
05800	S	M	OUG	II	00581	000		12	061674	1/1/0001
05800	S	M	OUG	II	00593	030		12	081475	1/1/0001
05800	S	M	OUG	II	00598	033		12	081475	1/1/0001
05800	S	M	OUG	II	00609	000		12	061674	1/1/0001
05800	S	M	OUG	II	00618	035		12	051475	1/1/0001
05800	S	M	OUG	II	00629	000		12	061674	1/1/0001
05800	S	M	OUG	II	00638	000		12	061674	1/1/0001
05800	S	M	OUG	II	00649	000		12	061674	1/1/0001

OFFICE: 311

ROUTE: 564

ST_REF_NO: 00000091780

HOLLY WAY

LUMENS	BULB TYPE	MULT SERIES	POLE TYPE	SHADE	ADDRESS NUMBER	REF	LOCATION	TAX DIST	DATE INST	DATE CHANGE
05800	S	M	CNT	II	00000	001	OPP. SIDE OF 5008 IVY BRIDGE DR.	12	090800	1/1/0001
05800	S	M	CNT	II	00000	002	OPP. 1004	12	090800	1/1/0001
05800	S	M	CNT	III	00000	003	OPP. 1012	12	090800	1/1/0001

OFFICE: 311

ROUTE: 564

ST_REF_NO: 00000091800

HOLLY SPRINGS ROAD

LUMENS	BULB TYPE	MULT SERIES	POLE TYPE	SHADE	ADDRESS NUMBER	REF	LOCATION	TAX DIST	DATE INST	DATE CHANGE
05800	S	M	OUG	II	00000	002	SIDE OF 1930 NATCHEZ TRAIL	12	100888	4/22/2013

OFFICE: 311

ROUTE: 564

ST_REF_NO: 0000091800

HOLLY SPRINGS ROAD

LUMENS	BULB TYPE	MULT SERIES	POLE TYPE	SHADE	ADDRESS NUMBER	REF	LOCATION	TAX DIST	DATE INST	DATE CHANGE
05800	S	M	OUG	II	00901	001	upgrade due to bad fixture	12	110888	10/15/2008
05800	S	M	OUG	II	00984	010		12	100888	5/18/2011
04000	S	M	OUG	II	00000	004	NEXT TO 925 IN FRONT OF PARK	12	100888	1/1/0001
04000	S	M	OUG	II	00000	011	SIDE OF 1900 APPOMATTOX RD.	12	100888	1/1/0001
04000	S	M	OUG	II	00921	003		12	100888	1/1/0001
04000	S	M	OUG	II	00941	005		12	100888	1/1/0001
04000	S	M	OUG	II	00949	006		12	100888	1/1/0001
04000	S	M	OUG	II	00956	007		12	100888	1/1/0001
04000	S	M	OUG	II	00968	008		12	100888	1/1/0001
04000	S	M	OUG	II	00976	009		12	100888	1/1/0001

OFFICE: 311

ROUTE: 564

ST_REF_NO: 0000091850

HOLLYBERRY LANE

LUMENS	BULB TYPE	MULT SERIES	POLE TYPE	SHADE	ADDRESS NUMBER	REF	LOCATION	TAX DIST	DATE INST	DATE CHANGE
05800	S	M	CNT	II	00000	001	SIDE OF 725 SUNNY SLOPE TRACE ON HOLLYBERRY LANE	12	111907	1/1/0001
05800	S	M	CNT	II	00000	006	SIDE OF 865 SUNNY SLOPE TRACE ON HOLLYBERRY LANE	12	111907	1/1/0001
05800	S	M	CNT	II	00000	010	1ST LT S OF WYNDHAM HILLS, E SIDE ON HOLLYBERRY LN	12	111907	1/1/0001
05800	S	M	CNT	II	00000	012	1ST LT N OF SUNNY SLOPE TR,W SIDE ON HOLLYBERRY LN	12	111907	1/1/0001
05800	S	M	CNT	II	03905	005		12	111907	1/1/0001
05800	S	M	CNT	II	03920	004		12	111907	1/1/0001
05800	S	M	CNT	II	03937	003		12	111907	1/1/0001
05800	S	M	CNT	II	03948	002		12	111907	1/1/0001

OFFICE: 311

ROUTE: 564

ST_REF_NO: 0000091900

HOLLYHILL DRIVE

LUMENS	BULB TYPE	MULT SERIES	POLE TYPE	SHADE	ADDRESS NUMBER	REF	LOCATION	TAX DIST	DATE INST	DATE CHANGE
05800	S	M	OUG	II	00000	073	SIDE OF 2341 SOUTHVIEW DR. - bad fixture	12	090968	4/14/2010
04000	S	M	OUG	II	00000	040	SIDE OF 2330 MAPLEWOOD DR.	12	051166	1/1/0001
04000	S	M	OUG	II	00000	041	SIDE OF 2325 MAPLEWOOD DR.	12	051166	1/1/0001
04000	S	M	OUG	II	00000	074	SIDE OF 2331 MAPLEWOOD DR.	12	090968	1/1/0001
04000	S	M	OUG	II	00345	039		12	051166	1/1/0001
04000	S	M	OUG	II	00478	042		12	051166	1/1/0001

Street Light Listing run 1/11/2015 10:43:21 AM

Page 493 of 1254

OFFICE: 311		ROUTE: 564		ST_REF_NO: 00000091900		HOLLYHILL DRIVE		TAX DIST	DATE INST	DATE CHANGE
LUMENS	BULB TYPE	MULT SERIES	POLE TYPE	SHADE	ADDRESS NUMBER	REF	LOCATION			
04000	S	M	OUG	II	00491	043		12	051166	1/1/0001
05800	S	M	OUG	II	00498	044	upgraded 2/08	12	060766	1/1/0001
04000	S	M	OUG	II	00505	072		12	092368	1/1/0001
04000	S	M	OUG	II	00512	071		12	092368	1/1/0001
04000	S	M	OUG	II	00521	070		12	092368	1/1/0001
04000	S	M	OUG	II	00528	069		12	092368	1/1/0001
04000	S	M	OUG	II	00537	068		12	112068	1/1/0001
04000	S	M	OUG	II	00544	067		12	090968	1/1/0001
04000	S	M	OUG	II	00300	036		12	051166	1/1/0001
04000	S	M	OUG	II	00316	037		12	051166	1/1/0001
04000	S	M	OUG	II	00332	038		12	051166	1/1/0001
OFFICE: 311		ROUTE: 564		ST_REF_NO: 00000092000		HOLLYWOOD DRIVE		TAX DIST	DATE INST	DATE CHANGE
LUMENS	BULB TYPE	MULT SERIES	POLE TYPE	SHADE	ADDRESS NUMBER	REF	LOCATION			
05800	S	M	SOH	II	00420	004		12	053003	1/1/0001
05800	S	M	SOH	I	00000	565	1ST LT. S. OF ASHLAND AVE., W. SIDE	12	070767	1/1/0001
05800	S	S	SOH	I	00000	567	1ST LT. N. OF SUNSET, E. SIDE	12	070767	1/1/0001
05800	S	S	SOH	I	00430	566		12	070767	1/1/0001
OFFICE: 311		ROUTE: 564		ST_REF_NO: 00000092030		HOLMES WAY		TAX DIST	DATE INST	DATE CHANGE
LUMENS	BULB TYPE	MULT SERIES	POLE TYPE	SHADE	ADDRESS NUMBER	REF	LOCATION			
05800	S	M	CNT	II	00000	001	SIDE OF 212 HAMMER TODD PLACE ON HOLMES WAY	12	052607	1/1/0001
05800	S	M	CNT	II	00000	002	SIDE OF 233 JANE BRIGGS AVE ON HOLMES WAY	12	052607	1/1/0001
05800	S	M	CNT	II	00000	003	SIDE OF 220 JANE BRIGGS AVE ON HOLMES WAY	12	052607	1/1/0001
05800	S	M	CNT	II	00000	004	SIDE OF 232 JANE BRIGGS AVE ON HOLMES WAY	12	052607	1/1/0001
05800	S	M	CNT	II	00000	007	SIDE OF 4497 HOLMES WAY	12	052607	1/1/0001
05800	S	M	CNT	II	04429	005		12	052607	1/1/0001
05800	S	M	CNT	II	04441	006		12	052607	1/1/0001
05800	S	M	CNT	II	04461	008		12	052607	1/1/0001

OFFICE: 311		ROUTE: 564		ST_REF_NO: 0000092100		HOLWYN ROAD				
LUMENS	BULB TYPE	MULT SERIES	POLE TYPE	SHADE	ADDRESS NUMBER	REF	LOCATION	TAX DIST	DATE INST	DATE CHANGE
09500	S	M	OUG	II	00000	028	SIDE 3341 POST RD.	12	080885	1/1/0001
04000	S	M	OUG	II	00000	114	SIDE OF 701 MONTICELLO BLVD	12	090885	1/1/0001
04000	S	M	OUG	II	00000	140	OPP. 3434 HOLWYN DR.	12	110885	1/1/0001
09500	S	M	OUG	II	03340	012		12	080885	1/1/0001
09500	S	M	OUG	II	03340	014		12	080885	1/1/0001
09500	S	M	OUG	II	03340	016		12	080885	1/1/0001
09500	S	M	OUG	II	03341	013		12	080885	1/1/0001
09500	S	M	OUG	II	03341	015		12	080885	1/1/0001
04000	S	M	OUG	II	03369	116		12	090885	1/1/0001
04000	S	M	OUG	II	03382	115		12	090885	1/1/0001
04000	S	M	OUG	II	03406	113		12	090885	1/1/0001
04000	S	M	OUG	II	03417	112		12	090885	1/1/0001
04000	S	M	OUG	II	03426	111		12	090885	1/1/0001
04000	S	M	OUG	II	03439	115		12	110885	1/1/0001

OFFICE: 311		ROUTE: 564		ST_REF_NO: 0000092175		HONEYCOMB TRAIL				
LUMENS	BULB TYPE	MULT SERIES	POLE TYPE	SHADE	ADDRESS NUMBER	REF	LOCATION	TAX DIST	DATE INST	DATE CHANGE
05800	S		CNT	II	00000	001	SIDE OF 676 MAIDENCANE DR, ON HONEYCOMB TRAIL	12	061710	1/1/0001
05800	S		CNT	II	04613	002		12	061710	1/1/0001
05800	S		CNT	II	04617	003		12	061710	1/1/0001
05800	S		CNT	II	04637	004		12	061710	1/1/0001
05800	S		CNT	II	04649	005		12	061710	1/1/0001
05800	S		CNT	III	04660	006		12	061710	1/1/0001

OFFICE: 311		ROUTE: 564		ST_REF_NO: 0000092200		HONEY CREEK DRIVE				
LUMENS	BULB TYPE	MULT SERIES	POLE TYPE	SHADE	ADDRESS NUMBER	REF	LOCATION	TAX DIST	DATE INST	DATE CHANGE
04000	S	M	OUG	II	01000	093		12	061580	1/1/0001
04000	S	M	OUG	II	01009	094		12	061580	1/1/0001
04000	S	M	OUG	II	01012	095		12	061580	1/1/0001

OFFICE: 311

ROUTE: 564

ST_REF_NO: 0000092310

HONEY LOCUST WAY

LUMENS	BULB TYPE	MULT SERIES	POLE TYPE	SHADE	ADDRESS NUMBER	REF	LOCATION	TAX DIST	DATE INST	DATE CHANGE
05800	S	M	OUG	IV	00604	001		12	020895	1/1/0001
05800	S	M	OUG	II	00617	002		12	020895	1/1/0001
05800	S	M	OUG	II	00629	003		12	020895	1/1/0001
05800	S	M	OUG	II	00649	005		12	050897	1/1/0001
05800	S	M	OUG	III	00665	006		12	050897	1/1/0001
05800	S	M	OUG	II	00632	004		12	050897	1/1/0001

OFFICE: 311

ROUTE: 564

ST_REF_NO: 0000092400

HONEYSUCKLE ROAD

LUMENS	BULB TYPE	MULT SERIES	POLE TYPE	SHADE	ADDRESS NUMBER	REF	LOCATION	TAX DIST	DATE INST	DATE CHANGE
05800	S	M	OUG	II	00806	000		12	110162	1/1/0001
05800	S	M	OUG	II	00819	000		12	102263	1/1/0001
05800	S	M	OUG	II	00846	000		12	080164	1/1/0001
05800	S	M	OUG	II	00861	000		12	080164	1/1/0001
05800	S	M	OUG	II	00885	000		12	102263	1/1/0001
05800	S	M	OUG	II	00898	000		12	102263	1/1/0001
05800	S	M	OUG	II	00924	000		12	110162	1/1/0001
05800	S	M	OUG	II	00941	000		12	102263	1/1/0001
05800	S	M	OUG	II	00972	000		12	070162	1/1/0001
05800	S	M	OUG	II	00991	000		12	110162	1/1/0001
05800	S	M	OUG	II	00998	000		12	070162	1/1/0001

OFFICE: 311

ROUTE: 564

ST_REF_NO: 0000092490

HOPEMONT COURT

LUMENS	BULB TYPE	MULT SERIES	POLE TYPE	SHADE	ADDRESS NUMBER	REF	LOCATION	TAX DIST	DATE INST	DATE CHANGE
04000	S	M	OUG	II	01800	064		12	021580	1/1/0001
04000	S	M	OUG	II	01805	065		12	021580	1/1/0001
04000	S	M	OUG	II	01824	066		12	021580	1/1/0001

OFFICE: 311

ROUTE: 564

ST_REF_NO: 0000092500

HOPEMONT DRIVE

LUMENS	BULB TYPE	MULT SERIES	POLE TYPE	SHADE	ADDRESS NUMBER	REF	LOCATION	TAX DIST	DATE INST	DATE CHANGE
04000	S	M	OUG	II	03812	063		12	021580	1/1/0001
04000	S	M	OUG	II	03817	062		12	021580	1/1/0001

OFFICE: 311

ROUTE: 564

ST_REF_NO: 00000092500

HOPEMONT DRIVE

LUMENS	BULB TYPE	MULT SERIES	POLE TYPE	SHADE	ADDRESS NUMBER	REF	LOCATION	TAX DIST	DATE INST	DATE CHANGE
04000	S	M	OUG	II	03832	061		12	021580	1/1/0001
04000	S	M	OUG	II	03837	060		12	021580	1/1/0001

OFFICE: 311

ROUTE: 564

ST_REF_NO: 00000092510

Hopemont Lane

LUMENS	BULB TYPE	MULT SERIES	POLE TYPE	SHADE	ADDRESS NUMBER	REF	LOCATION	TAX DIST	DATE INST	DATE CHANGE
05800	S	M	OUG	II	00000	003	SIDE OF 3840 HOPEMONT DR ON HOPEMONT LN	12	101802	1/1/0001
05800	S	M	OUG	II	00000	006	2ND LT N OF OLD HIGBEE MILL,W SIDE ON HOPEMONT LN	12	101802	1/1/0001
05800	S	M	OUG	II	00000	007	1ST LT N OF OLD HIGBEE MILL,W SIDE ON HOPEMONT LN	12	101802	1/1/0001
05800	S	M	OUG	II	01791	001		12	101802	1/1/0001
05800	S	M	OUG	II	01795	002		12	101802	1/1/0001

OFFICE: 311

ROUTE: 564

ST_REF_NO: 00000092525

HOPEWELL PARK

LUMENS	BULB TYPE	MULT SERIES	POLE TYPE	SHADE	ADDRESS NUMBER	REF	LOCATION	TAX DIST	DATE INST	DATE CHANGE
05800	S	M	CNT	II	00000	002	SIDE OF 601 KENOVA CIRCLE ON HOPEWELL PARK	12	120203	1/1/0001
05800	S	M	CNT	II	00000	003	SIDE OF 600 KENOVA CIRCLE ON HOPEWELL PARK	12	120203	1/1/0001
05800	S	M	CNT	II	00000	005	SIDE OF 625 HAVANA COURT ON HOPEWELL PARK	12	120203	1/1/0001
05800	S	M	CNT	III	00508	008		12	120203	1/1/0001
05800	S	M	CNT	II	00516	006		12	120203	1/1/0001
05800	S	M	CNT	III	00525	007		12	120203	1/1/0001
05800	S	M	CNT	II	00581	004		12	120203	1/1/0001
05800	S	M	CNT	II	00621	001		12	120203	1/1/0001

OFFICE: 311

ROUTE: 564

ST_REF_NO: 00000092608

HORSEMINT TRAIL

LUMENS	BULB TYPE	MULT SERIES	POLE TYPE	SHADE	ADDRESS NUMBER	REF	LOCATION	TAX DIST	DATE INST	DATE CHANGE
05800	S		CNT	II	03664	027		12	071409	1/1/0001
05800	S		CNT	II	03693	024		12	071409	1/1/0001
05800	S		CNT	II	03701	023		12	071409	1/1/0001
05800	S		CNT	II	03704	021		12	071409	1/1/0001
05800	S		CNT	II	03709	022		12	071409	1/1/0001
05800	S		CNT	II	03728	011		12	071409	1/1/0001

OFFICE: 311

ROUTE: 564

ST_REF_NO: 0000092608

HORSEMINT TRAIL

LUMENS	BULB TYPE	MULT SERIES	POLE TYPE	SHADE	ADDRESS NUMBER	REF	LOCATION	TAX DIST	DATE INST	DATE CHANGE
05800	S	M	CNT	II	00000	003	SIDE OF 3805 HORSEMINT TRAIL	12	111306	1/1/0001
05800	S	M	CNT	II	00000	006	SIDE OF 3800 HORSEMINT TRAIL	12	111306	1/1/0001
05800	S	M	CNT	II	03729	010		12	111306	1/1/0001
05800	S	M	CNT	II	03753	007		12	111306	1/1/0001
05800	S	M	CNT	II	03773	005		12	111306	1/1/0001
05800	S	M	CNT	II	03787	004		12	111306	1/1/0001
05800	S	M	CNT	II	03809	020		12	111306	1/1/0001
05800	S	M	CNT	II	03812	002		12	111306	1/1/0001
05800	S	M	CNT	II	03821	001		12	111306	1/1/0001

OFFICE: 311

ROUTE: 564

ST_REF_NO: 0000092609

HORSEMANS LANE

LUMENS	BULB TYPE	MULT SERIES	POLE TYPE	SHADE	ADDRESS NUMBER	REF	LOCATION	TAX DIST	DATE INST	DATE CHANGE
09500	S		OUG	III	00000	021	12TH LT S OF RED MILE RD ON HORSEMANS LANE	12	102809	1/1/0001
05800	S		OUG	II	00000	022	2ND LT S OF RED MILE RD ON HORSEMANS LANE	12	102809	1/1/0001
05800	S		OUG	II	00000	023	4TH LT S OF RED MILE RD ON HORSEMANS LANE	12	102809	1/1/0001
05800	S		OUG	II	01155	020		12	102809	1/1/0001
05800	S	M	OUG	II	00000	003	1100 HORSEMAN LANE, EAST OF BLDG. B	12	060893	1/1/0001
05800	S	M	OUG	II	00000	005	1100 HORSEMAN LANE, FRONT OF BLDG. A	12	060893	1/1/0001
05800	S	M	OUG	II	00000	007	1150, APT.1	12	020890	1/1/0001
05800	S	M	OUG	II	00000	008	1150, APT.6	12	020890	1/1/0001
05800	S	M	OUG	II	00000	009	1156 HORSEMAN'S LANE, 9TH LT. S OF RED MILE RD.	12	030897	1/1/0001
05800	S	M	OUG	II	00000	010	1156 HORSEMAN'S LANE, 10TH LT S OF RED MILE RD.	12	030897	1/1/0001
05800	S	M	OUG	III	00000	011	1156 HORSEMAN'S LANE, 11TH LT. S OF RED MILE RD.	12	030897	1/1/0001

OFFICE: 311

ROUTE: 564

ST_REF_NO: 0000092610

HORTON COURT

LUMENS	BULB TYPE	MULT SERIES	POLE TYPE	SHADE	ADDRESS NUMBER	REF	LOCATION	TAX DIST	DATE INST	DATE CHANGE
05800	S	M	OUG	II	00500	007		12	011581	1/1/0001
05800	S	M	OUG	II	00550	009		12	081582	1/1/0001
05800	S	M	OUG	V	00550	010		12	081582	1/1/0001
05800	S	M	OUG	II	00551	008		12	061580	1/1/0001

OFFICE: 311

ROUTE: 564

ST_REF_NO: 00000092700

HOT SPRINGS COURT

LUMENS	BULB TYPE	MULT SERIES	POLE TYPE	SHADE	ADDRESS NUMBER	REF	LOCATION	TAX DIST	DATE INST	DATE CHANGE
05800	S	M	OUG	II	00000	091	SIDE OF 3564 CAULDER RD.	12	032274	1/1/0001
05800	S	M	OUG	II	01236	000		12	120172	1/1/0001
05800	S	M	OUG	II	01249	000		12	032274	1/1/0001
05800	S	M	OUG	II	01260	000		12	120172	1/1/0001
04000	S	M	OUG	IV	01268	095		12	090891	1/1/0001

OFFICE: 311

ROUTE: 564

ST_REF_NO: 00000092800

HOUSTON ALLEY

LUMENS	BULB TYPE	MULT SERIES	POLE TYPE	SHADE	ADDRESS NUMBER	REF	LOCATION	TAX DIST	DATE INST	DATE CHANGE
05800	S	M	SOH	I	00000	001	1ST LT. E. OF LIME	12	020165	1/1/0001
05800	S	M	SOH	I	00000	002	2ND LT. E. OF LIME	12	020165	1/1/0001
05800	S	M	SOH	I	00000	003	3RD LT. E. OF LIME	12	050365	1/1/0001
05800	S	M	SOH	I	00000	004	4TH LT. E. OF LIME	12	040165	1/1/0001

OFFICE: 311

ROUTE: 564

ST_REF_NO: 00000092900

HOWARD STREET

LUMENS	BULB TYPE	MULT SERIES	POLE TYPE	SHADE	ADDRESS NUMBER	REF	LOCATION	TAX DIST	DATE INST	DATE CHANGE
05800	S	M	SOH	I	00000	001	OPP. 705-B	12	101583	1/1/0001
05800	S	M	SOH	I	00000	002	SIDE 706-A	12	101583	1/1/0001
05800	S	M	SOH	I	00000	003	OPP. 706-F	12	101583	1/1/0001
05800	S	M	SOH	I	00000	004	718-B	12	101583	1/1/0001
05800	S	M	SOH	II	00000	005	1ST LT E OF GEORGETOWN RD OPP DOUGLAS PK ON HOWARD	12	050891	1/1/0001
05800	S	M	SOH	II	00000	006	2ND LT E OF GEORGETOWN RD OPP DOUGLAS PK ON HOWARD	12	050891	1/1/0001
05800	S	M	SOH	II	00000	007	3RD LT E OF GEORGETOWN RD OPP DOUGLAS PK ON HOWARD	12	050891	1/1/0001
05800	S	M	SOH	II	00000	008	4TH LT E OF GEORGETOWN RD OPP DOUGLAS PK ON HOWARD	12	050891	1/1/0001
05800	S	M	SOH	II	00000	009	OPP. 712 HOWARD ST	12	050891	1/1/0001

OFFICE: 311

ROUTE: 564

ST_REF_NO: 00000092910

HUCKLEBERRY CIRCLE

LUMENS	BULB TYPE	MULT SERIES	POLE TYPE	SHADE	ADDRESS NUMBER	REF	LOCATION	TAX DIST	DATE INST	DATE CHANGE
04000	S	M	OUG	II	02000	057		12	011581	1/1/0001
04000	S	M	OUG	II	02017	056		12	070886	1/1/0001

OFFICE: 311

ROUTE: 564

ST_REF_NO: 0000092910

HUCKLEBERRY CIRCLE

LUMENS	BULB TYPE	MULT SERIES	POLE TYPE	SHADE	ADDRESS NUMBER	REF	LOCATION	TAX DIST	DATE INST	DATE CHANGE
04000	S	M	OUG	II	02032	055		12	011581	1/1/0001
05800	S	M	OUG	II	02049	054		12	010885	1/1/0001
04000	S	M	OUG	II	02056	053		12	011581	1/1/0001

OFFICE: 311

ROUTE: 564

ST_REF_NO: 0000093000

HUDSON AVENUE

LUMENS	BULB TYPE	MULT SERIES	POLE TYPE	SHADE	ADDRESS NUMBER	REF	LOCATION	TAX DIST	DATE INST	DATE CHANGE
04000	S	M	OUG	II	00000	004	SIDE OF 2004 PARALLEL RD.	12	051477	1/1/0001
04000	S	M	OUG	II	00000	005	SIDE OF 1002 BIRCH RD.	12	051477	1/1/0001
04000	S	M	OUG	II	00000	006	SIDE OF 1004 PATRICIA LANE	12	051477	1/1/0001
04000	S	M	OUG	II	00000	007	SIDE OF 1004	12	051477	1/1/0001
05800	S	M	OUG	II	00000	013	SIDE OF 1057 HUDSON AVE ON PARK ENTRANCE	12	051477	1/1/0001
04000	S	M	OUG	V	01016	005		12	051477	1/1/0001
04000	S	M	OUG	II	01025	008		12	051477	1/1/0001
04000	S	M	OUG	II	01036	009		12	051477	1/1/0001
04000	S	M	OUG	II	01045	010		12	051477	1/1/0001
04000	S	M	OUG	II	01064	011		12	051477	1/1/0001
04000	S	M	OUG	II	01076	012		12	051477	1/1/0001

OFFICE: 311

ROUTE: 564

ST_REF_NO: 0000093100

HUFFMAN MILL ROAD

LUMENS	BULB TYPE	MULT SERIES	POLE TYPE	SHADE	ADDRESS NUMBER	REF	LOCATION	TAX DIST	DATE INST	DATE CHANGE
05800	S	M	SOH	II	00000	001	1ST LT. E. OF MATTOX LANE, S. SIDE	22	020887	1/1/0001
05800	S	M	SOH	II	00000	002	AT MATTOX LANE, S.W. CORNER	22	020887	1/1/0001
05800	S	M	SOH	II	00000	003	1ST LT. N. OF MATTOX LANE, E. SIDE	22	020887	1/1/0001

OFFICE: 311

ROUTE: 564

ST_REF_NO: 0000093200

HUGELETT DRIVE

LUMENS	BULB TYPE	MULT SERIES	POLE TYPE	SHADE	ADDRESS NUMBER	REF	LOCATION	TAX DIST	DATE INST	DATE CHANGE
22000	S	M	SOH	II	00000	049	2ND LT. S. OF WASHINGTON AVE., E. SIDE-moved from Rose	12	091263	1/17/2011

OFFICE: 311		ROUTE: 564		ST_REF_NO: 00000093220		HUGGING BEAR LANE		LUMENS	BULB TYPE	MULT SERIES	POLE TYPE	SHADE	ADDRESS NUMBER	REF	LOCATION	TAX DIST	DATE INST	DATE CHANGE
05800	S	M	OUG	II	00605	001										12	110899	1/1/0001
05800	S	M	OUG	II	00617	002										12	110899	1/1/0001
05800	S	M	OUG	II	00629	003										12	110899	1/1/0001
05800	S	M	OUG	II	00649	004										12	110899	1/1/0001
05800	S	M	OUG	II	00661	005										12	110899	1/1/0001
05800	S	M	OUG	II	00672	006										12	110899	1/1/0001
OFFICE: 311		ROUTE: 564		ST_REF_NO: 00000093410		HUGUENARD DRIVE		LUMENS	BULB TYPE	MULT SERIES	POLE TYPE	SHADE	ADDRESS NUMBER	REF	LOCATION	TAX DIST	DATE INST	DATE CHANGE
05800	S	M	OUG	II	00000	002									2ND LT. S. OF LOWRY LANE, E. SIDE	12	020887	1/1/0001
05800	S	M	OUG	II	00000	004									4TH LT. S. OF LOWRY LANE, E. SIDE	12	020887	1/1/0001
OFFICE: 311		ROUTE: 564		ST_REF_NO: 00000093490		HUMBARD ALLEY		LUMENS	BULB TYPE	MULT SERIES	POLE TYPE	SHADE	ADDRESS NUMBER	REF	LOCATION	TAX DIST	DATE INST	DATE CHANGE
05800	S	M	SOH	I	00000	001									SIDE OF 112 E. 5TH ST.	12	070163	1/1/0001
05800	S	M	SOH	I	00000	002									2ND LT. S. OF 5TH ST., E. SIDE	12	070163	1/1/0001
05800	S	M	SOH	I	00000	003									3RD LT. S. OF 5TH ST., E. SIDE	12	070163	1/1/0001
05800	S	M	SOH	I	00000	004									3RD LT. N. OF 4TH ST., E. SIDE	12	050363	1/1/0001
05800	S	M	SOH	V	00000	005									2ND LT. N. OF 4TH ST., E. SIDE	12	050365	1/1/0001
05800	S	M	SOH	III	00000	006									1ST LT. N. OF 4TH ST., W. SIDE	12	061478	1/1/0001
OFFICE: 311		ROUTE: 564		ST_REF_NO: 00000093700		HUMMINGBIRD LANE		LUMENS	BULB TYPE	MULT SERIES	POLE TYPE	SHADE	ADDRESS NUMBER	REF	LOCATION	TAX DIST	DATE INST	DATE CHANGE
04000	S	M	OUG	II	00000	041									SIDE 1567 JACANA DR	12	110884	1/1/0001
04000	S	M	OUG	II	00314	040										12	110884	1/1/0001
04000	S	M	OUG	II	00330	039										12	110884	1/1/0001
04000	S	M	OUG	II	00341	038										12	110884	1/1/0001
04000	S	M	OUG	II	00354	037										12	110884	1/1/0001
04000	S	M	OUG	II	00365	036										12	110884	1/1/0001

OFFICE: 311

ROUTE: 564

ST_REF_NO: 00000093750

HUMMONS AVENUE

LUMENS	BULB TYPE	MULT SERIES	POLE TYPE	SHADE	ADDRESS NUMBER	REF	LOCATION	TAX DIST	DATE INST	DATE CHANGE
05800	S	M	OUG	II	00000	001	SDIE OF 265 4TH STR ON HUMMONS AVE	12	091702	1/1/0001
05800	S	M	OUG	II	00000	002	REAR OF 412 ELM TREE LANE ON HUMMONS AVE	12	091702	1/1/0001
05800	S	M	OUG	II	00000	003	REAR OF 420 ELM TREE LANE ON HUMMONS AVE	12	091702	1/1/0001
05800	S	M	OUG	II	00000	004	REAR OF 432 ELM TREE LANE ON HUMMONS AVE	12	091702	1/1/0001
05800	S	M	OUG	II	00000	005	SIDE OF 432 ELM TREE LANE ON HUMMONS AVE	12	091702	1/1/0001
05800	S	M	OUG	II	00000	006	SIDE OF 433 ELM TREE LANE ON HUMMONS AVE	12	091702	1/1/0001
05800	S	M	OUG	II	00000	007	REAR OF 433 ELM TREE LANE ON HUMMONS AVE	12	091702	1/1/0001
05800	S	M	OUG	II	00000	008	REAR OF 425 ELM TREE LANE ON HUMMONS AVE	12	091702	1/1/0001
05800	S	M	OUG	II	00000	009	REAR OF 409 ELM TREE LANE ON HUMMONS AVE	12	091702	1/1/0001
05800	S	M	OUG	II	00000	010	2ND LT FROM 4TH STR ON HUMMONS AVE	12	091702	1/1/0001
05800	S	M	OUG	II	00000	011	1ST LT FROM 4TH STR ON HUMMONS AVE	12	091702	1/1/0001

OFFICE: 311

ROUTE: 564

ST_REF_NO: 00000093900

HUNTER ROAD

LUMENS	BULB TYPE	MULT SERIES	POLE TYPE	SHADE	ADDRESS NUMBER	REF	LOCATION	TAX DIST	DATE INST	DATE CHANGE
05800	S	M	OUG	II	00000	042	SIDE OF 2483 HEATHER WAY	12	080166	1/1/0001
05800	S	M	OUG	II	03352	236		12	120892	1/1/0001
05800	S	M	OUG	II	03364	235		12	120892	1/1/0001

OFFICE: 311

ROUTE: 564

ST_REF_NO: 00000093910

HUNTERS POINT

LUMENS	BULB TYPE	MULT SERIES	POLE TYPE	SHADE	ADDRESS NUMBER	REF	LOCATION	TAX DIST	DATE INST	DATE CHANGE
04000	S	M	OUG	II	03200	001		12	070885	1/1/0001
04000	S	M	OUG	II	03209	002		12	070885	1/1/0001
04000	S	M	OUG	II	03228	003		12	070885	1/1/0001
04000	S	M	OUG	II	03240	004		12	070885	1/1/0001
04000	S	M	OUG	II	03253	005		12	070885	1/1/0001
04000	S	M	OUG	II	03272	006		12	070885	1/1/0001
04000	S	M	OUG	II	03277	007		12	070885	1/1/0001

OFFICE: 311

ROUTE: 564

ST_REF_NO: 00000093915

HUNTERS GREEN COURT

LUMENS	BULB TYPE	MULT SERIES	POLE TYPE	SHADE	ADDRESS NUMBER	REF	LOCATION	TAX DIST	DATE INST	DATE CHANGE
05800	S	M	CNT	II	00000	002	SIDE OF 600 BROOKGREEN LANE	12	060800	1/1/0001

OFFICE: 311		ROUTE: 564		ST_REF_NO: 00000093915		HUNTERS GREEN COURT		LUMENS	BULB TYPE	MULT SERIES	POLE TYPE	SHADE	ADDRESS NUMBER	REF	LOCATION	TAX DIST	DATE INST	DATE CHANGE
05800	S	M	CNT	II	00000	004										12	050899	1/1/0001
05800	S	M	CNT	II	00000	006	OPP. 572									12	100800	1/1/0001
05800	S	M	CNT	II	00584	005										12	100800	1/1/0001
05800	S	M	CNT	II	00601	001										12	050899	1/1/0001
05800	S	M	CNT	II	00604	002										12	050899	1/1/0001
05800	S	M	CNT	III	00608	003										12	050899	1/1/0001
05800	S	M	CNT	II	03587	004										12	060800	1/1/0001
05800	S	M	CNT	II	03590	003										12	060800	1/1/0001
OFFICE: 311		ROUTE: 564		ST_REF_NO: 00000093920		HUNTERS GREEN WAY		LUMENS	BULB TYPE	MULT SERIES	POLE TYPE	SHADE	ADDRESS NUMBER	REF	LOCATION	TAX DIST	DATE INST	DATE CHANGE
05800	S	M	CNT	II	00000	001	SIDE 611 GINGERMILL LANE									12	120894	1/1/0001
05800	S	M	CNT	II	00000	005	SIDE OF 501 HUNTINGTON CT.									12	100897	1/1/0001
05800	S	M	CNT	II	00000	007	SIDE OF 453 FOREST HILL DR.									12	100897	1/1/0001
05800	S	M	CNT	III	03524	011										12	050899	1/1/0001
05800	S	M	CNT	II	03537	012										12	050899	1/1/0001
05800	S	M	CNT	II	03544	013										12	050899	1/1/0001
05800	S	M	CNT	II	03549	014										12	050899	1/1/0001
05800	S	M	CNT	II	03567	006										12	100897	1/1/0001
OFFICE: 311		ROUTE: 564		ST_REF_NO: 00000093930		HUNTERSKNOLL COURT		LUMENS	BULB TYPE	MULT SERIES	POLE TYPE	SHADE	ADDRESS NUMBER	REF	LOCATION	TAX DIST	DATE INST	DATE CHANGE
05800	S	M	CNT	III	00524	005										12	050899	1/1/0001
05800	S	M	CNT	III	00525	003										12	050899	1/1/0001
OFFICE: 311		ROUTE: 564		ST_REF_NO: 00000093940		HUNTERSKNOLL PLACE		LUMENS	BULB TYPE	MULT SERIES	POLE TYPE	SHADE	ADDRESS NUMBER	REF	LOCATION	TAX DIST	DATE INST	DATE CHANGE
05800	S	M	CNT	II	00500	004										12	050899	1/1/0001
05800	S	M	CNT	II	00537	002										12	050899	1/1/0001
05800	S	M	CNT	II	00548	001										12	050899	1/1/0001

OFFICE: 311

ROUTE: 564

ST_REF_NO: 00000094050

HUNTINGTON COURT

LUMENS	BULB TYPE	MULT SERIES	POLE TYPE	SHADE	ADDRESS NUMBER	REF	LOCATION	TAX DIST	DATE INST	DATE CHANGE
05800	S	M	CNT	II	00000	003	SIDE OF 3582 HUNTERS GREEN	12	100897	1/1/0001
05800	S	M	CNT	III	00467	006		12	060800	1/1/0001
05800	S	M	CNT	II	00482	005		12	020800	1/1/0001
05800	S	M	CNT	II	00495	004		12	020800	1/1/0001
05800	S	M	CNT	II	00504	001		12	100897	1/1/0001
05800	S	M	CNT	III	00513	002		12	100897	1/1/0001

OFFICE: 311

ROUTE: 564

ST_REF_NO: 00000094055

HUNTLY PLACE

LUMENS	BULB TYPE	MULT SERIES	POLE TYPE	SHADE	ADDRESS NUMBER	REF	LOCATION	TAX DIST	DATE INST	DATE CHANGE
05800	S		CNT	II	00000	003	SIDE OF 2388 WALCOT WAY ON HUNTLY PLACE	12	070210	1/1/0001
05800	S		CNT	II	00000	004	REAR OF 2388 HUNTLY PLACE	12	070210	1/1/0001
05800	S		CNT	II	00000	005	BESIDE PARK ON HUNTLY PLACE	12	070210	1/1/0001
05800	S		CNT	II	00000	006	2ND LT BESIDE PARK ON HUNTLY PLACE	12	070210	1/1/0001
05800	S		CNT	II	02484	002		12	070210	1/1/0001
05800	S	M	CNT	II	02492	001		12	042506	1/1/0001

OFFICE: 311

ROUTE: 564

ST_REF_NO: 00000094100

HUNTSVILLE DRIVE

LUMENS	BULB TYPE	MULT SERIES	POLE TYPE	SHADE	ADDRESS NUMBER	REF	LOCATION	TAX DIST	DATE INST	DATE CHANGE
05800	S	M	OUG	II	01438	000		12	010173	1/1/0001
05800	S	M	OUG	II	01450	000		12	090766	1/1/0001
05800	S	M	OUG	II	01461	000		12	110168	1/1/0001
05800	S	M	OUG	II	01474	000		12	120169	1/1/0001

OFFICE: 311

ROUTE: 564

ST_REF_NO: 00000094300

HYANNISPORT COURT

LUMENS	BULB TYPE	MULT SERIES	POLE TYPE	SHADE	ADDRESS NUMBER	REF	LOCATION	TAX DIST	DATE INST	DATE CHANGE
04000	S	M	OUG	II	00000	083	SIDE 3437 BRUNSWICK DR.	12	100885	1/1/0001

OFFICE: 311

ROUTE: 564

ST_REF_NO: 00000094400

HYDE PARK DRIVE

LUMENS	BULB TYPE	MULT SERIES	POLE TYPE	SHADE	ADDRESS NUMBER	REF	LOCATION	TAX DIST	DATE INST	DATE CHANGE
04000	S	M	OUG	II	00000	001	SIDE OF 808 APACHE TRAIL	12	050890	1/1/0001
04000	S	M	OUG	II	03121	002		12	100890	1/1/0001

OFFICE: 311

ROUTE: 564

ST_REF_NO: 00000094400

HYDE PARK DRIVE

LUMENS	BULB TYPE	MULT SERIES	POLE TYPE	SHADE	ADDRESS NUMBER	REF	LOCATION	TAX DIST	DATE INST	DATE CHANGE
04000	S	M	OUG	II	03128	003		12	100890	1/1/0001
04000	S	M	OUG	II	03137	004		12	100890	1/1/0001
04000	S	M	OUG	II	03144	005		12	100890	1/1/0001
04000	S	M	OUG	II	03153	006		12	100890	1/1/0001
04000	S	M	OUG	II	03169	008		12	100890	1/1/0001
04000	S	M	OUG	II	03174	009		12	100890	1/1/0001
04000	S	M	OUG	II	03156	007		12	100890	1/1/0001

OFFICE: 311

ROUTE: 564

ST_REF_NO: 00000094500

HYDEN COURT

LUMENS	BULB TYPE	MULT SERIES	POLE TYPE	SHADE	ADDRESS NUMBER	REF	LOCATION	TAX DIST	DATE INST	DATE CHANGE
05800	S	M	OUG	II	00000	050	SIDE OF 727 BISHOP DR.	12	100169	1/1/0001
05800	S	M	OUG	II	00630	000		12	011667	1/1/0001
05800	S	M	OUG	II	00639	000		12	011667	1/1/0001

OFFICE: 311

ROUTE: 564

ST_REF_NO: 00000094600

ICE CIRCLE

LUMENS	BULB TYPE	MULT SERIES	POLE TYPE	SHADE	ADDRESS NUMBER	REF	LOCATION	TAX DIST	DATE INST	DATE CHANGE
04000	S	M	OUG	II	00609	051		12	101478	1/1/0001

OFFICE: 311

ROUTE: 564

ST_REF_NO: 00000094625

ICE HOUSE WAY

LUMENS	BULB TYPE	MULT SERIES	POLE TYPE	SHADE	ADDRESS NUMBER	REF	LOCATION	TAX DIST	DATE INST	DATE CHANGE
05800	S		OUG	II	02184	015		12	111813	1/1/0001
05800	S		OUG	II	02197	014		12	111813	1/1/0001

OFFICE: 311

ROUTE: 564

ST_REF_NO: 00000094650

IDLE BROOK WAY

LUMENS	BULB TYPE	MULT SERIES	POLE TYPE	SHADE	ADDRESS NUMBER	REF	LOCATION	TAX DIST	DATE INST	DATE CHANGE
05800	S	M	OUG	II	00000	002	SIDE OF 1969 ARBOR STATION WAY	12	120800	1/1/0001
05800	S	M	OUG	II	00000	003	SIDE REAR OF 1960 ARBOR STATION WAY	12	120800	1/1/0001
05800	S	M	OUG	II	01833	004		12	120800	1/1/0001
05800	S	M	OUG	III	01848	005		12	120800	1/1/0001

OFFICE: 311

ROUTE: 564

ST_REF_NO: 00000094700

IDLE HOUR DRIVE

LUMENS	BULB TYPE	MULT SERIES	POLE TYPE	SHADE	ADDRESS NUMBER	REF	LOCATION	TAX DIST	DATE INST	DATE CHANGE
05800	S	M	OUG	V	00000	001	IN ISLAND AT RICHMOND RD.	12	070158	1/1/0001
05800	S	M	OUG	III	00119	000		12	041557	1/1/0001
05800	S	M	OUG	II	00140	000		12	070886	1/1/0001
05800	S	M	OUG	III	00159	000		12	070155	1/1/0001
05800	S	M	OUG	III	00172	000		12	070155	1/1/0001
05800	S	M	OUG	III	00203	000		12	070155	1/1/0001
05800	S	M	OUG	III	00210	000		12	041557	1/1/0001
05800	S	M	OUG	III	00243	000	upgraded to 5800 hps cobra 10/07	12	041557	1/1/0001
05800	S	M	OUG	III	00250	000		12	041557	1/1/0001
05800	S	M	OUG	III	00267	000		12	040158	1/1/0001
05800	S	M	OUG	II	00274	000		12	071258	1/1/0001
05800	S	M	OUG	II	00291	000		12	071258	1/1/0001
05800	S	M	OUG	II	00294	000		12	080863	1/1/0001
05800	S	M	OUG	V	00306	000		12	080863	1/1/0001

OFFICE: 311

ROUTE: 564

ST_REF_NO: 00000094800

IDLEWILD COURT

LUMENS	BULB TYPE	MULT SERIES	POLE TYPE	SHADE	ADDRESS NUMBER	REF	LOCATION	TAX DIST	DATE INST	DATE CHANGE
05800	S	M	SOH	III	00000	001	1ST LT. N. OF LOUDEN AVE.	12	011156	1/1/0001
05800	S	M	SOH	II	00000	003	OPP. 818	12	120885	1/1/0001
05800	S	M	SOH	II	00000	004	OPP. 912	12	120885	1/1/0001
05800	S	M	SOH	II	00000	008	OPP. 937	12	120885	1/1/0001
05800	S	M	SOH	II	00000	009	OPP. 941	12	120885	1/1/0001
05800	S	M	SOH	II	00809	002		12	120885	1/1/0001
05800	S	M	SOH	III	00919	005		12	011156	1/1/0001
05800	S	M	SOH	II	00923	006		12	120885	1/1/0001
05800	S	M	SOH	III	00931	007		12	011156	1/1/0001

OFFICE: 311

ROUTE: 564

ST_REF_NO: 00000094810

IDLEWOOD CIRCLE

LUMENS	BULB TYPE	MULT SERIES	POLE TYPE	SHADE	ADDRESS NUMBER	REF	LOCATION	TAX DIST	DATE INST	DATE CHANGE
05800	S	M	CNT	III	04905	001		12	080896	1/1/0001

OFFICE: 311		ROUTE: 564		ST_REF_NO: 00000094820		IDLEWOOD DRIVE		TAX DIST	DATE INST	DATE CHANGE
LUMENS	BULB TYPE	MULT SERIES	POLE TYPE	SHADE	ADDRESS NUMBER	REF	LOCATION			
05800	S	M	CNT	II	02604	001		12	080896	1/1/0001
05800	S	M	CNT	II	02613	002		12	080896	1/1/0001
05800	S	M	CNT	II	02620	003		12	080896	1/1/0001
05800	S	M	CNT	II	02629	004		12	080896	1/1/0001
05800	S	M	CNT	II	02633	005		12	080896	1/1/0001
05800	S	M	CNT	II	02641	006		12	080896	1/1/0001
05800	S	M	CNT	II	02644	007		12	080896	1/1/0001
05800	S	M	CNT	II	02649	008		12	080896	1/1/0001
05800	S	M	CNT	II	02661	009		12	080896	1/1/0001
OFFICE: 311		ROUTE: 564		ST_REF_NO: 00000094910		IMPALA LANE		TAX DIST	DATE INST	DATE CHANGE
LUMENS	BULB TYPE	MULT SERIES	POLE TYPE	SHADE	ADDRESS NUMBER	REF	LOCATION			
04000	S	M	OUG	II	00000	246	SIDE OF 3517 COLTNECK LANE	12	051582	1/1/0001
04000	S	M	OUG	II	02009	249		12	120887	1/1/0001
04000	S	M	OUG	II	02028	248		12	051582	1/1/0001
04000	S	M	OUG	II	02029	247		12	111580	1/1/0001
OFFICE: 311		ROUTE: 564		ST_REF_NO: 00000094985		INDEPENDENCE COURT		TAX DIST	DATE INST	DATE CHANGE
LUMENS	BULB TYPE	MULT SERIES	POLE TYPE	SHADE	ADDRESS NUMBER	REF	LOCATION			
05800	S	M	OUG	II	02300	001		12	100896	1/1/0001
05800	S	M	OUG	III	02317	002		12	100896	1/1/0001
OFFICE: 311		ROUTE: 564		ST_REF_NO: 00000095000		INDIAN MOUND ROAD		TAX DIST	DATE INST	DATE CHANGE
LUMENS	BULB TYPE	MULT SERIES	POLE TYPE	SHADE	ADDRESS NUMBER	REF	LOCATION			
05800	S	M	OUG	II	00000	146	SIDE OF 421 ANDOVER	12	030166	1/1/0001
05800	S	M	OUG	II	01091	000		12	100165	1/1/0001
05800	S	M	OOH	II	01162	000		12	100165	1/1/0001
05800	S	M	OUG	II	01169	000		12	110165	1/1/0001
05800	S	M	OUG	II	01182	000		12	110165	1/1/0001
05800	S	M	OUG	II	01189	000		12	110165	1/1/0001
05800	S	M	OUG	II	01204	000		12	110165	1/1/0001

OFFICE: 311

ROUTE: 564

ST_REF_NO: 00000095000

INDIAN MOUND ROAD

LUMENS	BULB TYPE	MULT SERIES	POLE TYPE	SHADE	ADDRESS NUMBER	REF	LOCATION	TAX DIST	DATE INST	DATE CHANGE
05800	S	M	OUG	II	01221	000		12	110165	1/1/0001
05800	S	M	OUG	II	01236	000		12	030166	1/1/0001

OFFICE: 311

ROUTE: 564

ST_REF_NO: 00000095010

INDIAN SUMMER TRAIL

LUMENS	BULB TYPE	MULT SERIES	POLE TYPE	SHADE	ADDRESS NUMBER	REF	LOCATION	TAX DIST	DATE INST	DATE CHANGE
05800	S	M	CNT	II	00000	004	SIDE 1084 AUTUMN RIDGE DR.	12	060894	1/1/0001
05800	S	M	CNT	II	00000	007	SIDE 1096 RAMBLEWOOD WAY	12	060895	1/1/0001
05800	S	M	CNT	II	03508	001		12	060894	1/1/0001
05800	S	M	CNT	II	03521	002		12	060894	1/1/0001
05800	S	M	CNT	II	03532	003		12	060894	1/1/0001
05800	S	M	CNT	II	03548	005		12	060895	1/1/0001
05800	S	M	CNT	II	03561	006		12	060895	1/1/0001
05800	S	M	CNT	II	03577	008		12	050897	1/1/0001

OFFICE: 311

ROUTE: 564

ST_REF_NO: 00000095100

INDIANA AVENUE

LUMENS	BULB TYPE	MULT SERIES	POLE TYPE	SHADE	ADDRESS NUMBER	REF	LOCATION	TAX DIST	DATE INST	DATE CHANGE
05800	S	M	SOH	II	00000	005	5TH LT. FROM MAIN ST., E. SIDE	12	061581	1/1/0001
05800	S	M	SOH	II	00000	006	6TH LT. FROM MAIN ST., E. SIDE	12	061581	1/1/0001
05800	S	M	SOH	II	00000	007	7TH LT. FROM MAIN ST., E. SIDE	12	061581	1/1/0001
05800	S	M	SOH	II	00000	008	8TH LT. FROM MAIN ST., E. SIDE	12	061581	1/1/0001
05800	S	M	SOH	II	00000	009	9TH LT. FROM MAIN ST., E. SIDE	12	061581	1/1/0001
05800	S	M	SOH	II	00000	010	10TH LT. FROM MAIN ST., E. SIDE	12	061581	1/1/0001
05800	S	M	OUG	II	00000	001	1ST LT. FROM MAIN ST., W. SIDE	12	061581	1/1/0001
05800	S	M	OUG	II	00000	002	2ND LT. FROM MAIN ST., W. SIDE	12	061581	1/1/0001
05800	S	M	OUG	II	00000	003	3RD LT. FROM MAIN ST., W. SIDE	12	061581	1/1/0001
05800	S	M	SOH	II	00000	004	4TH LT. FROM MAIN ST., E. SIDE	12	061581	1/1/0001

OFFICE: 311

ROUTE: 564

ST_REF_NO: 00000095200

INDUSTRY ROAD

LUMENS	BULB TYPE	MULT SERIES	POLE TYPE	SHADE	ADDRESS NUMBER	REF	LOCATION	TAX DIST	DATE INST	DATE CHANGE
09500	S	M	OUG	II	00000	004	OPP. 1019	12	040170	12/5/2011
10000	M	M	OOH	II	00000	002	SIDE OF 1209 WINCHESTER RD.	12	040170	1/1/0001

OFFICE: 311

ROUTE: 564

ST_REF_NO: 00000095200

INDUSTRY ROAD

LUMENS	BULB TYPE	MULT SERIES	POLE TYPE	SHADE	ADDRESS NUMBER	REF	LOCATION	TAX DIST	DATE INST	DATE CHANGE
10000	M	M	OUG	II	00000	006	OPP. 1031	12	040170	1/1/0001
20000	M	M	OUG	II	00000	007	2ND LT. S. OF EASTLAND DR., W. SIDE	12	040170	1/1/0001
20000	M	M	OUG	II	00000	008	2ND LT. S. OF EASTLAND DR., E. SIDE	12	040170	1/1/0001
20000	M	M	OUG	II	00000	010	1ST LT. S. OF EASTLAND DR., E. SIDE	12	040170	1/1/0001
22000	S	M	SOH	II	00000	020	OPP. 1260	12	120894	1/1/0001
22000	S	M	SOH	II	00000	021	1ST LT. W. OF NEW CIRCLE RD.	12	120894	1/1/0001
10000	M	M	OUG	II	01013	003		12	040170	1/1/0001
10000	M	M	OUG	II	01023	005		12	040170	1/1/0001
20000	M	M	OUG	II	01073	009		12	040170	1/1/0001
20000	M	M	OOH	II	01105	011		12	040170	1/1/0001
20000	M	M	OOH	II	01112	012		12	040170	1/1/0001
20000	M	M	OOH	II	01133	013		12	040170	1/1/0001
20000	M	M	OOH	II	01142	014		12	040170	1/1/0001
20000	M	M	OOH	II	01145	015		12	040170	1/1/0001
22000	S	M	SOH	II	01201	016		12	120894	1/1/0001
22000	S	M	SOH	II	01211	017		12	120894	1/1/0001
22000	S	M	SOH	II	01233	018		12	120894	1/1/0001
22000	S	M	SOH	II	01267	019		12	120894	1/1/0001

OFFICE: 311

ROUTE: 564

ST_REF_NO: 00000095290

INGLESIDE DRIVE

LUMENS	BULB TYPE	MULT SERIES	POLE TYPE	SHADE	ADDRESS NUMBER	REF	LOCATION	TAX DIST	DATE INST	DATE CHANGE
05800	S	M	SOH	II	00495	020		12	050898	1/1/0001
05800	S	M	SOH	II	00505	019		12	050898	1/1/0001

OFFICE: 311

ROUTE: 564

ST_REF_NO: 00000095370

INGLEWOOD CIRCLE

LUMENS	BULB TYPE	MULT SERIES	POLE TYPE	SHADE	ADDRESS NUMBER	REF	LOCATION	TAX DIST	DATE INST	DATE CHANGE
05800	S	M	CNT	II	02208	001		12	030897	1/1/0001

OFFICE: 311

ROUTE: 564

ST_REF_NO: 00000095380

INMAN DRIVE

LUMENS	BULB TYPE	MULT SERIES	POLE TYPE	SHADE	ADDRESS NUMBER	REF	LOCATION	TAX DIST	DATE INST	DATE CHANGE
05800	S	M	CNT	II	04729	004		12	100898	1/1/0001

OFFICE: 311		ROUTE: 564		ST_REF_NO: 00000095385		INNOVATION DRIVE				
LUMENS	BULB TYPE	MULT SERIES	POLE TYPE	SHADE	ADDRESS NUMBER	REF	LOCATION	TAX DIST	DATE INST	DATE CHANGE
09500	S	M	OUG	II	00000	001	1ST LT W OF GEORGETOWN RD, N SIDE ON INNOVATION	12	052308	1/1/0001
09500	S	M	OUG	II	00000	002	2ND LT W OF GEORGETOWN RD, N SIDE ON INNOVATION	12	052308	1/1/0001
09500	S	M	OUG	II	00000	003	3RD LT W OF GEORGETOWN RD, N SIDE ON INNOVATION	12	052308	1/1/0001
09500	S	M	OUG	II	00000	004	4TH LT W OF GEORGETOWN RD, N SIDE ON INNOVATION	12	052308	1/1/0001
09500	S	M	OUG	II	00000	005	5TH LT W OF GEORGETOWN RD, N SIDE ON INNOVATION	12	052308	1/1/0001
09500	S	M	OUG	II	00000	006	6TH LT W OF GEORGETOWN RD, N SIDE ON INNOVATION	12	052308	1/1/0001
09500	S	M	OUG	II	00000	007	7TH LT W OF GEORGETOWN RD, N SIDE ON INNOVATION	12	052308	1/1/0001
09500	S	M	OUG	II	00000	008	8TH LT W OF GEORGETOWN RD, N SIDE ON INNOVATION	12	052308	1/1/0001
09500	S	M	OUG	II	00000	009	9TH LT W OF GEORGETOWN RD, N SIDE ON INNOVATION	12	052308	1/1/0001
09500	S	M	OUG	II	00000	010	1ST LT W OF JAGGIE FOX WAY, N SIDE ON INNOVATION	12	052308	1/1/0001
09500	S	M	OUG	II	00000	011	2ND LT W OF JAGGIE FOX WAY, N SIDE ON INNOVATION	12	052308	1/1/0001
09500	S	M	OUG	II	00000	012	3RD LT W OF JAGGIE FOX WAY, N SIDE ON INNOVATION	12	052308	1/1/0001
09500	S	M	OUG	II	00000	013	4TH LT W OF JAGGIE FOX WAY, N SIDE ON INNOVATION	12	052308	1/1/0001

OFFICE: 311

ROUTE: 564

ST_REF_NO: 00000095500

INVERNESS DRIVE

LUMENS	BULB TYPE	MULT SERIES	POLE TYPE	SHADE	ADDRESS NUMBER	REF	LOCATION	TAX DIST	DATE INST	DATE CHANGE
04000	S	M	OUG	II	00000	047	SIDE 2932 BRIGADOON PKWY.	12	110885	1/1/0001
04000	S	M	OUG	II	00202	048		12	110885	1/1/0001
04000	S	M	OUG	II	00209	049		12	110885	1/1/0001
04000	S	M	OUG	II	00214	050		12	110885	1/1/0001
04000	S	M	OUG	II	00218	051		12	010886	1/1/0001

OFFICE: 311

ROUTE: 564

ST_REF_NO: 00000095600 IPSWICH COURT

LUMENS	BULB TYPE	MULT SERIES	POLE TYPE	SHADE	ADDRESS NUMBER	REF	LOCATION	TAX DIST	DATE INST	DATE CHANGE
04000	S	M	OUG	II	03482	073		12	110885	1/1/0001
04000	S	M	OUG	II	03490	072		12	110885	1/1/0001

OFFICE: 311

ROUTE: 564

ST_REF_NO: 00000095650 IRBY COURT

LUMENS	BULB TYPE	MULT SERIES	POLE TYPE	SHADE	ADDRESS NUMBER	REF	LOCATION	TAX DIST	DATE INST	DATE CHANGE
04000	S	M	OUG	II	00800	001		12	100890	1/1/0001

OFFICE: 311

ROUTE: 564

ST_REF_NO: 00000095675 IRIS COVE

LUMENS	BULB TYPE	MULT SERIES	POLE TYPE	SHADE	ADDRESS NUMBER	REF	LOCATION	TAX DIST	DATE INST	DATE CHANGE
05800	S	M	CNT	III	02300	001		12	080806	1/1/0001

OFFICE: 311

ROUTE: 564

ST_REF_NO: 00000095750 IRON LACE COURT

LUMENS	BULB TYPE	MULT SERIES	POLE TYPE	SHADE	ADDRESS NUMBER	REF	LOCATION	TAX DIST	DATE INST	DATE CHANGE
05800	S	M	CNT	II	00000	001	SIDE OF 3613 IRON LACE DR.	12	100896	1/1/0001
05800	S	M	CNT	II	01101	008		12	100896	1/1/0001
05800	S	M	CNT	II	01120	009		12	100896	1/1/0001
05800	S	M	CNT	II	01125	007		12	100896	1/1/0001
05800	S	M	CNT	II	01148	006		12	100896	1/1/0001
05800	S	M	CNT	II	01161	005		12	100896	1/1/0001
05800	S	M	CNT	II	01164	004		12	100896	1/1/0001
05800	S	M	CNT	II	01212	002		12	100896	1/1/0001
05800	S	M	CNT	II	01225	003		12	100896	1/1/0001

OFFICE: 311

ROUTE: 564

ST_REF_NO: 00000095760 IRON LACE DRIVE

LUMENS	BULB TYPE	MULT SERIES	POLE TYPE	SHADE	ADDRESS NUMBER	REF	LOCATION	TAX DIST	DATE INST	DATE CHANGE
05800	S	M	CNT	II	00000	001	SIDE OF 1226 PLEASANT RIDGE DR.	12	100896	1/1/0001
05800	S	M	CNT	II	03605	002		12	100896	1/1/0001
05800	S	M	CNT	II	03632	003		12	100896	1/1/0001
05800	S	M	CNT	II	03641	004		12	100896	1/1/0001
05800	S	M	CNT	II	03656	005		12	100896	1/1/0001

OFFICE: 311		ROUTE: 564		ST_REF_NO: 00000095800		IRON WORKS PIKE				
LUMENS	BULB TYPE	MULT SERIES	POLE TYPE	SHADE	ADDRESS NUMBER	REF	LOCATION	TAX DIST	DATE INST	DATE CHANGE
09500	S	M	SOH	II	00000	312	1ST LT. E OF MT. HOREB RD., NORTHSIDE	12	020899	1/1/0001
09500	S	M	OUG	II	00000	313	1ST LT. W OF MT. HOREB RD., NORTHSIDE	12	020899	1/1/0001
09500	S	M	SOH	II	00000	317		12	020899	1/1/0001
09500	S	M	OUG	II	00000	332	1ST LT. E OF KENNY LANE, S SIDE	12	070899	1/1/0001
09500	S	M	OUG	II	00000	333	1ST LT. W OF KENNY LANE, S SIDE	12	070899	1/1/0001

OFFICE: 311		ROUTE: 564		ST_REF_NO: 00000095840		IRONBRIDGE COURT				
LUMENS	BULB TYPE	MULT SERIES	POLE TYPE	SHADE	ADDRESS NUMBER	REF	LOCATION	TAX DIST	DATE INST	DATE CHANGE
04000	S	M	OUG	II	00000	015	SIDE 4716 IRONBRIDGE RD.	12	060887	1/1/0001
04000	S	M	OUG	V	04756	014		12	020888	1/1/0001

OFFICE: 311		ROUTE: 564		ST_REF_NO: 00000095850		IRONBRIDGE DRIVE				
LUMENS	BULB TYPE	MULT SERIES	POLE TYPE	SHADE	ADDRESS NUMBER	REF	LOCATION	TAX DIST	DATE INST	DATE CHANGE
04000	S	M	OUG	II	00000	009	SIDE 1013 TURNBRIDGE CT.	12	060887	1/1/0001
04000	S	M	OUG	II	00000	010	SIDE 1016 TURNBRIDGE ON IRONBRIDGE DR.	12	090892	1/1/0001
04000	S	M	OUG	II	04646	007		12	110889	1/1/0001
04000	S	M	OUG	II	04647	008		12	020888	1/1/0001
04000	S	M	OUG	II	04659	006		12	050887	1/1/0001
04000	S	M	OUG	II	04666	005		12	050887	1/1/0001
04000	S	M	OUG	II	04683	004		12	050887	1/1/0001
04000	S	M	OUG	II	04687	003		12	050887	1/1/0001
04000	S	M	OUG	II	04697	002		12	050887	1/1/0001
04000	S	M	OUG	II	04700	001		12	060887	1/1/0001
04000	S	M	OUG	II	04720	011		12	050891	1/1/0001
04000	S	M	OUG	II	04732	012		12	060887	1/1/0001
04000	S	M	OUG	II	04744	013		12	060887	1/1/0001

OFFICE: 311		ROUTE: 564		ST_REF_NO: 00000096000		IRVINE ROAD				
LUMENS	BULB TYPE	MULT SERIES	POLE TYPE	SHADE	ADDRESS NUMBER	REF	LOCATION	TAX DIST	DATE INST	DATE CHANGE
05800	S	M	SOH	II	00000	038	SIDE OF 1024 RICHMOND RD.	12	060168	1/1/0001
05800	S	M	SOH	I	00000	041	SIDE OF 1100 FINCASTLE RD.	12	061068	1/1/0001

OFFICE: 311 ROUTE: 564										
ST_REF_NO: 00000096000 IRVINE ROAD										
LUMENS	BULB TYPE	MULT SERIES	POLE TYPE	SHADE	ADDRESS NUMBER	REF	LOCATION	TAX DIST	DATE INST	DATE CHANGE
05800	S	M	SOH	I	00109	040		12	100268	1/1/0001
05800	S	M	SOH	I	00110	039		12	061068	1/1/0001
05800	S	M	SOH	I	00227	042		12	061068	1/1/0001
05800	S	M	SOH	I	00241	043		12	061068	1/1/0001
05800	S	M	SOH	I	00256	044		12	061068	1/1/0001
05800	S	M	SOH	I	00301	045		12	061068	1/1/0001
05800	S	M	SOH	I	00306	046		12	061068	1/1/0001
05800	S	M	SOH	I	00315	047		12	061068	1/1/0001
05800	S	M	SOH	I	00340	048		12	061068	1/1/0001
OFFICE: 311 ROUTE: 564										
ST_REF_NO: 00000096050 ISABELLA LANE										
LUMENS	BULB TYPE	MULT SERIES	POLE TYPE	SHADE	ADDRESS NUMBER	REF	LOCATION	TAX DIST	DATE INST	DATE CHANGE
05800	S	M	CNT	II	00300	001		12	010407	1/1/0001
05800	S	M	CNT	II	00313	003		12	010407	1/1/0001
OFFICE: 311 ROUTE: 564										
ST_REF_NO: 00000096170 ISLAND POND ROAD										
LUMENS	BULB TYPE	MULT SERIES	POLE TYPE	SHADE	ADDRESS NUMBER	REF	LOCATION	TAX DIST	DATE INST	DATE CHANGE
05800	S	M	OUG	II	02528	003		12	080203	1/1/0001
05800	S	M	OUG	II	00000	001	REAR OF 784 GRAFTONS MILL LANE	12	110899	1/1/0001
05800	S	M	OUG	II	02512	002		12	110899	1/1/0001
05800	S	M	OUG	II	02537	004		12	110899	1/1/0001
OFFICE: 311 ROUTE: 564										
ST_REF_NO: 00000096300 IVY COURT										
LUMENS	BULB TYPE	MULT SERIES	POLE TYPE	SHADE	ADDRESS NUMBER	REF	LOCATION	TAX DIST	DATE INST	DATE CHANGE
05800	S	M	OUG	II	00603	000		12	010166	1/1/0001
OFFICE: 311 ROUTE: 564										
ST_REF_NO: 00000096310 IVY BRIDGE										
LUMENS	BULB TYPE	MULT SERIES	POLE TYPE	SHADE	ADDRESS NUMBER	REF	LOCATION	TAX DIST	DATE INST	DATE CHANGE
05800	S	M	CNT	II	00000	015	SIDE OF 897 GOLDEN BELL PL ON IVY BRIDGE DR	12	033007	1/1/0001
05800	S	M	CNT	II	00000	016	SIDE OF 901 GOLDEN BELL PL ON IVY BRIDGE DR	12	033007	1/1/0001
05800	S	M	CNT	II	05037	009		12	072803	1/1/0001

OFFICE: 311		ROUTE: 564		ST_REF_NO: 00000096310		IVY BRIDGE		LUMENS	BULB TYPE	MULT SERIES	POLE TYPE	SHADE	ADDRESS NUMBER	REF	LOCATION	TAX DIST	DATE INST	DATE CHANGE
05800	S	M	CNT	II	05068	011		12	072803	1/1/0001								
05800	S	M	CNT	II	05084	013		12	072803	1/1/0001								
05800	S	M	CNT	II	05089	014		12	072803	1/1/0001								
05800	S	M	CNT	II	05100	017		12	072803	1/1/0001								
05800	S	M	CNT	II	05101	018		12	033007	1/1/0001								
05800	S	M	CNT	II	05104	019		12	072803	1/1/0001								
05800	S	M	CNT	II	05113	020		12	033007	1/1/0001								
05800	S	M	CNT	II	05124	021		12	081404	1/1/0001								
05800	S	M	CNT	II	05133	022		12	081404	1/1/0001								
05800	S	M	CNT	II	05141	023		12	033007	1/1/0001								
05800	S	M	CNT	II	05230	008		12	072803	1/1/0001								
05800	S	M	CNT	II	00000	002	OPP. 5005	12	090800	1/1/0001								
05800	S	M	CNT	II	05005	001		12	090800	1/1/0001								
05800	S	M	CNT	II	05012	003		12	090800	1/1/0001								
05800	S	M	CNT	II	05017	004		12	090800	1/1/0001								
05800	S	M	CNT	II	05020	005		12	090800	1/1/0001								
05800	S	M	CNT	II	05021	007		12	090800	1/1/0001								
05800	S	M	CNT	II	05024	006		12	090800	1/1/0001								

OFFICE: 311		ROUTE: 564		ST_REF_NO: 00000096400		JACANA DRIVE		LUMENS	BULB TYPE	MULT SERIES	POLE TYPE	SHADE	ADDRESS NUMBER	REF	LOCATION	TAX DIST	DATE INST	DATE CHANGE
04000	S	M	OUG	II	00000	042	SIDE 462 BOB-O-LINK DR	12	110884	1/1/0001								
04000	S	M	OUG	II	00000	043	SIDE 399 BOB-O-LINK DR	12	110884	1/1/0001								
04000	S	M	OUG	II	00000	044	SIDE 300 MOCKINGBIRD DR	12	110884	1/1/0001								
04000	S	M	OUG	II	01546	047		12	110884	1/1/0001								
04000	S	M	OUG	II	01562	046		12	110884	1/1/0001								
04000	S	M	OUG	II	01574	045		12	110884	1/1/0001								

OFFICE: 311		ROUTE: 564		ST_REF_NO: 00000096700		JACKSON STREET		LUMENS	BULB TYPE	MULT SERIES	POLE TYPE	SHADE	ADDRESS NUMBER	REF	LOCATION	TAX DIST	DATE INST	DATE CHANGE
05800	S	M	SOH	II	00000	001	SIDE OF 561 BRECKINRIDGE ST.	12	020761	1/1/0001								
05800	S	M	SOH	II	00651	000		12	020761	1/1/0001								

OFFICE: 311

ROUTE: 564

ST_REF_NO: 00000096700

JACKSON STREET

LUMENS	BULB TYPE	MULT SERIES	POLE TYPE	SHADE	ADDRESS NUMBER	REF	LOCATION	TAX DIST	DATE INST	DATE CHANGE
05800	S	M	SOH	II	00713	000		12	020761	1/1/0001
05800	S	M	SOH	II	00719	000		12	041581	1/1/0001
05800	S	M	SOH	II	00725	000		12	020761	1/1/0001

OFFICE: 311

ROUTE: 564

ST_REF_NO: 00000096750

JACQUELYN LANE

LUMENS	BULB TYPE	MULT SERIES	POLE TYPE	SHADE	ADDRESS NUMBER	REF	LOCATION	TAX DIST	DATE INST	DATE CHANGE
05800	S	M	CNT	II	00000	001	1ST LT S OF MASTERSON STA DR W SIDE ON JACQUELYN	12	072401	1/1/0001
05800	S	M	CNT	II	00000	002	2ND LT S OF MASTERSON STA DR E SIDE ON JACQUELYN	12	072401	1/1/0001
05800	S	M	CNT	II	00000	003	3RD LT S OF MASTERSON STA DR W SIDE ON JACQUELYN	12	072401	1/1/0001
05800	S	M	CNT	II	00000	004	4TH LT S OF MASTERSON STA DR 3 SIDE ON JACQUELYN	12	072401	1/1/0001
05800	S	M	CNT	II	00000	005	SIDE OF 381 LUCILLE DR ON JACQUELYN LANE	12	072401	1/1/0001
05800	S	M	CNT	II	00000	009	SIDE OF 357 SILVER CREEK WAY ON JACQUELYN LANE	12	072401	1/1/0001
05800	S	M	CNT	II	02680	012		12	072401	1/1/0001
05800	S	M	CNT	II	02693	011		12	072401	1/1/0001
05800	S	M	CNT	II	02712	010		12	072401	1/1/0001
05800	S	M	CNT	II	02745	008		12	072401	1/1/0001
05800	S	M	CNT	II	02752	007		12	072401	1/1/0001
05800	S	M	CNT	II	02761	006		12	072401	1/1/0001

OFFICE: 311

ROUTE: 564

ST_REF_NO: 00000096800

JADE CIRCLE

LUMENS	BULB TYPE	MULT SERIES	POLE TYPE	SHADE	ADDRESS NUMBER	REF	LOCATION	TAX DIST	DATE INST	DATE CHANGE
04000	S	M	OUG	V	00400	016		12	060886	1/1/0001
04000	S	M	OUG	II	00409	017		12	060886	1/1/0001

OFFICE: 311

ROUTE: 564

ST_REF_NO: 00000096805

JAEDUKE COURT

LUMENS	BULB TYPE	MULT SERIES	POLE TYPE	SHADE	ADDRESS NUMBER	REF	LOCATION	TAX DIST	DATE INST	DATE CHANGE
04000	S	M	OUG	V	00600	082		12	120887	1/1/0001

OFFICE: 311

ROUTE: 564

ST_REF_NO: 00000096810

JAEDUKE DRIVE

LUMENS	BULB TYPE	MULT SERIES	POLE TYPE	SHADE	ADDRESS NUMBER	REF	LOCATION	TAX DIST	DATE INST	DATE CHANGE
04000	S	M	OUG	II	00704	081		12	120887	1/1/0001
04000	S	M	OUG	II	00717	080		12	110885	1/1/0001
04000	S	M	OUG	II	00729	079		12	110885	1/1/0001
04000	S	M	OUG	II	00736	078		12	110885	1/1/0001
04000	S	M	OUG	II	00749	077		12	110885	1/1/0001
04000	S	M	OUG	II	00760	076		12	110885	1/1/0001
04000	S	M	OUG	II	00765	075		12	050890	1/1/0001

OFFICE: 311

ROUTE: 564

ST_REF_NO: 00000096815

JAGGIE FOX WAY

LUMENS	BULB TYPE	MULT SERIES	POLE TYPE	SHADE	ADDRESS NUMBER	REF	LOCATION	TAX DIST	DATE INST	DATE CHANGE
09500	S	M	OUG	II	00000	014	2ND LT N OF CAPSTONE DR WEST SIDE ON JAGGIE FOX	12	110601	1/1/0001
09500	S	M	OUG	II	00000	015	3RD LT N OF CAPSTONE DR WEST SIDE ON JAGGIE FOX	12	110601	1/1/0001
09500	S	M	OUG	II	00000	016	4TH LT N OF CAPSTONE DR WEST SIDE ON JAGGIE FOX	12	110601	1/1/0001
09500	S	M	OUG	II	00000	017	5TH LT N OF CAPSTONE DR WEST SIDE ON JAGGIE FOX	12	110601	1/1/0001
09500	S	M	OUG	II	00000	018	6TH LT N OF CAPSTONE DR WEST SIDE ON JAGGIE FOX	12	110601	1/1/0001
09500	S	M	OUG	II	00000	019	7TH LT N OF CAPSTONE DR WEST SIDE ON JAGGIE FOX	12	110601	1/1/0001
09500	S	M	OUG	II	00000	020	8TH LT N OF CAPSTONE DR WEST SIDE ON JAGGIE FOX	12	110601	1/1/0001
09500	S	M	OUG	II	00000	021	9TH LT N OF CAPSTONE DR WEST SIDE ON JAGGIE FOX	12	110601	1/1/0001
09500	S	M	OUG	II	00000	022	10TH LT N OF CAPSTONE DR WEST SIDE ON JAGGIE FOX	12	110601	1/1/0001
09500	S	M	OUG	II	00000	070	1ST LT N OF CITATION BLVD, E SIDE ON JAGGIE FOX	12	052308	1/1/0001
09500	S	M	OUG	II	00000	071	2ND LT N OF CITATION BLVD, E SIDE ON JAGGIE FOX	12	052308	1/1/0001
09500	S	M	OUG	II	00000	072	3RD LT N OF CITATION BLVD, E SIDE ON JAGGIE FOX	12	052308	1/1/0001
09500	S	M	OUG	II	00000	073	4TH LT N OF CITATION BLVD, E SIDE ON JAGGIE FOX	12	052308	1/1/0001

OFFICE: 311		ROUTE: 564		ST_REF_NO: 00000096815		JAGGIE FOX WAY		LUMENS	BULB TYPE	MULT SERIES	POLE TYPE	SHADE	ADDRESS NUMBER	REF	LOCATION	TAX DIST	DATE INST	DATE CHANGE
09500	S	M	OUG	II	00000	074	5TH LT N OF CITATION BLVD, E SIDE ON JAGGIE FOX	12	052308	1/1/0001								
09500	S	M	OUG	II	00000	075	6TH LT N OF CITATION BLVD, E SIDE ON JAGGIE FOX	12	052308	1/1/0001								
09500	S	M	OUG	II	01753	013		12	110601	1/1/0001								
09500	S	M	OUG	II	00000	051	1ST LT. N OF SANDERSVILLE RD., W SIDE	12	040800	1/1/0001								
09500	S	M	OUG	II	00000	053	OPP. 1708	12	040800	1/1/0001								
09500	S	M	OUG	II	00000	055	OPP. 1712	12	040800	1/1/0001								
09500	S	M	OUG	II	00000	056	OPP. 1713	12	040800	1/1/0001								
09500	S	M	OUG	II	00000	062	OPP. 1753	12	040800	1/1/0001								
09500	S	M	OUG	II	01628	013		12	110897	1/1/0001								
09500	S	M	OUG	II	01636	011		12	110897	1/1/0001								
09500	S	M	OUG	II	01637	012		12	110897	1/1/0001								
09500	S	M	OUG	II	01645	010		12	110897	1/1/0001								
09500	S	M	OUG	II	01652	008		12	110897	1/1/0001								
09500	S	M	OUG	II	01653	009		12	110897	1/1/0001								
09500	S	M	OUG	II	01661	007		12	110897	1/1/0001								
09500	S	M	OUG	II	01668	006		12	110897	1/1/0001								
09500	S	M	OUG	II	01676	004		12	110897	1/1/0001								
09500	S	M	OUG	II	01677	005		12	110897	1/1/0001								
09500	S	M	OUG	II	01685	003		12	110897	1/1/0001								
09500	S	M	OUG	II	01692	002		12	110897	1/1/0001								
09500	S	M	OUG	II	01693	001		12	110897	1/1/0001								
09500	S	M	OUG	II	01708	052		12	040800	1/1/0001								
09500	S	M	OUG	II	01712	054		12	040800	1/1/0001								
09500	S	M	OUG	II	01713	057		12	040800	1/1/0001								
09500	S	M	OUG	II	01728	058		12	040800	1/1/0001								
09500	S	M	OUG	II	01728	060		12	040800	1/1/0001								
09500	S	M	OUG	II	01729	059		12	040800	1/1/0001								
09500	S	M	OUG	II	01753	061		12	040800	1/1/0001								
OFFICE: 311		ROUTE: 564		ST_REF_NO: 00000096820		JAIRUS DRIVE		LUMENS	BULB TYPE	MULT SERIES	POLE TYPE	SHADE	ADDRESS NUMBER	REF	LOCATION	TAX DIST	DATE INST	DATE CHANGE
05800	S	M	OUG	II	00867	011		12	020887	11/3/2013								

OFFICE: 311		ROUTE: 564		ST_REF_NO: 00000096820		JAIRUS DRIVE		LUMENS	BULB TYPE	MULT SERIES	POLE TYPE	SHADE	ADDRESS NUMBER	REF	LOCATION	TAX DIST	DATE INST	DATE CHANGE
	04000	S	M	OUG	II	00918	008	CORRECTING HOUSE NUMBER ONLY								12	020887	2/8/1987
	04000	S	M	OUG	II	00922	007									12	020887	2/8/1987
	04000	S	M	OUG	II	00795	017									12	020888	1/1/0001
	04000	S	M	OUG	II	00810	016									12	020888	1/1/0001
	04000	S	M	OUG	II	00815	015									12	020888	1/1/0001
	04000	S	M	OUG	II	00830	014									12	020888	1/1/0001
	04000	S	M	OUG	II	00839	013									12	020887	1/1/0001
	04000	S	M	OUG	II	00850	012									12	020887	1/1/0001
	04000	S	M	OUG	II	00878	010									12	020887	1/1/0001
	04000	S	M	OUG	II	00891	009									12	020887	1/1/0001
	04000	S	M	OUG	II	00939	006									12	020887	1/1/0001
	04000	S	M	OUG	II	00946	005									12	020887	1/1/0001
	04000	S	M	OUG	II	00963	004									12	020887	1/1/0001
	04000	S	M	OUG	II	00970	003									12	020887	1/1/0001
	04000	S	M	OUG	II	00991	002									12	020887	1/1/0001

OFFICE: 311		ROUTE: 564		ST_REF_NO: 00000096900		JAMES COURT		LUMENS	BULB TYPE	MULT SERIES	POLE TYPE	SHADE	ADDRESS NUMBER	REF	LOCATION	TAX DIST	DATE INST	DATE CHANGE
	05800	S	M	SOH	II	00105	010									12	032304	1/1/0001
	05800	S	M	OUG	II	00000	003	1 ST. LT. E. OF HELM ST.								12	011581	1/1/0001
	05800	S	M	OOH	V	00000	004	AT END, IN COURT								12	011581	1/1/0001
	04000	S	M	SOH	II	00101	163									12	010885	1/1/0001
	04000	S	M	SOH	II	00109	164									12	010885	1/1/0001

OFFICE: 311		ROUTE: 564		ST_REF_NO: 00000097200		JANE STREET		LUMENS	BULB TYPE	MULT SERIES	POLE TYPE	SHADE	ADDRESS NUMBER	REF	LOCATION	TAX DIST	DATE INST	DATE CHANGE
	05800	S	M	SOH	I	00000	001	1ST LT. W. OF ROBERTSON, S. SIDE								12	011369	1/1/0001
	05800	S	M	SOH	I	00000	003	JANE AND FERGUSON								12	050162	1/1/0001
	05800	S	M	SOH	I	00000	004	SIDE OF 449 ROBERTSON								12	050162	1/1/0001
	05800	S	M	SOH	I	01045	005									12	050162	1/1/0001
	05800	S	M	SOH	I	01157	002									12	011369	1/1/0001
	05800	S	M	SOH	I	00000	006	JANE AND SPEIGLE								12	050162	1/1/0001

OFFICE: 311		ROUTE: 564		ST_REF_NO: 00000097200		JANE STREET		LUMENS	BULB TYPE	MULT SERIES	POLE TYPE	SHADE	ADDRESS NUMBER	REF	LOCATION	TAX DIST	DATE INST	DATE CHANGE
	09500	S	M	SOH	I	01017	007	upgraded 10/07	12	010222	1/1/0001							

OFFICE: 311		ROUTE: 564		ST_REF_NO: 00000097210		JANE BRIGGS AVENUE		LUMENS	BULB TYPE	MULT SERIES	POLE TYPE	SHADE	ADDRESS NUMBER	REF	LOCATION	TAX DIST	DATE INST	DATE CHANGE
	05800	S	M	CNT	II	00000	010	SIDE OF 4409 LOGANS FORT LANE ON JANE BRIGGS AVE	12	052607	1/1/0001							
	05800	S	M	CNT	II	00000	048	SIDE OF 326 RICHARDSON PL ON JANE BRIGGS AVE	12	010407	1/1/0001							
	05800	S	M	CNT	II	00212	009		12	052607	1/1/0001							
	05800	S	M	CNT	II	00221	008		12	052607	1/1/0001							
	05800	S	M	CNT	II	00232	007		12	052607	1/1/0001							
	05800	S	M	CNT	II	00240	006		12	052607	1/1/0001							
	05800	S	M	CNT	II	00248	005		12	052607	1/1/0001							
	05800	S	M	CNT	II	00257	011		12	052607	1/1/0001							
	05800	S	M	CNT	II	00273	003		12	053106	1/1/0001							
	05800	S	M	CNT	II	00285	002		12	053106	1/1/0001							
	05800	S	M	CNT	II	00288	001		12	053106	1/1/0001							
	05800	S	M	CNT	II	00301	004		12	053106	1/1/0001							
	05800	S	M	CNT	II	00309	045		12	010407	1/1/0001							
	05800	S	M	CNT	II	00321	046		12	010407	1/1/0001							
	05800	S	M	CNT	II	00337	047		12	010407	1/1/0001							
	05800	S	M	CNT	II	00361	049		12	010407	1/1/0001							
	05800	S	M	CNT	II	00376	050		12	010407	1/1/0001							

OFFICE: 311		ROUTE: 564		ST_REF_NO: 00000097300		JANNELLE COURT		LUMENS	BULB TYPE	MULT SERIES	POLE TYPE	SHADE	ADDRESS NUMBER	REF	LOCATION	TAX DIST	DATE INST	DATE CHANGE
	05800	S	M	OUG	V	01301	000		12	080173	1/1/0001							
	05800	S	M	OUG	II	01317	000		12	080173	1/1/0001							

OFFICE: 311		ROUTE: 564		ST_REF_NO: 00000097400		JASMINE DRIVE		LUMENS	BULB TYPE	MULT SERIES	POLE TYPE	SHADE	ADDRESS NUMBER	REF	LOCATION	TAX DIST	DATE INST	DATE CHANGE
	05800	S	M	OUG	II	00000	107	SIDE OF 2172 GARDEN SPRINGS DR.	12	090363	1/1/0001							

OFFICE: 311

ROUTE: 564

ST_REF_NO: 0000097400

JASMINE DRIVE

LUMENS	BULB TYPE	MULT SERIES	POLE TYPE	SHADE	ADDRESS NUMBER	REF	LOCATION	TAX DIST	DATE INST	DATE CHANGE
05800	S	M	OUG	II	00000	111	SIDE OF 2140 GARDEN SPRINGS DR.	12	090363	1/1/0001
05800	S	M	OUG	II	00000	187	SIDE OF 2205 JASMINE DR.	12	111565	1/1/0001
05800	S	M	OUG	II	00000	189	SIDE OF 2143 JASMINE DR.	12	111565	1/1/0001
05800	S	M	OUG	II	02111	112		12	090363	1/1/0001
05800	S	M	OUG	II	02128	191		12	111565	1/1/0001
05800	S	M	OUG	II	02139	190		12	120165	1/1/0001
05800	S	M	OUG	II	02176	188		12	111565	1/1/0001
05800	S	M	OUG	II	02208	186		12	111565	1/1/0001
05800	S	M	OUG	II	02217	185		12	111565	1/1/0001
05800	S	M	OUG	II	02236	108		12	090363	1/1/0001

OFFICE: 311

ROUTE: 564

ST_REF_NO: 0000097450

JASMINE ROSE WAY

LUMENS	BULB TYPE	MULT SERIES	POLE TYPE	SHADE	ADDRESS NUMBER	REF	LOCATION	TAX DIST	DATE INST	DATE CHANGE
05800	S		CNT	II	00000	013	BESIDE 4360 JASMINE ROSE WAY	12	031309	1/1/0001
05800	S		CNT	II	04360	014		12	031309	1/1/0001
05800	S		CNT	II	04372	016		12	031309	1/1/0001
05800	S		CNT	II	04388	017		12	031309	1/1/0001
05800	S	M	CNT	II	00000	001	SIDE OF 1009 LEMON RUE WAY ON JASMINE ROSE WAY	12	110306	1/1/0001
05800	S	M	CNT	II	00000	005	ACROSS FROM 4248 JASMINE ROSE WAY	12	110306	1/1/0001
05800	S	M	CNT	II	00000	008	CORNER OF NETTLE ALLEY AND JASMINE ROSE WAY	12	110306	1/1/0001
05800	S		CNT	II	00000	018	SIDE OF 973 CHAS DR ON JASMINE ROSE WAY	12	031309	3/13/2009
05800	S	M	CNT	II	04217	002		12	110306	1/1/0001
05800	S	M	CNT	II	04232	003		12	110306	1/1/0001
05800	S	M	CNT	II	04249	004		12	110306	1/1/0001
05800	S	M	CNT	II	04264	006		12	110306	1/1/0001
05800	S	M	CNT	II	04284	007		12	110306	1/1/0001
05800	S	M	CNT	II	04300	009		12	110306	1/1/0001
05800	S	M	CNT	II	04308	010		12	110306	1/1/0001
05800	S	M	CNT	II	04328	011		12	110306	1/1/0001
05800	S	M	CNT	II	04340	012		12	110306	1/1/0001

OFFICE: 311

ROUTE: 564

ST_REF_NO: 00000097500

JASON COURT

LUMENS	BULB TYPE	MULT SERIES	POLE TYPE	SHADE	ADDRESS NUMBER	REF	LOCATION	TAX DIST	DATE INST	DATE CHANGE
04000	S	M	OUG	II	02904	006		12	050886	1/1/0001
04000	S	M	OUG	V	02917	005		12	071582	1/1/0001

OFFICE: 311

ROUTE: 564

ST_REF_NO: 00000097700

JEFFERSON STREET

LUMENS	BULB TYPE	MULT SERIES	POLE TYPE	SHADE	ADDRESS NUMBER	REF	LOCATION	TAX DIST	DATE INST	DATE CHANGE
09500	S	M	SOH	II	00000	009	1ST LT. N. OF SECOND ST., W. SIDE - bad fixture	12	080165	8/6/2010
22000	S	M	SOH	II	00000	100	SIDE OF 485 W FOURTH ST ON JEFFERSON STREET	12	012907	1/1/0001
10000	M	M	SOH	II	00000	023	OPP. 450	12	090165	1/1/0001
10000	M	M	SOH	II	00000	024	SIDE OF 560 W. FIFTH ST.	12	050165	1/1/0001
10000	M	M	SOH	II	00000	028	SIDE OF 490 W. SIXTH ST.	12	080165	1/1/0001
10000	M	M	SOH	II	00511	025		12	080165	1/1/0001
10000	M	M	SOH	II	00532	026		12	050165	1/1/0001
10000	M	M	SOH	II	00549	027		12	090165	1/1/0001
22000	S	M	SOH	II	00000	001	SIDE OF 601 W. MAIN ST.	12	080165	1/1/0001
22000	S	M	SOH	II	00000	002	SIDE OF 592 W. SHORT ST.	12	050165	1/1/0001
22000	S	M	SOH	II	00000	003	SIDE OF 601 W. SHORT ST.	12	080165	1/1/0001
22000	S	M	SOH	II	00000	006	OPP. 163	12	080165	1/1/0001
22000	S	M	SOH	II	00000	007	OPP. 176	12	080165	1/1/0001
22000	S	M	SOH	II	00000	008	SIDE OF 486 W. SECOND ST.	12	080165	1/1/0001
10000	M	M	SOH	II	00000	013	OPP. 250	12	090165	1/1/0001
10000	M	M	SOH	II	00000	014	SIDE OF 500 W. THIRD ST.	12	090165	1/1/0001
10000	M	M	SOH	II	00000	015	SIDE OF 501 W. THIRD ST.	12	090165	1/1/0001
10000	M	M	SOH	II	00000	021	1ST LT. N. OF FOURTH ST., W. SIDE	12	090165	1/1/0001
22000	S	M	SOH	II	00142	004		12	080165	1/1/0001
22000	S	M	SOH	II	00151	005		12	080165	1/1/0001
10000	M	M	SOH	II	00212	010		12	050165	1/1/0001
10000	M	M	SOH	II	00219	011		12	080165	1/1/0001
10000	M	M	SOH	II	00244	012		12	050165	1/1/0001
10000	M	M	SOH	II	00314	016		12	050165	1/1/0001
10000	M	M	SOH	II	00335	017		12	050165	1/1/0001
10000	M	M	SOH	II	00342	018		12	080165	1/1/0001
10000	M	M	SOH	II	00357	019		12	090165	1/1/0001

OFFICE: 311		ROUTE: 564		ST_REF_NO: 00000097700		JEFFERSON STREET				
LUMENS	BULB TYPE	MULT SERIES	POLE TYPE	SHADE	ADDRESS NUMBER	REF	LOCATION	TAX DIST	DATE INST	DATE CHANGE
10000	M	M	SOH	II	00366	020		12	050165	1/1/0001
10000	M	M	SOH	II	00430	022		12	080165	1/1/0001

OFFICE: 311		ROUTE: 564		ST_REF_NO: 00000097710		JEFFERSON STREET VIADUCT				
LUMENS	BULB TYPE	MULT SERIES	POLE TYPE	SHADE	ADDRESS NUMBER	REF	LOCATION	TAX DIST	DATE INST	DATE CHANGE
22000	S	M	OUG	II	00000	017	8TH LT. S. OF W. MAIN ST., W. SIDE	12	051581	9/23/2008
20000	M	M	OUG	II	00000	002	1ST LT. S. OF W. MAIN ST., E. SIDE	12	051581	1/1/0001
20000	M	M	OUG	II	00000	003	1ST LT. S. OF W. MAIN ST., W. SIDE	12	051581	1/1/0001
20000	M	M	OUG	II	00000	004	2ND LT. S. OF W. MAIN ST., E. SIDE	12	051581	1/1/0001
20000	M	M	OUG	II	00000	005	2ND LT. S. OF W. MAIN ST., W. SIDE	12	051581	1/1/0001
20000	M	M	OUG	II	00000	006	3RD LT. S. OF W. MAIN ST., E. SIDE	12	051581	1/1/0001
20000	M	M	OUG	II	00000	007	3RD LT. S. OF W. MAIN ST., W. SIDE	12	051581	1/1/0001
20000	M	M	OUG	II	00000	008	4TH LT. S. OF W. MAIN ST., E. SIDE	12	051581	1/1/0001
20000	M	M	OUG	II	00000	009	4TH LT. S. OF W. MAIN ST., W. SIDE	12	051581	1/1/0001
20000	M	M	OUG	II	00000	010	5TH LT. S. OF W. MAIN ST., E. SIDE	12	051581	1/1/0001
20000	M	M	OUG	II	00000	011	5TH LT. S. OF W. MAIN ST., W. SIDE	12	051581	1/1/0001
20000	M	M	OUG	II	00000	012	6TH LT. S. OF W. MAIN ST., E. SIDE	12	051581	1/1/0001
20000	M	M	OUG	II	00000	013	6TH LT. S. OF W. MAIN ST., W. SIDE	12	051581	1/1/0001
20000	M	M	OUG	II	00000	014	7TH LT. S. OF W. MAIN ST., E. SIDE	12	051581	1/1/0001
20000	M	M	OUG	II	00000	015	7TH LT. S. OF W. MAIN ST., W. SIDE	12	051581	1/1/0001
20000	M	M	OUG	II	00000	016	8TH LT. S. OF W. MAIN ST., E. SIDE	12	051581	1/1/0001

OFFICE: 311		ROUTE: 564		ST_REF_NO: 00000097730		JEFFREY CT				
LUMENS	BULB TYPE	MULT SERIES	POLE TYPE	SHADE	ADDRESS NUMBER	REF	LOCATION	TAX DIST	DATE INST	DATE CHANGE
05800	S	M	OUG	II	00000	047	SIDE OF 1242 VILLAGE DR. - 911 ADDRESS CHG	12	091477	2/21/2011
05800	S	M	OUG	V	02022	049	911 ADDRESS CHANGE	12	041476	2/21/2011
05800	S	M	OUG	II	02030	048	911 ADDRESS CHANGE	12	041476	2/21/2011

OFFICE: 311		ROUTE: 564		ST_REF_NO: 00000097750		JEKYLL DRIVE				
LUMENS	BULB TYPE	MULT SERIES	POLE TYPE	SHADE	ADDRESS NUMBER	REF	LOCATION	TAX DIST	DATE INST	DATE CHANGE
05800	S	M	CNT	II	00000	001	ACROSS FROM 1217 JEKYLL DRIVE	12	033006	1/1/0001

OFFICE: 311

ROUTE: 564

ST_REF_NO: 0000097750

JEKYLL DRIVE

LUMENS	BULB TYPE	MULT SERIES	POLE TYPE	SHADE	ADDRESS NUMBER	REF	LOCATION	TAX DIST	DATE INST	DATE CHANGE
05800	S	M	CNT	II	00000	004	SIDE OF 1244 RAEFORD LN ON JEKYLL DR	12	033006	1/1/0001
05800	S	M	CNT	II	00000	005	SIDE OF 3193 HEMINGWAY LN ON JEKYLL DR	12	033006	1/1/0001
05800	S	M	CNT	II	01209	003		12	033006	1/1/0001
05800	S	M	CNT	II	01217	002		12	033006	1/1/0001
05800	S	M	CNT	II	00000	001	REAR OF 1301 MUMFORD LANE	12	100899	1/1/0001
05800	S	M	CNT	II	00000	002	SIDE OF 1251 BEAUMONT CENTRE LANE	12	100899	1/1/0001
05800	S	M	CNT	II	00000	003	REAR OF 1305 MUMFORD LANE	12	100899	1/1/0001
05800	S	M	CNT	II	00000	004	REAR OF 1309 MUMFORD LANE	12	100899	1/1/0001
05800	S	M	CNT	II	00000	005	SIDE OF 2292 CHAMBLEE LANE	12	100899	1/1/0001

OFFICE: 311

ROUTE: 564

ST_REF_NO: 0000097850

JENNA REST

LUMENS	BULB TYPE	MULT SERIES	POLE TYPE	SHADE	ADDRESS NUMBER	REF	LOCATION	TAX DIST	DATE INST	DATE CHANGE
05800	S	M	CNT	II	00000	001	SIDE OF 2941 MAJESTIC VIEW WALK ON JENNA REST	12	092507	1/1/0001
05800	S	M	CNT	II	00000	002	SIDE OF 701 CORBIN WALK ON JENNA REST	12	092507	1/1/0001
05800	S	M	CNT	II	02801	007		12	092507	1/1/0001
05800	S	M	CNT	II	02829	005		12	092507	1/1/0001
05800	S	M	CNT	II	02840	004		12	092507	1/1/0001

OFFICE: 311

ROUTE: 564

ST_REF_NO: 0000097900

JENNIFER ROAD

LUMENS	BULB TYPE	MULT SERIES	POLE TYPE	SHADE	ADDRESS NUMBER	REF	LOCATION	TAX DIST	DATE INST	DATE CHANGE
05800	S	M	OUG	II	00000	020	OPP. 1750	12	091475	1/1/0001
05800	S	M	OUG	II	00000	022	OPP. 1708	12	031581	1/1/0001
05800	S	M	OUG	II	01601	000		12	050167	1/1/0001
05800	S	M	OUG	II	01602	027		12	040165	1/1/0001
05800	S	M	OUG	II	01609	026		12	031581	1/1/0001
05800	S	M	OUG	II	01616	025		12	040165	1/1/0001
05800	S	M	OUG	II	01704	023		12	040165	1/1/0001
05800	S	M	OUG	II	01705	024		12	072474	1/1/0001
05800	S	M	OUG	II	01750	021		12	040165	1/1/0001

OFFICE: 311

ROUTE: 564

ST_REF_NO: 0000098000

JERRICO DRIVE

LUMENS	BULB TYPE	MULT SERIES	POLE TYPE	SHADE	ADDRESS NUMBER	REF	LOCATION	TAX DIST	DATE INST	DATE CHANGE
10000	M	M	SOH	II	00000	001	OPP. 101	12	061579	1/1/0001
10000	M	M	SOH	II	00000	003	OPP. 101	12	061579	1/1/0001
10000	M	M	SOH	II	00000	005	OPP. 101	12	061579	1/1/0001
10000	M	M	SOH	II	00000	007	OPP. 101	12	061579	1/1/0001
10000	M	M	SOH	II	00000	009	OPP. 101	12	061579	1/1/0001
10000	M	M	SOH	II	00000	011	OPP. 101	12	061579	1/1/0001
10000	M	M	SOH	II	00000	013	OPP. 101	12	061579	1/1/0001
10000	M	M	OOH	II	00000	015	OPP. 101	12	011581	1/1/0001
10000	M	M	OOH	II	00000	017	OPP. 201	12	011581	1/1/0001
10000	M	M	OOH	II	00000	019	OPP. 201	12	011581	1/1/0001
10000	M	M	OOH	II	00000	021	OPP. 201	12	011581	1/1/0001
10000	M	M	OOH	II	00000	023	OPP. 201	12	011581	1/1/0001
10000	M	M	OOH	II	00000	025	OPP. 201	12	011581	1/1/0001
10000	M	M	OOH	II	00000	027	OPP. 201	12	011581	1/1/0001
10000	M	M	OOH	II	00000	029	OPP. 201	12	011581	1/1/0001
05800	S	M	CNT	II	00000	030	SIDE OF 400 FOREST HILL DR.	12	040897	1/1/0001
10000	M	M	OUG	II	00101	002		12	061579	1/1/0001
10000	M	M	OUG	II	00101	004		12	061579	1/1/0001
10000	M	M	OUG	II	00101	006		12	061579	1/1/0001
10000	M	M	OUG	II	00101	008		12	061579	1/1/0001
10000	M	M	OUG	II	00101	010		12	061579	1/1/0001
10000	M	M	OUG	II	00101	012		12	061579	1/1/0001
10000	M	M	OUG	II	00101	014		12	061579	1/1/0001
10000	M	M	OUG	II	00101	016		12	011581	1/1/0001
10000	M	M	OUG	II	00201	018		12	011581	1/1/0001
10000	M	M	OUG	II	00201	020		12	011581	1/1/0001
10000	M	M	OUG	II	00201	022		12	011581	1/1/0001
10000	M	M	OUG	II	00201	024		12	011581	1/1/0001
10000	M	M	OUG	II	00201	026		12	011581	1/1/0001
10000	M	M	OUG	II	00201	028		12	011581	1/1/0001

OFFICE: 311

ROUTE: 564

ST_REF_NO: 0000098100

JERSEY STREET

LUMENS	BULB TYPE	MULT SERIES	POLE TYPE	SHADE	ADDRESS NUMBER	REF	LOCATION	TAX DIST	DATE INST	DATE CHANGE
22000	S	M	SOH	II	00000	001	SIDE OF 120 W. MAXWELL ST.-upgraded to 22,000 9/05	12	070162	1/1/0001
09500	S	M	SOH	II	00000	002	REAR OF 303 S. LIMESTONE ST.-upgraded 9/05	12	070162	1/1/0001
09500	S	M	SOH	II	00000	003	REAR OF 325 S. LIMESTONE ST.-upgraded 9/05	12	070162	1/1/0001
50000	S	M	SOH	II	00000	004	SE CORNER OF JERSEY AND PINE ST. upgraded 9/05	12	070162	1/1/0001
09500	S	M	SOH	II	00000	005	REAR OF 355 S. LIMESTONE ST.-upgraded 9/05	12	070162	1/1/0001
09500	S	M	SOH	II	00000	006	REAR OF 367 S. LIMESTONE ST.-upgraded 9/05	12	070162	1/1/0001
09500	S	M	SOH	II	00000	007	REAR OF 377 S. LIMESTONE ST.-upgraded 9/05	12	070162	1/1/0001
09500	S	M	SOH	II	00000	008	REAR OF 395 S. LIMESTONE ST.upgraded 9/05	12	070162	1/1/0001

OFFICE: 311

ROUTE: 564

ST_REF_NO: 0000098300

JESSELIN DRIVE

LUMENS	BULB TYPE	MULT SERIES	POLE TYPE	SHADE	ADDRESS NUMBER	REF	LOCATION	TAX DIST	DATE INST	DATE CHANGE
04000	S	M	OUG	II	00000	025	SIDE 1941 BELLEFONTE	12	050888	1/1/0001
05800	S	M	OUG	II	00000	048	SIDE OF 2020 NICHOLASVILLE RD.	12	051581	1/1/0001
05800	S	M	OUG	II	00106	047		12	051581	1/1/0001
05800	S	M	OUG	II	00111	046		12	051581	1/1/0001
05800	S	M	OUG	II	00122	045		12	051581	1/1/0001
05800	S	M	OUG	II	00127	044		12	051581	1/1/0001
05800	S	M	OUG	II	00134	043		12	051581	1/1/0001
05800	S	M	OUG	II	00143	042		12	051581	1/1/0001
05800	S	M	OUG	II	00151	041		12	051581	1/1/0001
05800	S	M	OUG	II	00159	040		12	051581	1/1/0001
04000	S	M	OUG	II	00170	038		12	070888	1/1/0001
04000	S	M	OUG	II	00179	037		12	070888	1/1/0001
04000	S	M	OUG	II	00190	036		12	070888	1/1/0001
04000	S	M	OUG	II	00201	035		12	070888	1/1/0001
04000	S	M	OUG	II	00210	034		12	070888	1/1/0001
04000	S	M	OUG	II	00217	033		12	070888	1/1/0001
04000	S	M	OUG	II	00223	032		12	070888	1/1/0001
04000	S	M	OUG	II	00310	031		12	070888	1/1/0001
04000	S	M	OUG	II	00313	030		12	070888	1/1/0001
04000	S	M	OUG	II	00321	029		12	070888	1/1/0001
04000	S	M	OUG	II	00337	027		12	070888	1/1/0001

Street Light Listing run 1/11/2015 10:43:21 AM

Page 525 of 1254

OFFICE: 311

ROUTE: 564

ST_REF_NO: 00000098300 JESSELIN DRIVE

LUMENS	BULB TYPE	MULT SERIES	POLE TYPE	SHADE	ADDRESS NUMBER	REF	LOCATION	TAX DIST	DATE INST	DATE CHANGE
04000	S	M	OUG	II	00350	026		12	070888	1/1/0001

OFFICE: 311

ROUTE: 564

ST_REF_NO: 00000098350 JESSES DOMINION

LUMENS	BULB TYPE	MULT SERIES	POLE TYPE	SHADE	ADDRESS NUMBER	REF	LOCATION	TAX DIST	DATE INST	DATE CHANGE
05800	S	M	OUG	III	00000	001	SIDE OF 1145 WYNDHAM HILLS DRIVE	12	020897	1/1/0001

OFFICE: 311

ROUTE: 564

ST_REF_NO: 00000098374 JESSICA CIRCLE

LUMENS	BULB TYPE	MULT SERIES	POLE TYPE	SHADE	ADDRESS NUMBER	REF	LOCATION	TAX DIST	DATE INST	DATE CHANGE
05800	S	M	CNT	III	00508	001		12	071902	1/1/0001

OFFICE: 311

ROUTE: 564

ST_REF_NO: 00000098375 JESSICA LANE

LUMENS	BULB TYPE	MULT SERIES	POLE TYPE	SHADE	ADDRESS NUMBER	REF	LOCATION	TAX DIST	DATE INST	DATE CHANGE
05800	S	M	CNT	II	02700	002		12	071902	1/1/0001
05800	S	M	CNT	II	02725	003		12	071902	1/1/0001
05800	S	M	CNT	II	02729	004		12	071902	1/1/0001
05800	S	M	CNT	II	02749	006		12	071902	1/1/0001
05800	S	M	CNT	II	02760	007		12	071902	1/1/0001
05800	S	M	CNT	II	02769	008		12	071902	1/1/0001

OFFICE: 311

ROUTE: 564

ST_REF_NO: 00000098410 J.F.D. COURT

LUMENS	BULB TYPE	MULT SERIES	POLE TYPE	SHADE	ADDRESS NUMBER	REF	LOCATION	TAX DIST	DATE INST	DATE CHANGE
05800	S	M	OUG	V	04004	001		12	110893	1/1/0001

OFFICE: 311

ROUTE: 564

ST_REF_NO: 00000098450 JIMTOWN LANE

LUMENS	BULB TYPE	MULT SERIES	POLE TYPE	SHADE	ADDRESS NUMBER	REF	LOCATION	TAX DIST	DATE INST	DATE CHANGE
22000	S	M	SOH	II	00000	001	ON JIMTOWN LANE AT GREENWICH RD	12	013004	1/1/0001

OFFICE: 311		ROUTE: 564		ST_REF_NO: 00000098500		JINGLE BELL LANE		LUMENS	BULB TYPE	MULT SERIES	POLE TYPE	SHADE	ADDRESS NUMBER	REF	LOCATION	TAX DIST	DATE INST	DATE CHANGE
05800	S	M	OOH	II	00000	002	SIDE OF PAUL MILLER FORD	12	051667	1/1/0001								
05800	S	M	OOH	II	00000	003	200' E. OF CASE ST.	12	051667	1/1/0001								
05800	S	M	OOH	II	00000	007	SIDE OF 1201 CASE ST.	12	030890	1/1/0001								
05800	S	M	OUG	II	01454	008		12	051667	1/1/0001								
05800	S	M	OOH	II	01475	009		12	030890	1/1/0001								
05800	S	M	OUG	II	01475	010		12	030890	1/1/0001								
05800	S	M	OUG	II	01475	011		12	030890	1/1/0001								
OFFICE: 311		ROUTE: 564		ST_REF_NO: 00000098600		JOAN DRIVE		LUMENS	BULB TYPE	MULT SERIES	POLE TYPE	SHADE	ADDRESS NUMBER	REF	LOCATION	TAX DIST	DATE INST	DATE CHANGE
05800	S	M	OUG	II	01801	000		12	072474	1/1/0001								
05800	S	M	OUG	II	01808	000		12	082573	1/1/0001								
05800	S	M	OUG	II	01817	000		12	082573	1/1/0001								
05800	S	M	OUG	II	01824	000		12	092066	1/1/0001								
OFFICE: 311		ROUTE: 564		ST_REF_NO: 00000098800		JOEL STREET		LUMENS	BULB TYPE	MULT SERIES	POLE TYPE	SHADE	ADDRESS NUMBER	REF	LOCATION	TAX DIST	DATE INST	DATE CHANGE
05800	S	M	SOH	II	00524	002		12	091707	1/1/0001								
05800	S	M	SOH	I	00521	000		12	050162	1/1/0001								
OFFICE: 311		ROUTE: 564		ST_REF_NO: 00000098900		JOHN ALDEN LANE		LUMENS	BULB TYPE	MULT SERIES	POLE TYPE	SHADE	ADDRESS NUMBER	REF	LOCATION	TAX DIST	DATE INST	DATE CHANGE
05800	S	M	CNT	II	00000	028	SIDE OF 4204 JOHN ALDEN LANE	12	081705	1/1/0001								
05800	S	M	CNT	II	04033	011		12	081705	1/1/0001								
05800	S	M	CNT	II	04041	012		12	081705	1/1/0001								
05800	S	M	CNT	II	04041	013		12	081705	1/1/0001								
05800	S	M	CNT	II	04101	014		12	081705	1/1/0001								
05800	S	M	CNT	II	04117	016		12	081705	1/1/0001								
05800	S	M	CNT	II	04125	017		12	081705	1/1/0001								
05800	S	M	CNT	II	04132	018		12	081705	1/1/0001								
05800	S	M	CNT	II	04137	019		12	081705	1/1/0001								

OFFICE: 311		ROUTE: 564		ST_REF_NO: 00000098900		JOHN ALDEN LANE		LUMENS	BULB TYPE	MULT SERIES	POLE TYPE	SHADE	ADDRESS NUMBER	REF	LOCATION	TAX DIST	DATE INST	DATE CHANGE
	05800	S	M	CNT	II	04157	021									12	081705	1/1/0001
	05800	S	M	CNT	II	04164	022									12	081705	1/1/0001
	05800	S	M	CNT	II	04172	023									12	081705	1/1/0001
	05800	S	M	CNT	II	04181	024									12	081705	1/1/0001
	05800	S	M	CNT	II	04189	025									12	081705	1/1/0001
	05800	S	M	CNT	II	04196	026									12	081705	1/1/0001
	05800	S	M	CNT	II	04200	027									12	081705	1/1/0001

OFFICE: 311		ROUTE: 564		ST_REF_NO: 00000099100		JOHNSDALE DRIVE		LUMENS	BULB TYPE	MULT SERIES	POLE TYPE	SHADE	ADDRESS NUMBER	REF	LOCATION	TAX DIST	DATE INST	DATE CHANGE
	05800	S	M	OUG	II	00000	008								SIDE OF 1744 BENWOOD DR.	12	040172	1/1/0001
	05800	S	M	OUG	II	00850	000									12	091967	1/1/0001
	05800	S	M	OUG	II	00874	009									12	040172	1/1/0001

OFFICE: 311		ROUTE: 564		ST_REF_NO: 00000099300		JOHNSON AVENUE		LUMENS	BULB TYPE	MULT SERIES	POLE TYPE	SHADE	ADDRESS NUMBER	REF	LOCATION	TAX DIST	DATE INST	DATE CHANGE
	05800	S	M	SOH	II	00442	000									12	091477	1/1/0001
	05800	S	M	SOH	II	00457	000									12	091477	1/1/0001
	05800	S	M	SOH	II	00000	001								1ST LT. N. OF 4TH ST., E. SIDE	12	091477	1/1/0001
	05800	S	M	SOH	II	00409	000									12	091477	1/1/0001
	05800	S	M	SOH	II	00420	000									12	091477	1/1/0001

OFFICE: 311		ROUTE: 564		ST_REF_NO: 00000099500		JOHNSTON BOULEVARD		LUMENS	BULB TYPE	MULT SERIES	POLE TYPE	SHADE	ADDRESS NUMBER	REF	LOCATION	TAX DIST	DATE INST	DATE CHANGE
	05800	S	M	OUG	II	00100	001									12	070899	1/1/0001
	05800	S	M	SOH	II	00102	002									12	070899	1/1/0001
	05800	S	M	SOH	II	00106	003									12	070899	1/1/0001
	05800	S	M	SOH	II	00112	004									12	070899	1/1/0001
	05800	S	M	SOH	II	00116	005									12	070899	1/1/0001
	05800	S	M	SOH	II	00122	006									12	070899	1/1/0001
	05800	S	M	SOH	II	00126	007									12	070899	1/1/0001

OFFICE: 311		ROUTE: 564		ST_REF_NO: 00000099605		JOI CIRCLE		LUMENS	BULB TYPE	MULT SERIES	POLE TYPE	SHADE	ADDRESS NUMBER	REF	LOCATION	TAX DIST	DATE INST	DATE CHANGE
	05800	S	M	CNT	II	03205	001									12	040897	1/1/0001
OFFICE: 311		ROUTE: 564		ST_REF_NO: 00000099610		JON ALLEN LANE		LUMENS	BULB TYPE	MULT SERIES	POLE TYPE	SHADE	ADDRESS NUMBER	REF	LOCATION	TAX DIST	DATE INST	DATE CHANGE
	04000	S	M	OUG	II	00000	004								SIDE 4476 PRINCE ALBERT WAY	12	090886	1/1/0001
	04000	S	M	OUG	II	00208	005									12	090886	1/1/0001
OFFICE: 311		ROUTE: 564		ST_REF_NO: 00000099705		JONESTOWN LANE		LUMENS	BULB TYPE	MULT SERIES	POLE TYPE	SHADE	ADDRESS NUMBER	REF	LOCATION	TAX DIST	DATE INST	DATE CHANGE
	05800	S	M	OUG	II	01130	040									12	041902	1/1/0001
	05800	S	M	OUG	II	00000	001								SIDE 3768 OLD TATES CREEK ROAD	12	060895	1/1/0001
	05800	S	M	OUG	II	01108	002									12	060895	1/1/0001
	05800	S	M	OUG	II	01115	003									12	060895	1/1/0001
	05800	S	M	OUG	II	01118	004									12	060895	1/1/0001
OFFICE: 311		ROUTE: 564		ST_REF_NO: 00000099710		JORDAN ALLEY		LUMENS	BULB TYPE	MULT SERIES	POLE TYPE	SHADE	ADDRESS NUMBER	REF	LOCATION	TAX DIST	DATE INST	DATE CHANGE
	05800	S	M	SOH	II	00000	088								REAR 136 LOCUST AVE.	12	050885	1/1/0001
	05800	S	M	SOH	II	00000	089								OPP. REAR SIDE 1212 NORTH COURT	12	080885	1/1/0001
	05800	S	M	SOH	II	00000	090								REAR 120 LOCUST AVE.	12	050885	1/1/0001
	05800	S	M	SOH	II	00000	091								REAR 1208 N. LIMESTONE	12	050885	1/1/0001
	05800	S	M	SOH	II	00000	092								SIDE 115 LOCUST AVE.	12	050885	1/1/0001
	05800	S	M	SOH	II	00000	093								SIDE 106 BLUEGRASS AVE.	12	050885	1/1/0001
	05800	S	M	SOH	II	00000	094								SIDE 103 BLUEGRASS AVE.	12	050885	1/1/0001
OFFICE: 311		ROUTE: 564		ST_REF_NO: 00000099750		JOSEPH BRYAN WAY		LUMENS	BULB TYPE	MULT SERIES	POLE TYPE	SHADE	ADDRESS NUMBER	REF	LOCATION	TAX DIST	DATE INST	DATE CHANGE
	05800	S	M	CNT	II	00000	003								SIDE OF 3813 LOCHDALE TERRACE ON JOSEPH BRYAN WAY	12	071407	1/1/0001
	05800	S	M	CNT	III	00408	001									12	071407	1/1/0001
	05800	S	M	CNT	II	00425	002									12	071407	1/1/0001

OFFICE: 311		ROUTE: 564		ST_REF_NO: 0000099750		JOSEPH BRYAN WAY		LUMENS	BULB TYPE	MULT SERIES	POLE TYPE	SHADE	ADDRESS NUMBER	REF	LOCATION	TAX DIST	DATE INST	DATE CHANGE
05800	S	M	CNT	II	00453	004										12	071407	1/1/0001
05800	S	M	CNT	II	00472	005										12	071407	1/1/0001
05800	S	M	CNT	II	00485	006										12	071407	1/1/0001
05800	S	M	CNT	II	00501	007										12	071407	1/1/0001
05800	S	M	CNT	III	00512	008										12	071407	1/1/0001

OFFICE: 311		ROUTE: 564		ST_REF_NO: 0000099800		JOSHUA CIRCLE		LUMENS	BULB TYPE	MULT SERIES	POLE TYPE	SHADE	ADDRESS NUMBER	REF	LOCATION	TAX DIST	DATE INST	DATE CHANGE
05800	S	M	OUG	II	03881	071	bad fixutre									12	061581	3/2/2009
05800	S	M	OUG	II	03817	066	upgraded-bad fixture									12	031581	1/1/0001
04000	S	M	OUG	II	03828	067										12	031581	1/1/0001
04000	S	M	OUG	II	03839	068										12	031581	1/1/0001
04000	S	M	OUG	II	03858	069										12	011583	1/1/0001
04000	S	M	OUG	II	03870	070										12	061581	1/1/0001
04000	S	M	OUG	II	03804	065										12	031581	1/1/0001

OFFICE: 311		ROUTE: 564		ST_REF_NO: 0000099850		JOSIAH WAY		LUMENS	BULB TYPE	MULT SERIES	POLE TYPE	SHADE	ADDRESS NUMBER	REF	LOCATION	TAX DIST	DATE INST	DATE CHANGE
05800	S	M	CNT	II	00000	001	OPP 4433									12	080897	1/1/0001
05800	S	M	CNT	II	00000	002	SIDE OF 753 PINNACLE COURT									12	080897	1/1/0001
05800	S	M	CNT	II	00000	004	SIDE OF 4193 CLEARWATER WAY									12	020899	1/1/0001
05800	S	M	CNT	II	04393	005										12	020899	1/1/0001
05800	S	M	CNT	II	04488	006										12	020899	1/1/0001

OFFICE: 311		ROUTE: 564		ST_REF_NO: 0000099875		JOUETT CREEK DRIVE		LUMENS	BULB TYPE	MULT SERIES	POLE TYPE	SHADE	ADDRESS NUMBER	REF	LOCATION	TAX DIST	DATE INST	DATE CHANGE
05800	S		CNT	II	00000	051	ACROSS FROM 1024 JOUETT CREEK DR									12	070910	1/1/0001
05800	S		CNT	II	00000	053	SIDE OF 4000 DOWNY PARK ON JOUETT CREEK DR									12	070910	1/1/0001
05800	S		CNT	II	00000	054	SIDE OF 4001 DOWNY PARK ON JOUETT CREEK DRIVE									12	070910	1/1/0001
05800	S		CNT	II	00000	060	SIDE OF 4401 NATAL PL, ON JOUETT CREEK DR									12	062810	1/1/0001

OFFICE: 311		ROUTE: 564		ST_REF_NO: 0000099875		JOUETT CREEK DRIVE		LUMENS	BULB TYPE	MULT SERIES	POLE TYPE	SHADE	ADDRESS NUMBER	REF	LOCATION	TAX DIST	DATE INST	DATE CHANGE
05800	S		CNT	II	00000	061	2ND LT N OF NATAL PL, E SIDE ON JOUETT CREEK DR	12	062810									1/1/0001
05800	S		CNT	II	00965	057		12	070910									1/1/0001
05800	S		CNT	II	00977	056		12	070910									1/1/0001
05800	S		CNT	II	01016	052		12	070910									1/1/0001
05800	S		CNT	II	00000	062	ACROSS FROM 1064 JOUETT CREEK DR	12	062810									6/28/2010
05800	S		CNT	II	00000	063	ACROSS FROM 1056 JOUETT CREEK DR	12	062810									6/28/2010
05800	S		CNT	II	00000	064	ACROSS FROM 1044 JOUETT CREEK DRIVE	12	062810									6/28/2010
05800	S	M	CNT	II	00901	003		12	020305									1/1/0001
05800	S	M	CNT	II	00909	001		12	102103									1/1/0001
05800	S	M	CNT	II	00921	002		12	102103									1/1/0001
OFFICE: 311		ROUTE: 564		ST_REF_NO: 0000099900		JOURNAL AVENUE		LUMENS	BULB TYPE	MULT SERIES	POLE TYPE	SHADE	ADDRESS NUMBER	REF	LOCATION	TAX DIST	DATE INST	DATE CHANGE
09500	S	M	SOH	I	00000	001	JOURNAL & TRANSCRIPT	12	010855									1/1/0001
09500	S	M	SOH	I	00919	000	upgraded both lights on Journal to 9500 7/07	12	011061									1/1/0001
OFFICE: 311		ROUTE: 564		ST_REF_NO: 00000100000		JUDY LANE		LUMENS	BULB TYPE	MULT SERIES	POLE TYPE	SHADE	ADDRESS NUMBER	REF	LOCATION	TAX DIST	DATE INST	DATE CHANGE
04000	S	M	SOH	II	00000	006	SIDE OF 2203 N. BROADWAY	12	050884									1/1/0001
04000	S	M	OUG	II	00000	007	OPP. CIRCLE DR.	12	050884									1/1/0001
04000	S	M	OUG	II	00000	008	SIDE OF 2203 CIRCLE DR.	12	050884									1/1/0001
04000	S	M	OUG	II	00000	009	OPP. 505	12	050884									1/1/0001
04000	S	M	OUG	II	00517	010		12	050884									1/1/0001
05800	S	M	OUG	II	00525	011	upgraded to 5800 due to car accident 7/31/07	12	050884									1/1/0001
04000	S	M	OUG	II	00537	012		12	050884									1/1/0001
04000	S	M	OUG	II	00550	013		12	050884									1/1/0001
04000	S	M	OUG	II	00553	014		12	050884									1/1/0001
04000	S	M	OUG	II	00562	015		12	050884									1/1/0001
04000	S	M	OUG	II	00565	016		12	050884									1/1/0001
04000	S	M	OUG	II	00576	017		12	050884									1/1/0001
04000	S	M	OUG	II	00577	018		12	050884									1/1/0001
04000	S	M	OUG	II	00581	019		12	050884									1/1/0001

OFFICE: 311		ROUTE: 564		ST_REF_NO: 00000100000		JUDY LANE		LUMENS	BULB TYPE	MULT SERIES	POLE TYPE	SHADE	ADDRESS NUMBER	REF	LOCATION	TAX DIST	DATE INST	DATE CHANGE
	04000	S	M	OUG	II	00605	020									12	050884	1/1/0001
	04000	S	M	OUG	II	00610	021									12	050884	1/1/0001
	04000	S	M	OUG	II	00618	022									12	050884	1/1/0001
	04000	S	M	OUG	V	00622	023									12	050884	1/1/0001

OFFICE: 311		ROUTE: 564		ST_REF_NO: 00000100090		JULIA WAY		LUMENS	BULB TYPE	MULT SERIES	POLE TYPE	SHADE	ADDRESS NUMBER	REF	LOCATION	TAX DIST	DATE INST	DATE CHANGE
	05800	S		CNT	II	00000	005								SIDE OF 548 E FIFTH ST, ON JULIA WAY	12	080610	1/1/0001
	05800	S		CNT	II	00441	003									12	080610	1/1/0001
	05800	S		CNT	II	00464	004									12	080610	1/1/0001
	05800	S	M	OUG	II	00000	133								SIDE OF 1325 WARD DR.	12	100774	1/1/0001
	05800	S	M	OUG	V	01309	000									12	100774	1/1/0001

OFFICE: 311		ROUTE: 564		ST_REF_NO: 00000100100		JULIANN CIRCLE		LUMENS	BULB TYPE	MULT SERIES	POLE TYPE	SHADE	ADDRESS NUMBER	REF	LOCATION	TAX DIST	DATE INST	DATE CHANGE
	04000	S	M	OUG	II	00000	001								SIDE OF 687 LONGWOOD RD.	12	020891	1/1/0001
	04000	S	M	OUG	II	03551	003									12	020891	1/1/0001
	04000	S	M	OUG	II	03558	002									12	020891	1/1/0001

OFFICE: 311		ROUTE: 564		ST_REF_NO: 00000100200		JUNIPER DRIVE		LUMENS	BULB TYPE	MULT SERIES	POLE TYPE	SHADE	ADDRESS NUMBER	REF	LOCATION	TAX DIST	DATE INST	DATE CHANGE
	05800	S	M	OUG	II	00000	162								OPP. 1041	12	111565	1/1/0001
	05800	S	M	OUG	II	01000	000									12	110162	1/1/0001
	05800	S	M	OUG	II	01009	000									12	110162	1/1/0001
	05800	S	M	OUG	II	01020	000									12	102263	1/1/0001
	05800	S	M	OUG	II	01029	000									12	110162	1/1/0001
	05800	S	M	OOH	II	01053	000									12	111565	1/1/0001

OFFICE: 311		ROUTE: 564		ST_REF_NO: 00000100250		JUSTIN PLACE		LUMENS	BULB TYPE	MULT SERIES	POLE TYPE	SHADE	ADDRESS NUMBER	REF	LOCATION	TAX DIST	DATE INST	DATE CHANGE
	05800	S	M	OUG	III	02400	002									12	101201	1/1/0001

OFFICE: 311		ROUTE: 564		ST_REF_NO: 00000100250		JUSTIN PLACE		LUMENS	BULB TYPE	MULT SERIES	POLE TYPE	SHADE	ADDRESS NUMBER	REF	LOCATION	TAX DIST	DATE INST	DATE CHANGE
	05800	S	M	OUG	II	02424	001									12	101201	1/1/0001
OFFICE: 311		ROUTE: 564		ST_REF_NO: 00000100300		KAKAGI COURT		LUMENS	BULB TYPE	MULT SERIES	POLE TYPE	SHADE	ADDRESS NUMBER	REF	LOCATION	TAX DIST	DATE INST	DATE CHANGE
	04000	S	M	OUG	V	01000	084									12	061580	1/1/0001
	04000	S	M	OUG	II	01009	085									12	090884	1/1/0001
OFFICE: 311		ROUTE: 564		ST_REF_NO: 00000100400		KALMIA AVENUE		LUMENS	BULB TYPE	MULT SERIES	POLE TYPE	SHADE	ADDRESS NUMBER	REF	LOCATION	TAX DIST	DATE INST	DATE CHANGE
	04000	S	M	SOH	I	00258	000									12	010163	1/1/0001
	04000	S	M	SOH	I	00271	000									12	010163	1/1/0001
OFFICE: 311		ROUTE: 564		ST_REF_NO: 00000100500		KALONE WAY		LUMENS	BULB TYPE	MULT SERIES	POLE TYPE	SHADE	ADDRESS NUMBER	REF	LOCATION	TAX DIST	DATE INST	DATE CHANGE
	04000	S	M	OUG	II	01109	034									12	061580	1/1/0001
	04000	S	M	OUG	II	01124	035									12	011581	1/1/0001
	04000	S	M	OUG	II	01133	062									12	011581	1/1/0001
	04000	S	M	OUG	II	01144	063									12	061580	1/1/0001
	04000	S	M	OUG	II	01165	064									12	061580	1/1/0001
	04000	S	M	OUG	II	01172	065									12	061580	1/1/0001
	04000	S	M	OUG	II	01189	066									12	061580	1/1/0001
	04000	S	M	OUG	II	01200	067									12	061580	1/1/0001
	04000	S	M	OUG	II	01217	068									12	061580	1/1/0001
	04000	S	M	OUG	II	01228	069									12	061580	1/1/0001
OFFICE: 311		ROUTE: 564		ST_REF_NO: 00000100550		KANNAPOLIS PLACE		LUMENS	BULB TYPE	MULT SERIES	POLE TYPE	SHADE	ADDRESS NUMBER	REF	LOCATION	TAX DIST	DATE INST	DATE CHANGE
	05800	S	M	CNT	III	01200	005									12	072203	1/1/0001
	05800	S	M	CNT	II	01220	003									12	072203	1/1/0001
	05800	S	M	CNT	II	01236	002									12	072203	1/1/0001
	05800	S	M	CNT	III	01248	001									12	072203	1/1/0001

OFFICE: 311

ROUTE: 564

ST_REF_NO: 00000100590 KASEY COURT

LUMENS	BULB TYPE	MULT SERIES	POLE TYPE	SHADE	ADDRESS NUMBER	REF	LOCATION	TAX DIST	DATE INST	DATE CHANGE
09500	S	M	OUG	II	02805	001	lfucg upgrade	12	020888	11/23/2010

OFFICE: 311

ROUTE: 564

ST_REF_NO: 00000100600 KASTLE ROAD

LUMENS	BULB TYPE	MULT SERIES	POLE TYPE	SHADE	ADDRESS NUMBER	REF	LOCATION	TAX DIST	DATE INST	DATE CHANGE
05800	S	M	OUG	III	00000	001	BETWEEN COOPER & PROVIDENCE	12	082756	1/1/0001
05800	S	M	OUG	III	00000	002	BETWEEN BERRY LANE & PROVIDENCE	12	100155	1/1/0001
05800	S	M	OUG	III	00000	003	BETWEEN BERRY LANE & MT. VERNON	12	082756	1/1/0001
05800	S	M	OUG	II	00000	025	SIDE OF 702 COOPER DR.	12	120864	1/1/0001
05800	S	M	SOH	I	00000	031	SIDE OF 701 MT. VERNON DR.	12	070767	1/1/0001
05800	S	M	OUG	II	01215	026		12	120864	1/1/0001
05800	S	M	OUG	II	01240	027		12	120864	1/1/0001
05800	S	M	OUG	II	01253	028		12	020165	1/1/0001
05800	S	M	OUG	II	01265	029		12	020165	1/1/0001
05800	S	M	SOH	V	00000	042	KASTLE RD., AT END	12	071367	1/1/0001
05800	S	M	OUG	II	01280	030		12	120864	1/1/0001

OFFICE: 311

ROUTE: 564

ST_REF_NO: 00000100610 KATIE COURT

LUMENS	BULB TYPE	MULT SERIES	POLE TYPE	SHADE	ADDRESS NUMBER	REF	LOCATION	TAX DIST	DATE INST	DATE CHANGE
04000	S	M	OUG	II	03705	083		12	110885	1/1/0001

OFFICE: 311

ROUTE: 564

ST_REF_NO: 00000100650 KAVENAUGH LANE

LUMENS	BULB TYPE	MULT SERIES	POLE TYPE	SHADE	ADDRESS NUMBER	REF	LOCATION	TAX DIST	DATE INST	DATE CHANGE
05800	S		CNT	II	00000	009	SIDE OF 3401 SANIBEL LN, ON KAVENBAUGH LANE	12	062909	1/1/0001
05800	S		CNT	II	01044	010		12	062909	1/1/0001
05800	S		CNT	II	01056	011		12	062909	1/1/0001
05800	S		CNT	II	01064	012		12	062909	1/1/0001
05800	S	M	CNT	II	00000	002	SIDE REAR OF 3412 DESTIN CT.	12	070896	1/1/0001
05800	S	M	CNT	II	00000	004	SIDE OF 3409 DESTIN CT.	12	070896	1/1/0001
05800	S	M	CNT	II	00000	008	SIDE REAR OF 3400 SANIBEL DR.	12	070896	1/1/0001
05800	S	M	CNT	II	01000	001		12	070896	1/1/0001
05800	S	M	CNT	II	01004	003		12	070896	1/1/0001

OFFICE: 311

ROUTE: 564

ST_REF_NO: 00000100650

KAVERNAUGH LANE

LUMENS	BULB TYPE	MULT SERIES	POLE TYPE	SHADE	ADDRESS NUMBER	REF	LOCATION	TAX DIST	DATE INST	DATE CHANGE
05800	S	M	CNT	II	01012	005		12	070896	1/1/0001
05800	S	M	CNT	II	01013	006		12	070896	1/1/0001
05800	S	M	CNT	II	01021	007		12	070896	1/1/0001

OFFICE: 311

ROUTE: 564

ST_REF_NO: 00000100700

KEARNEY ROAD

LUMENS	BULB TYPE	MULT SERIES	POLE TYPE	SHADE	ADDRESS NUMBER	REF	LOCATION	TAX DIST	DATE INST	DATE CHANGE
09500	S	M	SOH	III	00000	001	392' NW OF SOUTHERN R.R. ACROSS FROM KEARNEY HILLS	12	120894	1/1/0001
09500	S	M	SOH	III	00000	002		12	120894	1/1/0001
09500	S	M	SOH	III	00000	003	811' NW OF SOUTHERN R.R. ACROSS FROM KEARNEY HILLS	12	120894	1/1/0001
09500	S	M	SOH	III	00000	004	1004' NW OF SOUTHERN RR ACROSS FROM KEARNEY HILLS	12	120894	1/1/0001
09500	S	M	SOH	III	00000	005	1239' NW OF SOUTHERN RR ACROSS FROM KEARNEY HILLS	12	120894	1/1/0001
09500	S	M	SOH	III	00000	006	1480' NW OF SOUTHERN RR ACROSS FROM KEARNEY HILLS	12	120894	1/1/0001
09500	S	M	SOH	III	00000	007	1723' NW OF SOUTHERN RR ACROSS FROM KEARNEY HILLS	12	120894	1/1/0001
09500	S	M	SOH	III	00000	008	1960' NW OF SOUTHERN RR ACROSS FROM KEARNEY HILLS	12	120894	1/1/0001
09500	S	M	SOH	III	00000	009	2207' NW OF SOUTHERN RR ACROSS FROM KEARNEY HILLS	12	120894	1/1/0001
09500	S	M	SOH	III	00000	010	2445' NW OF SOUTHERN RR ACROSS FROM KEARNEY HILLS	12	120894	1/1/0001
09500	S	M	SOH	III	00000	011	2687' NW OF SOUTHERN RR ACROSS FROM KEARNEY HILLS	12	120894	1/1/0001
09500	S	M	SOH	III	00000	012	2889' NW OF SOUTHERN RR ACROSS FROM KEARNEY HILLS	12	120894	1/1/0001

OFFICE: 311

ROUTE: 564

ST_REF_NO: 00000100702

KEARNEY CREEK LANE

LUMENS	BULB TYPE	MULT SERIES	POLE TYPE	SHADE	ADDRESS NUMBER	REF	LOCATION	TAX DIST	DATE INST	DATE CHANGE
05800	S		CNT	II	00000	001	SIDE OF 2765 SULLIVANS TR, ON KEARNEY CREEK LN	12	080513	1/1/0001
05800	S		CNT	II	00000	015	SIDE OF 2748 SULLIVANS TR, ON KEARNEY CR LANE	12	080513	1/1/0001

OFFICE: 311

ROUTE: 564

ST_REF_NO: 00000100702

KEARNEY CREEK LANE

LUMENS	BULB TYPE	MULT SERIES	POLE TYPE	SHADE	ADDRESS NUMBER	REF	LOCATION	TAX DIST	DATE INST	DATE CHANGE
05800	S		CNT	II	00000	016	SIDE OF 2873 KEARNEY CREEK LANE	12	080513	1/1/0001
05800	S		CNT	II	00000	021	REAR OF 2788 KEARNEY CREEK LANE	12	080513	1/1/0001
05800	S		CNT	II	02613	002		12	041109	1/1/0001
05800	S		CNT	II	02661	006		12	041109	1/1/0001
05800	S		CNT	II	02689	009		12	080513	1/1/0001
05800	S		CNT	II	02700	011		12	080513	1/1/0001
05800	S		CNT	II	02709	012		12	080513	1/1/0001
05800	S		CNT	II	02760	017		12	080513	1/1/0001
05800	S		CNT	II	02789	020		12	080513	1/1/0001
05800	S		CNT	II	02813	022		12	080513	1/1/0001
05800	S		CNT	II	02861	026		12	080513	1/1/0001
05800	S		CNT	II	02873	027		12	080513	1/1/0001

OFFICE: 311

ROUTE: 564

ST_REF_NO: 00000100705

KEARNEY RIDGE BLVD

LUMENS	BULB TYPE	MULT SERIES	POLE TYPE	SHADE	ADDRESS NUMBER	REF	LOCATION	TAX DIST	DATE INST	DATE CHANGE
09500	S		CNT	II	00000	018	SIDE OF 2797 SULLIVANS TR, ON KEARNEY RIDGE BLVD	12	041109	4/11/2009
05800	S		CNT	II	00000	023	SIDE OF 2932 SULLIVANS TR, ON KEARNEY RIDGE BLVD	12	041109	4/11/2009
09500	S		CNT	II	02601	017		12	041109	4/11/2009
09500	S		CNT	II	02613	019		12	041109	4/11/2009
05800	S		CNT	II	02624	020		12	041109	4/11/2009

OFFICE: 311

ROUTE: 564

ST_REF_NO: 00000101100

KEENELAND COURT

LUMENS	BULB TYPE	MULT SERIES	POLE TYPE	SHADE	ADDRESS NUMBER	REF	LOCATION	TAX DIST	DATE INST	DATE CHANGE
05800	S	M	OUG	II	00000	086	SIDE OF 3560 CAULDER DR.	12	032274	1/1/0001
05800	S	M	OUG	II	01236	087		12	032274	1/1/0001
05800	S	M	OUG	II	01249	000		12	120172	1/1/0001
05800	S	M	OUG	II	01264	089		12	040974	1/1/0001
05800	S	M	OUG	V	01268	090		12	040974	1/1/0001

OFFICE: 311

ROUTE: 564

ST_REF_NO: 00000101170

KEENE WOOD DRIVE

LUMENS	BULB TYPE	MULT SERIES	POLE TYPE	SHADE	ADDRESS NUMBER	REF	LOCATION	TAX DIST	DATE INST	DATE CHANGE
05800	S	M	CNT	II	00805	001		12	110897	1/1/0001
05800	S	M	CNT	II	00812	002		12	110897	1/1/0001

OFFICE: 311

ROUTE: 564

ST_REF_NO: 00000101200

KEES ROAD

LUMENS	BULB TYPE	MULT SERIES	POLE TYPE	SHADE	ADDRESS NUMBER	REF	LOCATION	TAX DIST	DATE INST	DATE CHANGE
05800	S	M	OUG	III	00000	002	OPP. 1006	12	042356	1/1/0001
05800	S	M	OUG	II	00000	006	OPP. 1113	12	090761	1/1/0001
05800	S	M	OUG	II	01026	001		12	090761	1/1/0001
05800	S	M	OUG	III	01041	000		12	040556	1/1/0001
05800	S	M	OUG	II	01124	000		12	100170	1/1/0001
05800	S	M	OUG	II	01125	000		12	061264	1/1/0001
05800	S	M	OUG	II	01145	000		12	061264	1/1/0001

OFFICE: 311

ROUTE: 564

ST_REF_NO: 00000101250

KEIRFIELD COURT

LUMENS	BULB TYPE	MULT SERIES	POLE TYPE	SHADE	ADDRESS NUMBER	REF	LOCATION	TAX DIST	DATE INST	DATE CHANGE
05800	S	M	OUG	III	00905	001		12	042508	1/1/0001

OFFICE: 311

ROUTE: 564

ST_REF_NO: 00000101300

KEITHSHIRE WAY

LUMENS	BULB TYPE	MULT SERIES	POLE TYPE	SHADE	ADDRESS NUMBER	REF	LOCATION	TAX DIST	DATE INST	DATE CHANGE
22000	S	M	CNT	II	00000	001	1ST LT S OF ROUND-ABOUT, W SIDE ON KEITHSHIRE WAY	12	021202	1/1/0001
22000	S	M	CNT	II	00000	002	2ND LT S OF ROUND-ABOUT, E SIDE ON KEITHSHIRE WAY	12	021202	1/1/0001
22000	S	M	CNT	II	00000	003	3RD LT S OF ROUND-ABOUT, W SIDE ON KEITHSHIRE WAY	12	021202	1/1/0001
22000	S	M	CNT	II	00000	004	4TH LT S OF ROUND-ABOUT, E SIDE ON KEITHSHIRE WAY	12	021202	1/1/0001
22000	S	M	CNT	II	00000	005	5TH LT S OF ROUND-ABOUT, W SIDE ON KEITHSHIRE WAY	12	021202	1/1/0001
22000	S	M	CNT	II	00000	006	6TH LT S OF ROUND-ABOUT, E SIDE ON KEITHSHIRE WAY	12	021202	1/1/0001
22000	S	M	CNT	II	00000	007	7TH LT S OF ROUND-ABOUT, W SIDE ON KEITHSHIRE WAY	12	021202	1/1/0001

OFFICE: 311

ROUTE: 564

ST_REF_NO: 00000101300

KEITHSHIRE WAY

LUMENS	BULB TYPE	MULT SERIES	POLE TYPE	SHADE	ADDRESS NUMBER	REF	LOCATION	TAX DIST	DATE INST	DATE CHANGE
22000	S	M	CNT	II	00000	008	8TH LT S OF ROUND-ABOUT, E SIDE ON KEITHSHIRE WAY	12	021202	1/1/0001
22000	S	M	CNT	II	00000	009	9TH LT S OF ROUND-ABOUT, W SIDE ON KEITHSHIRE WAY	12	021202	1/1/0001
22000	S	M	CNT	II	00000	010	10TH LT S OF ROUND-ABOUT, E SIDE ON KEITHSHIRE WAY	12	021202	1/1/0001
22000	S	M	CNT	II	00000	011	11TH LT S OF ROUND-ABOUT, W SIDE ON KEITHSHIRE WAY	12	021202	1/1/0001
22000	S	M	CNT	II	00000	012	12TH LT S OF ROUND-ABOUT, E SIDE ON KEITHSHIRE WAY	12	021202	1/1/0001
22000	S	M	CNT	II	00000	013	13TH LT S OF ROUND-ABOUT, W SIDE ON KEITHSHIRE WAY	12	021202	1/1/0001
22000	S	M	CNT	II	00000	014	14TH LT S OF ROUND-ABOUT, E SIDE ON KEITHSHIRE WAY	12	021202	1/1/0001
22000	S	M	CNT	II	00000	015	15TH LT S OF ROUND-ABOUT, W SIDE ON KEITHSHIRE WAY	12	021202	1/1/0001
22000	S	M	CNT	II	00000	016	16TH LT S OF ROUND-ABOUT, E SIDE ON KEITHSHIRE WAY	12	021202	1/1/0001
22000	S	M	CNT	II	00000	017	17TH LT S OF ROUND-ABOUT, W SIDE ON KEITHSHIRE WAY	12	021202	1/1/0001
22000	S	M	CNT	II	00000	018	18TH LT S OF ROUND-ABOUT, E SIDE ON KEITHSHIRE WAY	12	021202	1/1/0001
22000	S	M	CNT	II	00000	019	19TH LT S OF ROUND-ABOUT, W SIDE ON KEITHSHIRE WAY	12	021202	1/1/0001
22000	S	M	CNT	II	00000	020	20TH LT S OF ROUND-ABOUT, E SIDE ON KEITHSHIRE WAY	12	021202	1/1/0001
04000	S	M	OUG	II	03429	012		12	050891	1/1/0001
04000	S	M	OUG	II	03432	013		12	050891	1/1/0001
04000	S	M	OUG	II	03441	014		12	050891	1/1/0001
04000	S	M	OUG	II	03448	015		12	050891	1/1/0001
04000	S	M	OUG	II	03457	016		12	050891	1/1/0001
04000	S	M	OUG	II	03468	017		12	050891	1/1/0001
04000	S	M	OUG	II	03473	018		12	050891	1/1/0001
04000	S	M	OUG	II	03476	019		12	050891	1/1/0001
04000	S	M	OUG	II	00000	009	SIDE OF 652 CINDY BLAIR WAY ON KEITHSHIRE WAY	12	120890	1/1/0001
04000	S	M	OUG	II	03343	001		12	120890	1/1/0001
04000	S	M	OUG	II	03351	002		12	120890	1/1/0001

OFFICE: 311		ROUTE: 564		ST_REF_NO: 00000101300		KEITHSHIRE WAY		LUMENS	BULB TYPE	MULT SERIES	POLE TYPE	SHADE	ADDRESS NUMBER	REF	LOCATION	TAX DIST	DATE INST	DATE CHANGE
	04000	S	M	OUG	II	03359	003									12	120890	1/1/0001
	04000	S	M	OUG	II	03364	004									12	120890	1/1/0001
	04000	S	M	OUG	II	03372	005									12	120890	1/1/0001
	04000	S	M	OUG	II	03383	006									12	120890	1/1/0001
	04000	S	M	OUG	II	03388	007									12	120890	1/1/0001
	04000	S	M	OUG	II	03392	008									12	120890	1/1/0001
	04000	S	M	OUG	II	03409	010									12	050891	1/1/0001
	04000	S	M	OUG	II	03416	011									12	050891	1/1/0001

OFFICE: 311		ROUTE: 564		ST_REF_NO: 00000101400		KELLER ALLEY		LUMENS	BULB TYPE	MULT SERIES	POLE TYPE	SHADE	ADDRESS NUMBER	REF	LOCATION	TAX DIST	DATE INST	DATE CHANGE
	09500	S		SOH	II	00000	010								REAR OF 664 N LIMESTONE ST, ON KELLER ALLEY	12	090110	1/1/0001
	04000	S	M	SOH	I	00000	001								1ST LT. N. OF 6TH ST.	12	020865	1/1/0001
	04000	S	M	SOH	I	00000	002								2ND LT. N. OF 6TH ST.	12	020865	1/1/0001

OFFICE: 311		ROUTE: 564		ST_REF_NO: 00000101600		KELSEY COURT		LUMENS	BULB TYPE	MULT SERIES	POLE TYPE	SHADE	ADDRESS NUMBER	REF	LOCATION	TAX DIST	DATE INST	DATE CHANGE
	05800	S	M	OUG	V	01183	000									12	062167	1/1/0001

OFFICE: 311		ROUTE: 564		ST_REF_NO: 00000101700		KELSEY DRIVE		LUMENS	BULB TYPE	MULT SERIES	POLE TYPE	SHADE	ADDRESS NUMBER	REF	LOCATION	TAX DIST	DATE INST	DATE CHANGE
	05800	S	M	OUG	II	00000	016								SIDE OF 1154 ALEXANDRIA DR.	12	062167	1/1/0001
	05800	S	M	OUG	II	00000	062								SIDE OF 1141 CAYWOOD DR.	12	120171	1/1/0001
	05800	S	M	OUG	II	00000	064								OPP. 1103	12	030774	1/1/0001
	05800	S	M	OUG	II	01067	000									12	100172	1/1/0001
	05800	S	M	OUG	II	01080	000									12	100172	1/1/0001
	05800	S	M	OUG	II	01091	000									12	100172	1/1/0001
	05800	S	M	OUG	II	01119	063									12	120171	1/1/0001
	05800	S	M	OUG	II	01143	061									12	120171	1/1/0001
	05800	S	M	OUG	V	01146	060									12	120171	1/1/0001
	05800	S	M	OUG	II	01158	059									12	120171	1/1/0001

OFFICE: 311		ROUTE: 564		ST_REF_NO: 00000101700		KELSEY DRIVE		LUMENS	BULB TYPE	MULT SERIES	POLE TYPE	SHADE	ADDRESS NUMBER	REF	LOCATION	TAX DIST	DATE INST	DATE CHANGE
05800	S	M	OUG	II	01167	000										12	030868	1/1/0001
05800	S	M	OUG	II	01186	000										12	062167	1/1/0001

OFFICE: 311		ROUTE: 564		ST_REF_NO: 00000101800		KEMPER COURT		LUMENS	BULB TYPE	MULT SERIES	POLE TYPE	SHADE	ADDRESS NUMBER	REF	LOCATION	TAX DIST	DATE INST	DATE CHANGE
05800	S	M	SOH	I	00301	000										12	110369	1/1/0001

OFFICE: 311		ROUTE: 564		ST_REF_NO: 00000101810		KENESAW DRIVE		LUMENS	BULB TYPE	MULT SERIES	POLE TYPE	SHADE	ADDRESS NUMBER	REF	LOCATION	TAX DIST	DATE INST	DATE CHANGE
09500	S		OUG	II	00000	250	SIDE OF 4794 HARTLAND PKWY ON KENESAW DRIVE									12	032509	1/1/0001
05800	S	M	OUG	II	00000	012	SIDE OF 4817 WESLEY CT ON KENESAW DR									12	061201	1/1/0001
05800	S	M	OUG	II	00000	014	SIDE OF 4852 CLIFFORD CT ON KENESAW DR									12	061201	1/1/0001
05800	S	M	OUG	II	03960	013										12	061201	1/1/0001
05800	S	M	OUG	II	03984	011										12	061201	1/1/0001
05800	S	M	OUG	II	04012	009										12	061201	1/1/0001
05800	S	M	OUG	II	04017	010										12	061201	1/1/0001
05800	S	M	OUG	II	04033	008										12	061201	1/1/0001
05800	S	M	OUG	II	00000	044	SIDE OF 4799 MOSS CREEK DR.									12	030895	1/1/0001
05800	S	M	OUG	II	00000	047	OPP. 3844									12	030895	1/1/0001
05800	S	M	OUG	II	00000	048	SIDE OF 3824-A									12	030895	1/1/0001
05800	S	M	OUG	II	00000	049	SIDE REAR OF 3832-C									12	030895	1/1/0001
05800	S	M	OUG	II	00000	050	OPP. 3844									12	030895	1/1/0001
05800	S	M	OUG	II	00000	051	SIDE 4781 HARTLAND PARWAY									12	080893	1/1/0001
05800	S	M	OUG	II	00000	107	SIDE OF 4809 BENTLEY WAY									12	110899	1/1/0001
05800	S	M	OUG	II	03915	052										12	080893	1/1/0001
05800	S	M	OUG	II	03924	053										12	080893	1/1/0001
05800	S	M	OUG	II	03931	054										12	080893	1/1/0001
05800	S	M	OUG	II	03940	055										12	080893	1/1/0001
05800	S	M	OUG	II	04057	106										12	110899	1/1/0001
05800	S	M	OUG	II	04068	105										12	110899	1/1/0001
05800	S	M	OUG	II	04081	104										12	110899	1/1/0001
05800	S	M	OUG	II	04092	103										12	110899	1/1/0001

OFFICE: 311		ROUTE: 564		ST_REF_NO: 00000101810		KENESAW DRIVE		LUMENS	BULB TYPE	MULT SERIES	POLE TYPE	SHADE	ADDRESS NUMBER	REF	LOCATION	TAX DIST	DATE INST	DATE CHANGE
	05800	S	M	OUG	II	04096	101									12	110899	1/1/0001
	05800	S	M	OUG	II	04097	102									12	110899	1/1/0001

OFFICE: 311		ROUTE: 564		ST_REF_NO: 00000101820		KENESAW VILLAGE DRIVE		LUMENS	BULB TYPE	MULT SERIES	POLE TYPE	SHADE	ADDRESS NUMBER	REF	LOCATION	TAX DIST	DATE INST	DATE CHANGE
	05800	S	M	OUG	II	01201	001									12	080893	1/1/0001
	05800	S	M	OUG	II	01204	002									12	080893	1/1/0001
	05800	S	M	OUG	II	01213	003									12	08093	1/1/0001
	05800	S	M	OUG	II	01229	004									12	080893	1/1/0001
	05800	S	M	OUG	II	01237	005									12	080893	1/1/0001
	05800	S	M	OUG	IV	01248	006									12	080893	1/1/0001

OFFICE: 311		ROUTE: 564		ST_REF_NO: 00000101900		KENAWOOD DRIVE		LUMENS	BULB TYPE	MULT SERIES	POLE TYPE	SHADE	ADDRESS NUMBER	REF	LOCATION	TAX DIST	DATE INST	DATE CHANGE
	05800	S	M	OUG	II	00000	004								SIDE OF 401 MCKENNA CT.	12	050164	1/1/0001
	05800	S	M	OUG	II	00000	017								SIDE OF 404 BRYANWOOD PKWY	12	050466	1/1/0001
	05800	S	M	OUG	II	00400	003									12	050164	1/1/0001

OFFICE: 311		ROUTE: 564		ST_REF_NO: 00000101990		KENIL COURT		LUMENS	BULB TYPE	MULT SERIES	POLE TYPE	SHADE	ADDRESS NUMBER	REF	LOCATION	TAX DIST	DATE INST	DATE CHANGE
	04000	S	M	OUG	II	04500	123									12	090886	1/1/0001
	04000	S	M	OUG	II	04512	122									12	090886	1/1/0001

OFFICE: 311		ROUTE: 564		ST_REF_NO: 00000102000		KENILWORTH COURT		LUMENS	BULB TYPE	MULT SERIES	POLE TYPE	SHADE	ADDRESS NUMBER	REF	LOCATION	TAX DIST	DATE INST	DATE CHANGE
	05800	S	M	SOH	II	00000	260								1ST LT. W. OF N. BROADWAY	12	092366	1/1/0001
	05800	S	M	SOH	II	00401	000									12	090963	1/1/0001
	05800	S	M	SOH	II	00409	000									12	032520	1/1/0001

OFFICE: 311

ROUTE: 564

ST_REF_NO: 00000102100

KENLOCK DRIVE

LUMENS	BULB TYPE	MULT SERIES	POLE TYPE	SHADE	ADDRESS NUMBER	REF	LOCATION	TAX DIST	DATE INST	DATE CHANGE
04000	S	M	OUG	II	00200	041		12	020887	1/1/0001
04000	S	M	OUG	II	00209	042		12	020887	1/1/0001
04000	S	M	OUG	II	00220	043		12	020887	1/1/0001
04000	S	M	OUG	II	00237	044		12	020887	1/1/0001
04000	S	M	OUG	II	00248	045		12	020887	1/1/0001
04000	S	M	OUG	II	00261	046		12	020887	1/1/0001
04000	S	M	OUG	II	00277	047		12	020887	1/1/0001
04000	S	M	OUG	II	00288	048		12	020887	1/1/0001
04000	S	M	OUG	II	00301	049		12	020887	1/1/0001

OFFICE: 311

ROUTE: 564

ST_REF_NO: 00000102150

KENNECOTT WAY

LUMENS	BULB TYPE	MULT SERIES	POLE TYPE	SHADE	ADDRESS NUMBER	REF	LOCATION	TAX DIST	DATE INST	DATE CHANGE
05800	S	M	OUG	II	00000	006	SIDE OF 1281	12	040897	1/1/0001
05800	S	M	OUG	II	01205	001		12	040897	1/1/0001
05800	S	M	OUG	II	01220	002		12	040897	1/1/0001
05800	S	M	OUG	III	01232	003		12	040897	1/1/0001
05800	S	M	OUG	II	01241	004		12	040897	1/1/0001
05800	S	M	OUG	II	01260	005		12	040897	1/1/0001
05800	S	M	OUG	II	01288	007		12	040897	1/1/0001

OFFICE: 311

ROUTE: 564

ST_REF_NO: 00000102200

KENNEDY ROAD

LUMENS	BULB TYPE	MULT SERIES	POLE TYPE	SHADE	ADDRESS NUMBER	REF	LOCATION	TAX DIST	DATE INST	DATE CHANGE
04000	S	M	OUG	II	00000	001	1ST LT. W. OF NEWTOWN PIKE, N. SIDE	12	012974	1/1/0001
04000	S	M	OUG	II	00000	002	2ND LT. W. OF NEWTOWN ON NORTHSIDE	12	080885	1/1/0001
04000	S	M	OUG	II	00000	003	3RD LT. W. OF NEWTOWN ON N. SIDE	12	080885	1/1/0001
04000	S	M	OUG	II	00000	005	BESIDE 655	12	050169	1/1/0001
04000	S	M	OUG	II	00650	004		12	040467	1/1/0001
04000	S	M	OUG	II	00674	006		12	100170	1/1/0001
04000	S	M	OUG	II	00691	007		12	040467	1/1/0001
04000	S	M	OUG	V	00698	008		12	040467	1/1/0001

OFFICE: 311		ROUTE: 564		ST_REF_NO: 00000102310		KENNING PLACE		LUMENS	BULB TYPE	MULT SERIES	POLE TYPE	SHADE	ADDRESS NUMBER	REF	LOCATION	TAX DIST	DATE INST	DATE CHANGE
05800	S	M	OUG	II	00000	001		05800	S	M	OUG	II	00000	001	SIDE OF 4300 BUCKLAND PLACE	12	040894	1/1/0001
05800	S	M	OUG	V	01700	002		05800	S	M	OUG	V	01700	002		12	040894	1/1/0001
OFFICE: 311		ROUTE: 564		ST_REF_NO: 00000102350		KENOVA TRACE		LUMENS	BULB TYPE	MULT SERIES	POLE TYPE	SHADE	ADDRESS NUMBER	REF	LOCATION	TAX DIST	DATE INST	DATE CHANGE
05800	S	M	CNT	II	00605	008		05800	S	M	CNT	II	00605	008		12	120203	1/1/0001
05800	S	M	CNT	II	00616	007		05800	S	M	CNT	II	00616	007		12	120203	1/1/0001
05800	S	M	CNT	II	00632	005		05800	S	M	CNT	II	00632	005		12	120203	1/1/0001
05800	S	M	CNT	II	00633	006		05800	S	M	CNT	II	00633	006		12	120203	1/1/0001
05800	S	M	CNT	II	00669	004		05800	S	M	CNT	II	00669	004		12	120203	1/1/0001
05800	S	M	CNT	II	00697	003		05800	S	M	CNT	II	00697	003		12	120203	1/1/0001
05800	S	M	CNT	II	00709	002		05800	S	M	CNT	II	00709	002		12	120203	1/1/0001
05800	S	M	CNT	II	00724	001		05800	S	M	CNT	II	00724	001		12	120203	1/1/0001
OFFICE: 311		ROUTE: 564		ST_REF_NO: 00000102440		KENSINGTON GARDEN COURT		LUMENS	BULB TYPE	MULT SERIES	POLE TYPE	SHADE	ADDRESS NUMBER	REF	LOCATION	TAX DIST	DATE INST	DATE CHANGE
05800	S	M	OUG	III	04200	004		05800	S	M	OUG	III	04200	004		12	110896	1/1/0001
05800	S	M	OUG	II	04217	003		05800	S	M	OUG	II	04217	003		12	110896	1/1/0001
05800	S	M	OUG	II	04224	002		05800	S	M	OUG	II	04224	002		12	110896	1/1/0001
05800	S	M	OUG	II	04245	001		05800	S	M	OUG	II	04245	001		12	110896	1/1/0001
OFFICE: 311		ROUTE: 564		ST_REF_NO: 00000102500		KENT DRIVE		LUMENS	BULB TYPE	MULT SERIES	POLE TYPE	SHADE	ADDRESS NUMBER	REF	LOCATION	TAX DIST	DATE INST	DATE CHANGE
05800	S	M	OUG	II	00604	074		05800	S	M	OUG	II	00604	074	upgrade due to bad fixture	12	050884	10/1/2008
04000	S	M	OUG	II	00000	071		04000	S	M	OUG	II	00000	071	OPP. 623	12	050884	1/1/0001
05800	S	M	OUG	II	00629	000		05800	S	M	OUG	II	00629	000		12	091967	1/1/0001
04000	S	M	OUG	II	00609	073		04000	S	M	OUG	II	00609	073		12	050884	1/1/0001
04000	S	M	OUG	II	00615	072		04000	S	M	OUG	II	00615	072		12	050884	1/1/0001

OFFICE: 311		ROUTE: 564		ST_REF_NO: 00000102600		KENTON STREET		LUMENS	BULB TYPE	MULT SERIES	POLE TYPE	SHADE	ADDRESS NUMBER	REF	LOCATION	TAX DIST	DATE INST	DATE CHANGE
05800	S	M	SOH	II	00000	007	SIDE OF 329 W. 5TH ST.	12	040165	1/1/0001								
05800	S	M	SOH	I	00000	008	OPP. 534	12	020166	1/1/0001								
05800	S	M	SOH	I	00000	009	3RD LT. N. OF W. 5TH ST., W. SIDE	12	040165	1/1/0001								
05800	S	M	SOH	II	00453	000		12	021563	1/1/0001								
05800	S	M	SOH	II	00463	000		12	021563	1/1/0001								
05800	S	M	SOH	II	00000	001	1ST LT. N. OF W. 4TH ST., W. SIDE	12	021563	1/1/0001								
05800	S	M	SOH	II	00419	000		12	021563	1/1/0001								
05800	S	M	SOH	II	00433	000		12	021563	1/1/0001								
05800	S	M	SOH	II	00443	000		12	021563	1/1/0001								

OFFICE: 311

ROUTE: 564

OFFICE: 311		ROUTE: 564		ST_REF_NO: 00000102700		KENTUCKY AVENUE		LUMENS	BULB TYPE	MULT SERIES	POLE TYPE	SHADE	ADDRESS NUMBER	REF	LOCATION	TAX DIST	DATE INST	DATE CHANGE
05800	S	M	SOH	II	00000	640	SIDE OF 540 E. MAIN	12	101267	1/1/0001								
05800	S	M	SOH	II	00000	646	OPP. 181	12	101267	1/1/0001								
05800	S	M	SOH	I	00000	652	1ST LT. S. OF HIGH	12	101267	1/1/0001								
05800	S	M	SOH	II	00120	642		12	101267	1/1/0001								
05800	S	M	SOH	II	00131	641		12	100267	1/1/0001								
05800	S	M	SOH	II	00145	643		12	100267	1/1/0001								
05800	S	M	SOH	II	00156	644		12	101267	1/1/0001								
05800	S	M	SOH	II	00169	645		12	100267	1/1/0001								
05800	S	M	SOH	II	00193	647		12	101267	1/1/0001								
05800	S	M	SOH	I	00224	653		12	101267	1/1/0001								
05800	S	M	SOH	I	00230	654		12	101267	1/1/0001								
05800	S	M	SOH	I	00240	655		12	101267	1/1/0001								
05800	S	M	SOH	I	00256	656		12	101267	1/1/0001								
05800	S	M	SOH	I	00270	657		12	101267	1/1/0001								
05800	S	M	SOH	I	00274	658		12	101267	1/1/0001								

OFFICE: 311

ROUTE: 564

OFFICE: 311		ROUTE: 564		ST_REF_NO: 00000102800		KENTUCKY COURT		LUMENS	BULB TYPE	MULT SERIES	POLE TYPE	SHADE	ADDRESS NUMBER	REF	LOCATION	TAX DIST	DATE INST	DATE CHANGE
05800	S	M	SOH	V	00000	600	IN ISLAND	12	070767	1/1/0001								
05800	S	M	SOH	I	00406	597		12	070767	1/1/0001								

OFFICE: 311

ROUTE: 564

ST_REF_NO: 00000102800 KENTUCKY COURT

LUMENS	BULB TYPE	MULT SERIES	POLE TYPE	SHADE	ADDRESS NUMBER	REF	LOCATION	TAX DIST	DATE INST	DATE CHANGE
05800	S	M	SOH	I	00411	598		12	070767	1/1/0001
05800	S	M	SOH	I	00421	599		12	070767	1/1/0001

OFFICE: 311

ROUTE: 564

ST_REF_NO: 00000102880 KENWOOD DRIVE

LUMENS	BULB TYPE	MULT SERIES	POLE TYPE	SHADE	ADDRESS NUMBER	REF	LOCATION	TAX DIST	DATE INST	DATE CHANGE
05800	S	M	OUG	II	00000	001	SIDE REAR OF 828 BURKEWOOD DR.	12	110899	1/1/0001
05800	S	M	OUG	II	02212	002		12	110899	1/1/0001
05800	S	M	OUG	II	02221	003		12	110899	1/1/0001
05800	S	M	OUG	II	02236	004		12	110899	1/1/0001
05800	S	M	OUG	II	02245	005		12	110899	1/1/0001

OFFICE: 311

ROUTE: 564

ST_REF_NO: 00000102900 KENYON ROAD

LUMENS	BULB TYPE	MULT SERIES	POLE TYPE	SHADE	ADDRESS NUMBER	REF	LOCATION	TAX DIST	DATE INST	DATE CHANGE
05800	S	M	OUG	III	00000	001	SIDE OF 901 N. BROADWAY-upgraded to 5800 hps	12	040156	1/1/0001
05800	S	M	SOH	III	00000	002	OPP. MCCLAIN RD.-upgraded to 5800 hps 10/07	12	050461	1/1/0001

OFFICE: 311

ROUTE: 564

ST_REF_NO: 00000102910 KESS CIRCLE

LUMENS	BULB TYPE	MULT SERIES	POLE TYPE	SHADE	ADDRESS NUMBER	REF	LOCATION	TAX DIST	DATE INST	DATE CHANGE
05800	S	M	OUG	II	02912	001		12	080895	1/1/0001

OFFICE: 311

ROUTE: 564

ST_REF_NO: 00000102930 KETTERING COURT

LUMENS	BULB TYPE	MULT SERIES	POLE TYPE	SHADE	ADDRESS NUMBER	REF	LOCATION	TAX DIST	DATE INST	DATE CHANGE
05800	S	M	CNT	II	00000	001	SIDE OF 1129 ANDOVER FOREST DR.	12	120896	1/1/0001
05800	S	M	CNT	II	03209	003		12	030897	1/1/0001
05800	S	M	CNT	II	03212	002		12	030897	1/1/0001

OFFICE: 311

ROUTE: 564

ST_REF_NO: 00000102950 KEYSTONE CT

LUMENS	BULB TYPE	MULT SERIES	POLE TYPE	SHADE	ADDRESS NUMBER	REF	LOCATION	TAX DIST	DATE INST	DATE CHANGE
04000	S	M	OUG	II	03601	001		12	090891	1/1/0001
04000	S	M	OUG	II	03615	002		12	090891	1/1/0001

OFFICE: 311		ROUTE: 564		ST_REF_NO: 00000102950		KEYSTONE CT		LUMENS	BULB TYPE	MULT SERIES	POLE TYPE	SHADE	ADDRESS NUMBER	REF	LOCATION	TAX DIST	DATE INST	DATE CHANGE
	04000	S	M	OUG	II	03631	003									12	090891	1/1/0001
	04000	S	M	OUG	V	03632	004									12	090891	1/1/0001

OFFICE: 311		ROUTE: 564		ST_REF_NO: 00000102975		KIAWAH DRIVE		LUMENS	BULB TYPE	MULT SERIES	POLE TYPE	SHADE	ADDRESS NUMBER	REF	LOCATION	TAX DIST	DATE INST	DATE CHANGE
	05800	S	M	CNT	II	01000	001									12	121505	1/1/0001
	05800	S	M	CNT	II	01009	002									12	121505	1/1/0001
	05800	S	M	CNT	II	01016	003									12	121505	1/1/0001
	05800	S	M	CNT	II	01028	004									12	121505	1/1/0001
	05800	S	M	CNT	II	01037	005									12	121505	1/1/0001
	05800	S	M	CNT	II	01048	006									12	121505	1/1/0001
	05800	S	M	CNT	II	01060	007									12	121505	1/1/0001
	05800	S	M	CNT	III	01073	008									12	121505	1/1/0001

OFFICE: 311		ROUTE: 564		ST_REF_NO: 00000103200		KILDARE COURT		LUMENS	BULB TYPE	MULT SERIES	POLE TYPE	SHADE	ADDRESS NUMBER	REF	LOCATION	TAX DIST	DATE INST	DATE CHANGE
	05800	S	M	OUG	V	00500	000									12	110369	1/1/0001
	05800	S	M	OUG	II	00516	000									12	110369	1/1/0001
	05800	S	M	OUG	II	00533	000									12	110369	1/1/0001

OFFICE: 311		ROUTE: 564		ST_REF_NO: 00000103225		KILGARY CIRCLE		LUMENS	BULB TYPE	MULT SERIES	POLE TYPE	SHADE	ADDRESS NUMBER	REF	LOCATION	TAX DIST	DATE INST	DATE CHANGE
	05800	S	M	OUG	IV	03901	002									12	120892	1/1/0001
	05800	S	M	OUG	II	03924	001									12	120892	1/1/0001

OFFICE: 311		ROUTE: 564		ST_REF_NO: 00000103300		KILKENNY DRIVE		LUMENS	BULB TYPE	MULT SERIES	POLE TYPE	SHADE	ADDRESS NUMBER	REF	LOCATION	TAX DIST	DATE INST	DATE CHANGE
	05800	S	M	OUG	II	00000	129								SIDE OF 1839 ARUNDEL DR.	12	120170	1/1/0001
	05800	S	M	OUG	II	00000	142								OPP. 1543 KILKENNY DR.	12	060884	1/1/0001
	05800	S	M	OUG	II	01551	000									12	081973	1/1/0001
	05800	S	M	OUG	II	01574	000									12	071973	1/1/0001

OFFICE: 311		ROUTE: 564		ST_REF_NO: 00000103300		KILKENNY DRIVE				
LUMENS	BULB TYPE	MULT SERIES	POLE TYPE	SHADE	ADDRESS NUMBER	REF	LOCATION	TAX DIST	DATE INST	DATE CHANGE
05800	S	M	OUG	II	01575	000		12	071973	1/1/0001
05800	S	M	OUG	II	01591	000		12	071973	1/1/0001
05800	S	M	OUG	II	01623	000		12	100466	1/1/0001
05800	S	M	OUG	II	01634	000		12	100466	1/1/0001
05800	S	M	OUG	II	01647	000		12	051167	1/1/0001
05800	S	M	OUG	II	01658	000		12	040969	1/1/0001
05800	S	M	OUG	II	01671	000		12	051167	1/1/0001
05800	S	M	OUG	II	01686	000		12	051167	1/1/0001
05800	S	M	OUG	II	01699	000		12	100466	1/1/0001

OFFICE: 311		ROUTE: 564		ST_REF_NO: 00000103350		KILLEAN COURT				
LUMENS	BULB TYPE	MULT SERIES	POLE TYPE	SHADE	ADDRESS NUMBER	REF	LOCATION	TAX DIST	DATE INST	DATE CHANGE
05800	S	M	OUG	II	00000	001	SIDE OF 2328 MULUNDY WAY ON KILLEAN CT	12	042508	1/1/0001
05800	S	M	OUG	II	00901	002		12	042508	1/1/0001

OFFICE: 311		ROUTE: 564		ST_REF_NO: 00000103400		KILPATRICK COURT				
LUMENS	BULB TYPE	MULT SERIES	POLE TYPE	SHADE	ADDRESS NUMBER	REF	LOCATION	TAX DIST	DATE INST	DATE CHANGE
05800	S	M	OUG	II	00000	057	SIDE OF 1586 ELSTON DR.	12	010172	1/1/0001
05800	S	M	OUG	I	00401	061		12	010172	1/1/0001
05800	S	M	OUG	II	00412	060		12	010172	1/1/0001
05800	S	M	OUG	II	00429	059		12	010172	1/1/0001
05800	S	M	OUG	II	00440	000		12	010173	1/1/0001

OFFICE: 311		ROUTE: 564		ST_REF_NO: 00000103500		KILRUSH DRIVE				
LUMENS	BULB TYPE	MULT SERIES	POLE TYPE	SHADE	ADDRESS NUMBER	REF	LOCATION	TAX DIST	DATE INST	DATE CHANGE
05800	S	M	OUG	II	00000	058	SIDE OF 1146 CAYWOOD DR.	12	030874	1/1/0001
05800	S	M	OUG	II	00000	075	SIDE OF 1076 KELSEY DR.	12	100172	1/1/0001
05800	S	M	OUG	II	01120	000		12	100172	1/1/0001
05800	S	M	OUG	II	01139	074		12	111580	1/1/0001
05800	S	M	OUG	II	01152	000		12	100172	1/1/0001
05800	S	M	OUG	II	01159	000		12	100172	1/1/0001

OFFICE: 311

ROUTE: 564

ST_REF_NO: 00000103500 KILRUSH DRIVE

LUMENS	BULB TYPE	MULT SERIES	POLE TYPE	SHADE	ADDRESS NUMBER	REF	LOCATION	TAX DIST	DATE INST	DATE CHANGE
05800	S	M	OUG	II	01178	000		12	100172	1/1/0001
05800	S	M	OUG	II	01191	000		12	100172	1/1/0001

OFFICE: 311

ROUTE: 564

ST_REF_NO: 00000103600 KIMBERLITE COURT

LUMENS	BULB TYPE	MULT SERIES	POLE TYPE	SHADE	ADDRESS NUMBER	REF	LOCATION	TAX DIST	DATE INST	DATE CHANGE
04000	S	M	OUG	II	00406	030		12	060886	1/1/0001

OFFICE: 311

ROUTE: 564

ST_REF_NO: 00000103700 KIMBERLY PLACE

LUMENS	BULB TYPE	MULT SERIES	POLE TYPE	SHADE	ADDRESS NUMBER	REF	LOCATION	TAX DIST	DATE INST	DATE CHANGE
04000	S	M	OUG	II	00000	074	SIDE OF 2920 SOUTHVIEW	12	121583	1/1/0001
04000	S	M	OUG	II	00000	077	OPP. 436 KIMBERLY PLACE	12	121583	1/1/0001
04000	S	M	OUG	II	00400	080		12	121583	1/1/0001
04000	S	M	OUG	II	00407	079		12	121583	1/1/0001
04000	S	M	OUG	II	00412	078		12	121583	1/1/0001
04000	S	M	OUG	II	00448	076		12	121583	1/1/0001
04000	S	M	OUG	II	00461	075		12	121583	1/1/0001

OFFICE: 311

ROUTE: 564

ST_REF_NO: 00000103730 KIMBOLTON DRIVE

LUMENS	BULB TYPE	MULT SERIES	POLE TYPE	SHADE	ADDRESS NUMBER	REF	LOCATION	TAX DIST	DATE INST	DATE CHANGE
05800	S	M	CNT	II	01001	001		12	090898	1/1/0001
05800	S	M	CNT	II	01004	002		12	090898	1/1/0001
05800	S	M	CNT	II	01021	003		12	090898	1/1/0001

OFFICE: 311

ROUTE: 564

ST_REF_NO: 00000103800 KING STREET

LUMENS	BULB TYPE	MULT SERIES	POLE TYPE	SHADE	ADDRESS NUMBER	REF	LOCATION	TAX DIST	DATE INST	DATE CHANGE
05800	S	M	SOH	I	00000	001	1 ST. LT. W. OF HENRY ST., S. SIDE	12	101478	1/1/0001
05800	S	M	SOH	I	00000	002	2 ND. LT. E. OF NEWTOWN ST., N. SIDE	12	011569	1/1/0001
05800	S	M	SOH	I	00000	003	1 ST. LT. E. OF NEWTOWN ST., N. SIDE	12	050365	1/1/0001

OFFICE: 311		ROUTE: 564		ST_REF_NO: 00000103890		KING ARTHUR CIRCLE		LUMENS	BULB TYPE	MULT SERIES	POLE TYPE	SHADE	ADDRESS NUMBER	REF	LOCATION	TAX DIST	DATE INST	DATE CHANGE
	05800	S	M	OUG	II	03684	000									12	091167	1/1/0001
OFFICE: 311		ROUTE: 564		ST_REF_NO: 00000103900		KING ARTHUR COURT		LUMENS	BULB TYPE	MULT SERIES	POLE TYPE	SHADE	ADDRESS NUMBER	REF	LOCATION	TAX DIST	DATE INST	DATE CHANGE
	05800	S	M	OUG	II	00000	036								SIDE OF 3476 KING ARTHUR DR.	12	120171	1/1/0001
	05800	S	M	OUG	II	00358	037									12	081869	1/1/0001
OFFICE: 311		ROUTE: 564		ST_REF_NO: 00000104000		KING ARTHUR DRIVE		LUMENS	BULB TYPE	MULT SERIES	POLE TYPE	SHADE	ADDRESS NUMBER	REF	LOCATION	TAX DIST	DATE INST	DATE CHANGE
	05800	S	M	OUG	II	03472	000									12	081869	1/1/0001
	05800	S	M	OUG	II	03481	000									12	061968	1/1/0001
	05800	S	M	OUG	II	03492	000									12	081869	1/1/0001
	05800	S	M	OUG	II	03505	000									12	081869	1/1/0001
	05800	S	M	OUG	II	03516	031									12	120171	1/1/0001
	05800	S	M	OUG	II	03533	000									12	010270	1/1/0001
	05800	S	M	OUG	II	03544	000									12	081869	1/1/0001
	05800	S	M	OUG	II	03561	000									12	102367	1/1/0001
	05800	S	M	OUG	II	03572	000									12	081867	1/1/0001
	05800	S	M	OUG	II	03585	000									12	102367	1/1/0001
	05800	S	M	OUG	II	03608	000									12	081867	1/1/0001
	05800	S	M	OUG	II	03621	000									12	091167	1/1/0001
	05800	S	M	OUG	II	03632	000									12	091167	1/1/0001
	05800	S	M	OUG	II	03649	000									12	090170	1/1/0001
	05800	S	M	OUG	II	03660	000									12	051368	1/1/0001
	05800	S	M	OUG	II	03673	007									12	120171	1/1/0001
OFFICE: 311		ROUTE: 564		ST_REF_NO: 00000104105		KINGSBURY DRIVE		LUMENS	BULB TYPE	MULT SERIES	POLE TYPE	SHADE	ADDRESS NUMBER	REF	LOCATION	TAX DIST	DATE INST	DATE CHANGE
	05800	S	M	OUG	II	00692	013									12	120897	1/1/0001

OFFICE: 311

ROUTE: 564

ST_REF_NO: 00000104110

KINGSBURY ROAD

LUMENS	BULB TYPE	MULT SERIES	POLE TYPE	SHADE	ADDRESS NUMBER	REF	LOCATION	TAX DIST	DATE INST	DATE CHANGE
05800	S	M	OUG	II	00000	001	SIDE OF 2383 STONEWOOD LANE	12	120893	1/1/0001
05800	S	M	OUG	II	00000	002	SIDE OF 2290 STONEWOOD LANE	12	120893	1/1/0001
05800	S	M	OUG	II	00000	008	SIDE OF 917 RIDGEBROOK RD.	12	070896	1/1/0001
05800	S	M	OUG	II	00000	009	SIDE OF 2250 STONEWOOD	12	110897	1/1/0001
05800	S	M	OUG	II	00000	016	SIDE OF 845 REVERE RUN DR.	12	080800	1/1/0001
05800	S	M	OUG	II	00668	015		12	080800	1/1/0001
05800	S	M	OUG	II	00682	014		12	080800	1/1/0001
05800	S	M	OUG	II	00808	003		12	120893	1/1/0001
05800	S	M	OUG	II	00825	004		12	120893	1/1/0001
05800	S	M	OUG	II	00832	005		12	120893	1/1/0001
05800	S	M	OUG	II	00845	006		12	070896	1/1/0001
05800	S	M	OUG	II	00857	007		12	070896	1/1/0001

OFFICE: 311

ROUTE: 564

ST_REF_NO: 00000104115

KING GLEN PARK

LUMENS	BULB TYPE	MULT SERIES	POLE TYPE	SHADE	ADDRESS NUMBER	REF	LOCATION	TAX DIST	DATE INST	DATE CHANGE
05800	S	M	OUG	II	00000	001	OPP. 3793	12	010897	1/1/0001
05800	S	M	OUG	II	03773	003		12	010897	1/1/0001
05800	S	M	OUG	II	00000	002	OPP. 3781	12	010897	1/1/0001
05800	S	M	OUG	II	03761	004		12	010897	1/1/0001

OFFICE: 311

ROUTE: 564

ST_REF_NO: 00000104200

KINGSTON ROAD

LUMENS	BULB TYPE	MULT SERIES	POLE TYPE	SHADE	ADDRESS NUMBER	REF	LOCATION	TAX DIST	DATE INST	DATE CHANGE
05800	S	M	SOH	II	00689	200		12	120705	1/1/0001
05800	S	M	OUG	II	00000	004	SIDE OF 2441 PIERSON DR.	12	091967	1/1/0001
05800	S	M	OUG	III	00624	017		12	071063	1/1/0001
05800	S	M	OUG	III	00636	018		12	071063	1/1/0001
05800	S	M	OUG	III	00648	019		12	040664	1/1/0001
05800	S	M	OUG	III	00660	020		12	040664	1/1/0001
05800	S	M	OUG	III	00672	021		12	071063	1/1/0001
05800	S	M	OUG	III	00684	022		12	071063	1/1/0001
05800	S	M	OUG	II	00700	001		12	091967	1/1/0001
05800	S	M	OUG	II	00709	002		12	120167	1/1/0001

OFFICE: 311		ROUTE: 564		ST_REF_NO: 00000104200		KINGSTON ROAD		LUMENS	BULB TYPE	MULT SERIES	POLE TYPE	SHADE	ADDRESS NUMBER	REF	LOCATION	TAX DIST	DATE INST	DATE CHANGE
	05800	S	M	OUG	II	00720	003									12	091967	1/1/0001
	05800	S	M	OUG	II	00744	005									12	091967	1/1/0001
	05800	S	M	OUG	II	00757	006									12	050969	1/1/0001
	05800	S	M	OUG	III	00000	014							SIDE OF 2398 ALLEN DR.		12	071063	1/1/0001
	05800	S	M	OUG	III	00000	015							SIDE OF 2399 ALLEN DR.		12	071063	1/1/0001
	05800	S	M	SOH	II	00000	025							1ST LT. W OF PARIS PK., SOUTHSIDE		12	120898	1/1/0001
	05800	S	M	SOH	II	00000	026							2ND LT. W OF PARIS PK., SOUTHSIDE		12	120898	1/1/0001
	05800	S	M	SOH	II	00000	027							3RD LT. W OF PARIS PK., SOUTHSIDE		12	120898	1/1/0001
	05800	S	M	OUG	III	00612	016									12	071063	1/1/0001
OFFICE: 311		ROUTE: 564		ST_REF_NO: 00000104210		KINGSTON, OLD ROAD		LUMENS	BULB TYPE	MULT SERIES	POLE TYPE	SHADE	ADDRESS NUMBER	REF	LOCATION	TAX DIST	DATE INST	DATE CHANGE
	05800	S	M	OUG	II	00272	007									12	031868	1/1/0001
	05800	S	M	OUG	II	00284	008									12	052068	1/1/0001
OFFICE: 311		ROUTE: 564		ST_REF_NO: 00000104300		KINGSWAY DRIVE		LUMENS	BULB TYPE	MULT SERIES	POLE TYPE	SHADE	ADDRESS NUMBER	REF	LOCATION	TAX DIST	DATE INST	DATE CHANGE
	04000	S	M	OUG	II	00000	034							SIDE OF 1703 FAIRWAY DRIVE		12	080966	1/1/0001
	04000	S	M	OUG	II	00000	037							SIDE 1612 BON AIR		12	120884	1/1/0001
	04000	S	M	OOH	II	00000	038							SIDE OF 1701 BON AIR DR.		12	080966	1/1/0001
	04000	S	M	OUG	II	00225	035									12	110266	1/1/0001
	04000	S	M	OUG	II	00236	036									12	110266	1/1/0001
	04000	S	M	OUG	II	00235	039									12	080966	1/1/0001
	04000	S	M	OUG	II	00336	000									12	080966	1/1/0001
	04000	S	M	OUG	II	00401	146									12	120884	1/1/0001
	04000	S	M	OUG	II	00406	147									12	120884	1/1/0001
	04000	S	M	OUG	II	00413	148									12	120884	1/1/0001
	04000	S	M	OUG	II	00421	149									12	120884	1/1/0001
	04000	S	M	OUG	II	00429	190									12	110884	1/1/0001
	04000	S	M	OUG	II	00434	189									12	110884	1/1/0001
	04000	S	M	OUG	II	00441	188									12	110884	1/1/0001

OFFICE: 311		ROUTE: 564		ST_REF_NO: 00000104400		KINGTREE COURT		LUMENS	BULB TYPE	MULT SERIES	POLE TYPE	SHADE	ADDRESS NUMBER	REF	LOCATION	TAX DIST	DATE INST	DATE CHANGE
05800	S	M	OUG	II	01908	000										12	010166	1/1/0001
05800	S	M	OUG	II	01911	000										12	010166	1/1/0001

OFFICE: 311		ROUTE: 564		ST_REF_NO: 00000104410		KINGTREE DRIVE		LUMENS	BULB TYPE	MULT SERIES	POLE TYPE	SHADE	ADDRESS NUMBER	REF	LOCATION	TAX DIST	DATE INST	DATE CHANGE
05800	S	M	OUG	II	01926	000										12	010166	1/1/0001
05800	S	M	OUG	II	01935	000										12	010166	1/1/0001
05800	S	M	OUG	II	01948	000										12	010166	1/1/0001
05800	S	M	OUG	II	01959	000										12	010166	1/1/0001
05800	S	M	OUG	II	01976	000										12	010166	1/1/0001
05800	S	M	OUG	II	01987	000										12	010166	1/1/0001
05800	S	M	OUG	II	01998	000										12	010166	1/1/0001

OFFICE: 311		ROUTE: 564		ST_REF_NO: 00000104510		KINSAIL CIRCLE		LUMENS	BULB TYPE	MULT SERIES	POLE TYPE	SHADE	ADDRESS NUMBER	REF	LOCATION	TAX DIST	DATE INST	DATE CHANGE
05800	S	M	OUG	III	01901	001										12	040894	1/1/0001

OFFICE: 311		ROUTE: 564		ST_REF_NO: 00000104600		KIRK COURT		LUMENS	BULB TYPE	MULT SERIES	POLE TYPE	SHADE	ADDRESS NUMBER	REF	LOCATION	TAX DIST	DATE INST	DATE CHANGE
05800	S	M	OUG	II	00000	026										12	060170	1/1/0001
05800	S	M	OUG	V	01574	000										12	010172	1/1/0001
05800	S	M	OUG	II	01586	000										12	010172	1/1/0001

OFFICE: 311		ROUTE: 564		ST_REF_NO: 00000104700		KIRKLAND DRIVE		LUMENS	BULB TYPE	MULT SERIES	POLE TYPE	SHADE	ADDRESS NUMBER	REF	LOCATION	TAX DIST	DATE INST	DATE CHANGE
05800	S	M	OUG	II	00712	003										12	060897	1/1/0001
05800	S	M	OUG	II	00715	004										12	060897	1/1/0001
05800	S	M	OUG	II	00000	008										12	060897	1/1/0001
05800	S	M	OUG	II	00000	010										12	060897	1/1/0001
05800	S	M	OUG	II	00707	002										12	060897	1/1/0001
05800	S	M	OUG	II	00720	005										12	060897	1/1/0001

OFFICE: 311		ROUTE: 564		ST_REF_NO: 00000104700		KIRKLAND DRIVE		LUMENS	BULB TYPE	MULT SERIES	POLE TYPE	SHADE	ADDRESS NUMBER	REF	LOCATION	TAX DIST	DATE INST	DATE CHANGE
05800	S	M	OUG	II	00725	006										12	060897	1/1/0001
05800	S	M	OUG	II	00732	007										12	060897	1/1/0001
05800	S	M	OUG	II	00742	009										12	060897	1/1/0001

OFFICE: 311		ROUTE: 564		ST_REF_NO: 00000104800		KIRKLEVINGTON DRIVE		LUMENS	BULB TYPE	MULT SERIES	POLE TYPE	SHADE	ADDRESS NUMBER	REF	LOCATION	TAX DIST	DATE INST	DATE CHANGE
05800	S	M	OUG	II	03050	001										12	030897	1/1/0001
05800	S	M	OUG	II	03050	003										12	120374	1/1/0001
05800	S	M	OUG	II	03050	005										12	120374	1/1/0001
05800	S	M	OUG	II	03050	007										12	120374	1/1/0001
05800	S	M	OUG	II	03051	002										12	081873	1/1/0001
05800	S	M	OUG	II	03051	004										12	081873	1/1/0001
05800	S	M	OUG	II	03051	006										12	081873	1/1/0001
05800	S	M	OUG	II	03051	008										12	081873	1/1/0001
05800	S	M	OUG	II	03125	015										12	121579	1/1/0001
05800	S	M	OUG	II	03050	009										12	120374	1/1/0001
05800	S	M	OUG	II	03099	010										12	121579	1/1/0001
05800	S	M	OUG	II	03099	012										12	121579	1/1/0001
05800	S	M	OUG	II	03100	011										12	041874	1/1/0001
05800	S	M	OUG	II	03180	014										12	120374	1/1/0001

OFFICE: 311		ROUTE: 564		ST_REF_NO: 00000104950		KITANO COURT		LUMENS	BULB TYPE	MULT SERIES	POLE TYPE	SHADE	ADDRESS NUMBER	REF	LOCATION	TAX DIST	DATE INST	DATE CHANGE
05800	S	M	CNT	II	00000	001										12	020899	1/1/0001
05800	S	M	CNT	III	04212	002										12	020899	1/1/0001

OFFICE: 311		ROUTE: 564		ST_REF_NO: 00000104958		KITTENS JOY CIRCLE		LUMENS	BULB TYPE	MULT SERIES	POLE TYPE	SHADE	ADDRESS NUMBER	REF	LOCATION	TAX DIST	DATE INST	DATE CHANGE
05800	S		CNT	II	02504	003										12	080513	1/1/0001

OFFICE: 311

ROUTE: 564

ST_REF_NO: 00000105100 KLAIR ALLEY

LUMENS	BULB TYPE	MULT SERIES	POLE TYPE	SHADE	ADDRESS NUMBER	REF	LOCATION	TAX DIST	DATE INST	DATE CHANGE
05800	S	M	SOH	I	00000	270	1ST LT. W. OF JEFFERSON ST.	12	100266	1/1/0001
05800	S	M	SOH	I	00000	272	1ST LT. E. OF GEORGETOWN ST.	12	100266	1/1/0001

OFFICE: 311

ROUTE: 564

ST_REF_NO: 00000105200 KLEISER ALLEY

LUMENS	BULB TYPE	MULT SERIES	POLE TYPE	SHADE	ADDRESS NUMBER	REF	LOCATION	TAX DIST	DATE INST	DATE CHANGE
09500	S		SOH	II	00000	006	2ND LT S OF 5TH ST, E SIDE ON KLEISER ALLEY	12	121010	1/1/0001
09500	S	M	SOH	I	00000	001	1ST LT. N. OF 4TH ST. - Ifucg upgrade	12	020165	12/10/2010
09500	S	M	SOH	I	00000	002	2ND LT. N. OF 4TH ST. Ifucg upgrade	12	020165	12/10/2010
09500	S	M	SOH	I	00000	003	3RD LT. N. OF 4TH ST. Ifucg upgrade	12	020165	12/10/2010
09500	S	M	SOH	I	00000	004	3rd LT S OF 5TH ST - Ifucg upgrade	12	020165	12/10/2010
09500	S	M	SOH	I	00000	005	1ST LT. S. OF 5TH ST. Ifucg upgrade	12	020165	12/10/2010

OFFICE: 311

ROUTE: 564

ST_REF_NO: 00000105300 KNIGHT LANE

LUMENS	BULB TYPE	MULT SERIES	POLE TYPE	SHADE	ADDRESS NUMBER	REF	LOCATION	TAX DIST	DATE INST	DATE CHANGE
04000	S	M	OUG	II	00000	048	SIDE OF 1955 ALICE DR.	12	051477	1/1/0001
04000	S	M	OUG	II	01971	049		12	051477	1/1/0001
04000	S	M	OUG	II	01986	050		12	051477	1/1/0001
04000	S	M	OUG	II	01999	051		12	051477	1/1/0001

OFFICE: 311

ROUTE: 564

ST_REF_NO: 00000105500 KNOXVILLE COURT

LUMENS	BULB TYPE	MULT SERIES	POLE TYPE	SHADE	ADDRESS NUMBER	REF	LOCATION	TAX DIST	DATE INST	DATE CHANGE
05800	S	M	OUG	II	01707	000		12	090866	1/1/0001
05800	S	M	OUG	II	01714	000		12	090866	1/1/0001

OFFICE: 311

ROUTE: 564

ST_REF_NO: 00000105550 KONNER WOODS DRIVE

LUMENS	BULB TYPE	MULT SERIES	POLE TYPE	SHADE	ADDRESS NUMBER	REF	LOCATION	TAX DIST	DATE INST	DATE CHANGE
05800	S	M	OUG	II	00000	006	SIDE OF 2000 WILLIS DRIVE ON KONNER WOODS DRIVE	12	121606	1/1/0001
05800	S	M	OUG	II	01604	007		12	121606	1/1/0001
05800	S	M	OUG	II	01624	005		12	121606	1/1/0001
05800	S	M	OUG	II	01649	004		12	121606	1/1/0001

OFFICE: 311							ROUTE: 564			
ST_REF_NO: 00000105550							KONNER WOODS DRIVE			
LUMENS	BULB TYPE	MULT SERIES	POLE TYPE	SHADE	ADDRESS NUMBER	REF	LOCATION	TAX DIST	DATE INST	DATE CHANGE
05800	S	M	OUG	II	01657	003		12	121606	1/1/0001
05800	S	M	OUG	II	01673	002		12	121606	1/1/0001
05800	S	M	OUG	II	01680	001		12	121606	1/1/0001

OFFICE: 311							ROUTE: 564			
ST_REF_NO: 00000105600							KOSTER DRIVE			
LUMENS	BULB TYPE	MULT SERIES	POLE TYPE	SHADE	ADDRESS NUMBER	REF	LOCATION	TAX DIST	DATE INST	DATE CHANGE
04000	S	M	OUG	II	00000	121	SIDE 202 SOUTHPORT ST.	12	100884	1/1/0001
04000	S	M	SOH	II	00000	122	251 AND 253	12	100884	1/1/0001
04000	S	M	OUG	II	00000	123		12	100884	1/1/0001
04000	S	M	OUG	II	00000	124	217 AND 219	12	100884	1/1/0001
04000	S	M	OUG	II	00202	125		12	090884	1/1/0001

OFFICE: 311							ROUTE: 564			
ST_REF_NO: 00000105700							KRISSEY WAY			
LUMENS	BULB TYPE	MULT SERIES	POLE TYPE	SHADE	ADDRESS NUMBER	REF	LOCATION	TAX DIST	DATE INST	DATE CHANGE
04000	S	M	OUG	II	00000	029	SIDE 3841 LEE ADAMS	12	110884	1/1/0001
04000	S	M	OUG	II	00913	030		12	110884	1/1/0001
04000	S	M	OUG	II	00924	031		12	031581	1/1/0001
04000	S	M	OUG	II	00941	032		12	080884	1/1/0001
04000	S	M	OUG	II	00957	033		12	031581	1/1/0001

OFFICE: 311							ROUTE: 564			
ST_REF_NO: 00000105900							LACKAWANNA ROAD			
LUMENS	BULB TYPE	MULT SERIES	POLE TYPE	SHADE	ADDRESS NUMBER	REF	LOCATION	TAX DIST	DATE INST	DATE CHANGE
04000	S	M	SOH	I	00000	001	1ST LT. FROM NICHOLASVILLE RD.	12	100162	1/1/0001
04000	S	M	SOH	I	00000	002	REAR OF 107	12	100162	1/1/0001
04000	S	M	SOH	I	00000	003	SIDE OF 209 WABASH	12	100162	1/1/0001
04000	S	M	SOH	I	00101	000		12	100162	1/1/0001
04000	S	M	SOH	I	00105	000		12	100162	1/1/0001
04000	S	M	SOH	I	00107	000		12	100162	1/1/0001
04000	S	M	SOH	I	00119	000		12	100162	1/1/0001
04000	S	M	SOH	I	00125	000		12	100162	1/1/0001
04000	S	M	SOH	I	00131	000		12	100162	1/1/0001

OFFICE: 311

ROUTE: 564

ST_REF_NO: 00000105900

LACKAWANNA ROAD

LUMENS	BULB TYPE	MULT SERIES	POLE TYPE	SHADE	ADDRESS NUMBER	REF	LOCATION	TAX DIST	DATE INST	DATE CHANGE
04000	S	M	SOH	I	00135	000		12	100162	1/1/0001
04000	S	M	SOH	I	00145	000		12	100162	1/1/0001
04000	S	M	SOH	I	00201	000		12	100162	1/1/0001
04000	S	M	SOH	I	00207	000		12	100162	1/1/0001
04000	S	M	SOH	I	00213	000		12	100162	1/1/0001
04000	S	M	SOH	I	00220	000		12	100162	1/1/0001

OFFICE: 311

ROUTE: 564

ST_REF_NO: 00000106100

LACO DRIVE

LUMENS	BULB TYPE	MULT SERIES	POLE TYPE	SHADE	ADDRESS NUMBER	REF	LOCATION	TAX DIST	DATE INST	DATE CHANGE
05800	S	M	CNT	II	00000	020	1ST LT E OF OLD FRANKFORT CR, S SIDE ON LACO DR	12	052402	1/1/0001
05800	S	M	CNT	II	00000	021	2ND LT E OF OLD FRANKFORT CR, S SIDE ON LACO DR	12	052402	1/1/0001
05800	S	M	CNT	II	00000	022	3RD LT E OF OLD FRANKFORT CR, S SIDE ON LACO DR	12	052402	1/1/0001
05800	S	M	CNT	II	00000	023	4TH LT E OF OLD FRANKFORT CR, S SIDE ON LACO DR	12	052402	1/1/0001
05800	S	M	CNT	II	00000	024	5TH LT E OF OLD FRANKFORT CR, S SIDE ON LACO DR	12	052402	1/1/0001
05800	S	M	CNT	II	00000	025	6TH LT E OF OLD FRANKFORT CR, S SIDE ON LACO DR	12	052402	1/1/0001
05800	S	M	CNT	II	00000	026	7TH LT E OF OLD FRANKFORT CR, N SIDE ON LACO DR	12	052402	1/1/0001
05800	S	M	CNT	II	00000	027	8TH LT E OF OLD FRANKFORT CR, N SIDE ON LACO DR	12	052402	1/1/0001
05800	S	M	OUG	II	00000	028	9TH LT E OF OLD FRANKFORT CR, N SIDE ON LACO DR	12	052402	1/1/0001
05800	S	M	OUG	II	00000	029	10TH LT E OF OLD FRANKFORT CR, N SIDE ON LACO DR	12	052402	1/1/0001
05800	S	M	OUG	II	00000	030	11TH LT E OF OLD FRANKFORT CR, N SIDE ON LACO DR	12	052402	1/1/0001
05800	S	M	OUG	II	00000	031	12TH LT E OF OLD FRANKFORT CR, N SIDE ON LACO DR	12	052402	1/1/0001
05800	S	M	OUG	II	00000	032	1ST LT E OF BIZZELL DR, N SIDE ON LACO DR	12	052402	1/1/0001
05800	S	M	OUG	II	00000	033	2ND LT E OF BIZZELL DR, N SIDE ON LACO DR	12	052402	1/1/0001
05800	S	M	SOH	II	00000	001	1ST LT., E. SIDE	12	111067	1/1/0001
05800	S	M	SOH	II	00000	002	W. SIDE OF LACO DR.	12	111067	1/1/0001

OFFICE: 311 ROUTE: 564										
ST_REF_NO: 00000106100 LACO DRIVE										
LUMENS	BULB TYPE	MULT SERIES	POLE TYPE	SHADE	ADDRESS NUMBER	REF	LOCATION	TAX DIST	DATE INST	DATE CHANGE
05800	S	M	SOH	II	00000	003	2ND LT. ON E. SIDE	12	111067	1/1/0001
OFFICE: 311 ROUTE: 564										
ST_REF_NO: 00000106140 LACY LANE										
LUMENS	BULB TYPE	MULT SERIES	POLE TYPE	SHADE	ADDRESS NUMBER	REF	LOCATION	TAX DIST	DATE INST	DATE CHANGE
05800	S	M	CNT	II	01177	001		12	120899	1/1/0001
05800	S	M	CNT	II	01184	002		12	120899	1/1/0001
05800	S	M	CNT	II	01197	003		12	120899	1/1/0001
OFFICE: 311 ROUTE: 564										
ST_REF_NO: 00000106160 LADY DI LANE										
LUMENS	BULB TYPE	MULT SERIES	POLE TYPE	SHADE	ADDRESS NUMBER	REF	LOCATION	TAX DIST	DATE INST	DATE CHANGE
05800	S	M	OUG	II	03796	042		12	041902	1/1/0001
05800	S	M	OUG	II	03813	041		12	041902	1/1/0001
05800	S	M	OUG	II	03705	001		12	110899	1/1/0001
05800	S	M	OUG	II	03728	002		12	110899	1/1/0001
05800	S	M	OUG	II	03745	003		12	110899	1/1/0001
05800	S	M	OUG	II	03768	004		12	110899	1/1/0001
05800	S	M	OUG	II	03785	005		12	110899	1/1/0001
OFFICE: 311 ROUTE: 564										
ST_REF_NO: 00000106200 LAFAYETTE AVENUE										
LUMENS	BULB TYPE	MULT SERIES	POLE TYPE	SHADE	ADDRESS NUMBER	REF	LOCATION	TAX DIST	DATE INST	DATE CHANGE
05800	S	M	SOH	II	00328	000		12	121365	3/21/2012
04000	S	M	SOH	I	00510	669		12	102367	9/9/2009
04000	S	S	SOH	II	00000	001	SIDE OF 632 E. HIGH	12	121365	1/1/0001
05800	S	M	SOH	II	00000	672	OPP. 118	12	102367	1/1/0001
05800	S	M	SOH	II	00114	673		12	102367	1/1/0001
05800	S	M	SOH	II	00130	671		12	102367	1/1/0001
05800	S	M	SOH	II	00141	670		12	102367	1/1/0001
04000	S	M	SOH	II	00316	000		12	121365	1/1/0001
04000	S	M	SOH	II	00336	000		12	121365	1/1/0001
04000	S	M	SOH	II	00346	000		12	121365	1/1/0001

OFFICE: 311		ROUTE: 564		ST_REF_NO: 00000106210		LAFAYETTE DRIVE		LUMENS	BULB TYPE	MULT SERIES	POLE TYPE	SHADE	ADDRESS NUMBER	REF	LOCATION	TAX DIST	DATE INST	DATE CHANGE
09500	S	M	SOH	II	00000	082	OPP. 301	12	100884	1/1/0001								
09500	S	M	SOH	II	00000	084	OPP. 315	12	100884	1/1/0001								
09500	S	M	OUG	II	00000	085	OPP. 321	12	100884	1/1/0001								
09500	S	M	OUG	II	00000	087	SIDE OF 497 SPRINGHILL	12	100884	1/1/0001								
04000	S	M	SOH	II	00000	088	OPP. SIDE 502 RIDGE ROAD	12	100884	1/1/0001								
09500	S	M	OUG	II	00405	086		12	100884	1/1/0001								
OFFICE: 311		ROUTE: 564		ST_REF_NO: 00000106300		LAFAYETTE PARKWAY		LUMENS	BULB TYPE	MULT SERIES	POLE TYPE	SHADE	ADDRESS NUMBER	REF	LOCATION	TAX DIST	DATE INST	DATE CHANGE
05800	S	M	OUG	III	00000	148	SIDE OF 501 ROSEMONT GARDEN	12	071583	1/1/0001								
05800	S	M	OUG	III	00264	153		12	071583	1/1/0001								
05800	S	M	OUG	III	00264	154		12	071583	1/1/0001								
05800	S	M	OUG	III	00265	149		12	071583	1/1/0001								
05800	S	M	OUG	III	00271	150		12	071583	1/1/0001								
05800	S	M	OUG	III	00272	155		12	071583	1/1/0001								
05800	S	M	OUG	III	00278	156		12	071583	1/1/0001								
05800	S	M	OUG	III	00279	151		12	071583	1/1/0001								
05800	S	M	OUG	III	00284	157		12	071583	1/1/0001								
05800	S	M	OUG	III	00287	152		12	071583	1/1/0001								
09500	S	M	OUG	II	00000	083	SIDE OF 508 WOODBINE RD.	12	080884	1/1/0001								
05800	S	M	OUG	III	00290	158		12	071583	1/1/0001								
05800	S	M	OUG	II	00296	080		12	100884	1/1/0001								
05800	S	M	OUG	II	00297	081		12	100884	1/1/0001								
OFFICE: 311		ROUTE: 564		ST_REF_NO: 00000106400		LAFE ALLEY		LUMENS	BULB TYPE	MULT SERIES	POLE TYPE	SHADE	ADDRESS NUMBER	REF	LOCATION	TAX DIST	DATE INST	DATE CHANGE
04000	S	M	SOH	III	00000	001	1ST LT. N. OF SECOND ST., WESTSIDE	12	040893	1/1/0001								
04000	S	M	SOH	III	00000	002	2ND LT. N. OF SECOND ST., WESTSIDE	12	040893	1/1/0001								

OFFICE: 311		ROUTE: 564		ST_REF_NO: 00000106410		LAFLAME ALLEY		LUMENS	BULB TYPE	MULT SERIES	POLE TYPE	SHADE	ADDRESS NUMBER	REF	LOCATION	TAX DIST	DATE INST	DATE CHANGE
	05800	S	M	SOH	I	00000	001								1ST LT. E. OF 7TH ST.	12	101866	1/1/0001
	05800	S	M	SOH	V	00000	002								REAR 931 E. 3RD ST.	12	011865	1/1/0001

OFFICE: 311		ROUTE: 564		ST_REF_NO: 00000106500		LAGONDA AVENUE		LUMENS	BULB TYPE	MULT SERIES	POLE TYPE	SHADE	ADDRESS NUMBER	REF	LOCATION	TAX DIST	DATE INST	DATE CHANGE
	05800	S	M	SOH	II	00000	032								SIDE 1100 SPARKS RD.	12	120884	1/1/0001
	05800	S	M	SOH	II	00536	031									12	120884	1/1/0001
	05800	S	M	OUG	II	00601	033									12	110884	1/1/0001
	05800	S	M	OUG	II	00602	034									12	110884	1/1/0001
	05800	S	M	OUG	II	00611	035									12	110884	1/1/0001
	05800	S	M	SOH	II	00501	029									12	120884	1/1/0001
	05800	S	M	SOH	II	00516	030									12	120884	1/1/0001

OFFICE: 311		ROUTE: 564		ST_REF_NO: 00000106503		LAGUNA COURT		LUMENS	BULB TYPE	MULT SERIES	POLE TYPE	SHADE	ADDRESS NUMBER	REF	LOCATION	TAX DIST	DATE INST	DATE CHANGE
	05800	S		CNT	II	00000	001								ACROSS FROM 3045 LAGUNA COURT	12	080210	1/1/0001
	05800	S		CNT	II	03005	005									12	080210	1/1/0001
	05800	S		CNT	II	03012	004									12	080210	1/1/0001
	05800	S		CNT	II	03016	003									12	080210	1/1/0001
	05800	S		CNT	II	03041	002									12	080210	1/1/0001

OFFICE: 311		ROUTE: 564		ST_REF_NO: 00000106510		LAKE ALLEY		LUMENS	BULB TYPE	MULT SERIES	POLE TYPE	SHADE	ADDRESS NUMBER	REF	LOCATION	TAX DIST	DATE INST	DATE CHANGE
	05800	S	M	SOH	I	00000	001								REAR OF 147 E. THIRD ST.	12	021965	1/1/0001

OFFICE: 311		ROUTE: 564		ST_REF_NO: 00000106650		LAKE PARK ROAD		LUMENS	BULB TYPE	MULT SERIES	POLE TYPE	SHADE	ADDRESS NUMBER	REF	LOCATION	TAX DIST	DATE INST	DATE CHANGE
	05800	S	M	OOH	II	00000	001								1ST LT. S. OF RICHMOND RD., W. SIDE	12	120889	1/1/0001
	05800	S	M	OOH	II	00000	002								2ND LT. S. OF RICHMOND RD., W. SIDE	12	120889	1/1/0001
	05800	S	M	OOH	II	00000	003								3RD LT. S. OF RICHMOND RD., W. SIDE	12	120889	1/1/0001
	05800	S	M	OUG	II	00000	005								OPP. 2334	12	120889	1/1/0001

OFFICE: 311

ROUTE: 564

ST_REF_NO: 00000106650

LAKE PARK ROAD

LUMENS	BULB TYPE	MULT SERIES	POLE TYPE	SHADE	ADDRESS NUMBER	REF	LOCATION	TAX DIST	DATE INST	DATE CHANGE
05800	S	M	OUG	II	00000	006	OPP. 2334	12	120088	1/1/0001
05800	S	M	SOH	II	00000	007	OPP. 2334	12	120889	1/1/0001
05800	S	M	OUG	II	00000	008	2375, BLDG. 4	12	120889	1/1/0001
05800	S	M	OUG	II	00000	009	2375, BLDG. 4	12	120889	1/1/0001
05800	S	M	OUG	II	00000	010	2375, BLDG. 5	12	120889	1/1/0001
05800	S	M	OUG	II	00000	011	2375, BLDG. 6	12	120889	1/1/0001
05800	S	M	OUG	V	00000	012	2375, BLDG. 6	12	120889	1/1/0001
05800	S	M	OUG	II	00000	013	2394, BLDG. 7	12	120889	1/1/0001
05800	S	M	OUG	II	00000	014	2394, BLDG. 9	12	120889	1/1/0001
05800	S	M	SOH	II	02334	004		12	120889	1/1/0001

OFFICE: 311

ROUTE: 564

ST_REF_NO: 00000106700

LAKE TOWER DRIVE

LUMENS	BULB TYPE	MULT SERIES	POLE TYPE	SHADE	ADDRESS NUMBER	REF	LOCATION	TAX DIST	DATE INST	DATE CHANGE
09500	S	M	OUG	II	00500	107	bad fixture	12	061475	4/6/2010
09500	S	M	OUG	II	00500	109		12	061475	6/19/2012
10000	M	M	OUG	II	00000	113	OPP. 507	12	021475	1/1/0001
10000	M	M	OUG	II	00000	147	OPP. 527	12	031475	1/1/0001
10000	M	M	OUG	II	00000	149	OPP. 531	12	071476	1/1/0001
10000	M	M	OUG	II	00000	151	OPP. 539	12	071476	1/1/0001
10000	M	M	OUG	II	00479	108		12	050172	1/1/0001
10000	M	M	OUG	II	00491	110		12	050172	1/1/0001
10000	M	M	OUG	II	00500	111		12	061475	1/1/0001
10000	M	M	OUG	II	00503	112		12	060172	1/1/0001
10000	M	M	OUG	II	00515	114		12	060172	1/1/0001
10000	M	M	OUG	II	00527	148		12	091573	1/1/0001
10000	M	M	OUG	II	00535	150		12	071476	1/1/0001
10000	M	M	OUG	II	00547	152		12	071476	1/1/0001

OFFICE: 311

ROUTE: 564

ST_REF_NO: 00000106705

LAKE VALLEY COURT

LUMENS	BULB TYPE	MULT SERIES	POLE TYPE	SHADE	ADDRESS NUMBER	REF	LOCATION	TAX DIST	DATE INST	DATE CHANGE
05800	S	M	CNT	II	00000	001	SIDE OF 529 LAKE VALLEY DRIVE	12	090800	1/1/0001
05800	S	M	CNT	III	03704	002		12	090800	1/1/0001

OFFICE: 311		ROUTE: 564		ST_REF_NO: 00000106710		LAKE VALLEY DRIVE				
LUMENS	BULB TYPE	MULT SERIES	POLE TYPE	SHADE	ADDRESS NUMBER	REF	LOCATION	TAX DIST	DATE INST	DATE CHANGE
05800	S	M	CNT	II	00500	001		12	090800	1/1/0001
05800	S	M	CNT	II	00509	002		12	090800	1/1/0001
05800	S	M	CNT	II	00520	003		12	090800	1/1/0001
05800	S	M	CNT	II	00537	004		12	090800	1/1/0001
05800	S	M	CNT	III	00541	005		12	090800	1/1/0001

OFFICE: 311		ROUTE: 564		ST_REF_NO: 00000106720		LAKEBEND COURT				
LUMENS	BULB TYPE	MULT SERIES	POLE TYPE	SHADE	ADDRESS NUMBER	REF	LOCATION	TAX DIST	DATE INST	DATE CHANGE
04000	S	M	OUG	II	00000	001	SIDE OF 381 SQUIRES CIRCLE	12	030888	1/1/0001
04000	S	M	OUG	V	00325	003		12	030888	1/1/0001
04000	S	M	OUG	II	00320	002		12	030888	1/1/0001

OFFICE: 311		ROUTE: 564		ST_REF_NO: 00000106730		LAKEBOW COURT				
LUMENS	BULB TYPE	MULT SERIES	POLE TYPE	SHADE	ADDRESS NUMBER	REF	LOCATION	TAX DIST	DATE INST	DATE CHANGE
04000	S	M	OUG	II	00404	001		12	030888	1/1/0001
04000	S	M	OUG	II	00409	002		12	030888	1/1/0001
04000	S	M	OUG	II	00428	003		12	030888	1/1/0001

OFFICE: 311		ROUTE: 564		ST_REF_NO: 00000106740		LAKECREST CIRCLE				
LUMENS	BULB TYPE	MULT SERIES	POLE TYPE	SHADE	ADDRESS NUMBER	REF	LOCATION	TAX DIST	DATE INST	DATE CHANGE
09500	S	M	CNT	II	00000	002	REAR OF 911 BEAUMONT CTR. PARKWAY	12	110899	1/1/0001
09500	S	M	CNT	II	00000	003	OPP. 911 BEAUMONT CTR. PARKWAY	12	110899	1/1/0001
09500	S	M	CNT	II	00000	004	REAR OF 901 BEAUMONT CTR. PARKWAY	12	110899	1/1/0001
09500	S	M	CNT	II	00000	006	OPP. 3040	12	110899	1/1/0001
09500	S	M	CNT	II	00000	007	OPP. 3051	12	110899	1/1/0001
09500	S	M	CNT	II	00000	010	OPP. 3050	12	110899	1/1/0001
09500	S	M	CNT	II	00000	014	SIDE OF 3100 WALL STREET	12	110899	1/1/0001
09500	S	M	CNT	II	00000	019	OPP. 3001	12	110899	1/1/0001
09500	S	M	CNT	II	00000	022	REAR OF 921 BEAUMONT CTR. PARKWAY	12	110899	1/1/0001
09500	S	M	CNT	II	03000	017		12	110899	1/1/0001
09500	S	M	CNT	II	03010	021		12	110899	1/1/0001

OFFICE: 311		ROUTE: 564		ST_REF_NO: 00000106740		LAKECREST CIRCLE		TAX DIST	DATE INST	DATE CHANGE
LUMENS	BULB TYPE	MULT SERIES	POLE TYPE	SHADE	ADDRESS NUMBER	REF	LOCATION			
09500	S	M	CNT	II	03011	020		12	110899	1/1/0001
09500	S	M	CNT	II	03020	001		12	110899	1/1/0001
09500	S	M	CNT	II	03030	005		12	110899	1/1/0001
09500	S	M	CNT	II	03040	009		12	110899	1/1/0001
09500	S	M	CNT	II	03050	011		12	110899	1/1/0001
09500	S	M	CNT	II	03051	008		12	110899	1/1/0001
09500	S	M	CNT	II	03060	013		12	110899	1/1/0001
09500	S	M	CNT	II	03061	012		12	110899	1/1/0001
09500	S	M	CNT	II	03070	015		12	110899	1/1/0001
09500	S	M	CNT	II	03071	016		12	110899	1/1/0001
09500	S	M	CNT	II	03001	018		12	110899	1/1/0001
OFFICE: 311		ROUTE: 564		ST_REF_NO: 00000106800		LAKEHILL CIRCLE		TAX DIST	DATE INST	DATE CHANGE
LUMENS	BULB TYPE	MULT SERIES	POLE TYPE	SHADE	ADDRESS NUMBER	REF	LOCATION			
09500	S	M	OUG	V	00000	033	OPP. FROM SIDE OF 2040 LAKESIDE DR., IN ISLAND	12	091573	1/1/0001
09500	S	M	OUG	II	01814	034	upgraded 033 & 034 to 9500 hps cobra 1/06	12	072674	1/1/0001
OFFICE: 311		ROUTE: 564		ST_REF_NO: 00000106900		LAKELAND DRIVE		TAX DIST	DATE INST	DATE CHANGE
LUMENS	BULB TYPE	MULT SERIES	POLE TYPE	SHADE	ADDRESS NUMBER	REF	LOCATION			
05800	S	M	OUG	II	00000	004	SIDE OF 940 EDGEWATER DR.	12	051771	1/1/0001
05800	S	M	OUG	II	00986	003		12	091477	1/1/0001
05800	S	M	OUG	II	00995	000		12	030672	1/1/0001
05800	S	M	OUG	II	00998	000		12	040170	1/1/0001
OFFICE: 311		ROUTE: 564		ST_REF_NO: 00000107100		LAKESHORE DRIVE		TAX DIST	DATE INST	DATE CHANGE
LUMENS	BULB TYPE	MULT SERIES	POLE TYPE	SHADE	ADDRESS NUMBER	REF	LOCATION			
22000	S	M	OUG	II	00000	067	SIDE OF 2069 FONTAINE RD. upgrade per city request	12	042468	9/24/2009
22000	S	M	OUG	II	00301	066	upgraded per city request	12	020367	9/24/2009
05800	S	M	OUG	II	00000	059	OPP. 337	12	070767	1/1/0001
05800	S	M	OUG	II	00000	098	OPP. 445	12	101674	1/1/0001
05800	S	M	OUG	II	00000	099	SIDE OF 2092 MANOR DR.	12	091573	1/1/0001

OFFICE: 311

ROUTE: 564

ST_REF_NO: 00000107100

LAKESHORE DRIVE

LUMENS	BULB TYPE	MULT SERIES	POLE TYPE	SHADE	ADDRESS NUMBER	REF	LOCATION	TAX DIST	DATE INST	DATE CHANGE
05800	S	M	OUG	II	00345	000		12	040172	1/1/0001
05800	S	M	OUG	II	00400	057		12	041674	1/1/0001
05800	S	M	OUG	II	00405	056		12	020367	1/1/0001
05800	S	M	OUG	II	00412	055		12	090169	1/1/0001
05800	S	M	OUG	II	00417	054		12	070767	1/1/0001
05800	S	M	OUG	II	00424	094		12	061475	1/1/0001
05800	S	M	OUG	II	00433	095		12	101674	1/1/0001
05800	S	M	OUG	II	00436	096		12	111478	1/1/0001
05800	S	M	OUG	II	00441	097		12	101774	1/1/0001
05800	S	M	OUG	II	00460	119		12	071476	1/1/0001
05800	S	M	OUG	II	00461	120		12	061581	1/1/0001
05800	S	M	OUG	II	00000	061	OPP. 325	12	070767	1/1/0001
05800	S	M	OUG	II	00000	063	OPP. 313	12	070767	1/1/0001
05800	S	M	OUG	II	00000	065	OPP. 305	12	070767	1/1/0001
05800	S	M	OUG	II	00000	069	SIDE OF 2066 FAIRMONT CT.	12	090169	1/1/0001
05800	S	M	OUG	II	00000	090	OPP. 145	12	070170	1/1/0001
05800	S	M	OUG	II	00000	091	1ST LT. S. OF RICHMOND RD., W. SIDE	12	010171	1/1/0001
05800	S	M	OUG	II	00000	092	IN MEDIAN AT RICHMOND RD.	12	010171	1/1/0001
05800	S	M	OUG	II	00000	093	IN MEDIAN AT RICHMOND RD.	12	010171	1/1/0001
05800	S	M	OUG	II	00000	130	SIDE OF 2092 HARMONY CT.	12	091573	1/1/0001
05800	S	M	OUG	II	00000	131	SIDE OF 2101 BRIDGEPORT DR.	12	091573	1/1/0001
05800	S	M	OUG	II	00000	132	SIDE OF 2092 BRIDGEPORT DR.	12	041674	1/1/0001
05800	S	M	OUG	II	00147	072		12	020367	1/1/0001
05800	S	M	OUG	II	00156	071		12	120667	1/1/0001
05800	S	M	OUG	II	00171	070		12	090169	1/1/0001
05800	S	M	OUG	II	00209	068		12	051967	1/1/0001
05800	S	M	OUG	II	00309	064		12	090169	1/1/0001
05800	S	M	OUG	II	00321	062		12	071476	1/1/0001
05800	S	M	OUG	II	00329	060		12	070170	1/1/0001
05800	S	M	OUG	II	00468	121		12	101774	1/1/0001
05800	S	M	OUG	II	00473	122		12	111478	1/1/0001
05800	S	M	OUG	II	00476	123		12	041674	1/1/0001
05800	S	M	OUG	II	00481	000		12	072674	1/1/0001
05800	S	M	OUG	II	00488	126		12	091477	1/1/0001

OFFICE: 311

ROUTE: 564

ST_REF_NO: 00000107100

LAKESHORE DRIVE

LUMENS	BULB TYPE	MULT SERIES	POLE TYPE	SHADE	ADDRESS NUMBER	REF	LOCATION	TAX DIST	DATE INST	DATE CHANGE
05800	S	M	OUG	II	00500	127		12	031475	1/1/0001
05800	S	M	OUG	II	00501	128		12	111478	1/1/0001
05800	S	M	OUG	II	00512	129		12	111478	1/1/0001
05800	S	M	OUG	II	00532	133		12	091573	1/1/0001
05800	S	M	OUG	II	00541	000		12	100173	1/1/0001
05800	S	M	OUG	II	00544	000		12	091573	1/1/0001

OFFICE: 311

ROUTE: 564

ST_REF_NO: 00000107200

LAKESIDE DRIVE

LUMENS	BULB TYPE	MULT SERIES	POLE TYPE	SHADE	ADDRESS NUMBER	REF	LOCATION	TAX DIST	DATE INST	DATE CHANGE
09500	S	M	OUG	II	02009	037	upgrade to 9500 hps cobra 1/06	12	121583	1/1/0001
09500	S	M	OUG	II	02012	000	upgrade to 9500 cobra 1/06	12	070170	1/1/0001
09500	S	M	OUG	II	02016	000	upgrade to 9500 hps cobra 1/06	12	030169	1/1/0001
09500	S	M	OUG	II	02021	000	upgrade to 9500 hps cobra 1/06	12	090169	1/1/0001
09500	S	M	OUG	II	02196	000	upgrade to 9500 hps cobra 1/06	12	030169	1/1/0001
09500	S	M	OUG	II	02205	000	upgrade to 9500 hps cobra 1/06	12	050170	1/1/0001
09500	S	M	OUG	II	02213	000	upgrade to 9500 hps cobra 1/06	12	030169	1/1/0001
04000	S	M	OUG	II	00000	001	IN MEDIAN, ENTRANCE TO LAKEVIEW ESTATES	12	010168	1/1/0001
04000	S	M	OUG	II	00000	002	IN MEDIAN , ENTRANCE TO LAKEVIEW ESTATES	12	010168	1/1/0001
04000	S	M	OUG	II	00000	003	BEHIND SIGN TO LAKEVIEW ESTATES	12	010168	1/1/0001
04000	S	M	OUG	II	00000	004	BEHIND SIGN TO LAKEVIEW ESTATES	12	010168	1/1/0001
09500	S	M	OUG	II	00000	010	SIDE OF 2120 Lakeside Ct-upgrade to 9500 1/06	12	090169	1/1/0001
09500	S	M	OUG	II	00000	013	SIDE OF 2141 Lakeside Ct-upgrade to 9500 1/06	12	010171	1/1/0001
05800	S	M	OUG	II	00000	240	SIDE OF 3533 COLTNECK LANE	12	080884	1/1/0001
05800	S	M	OUG	II	00000	243	SIDE OF 1992 ALUMNI DR. ON LAKESIDE	12	080884	1/1/0001
05800	S	M	OUG	II	00000	244	SIDE OF 1192 ALUMNI DR. ON LAKESIDE IN MEDIAN	12	080884	1/1/0001
05800	S	M	OUG	II	00000	245	SIDE OF 1992 ALUMNI DR. ON LAKESIDE IN MEDIAN	12	080884	1/1/0001
09500	S	M	OUG	II	02028	000	upgrade to 9500 hps cobra 1/06	12	090169	1/1/0001
09500	S	M	OUG	II	02037	000	upgrade to 9500 hps cobra 1/06	12	060172	1/1/0001
09500	S	M	OUG	II	02040	000	upgraded to 9500 hps cobra 1/06	12	030169	1/1/0001
09500	S	M	OUG	II	02048	000	upgraded to 9500 hps cobra 1/06	12	091573	1/1/0001
09500	S	M	OUG	II	02057	000	upgrade to 9500 hps cobra 1/06	12	090172	1/1/0001
09500	S	M	OUG	II	02064	000	upgraded to 9500 hps cobra 1/06	12	091573	1/1/0001
09500	S	M	OUG	II	02069	000	upgrade to 9500 hps cobra 1/06	12	030169	1/1/0001

OFFICE: 311

ROUTE: 564

ST_REF_NO: 00000107200

LAKESIDE DRIVE

LUMENS	BULB TYPE	MULT SERIES	POLE TYPE	SHADE	ADDRESS NUMBER	REF	LOCATION	TAX DIST	DATE INST	DATE CHANGE
09500	S	M	OUG	II	02076	000	upgrade to 9500 hps cobra 1/06	12	091573	1/1/0001
09500	S	M	OUG	II	02081	000	on Lakeside Place-upgrade to 9500 hps cobra 1/06	12	050668	1/1/0001
09500	S	M	OUG	V	02089	000	on Lakeside Place-upgrade to 9500 hps cobra 1/06	12	090169	1/1/0001
09500	S	M	OUG	II	02101	000	upgrade to 9500 hps cobra 1/06	12	091573	1/1/0001
09500	S	M	OUG	II	02104	000	upgrade to 9500 hps cobra 1/06	12	090169	1/1/0001
09500	S	M	OUG	II	02117	000	upgrade to 9500 hps cobra 1/06	12	091573	1/1/0001
09500	S	M	OUG	II	02120	000	upgrade to 9500 hps cobra 1/06	12	060269	1/1/0001
09500	S	M	OUG	II	02141	000	upgrade to 9500 hps cobra 1/06	12	090169	1/1/0001
09500	S	M	OUG	II	02148	000	upgrade to 9500 hps cobra 1/06	12	090169	1/1/0001
09500	S	M	OUG	II	02157	000	upgrade to 9500 hps cobra 1/06	12	050170	1/1/0001
09500	S	M	OUG	II	02160	000	upgrade to 9500 hps cobra 1/06	12	090172	1/1/0001
09500	S	M	OUG	II	02169	000	upgrade to 9500 hps cobra 1/06	12	090172	1/1/0001
09500	S	M	OUG	II	02177	000	upgrade to 9500 hps cobra 1/06	12	090172	1/1/0001
09500	S	M	OUG	II	02184	000	upgrade to 9500 hps cobra 1/06	12	030169	1/1/0001
09500	S	M	OUG	II	02193	000	upgrade to 9500 hps cobra 1/06	12	030169	1/1/0001
05800	S	M	OUG	II	02308	242		12	080884	1/1/0001

OFFICE: 311

ROUTE: 564

ST_REF_NO: 00000107300

LAKEVIEW DRIVE

LUMENS	BULB TYPE	MULT SERIES	POLE TYPE	SHADE	ADDRESS NUMBER	REF	LOCATION	TAX DIST	DATE INST	DATE CHANGE
05800	S	M	SOH	II	00718	209	upgrade due to bad fixture	12	120884	8/28/2008
04000	S	M	SOH	II	00000	206	SIDE 1904 LIBERTY RD.	12	010885	1/1/0001
04000	S	M	SOH	II	00726	208		12	120884	1/1/0001
05800	S	M	SOH	II	00738	207	upgrade 6/08	12	010885	1/1/0001

OFFICE: 311

ROUTE: 564

ST_REF_NO: 00000107310

LAKE WALES COURT

LUMENS	BULB TYPE	MULT SERIES	POLE TYPE	SHADE	ADDRESS NUMBER	REF	LOCATION	TAX DIST	DATE INST	DATE CHANGE
04000	S	M	OUG	II	03301	070		12	051581	1/1/0001

OFFICE: 311

ROUTE: 564

ST_REF_NO: 00000107320

LAKE WALES DRIVE

LUMENS	BULB TYPE	MULT SERIES	POLE TYPE	SHADE	ADDRESS NUMBER	REF	LOCATION	TAX DIST	DATE INST	DATE CHANGE
04000	S	M	OUG	II	00274	069		12	051581	1/1/0001

OFFICE: 311		ROUTE: 564		ST_REF_NO: 00000107320		LAKE WALES DRIVE				
LUMENS	BULB TYPE	MULT SERIES	POLE TYPE	SHADE	ADDRESS NUMBER	REF	LOCATION	TAX DIST	DATE INST	DATE CHANGE
04000	S	M	OUG	II	00275	068		12	051581	1/1/0001
04000	S	M	OUG	II	00290	067		12	121581	1/1/0001
05800	S	M	OUG	II	00299	066		12	090893	1/1/0001

OFFICE: 311		ROUTE: 564		ST_REF_NO: 00000107400		LAKEWOOD COURT				
LUMENS	BULB TYPE	MULT SERIES	POLE TYPE	SHADE	ADDRESS NUMBER	REF	LOCATION	TAX DIST	DATE INST	DATE CHANGE
05800	S	M	OUG	II	00000	001	SIDE OF 1509 LAKEWOOD DR.	12	021367	1/1/0001
05800	S	M	OUG	II	00000	002	SIDE OF 1525 LAKEWOOD DR.	12	021367	1/1/0001
05800	S	M	OUG	II	01523	003		12	110268	1/1/0001
05800	S	M	OUG	II	01558	004		12	110268	1/1/0001
05800	S	M	OUG	II	01567	005		12	083173	1/1/0001

OFFICE: 311		ROUTE: 564		ST_REF_NO: 00000107410		LAKEWOOD, WEST COURT				
LUMENS	BULB TYPE	MULT SERIES	POLE TYPE	SHADE	ADDRESS NUMBER	REF	LOCATION	TAX DIST	DATE INST	DATE CHANGE
05800	S	M	OUG	II	00000	008	SIDE OF 1559 LAKEWOOD CT.	12	110268	1/1/0001
05800	S	M	OUG	V	01535	009		12	032568	1/1/0001

OFFICE: 311		ROUTE: 564		ST_REF_NO: 00000107420		LAKEWOOD, EAST COURT				
LUMENS	BULB TYPE	MULT SERIES	POLE TYPE	SHADE	ADDRESS NUMBER	REF	LOCATION	TAX DIST	DATE INST	DATE CHANGE
05800	S	M	OUG	II	01582	006		12	100169	1/1/0001
05800	S	M	OUG	V	01598	007		12	102274	1/1/0001

OFFICE: 311		ROUTE: 564		ST_REF_NO: 00000107500		LAKEWOOD DRIVE				
LUMENS	BULB TYPE	MULT SERIES	POLE TYPE	SHADE	ADDRESS NUMBER	REF	LOCATION	TAX DIST	DATE INST	DATE CHANGE
05800	S	M	OOH	II	00000	147	SIDE OF 1601 TATES CREEK RD.	12	100265	1/1/0001
05800	S	M	OUG	II	00000	162	SIDE OF 440 ANDOVER	12	030166	1/1/0001
05800	S	M	OUG	II	00905	148		12	100265	1/1/0001
05800	S	M	OUG	II	01062	149		12	100265	1/1/0001
05800	S	M	OUG	II	01067	150		12	100165	1/1/0001
05800	S	M	OUG	II	01074	151		12	110165	1/1/0001
05800	S	M	OUG	II	01085	152		12	110165	1/1/0001

OFFICE: 311		ROUTE: 564		ST_REF_NO: 00000107500		LAKEWOOD DRIVE		TAX DIST	DATE INST	DATE CHANGE
LUMENS	BULB TYPE	MULT SERIES	POLE TYPE	SHADE	ADDRESS NUMBER	REF	LOCATION			
05800	S	M	OUG	II	01160	153		12	020166	1/1/0001
05800	S	M	OUG	II	01167	154		12	100165	1/1/0001
05800	S	M	OUG	II	01176	155		12	110268	1/1/0001
05800	S	M	OUG	II	01181	156		12	110165	1/1/0001
05800	S	M	OUG	II	01196	157		12	110165	1/1/0001
05800	S	M	OUG	II	01203	158		12	111067	1/1/0001
05800	S	M	OUG	II	01226	159		12	111067	1/1/0001
05800	S	M	OUG	II	01243	160		12	030166	1/1/0001
05800	S	M	OUG	II	01372	161		12	030166	1/1/0001
05800	S	M	OUG	II	01392	000		12	010665	1/1/0001
05800	S	M	OUG	II	01409	077		12	010171	1/1/0001
05800	S	M	OUG	II	01414	078		12	080966	1/1/0001
05800	S	M	OUG	II	01425	079		12	021367	1/1/0001
05800	S	M	OUG	II	01434	080		12	020166	1/1/0001
05800	S	M	OUG	II	01445	081		12	020166	1/1/0001
05800	S	M	OUG	II	01500	082		12	020166	1/1/0001
04000	S	M	OUG	II	01600	090		12	120888	1/1/0001
04000	S	M	OUG	II	01613	091		12	120888	1/1/0001
04000	S	M	OUG	II	01625	092		12	120888	1/1/0001
04000	S	M	OUG	II	01633	093		12	120888	1/1/0001
OFFICE: 311		ROUTE: 564		ST_REF_NO: 00000107600		LAMAR DRIVE		TAX DIST	DATE INST	DATE CHANGE
LUMENS	BULB TYPE	MULT SERIES	POLE TYPE	SHADE	ADDRESS NUMBER	REF	LOCATION			
05800	S	M	OUG	II	00000	019	SIDE OF 3046 MONTAVESTA DR.	12	031769	1/1/0001
05800	S	M	OUG	II	00000	028	SIDE OF 3034 MONTAVESTA DR.	12	091167	1/1/0001
05800	S	M	OUG	II	03110	000		12	030171	1/1/0001
05800	S	M	OUG	II	03117	000		12	031769	1/1/0001
05800	S	M	OUG	II	03126	000		12	010171	1/1/0001
05800	S	M	OUG	II	03137	000		12	110172	1/1/0001
05800	S	M	OUG	II	03152	000		12	010171	1/1/0001
05800	S	M	OUG	II	03165	000		12	091167	1/1/0001
05800	S	M	OUG	II	03174	000		12	040368	1/1/0001
05800	S	M	OUG	II	03181	000		12	040368	1/1/0001

OFFICE: 311

ROUTE: 564

ST_REF_NO: 00000107800

LAMONT DRIVE

LUMENS	BULB TYPE	MULT SERIES	POLE TYPE	SHADE	ADDRESS NUMBER	REF	LOCATION	TAX DIST	DATE INST	DATE CHANGE
05800	S	M	OUG	II	00478	066	bad fixture	12	111583	4/5/2010
04000	S	M	OUG	II	00000	057	SIDE OF 2800 CLAYS MILL	12	111583	1/1/0001
04000	S	M	OUG	II	00000	063	SIDE OF 2712 SOUTHVIEW	12	111583	1/1/0001
04000	S	M	OUG	II	00000	084	SIDE OF 2849 ARK ROYAL WAY	12	041581	1/1/0001
04000	S	M	OUG	II	00451	085		12	071581	1/1/0001
04000	S	M	OUG	II	00456	086		12	071581	1/1/0001
04000	S	M	OUG	II	00475	087		12	071581	1/1/0001
04000	S	M	OUG	V	00486	067		12	111583	1/1/0001
04000	S	M	OUG	II	00487	065		12	111583	1/1/0001
04000	S	M	OUG	II	00493	064		12	111583	1/1/0001
04000	S	M	OUG	II	00509	062		12	111583	1/1/0001
05800	S	M	OUG	II	00577	061	upgrade 6/08	12	111583	1/1/0001
04000	S	M	OUG	II	00583	060		12	111583	1/1/0001
04000	S	M	OUG	II	00590	059		12	111583	1/1/0001
04000	S	M	OUG	II	00595	058		12	111583	1/1/0001

OFFICE: 311

ROUTE: 564

ST_REF_NO: 00000107850

LAMPTON COURT

LUMENS	BULB TYPE	MULT SERIES	POLE TYPE	SHADE	ADDRESS NUMBER	REF	LOCATION	TAX DIST	DATE INST	DATE CHANGE
05800	S	M	OUG	II	02000	001		12	080896	1/1/0001

OFFICE: 311

ROUTE: 564

ST_REF_NO: 00000107875

LANARKSHIRE PLACE

LUMENS	BULB TYPE	MULT SERIES	POLE TYPE	SHADE	ADDRESS NUMBER	REF	LOCATION	TAX DIST	DATE INST	DATE CHANGE
05800	S	M	CNT	II	00000	010	SIDE OF 4500 LARKHILL LN ON LANARKSHIRE PL	12	051107	1/1/0001
05800	S	M	CNT	II	00422	009		12	051107	1/1/0001
05800	S	M	CNT	II	00434	008		12	051107	1/1/0001
05800	S	M	CNT	II	00449	007		12	051107	1/1/0001
05800	S	M	CNT	II	00465	006		12	051107	1/1/0001
05800	S	M	CNT	II	00480	005		12	051107	1/1/0001
05800	S	M	CNT	II	00492	004		12	051107	1/1/0001
05800	S	M	CNT	II	00508	003		12	051107	1/1/0001
05800	S	M	CNT	II	00525	002		12	051107	1/1/0001
05800	S	M	CNT	II	00533	001		12	051107	1/1/0001

OFFICE: 311		ROUTE: 564		ST_REF_NO: 00000107875		LANARKSHIRE PLACE		LUMENS	BULB TYPE	MULT SERIES	POLE TYPE	SHADE	ADDRESS NUMBER	REF	LOCATION	TAX DIST	DATE INST	DATE CHANGE
	05800	S	M	CNT	II	00573	012									12	051107	1/1/0001
	05800	S	M	CNT	II	00588	011									12	051107	1/1/0001

OFFICE: 311		ROUTE: 564		ST_REF_NO: 00000107900		LANCASTER AVENUE		LUMENS	BULB TYPE	MULT SERIES	POLE TYPE	SHADE	ADDRESS NUMBER	REF	LOCATION	TAX DIST	DATE INST	DATE CHANGE
	05800	S	M	SOH	II	00000	149	LANCASTER & YORK ST.								12	111366	1/1/0001
	05800	S	M	SOH	II	00000	150	LANCASTER AVE. AT BELTINE RR								12	120164	1/1/0001
	05800	S	M	SOH	II	00709	148									12	111366	1/1/0001
	05800	S	M	SOH	II	00712	000									12	120257	1/1/0001

OFFICE: 311		ROUTE: 564		ST_REF_NO: 00000107910		LANCASTER COURT		LUMENS	BULB TYPE	MULT SERIES	POLE TYPE	SHADE	ADDRESS NUMBER	REF	LOCATION	TAX DIST	DATE INST	DATE CHANGE
	05800	S	M	OUG	II	00000	001	SIDE REAR OF 4424 LANCASTER CT.								12	110893	1/1/0001
	05800	S	M	OUG	V	04413	002									12	110893	1/1/0001
	05800	S	M	OUG	V	04425	003									12	110893	1/1/0001

OFFICE: 311		ROUTE: 564		ST_REF_NO: 00000108000		LANCLOT LANE		LUMENS	BULB TYPE	MULT SERIES	POLE TYPE	SHADE	ADDRESS NUMBER	REF	LOCATION	TAX DIST	DATE INST	DATE CHANGE
	04000	S	M	OUG	II	00000	015	SIDE 3500 GREENLAWN								12	060886	1/1/0001
	05800	S	M	OUG	II	00000	038	SIDE OF 3493 KING ARTHUR								12	081869	1/1/0001
	05800	S	M	OUG	II	00356	039									12	081869	1/1/0001
	05800	S	M	OUG	II	00367	000									12	090170	1/1/0001
	05800	S	M	OUG	II	00384	000									12	080173	1/1/0001
	05800	S	M	OUG	II	00395	000									12	091774	1/1/0001
	05800	S	M	OUG	II	00408	000									12	060171	1/1/0001
	05800	S	M	OUG	II	00417	055									12	061580	1/1/0001
	05800	S	M	OUG	II	00428	000									12	060171	1/1/0001
	05800	S	M	OUG	II	00443	057									12	061580	1/1/0001
	05800	S	M	OUG	II	00452	000									12	060171	1/1/0001
	05800	S	M	OUG	II	00463	060									12	111580	1/1/0001

OFFICE: 311

ROUTE: 564

ST_REF_NO: 00000108050

LANDER COURT

LUMENS	BULB TYPE	MULT SERIES	POLE TYPE	SHADE	ADDRESS NUMBER	REF	LOCATION	TAX DIST	DATE INST	DATE CHANGE
05800	S		CNT	II	00000	002	SIDE OF 3245 SANDERSVILLE RD, ON LANDER CT	12	080210	1/1/0001
05800	S		CNT	II	03113	001		12	080210	1/1/0001

OFFICE: 311

ROUTE: 564

ST_REF_NO: 00000108100

LANE ALLEN ROAD

LUMENS	BULB TYPE	MULT SERIES	POLE TYPE	SHADE	ADDRESS NUMBER	REF	LOCATION	TAX DIST	DATE INST	DATE CHANGE
22000	S	M	SOH	III	00000	005	S side, W of Harrodsburg Rd.	12	110761	11/7/1961
22000	S	M	OOH	II	00000	112	OPP. 645 (ug to oh feed 10/2011)	12	071583	10/17/2011
09500	S	M	OUG	II	00000	052	OPP. 1065	12	020889	1/1/0001
09500	S	M	OUG	II	00000	053	OPP. 1073	12	020889	1/1/0001
09500	S	M	OUG	II	01061	051		12	020889	1/1/0001
09500	S	M	OUG	II	01100	054		12	020889	1/1/0001
09500	S	M	OUG	II	01105	055		12	020889	1/1/0001
09500	S	M	OUG	II	01112	056		12	020889	1/1/0001
09500	S	M	OUG	II	01121	057		12	020889	1/1/0001
09500	S	M	OUG	II	01126	058		12	020889	1/1/0001
09500	S	M	OUG	II	01133	059		12	020889	1/1/0001
09500	S	M	OUG	II	01136	060		12	020889	1/1/0001
09500	S	M	OUG	II	01149	061		12	020889	1/1/0001
09500	S	M	OUG	II	01154	062		12	020889	1/1/0001
09500	S	M	OUG	II	01168	063		12	020889	1/1/0001
09500	S	M	OUG	II	01169	064		12	020889	1/1/0001
09500	S	M	OUG	II	01176	065		12	020889	1/1/0001
09500	S	M	OUG	II	01180	066		12	020889	1/1/0001
22000	S	M	OOH	III	00000	004	N. SIDE, W. OF HARRODSBURG RD.	12	110761	1/1/0001
22000	S	M	OUG	II	00000	006	OPP. 721 & 725	12	050889	1/1/0001
22000	S	M	OUG	II	00000	007	OPP. 747	12	050889	1/1/0001
22000	S	M	OUG	II	00000	008	OPP. 755	12	050889	1/1/0001
22000	S	M	OUG	II	00000	009	OPP. 767	12	050889	1/1/0001
22000	S	M	OUG	II	00000	011	OPP. 801	12	050889	1/1/0001
22000	S	M	OUG	II	00000	013	OPP. 827	12	050889	1/1/0001
22000	S	M	OUG	II	00000	015	OPP. 833	12	050889	1/1/0001
22000	S	M	OUG	II	00000	017	SIDE OF 2001 GARDEN SPRINGS DR.	12	110888	1/1/0001
09500	S	M	OUG	II	00000	018	OPP. 881	12	110888	1/1/0001

OFFICE: 311

ROUTE: 564

ST_REF_NO: 00000108100

LANE ALLEN ROAD

LUMENS	BULB TYPE	MULT SERIES	POLE TYPE	SHADE	ADDRESS NUMBER	REF	LOCATION	TAX DIST	DATE INST	DATE CHANGE
09500	S	M	OUG	II	00000	020	OPP. 887	12	100888	1/1/0001
09500	S	M	OUG	II	00000	031	OPP. 937	12	020889	1/1/0001
09500	S	M	OUG	II	00000	042	OPP. 1029	12	020889	1/1/0001
09500	S	M	OUG	II	00000	043	OPP. 1029	12	020889	1/1/0001
09500	S	M	OUG	II	00000	045	OPP. TRAVELLER RD.	12	020889	1/1/0001
09500	S	M	OUG	II	00000	046	SIDE OF 1857 TRAVELLER RD.	12	020889	1/1/0001
09500	S	M	OUG	II	00000	047	SIDE OF 1857 TRAVELLER RD., S. SIDE	12	020889	1/1/0001
09500	S	M	OUG	II	00000	050	OPP. 1053	12	020889	1/1/0001
22000	S	M	OUG	II	00779	010		12	050889	1/1/0001
22000	S	M	OUG	II	00817	012		12	050889	1/1/0001
09500	S	M	OUG	II	00830	019		12	110888	1/1/0001
22000	S	M	OUG	II	00831	014		12	050889	1/1/0001
22000	S	M	OUG	II	00847	016		12	050889	1/1/0001
09500	S	M	OUG	II	00866	022		12	100888	1/1/0001
09500	S	M	OUG	II	00890	024		12	100888	1/1/0001
09500	S	M	OUG	II	00891	021		12	100888	1/1/0001
09500	S	M	OUG	II	00899	023		12	100888	1/1/0001
09500	S	M	OUG	II	00909	026		12	100888	1/1/0001
09500	S	M	OUG	II	00914	025		12	100888	1/1/0001
09500	S	M	OUG	II	00925	028		12	100888	1/1/0001
09500	S	M	OUG	II	00937	030		12	020889	1/1/0001
09500	S	M	OUG	II	00938	027		12	100888	1/1/0001
09500	S	M	OUG	II	00968	029		12	100888	1/1/0001
09500	S	M	OUG	II	00995	032		12	020889	1/1/0001
09500	S	M	OUG	II	00998	033		12	020889	1/1/0001
22000	S	M	SOH	II	00998	034		12	020889	1/1/0001
22000	S	M	OUG	II	01001	035		12	020889	1/1/0001
09500	S	M	OUG	II	01004	036		12	020889	1/1/0001
09500	S	M	OUG	II	01005	037		12	020889	1/1/0001
09500	S	M	OUG	II	01013	039		12	020889	1/1/0001
09500	S	M	OUG	II	01014	038		12	020889	1/1/0001
09500	S	M	OUG	II	01020	040		12	020889	1/1/0001
09500	S	M	OUG	II	01025	041		12	020889	1/1/0001
09500	S	M	OUG	II	01033	044		12	020889	1/1/0001

OFFICE: 311

ROUTE: 564

ST_REF_NO: 00000108100 LANE ALLEN ROAD

LUMENS	BULB TYPE	MULT SERIES	POLE TYPE	SHADE	ADDRESS NUMBER	REF	LOCATION	TAX DIST	DATE INST	DATE CHANGE
09500	S	M	OUG	II	01049	049		12	020889	1/1/0001
22000	S	M	OOH	III	00000	001	N. SIDE, E. OF HARRODSBURG RD.	12	071583	1/1/0001
22000	S	M	OOH	III	00000	002	S. SIDE, E. OF HARRODSBURG RD.	12	071583	1/1/0001
22000	S	M	SOH	III	00000	003	S. SIDE , AT HARRODSBURG RD.	12	071583	1/1/0001
22000	S	M	SOH	III	00601	118		12	071583	1/1/0001
22000	S	M	OUG	II	00603	117		12	071583	1/1/0001
22000	S	M	OUG	II	00606	116		12	071583	1/1/0001
22000	S	M	OUG	II	00614	115		12	071583	1/1/0001
22000	S	M	OUG	II	00619	114		12	071583	1/1/0001
22000	S	M	OUG	II	00624	113		12	071583	1/1/0001

OFFICE: 311

ROUTE: 564

ST_REF_NO: 00000108115 LANGDON COURT

LUMENS	BULB TYPE	MULT SERIES	POLE TYPE	SHADE	ADDRESS NUMBER	REF	LOCATION	TAX DIST	DATE INST	DATE CHANGE
05800	S	M	OUG	II	02109	001		12	080896	1/1/0001

OFFICE: 311

ROUTE: 564

ST_REF_NO: 00000108120 LANGHORNE DRIVE

LUMENS	BULB TYPE	MULT SERIES	POLE TYPE	SHADE	ADDRESS NUMBER	REF	LOCATION	TAX DIST	DATE INST	DATE CHANGE
05800	S	M	OUG	II	00000	013	SIDE REAR OF 4217 STEAMBOAT ROAD	12	060897	1/1/0001
05800	S	M	OUG	II	01980	012		12	060897	1/1/0001
04000	S	M	OUG	II	01992	014		12	121579	1/1/0001
04000	S	M	OUG	II	02005	015		12	121579	1/1/0001
04000	S	M	OUG	II	02016	016		12	121579	1/1/0001
04000	S	M	OUG	II	02025	017		12	121579	1/1/0001
04000	S	M	OUG	II	02033	018		12	121579	1/1/0001
04000	S	M	OUG	II	02044	019		12	121579	1/1/0001
04000	S	M	OUG	II	02053	050		12	121582	1/1/0001

OFFICE: 311

ROUTE: 564

ST_REF_NO: 00000108125 LANDRIDGE DRIVE

LUMENS	BULB TYPE	MULT SERIES	POLE TYPE	SHADE	ADDRESS NUMBER	REF	LOCATION	TAX DIST	DATE INST	DATE CHANGE
05800	S	M	OUG	II	00000	001	SIDE REAR 1217 WYNDHAM FOREST CIRCLE	12	020897	1/1/0001
05800	S	M	OUG	II	00000	004	SIDE REAR OF 3897 ARIA LANE	12	020897	1/1/0001

OFFICE: 311		ROUTE: 564		ST_REF_NO: 00000108125		LANDRIDGE DRIVE		LUMENS	BULB TYPE	MULT SERIES	POLE TYPE	SHADE	ADDRESS NUMBER	REF	LOCATION	TAX DIST	DATE INST	DATE CHANGE
05800	S	M	OUG	III	03808	007										12	070899	1/1/0001
05800	S	M	OUG	II	03825	006										12	070899	1/1/0001
05800	S	M	OUG	II	03832	005										12	020897	1/1/0001
05800	S	M	OUG	II	03856	003										12	070899	1/1/0001
05800	S	M	OUG	II	03869	002										12	070899	1/1/0001

OFFICE: 311		ROUTE: 564		ST_REF_NO: 00000108135		LANGLEY CIRCLE		LUMENS	BULB TYPE	MULT SERIES	POLE TYPE	SHADE	ADDRESS NUMBER	REF	LOCATION	TAX DIST	DATE INST	DATE CHANGE
05800	S	M	CNT	III	04513	004										12	080897	1/1/0001
05800	S	M	CNT	II	04521	003										12	080897	1/1/0001
05800	S	M	CNT	II	04528	002										12	080897	1/1/0001
05800	S	M	CNT	II	04545	001										12	080897	1/1/0001

OFFICE: 311		ROUTE: 564		ST_REF_NO: 00000108180		LANGSFORD COURT		LUMENS	BULB TYPE	MULT SERIES	POLE TYPE	SHADE	ADDRESS NUMBER	REF	LOCATION	TAX DIST	DATE INST	DATE CHANGE
04000	S	M	OUG	II	00000	001									SIDE 3949 BOSTON RD AT 800 LANSFORD CT	12	100890	1/1/0001

OFFICE: 311		ROUTE: 564		ST_REF_NO: 00000108190		LANGSTANE LANE		LUMENS	BULB TYPE	MULT SERIES	POLE TYPE	SHADE	ADDRESS NUMBER	REF	LOCATION	TAX DIST	DATE INST	DATE CHANGE
05800	S	M	CNT	II	00000	001									SIDE OF 2269 SPURR ROAD ON LANGSTANE LANE	12	042506	1/1/0001
05800	S	M	CNT	II	00000	006									SIDE OF 2040 DRUMMOND DR ON LANGSTANE LANE	12	042506	1/1/0001
05800	S	M	CNT	II	00000	007									SIDE OF 2041 DRUMMOND DR ON LANSTANE LANE	12	042506	1/1/0001
05800	S	M	CNT	II	02505	002										12	042506	1/1/0001
05800	S	M	CNT	II	02520	003										12	042506	1/1/0001
05800	S	M	CNT	II	02532	004										12	042506	1/1/0001
05800	S	M	CNT	II	02548	005										12	042506	1/1/0001

OFFICE: 311		ROUTE: 564		ST_REF_NO: 00000108200		LANNETTE LANE		LUMENS	BULB TYPE	MULT SERIES	POLE TYPE	SHADE	ADDRESS NUMBER	REF	LOCATION	TAX DIST	DATE INST	DATE CHANGE
04000	S	M	OUG	II	00000	009									OPP. 3477 LANNETTE LANE	12	050891	1/1/0001

OFFICE: 311

ROUTE: 564

ST_REF_NO: 00000108200

LANNETTE LANE

LUMENS	BULB TYPE	MULT SERIES	POLE TYPE	SHADE	ADDRESS NUMBER	REF	LOCATION	TAX DIST	DATE INST	DATE CHANGE
04000	S	M	OUG	II	00000	011	OPP. 3492 LANNETTE LANE	12	050891	1/1/0001
04000	S	M	OUG	II	03417	001		12	050891	1/1/0001
04000	S	M	OUG	II	03420	002		12	050891	1/1/0001
05800	S	M	OUG	II	03433	003		12	050891	1/1/0001
04000	S	M	OUG	II	03436	004		12	050891	1/1/0001
04000	S	M	OUG	II	03445	005		12	050891	1/1/0001
04000	S	M	OUG	II	03452	006		12	050891	1/1/0001
04000	S	M	OUG	II	03461	007		12	050891	1/1/0001
04000	S	M	OUG	V	03465	008		12	050891	1/1/0001
04000	S	M	OUG	II	03484	010		12	050891	1/1/0001

OFFICE: 311

ROUTE: 564

ST_REF_NO: 00000108300

LANSLOWNE DRIVE

LUMENS	BULB TYPE	MULT SERIES	POLE TYPE	SHADE	ADDRESS NUMBER	REF	LOCATION	TAX DIST	DATE INST	DATE CHANGE
09500	S	M	OUG	II	03589	073	light found not in system	12	060105	1/1/0001
05800	S	M	OUG	II	00000	002	SIDE OF 274 ARGONNE DR.	12	010171	1/1/0001
09500	S	M	OUG	II	00000	037	SIDE OF A-75 CROSS CREEK APTS-upgrade 6/05	12	060269	1/1/0001
09500	S	M	OUG	II	00000	039	SIDE 3489-H CROSS CREEK APTS-upgrade 6/05	12	060269	1/1/0001
09500	S	M	OUG	II	00000	041	SIDE OF 3489-A CROSS CREEK APTS-upgrade 6/05	12	060269	1/1/0001
22000	S	M	OUG	II	00000	079	SSIDE OF LANSLOWNE DR. AT NEW CIRCLE ROAD OVERPASS	12	040899	1/1/0001
22000	S	M	OUG	II	00000	080	1ST LT E OF NEW CIRCLE RD., SSIDE-upgraded 6/05	12	040899	1/1/0001
09500	S	M	OUG	II	00000	085	OPP. 3424 LANSLOWNE DR., SSIDE IN MEDIAN	12	040899	1/1/0001
09500	S	M	OUG	II	00000	086	OPP. 3425 LANSLOWNE DR., NSIDE IN MEDIAN	12	040899	1/1/0001
09500	S	M	OUG	II	00000	087	OPP. 3416 LANSLOWNE DR., SSIDE IN MEDIAN	12	040899	1/1/0001
09500	S	M	OUG	II	00000	088	OPP. 3417 LANSLOWNE DR., NSIDE IN MEDIAN	12	040899	1/1/0001
09500	S	M	OUG	II	00000	090	SIDE OF 3428 BELLEFONTE DR.	12	040899	1/1/0001
22000	S	M	OUG	II	00000	092	SIDE OF 424 MALABU DR.-upgraded to 22,000 6/05	12	040899	1/1/0001
22000	S	M	OUG	II	00000	093	SIDE OF 701 MALABU DR-upgraded to 22,000 6/05	12	040899	1/1/0001
22000	S	M	OUG	II	00000	094	SIDE OF 429 MALABU DR-upgraded to 22,000 6/05	12	040899	1/1/0001
09500	S	M	OUG	II	00000	095	SIDE OF 3401 NANTUCKET RD.	12	040899	1/1/0001
09500	S	M	OUG	II	00000	096	SIDE OF 3551 NANTUCKET RD.	12	040899	1/1/0001
09500	S	M	OUG	II	00000	097	SIDE OF 3400 NANTUCKET RD.	12	040899	1/1/0001
09500	S	M	OUG	II	00000	098	SIDE OF 3348 NANTUCKET RD.	12	040899	1/1/0001

OFFICE: 311

ROUTE: 564

ST_REF_NO: 00000108300

LANSDOWNE DRIVE

LUMENS	BULB TYPE	MULT SERIES	POLE TYPE	SHADE	ADDRESS NUMBER	REF	LOCATION	TAX DIST	DATE INST	DATE CHANGE
09500	S	M	OUG	II	00000	100	SIDE OF 3349 BRAEMER DR.	12	040899	1/1/0001
09500	S	M	OUG	II	00000	101	SIDE OF 700 KIRKLAND DR.	12	040899	1/1/0001
09500	S	M	OUG	II	00000	102	SIDE OF 3340 BRAEMER DR.	12	040899	1/1/0001
09500	S	M	OUG	II	00000	103	SIDE OF 703 KIRKLAND DR.	12	040899	1/1/0001
09500	S	M	OUG	II	00000	105	SIDE OF 700 BURKSHIRE DR.	12	040899	1/1/0001
09500	S	M	OUG	II	00000	107	SIDE OF 701 BURKSHIRE DR.	12	040899	1/1/0001
09500	S	M	OUG	II	00000	109	SIDE OF 800 WESTCHESTER DR.	12	040899	1/1/0001
09500	S	M	OUG	II	00000	111	SIDE OF 801 WESTCHESTER DR.	12	040899	1/1/0001
09500	S	M	OUG	II	00000	113	SIDE OF 800 BROOK HILL DR.	12	040899	1/1/0001
09500	S	M	OUG	II	00000	114	SIDE OF 750 BROOK HILL DR.	12	040899	1/1/0001
09500	S	M	OUG	II	00000	115	SIDE OF 801 BROOK HILL DR.	12	040899	1/1/0001
09500	S	M	OUG	II	00000	116	SIDE OF 755 BROOK HILL DR.	12	040899	1/1/0001
09500	S	M	OUG	II	00000	117	2ND LT E OF BROOK HILL DR., NSIDE OF LANSDOWNE DR.	12	040899	1/1/0001
09500	S	M	OUG	II	00000	118	2ND LT E OF BROOK HILL DR., SSIDE OF LANSDOWNE DR.	12	040899	1/1/0001
09500	S	M	OUG	II	00000	119	3RD LT E OF BROOK HILL DR., SSIDE OF LANSDOWNE DR.	12	040899	1/1/0001
09500	S	M	OUG	II	00000	129	SIDE OF 3257 TATES CREEK RD.	12	040899	1/1/0001
09500	S	M	SOH	II	00000	131	SIDE OF 3257 TATES CREEK RD.	12	040899	1/1/0001
09500	S	M	OUG	II	00000	132	SSIDE OF 3245 TATES CREEK RD.	12	040899	1/1/0001
09500	S	M	OUG	II	03200	121		12	040899	1/1/0001
09500	S	M	OUG	II	03200	123		12	040899	1/1/0001
09500	S	M	OUG	II	03205	130		12	040899	1/1/0001
09500	S	M	OUG	II	03208	127		12	040899	1/1/0001
09500	S	M	OUG	II	03213	128		12	040899	1/1/0001
09500	S	M	OUG	II	03220	125		12	040899	1/1/0001
09500	S	M	OUG	II	03221	126		12	040899	1/1/0001
09500	S	M	OUG	II	03245	124		12	040899	1/1/0001
09500	S	M	OUG	II	03253	122		12	040899	1/1/0001
09500	S	M	OUG	II	03301	120		12	040899	1/1/0001
09500	S	M	OUG	II	03321	112		12	040899	1/1/0001
09500	S	M	OUG	II	03325	110		12	040899	1/1/0001
09500	S	M	OUG	II	03333	108		12	040899	1/1/0001
09500	S	M	OUG	II	03337	106		12	040899	1/1/0001

OFFICE: 311

ROUTE: 564

ST_REF_NO: 00000108300

LANSDOWNE DRIVE

LUMENS	BULB TYPE	MULT SERIES	POLE TYPE	SHADE	ADDRESS NUMBER	REF	LOCATION	TAX DIST	DATE INST	DATE CHANGE
09500	S	M	OUG	II	03341	104		12	040899	1/1/0001
09500	S	M	OUG	II	03354	099		12	040899	1/1/0001
22000	S	M	OUG	II	03400	091	upgraded to 22,000 hps cobra June 2005	12	040899	1/1/0001
09500	S	M	OUG	II	03408	089		12	040899	1/1/0001
09500	S	M	OUG	II	03437	084		12	040899	1/1/0001
09500	S	M	OUG	II	03440	083		12	040899	1/1/0001
09500	S	M	OUG	II	03449	082		12	040899	1/1/0001
09500	S	M	OUG	II	03454	001	upgraded to 9500 hps cobra June 2005	12	010172	1/1/0001
09500	S	M	OUG	II	03462	003	upgraded to 9500 hps cobra June 2005	12	080173	1/1/0001
09500	S	M	OUG	II	03472	005	upgraded to 9500 hps cobra June 2005	12	080173	1/1/0001
09500	S	M	OUG	II	03475	004	upgraded to 9500 hps cobra June 2005	12	051967	1/1/0001
09500	S	M	OUG	II	03476	007	upgraded to 9500 hps cobra June 2005	12	060269	1/1/0001
09500	S	M	OUG	II	03480	040	upgraded to 9500 hps cobra June 2005	12	090170	1/1/0001
09500	S	M	OUG	II	03483	006	upgraded to 9500 hps cobra June 2005	12	080173	1/1/0001
09500	S	M	OUG	II	03490	038	upgraded to 9500 hps cobra June 2005	12	090170	1/1/0001
09500	S	M	OUG	II	03492	050	upgraded to 9500 hps cobra June 2005	12	060886	1/1/0001
22000	S	M	OUG	II	03498	052	upgraded to 22,000 hps cobra June 2005	12	060886	1/1/0001
09500	S	M	OUG	II	03499	051	upgraded to 9500 hps cobra June 2005	12	060886	1/1/0001
05800	S	M	OUG	II	00000	046	SIDE OF 3205 MONTAVESTA IN MEDIAN	12	010172	1/1/0001
05800	S	M	OUG	II	00000	047	OPP. 3193 IN MEDIAN	12	010172	1/1/0001
22000	S	M	OUG	II	00000	053	OPP. 3500-upgraded to 22,000 hps cobra June 2005	12	060886	1/1/0001
09500	S	M	OUG	II	00000	055	OPP. 3506-upgraded to 9500 hps cobra June 2005	12	060886	1/1/0001
09500	S	M	OUG	II	00000	057	OPP. 3512-upgraded to 9500 hps cobra June 2005	12	060886	1/1/0001
09500	S	M	OUG	II	00000	059	OPP. 3518-upgraded to 9500 hps cobra June 2005	12	060886	1/1/0001
09500	S	M	OUG	II	00000	069	OPP. 3570-upgraded to 9500 hps cobra June 2005	12	060886	1/1/0001
09500	S	M	OUG	II	00000	072	OPP. 3593-upgraded to 9500 hps cobra June 2005	12	060886	1/1/0001
22000	S	M	OUG	II	03502	054	upgraded to 22,000 hps cobra June 2005	12	060886	1/1/0001
09500	S	M	OUG	II	03508	056	upgraded to 9500 hps cobra June 2005	12	060886	1/1/0001
09500	S	M	OUG	II	03516	058	upgraded to 9500 hps cobra June 2005	12	060886	1/1/0001
09500	S	M	OUG	II	03522	060	upgraded to 9500 hps cobra June 2005	12	060886	1/1/0001
09500	S	M	OUG	II	03528	062	upgraded to 9500 hps cobra June 2005	12	010885	1/1/0001
09500	S	M	OUG	II	03529	061	upgraded to 9500 hps cobra June 2005	12	010886	1/1/0001
09500	S	M	OUG	II	03535	063	upgraded to 9500 hps cobra June 2005	12	010886	1/1/0001
09500	S	M	OUG	II	03536	064	upgraded to 9500 hps cobra June 2005	12	060886	1/1/0001

Street Light Listing run 1/11/2015 10:43:21 AM

Page 576 of 1254

OFFICE: 311		ROUTE: 564		ST_REF_NO: 00000108300		LANSDOWNE DRIVE		LUMENS	BULB TYPE	MULT SERIES	POLE TYPE	SHADE	ADDRESS NUMBER	REF	LOCATION	TAX DIST	DATE INST	DATE CHANGE
09500	S	M	OUG	II	03545	065	upgraded to 9500 hps cobra June 2005	12	060886	1/1/0001								
09500	S	M	OUG	II	03552	066	upgraded to 9500 hps cobra June 2005	12	060886	1/1/0001								
09500	S	M	OUG	II	03559	067	upgraded to 9500 hps cobra June 2005	12	060886	1/1/0001								
09500	S	M	OUG	II	03564	068	upgraded to 9500 hps cobra June 2005	12	060886	1/1/0001								
09500	S	M	OUG	II	03570	070	upgraded to 9500 hps cobra June 2005	12	060886	1/1/0001								
22000	S	M	OUG	II	03593	071	upgraded to 22,000 hps cobra June 2005	12	060886	1/1/0001								

OFFICE: 311		ROUTE: 564		ST_REF_NO: 00000108500		LANSILL ROAD		LUMENS	BULB TYPE	MULT SERIES	POLE TYPE	SHADE	ADDRESS NUMBER	REF	LOCATION	TAX DIST	DATE INST	DATE CHANGE
05800	S	M	OUG	II	00000	063	SIDE OF 1003 PINE BLOOM	12	081265	1/1/0001								
05800	S	M	OUG	II	02147	067		12	081265	1/1/0001								
05800	S	M	OUG	II	02160	066		12	081265	1/1/0001								
05800	S	M	OUG	II	02175	065		12	081265	1/1/0001								
05800	S	M	OUG	II	02188	064		12	081265	1/1/0001								
05800	S	M	OUG	II	00000	069	OPP. 2120	12	081265	1/1/0001								
05800	S	M	OUG	II	00000	071	OPP. JUNIPER DR.	12	081265	1/1/0001								
05800	S	M	OUG	II	02108	070		12	081265	1/1/0001								
05800	S	M	OUG	II	02136	068		12	081265	1/1/0001								

OFFICE: 311		ROUTE: 564		ST_REF_NO: 00000108605		LANTA PARK		LUMENS	BULB TYPE	MULT SERIES	POLE TYPE	SHADE	ADDRESS NUMBER	REF	LOCATION	TAX DIST	DATE INST	DATE CHANGE
05800	S	M	CNT	II	00412	002		12	050404	1/1/0001								

OFFICE: 311		ROUTE: 564		ST_REF_NO: 00000108610		LAPPIN LANE		LUMENS	BULB TYPE	MULT SERIES	POLE TYPE	SHADE	ADDRESS NUMBER	REF	LOCATION	TAX DIST	DATE INST	DATE CHANGE
09500	S	M	CNT	II	00000	102	SIDE OF 841 QUARTER HORSE CT.	12	080894	11/14/2012								
05800	S	M	CNT	II	00000	100	SIDE OF 836 PALAMINO LANE	12	080894	1/1/0001								
05800	S	M	CNT	II	00000	101	SIDE OF 901 PALAMINO LANE	12	080894	1/1/0001								
05800	S	M	CNT	II	03033	103		12	080897	1/1/0001								

OFFICE: 311

ROUTE: 564

ST_REF_NO: 00000108700

LARAMIE DRIVE

LUMENS	BULB TYPE	MULT SERIES	POLE TYPE	SHADE	ADDRESS NUMBER	REF	LOCATION	TAX DIST	DATE INST	DATE CHANGE
04000	S	M	OUG	II	00000	018	SIDE OF 634 CARDINAL LANE	12	101583	1/1/0001
04000	S	M	OUG	II	00000	019	SIDE OF 601 LARAMIE	12	101583	1/1/0001
05800	S	M	OUG	II	00000	024	OPP. 641 upgrade 6/08	12	101583	1/1/0001
04000	S	M	OUG	II	00600	020		12	101583	1/1/0001
04000	S	M	OUG	II	00612	021		12	101583	1/1/0001
04000	S	M	OUG	II	00624	022		12	101583	1/1/0001
04000	S	M	OUG	II	00633	023		12	101583	1/1/0001

OFFICE: 311

ROUTE: 564

ST_REF_NO: 00000108800

LARCH LANE

LUMENS	BULB TYPE	MULT SERIES	POLE TYPE	SHADE	ADDRESS NUMBER	REF	LOCATION	TAX DIST	DATE INST	DATE CHANGE
04000	S	M	OUG	II	00310	128		12	121582	1/1/0001
04000	S	M	OUG	II	00317	129		12	121582	1/1/0001
04000	S	M	OUG	II	00330	130		12	121582	1/1/0001
04000	S	M	OUG	II	00219	121		12	121582	1/1/0001
04000	S	M	OUG	II	00232	122		12	121582	1/1/0001
04000	S	M	OUG	II	00247	123		12	121582	1/1/0001
04000	S	M	OUG	II	00260	124		12	121582	1/1/0001
04000	S	M	OUG	II	00271	125		12	121582	1/1/0001
04000	S	M	OUG	II	00284	126		12	121582	1/1/0001
04000	S	M	OUG	II	00299	127		12	121582	1/1/0001

OFFICE: 311

ROUTE: 564

ST_REF_NO: 00000108900

LAREDO DRIVE

LUMENS	BULB TYPE	MULT SERIES	POLE TYPE	SHADE	ADDRESS NUMBER	REF	LOCATION	TAX DIST	DATE INST	DATE CHANGE
09500	S	M	OUG	II	00000	042	1ST LT E OF WALDEN DRIVE, S SIDE ON LAREDO	12	011702	1/1/0001
09500	S	M	OUG	II	00000	043	2ND LT E OF WALDE DRIVE, N SIDE ON LAREDO	12	011702	1/1/0001
09500	S	M	OUG	II	00000	044	3RD LT E OF WALDEN DRIVE, S SIDE ON LAREDO	12	011702	1/1/0001
09500	S	M	OUG	II	00000	045	4TH LT E OF WALDEN DRIVE, N SIDE ON LAREDO	12	011702	1/1/0001
09500	S	M	OUG	II	00000	046	5TH LT E OF WALDEN DRIVE, S SIDE ON LAREDO	12	011702	1/1/0001
05800	S	M	OUG	II	00000	001	OPP. 3512 LAREDO	12	090884	1/1/0001
05800	S	M	OUG	II	00000	027	SIDE OF 3341 DOWNING PLACE	12	110893	1/1/0001
05800	S	M	OUG	II	00000	031	OPP. 3612	12	051582	1/1/0001
05800	S	M	OUG	II	00000	033	OPP. 3600	12	051582	1/1/0001

OFFICE: 311

ROUTE: 564

ST_REF_NO: 00000108900

LAREDO DRIVE

LUMENS	BULB TYPE	MULT SERIES	POLE TYPE	SHADE	ADDRESS NUMBER	REF	LOCATION	TAX DIST	DATE INST	DATE CHANGE
09500	S	M	OUG	II	00000	038	SIDE OF 3311 MORHAM DRIVE	12	020800	1/1/0001
09500	S	M	OUG	II	00000	039	REAR OF 509 BIG BEAR DRIVE	12	020800	1/1/0001
09500	S	M	OUG	II	00000	041	REAR OF 521 BIG BEAR DRIVE	12	020800	1/1/0001
05800	S	M	OUG	II	00000	066	SIDE OF 368 REDDING RD.	12	051475	1/1/0001
05800	S	M	OUG	II	03404	068		12	051475	1/1/0001
05800	S	M	OUG	II	03413	083		12	120889	1/1/0001
05800	S	M	OUG	II	03413	084		12	120889	1/1/0001
05800	S	M	OUG	II	03440	085		12	120889	1/1/0001
05800	S	M	OUG	II	03445	086		12	120889	1/1/0001
05800	S	M	OUG	II	03464	087		12	120889	1/1/0001
05800	S	M	OUG	II	03500	002		12	111580	1/1/0001
05800	S	M	OUG	II	03500	004		12	111580	1/1/0001
05800	S	M	OUG	II	03501	001		12	111580	1/1/0001
05800	S	M	OUG	II	03501	003		12	111580	1/1/0001
05800	S	M	OUG	II	03517	002		12	090884	1/1/0001
05800	S	M	OUG	II	03542	003		12	090884	1/1/0001
05800	S	M	OUG	II	03562	004		12	090884	1/1/0001
05800	S	M	OUG	II	03579	005		12	120889	1/1/0001
05800	S	M	OUG	II	03580	006		12	111580	1/1/0001
05800	S	M	OUG	II	03605	007		12	120889	1/1/0001
05800	S	M	OUG	II	03608	032		12	111478	1/1/0001
05800	S	M	OUG	II	03624	030		12	051581	1/1/0001
05800	S	M	OUG	II	03632	028		12	051581	1/1/0001
05800	S	M	OUG	II	03633	029		12	081582	1/1/0001
09500	S	M	OUG	II	03652	034		12	020800	1/1/0001
09500	S	M	OUG	II	03665	035		12	020800	1/1/0001
09500	S	M	OUG	II	03676	036		12	020800	1/1/0001
09500	S	M	OUG	II	03689	037		12	020800	1/1/0001
09500	S	M	OUG	II	03708	040		12	020800	1/1/0001

OFFICE: 311

ROUTE: 564

ST_REF_NO: 00000108950

LARGO CIRCLE

LUMENS	BULB TYPE	MULT SERIES	POLE TYPE	SHADE	ADDRESS NUMBER	REF	LOCATION	TAX DIST	DATE INST	DATE CHANGE
05800	S	M	CNT	III	00412	001		12	050404	1/1/0001

OFFICE: 311		ROUTE: 564		ST_REF_NO: 00000108955		LARGO LANE		LUMENS	BULB TYPE	MULT SERIES	POLE TYPE	SHADE	ADDRESS NUMBER	REF	LOCATION	TAX DIST	DATE INST	DATE CHANGE
05800	S		CNT	III	04412	010										12	041013	1/1/0001
05800	S	M	CNT	II	00000	001	SIDE OF 440 SOUTH POINT DR ON LARGO LANE									12	050404	1/1/0001
05800	S	M	CNT	II	04425	007										12	050404	1/1/0001
05800	S	M	CNT	II	04437	006										12	060205	1/1/0001
05800	S	M	CNT	II	04512	002										12	050404	1/1/0001
05800	S	M	CNT	II	04517	003										12	060205	1/1/0001
05800	S	M	CNT	II	04525	004										12	060205	1/1/0001
05800	S	M	CNT	III	04537	005										12	050404	1/1/0001

OFFICE: 311

ROUTE: 564

OFFICE: 311		ROUTE: 564		ST_REF_NO: 00000108957		LARKHILL LANE		LUMENS	BULB TYPE	MULT SERIES	POLE TYPE	SHADE	ADDRESS NUMBER	REF	LOCATION	TAX DIST	DATE INST	DATE CHANGE
05800	S	M	CNT	II	00000	002	SIDE OF 585 LANARKSHIRE PLACE ON LARKHILL LANE									12	051107	1/1/0001
05800	S	M	CNT	II	04500	001										12	051107	1/1/0001
05800	S	M	CNT	II	04528	003										12	051107	1/1/0001

OFFICE: 311

ROUTE: 564

OFFICE: 311		ROUTE: 564		ST_REF_NO: 00000109000		LARKIN ROAD		LUMENS	BULB TYPE	MULT SERIES	POLE TYPE	SHADE	ADDRESS NUMBER	REF	LOCATION	TAX DIST	DATE INST	DATE CHANGE
10000	M	M	OUG	II	00000	001	SIDE OF 2490 NICHOLASVILLE RD.									12	090172	1/1/0001
10000	M	M	OUG	II	00000	002	1ST LT. E. OF NICHOLASVILLE RD., S. SIDE									12	120869	1/1/0001
10000	M	M	OUG	II	00000	004	2ND LT. E. OF NICHOLASVILLE RD., S. SIDE									12	120869	1/1/0001
10000	M	M	OUG	II	00000	006	3RD LT. E. OF NICHOLASVILLE RD., S. SIDE									12	120869	1/1/0001
10000	M	M	OUG	II	00000	008	4TH LT. E. OF NICHOLASVILLE RD., S. SIDE									12	120869	1/1/0001
05800	S	M	OUG	II	00000	012	SIDE OF 220 MALIBU DR.									12	100174	1/1/0001
05800	S	M	OUG	II	00000	059	SIDE OF 255 MALIBU DR.									12	080166	1/1/0001
05800	S	M	SOH	II	00000	060	OPP. 2462									12	110166	1/1/0001
05800	S	M	OUG	II	00000	061	SIDE OF 2402 HEATHER WAY									12	080166	1/1/0001
05800	S	M	OUG	II	00000	066	SIDE OF 256 MELBOURNE WAY									12	051967	1/1/0001
05800	S	M	OUG	II	02412	065										12	080166	1/1/0001
05800	S	M	OUG	II	02421	064										12	080166	1/1/0001
05800	S	M	OUG	II	02436	063										12	080166	1/1/0001
05800	S	M	OUG	II	02445	062										12	080166	1/1/0001
05800	S	M	OUG	II	02504	010										12	090172	1/1/0001

Street Light Listing run 1/11/2015 10:43:21 AM

Page 580 of 1254

OFFICE: 311

ROUTE: 564

ST_REF_NO: 00000109000

LARKIN ROAD

LUMENS	BULB TYPE	MULT SERIES	POLE TYPE	SHADE	ADDRESS NUMBER	REF	LOCATION	TAX DIST	DATE INST	DATE CHANGE
05800	S	M	OUG	II	02504	011		12	090172	1/1/0001
10000	M	M	OUG	II	02505	009		12	050172	1/1/0001
10000	M	M	OUG	II	02537	007		12	100174	1/1/0001
10000	M	M	OUG	II	02553	003		12	100174	1/1/0001
10000	M	M	OUG	II	02553	005		12	100174	1/1/0001

OFFICE: 311

ROUTE: 564

ST_REF_NO: 00000109100

LARKSPUR DRIVE

LUMENS	BULB TYPE	MULT SERIES	POLE TYPE	SHADE	ADDRESS NUMBER	REF	LOCATION	TAX DIST	DATE INST	DATE CHANGE
05800	S	M	OUG	II	00000	071	OPP. SIDE OF 2082 GARDEN SPRINGS DR.	12	012474	1/1/0001
05800	S	M	OUG	II	00000	114	SIDE OF 2315 HARRODSBURG RD.	12	060170	1/1/0001
05800	S	M	OUG	II	00000	115	SIDE OF 2273 HARRODSBURG RD.	12	041476	1/1/0001
05800	S	M	OUG	II	00000	119	OPP. 2121	12	012474	1/1/0001
05800	S	M	OUG	II	02001	000		12	102263	1/1/0001
05800	S	M	OUG	II	02012	000		12	110162	1/1/0001
05800	S	M	OUG	II	02025	000		12	102263	1/1/0001
05800	S	M	OUG	II	02036	000		12	102263	1/1/0001
05800	S	M	OUG	II	02053	000		12	102263	1/1/0001
05800	S	M	OUG	II	02109	000		12	090164	1/1/0001
05800	S	M	OUG	II	02133	000		12	090164	1/1/0001
05800	S	M	OUG	II	02148	000		12	060170	1/1/0001
05800	S	M	OUG	II	02157	000		12	080164	1/1/0001

OFFICE: 311

ROUTE: 564

ST_REF_NO: 00000109200

LARKWOOD DRIVE

LUMENS	BULB TYPE	MULT SERIES	POLE TYPE	SHADE	ADDRESS NUMBER	REF	LOCATION	TAX DIST	DATE INST	DATE CHANGE
05800	S	M	OUG	II	00000	092	SIDE OF 370	12	080172	1/1/0001
05800	S	M	OUG	II	00304	000		12	080172	1/1/0001
05800	S	M	OUG	II	00313	000		12	080172	1/1/0001
05800	S	M	OUG	II	00324	000		12	080172	1/1/0001
05800	S	M	OUG	II	00341	000		12	080172	1/1/0001
05800	S	M	OUG	II	00369	000		12	080172	1/1/0001
05800	S	M	OUG	II	00386	000		12	080172	1/1/0001
05800	S	M	OUG	II	00397	000		12	062774	1/1/0001

OFFICE: 311 ROUTE: 564										
ST_REF_NO: 00000109200 LARKWOOD DRIVE										
LUMENS	BULB TYPE	MULT SERIES	POLE TYPE	SHADE	ADDRESS NUMBER	REF	LOCATION	TAX DIST	DATE INST	DATE CHANGE
04000	S	M	OUG	II	00000	015	OPP. SIDE OF 444 LARKWOOD DR.	12	090884	1/1/0001
05800	S	M	OUG	II	00408	000		12	062774	1/1/0001
05800	S	M	OUG	II	00421	000		12	062774	1/1/0001
05800	S	M	OUG	II	00437	113		12	091475	1/1/0001
04000	S	M	OUG	II	00452	016		12	090884	1/1/0001
04000	S	M	OUG	II	00468	017		12	090884	1/1/0001
05800	S	M	OUG	II	00481	018	upgrade-bad fixture	12	090884	1/1/0001
05800	S	M	OUG	II	00492	019		12	051581	1/1/0001

OFFICE: 311 ROUTE: 564										
ST_REF_NO: 00000109210 LA ROCHELLE ROAD										
LUMENS	BULB TYPE	MULT SERIES	POLE TYPE	SHADE	ADDRESS NUMBER	REF	LOCATION	TAX DIST	DATE INST	DATE CHANGE
05800	S	M	OUG	II	02403	000		12	072363	1/1/0001
05800	S	M	OUG	II	02412	000		12	072363	1/1/0001
05800	S	M	OUG	II	02423	000		12	080565	1/1/0001
05800	S	M	OUG	II	02436	000		12	100172	1/1/0001
05800	S	M	OUG	II	00000	023	SIDE OF 1300 BORDEAUX DR.	12	080565	1/1/0001

OFFICE: 311 ROUTE: 564										
ST_REF_NO: 00000109300 LASALLE ROAD										
LUMENS	BULB TYPE	MULT SERIES	POLE TYPE	SHADE	ADDRESS NUMBER	REF	LOCATION	TAX DIST	DATE INST	DATE CHANGE
05800	S	M	OUG	II	00000	022	SIDE OF 501 ASBURY	12	110369	1/1/0001
05800	S	M	OUG	II	00000	023	SIDE OF 496 ASBURY	12	110369	1/1/0001
05800	S	M	OUG	II	00000	025	SIDE OF 532 KILDARE CT.	12	100170	1/1/0001
05800	S	M	OUG	II	00000	027	OPP. MONTROSE DR.	12	010173	1/1/0001
05800	S	M	OUG	II	00000	028	SIDE OF 1531 MONTROSE DR.	12	110369	1/1/0001
05800	S	M	OUG	II	01531	063		12	070173	1/1/0001
05800	S	M	OUG	II	01534	062		12	081475	1/1/0001
05800	S	M	OUG	II	01563	026		12	010172	1/1/0001
05800	S	M	OUG	II	01583	024		12	110369	1/1/0001

OFFICE: 311		ROUTE: 564		ST_REF_NO: 00000109310		LASOMME DRIVE		LUMENS	BULB TYPE	MULT SERIES	POLE TYPE	SHADE	ADDRESS NUMBER	REF	LOCATION	TAX DIST	DATE INST	DATE CHANGE
05800	S	M	OUG	II	00180	002										22	100887	1/1/0001
05800	S	M	OUG	II	00183	001										22	100887	1/1/0001
05800	S	M	OUG	II	00215	003										22	100887	1/1/0001
05800	S	M	OUG	II	00228	004										22	100887	1/1/0001
05800	S	M	OUG	II	00245	005										22	100887	1/1/0001
05800	S	M	OUG	II	00272	006										22	100887	1/1/0001

OFFICE: 311		ROUTE: 564		ST_REF_NO: 00000109400		LATONIA PARK		LUMENS	BULB TYPE	MULT SERIES	POLE TYPE	SHADE	ADDRESS NUMBER	REF	LOCATION	TAX DIST	DATE INST	DATE CHANGE
04000	S	M	OUG	II	00000	232										12	120172	1/1/0001

OFFICE: 311		ROUTE: 564		ST_REF_NO: 00000109480		LAUDERDALE DRIVE		LUMENS	BULB TYPE	MULT SERIES	POLE TYPE	SHADE	ADDRESS NUMBER	REF	LOCATION	TAX DIST	DATE INST	DATE CHANGE
05800	S	M	CNT	II	00000	004										12	031704	1/1/0001
05800	S	M	CNT	III	00812	001										12	031704	1/1/0001
05800	S	M	CNT	II	00821	002										12	031704	1/1/0001
05800	S	M	CNT	II	00833	003										12	031704	1/1/0001
05800	S	M	CNT	II	00853	005										12	031704	1/1/0001
05800	S	M	CNT	II	00865	006										12	031704	1/1/0001
05800	S	M	CNT	II	00872	007										12	031704	1/1/0001
05800	S	M	CNT	II	00888	008										12	031704	1/1/0001
05800	S	M	CNT	II	00901	009										12	031704	1/1/0001
05800	S	M	CNT	II	00924	011										12	031704	1/1/0001
05800	S	M	CNT	II	00944	012										12	031704	1/1/0001

OFFICE: 311		ROUTE: 564		ST_REF_NO: 00000109550		LAUREL CREEK CIRCLE		LUMENS	BULB TYPE	MULT SERIES	POLE TYPE	SHADE	ADDRESS NUMBER	REF	LOCATION	TAX DIST	DATE INST	DATE CHANGE
04000	S	M	OUG	II	00000	001										12	080890	1/1/0001

OFFICE: 311 ROUTE: 564										
ST_REF_NO: 00000109595 LAUREL HILL LANE										
LUMENS	BULB TYPE	MULT SERIES	POLE TYPE	SHADE	ADDRESS NUMBER	REF	LOCATION	TAX DIST	DATE INST	DATE CHANGE
05800	S	M	CNT	III	00780	003		12	120800	1/1/0001
05800	S	M	CNT	II	00788	002		12	120800	1/1/0001
05800	S	M	CNT	II	00796	001		12	120800	1/1/0001
OFFICE: 311 ROUTE: 564										
ST_REF_NO: 00000109600 LAUREL HILL ROAD										
LUMENS	BULB TYPE	MULT SERIES	POLE TYPE	SHADE	ADDRESS NUMBER	REF	LOCATION	TAX DIST	DATE INST	DATE CHANGE
04000	S	M	OUG	II	00804	001		12	100888	1/1/0001
04000	S	M	OUG	II	00816	002		12	100888	1/1/0001
04000	S	M	OUG	II	00824	003		12	100888	1/1/0001
04000	S	M	OUG	II	00837	004		12	100888	1/1/0001
04000	S	M	OUG	II	00848	005		12	100888	1/1/0001
04000	S	M	OUG	II	00857	006		12	100888	1/1/0001
04000	S	M	OUG	II	00868	007		12	100888	1/1/0001
04000	S	M	OUG	II	00877	008		12	100888	1/1/0001
OFFICE: 311 ROUTE: 564										
ST_REF_NO: 00000109605 LAUREL OAK LANE										
LUMENS	BULB TYPE	MULT SERIES	POLE TYPE	SHADE	ADDRESS NUMBER	REF	LOCATION	TAX DIST	DATE INST	DATE CHANGE
05800	S	M	CNT	II	00000	001	SIDE 720 MILL RIDGE ROAD	12	120895	1/1/0001
05800	S	M	CNT	II	00000	002	SIDE 701 RIVERWOOD LANE	12	120895	1/1/0001
05800	S	M	CNT	II	00000	004	SIDE 700 FERNWOOD COURT	12	120895	1/1/0001
05800	S	M	CNT	II	03916	003		12	120895	1/1/0001
OFFICE: 311 ROUTE: 564										
ST_REF_NO: 00000109610 LAURELWOOD WOOD										
LUMENS	BULB TYPE	MULT SERIES	POLE TYPE	SHADE	ADDRESS NUMBER	REF	LOCATION	TAX DIST	DATE INST	DATE CHANGE
05800	S	M	OUG	III	04662	005		12	060897	1/1/0001
05800	S	M	OUG	II	04667	004		12	060897	1/1/0001
05800	S	M	OUG	II	04679	003		12	060897	1/1/0001
04000	S	M	OUG	II	04687	002		12	020895	1/1/0001
04000	S	M	OUG	II	04694	001		12	020895	1/1/0001

OFFICE: 311		ROUTE: 564		ST_REF_NO: 00000109620		LAURENHAVEN COURT		LUMENS	BULB TYPE	MULT SERIES	POLE TYPE	SHADE	ADDRESS NUMBER	REF	LOCATION	TAX DIST	DATE INST	DATE CHANGE
05800	S	M	CNT	III	03509	003										12	050899	1/1/0001
05800	S	M	CNT	II	03520	002										12	050899	1/1/0001
05800	S	M	CNT	II	03533	001										12	050899	1/1/0001
OFFICE: 311		ROUTE: 564		ST_REF_NO: 00000109700		LAWRENCE STREET		LUMENS	BULB TYPE	MULT SERIES	POLE TYPE	SHADE	ADDRESS NUMBER	REF	LOCATION	TAX DIST	DATE INST	DATE CHANGE
05800	S	M	SOH	II	00000	001	OPP. 420									12	070171	1/1/0001
05800	S	M	SOH	II	00508	000										12	070171	1/1/0001
OFFICE: 311		ROUTE: 564		ST_REF_NO: 00000109725		LAWSON LANE		LUMENS	BULB TYPE	MULT SERIES	POLE TYPE	SHADE	ADDRESS NUMBER	REF	LOCATION	TAX DIST	DATE INST	DATE CHANGE
05800	S		CNT	II	03360	004										12	062909	1/1/0001
05800	S		CNT	II	03365	003										12	062909	1/1/0001
05800	S		CNT	II	03384	002										12	062909	1/1/0001
05800	S		CNT	II	03389	001										12	062909	1/1/0001
OFFICE: 311		ROUTE: 564		ST_REF_NO: 00000109800		LE HARVE ROAD		LUMENS	BULB TYPE	MULT SERIES	POLE TYPE	SHADE	ADDRESS NUMBER	REF	LOCATION	TAX DIST	DATE INST	DATE CHANGE
05800	S	M	OUG	II	00000	011	OPP. THE SIDE OF 1376 BORDEAUX DR.									12	080565	1/1/0001
05800	S	M	OUG	II	00000	016	SIDE OF 1332 BORDEAUX DR.									12	101964	1/1/0001
05800	S	M	OUG	II	02371	014										12	080565	1/1/0001
05800	S	M	OUG	II	02376	013										12	020888	1/1/0001
05800	S	M	OUG	II	02387	012										12	101964	1/1/0001
05800	S	M	OUG	II	02356	015										12	072363	1/1/0001
OFFICE: 311		ROUTE: 564		ST_REF_NO: 00000109900		LEADER AVENUE		LUMENS	BULB TYPE	MULT SERIES	POLE TYPE	SHADE	ADDRESS NUMBER	REF	LOCATION	TAX DIST	DATE INST	DATE CHANGE
09500	S	M	SOH	I	00000	001	SIDE OF 755 S. LIME									12	070162	1/1/0001
09500	S	M	SOH	I	00165	000										12	070162	1/1/0001
09500	S	M	SOH	I	00185	000										12	070162	1/1/0001

OFFICE: 311

ROUTE: 564

ST_REF_NO: 00000110000

LEANING TREE LANE

LUMENS	BULB TYPE	MULT SERIES	POLE TYPE	SHADE	ADDRESS NUMBER	REF	LOCATION	TAX DIST	DATE INST	DATE CHANGE
04000	S	M	OUG	II	00000	026	SIDE OF 1313 POST OAK RD.	12	021580	1/1/0001
05800	S	M	OUG	II	00000	049	SIDE OF 1318	12	050897	1/1/0001
05800	S	M	OUG	II	00000	054	SIDE OF 3167 YELLOWSTONE PKWY	12	050897	1/1/0001
04000	S	M	OUG	II	01308	047		12	011581	1/1/0001
04000	S	M	OUG	II	01321	048		12	111580	1/1/0001
04000	S	M	OUG	II	01345	051		12	111580	1/1/0001
05800	S	M	OUG	II	01353	052		12	050897	1/1/0001
04000	S	M	OUG	II	01361	053		12	021580	1/1/0001

OFFICE: 311

ROUTE: 564

ST_REF_NO: 00000110050

LEATHERWOOD LANE

LUMENS	BULB TYPE	MULT SERIES	POLE TYPE	SHADE	ADDRESS NUMBER	REF	LOCATION	TAX DIST	DATE INST	DATE CHANGE
05800	S	M	CNT	II	00000	001	SIDE OF 3001 CADDIS LANE ON LEATHER WOOD LN	12	080102	1/1/0001
05800	S	M	CNT	II	00000	999	SIDE OF 3028 TOWN BRANCH RD ON LEATHER WOOD LN	12	080102	1/1/0001
05800	S	M	CNT	II	00116	002		12	080102	1/1/0001
05800	S	M	CNT	II	00133	003		12	080102	1/1/0001
05800	S	M	CNT	II	00149	004		12	051705	1/1/0001
05800	S	M	CNT	II	00160	005		12	051705	1/1/0001
05800	S	M	CNT	II	00177	006		12	051705	1/1/0001

OFFICE: 311

ROUTE: 564

ST_REF_NO: 00000110100

LEAWOOD DRIVE

LUMENS	BULB TYPE	MULT SERIES	POLE TYPE	SHADE	ADDRESS NUMBER	REF	LOCATION	TAX DIST	DATE INST	DATE CHANGE
05800	S	M	OUG	II	00000	005	SIDE OF 3425 BELVOIR DRIVE ON LEAWOOD	12	071801	1/1/0001
05800	S	M	OUG	II	00205	012		12	071801	1/1/0001
05800	S	M	OUG	II	00212	011		12	071801	1/1/0001
05800	S	M	OUG	II	00220	009		12	071801	1/1/0001
05800	S	M	OUG	II	00221	010		12	071801	1/1/0001
05800	S	M	OUG	II	00241	008		12	071801	1/1/0001
05800	S	M	OUG	II	00257	007		12	071801	1/1/0001
05800	S	M	SOH	II	00262	006		12	071801	1/1/0001
04000	S	M	OUG	II	00300	004		12	050890	1/1/0001
04000	S	M	OUG	II	00309	003		12	050890	1/1/0001

OFFICE: 311		ROUTE: 564		ST_REF_NO: 00000110100		LEAWOOD DRIVE		LUMENS	BULB TYPE	MULT SERIES	POLE TYPE	SHADE	ADDRESS NUMBER	REF	LOCATION	TAX DIST	DATE INST	DATE CHANGE
	04000	S	M	OUG	II	00316	002									12	050890	1/1/0001
	04000	S	M	OUG	II	00323	001									12	050890	1/1/0001

OFFICE: 311		ROUTE: 564		ST_REF_NO: 00000110200		LEDFORD COURT		LUMENS	BULB TYPE	MULT SERIES	POLE TYPE	SHADE	ADDRESS NUMBER	REF	LOCATION	TAX DIST	DATE INST	DATE CHANGE
	04000	S	M	OUG	II	00000	058								SIDE OF 3415 SNAFFLE RD.	12	031581	1/1/0001
	04000	S	M	OUG	V	03387	057									12	021582	1/1/0001

OFFICE: 311		ROUTE: 564		ST_REF_NO: 00000110210		LEDGEBROOK COURT		LUMENS	BULB TYPE	MULT SERIES	POLE TYPE	SHADE	ADDRESS NUMBER	REF	LOCATION	TAX DIST	DATE INST	DATE CHANGE
	05800	S	M	OUG	V	00000	001								SIDE OF 4437 HARTLAND PKWY	12	110893	1/1/0001

OFFICE: 311		ROUTE: 564		ST_REF_NO: 00000110300		LEE STREET		LUMENS	BULB TYPE	MULT SERIES	POLE TYPE	SHADE	ADDRESS NUMBER	REF	LOCATION	TAX DIST	DATE INST	DATE CHANGE
	05800	S	M	SOH	I	00000	001								OPP. 209	12	112068	1/1/0001
	05800	S	M	SOH	I	00000	002								OPP. 221	12	112068	1/1/0001
	05800	S	M	SOH	I	00000	003								OPP. 229	12	112068	1/1/0001
	05800	S	M	SOH	I	00000	004								OPP. THE SIDE OF 652 W. SECOND ST.	12	112068	1/1/0001
	05800	S	M	SOH	I	00000	005								OPP. 189	12	112068	1/1/0001
	05800	S	M	SOH	I	00000	006								OPP. 181	12	112068	1/1/0001

OFFICE: 311		ROUTE: 564		ST_REF_NO: 00000110400		LEE ADAMS LANE		LUMENS	BULB TYPE	MULT SERIES	POLE TYPE	SHADE	ADDRESS NUMBER	REF	LOCATION	TAX DIST	DATE INST	DATE CHANGE
	05800	S	M	OUG	II	00000	023								SIDE 900 BORDALLO DR.	12	060899	1/1/0001
	04000	S	M	OUG	II	03833	020									12	110884	1/1/0001
	04000	S	M	OUG	II	03844	021									12	061581	1/1/0001
	04000	S	M	OUG	II	03860	017									12	121583	1/1/0001
	04000	S	M	OUG	II	03869	018									12	081582	1/1/0001
	04000	S	M	OUG	II	03880	019									12	120890	1/1/0001
	04000	S	M	OUG	II	03881	022									12	100890	1/1/0001
	04000	S	M	OUG	II	03805	057									12	011583	1/1/0001

OFFICE: 311

ROUTE: 564

ST_REF_NO: 00000110400

LEE ADAMS LANE

LUMENS	BULB TYPE	MULT SERIES	POLE TYPE	SHADE	ADDRESS NUMBER	REF	LOCATION	TAX DIST	DATE INST	DATE CHANGE
04000	S	M	OUG	II	03812	056		12	031581	1/1/0001
04000	S	M	OUG	II	03829	055		12	100892	1/1/0001

OFFICE: 311

ROUTE: 564

ST_REF_NO: 00000110500

LEESTOWN PIKE

LUMENS	BULB TYPE	MULT SERIES	POLE TYPE	SHADE	ADDRESS NUMBER	REF	LOCATION	TAX DIST	DATE INST	DATE CHANGE
22000	S	M	SOH	II	00000	008	ACROSS FROM ENTRANCE TO MASTERSON STATION PARK	22	071581	12/15/2010
09500	S	M	OUG	II	00000	200	1ST LT E OF CHESTNUT RIDGE DR, S SIDE ON LEESTOWN	12	063003	1/1/0001
09500	S	M	SOH	II	00000	201	ACROSS FROM CHESTNUT RIDGE DR ON LEESTOWN RD	12	063003	1/1/0001
09500	S	M	OUG	II	00000	202	1ST LT E OF WHITE OAK TRACE,SOUTH SIDE ON LEESTOWN	12	063003	1/1/0001
09500	S	M	OUG	II	00000	203	1ST LT W OF WHITE OAK TRACE,SOUTH SIDE ON LEESTOWN	12	063003	1/1/0001
22000	S	M	OUG	II	00000	204	3RD LT S OF TOWNE CENTER, W SIDE ON LEESTOWN	12	042107	1/1/0001
22000	S	M	SOH	II	00000	205	3RD LT S OF TAYLOR DR, E SIDE ON LEESTOWN RD	12	051007	1/1/0001
22000	S	M	OUG	II	00000	206	4TH LT S OF TOWNE CENTER, W SIDE ON LEESTOWN	12	042107	1/1/0001
22000	S	M	OUG	II	00000	207	5TH LT S OF TOWNE CENTER, W SIDE ON LEESTOWN	12	042107	1/1/0001
22000	S	M	SOH	II	00000	208	4TH LT S OF TAYLOR DR, E SIDE ON LEESTOWN RD	12	051007	1/1/0001
50000	S	M	OUG	II	00000	209	6TH LT S OF TOWNE CENTER, W SIDE ON LEESTOWN	12	042107	1/1/0001
22000	S	M	OUG	II	00000	210	1ST LT S OF NEW CIRCLE, W SIDE ON LEESTOWN	12	042107	1/1/0001
50000	S	M	OUG	II	00000	211	2ND LT S OF NEW CIRCLE, W SIDE ON LEESTOWN	12	042107	1/1/0001
50000	S	M	OUG	II	00000	212	1ST LT S OF TOWNE CENTER, W SIDE ON LEESTOWN	12	042107	1/1/0001
22000	S	M	OUG	II	00000	213	2ND LT S OF TOWNE CENTER, W SIDE ON LEESTOWN	12	042107	1/1/0001
22000	S	M	OUG	III	00000	044	3RD LT. E. OF VO-TECH DR., S. SIDE	12	010887	1/1/0001
22000	S	M	OUG	III	00000	045	3RD LT. E. OF VO-TECH DR., N. SIDE	12	010887	1/1/0001
22000	S	M	OUG	III	00000	046	2ND LT. E. OF VO-TECH DR., S. SIDE	12	010887	1/1/0001
22000	S	M	OUG	III	00000	047	2ND LT. E. OF VO-TECH DR., N. SIDE	12	010887	1/1/0001

OFFICE: 311

ROUTE: 564

ST_REF_NO: 0000110500

LEESTOWN PIKE

LUMENS	BULB TYPE	MULT SERIES	POLE TYPE	SHADE	ADDRESS NUMBER	REF	LOCATION	TAX DIST	DATE INST	DATE CHANGE
22000	S	M	OUG	III	00000	048	1ST LT. E. OF VO-TECH DR., S. SIDE	12	010887	1/1/0001
22000	S	M	OUG	III	00000	049	1ST LT. E. OF VO-TECH DR., N. SIDE	12	010887	1/1/0001
22000	S	M	OUG	III	00000	050	1ST LT. W. OF VO-TECH DR., S. SIDE	12	010887	1/1/0001
22000	S	M	OUG	III	00000	051	1ST LT. W. OF VO-TECH DR., N. SIDE	12	010887	1/1/0001
22000	S	M	OUG	III	00000	052	2ND LT. W. OF VO-TECH DR., S. SIDE	12	010887	1/1/0001
22000	S	M	OUG	III	00000	053	2ND LT. W. OF VO-TECH DR., N. SIDE	12	010887	1/1/0001
22000	S	M	OUG	III	00000	054	3RD LT. W. OF VO-TECH DR., S. SIDE	12	010887	1/1/0001
22000	S	M	OUG	III	00000	055	3RD LT. W. OF VO-TECH DR., N. SIDE	12	010887	1/1/0001
22000	S	M	OUG	III	00000	056	4TH LT. W. OF VO-TECH DR., S. SIDE	12	010887	1/1/0001
22000	S	M	OUG	III	00000	057	4TH LT. W. OF VO-TECH DR., N. SIDE	12	010887	1/1/0001
22000	S	M	OUG	III	00000	058	2ND LT. E. OF GREENDALE RD., S. SIDE	12	010887	1/1/0001
22000	S	M	OUG	III	00000	059	2ND LT. E. OF GREENDALE RD., N. SIDE	12	010887	1/1/0001
22000	S	M	OUG	III	00000	060	1ST LT. E. OF GREENDALE RD., S. SIDE	12	010887	1/1/0001
22000	S	M	OUG	III	00000	061	1ST LT. E. OF GREENDALE RD., N. SIDE	12	010887	1/1/0001
22000	S	M	OUG	III	00000	062	OPP. GREENDALE RD.	12	010887	1/1/0001
09500	S	M	OUG	III	00000	063	1ST LT. W. OF GREENDALE RD., N. SIDE	12	010887	1/1/0001
09500	S	M	OUG	III	00000	064	1ST LT. W. OF GREENDALE RD., S. SIDE	12	010887	1/1/0001
09500	S	M	OUG	III	00000	065	2ND LT. W. OF GREENDALE RD., N. SIDE	12	010887	1/1/0001
09500	S	M	OUG	III	00000	066	2ND LT. W. OF GREENDALE RD., S. SIDE	12	010887	1/1/0001
09500	S	M	OUG	III	00000	067	3RD LT. W. OF GREENDALE RD., N. SIDE	12	010887	1/1/0001
09500	S	M	OUG	III	00000	068	4TH LT. E. OF TRADE ST., S. SIDE	12	010887	1/1/0001
09500	S	M	OUG	III	00000	069	3RD LT. E. OF TRADE ST., S. SIDE	12	010887	1/1/0001
09500	S	M	OUG	III	00000	071	2ND LT. E. OF TRADE ST., S. SIDE	12	010887	1/1/0001
09500	S	M	OUG	III	00000	073	1ST LT. E. OF TRADE ST., S. SIDE	12	010887	1/1/0001
09500	S	M	OUG	III	00000	075	1ST LT. W. OF TRADE ST., S. SIDE	12	010887	1/1/0001
09500	S	M	OUG	III	00000	077	2ND LT W. OF TRADE ST., S. SIDE	12	010887	1/1/0001
09500	S	M	OUG	III	00000	079	4TH LT. E. OF ALEXANDRIA DR., S. SIDE	12	010887	1/1/0001
09500	S	M	OUG	III	00000	081	3RD LT. E. OF ALEXANDRIA DR., S. SIDE	12	010887	1/1/0001
09500	S	M	OUG	III	00000	083	2ND LT. E. OF ALEXANDRIA DR., S. SIDE	12	010887	1/1/0001
09500	S	M	SOH	III	00000	084	1ST LT. E. OF ALEXANDRIA DR, N. SIDE	12	010887	1/1/0001
09500	S	M	OUG	III	00000	085	1ST LT. E. OF ALEXANDRIA DR, S. SIDE	12	010887	1/1/0001
09500	S	M	SOH	III	00000	086	1ST LT. W. OF ALEXANDRIA DR, N. SIDE	12	010887	1/1/0001
09500	S	M	OUG	III	00000	087	1ST LT. W. OF ALEXANDRIA, S. SIDE	12	010887	1/1/0001
09500	S	M	SOH	III	00000	088	2ND LT. W. OF ALEANDRIA DR, N. SIDE	12	010887	1/1/0001

Street Light Listing run 1/11/2015 10:43:21 AM

Page 589 of 1254

OFFICE: 311

ROUTE: 564

ST_REF_NO: 00000110500

LEESTOWN PIKE

LUMENS	BULB TYPE	MULT SERIES	POLE TYPE	SHADE	ADDRESS NUMBER	REF	LOCATION	TAX DIST	DATE INST	DATE CHANGE
22000	S	M	SOH	II	02695	001		12	030897	1/1/0001
22000	S	M	SOH	II	02701	002		12	030897	1/1/0001
22000	S	M	SOH	II	02709	003		12	030897	1/1/0001
22000	S	M	SOH	II	02721	004		12	030897	1/1/0001
22000	S	M	SOH	II	02729	005		12	030897	1/1/0001
22000	S	M	OUG	III	00000	038	1ST LT. E. OF TAYLOR DR., S. SIDE	12	010887	1/1/0001
22000	S	M	OUG	III	00000	039	1ST LT. E. OF TAYLOR DR., N. SIDE	12	010887	1/1/0001
22000	S	M	OUG	III	00000	040	1ST LT. W. OF TAYLOR DR., S. SIDE	12	010887	1/1/0001
22000	S	M	OUG	III	00000	041	1ST LT. W. OF TAYLOR DR., N. SIDE	12	010887	1/1/0001
22000	S	M	OUG	III	00000	042	2ND LT. W. OF TAYLOR DR., S. SIDE	12	010887	1/1/0001
22000	S	M	OUG	III	00000	043	2ND LT. W. OF TAYLOR DR., N. SIDE	12	010887	1/1/0001
22000	S	M	OUG	III	00000	011	1ST LT. E. OF SOUTH FORBES RD.	12	010887	1/1/0001
22000	S	M	SOH	II	00000	012	2ND LT. E. OF S. FORBES RD.	12	111067	1/1/0001
22000	S	M	SOH	II	00000	013	OPP. CLYDE ST.	12	111067	1/1/0001
22000	S	M	SOH	II	00000	014	1ST LT. E. OF CLYDE ST.	12	111067	1/1/0001
22000	S	M	OUG	III	00000	018	3RD LT. E. OF NORTH FORBES RD.	12	010887	1/1/0001
22000	S	M	OUG	III	00000	019	2ND LT. E. OF NORTH FORBES RD.	12	010887	1/1/0001
22000	S	M	OUG	III	00000	020	1ST LT. E. OF NORTH FORBES RD.	12	010887	1/1/0001
22000	S	M	OUG	III	00000	021	1ST LT. W. OF NORTH FORBES RD.	12	010887	1/1/0001
22000	S	M	OUG	III	00000	022	2ND LT. W. OF NORTH FORBES RD.	12	010887	1/1/0001
22000	S	M	OUG	III	00000	023	3RD LT. W. OF NORTH FORBES RD.	12	010887	1/1/0001
22000	S	M	OUG	III	00000	024	4TH LT. W. OF NORTH FORBES RD.	12	010887	1/1/0001
22000	S	M	OUG	III	00000	025	5TH LT. W. OF NORTH FORBES RD.	12	010887	1/1/0001
22000	S	M	OUG	III	00000	026	3RD LT. E. OF BURKE RD.	12	010887	1/1/0001
22000	S	M	OUG	III	00000	027	2ND LT. E. OF BURKE RD.	12	010887	1/1/0001
22000	S	M	OUG	III	00000	028	1ST LT. E. OF BURKE RD.	12	010887	1/1/0001
22000	S	M	OUG	III	00000	029	1ST LT. W. OF BURKE RD., N. SIDE	12	010887	1/1/0001
22000	S	M	OUG	III	00000	030	1ST LT. W. OF LISLE RD., S. SIDE	12	010887	1/1/0001
22000	S	M	OUG	III	00000	031	2ND LT. W. OF BURKE RD., N. SIDE	12	060888	1/1/0001
22000	S	M	OUG	III	00000	032	2ND LT. W. OF LISLE RD., S. SIDE	12	010887	1/1/0001
22000	S	M	OUG	III	00000	033	1ST LT. W. OF BOILING SPRINGS DR., S. SIDE	12	010887	1/1/0001
22000	S	M	OUG	III	00000	034	2ND LT. W. OF BOILING SPRINGS DR., S. SIDE	12	010887	1/1/0001
22000	S	M	OUG	III	00000	035	3RD LT. W. OF BOILING SPRINGS DR., S. SIDE	12	010887	1/1/0001
22000	S	M	OUG	III	00000	036	4TH LT. W. OF BOILING SPRINGS DR., S. SIDE	12	010887	1/1/0001

Street Light Listing run 1/11/2015 10:43:21 AM

Page 590 of 1254

OFFICE: 311		ROUTE: 564		ST_REF_NO: 00000110500		LEESTOWN PIKE				
LUMENS	BULB TYPE	MULT SERIES	POLE TYPE	SHADE	ADDRESS NUMBER	REF	LOCATION	TAX DIST	DATE INST	DATE CHANGE
22000	S	M	SOH	III	00000	037	2ND LT. E. OF TAYLOR DR., N. SIDE	12	020887	1/1/0001
22000	S	M	SOH	II	01200	017		12	070886	1/1/0001
09500	S	M	SOH	II	00000	150	2ND LT. E OF YARNALLTON RD, SOUTHSIDE	12	040897	1/1/0001
09500	S	M	SOH	II	00000	151	1ST LT. E OF YARNALLTON ROAD, SOUTHSIDE	12	040897	1/1/0001
09500	S	M	SOH	II	00000	152	1ST LT. W OF YARNALLTON RD., SOUTHSIDE	12	040897	1/1/0001
09500	S	M	SOH	II	00000	200	1ST LT. E OF DOLAN LANE, SOUTHSIDE	12	040897	1/1/0001
09500	S	M	SOH	II	00000	201	OPP. DOALN LANE, SOUTHSIDE	12	040897	1/1/0001
09500	S	M	SOH	II	00000	202	1ST LT. W OF DOLAN LANE, SOUTHSIDE	12	040897	1/1/0001
20000	M	M	SOH	II	00000	006	ACROSS FROM ENTRANCE TO MASTERSON STATION PARK	22	071581	1/1/0001
20000	M	M	SOH	II	00000	007	ACROSS FROM ENTRANCE TO MASTERSON STATION PARK	22	071581	1/1/0001
20000	M	M	SOH	II	00000	009	ACROSS FROM ENTRANCE TO MASTERSON STATION PARK	22	071581	1/1/0001
20000	M	M	SOH	II	00000	010	ACROSS FROM ENTRANCE TO MASTERSON STATION PARK	22	071581	1/1/0001

OFFICE: 311

ROUTE: 564

ST_REF_NO: 00000110505

LEESTOWN CENTER WAY

LUMENS	BULB TYPE	MULT SERIES	POLE TYPE	SHADE	ADDRESS NUMBER	REF	LOCATION	TAX DIST	DATE INST	DATE CHANGE
09500	S	M	CNT	II	00000	001	1ST LT E OF VO TECH DR, S SIDE ON LEESTOWN CENTER	12	041707	1/1/0001
09500	S	M	CNT	II	00000	002	2ND LT E OF VO TECH DR, S SIDE ON LEESTOWN CENTER	12	041707	1/1/0001
09500	S	M	CNT	II	00000	003	3RD LT E OF VO TECH DR, S SIDE ON LEESTOWN CENTER	12	041707	1/1/0001
09500	S	M	CNT	II	00000	004	4TH LT E OF VO TECH DR, S SIDE ON LEESTOWN CENTER	12	041707	1/1/0001
09500	S	M	CNT	II	00000	005	5TH LT E OF VO TECH DR, S SIDE ON LEESTOWN CENTER	12	041707	1/1/0001

OFFICE: 311

ROUTE: 564

ST_REF_NO: 00000110510

LEESTOWN SERVICE ROAD

LUMENS	BULB TYPE	MULT SERIES	POLE TYPE	SHADE	ADDRESS NUMBER	REF	LOCATION	TAX DIST	DATE INST	DATE CHANGE
05800	S	M	OUG	II	01601	053	bad fixture	12	121582	10/9/2009
05800	S	M	OUG	II	01609	054		12	121582	7/6/2011
05800	S	M	OUG	II	01649	058	bad fixture	12	121582	5/11/2010

OFFICE: 311		ROUTE: 564		ST_REF_NO: 00000110510		LEESTOWN SERVICE ROAD				
LUMENS	BULB TYPE	MULT SERIES	POLE TYPE	SHADE	ADDRESS NUMBER	REF	LOCATION	TAX DIST	DATE INST	DATE CHANGE
04000	S	M	OUG	II	00000	001	OPP. 1100	12	120887	1/1/0001
04000	S	M	SOH	II	00000	004	OPP. 1204	12	020887	1/1/0001
04000	S	M	SOH	II	01110	003		12	020893	1/1/0001
04000	S	M	OUG	II	01519	049		12	121582	1/1/0001
04000	S	M	OUG	II	01527	050		12	121582	1/1/0001
04000	S	M	OUG	II	01537	051		12	121582	1/1/0001
04000	S	M	OUG	II	01549	052		12	121582	1/1/0001
04000	S	M	OUG	II	01621	055		12	121582	1/1/0001
04000	S	M	OUG	II	01629	056		12	121582	1/1/0001
04000	S	M	OUG	II	01641	057		12	121582	1/1/0001

OFFICE: 311		ROUTE: 564		ST_REF_NO: 00000110700		LEGION DRIVE				
LUMENS	BULB TYPE	MULT SERIES	POLE TYPE	SHADE	ADDRESS NUMBER	REF	LOCATION	TAX DIST	DATE INST	DATE CHANGE
05800	S	M	OUG	II	00000	001	1ST LT. E. OF BROADWAY, S. SIDE	12	111580	1/1/0001
05800	S	M	OUG	II	00000	003	3RD LT. E. OF BROADWAY, N. SIDE	12	080169	1/1/0001
05800	S	M	OUG	II	00000	004	SIDE OF 1229 MAN O WAR	12	011475	1/1/0001
05800	S	M	OUG	II	00333	005		12	080169	1/1/0001
05800	S	M	OUG	II	00340	002		12	111580	1/1/0001

OFFICE: 311		ROUTE: 564		ST_REF_NO: 00000110750		LEIGHTON LANE				
LUMENS	BULB TYPE	MULT SERIES	POLE TYPE	SHADE	ADDRESS NUMBER	REF	LOCATION	TAX DIST	DATE INST	DATE CHANGE
09500	S		CLN	III	00000	001	SIDE OF 181 SOMERSLY PL, ON LEIGHTON LANE	12	041511	1/1/0001
09500	S		CLN	III	03893	002		12	041511	1/1/0001

OFFICE: 311		ROUTE: 564		ST_REF_NO: 00000110800		LEITH COURT				
LUMENS	BULB TYPE	MULT SERIES	POLE TYPE	SHADE	ADDRESS NUMBER	REF	LOCATION	TAX DIST	DATE INST	DATE CHANGE
09500	S	M	OUG	II	01712	014	upgrade per LFUCG req	12	030166	6/27/2011
05800	S	M	OUG	II	00000	013	SIDE OF 600 LINWAL RD.	12	030166	1/1/0001

OFFICE: 311		ROUTE: 564		ST_REF_NO: 00000110810		LEITNER COURT		LUMENS	BULB TYPE	MULT SERIES	POLE TYPE	SHADE	ADDRESS NUMBER	REF	LOCATION	TAX DIST	DATE INST	DATE CHANGE
05800	S	M	OUG	II	01900	127		12	111580	1/1/0001								
05800	S	M	OUG	II	01913	000		12	050774	1/1/0001								
05800	S	M	OUG	II	01924	000		12	050774	1/1/0001								

OFFICE: 311		ROUTE: 564		ST_REF_NO: 00000110850		LEMON DROP LANE		LUMENS	BULB TYPE	MULT SERIES	POLE TYPE	SHADE	ADDRESS NUMBER	REF	LOCATION	TAX DIST	DATE INST	DATE CHANGE
05800	S	M	CNT	II	00000	001	ACROSS FROM 524 LEMON DROP LANE	12	071902	1/1/0001								
05800	S	M	CNT	II	00405	013		12	071902	1/1/0001								
05800	S	M	CNT	II	00408	012		12	071902	1/1/0001								
05800	S	M	CNT	II	00425	011		12	071902	1/1/0001								
05800	S	M	CNT	II	00436	010		12	071902	1/1/0001								
05800	S	M	CNT	III	00445	009		12	071902	1/1/0001								
05800	S	M	CNT	II	00460	008		12	071902	1/1/0001								
05800	S	M	CNT	II	00469	007		12	071902	1/1/0001								
05800	S	M	CNT	II	00484	006		12	071902	1/1/0001								
05800	S	M	CNT	II	00488	005		12	071902	1/1/0001								
05800	S	M	CNT	II	00496	004		12	071902	1/1/0001								
05800	S	M	CNT	II	00504	003		12	071902	1/1/0001								
05800	S	M	CNT	II	00520	002		12	071902	1/1/0001								

OFFICE: 311		ROUTE: 564		ST_REF_NO: 00000110860		LEMON RUE WAY		LUMENS	BULB TYPE	MULT SERIES	POLE TYPE	SHADE	ADDRESS NUMBER	REF	LOCATION	TAX DIST	DATE INST	DATE CHANGE
05800	S	M	CNT	II	00000	001	1ST LT N OF CHAS DR, WEST SIDE ON LEMON RUE WAY	12	110306	1/1/0001								
05800	S	M	CNT	II	00000	002	2ND LT N OF CHAS DR, EAST SIDE ON LEMON RUE WAY	12	110306	1/1/0001								
05800	S	M	CNT	II	00000	006	SIDE OF 4340 JASMINE ROSE WAY ON LEMON RUE WAY	12	110306	1/1/0001								
05800	S	M	CNT	II	01025	003		12	110306	1/1/0001								
05800	S	M	CNT	II	01037	004		12	110306	1/1/0001								
05800	S	M	CNT	II	01053	005		12	110306	1/1/0001								

OFFICE: 311

ROUTE: 564

ST_REF_NO: 00000110990

LENNY COURT

LUMENS	BULB TYPE	MULT SERIES	POLE TYPE	SHADE	ADDRESS NUMBER	REF	LOCATION	TAX DIST	DATE INST	DATE CHANGE
04000	S	M	OUG	II	00000	021	SIDE OF 3721 CAMELOT DR.	12	041478	1/1/0001
04000	S	M	OUG	V	00401	022		12	041478	1/1/0001

OFFICE: 311

ROUTE: 564

ST_REF_NO: 00000111000

LENNEY DRIVE

LUMENS	BULB TYPE	MULT SERIES	POLE TYPE	SHADE	ADDRESS NUMBER	REF	LOCATION	TAX DIST	DATE INST	DATE CHANGE
04000	S	M	OUG	II	00000	027	SIDE OF 3728 CAMELOT DR.	12	061580	1/1/0001
04000	S	M	OUG	II	00000	037	SIDE OF 3780 CAMELOT DR.	12	061580	1/1/0001
04000	S	M	OUG	II	00409	028		12	061580	1/1/0001
04000	S	M	OUG	II	00421	029		12	061580	1/1/0001
04000	S	M	OUG	II	00433	030		12	061580	1/1/0001
04000	S	M	OUG	II	00453	035		12	061580	1/1/0001
04000	S	M	OUG	II	00456	036		12	061580	1/1/0001

OFFICE: 311

ROUTE: 564

ST_REF_NO: 00000111100

LESLIE COURT

LUMENS	BULB TYPE	MULT SERIES	POLE TYPE	SHADE	ADDRESS NUMBER	REF	LOCATION	TAX DIST	DATE INST	DATE CHANGE
05800	S	M	OUG	II	00666	012		12	071063	1/1/0001
05800	S	M	OUG	V	00681	013		12	071063	1/1/0001

OFFICE: 311

ROUTE: 564

ST_REF_NO: 00000111200

LESLIE DRIVE

LUMENS	BULB TYPE	MULT SERIES	POLE TYPE	SHADE	ADDRESS NUMBER	REF	LOCATION	TAX DIST	DATE INST	DATE CHANGE
05800	S	M	OUG	II	00000	011	SIDE OF 672 KINGSTON RD.	12	071063	1/1/0001
05800	S	M	OUG	II	00637	008		12	071063	1/1/0001
05800	S	M	OUG	II	00646	000		12	040664	1/1/0001
05800	S	M	OUG	II	00667	010		12	071063	1/1/0001
05800	S	M	OUG	II	00602	000		12	060663	1/1/0001
05800	S	M	OUG	II	00613	000		12	060663	1/1/0001
05800	S	M	OUG	II	00622	000		12	060663	1/1/0001

OFFICE: 311

ROUTE: 564

ST_REF_NO: 00000111350

LEVI TODD BOULEVARD

LUMENS	BULB TYPE	MULT SERIES	POLE TYPE	SHADE	ADDRESS NUMBER	REF	LOCATION	TAX DIST	DATE INST	DATE CHANGE
09500	S	M	CNT	II	00000	001	SIDE OF 336 HAYS BLVD ON LEVI TODD BLVD	12	053106	1/1/0001

OFFICE: 311		ROUTE: 564		ST_REF_NO: 0000011350		LEVI TODD BOULEVARD		LUMENS	BULB TYPE	MULT SERIES	POLE TYPE	SHADE	ADDRESS NUMBER	REF	LOCATION	TAX DIST	DATE INST	DATE CHANGE
09500	S	M	CNT	II	00000	004	SIDE OF 264 JANE BRIGGS AVE ON LEVI TODD BLVD	12	053106	1/1/0001								
09500	S	M	CNT	II	00000	005	SIDE OF 265 RICHARDSON PL ON LEVI TODD BLVD	12	053106	1/1/0001								
09500	S	M	CNT	II	04409	002		12	053106	1/1/0001								
09500	S	M	CNT	II	04420	003		12	053106	1/1/0001								

OFFICE: 311

ROUTE: 564

OFFICE: 311		ROUTE: 564		ST_REF_NO: 0000011400		LEWIS STREET		LUMENS	BULB TYPE	MULT SERIES	POLE TYPE	SHADE	ADDRESS NUMBER	REF	LOCATION	TAX DIST	DATE INST	DATE CHANGE
09500	S	M	SOH	II	00000	037	1ST LT. N. OF GOODLOE	12	120566	1/1/0001								
09500	S	M	SOH	II	00000	038	2ND LT. N. OF GOODLOE	12	120566	1/1/0001								
09500	S	M	SOH	II	00000	039	1ST LT. S. OF 3RD ST.	12	120566	1/1/0001								

OFFICE: 311

ROUTE: 564

OFFICE: 311		ROUTE: 564		ST_REF_NO: 0000011500		LEXINGTON AVENUE		LUMENS	BULB TYPE	MULT SERIES	POLE TYPE	SHADE	ADDRESS NUMBER	REF	LOCATION	TAX DIST	DATE INST	DATE CHANGE
09500	S		SOH	II	00000	020	SIDE OF 185 E MAXWELL ST, ON LEXINGTON AVENUE	12	102009	1/1/0001								
04000	S	M	SOH	I	00000	001	OPP. 326	12	111568	1/1/0001								
04000	S	M	SOH	I	00000	004	1ST LT. N. OF COLLEGE VIEW, W. SIDE	12	021861	1/1/0001								
04000	S	M	SOH	I	00000	010	OPP. 216	12	021861	1/1/0001								
04000	S	M	SOH	I	00231	009		12	021861	1/1/0001								
04000	S	M	SOH	I	00257	008		12	021861	1/1/0001								
04000	S	M	SOH	I	00273	007		12	021861	1/1/0001								
04000	S	M	SOH	I	00319	006		12	021861	1/1/0001								
04000	S	M	SOH	I	00333	002		12	021861	1/1/0001								
05800	S	M	SOH	I	00337	003	upgraded to 5800 hps cobra 12/05	12	021861	1/1/0001								

OFFICE: 311

ROUTE: 564

OFFICE: 311		ROUTE: 564		ST_REF_NO: 0000011700		LIBBY LANE		LUMENS	BULB TYPE	MULT SERIES	POLE TYPE	SHADE	ADDRESS NUMBER	REF	LOCATION	TAX DIST	DATE INST	DATE CHANGE
04000	S	M	OUG	II	00000	001	SIDE OF 243 LOWRY LANE	12	110888	1/1/0001								
04000	S	M	SOH	II	00000	004	SIDE OF 288 ZANDALE DR.	12	110888	1/1/0001								
04000	S	M	OUG	II	00000	005	SIDE OF 300 ZANDALE DR.	12	110888	1/1/0001								
04000	S	M	OUG	II	02024	002		12	110888	1/1/0001								

OFFICE: 311

ROUTE: 564

ST_REF_NO: 00000111800

LIBERTY ROAD

LUMENS	BULB TYPE	MULT SERIES	POLE TYPE	SHADE	ADDRESS NUMBER	REF	LOCATION	TAX DIST	DATE INST	DATE CHANGE
22000	S		OUG	II	00000	096	1ST LT W OF MOW, N SIDE ON LIBERTY RD	12	122110	1/1/0001
22000	S		OUG	II	00000	097	1ST LT W OF MOW, S SIDE ON LIBERTY RD	12	122110	1/1/0001
22000	S		OUG	II	00000	098	2ND LT W OF MOW, N SIDE ON LIBERTY RD	12	122110	1/1/0001
22000	S		OUG	II	00000	099	2ND LT W OF MOW, S SIDE ON LIBERTY RD	12	122110	1/1/0001
22000	S		OUG	II	00000	120	1ST LT W OF OLD TODDS RD, N SIDE ON LIBERTY RD	12	011509	1/1/0001
22000	S		OUG	II	00000	121	5TH LT E OF MICKEY LN, S SIDE ON LIBERTY RD	12	011509	1/1/0001
22000	S		OUG	II	00000	122	2ND LT W OF OLD TODDS RD, N SIDE ON LIBERTY RD	12	011509	1/1/0001
22000	S		OUG	II	00000	123	4TH LT E OF MICKEY LN, S SIDE ON LIBERTY RD	12	011509	1/1/0001
22000	S		OUG	II	00000	124	3RD LT W OF OLD TODDS RD, N SIDE ON LIBERTY RD	12	011509	1/1/0001
22000	S		OUG	II	00000	125	3RD LT E OF MICKEY LN, S SIDE ON LIBERTY RD	12	011509	1/1/0001
22000	S		OUG	II	00000	126	4TH LT W OF OLD TODDS RD, N SIDE ON LIBERTY RD	12	011509	1/1/0001
22000	S		OUG	II	00000	127	2ND LT E OF MICKEY LN, S SIDE ON LIBERTY RD	12	011509	1/1/0001
22000	S		OUG	II	00000	128	5TH LT W OF OLD TODDS RD, N SIDE ON LIBERTY RD	12	011509	1/1/0001
22000	S		OUG	II	00000	129	1ST LT E OF MICKEY LN, S SIDE ON LIBERTY RD	12	011509	1/1/0001
22000	S		OUG	II	00000	130	1ST LT W OF MICKEY LN, N SIDE ON LIBERTY RD	12	011509	1/1/0001
22000	S		OUG	II	00000	131	1ST LT W OF MICKEY LN, S SIDE ON LIBERTY RD	12	011509	1/1/0001
22000	S		OUG	II	00000	132	2ND LT W OF MICKEY LN, N SIDE ON LIBERTY RD	12	011509	1/1/0001
22000	S		OUG	II	00000	133	2ND LT W OF MICKEY LN, S SIDE ON LIBERTY RD	12	011509	1/1/0001
22000	S		OUG	II	00000	134	1ST LT W OF CAMPBELL LN, N SIDE ON LIBERTY RD	12	011509	1/1/0001
22000	S		OUG	II	00000	135	3RD LT W OF MICKEY LN, S SIDE ON LIBERTY RD	12	011509	1/1/0001
22000	S		OUG	II	00000	136	2ND LT W OF CAMPBELL LN, N SIDE ON LIBERTY RD	12	011509	1/1/0001
22000	S		OUG	II	00000	138	3RD LT W OF CAMPBELL LN, N SIDE ON LIBERTY RD	12	011509	1/1/0001
22000	S		OUG	II	00000	139	9TH LT E OF RAMBLING CREEK DR, S SIDE ON LIBERTY RD	12	011509	1/1/0001
22000	S		OUG	II	00000	140	4TH LT W OF CAMPBELL LN, N SIDE ON LIBERTY RD	12	011509	1/1/0001
22000	S		OUG	II	00000	141	8TH LT E OF RAMBLING CREEK DR, S SIDE ON LIBERTY RD	12	011509	1/1/0001
22000	S		OUG	II	00000	142	5TH LT W OF CAMPBELL LN, N SIDE ON LIBERTY RD	12	011509	1/1/0001

Street Light Listing run 1/11/2015 10:43:21 AM

Page 596 of 1254

OFFICE: 311

ROUTE: 564

ST_REF_NO: 00000111800

LIBERTY ROAD

LUMENS	BULB TYPE	MULT SERIES	POLE TYPE	SHADE	ADDRESS NUMBER	REF	LOCATION	TAX DIST	DATE INST	DATE CHANGE
22000	S		OUG	II	00000	143	7TH LT E OF RAMBLING CREEK DR, S SIDE ON LIBERTY RD	12	011509	1/1/0001
22000	S		OUG	II	00000	144	6TH LT W OF CAMPBELL LN, N SIDE ON LIBERTY RD	12	011509	1/1/0001
22000	S		OUG	II	00000	145	6TH LT E OF RAMBLING CREEK DR, S SIDE ON LIBERTY RD	12	011509	1/1/0001
22000	S		OUG	II	00000	146	7TH LT W OF CAMPBELL LN, N SIDE ON LIBERTY RD	12	011509	1/1/0001
22000	S		OUG	II	00000	147	5TH LT E OF RAMBLING CREEK DR, S SIDE ON LIBERTY RD	12	011509	1/1/0001
22000	S		OUG	II	00000	148	8TH LT W OF CAMPBELL LN, N SIDE ON LIBERTY RD	12	011509	1/1/0001
22000	S		OUG	II	00000	149	4TH LT E OF RAMBLING CREEK DR, S SIDE ON LIBERTY RD	12	011509	1/1/0001
22000	S		OUG	II	00000	150	9TH LT W OF CAMPELL LN, N SIDE ON LIBERTY RD	12	011509	1/1/0001
22000	S		OUG	II	00000	151	3RD LT E OF RAMBLING CREEK DR, S SIDE ON LIBERTY RD	12	011509	1/1/0001
22000	S		OUG	II	00000	152	10TH LT W OF CAMPBELL LN, N SIDE ON LIBERTY RD	12	011509	1/1/0001
22000	S		OUG	II	00000	153	2ND LT E OF RAMBLING CREEK DR, S SIDE ON LIBERTY RD	12	011509	1/1/0001
22000	S		OUG	II	00000	154	11TH LT W OF CAMPBELL LN, N SIDE ON LIBERTY RD	12	011509	1/1/0001
22000	S		OUG	II	00000	155	1ST LT E OF RAMBLIN CREEK DR, S SIDE ON LIBERTY RD	12	011509	1/1/0001
22000	S		OUG	II	00000	156	12TH LT W OF CAMPBELL LN, N SIDE ON LIBERTY RD	12	011509	1/1/0001
22000	S		OUG	II	00000	157	8TH LT E OF LIBERTY RIDGE LN, S SIE ON LIBERTY RD	12	011509	1/1/0001
22000	S		OUG	II	00000	158	13TH LT W OF CAMPBELL LN, N SIDE ON LIBERTY RD	12	011509	1/1/0001
22000	S		OUG	II	00000	159	7TH LT E OF LIBERTY RIDGE LN, S SIDE ON LIBERTY RD	12	011509	1/1/0001
22000	S		OUG	II	00000	160	14TH LT W OF CAMPBELL LN, N SIDE ON LIBERTY RD	12	011509	1/1/0001
22000	S		OUG	II	00000	161	6TH LT E OF LIBERTY RIDGE LN, S SIDE ON LIBERTY RD	12	011509	1/1/0001
22000	S		OUG	II	00000	162	15TH LT W OF CAMPBELL LN, N SIDE ON LIBERTY RD	12	011509	1/1/0001

OFFICE: 311

ROUTE: 564

ST_REF_NO: 00000111800

LIBERTY ROAD

LUMENS	BULB TYPE	MULT SERIES	POLE TYPE	SHADE	ADDRESS NUMBER	REF	LOCATION	TAX DIST	DATE INST	DATE CHANGE
22000	S		OUG	II	00000	163	5TH LT E OF LIBERTY RIDGE LN, S SIDE ON LIBERTY RD	12	011509	1/1/0001
22000	S		OUG	II	00000	164	1ST LT W OF STAR SHOOT PKWY, N SIDE ON LIBERTY RD	12	011509	1/1/0001
22000	S		OUG	II	00000	165	4TH E OF LIBERTY RDIGE LN, S SIDE ON LIBERTY RD	12	011509	1/1/0001
22000	S		OUG	II	00000	166	2ND LT W OF STAR SHOOT PKWY, N SIDE ON LIBERTY RD	12	011509	1/1/0001
22000	S		OUG	II	00000	167	3RD LT E OF LIBERTY RIDGE LN, S SIDE ON LIBERTY RD	12	011509	1/1/0001
22000	S		OUG	II	00000	168	3RD LT W OF STAR SHOOT PKWY, N SIDE ON LIBERTY RD	12	011509	1/1/0001
22000	S		OUG	II	00000	169	2ND LT E OF LIBERTY RIDGE LN, S SIDE ON LIBERTY RD	12	011509	1/1/0001
22000	S		OUG	II	00000	170	4TH LT W OF STAR SHOOT PKWY, N SIDE ON LIBERTY RD	12	011509	1/1/0001
22000	S		OUG	II	00000	171	1ST LT E OF LIBERTY RIDGE LN, S SIDE ON LIBERTY RD	12	011509	1/1/0001
22000	S		OUG	II	00000	172	5TH LT W OF STAR SHOOT PKWY, N SIDE ON LIBERTY RD	12	011509	1/1/0001
22000	S		OUG	II	00000	173	5TH LT E OF GRAFTONS MILL, S SIDE ON LIBERTY RD	12	011509	1/1/0001
22000	S		OUG	II	00000	174	6TH LT W OF STAR SHOOT PKWY, N SIDE ON LIBERTY RD	12	011509	1/1/0001
22000	S		OUG	II	00000	175	4TH LT E OF GRAFTONS MILL, S SIDE ON LIBERTY RD	12	011509	1/1/0001
22000	S		OUG	II	00000	176	7TH LT W OF STAR SHOOT PKWY, N SIDE ON LIBERTY RD	12	011509	1/1/0001
22000	S		OUG	II	00000	177	3RD LT E OF GRAFTONS MILL, S SIDE ON LIBERTY RD	12	011509	1/1/0001
22000	S		OUG	II	00000	178	8TH LT W OF STAR SHOOT PKWY, N SIDE ON LIBERTY RD	12	011509	1/1/0001
22000	S		OUG	II	00000	179	2ND LT E OF GRAFTONS MILL, S SIDE ON LIBERTY RD	12	011509	1/1/0001
22000	S		OUG	II	00000	180	9TH LT W OF STAR SHOOT PKWY, N SIDE ON LIBERTY RD	12	011109	1/1/0001
22000	S		OUG	II	00000	181	1ST LT E OF GRAFTONS MILL, S SIDE ON LIBERTY RD	12	011509	1/1/0001
22000	S		OUG	II	00000	182	10TH LT W OF STAR SHOOT PKWY, N SIDE ON LIBERTY RD	12	011509	1/1/0001

OFFICE: 311

ROUTE: 564

ST_REF_NO: 0000111800

LIBERTY ROAD

LUMENS	BULB TYPE	MULT SERIES	POLE TYPE	SHADE	ADDRESS NUMBER	REF	LOCATION	TAX DIST	DATE INST	DATE CHANGE
22000	S		OUG	II	00000	183	1ST LT W OF GRAFTONS MILL, S SIDE ON LIBERTY RD	12	011509	1/1/0001
22000	S		OUG	II	00000	185	2ND LT W OF GRAFTONS MILL, S SIDE ON LIBERTY RD	12	011509	1/1/0001
22000	S		OUG	II	02454	187		12	011509	1/1/0001
22000	S		OUG	II	02457	186		12	011509	1/1/0001
22000	S		OUG	II	02497	184		12	011509	1/1/0001
22000	S		OUG	II	02830	137		12	011509	1/1/0001
22000	S		OUG	II	02449	188		12	011509	1/15/2009
22000	S	M	SOH	III	00904	042		12	010885	1/1/0001
22000	S	M	SOH	II	00916	043		12	120884	1/1/0001
22000	S	M	SOH	III	00924	044		12	010885	1/1/0001
22000	S	M	SOH	II	00940	045		12	120884	1/1/0001
22000	S	M	OUG	II	01004	046		12	110884	1/1/0001
22000	S	M	OUG	II	01015	047		12	110884	1/1/0001
22000	S	M	OUG	II	01028	048		12	110884	1/1/0001
22000	S	M	OUG	II	01039	049		12	110884	1/1/0001
22000	S	M	OUG	II	01114	050		12	110884	1/1/0001
22000	S	M	OUG	II	01119	051		12	110884	1/1/0001
22000	S	M	OUG	II	01126	052		12	110884	1/1/0001
22000	S	M	OUG	II	01138	054		12	110884	1/1/0001
22000	S	M	OUG	II	01153	053		12	110884	1/1/0001
22000	S	M	OUG	II	01601	055		12	110884	1/1/0001
22000	S	M	OOH	II	00000	070	OPP. 1776	12	110884	1/1/0001
22000	S	M	SOH	III	00000	076	OPP. 1869	12	010885	1/1/0001
22000	S	M	OUG	II	00000	082	OPP. 2025	12	110884	1/1/0001
22000	S	M	OUG	II	00000	083	OPP. 2035	12	110884	1/1/0001
22000	S	M	OUG	II	00000	084	OPP. 2045	12	110884	1/1/0001
22000	S	M	OUG	II	01609	056		12	110884	1/1/0001
22000	S	M	OUG	II	01621	057		12	110884	1/1/0001
22000	S	M	OUG	II	01633	058		12	110884	1/1/0001
22000	S	M	OUG	II	01645	059		12	110884	1/1/0001
22000	S	M	OUG	II	01657	060		12	110884	1/1/0001
22000	S	M	OUG	II	01664	061		12	110884	1/1/0001
22000	S	M	OUG	II	01703	062		12	110884	1/1/0001

OFFICE: 311

ROUTE: 564

ST_REF_NO: 0000111800

LIBERTY ROAD

LUMENS	BULB TYPE	MULT SERIES	POLE TYPE	SHADE	ADDRESS NUMBER	REF	LOCATION	TAX DIST	DATE INST	DATE CHANGE
22000	S	M	OUG	II	01708	063		12	110884	1/1/0001
22000	S	M	OOH	II	01721	064		12	110884	1/1/0001
22000	S	M	SOH	II	01724	065		12	120884	1/1/0001
22000	S	M	OOH	II	01737	066		12	110884	1/1/0001
22000	S	M	SOH	II	01744	067		12	120884	1/1/0001
22000	S	M	OOH	II	01749	068		12	110884	1/1/0001
22000	S	M	SOH	II	01764	069		12	120884	1/1/0001
22000	S	M	SOH	III	01806	071		12	010885	1/1/0001
22000	S	M	SOH	III	01825	072		12	010885	1/1/0001
22000	S	M	SOH	II	01830	073		12	120884	1/1/0001
22000	S	M	SOH	III	01831	074		12	010885	1/1/0001
22000	S	M	SOH	III	01846	075		12	010885	1/1/0001
22000	S	M	SOH	III	01901	078		12	010885	1/1/0001
22000	S	M	SOH	III	01904	077		12	010885	1/1/0001
22000	S	M	SOH	II	01924	079		12	120884	1/1/0001
22000	S	M	OOH	II	02003	080		12	110884	1/1/0001
22000	S	M	OOH	II	02015	081		12	110884	1/1/0001
09500	S	M	SOH	II	00000	104	1ST LT. W OF WOODWARD LANE, NORTHSIDE	12	040898	1/1/0001
09500	S	M	SOH	II	00000	105	SE CORNER OF LIBERTY RD. AT WOODWARD LANE	12	040898	1/1/0001
09500	S	M	SOH	II	00000	106	1ST LT. E OF WOODWARD LANE, NORTHSIDE	12	040898	1/1/0001
22000	S	M	SOH	II	00000	107	1ST LT. E OF WOODWARD LANE, SOUTHSIDE	12	040898	1/1/0001
22000	S	M	SOH	II	00000	108	1ST LT. E OF GERARDI RD., NORTHSIDE	12	040898	1/1/0001
22000	S	M	SOH	II	00000	110	1ST LT. E OF GRATONS MILL LANE, SOUTHSIDE	12	040898	1/1/0001
09500	S	M	SOH	II	00000	115	1ST LT. W OF CADEN LANE, SOUTHSIDE	12	040898	1/1/0001
22000	S	M	SOH	II	02374	114		12	040898	1/1/0001
22000	S	M	SOH	II	02598	111		12	040898	1/1/0001
22000	S	M	SOH	II	02598	112		12	040898	1/1/0001
22000	S	M	SOH	II	02598	113		12	040898	1/1/0001
09500	S	M	SOH	II	02861	116		12	040898	1/1/0001
22000	S	M	SOH	II	02986	117		12	040898	1/1/0001

OFFICE: 311		ROUTE: 564		ST_REF_NO: 0000011820		LIBERTY HILL DRIVE				
LUMENS	BULB TYPE	MULT SERIES	POLE TYPE	SHADE	ADDRESS NUMBER	REF	LOCATION	TAX DIST	DATE INST	DATE CHANGE
05800	S	M	OUG	II	00000	002	SIDE OF 2300 LIBERTY STATION CT.	12	100896	1/1/0001
05800	S	M	OUG	II	00000	004	SIDE REAR OF 2300 INDEPENDENCE CT.	12	100896	1/1/0001
05800	S	M	OUG	II	00000	007	SIDE OF 625 PATRIOT COURT	12	050897	1/1/0001
05800	S	M	OUG	II	00000	008	SIDE OF 628 DECLARATION COURT	12	050897	1/1/0001
05800	S	M	OUG	II	00000	009	SIDE OF 668 MORGAN HILLS DR.	12	020899	1/1/0001
05800	S	M	OUG	III	00691	010		12	020899	1/1/0001
05800	S	M	OUG	II	00736	006		12	050897	1/1/0001
05800	S	M	OUG	II	00739	005		12	050897	1/1/0001
05800	S	M	OUG	II	00779	003		12	100896	1/1/0001
05800	S	M	OUG	II	00799	001		12	100896	1/1/0001

OFFICE: 311		ROUTE: 564		ST_REF_NO: 0000011830		LIBERTY STATION COURT				
LUMENS	BULB TYPE	MULT SERIES	POLE TYPE	SHADE	ADDRESS NUMBER	REF	LOCATION	TAX DIST	DATE INST	DATE CHANGE
05800	S	M	OUG	II	00000	001	OPP. 2300	12	100896	1/1/0001
05800	S	M	OUG	II	02313	002		12	100896	1/1/0001
05800	S	M	OUG	III	02316	003		12	100896	1/1/0001

OFFICE: 311		ROUTE: 564		ST_REF_NO: 0000011950		LIDIAN COURT				
LUMENS	BULB TYPE	MULT SERIES	POLE TYPE	SHADE	ADDRESS NUMBER	REF	LOCATION	TAX DIST	DATE INST	DATE CHANGE
05800	S	M	OUG	II	00000	003	SIDE OF 3812 EMERSON WOODS WAY	12	020800	1/1/0001
05800	S	M	OUG	II	00512	001		12	020800	1/1/0001
05800	S	M	OUG	II	00521	002		12	020800	1/1/0001
05800	S	M	OUG	III	00553	004		12	020800	1/1/0001

OFFICE: 311		ROUTE: 564		ST_REF_NO: 00000112000		LIGGETT STREET				
LUMENS	BULB TYPE	MULT SERIES	POLE TYPE	SHADE	ADDRESS NUMBER	REF	LOCATION	TAX DIST	DATE INST	DATE CHANGE
04000	S	M	SOH	II	00000	021	SIDE OF 210 CLYDE ST.	12	010171	1/1/0001
05800	S	M	SOH	II	00000	027	SIDE OF 166 FORBES RD.	12	070886	1/1/0001
04000	S	M	SOH	II	01105	025		12	091476	1/1/0001
04000	S	M	SOH	II	01107	026		12	091476	1/1/0001
05800	S	M	SOH	II	01203	022		12	010171	1/1/0001

OFFICE: 311		ROUTE: 564		ST_REF_NO: 00000112000		LIGGETT STREET		LUMENS	BULB TYPE	MULT SERIES	POLE TYPE	SHADE	ADDRESS NUMBER	REF	LOCATION	TAX DIST	DATE INST	DATE CHANGE
05800	S	M	SOH	II	01207	023										12	010171	1/1/0001
05800	S	M	SOH	II	01215	024										12	010171	1/1/0001

OFFICE: 311		ROUTE: 564		ST_REF_NO: 00000112040		LILAC PARK		LUMENS	BULB TYPE	MULT SERIES	POLE TYPE	SHADE	ADDRESS NUMBER	REF	LOCATION	TAX DIST	DATE INST	DATE CHANGE
05800	S	M	CNT	III	02309	002										12	080806	1/1/0001
05800	S	M	CNT	II	02325	001										12	080806	1/1/0001

OFFICE: 311		ROUTE: 564		ST_REF_NO: 00000112090		LILY COURT		LUMENS	BULB TYPE	MULT SERIES	POLE TYPE	SHADE	ADDRESS NUMBER	REF	LOCATION	TAX DIST	DATE INST	DATE CHANGE
05800	S	M	OUG	II	00973	082										12	022167	1/1/0001
05800	S	M	OUG	II	00980	081										12	022167	1/1/0001

OFFICE: 311		ROUTE: 564		ST_REF_NO: 00000112100		LILY DRIVE		LUMENS	BULB TYPE	MULT SERIES	POLE TYPE	SHADE	ADDRESS NUMBER	REF	LOCATION	TAX DIST	DATE INST	DATE CHANGE
05800	S	M	OUG	II	00000	083									SIDE OF 2202 ALEXANDRIA DR.	12	060867	1/1/0001
05800	S	M	OUG	II	00904	103										12	060867	1/1/0001
05800	S	M	OUG	II	00913	102										12	022167	1/1/0001
05800	S	M	OUG	II	00924	101										12	122067	1/1/0001
05800	S	M	OUG	II	00937	100										12	060867	1/1/0001
05800	S	M	OUG	II	00940	099										12	022167	1/1/0001
05800	S	M	OUG	II	00953	084										12	022167	1/1/0001

OFFICE: 311		ROUTE: 564		ST_REF_NO: 00000112200		LIMA DRIVE		LUMENS	BULB TYPE	MULT SERIES	POLE TYPE	SHADE	ADDRESS NUMBER	REF	LOCATION	TAX DIST	DATE INST	DATE CHANGE
09500	S	M	OUG	II	00000	003									OPP. 522	12	080172	1/1/0001
09500	S	M	OUG	II	00000	004									OPP. 520	12	070566	1/1/0001
09500	S	M	OUG	II	00000	005									OPP. 494	12	070566	1/1/0001
09500	S	M	OUG	II	00000	006									OPP. 466	12	070566	1/1/0001
09500	S	M	OUG	II	00000	007									OPP. 456	12	070566	1/1/0001
09500	S	M	OUG	II	00000	008									OPP. 412	12	080172	1/1/0001

OFFICE: 311

ROUTE: 564

ST_REF_NO: 00000112200 LIMA DRIVE

LUMENS	BULB TYPE	MULT SERIES	POLE TYPE	SHADE	ADDRESS NUMBER	REF	LOCATION	TAX DIST	DATE INST	DATE CHANGE
09500	S	M	OUG	II	00000	009	OPP. 364	12	080172	1/1/0001
09500	S	M	OUG	II	00000	012	1ST LT W OF GEORGETOWN RD,NORTHSIDE ON LIMA DR	12	090891	1/1/0001
09500	S	M	OUG	II	00000	013	2ND LT W OF GEORGETOWN RD,SOUTHSIDE ON LIMA DR	12	090891	1/1/0001
09500	S	M	OUG	II	00000	014	3RD LT W OF GEORGETOWN RD,NORTHSIDE ON LIMA DR	12	090891	1/1/0001
09500	S	M	OUG	II	00000	015	4TH LT W OF GEORGETOWN RD,SOUTHSIDE ON LIMA DR	12	090891	1/1/0001
09500	S	M	OUG	II	00000	016	5TH LT W OF GEORGETOWN RD,NORTHSIDE ON LIMA DR	12	090891	1/1/0001
09500	S	M	OUG	II	00340	011		12	081475	1/1/0001
09500	S	M	OUG	II	00364	010		12	080172	1/1/0001
09500	S	M	OUG	II	00542	002		12	080169	1/1/0001
09500	S	M	OUG	II	00598	001		12	080169	1/1/0001

OFFICE: 311

ROUTE: 564

ST_REF_NO: 00000112210 LIMA COURT

LUMENS	BULB TYPE	MULT SERIES	POLE TYPE	SHADE	ADDRESS NUMBER	REF	LOCATION	TAX DIST	DATE INST	DATE CHANGE
05800	S	M	OUG	II	00000	003	SIDE OF 909	12	090800	1/1/0001
05800	S	M	OUG	II	00000	005	OPP. 905	12	090800	1/1/0001
05800	S	M	OUG	II	00912	004		12	090800	1/1/0001
05800	S	M	OUG	II	00924	002		12	090800	1/1/0001
05800	S	M	OUG	II	00932	001		12	090800	1/1/0001

OFFICE: 311

ROUTE: 564

ST_REF_NO: 00000112300 LIMESTONE, NORTH STREET

LUMENS	BULB TYPE	MULT SERIES	POLE TYPE	SHADE	ADDRESS NUMBER	REF	LOCATION	TAX DIST	DATE INST	DATE CHANGE
22000	S	M	SOH	III	00000	015	N. LIMESTONE & W. SECOND - bad fixture	12	011063	9/13/2007
09500	S	M	SOH	II	00000	036	1ST LT. N. OF 5TH ST., E. SIDE	12	030964	11/3/2008
22000	S	M	SOH	II	00000	051	opposite 738	12	030964	4/18/2013
09500	S	M	SOH	II	00000	074	BETWEEN 1217 & 1313	12	041478	2/12/2012
16000	S	M	GRN	IV	00000	307	1ST LT N OF E MAIN ST,E SIDE ON N LIMESTONE ST	12	070101	1/1/0001
16000	S	M	GRN	IV	00000	308	2ND LT N OF E MAIN ST,E SIDE ON N LIMESTONE ST	12	070101	1/1/0001

OFFICE: 311

ROUTE: 564

ST_REF_NO: 00000112300

LIMESTONE, NORTH STREET

LUMENS	BULB TYPE	MULT SERIES	POLE TYPE	SHADE	ADDRESS NUMBER	REF	LOCATION	TAX DIST	DATE INST	DATE CHANGE
16000	S	M	GRN	IV	00000	309	3RD LT N OF E MAIN ST,E SIDE ON N LIMESTONE ST	12	070101	1/1/0001
16000	S	M	GRN	IV	00000	310	4TH LT N OF E MAIN ST,E SIDE ON N LIMESTONE ST	12	070101	1/1/0001
16000	S	M	GRN	IV	00000	311	1ST LT N OF E SHORT ST,E SIDE ON N LIMESTONE ST	12	070101	1/1/0001
16000	S	M	GRN	IV	00000	312	2ND LT N OF E SHORT ST,E SIDE ON N LIMESTONE ST	12	070101	1/1/0001
16000	S	M	GRN	IV	00000	313	3RD LT N OF E SHORT ST,E SIDE ON N LIMESTONE ST	12	070101	1/1/0001
16000	S	M	GRN	IV	00000	314	4TH LT N OF E SHORT ST,E SIDE ON N LIMESTONE ST	12	070101	1/1/0001
10000	M	M	SOH	II	00000	046	N. LIME & ALABAMA, NE CORNER	12	030964	1/1/0001
10000	M	M	SOH	II	00000	054	LIMESTONE & BRYAN AVE.	12	030964	1/1/0001
10000	M	M	SOH	II	00000	057	OPP. 810	12	011967	1/1/0001
10000	M	M	SOH	II	00000	058	N. LIME & PARIS CT., SE CORNER	12	011967	1/1/0001
10000	M	M	SOH	II	00000	065	AT ARLINGTON SCHOOL	12	011967	1/1/0001
10000	M	M	SOH	II	00000	073	NW CORNER OF N. LIME & WITHERS	12	011967	1/1/0001
10000	M	M	SOH	II	00000	075	BETWEEN 1306 & 1312	12	041478	1/1/0001
10000	M	M	SOH	II	00000	076	SW CORNER OF PARIS AVE. & LIME	12	041478	1/1/0001
10000	M	M	SOH	II	00000	077	OPP. BLUEGRASS AVE.	12	041478	1/1/0001
10000	M	M	SOH	II	00000	078	BESIDE OF 1409	12	041478	1/1/0001
10000	M	M	SOH	II	00000	079	OPP. 1408	12	041478	1/1/0001
10000	M	M	SOH	II	00000	080	NE CORNER OF BERMUDA AVE. & LIME	12	041478	1/1/0001
10000	M	M	SOH	II	00643	045		12	030964	1/1/0001
10000	M	M	SOH	II	00671	047		12	030964	1/1/0001
10000	M	M	SOH	II	00702	048		12	082464	1/1/0001
10000	M	M	SOH	II	00717	049		12	030964	1/1/0001
10000	M	M	SOH	II	00726	050		12	082464	1/1/0001
10000	M	M	SOH	II	00754	052		12	030964	1/1/0001
10000	M	M	SOH	II	00763	053		12	030964	1/1/0001
10000	M	M	SOH	II	00791	055		12	030964	1/1/0001
10000	M	M	SOH	II	00800	056		12	011967	1/1/0001
09500	S	M	SOH	II	00817	060	upgrade due to bad fixture 1/08	12	011967	1/1/0001
10000	M	M	SOH	II	00822	059		12	011967	1/1/0001
10000	M	M	SOH	II	00904	061		12	011967	1/1/0001

OFFICE: 311

ROUTE: 564

ST_REF_NO: 00000112300

LIMESTONE, NORTH STREET

LUMENS	BULB TYPE	MULT SERIES	POLE TYPE	SHADE	ADDRESS NUMBER	REF	LOCATION	TAX DIST	DATE INST	DATE CHANGE
10000	M	M	SOH	II	00909	062		12	011967	1/1/0001
10000	M	M	SOH	II	00918	063		12	011967	1/1/0001
10000	M	M	SOH	II	01003	064		12	011967	1/1/0001
10000	M	M	SOH	II	01004	067		12	011967	1/1/0001
10000	M	M	SOH	II	01021	066		12	011967	1/1/0001
10000	M	M	SOH	II	01028	069		12	011967	1/1/0001
10000	M	M	SOH	II	01101	068		12	011967	1/1/0001
10000	M	M	SOH	II	01109	070		12	011967	1/1/0001
10000	M	M	SOH	III	01186	083		12	070885	1/1/0001
10000	M	M	SOH	II	01203	071		12	011967	1/1/0001
10000	M	M	SOH	II	01206	072		12	011967	1/1/0001
10000	M	M	SOH	III	01420	084		12	070885	1/1/0001
09500	S	M	SOH	III	01426	085		12	070885	1/1/0001
20000	M	M	OUG	II	00000	081	1ST LT. S. OF NEW CIRCLE RD.	12	071579	1/1/0001
20000	M	M	SOH	II	00000	082	1ST LT. N. OF NEW CIRCLE RD	12	071579	1/1/0001
10000	M	M	SOH	III	00000	086	1525-1527	12	070885	1/1/0001
10000	M	M	SOH	III	00000	088	OPP. 1534	12	070885	1/1/0001
10000	M	M	SOH	III	00000	089	1538-1540	12	070885	1/1/0001
10000	M	M	SOH	III	01532	087		12	070885	1/1/0001
10000	M	M	SOH	III	01537	090		12	070885	1/1/0001
10000	M	M	SOH	II	00000	035	SW CORNER OF N. LIME & 5TH ST.	12	030964	1/1/0001
10000	M	M	SOH	II	00000	038	1ST LT. S. OF RAND, E. SIDE	12	030964	1/1/0001
10000	M	M	SOH	II	00000	041	SW CORNER OF N. LIME & 6TH ST.	12	030964	1/1/0001
10000	M	M	SOH	II	00000	042	1ST LT. N. OF 6TH ST., E. SIDE	12	030964	1/1/0001
10000	M	M	SOH	II	00460	034		12	030964	1/1/0001
10000	M	M	SOH	II	00519	037		12	030964	1/1/0001
10000	M	M	SOH	II	00549	039		12	030964	1/1/0001
09500	S	M	SOH	II	00560	040	changed out to 9500 5/9/07	12	030964	1/1/0001
09500	S	M	SOH	II	00621	043	change out due to bad fixture 1/08	12	030964	1/1/0001
10000	M	M	SOH	II	00632	044		12	030964	1/1/0001
20000	M	M	SOH	III	00000	010	1ST LT. N. OF BARR ST., E. SIDE	12	011063	1/1/0001
20000	M	M	SOH	III	00000	012	2ND LT. N. OF BARR ST., E. SIDE	12	011063	1/1/0001
20000	M	M	SOH	III	00000	014	1ST LT. N. OF PLEASANT STONE	12	011063	1/1/0001
20000	M	M	SOH	III	00000	016	N. LIMESTONE & TEMPLETON	12	011063	1/1/0001

OFFICE: 311

ROUTE: 564

ST_REF_NO: 00000112300

LIMESTONE, NORTH STREET

LUMENS	BULB TYPE	MULT SERIES	POLE TYPE	SHADE	ADDRESS NUMBER	REF	LOCATION	TAX DIST	DATE INST	DATE CHANGE
20000	M	M	SOH	II	00000	019	N. LIMESTONE & MECHANIC ST.	12	011063	1/1/0001
22000	S	M	SOH	II	00000	023	NW CORNER OF LIME & W. 3RD ST.	12	011063	1/1/0001
22000	S	M	SOH	II	00000	024	1ST LT. N. OF 3RD, E. SIDE	12	011063	1/1/0001
22000	S	M	SOH	II	00000	026	OPP. 335	12	011063	1/1/0001
22000	S	M	SOH	II	00000	028	OPP. 359	12	011063	1/1/0001
22000	S	M	SOH	II	00000	029	LIMESTONE & FOURTH ST.	12	011063	1/1/0001
22000	S	M	SOH	III	00169	011	mv changeout	12	011063	1/1/0001
20000	M	M	SOH	III	00183	013		12	011063	1/1/0001
10000	M	M	SOH	II	00221	017		12	010163	1/1/0001
10000	M	M	SOH	II	00229	018		12	011063	1/1/0001
22000	S	M	SOH	II	00243	020		12	011063	1/1/0001
22000	S	M	SOH	II	00257	021		12	011063	1/1/0001
22000	S	M	SOH	II	00265	022		12	010163	1/1/0001
22000	S	M	SOH	II	00323	025		12	011063	1/1/0001
22000	S	M	SOH	II	00343	027		12	011063	1/1/0001
10000	M	M	SOH	II	00408	030		12	082464	1/1/0001
10000	M	M	SOH	II	00421	031		12	030964	1/1/0001
10000	M	M	SOH	II	00436	032		12	030964	1/1/0001
10000	M	M	SOH	II	00449	033		12	030964	1/1/0001

OFFICE: 311

ROUTE: 564

ST_REF_NO: 00000112310

LIMESTONE, SOUTH STREET

LUMENS	BULB TYPE	MULT SERIES	POLE TYPE	SHADE	ADDRESS NUMBER	REF	LOCATION	TAX DIST	DATE INST	DATE CHANGE
50000	S		SOH	III	00000	101	1ST LT S OF HUGUELET, E SIDE ON S LIMESTONE ST	12	110510	1/1/0001
22000	S		CNT	III	00000	103	2ND LT S OF HUGUELET, E SIDE ON S LIMESTONE ST	12	061311	1/1/0001
22000	S		CNT	III	00000	107	4th LT S OF HUGUELET, E SIDE ON S LIMESTONE ST	12	070111	1/1/0001
22000	S		CNT	III	00000	120	2ND LT N OF GAZETTE, W SIDE ON S LIMESTONE ST	12	110510	1/1/0001
50000	S		CNT	III	00000	121	3RD LT N OF TRANSCRIPT, E SIDE ON S LIMESTONE ST	12	110510	1/1/0001
50000	S		CNT	II	00000	122	1ST LT N OF TRANSCRIPT, W SIDE ON S LIMESTONE ST	12	110510	1/1/0001

OFFICE: 311

ROUTE: 564

ST_REF_NO: 00000112310

LIMESTONE, SOUTH STREET

LUMENS	BULB TYPE	MULT SERIES	POLE TYPE	SHADE	ADDRESS NUMBER	REF	LOCATION	TAX DIST	DATE INST	DATE CHANGE
50000	S		CNT	II	00000	123	2ND LT N OF TRANSCRIPT, E SIDE ON S LIMESTONE ST	12	110510	1/1/0001
50000	S		CNT	III	00000	125	1ST LT N OF TRANSCRIPT, E SIDE ON S LIMESTONE ST	12	110510	1/1/0001
50000	S		CNT	III	00000	127	1ST LT S OF TRANSCRIPT, E SIDE ON S LIMESTONE ST	12	110510	1/1/0001
50000	S		CNT	III	00000	128	1ST LT S OF TRANSCRIPT, W SIDE ON S LIMESTONE ST	12	110510	1/1/0001
50000	S		CNT	III	00000	129	2ND LT S OF TRANSCRIPT, E SIDE ON S LIMESTONE ST	12	110510	1/1/0001
50000	S		CNT	III	00000	130	1ST LT S OF CONN TERRACE, W SIDE ON S LIMESTONE ST	12	061311	1/1/0001
50000	S		CNT	III	00000	131	1ST LT S OF CONN TERRACE, E SIDE ON S LIMESTONE ST	12	110510	1/1/0001
50000	S		CNT	III	00000	132	2ND LT S OF CONN TERRACE, W SIDE ON S LIMESTONE ST	12	061311	1/1/0001
50000	S		CNT	III	00000	133	1ST LT S OF STATE ST, E SIDE ON S LIMESTONE ST	12	110510	1/1/0001
50000	S		CNT	III	00000	134	1ST LT S OF STATE ST, W SIDE ON S LIMESTONE ST	12	061311	1/1/0001
50000	S		CNT	III	00000	135	2ND LT S OF STATE ST, E SIDE ON S LIMESTONE ST	12	110510	1/1/0001
50000	S		CNT	III	00000	136	1ST LT S OF UNIVERSITY AVE, W SIDE ON S LIMESTONE ST	12	061311	1/1/0001
50000	S		CNT	III	00000	138	1ST LT N OF WALLER AVE, W SIDE ON S LIMESTONE ST	12	061311	1/1/0001
50000	S		CNT	III	00000	139	1ST LT S OF COOPER, E SIDE ON S LIMESTONE ST	12	110510	1/1/0001
16000	S		GRN	II	00000	300	3RD LT N OF HIGH ST, W SIDE ON S LIMESTONE ST	12	070810	1/1/0001
16000	S		GRN	II	00000	301	3RD LT N OF HIGH ST, E SIDE ON S LIMESTONE ST	12	070810	1/1/0001
16000	S		GRN	II	00000	302	2ND LT N OF HIGH ST, W SIDE ON S LIMESTONE ST	12	070810	1/1/0001
16000	S		GRN	II	00000	303	2ND LT N OF HIGH ST, E SIDE ON S LIMESTONE ST	12	070810	1/1/0001
16000	S		GRN	II	00000	304	1ST LT N OF HIGH ST, W SIDE ON S LIMESTONE ST	12	070810	1/1/0001
16000	S		GRN	II	00000	305	1ST LT N OF HIGH ST, E SIDE ON S LIMESTONE ST	12	070810	1/1/0001
16000	S		GRN	II	00000	306	15TH LT N OF MAXWELL ST, W SIDE ON S LIMESTONE ST	12	070810	1/1/0001
16000	S		GRN	II	00000	307	12TH LT N OF MAXWELL, E SIDE ON S LIMESTONE ST	12	070810	1/1/0001
16000	S		GRN	II	00000	308	14TH LT N OF MAXWELL, W SIDE ON S LIMESTONE ST	12	070810	1/1/0001

Street Light Listing run 1/11/2015 10:43:21 AM

Page 607 of 1254

OFFICE: 311

ROUTE: 564

ST_REF_NO: 00000112310

LIMESTONE, SOUTH STREET

LUMENS	BULB TYPE	MULT SERIES	POLE TYPE	SHADE	ADDRESS NUMBER	REF	LOCATION	TAX DIST	DATE INST	DATE CHANGE
16000	S		GRN	II	00000	309	11TH LT N OF MAXWELL, E SIDE ON S LIMESTONE ST	12	070810	1/1/0001
16000	S		GRN	II	00000	310	13TH LT N OF MAXWELL, W SIDE ON S LIMESTONE ST	12	070810	1/1/0001
16000	S		GRN	II	00000	311	10TH LT N OF MAXWELL, E SIDE ON S LIMESTONE ST	12	070810	1/1/0001
16000	S		GRN	II	00000	312	12TH LT N OF MAXWELL, W SIDE ON S LIMESTONE ST	12	070810	1/1/0001
16000	S		GRN	II	00000	313	9TH LT N OF MAXWELL ST, E SIDE ON S LIMESTONE ST	12	070810	1/1/0001
16000	S		GRN	II	00000	314	11TH LT N OF MAXWELL ST, W SIDE ON S LIMESTONE ST	12	070810	1/1/0001
16000	S		GRN	II	00000	315	8TH LT N OF MAXWELL ST, E SIDE ON S LIMESTONE ST	12	070810	1/1/0001
16000	S		GRN	II	00000	316	10TH LT N OF MAXWELL ST, W SIDE ON S LIMESTONE ST	12	070810	1/1/0001
16000	S		GRN	II	00000	317	7TH LT N OF MAXWELL ST, E SIDE ON S LIMESTONE ST	12	070810	1/1/0001
16000	S		GRN	II	00000	318	9TH LT N OF MAXWELL ST, W SIDE ON S LIMESTONE ST	12	070810	1/1/0001
16000	S		GRN	II	00000	319	6TH LT N OF MAXWELL ST, E SIDE ON S LIMESTONE ST	12	070810	1/1/0001
16000	S		GRN	II	00000	320	8TH LT N OF MAXWELL ST, W SIDE ON S LIMESTONE ST	12	070810	1/1/0001
16000	S		GRN	II	00000	321	5TH LT N OF MAXWELL ST, E SIDE ON S LIMESTONE ST	12	708010	1/1/0001
16000	S		GRN	II	00000	322	7TH LT N OF MAXWELL ST, W SIDE ON S LIMESTONE ST	12	070810	1/1/0001
16000	S		GRN	II	00000	323	4TH LT N OF MAXWELL ST, E SIDE ON S LIMESTONE ST	12	070810	1/1/0001
16000	S		GRN	II	00000	324	6TH LT N OF MAXWELL ST, W SIDE ON S LIMESTONE ST	12	070810	1/1/0001
16000	S		GRN	II	00000	325	3RD LT N OF MAXWELL ST, E SIDE ON S LIMESTONE ST	12	070810	1/1/0001
16000	S		GRN	II	00000	326	5TH LT N OF MAXWELL ST, W SIDE ON S LIMESTONE ST	12	070810	1/1/0001
16000	S		GRN	II	00000	327	2ND LT N OF MAXWELL ST, E SIDE ON S LIMESTONE ST	12	070810	1/1/0001
16000	S		GRN	II	00000	328	4TH LT N OF MAXWELL ST, W SIDE ON S LIMESTONE ST	12	070810	1/1/0001

OFFICE: 311

ROUTE: 564

ST_REF_NO: 00000112310

LIMESTONE, SOUTH STREET

LUMENS	BULB TYPE	MULT SERIES	POLE TYPE	SHADE	ADDRESS NUMBER	REF	LOCATION	TAX DIST	DATE INST	DATE CHANGE
16000	S		GRN	II	00000	329	1ST LT N OF MAXWELL ST, E SIDE ON S LIMESTONE ST	12	070810	1/1/0001
16000	S		GRN	II	00000	330	3RD LT N OF MAXWELL ST, W SIDE ON S LIMESTONE ST	12	070810	1/1/0001
16000	S		GRN	II	00000	331	6TH LT N OF PINE ST, E SIDE ON S LIMESTONE	12	070810	1/1/0001
16000	S		GRN	II	00000	332	2ND LT N OF MAXWELL ST, W SIDE ON S LIMESTONE ST	12	070810	1/1/0001
16000	S		GRN	II	00000	333	5TH LT N OF PINE ST, E SIDE ON S LIMESTONE ST	12	070810	1/1/0001
16000	S		GRN	II	00000	334	1ST LT N OF MAXWELL ST, W SIDE ON S LIMESTONE ST	12	070810	1/1/0001
16000	S		GRN	II	00000	335	4TH LT N OF PINE ST, E SIDE ON S LIMESTONE ST	12	070810	1/1/0001
16000	S		GRN	II	00000	336	6TH LT N OF PINE ST, W SIDE ON S LIMESTONE ST	12	070810	1/1/0001
16000	S		GRN	II	00000	337	3RD LT N OF PINE ST, E SIDE ON S LIMESTONE ST	12	070810	1/1/0001
16000	S		GRN	II	00000	338	5TH LT N OF PINE ST, W SIDE ON S LIMESTONE ST	12	070810	1/1/0001
16000	S		GRN	II	00000	339	2ND LT N OF PINE ST, E SIDE ON S LIMESTONE ST	12	070810	1/1/0001
16000	S		GRN	II	00000	340	4TH LT N OF PINE ST, W SIDE ON S LIMESTONE ST	12	070810	1/1/0001
16000	S		GRN	II	00000	341	1ST LT N OF PINE ST, E SIDE ON S LIMESTONE ST	12	070810	1/1/0001
16000	S		GRN	II	00000	342	3RD LT N OF PINE ST, W SIDE ON S LIMESTONE ST	12	070810	1/1/0001
16000	S		GRN	II	00000	343	9TH LT N OF AVE OF CHAMPIONS, E SIDE ON S LIMESTONE ST	12	070810	1/1/0001
16000	S		GRN	II	00000	344	2ND LT N OF PINE ST, W SIDE ON S LIMESTONE ST	12	070810	1/1/0001
16000	S		GRN	II	00000	345	8TH LT N OF AVE OF CHAMPIONS, E SIDE ON S LIMESTONE ST	12	070810	1/1/0001
16000	S		GRN	II	00000	346	1ST LT N OF PINE ST, W SIDE ON S LIMESTONE	12	070810	1/1/0001
16000	S		GRN	II	00000	347	7TH LT N OF AVE OF CHAMPIONS, E SIDE ON S LIMESTONE ST	12	070810	1/1/0001
16000	S		GRN	II	00000	348	10TH LT N OF AVE OF CHAMPIONS, W SIDE ON S LIMESTONE ST	12	070810	1/1/0001
16000	S		GRN	II	00000	349	6TH LT N OF AVE OF CHAMPIONS, E SIDE ON S LIMESTONE ST	12	070810	1/1/0001
16000	S		GRN	II	00000	350	9TH LT N OF AVE OF CHAMPIONS, W SIDE ON S LIMESTONE ST	12	070810	1/1/0001
16000	S		GRN	II	00000	351	5TH LT N OF AVE OF CHAMPIONS, E SIDE ON S LIMESTONE ST	12	070810	1/1/0001
16000	S		GRN	II	00000	352	8TH LT N OF AVE OF CHAMPIONS, W SIDE ON S LIMESTONE ST	12	070810	1/1/0001
16000	S		GRN	II	00000	353	4TH LT N OF AVE OF CHAMPIONS, E SIDE ON S LIMESTONE ST	12	070810	1/1/0001

OFFICE: 311

ROUTE: 564

ST_REF_NO: 00000112310

LIMESTONE, SOUTH STREET

LUMENS	BULB TYPE	MULT SERIES	POLE TYPE	SHADE	ADDRESS NUMBER	REF	LOCATION	TAX DIST	DATE INST	DATE CHANGE
16000	S		GRN	II	00000	354	7TH LT N OF AVE OF CHAMPIONS, W SIDE ON S LIMESTONE ST	12	070810	1/1/0001
16000	S		GRN	II	00000	355	3RD LT N OF AVE OF CHAMPIONS, E SIDE ON S LIMESTONE ST	12	070810	1/1/0001
16000	S		GRN	II	00000	356	6TH LT N OF AVE OF CHAMPIONS, W SIDE ON S LIMESTONE ST	12	070810	1/1/0001
16000	S		GRN	II	00000	357	3RD LT N OF AVE OF CHAMPIONS, W SIDE ON S LIMESTONE ST	12	070810	1/1/0001
16000	S		GRN	II	00000	358	5TH LT N OF AVE OF CHAMPIONS, W SIDE ON S LIMESTONE ST	12	070810	1/1/0001
16000	S		GRN	II	00000	359	2ND LT N OF AVE OF CHAMPIONS, E SIDE ON S LIMESTONE ST	12	070810	1/1/0001
16000	S		GRN	II	00000	360	4TH LT N OF AVE OF CHAMPIONS, W SIDE ON S LIMESTONE ST	12	070810	1/1/0001
16000	S		GRN	II	00000	361	2ND LT N OF AVE OF CHAMPIONS, W SIDE ON S LIMESTONE ST	12	070810	1/1/0001
16000	S		GRN	II	00000	362	1ST LT N OF AVE OF CHAMPIONS, W SIDE ON S LIMESTONE ST*TWO FIXTURES*	12	070810	1/1/0001
16000	S		GRN	II	00000	363	1ST LT N OF AVE OF CHAMPIONS, E SIDE ON S LIMESTONE ST*TWO FIXTURES*	12	070810	1/1/0001
22000	S		SOH	II	00000	701	ACROSS FROM MONTMULLIN ST, ON S LIMESTONE	12	030910	1/1/0001
22000	S		SOH	II	00521	702		12	030910	1/1/0001
22000	S		SOH	II	00657	700		12	030910	1/1/0001
22000	S		CNT	II	00000	037	1ST LT S OF WINSLOW ST, W SIDE ON S LIMESTONE	12	052710	5/27/2010
22000	S	M	CNT	II	00000	038	2ND LT S OF WINSLOW ST, E SIDE ON S LIMESTONE	12	052710	5/27/2010
50000	S	M	SOH	IV	00000	047	1ST LT. S. OF SCOTT ST., W. SIDE	12	030563	3/8/2010
50000	S	M	OOH	II	00000	048	COUNTRYSIDE OF ENTRANCE TO U.K. ON S. LIMESTONE	12	010892	3/8/2010
50000	S	M	CNT	II	00000	100	1ST LT S OF VIRGINIA AVE, W SIDE ON S LIME	12	040105	1/1/0001
22000	S	M	CNT	II	00000	102	2ND LT S OF VIRGINIA AVE, W SIDE ON S LIME	12	040105	1/1/0001
22000	S	M	CNT	II	00000	104	3RD LT S OF VIRGINIA AVE, W SIDE ON S LIME	12	040105	1/1/0001
22000	S		CNT	III	00000	105	3RD LT S OF HUGUELET, E SIDE ON S LIMESTONE ST	12	110510	11/5/2010
22000	S	M	CNT	II	00000	106	4TH LT S OF VIRGINIA AVE, W SIDE ON S LIME	12	040105	1/1/0001
22000	S	M	CNT	II	00000	108	5TH LT S OF VIRGINIA AVE, W SIDE ON S LIME	12	040105	1/1/0001
22000	S		CNT	III	00000	109	5TH LT S OF HUGUELET, E SIDE ON S LIMESTONE ST	12	110510	11/5/2010

Street Light Listing run 1/11/2015 10:43:21 AM

Page 610 of 1254

OFFICE: 311

ROUTE: 564

ST_REF_NO: 00000112310

LIMESTONE, SOUTH STREET

LUMENS	BULB TYPE	MULT SERIES	POLE TYPE	SHADE	ADDRESS NUMBER	REF	LOCATION	TAX DIST	DATE INST	DATE CHANGE
50000	S	M	CNT	II	00000	110	6TH LT S OF VIRGINIA AVE,W SIDE ON S LIME	12	040105	1/1/0001
50000	S	M	CNT		00000	137	1ST LT N OF COOPER DR, ON E SIDE OF S LIMESTONE	12	030563	5/27/2010
22000	S	M	SOH	II	00000	200	SOUTH LIMESTONE ST IN FRONT OF KENTUCKY CLINIC	12	072804	1/1/0001
16000	S	M	GRN	IV	00000	403	1ST LT N OF WATER ST,E SIDE ON S LIMESTONE ST-chg ref #	12	070101	1/24/2011
16000	S	M	GRN	IV	00000	404	2ND LT N OF WATER ST,E SIDE ON S LIMESTONE ST-ch ref #	12	070101	1/24/2011
16000	S	M	GRN	IV	00000	405	3RD LT N OF WATER ST,E SIDE ON S LIMESTONE ST-chg ref #	12	070101	1/24/2011
16000	S	M	GRN	IV	00000	406	4TH LT N OF WATER ST,E SIDE ON S LIMESTONE ST-chg ref #	12	070101	1/24/2011
50000	S	M	SOH	II	00000	500	2ND LT S OF AVE OF CHAMPIONS,E SIDE ON S LIMESTONE	12	020906	1/1/0001
50000	S	M	SOH	IV	00625	054		12	030563	3/8/2010
50000	S	M	SOH	IV	00658	059		12	071663	3/8/2010
22000	S	M	OUG	IV	00000	042	3RD LT. S OF EUCLID, EASTSIDE	12	040896	1/1/0001
22000	S	M	SOH	IV	00000	043	3RD LT. S. OF EUCLID, W. SIDE	12	030563	1/1/0001
22000	S	M	SOH	IV	00000	044	4TH LT. S. OF EUCLID, E. SIDE	12	030563	1/1/0001
50000	S	M	SOH	IV	00000	045	4TH LT. S. OF EUCLID, W. SIDE	12	030563	1/1/0001
50000	S	M	OOH	II	00000	046	TOWNSIDE OF ENTRANCE TO U.K. ON S. LIMESTONE	12	010892	1/1/0001
50000	S	M	SOH	IV	00000	049	NW CORNER OF S. LIME & COLFAX	12	030563	1/1/0001
50000	S	M	SOH	II	00000	051	ON S. LIMESTONE AT MONTMULLIN, NW CORNER	12	010892	1/1/0001
22000	S	M	SOH	IV	00527	050		12	030563	1/1/0001
22000	S	M	SOH	IV	00553	052		12	030563	1/1/0001
50000	S	M	SOH	IV	00000	053	OPP. PRALL ST.	12	030563	1/1/0001
50000	S	M	SOH	IV	00000	057	OPP. 641	12	101063	1/1/0001
50000	S	M	SOH	IV	00000	061	OPP. 663	12	071663	1/1/0001
50000	S	M	SOH	IV	00000	063	OPP. 693	12	101063	1/1/0001
22000	S	M	OOH	IV	00000	077	OPP. 929, IN ISLAND	12	101063	1/1/0001
22000	S	M	SOH	IV	00620	055		12	071663	1/1/0001
22000	S	M	SOH	IV	00631	056		12	101063	1/1/0001
22000	S	M	SOH	IV	00649	058		12	071663	1/1/0001
22000	S	M	SOH	IV	00657	060		12	071663	1/1/0001

OFFICE: 311

ROUTE: 564

ST_REF_NO: 00000112310

LIMESTONE, SOUTH STREET

LUMENS	BULB TYPE	MULT SERIES	POLE TYPE	SHADE	ADDRESS NUMBER	REF	LOCATION	TAX DIST	DATE INST	DATE CHANGE
22000	S	M	SOH	IV	00749	068		12	071663	1/1/0001
22000	S	M	OUG	IV	00000	040	2ND LT. S OF EUCLID, EASTSIDE	12	040896	1/1/0001
10000	M	M	SOH	II	00230	017		12	040163	1/1/0001
10000	M	M	SOH	II	00235	018		12	040163	1/1/0001
10000	M	M	SOH	II	00249	020		12	040163	1/1/0001
10000	M	M	SOH	II	00250	021		12	040163	1/1/0001
10000	M	M	SOH	II	00257	022		12	040163	1/1/0001
10000	M	M	SOH	II	00273	024		12	040163	1/1/0001
10000	M	M	SOH	II	00281	026		12	040163	1/1/0001
22000	S	M	SOH	IV	00325	031		12	030563	1/1/0001
22000	S	M	SOH	IV	00334	032		12	030563	1/1/0001
22000	S	M	SOH	IV	00377	035		12	030563	1/1/0001

OFFICE: 311

ROUTE: 564

ST_REF_NO: 00000112390

LINWAL COURT

LUMENS	BULB TYPE	MULT SERIES	POLE TYPE	SHADE	ADDRESS NUMBER	REF	LOCATION	TAX DIST	DATE INST	DATE CHANGE
05800	S	M	OUG	II	00000	012	SIDE OF 568 LINWAL DR.	12	040166	1/1/0001

OFFICE: 311

ROUTE: 564

ST_REF_NO: 00000112400

LIN-WAL DRIVE

LUMENS	BULB TYPE	MULT SERIES	POLE TYPE	SHADE	ADDRESS NUMBER	REF	LOCATION	TAX DIST	DATE INST	DATE CHANGE
05800	S	M	OUG	II	00404	046		12	091582	1/1/0001
05800	S	M	OUG	II	00413	045		12	091582	1/1/0001
05800	S	M	OUG	II	00424	044		12	091582	1/1/0001
05800	S	M	OUG	II	00437	043		12	091582	1/1/0001
05800	S	M	OUG	II	00444	042		12	091582	1/1/0001
05800	S	M	OUG	II	00457	041		12	091582	1/1/0001
05800	S	M	OUG	II	00508	040		12	091582	1/1/0001
05800	S	M	OUG	II	00517	022		12	040166	1/1/0001
05800	S	M	OUG	II	00528	021		12	040166	1/1/0001
05800	S	M	OUG	II	00537	020		12	040166	1/1/0001
05800	S	M	OUG	II	00548	019		12	040166	1/1/0001
05800	S	M	OUG	II	00561	011		12	040166	1/1/0001
05800	S	M	OUG	II	00572	010		12	040166	1/1/0001

OFFICE: 311

ROUTE: 564

ST_REF_NO: 00000112400

LIN-WAL DRIVE

LUMENS	BULB TYPE	MULT SERIES	POLE TYPE	SHADE	ADDRESS NUMBER	REF	LOCATION	TAX DIST	DATE INST	DATE CHANGE
05800	S	M	OUG	II	00581	009		12	030166	1/1/0001
05800	S	M	OUG	II	00592	008		12	030166	1/1/0001
05800	S	M	OUG	II	00605	007		12	030166	1/1/0001
05800	S	M	OUG	II	00616	006		12	030166	1/1/0001

OFFICE: 311

ROUTE: 564

ST_REF_NO: 00000112500

LINCOLN AVENUE

LUMENS	BULB TYPE	MULT SERIES	POLE TYPE	SHADE	ADDRESS NUMBER	REF	LOCATION	TAX DIST	DATE INST	DATE CHANGE
04000	S	M	SOH	II	00000	058	SIDE 1211 RICHMOND RD.	12	050885	1/1/0001
04000	S	M	SOH	II	00116	059		12	050885	1/1/0001
04000	S	M	SOH	II	00129	060		12	050885	1/1/0001
04000	S	M	SOH	II	00145	061		12	050885	1/1/0001
04000	S	M	SOH	II	00161	062		12	050885	1/1/0001
04000	S	M	SOH	II	00177	063		12	050885	1/1/0001
04000	S	M	SOH	II	00203	064		12	050885	1/1/0001
04000	S	M	SOH	II	00216	065		12	050885	1/1/0001
04000	S	M	SOH	II	00233	066		12	050885	1/1/0001
04000	S	M	SOH	II	00245	067		12	050885	1/1/0001
04000	S	M	SOH	II	00255	068		12	050885	1/1/0001
04000	S	M	SOH	II	00269	069		12	050885	1/1/0001
04000	S	M	SOH	II	00280	070		12	050885	1/1/0001
04000	S	M	SOH	II	00311	071		12	050885	1/1/0001
04000	S	M	SOH	II	00315	072		12	050885	1/1/0001
04000	S	M	SOH	II	00337	073		12	050885	1/1/0001
04000	S	M	SOH	II	00349	074		12	050885	1/1/0001
04000	S	M	SOH	II	00357	075		12	050885	1/1/0001
04000	S	M	SOH	II	00369	076		12	050885	1/1/0001
04000	S	M	SOH	II	00385	077		12	050885	1/1/0001

OFFICE: 311

ROUTE: 564

ST_REF_NO: 00000112600

LINDBERG DRIVE

LUMENS	BULB TYPE	MULT SERIES	POLE TYPE	SHADE	ADDRESS NUMBER	REF	LOCATION	TAX DIST	DATE INST	DATE CHANGE
05800	S	M	SOH	I	00431	082		12	081869	1/1/0001
05800	S	M	SOH	I	00435	081		12	081869	1/1/0001

OFFICE: 311

ROUTE: 564

ST_REF_NO: 00000112600

LINDBERG DRIVE

LUMENS	BULB TYPE	MULT SERIES	POLE TYPE	SHADE	ADDRESS NUMBER	REF	LOCATION	TAX DIST	DATE INST	DATE CHANGE
05800	S	M	SOH	I	00445	080		12	081869	1/1/0001
05800	S	M	SOH	I	00453	079		12	081869	1/1/0001
05800	S	M	SOH	I	00457	078		12	081869	1/1/0001
05800	S	M	SOH	I	00463	077		12	081869	1/1/0001

OFFICE: 311

ROUTE: 564

ST_REF_NO: 00000112700

LINDEN WALK

LUMENS	BULB TYPE	MULT SERIES	POLE TYPE	SHADE	ADDRESS NUMBER	REF	LOCATION	TAX DIST	DATE INST	DATE CHANGE
09500	S	M	SOH	II	00428	001		12	120170	1/1/0001
05800	S	M	SOH	II	00000	013	SIDE OF 324 E. MAXWELL ST.	12	120170	1/1/0001
05800	S	M	SOH	II	00312	012		12	120170	1/1/0001
05800	S	M	SOH	II	00320	011		12	120170	1/1/0001
05800	S	M	SOH	II	00325	010		12	120170	1/1/0001
05800	S	M	SOH	II	00340	009		12	120170	1/1/0001
05800	S	M	SOH	II	00347	008		12	120170	1/1/0001
05800	S	M	SOH	II	00350	007		12	120170	1/1/0001
05800	S	M	SOH	II	00365	006	upgraded 10/07	12	120170	1/1/0001
05800	S	M	SOH	II	00398	005		12	120170	1/1/0001
09500	S	M	SOH	II	00401	004		12	120170	1/1/0001
09500	S	M	SOH	II	00408	003		12	120170	1/1/0001
09500	S	M	SOH	II	00417	002		12	120170	1/1/0001

OFFICE: 311

ROUTE: 564

ST_REF_NO: 00000112800

LINDENHURST DRIVE

LUMENS	BULB TYPE	MULT SERIES	POLE TYPE	SHADE	ADDRESS NUMBER	REF	LOCATION	TAX DIST	DATE INST	DATE CHANGE
05800	S	M	OUG	II	00000	020	OPP. 301	12	110885	1/1/0001
05800	S	M	OUG	II	00301	021		12	110885	1/1/0001
05800	S	M	OUG	II	00304	023		12	110885	1/1/0001
05800	S	M	OUG	II	00304	024		12	110885	1/1/0001
05800	S	M	OUG	II	00304	025		12	110885	1/1/0001
05800	S	M	OUG	II	00304	026		12	110885	1/1/0001
05800	S	M	OUG	II	00305	022		12	030895	1/1/0001
05800	S	M	OUG	II	00308	028		12	110885	1/1/0001
05800	S	M	OUG	II	00317	027		12	110885	1/1/0001

OFFICE: 311		ROUTE: 564		ST_REF_NO: 00000112900		LINDY COURT		LUMENS	BULB TYPE	MULT SERIES	POLE TYPE	SHADE	ADDRESS NUMBER	REF	LOCATION	TAX DIST	DATE INST	DATE CHANGE
05800	S	M	OUG	II	01720	000										12	020167	1/1/0001
OFFICE: 311		ROUTE: 564		ST_REF_NO: 00000113000		LINDY LANE		LUMENS	BULB TYPE	MULT SERIES	POLE TYPE	SHADE	ADDRESS NUMBER	REF	LOCATION	TAX DIST	DATE INST	DATE CHANGE
05800	S	M	OUG	II	00000	101	SIDE 820 HENRY CLAY BLVD									12	110884	1/1/0001
05800	S	M	OUG	II	00000	108	OPP. 1588									12	100898	1/1/0001
05800	S	M	OUG	II	00000	110	OPP. 1568									12	100898	1/1/0001
05800	S	M	OUG	II	00000	112	OPP. 1544									12	100898	1/1/0001
05800	S	M	OUG	III	01516	114										12	100898	1/1/0001
05800	S	M	OUG	II	01531	113										12	100898	1/1/0001
05800	S	M	OUG	II	01556	111										12	100898	1/1/0001
05800	S	M	OUG	II	01580	109										12	100898	1/1/0001
05800	S	M	OUG	II	01609	102										12	110884	1/1/0001
05800	S	M	OUG	II	01622	103										12	110884	1/1/0001
05800	S	M	OUG	II	01637	104										12	110884	1/1/0001
05800	S	M	OUG	II	01646	105										12	110884	1/1/0001
05800	S	M	OUG	II	01661	106										12	110884	1/1/0001
05800	S	M	OUG	II	01704	107										12	110884	1/1/0001
OFFICE: 311		ROUTE: 564		ST_REF_NO: 00000113200		LINSTAD COURT		LUMENS	BULB TYPE	MULT SERIES	POLE TYPE	SHADE	ADDRESS NUMBER	REF	LOCATION	TAX DIST	DATE INST	DATE CHANGE
04000	S	M	OUG	II	00000	001	SIDE OF 1801 WILLIAMSBURG RD.									12	020889	1/1/0001
04000	S	M	OUG	V	01753	002										12	020889	1/1/0001
OFFICE: 311		ROUTE: 564		ST_REF_NO: 00000113300		LINSTAD DRIVE		LUMENS	BULB TYPE	MULT SERIES	POLE TYPE	SHADE	ADDRESS NUMBER	REF	LOCATION	TAX DIST	DATE INST	DATE CHANGE
04000	S	M	OUG	II	00000	001	SIDE OF 1800 WILLIAMSBURG RD.									12	020889	1/1/0001
04000	S	M	OUG	II	01624	010										12	020889	1/1/0001
04000	S	M	OUG	II	01628	009										12	020889	1/1/0001
04000	S	M	OUG	II	01636	008										12	020889	1/1/0001
04000	S	M	OUG	II	01645	007										12	020889	1/1/0001

OFFICE: 311		ROUTE: 564		ST_REF_NO: 00000113300		LINSTEAD DRIVE				
LUMENS	BULB TYPE	MULT SERIES	POLE TYPE	SHADE	ADDRESS NUMBER	REF	LOCATION	TAX DIST	DATE INST	DATE CHANGE
04000	S	M	OUG	II	01652	006		12	020889	1/1/0001
04000	S	M	OUG	II	01660	005		12	020889	1/1/0001
04000	S	M	OUG	II	01677	003		12	020889	1/1/0001
04000	S	M	OUG	II	01688	002		12	020889	1/1/0001
04000	S	M	OUG	II	01672	004		12	020889	1/1/0001

OFFICE: 311		ROUTE: 564		ST_REF_NO: 00000113400		LINTON ROAD				
LUMENS	BULB TYPE	MULT SERIES	POLE TYPE	SHADE	ADDRESS NUMBER	REF	LOCATION	TAX DIST	DATE INST	DATE CHANGE
05800	S	M	OUG	II	00000	043	SIDE OF 609 RADCLIFFE RD.	12	040166	1/1/0001
05800	S	M	OUG	II	00000	044	SIDE OF 598 BISHOP DR.	12	040166	1/1/0001
05800	S	M	OUG	II	01823	000		12	081867	1/1/0001
05800	S	M	OUG	II	01830	000		12	081867	1/1/0001
05800	S	M	OUG	II	01843	000		12	100169	1/1/0001
05800	S	M	OUG	II	01854	000		12	100169	1/1/0001
05800	S	M	OUG	II	01871	000		12	120170	1/1/0001
05800	S	M	OUG	II	01878	000		12	042067	1/1/0001
05800	S	M	OUG	II	01891	000		12	011667	1/1/0001
05800	S	M	OUG	II	01902	000		12	031372	1/1/0001
05800	S	M	OUG	II	01911	000		12	100169	1/1/0001

OFFICE: 311		ROUTE: 564		ST_REF_NO: 00000113450		LINVILLE LANE				
LUMENS	BULB TYPE	MULT SERIES	POLE TYPE	SHADE	ADDRESS NUMBER	REF	LOCATION	TAX DIST	DATE INST	DATE CHANGE
05800	S		CNT	II	00000	001	ACROSS FROM 3200 LINVILLE LANE	12	091109	1/1/0001
05800	S		CNT	II	00000	002	SIDE OF 3220 LINVILLE LANE	12	091109	1/1/0001
05800	S		CNT	II	03217	003		12	091109	1/1/0001
05800	S		CNT	II	03236	006		12	091109	1/1/0001

OFFICE: 311		ROUTE: 564		ST_REF_NO: 00000113600		LINWOOD DRIVE				
LUMENS	BULB TYPE	MULT SERIES	POLE TYPE	SHADE	ADDRESS NUMBER	REF	LOCATION	TAX DIST	DATE INST	DATE CHANGE
09500	S	M	SOH	II	00201	001		12	111583	1/1/0001
09500	S	M	SOH	II	00211	002		12	111583	1/1/0001

OFFICE: 311		ROUTE: 564		ST_REF_NO: 00000113690		LISA CIRCLE		LUMENS	BULB TYPE	MULT SERIES	POLE TYPE	SHADE	ADDRESS NUMBER	REF	LOCATION	TAX DIST	DATE INST	DATE CHANGE
05800	S	M	OUG	II	02116	041										12	051475	1/1/0001
OFFICE: 311		ROUTE: 564		ST_REF_NO: 00000113700		LISA COURT		LUMENS	BULB TYPE	MULT SERIES	POLE TYPE	SHADE	ADDRESS NUMBER	REF	LOCATION	TAX DIST	DATE INST	DATE CHANGE
05800	S	M	OUG	II	00600	000										12	120667	1/1/0001
05800	S	M	OUG	II	00613	000										12	030868	1/1/0001
05800	S	M	OUG	II	00620	000										12	120667	1/1/0001
05800	S	M	OUG	II	00637	000										12	120667	1/1/0001
OFFICE: 311		ROUTE: 564		ST_REF_NO: 00000113800		LISA DRIVE		LUMENS	BULB TYPE	MULT SERIES	POLE TYPE	SHADE	ADDRESS NUMBER	REF	LOCATION	TAX DIST	DATE INST	DATE CHANGE
05800	S	M	OUG	II	00000	039	OPP. 509									12	051475	1/1/0001
04000	S	M	OUG	II	00000	090	SIDE OF 534 PARKSIDE DR.									12	050884	1/1/0001
04000	S	M	OUG	II	00000	091	SIDE OF 551 FREEMAN DR.									12	050884	1/1/0001
04000	S	M	OUG	II	00000	092	SIDE OF 546 FREEMAN DR.									12	050884	1/1/0001
04000	S	M	OUG	II	00000	093	SIDE OF 549 JUDY LANE									12	050884	1/1/0001
04000	S	M	OUG	II	00000	094	SIDE OF 546 JUDY LANE									12	050884	1/1/0001
05800	S	M	OUG	III	00505	040										12	080897	1/1/0001
05800	S	M	OUG	II	00525	000										12	050774	1/1/0001
05800	S	M	OUG	II	00532	000										12	050774	1/1/0001
05800	S	M	OUG	II	00545	000										12	030868	1/1/0001
05800	S	M	OUG	II	00556	000										12	120667	1/1/0001
05800	S	M	OUG	II	00573	000										12	030868	1/1/0001
OFFICE: 311		ROUTE: 564		ST_REF_NO: 00000113900		LISLE ROAD		LUMENS	BULB TYPE	MULT SERIES	POLE TYPE	SHADE	ADDRESS NUMBER	REF	LOCATION	TAX DIST	DATE INST	DATE CHANGE
09500	S	M	SOH	II	00000	001	1ST LT. S. OF LEESTOWN RD., W. SIDE									12	070886	1/1/0001
09500	S	M	SOH	II	00000	002	2ND LT. S. OF LEESTOWN RD., E. SIDE									12	070886	1/1/0001
09500	S	M	SOH	II	00000	003	3RD LT. S. OF LEESTOWN RD., W. SIDE									12	070886	1/1/0001
09500	S	M	SOH	II	00000	004	4TH LT. S. OF LEESTOWN RD., W. SIDE									12	070886	1/1/0001
09500	S	M	SOH	II	00000	005	5TH LT. S. OF LEESTOWN RD., E. SIDE									12	070886	1/1/0001

OFFICE: 311		ROUTE: 564		ST_REF_NO: 00000113900		LISLE ROAD		LUMENS	BULB TYPE	MULT SERIES	POLE TYPE	SHADE	ADDRESS NUMBER	REF	LOCATION	TAX DIST	DATE INST	DATE CHANGE
09500	S	M	SOH	II	00000	006	6TH LT. S. OF LEESTOWN RD., W. SIDE	12	070886	1/1/0001								
09500	S	M	SOH	II	00000	007	7TH LT. S. OF LEESTOWN RD., E. SIDE	12	070886	1/1/0001								
09500	S	M	SOH	II	00000	013	SIDE OF 238	12	070886	1/1/0001								
09500	S	M	SOH	II	00203	008		12	070886	1/1/0001								
09500	S	M	SOH	II	00203	009		12	070886	1/1/0001								
09500	S	M	SOH	II	00210	010		12	070886	1/1/0001								
09500	S	M	SOH	II	00229	012		12	070886	1/1/0001								
09500	S	M	SOH	II	00229	019		12	070886	1/1/0001								
09500	S	M	SOH	II	00236	011		12	070886	1/1/0001								
09500	S	M	SOH	II	01221	018		12	070886	1/1/0001								
09500	S	M	SOH	II	01223	017		12	070886	1/1/0001								
09500	S	M	SOH	II	01225	016		12	070886	1/1/0001								
09500	S	M	SOH	II	01231	015		12	070886	1/1/0001								
09500	S	M	SOH	II	01235	014		12	070886	1/1/0001								
09500	S	M	SOH	II	01301	020		12	070886	1/1/0001								

OFFICE: 311		ROUTE: 564		ST_REF_NO: 00000113950		LITCHFIELD LANE		LUMENS	BULB TYPE	MULT SERIES	POLE TYPE	SHADE	ADDRESS NUMBER	REF	LOCATION	TAX DIST	DATE INST	DATE CHANGE
05800	S	M	CNT	II	00000	001	SIDE OF 2248 CHAMBLEE LN ON LITCHFIELD LN	12	071102	1/1/0001								
05800	S	M	CNT	III	01208	008		12	071102	1/1/0001								
05800	S	M	CNT	II	01220	006		12	071102	1/1/0001								
05800	S	M	CNT	II	01221	007		12	071102	1/1/0001								
05800	S	M	CNT	II	01233	005		12	071102	1/1/0001								
05800	S	M	CNT	II	01240	004		12	071102	1/1/0001								
05800	S	M	CNT	II	01244	003		12	071102	1/1/0001								
05800	S	M	CNT	II	01269	002		12	071102	1/1/0001								

OFFICE: 311		ROUTE: 564		ST_REF_NO: 00000114140		LITTLE SILVER COURT		LUMENS	BULB TYPE	MULT SERIES	POLE TYPE	SHADE	ADDRESS NUMBER	REF	LOCATION	TAX DIST	DATE INST	DATE CHANGE
09500	S		CLN	II	00801	001		12	051609	1/1/0001								
09500	S		CLN	II	00804	002		12	051609	1/1/0001								
09500	S		CLN	II	00805	003		12	051609	1/1/0001								

OFFICE: 311		ROUTE: 564		ST_REF_NO: 00000114195		LIVANIA LANE		LUMENS	BULB TYPE	MULT SERIES	POLE TYPE	SHADE	ADDRESS NUMBER	REF	LOCATION	TAX DIST	DATE INST	DATE CHANGE
09500	S		CLN	II	00000	001	ACROSS FROM 801 LIVANIA LANE	12	051609	1/1/0001								
09500	S		CLN	II	00805	002		12	051609	1/1/0001								
09500	S		CLN	II	00809	004		12	051609	1/1/0001								
09500	S		CLN	II	00812	003		12	051609	1/1/0001								
09500	S		CLN	II	00825	005		12	051609	1/1/0001								
09500	S		CLN	II	00829	006		12	051609	1/1/0001								
09500	S		CLN	II	00832	007		12	051609	1/1/0001								

OFFICE: 311		ROUTE: 564		ST_REF_NO: 00000114200		LIVERPOOL ROAD		LUMENS	BULB TYPE	MULT SERIES	POLE TYPE	SHADE	ADDRESS NUMBER	REF	LOCATION	TAX DIST	DATE INST	DATE CHANGE
09500	S	M	OUG	II	00200	000		12	081363	1/1/0001								
09500	S	M	OUG	II	00213	000		12	081366	1/1/0001								
09500	S	M	OUG	II	00224	000		12	090166	1/1/0001								
09500	S	M	OUG	II	00237	000		12	081363	1/1/0001								
09500	S	M	OUG	II	00252	000		12	081363	1/1/0001								
09500	S	M	OUG	II	00267	000		12	081363	1/1/0001								
09500	S	M	OUG	II	00278	000		12	122065	1/1/0001								

OFFICE: 311		ROUTE: 564		ST_REF_NO: 00000114300		LOCH LOMOND DRIVE		LUMENS	BULB TYPE	MULT SERIES	POLE TYPE	SHADE	ADDRESS NUMBER	REF	LOCATION	TAX DIST	DATE INST	DATE CHANGE
05800	S	M	OUG	II	00000	057	SIDE OF 2933 BRIGADOON PKWY	12	080896	1/1/0001								
05800	S	M	OUG	II	00000	060	SIDE OF 118 DUNDEE DR.	12	080896	1/1/0001								
04000	S	M	OUG	II	00000	082	SIDE 3559 LANSDOWNE DR.	12	060886	1/1/0001								
05800	S	M	OUG	II	00107	062		12	080896	1/1/0001								
05800	S	M	SOH	II	00108	061		12	080896	1/1/0001								
05800	S	M	OUG	II	00116	059		12	080896	1/1/0001								
05800	S	M	OUG	II	00120	058		12	080896	1/1/0001								
04000	S	M	OUG	II	00203	056		12	010886	1/1/0001								
04000	S	M	OUG	II	00209	055		12	010886	1/1/0001								
04000	S	M	OUG	II	00210	054		12	010886	1/1/0001								
04000	S	M	OUG	II	00218	053		12	010886	1/1/0001								
04000	S	M	OUG	II	00224	052		12	010886	1/1/0001								

OFFICE: 311		ROUTE: 564		ST_REF_NO: 00000114350		LOCHDALE TERRACE		LUMENS	BULB TYPE	MULT SERIES	POLE TYPE	SHADE	ADDRESS NUMBER	REF	LOCATION	TAX DIST	DATE INST	DATE CHANGE
05800	S	M	CNT	II	00000	002	ACROSS FRM 1101 WAVELAND TOWNHOMES ON LOCHDALE TER	12	071407	1/1/0001								
05800	S	M	CNT	II	00000	003	SIDE OF 500 BAYLOR PL ON LOCHDALE TER	12	071407	1/1/0001								
05800	S	M	CNT	II	00000	006	SIDE OF 433 JOSEPH BRYAN WAY ON LOCHDALE TER	12	071407	1/1/0001								
05800	S	M	CNT	II	00000	007	SIDE OF 496 NEWBURY WAY ON LOCHDALE TERR	12	122205	1/1/0001								
05800	S	M	CNT	II	00000	008	SIDE OF 501 NEWBURY WAY ON LOCHDALE TERR	12	122205	1/1/0001								
05800	S	M	CNT	II	00000	010	SIDE OF 500 MILLPOIND RD ON LOCHDALE TERR	12	122205	1/1/0001								
05800	S	M	CNT	II	00000	012	SIDE OF 348 OUTRIDER WAY ON LOCHDALE TERR	12	122205	1/1/0001								
05800	S	M	CNT	II	00000	013	SIE OF 343 OUTRIDER WAY ON LOCHDALE TERR	12	122205	1/1/0001								
05800	S	M	CNT	II	00000	014	ACROSS FROM 3610 LOCHDALE TERR	12	122205	1/1/0001								
05800	S	M	CNT	II	00000	016	SIDE OF 300 TWIN SPRIES TRAIL ON LOCHDALE TERR	12	122205	1/1/0001								
05800	S	M	CNT	III	00000	017	SIDE OF 301 TWIN PSIRES TRAIL ON LOCHDALE TERR	12	122205	1/1/0001								
05800	S	M	CNT	II	00300	050		12	011708	1/1/0001								
05800	S	M	CNT	II	03600	015		12	122205	1/1/0001								
05800	S	M	CNT	II	03709	011		12	122205	1/1/0001								
05800	S	M	CNT	II	03737	009		12	122205	1/1/0001								
05800	S	M	CNT	II	03822	005	correcting house number 1/2008	12	071407	1/1/0001								
05800	S	M	CNT	II	03832	004	correcting house number 1/2008	12	071407	1/1/0001								

OFFICE: 311

ROUTE: 564

OFFICE: 311		ROUTE: 564		ST_REF_NO: 00000114600		LOCKHURST ROAD		LUMENS	BULB TYPE	MULT SERIES	POLE TYPE	SHADE	ADDRESS NUMBER	REF	LOCATION	TAX DIST	DATE INST	DATE CHANGE
05800	S	M	OUG	II	00000	014	SIDE OF 525 PLAINVIEW ROAD	12	080169	1/1/0001								
05800	S	M	OUG	II	02744	018		12	061868	1/1/0001								
05800	S	M	OUG	II	02751	017		12	042468	1/1/0001								
05800	S	M	OUG	II	02768	016		12	080169	1/1/0001								
05800	S	M	OUG	II	02775	015		12	050170	1/1/0001								

OFFICE: 311

ROUTE: 564

OFFICE: 311		ROUTE: 564		ST_REF_NO: 00000114700		LOCHNESS DRIVE		LUMENS	BULB TYPE	MULT SERIES	POLE TYPE	SHADE	ADDRESS NUMBER	REF	LOCATION	TAX DIST	DATE INST	DATE CHANGE
09500	S	M	OUG	III	00000	020	SIDE 179 E. REYNOLDS RD.	12	110885	1/1/0001								
09500	S	M	OUG	III	00000	021	SIDE 205-207 E. REYNOLDS RD.	12	110885	1/1/0001								

Street Light Listing run 1/11/2015 10:43:21 AM

Page 620 of 1254

OFFICE: 311		ROUTE: 564		ST_REF_NO: 00000114700		LOCHNESS DRIVE		LUMENS	BULB TYPE	MULT SERIES	POLE TYPE	SHADE	ADDRESS NUMBER	REF	LOCATION	TAX DIST	DATE INST	DATE CHANGE
04000	S	M	OUG	II	00000	025	SIDE 127 TARTAN DR.	12	010886	1/1/0001								
09500	S	M	SOH	III	03257	018		12	110885	1/1/0001								
09500	S	M	OUG	III	03264	019		12	110885	1/1/0001								
OFFICE: 311		ROUTE: 564		ST_REF_NO: 00000114800		LOCUST AVENUE		LUMENS	BULB TYPE	MULT SERIES	POLE TYPE	SHADE	ADDRESS NUMBER	REF	LOCATION	TAX DIST	DATE INST	DATE CHANGE
09500	S	M	SOH	II	00000	079	SIDE 1212 N. LIMESTONE-upgrade 8/06	12	050885	1/1/0001								
09500	S	M	SOH	II	00117	080	upgraded 8/06	12	050885	1/1/0001								
09500	S	M	SOH	II	00130	081	upgrade 8/06	12	050885	1/1/0001								
09500	S	M	SOH	II	00201	082	upgrade 8/06	12	050885	1/1/0001								
09500	S	M	SOH	II	00208	083	upgrade 8/06	12	050885	1/1/0001								
09500	S	M	SOH	II	00217	084	upgraded 8/06	12	050885	1/1/0001								
09500	S	M	SOH	II	00306	085	upgraded 8/06	12	050885	1/1/0001								
09500	S	M	OOH	II	00000	036	SIDE OF 1222 BRYAN AVE.-upgrade 8/06	12	020171	1/1/0001								
09500	S	M	SOH	II	00000	087	SIDE 1215 BRYAN AVE.-upgrade 8/06	12	050885	1/1/0001								
09500	S	M	OUG	II	00000	104	SIDE OF 1202 OAKHILL DRIVE-upgrade 8/06	12	100164	1/1/0001								
09500	S	M	OUG	II	00000	105	SIDE OF 967 CARNEAL RD.	12	100164	1/1/0001								
09500	S	M	OUG	II	00000	106	SIDE OF 1002 CARNEAL ROAD-upgrade 8/06	12	110863	1/1/0001								
09500	S	M	OUG	II	00000	107	SIDE OF 999 MARCELLUS DRIVE-upgrade 8/06	12	110863	1/1/0001								
09500	S	M	SOH	II	00324	086	upgraded 8/06	12	050885	1/1/0001								
09500	S	M	SOH	II	00337	001	upgraded 8/06	12	091477	1/1/0001								
09500	S	M	OUG	II	00408	035	upgraded 8/06	12	020171	1/1/0001								
09500	S	M	OUG	II	00420	034	upgraded 8/06	12	020171	1/1/0001								
09500	S	M	OUG	II	00452	033	upgraded 8/06	12	020171	1/1/0001								
09500	S	M	OUG	II	00468	032	upgraded 8/06	12	020171	1/1/0001								
09500	S	M	OUG	II	00484	000	upgraded 8/06	12	052456	1/1/0001								
09500	S	M	OUG	II	00000	108	SIDE OF 1002 MARCELLUS DRIVE-upgrade 9/06	12	110863	1/1/0001								
09500	S	M	OUG	II	00000	109	SIDE OF 1015 DARLEY DRIVE-upgrade 8/06	12	110863	1/1/0001								
OFFICE: 311		ROUTE: 564		ST_REF_NO: 00000114802		LOCUST BLOSSOM COVE		LUMENS	BULB TYPE	MULT SERIES	POLE TYPE	SHADE	ADDRESS NUMBER	REF	LOCATION	TAX DIST	DATE INST	DATE CHANGE
05800	S		CNT	II	03000	001		12	080513	1/1/0001								

OFFICE: 311		ROUTE: 564		ST_REF_NO: 00000114802		LOCUST BLOSSOM COVE		LUMENS	BULB TYPE	MULT SERIES	POLE TYPE	SHADE	ADDRESS NUMBER	REF	LOCATION	TAX DIST	DATE INST	DATE CHANGE
05800	S		CNT	II	03024	003	CORRECTING STREET ADDRESS 2/26/2013	12	041109	4/11/2009								

OFFICE: 311		ROUTE: 564		ST_REF_NO: 00000114805		LOCUST HILL DRIVE		LUMENS	BULB TYPE	MULT SERIES	POLE TYPE	SHADE	ADDRESS NUMBER	REF	LOCATION	TAX DIST	DATE INST	DATE CHANGE
22000	S	M	OUG	II	00000	400	2ND LT E OF RICHMOND RD, N SIDE ON LOCUST HILL DR	12	062404	1/1/0001								
50000	S	M	OUG	II	00000	401	1ST LT E OF RICHMOND RD, S SIDE ON LOCUST HILL DR	12	062404	1/1/0001								
50000	S	M	OUG	II	00000	402	1ST LT W OF RICHMOND RD, S SIDE ON LOCUST HILL DR	12	062404	1/1/0001								
09500	S	M	OUG	II	00000	021	SIDE 3050 RIO DOSA DR.	12	120886	1/1/0001								
09500	S	M	OUG	II	00000	022	1ST LT. S. OF RIO DOSA DR., W. SIDE	12	120886	1/1/0001								
09500	S	M	OUG	II	00000	023	SIDE 3050 RIO DOSA	12	120886	1/1/0001								
09500	S	M	OUG	II	00000	025	SIDE 3050 RIO DOSA	12	120886	1/1/0001								
09500	S	M	OUG	II	00000	026	2ND LT. S. OF RIO DOSA, W. SIDE	12	120886	1/1/0001								
09500	S	M	OUG	II	00100	036		12	110891	1/1/0001								
09500	S	M	OUG	II	00109	033		12	110891	1/1/0001								
09500	S	M	OUG	II	00117	031		12	110891	1/1/0001								
09500	S	M	OUG	II	00125	029		12	110891	1/1/0001								
09500	S	M	OUG	II	00130	028		12	110891	1/1/0001								
09500	S	M	OUG	II	00130	030		12	110891	1/1/0001								
09500	S	M	OUG	II	00130	032		12	110891	1/1/0001								
09500	S	M	OUG	II	00130	034		12	110891	1/1/0001								
09500	S	M	OUG	II	00133	027		12	110891	1/1/0001								

OFFICE: 311		ROUTE: 564		ST_REF_NO: 00000114806		LOCUST HILL, SOUTH DRIVE		LUMENS	BULB TYPE	MULT SERIES	POLE TYPE	SHADE	ADDRESS NUMBER	REF	LOCATION	TAX DIST	DATE INST	DATE CHANGE
09500	S	M	OUG	II	00000	002	1ST LT. S. OF RICHMOND RD., E. SIDE	12	020888	1/1/0001								
09500	S	M	OUG	II	00000	003	2ND LT. S. OF RICHMOND RD., W. SIDE	12	020888	1/1/0001								
09500	S	M	OUG	II	00000	005	3RD LT. S. OF RICHMOND RD., W. SIDE	12	020888	1/1/0001								
09500	S	M	OUG	II	00000	007	4TH LT. S. OF RICHMOND RD., W. SIDE	12	020888	1/1/0001								
09500	S	M	OUG	II	00000	009	5TH LT. S. OF RICHMOND RD., W. SIDE	12	020888	1/1/0001								
09500	S	M	OUG	II	00000	011	6TH LT. S. OF RICHMOND RD., W. SIDE	12	020888	1/1/0001								

OFFICE: 311

ROUTE: 564

ST_REF_NO: 00000114806 LOCUST HILL, SOUTH DRIVE

LUMENS	BULB TYPE	MULT SERIES	POLE TYPE	SHADE	ADDRESS NUMBER	REF	LOCATION	TAX DIST	DATE INST	DATE CHANGE
09500	S	M	OUG	II	00000	013	7TH LT. S. OF RICHMOND RD., W. SIDE	12	020888	1/1/0001
09500	S	M	OUG	II	00000	014	8TH LT. S. OF RICHMOND RD., W. SIDE	12	020888	1/1/0001

OFFICE: 311

ROUTE: 564

ST_REF_NO: 00000114808 LOCUST POINTE WAY

LUMENS	BULB TYPE	MULT SERIES	POLE TYPE	SHADE	ADDRESS NUMBER	REF	LOCATION	TAX DIST	DATE INST	DATE CHANGE
22000	S	M	OUG	II	00000	002	1ST LT N OF LOCUST HILL, E SIDE ON LOCUST POINTE WAY	12	063005	1/1/0001
22000	S	M	OUG	II	00000	003	1ST LT N OF LOCUST HILL, E SIDE ON LOCUST POINTE	12	050505	1/1/0001

OFFICE: 311

ROUTE: 564

ST_REF_NO: 00000114810 LOGAN PLACE

LUMENS	BULB TYPE	MULT SERIES	POLE TYPE	SHADE	ADDRESS NUMBER	REF	LOCATION	TAX DIST	DATE INST	DATE CHANGE
05800	S	M	OUG	II	00000	118	SIDE OF 857 CARNEAL	12	031908	3/19/2008
05800	S	M	OUG	II	00600	119		12	031908	1/1/0001

OFFICE: 311

ROUTE: 564

ST_REF_NO: 00000114820 LOGANS FORT LANE

LUMENS	BULB TYPE	MULT SERIES	POLE TYPE	SHADE	ADDRESS NUMBER	REF	LOCATION	TAX DIST	DATE INST	DATE CHANGE
05800	S	M	CNT	II	00000	004	SIDE OF 201 RICHARDSON PLACE ON LOGANS FORT LANE	12	052607	1/1/0001
05800	S	M	CNT	II	00000	006	SIDE OF 201 EMILIE LANE ON LOGANS FORT LANE	12	052607	1/1/0001
05800	S	M	CNT	II	00000	007	SIDE OF 200 EMILIE LANE ON LOGANS FORT LANE	12	052607	1/1/0001
05800	S	M	CNT	II	00000	008	SIDE OF 4477 LOGANS FORT LANE	12	052607	1/1/0001
05800	S	M	CNT	II	04405	002		12	052607	1/1/0001
05800	S	M	CNT	II	04417	003		12	052607	1/1/0001
05800	S	M	CNT	II	04432	005		12	052607	1/1/0001
05800	S	M	CNT	II	04476	009		12	052607	1/1/0001
05800	S	M	CNT	II	04489	010		12	052607	1/1/0001
05800	S	M	CNT	II	04496	011		12	052607	1/1/0001

OFFICE: 311

ROUTE: 564

ST_REF_NO: 00000115000 LOMBARDY DRIVE

LUMENS	BULB TYPE	MULT SERIES	POLE TYPE	SHADE	ADDRESS NUMBER	REF	LOCATION	TAX DIST	DATE INST	DATE CHANGE
05800	S	M	OUG	II	00000	071	SIDE OF 1944 BRYNELL DR.	12	042264	1/1/0001

OFFICE: 311

ROUTE: 564

ST_REF_NO: 00000115000

LOMBARDY DRIVE

LUMENS	BULB TYPE	MULT SERIES	POLE TYPE	SHADE	ADDRESS NUMBER	REF	LOCATION	TAX DIST	DATE INST	DATE CHANGE
05800	S	M	OUG	II	00617	000		12	061465	1/1/0001
05800	S	M	OUG	II	00628	073		12	042264	1/1/0001
05800	S	M	OUG	II	00645	074		12	042264	1/1/0001
05800	S	M	OUG	II	00656	075		12	042264	1/1/0001
05800	S	M	OUG	II	00669	000		12	010166	1/1/0001

OFFICE: 311

ROUTE: 564

ST_REF_NO: 00000115095

LONAN COURT

LUMENS	BULB TYPE	MULT SERIES	POLE TYPE	SHADE	ADDRESS NUMBER	REF	LOCATION	TAX DIST	DATE INST	DATE CHANGE
05800	S	M	OUG	II	00000	001	SIDE OF 953 APPLECROSS DRIVE ON LONAN CT	12	042508	1/1/0001
05800	S	M	OUG	II	02313	002		12	042508	1/1/0001
05800	S	M	OUG	II	02320	003		12	042508	1/1/0001
05800	S	M	OUG	II	02333	004		12	042508	1/1/0001
05800	S	M	OUG	II	02349	005		12	042508	1/1/0001
05800	S	M	OUG	II	02360	006		12	042508	1/1/0001

OFFICE: 311

ROUTE: 564

ST_REF_NO: 00000115100

LONDONDERRY DRIVE

LUMENS	BULB TYPE	MULT SERIES	POLE TYPE	SHADE	ADDRESS NUMBER	REF	LOCATION	TAX DIST	DATE INST	DATE CHANGE
09500	S	M	OUG	II	00221	000		12	092260	1/1/0001
09500	S	M	OUG	II	00228	000		12	092260	1/1/0001
09500	S	M	OUG	II	00118	000		12	120558	1/1/0001
09500	S	M	OUG	II	00123	000		12	110761	1/1/0001
09500	S	M	OUG	II	00130	000		12	102258	1/1/0001
09500	S	M	OUG	II	00133	000		12	091360	1/1/0001
09500	S	M	OUG	II	00138	000		12	121659	1/1/0001
09500	S	M	OUG	II	00151	000		12	121659	1/1/0001
09500	S	M	OUG	II	00152	000		12	050160	1/1/0001
09500	S	M	OUG	II	00207	000		12	050160	1/1/0001
09500	S	M	OUG	II	00214	000		12	050160	1/1/0001

OFFICE: 311

ROUTE: 564

ST_REF_NO: 00000115200

LONE OAK STREET

LUMENS	BULB TYPE	MULT SERIES	POLE TYPE	SHADE	ADDRESS NUMBER	REF	LOCATION	TAX DIST	DATE INST	DATE CHANGE
05800	S	M	OUG	II	00550	143	911 address change 1996	12	101583	2/2/2012
04000	S	M	OUG	II	00557	142	911 address change	12	101583	5/4/1996
04000	S	M	OUG	II	00566	141	911 address change	12	101583	5/4/1996
04000	S	M	OUG	II	00500	147		12	101583	1/1/0001
04000	S	M	OUG	II	00505	146		12	101583	1/1/0001
04000	S	M	OUG	II	00519	145		12	101583	1/1/0001
04000	S	M	OUG	II	00538	144		12	101583	1/1/0001

OFFICE: 311

ROUTE: 564

ST_REF_NO: 00000115300

LONETTA AVENUE

LUMENS	BULB TYPE	MULT SERIES	POLE TYPE	SHADE	ADDRESS NUMBER	REF	LOCATION	TAX DIST	DATE INST	DATE CHANGE
04000	S	M	SOH	II	00000	052	OPP. SIDE REAR 110	12	060685	1/1/0001
04000	S	M	SOH	II	00000	053	OPP. 112	12	060685	1/1/0001
04000	S	M	SOH	II	00000	054	112 1/2	12	060685	1/1/0001
04000	S	M	SOH	II	00104	050		12	060685	1/1/0001
04000	S	M	SOH	II	00110	051		12	060685	1/1/0001

OFFICE: 311

ROUTE: 564

ST_REF_NO: 00000115380

LONG BRANCH LANE

LUMENS	BULB TYPE	MULT SERIES	POLE TYPE	SHADE	ADDRESS NUMBER	REF	LOCATION	TAX DIST	DATE INST	DATE CHANGE
05800	S	M	CNT	II	00000	003	SIDE OF 3073 TOWN BRANCH RD ON LONG BRANCH RD	12	090605	1/1/0001
05800	S	M	CNT	II	00000	005	SIDE OF 3073 CADDIS LANE ON LONG BRANCH LANE	12	090605	1/1/0001
05800	S	M	CNT	II	00000	014	SIDE OF 192 BLUE HERON PLACE ON LONG BRANCH LN	12	090605	1/1/0001
05800	S	M	CNT	II	00000	016	SIDE OF 172 YAMACRAW PLACE ON LONG BRANCH LANE	12	090605	1/1/0001
05800	S	M	CNT	II	00000	017	SIDE OF 172 LEATHER WOOD LANE ON LONG BRANCH LN	12	090605	1/1/0001
05800	S	M	CNT	II	00000	018	SIDE OF 193 ANGEL FALLS DR ON LONG BRANCH LN	12	090605	1/1/0001
05800	S	M	CNT	II	00000	019	SIDE OF 173 MCCONNELLS TRACE BLVD ON LONG BRANCH LN	12	090605	1/1/0001
05800	S	M	CNT	II	00000	020	SIDE OF 164 MCCONNELLS TRACE BLVD ON LONG BRANCH LN	12	090605	1/1/0001
05800	S	M	CNT	II	00120	002		12	090605	1/1/0001

OFFICE: 311

ROUTE: 564

ST_REF_NO: 00000115380

LONG BRANCH LANE

LUMENS	BULB TYPE	MULT SERIES	POLE TYPE	SHADE	ADDRESS NUMBER	REF	LOCATION	TAX DIST	DATE INST	DATE CHANGE
05800	S	M	CNT	II	00168	006		12	090605	1/1/0001
05800	S	M	CNT	II	00176	007		12	090605	1/1/0001
05800	S	M	CNT	II	00192	008		12	090605	1/1/0001
05800	S	M	CNT	II	00208	009		12	090605	1/1/0001
05800	S	M	CNT	II	00228	010		12	090605	1/1/0001
05800	S	M	CNT	II	00248	011		12	090605	1/1/0001
05800	S	M	CNT	II	00260	012		12	090605	1/1/0001
05800	S	M	CNT	II	00273	013		12	090605	1/1/0001
05800	S	M	CNT	II	00313	015		12	090605	1/1/0001
05800	S	M	CNT	II	00408	019		12	100507	1/1/0001
05800	S	M	CNT	II	00440	017		12	100507	1/1/0001
05800	S	M	CNT	II	00449	016		12	100507	1/1/0001

OFFICE: 311

ROUTE: 564

ST_REF_NO: 00000115390

LONGBRIDGE LANE

LUMENS	BULB TYPE	MULT SERIES	POLE TYPE	SHADE	ADDRESS NUMBER	REF	LOCATION	TAX DIST	DATE INST	DATE CHANGE
04000	S	M	OUG	V	04517	013		12	110889	1/1/0001
04000	S	M	OUG	II	04524	012		12	110889	1/1/0001
04000	S	M	OUG	II	04544	010		12	110889	1/1/0001
04000	S	M	OUG	II	04553	009		12	110889	1/1/0001
04000	S	M	OUG	V	04560	008		12	09082	1/1/0001
04000	S	M	OUG	II	04576	007		12	090892	1/1/0001
04000	S	M	OUG	II	04585	006		12	110889	1/1/0001
04000	S	M	OUG	II	04593	005		12	110889	1/1/0001
04000	S	M	OUG	II	04600	004		12	090892	1/1/0001
04000	S	M	OUG	II	04608	003		12	090892	1/1/0001
04000	S	M	OUG	II	04617	002		12	110889	1/1/0001
04000	S	M	OUG	II	04621	001		12	110889	1/1/0001

OFFICE: 311

ROUTE: 564

ST_REF_NO: 00000115395

LONG MEADOW COURT

LUMENS	BULB TYPE	MULT SERIES	POLE TYPE	SHADE	ADDRESS NUMBER	REF	LOCATION	TAX DIST	DATE INST	DATE CHANGE
05800	S	M	CNT	II	03701	001		12	120898	1/1/0001
05800	S	M	CNT	III	03704	002		12	120898	1/1/0001

OFFICE: 311

ROUTE: 564

ST_REF_NO: 00000115400

LONGVIEW DRIVE

LUMENS	BULB TYPE	MULT SERIES	POLE TYPE	SHADE	ADDRESS NUMBER	REF	LOCATION	TAX DIST	DATE INST	DATE CHANGE
05800	S	M	OUG	II	00000	044	SIDE OF 2300 HARRODSBURG RD.	12	101583	1/1/0001
05800	S	M	OUG	II	00619	053		12	101583	1/1/0001
05800	S	M	OUG	II	00626	052		12	101583	1/1/0001
05800	S	M	OUG	II	00631	051		12	101583	1/1/0001
05800	S	M	OUG	II	00638	050		12	101583	1/1/0001
05800	S	M	OUG	II	00643	049		12	101583	1/1/0001
05800	S	M	OUG	II	00650	048		12	101583	1/1/0001
05800	S	M	OUG	II	00655	047		12	101583	1/1/0001
05800	S	M	OUG	II	00662	046		12	101583	1/1/0001
05800	S	M	OUG	II	00667	045		12	101583	1/1/0001
05800	S	M	OUG	II	00000	057	SIDE OF 2201 CLAYS MILL	12	101583	1/1/0001
05800	S	M	OUG	II	00000	058	SIDE OF 2120 CLAYS MILL RD.	12	061583	1/1/0001
05800	S	M	OUG	II	00000	068	OPP. 480	12	031583	1/1/0001
05800	S	M	OUG	II	00000	069	OPP. 450	12	031583	1/1/0001
05800	S	M	OUG	II	00000	070	OPP. 430	12	041583	1/1/0001
05800	S	M	OUG	II	00400	071		12	041583	1/1/0001
05800	S	M	OUG	II	00490	067		12	101583	1/1/0001
05800	S	M	OUG	II	00497	066		12	031583	1/1/0001
05800	S	M	OUG	II	00564	065		12	041583	1/1/0001
05800	S	M	OUG	II	00567	064		12	041583	1/1/0001
05800	S	M	OUG	II	00576	063		12	041583	1/1/0001
05800	S	M	OUG	II	00579	062		12	101583	1/1/0001
05800	S	M	OUG	II	00586	061		12	061583	1/1/0001
05800	S	M	OUG	II	00591	060		12	061583	1/1/0001
05800	S	M	OUG	II	00598	059		12	061583	1/1/0001
05800	S	M	OUG	II	00601	056		12	101583	1/1/0001
05800	S	M	OUG	II	00607	055		12	101583	1/1/0001
05800	S	M	OUG	II	00614	054		12	101583	1/1/0001

OFFICE: 311

ROUTE: 564

ST_REF_NO: 00000115600

LONGWOOD ROAD

LUMENS	BULB TYPE	MULT SERIES	POLE TYPE	SHADE	ADDRESS NUMBER	REF	LOCATION	TAX DIST	DATE INST	DATE CHANGE
04000	S	M	OUG	II	00000	005	OPP. 708 LONGWOOD RD	12	050891	1/1/0001
04000	S	M	OUG	II	00667	001		12	020891	1/1/0001

OFFICE: 311		ROUTE: 564		ST_REF_NO: 00000115600		LONGWOOD ROAD		LUMENS	BULB TYPE	MULT SERIES	POLE TYPE	SHADE	ADDRESS NUMBER	REF	LOCATION	TAX DIST	DATE INST	DATE CHANGE
	04000	S	M	OUG	II	00679	002									12	020891	1/1/0001
	04000	S	M	OUG	II	00691	003									12	050891	1/1/0001
	04000	S	M	OUG	II	00696	004									12	050891	1/1/0001
	04000	S	M	OUG	II	00716	049									12	021580	1/1/0001
	04000	S	M	OUG	II	00728	048									12	021580	1/1/0001
	04000	S	M	OUG	II	00735	047									12	021580	1/1/0001
	04000	S	M	OUG	II	00748	046									12	021580	1/1/0001
	04000	S	M	OUG	II	00755	045									12	021580	1/1/0001
	04000	S	M	OUG	II	00763	044									12	021580	1/1/0001
	04000	S	M	OUG	II	00772	013									12	111581	1/1/0001
	04000	S	M	OUG	II	00779	012									12	091579	1/1/0001
	04000	S	M	OUG	II	00788	011									12	091579	1/1/0001
	04000	S	M	OUG	II	00799	010									12	091579	1/1/0001
OFFICE: 311		ROUTE: 564		ST_REF_NO: 00000115700		LOOKOUT CIRCLE		LUMENS	BULB TYPE	MULT SERIES	POLE TYPE	SHADE	ADDRESS NUMBER	REF	LOCATION	TAX DIST	DATE INST	DATE CHANGE
	05800	S	M	OUG	II	00000	077								SIDE OF 2937 MONTAVESTA RD.	12	110172	1/1/0001
	05800	S	M	OUG	V	01412	000									12	121273	1/1/0001
OFFICE: 311		ROUTE: 564		ST_REF_NO: 00000115710		LOON LAKE CIRCLE		LUMENS	BULB TYPE	MULT SERIES	POLE TYPE	SHADE	ADDRESS NUMBER	REF	LOCATION	TAX DIST	DATE INST	DATE CHANGE
	05800	S	M	OUG	V	00000	001								REAR OF 4673 COLLINSWOOD	12	100893	1/1/0001
OFFICE: 311		ROUTE: 564		ST_REF_NO: 00000115800		LORETTA DRIVE		LUMENS	BULB TYPE	MULT SERIES	POLE TYPE	SHADE	ADDRESS NUMBER	REF	LOCATION	TAX DIST	DATE INST	DATE CHANGE
	04000	S	M	OUG	II	02900	007									12	071581	1/1/0001
	04000	S	M	OUG	II	02913	008									12	071581	1/1/0001
OFFICE: 311		ROUTE: 564		ST_REF_NO: 00000115890		LORI LANE		LUMENS	BULB TYPE	MULT SERIES	POLE TYPE	SHADE	ADDRESS NUMBER	REF	LOCATION	TAX DIST	DATE INST	DATE CHANGE
	05800	S	M	OUG	II	00725	003								bad fixture	12	120887	8/26/2010

OFFICE: 311		ROUTE: 564		ST_REF_NO: 00000115890		LORI LANE		LUMENS	BULB TYPE	MULT SERIES	POLE TYPE	SHADE	ADDRESS NUMBER	REF	LOCATION	TAX DIST	DATE INST	DATE CHANGE
04000	S	M	OUG	II	00704	005		12	120887	1/1/0001								
04000	S	M	OUG	II	00713	004		12	120887	1/1/0001								
04000	S	M	OUG	II	00737	002		12	120887	1/1/0001								
04000	S	M	OUG	II	00753	001		12	120887	1/1/0001								

OFFICE: 311		ROUTE: 564		ST_REF_NO: 00000116040		LOST TRAIL LANE		LUMENS	BULB TYPE	MULT SERIES	POLE TYPE	SHADE	ADDRESS NUMBER	REF	LOCATION	TAX DIST	DATE INST	DATE CHANGE
05800	S	M	OUG	II	00000	001	SIDE OF 861 CEDARWOOD DR ON LOST TRAIL DR	12	100802	1/1/0001								
05800	S	M	OUG	II	00000	007	SIDE OF 824 SEMINOLE CR CT ON LOST TRAIL LN	12	103103	1/1/0001								
05800	S	M	OUG	III	00804	002		12	103103	1/1/0001								
05800	S	M	OUG	II	01857	011		12	103103	1/1/0001								
05800	S	M	OUG	II	01877	010		12	103103	1/1/0001								
05800	S	M	OUG	II	01885	009		12	103103	1/1/0001								
05800	S	M	OUG	II	01905	008		12	103103	1/1/0001								
05800	S	M	OUG	II	01929	006		12	103103	1/1/0001								
05800	S	M	OUG	II	01941	005		12	100802	1/1/0001								
05800	S	M	OUG	II	01980	003		12	100802	1/1/0001								
05800	S	M	OUG	II	01989	004		12	100802	1/1/0001								

OFFICE: 311		ROUTE: 564		ST_REF_NO: 00000116055		LOTUS LANE		LUMENS	BULB TYPE	MULT SERIES	POLE TYPE	SHADE	ADDRESS NUMBER	REF	LOCATION	TAX DIST	DATE INST	DATE CHANGE
05800	S	M	CNT	II	04401	001		12	051107	1/1/0001								
05800	S	M	CNT	II	04408	002		12	051107	1/1/0001								

OFFICE: 311		ROUTE: 564		ST_REF_NO: 00000116070		LOU JOHNSON WAY		LUMENS	BULB TYPE	MULT SERIES	POLE TYPE	SHADE	ADDRESS NUMBER	REF	LOCATION	TAX DIST	DATE INST	DATE CHANGE
05800	S	M	OUG	II	00000	003	2ND LT S OF PRALL ST, W SIDE ON LOU JOHNSON WAY	12	110897	1/1/0001								
05800	S	M	OUG	II	00000	004	1ST LT S OF PRALL ST, W SIDE ON LOU JOHNSON WAY	12	110897	1/1/0001								

OFFICE: 311

ROUTE: 564

ST_REF_NO: 00000116090

LOUNDESBORO COURT

LUMENS	BULB TYPE	MULT SERIES	POLE TYPE	SHADE	ADDRESS NUMBER	REF	LOCATION	TAX DIST	DATE INST	DATE CHANGE
04000	S	M	OUG	II	00000	001	SIDE OF 3924 FOREST GREEN	12	120887	1/1/0001
04000	S	M	OUG	II	00000	022	SIDE OF 3701	12	120887	1/1/0001

OFFICE: 311

ROUTE: 564

ST_REF_NO: 00000116100

LOUDON, EAST AVENUE

LUMENS	BULB TYPE	MULT SERIES	POLE TYPE	SHADE	ADDRESS NUMBER	REF	LOCATION	TAX DIST	DATE INST	DATE CHANGE
22000	S		OUG	II	00000	106	SIDE OF 800 WARFIELD PL ON E LOUDON AVE	12	022809	1/1/0001
22000	S		OUG	II	00000	109	ACROSS FROM 653 E LOUDON AVENUE	12	022809	1/1/0001
22000	S		OUG	II	00000	115	SIDE OF 800 DARLEY DR ON E LOUDON AVENUE	12	022809	1/1/0001
22000	S		OUG	II	00000	117	SIDE OF 801 MEADOW LANE ON E LOUDON AVENUE	12	022809	1/1/0001
22000	S		OUG	II	00000	125	ACROSS FROM 720 E LOUDON AVEUE	12	022809	1/1/0001
09500	S		OUG	II	00000	127	ACROSS FROM 808 E LOUDON AVENUE	12	022809	1/1/0001
22000	S		OUG	II	00413	101		12	022809	1/1/0001
22000	S		OUG	II	00425	102		12	022809	1/1/0001
22000	S		OUG	II	00526	100		12	022809	1/1/0001
22000	S		OUG	II	00530	103		12	022809	1/1/0001
09500	S		OUG	II	00537	104		12	022809	1/1/0001
22000	S		OUG	II	00544	105		12	022809	1/1/0001
09500	S		OUG	II	00638	107		12	022809	1/1/0001
22000	S		OUG	II	00645	108		12	022809	1/1/0001
09500	S		OUG	II	00659	110		12	022809	1/1/0001
22000	S		OUG	II	00662	111		12	022809	1/1/0001
22000	S		OUG	II	00667	112		12	022809	1/1/0001
22000	S		OUG	II	00676	113		12	022809	1/1/0001
22000	S		OUG	II	00678	114		12	022809	1/1/0001
09500	S		OUG	II	00690	116		12	022809	1/1/0001
22000	S		OUG	II	00694	118		12	022809	1/1/0001
22000	S		OUG	II	00700	120		12	022809	1/1/0001
09500	S		OUG	II	00705	119		12	022809	1/1/0001
09500	S		OUG	II	00710	122		12	022809	1/1/0001
22000	S		OUG	II	00711	121		12	022809	1/1/0001
22000	S		OUG	II	00717	123		12	022809	1/1/0001
22000	S		OUG	II	00720	124		12	022809	1/1/0001

OFFICE: 311		ROUTE: 564		ST_REF_NO: 00000116100		LOUDON, EAST AVENUE		LUMENS	BULB TYPE	MULT SERIES	POLE TYPE	SHADE	ADDRESS NUMBER	REF	LOCATION	TAX DIST	DATE INST	DATE CHANGE
22000	S		OUG	II	00808	126										12	022809	1/1/0001
22000	S		OUG	II	00825	129										12	022809	1/1/0001
09500	S		OUG	II	00837	131										12	022809	1/1/0001
09500	S		OUG	II	00847	133										12	022809	1/1/0001
22000	S		OUG	II	00857	135										12	022809	1/1/0001
10000	M	M	SOH	II	00840	035	chg addr only									12	011478	4/4/2011
10000	M	M	SOH	II	00850	036	chg addr only									12	011478	4/4/2011
20000	M	M	SOH	II	00108	009										12	052068	1/1/0001
20000	M	M	SOH	II	00125	010										12	060368	1/1/0001
22000	S	M	SOH	II	00144	001										12	100168	1/1/0001
22000	S	M	SOH	II	00161	002										12	071568	1/1/0001
22000	S	M	SOH	II	00184	003	upgrade 6/08									12	071568	1/1/0001
20000	M	M	SOH	II	00197	004										12	071568	1/1/0001
20000	M	M	SOH	II	00202	005										12	071568	1/1/0001
10000	M	M	SOH	II	00000	006	SIDE OF 801 WARFIELD PLACE									12	100168	1/1/0001
10000	M	M	SOH	II	00000	008	SIDE OF 800 WARFIELD PLACE									12	100168	1/1/0001
20000	M	M	SOH	II	00219	006										12	100168	1/1/0001
22000	S	M	SOH	II	00238	007										12	100168	1/1/0001
20000	M	M	SOH	II	00251	008										12	071568	1/1/0001
20000	M	M	SOH	II	00266	009										12	100168	1/1/0001
20000	M	M	SOH	II	00269	010										12	071568	1/1/0001
20000	M	M	SOH	II	00290	011										12	100168	1/1/0001
22000	S	M	SOH	II	00411	012										12	100168	1/1/0001
10000	M	M	SOH	II	00412	001										12	100168	1/1/0001
05800	S	M	OUG	II	00000	050	SIDE REAR OF 816 STATESMAN WAY									12	100898	1/1/0001
10000	M	M	SOH	II	00820	031										12	011478	1/1/0001
10000	M	M	SOH	II	00838	032										12	011478	1/1/0001
05800	S	M	OUG	II	00930	051										12	100898	1/1/0001
OFFICE: 311		ROUTE: 564		ST_REF_NO: 00000116110		LOUDON, WEST AVENUE		LUMENS	BULB TYPE	MULT SERIES	POLE TYPE	SHADE	ADDRESS NUMBER	REF	LOCATION	TAX DIST	DATE INST	DATE CHANGE
22000	S		OUG	II	00000	102	4TH LT W OF RUSSELL CAVE, S SIDE ON W LOUDON AVE									12	061113	1/1/0001

OFFICE: 311

ROUTE: 564

ST_REF_NO: 00000116110

LOUDON, WEST AVENUE

LUMENS	BULB TYPE	MULT SERIES	POLE TYPE	SHADE	ADDRESS NUMBER	REF	LOCATION	TAX DIST	DATE INST	DATE CHANGE
22000	S		OUG	II	00000	103	5TH LT W OF RUSSELL CAVE, S SIDE ON W LOUDON AVE	12	061113	1/1/0001
22000	S		OUG	II	00000	104	6TH LT W OF RUSSELL CAVE, S SIDE ON W LOUDON AVE	12	061113	1/1/0001
22000	S		OUG	II	00000	105	7TH LT W OF RUSSELL CAVE, S SIDE ON W LOUDON AVE	12	061113	1/1/0001
22000	S		OUG	II	00000	106	8TH LT W OF RUSSELL CAVE, S SIDE ON W LOUDON AVE	12	061113	1/1/0001
22000	S		OUG	II	00000	107	9TH LT W OF RUSSELL CAVE, S SIDE ON W LOUDON AVE	12	061113	1/1/0001
22000	S	M	OUG	II	00109	006	bad fixture	12	111475	1/1/2009
20000	M	M	SOH	II	00000	001	SIDE OF 785 N. BROADWAY	12	052068	1/1/0001
20000	M	M	SOH	II	00000	003	1ST LT. E. OF BROADWAY, S. SIDE	12	052068	1/1/0001
20000	M	M	SOH	II	00000	004	1ST LT. E. OF BROADWAY, N. SIDE	12	052068	1/1/0001
20000	M	M	SOH	II	00000	005	2ND LT. E. OF BROADWAY, S. SIDE	12	052068	1/1/0001
22000	S	M	OUG	III	00000	010	1ST LT E OF NEWTOWN PK,NORTHSIDE ON LOUDON AVE EXT	12	080891	1/1/0001
22000	S	M	OUG	III	00000	012	2ND LT E OF NEWTOWN PK,NORTHSIDE ON LOUDON AVE EXT	12	080891	1/1/0001
22000	S	M	OUG	III	00000	014	3RD LT E OF NEWTOWN PK,NORTHSIDE ON LOUDON AVE EXT	12	080891	1/1/0001
22000	S	M	OUG	III	00000	016	4TH LT E OF NEWTOWN PK,NORTHSIDE ON LOUDON AVE EXT	12	080891	1/1/0001
22000	S	M	OUG	III	00000	018	5TH LT E OF NEWTOWN PK,NORTHSIDE ON LOUDON AVE EXT	12	080891	1/1/0001
22000	S	M	OUG	III	00000	019	6TH LT E OF NEWTOWN PK,SOUTHSIDE ON LOUDON AVE EXT	12	080891	1/1/0001
22000	S	M	OUG	III	00000	020	6TH LT E OF NEWTOWN PK,NORTHSIDE ON LOUDON AVE EXT	12	080891	1/1/0001
22000	S	M	OUG	III	00000	021	7TH LT E OF NEWTOWN PK,SOUTHSIDE ON LOUDON AVE EXT	12	080891	1/1/0001
22000	S	M	OUG	III	00000	022	7TH LT E OF NEWTOWN PK,NORTHSIDE ON LOUDON AVE EXT	12	080891	1/1/0001
22000	S	M	OUG	III	00000	023	8TH LT E OF NEWTOWN PK,SOUTHSIDE ON LOUDON AVE EXT	12	080891	1/1/0001
22000	S	M	OUG	III	00000	024	8TH LT E OF NEWTOWN PK,NORTHSIDE ON LOUDON AVE EXT	12	080891	1/1/0001
22000	S	M	OUG	III	00000	026	9TH LT E OF NEWTOWN PK,SOUTHSIDE ON LOUDON AVE EXT	12	080891	1/1/0001

Street Light Listing run 1/11/2015 10:43:21 AM

Page 632 of 1254

OFFICE: 311		ROUTE: 564								
		ST_REF_NO: 00000116110		LOUDON, WEST AVENUE						
LUMENS	BULB TYPE	MULT SERIES	POLE TYPE	SHADE	ADDRESS NUMBER	REF	LOCATION	TAX DIST	DATE INST	DATE CHANGE
22000	S	M	OUG	III	00000	028	10TH LT E OF NEWTOWN PK,NORTHSIDE ON LOUDON AVE EX	12	080891	1/1/0001
22000	S	M	OUG	III	00000	030	11TH LT E OF NEWTOWN PK,NORTHSIDE ON LOUDON AVE EX	12	080891	1/1/0001
22000	S	M	OUG	III	00000	032	12TH LT E OF NEWTOWN PK,NORTHSIDE ON LOUDON AVE EX	12	080891	1/1/0001
22000	S	M	OUG	III	00000	034	13TH LT E OF NEWTOWN PK,NORTHSIDE ON LOUDON AVE EX	12	080891	1/1/0001
22000	S	M	OUG	III	00000	036	14TH LT E OF NEWTOWN PK,NORTHSIDE ON LOUDON AVE EX	12	080891	1/1/0001
22000	S	M	OUG	III	00000	038	15TH LT E OF NEWTOWN PK,NORTHSIDE ON LOUDON AVE EX	12	080891	1/1/0001
22000	S	M	OUG	III	00000	040	16TH LT E OF NEWTOWN PK,NORTHSIDE ON LOUDON AVE EX	12	080891	1/1/0001
22000	S	M	OUG	III	00000	042	17TH LT E OF NEWTOWN PK,NORTHSIDE ON LOUDON AVE EX	12	080891	1/1/0001
22000	S	M	OUG	III	00000	044	18TH LT E OF NEWTOWN PK,NORTHSIDE ON LOUDON AVE EX	12	080891	1/1/0001
22000	S	M	OUG	III	00000	045	19TH LT E OF NEWTOWN PK,SOUTHSIDE ON LOUDON AVE EX	12	080891	1/1/0001
22000	S	M	OUG	III	00000	046	19TH LT E OF NEWTOWN PK,NORTHSIDE ON LOUDON AVE EX	12	080891	1/1/0001
22000	S	M	OUG	III	00000	047	20TH LT E OF NEWTOWN PK,SOUTHSIDE ON LOUDON AVE EX	12	080891	1/1/0001
22000	S	M	OUG	III	00000	048	20TH LT E OF NEWTOWN PK,NORTHSIDE ON LOUDON AVE EX	12	080891	1/1/0001
22000	S	M	OUG	III	00000	049	21ST LT E OF NEWTOWN PK,SOUTHSIDE ON LOUDON AVE EX	12	080891	1/1/0001
50000	S	M	OUG	III	00000	050	21ST LT E OF NEWTOWN PK ON NORTHSIDE AT RUSSELL CV	12	080891	1/1/0001
20000	M	M	SOH	II	00101	008		12	052068	1/1/0001
20000	M	M	SOH	II	00104	007		12	052068	1/1/0001
OFFICE: 311		ROUTE: 564								
		ST_REF_NO: 00000116160		LOUIE PLACE						
LUMENS	BULB TYPE	MULT SERIES	POLE TYPE	SHADE	ADDRESS NUMBER	REF	LOCATION	TAX DIST	DATE INST	DATE CHANGE
05800	S		CNT	II	00000	001	1ST LT S OF LEESTOWN RD, W SIDE ON LOUIE PLACE	12	021909	1/1/0001

OFFICE: 311		ROUTE: 564		ST_REF_NO: 00000116160		LOUIE PLACE		LUMENS	BULB TYPE	MULT SERIES	POLE TYPE	SHADE	ADDRESS NUMBER	REF	LOCATION	TAX DIST	DATE INST	DATE CHANGE
05800	S		CNT	II	00000	002	2ND LT S OF LEESTOWN RD, W SIDE ON LOUIE PLACE	12	021909									1/1/0001
05800	S		CNT	II	00000	003	3RD LT S OF LEESTOWN RD, W SIDE ON LOUIE PLACE	12	021909									1/1/0001
05800	S		CNT	II	00148	006		12	021909									1/1/0001

OFFICE: 311		ROUTE: 564		ST_REF_NO: 00000116200		LOUISIANA AVENUE		LUMENS	BULB TYPE	MULT SERIES	POLE TYPE	SHADE	ADDRESS NUMBER	REF	LOCATION	TAX DIST	DATE INST	DATE CHANGE
05800	S	M	OUG	II	00000	053	SIDE OF 345 COCHRAN ROAD	12	090165									1/1/0001
05800	S	M	OUG	II	00111	054		12	090165									1/1/0001
05800	S	M	OUG	II	00140	055		12	121665									1/1/0001
05800	S	M	OUG	II	00145	056		12	090165									1/1/0001
05800	S	M	OUG	II	00176	057		12	121665									1/1/0001
05800	S	M	OUG	II	00191	058		12	121665									1/1/0001

OFFICE: 311		ROUTE: 564		ST_REF_NO: 00000116230		LOVELL COURT		LUMENS	BULB TYPE	MULT SERIES	POLE TYPE	SHADE	ADDRESS NUMBER	REF	LOCATION	TAX DIST	DATE INST	DATE CHANGE
05800	S	M	CNT	II	02204	002		12	071202									1/1/0001
05800	S	M	CNT	II	02221	003		12	071202									1/1/0001
05800	S	M	CNT	II	02226	004		12	071202									1/1/0001
05800	S	M	CNT	III	02241	005		12	071202									1/1/0001

OFFICE: 311		ROUTE: 564		ST_REF_NO: 00000116250		LOWNDESBORO		LUMENS	BULB TYPE	MULT SERIES	POLE TYPE	SHADE	ADDRESS NUMBER	REF	LOCATION	TAX DIST	DATE INST	DATE CHANGE
04000	S	M	OUG	V	03713	002		12	050890									1/1/0001

OFFICE: 311		ROUTE: 564		ST_REF_NO: 00000116300		LOWER STREET		LUMENS	BULB TYPE	MULT SERIES	POLE TYPE	SHADE	ADDRESS NUMBER	REF	LOCATION	TAX DIST	DATE INST	DATE CHANGE
05800	S	M	SOH	I	00000	481	AT END OF STREET	12	060867									1/1/0001
05800	S	M	SOH	II	00643	482		12	080171									1/1/0001

OFFICE: 311

ROUTE: 564

ST_REF_NO: 00000116400

LOWRY LANE

LUMENS	BULB TYPE	MULT SERIES	POLE TYPE	SHADE	ADDRESS NUMBER	REF	LOCATION	TAX DIST	DATE INST	DATE CHANGE
09500	S	M	OUG	II	00000	002	OPPOSITE 110 LOWRY LANE	12	090401	1/1/0001
09500	S	M	OUG	II	00000	003	OPPOSITE 124 LOWRY LANE	12	090401	1/1/0001
50000	S	M	OUG	II	00000	300	1ST LT E OF NICH RD, S SIDE ON E LOWRY LANE	12	020206	1/1/0001
05800	S	M	OUG	II	00168	008	upgrade-3rd party damage	12	110888	1/3/2013
09500	S	M	OUG	II	00000	001	SIDE OF 2300 NICHOLASVILLE RD.	12	110888	1/1/0001
09500	S	M	OUG	II	00000	004	OPP. 130	12	110888	1/1/0001
09500	S	M	OUG	II	00140	005		12	110888	1/1/0001
04000	S	M	OUG	II	00148	006		12	110888	1/1/0001
04000	S	M	OUG	II	00160	007		12	110888	1/1/0001
05800	S	M	OUG	II	00208	009	bad fixture-upgrade to 5800	12	110888	1/1/0001
05800	S	M	OUG	II	00211	010	bad fixture-upgrade to 5800	12	110888	1/1/0001
04000	S	M	OUG	II	00220	011		12	110888	1/1/0001
04000	S	M	OUG	II	00224	012		12	110888	1/1/0001
04000	S	M	OUG	II	00227	013		12	110888	1/1/0001
04000	S	M	OUG	II	00235	014		12	110888	1/1/0001
04000	S	M	OUG	II	00239	015		12	110888	1/1/0001
04000	S	M	OUG	II	00247	016		12	110888	1/1/0001
04000	S	M	OUG	II	00251	017		12	110888	1/1/0001
04000	S	M	OUG	II	00257	018		12	110888	1/1/0001
04000	S	M	OUG	II	00307	019		12	110888	1/1/0001
04000	S	M	OUG	II	00313	020		12	110888	1/1/0001
04000	S	M	OUG	II	00317	021		12	110888	1/1/0001
04000	S	M	OUG	II	00325	022		12	110888	1/1/0001
04000	S	M	OUG	II	00331	023		12	110888	1/1/0001
04000	S	M	OUG	II	00336	024		12	110888	1/1/0001

OFFICE: 311

ROUTE: 564

ST_REF_NO: 00000116410

LOWRY, WEST LANE

LUMENS	BULB TYPE	MULT SERIES	POLE TYPE	SHADE	ADDRESS NUMBER	REF	LOCATION	TAX DIST	DATE INST	DATE CHANGE
09500	S		OUG	II	00000	001	1ST LT W OF NICHOLASVILLE, N SIDE OF W LOWRY LANE	12	030801	1/1/0001
09500	S	M	OUG	II	00000	002	2ND LT. W. OF NICHOLASVILLE RD., N. SIDE	12	020887	1/1/0001
09500	S		OUG	II	00000	003	3RD LT W OF NICHOLASVILLE, N SIDE OF WEST LOWRY LN	12	030801	1/1/0001
09500	S	M	OUG	II	00000	004	4TH LT. W. OF NICHOLASVILLE RD., N. SIDE	12	020887	1/1/0001

OFFICE: 311		ROUTE: 564		ST_REF_NO: 00000116410		LOWRY, WEST LANE		LUMENS	BULB TYPE	MULT SERIES	POLE TYPE	SHADE	ADDRESS NUMBER	REF	LOCATION	TAX DIST	DATE INST	DATE CHANGE
	09500	S	M	OUG	II	00000	005	5TH LT. W. OF NICHOLASVILLE RD., S. SIDE	12	020887	1/1/0001							
	09500	S	M	OUG	II	00000	006	6TH LT. W. OF NICHOLASVILLE RD., N. SIDE	12	020887	1/1/0001							
	09500	S	M	OUG	II	00000	007	7TH LT. W. OF NICHOLASVILLE RD., S. SIDE	12	020887	1/1/0001							
	09500	S	M	OUG	II	00000	008	8TH LT. W. OF NICHOLASVILLE RD., N. SIDE	12	020887	1/1/0001							
	09500	S	M	OUG	II	00000	009	9TH LT. W. OF NICHOLASVILLE RD., S. SIDE	12	020887	1/1/0001							
	09500	S	M	OUG	II	00000	010	10TH LT. W. OF NICHOLASVILLE RD., N. SIDE	12	020887	1/1/0001							
	09500	S	M	OUG	III	00191	012		12	020890	1/1/0001							
	09500	S	M	OUG	III	00201	014		12	020890	1/1/0001							
OFFICE: 311		ROUTE: 564		ST_REF_NO: 00000116480		LUCILLE DRIVE		LUMENS	BULB TYPE	MULT SERIES	POLE TYPE	SHADE	ADDRESS NUMBER	REF	LOCATION	TAX DIST	DATE INST	DATE CHANGE
	05800	S		CNT	II	00000	201	LUCILLE DR @ SPURR ROAD	12	102808	1/1/0001							
	05800	S		CNT	II	00000	209	SIDE OF 2749 RED CLOVER LN ON LUCILLE DR	12	102808	1/1/0001							
	05800	S		CNT	II	00636	127		12	080610	1/1/0001							
	05800	S		CNT	II	00649	126		12	080610	1/1/0001							
	05800	S		CNT	II	00656	125		12	080610	1/1/0001							
	05800	S		CNT	II	00685	123		12	080610	1/1/0001							
	05800	S		CNT	II	00696	122		12	080610	1/1/0001							
	05800	S		CNT	II	00709	121		12	080610	1/1/0001							
	05800	S		CNT	II	00721	120		12	080610	1/1/0001							
	05800	S		CNT	II	01017	208		12	102808	1/1/0001							
	05800	S		CNT	II	01025	207		12	102808	1/1/0001							
	05800	S		CNT	II	01041	206		12	102808	1/1/0001							
	05800	S		CNT	II	01052	205		12	102808	1/1/0001							
	05800	S		CNT	II	01069	204		12	102808	1/1/0001							
	05800	S		CNT	II	01076	202		12	102808	1/1/0001							
	05800	S		CNT	II	01081	203		12	102808	1/1/0001							
	05800	S		CNT	II	01097	200		12	102808	1/1/0001							
	05800	S	M	CNT	II	00000	006	SIDE OF 2764 JACQUELYN LANE ON LUCILLE DR	12	072401	1/1/0001							
	05800	S	M	CNT	II	00000	012	OPPOSITE 293 LUCILLE DRIVE	12	072401	1/1/0001							
	05800	S	M	CNT	II	00000	020	SIDE OF 2653 BUCK LANE ON LUCILLE DRIVE	12	042605	1/1/0001							
	05800	S	M	CNT	II	00000	050	SIDE OF 2796 MICHELLE PARK ON LUCILLE DRIVE	12	042605	1/1/0001							
	05800	S	M	CNT	II	00000	051	ACROSS FROM 245 LUCILLE DRIVE	12	042605	1/1/0001							

OFFICE: 311		ROUTE: 564		ST_REF_NO: 00000116480		LUCILLE DRIVE		LUMENS	BULB TYPE	MULT SERIES	POLE TYPE	SHADE	ADDRESS NUMBER	REF	LOCATION	TAX DIST	DATE INST	DATE CHANGE
05800	S	M	CNT	II	00000	053	CORNER OF HAYDEN PARK LANE ON LUCILLE DRIVE	12	042605								1/1/0001	
05800	S		CNT	II	00000	210	SIDE OF 2748 RED CLOVER LN ON LUCILLE DR	12	102808								10/28/2008	
05800	S	M	CNT	II	00189	022		12	062405								1/1/0001	
05800	S	M	CNT	II	00204	021		12	062405								1/1/0001	
05800	S	M	CNT	II	00252	052		12	042605								1/1/0001	
05800	S	M	CNT	II	00320	010		12	072401								1/1/0001	
05800	S	M	CNT	II	00337	009		12	072401								1/1/0001	
05800	S	M	CNT	II	00352	008		12	072401								1/1/0001	
05800	S	M	CNT	II	00361	007		12	072401								1/1/0001	
05800	S	M	CNT	II	00401	005		12	072401								1/1/0001	
05800	S	M	CNT	II	00416	004		12	072401								1/1/0001	
05800	S	M	CNT	II	00437	003		12	072401								1/1/0001	
05800	S	M	CNT	II	00456	002		12	072401								1/1/0001	
05800	S	M	CNT	II	00469	001		12	072401								1/1/0001	

OFFICE: 311

ROUTE: 564

OFFICE: 311		ROUTE: 564		ST_REF_NO: 00000116490		LUCCI COURT		LUMENS	BULB TYPE	MULT SERIES	POLE TYPE	SHADE	ADDRESS NUMBER	REF	LOCATION	TAX DIST	DATE INST	DATE CHANGE
04000	S	M	OUG	II	03709	084		12	120887								1/1/0001	

OFFICE: 311

ROUTE: 564

OFFICE: 311		ROUTE: 564		ST_REF_NO: 00000116500		LUCY LANE		LUMENS	BULB TYPE	MULT SERIES	POLE TYPE	SHADE	ADDRESS NUMBER	REF	LOCATION	TAX DIST	DATE INST	DATE CHANGE
05800	S	M	OUG	II	00000	001	SIDE OF 494 ERIE RD.	12	050159								1/1/0001	
05800	S	M	OUG	II	00949	000		12	010465								1/1/0001	
05800	S	M	OUG	II	00954	000		12	010465								1/1/0001	
05800	S	M	OUG	II	00963	000		12	010465								1/1/0001	

OFFICE: 311

ROUTE: 564

OFFICE: 311		ROUTE: 564		ST_REF_NO: 00000116600		LUGIART AVENUE		LUMENS	BULB TYPE	MULT SERIES	POLE TYPE	SHADE	ADDRESS NUMBER	REF	LOCATION	TAX DIST	DATE INST	DATE CHANGE
05800	S	M	SOH	I	00000	001	OPPOSITE 115	12	020924								1/1/0001	

OFFICE: 311

ROUTE: 564

ST_REF_NO: 00000116700

LULLWATER ROAD

LUMENS	BULB TYPE	MULT SERIES	POLE TYPE	SHADE	ADDRESS NUMBER	REF	LOCATION	TAX DIST	DATE INST	DATE CHANGE
05800	S	M	OUG	II	03400	000		12	060269	1/1/0001
05800	S	M	OUG	II	03413	000		12	060269	1/1/0001
05800	S	M	OUG	II	03420	000		12	060269	1/1/0001

OFFICE: 311

ROUTE: 564

ST_REF_NO: 00000116715

LUPINE LANE

LUMENS	BULB TYPE	MULT SERIES	POLE TYPE	SHADE	ADDRESS NUMBER	REF	LOCATION	TAX DIST	DATE INST	DATE CHANGE
05800	S		CNT	II	00000	003	SIDE OF 1485 DAY LILY DR ON LUPINE LN	12	102808	1/1/0001
05800	S		CNT	II	02900	001		12	102808	1/1/0001
05800	S		CNT	II	02912	002		12	102808	1/1/0001

OFFICE: 311

ROUTE: 564

ST_REF_NO: 00000116800

LYNDHURST PLACE

LUMENS	BULB TYPE	MULT SERIES	POLE TYPE	SHADE	ADDRESS NUMBER	REF	LOCATION	TAX DIST	DATE INST	DATE CHANGE
09500	S	M	SOH	I	00256	000	upgraded to 9500 Dec 2007	12	010163	1/1/0001
09500	S	M	SOH	I	00270	000	upgraded to 9500 Dec 2007	12	010163	1/1/0001

OFFICE: 311

ROUTE: 564

ST_REF_NO: 00000116900

LYNN ROAD

LUMENS	BULB TYPE	MULT SERIES	POLE TYPE	SHADE	ADDRESS NUMBER	REF	LOCATION	TAX DIST	DATE INST	DATE CHANGE
04000	S	M	OUG	II	00000	017	SIDE OF 1814 BEACON HILL RD.	12	120888	1/1/0001
04000	S	M	OUG	II	00701	001		12	100889	1/1/0001
04000	S	M	OUG	II	00708	002		12	100889	1/1/0001
04000	S	M	OUG	II	00729	003		12	100889	1/1/0001
04000	S	M	OUG	II	00744	004		12	100889	1/1/0001
04000	S	M	OUG	II	00757	005		12	100889	1/1/0001
04000	S	M	OUG	II	00772	006		12	100889	1/1/0001
04000	S	M	OUG	II	00789	007		12	100889	1/1/0001
04000	S	M	OUG	II	00805	008		12	100889	1/1/0001
05800	S	M	OUG	II	00816	009		12	100889	1/1/0001
04000	S	M	OUG	II	00829	010		12	100889	1/1/0001
04000	S	M	OUG	II	00836	011		12	100889	1/1/0001
04000	S	M	OUG	II	00848	012		12	100889	1/1/0001
04000	S	M	OUG	II	00860	013		12	100889	1/1/0001

OFFICE: 311

ROUTE: 564

ST_REF_NO: 00000116900 LYNN ROAD

LUMENS	BULB TYPE	MULT SERIES	POLE TYPE	SHADE	ADDRESS NUMBER	REF	LOCATION	TAX DIST	DATE INST	DATE CHANGE
04000	S	M	OUG	II	00873	014		12	100889	1/1/0001
04000	S	M	OUG	II	00884	015		12	100889	1/1/0001
04000	S	M	OUG	II	00896	016		12	100889	1/1/0001

OFFICE: 311

ROUTE: 564

ST_REF_NO: 00000117000 LYNNWOOD COURT

LUMENS	BULB TYPE	MULT SERIES	POLE TYPE	SHADE	ADDRESS NUMBER	REF	LOCATION	TAX DIST	DATE INST	DATE CHANGE
05800	S	M	OUG	V	00379	000		12	062774	1/1/0001
05800	S	M	OUG	II	00394	000		12	062774	1/1/0001

OFFICE: 311

ROUTE: 564

ST_REF_NO: 00000117050 LYON COURT

LUMENS	BULB TYPE	MULT SERIES	POLE TYPE	SHADE	ADDRESS NUMBER	REF	LOCATION	TAX DIST	DATE INST	DATE CHANGE
04000	S	M	OUG	II	00000	132	SIDE 3357 LYON DR.	12	020886	1/1/0001

OFFICE: 311

ROUTE: 564

ST_REF_NO: 00000117100 LYON DRIVE

LUMENS	BULB TYPE	MULT SERIES	POLE TYPE	SHADE	ADDRESS NUMBER	REF	LOCATION	TAX DIST	DATE INST	DATE CHANGE
05800	S	M	CNT	II	00000	050	SIDE OF 3917 PALOMAR COVE LANE ON LYON DRIVE	12	092206	1/1/0001
05800	S	M	OUG	II	00000	050	1ST LT. N OF COTTAGE CIRCLE, WESTSIDE	12	110894	1/1/0001
05800	S	M	OUG	II	00000	051	1ST LT. N OF WELLINGTON WAY, EASTSIDE	12	110894	1/1/0001
05800	S	M	OUG	II	00000	052	1ST LT. S OF COTTAGE CIRCLE, WESTSIDE	12	110894	1/1/0001
05800	S	M	OUG	II	00000	054	2ND LT. N OF MAN-O-WAR, WESTSIDE	12	110894	1/1/0001
05800	S	M	SOH	II	00000	055	1ST LT. N OF MAN-O-WAR, EASTSIDE	12	110894	1/1/0001
05800	S	M	OUG	II	00000	056	1ST LT. N OF MAN-O-WAR, WESTSIDE	12	110894	1/1/0001
05800	S	M	CNT	II	00000	060	1ST LT. S OF MAN-O-WAR, WESTSIDE	12	110894	1/1/0001
05800	S	M	CNT	II	00000	061	1ST LT. S OF MAN-O-WAR, EASTSIDE	12	110894	1/1/0001
05800	S	M	CNT	II	00000	062	2ND LT. S OF MAN-O-WAR, WESTSIDE	12	110894	1/1/0001
05800	S	M	CNT	II	00000	063	2ND LT, S OF MAN-O-WAR, EASTSIDE	12	110894	1/1/0001
05800	S	M	CNT	II	00000	064	1ST LT. S OF PALOMAR BLVD., WESTSIDE	12	110894	1/1/0001
05800	S	M	CNT	II	00000	065	1ST LT. S OF PALOMAR BLVD., EASTSIDE	12	110894	1/1/0001
05800	S	M	CNT	II	00000	066	2ND LT. S OF PALOMAR BLVD., WESTSIDE	12	110894	1/1/0001
05800	S	M	CNT	II	00000	067	1ST LT. S OF GLADE LANE, EASTSIDE	12	110894	1/1/0001
05800	S	M	CNT	II	00000	068	1ST LT. S OF GLADE LANE, WESTSIDE	12	110894	1/1/0001

OFFICE: 311

ROUTE: 564

ST_REF_NO: 00000117100

LYON DRIVE

LUMENS	BULB TYPE	MULT SERIES	POLE TYPE	SHADE	ADDRESS NUMBER	REF	LOCATION	TAX DIST	DATE INST	DATE CHANGE
05800	S	M	CNT	II	00000	069	2ND LT. S OF GLADE LANE, EASTSIDE	12	110894	1/1/0001
05800	S	M	CNT	II	00000	070	SIDE 2193 STONE GARDEN LANE	12	110894	1/1/0001
05800	S	M	CNT	II	00000	071	1ST LT. N OF PALMETTO DR., EASTSIDE	12	110894	1/1/0001
05800	S	M	CNT	II	00000	072	SW CORNER OF PALETTO DR.	12	110894	1/1/0001
05800	S	M	OUG	II	00000	094	SIDE OF 2120 FORT HARRODS DR.	12	070886	1/1/0001
05800	S	M	OUG	II	00000	095	1ST. LT. S. OF FT. HARRODS DRIVE, W. SIDE	12	081582	1/1/0001
05800	S	M	OUG	II	00000	097	1ST. LT. W. OF SNAFFEL CT., W. SIDE	12	081582	1/1/0001
05800	S	M	OUG	II	00000	108	SIDE OF 2192 SALLEE DR.	12	128092	1/1/0001
05800	S	M	OUG	II	00000	110	SIDE REAR OF 2196 WESTMONT CT.	12	120892	1/1/0001
05800	S	M	OUG	II	00000	112	SIDE REAR OF 2197 WESTMONT CT.	12	120892	1/1/0001
05800	S	M	OUG	II	00000	113	SIDE REAR OF 2200 BURRUS DR.	12	120892	1/1/0001
05800	S	M	OUG	II	00000	115	SIDE OF 2201 BURRUS DR.	12	110898	1/1/0001
05800	S	M	OUG	II	00000	116	SIDE OF 3466 SNAFFLE	12	100884	1/1/0001
05800	S	M	OUG	II	00000	117	OPP. 3460	12	070886	1/1/0001
05800	S	M	OUG	II	00000	119	2ND LT. N. OF SNAFFLE RD., W. SIDE	12	070886	1/1/0001
05800	S	M	OUG	II	00000	120	2ND LT. N. OF SNAFFLE RD., E. SIDE	12	070886	1/1/0001
04000	S	M	OUG	II	00000	121	OPP. 3404 LYON DR	12	090891	1/1/0001
04000	S	M	OUG	II	03292	131		12	090891	1/1/0001
04000	S	M	OUG	II	03312	130		12	020886	1/1/0001
04000	S	M	OUG	II	03317	129		12	100884	1/1/0001
04000	S	M	OUG	II	03332	128		12	100884	1/1/0001
04000	S	M	OUG	II	03333	127		12	100884	1/1/0001
04000	S	M	OUG	II	03352	126		12	070886	1/1/0001
04000	S	M	OUG	II	03364	125		12	100884	1/1/0001
04000	S	M	OUG	II	03372	124		12	020886	1/1/0001
04000	S	M	OUG	II	03389	123		12	100884	1/1/0001
04000	S	M	OUG	II	03392	122		12	100884	1/1/0001
05800	S	M	OUG	II	03420	096		12	070886	1/1/0001
05800	S	M	OUG	II	03460	118		12	070886	1/1/0001
05800	S	M	OUG	II	03504	114		12	120892	1/1/0001
05800	S	M	OUG	II	03521	111		12	120892	1/1/0001
05800	S	M	OUG	II	03537	109		12	090893	1/1/0001
05800	S	M	OUG	II	03580	053		12	110894	1/1/0001
05800	S	M	CNT	II	03904	073		12	030897	1/1/0001

OFFICE: 311		ROUTE: 564		ST_REF_NO: 00000117190		MABLE LANE		LUMENS	BULB TYPE	MULT SERIES	POLE TYPE	SHADE	ADDRESS NUMBER	REF	LOCATION	TAX DIST	DATE INST	DATE CHANGE
	05800	S	M	CNT	II	02621	013									12	072401	1/1/0001
	05800	S	M	CNT	II	02649	012									12	072401	1/1/0001
	05800	S	M	CNT	II	02661	011									12	072401	1/1/0001
	05800	S	M	CNT	II	02680	010									12	072401	1/1/0001
	05800	S	M	CNT	II	02705	008									12	072401	1/1/0001
	05800	S	M	CNT	II	02737	006									12	072401	1/1/0001
	05800	S	M	CNT	II	02749	005									12	072401	1/1/0001
	05800	S	M	CNT	II	02765	004									12	072401	1/1/0001
	05800	S	M	CNT	II	02785	002									12	072401	1/1/0001
	05800	S	M	CNT	II	02797	001									12	072401	1/1/0001

OFFICE: 311		ROUTE: 564		ST_REF_NO: 00000117200		MACADAM DRIVE		LUMENS	BULB TYPE	MULT SERIES	POLE TYPE	SHADE	ADDRESS NUMBER	REF	LOCATION	TAX DIST	DATE INST	DATE CHANGE
	05800	S	M	OUG	II	00000	013								SIDE OF 3100 KIRKLEVINGTON DR.	12	041874	1/1/0001

OFFICE: 311		ROUTE: 564		ST_REF_NO: 00000117400		MACKS ALLEY		LUMENS	BULB TYPE	MULT SERIES	POLE TYPE	SHADE	ADDRESS NUMBER	REF	LOCATION	TAX DIST	DATE INST	DATE CHANGE
	04000	S	M	SOH	I	00000	001								1ST LT. N. OF MAXWELL ST., W. SIDE	12	030887	1/1/0001
	04000	S	M	SOH	I	00000	002								2ND LT. N. OF MAXWELL ST., W. SIDE	12	030887	1/1/0001
	04000	S	M	SOH	I	00000	003								3RD LT. N. OF MAXWELL ST., W. SIDE	12	030887	1/1/0001
	04000	S	M	SOH	I	00000	004								4TH LT. N. OF MAXWELL ST., W. SIDE	12	030887	1/1/0001
	04000	S	M	SOH	V	00000	005								5TH LT. N. OF MAXWELL ST., AT TURN	12	030887	1/1/0001
	04000	S	M	SOH	I	00000	006								1ST LT. W. OF S. UPPER ST., S. SIDE	12	030887	1/1/0001

OFFICE: 311		ROUTE: 564		ST_REF_NO: 00000117500		MACON COURT		LUMENS	BULB TYPE	MULT SERIES	POLE TYPE	SHADE	ADDRESS NUMBER	REF	LOCATION	TAX DIST	DATE INST	DATE CHANGE
	05800	S	M	OUG	II	00000	139								SIDE OF 2012 NEW ORLEANS DR.	12	090866	1/1/0001

OFFICE: 311		ROUTE: 564		ST_REF_NO: 00000117600		MADDENHURST COURT		LUMENS	BULB TYPE	MULT SERIES	POLE TYPE	SHADE	ADDRESS NUMBER	REF	LOCATION	TAX DIST	DATE INST	DATE CHANGE
	05800	S	M	OUG	II	00000	163								SIDE OF 3318 COLDSTREAM DR.	12	042067	1/1/0001

OFFICE: 311							ROUTE: 564			
ST_REF_NO: 00000117600							MADDENHURST COURT			
LUMENS	BULB TYPE	MULT SERIES	POLE TYPE	SHADE	ADDRESS NUMBER	REF	LOCATION	TAX DIST	DATE INST	DATE CHANGE
05800	S	M	OUG	II	03273	164		12	042067	1/1/0001

OFFICE: 311							ROUTE: 564			
ST_REF_NO: 00000117650							MADDIE LANE			
LUMENS	BULB TYPE	MULT SERIES	POLE TYPE	SHADE	ADDRESS NUMBER	REF	LOCATION	TAX DIST	DATE INST	DATE CHANGE
05800	S	M	CNT	II	03000	007		12	121406	1/1/0001
05800	S	M	CNT	II	03017	006		12	121406	1/1/0001
05800	S	M	CNT	II	03032	005		12	121406	1/1/0001
05800	S	M	CNT	II	03048	004		12	121406	1/1/0001
05800	S	M	CNT	II	03065	003		12	121406	1/1/0001
05800	S	M	CNT	II	03080	002		12	121406	1/1/0001
05800	S	M	CNT	II	03093	001		12	121406	1/1/0001

OFFICE: 311							ROUTE: 564			
ST_REF_NO: 00000117700							MADISON PLACE			
LUMENS	BULB TYPE	MULT SERIES	POLE TYPE	SHADE	ADDRESS NUMBER	REF	LOCATION	TAX DIST	DATE INST	DATE CHANGE
09500	S	M	SOH	II	00340	000		12	081668	4/2/2009
10000	M	M	SOH	II	00300	000		12	081668	1/1/0001
10000	M	M	SOH	II	00321	000		12	081668	1/1/0001
10000	M	M	SOH	II	00355	000		12	020469	1/1/0001

OFFICE: 311							ROUTE: 564			
ST_REF_NO: 00000117710							MADRONE WAY			
LUMENS	BULB TYPE	MULT SERIES	POLE TYPE	SHADE	ADDRESS NUMBER	REF	LOCATION	TAX DIST	DATE INST	DATE CHANGE
05800	S	M	CNT	II	00000	001	SIDE 4185 PALMETTO DR.	12	100894	1/1/0001
05800	S	M	CNT	II	00000	003	SIDE OF 4184 PALMETTO DR.	12	110898	1/1/0001
05800	S	M	CNT	II	00000	004	SIDE OF 4237 EVERGREEN DR.	12	110898	1/1/0001
05800	S	M	CNT	II	00000	006	SIDE OF 4248 NUTMEG DR.	12	110898	1/1/0001
05800	S	M	CNT	II	00000	007	SIDE REAR OF 2096 MANGROVE DR.	12	110898	1/1/0001
05800	S	M	CNT	II	00000	008		12	110898	1/1/0001
05800	S	M	CNT	II	02180	005		12	110898	1/1/0001
05800	S	M	CNT	II	02213	002		12	100894	1/1/0001

OFFICE: 311

ROUTE: 564

ST_REF_NO: 00000117850

MAGGARD DRIVE

LUMENS	BULB TYPE	MULT SERIES	POLE TYPE	SHADE	ADDRESS NUMBER	REF	LOCATION	TAX DIST	DATE INST	DATE CHANGE
09500	S	M	OUG	II	00000	001	1st LT W OF JAGGIE FOX WAY ON MAGGARD DR	12	081202	1/1/0001
09500	S	M	OUG	II	00000	002	SIDE OF 1701 JAGGIE FOX WAY ON MAGGARD DR	12	081202	1/1/0001
09500	S	M	OUG	II	00000	003	3rd LT W OF JAGGIE FOX WAY ON MAGGARD DR	12	081202	1/1/0001
09500	S	M	OUG	II	02321	004		12	081202	1/1/0001
09500	S	M	OUG	II	00000	001	SIDE OF 1708 JAGGIE FOX WAY	12	040800	1/1/0001
09500	S	M	OUG	II	02293	002		12	040800	1/1/0001

OFFICE: 311

ROUTE: 564

ST_REF_NO: 00000117860

MAGGIE COVE

LUMENS	BULB TYPE	MULT SERIES	POLE TYPE	SHADE	ADDRESS NUMBER	REF	LOCATION	TAX DIST	DATE INST	DATE CHANGE
05800	S	M	CNT	II	00000	001	SIDE OF 324 SPRING VALLEY LANE ON MAGGIE COVE	12	090602	1/1/0001
05800	S	M	CNT	III	02509	004		12	090602	1/1/0001
05800	S	M	CNT	II	02524	003		12	090602	1/1/0001
05800	S	M	CNT	II	02544	002		12	090602	1/1/0001

OFFICE: 311

ROUTE: 564

ST_REF_NO: 00000118000

MAGNOLIA AVENUE

LUMENS	BULB TYPE	MULT SERIES	POLE TYPE	SHADE	ADDRESS NUMBER	REF	LOCATION	TAX DIST	DATE INST	DATE CHANGE
05800	S	M	SOH	II	00000	170	2ND LT. S. OF SEVENTH ST., W. SIDE	12	111866	1/1/0001
05800	S	M	SOH	II	00000	173	5TH LT. S. OF SEVENTH ST., W. SIDE	12	031165	1/1/0001
05800	S	M	SOH	II	00000	174	6TH LT. S. OF SEVENTH ST., W. SIDE	12	111866	1/1/0001
05800	S	M	SOH	II	00000	175	7TH LT. S. OF SEVENTH ST., W. SIDE	12	111866	1/1/0001
05800	S	M	SOH	II	00000	176	8TH LT. S. OF SEVENTH ST., W. SIDE	12	111866	1/1/0001
05800	S	M	SOH	II	00000	177	9TH LT. S. OF SEVENTH ST., W. SIDE	12	111866	1/1/0001
05800	S	M	SOH	II	00661	172		12	111866	1/1/0001
05800	S	M	SOH	II	00679	171		12	111866	1/1/0001
05800	S	M	SOH	II	00000	169	SIDE OF 752 E. SEVENTH ST.	12	111866	1/1/0001

OFFICE: 311

ROUTE: 564

ST_REF_NO: 00000118010

MAGNOLIA GARDENS PLACE

LUMENS	BULB TYPE	MULT SERIES	POLE TYPE	SHADE	ADDRESS NUMBER	REF	LOCATION	TAX DIST	DATE INST	DATE CHANGE
05800	S	M	CNT	II	00000	003	SIDE OF 3037 CHARLESTON GRDN BLVD ON MAGNOLIA GRDN	12	050603	1/1/0001

OFFICE: 311		ROUTE: 564		ST_REF_NO: 00000118010		MAGNOLIA GARDENS PLACE		LUMENS	BULB TYPE	MULT SERIES	POLE TYPE	SHADE	ADDRESS NUMBER	REF	LOCATION	TAX DIST	DATE INST	DATE CHANGE
05800	S	M	CNT	II	00000	007	SIDE OF 933 SENECA PARK ON MAGNOLIA GARDENS	12	091503	1/1/0001								
05800	S	M	CNT	II	00000	010	SIDE OF 800 CALYPSO BREEZE DR ON MAGNOLIA GARDENS	12	080504	1/1/0001								
05800	S	M	CNT	II	05000	011		12	080504	1/1/0001								
05800	S	M	CNT	II	05016	009		12	080504	1/1/0001								
05800	S	M	CNT	II	05032	008		12	080504	1/1/0001								
05800	S	M	CNT	II	05052	006		12	091503	1/1/0001								
05800	S	M	CNT	II	05061	005		12	091503	1/1/0001								
05800	S	M	CNT	II	05089	002		12	050603	1/1/0001								
05800	S	M	CNT	II	05096	001		12	050603	1/1/0001								

OFFICE: 311

ROUTE: 564

OFFICE: 311		ROUTE: 564		ST_REF_NO: 00000118100		MAGOFFIN STREET		LUMENS	BULB TYPE	MULT SERIES	POLE TYPE	SHADE	ADDRESS NUMBER	REF	LOCATION	TAX DIST	DATE INST	DATE CHANGE
09500	S	M	SOH	I	00000	136	SIDE OF 531 SHELBY ST.	12	111366	12/21/2009								
09500	S	M	SOH	I	00000	138	SIDE OF 544 LOUDON AVE.	12	111366	12/21/2009								
09500	S	M	SOH	I	00805	137		12	111366	1/18/2010								
05800	S	M	SOH	I	00000	134	OPP. 730	12	111366	1/1/0001								
05800	S	M	SOH	I	00000	135	SIDE OF 524 SHELBY ST.	12	111366	1/1/0001								
05800	S	M	SOH	I	00709	132		12	111366	1/1/0001								
05800	S	M	SOH	I	00719	133		12	111366	1/1/0001								

OFFICE: 311

ROUTE: 564

OFFICE: 311		ROUTE: 564		ST_REF_NO: 00000118140		MAHALA LANE		LUMENS	BULB TYPE	MULT SERIES	POLE TYPE	SHADE	ADDRESS NUMBER	REF	LOCATION	TAX DIST	DATE INST	DATE CHANGE
05800	S		CNT	II	00000	001	SIDE OF 3209 BLEDSOE PLACE ON MAHALA LANE	12	051510	1/1/0001								
05800	S		CNT	II	00000	007	SIDE OF 3001 DREXAL PASS ON MAHALA LANE	12	051510	1/1/0001								
05800	S		CNT	II	00000	011	SIDE OF 2961 CONSTANTINE AVE, ON MAHALA LANE	12	051510	1/1/0001								
05800	S		CNT	II	00000	013	AT END OF COURT ON MAHALA LANE	12	051510	1/1/0001								
05800	S		CNT	II	02856	012		12	051510	1/1/0001								
05800	S		CNT	II	02881	010		12	051510	1/1/0001								
05800	S		CNT	II	02896	009		12	051510	1/1/0001								
05800	S		CNT	II	02909	008		12	051510	1/1/0001								

OFFICE: 311		ROUTE: 564		ST_REF_NO: 00000118140		MAHALA LANE				
LUMENS	BULB TYPE	MULT SERIES	POLE TYPE	SHADE	ADDRESS NUMBER	REF	LOCATION	TAX DIST	DATE INST	DATE CHANGE
05800	S		CNT	II	02948	005		12	051510	1/1/0001
05800	S		CNT	II	02965	004		12	051510	1/1/0001
05800	S		CNT	II	02977	003		12	051510	1/1/0001
05800	S		CNT	II	02989	002		12	051510	1/1/0001
05800	S		CNT	II	03005	006		12	051510	1/1/0001

OFFICE: 311		ROUTE: 564		ST_REF_NO: 00000118190		MAIDENCANE DRIVE				
LUMENS	BULB TYPE	MULT SERIES	POLE TYPE	SHADE	ADDRESS NUMBER	REF	LOCATION	TAX DIST	DATE INST	DATE CHANGE
05800	S		CNT	II	00000	004	ACROSS FROM 760 MAIDENCANE DR	12	061710	1/1/0001
05800	S		CNT	II	00664	012		12	061710	1/1/0001
05800	S		CNT	II	00681	011		12	061710	1/1/0001
05800	S		CNT	II	00692	010		12	061710	1/1/0001
05800	S		CNT	II	00705	009		12	061710	1/1/0001
05800	S		CNT	II	00716	008		12	061710	1/1/0001
05800	S		CNT	II	00725	007		12	061710	1/1/0001
05800	S		CNT	II	00741	006		12	061710	1/1/0001
05800	S		CNT	II	00748	005		12	061710	1/1/0001
05800	S		CNT	II	00772	003		12	061710	1/1/0001
05800	S		CNT	II	00788	001		12	061710	1/1/0001

OFFICE: 311		ROUTE: 564		ST_REF_NO: 00000118200		MAIDSTONE COURT				
LUMENS	BULB TYPE	MULT SERIES	POLE TYPE	SHADE	ADDRESS NUMBER	REF	LOCATION	TAX DIST	DATE INST	DATE CHANGE
04000	S	M	OUG	II	00000	065	SIDE OF 604 CROMWELL WAY	12	110885	1/1/0001
04000	S	M	OUG	II	03513	064		12	110885	1/1/0001

OFFICE: 311		ROUTE: 564		ST_REF_NO: 00000118300		MAIN, EAST STREET				
LUMENS	BULB TYPE	MULT SERIES	POLE TYPE	SHADE	ADDRESS NUMBER	REF	LOCATION	TAX DIST	DATE INST	DATE CHANGE
16000	S	M	GRN	IV	00000	001	IN ISLAND AT MIDLAND AVE ON E MAIN ST	12	070101	1/1/0001
16000	S	M	GRN	IV	00000	002	SE CORNER OF E MAIN ST AND E VINE ST	12	070101	1/1/0001
16000	S	M	GRN	IV	00000	003	1ST LT W OF E VINE ST,N SIDE OF E MAIN ST	12	070101	1/1/0001
16000	S	M	GRN	IV	00000	004	1ST LT W OF E VINE ST,S SIDE OF E MAIN ST	12	070101	1/1/0001

OFFICE: 311

ROUTE: 564

ST_REF_NO: 00000118300

MAIN, EAST STREET

LUMENS	BULB TYPE	MULT SERIES	POLE TYPE	SHADE	ADDRESS NUMBER	REF	LOCATION	TAX DIST	DATE INST	DATE CHANGE
16000	S	M	GRN	IV	00000	005	2ND LT W OF E VINE ST,N SIDE OF E MAIN ST	12	070101	1/1/0001
16000	S	M	GRN	IV	00000	006	2ND LT W OF E VINE ST,S SIDE OF E MAIN ST	12	070101	1/1/0001
16000	S	M	GRN	IV	00000	007	3RD LT W OF E VINE ST,N SIDE OF E MAIN ST	12	070101	1/1/0001
16000	S	M	GRN	IV	00000	008	3RD LT W OF E VINE ST,S SIDE OF E MAIN ST	12	070101	1/1/0001
16000	S	M	GRN	IV	00000	009	4TH LT W OF E VINE ST,N SIDE OF E MAIN ST	12	070101	1/1/0001
16000	S	M	GRN	IV	00000	010	4TH LT W OF E VINE ST,S SIDE OF E MAIN ST	12	070101	1/1/0001
16000	S	M	GRN	IV	00000	011	5TH LT W OF E VINE ST,N SIDE OF E MAIN ST	12	070101	1/1/0001
16000	S	M	GRN	IV	00000	012	5TH LT W OF E VINE ST,S SIDE OF E MAIN ST	12	070101	1/1/0001
16000	S	M	GRN	IV	00000	013	6TH LT W OF E VINE ST,N SIDE OF E MAIN ST	12	070101	1/1/0001
16000	S	M	GRN	IV	00000	014	6TH LT W OF E VINE ST,S SIDE OF E MAIN ST	12	070101	1/1/0001
16000	S	M	GRN	IV	00000	015	7TH LT W OF E VINE ST,N SIDE OF E MAIN ST	12	070101	1/1/0001
16000	S	M	GRN	IV	00000	016	7TH LTW OF E VINE ST,S SIDE OF E MAIN ST	12	070101	1/1/0001
16000	S	M	GRN	IV	00000	017	8TH LT W OF E VINE ST,N SIDE OF E MAIN ST	12	070101	1/1/0001
16000	S	M	GRN	IV	00000	018	8TH LT W OF E VINE ST,S SIDE OF E MAIN ST	12	070101	1/1/0001
16000	S	M	GRN	IV	00000	019	9TH LT W OF E VINE ST,N SIDE OF E MAIN ST	12	070101	1/1/0001
16000	S	M	GRN	IV	00000	020	9TH LT W OF E VINE ST,S SIDE OF E MAIN ST	12	070101	1/1/0001
16000	S	M	GRN	IV	00000	021	10TH LT W OF E VINE ST,N SIDE OF E MAIN ST	12	070101	1/1/0001
16000	S	M	GRN	IV	00000	022	10TH LT W OF E VINE ST,S SIDE OF E MAIN ST	12	070101	1/1/0001
16000	S	M	GRN	IV	00000	023	11TH LT W OF E VINE ST,N SIDE OF E MAIN ST	12	070101	1/1/0001
16000	S	M	GRN	IV	00000	024	11TH LT W OF E VINE ST,S SIDE OF E MAIN ST	12	070101	1/1/0001
16000	S	M	GRN	IV	00000	025	12TH LT W OF E VINE ST,N SIDE OF E MAIN ST	12	070101	1/1/0001
16000	S	M	GRN	IV	00000	026	12TH LT W OF E VINE ST,S SIDE OF E MAIN ST	12	070101	1/1/0001
16000	S	M	GRN	IV	00000	027	IN ISLAND AT ELM TREE ON E MAIN ST	12	070101	1/1/0001
16000	S	M	GRN	IV	00000	028	1ST LT W OF ROSE ST, S SIDE ON E MAIN ST	12	070101	1/1/0001
16000	S	M	GRN	IV	00000	029	1ST LT W OF ROSE ST,N SIDE ON E MAIN ST	12	070101	1/1/0001
16000	S	M	GRN	IV	00000	030	2ND LT W OF ROSE ST,S SIDE ON E MAIN ST	12	070101	1/1/0001
16000	S	M	GRN	IV	00000	031	2ND LT W OF ROSE ST,N SIDE ON E MAIN ST	12	070101	1/1/0001
16000	S	M	GRN	IV	00000	032	3RD LT W OF ROSE ST,S SIDE ON E MAIN ST	12	070101	1/1/0001
16000	S	M	GRN	IV	00000	033	3RD LTW OF ROSE ST,N SIDE ON E MAIN ST	12	070101	1/1/0001
16000	S	M	GRN	IV	00000	034	4TH LT W OF ROSE ST,S SIDE ON E MAIN ST	12	070101	1/1/0001
16000	S	M	GRN	IV	00000	035	4TH LT W OF ROSE ST,N SIDE ON E MAIN ST	12	070101	1/1/0001
16000	S	M	GRN	IV	00000	036	5TH LT W OF ROSE ST,S SIDE ON E MAIN ST	12	070101	1/1/0001
16000	S	M	GRN	IV	00000	037	5TH LT W OF ROSE ST,N SIDE ON E MAIN ST	12	070101	1/1/0001
16000	S	M	GRN	IV	00000	038	6TH LT W OF ROSE ST,S SIDE ON E MAIN ST	12	070101	1/1/0001

OFFICE: 311

ROUTE: 564

ST_REF_NO: 00000118300

MAIN, EAST STREET

LUMENS	BULB TYPE	MULT SERIES	POLE TYPE	SHADE	ADDRESS NUMBER	REF	LOCATION	TAX DIST	DATE INST	DATE CHANGE
16000	S	M	GRN	IV	00000	039	6TH LT W OF ROSE ST,N SIDE ON E MAIN ST	12	070101	1/1/0001
16000	S	M	GRN	IV	00000	040	7TH LT W OF ROSE ST,S SIDE ON E MAIN ST	12	070101	1/1/0001
16000	S	M	GRN	IV	00000	041	7TH LT W OF ROSE ST,N SIDE ON E MAIN ST	12	070101	1/1/0001
16000	S	M	GRN	IV	00000	042	8TH LT W OF ROSE ST,S SIDE ON E MAIN ST	12	070101	1/1/0001
16000	S	M	GRN	IV	00000	043	8TH LT W OF ROSE ST,N SIDE ON E MAIN ST	12	070101	1/1/0001
16000	S	M	GRN	IV	00000	044	1ST LT W OF QUALITY ST,S SIDE ON E MAIN ST	12	070101	1/1/0001
16000	S	M	GRN	IV	00000	045	1ST LT W OF QUALITY ST,N SIDE ON E MAIN ST	12	070101	1/1/0001
16000	S	M	GRN	IV	00000	046	2ND LT W OF QUALITY ST,S SIDE ON E MAIN ST	12	070101	1/1/0001
16000	S	M	GRN	IV	00000	047	2ND LT W OF QUALITY ST,N SIDE ON E MAIN ST	12	070101	1/1/0001
16000	S	M	GRN	IV	00000	048	3RD LT W OF QUALITY ST,S SIDE ON E MAIN ST	12	070101	1/1/0001
16000	S	M	GRN	IV	00000	049	3RD LT W OF QUALITY ST,N SIDE ON E MAIN ST	12	070101	1/1/0001
16000	S	M	GRN	IV	00000	050	4TH LT W OF QUALITY ST,S SIDE ON E MAIN ST	12	070101	1/1/0001
16000	S	M	GRN	IV	00000	051	4TH LT W OF QUALITY ST,N SIDE ON E MAIN ST	12	070101	1/1/0001
16000	S	M	GRN	IV	00000	052	5TH LT W OF QUALITY ST,S SIDE ON E MAIN ST	12	070101	1/1/0001
16000	S	M	GRN	IV	00000	053	5TH LT W OF QUALITY ST,N SIDE ON E MAIN ST	12	070101	1/1/0001
16000	S	M	GRN	IV	00000	054	6TH LT W OF QUALITY ST,S SIDE ON E MAIN ST	12	070101	1/1/0001
16000	S	M	GRN	IV	00000	055	6TH LT W OF QUALITY ST,N SIDE ON E MAIN ST	12	070101	1/1/0001
16000	S	M	GRN	IV	00000	056	7TH LT W OF QUALITY ST,S SIDE ON E MAIN ST	12	070101	1/1/0001
16000	S	M	GRN	IV	00000	057	7TH LT W OF QUALITY ST,N SIDE ON E MAIN ST	12	070101	1/1/0001
16000	S	M	GRN	IV	00000	058	8TH LT W OF QUALITY ST,S SIDE ON E MAIN ST	12	070101	1/1/0001
16000	S	M	GRN	IV	00000	059	8TH LT W OF QUALITY ST,N SIDE ON E MAIN ST	12	070101	1/1/0001
16000	S	M	GRN	IV	00000	060	9TH LT W OF QUALITY ST,S SIDE ON E MAIN ST	12	070101	1/1/0001
16000	S	M	GRN	IV	00000	061	9TH LT W OF QUALITY ST,N SIDE ON E MAIN ST	12	070101	1/1/0001
16000	S	M	GRN	IV	00000	062	10TH LT W OF QUALITY ST,S SIDE ON E MAIN ST	12	070101	1/1/0001
16000	S	M	GRN	IV	00000	063	10TH LT W OF QUALITY ST,N SIDE ON E MAIN ST	12	070101	1/1/0001
16000	S	M	GRN	IV	00000	064	1ST LT W OF MLK BLVD,S SIDE ON E MAIN ST	12	070101	1/1/0001
16000	S	M	GRN	IV	00000	065	1ST LT W OF MLK BLVD,N SIDE ON E MAIN ST	12	070101	1/1/0001
16000	S	M	GRN	IV	00000	066	2ND LT W OF MLK BLVD,S SIDE ON E MAIN ST	12	070101	1/1/0001
16000	S	M	GRN	IV	00000	067	2ND LT W OF MLK BLVD,N SIDE ON E MAIN ST	12	070101	1/1/0001
16000	S	M	GRN	IV	00000	068	3RD LT W OF MLK NLVD,S SIDE ON E MAIN ST	12	070101	1/1/0001
16000	S	M	GRN	IV	00000	069	3RD LT W OF MLK BLVD,N SIDE ON E MAIN ST	12	070101	1/1/0001
16000	S	M	GRN	IV	00000	070	4TH LT W OF MLK BLVD,S SIDE ON E MAIN ST	12	070101	1/1/0001
16000	S	M	GRN	IV	00000	071	4TH LT W OF MLK BLVD,N SIDE ON E MAIN ST	12	070101	1/1/0001
16000	S	M	GRN	IV	00000	072	5TH LT W OF MLK BLVD,S SIDE ON E MAIN ST	12	070101	1/1/0001

OFFICE: 311

ROUTE: 564

ST_REF_NO: 00000118300

MAIN, EAST STREET

LUMENS	BULB TYPE	MULT SERIES	POLE TYPE	SHADE	ADDRESS NUMBER	REF	LOCATION	TAX DIST	DATE INST	DATE CHANGE
16000	S	M	GRN	IV	00000	073	5TH LT W OF MLK BLVD,N SIDE ON E MAIN ST	12	070101	1/1/0001
16000	S	M	GRN	IV	00000	074	6TH LT W OF MLK BLVD,S SIDE ON E MAIN ST	12	070101	1/1/0001
16000	S	M	GRN	IV	00000	075	6TH LT W OF MLK BLVD,N SIDE ON E MAIN ST	12	070101	1/1/0001
16000	S	M	GRN	IV	00000	076	7TH LT W OF MLK BLVD,S SIDE ON E MAIN ST	12	070101	1/1/0001
16000	S	M	GRN	IV	00000	077	7TH LT W OF MLK BLVD,N SIDE ON E MAIN ST	12	070101	1/1/0001
16000	S	M	GRN	IV	00000	078	8TH LT W OF MLK BLVD,S SIDE ON E MAIN ST	12	070101	1/1/0001
16000	S	M	GRN	IV	00000	079	8TH LT W OF MLK BLVD,N SIDE ON E MAIN ST	12	070101	1/1/0001
16000	S	M	GRN	IV	00000	080	9TH LT W OF MLK BLVD,S SIDE ON E MAIN ST	12	070101	1/1/0001
16000	S	M	GRN	IV	00000	081	9TH LT W OF MLK BLVD,N SIDE ON E MAIN ST	12	070101	1/1/0001
16000	S	M	GRN	IV	00000	082	10TH LT W OF MLK BLVD,S SIDE ON E MAIN ST	12	070101	1/1/0001
16000	S	M	GRN	IV	00000	083	10TH LT W OF MLK BLVD,N SIDE ON E MAIN ST	12	070101	1/1/0001
16000	S	M	GRN	IV	00000	084	11TH LT W OF MLK BLVD,S SIDE ON E MAIN ST	12	070101	1/1/0001
16000	S	M	GRN	IV	00000	085	11TH LT W OF MLK BLVD,N SIDE ON E MAIN ST	12	070101	1/1/0001
22000	S	M	SOH	IV	00499	026		12	040164	12/27/2010
22000	S	M	SOH	IV	00609	032	bad fixture	12	040164	9/17/2009
20000	M	M	SOH	IV	00480	025		12	040164	1/1/0001
20000	M	M	SOH	IV	00481	024		12	040164	1/1/0001
20000	M	S	SOH	IV	00512	027		12	040164	1/1/0001
20000	M	M	SOH	IV	00513	028		12	040164	1/1/0001
20000	M	M	SOH	IV	00533	030		12	040164	1/1/0001
20000	M	M	SOH	IV	00540	029		12	040164	1/1/0001
20000	M	S	SOH	IV	00000	038	1 ST. LT. E. OF WALTON AVE., N. SIDE	12	040164	1/1/0001
20000	M	M	SOH	IV	00000	040	2 ND. LT. E. OF WALTON AVE., N. SIDE	12	040164	1/1/0001
20000	M	M	SOH	IV	00564	031		12	040164	1/1/0001
20000	M	M	SOH	IV	00610	033		12	040164	1/1/0001
22000	S	M	SOH	IV	00625	034	upgrade 6/08	12	040164	1/1/0001
20000	M	M	SOH	IV	00638	035		12	040164	1/1/0001
20000	M	M	SOH	IV	00647	036		12	040164	1/1/0001
20000	M	S	SOH	IV	00656	037		12	040164	1/1/0001
20000	M	S	SOH	IV	00708	039		12	040164	1/1/0001
20000	M	S	SOH	IV	00726	041		12	040164	1/1/0001
20000	M	M	SOH	IV	00735	042		12	040164	1/1/0001
22000	S	M	OUG	IV	00443	020		12	040164	1/1/0001
20000	M	M	SOH	IV	00463	022		12	040164	1/1/0001

OFFICE: 311

ROUTE: 564

ST_REF_NO: 00000118300

MAIN, EAST STREET

LUMENS	BULB TYPE	MULT SERIES	POLE TYPE	SHADE	ADDRESS NUMBER	REF	LOCATION	TAX DIST	DATE INST	DATE CHANGE
20000	M	M	SOH	III	00430	019		12	061563	1/1/0001
20000	M	S	SOH	IV	00460	023		12	040164	1/1/0001

OFFICE: 311

ROUTE: 564

ST_REF_NO: 00000118310

MAIN, WEST STREET

LUMENS	BULB TYPE	MULT SERIES	POLE TYPE	SHADE	ADDRESS NUMBER	REF	LOCATION	TAX DIST	DATE INST	DATE CHANGE
16000	S	M	GRN	IV	00000	087	1ST LT W OF S LIMESTONE ST,N SIDE ON W MAIN ST	12	070101	1/1/0001
16000	S	M	GRN	IV	00000	089	2ND LT W OF S LIMESTONE ST,N SIDE ON W MAIN ST	12	070101	1/1/0001
16000	S	M	GRN	IV	00000	090	3RD LT W OF S LIMESTONE ST,S SIDE ON W MAIN ST	12	070101	1/1/0001
16000	S	M	GRN	IV	00000	091	3RD LT W OF S LIMESTONE ST,N SIDE ON W MAIN ST	12	070101	1/1/0001
16000	S	M	GRN	IV	00000	092	4TH LT W OF S LIMESTONE ST,S SIDE ON W MAIN ST	12	070101	1/1/0001
16000	S	M	GRN	IV	00000	093	4TH LT W OF S LIMESTONE ST,N SIDE ON W MAIN ST	12	070101	1/1/0001
16000	S	M	GRN	IV	00000	094	5TH LT W OF S LIMESTONE,S SIDE ON W MAIN ST	12	070101	1/1/0001
16000	S	M	GRN	IV	00000	095	5TH LT W OF S LIMESTONE,N SIDE ON W MAIN ST	12	070101	1/1/0001
16000	S	M	GRN	IV	00000	096	6TH LT W OF S LIMESTONE ST,S SIDE ON W MAIN ST	12	070101	1/1/0001
16000	S	M	GRN	IV	00000	097	6TH LT W OF S LIMESTONE ST,N SIDE ON W MAIN ST	12	070101	1/1/0001
16000	S	M	GRN	IV	00000	098	1ST LT W OF S UPPER ST,S SIDE ON W MAIN ST	12	070101	1/1/0001
16000	S	M	GRN	IV	00000	099	1ST LT W OF S UPPER ST,N SIDE ON W MAIN ST	12	070101	1/1/0001
16000	S	M	GRN	IV	00000	100	2ND LT W OF S UPPER ST, S SIDE ON W MAIN ST	12	070101	1/1/0001
16000	S	M	GRN	IV	00000	101	2ND LT W OF S UPPER ST,N SIDE ON W MAIN ST	12	070101	1/1/0001
16000	S	M	GRN	IV	00000	102	3RD LT W OF S UPPER, S SIDE ON W MAIN	12	070101	3/24/2010
16000	S	M	GRN	IV	00000	103	3RD LT W OF S UPPER, N SIDE ON W MAIN	12	070101	3/24/2010
16000	S	M	GRN	IV	00000	104	4TH LT W OF S UPPER, S SIDE ON W MAIN	12	070101	3/24/2010
16000	S	M	GRN	IV	00000	106	5TH LT W OF S UPPER, S SIDE ON W MAIN	12	070101	3/24/2010
16000	S	M	GRN	IV	00000	108	6TH LT W OF S UPPER, S SIDE ON W MAIN	12	070101	3/24/2010
16000	S	M	GRN	IV	00000	110	7TH LT W OF S UPPER, S SIDE ON W MAIN	12	070101	3/24/2010
16000	S	M	GRN	IV	00000	111	7TH LT W OF S UPPER, N SIDE ON W MAIN	12	070101	3/24/2010
16000	S	M	GRN	IV	00000	112	1ST LT W OF S MILL, S SIDE ON W MAIN	12	070101	3/24/2010
16000	S	M	GRN	IV	00000	113	1ST LT W OF S MILL, N SIDE ON W MAIN	12	070101	3/24/2010

OFFICE: 311

ROUTE: 564

ST_REF_NO: 00000118310

MAIN, WEST STREET

LUMENS	BULB TYPE	MULT SERIES	POLE TYPE	SHADE	ADDRESS NUMBER	REF	LOCATION	TAX DIST	DATE INST	DATE CHANGE
16000	S	M	GRN	IV	00000	114	2ND LT W OF S MILL, S SIDE ON W MAIN	12	070101	3/24/2010
16000	S	M	GRN	IV	00000	115	2ND LT W OF S MILL, N SIDE ON W MAIN	12	070101	3/24/2010
16000	S	M	GRN	IV	00000	116	3RD LT W OF S MILL, S SIDE ON W MAIN	12	070101	3/24/2010
16000	S	M	GRN	IV	00000	117	3RD LT W OF S MILL, N SIDE ON W MAIN	12	070101	3/24/2010
16000	S	M	GRN	IV	00000	118	4TH LT W OF S MILL ST, S SIDE ON W MAIN ST	12	070101	1/1/0001
16000	S	M	GRN	IV	00000	119	4TH LT W OF S MILL ST,N SIDE ON W MAIN ST	12	070101	1/1/0001
16000	S	M	GRN	IV	00000	120	5TH LT W OF S MILL ST,S SIDE ON W MAIN ST	12	070101	1/1/0001
16000	S	M	GRN	IV	00000	121	5TH LT W OF S MILL ST,N SIDE ON W MAIN ST	12	070101	1/1/0001
16000	S	M	GRN	IV	00000	122	6TH LT W OF S MILL ST,S SIDE ON W MAIN ST	12	070101	1/1/0001
16000	S	M	GRN	IV	00000	123	6TH LT W OF S MILL ST,N SIDE ON W MAIN ST	12	070101	1/1/0001
16000	S	M	GRN	IV	00000	124	7TH LT W OF S MILL ST,S SIDE ON W MAIN ST	12	070101	1/1/0001
16000	S	M	GRN	IV	00000	125	7TH LT W OF S MILL ST,N SIDE ON W MAIN ST	12	070101	1/1/0001
16000	S	M	GRN	IV	00000	126	1ST LT W OF S BROADWAY ST,S SIDE ON W MAIN ST	12	070101	1/1/0001
16000	S	M	GRN	IV	00000	127	1ST LT W OF S BROADWAY ST,N SIDE ON W MAIN ST	12	070101	1/1/0001
16000	S	M	GRN	IV	00000	128	2ND LT W OF S BROADWAY ST,S SIDE ON W MAIN ST	12	070101	1/1/0001
16000	S	M	GRN	IV	00000	129	2ND LT W OF S BROADWAY ST,N SIDE ON W MAIN ST	12	070101	1/1/0001
16000	S	M	GRN	IV	00000	130	3RD LT W OF S BROADWAY ST,S SIDE ON W MAIN ST	12	070101	1/1/0001
16000	S	M	GRN	IV	00000	131	3RD LT W OF S BROADWAY ST,N SIDE ON W MAIN ST	12	070101	1/1/0001
16000	S	M	GRN	IV	00000	132	4TH LT W OF S BROADWAY ST,S SIDE ON W MAIN ST	12	070101	1/1/0001
16000	S	M	GRN	IV	00000	133	4TH LT W OF S BROADWAY ST,N SIDE ON W MAIN ST	12	070101	1/1/0001
16000	S	M	GRN	IV	00000	134	5TH LT W OF S BROADWAY ST,S SIDE ON W MAIN ST	12	070101	1/1/0001
16000	S	M	GRN	IV	00000	135	5TH LT W OF S BROADWAY ST,N SIDE ON W MAIN ST	12	070101	1/1/0001
16000	S	M	GRN	IV	00000	136	6TH LT W OF S BROADWAY ST,S SIDE ON W MAIN ST	12	070101	1/1/0001
16000	S	M	GRN	IV	00000	137	6TH LT W OF S BROADWAY ST,N SIDE ON W MAIN ST	12	070101	1/1/0001
16000	S	M	GRN	IV	00000	138	IN ISLAND AT ALGONQUIN ST,AND W MAIN ST N SIDE	12	070101	1/1/0001

Street Light Listing run 1/11/2015 10:43:21 AM

Page 650 of 1254

OFFICE: 311

ROUTE: 564

ST_REF_NO: 00000118310

MAIN, WEST STREET

LUMENS	BULB TYPE	MULT SERIES	POLE TYPE	SHADE	ADDRESS NUMBER	REF	LOCATION	TAX DIST	DATE INST	DATE CHANGE
16000	S	M	GRN	IV	00000	139	7TH LT W OF S BROADWAY ST,N SIDE ON W MAIN ST	12	070101	1/1/0001
16000	S	M	GRN	IV	00000	140	IN ISLAND AT ALGONQUIN ST AND W MAIN ST, S SIDE	12	070101	1/1/0001
16000	S	M	GRN	IV	00000	141	1ST LT W OF ALGONQUIN ST,N SIDE ON W MAIN ST	12	070101	1/1/0001
16000	S	M	GRN	IV	00000	142	2ND LT W OF ALGONQUIN ST,N SIDE ON W MAIN ST	12	070101	1/1/0001
16000	S	M	GRN	IV	00000	143	3RD LT W OF ALGONQUIN ST,N SIDE ON W MAIN ST	12	070101	1/1/0001
16000	S	M	GRN	IV	00000	144	4TH LT W OF ALGONQUIN ST,N SIDE ON W MAIN ST	12	070101	1/1/0001
16000	S	M	GRN	IV	00000	145	5TH LT W OF ALGONQUIN ST,N SIDE ON W MAIN ST	12	070101	1/1/0001
16000	S	M	GRN	IV	00000	146	6TH LT W OF ALGONQUIN ST,N SIDE ON W MAIN ST	12	070101	1/1/0001
16000	S	M	GRN	IV	00000	147	7TH LT W OF ALGONQUIN ST,N SIDE ON W MAIN ST	12	070101	1/1/0001
16000	S	M	GRN	IV	00000	148	8TH LT W OF ALGONQUIN ST,N SIDE ON W MAIN ST	12	070101	1/1/0001
16000	S	M	GRN	IV	00000	149	9TH LT W OF ALGONQUIN ST,N SIDE ON W MAIN ST	12	070101	1/1/0001
16000	S	M	GRN	IV	00000	150	10TH LT W OF ALGONQUIN ST,N SIDE ON W MAIN ST	12	070101	1/1/0001
16000	S	M	GRN	IV	00000	151	11TH LT W OF ALGONQUIN ST,N SIDE ON W MAIN ST	12	070101	1/1/0001
16000	S	M	GRN	IV	00000	152	12TH LT W OF ALGONQUIN ST,N SIDE ON W MAIN ST	12	070101	1/1/0001
16000	S	M	GRN	IV	00000	153	13TH LT W OF ALGONQUIN ST,N SIDE ON W MAIN ST	12	070101	1/1/0001
16000	S	M	GRN	IV	00000	154	14TH LT W OF ALGONQUIN ST,N SIDE ON W MAIN ST	12	070101	1/1/0001
16000	S	M	GRN	IV	00000	155	15TH LT W OF ALGONQUIN ST,N SIDE ON W MAIN ST	12	070101	1/1/0001
16000	S	M	GRN	IV	00000	156	1ST LT E OF JEFFERSON ST,S SIDE ON W MAIN ST	12	070101	1/1/0001
16000	S	M	GRN	IV	00000	157	2ND LT E OF JEFFERSON ST,S SIDE ON W MAIN ST	12	070101	1/1/0001
16000	S	M	GRN	IV	00000	158	3RD LT E OF JEFFERSON ST,S SIDE ON W MAIN ST	12	070101	1/1/0001
16000	S	M	GRN	IV	00000	159	4TH LT E OF JEFFERSON ST,S SIDE ON W MAIN ST	12	070101	1/1/0001
16000	S	M	GRN	IV	00000	160	5TH LT E OF JEFFERSON ST,S SIDE ON W MAIN ST	12	070101	1/1/0001
16000	S	M	GRN	IV	00000	161	6TH LT E OF JEFFERSON ST,S SIDE ON W MAIN ST	12	070101	1/1/0001
16000	S	M	GRN	IV	00000	162	7TH LT E OF JEFFERSON ST,S SIDE ON W MAIN ST	12	070101	1/1/0001
16000	S	M	GRN	IV	00000	163	8TH LT E OF JEFFERSON ST,S SIDE ON W MAIN ST	12	070101	1/1/0001
16000	S	M	GRN	IV	00000	164	9TH LT E OF JEFFERSON ST,S SIDE ON W MAIN ST	12	070101	1/1/0001

OFFICE: 311

ROUTE: 564

ST_REF_NO: 00000118310

MAIN, WEST STREET

LUMENS	BULB TYPE	MULT SERIES	POLE TYPE	SHADE	ADDRESS NUMBER	REF	LOCATION	TAX DIST	DATE INST	DATE CHANGE
16000	S	M	GRN	IV	00000	165	10TH LT E OF JEFFERSON ST,S SIDE ON W MAIN ST	12	070101	1/1/0001
16000	S	M	GRN	IV	00000	166	11TH LT E OF JEFFERSON ST,S SIDE ON W MAIN ST	12	070101	1/1/0001
16000	S	M	GRN	IV	00000	167	12TH LT E OF JEFFERSON ST, S SIDE ON W MAIN ST	12	070101	1/1/0001
16000	S	M	GRN	IV	00000	168	13TH LT E OF JEFFERSON ST,S SIDE ON W MAIN ST	12	070101	1/1/0001
16000	S	M	GRN	IV	00000	169	14TH LT E OF JEFFERSON ST,S SIDE ON W MAIN ST	12	070101	1/1/0001
16000	S	M	GRN	IV	00000	170	15TH LT E OF JEFFERSON ST,S SIDE ON W MAIN ST	12	070101	1/1/0001
16000	S	M	GRN	IV	00000	171	16TH LT E OF JEFFERSON ST,S SIDE ON W MAIN ST	12	070101	1/1/0001
16000	S	M	GRN	IV	00000	172	17TH LT E OF JEFFERSON ST,S SIDE ON W MAIN ST	12	070101	1/1/0001
16000	S	M	GRN	IV	00000	173	18TH LT E OF JEFFERSON ST,S SIDE ON W MAIN ST	12	070101	1/1/0001
16000	S	M	GRN	IV	00000	174	19TH LT E OF JEFFERSON ST,S SIDE ON W MAIN ST	12	070101	1/1/0001
16000	S	M	GRN	IV	00000	175	20TH LT E OF JEFFERSON ST,S SIDE ON W MAIN ST	12	070101	1/1/0001
22000	S	M	OUG	II	00000	402	1ST LT E OF PRICE RD, NORTH SIDE OF W MAIN STREET	12	121905	3/24/2010
22000	S	M	OUG	II	00000	403	1ST LT W OF PRICE RD, S SIDE OF WEST MAIN ST	12	022306	3/24/2010
22000	S	M	OUG	II	00000	404	2ND LT W OF PRICE RD,NORTH SIDE OF W MAIN STREET	12	121905	3/24/2010
22000	S	M	OUG	II	00000	405	2ND LT W OF PRICE RD, S SIDE OF WEST MAIN ST	12	022306	3/24/2010
22000	S	M	OUG	II	00000	406	3RD LTW OF PRICE RD, N SIDE OF WEST MAIN ST	12	022306	3/24/2010
22000	S	M	OUG	II	00000	407	3RD LT W OF PRICE RD, S SIDE OF WEST MAIN ST	12	022306	3/24/2010
22000	S	M	OUG	II	00000	408	6TH LT W OF PRICE RD, NORTH SIDE OF W MAIN STREET	12	121905	3/24/2010
22000	S	M	OUG	II	00000	409	4TH LT W OF PRICE RD, S SIDE OF WEST MAIN ST	12	022306	3/24/2010
22000	S	M	OUG	II	00000	410	1ST LT E OF CLYDE ST, NORTH SIDE OF W MAIN STREET	12	121905	3/24/2010
22000	S	M	OUG	II	00000	411	1ST LT W OF CLYDE ST, NORTH SIDE OF W MAIN STREET	12	121905	3/24/2010
22000	S	M	OUG	II	00000	412	2ND LT W OF CLYDE ST, SOUTH SIDE OF W MAIN STREET	12	121905	3/24/2010

Street Light Listing run 1/11/2015 10:43:21 AM

Page 652 of 1254

OFFICE: 311

ROUTE: 564

ST_REF_NO: 00000118310

MAIN, WEST STREET

LUMENS	BULB TYPE	MULT SERIES	POLE TYPE	SHADE	ADDRESS NUMBER	REF	LOCATION	TAX DIST	DATE INST	DATE CHANGE
22000	S	M	OUG	II	00000	413	3RD LT W OF CLYDE ST,SOUTH SIDE OF W MAIN STREET	12	121905	3/24/2010
22000	S	M	OUG	II	00000	414	4TH LT W OF CLYDE ST,SOUTH SIDE OF W MAIN STREET	12	121905	3/24/2010
22000	S	M	OUG	II	00000	415	5TH LT W OF CLYDE ST,SOUTH SIDE OF W MAIN STREET	12	121905	3/24/2010
22000	S	M	OUG	II	00000	416	6TH LT W OF CLYDE ST,NORTH SIDE OF W MAIN STREET	12	121905	3/24/2010
22000	S	M	OUG	II	00000	417	7TH LT W OF CLYDE ST,SOUTH SIDE OF W MAIN STREET	12	121905	3/24/2010
50000	S		CNT	II	00000	500	1ST LT E OF NEWTOWN PK, N SIDE ON W MAIN ST	12	031511	3/15/2011
22000	S		CNT	II	00000	501	1ST LT E OF NEWTOWN PK, S SIDE ON W MAIN ST	12	031511	3/15/2011
22000	S		CNT	II	00000	502	2ND LT E OF NEWTOWN PK, S SIDE ON W MAIN ST	12	031511	3/15/2011
22000	S		CNT	II	00000	503	3RD LT E OF NEWTOWN PK, S SIDE ON W MAIN ST	12	031511	3/15/2011
50000	S		CNT	II	00000	504	1ST LT W OF NEWTOWN PK, S SIDE ON W MAIN ST	12	031511	3/15/2011
22000	S		CNT	II	00000	505	1ST LT W OF NEWTOWN PK, N SIDE ON W MAIN ST	12	031511	3/15/2011
22000	S		CNT	II	00000	506	2ND LT W OF NEWTOWN PK, S SIDE ON W MAIN ST	12	031511	3/15/2011
22000	S		CNT	II	00000	507	2ND LT W OF NEWTOWN PK, N SIDE ON W MAIN ST	12	031511	3/15/2011
22000	S		CNT	II	00000	508	3RD LT W OF NEWTOWN PK, S SIDE ON W MAIN ST	12	031511	3/15/2011
22000	S		CNT	II	00000	509	3RD LT W OF NEWTOWN PK, N SIDE ON W MAIN ST	12	031511	3/15/2011
22000	S		OUG	II	00000	510	4TH LT W OF NEWTOWN PK, S SIDE ON W MAIN ST	12	031511	3/15/2011
22000	S		OUG	II	00000	511	4TH LT W OF NEWTOWN PK, N SIDE ON W MAIN ST	12	031511	3/15/2011
22000	S	M	SOH	II	00000	032	4 TH. LT. W. OF VIADUCT, N. SIDE	12	111464	1/1/0001
22000	S	M	SOH	II	00000	034	5 TH. LT. W. OF VIADUCT, N. SIDE	12	111464	1/1/0001
22000	S	M	SOH	II	00000	036	6 TH. LT. W. OF VIADUCT, N. SIDE	12	111464	1/1/0001
22000	S	M	SOH	II	00000	038	7 TH. LT. W. OF VIADUCT, N. SIDE	12	111464	1/1/0001
22000	S	M	SOH	II	00000	039	1 ST. LT. E. OF CALVARY CEMETARY, S. SIDE	12	111464	1/1/0001
22000	S	M	SOH	II	00000	040	8 TH. LT. W. OF VIADUCT, N. SIDE	12	111464	1/1/0001
22000	S	M	SOH	II	00000	041	1 ST. LT. W. OF CALVARY CEMETARY, S. SIDE	12	111464	1/1/0001
22000	S	M	SOH	II	00000	042	9 TH. LT. W. OF VIADUCT, N. SIDE	12	111464	1/1/0001
22000	S	M	SOH	II	00000	044	10 TH. LT. W. OF VIADUCT, N. SIDE	12	111464	1/1/0001
22000	S	M	SOH	II	00000	046	11 TH. LT. W. OF VIADUCT, N. SIDE	12	111464	1/1/0001
22000	S	M	SOH	II	00000	048	12 TH. LT. W. OF VIADUCT, N. SIDE	12	111464	1/1/0001
22000	S	M	SOH	II	00000	050	13 TH. LT. W. OF VIADUCT, N. SIDE	12	111464	1/1/0001
22000	S	M	SOH	II	00000	052	14 TH. LT. W. OF VIADUCT, N. SIDE	12	111464	1/1/0001
22000	S	M	SOH	II	00000	054	15 TH. LT. W. OF VIADUCT, N. SIDE	12	111464	1/1/0001

Street Light Listing run 1/11/2015 10:43:21 AM

Page 653 of 1254

OFFICE: 311		ROUTE: 564		ST_REF_NO: 00000118310		MAIN, WEST STREET		LUMENS	BULB TYPE	MULT SERIES	POLE TYPE	SHADE	ADDRESS NUMBER	REF	LOCATION	TAX DIST	DATE INST	DATE CHANGE
22000	S	M	SOH	II	00854	035		12	111464	1/1/0001								
22000	S	M	SOH	II	00866	037		12	111464	1/1/0001								
22000	S	M	SOH	IV	00601	019		12	010264	1/1/0001								
22000	S	M	SOH	IV	00611	020		12	010264	1/1/0001								
22000	S	M	SOH	IV	00621	021		12	020885	1/1/0001								
22000	S	M	SOH	IV	00633	022		12	010264	1/1/0001								
22000	S	M	SOH	IV	00647	023		12	010264	1/1/0001								
22000	S	M	SOH	IV	00707	024		12	010264	1/1/0001								
22000	S	M	SOH	IV	00719	025		12	020885	1/1/0001								
22000	S	M	SOH	IV	00731	026		12	010264	1/1/0001								
22000	S	M	SOH	IV	00751	028		12	010264	1/1/0001								
22000	S	M	OUG	III	00000	029	1ST LT. W. OF VIADUCT, N. SIDE	12	090885	1/1/0001								
22000	S	M	SOH	II	00000	031	3 RD. LT. W. OF VIADUCT, N. SIDE	12	111464	1/1/0001								
22000	S	M	OUG	II	00606	101		12	051581	1/1/0001								
22000	S	M	SOH	IV	00736	027		12	010264	1/1/0001								
22000	S	M	OUG	III	00832	030		12	090885	1/1/0001								
OFFICE: 311		ROUTE: 564		ST_REF_NO: 00000118400		MAJAUN ROAD		LUMENS	BULB TYPE	MULT SERIES	POLE TYPE	SHADE	ADDRESS NUMBER	REF	LOCATION	TAX DIST	DATE INST	DATE CHANGE
05800	S	M	OUG	II	00000	018	OPPOSITE 1000	12	082373	1/1/0001								
05800	S	M	OUG	II	00000	020	OPPOSITE 1016	12	082373	1/1/0001								
05800	S	M	OUG	II	00000	022	OPP. 1032	12	082373	1/1/0001								
05800	S	M	OUG	II	00000	023	SIDE OF 1032	12	041475	1/1/0001								
05800	S	M	OUG	II	00000	025	SIDE OF 1033 TROTWOOD DR.	12	092674	1/1/0001								
05800	S	M	OUG	II	01000	019		12	091477	1/1/0001								
05800	S	M	OUG	II	01032	021		12	041475	1/1/0001								
05800	S	M	OUG	II	01063	024		12	091477	1/1/0001								
05800	S	M	OUG	II	01095	026		12	082373	1/1/0001								
05800	S	M	OUG	V	01111	027		12	091477	1/1/0001								

OFFICE: 311		ROUTE: 564		ST_REF_NO: 00000118418		MAJESTIC VIEW COVE		LUMENS	BULB TYPE	MULT SERIES	POLE TYPE	SHADE	ADDRESS NUMBER	REF	LOCATION	TAX DIST	DATE INST	DATE CHANGE
05800	S	M	CNT	II	00000	001	SIDE OF 3037 MAJESTIC VIEW WLK ON MAJESTIC VIEW CO	12	092507	1/1/0001								
05800	S	M	CNT	III	00805	002		12	092507	1/1/0001								
OFFICE: 311		ROUTE: 564		ST_REF_NO: 00000118420		MAJESTIC VIEW WALK		LUMENS	BULB TYPE	MULT SERIES	POLE TYPE	SHADE	ADDRESS NUMBER	REF	LOCATION	TAX DIST	DATE INST	DATE CHANGE
05800	S	M	CNT	II	00000	014	SIDE OF 2876 JENNA REST ON MAJESTIC VIEW WK	12	083107	1/1/0001								
05800	S	M	CNT	II	00000	021	SIDE OF 2877 BAY COLONY LN ON MAJESTIC VIEW WK	12	083107	1/1/0001								
05800	S	M	CNT	II	00000	023	SIDE OF 2849 SATIN LEAF PARK ON MAJESTIC VIEW WK	12	083107	1/1/0001								
05800	S	M	CNT	II	00000	033	SIDE OF 2812 BAY COLONY LN ON MAJESTIC VIEW WK	12	083107	1/1/0001								
05800	S	M	CNT	II	00000	037	SIDE OF 2817 MAJESTIC VIEW WK	12	083107	1/1/0001								
05800	S	M	CNT	II	02804	001		12	083107	1/1/0001								
05800	S	M	CNT	II	02809	002		12	083107	1/1/0001								
05800	S	M	CNT	II	02824	003		12	011304	1/1/0001								
05800	S	M	CNT	II	02829	004		12	083107	1/1/0001								
05800	S	M	CNT	II	02844	005		12	083107	1/1/0001								
05800	S	M	CNT	II	02849	006		12	083107	1/1/0001								
05800	S	M	CNT	II	02860	007		12	083107	1/1/0001								
05800	S	M	CNT	II	02872	008		12	083107	1/1/0001								
05800	S	M	CNT	II	02877	009		12	083107	1/1/0001								
05800	S	M	CNT	II	02888	010		12	083107	1/1/0001								
05800	S	M	CNT	II	02900	011		12	083107	1/1/0001								
05800	S	M	CNT	II	02909	012		12	083107	1/1/0001								
05800	S	M	CNT	II	02920	013		12	083107	1/1/0001								
05800	S	M	CNT	II	02944	015		12	083107	1/1/0001								
05800	S	M	CNT	II	02953	016		12	083107	1/1/0001								
05800	S	M	CNT	II	02960	017		12	083107	1/1/0001								
05800	S	M	CNT	II	02972	018		12	083107	1/1/0001								
05800	S	M	CNT	II	02985	019		12	083107	1/1/0001								
05800	S	M	CNT	II	02990	020		12	083107	1/1/0001								
05800	S	M	CNT	II	03016	022		12	083107	1/1/0001								

OFFICE: 311		ROUTE: 564		ST_REF_NO: 00000118420		MAJESTIC VIEW WALK		TAX DIST	DATE INST	DATE CHANGE
LUMENS	BULB TYPE	MULT SERIES	POLE TYPE	SHADE	ADDRESS NUMBER	REF	LOCATION			
05800	S	M	CNT	II	03029	024		12	083107	1/1/0001
05800	S	M	CNT	II	03049	025		12	083107	1/1/0001
05800	S	M	CNT	II	03053	026		12	083107	1/1/0001
05800	S	M	CNT	II	03076	028		12	083107	1/1/0001
05800	S	M	CNT	II	03085	029		12	083107	1/1/0001
05800	S	M	CNT	II	03096	030		12	083107	1/1/0001
05800	S	M	CNT	II	03108	031		12	083107	1/1/0001
05800	S	M	CNT	II	03116	032		12	083107	1/1/0001
05800	S	M	CNT	II	03136	034		12	083107	1/1/0001
05800	S	M	CNT	II	03148	035		12	083107	1/1/0001
05800	S	M	CNT	II	03164	052		12	011304	1/1/0001
OFFICE: 311		ROUTE: 564		ST_REF_NO: 00000118700		MALABU DRIVE		TAX DIST	DATE INST	DATE CHANGE
LUMENS	BULB TYPE	MULT SERIES	POLE TYPE	SHADE	ADDRESS NUMBER	REF	LOCATION			
09500	S	M	OUG	II	00870	005		12	020474	4/25/2013
05800	S	M	OUG	II	00000	076	OPP. 255	12	090172	1/1/0001
05800	S	M	OUG	II	00000	081	SIDE OF 247 SURFSIDE DR.	12	090172	1/1/0001
05800	S	M	OUG	II	00000	083	2ND LT. E. OF NICHOLASVILLE RD., N. SIDE	12	012268	1/1/0001
05800	S	M	OUG	II	00000	085	1ST LT. E. OF NICHOLASVILLE RD., S. SIDE	12	012268	1/1/0001
05800	S	M	OUG	II	00000	086	2ND LT. E. OF NICHOLASVILLE RD., S. SIDE	12	012268	1/1/0001
05800	S	M	OUG	II	00000	087	3RD LT. E. OF NICHOLASVILLE RD., S. SIDE	12	012268	1/1/0001
05800	S	M	OUG	II	00101	084		12	090170	1/1/0001
05800	S	M	OUG	II	00147	082		12	090170	1/1/0001
05800	S	M	OUG	II	00175	078		12	040969	1/1/0001
05800	S	M	OUG	II	00175	080		12	040969	1/1/0001
05800	S	M	OUG	II	00220	079		12	100174	1/1/0001
05800	S	M	OUG	II	00259	077		12	080166	1/1/0001
10000	M	M	OUG	II	00000	001	SIDE OF 3399 TATES CREEK RD.	12	020474	1/1/0001
10000	M	M	OUG	II	00000	002	SIDE OF 3393 TATES CREEK RD.	12	020474	1/1/0001
09500	S	M	OUG	II	00000	003	SIDE REAR OF 3393 TATES CREEK RD.	12	020474	1/1/0001
09500	S	M	OUG	II	00000	034	SIDE OF 3364 BELLEFONTE DRIVE	12	110800	1/1/0001
09500	S	M	OUG	II	00000	035	SIDE REAR OF 3401 BELLEFONTE DRIVE	12	110800	1/1/0001
09500	S	M	OUG	II	00000	036	SIDE OF 3364 HUNTER ROAD	12	110800	1/1/0001

OFFICE: 311

ROUTE: 564

ST_REF_NO: 00000118700

MALABU DRIVE

LUMENS	BULB TYPE	MULT SERIES	POLE TYPE	SHADE	ADDRESS NUMBER	REF	LOCATION	TAX DIST	DATE INST	DATE CHANGE
09500	S	M	OUG	II	00000	037	SIDE OF 3401 HUNTER ROAD	12	110800	1/1/0001
09500	S	M	OUG	II	00000	042	SIDE OF 3400 FARMINGTON ROAD	12	110800	1/1/0001
09500	S	M	OUG	II	00000	043	OPP. 308	12	110800	1/1/0001
09500	S	M	OUG	II	00000	045	SIDE OF 329 MALABU PLACE	12	110800	1/1/0001
09500	S	M	OUG	II	00267	038		12	110800	1/1/0001
09500	S	M	OUG	II	00279	039		12	110800	1/1/0001
09500	S	M	OUG	II	00287	040		12	110800	1/1/0001
09500	S	M	OUG	II	00295	041		12	110800	1/1/0001
09500	S	M	OUG	II	00312	044		12	110800	1/1/0001
09500	S	M	OUG	II	00412	033		12	110800	1/1/0001
09500	S	M	OUG	II	00421	032		12	110800	1/1/0001
09500	S	M	OUG	II	00424	031		12	110800	1/1/0001
09500	S	M	OUG	II	00701	030		12	110800	1/1/0001
09500	S	M	OUG	II	00704	029		12	110800	1/1/0001
09500	S	M	OUG	II	00709	028		12	110800	1/1/0001
09500	S	M	OUG	II	00712	027		12	110800	1/1/0001
09500	S	M	OUG	II	00721	026		12	110800	1/1/0001
09500	S	M	OUG	II	00732	019		12	110800	1/1/0001
09500	S	M	OUG	II	00733	025		12	110800	1/1/0001
09500	S	M	OUG	II	00740	024		12	110800	1/1/0001
09500	S	M	OUG	II	00745	023		12	110800	1/1/0001
09500	S	M	OUG	II	00750	022		12	110800	1/1/0001
09500	S	M	OUG	II	00761	021		12	110800	1/1/0001
09500	S	M	OUG	II	00769	018		12	110800	1/1/0001
09500	S	M	OUG	II	00776	017		12	110800	1/1/0001
09500	S	M	OUG	II	00800	016		12	110800	1/1/0001
09500	S	M	OUG	II	00803	015		12	110800	1/1/0001
09500	S	M	OUG	II	00808	014		12	110800	1/1/0001
09500	S	M	OUG	II	00819	013		12	110800	1/1/0001
09500	S	M	OUG	II	00820	012		12	110800	1/1/0001
09500	S	M	OUG	II	00828	010		12	110800	1/1/0001
09500	S	M	OUG	II	00829	011		12	110800	1/1/0001
05800	S	M	OUG	II	00840	009		12	060897	1/1/0001
05800	S	M	OUG	II	00848	008		12	060897	1/1/0001

OFFICE: 311 ROUTE: 564							ST_REF_NO: 00000118700 MALABU DRIVE			
LUMENS	BULB TYPE	MULT SERIES	POLE TYPE	SHADE	ADDRESS NUMBER	REF	LOCATION	TAX DIST	DATE INST	DATE CHANGE
05800	S	M	OUG	II	00852	007		12	060897	1/1/0001
10000	M	M	OUG	II	00857	006		12	020474	1/1/0001
10000	M	M	OUG	II	00882	004		12	020474	1/1/0001

OFFICE: 311 ROUTE: 564							ST_REF_NO: 00000118950 MALLORY CIRCLE			
LUMENS	BULB TYPE	MULT SERIES	POLE TYPE	SHADE	ADDRESS NUMBER	REF	LOCATION	TAX DIST	DATE INST	DATE CHANGE
05800	S	M	CNT	III	03305	001		12	080897	1/1/0001

OFFICE: 311 ROUTE: 564							ST_REF_NO: 00000119010 MALONE DRIVE			
LUMENS	BULB TYPE	MULT SERIES	POLE TYPE	SHADE	ADDRESS NUMBER	REF	LOCATION	TAX DIST	DATE INST	DATE CHANGE
05800	S	M	CNT	II	00000	006	SIDE OF 2252 BARNWELL LANE ON MALONE DR	12	060105	1/1/0001
05800	S	M	CNT	II	00000	007	SIDE OF 3285 SEBASTIAN LANE ON MALONE DR	12	060105	1/1/0001
05800	S	M	CNT	II	03200	002		12	072203	1/1/0001
05800	S	M	CNT	II	03201	001		12	072203	1/1/0001
05800	S	M	CNT	II	03209	003		12	072203	1/1/0001
05800	S	M	CNT	II	03213	004		12	072203	1/1/0001
05800	S	M	CNT	II	03220	005		12	060105	1/1/0001
05800	S	M	CNT	II	03236	008		12	060105	1/1/0001
05800	S	M	CNT	II	03241	009		12	060105	1/1/0001
05800	S	M	CNT	II	03260	010		12	060105	1/1/0001
05800	S	M	CNT	II	03261	011		12	060105	1/1/0001
05800	S	M	CNT	II	03277	012		12	060105	1/1/0001
05800	S	M	CNT	II	03280	013		12	060105	1/1/0001
05800	S	M	CNT	II	03289	014		12	060105	1/1/0001
05800	S	M	CNT	II	03301	015		12	060105	1/1/0001
05800	S	M	CNT	II	03308	016		12	060105	1/1/0001
05800	S	M	CNT	II	03329	017		12	060105	1/1/0001
05800	S	M	CNT	II	03340	008		12	071202	1/1/0001
05800	S	M	CNT	II	03344	007		12	071202	1/1/0001
05800	S	M	CNT	II	00000	001	SIDE 2200 BURNS COURT	12	110800	1/1/0001
05800	S	M	CNT	II	00000	003	SIDE REAR OF 2200 WILMINGTON LANE	12	110800	1/1/0001
05800	S	M	CNT	II	03364	006		12	110800	1/1/0001

OFFICE: 311		ROUTE: 564		ST_REF_NO: 00000119010		MALONE DRIVE		LUMENS	BULB TYPE	MULT SERIES	POLE TYPE	SHADE	ADDRESS NUMBER	REF	LOCATION	TAX DIST	DATE INST	DATE CHANGE
	05800	S	M	CNT	II	03373	005									12	110800	1/1/0001
	05800	S	M	CNT	II	03376	004									12	110800	1/1/0001
	05800	S	M	CNT	II	03788	002									12	110800	1/1/0001

OFFICE: 311		ROUTE: 564		ST_REF_NO: 00000119100		MALVERN ROAD		LUMENS	BULB TYPE	MULT SERIES	POLE TYPE	SHADE	ADDRESS NUMBER	REF	LOCATION	TAX DIST	DATE INST	DATE CHANGE
	05800	S	M	OUG	II	01983	001								upgrade due to car accident	12	020889	4/17/2009
	04000	S	M	OUG	II	00000	003								SIDE OF 1864 TRAVELLER RD.	12	020889	1/1/0001
	04000	S	M	OUG	II	01995	002									12	020889	1/1/0001

OFFICE: 311		ROUTE: 564		ST_REF_NO: 00000119200		MAMMOTH DRIVE		LUMENS	BULB TYPE	MULT SERIES	POLE TYPE	SHADE	ADDRESS NUMBER	REF	LOCATION	TAX DIST	DATE INST	DATE CHANGE
	04000	S	M	OUG	II	00000	008								SIDE OF 3170 PIMLICO PARKWAY	12	081477	1/1/0001
	04000	S	M	OUG	II	03201	004									12	091476	1/1/0001
	04000	S	M	OUG	II	03216	005									12	081477	1/1/0001
	04000	S	M	OUG	II	03225	006									12	081477	1/1/0001
	04000	S	M	OUG	II	03241	007									12	081477	1/1/0001

OFFICE: 311		ROUTE: 564		ST_REF_NO: 00000119300		MAN O' WAR BOULEVARD		LUMENS	BULB TYPE	MULT SERIES	POLE TYPE	SHADE	ADDRESS NUMBER	REF	LOCATION	TAX DIST	DATE INST	DATE CHANGE
	22000	S		OUG	II	00000	900								6TH LT W OF LIBERTY RD, N SIDE ON MOW BLVD	12	122110	1/1/0001
	22000	S		OUG	II	00000	902								5TH LT W OF LIBERTY RD, N SIDE ON MOW BLVD	12	122110	1/1/0001
	22000	S		OUG	II	00000	904								4TH LT W OF LIBERTY RD, N SIDE ON MOW BLVD	12	122110	1/1/0001
	22000	S		OUG	II	00000	906								3RD LT W OF LIBERTY RD, N SIDE ON MOW BLVD	12	122110	1/1/0001
	22000	S		OUG	II	00000	908								2ND LT W OF LIBERTY RD, N SIDE ON MOW BLVD	12	122110	1/1/0001
	22000	S		OUG	II	00000	910								1ST LT W OF LIBERTY RD, N SIDE ON MOW BLVD	12	122110	1/1/0001
	22000	S		OUG	II	00000	912								2ND LT S OF HELMSDALE PL, W SIDE ON MOW BLVD	12	122110	1/1/0001
	22000	S		OUG	II	00000	914								3RD LT S OF HELMSDALE PL, W SIDE ON MOW BLVD	12	122110	1/1/0001
	22000	S		OUG	II	00000	916								4TH LT S OF HELMSDALE PL, W SIDE ON MOW BLVD	12	122110	1/1/0001

OFFICE: 311

ROUTE: 564

ST_REF_NO: 00000119300

MAN O' WAR BOULEVARD

LUMENS	BULB TYPE	MULT SERIES	POLE TYPE	SHADE	ADDRESS NUMBER	REF	LOCATION	TAX DIST	DATE INST	DATE CHANGE
22000	S		OUG	II	00000	918	5TH LT S OF HELMSDALE PL, W SIDE ON MOW BLVD	12	122110	1/1/0001
22000	S		OUG	II	00000	920	6TH LT S OF HELMSDALE PL, W SIDE ON MOW BLVD	12	122110	1/1/0001
22000	S		OUG	II	00000	922	7TH LT S OF HELMSDALE PL, W SIDE ON MOW BLVD	12	122110	1/1/0001
22000	S		OUG	II	00000	926	8TH LT S OF HELMSDALE PL, W SIDE ON MOW BLVD	12	122110	1/1/0001
22000	S		OUG	II	00000	928	9TH LT S OF HELMSDALE PL, W SIDE ON MOW BLVD	12	122110	1/1/0001
50000	S	M	OUG	II	00000	001	1ST LT W OF RICHMOND RD, SOUTH SIDE ON MAN O WAR	12	060604	1/1/0001
22000	S	M	OUG	II	00000	002	2ND LT W OF RICHMOND RD, SOUTH SIDE ON MAN O WAR	12	060604	1/1/0001
22000	S	M	OUG	II	00000	003	3RD LT W OF RICHMOND RD, SOUTH SIDE ON MAN O WAR	12	060604	1/1/0001
22000	S	M	OUG	II	00000	004	4TH LT W OF RICHMOND RD, SOUTH SIDE ON MAN O WAR	12	060604	1/1/0001
22000	S	M	OUG	II	00000	005	5TH LT W OF RICHMOND RD, SOUTH SIDE ON MAN O WAR	12	060604	1/1/0001
50000	S	M	OUG	III	00000	228	1ST LT. W. OF HABERSHAM DR., N. SIDE	12	110887	1/17/2013
50000	S	M	OUG	III	00000	421	1ST LT. E. OF VICTORIA WAY, S. SIDE	12	100889	1/17/2013
50000	S	M	OUG	III	00000	653	1ST LT. N. OF AIRPORT RD., W. SIDE-upgrade per LFUCG	12	020891	7/6/2009
50000	S	M	OUG	III	00000	654	OPP. AIRPORT, E. SIDE-upgrade per LFUCG	12	020891	7/6/2009
50000	S	M	OUG	III	00000	656	1ST LT. S. OF AIRPORT ENTRANCE, E. SIDE-upgrade per LFUCG	12	020891	7/6/2009
22000	S	M	OUG	III	00000	945	7th LT N OF HELMSDALE PLACE, E SIDE	12	081202	1/1/0001
22000	S	M	OUG	III	00000	947	8th LT N OF HELMSDALE PLACE, E SIDE	12	081202	1/1/0001
50000	S	M	OUG	III	00000	949	9th LT N OF HELMSDALE PLACE, E SIDE	12	081202	1/1/0001
22000	S	M	OUG	III	00000	951	10th LT N OF HELMSDALE PLACE, E SIDE	12	081202	1/1/0001
09500	S	M	OUG	II	00000	985	1ST LT E OF 1-75 INTERCHANGE, S SIDE OF MAN O WAR	12	030602	1/1/0001
09500	S	M	OUG	II	00000	986	2ND LT E OF 1-75 INTERCHANGE, S SIDE OF MAN O WAR	12	030602	1/1/0001
09500	S	M	OUG	II	00000	987	3RD LT E OF 1-75 INTERCHANGE, S SIDE OF MAN O WAR	12	030602	1/1/0001
09500	S	M	OUG	II	00000	988	4TH LT E OF 1-75 INTERCHANGE, S SIDE OF MAN O WAR	12	030602	1/1/0001

Street Light Listing run 1/11/2015 10:43:21 AM

Page 660 of 1254

OFFICE: 311

ROUTE: 564

ST_REF_NO: 00000119300

MAN O' WAR BOULEVARD

LUMENS	BULB TYPE	MULT SERIES	POLE TYPE	SHADE	ADDRESS NUMBER	REF	LOCATION	TAX DIST	DATE INST	DATE CHANGE
09500	S	M	OUG	II	00000	989	5TH LT E OF 1-75 INTERCHANGE, S SIDE OF MAN O WAR	12	030602	1/1/0001
09500	S	M	OUG	II	00000	990	6TH LT E OF 1-75 INTERCHANGE, S SIDE OF MAN O WAR	12	030602	1/1/0001
09500	S	M	OUG	II	00000	991	7TH LT E OF 1-75 INTERCHANGE, S SIDE OF MAN O WAR	12	030602	1/1/0001
09500	S	M	OUG	II	00000	992	8TH LT E OF 1-75 INTERCHANGE, S SIDE OF MAN O WAR	12	030602	1/1/0001
22000	S	M	OUG	III	00000	062	NE CORNER OF PALUMBO DR.	12	050898	1/1/0001
22000	S	M	OUG	III	00000	063	2ND LT. W. OF PALUMBO DR., N. SIDE	12	100885	1/1/0001
22000	S	M	OUG	III	00000	064	1ST LT. W. OF PALUMBO DR., N. SIDE	12	100885	1/1/0001
22000	S	M	OUG	III	00000	117	7TH LT. S. OF PALUMBO DR., W. SIDE	12	010887	1/1/0001
22000	S	M	OUG	III	00000	118	6TH LT. S. OF PALUMBO DR., W. SIDE	12	010887	1/1/0001
22000	S	M	OUG	III	00000	119	5TH LT. S. OF PALUMBO DR., W. SIDE	12	010887	1/1/0001
22000	S	M	OUG	III	00000	120	4TH LT. S. OF PALUMBO DR., W. SIDE	12	010887	1/1/0001
22000	S	M	OUG	III	00000	607	4TH LT. W. OF PALUMBO DR., S. SIDE	12	100889	1/1/0001
22000	S	M	OUG	III	00000	608	3RD LT. W. OF PALUMBO DR., S. SIDE	12	100889	1/1/0001
22000	S	M	OUG	III	00000	609	2ND LT. W. OF PALUMBO DR., S. SIDE	12	100889	1/1/0001
22000	S	M	OUG	III	00000	610	1ST LT. W. OF PALUMBO DR., S. SIDE	12	100889	1/1/0001
22000	S	M	OUG	III	00000	611	1ST LT. E. OF PALUMBO DR., S. SIDE	12	100889	1/1/0001
22000	S	M	OUG	III	00000	612	2ND LT. E. OF PALUMBO DR., S. SIDE	12	100889	1/1/0001
22000	S	M	OUG	III	00000	613	1ST LT. E. OF PALUMBO DR., N. SIDE	12	100889	1/1/0001
22000	S	M	OUG	III	00000	614	3RD LT. E. OF PALUMBO DR., S. SIDE	12	100889	1/1/0001
22000	S	M	OUG	III	00000	615	2ND LT. E. OF PALUMBO DR., N. SIDE	12	100889	1/1/0001
22000	S	M	OUG	III	00000	616	3RD LT. E. OF PALUMBO DR., N. SIDE	12	100889	1/1/0001
22000	S	M	OUG	III	00000	855	7TH LT W OF DARBY CREEK ON NORTHSIDE OF MAN-O-WAR	12	050891	1/1/0001
22000	S	M	OUG	III	00000	856	7TH LT W OF DARBY CREEK ON SOUTHSIDE OF MAN-O-WAR	12	050891	1/1/0001
22000	S	M	OUG	III	00000	857	6TH LT W OF DARBY CREEK ON SOUTHSIDE OF MAN-O-WAR	12	050891	1/1/0001
22000	S	M	OUG	III	00000	858	6TH LT W OF DARBY CREEK ON NORTHSIDE OF MAN-O-WAR	12	050891	1/1/0001
22000	S	M	OUG	III	00000	859	5TH LT W OF DARBY CREEK ON SOUTHSIDE OF MAN-O-WAR	12	050891	1/1/0001
22000	S	M	OUG	III	00000	860	5TH LT W OF DARBY CREEK ON NORTHSIDE OF MAN-O-WAR	12	050891	1/1/0001

OFFICE: 311

ROUTE: 564

ST_REF_NO: 00000119300

MAN O' WAR BOULEVARD

LUMENS	BULB TYPE	MULT SERIES	POLE TYPE	SHADE	ADDRESS NUMBER	REF	LOCATION	TAX DIST	DATE INST	DATE CHANGE
22000	S	M	OUG	III	00000	861	4TH LT W OF DARBY CREEK ON SOUTHSIDE OF MAN-O-WAR	12	050891	1/1/0001
22000	S	M	OUG	III	00000	862	4TH LT W OF DARBY CREEK ON NORTHSIDE OF MAN-O-WAR	12	050891	1/1/0001
22000	S	M	OUG	III	00000	863	3RD LT W OF DARBY CREEK ON SOUTHSIDE OF MAN-O-WAR	12	050891	1/1/0001
22000	S	M	OUG	III	00000	864	3RD LT W OF DARBY CREEK ON NORTHSIDE OF MAN-O-WAR	12	050891	1/1/0001
22000	S	M	OUG	III	00000	865	2ND LT W OF DARBY CREEK ON SOUTHSIDE OF MAN-O-WAR	12	050891	1/1/0001
22000	S	M	OUG	III	00000	866	2ND LT W OF DARBY CREEK ON NORTHSIDE OF MAN-O-WAR	12	050891	1/1/0001
22000	S	M	OUG	III	00000	867	1ST LT W OF DARBY CREEK ON SOUTHSIDE OF MAN-O-WAR	12	050891	1/1/0001
50000	S	M	OUG	III	00000	868	1ST LT W OF DARBY CREEK ON NORTHSIDE OF MAN-O-WAR	12	050891	1/1/0001
50000	S	M	OUG	III	00000	869	1ST LT E OF DARBY CREEK ON SOUTHSIDE OF MAN-O-WAR	12	050891	1/1/0001
22000	S	M	OUG	III	00000	870	1ST LT E OF DARBY CREEK ON NORTHSIDE OF MAN-O-WAR	12	050891	1/1/0001
22000	S	M	OUG	III	00000	871	2ND LT E OF DARBY CREEK ON SOUTHSIDE OF MAN-O-WAR	12	050891	1/1/0001
22000	S	M	OUG	III	00000	872	2ND LT E OF DARBY CREEK ON NORTHSIDE OF MAN-O-WAR	12	050891	1/1/0001
22000	S	M	OUG	III	00000	873	3RD LT E OF DARBY CREEK ON SOUTHSIDE OF MAN-O-WAR	12	050891	1/1/0001
22000	S	M	OUG	III	00000	874	3RD LT W OF DARBY CREEK ON NORTHSIDE OF MAN-O-WAR	12	050891	1/1/0001
22000	S	M	OUG	III	00000	875	4TH LT E OF DARBY CREEK ON SOUTHSIDE OF MAN-O-WAR	12	050891	1/1/0001
22000	S	M	OUG	III	00000	876	4TH LT E OF DARBY CREEK ON NORTHSIDE OF MAN-O-WAR	12	050891	1/1/0001
22000	S	M	OUG	III	00000	877	7TH LT W OF MAPLELEAF DR ON SOUTHSIDE OF MAN-O-WAR	12	050891	1/1/0001
22000	S	M	OUG	III	00000	878	6TH LT W OF MAPLELEAF DR ON NORTHSIDE OF MAN-O-WAR	12	050891	1/1/0001
22000	S	M	OUG	III	00000	879	6TH LT W OF MAPLELEAF DR ON SOUTHSIDE OF MAN-O-WAR	12	050891	1/1/0001
22000	S	M	OUG	III	00000	880	5TH LT W OF MAPLELEAF DR ON NORTHSIDE OF MAN-O-WAR	12	050891	1/1/0001

OFFICE: 311

ROUTE: 564

ST_REF_NO: 00000119300

MAN O' WAR BOULEVARD

LUMENS	BULB TYPE	MULT SERIES	POLE TYPE	SHADE	ADDRESS NUMBER	REF	LOCATION	TAX DIST	DATE INST	DATE CHANGE
22000	S	M	OUG	III	00000	881	5TH LT W OF MAPLELEAF DR ON SOUTHSIDE OF MAN-O-WAR	12	050891	1/1/0001
22000	S	M	OUG	III	00000	882	4TH LT W OF MAPLELEAF DR ON NORTHSIDE OF MAN-O-WAR	12	050891	1/1/0001
22000	S	M	OUG	III	00000	883	4TH LT W OF MAPLELEAF DR ON SOUTHSIDE OF MAN-O-WAR	12	050891	1/1/0001
22000	S	M	OUG	III	00000	884	3RD LT W OF MAPLELEAF DR ON NORTHSIDE OF MAN-O-WAR	12	050891	1/1/0001
22000	S	M	OUG	III	00000	885	3RD LT W OF MAPLELEAF DR ON SOUTHSIDE OF MAN-O-WAR	12	050891	1/1/0001
22000	S	M	OUG	III	00000	886	2ND LT W OF MAPLELEAF DR ON NORTHSIDE OF MAN-O-WAR	12	050891	1/1/0001
22000	S	M	OUG	III	00000	887	2ND LT W OF MAPLELEAF DR ON SOUTHSIDE OF MAN-O-WAR	12	050891	1/1/0001
22000	S	M	OUG	III	00000	888	1ST LT W OF MAPLELEAF DR ON NORTHSIDE OF MAN-O-WAR	12	050891	1/1/0001
50000	S	M	OUG	III	00000	889	1ST LT W OF MAPLELEAF DR ON SOUTHSIDE OF MAN-O-WAR	12	050891	1/1/0001
50000	S	M	OUG	III	00000	890	1ST LT E OF MAPLELEAF DR ON NORTHSIDE OF MAN-O-WAR	12	050891	1/1/0001
22000	S	M	OUG	III	00000	891	1ST LT E OF MAPLELEAF DR ON SOUTHSIDE OF MAN-O-WAR	12	050891	1/1/0001
22000	S	M	OUG	III	00000	892	2ND LT E OF MAPLELEAF DR ON NORTHSIDE OF MAN-O-WAR	12	050891	1/1/0001
22000	S	M	OUG	III	00000	893	2ND LT E OF MAPLELEAF DR ON SOUTHSIDE OF MAN-O-WAR	12	050891	1/1/0001
22000	S	M	OUG	III	00000	894	3RD LT E OF MAPLELEAF DR ON NORTHSIDE OF MAN-O-WAR	12	050891	1/1/0001
22000	S	M	OUG	III	00000	895	3RD LT E OF MAPLELEAF DR ON SOUTHSIDE OF MAN-O-WAR	12	050891	1/1/0001
22000	S	M	OUG	III	00000	896	4TH LT E OF MAPLELEAF DR ON NORTHSIDE OF MAN-O-WAR	12	050891	1/1/0001
22000	S	M	OUG	III	00000	897	4TH LT E OF MAPLELEAF DR ON SOUTHSIDE OF MAN-O-WAR	12	050891	1/1/0001
22000	S	M	OUG	III	00000	898	5TH LT E OF MAPLELEAF DR ON NORTHSIDE OF MAN-O-WAR	12	050891	1/1/0001
22000	S	M	OUG	III	00000	899	7TH LT W OF TODDS RD ON SOUTHSIDE OF MAN-O-WAR	12	050891	1/1/0001
22000	S	M	OUG	III	00000	901	6TH LT W OF TODDS RD ON SOUTHSIDE OF MAN-O-WAR	12	050891	1/1/0001

OFFICE: 311

ROUTE: 564

ST_REF_NO: 00000119300

MAN O' WAR BOULEVARD

LUMENS	BULB TYPE	MULT SERIES	POLE TYPE	SHADE	ADDRESS NUMBER	REF	LOCATION	TAX DIST	DATE INST	DATE CHANGE
22000	S	M	OUG	III	00000	903	5TH LT W OF TODDS RD ON SOUTHSIDE OF MAN-O-WAR	12	050891	1/1/0001
22000	S	M	OUG	III	00000	905	4TH LT W OF TODDS RD ON SOUTHSIDE OF MAN-O-WAR	12	050891	1/1/0001
22000	S	M	OUG	III	00000	907	3RD LT W OF TODDS RD ON SOUTHSIDE OF MAN-O-WAR	12	050891	1/1/0001
22000	S	M	OUG	III	00000	909	2ND LT W OF TODDS RD ON SOUTHSIDE OF MAN-O-WAR	12	050891	1/1/0001
50000	S	M	OUG	III	00000	911	1ST LT W OF TODDS RD ON SOUTHSIDE OF MAN O WAR	12	050891	1/1/0001
22000	S	M	OUG	III	00000	913	1ST LT E OF TODDS RD,SOUTHSIDE OF MAN-O-WAR	12	090891	1/1/0001
22000	S	M	OUG	III	00000	915	2ND LT E OF TODDS RD,SOUTHSIDE OF MAN-O-WAR	12	090891	1/1/0001
22000	S	M	OUG	III	00000	917	3RD LT E OF TODDS RD,SOUTHSIDE OF MAN-O-WAR	12	090891	1/1/0001
22000	S	M	OUG	III	00000	919	4TH LT E OF TODDS RD,SOUTHSIDE OF MAN-O-WAR	12	090891	1/1/0001
22000	S	M	OUG	III	00000	921	5TH LT E OF TODDS RD,SOUTHSIDE OF MAN-O-WAR	12	090891	1/1/0001
22000	S	M	OUG	III	00000	925	6TH LT. N OF TODDS ROAD, EASTSIDE	12		1/1/0001
22000	S	M	OUG	III	00000	927	7TH LT. N OF TODDS ROAD, EASTSIDE	12	030896	1/1/0001
22000	S	M	OUG	III	00000	929	8TH LT. N OF TODDS ROAD, EASTSIDE	12	030896	1/1/0001
22000	S	M	OUG	III	00000	931	9TH LT. N OF TODDS ROAD, EASTSIDE	12	030896	1/1/0001
22000	S	M	OUG	III	00000	933	1ST LT. N OF HELMSDALE PLACE, EASTSIDE	12	030896	1/1/0001
22000	S	M	OUG	III	00000	935	2ND LT. N OF HELMSDALE PLACE, EASTSIDE	12	030896	1/1/0001
22000	S	M	OUG	III	00000	953	11TH LT N OF HELMSDALE PLACE, ESIDE	12	050898	1/1/0001
22000	S	M	OUG	III	00000	955	12TH LT N OF HELMSDALE PLACE, ESIDE	12	050898	1/1/0001
22000	S	M	OUG	III	00000	957	13TH LT N OF HELMSDALE PLACE, ESIDE	12	050898	1/1/0001
22000	S	M	OUG	III	00000	959	14TH LT N OF HELMSDALE PLACE, ESIDE	12	050898	1/1/0001
22000	S	M	OUG	III	00000	937	3RD LT N OF HELMSDALE PLACE, ESIDE	12	050898	1/1/0001
22000	S	M	OUG	III	00000	939	4TH LT N OF HELMSDALE PLACE, ESIDE	12	050898	1/1/0001
22000	S	M	OUG	III	00000	941	5TH LT N OF HELMSDALE PLACE, ESIDE	12	050898	1/1/0001
22000	S	M	OUG	III	00000	943	6TH LT N OF HELMSDALE PLACE, ESIDE	12	050898	1/1/0001
50000	S	M	OUG	III	00000	104	1ST LT. N. OF RICHMOND RD., W. SIDE	12	010887	1/1/0001
22000	S	M	OUG	III	00000	105	2ND LT. N. OF RICHMOND RD., W. SIDE	12	010887	1/1/0001
22000	S	M	OUG	III	00000	106	3RD LT. N. OF RICHMOND RD., W. SIDE	12	010887	1/1/0001

OFFICE: 311

ROUTE: 564

ST_REF_NO: 00000119300

MAN O' WAR BOULEVARD

LUMENS	BULB TYPE	MULT SERIES	POLE TYPE	SHADE	ADDRESS NUMBER	REF	LOCATION	TAX DIST	DATE INST	DATE CHANGE
22000	S	M	OUG	III	00000	107	4TH LT. N. OF RICHMOND RD., W. SIDE	12	010887	1/1/0001
22000	S	M	OUG	III	00000	590	1ST LT. N. OF RICHMOND RD., E. SIDE	12	100889	1/1/0001
22000	S	M	OUG	III	00000	591	2ND LT. N. OF RICHMOND RD., E. SIDE	12	100889	1/1/0001
22000	S	M	OUG	III	00000	592	3RD LT. N. OF RICHMOND RD., E. SIDE	12	100889	1/1/0001
22000	S	M	OUG	III	00000	108	5TH LT. N. OF RICHMOND RD., W. SIDE	12	010887	1/1/0001
22000	S	M	OUG	III	00000	109	6TH LT. N. OF RICHMOND RD., W. SIDE	12	010887	1/1/0001
22000	S	M	OUG	III	00000	110	7TH LT. N. OF RICHMOND RD., W. SIDE	12	010887	1/1/0001
22000	S	M	OUG	III	00000	111	8TH LT. N. OF RICHMOND RD., W. SIDE	12	010887	1/1/0001
22000	S	M	OUG	III	00000	112	9TH LT. N. OF RICHMOND RD., W. SIDE	12	010887	1/1/0001
22000	S	M	OUG	III	00000	113	10TH LT. N. OF RICHMOND RD., W. SIDE	12	010887	1/1/0001
22000	S	M	OUG	III	00000	114	10TH LT. S. OF PALUMBO DR., W. SIDE	12	010887	1/1/0001
22000	S	M	OUG	III	00000	115	9TH LT. S. OF PALUMBO DR., W. SIDE	12	010887	1/1/0001
22000	S	M	OUG	III	00000	116	8TH LT. S. OF PALUMBO DR., W. SIDE	12	010887	1/1/0001
22000	S	M	OUG	III	00000	593	4TH LT. N. OF RICHMOND RD., E. SIDE	12	100889	1/1/0001
22000	S	M	OUG	III	00000	594	5TH LT N OF RICHMOND RD., EASTSIDE	12	050898	1/1/0001
22000	S	M	OUG	III	00000	595	6TH LT N OF RICHMOND RD., EASTSIDE	12	050898	1/1/0001
22000	S	M	OUG	III	00000	596	7TH LT N OF RICHMOND RD., EASTSIDE	12	050898	1/1/0001
22000	S	M	OUG	III	00000	597	8TH LT N OF RICHMOND RD., EASTSIDE	12	050898	1/1/0001
22000	S	M	OUG	III	00000	598	3RD LT. S. OF DABNEY DR., E. SIDE	12	100889	1/1/0001
22000	S	M	OUG	III	00000	599	2ND LT. S. OF DABNEY DR., E. SIDE	12	100889	1/1/0001
22000	S	M	OUG	III	00000	600	1ST LT. S. OF DABNEY DR., E. SIDE	12	100889	1/1/0001
22000	S	M	OUG	III	00000	601	1ST LT. N. OF DABNEY DR., E. SIDE	12	100889	1/1/0001
22000	S	M	OUG	III	00000	602	2ND LT. N. OF DABNEY DR., E. SIDE	12	100889	1/1/0001
22000	S	M	OUG	III	00000	603	3RD LT N OF BLAZER PKWY, EASTSIDE	12	050898	1/1/0001
22000	S	M	OUG	III	00000	604	4TH LT N OF BLAZER PKWY, EASTSIDE	12	050898	1/1/0001
22000	S	M	OUG	III	00000	605	5TH LT N OF BLAZER PKWY, EASTSIDE	12	050898	1/1/0001
22000	S	M	OUG	III	00000	606	6TH LT N OF BLAZER PKWY, EASTSIDE	12	050898	1/1/0001
22000	S	M	OUG	III	00000	735	4TH LT S OF PARKERS MILL, WSIDE	12	050898	1/1/0001
22000	S	M	OUG	III	00000	629	1ST LT. S. OF VERSAILLES RD., W. SIDE	12	020891	1/1/0001
22000	S	M	OUG	III	00000	630	1ST LT. S. OF VERSAILLES RD., E. SIDE	12	020891	1/1/0001
22000	S	M	OUG	III	00000	631	2ND LT. S. OF VERSAILLES RD., W. SIDE	12	020891	1/1/0001
22000	S	M	OUG	III	00000	632	2ND LT. S. OF VERSAILLES RD., E. SIDE	12	020891	1/1/0001
22000	S	M	OUG	III	00000	633	3RD LT. S. OF VERSAILLES RD., W. SIDE	12	020891	1/1/0001
22000	S	M	OUG	III	00000	634	3RD LT. S. OF VERSAILLES RD., E. SIDE	12	020891	1/1/0001

OFFICE: 311

ROUTE: 564

ST_REF_NO: 00000119300

MAN O' WAR BOULEVARD

LUMENS	BULB TYPE	MULT SERIES	POLE TYPE	SHADE	ADDRESS NUMBER	REF	LOCATION	TAX DIST	DATE INST	DATE CHANGE
22000	S	M	OUG	III	00000	635	4TH LT. S. OF VERSAILLES RD., W. SIDE	12	020891	1/1/0001
22000	S	M	OUG	III	00000	636	4TH LT. S. OF VERSAILLES RD., E. SIDE	12	020891	1/1/0001
22000	S	M	OUG	III	00000	637	5TH LT. S. OF VERSAILLES RD., W. SIDE	12	020891	1/1/0001
22000	S	M	OUG	III	00000	638	5TH LT. S. OF VERSAILLES RD., E. SIDE	12	020891	1/1/0001
22000	S	M	OUG	III	00000	639	6TH LT. S. OF VERSAILLES RD., W. SIDE	12	020891	1/1/0001
22000	S	M	OUG	III	00000	640	6TH LT. S. OF VERSAILLES RD., E. SIDE	12	020891	1/1/0001
22000	S	M	OUG	III	00000	641	7TH LT. N. OF AIRPORT RD., W. SIDE	12	020891	1/1/0001
22000	S	M	OUG	III	00000	642	6TH LT. N. OF AIRPORT RD., E. SIDE	12	020891	1/1/0001
22000	S	M	OUG	III	00000	643	6TH LT. N. OF AIRPORT RD., W. SIDE	12	020891	1/1/0001
22000	S	M	OUG	III	00000	644	5TH LT. N. OF AIRPORT RD., E. SIDE	12	020891	1/1/0001
22000	S	M	OUG	III	00000	645	5TH LT. N. OF AIRPORT RD., W. SIDE	12	020891	1/1/0001
22000	S	M	OUG	III	00000	646	4TH LT. N. OF AIRPORT RD., E. SIDE	12	020891	1/1/0001
22000	S	M	OUG	III	00000	647	4TH LT. N. OF AIRPORT RD., W. SIDE	12	020891	1/1/0001
22000	S	M	OUG	III	00000	648	3RD LT. N. OF AIRPORT RD., E. SIDE	12	020891	1/1/0001
22000	S	M	OUG	III	00000	649	3RD LT. N. OF AIRPORT RD., W. SIDE	12	020891	1/1/0001
22000	S	M	OUG	III	00000	650	2ND LT. N. OF AIRPORT RD., E. SIDE	12	020891	1/1/0001
22000	S	M	OUG	III	00000	651	2ND LT. N. OF AIRPORT RD., W. SIDE	12	020891	1/1/0001
22000	S	M	OUG	III	00000	652	1ST LT. N. OF AIRPORT RD., E. SIDE	12	020891	1/1/0001
22000	S	M	OUG	III	00000	657	1ST LT. S. OF AIRPORT ENTRANCE, W. SIDE	12	020891	1/1/0001
22000	S	M	OUG	III	00000	658	2ND LT. S. OF AIRPORT ENTRANCE, E. SIDE	12	020891	1/1/0001
22000	S	M	OUG	III	00000	659	2ND LT. S. OF AIRPORT ENTRANCE, W. SIDE	12	020891	1/1/0001
22000	S	M	OUG	III	00000	660	3RD LT. S. OF AIRPORT ENTRANCE, E. SIDE	12	020891	1/1/0001
22000	S	M	OUG	III	00000	661	3RD LT. S. OF AIRPORT ENTRANCE, W. SIDE	12	020891	1/1/0001
22000	S	M	OUG	III	00000	662	4TH LT. S. OF AIRPORT ENTRANCE, E. SIDE	12	020891	1/1/0001
22000	S	M	OUG	III	00000	663	4TH LT. S. OF AIRPORT ENTRANCE, W. SIDE	12	020891	1/1/0001
22000	S	M	OUG	III	00000	664	5TH LT. S. OF AIRPORT ENTRANCE, E. SIDE	12	020891	1/1/0001
22000	S	M	OUG	III	00000	665	5TH LT. S. OF AIRPORT ENTRANCE, W. SIDE	12	020891	1/1/0001
22000	S	M	OUG	III	00000	666	6TH LT. S. OF AIRPORT ENTRANCE, E. SIDE	12	020891	1/1/0001
22000	S	M	OUG	III	00000	667	5TH LT. N. OF AIRPORT RD., W. SIDE	12	020891	1/1/0001
22000	S	M	OUG	III	00000	668	5TH LT. N. OF AIRPORT RD., E. SIDE	12	020891	1/1/0001
22000	S	M	OUG	III	00000	669	4TH LT. N. OF AIRPORT RD., W. SIDE	12	020891	1/1/0001
22000	S	M	OUG	III	00000	670	4TH LT. N. OF AIRPORT RD., E. SIDE	12	020891	1/1/0001
22000	S	M	OUG	III	00000	671	3RD LT. N. OF AIRPORT RD., W. SIDE	12	020891	1/1/0001
22000	S	M	OUG	III	00000	672	3RD LT. N. OF AIRPORT RD., E. SIDE	12	020891	1/1/0001

OFFICE: 311

ROUTE: 564

ST_REF_NO: 00000119300

MAN O' WAR BOULEVARD

LUMENS	BULB TYPE	MULT SERIES	POLE TYPE	SHADE	ADDRESS NUMBER	REF	LOCATION	TAX DIST	DATE INST	DATE CHANGE
22000	S	M	OUG	III	00000	673	2ND LT. N. OF AIRPORT RD., W. SIDE	12	020891	1/1/0001
22000	S	M	OUG	III	00000	674	2ND LT. N. OF AIRPORT RD., E. SIDE	12	020891	1/1/0001
22000	S	M	OUG	III	00000	675	1ST LT. N. OF AIRPORT RD., W. SIDE	12	020891	1/1/0001
22000	S	M	OUG	III	00000	676		12	020891	1/1/0001
22000	S	M	OUG	III	00000	677		12	020891	1/1/0001
22000	S	M	OUG	III	00000	678	1ST LT. S. OF AIRPORT RD., E. SIDE	12	020891	1/1/0001
22000	S	M	OUG	III	00000	679	2ND LT. S. OF AIRPORT RD., W. SIDE	12	020891	1/1/0001
22000	S	M	OUG	III	00000	680	2ND LT. S. OF AIRPORT RD., E. SIDE	12	020891	1/1/0001
22000	S	M	OUG	III	00000	681	3RD LT. S. OF AIRPORT RD., W. SIDE	12	020891	1/1/0001
22000	S	M	OUG	III	00000	682		12	020891	1/1/0001
22000	S	M	OUG	III	00000	683		12	020891	1/1/0001
22000	S	M	OUG	III	00000	684	4TH LT. S. OF AIRPORT RD., E. SIDE	12	020891	1/1/0001
22000	S	M	OUG	III	00000	686	5TH LT. S. OF AIRPORT RD., E. SIDE	12	020891	1/1/0001
22000	S	M	OUG	III	00000	688	6TH LT. S. OF AIRPORT RD., E. SIDE	12	020891	1/1/0001
22000	S	M	OUG	III	00000	721	4TH LT N OF PARKERS MILL ON WESTSIDE OF MAN-O-WAR	12	050891	1/1/0001
22000	S	M	OUG	III	00000	722	3RD LT N OF PARKERS MILL ON EASTSIDE OF MAN-O-WAR	12	050891	1/1/0001
22000	S	M	OUG	III	00000	723	3RD LT N OF PARKERS MILL ON WESTSIDE OF MAN-O-WAR	12	050891	1/1/0001
22000	S	M	OUG	III	00000	724	2ND LT N OF PARKERS MILL ON EASTSIDE OF MAN-O-WAR	12	050891	1/1/0001
22000	S	M	OUG	III	00000	725	2ND LT N OF PARKERS MILL ON WESTSIDE OF MAN-O-WAR	12	050891	1/1/0001
22000	S	M	OUG	III	00000	726	1ST LT N OF PARKERS MILL ON EASTSIDE OF MAN-O-WAR	12	050891	1/1/0001
50000	S	M	OUG	III	00000	727	1ST LT N OF PARKERS MILL ON WESTSIDE OF MAN-O-WAR	12	050891	1/1/0001
50000	S	M	OUG	III	00000	728	1ST LT S OF PARKERS MILL ON EASTSIDE OF MAN-O-WAR	12	050891	1/1/0001
22000	S	M	OUG	III	00000	729	1ST LT S OF PARKERS MILL ON WESTSIDE OF MAN-O-WAR	12	050891	1/1/0001
22000	S	M	OUG	III	00000	731	2ND LT S OF PARKERS MILL ON WESTSIDE OF MAN-O-WAR	12	050891	1/1/0001
22000	S	M	OUG	III	00000	730	2ND LT S OF PARKERS MILL ON EASTSIDE OF MAN-O-WAR	12	050891	1/1/0001
22000	S	M	OUG	III	00000	732	3RD LT S OF PARKERS MILL ON EASTSIDE OF MAN-O-WAR	12	050891	1/1/0001

OFFICE: 311

ROUTE: 564

ST_REF_NO: 00000119300

MAN O' WAR BOULEVARD

LUMENS	BULB TYPE	MULT SERIES	POLE TYPE	SHADE	ADDRESS NUMBER	REF	LOCATION	TAX DIST	DATE INST	DATE CHANGE
22000	S	M	OUG	III	00000	733	3RD LT S OF PARKERS MILL ON WESTSIDE OF MAN-O-WAR	12	050891	1/1/0001
22000	S	M	OUG	III	00000	734	4TH LT S OF PARKERS MILL ON EASTSIDE OF MAN-O-WAR	12	050891	1/1/0001
22000	S	M	OUG	III	00000	736	5TH LT S OF PARKERS MILL ON EASTSIDE OF MAN-O-WAR	12	050891	1/1/0001
22000	S	M	OUG	III	00000	737	5TH LT S OF PARKERS MILL, WSIDE	12	050898	1/1/0001
22000	S	M	OUG	III	00000	738	6TH LT S OF PARKERS MILL ON EASTSIDE OF MAN-O-WAR	12	050891	1/1/0001
22000	S	M	OUG	III	00000	740	6TH LT S OF PARKERS MILL, WSIDE	12	050898	1/1/0001
22000	S	M	OUG	III	00000	741	7TH LT S OF PARKERS MILL ON EASTSIDE OF MAN-O-WAR	12	050891	1/1/0001
22000	S	M	OUG	III	00000	742	7TH LT S OF PARKERS MILL, WSIDE	12	050898	1/1/0001
22000	S	M	OUG	III	00000	743	8TH LT S OF PARKERS MILL ON EASTSIDE OF MAN-O-WAR	12	050891	1/1/0001
22000	S	M	OUG	III	00000	744	8TH LT S OF PARKERS MILL, WSIDE	12	050898	1/1/0001
22000	S	M	OUG	III	00000	746	9TH LT. S OF PARKERS MILL RD., WSIDE	12	050898	1/1/0001
22000	S	M	OUG	III	00000	747	10TH LT S OF PARKERS MILL ON EASTSIDE OF MAN-O-WAR	12	050891	1/1/0001
22000	S	M	OUG	III	00000	748	10TH LT S OF PARKERS MILL, WSIDE	12	050898	1/1/0001
22000	S	M	OUG	III	00000	749	11TH LT S OF PARKERS MILL ON EASTSIDE OF MAN-O-WAR	12	050891	1/1/0001
22000	S	M	OUG	III	00000	750	11TH LT S OF PARKERS MILL, WSIDE	12	050898	1/1/0001
22000	S	M	OUG	III	00000	751	12TH LT S OF PARKERS MILL ON EASTSIDE OF MAN-O-WAR	12	050891	1/1/0001
22000	S	M	OUG	III	00000	752	12TH LT S OF PARKERS MILL, WSIDE	12	050898	1/1/0001
22000	S	M	OUG	III	00000	753	13TH LT S OF PARKERS MILL ON EASTSIDE OF MAN-O-WAR	12	050891	1/1/0001
22000	S	M	OUG	III	00000	754	13TH LT S OF PARKERS MILL, WSIDE	12	050898	1/1/0001
22000	S	M	OUG	III	00000	755	14TH LT S OF PARKERS MILL ON EASTSIDE OF MAN-O-WAR	12	050891	1/1/0001
22000	S	M	OUG	III	00000	756	14TH LT S OF PARKERS MILL, WSIDE	12	050898	1/1/0001
22000	S	M	OUG	III	00000	757	16TH LT S OF PARKERS MILL ON EASTSIDE OF MAN-O-WAR	12	050891	1/1/0001
22000	S	M	OUG	III	00000	758	15TH LT S OF PARKERS MILL, WSIDE	12	050898	1/1/0001
22000	S	M	OUG	III	00000	759	17TH LT S OF PARKERS MILL ON EASTSIDE OF MAN-O-WAR	12	050891	1/1/0001
22000	S	M	OUG	III	00000	760	16TH LT S OF PARKERS MILL, WSIDE	12	050898	1/1/0001

OFFICE: 311

ROUTE: 564

ST_REF_NO: 00000119300

MAN O' WAR BOULEVARD

LUMENS	BULB TYPE	MULT SERIES	POLE TYPE	SHADE	ADDRESS NUMBER	REF	LOCATION	TAX DIST	DATE INST	DATE CHANGE
22000	S	M	OUG	III	00000	761	18TH LT S OF PARKERS MILL ON EASTSIDE OF MAN-O-WAR	12	050891	1/1/0001
22000	S	M	OUG	III	00000	762	17TH LT S OF PARKERS MILL, WSIDE	12	050898	1/1/0001
22000	S	M	OUG	III	00000	763	19TH LT S OF PARKERS MILL ON EASTSIDE OF MAN-O-WAR	12	050891	1/1/0001
22000	S	M	OUG	III	00000	764	18TH LT S OF PARKERS MILL, WSIDE	12	050898	1/1/0001
22000	S	M	OUG	III	00000	765	20TH LT S OF PARKERS MILL ON EASTSIDE OF MAN-O-WAR	12	050891	1/1/0001
22000	S	M	OUG	III	00000	766	19TH LT S OF PARKERS MILL, WSIDE	12	050898	1/1/0001
22000	S	M	OUG	III	00000	767	21ST LT. S. OF PARKERS MILL, EASTSIDE	12	010895	1/1/0001
22000	S	M	OUG	III	00000	768	20TH LT S OF PARKERS MILL, WSIDE	12	050898	1/1/0001
22000	S	M	OUG	III	00000	769	22ND LT. S. OF PARKERS MILL, EASTSIDE	12	010895	1/1/0001
22000	S	M	OUG	III	00000	770	21ST LT S OF PARKERS MILL, WSIDE	12	050898	1/1/0001
22000	S	M	OUG	III	00000	771	17TH LT. N. OF FT. HARRODS, EASTSIDE	12	010895	1/1/0001
22000	S	M	OUG	III	00000	772	22ND LT S OF PARKERS MILL, WSIDE	12	050898	1/1/0001
22000	S	M	OUG	III	00000	773	16TH LT. N. OF FT. HARRODS, EASTSIDE	12	010595	1/1/0001
22000	S	M	OUG	III	00000	774	23RD LT S OF PARKERS MILL, WSIDE	12	050898	1/1/0001
22000	S	M	OUG	III	00000	775	15TH LT. N. OF FT. HARRODS, EASTSIDE	12	010595	1/1/0001
22000	S	M	OUG	III	00000	776	24TH LT S OF PARKERS MILL, WSIDE	12	050898	1/1/0001
22000	S	M	OUG	III	00000	778	25TH LT S OF PARKERS MILL, WSIDE	12	050898	1/1/0001
22000	S	M	OUG	III	00000	777	14TH LT N OF FT HARRODS ON EASTSIDE OF MAN-O-WAR	12	050891	1/1/0001
22000	S	M	OUG	III	00000	779	13TH LT N OF FT HARRODS ON EASTSIDE OF MAN-O-WAR	12	050891	1/1/0001
22000	S	M	OUG	III	00000	780	13TH LT N OF FT HARRODS ON WESTSIDE OF MAN-O-WAR	12	050891	1/1/0001
22000	S	M	OUG	III	00000	781	12TH LT N OF FT HARRODS ON EASTSIDE OF MAN-O-WAR	12	050891	1/1/0001
22000	S	M	OUG	III	00000	782	12TH LT N OF FT HARRODS ON WESTSIDE OF MAN-O-WAR	12	050891	1/1/0001
22000	S	M	OUG	III	00000	783	11TH LT N OF FT HARRODS ON EASTSIDE OF MAN-O-WAR	12	050891	1/1/0001
22000	S	M	OUG	III	00000	784	11TH LT N OF FT HARRODS ON WESTSIDE OF MAN-O-WAR	12	050891	1/1/0001
22000	S	M	OUG	III	00000	785	10TH LT N OF FT HARRODS ON EASTSIDE OF MAN-O-WAR	12	050891	1/1/0001
50000	S	M	OUG	III	00000	786	10TH LT N OF FT HARRODS ON WESTSIDE OF MAN-O-WAR	12	050891	1/1/0001

OFFICE: 311

ROUTE: 564

ST_REF_NO: 00000119300

MAN O' WAR BOULEVARD

LUMENS	BULB TYPE	MULT SERIES	POLE TYPE	SHADE	ADDRESS NUMBER	REF	LOCATION	TAX DIST	DATE INST	DATE CHANGE
50000	S	M	OUG	III	00000	787	9TH LT N OF FT HARRODS DR ON EASTSIDE OF MAN O WAR	12	050891	1/1/0001
22000	S	M	OUG	III	00000	788	9TH LT N OF FT HARRODS ON WESTSIDE OF MAN-O-WAR	12	050891	1/1/0001
22000	S	M	OUG	III	00000	789	8TH LT N OF FT HARRODS ON EASTSIDE OF MAN-O-WAR	12	050891	1/1/0001
22000	S	M	OUG	III	00000	790	8TH LT N OF FT HARRODS ON WESTSIDE OF MAN-O-WAR	12	050891	1/1/0001
22000	S	M	OUG	III	00000	791	7TH LT N OF FT HARRODS ON EASTSIDE OF MAN-O-WAR	12	050891	1/1/0001
22000	S	M	OUG	III	00000	792	7TH LT N OF FT HARRODS ON WESTSIDE OF MAN-O-WAR	12	050891	1/1/0001
22000	S	M	OUG	III	00000	793	6TH LT N OF FT HARRODS ON EASTSIDE OF MAN-O-WAR	12	050891	1/1/0001
22000	S	M	OUG	III	00000	794	6TH LT N OF FT HARRODS ON WESTSIDE OF MAN-O-WAR	12	050891	1/1/0001
22000	S	M	OUG	III	00000	795	5TH LT N OF FT HARRODS ON EASTSIDE OF MAN-O-WAR	12	050891	1/1/0001
22000	S	M	OUG	III	00000	796	5TH LT N OF FT HARRODS ON WESTSIDE OF MAN-O-WAR	12	050891	1/1/0001
22000	S	M	OUG	III	00000	797	4TH LT N OF FT HARRODS ON EASTSIDE OF MAN-O-WAR	12	050891	1/1/0001
22000	S	M	OUG	III	00000	798	4TH LT N OF FT HARRODS ON WESTSIDE OF MAN-O-WAR	12	050891	1/1/0001
22000	S	M	OUG	III	00000	799	3RD LT N OF FT HARRODS ON EASTSIDE OF MAN-O-WAR	12	050891	1/1/0001
22000	S	M	OUG	III	00000	800	3RD LT N OF FT HARRODS ON WESTSIDE OF MAN-O-WAR	12	050891	1/1/0001
22000	S	M	OUG	III	00000	801	2ND LT N OF FT HARRODS ON EASTSIDE OF MAN-O-WAR	12	050891	1/1/0001
22000	S	M	OUG	III	00000	802	2ND LT N OF FT HARRODS ON WESTSIDE OF MAN-O-WAR	12	050891	1/1/0001
22000	S	M	OUG	III	00000	803	1ST LT N OF FT HARRODS ON EASTSIDE OF MAN-O-WAR	12	050891	1/1/0001
50000	S	M	OUG	III	00000	804	1ST LT N OF FT HARRODS DR ON WESTSIDE OF MAN O WAR	12	050891	1/1/0001
50000	S	M	OUG	III	00000	805	1ST LT S OF FT HARRODS DR ON EASTSIDE OF MAN O WAR	12	050891	1/1/0001
22000	S	M	OUG	III	00000	806	1ST LT S OF FT HARRODS DR ON WESTSIDE OF MAN-O-WAR	12	080891	1/1/0001

OFFICE: 311

ROUTE: 564

ST_REF_NO: 00000119300

MAN O' WAR BOULEVARD

LUMENS	BULB TYPE	MULT SERIES	POLE TYPE	SHADE	ADDRESS NUMBER	REF	LOCATION	TAX DIST	DATE INST	DATE CHANGE
22000	S	M	OUG	III	00000	807	2ND LT S OF FT HARRODS DR ON EASTSIDE OF MAN-O-WAR	12	080891	1/1/0001
22000	S	M	OUG	III	00000	808	2ND LT S OF FT HARRODS DR ON WESTSIDE OF MAN-O-WAR	12	080891	1/1/0001
22000	S	M	OUG	III	00000	809	3RD LT S OF FT HARRODS DR ON EASTSIDE OF MAN-O-WAR	12	080891	1/1/0001
22000	S	M	OUG	III	00000	810	3RD LT S OF FT HARRODS DR ON WESTSIDE OF MAN-O-WAR	12	080891	1/1/0001
22000	S	M	OUG	III	00000	811	4TH LT S OF FT HARRODS DR ON EASTSIDE OF MAN-O-WAR	12	080891	1/1/0001
22000	S	M	OUG	III	00000	812	4TH LT S OF FT HARRODS DR ON WESTSIDE OF MAN-O-WAR	12	080891	1/1/0001
22000	S	M	OUG	III	00000	813	5TH LT S OF FT HARRODS DR ON EASTSIDE OF MAN-O-WAR	12	080891	1/1/0001
22000	S	M	OUG	III	00000	814	5TH LT S OF FT HARRODS DR ON WESTSIDE OF MAN-O-WAR	12	080891	1/1/0001
22000	S	M	OUG	III	00000	815	6TH LT S OF FT HARRODS DR ON EASTSIDE OF MAN-O-WAR	12	080891	1/1/0001
22000	S	M	OUG	III	00000	816	6TH LT S OF FT HARRODS DR ON WESTSIDE OF MAN-O-WAR	12	080891	1/1/0001
22000	S	M	OUG	III	00000	817	7TH LT S OF FT HARRODS DR ON EASTSIDE OF MAN-O-WAR	12	080891	1/1/0001
22000	S	M	OUG	III	00000	819	7TH LT S OF FT HARRODS DR ON WESTSIDE OF MAN-O-WAR	12	080891	1/1/0001
22000	S	M	OUG	III	00000	820	8TH LT S OF FT HARRODS DR ON EASTSIDE OF MAN-O-WAR	12	080891	1/1/0001
22000	S	M	OUG	III	00000	821	8TH LT S OF FT HARRODS DR ON WESTSIDE OF MAN-O-WAR	12	080891	1/1/0001
22000	S	M	OUG	III	00000	822	7TH LT N OF LYON DR ON EASTSIDE OF MAN-O-WAR	12	080891	1/1/0001
22000	S	M	OUG	III	00000	823	6TH LT N OF LYON DR ON WESTSIDE OF MAN-O-WAR	12	080891	1/1/0001
22000	S	M	OUG	III	00000	824	6TH LT N OF LYON DR ON EASTSIDE OF MAN-O-WAR	12	080891	1/1/0001
22000	S	M	OUG	III	00000	825	5TH LT N OF LYON DR ON WESTSIDE OF MAN-O-WAR	12	080891	1/1/0001
22000	S	M	OUG	III	00000	826	5TH LT N OF LYON DR ON EASTSIDE OF MAN-O-WAR	12	080891	1/1/0001
22000	S	M	OUG	III	00000	827	4TH LT N OF LYON DR ON WESTSIDE OF MAN-O-WAR	12	080891	1/1/0001

OFFICE: 311

ROUTE: 564

ST_REF_NO: 00000119300

MAN O' WAR BOULEVARD

LUMENS	BULB TYPE	MULT SERIES	POLE TYPE	SHADE	ADDRESS NUMBER	REF	LOCATION	TAX DIST	DATE INST	DATE CHANGE
22000	S	M	OUG	III	00000	828	4TH LT N OF LYON DR ON EASTSIDE OF MAN-O-WAR	12	080891	1/1/0001
22000	S	M	OUG	III	00000	829	3RD LT N OF LYON DR ON WESTSIDE OF MAN-O-WAR	12	080891	1/1/0001
22000	S	M	OUG	III	00000	830	3RD LT N OF LYON DR ON EASTSIDE OF MAN-O-WAR	12	080891	1/1/0001
22000	S	M	OUG	III	00000	831	2ND LT N OF LYON DR ON WESTSIDE OF MAN-O-WAR	12	080891	1/1/0001
22000	S	M	OUG	III	00000	832	2ND LT N OF LYON DR ON EASTSIDE OF MAN-O-WAR	12	080891	1/1/0001
22000	S	M	OUG	III	00000	833	1ST LT N OF LYON DR ON WESTSIDE OF MAN-O-WAR	12	080891	1/1/0001
50000	S	M	OUG	III	00000	834	1ST LT N OF LYON DR ON EASTSIDE OF MAN-O-WAR	12	080891	1/1/0001
50000	S	M	OUG	III	00000	835	1ST LT S OF LYON DR ON WESTSIDE OF MAN-O-WAR	12	080891	1/1/0001
22000	S	M	OUG	III	00000	836	1ST LT S OF LYON DR ON EASTSIDE OF MAN-O-WAR	12	080891	1/1/0001
22000	S	M	OUG	III	00000	837	2ND LT S OF LYON DR ON WESTSIDE OF MAN-O-WAR	12	080891	1/1/0001
22000	S	M	OUG	III	00000	838	2ND LT S OF LYON DR ON EASTSIDE OF MAN-O-WAR	12	080891	1/1/0001
22000	S	M	OUG	III	00000	839	3RD LT S OF LYON DR ON WESTSIDE OF MAN-O-WAR	12	080891	1/1/0001
22000	S	M	OUG	III	00000	840	3RD LT S OF LYON DR ON EASTSIDE OF MAN-O-WAR	12	080891	1/1/0001
22000	S	M	OUG	III	00000	841	4TH LT S OF LYON DR ON WESTSIDE OF MAN-O-WAR	12	080891	1/1/0001
22000	S	M	OUG	III	00000	842	8TH LT N OF HARRODSBURG RD ON EASTSIDE OF MAN-O-WA	12	080891	1/1/0001
22000	S	M	OUG	III	00000	843	7TH LT N OF HARRODSBURG RD ON WESTSIDE OF MAN-O-WA	12	080891	1/1/0001
22000	S	M	OUG	III	00000	844	7TH LT N OF HARRODSBURG RD ON EASTSIDE OF MAN-O-WA	12	080891	1/1/0001
22000	S	M	OUG	III	00000	845	6TH LT N OF HARRODSBURG RD ON WESTSIDE OF MAN-O-WA	12	080891	1/1/0001
22000	S	M	OUG	III	00000	846	6TH LT N OF HARRODSBURG RD ON EASTSIDE OF MAN-O-WA	12	080891	1/1/0001
22000	S	M	OUG	III	00000	847	5TH LT N OF HARRODSBURG RD ON WESTSIDE OF MAN-O-WA	12	080891	1/1/0001

OFFICE: 311

ROUTE: 564

ST_REF_NO: 00000119300

MAN O' WAR BOULEVARD

LUMENS	BULB TYPE	MULT SERIES	POLE TYPE	SHADE	ADDRESS NUMBER	REF	LOCATION	TAX DIST	DATE INST	DATE CHANGE
22000	S	M	OUG	III	00000	848	5TH LT N OF HARRODSBURG RD ON EASTSIDE OF MAN-O-WA	12	080891	1/1/0001
22000	S	M	OUG	III	00000	849	4TH LT N OF HARRODSBURG RD ON WESTSIDE OF MAN-O-WA	12	080891	1/1/0001
22000	S	M	OUG	III	00000	850	4TH LT N OF HARRODSBURG RD ON EASTSIDE OF MAN-O-WA	12	080891	1/1/0001
22000	S	M	OUG	III	00000	851	3RD LT N OF HARRODSBURG RD ON WESTSIDE OF MAN-O-WA	12	080891	1/1/0001
22000	S	M	OUG	III	00000	852	3RD LT N OF HARRODSBURG RD ON EASTSIDE OF MAN-O-WA	12	080891	1/1/0001
22000	S	M	OUG	III	00000	853	2ND LT N OF HARRODSBURG RD ON WESTSIDE OF MAN-O-WA	12	080891	1/1/0001
22000	S	M	OUG	III	00000	854	2ND LT N OF HARRODSBURG RD ON EASTSIDE OF MAN-O-WA	12	080891	1/1/0001
22000	S	M	OUG	III	00000	923	1ST LT N OF HARRODSBURG RD ON WESTSIDE OF MAN-O-WA	12	080891	1/1/0001
50000	S	M	OUG	III	00000	924	1ST LT N OF HARRODSBURG RD ON EASTSIDE OF MAN-O-WA	12	080891	1/1/0001
22000	S	M	OUG	III	00000	930	9TH LT. N. OF TODDS ROAD ON WESTSIDE	12	070891	1/1/0001
22000	S	M	OUG	III	00000	932	10TH LT. N. OF TODDS ROAD ON WESTSIDE	12	070891	1/1/0001
22000	S	M	OUG	III	00000	934	11TH LT. N. OF TODDS ROAD ON WESTSIDE	12	070891	1/1/0001
22000	S	M	OUG	III	00000	936	12TH LT. N. OF TODDS ROAD ON WESTSIDE	12	070891	1/1/0001
22000	S	M	OUG	III	00000	938	13TH LT. N. OF TODDS ROAD ON WESTSIDE	12	070891	1/1/0001
22000	S	M	OUG	III	00000	940	14TH LT. N. OF TODDS ROAD ON WESTSIDE	12	070891	1/1/0001
22000	S	M	OUG	III	00000	942	15TH LT. N. OF TODDS ROAD ON WESTSIDE	12	070891	1/1/0001
22000	S	M	OUG	III	00000	944	16TH LT. N. OF TODDS ROAD ON WESTSIDE	12	070891	1/1/0001
22000	S	M	OUG	III	00000	946	17TH LT. N. OF TODDS ROAD ON WESTSIDE	12	070891	1/1/0001
22000	S	M	OUG	II	00000	948	18TH LT. N OF TODDS RD., WESTSIDE	12	100897	1/1/0001
22000	S	M	OUG	II	00000	950	19TH LT. N OF TODDS RD., WESTSIDE	12	100897	1/1/0001
22000	S	M	OUG	II	00000	952	20TH LT. N OF TODDS RD., WESTSIDE	12	100897	1/1/0001
22000	S	M	OUG	II	00000	954	21ST LT N OF TODDS RD., WESTSIDE	12	100897	1/1/0001
22000	S	M	OUG	II	00000	956	22ND LT. N OF TODDS RD., WESTSIDE	12	100897	1/1/0001
22000	S	M	OUG	II	00000	958	23RD LT. N OF TODDS RD., WESTSIDE	12	100897	1/1/0001
22000	S	M	OUG	III	00000	960	24TH LT. N. OF TODDS ROAD ON WESTSIDE	12	070891	1/1/0001
22000	S	M	OUG	III	00000	961	12TH LT. S. OF I-75 ON EASTSIDE	12	070891	1/1/0001
22000	S	M	OUG	III	00000	962	25TH LT. N. OF TODDS ROAD ON WESTSIDE	12	070891	1/1/0001
22000	S	M	OUG	III	00000	963	11TH LT. S. OF I-75 ON EASTSIDE	12	070891	1/1/0001

OFFICE: 311

ROUTE: 564

ST_REF_NO: 00000119300

MAN O' WAR BOULEVARD

LUMENS	BULB TYPE	MULT SERIES	POLE TYPE	SHADE	ADDRESS NUMBER	REF	LOCATION	TAX DIST	DATE INST	DATE CHANGE
22000	S	M	OUG	III	00000	964	10TH LT. S. OF I-75 ON WESTSIDE	12	070891	1/1/0001
22000	S	M	OUG	III	00000	965	10TH LT. S. OF I-75 ON EASTSIDE	12	070891	1/1/0001
22000	S	M	OUG	II	00000	966	1ST LT. S. OF SIR BARTON WAY, WESTSIDE	12	100897	1/1/0001
22000	S	M	OUG	III	00000	967	9TH LT. S. OF I-75 ON EASTSIDE	12	070891	1/1/0001
50000	S	M	OUG	III	00000	969	8TH LT. S. OF I-75 ON EASTSIDE	12	070891	1/1/0001
22000	S	M	OUG	III	00000	971	7TH LT. S. OF I-75 ON EASTSIDE	12	070891	1/1/0001
22000	S	M	OUG	III	00000	973	6TH LT. S. OF I-75 ON EASTSIDE	12	070891	1/1/0001
22000	S	M	OUG	III	00000	975	5TH LT. S. OF I-75 ON EASTSIDE	12	070891	1/1/0001
22000	S	M	OUG	III	00000	977	4TH LT. S. OF I-75 ON EASTSIDE	12	070891	1/1/0001
22000	S	M	OUG	III	00000	979	3RD LT. S. OF I-75 ON EASTSIDE	12	070891	1/1/0001
22000	S	M	OUG	III	00000	981	2ND LT. S. OF I-75 ON EASTSIDE	12	070891	1/1/0001
22000	S	M	OUG	III	00000	983	1ST LT. S. OF I-75 ON EASTSIDE	12	070891	1/1/0001
22000	S	M	OUG	III	00000	065	1ST LT. S. OF HARRODSBURG RD., E. SIDE	12	110889	1/1/0001
22000	S	M	OUG	III	00000	066	2ND LT. S. OF HARRODSBURG RD., E. SIDE	12	110889	1/1/0001
22000	S	M	OUG	III	00000	067	3RD LT. S. OF HARRODSBURG RD., E. SIDE	12	110889	1/1/0001
22000	S	M	OUG	III	00000	068	4TH LT. S. OF HARRODSBURG RD., EASTSIDE	12	060685	1/1/0001
22000	S	M	OUG	III	00000	069	2ND LT. N. OF GLADMAN WAY, EASTSIDE	12	060685	1/1/0001
50000	S	M	OUG	III	00000	070	1ST LT. N. OF GLADMAN WAY, EASTSIDE	12	060685	1/1/0001
50000	S	M	OUG	III	00000	071	1ST LT. S. OF GLADMAN WAY, W. SIDE	12	110889	1/1/0001
22000	S	M	OUG	III	00000	072	1ST LT. S. OF GLADMAN WAY, EASTSIDE	12	060685	1/1/0001
22000	S	M	OUG	III	00000	073	2ND LT. S. OF GLADMAN WAY, EASTSIDE	12	060685	1/1/0001
22000	S	M	OUG	III	00000	121	3RD LT. S. OF GLADMAN WAY, EAST SIDE	12	090887	1/1/0001
22000	S	M	OUG	III	00000	122	4TH LT. S. OF GLADMAN WAY, EAST SIDE	12	090887	1/1/0001
22000	S	M	OUG	III	00000	123	5TH LT. S. OF GLADMAN WAY, EAST SIDE	12	090887	1/1/0001
22000	S	M	OUG	III	00000	124	2ND LT. N. OF BRAVINGTON WAY, EAST SIDE	12	090887	1/1/0001
22000	S	M	OUG	III	00000	125	1ST LT. N. OF BRAVINGTON WAY, EAST SIDE	12	090887	1/1/0001
22000	S	M	OUG	III	00000	126	1ST LT. S. OF BRAVINGTON WAY, EAST SIDE	12	090887	1/1/0001
22000	S	M	OUG	III	00000	127	2ND LT. S. OF BRAVINGTON WAY, EAST SIDE	12	090887	1/1/0001
22000	S	M	OUG	III	00000	128	3RD LT. S. OF BRAVINGTON WAY, EAST SIDE	12	090887	1/1/0001
22000	S	M	OUG	III	00000	129	4TH LT. S. OF BRAVINGTON WAY, EAST SIDE	12	090887	1/1/0001
22000	S	M	OUG	III	00000	130	5TH LT. S. OF BRAVINGTON WAY, EAST SIDE	12	090887	1/1/0001
22000	S	M	OUG	III	00000	131	6TH LT. S. OF BRAVINGTON WAY, EAST SIDE	12	090887	1/1/0001
22000	S	M	OUG	III	00000	132	8TH LT. N. OF HIGBEE MILL RD., EAST SIDE	12	090887	1/1/0001
22000	S	M	OUG	III	00000	133	7TH LT. N. OF HIGBEE MILL RD., EAST SIDE	12	090887	1/1/0001

OFFICE: 311

ROUTE: 564

ST_REF_NO: 00000119300

MAN O' WAR BOULEVARD

LUMENS	BULB TYPE	MULT SERIES	POLE TYPE	SHADE	ADDRESS NUMBER	REF	LOCATION	TAX DIST	DATE INST	DATE CHANGE
22000	S	M	OUG	III	00000	134	6TH LT. N. OF HIGBEE MILL RD., EAST SIDE	12	090887	1/1/0001
22000	S	M	OUG	III	00000	135	5TH LT. N. OF HIGBEE MILL RD., EAST SIDE	12	090887	1/1/0001
22000	S	M	OUG	III	00000	136	4TH LT. N. OF HIGBEE MILL RD., EAST SIDE	12	090887	1/1/0001
22000	S	M	OUG	III	00000	137	3RD LT. N. OF HIGBEE MILL RD., EASTSIDE	12	090887	1/1/0001
22000	S	M	OUG	III	00000	138	2ND LT. N. OF HIGBEE MILL RD., EAST SIDE	12	090887	1/1/0001
22000	S	M	OUG	III	00000	139	1ST LT. N. OF HIGBEE MILL RD., EAST SIDE	12	090887	1/1/0001
22000	S	M	OUG	III	00000	140	OPP. HIGBEE MILL RD.	12	090887	1/1/0001
22000	S	M	OUG	III	00000	141	1ST LT. S. OF HIGBEE MILL RD., EAST SIDE	12	090887	1/1/0001
22000	S	M	OUG	III	00000	142	2ND LT. S. OF HIGBEE MILL RD., EAST SIDE	12	090887	1/1/0001
22000	S	M	OUG	III	00000	143	3RD LT. S. OF HIGBEE MILL RD., EAST SIDE	12	090887	1/1/0001
22000	S	M	OUG	III	00000	144	4TH LT. S. OF HIGBEE MILL RD., EAST SIDE	12	090887	1/1/0001
22000	S	M	OUG	III	00000	145	5TH LT. S. OF HIGBEE MILL RD., EAST SIDE	12	090887	1/1/0001
22000	S	M	OUG	III	00000	146	6TH LT. S. OF HIGBEE MILL RD., EAST SIDE	12	090887	1/1/0001
22000	S	M	OUG	III	00000	147	7TH LT. S. OF HIGBEE MILL RD., EAST SIDE	12	090887	1/1/0001
22000	S	M	OUG	III	00000	309	1ST LT. S. OF HARRODSBURG RD., W. SIDE	12	110889	1/1/0001
22000	S	M	OUG	III	00000	310	2ND LT. S. OF HARRODSBURG RD., W. SIDE	12	110889	1/1/0001
22000	S	M	OUG	III	00000	311	3RD LT. S. OF HARRODSBURG RD., W. SIDE	12	110889	1/1/0001
22000	S	M	OUG	III	00000	312	4TH LT. S. OF HARRODSBURG RD., W. SIDE	12	110889	1/1/0001
22000	S	M	OUG	III	00000	313	5TH LT. S. OF HARRODSBURG RD., W. SIDE	12	110889	1/1/0001
22000	S	M	OUG	III	00000	315	2ND LT. S. OF GLADMAN WAY, W. SIDE	12	110889	1/1/0001
22000	S	M	OUG	III	00000	316	3RD LT S OF GLADMAN WAY, W. SIDE	12	050898	1/1/0001
22000	S	M	OUG	III	00000	317	4TH LT S OF GLADMAN WAY, W. SIDE	12	050898	1/1/0001
22000	S	M	OUG	III	00000	318	5TH LT S OF GLADMAN WAY, W. SIDE	12	050898	1/1/0001
22000	S	M	OUG	III	00000	319	6TH LT S OF GLADMAN WAY, W. SIDE	12	050898	1/1/0001
22000	S	M	OUG	III	00000	320	7TH LT S OF GLADMAN WAY, W. SIDE	12	050898	1/1/0001
22000	S	M	OUG	III	00000	321	8TH LT S OF GLADMAN WAY, W. SIDE	12	050898	1/1/0001
22000	S	M	OUG	III	00000	322	9TH LT S OF GLADMAN WAY, W. SIDE	12	050898	1/1/0001
22000	S	M	OUG	III	00000	323	10TH LT S OF GLADMAN WAY, W. SIDE	12	050898	1/1/0001
22000	S	M	OUG	III	00000	324	11TH LT S OF GLADMAN WAY, W. SIDE	12	050898	1/1/0001
22000	S	M	OUG	III	00000	325	12TH LT S OF GLADMAN WAY, W. SIDE	12	050898	1/1/0001
22000	S	M	OUG	III	00000	326	13TH LT S OF GLADMAN WAY, W. SIDE	12	050898	1/1/0001
22000	S	M	OUG	III	00000	327	14TH LT S OF GLADMAN WAY, W. SIDE	12	050898	1/1/0001
22000	S	M	OUG	III	00000	328	15TH LT S OF GLADMAN WAY, W. SIDE	12	050898	1/1/0001
22000	S	M	OUG	III	00000	329	16TH LT S OF GLADMAN WAY, W. SIDE	12	050898	1/1/0001

OFFICE: 311

ROUTE: 564

ST_REF_NO: 00000119300

MAN O' WAR BOULEVARD

LUMENS	BULB TYPE	MULT SERIES	POLE TYPE	SHADE	ADDRESS NUMBER	REF	LOCATION	TAX DIST	DATE INST	DATE CHANGE
22000	S	M	OUG	III	00000	330	17TH LT S OF GLADMAN WAY, WSIDE	12	050898	1/1/0001
22000	S	M	OUG	III	00000	331	5TH LT. N. OF HIGBEE MILL, W. SIDE	12	110889	1/1/0001
22000	S	M	OUG	III	00000	332	4TH LT. N. OF HIGBEE MILL, W. SIDE	12	110889	1/1/0001
22000	S	M	OUG	III	00000	333	3RD LT. N. OF HIGBEE MILL, W. SIDE	12	110889	1/1/0001
22000	S	M	OUG	III	00000	334	2ND LT. N. OF HIGBEE MILL, W. SIDE	12	110889	1/1/0001
22000	S	M	OUG	III	00000	335	1ST LT. N. OF HIGBEE MILL, W. SIDE	12	110889	1/1/0001
22000	S	M	OUG	III	00000	336	1ST LT. S. OF HIGBEE MILL, W. SIDE	12	110889	1/1/0001
22000	S	M	OUG	III	00000	337	2ND LT. S. OF HIGBEE MILL, W. SIDE	12	110889	1/1/0001
22000	S	M	OUG	III	00000	338	3RD LT. S. OF HIGBEE MILL, W. SIDE	12	110889	1/1/0001
22000	S	M	OUG	III	00000	339	4TH LT. S OF HIGBEE MILL RD., WSIDE	12	050898	1/1/0001
22000	S	M	OUG	III	00000	340	5TH LT. S OF HIGBEE MILL RD., WSIDE	12	050898	1/1/0001
22000	S	M	OUG	III	00000	341	6TH LT. S OF HIGBEE MILL RD., WSIDE	12	050898	1/1/0001
22000	S	M	OUG	III	00000	342	7TH LT S OF HIGBEE MILL RD., WSIDE	12	050898	1/1/0001
22000	S	M	OUG	III	00000	386	3RD LT E OF WINTHROP, SOUTHSIDE	12	050898	1/1/0001
22000	S	M	OUG	III	00000	054	4TH LT. S. OF ALUMNI DR., W. SIDE	12	100889	1/1/0001
22000	S	M	OUG	III	00000	055	3RD LT. S. OF ALUMNI DR., W. SIDE	12	100889	1/1/0001
22000	S	M	OUG	III	00000	056	2ND LT. S. OF ALUMNI DR., W. SIDE	12	100889	1/1/0001
50000	S	M	OUG	III	00000	057	1ST LT. S. OF ALUMNI DR., W. SIDE	12	100889	1/1/0001
50000	S	M	OUG	III	00000	058	1ST LT. N. OF ALUMNI DR., E. SIDE	12	100889	1/1/0001
22000	S	M	OUG	III	00000	059	1ST LT. N. OF ALUMNI DR., W. SIDE	12	100885	1/1/0001
22000	S	M	OUG	III	00000	060	2ND LT. N. OF ALUMNI DR., W. SIDE	12	100885	1/1/0001
22000	S	M	OUG	III	00000	061	3RD LT. N. OF ALUMNI DR., W. SIDE	12	100885	1/1/0001
22000	S	M	OUG	III	00000	076	4TH LT. N. OF ALUMNI DR., W. SIDE	12	010887	1/1/0001
22000	S	M	OUG	III	00000	077	5TH LT. N. OF ALUMNI DR., W. SIDE	12	010887	1/1/0001
22000	S	M	OUG	III	00000	078	5TH LT. S. OF EAST HILLS DR., W. SIDE	12	010887	1/1/0001
22000	S	M	OUG	III	00000	079	4TH LT. S. OF EAST HILLS DR., W. SIDE	12	010887	1/1/0001
22000	S	M	OUG	III	00000	080	3RD LT. S. OF EAST HILLS DR., W. SIDE	12	010887	1/1/0001
22000	S	M	OUG	III	00000	081	2ND LT. S. OF EAST HILLS DR., W. SIDE	12	010887	1/1/0001
22000	S	M	OUG	III	00000	082	1ST LT. S. OF EAST HILLS DR., W. SIDE	12	010887	1/1/0001
50000	S	M	OUG	III	00000	083	1ST LT. N. OF EAST HILLS DR., W. SIDE	12	010887	1/1/0001
22000	S	M	OUG	III	00000	084	2ND LT. N. OF EAST HILLS DR., W. SIDE	12	010887	1/1/0001
22000	S	M	OUG	III	00000	085	3RD LT. N. OF EAST HILLS DR., W. SIDE	12	010887	1/1/0001
22000	S	M	OUG	III	00000	086	4TH LT. N. OF EAST HILLS DR., W. SIDE	12	010887	1/1/0001
22000	S	M	OUG	III	00000	087	5TH LT. N. OF EAST HILLS DR., W. SIDE	12	010887	1/1/0001

OFFICE: 311

ROUTE: 564

ST_REF_NO: 00000119300

MAN O' WAR BOULEVARD

LUMENS	BULB TYPE	MULT SERIES	POLE TYPE	SHADE	ADDRESS NUMBER	REF	LOCATION	TAX DIST	DATE INST	DATE CHANGE
22000	S	M	OUG	III	00000	088	5TH LT. S. OF BEAVER CREEK DR., W. SIDE	12	010887	1/1/0001
22000	S	M	OUG	III	00000	089	4TH LT. S. OF BEAVER CREEK DR., W. SIDE	12	010887	1/1/0001
22000	S	M	OUG	III	00000	090	3RD LT. S. OF BEAVER CREEK DR., W. SIDE	12	010887	1/1/0001
22000	S	M	OUG	III	00000	091	2ND LT. S. OF BEAVER CREEK DR., W. SIDE	12	010887	1/1/0001
22000	S	M	OUG	III	00000	092	1ST LT. S. OF BEAVER CREEK DR., W. SIDE	12	010887	1/1/0001
50000	S	M	OUG	III	00000	093	1ST LT. N. OF BEAVER CREEK DR., W. SIDE	12	010887	1/1/0001
22000	S	M	OUG	III	00000	094	2ND LT. N. OF BEAVER CREEK DR., W. SIDE	12	010887	1/1/0001
22000	S	M	OUG	III	00000	095	3RD LT. N. OF BEAVER CREEK DR., W. SIDE	12	010887	1/1/0001
22000	S	M	OUG	III	00000	096	4TH LT. N. OF BEAVER CREEK DR., W. SIDE	12	010887	1/1/0001
22000	S	M	OUG	III	00000	097	5TH LT. N. OF BEAVER CREEK DR., W. SIDE	12	010887	1/1/0001
22000	S	M	OUG	III	00000	098	6TH LT. N. OF BEAVER CREEK DR., W. SIDE	12	010887	1/1/0001
22000	S	M	OUG	III	00000	099	5TH LT. S. OF RICHMOND RD., W. SIDE	12	010887	1/1/0001
22000	S	M	OUG	III	00000	100	4TH LT. S. OF RICHMOND RD., W. SIDE	12	010887	1/1/0001
22000	S	M	OUG	III	00000	101	3RD LT. S. OF RICHMOND RD., W. SIDE	12	010887	1/1/0001
22000	S	M	OUG	III	00000	102	2ND LT. S. OF RICHMOND RD., W. SIDE	12	010887	1/1/0001
22000	S	M	OUG	III	00000	103	1ST LT. S. OF RICHMOND RD., W. SIDE	12	010887	1/1/0001
22000	S	M	OUG	III	00000	555	4TH LT. S. OF ALUMNI DR., E. SIDE	12	100889	1/1/0001
22000	S	M	OUG	III	00000	556	3RD LT. S. OF ALUMNI DR., E. SIDE	12	100889	1/1/0001
22000	S	M	OUG	III	00000	557	2ND LT. S. OF ALUMNI DR., E. SIDE	12	100889	1/1/0001
22000	S	M	OUG	III	00000	558	1ST LT. S. OF ALUMNI DR., E. SIDE	12	100889	1/1/0001
22000	S	M	OUG	III	00000	559	2ND LT. N. OF ALUMNI DR., E. SIDE	12	100889	1/1/0001
22000	S	M	OUG	III	00000	560	3RD LT. N. OF ALUMNI DR., E. SIDE	12	100889	1/1/0001
22000	S	M	OUG	III	00000	561	4TH LT. N. OF ALUMNI DR., E. SIDE	12	100889	1/1/0001
22000	S	M	OUG	III	00000	562	5TH LT N OF ALUMNI DR., EASTSIDE	12	050898	1/1/0001
22000	S	M	OUG	III	00000	563	6TH LT N OF ALUMNI DR., EASTSIDE	12	050898	1/1/0001
22000	S	M	OUG	III	00000	564	7TH LT N OF ALUMNI DR., EASTSIDE	12	050898	1/1/0001
22000	S	M	OUG	III	00000	565	4TH LT. S. OF EAST HILLS DR., E. SIDE	12	100889	1/1/0001
22000	S	M	OUG	III	00000	566	3RD LT. S. OF EAST HILLS DR., E. SIDE	12	100889	1/1/0001
22000	S	M	OUG	III	00000	567	2ND LT. S. OF EAST HILLS DR., E. SIDE	12	100889	1/1/0001
50000	S	M	OUG	III	00000	568	1ST LT. S. OF EAST HILLS DR., E. SIDE	12	100889	1/1/0001
22000	S	M	OUG	III	00000	569	1ST LT. N. OF EAST HILLS DR., E. SIDE	12	100889	1/1/0001
22000	S	M	OUG	III	00000	570	2ND LT. N. OF EAST HILLS DR., E. SIDE	12	100889	1/1/0001
22000	S	M	OUG	III	00000	571	3RD LT N OF EAST HILLS DR., EASTSIDE	12	050898	1/1/0001
22000	S	M	OUG	III	00000	572	4TH LT N OF EAST HILLS DR., EASTSIDE	12	050898	1/1/0001

OFFICE: 311

ROUTE: 564

ST_REF_NO: 00000119300

MAN O' WAR BOULEVARD

LUMENS	BULB TYPE	MULT SERIES	POLE TYPE	SHADE	ADDRESS NUMBER	REF	LOCATION	TAX DIST	DATE INST	DATE CHANGE
22000	S	M	OUG	III	00000	573	5TH LT N OF EAST HILLS DR., EASTSIDE	12	050898	1/1/0001
22000	S	M	OUG	III	00000	574	6TH LT N OF EAST HILLS DR., EASTSIDE	12	050898	1/1/0001
22000	S	M	OUG	III	00000	575	4TH LT. S. OF BEAVER CREEK DR., E. SIDE	12	100889	1/1/0001
22000	S	M	OUG	III	00000	576	3RD LT. S. OF BEAVER CREEK DR., E. SIDE	12	100889	1/1/0001
22000	S	M	OUG	III	00000	577	2ND LT. S. OF BEAVER CREEK DR., E. SIDE	12	100889	1/1/0001
50000	S	M	OUG	III	00000	578	1ST LT. S. OF BEAVER CREEK DR., E. SIDE	12	100889	1/1/0001
22000	S	M	OUG	III	00000	579	1ST LT. N. OF BEAVER CREEK DR., E. SIDE	12	100889	1/1/0001
22000	S	M	OUG	III	00000	580	2ND LT. N. OF BEAVER CREEK DR., E. SIDE	12	100889	1/1/0001
22000	S	M	OUG	III	00000	581	3RD LT N OF BEAVER CREEK DR., EASTSIDE	12	050898	1/1/0001
22000	S	M	OUG	III	00000	582	4TH LT N OF BEAVER CREEK DR., EASTSIDE	12	050898	1/1/0001
22000	S	M	OUG	III	00000	583	5TH LT N OF BEAVER CREEK DR., EASTSIDE	12	050898	1/1/0001
22000	S	M	OUG	III	00000	584	6TH LT. S. OF RICHMOND RD., E. SIDE	12	100889	1/1/0001
22000	S	M	OUG	III	00000	148	8TH LT. S. OF HIGBEE MILL RD., EAST SIDE	12	090887	1/1/0001
22000	S	M	OUG	III	00000	149	5TH LT. N. OF CLAYS MILL RD., EAST SIDE	12	090887	1/1/0001
22000	S	M	OUG	III	00000	150	4TH LT. N. OF CLAYS MILL RD., EAST SIDE	12	090887	1/1/0001
22000	S	M	OUG	III	00000	151	3RD LT. N. OF CLAYS MILL RD., EAST SIDE	12	090887	1/1/0001
22000	S	M	OUG	III	00000	152	2ND LT. N. OF CLAYS MILL RD., EAST SIDE	12	090887	1/1/0001
50000	S	M	OUG	III	00000	153	1ST LT. N. OF CLAYS MILL RD., EAST SIDE	12	090887	1/1/0001
22000	S	M	OUG	III	00000	154	1ST LT. E. OF CLAYS MILL RD., N. SIDE	12	110887	1/1/0001
22000	S	M	OUG	III	00000	155	2ND LT. E. OF CLAYS MILL RD., N. SIDE	12	110887	1/1/0001
22000	S	M	OUG	III	00000	156	3RD LT. E. OF CLAYS MILL RD., N. SIDE	12	110887	1/1/0001
22000	S	M	OUG	III	00000	157	4TH LT. E. OF CLAYS MILL RD., N.SIDE	12	110887	1/1/0001
22000	S	M	OUG	III	00000	158	5TH LT. E. OF CLAYS MILL RD., N. SIDE	12	110887	1/1/0001
22000	S	M	OUG	III	00000	159	6TH LT. E. OF CLAYS MILL RD., N. SIDE	12	110887	1/1/0001
22000	S	M	OUG	III	00000	160	7TH LT. E. OF CLAYS MILL RD., N. SIDE	12	110887	1/1/0001
22000	S	M	OUG	III	00000	161	6TH LT. W. OF GRASSY CREEK DR., N.SIDE	12	110887	1/1/0001
22000	S	M	OUG	III	00000	162	5TH LT. W. OF GRASSY CREEK DR., N.SIDE	12	110887	1/1/0001
22000	S	M	OUG	III	00000	163	4TH LT. W. OF GRASSY CREEK DR., N. SIDE	12	110887	1/1/0001
22000	S	M	OUG	III	00000	164	3RD LT. W. OF GRASSY CREEK DR., N. SIDE	12	110887	1/1/0001
22000	S	M	OUG	III	00000	165	2ND LT. W. OF GRASSY CREEK DR.,N. SIDE	12	110887	1/1/0001
50000	S	M	OUG	III	00000	166	1ST LT. W. OF GRASSY CREEK DR.,N. SIDE	12	110887	1/1/0001
22000	S	M	OUG	III	00000	167	1ST LT. E. OF GRASSY CREEK RD., N. SIDE	12	100887	1/1/0001
22000	S	M	OUG	III	00000	168	2ND LT. E. OF GRASSY CREEK RD., N. SIDE	12	100887	1/1/0001
22000	S	M	OUG	III	00000	343	4TH LT. NORTHWEST OF CLAYS MILL, S. SIDE	12	110889	1/1/0001

OFFICE: 311

ROUTE: 564

ST_REF_NO: 00000119300

MAN O' WAR BOULEVARD

LUMENS	BULB TYPE	MULT SERIES	POLE TYPE	SHADE	ADDRESS NUMBER	REF	LOCATION	TAX DIST	DATE INST	DATE CHANGE
22000	S	M	OUG	III	00000	344	3RD LT. NORTHWEST OF CLAYS MILL, S. SIDE	12	110889	1/1/0001
22000	S	M	OUG	III	00000	345	2ND LT. NORTHWEST OF CLAYS MILL, S. SIDE	12	110889	1/1/0001
22000	S	M	OUG	III	00000	346	1ST LT. NORTHWEST OF CLAYS MILL, S. SIDE	12	110889	1/1/0001
50000	S	M	OUG	III	00000	347	1ST LT. SOUTHEAST OF CLAYS MILL, S. SIDE	12	110889	1/1/0001
22000	S	M	OUG	III	00000	348	2ND LT. SOUTHEAST OF CLAYS MILL, S. SIDE	12	110889	1/1/0001
22000	S	M	OUG	III	00000	349	3RD LT. SOUTHEAST OF CLAYS MILL, S. SIDE	12	110889	1/1/0001
22000	S	M	OUG	III	00000	350	4TH LT. SOUTHEAST OF CLAYS MILL, S. SIDE	12	110889	1/1/0001
22000	S	M	OUG	III	00000	351	5TH LT. SE OF CLAYS MILL RD., SOUTHSIDE	12	030898	1/1/0001
22000	S	M	OUG	III	00000	352	6TH LT. SE OF CLAYS MILL RD., SOUTHSIDE	12	030898	1/1/0001
22000	S	M	OUG	III	00000	353	7TH LT. SE OF CLAYS MILL RD., SOUTHSIDE	12	030898	1/1/0001
22000	S	M	OUG	III	00000	354	8TH LT. SE OF CLAYS MILL RD., SOUTHSIDE	12	030898	1/1/0001
22000	S	M	OUG	III	00000	355	9TH LT. SE OF CLAYS MILL RD., SOUTHSIDE	12	030898	1/1/0001
22000	S	M	OUG	III	00000	356	4TH LT. W. OF GRASSY CREEK, S. SIDE	12	110889	1/1/0001
22000	S	M	OUG	III	00000	357	3RD LT. W. OF GRASSY CREEK, S. SIDE	12	110889	1/1/0001
22000	S	M	OUG	III	00000	358	2ND LT. W. OF GRASSY CREEK, S. SIDE	12	110889	1/1/0001
22000	S	M	OUG	III	00000	359	1ST LT. W. OF GRASSY CREEK, S. SIDE	12	110889	1/1/0001
50000	S	M	OUG	III	00000	360	1ST LT. E. OF GRASSY CREEK, S. SIDE	12	110889	1/1/0001
22000	S	M	OUG	III	00000	361	2ND LT. E. OF GRASSY CREEK, S. SIDE	12	110889	1/1/0001
22000	S	M	OUG	III	00000	362	3RD LT. E. OF GRASSY CREEK, S. SIDE	12	110889	1/1/0001
22000	S	M	OUG	III	00000	364	5TH LT. E OF GRASSY CREEK DR., SOUTHSIDE	12	030898	1/1/0001
22000	S	M	OUG	III	00000	365	6TH LT. E OF GRASSY CREEK DR., SOUTHSIDE	12	030898	1/1/0001
22000	S	M	OUG	III	00000	366	7TH LT. E OF GRASSY CREEL DR., SOUTHSIDE	12	030898	1/1/0001
22000	S	M	OUG	III	00000	367	8TH LT. E OF GRASSY CREEK DR., SOUTHSIDE	12	030898	1/1/0001
22000	S	M	OUG	III	00000	413	6TH LT. E OF NICHOLASVILLE RD., SOUTHSIDE	12	030898	1/1/0001
22000	S	M	OUG	III	00000	169	3RD LT. E. OF GRASSY CREEK RD., N. SIDE	12	100887	1/1/0001
22000	S	M	OUG	III	00000	170	4TH LT. E. OF GRASSY CREEK RD., N. SIDE	12	100887	1/1/0001
22000	S	M	OUG	III	00000	171	5TH LT. E. OF GRASSY CREEK RD., N. SIDE	12	100887	1/1/0001
22000	S	M	OUG	III	00000	172	6TH LT. W. OF BOSTON RD., N. SIDE	12	100887	1/1/0001
22000	S	M	OUG	III	00000	173	5TH LT. W. OF BOSTON RD., N. SIDE	12	100887	1/1/0001
22000	S	M	OUG	III	00000	174	4TH LT. W. OF BOSTON RD., N. SIDE	12	100887	1/1/0001
22000	S	M	OUG	III	00000	175	3RD LT. W. OF BOSTON RD., N. SIDE	12	100887	1/1/0001
22000	S	M	OUG	III	00000	176	2ND LT. W. OF BOSTON RD., N. SIDE	12	100887	1/1/0001
22000	S	M	OUG	III	00000	177	1ST LT. W. OF BOSTON RD., N. SIDE	12	100887	1/1/0001
22000	S	M	OUG	III	00000	178	1ST LT. E. OF BOSTON RD., N. SIDE	12	100888	1/1/0001

OFFICE: 311

ROUTE: 564

ST_REF_NO: 00000119300

MAN O' WAR BOULEVARD

LUMENS	BULB TYPE	MULT SERIES	POLE TYPE	SHADE	ADDRESS NUMBER	REF	LOCATION	TAX DIST	DATE INST	DATE CHANGE
22000	S	M	OUG	III	00000	179	2ND LT. E. OF BOSTON RD., N. SIDE	12	100888	1/1/0001
22000	S	M	OUG	III	00000	180	3RD LT. E. OF BOSTON RD., N. SIDE	12	100888	1/1/0001
22000	S	M	OUG	III	00000	181	4TH LT. E. OF BOSTON RD., N. SIDE	12	100888	1/1/0001
22000	S	M	OUG	III	00000	182	5TH LT. E. OF BOSTON RD., N. SIDE	12	100888	1/1/0001
22000	S	M	OUG	III	00000	183	6TH LT. E. OF BOSTON RD., N. SIDE	12	100888	1/1/0001
22000	S	M	OUG	III	00000	184	6TH LT. W. OF CROMWELL WAY, N. SIDE	12	100888	1/1/0001
22000	S	M	OUG	III	00000	185	5TH LT. W. OF CROMWELL WAY, N. SIDE	12	100888	1/1/0001
22000	S	M	OUG	III	00000	186	4TH LT. W. OF CROMWELL WAY, N. SIDE	12	100888	1/1/0001
22000	S	M	OUG	III	00000	187	3RD LT. W. OF CROMWELL WAY, N. SIDE	12	100888	1/1/0001
22000	S	M	OUG	III	00000	188	2ND LT. W. OF CROMWELL WAY, N. SIDE	12	100888	1/1/0001
22000	S	M	OUG	III	00000	189	1ST LT. W. OF CROMWELL WAY, N. SIDE	12	100888	1/1/0001
22000	S	M	OUG	III	00000	190	1ST LT. E. OF CROMWELL WAY, N. SIDE	12	110887	1/1/0001
22000	S	M	OUG	III	00000	191	2ND LT. E. OF CROMWELL WAY, N. SIDE	12	110887	1/1/0001
22000	S	M	OUG	III	00000	192	3RD LT. E. OF CROMWELL WAY, N. SIDE	12	110887	1/1/0001
22000	S	M	OUG	III	00000	193	4TH LT. E. OF CROMWELL WAY, N. SIDE	12	110887	1/1/0001
22000	S	M	OUG	III	00000	194	5TH LT. E. OF CROMWELL WAY, N. SIDE	12	110887	1/1/0001
22000	S	M	OUG	III	00000	195	6TH LT. E. OF CROMWELL WAY, N. SIDE	12	110887	1/1/0001
22000	S	M	OUG	III	00000	196	6TH LT. W. OF SOUTHERN R.R., N. SIDE	12	110887	1/1/0001
22000	S	M	OUG	III	00000	197	5TH LT. W. OF SOUTHERN R.R., N. SIDE	12	110887	1/1/0001
22000	S	M	OUG	III	00000	198	4TH LT. W. OF SOUTHERN R.R., N. SIDE	12	110887	1/1/0001
22000	S	M	OUG	III	00000	199	3RD LT. W. OF SOUTHERN R.R., N. SIDE	12	110887	1/1/0001
22000	S	M	OUG	III	00000	200	2ND LT. W. OF SOUTHERN R.R., N. SIDE	12	110887	1/1/0001
22000	S	M	OUG	III	00000	201	1ST LT. W. OF SOUTHERN R.R.,N. SIDE(MNT ON BRIDGE)	12	110887	1/1/0001
22000	S	M	OUG	III	00000	202	1ST LT. E. OF SOUTHERN R.R.,N.SIDE (MNT ON BRIDGE)	12	110887	1/1/0001
22000	S	M	OUG	III	00000	203	2ND LT. E. OF SOUTHERN R.R.,N.SIDE	12	110887	1/1/0001
22000	S	M	OUG	III	00000	204	3RD LT. E. OF SOUTHERN R.R.,N. SIDE	12	110887	1/1/0001
22000	S	M	OUG	III	00000	205	4TH LT. E. OF SOUTHERN R.R., N. SIDE	12	110887	1/1/0001
22000	S	M	OUG	III	00000	206	5TH LT. E. OF SOUTHERN R.R., N. SIDE	12	110887	1/1/0001
22000	S	M	OUG	III	00000	207	8TH LT. W OF NICHOLASVILLE RD., NORTHSIDE	12	020899	1/1/0001
22000	S	M	OUG	III	00000	208	7TH LT. W. OF NICHOLASVILLE RD.,N. SIDE	12	110887	1/1/0001
22000	S	M	OUG	III	00000	209	6TH LT. W OF NICHOLASVILLE RD., NORTHSIDE	12	020899	1/1/0001
22000	S	M	OUG	III	00000	210	5TH LT. W OF NICHOLASVILLE RD., NORTHSIDE	12	020899	1/1/0001
22000	S	M	OUG	III	00000	211	4TH LT. W OF NICHOLASVILLE RD., NORTHSIDE	12	020899	1/1/0001

Street Light Listing run 1/11/2015 10:43:21 AM

Page 680 of 1254

OFFICE: 311

ROUTE: 564

ST_REF_NO: 00000119300

MAN O' WAR BOULEVARD

LUMENS	BULB TYPE	MULT SERIES	POLE TYPE	SHADE	ADDRESS NUMBER	REF	LOCATION	TAX DIST	DATE INST	DATE CHANGE
22000	S	M	OUG	III	00000	212	3RD LT. W OF NICHOLASVILLE RD., NORTHSIDE	12	020899	1/1/0001
22000	S	M	OUG	III	00000	213	2ND LT. W OF NICHOLASVILLE RD., NORTHSIDE	12	020899	1/1/0001
22000	S	M	OUG	III	00000	214	1ST LT. W OF NICHOLASVILLE RD., NORTHSIDE	12	020899	1/1/0001
22000	S	M	OUG	III	00000	215	1ST LT. E. OF NICHOLASVILLE RD., N. SIDE	12	110887	1/1/0001
22000	S	M	OUG	III	00000	216	2ND LT. E. OF NICHOLASVILLE RD., N. SIDE	12	110887	1/1/0001
22000	S	M	OUG	III	00000	217	3RD LT. E. OF NICHOLASVILLE RD., N. SIDE	12	110887	1/1/0001
22000	S	M	OUG	III	00000	218	4TH LT. E. OF NICHOLASVILLE RD., N. SIDE	12	110887	1/1/0001
22000	S	M	OUG	III	00000	219	5TH LT. E. OF NICHOLASVILLE RD., N. SIDE	12	110887	1/1/0001
22000	S	M	OUG	III	00000	220	6TH LT. E. OF NICHOLASVILLE RD., N. SIDE	12	110887	1/1/0001
22000	S	M	OUG	III	00000	363	4TH LT. E. OF GRASSY CREEK, S. SIDE	12	110889	1/1/0001
22000	S	M	OUG	III	00000	368	4TH LT. W. OF BOSTON RD., S. SIDE	12	110889	1/1/0001
22000	S	M	OUG	III	00000	369	3RD LT. W. OF BOSTON RD., S. SIDE	12	110889	1/1/0001
22000	S	M	OUG	III	00000	370	2ND LT. W. OF BOSTON RD., S. SIDE	12	110889	1/1/0001
22000	S	M	OUG	III	00000	371	1ST LT. W. OF BOSTON RD., S. SIDE	12	110889	1/1/0001
22000	S	M	OUG	III	00000	372	1ST LT. E. OF BOSTON RD., S. SIDE	12	110889	1/1/0001
22000	S	M	OUG	III	00000	373	2ND LT. E. OF BOSTON RD., S. SIDE	12	110889	1/1/0001
22000	S	M	OUG	III	00000	374	3RD LT. E. OF BOSTON RD., S. SIDE	12	110889	1/1/0001
22000	S	M	OUG	III	00000	375	4TH LT. E OF BOSTON RD., SOUTHSIDE	12	040897	1/1/0001
22000	S	M	OUG	III	00000	376	5TH LT. E OF BOSTON RD., SOUTHSIDE	12	040897	1/1/0001
22000	S	M	OUG	III	00000	377	6TH LT. E OF BOSTON RD., SOUTHSIDE	12	040897	1/1/0001
22000	S	M	OUG	III	00000	378	7TH LT. E OF BOSTON RD., SOUTHSIDE	12	040897	1/1/0001
22000	S	M	OUG	III	00000	379	8TH LT. E OF BOSTON RD., SOUTHSIDE	12	040897	1/1/0001
22000	S	M	OUG	III	00000	380	4TH LT. W. OF WINTHROP, S. SIDE	12	110889	1/1/0001
22000	S	M	OUG	III	00000	381	3RD LT. W. OF WINTHROP, S. SIDE	12	110889	1/1/0001
22000	S	M	OUG	III	00000	382	2ND LT. W. OF WINTHROP DR., S. SIDE	12	110889	1/1/0001
22000	S	M	OUG	III	00000	384	1ST LT. E. OF WINTHROP, S. SIDE	12	110889	1/1/0001
22000	S	M	OUG	III	00000	385	2ND LT. E. OF WINTHROP, S. SIDE	12	110889	1/1/0001
22000	S	M	OUG	III	00000	387	4TH LT E OF WINTHROP, SOUTHSIDE	12	050898	1/1/0001
22000	S	M	OUG	III	00000	388	5TH LT E OF WINTHROP, SOUTHSIDE	12	050898	1/1/0001
22000	S	M	OUG	III	00000	389	6TH LT E OF WINTHROP, SOUTHSIDE	12	050898	1/1/0001
22000	S	M	OUG	III	00000	390	7TH LT E OF WINTHROP, SOUTHSIDE	12	050898	1/1/0001
22000	S	M	OUG	III	00000	391	8TH LT E OF WINTHROP. SOUTHSIDE	12	050898	1/1/0001
22000	S	M	OUG	III	00000	392	9TH LT E OF WINTHROP, SOUTHSIDE	12	050898	1/1/0001
22000	S	M	OUG	III	00000	393	10TH LT E OF WINTHROP, SOUTHSIDE	12	050898	1/1/0001

OFFICE: 311

ROUTE: 564

ST_REF_NO: 00000119300

MAN O' WAR BOULEVARD

LUMENS	BULB TYPE	MULT SERIES	POLE TYPE	SHADE	ADDRESS NUMBER	REF	LOCATION	TAX DIST	DATE INST	DATE CHANGE
22000	S	M	OUG	III	00000	394	11TH LT E OF WINTHROP, SOUTHSIDE	12	050898	1/1/0001
22000	S	M	OUG	III	00000	395	12TH LT E OF WINTHROP, SOUTHSIDE	12	050898	1/1/0001
22000	S	M	OUG	III	00000	396	13TH LT E OF WINTHROP, SOUTHSIDE	12	050898	1/1/0001
22000	S	M	OUG	III	00000	397	14TH LT E OF WINTHROP, SOUTHSIDE	12	050898	1/1/0001
22000	S	M	OUG	III	00000	398	15TH LT E OF WINTHROP, SOUTHSIDE	12	050898	1/1/0001
22000	S	M	OUG	III	00000	399	16TH LT E OF WINTHROP, SOUTHSIDE	12	050898	1/1/0001
22000	S	M	OUG	III	00000	400	17TH LT E OF WINTHROP, SOUTHSIDE	12	050898	1/1/0001
22000	S	M	OUG	III	00000	401	18TH LT E OF WINTHROP, SOUTHSIDE	12	050898	1/1/0001
22000	S	M	OUG	III	00000	402	19TH LT E OF WINGHROP, SOUTHSIDE	12	050898	1/1/0001
22000	S	M	OUG	III	00000	403	5TH LT. W. OF NICHOLASVILLE RD., S. SIDE	12	110889	1/1/0001
22000	S	M	OUG	III	00000	404	4TH LT. W. OF NICHOLASVILLE RD., S. SIDE	12	110889	1/1/0001
22000	S	M	OUG	III	00000	405	3RD LT. W. OF NICHOLASVILLE RD., S. SIDE	12	110889	1/1/0001
22000	S	M	OUG	III	00000	406	2ND LT. W. OF NICHOLASVILLE RD., S. SIDE	12	110889	1/1/0001
22000	S	M	OUG	III	00000	407	1ST LT. W. OF NICHOLASVILLE RD., S. SIDE	12	110889	1/1/0001
22000	S	M	OUG	III	00000	408	1ST LT. E. OF NICHOLASVILLE RD., S. SIDE	12	100889	1/1/0001
22000	S	M	OUG	III	00000	409	2ND LT. E. OF NICHOLASVILLE RD., S. SIDE	12	100889	1/1/0001
22000	S	M	OUG	III	00000	410	3RD LT. E. OF NICHOLASVILLE RD., S. SIDE	12	100889	1/1/0001
22000	S	M	OUG	III	00000	411	4TH LT. E. OF NICHOLASVILLE RD., S. SIDE	12	100889	1/1/0001
22000	S	M	OUG	III	00000	412	5TH LT. E. OF NICHOLASVILLE RD., S. SIDE	12	100889	1/1/0001
22000	S	M	OUG	III	00000	414	7TH LT. E OF NICHOLASVILLE RD., SOUTHSIDE	12	030898	1/1/0001
22000	S	M	OUG	III	00000	415	8TH LT. E OF NICHOLASVILLE RD., SOUTHSIDE	12	030898	1/1/0001
22000	S	M	OUG	III	00000	416	9TH LT. E OF NICHOLASVILLE RD., SOUTHSIDE	12	030898	1/1/0001
22000	S	M	OUG	III	00000	417	10TH LT. E OF NICHOLASVILLE RD., SOUTHSIDE	12	030898	1/1/0001
22000	S	M	OUG	III	00000	221	7TH LT. E. OF NICHOLASVILLE RD., N. SIDE	12	110887	1/1/0001
22000	S	M	OUG	III	00000	222	7TH LT. W. OF HABERSHAM DR., N. SIDE	12	110887	1/1/0001
22000	S	M	OUG	III	00000	223	6TH LT. W. OF HABERSHAM DR., N. SIDE	12	110887	1/1/0001
22000	S	M	OUG	III	00000	224	5TH LT. W. OF HABERSHAM DR., N. SIDE	12	110887	1/1/0001
22000	S	M	OUG	III	00000	225	4TH LT. W. OF HABERSHAM DR., N. SIDE	12	110887	1/1/0001
22000	S	M	OUG	III	00000	226	3RD LT. W. OF HABERSHAM DR., N. SIDE	12	110887	1/1/0001
22000	S	M	OUG	III	00000	227	2ND LT. W. OF HABERSHAM DR., N. SIDE	12	110887	1/1/0001
22000	S	M	OUG	III	00000	229	1ST LT. E. OF HABERSHAM, N. SIDE	12	110887	1/1/0001
22000	S	M	OUG	III	00000	230	2ND LT. E. OF HABERSHAM, N. SIDE	12	110887	1/1/0001
22000	S	M	OUG	III	00000	231	3RD LT. E. OF HABERSHAM, N. SIDE	12	110887	1/1/0001
22000	S	M	OUG	III	00000	232	4TH LT. E. OF HABERSHAM, N. SIDE	12	110887	1/1/0001

OFFICE: 311

ROUTE: 564

ST_REF_NO: 00000119300

MAN O' WAR BOULEVARD

LUMENS	BULB TYPE	MULT SERIES	POLE TYPE	SHADE	ADDRESS NUMBER	REF	LOCATION	TAX DIST	DATE INST	DATE CHANGE
22000	S	M	OUG	III	00000	233	5TH LT. E. OF HABERSHAM, N. SIDE	12	110887	1/1/0001
22000	S	M	OUG	III	00000	234	6TH LT. E. OF HABERSHAM, N. SIDE	12	110887	1/1/0001
22000	S	M	OUG	III	00000	235	7TH LT. E. OF HABERSHAM, N. SIDE	12	110887	1/1/0001
22000	S	M	OUG	III	00000	236	8TH LT. E. OF HABERSHAM, N. SIDE	12	110887	1/1/0001
22000	S	M	OUG	III	00000	237	9TH LT. E. OF HABERSHAM, N. SIDE	12	110887	1/1/0001
22000	S	M	OUG	III	00000	238	10TH LT. E. OF HABERSHAM, N. SIDE	12	110887	1/1/0001
22000	S	M	OUG	III	00000	239	11TH LT. E. OF HABERSHAM, N. SIDE	12	110887	1/1/0001
22000	S	M	OUG	III	00000	240	11TH LT. W. OF BELLEAU WOOD DR., N. SIDE	12	110887	1/1/0001
22000	S	M	OUG	III	00000	241	10TH LT. W. OF BELLEAU WOOD DR., N. SIDE	12	110887	1/1/0001
22000	S	M	OUG	III	00000	242	9TH LT. W. OF BELLEAU WOOD DR., N. SIDE	12	110887	1/1/0001
22000	S	M	OUG	III	00000	243	8TH LT. W. OF BELLEAU WOOD DR., N. SIDE	12	110887	1/1/0001
22000	S	M	OUG	III	00000	244	7TH LT. W. OF BELLEAU WOOD DR., N. SIDE	12	110887	1/1/0001
22000	S	M	OUG	III	00000	245	6TH LT. W. OF BELLEAU WOOD DR., N. SIDE	12	110887	1/1/0001
22000	S	M	OUG	III	00000	418	3RD LT. W. OF VICTORIA WAY, S. SIDE	12	100889	1/1/0001
22000	S	M	OUG	III	00000	419	2ND LT. W. OF VICTORIA WAY, S. SIDE	12	100889	1/1/0001
22000	S	M	OUG	III	00000	420	1ST LT. W. OF VICTORIA WAY, S. SIDE	12	100889	1/1/0001
22000	S	M	OUG	III	00000	422	2ND LT. E. OF VICTORIA WAY, S. SIDE	12	100889	1/1/0001
22000	S	M	OUG	III	00000	423	3RD LT. E. OF VICTORIA WAY, S. SIDE	12	100889	1/1/0001
22000	S	M	OUG	III	00000	424	4TH LT. E OF VICOTRIA WAY, SOUTHSIDE	12	030898	1/1/0001
22000	S	M	OUG	III	00000	425	5TH LT. E OF VICTORIA WAY, SOUTHSIDE	12	030898	1/1/0001
22000	S	M	OUG	III	00000	426	6TH LT. E OF VICTORIA WAY, SOUTHSIDE	12	030898	1/1/0001
22000	S	M	OUG	III	00000	427	7TH LT. E OF VICOTRIA WAY, SOUTHSIDE	12	030898	1/1/0001
22000	S	M	OUG	III	00000	428	8TH LT. E OF VICTORIA WAY, SOUTHSIDE	12	030898	1/1/0001
22000	S	M	OUG	III	00000	429	9TH LT. E OF VICTORIA WAY, SOUTHSIDE	12	030898	1/1/0001
22000	S	M	OUG	III	00000	430	10TH LT. E OF VICTORIA WAY, SOUTHSIDE	12	030898	1/1/0001
22000	S	M	OUG	III	00000	431	11TH LT. E OF VICTORIA WAY, SOUTHSIDE	12	030898	1/1/0001
22000	S	M	OUG	III	00000	432	12TH LT. E OF VICTORIA WAY, SOUTHSIDE	12	030898	1/1/0001
22000	S	M	OUG	III	00000	433	13TH LT. E OF VICTORIA WAY, SOUTHSIDE	12	030898	1/1/0001
22000	S	M	OUG	III	00000	434	14TH LT. E OF VICTORIA WAY, SOUTHSIDE	12	030898	1/1/0001
22000	S	M	OUG	III	00000	435	15TH LT. E OF VICTORIA WAY, SOUTHSIDE	12	030898	1/1/0001
22000	S	M	OUG	III	00000	436	16TH LT. E OF VICTORIA WAY, SOUTHSIDE	12	030898	1/1/0001
22000	S	M	OUG	III	00000	437	17TH LT. E OF VICTORIA WAY, SOUTHSIDE	12	030898	1/1/0001
22000	S	M	OUG	III	00000	438	18TH LT. E OF VICTORIA WAY, SOUTHSIDE	12	030898	1/1/0001
22000	S	M	OUG	III	00000	439	19TH LT. E OF VICTORIA WAY, SOUTHSIDE	12	030898	1/1/0001

OFFICE: 311

ROUTE: 564

ST_REF_NO: 00000119300

MAN O' WAR BOULEVARD

LUMENS	BULB TYPE	MULT SERIES	POLE TYPE	SHADE	ADDRESS NUMBER	REF	LOCATION	TAX DIST	DATE INST	DATE CHANGE
22000	S	M	OUG	III	00000	027	2ND LT. N. OF JOCASTA DR., W. SIDE	12	100885	1/1/0001
22000	S	M	OUG	III	00000	028	3RD LT. N. OF JOCASTA DR., W. SIDE	12	100885	1/1/0001
22000	S	M	OUG	III	00000	029	4TH LT. N. OF JACOSTA DR., W. SIDE	12	100889	1/1/0001
22000	S	M	OUG	III	00000	030	5TH LT. N. OF JACOSTA DR., W. SIDE	12	100889	1/1/0001
22000	S	M	OUG	III	00000	031	6TH LT. N. OF JACOSTA DR., W. SIDE	12	100889	1/1/0001
22000	S	M	OUG	III	00000	032	7TH LT. N. OF JACOSTA DR., W. SIDE	12	100889	1/1/0001
22000	S	M	OUG	III	00000	033	8TH LT. N. OF JACOSTA DR., W. SIDE	12	100889	1/1/0001
22000	S	M	OUG	III	00000	034	3RD LT. S. OF MT. MCKINLEY WAY, W. SIDE	12	100889	1/1/0001
22000	S	M	OUG	III	00000	035	2ND LT. S. OF MT. MCKINLEY WAY, W. SIDE	12	100889	1/1/0001
22000	S	M	OUG	III	00000	036	1ST LT. S. OF MT. MCKINLEY WAY, W. SIDE	12	100889	1/1/0001
22000	S	M	OUG	III	00000	037	1ST LT. N. OF MT. MCKINLEY WAY, W. SIDE	12	100885	1/1/0001
22000	S	M	OUG	III	00000	038	2ND LT. N. OF MT. MCKINLEY WAY, W. SIDE	12	100885	1/1/0001
22000	S	M	OUG	III	00000	039	3RD LT. N. OF MT. MCKINLEY WAY, W. SIDE	12	100885	1/1/0001
22000	S	M	OUG	III	00000	040	4TH LT. N. OF MT. MCKINLEY WAY, W. SIDE	12	100889	1/1/0001
22000	S	M	OUG	III	00000	041	5TH LT. N. OF MT. MCKINLEY WAY, W. SIDE	12	100889	1/1/0001
22000	S	M	OUG	III	00000	042	6TH LT. N. OF MT. MCKINLEY WAY, W. SIDE	12	100889	1/1/0001
22000	S	M	OUG	III	00000	043	7TH LT. N. OF MT. MCKINLEY WAY, W. SIDE	12	100889	1/1/0001
22000	S	M	OUG	III	00000	044	2ND LT. S. OF PIMLICO PKWY., W. SIDE	12	100889	1/1/0001
22000	S	M	OUG	III	00000	045	1ST LT. S. OF PIMLICO PKWY., W. SIDE	12	100889	1/1/0001
22000	S	M	OUG	III	00000	046	1ST LT. N. OF PIMLICO PKWY., W. SIDE	12	100889	1/1/0001
22000	S	M	OUG	III	00000	047	2ND LT. N. OF PIMLICO PKWY., W. SIDE	12	100889	1/1/0001
22000	S	M	OUG	III	00000	048	3RD LT. N. OF PIMLICO PKWY., W. SIDE	12	100889	1/1/0001
22000	S	M	OUG	III	00000	049	4TH LT. N. OF PIMLICO PKWY., W. SIDE	12	100889	1/1/0001
22000	S	M	OUG	III	00000	050	5TH LT. N. OF PIMLICO PKWY., W. SIDE	12	100889	1/1/0001
22000	S	M	OUG	III	00000	051	6TH LT. N. OF PIMLICO PKWY., W. SIDE	12	100889	1/1/0001
22000	S	M	OUG	III	00000	052	7TH LT. N. OF PIMLICO PKWY., W. SIDE	12	100889	1/1/0001
22000	S	M	OUG	III	00000	053	8TH LT. N. OF PIMLICO PKWY., W. SIDE	12	100889	1/1/0001
22000	S	M	OUG	III	00000	531	7TH LT S OF MT. MCKINLEY WAY, EASTSIDE	12	050898	1/1/0001
22000	S	M	OUG	III	00000	532	6TH LT S OF MCKINLEY WAY, EASTSIDE	12	050898	1/1/0001
22000	S	M	OUG	III	00000	533	5TH LT S OF MT. MCKINLEY WAY, EASTSIDE	12	050898	1/1/0001
22000	S	M	OUG	III	00000	534	4TH LT. S. OF MT. MCKINLEY WAY, E. SIDE	12	100889	1/1/0001
22000	S	M	OUG	III	00000	535	3RD LT. S. OF MT. MCKINLEY WAY, E. SIDE	12	100889	1/1/0001
22000	S	M	OUG	III	00000	536	2ND LT. S. OF MT. MCKINLEY WAY, E. SIDE	12	100889	1/1/0001
22000	S	M	OUG	III	00000	537	1ST LT. S. OF MT. MCKINLEY WAY, E. SIDE	12	100889	1/1/0001

OFFICE: 311

ROUTE: 564

ST_REF_NO: 00000119300

MAN O' WAR BOULEVARD

LUMENS	BULB TYPE	MULT SERIES	POLE TYPE	SHADE	ADDRESS NUMBER	REF	LOCATION	TAX DIST	DATE INST	DATE CHANGE
22000	S	M	OUG	III	00000	538	1ST LT. N. OF MT. MCKINLEY WAY, E. SIDE	12	100889	1/1/0001
22000	S	M	OUG	III	00000	539	2ND LT. N. OF MT. MCKINLEY WAY, E. SIDE	12	100889	1/1/0001
22000	S	M	OUG	III	00000	540	3RD LT. N. OF MT. MCKINLEY WAY, E. SIDE	12	100889	1/1/0001
22000	S	M	OUG	III	00000	541	4TH LT N OF MT. MCKINLEY WAY, EASTSIDE	12	050898	1/1/0001
22000	S	M	OUG	III	00000	542	5TH LT N OF MT. MCKINLEY WAY, EASTSIDE	12	050898	1/1/0001
22000	S	M	OUG	III	00000	543	4TH LT. S. OF PIMLICO PKWY., E. SIDE	12	100889	1/1/0001
22000	S	M	OUG	III	00000	544	3RD LT. S. OF PIMLICO PKWY., E. SIDE	12	100889	1/1/0001
22000	S	M	OUG	III	00000	545	2ND LT. S. OF PIMLICO PKWY., E. SIDE	12	100889	1/1/0001
22000	S	M	OUG	III	00000	546	1ST LT. S. OF PIMLICO PKWY., E. SIDE	12	100889	1/1/0001
22000	S	M	OUG	III	00000	547	1ST LT. N. OF PIMLICO PKWY., E. SIDE	12	100889	1/1/0001
22000	S	M	OUG	III	00000	548	2ND LT. N. OF PIMLICO PKWY., E. SIDE	12	100889	1/1/0001
22000	S	M	OUG	III	00000	549	3RD LT. N. OF PIMLICO PKWY., E. SIDE	12	100889	1/1/0001
22000	S	M	OUG	III	00000	550	4TH LT. N. OF PIMLICO PKWY., E. SIDE	12	100889	1/1/0001
22000	S	M	OUG	III	00000	551	5TH LT N OF PIMLICO PKWY, EASTSIDE	12	050898	1/1/0001
22000	S	M	OUG	III	00000	552	6TH LT N OF PIMLICO PKWY, EASTSIDE	12	050898	1/1/0001
22000	S	M	OUG	III	00000	553	7TH LT N OF PIMLICO PKWY, EASTSIDE	12	050898	1/1/0001
22000	S	M	OUG	III	00000	554	8TH LT N OF PIMLICO PKWY, EASTSIDE	12	050898	1/1/0001
22000	S	M	OUG	III	00000	622	4TH LT E OF RAPID RUN DR., SOUTHSIDE	12	050898	1/1/0001
22000	S	M	OUG	III	00000	246	5TH LT. W. OF BELLEAU WOOD DR.,N. SIDE	12	110887	1/1/0001
22000	S	M	OUG	III	00000	247	4TH LT. W. OF BELLEAU WOOD DR.,N. SIDE	12	110887	1/1/0001
22000	S	M	OUG	III	00000	248	3RD LT. W. OF BELLEAU WOOD DR.,N. SIDE	12	110887	1/1/0001
22000	S	M	OUG	III	00000	249	2ND LT. W. OF BELLEAU WOOD DR.,N. SIDE	12	110887	1/1/0001
22000	S	M	OUG	III	00000	250	1ST LT. W. OF BELLEAU WOOD DR.,N. SIDE	12	110887	1/1/0001
22000	S	M	OUG	III	00000	251	1ST LT. E. OF BELLEAU WOOD DR.,N. SIDE	12	120887	1/1/0001
22000	S	M	OUG	III	00000	252	2ND LT. E. OF BELLEAU WOOD DR.,N. SIDE	12	120887	1/1/0001
22000	S	M	OUG	III	00000	253	3RD LT. E. OF BELLEAU WOOD DR., N. SIDE	12	120887	1/1/0001
22000	S	M	OUG	III	00000	254	4TH LT. E. OF BELLEAU WOOD DR., N. SIDE	12	120887	1/1/0001
22000	S	M	OUG	III	00000	255	5TH LT. E. OF BELLEAU WOOD DR., N. SIDE	12	120887	1/1/0001
22000	S	M	OUG	III	00000	256	6TH LT. E. OF BELLEAU WOOD RD., N. SIDE	12	120887	1/1/0001
22000	S	M	OUG	III	00000	257	7TH LT. E. OF BELLEAU WOOD DR.,N. SIDE	12	120887	1/1/0001
22000	S	M	OUG	III	00000	258	8TH LT. E. OF BELLEAU WOOD DR., N. SIDE	12	120887	1/1/0001
22000	S	M	OUG	III	00000	259	7TH LT. W. OF SHOPPING CENTER ACCESS,N. SIDE	12	120887	1/1/0001
22000	S	M	OUG	III	00000	260	6TH LT. W. OF SHOPPING CENTER ACCESS, N. SIDE	12	120887	1/1/0001

OFFICE: 311

ROUTE: 564

ST_REF_NO: 00000119300

MAN O' WAR BOULEVARD

LUMENS	BULB TYPE	MULT SERIES	POLE TYPE	SHADE	ADDRESS NUMBER	REF	LOCATION	TAX DIST	DATE INST	DATE CHANGE
22000	S	M	OUG	III	00000	261	5TH LT. W. OF SHOPPING CENTER ACCESS, N. SIDE	12	120887	1/1/0001
22000	S	M	OUG	III	00000	262	4TH LT. W. OF SHOPPING CENTER ACCESS, N. SIDE	12	120887	1/1/0001
22000	S	M	OUG	III	00000	263	3RD LT. W. OF SHOPPING CENTER ACCESS, N. SIDE	12	120887	1/1/0001
22000	S	M	OUG	III	00000	264	2ND LT. W. OF SHOPPING CENTER ACCESS, N. SIDE	12	120887	1/1/0001
22000	S	M	OUG	III	00000	265	1ST LT. W. OF SHOPPING CENTER ACCESS, N. SIDE	12	120887	1/1/0001
22000	S	M	OUG	III	00000	266	1ST LT. E. OF SHOPPING CENTER ACCESS, N. SIDE	12	120887	1/1/0001
22000	S	M	OUG	III	00000	267	2ND LT. E. OF SHOPPING CENTER ACCESS, N. SIDE	12	120887	1/1/0001
22000	S	M	OUG	III	00000	268	3RD LT. E. OF SHOPPING CENTER ACCESS, N. SIDE	12	120887	1/1/0001
22000	S	M	OUG	III	00000	269	4TH LT. E. OF SHOPPING CENTER ACCESS, N. SIDE	12	120887	1/1/0001
22000	S	M	OUG	III	00000	270	5TH LT. E. OF SHOPPING CENTER ACCESS, N. SIDE	12	120887	1/1/0001
22000	S	M	OUG	III	00000	440	3RD LT. W. OF BELLEAU WOOD, S. SIDE	12	100889	1/1/0001
22000	S	M	OUG	III	00000	441	2ND LT. W. OF BELLEAU WOOD, S. SIDE	12	100889	1/1/0001
22000	S	M	OUG	III	00000	442	1ST LT. W. OF BELLEAU WOOD, S. SIDE	12	100889	1/1/0001
22000	S	M	OUG	III	00000	443	1ST LT. E. OF BELLEAU WOOD, S. SIDE	12	100889	1/1/0001
22000	S	M	OUG	III	00000	444	2ND LT. E. OF BELLEAU WOOD, S. SIDE	12	100889	1/1/0001
22000	S	M	OUG	III	00000	445	3RD LT. E. OF BELLEAU WOOD, S. SIDE	12	100889	1/1/0001
22000	S	M	OUG	III	00000	446	4TH LT. E OF CLEARWATER WAY, SOUTHSIDE	12	030896	1/1/0001
22000	S	M	OUG	III	00000	447	5TH LT. E OF CLEARWATER WAY, SOUTHSIDE	12	030896	1/1/0001
22000	S	M	OUG	III	00000	448	6TH LT. E OF CLEARWATER WAY, SOUTHSIDE	12	030896	1/1/0001
22000	S	M	OUG	III	00000	449	7TH LT. E OF CLEARWATER WAY, SOUTHSIDE	12	030896	1/1/0001
22000	S	M	OUG	III	00000	450	8TH LT. E OF CLEARWATER WAY, SOUTHSIDE	12	030896	1/1/0001
22000	S	M	OUG	III	00000	451	9TH LT. E OF CLEARWATER WAY, SOUTHSIDE	12	030896	1/1/0001
22000	S	M	OUG	III	00000	452	10TH LT. E OF CLEARWATER WAY, SOUTHSIDE	12	030896	1/1/0001
22000	S	M	OUG	III	00000	453	11TH LT. E OF CLEARWATER WAY, SOUTHSIDE	12	030896	1/1/0001
22000	S	M	OUG	III	00000	454	12TH LT. E OF CLEARWATER WAY, SOUTHSIDE	12	030896	1/1/0001
22000	S	M	OUG	III	00000	455	13TH LT. E OF CLEARWATER WAY, SOUTHSIDE	12	030896	1/1/0001
50000	S	M	OUG	III	00000	456	13TH LT. W. OF TATES CREEK, S. SIDE	12	100889	1/1/0001
22000	S	M	OUG	III	00000	457	12TH LT. W. OF TATES CREEK, S. SIDE	12	100889	1/1/0001
22000	S	M	OUG	III	00000	458	1ST LT. E OF SARON DR., SOUTHSIDE		110892	1/1/0001

OFFICE: 311

ROUTE: 564

ST_REF_NO: 00000119300

MAN O' WAR BOULEVARD

LUMENS	BULB TYPE	MULT SERIES	POLE TYPE	SHADE	ADDRESS NUMBER	REF	LOCATION	TAX DIST	DATE INST	DATE CHANGE
22000	S	M	OUG	III	00000	459	10TH LT. W. OF TATES CREEK, S. SIDE	12	100889	1/1/0001
22000	S	M	OUG	III	00000	460	9TH LT. W. OF TATES CREEK, S. SIDE	12	100889	1/1/0001
22000	S	M	OUG	III	00000	461	8TH LT. W. OF TATES CREEK, S. SIDE	12	100889	1/1/0001
22000	S	M	OUG	III	00000	462	7TH LT. W. OF TATES CREEK, S. SIDE	12	100889	1/1/0001
22000	S	M	OUG	III	00000	271	5TH LT. W. OF TATES CREEK, N. SIDE	12	120887	1/1/0001
22000	S	M	OUG	III	00000	272	4TH LT. W. OF TATES CREEK, N. SIDE	12	120887	1/1/0001
22000	S	M	OUG	III	00000	273	3RD LT. W. OF TATES CREEK, N. SIDE	12	120887	1/1/0001
22000	S	M	OUG	III	00000	274	2ND LT. W. OF TATES CREEK, N.SIDE	12	120887	1/1/0001
22000	S	M	OUG	III	00000	275	1ST LT. W. OF TATES CREEK, N. SIDE	12	120887	1/1/0001
50000	S	M	OUG	III	00000	276	1ST LT. E. OF TATES CREEK, N. SIDE	12	100889	1/1/0001
22000	S	M	OUG	III	00000	277	2ND LT. E. OF TATES CREEK, N. SIDE	12	120887	1/1/0001
22000	S	M	OUG	III	00000	278	3RD LT. E. OF TATES CREEK,N. SIDE	12	120887	1/1/0001
22000	S	M	OUG	III	00000	279	4TH LT. E. OF TATES CREEK, N. SIDE	12	120887	1/1/0001
22000	S	M	OUG	III	00000	280	5TH LT. E. OF TATES CREEK, N. SIDE	12	120887	1/1/0001
22000	S	M	OUG	III	00000	281	6TH LT. E. OF TATES CREEK, N. SIDE	12	120887	1/1/0001
22000	S	M	OUG	III	00000	282	7TH LT. E. OF TATES CREEK, N. SIDE	12	120887	1/1/0001
22000	S	M	OUG	III	00000	283	8TH LT. E. OF TATES CREEK, N. SIDE	12	120887	1/1/0001
22000	S	M	OUG	III	00000	284	7TH LT. W. OF CROSBY DR., N. SIDE	12	120887	1/1/0001
22000	S	M	OUG	III	00000	285	6TH LT. W. OF CROSBY DR., N. SIDE	12	120887	1/1/0001
22000	S	M	OUG	III	00000	286	5TH LT. W. OF CROSBY DR.,N. SIDE	12	120887	1/1/0001
22000	S	M	OUG	III	00000	287	4TH LT. W. OF CROSBY DR., N. SIDE	12	120887	1/1/0001
22000	S	M	OUG	III	00000	288	3RD LT. W. OF CROSBY DR.,N. SIDE	12	120887	1/1/0001
22000	S	M	OUG	III	00000	289	2ND LT. W. OF CROSBY DR., N. SIDE	12	120887	1/1/0001
22000	S	M	OUG	III	00000	290	1ST LT. W. OF CROSBY DR., N. SIDE	12	120887	1/1/0001
22000	S	M	OUG	III	00000	291	1ST LT. E. OF CROSBY DR.,N. SIDE	12	120887	1/1/0001
22000	S	M	OUG	III	00000	292	2ND LT. E. OF CROSBY DR.,N. SIDE	12	120887	1/1/0001
22000	S	M	OUG	III	00000	293	3RD LT. E. OF CROSBY DR., N. SIDE	12	120887	1/1/0001
22000	S	M	OUG	III	00000	294	4TH LT. E. OF CROSBY DR., N. SIDE	12	120887	1/1/0001
22000	S	M	OUG	III	00000	295	5TH LT. E. OF CROSBY DR., N. SIDE	12	120887	1/1/0001
22000	S	M	OUG	III	00000	296	6TH LT. E. OF CROSBY DR., N. SIDE	12	120887	1/1/0001
22000	S	M	OUG	III	00000	297	5TH LT. W. OF RAPID RUN DR., N. SIDE	12	120887	1/1/0001
22000	S	M	OUG	III	00000	298	4TH LT. W. OF RAPID RUN DR., N. SIDE	12	120887	1/1/0001
22000	S	M	OUG	III	00000	299	3RD LT. W. OF RAPID RUN DR., N. SIDE	12	120887	1/1/0001
22000	S	M	OUG	III	00000	300	2ND LT. W. OF RAPID RUN DR., N. SIDE	12	120887	1/1/0001

OFFICE: 311

ROUTE: 564

ST_REF_NO: 00000119300

MAN O' WAR BOULEVARD

LUMENS	BULB TYPE	MULT SERIES	POLE TYPE	SHADE	ADDRESS NUMBER	REF	LOCATION	TAX DIST	DATE INST	DATE CHANGE
22000	S	M	OUG	III	00000	301	1ST LT. W. OF RAPID RUN DR., N. SIDE	12	120887	1/1/0001
22000	S	M	OUG	III	00000	302	1ST LT. E. OF RAPID RUN , N. SIDE	12	120887	1/1/0001
22000	S	M	OUG	III	00000	303	2ND LT. E. OF RAPID RUN, N. SIDE	12	120887	1/1/0001
22000	S	M	OUG	III	00000	304	3RD LT. E. OF RAPID RUN, N. SIDE	12	120887	1/1/0001
22000	S	M	OUG	III	00000	305	4TH LT. E. OF RAPID RUN, N. SIDE	12	120887	1/1/0001
22000	S	M	OUG	III	00000	306	5TH LT. E. OF RAPID RUN, N. SIDE	12	120887	1/1/0001
22000	S	M	OUG	III	00000	307	6TH LT. E. OF RAPID RUN, N. SIDE	12	120887	1/1/0001
22000	S	M	OUG	III	00000	308	7TH LT. E. OF RAPID RUN, N. SIDE	12	120887	1/1/0001
22000	S	M	OUG	III	00000	463	6TH LT. W. OF TATES CREEK, S. SIDE	12	100889	1/1/0001
22000	S	M	OUG	III	00000	464	5TH LT. W. OF TATES CREEK, S. SIDE	12	100889	1/1/0001
22000	S	M	OUG	III	00000	465	4TH LT. W. OF TATES CREEK, S. SIDE	12	100889	1/1/0001
22000	S	M	OUG	III	00000	466	3RD LT. W. OF TATES CREEK, S. SIDE	12	100889	1/1/0001
22000	S	M	OUG	III	00000	467	2ND LT. W. OF TATES CREEK, S. SIDE	12	100889	1/1/0001
50000	S	M	OUG	III	00000	468	1ST LT. W. OF TATES CREEK, S. SIDE	12	100889	1/1/0001
22000	S	M	OUG	III	00000	469	1ST LT. E. OF TATES CREEK, S. SIDE	12	100889	1/1/0001
22000	S	M	OUG	III	00000	470	2ND LT. E. OF TATES CREEK, S. SIDE	12	100889	1/1/0001
22000	S	M	OUG	III	00000	471	3RD LT. E. OF TATES CREEK, S. SIDE	12	100889	1/1/0001
22000	S	M	OUG	III	00000	472	4TH LT. E. OF TATES CREEK, S. SIDE	12	100889	1/1/0001
22000	S	M	OUG	III	00000	473	5TH LT. E. OF TATES CREEK, S. SIDE	12	100889	1/1/0001
22000	S	M	OUG	III	00000	474	6TH LT. E OF TATES CREEK RD., SOUTHSIDE	12	040897	1/1/0001
22000	S	M	OUG	III	00000	475	7TH LT. E OF TATES CREEK RD., SOUTHSIDE	12	040897	1/1/0001
22000	S	M	OUG	III	00000	476	8TH LT. E OF TATES CREEK, SOUTHSIDE	12	040897	1/1/0001
22000	S	M	OUG	III	00000	477	9TH LT. E OF TATES CREEKRD., SOUTHSIDE	12	040897	1/1/0001
22000	S	M	OUG	III	00000	478	10TH LT. E OF TATES CREEK RD., SOUTHSIDE	12	040897	1/1/0001
22000	S	M	OUG	III	00000	479	11TH LT. E OF TATES CREEK RD., SOUTHSIDE	12	040897	1/1/0001
22000	S	M	OUG	III	00000	480	4TH LT. W. OF CROSBY, S. SIDE	12	100889	1/1/0001
22000	S	M	OUG	III	00000	481	3RD LT. W. OF CROSBY, S. SIDE	12	100889	1/1/0001
22000	S	M	OUG	III	00000	482	2ND LT. W. OF CROSBY, S. SIDE	12	100889	1/1/0001
22000	S	M	OUG	III	00000	483	1ST LT. W. OF CROSBY, S. SIDE	12	100889	1/1/0001
22000	S	M	OUG	III	00000	484	1ST LT. E. OF CROSBY DR., S. SIDE	12	100889	1/1/0001
22000	S	M	OUG	III	00000	485	2ND LT. E. OF CROSBY DR., S. SIDE	12	100889	1/1/0001
22000	S	M	OUG	III	00000	486	3RD LT. E. OF CROSBY DR., S. SIDE	12	100889	1/1/0001
22000	S	M	OUG	III	00000	487	4TH LT. E OF CROSBY DR., SOUTHSIDE	12	040897	1/1/0001
22000	S	M	OUG	III	00000	488	4TH LT. E OF CROSBY DR., SOUTHSIDE	12	040897	1/1/0001

OFFICE: 311

ROUTE: 564

ST_REF_NO: 00000119300

MAN O' WAR BOULEVARD

LUMENS	BULB TYPE	MULT SERIES	POLE TYPE	SHADE	ADDRESS NUMBER	REF	LOCATION	TAX DIST	DATE INST	DATE CHANGE
22000	S	M	OUG	III	00000	489	6TH LT. E OF CROSBY DR., SOUTHSIDE	12	040897	1/1/0001
22000	S	M	OUG	III	00000	490	7TH LT. E OF CROSBY DR., SOUTHSIDE	12	040897	1/1/0001
22000	S	M	OUG	III	00000	491	3RD LT. W. OF RAPID RUN ON SOUTHSIDE OF MAN-O-WAR	12	040891	1/1/0001
22000	S	M	OUG	III	00000	617	2ND LT. W. OF RAPID RUN ON SOUTHSIDE OF MAN-O-WAR	12	040891	1/1/0001
22000	S	M	OUG	III	00000	618	1ST LT. W. OF RAPID RUN ON SOUTHSIDE OF MAN-O-WAR	12	040891	1/1/0001
22000	S	M	OUG	III	00000	619	1ST LT. E. OF RAPID RUN, S. SIDE	12	100889	1/1/0001
22000	S	M	OUG	III	00000	620	2ND LT. E. OF RAPID RUN, S. SIDE	12	100889	1/1/0001
22000	S	M	OUG	III	00000	621	3RD LT. E. OF RAPID RUN, S. SIDE	12	100889	1/1/0001
22000	S	M	OUG	III	00000	623	5TH LT E OF RAPID RUN DR., SOUTHSIDE	12	050898	1/1/0001
22000	S	M	OUG	III	00000	624	6TH LT E OF RAPID RUN DR., SOUTHSIDE	12	050898	1/1/0001
22000	S	M	OUG	III	00000	625	7TH LT E OF RAPID RUN DR., SOUTHSIDE	12	050898	1/1/0001

OFFICE: 311

ROUTE: 564

ST_REF_NO: 00000119400

MAN O' WAR PLACE

LUMENS	BULB TYPE	MULT SERIES	POLE TYPE	SHADE	ADDRESS NUMBER	REF	LOCATION	TAX DIST	DATE INST	DATE CHANGE
05800	S	M	OOH	II	00000	006	SIDE OF 286 AMERICAN AVE.	12	090166	1/1/0001
05800	S	M	OUG	II	00000	107	SIDE OF 339 ELAINE DR.	12	011475	1/1/0001
05800	S	M	OUG	II	01229	008		12	090166	1/1/0001
05800	S	M	OUG	II	01230	007		12	090166	1/1/0001
05800	S	M	OUG	II	01232	009		12	011475	1/1/0001

OFFICE: 311

ROUTE: 564

ST_REF_NO: 00000119500

MANASSAS DRIVE

LUMENS	BULB TYPE	MULT SERIES	POLE TYPE	SHADE	ADDRESS NUMBER	REF	LOCATION	TAX DIST	DATE INST	DATE CHANGE
04000	S	M	OUG	II	00000	001	SIDE OF 1982 ANTIETAM RD.	12	020889	1/1/0001
04000	S	M	OUG	II	01874	002		12	020889	1/1/0001
04000	S	M	OUG	II	01883	003		12	020889	1/1/0001
04000	S	M	SOH	II	01890	004		12	020889	1/1/0001
04000	S	M	OUG	V	01895	005		12	020889	1/1/0001

OFFICE: 311

ROUTE: 564

ST_REF_NO: 00000119600

MANCHESTER STREET

LUMENS	BULB TYPE	MULT SERIES	POLE TYPE	SHADE	ADDRESS NUMBER	REF	LOCATION	TAX DIST	DATE INST	DATE CHANGE
50000	S		SOH	II	00000	250	1ST LT E OF S FORBES, S SIDE ON MANCHESTER	12	022310	1/1/0001
22000	S		CNT	II	00000	400	1ST LT E OF OLIVER LEWIS WAY, N SIDE ON MANCHESTER ST	12	031511	1/1/0001
22000	S		CNT	II	00000	401	2ND LT E OF OLIVER LEWIS WAY, N SIDE ON MANCHESTER ST	12	031511	1/1/0001
22000	S		CNT	II	00000	402	3RD LT E OF OLIVER LEWIS WAY, N SIDE ON MANCHESTER ST	12	031511	1/1/0001
22000	S		CNT	II	00000	403	1ST LT E OF OLIVER LEWIS WAY, S SIDE ON MANCHESTER ST	12	031511	1/1/0001
22000	S		CNT	II	00000	404	2ND LT E OF OLIVER LEWIS WAY, S SIDE ON MANCHESTER ST	12	031511	1/1/0001
22000	S		CNT	II	00000	405	1ST LT W OF OLIVER LEWIS WAY, S SIDE ON MANCHESTER ST	12	031511	1/1/0001
22000	S		CNT	II	00000	406	2ND LT W OF OLIVER LEWIS WAY, S SIDE ON MANCHESTER	12	031511	1/1/0001
22000	S		CNT	II	00000	407	3RD LT W OF OLIVER LEWIS WAY, S SIDE ON MANCHESTER ST	12	031511	1/1/0001
22000	S		CNT	II	00000	408	4TH LT W OF OLIVER LEWIS WAY, S SIDE ON MANCHESTER ST	12	031511	1/1/0001
22000	S		CNT	II	00000	409	MANCHESTER STREET CORNER OF OLD COX STREET	12	031511	1/1/0001
22000	S	M	OUG	II	00000	023	VIADUCT, 3RD LT. W. OF JEFFERSON VIADUCT, N. SIDE	12	051581	12/12/2013
09500	S	M	SOH	II	00000	038	OPPOSITE 1004	12	021582	12/12/2013
10000	M	M	SOH	II	00000	043	1ST. LT. E. OF RR, N. SIDE	12	052163	1/1/0001
10000	M	M	SOH	II	00000	044	1ST. LT. E. OF RR, S. SIDE	12	052163	1/1/0001
10000	M	M	SOH	III	00000	046	1ST LT. W. OF RR OVERPASS, S. SIDE	12	111477	1/1/0001
10000	M	M	SOH	III	01091	047		12	111477	1/1/0001
10000	M	M	SOH	III	01091	048		12	111477	1/1/0001
10000	M	M	SOH	III	01091	049		12	111477	1/1/0001
10000	M	M	SOH	III	01091	050		12	111477	1/1/0001
09500	S	M	SOH	III	01091	051		12	111477	1/1/0001
10000	M	M	SOH	II	01115	042		12	070163	1/1/0001
10000	M	M	SOH	III	01200	052		12	111477	1/1/0001
10000	M	M	SOH	III	01200	053		12	111477	1/1/0001
10000	M	M	SOH	III	01200	054		12	111477	1/1/0001
10000	M	M	SOH	III	01200	055		12	111477	1/1/0001

OFFICE: 311

ROUTE: 564

ST_REF_NO: 00000119600

MANCHESTER STREET

LUMENS	BULB TYPE	MULT SERIES	POLE TYPE	SHADE	ADDRESS NUMBER	REF	LOCATION	TAX DIST	DATE INST	DATE CHANGE
10000	M	M	SOH	III	01200	056		12	111477	1/1/0001
10000	M	M	SOH	III	01200	057		12	111477	1/1/0001
10000	M	M	SOH	III	01200	058		12	111477	1/1/0001
10000	M	M	SOH	III	01200	059		12	111477	1/1/0001
10000	M	M	SOH	III	01201	060		12	111477	1/1/0001
10000	M	M	SOH	III	01201	061		12	111477	1/1/0001
10000	M	M	SOH	III	01269	062		12	111477	1/1/0001
10000	M	M	SOH	III	01269	063		12	111477	1/1/0001
10000	M	M	SOH	III	01269	064		12	111477	1/1/0001
10000	M	M	SOH	III	01269	065		12	111477	1/1/0001
10000	M	M	SOH	III	01269	066		12	111477	1/1/0001
10000	M	M	SOH	III	01270	067		12	111477	1/1/0001
10000	M	M	SOH	III	01280	069		12	111477	1/1/0001
10000	M	M	SOH	III	01285	068		12	111477	1/1/0001
10000	M	M	SOH	II	00000	039	OPPOSITE 1026	12	052163	1/1/0001
10000	M	M	SOH	II	00000	041	OPPOSITE 1058	12	052163	1/1/0001
10000	M	M	SOH	II	01040	040		12	021582	1/1/0001
20000	M	M	SOH	II	00000	001	1ST LT. W. OF HIGH ST., S. SIDE	12	031581	1/1/0001
20000	M	M	SOH	II	00000	002	2ND LT. W. OF HIGH ST., S. SIDE	12	031581	1/1/0001
20000	M	M	SOH	II	00000	003	3RD LT. W. OF HIGH ST., S. SIDE	12	031581	1/1/0001
20000	M	M	OUG	II	00000	018	VIADUCT, 1ST LT. W. OF JEFFERSON VIADUCT, S. SIDE	12	051581	1/1/0001
20000	M	M	OUG	II	00000	019	VIADUCT, 1ST LT. W. OF JEFFERSON VIADUCT, N. SIDE	12	051581	1/1/0001
20000	M	M	OUG	II	00000	020	VIADUCT, 2ND LT. W. OF JEFFERSON VIADUCT, S. SIDE	12	051581	1/1/0001
20000	M	M	OUG	II	00000	021	VIADUCT, 2ND LT. W. OF JEFFERSON VIADUCT, N. SIDE	12	051581	1/1/0001
20000	M	M	OUG	II	00000	022	VIADUCT, 3RD LT. W. OF JEFFERSON VIADUCT, S. SIDE	12	051581	1/1/0001
20000	M	M	OUG	II	00000	024	VIADUCT, 4TH LT. W. OF JEFFERSON VIADUCT, S. SIDE	12	051581	1/1/0001
20000	M	M	OUG	II	00000	025	VIADUCT, 4TH LT. W. OF JEFFERSON VIADUCT, N. SIDE	12	051581	1/1/0001
10000	M	M	SOH	II	00000	028	6TH LT. W. OF JEFFERSON ST., S. SIDE	12	052163	1/1/0001
10000	M	M	SOH	II	00000	035	OPPOSITE 930	12	070163	1/1/0001

OFFICE: 311

ROUTE: 564

ST_REF_NO: 00000119600

MANCHESTER STREET

LUMENS	BULB TYPE	MULT SERIES	POLE TYPE	SHADE	ADDRESS NUMBER	REF	LOCATION	TAX DIST	DATE INST	DATE CHANGE
10000	M	M	SOH	II	00000	037	OPPOSITE 958	12	070163	1/1/0001
22000	S	M	SOH	II	00912	034	upgrade 4/08	12	021582	1/1/0001
10000	M	M	SOH	II	00948	036		12	052163	1/1/0001

OFFICE: 311

ROUTE: 564

ST_REF_NO: 00000119700

MANDALAY ROAD

LUMENS	BULB TYPE	MULT SERIES	POLE TYPE	SHADE	ADDRESS NUMBER	REF	LOCATION	TAX DIST	DATE INST	DATE CHANGE
09500	S	M	OUG	II	00204	000		12	100163	1/1/0001
09500	S	M	OUG	II	00219	000		12	120461	1/1/0001
09500	S	M	OUG	II	00224	000		12	120960	1/1/0001
09500	S	M	OUG	II	00231	000		12	120461	1/1/0001
09500	S	M	OUG	II	00258	000		12	101162	1/1/0001
09500	S	M	OUG	II	00201	000		12	120461	1/1/0001

OFFICE: 311

ROUTE: 564

ST_REF_NO: 00000119750

MANDEVILLE WAY

LUMENS	BULB TYPE	MULT SERIES	POLE TYPE	SHADE	ADDRESS NUMBER	REF	LOCATION	TAX DIST	DATE INST	DATE CHANGE
04000	S	M	OUG	II	00000	054	SIDE OF 385 SOUTH POINT DR.	12	011581	1/1/0001

OFFICE: 311

ROUTE: 564

ST_REF_NO: 00000119760

MANGROVE DRIVE

LUMENS	BULB TYPE	MULT SERIES	POLE TYPE	SHADE	ADDRESS NUMBER	REF	LOCATION	TAX DIST	DATE INST	DATE CHANGE
05800	S	M	CNT	II	00000	001	SIDE 4149 PALMETTO DR.	12	100894	1/1/0001
05800	S	M	CNT	II	00000	007	SIDE OF 2216 MADRONE WAY	12	100894	1/1/0001
05800	S	M	CNT	II	00000	025	SIDE 4132 PALMETTO DR.	12	100894	1/1/0001
05800	S	M	CNT	II	00000	028	SIDE REAR OF 4200 NUTMEG DR.	12	110898	1/1/0001
05800	S	M	CNT	II	02100	034		12	110898	1/1/0001
05800	S	M	CNT	II	02113	033		12	110898	1/1/0001
05800	S	M	CNT	II	02120	032		12	110898	1/1/0001
05800	S	M	CNT	II	02129	031		12	110898	1/1/0001
05800	S	M	CNT	II	02140	030		12	110898	1/1/0001
05800	S	M	CNT	III	02149	029		12	110898	1/1/0001
05800	S	M	CNT	II	02177	027		12	110898	1/1/0001
05800	S	M	CNT	II	02180	026		12	110898	1/1/0001

OFFICE: 311

ROUTE: 564

ST_REF_NO: 00000119760

MANGROVE DRIVE

LUMENS	BULB TYPE	MULT SERIES	POLE TYPE	SHADE	ADDRESS NUMBER	REF	LOCATION	TAX DIST	DATE INST	DATE CHANGE
05800	S	M	CNT	II	02208	002		12	100894	1/1/0001
05800	S	M	CNT	II	02225	003		12	100894	1/1/0001
05800	S	M	CNT	II	02233	004		12	100894	1/1/0001
05800	S	M	CNT	II	02236	005		12	100894	1/1/0001
05800	S	M	CNT	II	02253	006		12	100894	1/1/0001
05800	S	M	CNT	II	02269	008		12	100894	1/1/0001
05800	S	M	CNT	III	02280	009		12	100894	1/1/0001

OFFICE: 311

ROUTE: 564

ST_REF_NO: 00000119800

MANHATTAN DRIVE

LUMENS	BULB TYPE	MULT SERIES	POLE TYPE	SHADE	ADDRESS NUMBER	REF	LOCATION	TAX DIST	DATE INST	DATE CHANGE
05800	S	M	OUG	II	00000	002	OPP. 381	12	091466	1/1/0001
05800	S	M	OUG	II	00000	003	OPP. 375	12	091466	1/1/0001
05800	S	M	OUG	II	00304	010		12	091466	1/1/0001
05800	S	M	OUG	II	00311	009		12	050169	1/1/0001
05800	S	M	OUG	II	00316	008		12	091466	1/1/0001
05800	S	M	OUG	II	00323	007		12	091466	1/1/0001
05800	S	M	OUG	II	00334	006		12	091466	1/1/0001
05800	S	M	OUG	II	00347	005		12	091466	1/1/0001
05800	S	M	OUG	II	00358	004		12	091466	1/1/0001
05800	S	M	OUG	II	00387	001		12	091466	1/1/0001

OFFICE: 311

ROUTE: 564

ST_REF_NO: 00000119900

MANITOBA LANE

LUMENS	BULB TYPE	MULT SERIES	POLE TYPE	SHADE	ADDRESS NUMBER	REF	LOCATION	TAX DIST	DATE INST	DATE CHANGE
04000	S	M	OUG	II	00113	056		12	110886	1/1/0001
04000	S	M	OUG	II	00000	020	SIDE OF 4116 BAFFIN BAY RD.	12	021579	1/1/0001
04000	S	M	OUG	II	00124	057		12	110886	1/1/0001
04000	S	M	OUG	II	00133	058		12	110886	1/1/0001
04000	S	M	OUG	II	00148	059		12	110886	1/1/0001
04000	S	M	OUG	II	00161	060		12	110886	1/1/0001
04000	S	M	OUG	II	00172	061		12	110886	1/1/0001
04000	S	M	OUG	II	00185	062		12	110886	1/1/0001
04000	S	M	OUG	II	00196	019		12	021579	1/1/0001

OFFICE: 311

ROUTE: 564

ST_REF_NO: 00000119950

MANNINGTON PLACE

LUMENS	BULB TYPE	MULT SERIES	POLE TYPE	SHADE	ADDRESS NUMBER	REF	LOCATION	TAX DIST	DATE INST	DATE CHANGE
05800	S	M	CNT	II	00617	003		12	113006	1/1/0001

OFFICE: 311

ROUTE: 564

ST_REF_NO: 00000120000

MANOR DRIVE

LUMENS	BULB TYPE	MULT SERIES	POLE TYPE	SHADE	ADDRESS NUMBER	REF	LOCATION	TAX DIST	DATE INST	DATE CHANGE
05800	S	M	OUG	II	00000	101	SIDE OF 445 LAKESHORE DR.	12	031475	1/1/0001
05800	S	M	OUG	V	02044	175		12	072574	1/1/0001
05800	S	M	OUG	II	02052	174		12	061475	1/1/0001
05800	S	M	OUG	II	02059	173		12	011581	1/1/0001
05800	S	M	OUG	II	02068	172		12	101674	1/1/0001
05800	S	M	OUG	II	02075	171		12	061475	1/1/0001
05800	S	M	OUG	II	02084	170		12	061475	1/1/0001
05800	S	M	OUG	II	02100	102		12	050172	1/1/0001
05800	S	M	OUG	II	00000	103	2 ND. LT. E. OF LAKESHORE DR., S. SIDE	12	050172	1/1/0001
05800	S	M	OUG	II	00000	104	1 ST. LT. E. OF LAKESHORE DR., N. SIDE	12	050172	1/1/0001
05800	S	M	OUG	II	00000	105	1 ST. LT. W. OF LAKETOWER DR., S. SIDE	12	050172	1/1/0001
05800	S	M	OUG	II	00000	106	1 ST. LT. W. OF LAKETOWER DR., N. SIDE	12	050172	1/1/0001

OFFICE: 311

ROUTE: 564

ST_REF_NO: 00000120005

MANSFIELD PLACE

LUMENS	BULB TYPE	MULT SERIES	POLE TYPE	SHADE	ADDRESS NUMBER	REF	LOCATION	TAX DIST	DATE INST	DATE CHANGE
05800	S	M	OUG	III	02201	199		12	040895	1/1/0001
05800	S	M	OUG	III	02209	198		12	040895	1/1/0001

OFFICE: 311

ROUTE: 564

ST_REF_NO: 00000120010

MANTILLA DRIVE

LUMENS	BULB TYPE	MULT SERIES	POLE TYPE	SHADE	ADDRESS NUMBER	REF	LOCATION	TAX DIST	DATE INST	DATE CHANGE
05800	S	M	CNT	II	03204	048		12	080897	1/1/0001
05800	S	M	CNT	II	03221	047		12	080897	1/1/0001
05800	S	M	CNT	II	03228	046		12	080897	1/1/0001
05800	S	M	CNT	II	03241	045		12	080897	1/1/0001
05800	S	M	CNT	II	03244	044		12	080897	1/1/0001
05800	S	M	CNT	II	03253	043		12	080897	1/1/0001
05800	S	M	CNT	II	03260	041		12	080897	1/1/0001

OFFICE: 311		ROUTE: 564		ST_REF_NO: 00000120010		MANTILLA DRIVE				
LUMENS	BULB TYPE	MULT SERIES	POLE TYPE	SHADE	ADDRESS NUMBER	REF	LOCATION	TAX DIST	DATE INST	DATE CHANGE
05800	S	M	CNT	II	03260	042		12	080897	1/1/0001
04000	S	M	OUG	II	03323	040		12	031581	1/1/0001
04000	S	M	OUG	II	03330	039		12	031581	1/1/0001
04000	S	M	OUG	II	03343	038		12	031581	1/1/0001
04000	S	M	OUG	II	03350	037		12	031581	1/1/0001
04000	S	M	OUG	II	03363	036		12	031581	1/1/0001
04000	S	M	OUG	II	03366	065		12	031581	1/1/0001
04000	S	M	OUG	II	03379	064		12	031581	1/1/0001
04000	S	M	OUG	II	03386	063		12	031581	1/1/0001
04000	S	M	OUG	II	03399	062		12	111581	1/1/0001

OFFICE: 311

ROUTE: 564

OFFICE: 311		ROUTE: 564		ST_REF_NO: 00000120025		MANY OAKS PARK				
LUMENS	BULB TYPE	MULT SERIES	POLE TYPE	SHADE	ADDRESS NUMBER	REF	LOCATION	TAX DIST	DATE INST	DATE CHANGE
05800	S	M	CNT	II	03000	001		12	080806	1/1/0001
05800	S	M	CNT	II	03017	002		12	080806	1/1/0001
05800	S	M	CNT	II	03036	003		12	080806	1/1/0001
05800	S	M	CNT	III	03057	004		12	080806	1/1/0001
05800	S	M	CNT	II	03073	006		12	080806	1/1/0001
05800	S	M	CNT	II	03088	005		12	080806	1/1/0001
05800	S	M	CNT	II	03092	007		12	080806	1/1/0001
05800	S	M	CNT	II	03105	008		12	080806	1/1/0001
05800	S	M	CNT	II	03120	009		12	080806	1/1/0001

OFFICE: 311

ROUTE: 564

OFFICE: 311		ROUTE: 564		ST_REF_NO: 00000120100		MAPLE AVENUE				
LUMENS	BULB TYPE	MULT SERIES	POLE TYPE	SHADE	ADDRESS NUMBER	REF	LOCATION	TAX DIST	DATE INST	DATE CHANGE
09500	S	M	SOH	II	00000	007	SIDE OF 218 E. SEVENTH ST.	12	062167	2/19/2013
09500	S	M	SOH	II	00624	005	bad fixture	12	010567	2/8/2011
09500	S	M	SOH	II	00627	006		12	010567	2/19/2013
10000	M	M	SOH	II	00000	014	SIDE OF 202 LOUDON AVE.	12	010567	1/1/0001
10000	M	M	SOH	II	00000	015	IN MEDIAN AT LOUDON AVE.	12	120869	1/1/0001
10000	M	M	SOH	II	00000	016	SIDE OF 201 LOUDON AVE.	12	010567	1/1/0001
10000	M	M	SOH	II	00000	017	SIDE OF 196 CASTLEWOOD DR.	12	010567	1/1/0001

OFFICE: 311

ROUTE: 564

ST_REF_NO: 00000120100

MAPLE AVENUE

LUMENS	BULB TYPE	MULT SERIES	POLE TYPE	SHADE	ADDRESS NUMBER	REF	LOCATION	TAX DIST	DATE INST	DATE CHANGE
10000	M	M	SOH	II	00000	018	BETWEEN CASTLEWOOD DR. & BRYAN AVE.	12	010567	1/1/0001
10000	M	M	SOH	II	00000	001	SIDE OF 227 E. SIXTH ST.	12	010567	1/1/0001
09500	S	M	SOH	II	00000	008	SIDE OF 217 E. SEVENTH ST-upgrade 1/08 DTS	12	010567	1/1/0001
09500	S	M	SOH	II	00000	013	OPP. 768 AT BELTLINE AVE. upgrade 6/08	12	010567	1/1/0001
05800	S	M	SOH	III	00463	047		12	120566	1/1/0001
10000	M	M	SOH	II	00605	002		12	010567	1/1/0001
10000	M	M	SOH	II	00612	003		12	010567	1/1/0001
10000	M	M	SOH	II	00615	004		12	010567	1/1/0001
09500	S	M	SOH	II	00709	009	upgrade-bad fixture	12	062167	1/1/0001
10000	M	M	SOH	II	00738	010		12	010567	1/1/0001
10000	M	M	SOH	II	00743	011		12	010567	1/1/0001
10000	M	M	SOH	II	00758	012		12	010567	1/1/0001
05800	S	M	SOH	III	00000	044	SIDE OF 235 E. FOURTH ST.	12	120566	1/1/0001
05800	S	M	SOH	III	00425	045		12	120566	1/1/0001
05800	S	M	SOH	III	00442	046		12	120566	1/1/0001

OFFICE: 311

ROUTE: 564

ST_REF_NO: 00000120220

MAPLELEAF DRIVE

LUMENS	BULB TYPE	MULT SERIES	POLE TYPE	SHADE	ADDRESS NUMBER	REF	LOCATION	TAX DIST	DATE INST	DATE CHANGE
09500	S	M	CNT	II	00000	001	1ST LT S OF MAN O WAR, E SIDE ON MAPLE LEAF DR	12	031402	1/1/0001
09500	S	M	CNT	II	00000	002	2ND LT S OF MAN O WAR, E SIDE ON MAPLE LEAF DR	12	031402	1/1/0001
09500	S	M	CNT	II	00000	003	3RD LT S OF MAN O WAR, E SIDE ON MAPLE LEAF DR	12	031402	1/1/0001
09500	S	M	CNT	II	00000	004	4TH LT S OF MAN O WAR, E SIDE ON MAPLE LEAF DR	12	031402	1/1/0001
09500	S	M	CNT	II	00000	005	5TH LT S OF MAN O WAR, E SIDE ON MAPLE LEAF DR	12	031402	1/1/0001
09500	S	M	CNT	II	00000	006	6TH LT S OF MAN O WAR, E SIDE ON MAPLE LEAF DR	12	031402	1/1/0001
09500	S	M	CNT	II	00000	007	7TH LT S OF MAN O WAR, E SIDE ON MAPLE LEAF DR	12	031402	1/1/0001
09500	S	M	CNT	II	00000	008	8TH LT S OF MAN O WAR, E SIDE ON MAPLE LEAF DR	12	031402	1/1/0001
09500	S	M	CNT	II	00000	009	9TH LT S OF MAN O WAR, E SIDE ON MAPLE LEAF DR	12	031402	1/1/0001

OFFICE: 311		ROUTE: 564		ST_REF_NO: 00000120220		MAPLELEAF DRIVE		LUMENS	BULB TYPE	MULT SERIES	POLE TYPE	SHADE	ADDRESS NUMBER	REF	LOCATION	TAX DIST	DATE INST	DATE CHANGE
09500	S	M	CNT	II	00000	010	10TH LT S OF MAN O WAR, E SIDE ON MAPLE LEAF DR	12	031402	1/1/0001								
09500	S	M	CNT	II	00000	011	11TH LT S OF MAN O WAR, E SIDE ON MAPLE LEAF DR	12	031402	1/1/0001								
09500	S	M	CNT	II	00000	012	12TH LT S OF MAN O WAR, E SIDE ON MAPLE LEAF DR	12	031402	1/1/0001								
09500	S	M	CNT	II	00000	013	13TH LT S OF MAN O WAR, E SIDE ON MAPLE LEAF DR	12	031402	1/1/0001								
09500	S	M	CNT	II	00000	014	14TH LT S OF MAN O WAR, E SIDE ON MAPLE LEAF DR	12	031402	1/1/0001								
05800	S	M	OUG	II	00000	001		12	020898	1/1/0001								
05800	S	M	OUG	II	00000	002		12	020898	1/1/0001								
05800	S	M	OUG	II	00000	003		12	020898	1/1/0001								

OFFICE: 311		ROUTE: 564		ST_REF_NO: 00000120230		MAPLELEAF PARK		LUMENS	BULB TYPE	MULT SERIES	POLE TYPE	SHADE	ADDRESS NUMBER	REF	LOCATION	TAX DIST	DATE INST	DATE CHANGE
05800	S	M	OUG	III	03001	004		12	020898	1/1/0001								
05800	S	M	OUG	II	03021	003		12	020898	1/1/0001								
05800	S	M	OUG	II	03032	005		12	020898	1/1/0001								
05800	S	M	OUG	II	03043	002		12	020898	1/1/0001								
05800	S	M	OUG	II	03056	006		12	020898	1/1/0001								
05800	S	M	OUG	II	03065	001		12	020898	1/1/0001								

OFFICE: 311		ROUTE: 564		ST_REF_NO: 00000120240		MAPLE RIDGE CIRCLE		LUMENS	BULB TYPE	MULT SERIES	POLE TYPE	SHADE	ADDRESS NUMBER	REF	LOCATION	TAX DIST	DATE INST	DATE CHANGE
05800	S	M	CNT	III	03708	002		12	060896	1/1/0001								
05800	S	M	CNT	II	03713	001		12	080896	1/1/0001								

OFFICE: 311		ROUTE: 564		ST_REF_NO: 00000120250		MAPLE RIDGE LANE		LUMENS	BULB TYPE	MULT SERIES	POLE TYPE	SHADE	ADDRESS NUMBER	REF	LOCATION	TAX DIST	DATE INST	DATE CHANGE
05800	S	M	CNT	III	00705	003		12	060896	1/1/0001								
05800	S	M	CNT	II	00717	002		12	060896	1/1/0001								
05800	S	M	CNT	II	00728	001		12	060896	1/1/0001								

OFFICE: 311

ROUTE: 564

ST_REF_NO: 00000120300

MAPLEWOOD DRIVE

LUMENS	BULB TYPE	MULT SERIES	POLE TYPE	SHADE	ADDRESS NUMBER	REF	LOCATION	TAX DIST	DATE INST	DATE CHANGE
04000	S	M	OUG	II	00000	040	SIDE OF 251 CLEARVIEW	12	121583	1/1/0001
04000	S	M	OUG	II	00000	045	SIDE OF 374 STRATFORD DR.	12	040766	1/1/0001
04000	S	M	OUG	II	00000	112	SIDE OF 224 BRADFORD DR.	12	121583	1/1/0001
04000	S	M	OUG	II	00000	124	IN FRONT OF HILL'N'DALE PARK	12	090968	1/1/0001
05800	S	M	OUG	II	02305	046	upgraded-bad fixture	12	060867	1/1/0001
04000	S	M	OUG	II	02318	047		12	051166	1/1/0001
04000	S	M	OUG	II	02331	048		12	060766	1/1/0001
04000	S	M	OUG	II	02342	049		12	060766	1/1/0001
04000	S	M	OUG	II	02400	125		12	090968	1/1/0001
04000	S	M	OUG	II	02441	126		12	090968	1/1/0001

OFFICE: 311

ROUTE: 564

ST_REF_NO: 00000120350

MARBELLA LANE

LUMENS	BULB TYPE	MULT SERIES	POLE TYPE	SHADE	ADDRESS NUMBER	REF	LOCATION	TAX DIST	DATE INST	DATE CHANGE
05800	S	M	CNT	II	00913	005		12	052703	1/1/0001
05800	S	M	CNT	II	00920	004		12	052703	1/1/0001
05800	S	M	CNT	II	00929	003		12	052703	1/1/0001
05800	S	M	CNT	II	00933	002		12	052703	1/1/0001
05800	S	M	CNT	II	00945	001		12	052703	1/1/0001

OFFICE: 311

ROUTE: 564

ST_REF_NO: 00000120430

MARBLEHEAD DRIVE

LUMENS	BULB TYPE	MULT SERIES	POLE TYPE	SHADE	ADDRESS NUMBER	REF	LOCATION	TAX DIST	DATE INST	DATE CHANGE
05800	S	M	OUG	II	00000	005	SIDE OF 669 KINGSBURY RD.	12	080800	1/1/0001
05800	S	M	OUG	II	00857	004		12	080800	1/1/0001
05800	S	M	OUG	II	00868	003		12	080800	1/1/0001
05800	S	M	OUG	II	00889	002		12	080800	1/1/0001
05800	S	M	OUG	III	00896	001		12	080800	1/1/0001

OFFICE: 311

ROUTE: 564

ST_REF_NO: 00000120450

MARBLEROCK WAY

LUMENS	BULB TYPE	MULT SERIES	POLE TYPE	SHADE	ADDRESS NUMBER	REF	LOCATION	TAX DIST	DATE INST	DATE CHANGE
05800	S	M	OUG	II	00000	014	SIDE REAR OF 416	12	100896	1/1/0001
05800	S	M	OUG	II	00368	020		12	100896	1/1/0001

OFFICE: 311

ROUTE: 564

ST_REF_NO: 00000120450

MARBLEROCK WAY

LUMENS	BULB TYPE	MULT SERIES	POLE TYPE	SHADE	ADDRESS NUMBER	REF	LOCATION	TAX DIST	DATE INST	DATE CHANGE
05800	S	M	OUG	II	00373	017		12	100896	1/1/0001
05800	S	M	OUG	II	00376	019		12	100896	1/1/0001
05800	S	M	OUG	II	00384	018		12	100896	1/1/0001
05800	S	M	OUG	II	00393	015		12	100896	1/1/0001
05800	S	M	OUG	II	00408	016		12	100896	1/1/0001
04000	S	M	OUG	II	00421	013		12	110891	1/1/0001
04000	S	M	OUG	II	00448	012		12	110891	1/1/0001
04000	S	M	OUG	II	00449	011		12	110891	1/1/0001
04000	S	M	OUG	II	00460	010		12	110891	1/1/0001
04000	S	M	OUG	II	00469	009		12	110891	1/1/0001
04000	S	M	OUG	II	00480	008		12	110891	1/1/0001
04000	S	M	OUG	II	00493	007		12	110891	1/1/0001
04000	S	M	OUG	II	00500	001		12	110891	1/1/0001
04000	S	M	OUG	II	00513	002		12	110891	1/1/0001
04000	S	M	OUG	II	00520	003		12	110891	1/1/0001
04000	S	M	OUG	II	00537	004		12	110891	1/1/0001
04000	S	M	OUG	II	00544	005		12	110891	1/1/0001
04000	S	M	OUG	II	00557	006		12	110891	1/1/0001

OFFICE: 311

ROUTE: 564

ST_REF_NO: 00000120500

MARCELLUS DRIVE

LUMENS	BULB TYPE	MULT SERIES	POLE TYPE	SHADE	ADDRESS NUMBER	REF	LOCATION	TAX DIST	DATE INST	DATE CHANGE
09500	S	M	OUG	II	01007	019	upgraded 2/08	12	031563	1/1/0001
09500	S	M	OUG	II	01022	020	upgraded 2/08	12	050163	1/1/0001
09500	S	M	OUG	II	01043	018	upgraded 2/08	12	012974	1/1/0001
09500	S	M	OUG	II	01054	088	upgraded 2/08	12	110863	1/1/0001
09500	S	M	OUG	II	00000	083	SIDE OF 663 LOUDON AVE.-upgraded 2/08	12	110863	1/1/0001
09500	S	M	OUG	II	00000	086	SIDE OF 1112 HIGHLAND PARK DR.upgraded 2/08	12	110863	1/1/0001
09500	S	M	OUG	II	00802	000	upgraded 2/08	12	062267	1/1/0001
09500	S	M	OUG	II	00817	000	upgraded 2/08	12	041763	1/1/0001
09500	S	M	OUG	II	00836	000	upgraded 2/08	12	041763	1/1/0001
09500	S	M	OUG	I	00852	000	upgraded 2/08	12	083051	1/1/0001
09500	S	M	OUG	II	00868	000	upgraded 2/08	12	010465	1/1/0001
09500	S	M	OUG	II	00902	087	upgraded 2/08	12	110863	1/1/0001

OFFICE: 311

ROUTE: 564

ST_REF_NO: 00000120500

MARCELLUS DRIVE

LUMENS	BULB TYPE	MULT SERIES	POLE TYPE	SHADE	ADDRESS NUMBER	REF	LOCATION	TAX DIST	DATE INST	DATE CHANGE
09500	S	M	OUG	II	00915	000	upgraded 2/08	12	060468	1/1/0001
09500	S	M	OUG	II	00930	000	upgraded 2/08	12	051165	1/1/0001
09500	S	M	OUG	II	00947	015	upgraded 2/08	12	040163	1/1/0001
09500	S	M	OUG	II	00962	016	upgraded 2/08	12	031563	1/1/0001
09500	S	M	OUG	II	00983	017	upgraded 2/08	12	040163	1/1/0001
09500	S	M	OUG	II	00998	000	upgraded 2/08	12	100164	1/1/0001

OFFICE: 311

ROUTE: 564

ST_REF_NO: 00000120550

MARCO LANE

LUMENS	BULB TYPE	MULT SERIES	POLE TYPE	SHADE	ADDRESS NUMBER	REF	LOCATION	TAX DIST	DATE INST	DATE CHANGE
05800	S	M	CNT	II	00000	001	SIDE OF 3409 SANIBEL DR.	12	070896	1/1/0001
05800	S	M	CNT	II	01004	002		12	070896	1/1/0001
05800	S	M	CNT	II	01021	003		12	070896	1/1/0001
05800	S	M	CNT	II	01032	004		12	070896	1/1/0001

OFFICE: 311

ROUTE: 564

ST_REF_NO: 00000120560

MARCUS TRAIL

LUMENS	BULB TYPE	MULT SERIES	POLE TYPE	SHADE	ADDRESS NUMBER	REF	LOCATION	TAX DIST	DATE INST	DATE CHANGE
05800	S	M	CNT	II	00000	001	1ST LT E OF HAYS BLVD, S SIDE ON MARCUS TRAIL	12	061606	1/1/0001
05800	S	M	CNT	II	00000	002	2ND LT E OF HAYS BLVD, S SIDE ON MARCUS TRAIL	12	061606	1/1/0001
05800	S	M	CNT	II	00000	003	SIDE OF 4501 PARSONS LANE ON MARCUS TRAIL	12	061606	1/1/0001
05800	S	M	CNT	II	00000	004	SIDE OF 4500 PARSONS LANE ON MARCUS TRAIL	12	061606	1/1/0001
05800	S	M	CNT	II	00000	005	1ST LT E OF HAYS BLVD, N SIDE ON MARCUS TRAIL	12	061606	1/1/0001
05800	S	M	CNT	II	00000	020	1ST LT W OF LOTUS LN, S SIDE ON MARCUS TRAIL	12	051107	1/1/0001
05800	S	M	CNT	II	00000	021	1ST LT E OF LOTUS LN, S SIDE ON MARCUS TRAIL	12	051107	1/1/0001
05800	S	M	CNT	II	00000	022	2ND LT E OF LOTUS LN, S SIDE ON MARCUS TRAIL	12	051107	1/1/0001
05800	S	M	CNT	II	00000	023	3RD LT E OF LOTUS LN, S SIDE ON MARCUS TRAIL	12	051107	1/1/0001
05800	S	M	CNT	II	00000	024	4TH LT E OF LOTUS LN, N SIDE ON MARCUS TRAIL	12	051107	1/1/0001
05800	S	M	CNT	II	00000	025	5TH LT E OF LOTUS LN, N SIDE ON MARCUS TRAIL	12	051107	1/1/0001
05800	S	M	CNT	II	00000	026	ACROSS FROM MAXON LANE ON MARCUS TRAIL	12	051107	1/1/0001

OFFICE: 311

ROUTE: 564

ST_REF_NO: 00000120600

MARGATE DRIVE

LUMENS	BULB TYPE	MULT SERIES	POLE TYPE	SHADE	ADDRESS NUMBER	REF	LOCATION	TAX DIST	DATE INST	DATE CHANGE
05800	S	M	OUG	II	01654	000		12	021866	1/1/0001
05800	S	M	OUG	II	01665	000		12	060164	1/1/0001
05800	S	M	OUG	II	01680	000		12	060164	1/1/0001
05800	S	M	OUG	II	01693	000		12	060164	1/1/0001

OFFICE: 311

ROUTE: 564

ST_REF_NO: 00000120800

MARIETTA DRIVE

LUMENS	BULB TYPE	MULT SERIES	POLE TYPE	SHADE	ADDRESS NUMBER	REF	LOCATION	TAX DIST	DATE INST	DATE CHANGE
05800	S	M	OUG	II	00000	160	SIDE OF 1433 ANNISTON DR.	12	090766	1/1/0001
05800	S	M	OUG	II	00000	161	SIDE OF 1424 ANNISTON DR.	12	090766	1/1/0001
05800	S	M	OUG	II	01815	167		12	090766	1/1/0001
05800	S	M	OUG	II	01838	166		12	090766	1/1/0001
05800	S	M	OUG	II	01851	165		12	090766	1/1/0001
05800	S	M	OUG	II	01872	164		12	090766	1/1/0001
05800	S	M	OUG	II	01885	163		12	090766	1/1/0001
05800	S	M	OUG	II	01896	162		12	090766	1/1/0001
05800	S	M	OUG	V	01937	159		12	080169	1/1/0001

OFFICE: 311

ROUTE: 564

ST_REF_NO: 00000120810

MARIPOSA COURT

LUMENS	BULB TYPE	MULT SERIES	POLE TYPE	SHADE	ADDRESS NUMBER	REF	LOCATION	TAX DIST	DATE INST	DATE CHANGE
05800	S	M	OUG	IV	03809	001		12	030895	1/1/0001

OFFICE: 311

ROUTE: 564

ST_REF_NO: 00000120900

MARK AVENUE

LUMENS	BULB TYPE	MULT SERIES	POLE TYPE	SHADE	ADDRESS NUMBER	REF	LOCATION	TAX DIST	DATE INST	DATE CHANGE
05800	S	M	OUG	II	00000	001	SIDE OF 1885 SANDERSVILLE RD ON MARK AVENUE	12	012202	1/1/0001
05800	S	M	OUG	II	00000	002	SIDE OF 1889 ARBOR STATION DR ON MARK AVENUE	12	012202	1/1/0001
05800	S	M	OUG	II	01949	003		12	012202	1/1/0001
04000	S	M	OUG	II	00000	021	SIDE OF 1065 HUDSON AVE.	12	051477	1/1/0001
04000	S	M	OUG	II	00000	042	SIDE OF 1999 KNIGHT LANE	12	051477	1/1/0001
04000	S	M	OUG	II	01959	037		12	051477	1/1/0001
04000	S	M	OUG	II	01970	036		12	051477	1/1/0001

OFFICE: 311

ROUTE: 564

ST_REF_NO: 00000120900

MARK AVENUE

LUMENS	BULB TYPE	MULT SERIES	POLE TYPE	SHADE	ADDRESS NUMBER	REF	LOCATION	TAX DIST	DATE INST	DATE CHANGE
04000	S	M	OUG	II	01990	039		12	051477	1/1/0001
04000	S	M	OUG	II	02000	040		12	051477	1/1/0001
04000	S	M	OUG	II	02021	041		12	051477	1/1/0001

OFFICE: 311

ROUTE: 564

ST_REF_NO: 00000121000

MARKET STREET

LUMENS	BULB TYPE	MULT SERIES	POLE TYPE	SHADE	ADDRESS NUMBER	REF	LOCATION	TAX DIST	DATE INST	DATE CHANGE
09500	S		ACD	II	00000	006	1ST LT S OF 2ND ST, W SIDE ON MARKET ST	12	101409	1/1/0001
09500	S	M	ACD	III	00000	007	1ST LT. N. OF SECOND ST., W. SIDE	12	020898	2/8/1998
09500	S	M	ACD	III	00000	008	2ND LT. N. OF SECOND ST., W. SIDE	12	020898	2/8/1998
09500	S	M	ACD	III	00000	009	3RD LT. N. OF SECOND ST., W. SIDE	12	020898	2/8/1998
09500	S	M	ACD	III	00000	010	4TH LT. N. OF SECOND ST., W. SIDE	12	020898	2/8/1998
09500	S	M	ACD	III	00000	011	5TH LT. N. OF SECOND ST., W. SIDE	12	020898	2/8/1998
09500	S	M	ACD	III	00000	012	6TH LT. N. OF SECOND ST., W. SIDE	12	020898	2/8/1998
20000	M	M	SOH	III	00000	001	1ST LT. N. OF SHORT ST., W. SIDE	12	102061	1/1/0001
20000	M	M	SOH	III	00000	002	1ST LT. N. OF SHORT ST., E. SIDE	12	102061	1/1/0001
20000	M	M	SOH	III	00000	003	2ND LT. N. OF SHORT ST., W. SIDE	12	102061	1/1/0001
10000	M	M	SOH	II	00000	004	1ST LT. N. OF CHURCH ST., E. SIDE	12	011863	1/1/0001
10000	M	M	SOH	II	00176	005		12	011863	1/1/0001

OFFICE: 311

ROUTE: 564

ST_REF_NO: 00000121050

MARKET GARDEN LANE

LUMENS	BULB TYPE	MULT SERIES	POLE TYPE	SHADE	ADDRESS NUMBER	REF	LOCATION	TAX DIST	DATE INST	DATE CHANGE
05800	S	M	CNT	II	00000	002	SIDE OF 2944 POLO CLUB BLVD ON MARKET GARDEN LANE	12	100505	1/1/0001
05800	S	M	CNT	II	00000	010	SIDE OF 3001 OLD HOUSE RD ON MARKET GARDEN LANE	12	100505	1/1/0001
05800	S	M	CNT	II	00000	011	SIDE OF 3000 OLD HOUSE RD ON MARKET GARDEN LANE	12	100505	1/1/0001
05800	S	M	CNT	III	02113	017		12	100505	1/1/0001
05800	S	M	CNT	II	02116	016		12	100505	1/1/0001
05800	S	M	CNT	II	02137	015		12	100505	1/1/0001
05800	S	M	CNT	II	02148	014		12	100505	1/1/0001
05800	S	M	CNT	II	02165	013		12	100505	1/1/0001
05800	S	M	CNT	II	02180	012		12	100505	1/1/0001

OFFICE: 311		ROUTE: 564		ST_REF_NO: 00000121050		MARKET GARDEN LANE				
LUMENS	BULB TYPE	MULT SERIES	POLE TYPE	SHADE	ADDRESS NUMBER	REF	LOCATION	TAX DIST	DATE INST	DATE CHANGE
05800	S	M	CNT	II	02232	009		12	100505	1/1/0001
05800	S	M	CNT	II	02257	008		12	100505	1/1/0001
05800	S	M	CNT	II	02261	007		12	100505	1/1/0001
05800	S	M	CNT	II	02269	006		12	100505	1/1/0001
05800	S	M	CNT	II	02284	005		12	100505	1/1/0001
05800	S	M	CNT	II	02301	004		12	100505	1/1/0001
05800	S	M	CNT	II	02316	003		12	100505	1/1/0001
05800	S	M	CNT	II	02328	001		12	100505	1/1/0001

OFFICE: 311		ROUTE: 564		ST_REF_NO: 00000121100		MARKHAM COURT				
LUMENS	BULB TYPE	MULT SERIES	POLE TYPE	SHADE	ADDRESS NUMBER	REF	LOCATION	TAX DIST	DATE INST	DATE CHANGE
05800	S	M	OUG	II	02217	000		12	060867	1/1/0001
05800	S	M	OUG	II	02228	000		12	060170	1/1/0001

OFFICE: 311		ROUTE: 564		ST_REF_NO: 00000121175		MARLBERRY PLACE				
LUMENS	BULB TYPE	MULT SERIES	POLE TYPE	SHADE	ADDRESS NUMBER	REF	LOCATION	TAX DIST	DATE INST	DATE CHANGE
05800	S		CNT	II	00000	001	SIDE OF 700 MAIDENCANE DR, ON MARLBERRY PL	12	061710	1/1/0001
05800	S		CNT	II	00000	004	SIDE OF 617 TALLOW COURT, ON MARLBERRY PLACE	12	061710	1/1/0001
05800	S		CNT	II	04612	002		12	061710	1/1/0001
05800	S		CNT	II	04613	003		12	061710	1/1/0001
05800	S		CNT	II	04637	005		12	061710	1/1/0001
05800	S		CNT	II	04641	006		12	061710	1/1/0001
05800	S		CNT	II	04661	008		12	061710	1/1/0001

OFFICE: 311		ROUTE: 564		ST_REF_NO: 00000121300		MARLBORO DRIVE				
LUMENS	BULB TYPE	MULT SERIES	POLE TYPE	SHADE	ADDRESS NUMBER	REF	LOCATION	TAX DIST	DATE INST	DATE CHANGE
05800	S	M	OUG	II	01802	000		12	120169	1/1/0001
05800	S	M	OUG	II	01815	000		12	040171	1/1/0001
05800	S	M	OUG	II	01831	000		12	040171	1/1/0001
05800	S	M	OUG	II	01842	000		12	120169	1/1/0001
05800	S	M	OUG	II	01855	000		12	100169	1/1/0001

OFFICE: 311

ROUTE: 564

ST_REF_NO: 00000121300

MARLBORO DRIVE

LUMENS	BULB TYPE	MULT SERIES	POLE TYPE	SHADE	ADDRESS NUMBER	REF	LOCATION	TAX DIST	DATE INST	DATE CHANGE
05800	S	M	OUG	II	01862	000		12	100169	1/1/0001
05800	S	M	OUG	II	01879	000		12	040171	1/1/0001
05800	S	M	OUG	II	01890	000		12	100169	1/1/0001

OFFICE: 311

ROUTE: 564

ST_REF_NO: 00000121400

MARNE AVENUE

LUMENS	BULB TYPE	MULT SERIES	POLE TYPE	SHADE	ADDRESS NUMBER	REF	LOCATION	TAX DIST	DATE INST	DATE CHANGE
04000	S	M	SOH	II	00000	021	SIDE 328 RICHMOND AVE.	12	050885	1/1/0001
04000	S	M	SOH	II	00108	022		12	050885	1/1/0001
04000	S	M	SOH	II	00115	053		12	020885	1/1/0001

OFFICE: 311

ROUTE: 564

ST_REF_NO: 00000121450

MARQUIS AVENUE

LUMENS	BULB TYPE	MULT SERIES	POLE TYPE	SHADE	ADDRESS NUMBER	REF	LOCATION	TAX DIST	DATE INST	DATE CHANGE
09500	S	M	SOH	II	00000	400	ACROSS FROM MCCAWS ALLEY ON MARQUIS AVENUE	12	010606	1/1/0001
04000	S	M	SOH	I	00000	662	OPPOSITE 407	12	102367	9/9/2009
04000	S	M	SOH	I	00000	664	SIDE OF 490 ASHLAND TERRACE	12	102367	9/9/2009
05800	S	M	SOH	I	00000	667	SIDE OF 701 SUNSET	12	102367	9/9/2009
04000	S	M	SOH	I	00424	663		12	102367	9/9/2009
04000	S	M	SOH	I	00436	665		12	102367	9/9/2009
09500	S	M	SOH	II	00444	300		12	010606	1/1/0001
04000	S	M	SOH	I	00448	666		12	102367	9/9/2009
04000	S	M	SOH	I	502	668		12	102367	9/9/2009

OFFICE: 311

ROUTE: 564

ST_REF_NO: 00000121500

MARSHALL LANE

LUMENS	BULB TYPE	MULT SERIES	POLE TYPE	SHADE	ADDRESS NUMBER	REF	LOCATION	TAX DIST	DATE INST	DATE CHANGE
05800	S	M	OUG	II	00632	000		12	060464	1/1/0001
05800	S	M	OUG	II	00643	000		12	060464	1/1/0001
05800	S	M	OUG	II	00660	000		12	060464	1/1/0001
05800	S	M	OUG	II	00671	034		12	040664	1/1/0001
05800	S	M	OUG	II	00000	028	SIDE OF 2345 ALLEN DR.	12	040664	1/1/0001
05800	S	M	OUG	II	00615	000		12	060464	1/1/0001

OFFICE: 311		ROUTE: 564		ST_REF_NO: 00000121600		MARTHA COURT		LUMENS	BULB TYPE	MULT SERIES	POLE TYPE	SHADE	ADDRESS NUMBER	REF	LOCATION	TAX DIST	DATE INST	DATE CHANGE
05800	S	M	OUG	II	01578	000										12	072474	1/1/0001
05800	S	M	OUG	II	01586	000										12	072474	1/1/0001
05800	S	M	OUG	II	01598	000										12	072474	1/1/0001
05800	S	M	OUG	II	01600	000										12	082573	1/1/0001
09500	S	M	OUG	II	01603	052										12	062364	1/1/0001

OFFICE: 311		ROUTE: 564		ST_REF_NO: 00000121700		MARTIN STREET		LUMENS	BULB TYPE	MULT SERIES	POLE TYPE	SHADE	ADDRESS NUMBER	REF	LOCATION	TAX DIST	DATE INST	DATE CHANGE
05800	S	M	SOH	II	01162	002										12	091707	1/1/0001
05800	S	M	SOH	I	01158	000										12	050162	1/1/0001

OFFICE: 311		ROUTE: 564		ST_REF_NO: 00000121800		MARTIN COURT		LUMENS	BULB TYPE	MULT SERIES	POLE TYPE	SHADE	ADDRESS NUMBER	REF	LOCATION	TAX DIST	DATE INST	DATE CHANGE
04000	S	M	SOH	II	00000	035									SIDE 137 PARIS AVE.	12	060685	1/1/0001
04000	S	M	SOH	II	01403	036										12	060685	1/1/0001

OFFICE: 311		ROUTE: 564		ST_REF_NO: 00000121850		MARTIN LUTHER KING BLVD, SOUTH		LUMENS	BULB TYPE	MULT SERIES	POLE TYPE	SHADE	ADDRESS NUMBER	REF	LOCATION	TAX DIST	DATE INST	DATE CHANGE
22000	S	M	OOH	II	00000	002									SIDE OF 151 E. MAXWELL ST. upgrade per city req		030169	10/8/2009
22000	S	M	SOH	II	00000	003									SIDE OF 158 E. MAXWELL ST. upgrade per city req	12	100168	10/8/2009
09500	S	M	OUG	II	00000	100									4th LT S OF E HIGH ST, EAST SIDE ON MLK BLVD	12	012208	1/1/0001
09500	S	M	OUG	II	00000	101									5th LT S OF E HIGH ST, EAST SIDE ON MLK BLVD	12	012208	1/1/0001
09500	S	M	OUG	II	00000	102									6th LT S OF E HIGH ST, EAST SIDE ON MLK BLVD	12	012208	1/1/0001
09500	S	M	OOH	II	00000	001									SIDE OF 151 E. MAXWELL ST. AT RHODES AVE.	12	030169	1/1/0001
09500	S	M	SOH	II	00000	004									2ND LT S OF MAXWELL ST., E. SIDE-6/08	12	050172	1/1/0001
09500	S	M	SOH	II	00000	005									OPPOSITE GOOD SAMARITAN HOSPITAL ENTRANCE	12	100168	1/1/0001
09500	S	M	SOH	II	00000	006									3RD LT. N. OF EUCLID AVE., W. SIDE	12	030169	1/1/0001
09500	S	M	OOH	II	00000	009									2ND LT. N. OF EUCLID AVE., E. SIDE	12	030169	1/1/0001
09500	S	M	SOH	II	00000	010									1ST. LT. N. OF EUCLID AVE., W. SIDE	12	100168	1/1/0001
09500	S	M	SOH	II	00000	011									1ST. LT. N. OF EUCLID AVE., E. SIDE	12	100168	1/1/0001
09500	S	M	OUG	IV	00000	019									CITY PARKING LOT	12	050157	1/1/0001

OFFICE: 311

ROUTE: 564

ST_REF_NO: 00000121850

MARTIN LUTHER KING BLVD, SOUTH

LUMENS	BULB TYPE	MULT SERIES	POLE TYPE	SHADE	ADDRESS NUMBER	REF	LOCATION	TAX DIST	DATE INST	DATE CHANGE
09500	S	M	OUG	II	00000	020	5TH LT. N. OF MAXWELL ST., E. SIDE	12	102253	1/1/0001
09500	S	M	OUG	II	00000	021	6TH LT. N. OF MAXWELL ST., E. SIDE	12	102253	1/1/0001
22000	S	M	CNT	II	00000	022	1ST LT S OF E HIGH ON EASTSIDE OF SOUTH M.L.K.BLVD	12	120890	1/1/0001
22000	S	M	CNT	II	00000	023	1ST LT N OF E HIGH ON WESTSIDE OF SOUTH M.L.K.BLVD	12	120890	1/1/0001
22000	S	M	CNT	II	00000	024	1ST LT N OF E HIGH ON EASTSIDE OF SOUTH M.L.K.BLVD	12	120890	1/1/0001
22000	S	M	CNT	II	00000	025	3RD LT S OF E MAIN ON WESTSIDE OF SOUTH M.L.K.BLVD	12	120890	1/1/0001
22000	S	M	CNT	II	00000	026	3RD LT S OF E MAIN ON EASTSIDE OF SOUTH M.L.K.BLVD	12	120890	1/1/0001
22000	S	M	CNT	II	00000	027	2ND LT S OF E MAIN ON WESTSIDE OF SOUTH M.L.K.BLVD	12	120890	1/1/0001
22000	S	M	CNT	II	00000	028	2ND LT S OF E MAIN ON EASTSIDE OF SOUTH M.L.K.BLVD	12	120890	1/1/0001
22000	S	M	CNT	II	00000	029	1ST LT S OF E MAIN ON WESTSIDE OF SOUTH M.L.K.BLVD	12	120890	1/1/0001
22000	S	M	CNT	II	00000	030	1ST LT S OF E MAIN ON EASTSIDE OF SOUTH M.L.K.BLVD	12	120890	1/1/0001
09500	S	M	OOH	II	00000	031	OPP. (UK) KEENELAND DR.		010893	1/1/0001

OFFICE: 311

ROUTE: 564

ST_REF_NO: 00000122000

MARYLAND AVENUE

LUMENS	BULB TYPE	MULT SERIES	POLE TYPE	SHADE	ADDRESS NUMBER	REF	LOCATION	TAX DIST	DATE INST	DATE CHANGE
09500	S		SOH	II	00000	051	SIDE OF 256 NEWTOWN PK ON MARYLAND AVE	12	032813	1/1/0001
09500	S		SOH	II	00569	050		12	032813	1/1/0001
05800	S	M	SOH	II	00503	000		12	010163	1/1/0001
05800	S	M	SOH	II	00514	000		12	010163	1/1/0001
05800	S	M	SOH	II	00533	000		12	010163	1/1/0001
05800	S	M	SOH	II	00546	000		12	010163	1/1/0001
05800	S	M	SOH	II	00560	000		12	010163	1/1/0001

OFFICE: 311

ROUTE: 564

ST_REF_NO: 00000122100

MASON HEADLEY ROAD

LUMENS	BULB TYPE	MULT SERIES	POLE TYPE	SHADE	ADDRESS NUMBER	REF	LOCATION	TAX DIST	DATE INST	DATE CHANGE
22000	S	M	OUG	II	00000	062	1ST LT E OF FAIRCREST DR ON MASON HEADLEY RD	12	100101	1/1/0001
22000	S	M	OUG	II	00000	063	2ND LT E OF FAIRCREST DR ON MASON HEADLEY RD	12	100101	1/1/0001
09500	S	M	OUG	II	00000	065	3RD LT E OF FAIRCREST DR ON MASON HEADLEY RD	12	100101	1/1/0001
09500	S	M	OUG	II	00000	066	4TH LT E OF FAIRCREST DR ON MASON HEADLEY RD	12	100101	1/1/0001
09500	S	M	OUG	II	00000	067	5TH LT E OF FAIRCREST DR ON MASON HEADLEY RD	12	100101	1/1/0001
09500	S	M	OUG	II	00000	068	6TH LT E OF FAIRCREST DR ON MASON HEADLEY RD	12	100101	1/1/0001
09500	S	M	OUG	II	00000	069	7TH LT E OF FAIRCREST DR ON MASON HEADLEY RD	12	100101	1/1/0001
09500	S	M	OUG	II	00700	070		12	100101	1/1/0001
09500	S	M	OUG	II	00700	071		12	100101	1/1/0001
09500	S	M	OUG	II	00700	072		12	100101	1/1/0001
09500	S	M	OUG	II	00700	073		12	100101	1/1/0001
09500	S	M	OUG	II	00000	029	OPP. 938	12	070889	1/1/0001
09500	S	M	OUG	II	00000	040	N.W. CORNER THE LANE AND MASON HEADLEY	12	080888	1/1/0001
09500	S	M	OUG	II	00000	041	N.E. CORNER DUNTREATH DR. AND MASON HEADLEY	12	080888	1/1/0001
09500	S	M	OUG	II	00000	042	2ND LT. N. OF DUNTREATH DR., E. SIDE	12	110889	1/1/0001
09500	S	M	OUG	II	00000	043	3RD LT. N. OF DUNTREATH DR., E. SIDE	12	110889	1/1/0001
09500	S	M	OUG	II	00000	044	4TH LT. N. OF DUNTREATH DR., E. SIDE	12	110889	1/1/0001
09500	S	M	OUG	II	00000	045	1ST LT. N. OF DUNTREATH DR., W. SIDE	12	110889	1/1/0001
09500	S	M	OUG	II	00000	046	5TH LT. N. OF DUNTREATH DR., E. SIDE	12	110889	1/1/0001
09500	S	M	OUG	II	00000	047	2ND LT. N. OF DUNTREATH DR., W. SIDE	12	110889	1/1/0001
09500	S	M	OUG	II	00000	048	6TH LT. N. OF DUNTREATH DR., E. SIDE	12	110889	1/1/0001
09500	S	M	OUG	II	00000	049	3RD LT. N. OF DUNTREATH DR., W. SIDE	12	110889	1/1/0001
09500	S	M	OUG	II	00000	050	7TH LT. N. OF DUNTREATH DR., E. SIDE	12	110889	1/1/0001
09500	S	M	OUG	II	00000	051	4TH LT. N. OF DUNTREATH DR., W. SIDE	12	110889	1/1/0001
22000	S	M	OUG	II	00000	052	8TH LT. N. OF DUNTREATH DR., E. SIDE	12	110889	1/1/0001
22000	S	M	OUG	II	00000	053	5TH LT. S. OF VERSAILLES RD., W. SIDE	12	110889	1/1/0001
22000	S	M	OUG	II	00000	054	4TH LT. S. OF VERSAILLES RD., W. SIDE	12	110889	1/1/0001
22000	S	M	OUG	II	00000	055	3RD LT. S. OF VERSAILLES RD., W. SIDE	12	110889	1/1/0001

Street Light Listing run 1/11/2015 10:43:21 AM

Page 707 of 1254

OFFICE: 311

ROUTE: 564

ST_REF_NO: 00000122100

MASON HEADLEY ROAD

LUMENS	BULB TYPE	MULT SERIES	POLE TYPE	SHADE	ADDRESS NUMBER	REF	LOCATION	TAX DIST	DATE INST	DATE CHANGE
22000	S	M	OUG	II	00000	056	2ND LT. S. OF VERSAILLES RD., W. SIDE	12	110889	1/1/0001
09500	S	M	OUG	II	00000	057	1ST LT. S OF VERSAILLES ROAD, WESTSIDE	12	020897	1/1/0001
09500	S	M	OUG	II	00808	006		12	080888	1/1/0001
09500	S	M	OUG	II	00816	007		12	080888	1/1/0001
09500	S	M	OUG	II	00824	008		12	080888	1/1/0001
09500	S	M	OUG	II	00832	009		12	080888	1/1/0001
09500	S	M	OUG	II	00840	010		12	080888	1/1/0001
09500	S	M	OUG	II	00848	011		12	080888	1/1/0001
09500	S	M	OUG	II	00856	012		12	080888	1/1/0001
09500	S	M	OUG	II	00864	013		12	080888	1/1/0001
09500	S	M	OUG	II	00872	014		12	080888	1/1/0001
09500	S	M	OUG	II	00880	015		12	080888	1/1/0001
09500	S	M	OUG	II	00888	016		12	080888	1/1/0001
09500	S	M	OUG	II	00888	017		12	080888	1/1/0001
09500	S	M	OUG	II	00894	018		12	080888	1/1/0001
09500	S	M	OUG	II	00898	019		12	080888	1/1/0001
09500	S	M	OUG	II	00901	020		12	020889	1/1/0001
09500	S	M	OUG	II	00904	021		12	020889	1/1/0001
09500	S	M	OUG	II	00910	022		12	020889	1/1/0001
09500	S	M	OUG	II	00913	024		12	020889	1/1/0001
09500	S	M	OUG	II	00914	023		12	020889	1/1/0001
09500	S	M	OUG	II	00921	026		12	070889	1/1/0001
09500	S	M	OUG	II	00922	025		12	070889	1/1/0001
09500	S	M	OUG	II	00925	027		12	070889	1/1/0001
09500	S	M	OUG	II	00929	028		12	070889	1/1/0001
09500	S	M	OUG	II	00937	030		12	070889	1/1/0001
09500	S	M	OUG	II	00946	031		12	070889	1/1/0001
09500	S	M	OUG	II	00946	032		12	080888	1/1/0001
09500	S	M	OUG	II	00953	036		12	080888	1/1/0001
09500	S	M	OUG	II	00954	033		12	080888	1/1/0001
09500	S	M	OUG	II	00957	037		12	080888	1/1/0001
09500	S	M	OUG	II	00957	038		12	080888	1/1/0001
09500	S	M	OUG	II	00958	034		12	080888	1/1/0001
09500	S	M	OUG	II	00961	039		12	080888	1/1/0001

OFFICE: 311		ROUTE: 564		ST_REF_NO: 00000122100		MASON HEADLEY ROAD				
LUMENS	BULB TYPE	MULT SERIES	POLE TYPE	SHADE	ADDRESS NUMBER	REF	LOCATION	TAX DIST	DATE INST	DATE CHANGE
09500	S	M	OUG	II	00962	035		12	080888	1/1/0001
09500	S	M	OUG	II	00000	001	4TH LT. E. OF COLD HARBOR DR., S. SIDE	12	080888	1/1/0001
09500	S	M	OUG	II	00000	002	3RD LT. E. OF COLD HARBOR DR., S. SIDE	12	080888	1/1/0001
09500	S	M	OUG	II	00000	003	2ND LT. E. OF COLD HARBOR DR., S. SIDE	12	080888	1/1/0001
09500	S	M	OUG	II	00000	058	5TH LT. E OF COLD HARBOR DRIVE, SOUTHSIDE	12	020897	1/1/0001
09500	S	M	OUG	II	00000	059	6TH LT. E OF COLD HARBOR DRVIE, SOUTHSIDE	12	020897	1/1/0001
09500	S	M	OUG	II	00000	060	7TH LT. E OF COLD HARBOR DRIVE, SOUTHSIDE	12	020897	1/1/0001
09500	S	M	OUG	II	00000	061	8TH LT. E OF COLD HARBOR DRIVE, SOUTHSIDE	12	020897	1/1/0001
09500	S	M	OUG	II	00798	004		12	080888	1/1/0001
09500	S	M	OUG	II	00800	005		12	080888	1/1/0001
22000	S	M	OUG	III	00000	075	1ST LT. E. OF SHAKER DR., S. SIDE	12	080789	1/1/0001
22000	S	M	OUG	III	00000	076	2ND LT. E. OF SHAKER DR., S. SIDE	12	080789	1/1/0001
22000	S	M	OUG	III	00000	078	2ND LT. W. OF HARRODSBURG RD., S. SIDE	12	080789	1/1/0001
22000	S	M	OUG	III	00000	079	1ST LT. W. OF HARRODSBURG RD., S. SIDE	12	080789	1/1/0001
22000	S	M	OUG	III	00000	080	1ST LT. W. OF HARRODSBURG RD., N. SIDE	12	080789	1/1/0001
22000	S	M	OUG	III	00690	074		12	080789	1/1/0001
OFFICE: 311		ROUTE: 564		ST_REF_NO: 00000122260		MASON PLACE COURT				
LUMENS	BULB TYPE	MULT SERIES	POLE TYPE	SHADE	ADDRESS NUMBER	REF	LOCATION	TAX DIST	DATE INST	DATE CHANGE
05800	S	M	CNT	III	00808	002		12	110897	1/1/0001
05800	S	M	CNT	II	00813	001		12	110897	1/1/0001
OFFICE: 311		ROUTE: 564		ST_REF_NO: 00000122265		MASTERS VIEW ROAD				
LUMENS	BULB TYPE	MULT SERIES	POLE TYPE	SHADE	ADDRESS NUMBER	REF	LOCATION	TAX DIST	DATE INST	DATE CHANGE
05800	S	M	CNT	II	02969	020		12	040204	1/1/0001
05800	S	M	CNT	II	00000	002	SIDE OF 201 WOODBROOK PLACE	12	060898	1/1/0001
05800	S	M	CNT	II	02904	001		12	060898	1/1/0001
05800	S	M	CNT	II	02928	003		12	060898	1/1/0001
05800	S	M	CNT	II	02948	004		12	060898	1/1/0001
05800	S	M	CNT	III	02984	006		12	060898	1/1/0001

OFFICE: 311

ROUTE: 564

ST_REF_NO: 00000122270

MASTERSON CIRCLE

LUMENS	BULB TYPE	MULT SERIES	POLE TYPE	SHADE	ADDRESS NUMBER	REF	LOCATION	TAX DIST	DATE INST	DATE CHANGE
05800	S	M	CNT	III	02804	001		12	030898	1/1/0001

OFFICE: 311

ROUTE: 564

ST_REF_NO: 00000122275

MASTERSON COURT

LUMENS	BULB TYPE	MULT SERIES	POLE TYPE	SHADE	ADDRESS NUMBER	REF	LOCATION	TAX DIST	DATE INST	DATE CHANGE
05800	S	M	CNT	III	02908	001		12	030898	1/1/0001

OFFICE: 311

ROUTE: 564

ST_REF_NO: 00000122280

MASTERSON STATION DRIVE

LUMENS	BULB TYPE	MULT SERIES	POLE TYPE	SHADE	ADDRESS NUMBER	REF	LOCATION	TAX DIST	DATE INST	DATE CHANGE
05800	S		CNT	II	00000	032	SIDE OF 400 SKYVIEW LN, ON MASTERSON STATION	12	062413	1/1/0001
05800	S	M	CNT	II	00000	029	ACROSS FROM LEMON DROP LN ON MASTERSON STATION DR	12	071902	1/1/0001
05800	S	M	CNT	II	00000	030	SIDE OF 400 LEMON DROP LN ON MASTERSON STATION DR	12	071902	1/1/0001
05800	S	M	CNT	II	00000	031	ACROSS FROM SKY VIEW LN ON MASTERSON STATION DR	12	071902	1/1/0001
05800	S	M	CNT	II	00000	001	SIDE OF 2808 MASTERSON CIRCLE	12	030898	1/1/0001
05800	S	M	CNT	II	00000	002	SIDE OF 2977 SUMMERFIELD DR.	12	030898	1/1/0001
05800	S	M	CNT	II	00000	007	SIDE OF 2893 SUMMERFIELD DR.	12	030898	1/1/0001
05800	S	M	CNT	II	00000	010	SIDE OF 2901 TRAILSIDE DR.	12	030898	1/1/0001
05800	S	M	CNT	II	00000	012	SIDE REAR 2900 GATEWAY PARK LANE	12	030898	1/1/0001
05800	S	M	CNT	II	00000	018	SIDE OF 228 MEADOW VALLEY DRIVE	12	110899	1/1/0001
05800	S	M	CNT	II	00108	003		12	030898	1/1/0001
05800	S	M	CNT	II	00113	004		12	060898	1/1/0001
05800	S	M	CNT	II	00124	005		12	030898	1/1/0001
05800	S	M	CNT	II	00129	006		12	030898	1/1/0001
05800	S	M	CNT	II	00145	008		12	030898	1/1/0001
05800	S	M	CNT	II	00156	009		12	030898	1/1/0001
05800	S	M	CNT	II	00176	011		12	030898	1/1/0001
05800	S	M	CNT	II	00200	013		12	030898	1/1/0001
05800	S	M	CNT	II	00209	014		12	110899	1/1/0001
05800	S	M	CNT	II	00220	015		12	110899	1/1/0001
05800	S	M	CNT	II	00229	016		12	110899	1/1/0001
05800	S	M	CNT	II	00236	017		21	110899	1/1/0001

OFFICE: 311		ROUTE: 564		ST_REF_NO: 00000122280		MASTERTON STATION DRIVE				
LUMENS	BULB TYPE	MULT SERIES	POLE TYPE	SHADE	ADDRESS NUMBER	REF	LOCATION	TAX DIST	DATE INST	DATE CHANGE
05800	S	M	CNT	II	00264	019		12	110899	1/1/0001
05800	S	M	CNT	II	00269	020		12	110899	1/1/0001
05800	S	M	CNT	II	00284	021		12	020801	1/1/0001
05800	S	M	CNT	II	00301	022		12	020801	1/1/0001
05800	S	M	CNT	II	00308	023		12	020801	1/1/0001
05800	S		CNT	II	00316	024		12	020801	1/1/0001
05800	S	M	CNT	II	00333	025		12	020801	1/1/0001
05800	S	M	CNT	II	00340	026		12	020801	1/1/0001
05800	S	M	CNT	II	00349	027		12	020801	1/1/0001
05800	S	M	CNT	II	00364	028		12	020801	1/1/0001
OFFICE: 311		ROUTE: 564		ST_REF_NO: 00000122282		MATHERN TRAIL				
LUMENS	BULB TYPE	MULT SERIES	POLE TYPE	SHADE	ADDRESS NUMBER	REF	LOCATION	TAX DIST	DATE INST	DATE CHANGE
05800	S		CNT	II	00000	001	SIDE OF 3399 BAY SPRINGS PARK ON MATHERN TRL	12	020510	1/1/0001
05800	S		CNT	II	00000	003	SIDE OF 3373 HIBERNIA PASS ON MATHERN TRAIL	12	020510	1/1/0001
05800	S		CNT	III	03204	012		12	020510	1/1/0001
05800	S		CNT	II	03221	011		12	020510	1/1/0001
05800	S		CNT	II	03233	010		12	020510	1/1/0001
05800	S		CNT	II	03308	009		12	020510	1/1/0001
05800	S		CNT	II	03321	008		12	020510	1/1/0001
05800	S		CNT	II	03336	007		12	020510	1/1/0001
05800	S		CNT	II	03353	006		12	020510	1/1/0001
05800	S		CNT	II	03364	005		12	020510	1/1/0001
05800	S		CNT	II	03377	004		12	020510	1/1/0001
05800	S		CNT	II	03409	002		12	020510	1/1/0001
OFFICE: 311		ROUTE: 564		ST_REF_NO: 00000122287		MATTEA COURT				
LUMENS	BULB TYPE	MULT SERIES	POLE TYPE	SHADE	ADDRESS NUMBER	REF	LOCATION	TAX DIST	DATE INST	DATE CHANGE
05800	S	M	CNT	II	00000	001	SIDE OF 2065 TWAIN RIDGE DR ON MATTEA CT	12	080505	1/1/0001
05800	S	M	CNT	III	04205	004		12	080505	1/1/0001
05800	S	M	CNT	II	04216	003		12	080505	1/1/0001
05800	S	M	CNT	II	04224	002		12	080505	1/1/0001

OFFICE: 311

ROUTE: 564

ST_REF_NO: 00000122295

Maura Trace

LUMENS	BULB TYPE	MULT SERIES	POLE TYPE	SHADE	ADDRESS NUMBER	REF	LOCATION	TAX DIST	DATE INST	DATE CHANGE
05800	S	M	CNT	II	02104	007		12	101402	1/1/0001
05800	S	M	CNT	II	02116	005		12	101402	1/1/0001
05800	S	M	CNT	II	02117	006		12	101402	1/1/0001
05800	S	M	CNT	II	02136	004		12	101402	1/1/0001
05800	S	M	CNT	II	02137	003		12	101402	1/1/0001
05800	S	M	CNT	II	02145	002		12	101402	1/1/0001
05800	S	M	CNT	II	02164	001		12	101402	1/1/0001

OFFICE: 311

ROUTE: 564

ST_REF_NO: 00000122298

MAXON WAY

LUMENS	BULB TYPE	MULT SERIES	POLE TYPE	SHADE	ADDRESS NUMBER	REF	LOCATION	TAX DIST	DATE INST	DATE CHANGE
05800	S	M	CNT	II	00000	001	ACROSS FROM 612 MAXON	12	051107	1/1/0001

OFFICE: 311

ROUTE: 564

ST_REF_NO: 00000122300

MAXWELL, EAST STREET

LUMENS	BULB TYPE	MULT SERIES	POLE TYPE	SHADE	ADDRESS NUMBER	REF	LOCATION	TAX DIST	DATE INST	DATE CHANGE
22000	S		SOH	II	00000	050	1ST LT E OF S LIMESTONE, N SIDE ON E MAXWELL ST	12	010411	1/1/0001
50000	S	M	SOH	II	00000	005	1 ST. LT. W. OF S MLK,upgrade 1/08 & again 10/09 per city req	12	082464	10/8/2009
22000	S	M	SOH	II	00125	004	upgrade 1/08	12	060164	1/1/2008
50000	S	M	SOH	II	00163	006	upgraded 1/08 & again 10/09	12	060164	10/8/2009
22000	S	M	SOH	II	00273	016		12	060164	11/3/2009
22000	S	M	SOH	II	00000	028	1 ST. LT. E. OF WOODLAND, S SIDE-upgrade 1/08	12	120964	1/1/0001
10000	M	M	SOH	II	00000	029	2 ND. LT. E. OF WOODLAND AVE., S. SIDE	12	120964	1/1/0001
10000	M	S	SOH	II	00000	030	1 ST. LT. E. OF WOODLAND AVE., N. SIDE	12	060164	1/1/0001
10000	M	S	SOH	II	00000	031	1 ST. LT. E. OF KENTUCKY AVE., S. SIDE	12	060164	1/1/0001
10000	M	S	SOH	II	00000	032	2 ND. LT. E. OF KENTUCKY AVE., S. SIDE	12	060164	1/1/0001
10000	M	M	SOH	II	00462	027		12	060164	1/1/0001
22000	S	M	SOH	II	00000	001	1 ST. LT. E. OF LIME, S. SIDE-upgrade 1/08	12	082464	1/1/0001
22000	S	M	SOH	II	00000	003	OPP. 125 upgrade 1/08	12	060164	1/1/0001
10000	M	M	SOH	II	00000	007	OPP. 169	12	100164	1/1/0001
22000	S	M	SOH	II	00000	025	OPP. 435 upgrade 1/08	12	100164	1/1/0001
10000	M	M	SOH	II	00115	002		12	060164	1/1/0001
10000	M	M	SOH	II	00179	008		12	060164	1/1/0001

OFFICE: 311

ROUTE: 564

ST_REF_NO: 00000122300

MAXWELL, EAST STREET

LUMENS	BULB TYPE	MULT SERIES	POLE TYPE	SHADE	ADDRESS NUMBER	REF	LOCATION	TAX DIST	DATE INST	DATE CHANGE
22000	S	M	SOH	II	00200	009	upgraded 1/08	12	082464	1/1/0001
10000	M	M	SOH	II	00211	010		12	060164	1/1/0001
10000	M	M	SOH	II	00218	011		12	100164	1/1/0001
22000	S	M	SOH	II	00235	012	upgraded 1/08	12	060164	1/1/0001
22000	S	M	SOH	II	00248	013	upgrade 1/08	12	082464	1/1/0001
10000	M	M	SOH	II	00253	014		12	060164	1/1/0001
10000	M	M	SOH	II	00268	015		12	082464	1/1/0001
22000	S	M	SOH	II	00300	017	upgrade 1/08	12	082464	1/1/0001
22000	S	M	SOH	II	00307	018	upgrade 1/08	12	060164	1/1/0001
10000	M	M	SOH	II	00322	019		12	060164	1/1/0001
22000	S	M	SOH	II	00325	020	upgrade 1/08	12	060164	1/1/0001
22000	S	M	SOH	II	00414	021	upgrade 1/08	12	082464	1/1/0001
22000	S	M	SOH	II	00415	022	upgraded to 22,000 hps cobra Dec 2006	12	060164	1/1/0001
10000	M	M	SOH	II	00424	023		12	100164	1/1/0001
10000	M	M	SOH	II	00429	024		12	060164	1/1/0001
10000	M	M	SOH	II	00455	026		12	060164	1/1/0001

OFFICE: 311

ROUTE: 564

ST_REF_NO: 00000122310

MAXWELL, WEST STREET

LUMENS	BULB TYPE	MULT SERIES	POLE TYPE	SHADE	ADDRESS NUMBER	REF	LOCATION	TAX DIST	DATE INST	DATE CHANGE
22000	S		CNT	II	00000	550	2ND LT E OF OLIVER LEWIS WAY, S SIDE ON W MAXWELL	12	031511	1/1/0001
22000	S		CNT	II	00000	551	1ST LT E OF OLIVER LEWIS WAY, S SIDE OF W MAXWELL	12	031511	1/1/0001
50000	S	M	SOH	II	00000	002	1 ST. LT. W. OF LIMESTONE ST., S. SIDE-Ifucg upgrade	12	081464	11/15/2010
22000	S	M	SOH	II	00000	008	S.E. CORNER OF MAXWELL & MILL ST.upgrade per city req	12	070171	10/6/2009
22000	S	M	SOH	II	00000	013	SIDE OF 401 S. BROADWAY	12	110171	2/24/2011
22000	S	M	SOH	II	00000	014	S.E. CORNER OF MAXWELL & TUCKER ALLEY	12	030165	2/24/2011
22000	S	M	SOH	II	00000	015	OPP. 422	12	051864	4/24/2011
22000	S	M	SOH	II	00000	017	S.W. CORNER OF MAXWELL & DUNAWAY ST.	12	051864	2/24/2011
22000	S	M	SOH	II	00000	019	SE CRNR OF MAXWELL & PATTERSON-upgrade 1/08	12	051864	2/24/2011
22000	S	M	SOH	II	00000	020	SW CRNR OF MAXWELL & POPLAR-upgrade 1/08	12	100164	2/24/2011
22000	S	M	SOH	II	00000	021	N.E. CORNER OF MAXWELL & MERINO ST.	12	051864	2/24/2011

OFFICE: 311		ROUTE: 564		ST_REF_NO: 00000122310		MAXWELL, WEST STREET		TAX DIST	DATE INST	DATE CHANGE
LUMENS	BULB TYPE	MULT SERIES	POLE TYPE	SHADE	ADDRESS NUMBER	REF	LOCATION			
22000	S		SOH	II	00000	300	SIDE OF 401 SPRING ST, ON W MAXWELL	12	100609	2/24/2011
09500	S	M	SOH	II	00319	011	replaced bad fixture	12	070173	10/22/2008
22000	S	M	SOH	II	00430	016		12	100164	2/24/2011
22000	S	M	SOH	II	00529	018		12	051864	2/24/2011
22000	S		SOH	II	00604	060		12	052109	2/24/2011
10000	M	M	SOH	II	00000	023	1 ST. LT. E. OF MADISON PLACE, N. SIDE	12	051864	1/1/0001
10000	M	M	SOH	II	00706	022		12	100174	1/1/0001
10000	M	M	SOH	II	00802	024		12	051864	1/1/0001
10000	M	M	SOH	II	00817	025		12	051864	1/1/0001
10000	M	M	SOH	II	00826	026		12	051864	1/1/0001
10000	M	M	SOH	II	00837	027		12	051864	1/1/0001
10000	M	M	SOH	II	00000	009	SIDE OF 385 S. MILL ST.	12	070171	1/1/0001
10000	M	M	SOH	II	00000	010	S.E. CORNER OF MAXWELL & PLUNKETT ST.	12	070171	1/1/0001
10000	M	M	SOH	II	00000	012	S.E. CORNER OF MAXWELL & BROADWAY	12	070171	1/1/0001
10000	M	M	SOH	II	00000	001	SIDE OF 289 S. LIMESTONE ST.	12	060164	1/1/0001
10000	M	M	SOH	II	00000	007	1 ST. LT. E. OF MILL ST., N. SIDE	12	070171	1/1/0001
10000	M	M	SOH	II	00117	003		12	060164	1/1/0001
10000	M	M	SOH	II	00124	004		12	070171	1/1/0001
09500	S	M	SOH	II	00211	005	upgrade 1/08	12	070171	1/1/0001
10000	M	M	SOH	II	00214	006		12	070171	1/1/0001
OFFICE: 311		ROUTE: 564		ST_REF_NO: 00000122400		MAXWELTON COURT		TAX DIST	DATE INST	DATE CHANGE
LUMENS	BULB TYPE	MULT SERIES	POLE TYPE	SHADE	ADDRESS NUMBER	REF	LOCATION			
05800	S	M	SOH	I	00000	534	SIDE OF 641 S. LIMESTONE ST.	12	062167	1/1/0001
05800	S	M	SOH	II	00000	536	OPP. 630	12	062167	1/1/0001
05800	S	M	SOH	I	00112	535		12	062167	1/1/0001
05800	S	M	SOH	I	00641	537		12	062167	1/1/0001
05800	S	M	SOH	I	00646	538		12	062167	1/1/0001
05800	S	M	SOH	I	00657	000		12	020466	1/1/0001

OFFICE: 311 ROUTE: 564							ST_REF_NO: 00000122600 MAYWICK COURT			
LUMENS	BULB TYPE	MULT SERIES	POLE TYPE	SHADE	ADDRESS NUMBER	REF	LOCATION	TAX DIST	DATE INST	DATE CHANGE
04000	S	M	OUG	II	01941	002		12	110888	1/1/0001
04000	S	M	OUG	II	01952	001		12	110888	1/1/0001

OFFICE: 311 ROUTE: 564							ST_REF_NO: 00000122700 MAYWICK DRIVE			
LUMENS	BULB TYPE	MULT SERIES	POLE TYPE	SHADE	ADDRESS NUMBER	REF	LOCATION	TAX DIST	DATE INST	DATE CHANGE
04000	S	M	OUG	II	00000	016	OPP. 998	12	110888	1/1/0001
04000	S	M	OUG	II	00880	001		12	110888	1/1/0001
04000	S	M	OUG	II	00885	002		12	110888	1/1/0001
04000	S	M	OUG	II	00891	003		12	110888	1/1/0001
04000	S	M	OUG	II	00896	004		12	110888	1/1/0001
04000	S	M	OUG	II	00900	005		12	110888	1/1/0001
04000	S	M	OUG	II	00909	006		12	110888	1/1/0001
04000	S	M	OUG	II	00917	007		12	100888	1/1/0001
04000	S	M	OUG	II	00928	008		12	100888	1/1/0001
04000	S	M	OUG	II	00941	009		12	100888	1/1/0001
04000	S	M	OUG	II	00949	010		12	100888	1/1/0001
04000	S	M	OUG	II	00960	011		12	110888	1/1/0001
04000	S	M	OUG	II	00973	012		12	110888	1/1/0001
04000	S	M	OUG	II	00982	013		12	110888	1/1/0001
04000	S	M	OUG	II	00988	014		12	110888	1/1/0001
04000	S	M	OUG	II	00993	015		12	110888	1/1/0001
04000	S	M	OUG	II	01010	017		12	020889	1/1/0001
04000	S	M	OUG	II	01030	018		12	020889	1/1/0001
04000	S	M	OUG	II	01050	019		12	020889	1/1/0001

OFFICE: 311 ROUTE: 564							ST_REF_NO: 00000122705 MAYWICK VIEW			
LUMENS	BULB TYPE	MULT SERIES	POLE TYPE	SHADE	ADDRESS NUMBER	REF	LOCATION	TAX DIST	DATE INST	DATE CHANGE
05800	S	M	OUG	II	00000	038	NW CORNER OF CROSS KEYS RD.	12	091167	1/1/0001
05800	S	M	OUG	II	00000	043	OPP. 1617	12	091167	1/1/0001
05800	S	M	OUG	II	01605	044		12	091167	1/1/0001
05800	S	M	OUG	II	01627	042		12	091167	1/1/0001
05800	S	M	OUG	II	01636	041		12	091167	1/1/0001

OFFICE: 311		ROUTE: 564		ST_REF_NO: 00000122705		MAYWICK VIEW		LUMENS	BULB TYPE	MULT SERIES	POLE TYPE	SHADE	ADDRESS NUMBER	REF	LOCATION	TAX DIST	DATE INST	DATE CHANGE
05800	S	M	OUG	II	01649	040										12	091167	1/1/0001
05800	S	M	OUG	II	01658	039										12	091167	1/1/0001
OFFICE: 311		ROUTE: 564		ST_REF_NO: 00000122800		MAYWOOD PARK		LUMENS	BULB TYPE	MULT SERIES	POLE TYPE	SHADE	ADDRESS NUMBER	REF	LOCATION	TAX DIST	DATE INST	DATE CHANGE
04000	S	M	OUG	II	00000	210									SIDE OF 3355 PIMLICO PARKWAY	12	040171	1/1/0001
04000	S	M	OUG	V	01285	216										12	040171	1/1/0001
OFFICE: 311		ROUTE: 564		ST_REF_NO: 00000123100		MCCLAIN DRIVE		LUMENS	BULB TYPE	MULT SERIES	POLE TYPE	SHADE	ADDRESS NUMBER	REF	LOCATION	TAX DIST	DATE INST	DATE CHANGE
05800	S	M	OUG	II	00000	005									SIDE OF 216 12TH ST.	12	090761	1/1/0001
05800	S	M	OUG	III	00905	000										12	040556	1/1/0001
05800	S	M	OUG	III	00924	000										12	040556	1/1/0001
05800	S	M	OUG	III	01030	000										12	040156	1/1/0001
OFFICE: 311		ROUTE: 564		ST_REF_NO: 00000123250		MCCONNELL SPRINGS ROAD		LUMENS	BULB TYPE	MULT SERIES	POLE TYPE	SHADE	ADDRESS NUMBER	REF	LOCATION	TAX DIST	DATE INST	DATE CHANGE
09500	S	M	OUG	III	01300	006										12	090898	1/1/0001
09500	S	M	OUG	III	01301	005										12	090898	1/1/0001
09500	S	M	OUG	II	01308	004										12	090898	1/1/0001
09500	S	M	OUG	II	01317	003										12	090898	1/1/0001
09500	S	M	OUG	II	01332	002										12	090898	1/1/0001
09500	S	M	OUG	II	01333	001										12	090898	1/1/0001
09500	S	M	OUG	II	01348	007										12	090898	1/1/0001
09500	S	M	OUG	II	01357	008										12	090898	1/1/0001
09500	S	M	OUG	II	01364	009										12	090898	1/1/0001
09500	S	M	OUG	III	01373	010										12	090898	1/1/0001
09500	S	M	OUG	II	01389	011										12	090898	1/1/0001
09500	S	M	OUG	II	01396	012										12	090898	1/1/0001

OFFICE: 311

ROUTE: 564

ST_REF_NO: 00000123275

MCCONNELLS TRACE BLVD

LUMENS	BULB TYPE	MULT SERIES	POLE TYPE	SHADE	ADDRESS NUMBER	REF	LOCATION	TAX DIST	DATE INST	DATE CHANGE
05800	S	M	CNT	II	00000	007	SIDE OF 201 GAULEY LN ON MCCONNELLS TRACE	12	103005	1/1/0001
05800	S	M	CNT	II	00000	009	SIDE OF 401 LONG BRANCH LN ON MCCONNELLS TRACE BLV	12	051705	1/1/0001
05800	S	M	CNT	II	00000	010	ACROSS FROM 184 MCCONNELLS TRACE BLVD	12	051705	1/1/0001
05800	S	M	CNT	II	00000	012	SIDE OF 3001 TRAILWOOD DR ON MCCONNELLS TRACE BLVD	12	051705	1/1/0001
05800	S	M	CNT	II	00000	014	SIDE OF 3001 NEW RIVER PL ON MCCONNELLS TRACE BLVD	12	051705	1/1/0001
05800	S	M	CNT	II	00100	001		12	080102	1/1/0001
05800	S	M	CNT	II	00101	002		12	080102	1/1/0001
05800	S	M	CNT	II	00104	003		12	080102	1/1/0001
05800	S	M	CNT	II	00117	004		12	080102	1/1/0001
05800	S	M	CNT	II	00128	005		12	080102	1/1/0001
05800	S	M	CNT	II	00140	006		12	051705	1/1/0001
05800	S	M	CNT	II	00153	007		12	051705	1/1/0001
05800	S	M	CNT	II	00161	008		12	051705	1/1/0001
05800	S	M	CNT	II	00200	011		12	051705	1/1/0001
05800	S	M	CNT	II	00216	013		12	051705	1/1/0001
05800	S	M	CNT	II	00244	015		12	051705	1/1/0001
05800	S	M	CNT	II	00261	016		12	051705	1/1/0001
05800	S	M	CNT	II	00409	006		12	100507	1/1/0001
05800	S	M	CNT	II	00425	005		12	100507	1/1/0001
05800	S	M	CNT	II	00441	004		12	100507	1/1/0001
05800	S	M	CNT	II	00461	003		12	103005	1/1/0001
05800	S	M	CNT	II	00476	002		12	103005	1/1/0001
05800	S	M	CNT	II	00493	001		12	103005	1/1/0001

OFFICE: 311

ROUTE: 564

ST_REF_NO: 00000123600

MCCUBBING DRIVE

LUMENS	BULB TYPE	MULT SERIES	POLE TYPE	SHADE	ADDRESS NUMBER	REF	LOCATION	TAX DIST	DATE INST	DATE CHANGE
04000	S	M	OUG	II	00000	043	SIDE REAR 1617 CLAYS MILL ON MCCUBBING DRIVE	12	100884	1/1/0001
04000	S	M	OUG	II	00000	044	SIDE 1617 CLAYS MILL	12	100884	1/1/0001
04000	S	M	OUG	II	00527	047		12	100884	1/1/0001
04000	S	M	OUG	II	00532	046		12	100884	1/1/0001

OFFICE: 311

ROUTE: 564

ST_REF_NO: 00000123600

MCCUBBING DRIVE

LUMENS	BULB TYPE	MULT SERIES	POLE TYPE	SHADE	ADDRESS NUMBER	REF	LOCATION	TAX DIST	DATE INST	DATE CHANGE
04000	S	M	SOH	II	00539	045		12	100884	1/1/0001
04000	S	M	OUG	II	00000	050	SIDE 321 LAFAYETTE DR.	12	100884	1/1/0001
04000	S	M	OUG	II	00515	049		12	100884	1/1/0001
04000	S	M	OUG	II	00519	048		12	100884	1/1/0001

OFFICE: 311

ROUTE: 564

ST_REF_NO: 00000123700

MCCULLOUGH DRIVE

LUMENS	BULB TYPE	MULT SERIES	POLE TYPE	SHADE	ADDRESS NUMBER	REF	LOCATION	TAX DIST	DATE INST	DATE CHANGE
05800	S		OUG	II	01668	004		12	031909	1/1/0001
05800	S	M	OUG	II	00000	039	opp 1881	12	061269	1/1/2008
09500	S	M	OUG	II	00000	046	OPP. 1760 MCCULLOUGH - changing addr per audit	12	010885	8/27/2013
09500	S	M	OUG	II	01788	045	side of 1218 Winburn - bad fixture	12	061269	1/22/2006
10000	M	M	OUG	II	1760	047	chg addr from 1766 to 1760 per audit	12	030171	1/1/2008
05800	S	M	OUG	II	00000	044	SIDE OF 1199 WINBURN DR.	12	061269	1/1/0001
05800	S	M	OUG	II	01840	041		12	080173	1/1/0001
05800	S	M	OUG	II	01840	043		12	080173	1/1/0001
05800	S	M	OUG	II	01841	040		12	060170	1/1/0001
05800	S	M	OUG	II	01841	042		12	060170	1/1/0001
10000	M	M	OUG	II	00000	048	SIDE OF 1681 GERALD DR.	12	120887	1/1/0001

OFFICE: 311

ROUTE: 564

ST_REF_NO: 00000123710

MCCURDY COURT

LUMENS	BULB TYPE	MULT SERIES	POLE TYPE	SHADE	ADDRESS NUMBER	REF	LOCATION	TAX DIST	DATE INST	DATE CHANGE
04000	S	M	OUG	V	00600	004		12	050890	1/1/0001
04000	S	M	OUG	II	00612	003		12	050890	1/1/0001
04000	S	M	OUG	V	00620	002		12	050890	1/1/0001
04000	S	M	OUG	II	00632	001		12	120887	1/1/0001

OFFICE: 311

ROUTE: 564

ST_REF_NO: 00000123800

MCDONALD AVENUE

LUMENS	BULB TYPE	MULT SERIES	POLE TYPE	SHADE	ADDRESS NUMBER	REF	LOCATION	TAX DIST	DATE INST	DATE CHANGE
05800	S	M	SOH	II	00000	002	SIDE REAR OF 126 JOHNSTON BLVD.	12	030896	1/1/0001
05800	S	M	SOH	II	00000	003	SIDE OF 126 JOHNSTON BLVD.	12	030896	1/1/0001
05800	S	M	SOH	II	00000	004	SIDE OF 127 JOHNSTON BLVD.	12	030896	1/1/0001

OFFICE: 311							ROUTE: 564			
ST_REF_NO: 00000123800							MCDONALD AVENUE			
LUMENS	BULB TYPE	MULT SERIES	POLE TYPE	SHADE	ADDRESS NUMBER	REF	LOCATION	TAX DIST	DATE INST	DATE CHANGE
05800	S	M	SOH	II	00000	006	SIDE OF 124 HILTONIA PARK	12	030896	1/1/0001
05800	S	M	SOH	II	01833	005		12	030896	1/1/0001
05800	S	M	SOH	II	01855	001		12	030896	1/1/0001
OFFICE: 311							ROUTE: 564			
ST_REF_NO: 00000123900							MCDOWELL ROAD			
LUMENS	BULB TYPE	MULT SERIES	POLE TYPE	SHADE	ADDRESS NUMBER	REF	LOCATION	TAX DIST	DATE INST	DATE CHANGE
05800	S		SOH	II	00200	075		12	091010	1/1/0001
05800	S	M	SOH	I	00000	049	SIDE OF 1302 RICHMOND RD.	12	061268	1/1/0001
05800	S	M	SOH	I	00000	052	OPP. 154	12	061268	1/1/0001
05800	S	M	SOH	I	00121	050		12	061268	1/1/0001
05800	S	M	SOH	I	00134	051		12	061268	1/1/0001
05800	S	M	SOH	I	00211	053		12	100268	1/1/0001
05800	S	M	SOH	I	00223	054		12	100268	1/1/0001
05800	S	M	SOH	I	00233	055		12	100268	1/1/0001
05800	S	M	SOH	I	00242	056		12	061268	1/1/0001
05800	S	M	SOH	I	00314	057		12	061268	1/1/0001
05800	S	M	SOH	I	00320	058	upgraded 10/07	12	100268	1/1/0001
05800	S	M	SOH	I	00330	059		12	061268	1/1/0001
OFFICE: 311							ROUTE: 564			
ST_REF_NO: 00000124000							MCGARRY DRIVE			
LUMENS	BULB TYPE	MULT SERIES	POLE TYPE	SHADE	ADDRESS NUMBER	REF	LOCATION	TAX DIST	DATE INST	DATE CHANGE
05800	S	M	OUG	II	00000	040	SIDE OF 1000 RIDGETREE LANE	12	070899	1/1/0001
05800	S	M	OUG	II	00000	042	SIDE OF 1009 WYNDHAM HILLS	12	070899	1/1/0001
05800	S	M	OUG	II	03797	059		12	050897	1/1/0001
05800	S	M	OUG	II	03808	058		12	050897	1/1/0001
05800	S	M	OUG	II	03817	057		12	050897	1/1/0001
05800	S	M	OUG	II	03828	056		12	050897	1/1/0001
05800	S	M	OUG	II	03845	055		12	050897	1/1/0001
05800	S	M	OUG	II	03848	054		12	031581	1/1/0001
05800	S	M	OUG	II	03861	053		12	031581	1/1/0001
05800	S	M	OUG	II	03868	034		12	031581	1/1/0001
05800	S	M	OUG	II	03873	036		12	031581	1/1/0001

OFFICE: 311		ROUTE: 564		ST_REF_NO: 00000124000		MCGARRY DRIVE				
LUMENS	BULB TYPE	MULT SERIES	POLE TYPE	SHADE	ADDRESS NUMBER	REF	LOCATION	TAX DIST	DATE INST	DATE CHANGE
05800	S	M	OUG	II	03876	035		12	031581	1/1/0001
05800	S	M	OUG	II	03885	038		12	031581	1/1/0001
05800	S	M	OUG	II	03892	037		12	121581	1/1/0001
05800	S	M	OUG	II	03900	039		12	070899	1/1/0001
05800	S	M	OUG	II	03916	041		12	070899	1/1/0001

OFFICE: 311		ROUTE: 564		ST_REF_NO: 00000124200		MCKENNA COURT				
LUMENS	BULB TYPE	MULT SERIES	POLE TYPE	SHADE	ADDRESS NUMBER	REF	LOCATION	TAX DIST	DATE INST	DATE CHANGE
05800	S	M	OUG	II	00000	005	SIDE OF 412	12	050164	1/1/0001
05800	S	M	OUG	II	00413	006		12	060465	1/1/0001
05800	S	M	OUG	II	00420	007		12	060465	1/1/0001

OFFICE: 311		ROUTE: 564		ST_REF_NO: 00000124300		MCKINLEY STREET				
LUMENS	BULB TYPE	MULT SERIES	POLE TYPE	SHADE	ADDRESS NUMBER	REF	LOCATION	TAX DIST	DATE INST	DATE CHANGE
05800	S	M	SOH	II	00619	010		12	100802	1/1/0001
05800	S	M	SOH	II	00000	442	1ST LT. N. OF DERODE ST., E. SIDE	12	060867	1/1/0001
05800	S	M	SOH	II	00561	443		12	060867	1/1/0001
05800	S	M	SOH	II	00613	444		12	060867	1/1/0001

OFFICE: 311		ROUTE: 564		ST_REF_NO: 00000124325		MCNAIR COURT				
LUMENS	BULB TYPE	MULT SERIES	POLE TYPE	SHADE	ADDRESS NUMBER	REF	LOCATION	TAX DIST	DATE INST	DATE CHANGE
05800	S		OUG	II	00000	001	SIDE OF 3528 MCNAIR WAY	12	120892	1/1/0001
05800	S	M	OUG	IV	02000	004		12	120892	1/1/0001
05800	S	M	OUG	II	02016	003		12	120892	1/1/0001
05800	S	M	OUG	II	02025	002		12	120892	1/1/0001

OFFICE: 311		ROUTE: 564		ST_REF_NO: 00000124350		MCNAIR WAY				
LUMENS	BULB TYPE	MULT SERIES	POLE TYPE	SHADE	ADDRESS NUMBER	REF	LOCATION	TAX DIST	DATE INST	DATE CHANGE
05800	S	M	OUG	II	00000	002	SIDE OF 2033 MCNAIR CT.	12	120892	1/1/0001
05800	S	M	OUG	II	00000	004	SIDE OF 2148 SALLEE DR.	12	120892	1/1/0001
05800	S	M	OUG	II	03516	001		12	120892	1/1/0001

OFFICE: 311

ROUTE: 564

ST_REF_NO: 00000124350 MCNAIR WAY

LUMENS	BULB TYPE	MULT SERIES	POLE TYPE	SHADE	ADDRESS NUMBER	REF	LOCATION	TAX DIST	DATE INST	DATE CHANGE
05800	S	M	OUG	II	03533	003		12	120892	1/1/0001

OFFICE: 311

ROUTE: 564

ST_REF_NO: 00000124480 MEADE COURT

LUMENS	BULB TYPE	MULT SERIES	POLE TYPE	SHADE	ADDRESS NUMBER	REF	LOCATION	TAX DIST	DATE INST	DATE CHANGE
05800	S	M	OUG	II	01552	000	911 address change	12	120263	1/1/0001
05800	S	M	OUG	II	01561	000	911 address change	12	120263	1/1/0001
05800	S	M	OUG	II	01584	000	911 address change	12	120263	1/1/0001

OFFICE: 311

ROUTE: 564

ST_REF_NO: 00000124500 MEADOW LANE

LUMENS	BULB TYPE	MULT SERIES	POLE TYPE	SHADE	ADDRESS NUMBER	REF	LOCATION	TAX DIST	DATE INST	DATE CHANGE
05800	S		OUG	II	00000	095	side of 1322 Highland Park Dr on Meadow Lane	12	122408	1/1/0001
05800	S		OUG	II	00800	094		12	122408	1/1/0001
05800	S		OUG	II	00817	034		12	122408	1/1/0001
05800	S		OUG	II	00849	036		12	122408	1/1/0001
05800	S	M	OUG	II	00000	054	SIDE OF 500 SHAFTSBURY RD.	12	030166	1/1/0001
05800	S	M	OUG	II	01101	098		12	110863	1/1/0001
05800	S	M	SOH	II	01108	000		12	041763	1/1/0001
05800	S	M	OUG	II	00000	096	1ST LT. N. OF HIGHLAND PARK DR., E SIDE	12	050163	1/1/0001
05800	S	M	OUG	II	00919	038		12	050163	1/1/0001
05800	S	M	OUG	II	00949	040		12	031563	1/1/0001
05800	S	M	OUG	II	00964	041		12	031563	1/1/0001
05800	S	M	OUG	II	01001	097		12	110863	1/1/0001
05800	S	M	OUG	II	01022	000		12	100164	1/1/0001
05800	S	M	OUG	II	01033	043		12	031563	1/1/0001
05800	S	M	OUG	II	01050	044		12	031563	1/1/0001
05800	S	M	OUG	II	01069	045		12	050163	1/1/0001

OFFICE: 311

ROUTE: 564

ST_REF_NO: 00000124600 MEADOW PARK

LUMENS	BULB TYPE	MULT SERIES	POLE TYPE	SHADE	ADDRESS NUMBER	REF	LOCATION	TAX DIST	DATE INST	DATE CHANGE
09500	S	M	OUG	II	00402	000		12	100967	10/30/2009
09500	S	M	OUG	II	00403	000		12	060163	10/30/2009

OFFICE: 311

ROUTE: 564

ST_REF_NO: 00000124600 MEADOW PARK

LUMENS	BULB TYPE	MULT SERIES	POLE TYPE	SHADE	ADDRESS NUMBER	REF	LOCATION	TAX DIST	DATE INST	DATE CHANGE
09500	S	M	OUG	II	00409	000		12	060163	10/30/2009
09500	S	M	OUG	II	00410	000		12	041763	10/30/2009
09500	S	M	OUG	II	00417	000		12	080173	10/30/2009
09500	S	M	OUG	II	00418	000		12	060163	10/30/2009
09500	S	M	OUG	II	00426	000		12	040163	10/30/2009
09500	S	M	OUG	II	00429	000		12	080173	10/30/2009
09500	S	M	OUG	II	00434	000		12	040163	10/30/2009

OFFICE: 311

ROUTE: 564

ST_REF_NO: 00000124650 MEADOWBRIDGE

LUMENS	BULB TYPE	MULT SERIES	POLE TYPE	SHADE	ADDRESS NUMBER	REF	LOCATION	TAX DIST	DATE INST	DATE CHANGE
04000	S	M	OUG	II	00000	001	SIDE OF 4549 OF LONGBRIDGE	12	110889	1/1/0001
04000	S	M	OUG	II	04509	002		12	090892	1/1/0001

OFFICE: 311

ROUTE: 564

ST_REF_NO: 00000124660 MEADOWBROOK DRIVE

LUMENS	BULB TYPE	MULT SERIES	POLE TYPE	SHADE	ADDRESS NUMBER	REF	LOCATION	TAX DIST	DATE INST	DATE CHANGE
05800	S	M	CNT	II	00000	001	SIDE OF 3245 BLENHEIM WAY	12	060894	1/1/0001
05800	S	M	CNT	II	00000	006	SIDE OF 1903 MEADOWBROOK CIRCLE	12	060899	1/1/0001
05800	S	M	CNT	II	00805	002		12	060899	1/1/0001
05800	S	M	CNT	II	00821	003		12	060899	1/1/0001
05800	S	M	CNT	II	00828	004		12	060899	1/1/0001
05800	S	M	CNT	II	00837	005		12	060899	1/1/0001
05800	S	M	CNT	II	00849	007		12	060899	1/1/0001
05800	S	M	CNT	III	01909	002		12	060899	1/1/0001

OFFICE: 311

ROUTE: 564

ST_REF_NO: 00000124670 MEADOWBROOK CIRCLE

LUMENS	BULB TYPE	MULT SERIES	POLE TYPE	SHADE	ADDRESS NUMBER	REF	LOCATION	TAX DIST	DATE INST	DATE CHANGE
05800	S	M	CNT	II	00000	001	SIDE OF 840 MEADOWBROOK DR.	12	060899	1/1/0001

OFFICE: 311		ROUTE: 564		ST_REF_NO: 00000124675		MEADOWCREST PARK		LUMENS	BULB TYPE	MULT SERIES	POLE TYPE	SHADE	ADDRESS NUMBER	REF	LOCATION	TAX DIST	DATE INST	DATE CHANGE
05800	S	M	CNT	III	00000	012	SIDE OF 4409 MEADOWCREST COURT ON MEADOWCREST PARK	12	030904	1/1/0001								
05800	S	M	CNT	II	00000	013	SIDE OF 549 MEADOWCREST PARK	12	030904	1/1/0001								
05800	S	M	CNT	II	00416	017		12	052005	1/1/0001								
05800	S	M	CNT	II	00428	016		12	052005	1/1/0001								
05800	S	M	CNT	II	00500	011		12	030904	1/1/0001								
05800	S	M	CNT	III	00556	015		12	030904	1/1/0001								

OFFICE: 311 ROUTE: 564

OFFICE: 311		ROUTE: 564		ST_REF_NO: 00000124676		MEADOWCREST COURT		LUMENS	BULB TYPE	MULT SERIES	POLE TYPE	SHADE	ADDRESS NUMBER	REF	LOCATION	TAX DIST	DATE INST	DATE CHANGE
05800	S	M	CNT	II	04412	001		12	030904	1/1/0001								

OFFICE: 311 ROUTE: 564

OFFICE: 311		ROUTE: 564		ST_REF_NO: 00000124680		MEADOWLAND COURT		LUMENS	BULB TYPE	MULT SERIES	POLE TYPE	SHADE	ADDRESS NUMBER	REF	LOCATION	TAX DIST	DATE INST	DATE CHANGE
05800	S	M	CNT	III	03108	002		12	020800	1/1/0001								
05800	S	M	CNT	II	03116	001		12	020800	1/1/0001								

OFFICE: 311 ROUTE: 564

OFFICE: 311		ROUTE: 564		ST_REF_NO: 00000124700		MEADOWTHORPE AVENUE		LUMENS	BULB TYPE	MULT SERIES	POLE TYPE	SHADE	ADDRESS NUMBER	REF	LOCATION	TAX DIST	DATE INST	DATE CHANGE
04000	S	M	OUG	II	00000	031	SIDE OF 1446 TOWNLEY DR.	12	121582	1/1/0001								
04000	S	M	OUG	II	00000	032	SIDE OF 1451 FORBES RD.	12	121582	1/1/0001								
05800	S	M	OUG	II	00000	033	OPP. 1462	12	121582	1/1/0001								
05800	S	M	OUG	II	00000	035	OPP. 1485	12	121582	1/1/0001								
05800	S	M	OUG	II	00000	037	OPP. 1526	12	121582	1/1/0001								
05800	S	M	OUG	II	00000	039	OPP. 1542	12	121582	1/1/0001								
05800	S	M	OUG	II	00000	041	OPP. 1554	12	121582	1/1/0001								
05800	S	M	OUG	II	00000	043	OPP. 1610	12	121582	1/1/0001								
05800	S	M	OUG	II	00000	045	OPP. 1626	12	121582	1/1/0001								
05800	S	M	OUG	II	00000	047	OPP. 1638	12	121582	1/1/0001								
05800	S	M	OUG	II	01476	034		12	121582	1/1/0001								
05800	S	M	OUG	II	01496	036		12	121582	1/1/0001								
05800	S	M	OUG	III	01520	153		12	010887	1/1/0001								

Street Light Listing run 1/11/2015 10:43:21 AM

Page 723 of 1254

OFFICE: 311		ROUTE: 564		ST_REF_NO: 00000124700		MEADOWTHORPE AVENUE		LUMENS	BULB TYPE	MULT SERIES	POLE TYPE	SHADE	ADDRESS NUMBER	REF	LOCATION	TAX DIST	DATE INST	DATE CHANGE
05800	S	M	OUG	II	01534	038										12	121582	1/1/0001
05800	S	M	OUG	II	01550	040										12	121582	1/1/0001
05800	S	M	OUG	II	01602	042										12	121582	1/1/0001
05800	S	M	OUG	II	01618	044										12	121582	1/1/0001
05800	S	M	OUG	II	01630	046										12	121582	1/1/0001
05800	S	M	OUG	II	01646	048										12	121582	1/1/0001

OFFICE: 311		ROUTE: 564		ST_REF_NO: 00000124750		MEADOW VALLEY ROAD		LUMENS	BULB TYPE	MULT SERIES	POLE TYPE	SHADE	ADDRESS NUMBER	REF	LOCATION	TAX DIST	DATE INST	DATE CHANGE
05800	S	M	CNT	II	00333	013										12	102605	1/1/0001
05800	S	M	CNT	II	00413	021										12	032304	1/1/0001
05800	S	M	CNT	II	00425	022										12	032304	1/1/0001
05800	S	M	CNT	II	00000	008	SIDE 2796 WOODLAWN									12	110899	1/1/0001
05800	S	M	CNT	II	00201	001										12	060898	1/1/0001
05800	S	M	CNT	II	00216	002										12	030898	1/1/0001
05800	S	M	CNT	II	00229	003										12	110899	1/1/0001
05800	S	M	CNT	II	00236	004										12	110899	1/1/0001
05800	S	M	CNT	II	00249	005										12	110899	1/1/0001
05800	S	M	CNT	II	00256	006										12	110899	1/1/0001
05800	S	M	CNT	II	00273	007										12	110899	1/1/0001
05800	S	M	CNT	II	00288	009										12	020108	1/1/0001
05800	S	M	CNT	II	00301	010										12	020801	1/1/0001
05800	S	M	CNT	II	00312	011										12	020801	1/1/0001
05800	S	M	CNT	II	00321	012										12	020801	1/1/0001
05800	S	M	CNT	II	00345	014										12	020801	1/1/0001
05800	S	M	CNT	II	00348	015										12	020801	1/1/0001
05800	S	M	CNT	II	00365	016										12	020801	1/1/0001
05800	S	M	CNT	II	00385	018										12	020801	1/1/0001
05800	S	M	CNT	II	00392	019										12	020108	1/1/0001
05800	S	M	CNT	II	00405	020										12	020801	1/1/0001

OFFICE: 311

ROUTE: 564

ST_REF_NO: 00000124800 MECHANIC STREET

LUMENS	BULB TYPE	MULT SERIES	POLE TYPE	SHADE	ADDRESS NUMBER	REF	LOCATION	TAX DIST	DATE INST	DATE CHANGE
10000	M	M	SOH	II	00000	001	1ST LT. E. OF MARKET ST., N. SIDE	12	011863	1/1/0001
10000	M	M	SOH	II	00000	002	SW CORNER OF MECHANIC & N. UPPER	12	011863	1/1/0001
10000	M	M	SOH	II	00000	004	1ST LT. W. OF LIME	12	020563	1/1/0001
10000	M	M	SOH	II	00120	003		12	011863	1/1/0001

OFFICE: 311

ROUTE: 564

ST_REF_NO: 00000124900 MEDELLIN COURT

LUMENS	BULB TYPE	MULT SERIES	POLE TYPE	SHADE	ADDRESS NUMBER	REF	LOCATION	TAX DIST	DATE INST	DATE CHANGE
05800	S	M	OUG	II	00000	150	SIDE OF 3345 PEPPERHILL RD.	12	011476	1/1/0001
05800	S	M	OUG	V	01201	151		12	081475	1/1/0001

OFFICE: 311

ROUTE: 564

ST_REF_NO: 00000125000 MEDLOCK ROAD

LUMENS	BULB TYPE	MULT SERIES	POLE TYPE	SHADE	ADDRESS NUMBER	REF	LOCATION	TAX DIST	DATE INST	DATE CHANGE
09500	S	M	OUG	II	00000	011	SIDE OF 3473 LANSDOWNE DR.	12	120667	1/1/0001
09500	S	M	OUG	II	00000	013	SIDE OF 3412 FLINTRIDGE CIRCLE	12	081866	1/1/0001
09500	S	M	OUG	II	00000	014	SIDE OF 3421 FLINTRIDGE DR.	12	051967	1/1/0001
09500	S	M	OUG	II	00000	069	SIDE OF 241	12	081476	1/1/0001
09500	S	M	OUG	V	00214	074		12	081476	1/1/0001
09500	S	M	OUG	II	00226	073		12	081476	1/1/0001
09500	S	M	OUG	II	00233	072		12	081476	1/1/0001
09500	S	M	OUG	II	00242	071		12	081476	1/1/0001
09500	S	M	OUG	V	00250	070		12	081476	1/1/0001
09500	S	M	OUG	II	00286	012	all exist 5800 on Medlock upgraded 2 9500hps 6/05	12	060269	1/1/0001

OFFICE: 311

ROUTE: 564

ST_REF_NO: 00000125200 MELBOURNE WAY

LUMENS	BULB TYPE	MULT SERIES	POLE TYPE	SHADE	ADDRESS NUMBER	REF	LOCATION	TAX DIST	DATE INST	DATE CHANGE
05800	S	M	OUG	II	00000	017	SIDE OF 3296 NANTUCKET RD.	12	080166	1/1/0001
05800	S	M	OUG	II	00000	034	SIDE OF 362 CURTIN DR.	12	080166	1/1/0001
05800	S	M	OUG	II	00000	075	SIDE OF 2390 HEATHER WAY	12	080166	1/1/0001
05800	S	M	OUG	II	00209	074		12	080166	1/1/0001
05800	S	M	OUG	II	00220	071		12	080166	1/1/0001
05800	S	M	OUG	II	00229	070		12	080166	1/1/0001

OFFICE: 311

ROUTE: 564

ST_REF_NO: 00000125200

MELBOURNE WAY

LUMENS	BULB TYPE	MULT SERIES	POLE TYPE	SHADE	ADDRESS NUMBER	REF	LOCATION	TAX DIST	DATE INST	DATE CHANGE
05800	S	M	OUG	II	00237	095		12	020887	1/1/0001
05800	S	M	OUG	II	00244	069		12	080166	1/1/0001
05800	S	M	OUG	II	00253	068		12	080166	1/1/0001
05800	S	M	OUG	II	00264	067		12	080166	1/1/0001
05800	S	M	OUG	II	00273	033		12	080166	1/1/0001
05800	S	M	OUG	II	00293	000		12	051967	1/1/0001
05800	S	M	OUG	II	00300	009		12	080166	1/1/0001
05800	S	M	OUG	II	00309	000		12	090170	1/1/0001
05800	S	M	OUG	II	00320	011		12	080166	1/1/0001
05800	S	M	OUG	II	00325	000		12	120170	1/1/0001
05800	S	M	OUG	V	00337	013		12	080166	1/1/0001
05800	S	M	OUG	II	00345	014		12	080166	1/1/0001
05800	S	M	OUG	II	00352	015		12	080166	1/1/0001
05800	S	M	OUG	II	00361	016		12	080166	1/1/0001

OFFICE: 311

ROUTE: 564

ST_REF_NO: 00000125210

MELFORD PLACE

LUMENS	BULB TYPE	MULT SERIES	POLE TYPE	SHADE	ADDRESS NUMBER	REF	LOCATION	TAX DIST	DATE INST	DATE CHANGE
05800	S	M	OUG	II	01900	001		12	040894	1/1/0001
05800	S	M	OUG	III	01908	002		12	040894	1/1/0001

OFFICE: 311

ROUTE: 564

ST_REF_NO: 00000125300

MELINOCKET COURT

LUMENS	BULB TYPE	MULT SERIES	POLE TYPE	SHADE	ADDRESS NUMBER	REF	LOCATION	TAX DIST	DATE INST	DATE CHANGE
04000	S	M	OUG	II	00000	036	SIDE OF 568 CROMWELL WAY	12	110885	1/1/0001
04000	S	M	OUG	II	03509	035		12	110885	1/1/0001

OFFICE: 311

ROUTE: 564

ST_REF_NO: 00000125400

MELROSE AVENUE

LUMENS	BULB TYPE	MULT SERIES	POLE TYPE	SHADE	ADDRESS NUMBER	REF	LOCATION	TAX DIST	DATE INST	DATE CHANGE
05800	S	M	SOH	I	00830	576	bad fixture	12	070767	1/20/2010
04000	S	M	SOH	I	00000	575	1ST LT. W. OF HIGH ST.	12	070767	1/1/0001
04000	S	M	SOH	I	00000	578	1ST LT. E. OF ASHLAND AVE., S. SIDE	12	070767	1/1/0001
04000	S	M	SOH	I	00000	581	SIDE OF 625 S. ASHLAND AVE.	12	070767	1/1/0001

OFFICE: 311 ROUTE: 564										
ST_REF_NO: 00000125400 MELROSE AVENUE										
LUMENS	BULB TYPE	MULT SERIES	POLE TYPE	SHADE	ADDRESS NUMBER	REF	LOCATION	TAX DIST	DATE INST	DATE CHANGE
04000	S	M	SOH	I	00706	580		12	070767	1/1/0001
04000	S	M	SOH	I	00726	579		12	070767	1/1/0001
04000	S	M	SOH	I	00814	577		12	040467	1/1/0001

OFFICE: 311 ROUTE: 564										
ST_REF_NO: 00000125450 MELODY LANE										
LUMENS	BULB TYPE	MULT SERIES	POLE TYPE	SHADE	ADDRESS NUMBER	REF	LOCATION	TAX DIST	DATE INST	DATE CHANGE
05800	S	M	OUG	II	01209	001		12	070899	1/1/0001
05800	S	M	OUG	II	01217	002		12	070899	1/1/0001
05800	S	M	OUG	III	01224	003		12	070899	1/1/0001

OFFICE: 311 ROUTE: 564										
ST_REF_NO: 00000125475 MEMORY LANE										
LUMENS	BULB TYPE	MULT SERIES	POLE TYPE	SHADE	ADDRESS NUMBER	REF	LOCATION	TAX DIST	DATE INST	DATE CHANGE
04000	S		SOH	II	00000	309	1ST LT N OF AURORA AVE	12	100666	1/1/0001
05800	S		SOH	II	00316	310		12	100666	1/1/0001
05800	S		SOH	II	00340	311		12	100666	1/1/0001
05800	S		SOH	II	00346	009		12	121266	6/26/2012

OFFICE: 311 ROUTE: 564										
ST_REF_NO: 00000125500 MEMPHIS COURT										
LUMENS	BULB TYPE	MULT SERIES	POLE TYPE	SHADE	ADDRESS NUMBER	REF	LOCATION	TAX DIST	DATE INST	DATE CHANGE
05800	S	M	OUG	II	02005	000		12	090866	1/1/0001
05800	S	M	OUG	II	02024	000		12	090866	1/1/0001

OFFICE: 311 ROUTE: 564										
ST_REF_NO: 00000125600 MENIFEE AVENUE										
LUMENS	BULB TYPE	MULT SERIES	POLE TYPE	SHADE	ADDRESS NUMBER	REF	LOCATION	TAX DIST	DATE INST	DATE CHANGE
05800	S	M	SOH	II	00000	156	SIDE 314 OWSLEY AVE.	12	020885	1/1/0001
05800	S	M	SOH	II	00000	158	SIDE 284 LINCOLN AVE.	12	050885	1/1/0001
05800	S	M	SOH	II	00000	160	SIDE 273 PRESTON AVE.	12	050885	1/1/0001
05800	S	M	SOH	II	00000	161	SIDE 300 PRESTON AVE.	12	050885	1/1/0001
05800	S	M	SOH	II	00000	162	SIDE 287 BASSETT AVE.	12	050885	1/1/0001
05800	S	M	SOH	II	01205	157		12	020885	1/1/0001
05800	S	M	SOH	II	01305	159		12	050885	1/1/0001

OFFICE: 311

ROUTE: 564

ST_REF_NO: 00000125600

MENIFEE AVENUE

LUMENS	BULB TYPE	MULT SERIES	POLE TYPE	SHADE	ADDRESS NUMBER	REF	LOCATION	TAX DIST	DATE INST	DATE CHANGE
05800	S	M	SOH	II	00000	163	SIDE 300 BASSETT AVE.	12	050885	1/1/0001
05800	S	M	SOH	II	00000	164	SIDE 299 SHERMAN AVE.	12	050885	1/1/0001
05800	S	M	SOH	II	00000	165	SIDE 300 SHERMAN AVE.	12	050885	1/1/0001
05800	S	M	SOH	II	00000	166	SIDE 377 HENRY CLAY BLVD.	12	050885	1/1/0001
05800	S	M	SOH	II	00000	167	SIDE 400 HENRY CLAY BLVD.	12	050885	1/1/0001
05800	S	M	SOH	II	00000	168	1ST LT. E OF HENRY CLAY BLVD., SOUTHSIDE	12	120898	1/1/0001
05800	S	M	SOH	II	00000	169	OPP. KINGSWOOD	12	120898	1/1/0001
05800	S	M	OUG	II	00000	170	SIDE 400 KINGSWAY DR.	12	120884	1/1/0001
05800	S	M	SOH	II	00000	171	SIDE OF 377 HENRY CLAY BLVD.	12	120898	1/1/0001
05800	S	M	OUG	II	00000	172	SIDE 368 QUEENSWAY DR.	12	120884	1/1/0001
05800	S	M	OUG	II	00000	173	SIDE 401 HOLIDAY RD.	12	120884	1/1/0001
05800	S	M	SOH	II	00000	174	SIDE 328 HOLIDAY RD.	12	050885	1/1/0001

OFFICE: 311

ROUTE: 564

ST_REF_NO: 00000125700

MENTELLE PARK

LUMENS	BULB TYPE	MULT SERIES	POLE TYPE	SHADE	ADDRESS NUMBER	REF	LOCATION	TAX DIST	DATE INST	DATE CHANGE
05800	S	M	OUG	I	00000	001	OPP. #4, IN MEDIAN	12	100170	1/1/0001
05800	S	M	OUG	I	00000	002	OPP. #7, IN MEDIAN	12	100170	1/1/0001
05800	S	M	OUG	I	00000	003	OPP. #18, IN MEDIAN	12	100170	1/1/0001
05800	S	M	OUG	I	00000	004	OPP. #19, IN MEDIAN	12	100170	1/1/0001
05800	S	M	OUG	I	00000	005	OPP. #34, IN MEDIAN	12	100170	1/1/0001
05800	S	M	OUG	I	00000	006	OPP. #33, IN MEDIAN	12	100170	1/1/0001
05800	S	M	OUG	I	00000	007	OPP. #46, IN MEDIAN	12	100170	1/1/0001
05800	S	M	OUG	I	00000	008	OPP. #45, IN MEDIAN	12	100170	1/1/0001
05800	S	M	SOH	II	00000	010	OPP. THE SIDE OF 909 RICHMOND RD., IN MEDIAN	12	120861	1/1/0001
05800	S	M	SOH	II	00000	011	OPP. THE SIDE OF 1005 RICHMOND RD., IN MEDIAN	12	120861	1/1/0001
05800	S	M	SOH	II	00000	012	OPP. #8, IN MEDIAN	12	120861	1/1/0001
05800	S	M	SOH	II	00000	013	OPP. #10, IN MEDIAN	12	120861	1/1/0001
05800	S	M	SOH	II	00000	014	OPP. #27, IN MEDIAN	12	120861	1/1/0001
05800	S	M	SOH	II	00000	015	OPP. #28, IN MEDIAN	12	120861	1/1/0001
05800	S	M	SOH	II	00000	016	OPP. #39, IN MEDIAN	12	120861	1/1/0001
05800	S	M	SOH	II	00000	017	OPP. #40, IN MEDIAN	12	120861	1/1/0001
05800	S	M	SOH	II	00000	018	OPP. #53, IN MEDIAN	12	120861	1/1/0001
05800	S	M	SOH	II	00000	019	OPP. #54, IN MEDIAN	12	120861	1/1/0001

OFFICE: 311

ROUTE: 564

ST_REF_NO: 00000125775

MERCER COURT

LUMENS	BULB TYPE	MULT SERIES	POLE TYPE	SHADE	ADDRESS NUMBER	REF	LOCATION	TAX DIST	DATE INST	DATE CHANGE
05800	S	M	OUG	II	00000	001	SIDE 2080 MERCER RD.	12	010894	1/1/0001
05800	S	M	OUG	III	00100	003		12	030897	1/1/0001
05800	S	M	OUG	II	00109	002		12	030897	1/1/0001

OFFICE: 311

ROUTE: 564

ST_REF_NO: 00000125800

MERCER ROAD

LUMENS	BULB TYPE	MULT SERIES	POLE TYPE	SHADE	ADDRESS NUMBER	REF	LOCATION	TAX DIST	DATE INST	DATE CHANGE
22000	S		SOH	II	00000	100	1ST LT W OF TRANSPORT CT, S SIDE ON MERCER RD	12	120512	1/1/0001
09500	S	M	CNT	II	00000	050	SIDE OF 201 SPRING VALLEY LANE ON MERCER ROAD	12	090104	1/1/0001
09500	S	M	SOH	II	00000	051	1ST LT E OF SPRING VALLEY LN, NORTH SIDE ON MERCER	12	050106	1/1/0001
09500	S	M	SOH	II	00000	052	2ND LT E OF SPRING VALLEY LN, NORTH SIDE ON MERCER	12	050106	1/1/0001
09500	S	M	SOH	II	00000	053	3RD LT E OF SPRING VALLEY LN, NORTH SIDE ON MERCER	12	050106	1/1/0001
09500	S	M	SOH	II	00000	054	4TH LT E OF SPRING VALLEY LN, NORTH SIDE ON MERCER	12	050106	1/1/0001
09500	S	M	SOH	II	00000	055	5TH LT E OF SPRING VALLEY LN, NORTH SIDE ON MERCER	12	050106	1/1/0001
10000	M	M	OUG	II	00000	046	3RD LT. W. OF HARBISON RD.,N. SIDE	12	110172	1/1/0001
10000	M	M	OUG	II	00000	047	5TH LT. W. OF HARBISON RD., S. SIDE	12	110172	1/1/0001
10000	M	M	OUG	II	00000	048	4TH LT. W. OF HARBISON RD., N. SIDE	12	110172	1/1/0001
10000	M	M	OUG	II	00000	049	6TH LT. W. OF HARBISON RD.,S. SIDE	12	110172	1/1/0001
10000	M	M	OUG	II	00000	050	5TH LT. W. OF HARBISON RD., N. SIDE	12	110172	1/1/0001
10000	M	M	OUG	II	00000	051	7TH LT. W. OF HARBISON RD., S. SIDE	12	110172	1/1/0001
10000	M	M	OUG	II	00000	052	6TH LT. W. OF HARBISON RD.	12	110172	1/1/0001
10000	M	M	OUG	II	00000	054	1ST LT. W. OF TRANSPORT CT., N. SIDE	12	110172	1/1/0001
10000	M	M	OUG	II	00000	055	1ST LT. W. OF TRANSPORT CT., S. SIDE	12	110172	1/1/0001
10000	M	M	OUG	II	00000	056	2ND LT. W. OF TRANSPORT CT., N. SIDE	12	110172	1/1/0001
10000	M	M	OUG	II	00000	058	3RD LT. W. OF TRANSPORT CT.,N. SIDE	12	110172	1/1/0001
10000	M	M	OUG	II	00000	059	3RD LT. W. OF TRANSPORT CT., S. SIDE	12	110172	1/1/0001
10000	M	M	OUG	II	00000	060	4TH LT. W. OF TRANSPORT CT., N. SIDE	12	110172	1/1/0001
10000	M	M	OUG	II	00000	061	4TH LT. W. OF TRANSPORT CT.,S. SIDE	12	110172	1/1/0001
10000	M	M	OUG	II	00000	062	5TH LT. W. OF TRANSPORT CT.,N. SIDE	12	110172	1/1/0001

OFFICE: 311

ROUTE: 564

ST_REF_NO: 00000125800

MERCER ROAD

LUMENS	BULB TYPE	MULT SERIES	POLE TYPE	SHADE	ADDRESS NUMBER	REF	LOCATION	TAX DIST	DATE INST	DATE CHANGE
09500	S	M	OUG	II	00000	063	5TH LT. W. OF TRANSPORT CT.,S. SIDE	12	110172	1/1/0001
05800	S	M	OUG	II	00000	064	2000 MERCER RD IN MEDIAN	12	010894	1/1/0001
05800	S	M	OUG	II	00000	065	2001 MERCER RD. IN MEDIAN	12	010894	1/1/0001
05800	S	M	OUG	II	00000	066	2000 MERCER RD. IN MEDIAN	12	010894	1/1/0001
05800	S	M	OUG	II	00000	067	2001 MERCER RD. IN MEDIAN	12	010894	1/1/0001
05800	S	M	OUG	II	02000	068		12	030897	1/1/0001
05800	S	M	OUG	II	02001	069		12	030897	1/1/0001
05800	S	M	OUG	II	02016	070		12	010894	1/1/0001
05800	S	M	OUG	II	02016	072		12	010894	1/1/0001
05800	S	M	OUG	II	02017	071		12	030897	1/1/0001
05800	S	M	OUG	II	02025	073		12	010894	1/1/0001
05800	S	M	OUG	II	02032	074		12	010894	1/1/0001
05800	S	M	OUG	II	02048	076		12	010894	1/1/0001
05800	S	M	OUG	II	02057	077		12	010894	1/1/0001
05800	S	M	OUG	II	02064	078		12	030897	1/1/0001
05800	S	M	OUG	II	02064	080		12	030897	1/1/0001
05800	S	M	OUG	II	02080	082		12	010894	1/1/0001
05800	S	M	OUG	II	02081	081		12	010894	1/1/0001
22000	S	M	OUG	II	00000	001	1ST LT. W. OF GEORGETOWN RD., N. SIDE	12	110172	1/1/0001
09500	S	M	OUG	II	00000	002	1ST LT. W. OF GEORGETOWN RD., S. SIDE	12	110172	1/1/0001
09500	S	M	OUG	II	00000	003	2ND LT. W. OF GEORGETOWN RD., N. SIDE	12	110172	1/1/0001
09500	S	M	OUG	II	00000	004	2ND LT. W. OF GEORGETOWN RD., S. SIDE	12	110172	1/1/0001
10000	M	M	OUG	II	00000	005	3RD LT. W. OF GEORGETOWN RD., N. SIDE	12	070171	1/1/0001
10000	M	M	OUG	II	00000	006	3RD LT. W. OF GEORGETOWN RD., S. SIDE	12	070171	1/1/0001
10000	M	M	OUG	II	00000	007	4TH LT. W. OF GEORGETOWN RD., N. SIDE	12	070171	1/1/0001
10000	M	M	OUG	II	00000	008	4TH LT. W. OF GEORGETOWN RD., S. SIDE	12	070171	1/1/0001
10000	M	M	OUG	II	00000	009	5TH LT. W. OF GEORGETOWN RD., N. SIDE	12	070171	1/1/0001
10000	M	M	OUG	II	00000	010	5TH LT. W. OF GEORGETOWN RD., S. SIDE	12	070171	1/1/0001
10000	M	M	OUG	II	00000	011	6TH LT. W. OF GEORGETOWN RD., N. SIDE	12	070171	1/1/0001
10000	M	M	OUG	II	00000	012	6TH LT. W. OF GEORGETOWN RD., S. SIDE	12	070171	1/1/0001
10000	M	M	OUG	II	00000	013	7TH LT. W. OF GEORGETOWN RD., N. SIDE	12	070171	1/1/0001
10000	M	M	OUG	II	00000	014	7TH LT. W. OF GEORGETOWN RD., S. SIDE	12	070171	1/1/0001
10000	M	M	OUG	II	00000	015	8TH LT. W. OF GEORGETOWN RD., N. SIDE	12	070171	1/1/0001
10000	M	M	OUG	II	00000	016	8TH LT. W. OF GEORGETOWN RD.,S. SIDE	12	070171	1/1/0001

OFFICE: 311		ROUTE: 564		ST_REF_NO: 00000125800		MERCER ROAD		LUMENS	BULB TYPE	MULT SERIES	POLE TYPE	SHADE	ADDRESS NUMBER	REF	LOCATION	TAX DIST	DATE INST	DATE CHANGE
10000	M	M	OUG	II	00000	017	9TH LT. W. OF GEORGETOWN RD., N. SIDE	12	070171	1/1/0001								
10000	M	M	OUG	II	00000	018	9TH LT. W. OF GEORGETOWN RD., S. SIDE	12	070171	1/1/0001								
10000	M	M	OUG	II	00000	019	10TH LT. W. OF GEORGETOWN RD., N. SIDE	12	070171	1/1/0001								
10000	M	M	OUG	II	00000	020	10TH LT. W. OF GEORGETOWN RD., S. SIDE	12	070171	1/1/0001								
10000	M	M	OUG	II	00000	021	1ST LT. W. OF BAKER CT., N. SIDE	12	070171	1/1/0001								
10000	M	M	OUG	II	00000	022	1ST LT. W. OF BAKER CT., S. SIDE	12	070171	1/1/0001								
10000	M	M	OUG	II	00000	023	2ND LT. W. OF BAKER CT., N. SIDE	12	070171	1/1/0001								
10000	M	M	OUG	II	00000	024	2ND LT. W. OF BAKER CT., S. SIDE	12	070171	1/1/0001								
10000	M	M	OUG	II	00000	025	3RD LT. W. OF BAKER CT., N. SIDE	12	070171	1/1/0001								
10000	M	M	OUG	II	00000	026	4TH LT. W. OF BAKER CT., N. SIDE	12	070171	1/1/0001								
09500	S	M	OUG	II	00000	027	3RD LT. W. OF BAKER CT., S. SIDE,upgrade DTS	12	070171	1/1/0001								
10000	M	M	OUG	II	00000	028	5TH LT. W. OF BAKER CT., N. SIDE	12	070171	1/1/0001								
10000	M	M	OUG	II	00000	029	4TH LT W OF BAKER CT, S SIDE	12	070171	1/1/0001								
10000	M	M	OUG	II	00000	030	6TH LT. W. OF BAKER CT., N. SIDE	12	070171	1/1/0001								
09500	S	M	OUG	II	00000	031	5TH LT. W. OF BAKER CT., S. SIDE-ch out bad mv fix	12	070171	1/1/0001								
10000	M	M	OUG	II	00000	032	7TH LT. W. OF BAKER CT., N. SIDE	12	070171	1/1/0001								
10000	M	M	OUG	II	00000	033	OPP. FAIRMAN RD.	12	070172	1/1/0001								
10000	M	M	OUG	II	00000	034	1ST LT. W. OF FAIRMAN RD., N. SIDE	12	070172	1/1/0001								
10000	M	M	OUG	II	00000	035	1ST LT. W. OF FAIRMAN RD., S. SIDE	12	070172	1/1/0001								
10000	M	M	OUG	II	00000	036	2ND LT. W. OF FAIRMAN RD., N. SIDE	12	070172	1/1/0001								
10000	M	M	OUG	II	00000	037	2ND LT. W. OF FAIRMAN RD., S. SIDE	12	070172	1/1/0001								
10000	M	M	OUG	II	00000	038	3RD LT. W. OF FAIRMAN RD., N. SIDE	12	070172	1/1/0001								
10000	M	M	OUG	II	00000	039	OPP. HARBISON RD.	12	070172	1/1/0001								
10000	M	M	OUG	II	00000	040	1ST LT. W. OF HARBISON RD., N. SIDE	12	070172	1/1/0001								
10000	M	M	OUG	II	00000	041	1ST LT. W. OF HARBISON RD., S. SIDE	12	070172	1/1/0001								
10000	M	M	OUG	II	00000	042	2ND LT. W. OF HARBISON RD.,N. SIDE	12	070172	1/1/0001								
10000	M	M	OUG	II	00000	043	2ND LT. W. OF HARBISON RD., S. SIDE	12	070172	1/1/0001								
10000	M	M	OUG	II	00000	044	3RD LT. W. OF HARBISON RD., S. SIDE	12	110172	1/1/0001								
10000	M	M	OUG	II	00000	045	4TH LT. W. OF HARBISON RD., S. SIDE	12	110172	1/1/0001								

OFFICE: 311

ROUTE: 564

ST_REF_NO: 00000125810

MERCHANT STREET

LUMENS	BULB TYPE	MULT SERIES	POLE TYPE	SHADE	ADDRESS NUMBER	REF	LOCATION	TAX DIST	DATE INST	DATE CHANGE
05800	S	M	OUG	II	02400	012		12	020888	1/1/0001

OFFICE: 311

ROUTE: 564

ST_REF_NO: 00000125810

MERCHANT STREET

LUMENS	BULB TYPE	MULT SERIES	POLE TYPE	SHADE	ADDRESS NUMBER	REF	LOCATION	TAX DIST	DATE INST	DATE CHANGE
05800	S	M	OUG	II	02401	011		12	110885	1/1/0001
05800	S	M	OUG	II	02409	013		12	020888	1/1/0001
05800	S	M	OUG	V	02424	015		12	020888	1/1/0001
05800	S	M	OUG	II	02425	014		12	020888	1/1/0001

OFFICE: 311

ROUTE: 564

ST_REF_NO: 00000125900

MEREWOOD DRIVE

LUMENS	BULB TYPE	MULT SERIES	POLE TYPE	SHADE	ADDRESS NUMBER	REF	LOCATION	TAX DIST	DATE INST	DATE CHANGE
04000	S	M	OUG	II	00000	030	SIDE OF 3601 FOX RUN RD.	12	111478	1/1/0001
04000	S	M	OUG	II	01135	033		12	111580	1/1/0001
04000	S	M	OUG	II	01146	032		12	111580	1/1/0001
04000	S	M	OUG	II	01163	031		12	111580	1/1/0001
04000	S	M	OUG	II	01187	029		12	111478	1/1/0001
04000	S	M	OUG	II	00000	016	SIDE OF 1194 TATESBROOK DR.	12	111478	1/1/0001
04000	S	M	OUG	II	01126	034		12	111580	1/1/0001

OFFICE: 311

ROUTE: 564

ST_REF_NO: 00000126000

MERIDIAN COURT

LUMENS	BULB TYPE	MULT SERIES	POLE TYPE	SHADE	ADDRESS NUMBER	REF	LOCATION	TAX DIST	DATE INST	DATE CHANGE
04000	S	M	OUG	II	00000	003	SIDE OF 1844 DARIEN DR.	12	020889	1/1/0001
04000	S	M	OUG	II	00000	004	SIDE OF 1841 DARIEN DR.	12	020889	1/1/0001
04000	S	M	OUG	II	01095	002		12	020889	1/1/0001
04000	S	M	OUG	II	01082	001		12	020889	1/1/0001

OFFICE: 311

ROUTE: 564

ST_REF_NO: 00000126100

MERIDIAN DRIVE

LUMENS	BULB TYPE	MULT SERIES	POLE TYPE	SHADE	ADDRESS NUMBER	REF	LOCATION	TAX DIST	DATE INST	DATE CHANGE
04000	S	M	OUG	II	00000	010	SIDE OF 1832 WILLIAMSBURG RD.	12	020889	1/1/0001
04000	S	M	OUG	II	01112	005		12	020889	1/1/0001
04000	S	M	OUG	II	01121	006		12	020889	1/1/0001
04000	S	M	OUG	II	01132	007		12	020889	1/1/0001
04000	S	M	OUG	II	01141	008		12	020889	1/1/0001
04000	S	M	OUG	II	01152	009		12	020889	1/1/0001

OFFICE: 311		ROUTE: 564		ST_REF_NO: 00000126200		MERINO STREET				
LUMENS	BULB TYPE	MULT SERIES	POLE TYPE	SHADE	ADDRESS NUMBER	REF	LOCATION	TAX DIST	DATE INST	DATE CHANGE
10000	M	M	SOH	II	00000	001	OPP. 368	12	100768	1/1/0001
05800	S	M	SOH	II	00000	446	OPP. 568	12	060867	1/1/0001
05800	S	M	SOH	II	00000	447	1ST LT. S. OF R.R. OVERPASS, E. SIDE	12	060867	1/1/0001
05800	S	M	SOH	II	00000	450	1ST LT. S. OF PINE ST., W. SIDE	12	060867	1/1/0001
05800	S	M	SOH	II	00000	452	1ST LT. S. OF MAXWELL ST., E. SIDE	12	060867	1/1/0001
05800	S	M	SOH	II	00000	453	SW CORNER OF MERINO & MALONEY ALLEY	12	090162	1/1/0001
10000	M	M	SOH	II	00314	004		12	100768	1/1/0001
10000	M	M	SOH	II	00327	003		12	100768	1/1/0001
10000	M	M	SOH	II	00352	002		12	100768	1/1/0001
05800	S	M	SOH	II	00426	451		12	060867	1/1/0001
05800	S	M	SOH	II	00524	449		12	060867	1/1/0001
05800	S	M	SOH	II	00539	448		12	060867	1/1/0001

OFFICE: 311		ROUTE: 564		ST_REF_NO: 00000126400		MERMEN DRIVE				
LUMENS	BULB TYPE	MULT SERIES	POLE TYPE	SHADE	ADDRESS NUMBER	REF	LOCATION	TAX DIST	DATE INST	DATE CHANGE
04000	S	M	OUG	II	01180	026		12	061580	1/1/0001
04000	S	M	OUG	II	01187	025		12	061580	1/1/0001
04000	S	M	OUG	II	01200	024		12	061580	1/1/0001
04000	S	M	OUG	II	01207	023		12	061580	1/1/0001
04000	S	M	OUG	II	01216	022		12	061580	1/1/0001
04000	S	M	OUG	II	01223	021		12	061580	1/1/0001
04000	S	M	OUG	II	01255	000		12	060867	1/1/0001
04000	S	M	OUG	II	01268	000		12	041067	1/1/0001
05800	S	M	OUG	II	01283	000		12	120667	1/1/0001
04000	S	M	OUG	II	01294	000		12	120667	1/1/0001

OFFICE: 311		ROUTE: 564		ST_REF_NO: 00000126450		MERRIBROOK CT				
LUMENS	BULB TYPE	MULT SERIES	POLE TYPE	SHADE	ADDRESS NUMBER	REF	LOCATION	TAX DIST	DATE INST	DATE CHANGE
04000	S	M	OUG	II	00401	001		12	110891	1/1/0001
04000	S	M	OUG	II	00408	002		12	110891	1/1/0001
04000	S	M	OUG	II	00421	003		12	110891	1/1/0001

OFFICE: 311

ROUTE: 564

ST_REF_NO: 00000126605

MERIDETH CIRCLE

LUMENS	BULB TYPE	MULT SERIES	POLE TYPE	SHADE	ADDRESS NUMBER	REF	LOCATION	TAX DIST	DATE INST	DATE CHANGE
05800	S	M	CNT	III	03009	002		12	100899	1/1/0001
05800	S	M	CNT	II	03013	001		12	100899	1/1/0001

OFFICE: 311

ROUTE: 564

ST_REF_NO: 00000126610

MERRIDEW WAY

LUMENS	BULB TYPE	MULT SERIES	POLE TYPE	SHADE	ADDRESS NUMBER	REF	LOCATION	TAX DIST	DATE INST	DATE CHANGE
04000	S	M	OUG	II	03801	027		12	091579	1/1/0001
04000	S	M	OUG	II	03812	026		12	091579	1/1/0001
04000	S	M	OUG	II	03825	025		12	091579	1/1/0001
04000	S	M	OUG	II	03836	024		12	091579	1/1/0001

OFFICE: 311

ROUTE: 564

ST_REF_NO: 00000126700

MERRIMAC DRIVE

LUMENS	BULB TYPE	MULT SERIES	POLE TYPE	SHADE	ADDRESS NUMBER	REF	LOCATION	TAX DIST	DATE INST	DATE CHANGE
05800	S	M	OUG	II	00000	085	OPP. 619	12	110885	1/1/0001
05800	S	M	OUG	II	00000	090	OPP. 611	12	110885	1/1/0001
05800	S	M	OUG	II	00000	094	OPP. 587	12	110885	1/1/0001
05800	S	M	OUG	II	00567	099		12	110885	1/1/0001
05800	S	M	OUG	II	00572	098		12	110885	1/1/0001
05800	S	M	OUG	II	00575	097		12	110885	1/1/0001
05800	S	M	OUG	II	00580	096		12	110885	1/1/0001
05800	S	M	OUG	II	00583	095		12	110885	1/1/0001
05800	S	M	OUG	II	00591	093		12	110885	1/1/0001
05800	S	M	OUG	II	00596	092		12	110885	1/1/0001
05800	S	M	OUG	II	00607	091		12	110885	1/1/0001
05800	S	M	OUG	II	00000	033	SIDE OF 561 CROMWELL WAY	12	110885	1/1/0001
05800	S	M	OUG	II	00548	034		12	110885	1/1/0001
05800	S	M	OUG	II	00555	101		12	110885	1/1/0001
05800	S	M	OUG	II	00560	100		12	110885	1/1/0001

OFFICE: 311

ROUTE: 564

ST_REF_NO: 00000126800

MESA COURT

LUMENS	BULB TYPE	MULT SERIES	POLE TYPE	SHADE	ADDRESS NUMBER	REF	LOCATION	TAX DIST	DATE INST	DATE CHANGE
04000	S	M	OUG	II	00000	052	SIDE OF 2016 PARASOL DR.	12	031581	1/1/0001

OFFICE: 311 **ROUTE:** 564

ST_REF_NO: 00000126905 MIAMI CIRCLE

LUMENS	BULB TYPE	MULT SERIES	POLE TYPE	SHADE	ADDRESS NUMBER	REF	LOCATION	TAX DIST	DATE INST	DATE CHANGE
05800	S	M	CNT	III	04704	001		12	032404	1/1/0001

OFFICE: 311 **ROUTE:** 564

ST_REF_NO: 00000126910 MICHAELS COVE

LUMENS	BULB TYPE	MULT SERIES	POLE TYPE	SHADE	ADDRESS NUMBER	REF	LOCATION	TAX DIST	DATE INST	DATE CHANGE
05800	S	M	CNT	II	00000	003	SIDE OF 3591 BRIARPATCH WAY	12	060894	1/1/0001
05800	S	M	CNT	II	00000	007	SIDE OF 1040 VERO CT.	12	070896	1/1/0001
05800	S	M	CNT	II	03570	006		12	060894	1/1/0001
05800	S	M	CNT	II	03571	005		12	060894	1/1/0001
05800	S	M	CNT	II	03574	004		12	060894	1/1/0001
05800	S	M	CNT	II	03595	002		12	060894	1/1/0001

OFFICE: 311 **ROUTE:** 564

ST_REF_NO: 00000126930 MICHELLE PARK

LUMENS	BULB TYPE	MULT SERIES	POLE TYPE	SHADE	ADDRESS NUMBER	REF	LOCATION	TAX DIST	DATE INST	DATE CHANGE
05800	S	M	CNT	II	00000	001	SIDE OF 2553 BUCK LANE ON MICHELLE PARK	12	042605	1/1/0001
05800	S	M	CNT	II	00000	009	SIDE OF 233 LUCILLE DR ON MICHELLE PARK	12	042605	1/1/0001
05800	S	M	CNT	II	00000	025	SIDE OF 2581 MICHELLE PARK	12	062405	1/1/0001
05800	S	M	CNT	II	02553	021		12	062405	1/1/0001
05800	S	M	CNT	II	02568	022		12	062405	1/1/0001
05800	S	M	CNT	II	02584	023		12	062405	1/1/0001
05800	S	M	CNT	II	02605	024		12	062405	1/1/0001
05800	S	M	CNT	II	02629	026		12	062405	1/1/0001
05800	S	M	CNT	II	02645	027		12	062405	1/1/0001
05800	S	M	CNT	II	02660	028		12	062405	1/1/0001
05800	S	M	CNT	II	02673	029		12	062405	1/1/0001
05800	S	M	CNT	II	02685	002		12	042605	1/1/0001
05800	S	M	CNT	III	02717	003		12	042605	1/1/0001
05800	S	M	CNT	II	02733	004		12	042605	1/1/0001
05800	S	M	CNT	II	02744	005		12	042605	1/1/0001
05800	S	M	CNT	II	02765	006		12	042605	1/1/0001
05800	S	M	CNT	II	02776	007		12	042605	1/1/0001
05800	S	M	CNT	II	02793	008		12	042605	1/1/0001
05800	S	M	CNT	II	02817	010		12	062405	1/1/0001

OFFICE: 311

ROUTE: 564

ST_REF_NO: 00000126930

MICHELLE PARK

LUMENS	BULB TYPE	MULT SERIES	POLE TYPE	SHADE	ADDRESS NUMBER	REF	LOCATION	TAX DIST	DATE INST	DATE CHANGE
05800	S	M	CNT	II	02836	011		12	062405	1/1/0001
05800	S	M	CNT	II	02845	012		12	062405	1/1/0001

OFFICE: 311

ROUTE: 564

ST_REF_NO: 00000127000

MICHIGAN STREET

LUMENS	BULB TYPE	MULT SERIES	POLE TYPE	SHADE	ADDRESS NUMBER	REF	LOCATION	TAX DIST	DATE INST	DATE CHANGE
05800	S	M	SOH	II	00000	001	1ST LT. W. OF NEWTOWN RD., N. SIDE	12	061661	1/1/0001
05800	S	M	SOH	II	00000	002	2ND LT. W. OF NEWTOWN RD., N. SIDE	12	061661	1/1/0001
05800	S	M	SOH	II	00000	003	3RD LT. W. OF NEWTOWN RD., N. SIDE	12	061661	1/1/0001
05800	S	M	SOH	II	00000	004	4TH LT. W. OF NEWTOWN RD., N. SIDE	12	061661	1/1/0001
05800	S	M	SOH	II	00000	006	SIDE OF 901 CHARLES AVE.	12	060166	1/1/0001
05800	S	M	SOH	II	00323	000		12	011865	1/1/0001
05800	S	M	SOH	II	00419	000		12	011865	1/1/0001
05800	S	M	SOH	II	00433	000		12	060368	1/1/0001
05800	S	M	SOH	II	00439	000		12	011865	1/1/0001
05800	S	M	SOH	II	00461	000		12	011865	1/1/0001

OFFICE: 311

ROUTE: 564

ST_REF_NO: 00000127090

MIDDLESEX COURT

LUMENS	BULB TYPE	MULT SERIES	POLE TYPE	SHADE	ADDRESS NUMBER	REF	LOCATION	TAX DIST	DATE INST	DATE CHANGE
04000	S	M	OUG	II	02900	025		12	050172	1/1/0001
04000	S	M	OUG	II	02909	026		12	041470	1/1/0001

OFFICE: 311

ROUTE: 564

ST_REF_NO: 00000127100

MIDDLESEX WAY

LUMENS	BULB TYPE	MULT SERIES	POLE TYPE	SHADE	ADDRESS NUMBER	REF	LOCATION	TAX DIST	DATE INST	DATE CHANGE
05800	S	M	OUG	II	02889	024		12	101570	3/20/2013
04000	S	M	OUG	II	02853	020		12	101570	1/1/0001
04000	S	M	OUG	II	02860	021		12	041470	1/1/0001
04000	S	M	OUG	II	02869	022		12	101570	1/1/0001
04000	S	M	OUG	II	02880	023		12	080173	1/1/0001

OFFICE: 311		ROUTE: 564		ST_REF_NO: 00000127110		MIDDLETON PLACE		LUMENS	BULB TYPE	MULT SERIES	POLE TYPE	SHADE	ADDRESS NUMBER	REF	LOCATION	TAX DIST	DATE INST	DATE CHANGE
05800	S	M	CNT	III	05048	005										12	091503	1/1/0001
05800	S	M	CNT	II	05084	004										12	091503	1/1/0001
05800	S	M	CNT	II	05096	003										12	050603	1/1/0001
05800	S	M	CNT	II	05101	004										12	050603	1/1/0001
OFFICE: 311		ROUTE: 564		ST_REF_NO: 00000127200		MIDLAND AVENUE		LUMENS	BULB TYPE	MULT SERIES	POLE TYPE	SHADE	ADDRESS NUMBER	REF	LOCATION	TAX DIST	DATE INST	DATE CHANGE
20000	M	S	SOH	III	00000	014									4TH LT. FROM MAIN, E. SIDE	12	041163	1/1/0001
20000	M	M	SOH	II	00000	015									12TH LT. FROM MAIN, WESTSIDE	12	101580	1/1/0001
20000	M	S	SOH	III	00000	016									5TH LT. FROM MAIN, E. SIDE	12	041163	1/1/0001
20000	M	M	SOH	II	00000	017									13TH LT. FROM MAIN, WESTSIDE	12	101580	1/1/0001
20000	M	S	SOH	III	00000	018									6TH LT. FROM MAIN, E. SIDE	12	041163	1/1/0001
20000	M	M	SOH	II	00000	019									14TH LT. FROM MAIN, WESTSIDE	12	101580	1/1/0001
20000	M	S	SOH	III	00000	020									7TH LT. FROM MAIN, E. SIDE	12	041163	1/1/0001
20000	M	M	SOH	II	00000	021									15TH LT. FROM MAIN, WESTSIDE	12	101580	1/1/0001
20000	M	S	SOH	III	00000	022									8TH LT. FROM MAIN, E. SIDE	12	041163	1/1/0001
20000	M	M	SOH	II	00000	023									16TH LT. FROM MAIN, WESTSIDE	12	101580	1/1/0001
20000	M	S	SOH	III	00000	024									9TH LT. FROM MAIN, E. SIDE	12	041163	1/1/0001
20000	M	M	SOH	II	00000	025									17TH LT. FROM MAIN, WESTSIDE	12	101580	1/1/0001
20000	M	S	SOH	III	00000	026									10TH LT. FROM MAIN, E. SIDE	12	041163	1/1/0001
22000	S	M	OOH	II	00000	002									1ST LT. FROM MAIN, E. SIDE	12	101580	1/1/0001
22000	S	M	OOH	II	00000	004									2ND LT. FROM MAIN, E. SIDE	12	101580	1/1/0001
22000	S	M	OUG	II	00000	009									7TH LT. FROM MAIN, WESTSIDE	12	020892	1/1/0001
20000	M	M	SOH	III	00000	010									8TH LT. FROM MAIN, WESTSIDE	12	041163	1/1/0001
20000	M	M	SOH	II	00000	011									9TH LT. FROM MAIN, WESTSIDE	12	101580	1/1/0001
20000	M	M	SOH	II	00000	012									10TH LT. FROM MAIN, WESTSIDE	12	101580	1/1/0001
20000	M	M	SOH	II	00000	013									11TH LT. FROM MAIN, WESTSIDE	12	101580	1/1/0001
22000	S	M	SOH	I	00000	027									OPP. 155 MIDLAND AVE	12	090891	1/1/0001
22000	S	M	OUG	III	00000	028									5TH LT. FROM MAIN, WESTSIDE	12	010892	1/1/0001

OFFICE: 311		ROUTE: 564		ST_REF_NO: 00000127490		MIKAN COURT		LUMENS	BULB TYPE	MULT SERIES	POLE TYPE	SHADE	ADDRESS NUMBER	REF	LOCATION	TAX DIST	DATE INST	DATE CHANGE
	05800	S	M	OUG	II	01700	002									12	100895	1/1/0001
	05800	S	M	OUG	II	01716	001									12	120887	1/1/0001

OFFICE: 311		ROUTE: 564		ST_REF_NO: 00000127600		MILANO ROAD		LUMENS	BULB TYPE	MULT SERIES	POLE TYPE	SHADE	ADDRESS NUMBER	REF	LOCATION	TAX DIST	DATE INST	DATE CHANGE
	05800	S	M	OUG	II	00000	021								SIDE OF 1159 VENETIAN WAY	12	071562	1/1/0001
	05800	S	M	OUG	II	00000	062								2ND LT. N. OF CENTRE PARKWAY, W. SIDE	12	120171	1/1/0001
	05800	S	M	OUG	II	00000	063								1ST LT. N. OF CENTRE PARKWAY, E. SIDE	12	120869	1/1/0001
	05800	S	M	OUG	II	00000	064								1ST. LT. N. OF CENTRE PARKWAY, W. SIDE	12	120869	1/1/0001
	05800	S	M	OUG	II	00000	065								SIDE OF 1152 CENTRE PARKWAY	12	050768	1/1/0001
	05800	S	M	OUG	II	03518	066									12	120171	1/1/0001
	05800	S	M	OUG	II	03531	000									12	090166	1/1/0001
	05800	S	M	OUG	II	03546	000									12	090166	1/1/0001

OFFICE: 311		ROUTE: 564		ST_REF_NO: 00000127700		MILITARY PIKE		LUMENS	BULB TYPE	MULT SERIES	POLE TYPE	SHADE	ADDRESS NUMBER	REF	LOCATION	TAX DIST	DATE INST	DATE CHANGE
	22000	S	M	OUG	II	00000	001								1ST LT W OF HARRODSBURG RD,N SIDE ON MILITARY PK	12	040805	1/1/0001
	09500	S	M	OUG	II	00000	002								2ND LT W OF HARRODSBURG RD,N SIDE ON MILITARY PK	12	040805	1/1/0001
	05800	S		SOH	II	00000	021								1ST LT W OF FT-SPGS PINKARD ON S SIDE OF MILITARY	12	030801	1/1/0001
	05800	S		SOH	II	00000	022								OPP FORT-SPRINGS PINKARD LN ON S SIDE OF MILITARY	12	030801	1/1/0001
	05800	S		SOH	II	00000	023								1ST LT E OF FT-SPGS PINKARD ON S SIDE OF MILITARY	12	030801	1/1/0001

OFFICE: 311		ROUTE: 564		ST_REF_NO: 00000127800		MILL, NORTH STREET		LUMENS	BULB TYPE	MULT SERIES	POLE TYPE	SHADE	ADDRESS NUMBER	REF	LOCATION	TAX DIST	DATE INST	DATE CHANGE
	22000	S	M	SOH	III	00000	004								2ND LT. N. OF MAIN ST.,E. SIDE-bad fixture	12	102061	3/2/2009
	09500	S	M	ACD	III	00000	011								1ST LT. N. OF SECOND ST., E. SIDE	12	020898	2/8/1998
	09500	S	M	ACD	III	00000	012								2ND LT. N. OF SECOND ST., E. SIDE	12	020898	2/8/1998
	09500	S	M	ACD	III	00000	013								3RD LT. N. OF SECOND ST., E. SIDE	12	020898	2/8/1998

OFFICE: 311

ROUTE: 564

ST_REF_NO: 00000127800

MILL, NORTH STREET

LUMENS	BULB TYPE	MULT SERIES	POLE TYPE	SHADE	ADDRESS NUMBER	REF	LOCATION	TAX DIST	DATE INST	DATE CHANGE
09500	S	M	ACD	III	00000	014	4TH LT. N. OF SECOND ST., E. SIDE	12	020898	2/8/1998
09500	S	M	ACD	III	00000	015	5TH LT. N. OF SECOND ST., E. SIDE	12	020898	2/8/1998
09500	S	M	ACD	III	00000	016	6TH LT. N. OF SECOND ST., E. SIDE	12	020898	2/8/1998
50000	S	M	OUG	II	00000	001	1ST LT. N. OF MAIN ST., W. SIDE	12	050886	1/1/0001
20000	M	M	SOH	III	00000	003	2ND LT. N. OF MAIN ST., W. SIDE	12	102061	1/1/0001
20000	M	M	SOH	III	00000	005	1ST LT. N. OF SHORT ST., W. SIDE	12	102061	1/1/0001
20000	M	M	SOH	III	00000	007	2ND LT. N. OF SHORT ST., W. SIDE	12	102061	1/1/0001
22000	S	M	SOH	II	00000	008	1ST LT. N. OF CHURCH ST., W. SIDE	12	020563	1/1/0001
22000	S	M	SOH	II	00000	010	SW CORNER OF MILL & W. SECOND ST.	12	011863	1/1/0001
22000	S	M	SOH	II	00181	009		12	011863	1/1/0001
20000	M	M	SOH	III	00000	002	1ST LT. N. OF MAIN ST., E. SIDE	12	102061	1/1/0001
20000	M	M	SOH	III	00000	006	1ST LT. N. OF SHORT ST., E. SIDE	12	102061	1/1/0001

OFFICE: 311

ROUTE: 564

ST_REF_NO: 00000127810

MILL, SOUTH STREET

LUMENS	BULB TYPE	MULT SERIES	POLE TYPE	SHADE	ADDRESS NUMBER	REF	LOCATION	TAX DIST	DATE INST	DATE CHANGE
50000	S	M	CNT	II	00000	001	1ST LT. S. OF MAIN, E. SIDE-lfucg upgrades	12	100886	8/18/2010
50000	S	M	CNT	II	00000	002	2ND LT. S. OF MAIN, E. SIDE-lfucg upgrade	12	100886	8/18/2010
50000	S	M	CNT	III	00000	003	1ST LT. N. OF VINE ST., E. SIDE-lfucg upgrade	12	070171	8/18/2010
22000	S	M	SOH	II	00000	015	NE CORNER OF MILL & W. MAXWELL ST.upgrade per city req	12	030168	10/6/2009
09500	S	M	SOH	II	00417	017		12	030168	1/10/2013
50000	S	M	OUG	III	00000	004	1ST LT. S. OF VINE ST., W. SIDE	12	070171	1/1/0001
50000	S	M	OUG	III	00000	005	2ND LT. S. OF VINE ST., W. SIDE	12	070171	1/1/0001
10000	M	M	SOH	II	00000	023	OPP. 622	12	030168	1/1/0001
10000	M	M	SOH	II	00321	009		12	030168	1/1/0001
10000	M	M	SOH	II	00347	011		12	030168	1/1/0001
10000	M	M	SOH	II	00363	013		12	030168	1/1/0001
09500	S	M	SOH	II	00407	016	upgrade 1/08	12	030168	1/1/0001
10000	M	M	SOH	II	00431	018		12	030168	1/1/0001
10000	M	M	SOH	II	00517	020		12	030168	1/1/0001
10000	M	M	SOH	III	00000	006	NE CORNER OF MILL & W. HIGH ST.	12	020164	1/1/0001
10000	M	M	SOH	II	00000	007	SIDE OF 300 W. HIGH ST.	12	030168	1/1/0001
10000	M	M	SOH	II	00000	008	OPP. 315	12	030168	1/1/0001

OFFICE: 311		ROUTE: 564		ST_REF_NO: 00000127810		MILL, SOUTH STREET				
LUMENS	BULB TYPE	MULT SERIES	POLE TYPE	SHADE	ADDRESS NUMBER	REF	LOCATION	TAX DIST	DATE INST	DATE CHANGE
10000	M	M	SOH	II	00000	014	OPP. 379	12	030168	1/1/0001
10000	M	M	SOH	II	00000	024	SIDE OF 235 BOLIVAR ST.	12	061768	1/1/0001
10000	M	M	SOH	II	00330	010		12	080668	1/1/0001
10000	M	M	SOH	II	00358	012		12	061768	1/1/0001
10000	M	M	SOH	II	00600	021		12	110268	1/1/0001
10000	M	M	SOH	II	00604	022		12	080668	1/1/0001
OFFICE: 311		ROUTE: 564		ST_REF_NO: 00000127860		MILL WOOD COVE				
LUMENS	BULB TYPE	MULT SERIES	POLE TYPE	SHADE	ADDRESS NUMBER	REF	LOCATION	TAX DIST	DATE INST	DATE CHANGE
05800	S	M	CNT	II	02701	001		12	101905	1/1/0001
05800	S	M	CNT	II	02708	002		12	101905	1/1/0001
05800	S	M	CNT	II	02724	003		12	101905	1/1/0001
05800	S	M	CNT	III	02740	004		12	101905	1/1/0001
OFFICE: 311		ROUTE: 564		ST_REF_NO: 00000127890		MILLBANK ROAD				
LUMENS	BULB TYPE	MULT SERIES	POLE TYPE	SHADE	ADDRESS NUMBER	REF	LOCATION	TAX DIST	DATE INST	DATE CHANGE
05800	S		OUG	II	00000	020	SIDE OF 788 BURGESS AVE, ON MILLBANK RD	12	080710	1/1/0001
05800	S		OUG	II	01709	019		12	080710	1/1/0001
05800	S		OUG	II	01717	018		12	080710	1/1/0001
05800	S		OUG	II	01732	017		12	080710	1/1/0001
05800	S		OUG	II	01744	016		12	080710	1/1/0001
05800	S		OUG	II	01761	016		12	031909	1/1/0001
05800	S		OUG	II	01772	015		12	031909	1/1/0001
05800	S		OUG	II	01788	014		12	031909	1/1/0001
05800	S		OUG	II	01797	013		12	031909	1/1/0001
05800	S		OUG	II	01808	011		12	031909	1/1/0001
05800	S		OUG	II	01813	010		12	031909	1/1/0001
05800	S		OUG	II	01849	009		12	031909	1/1/0001
05800	S		OUG	II	01864	008		12	031909	1/1/0001
05800	S		OUG	II	01873	007		12	031909	1/1/0001
05800	S		OUG	II	01889	006		12	031909	1/1/0001
05800	S		OUG	II	01900	005		12	031909	1/1/0001

OFFICE: 311		ROUTE: 564		ST_REF_NO: 00000127890		MILLBANK ROAD				
LUMENS	BULB TYPE	MULT SERIES	POLE TYPE	SHADE	ADDRESS NUMBER	REF	LOCATION	TAX DIST	DATE INST	DATE CHANGE
05800	S		OUG	II	01920	004		12	031909	1/1/0001
05800	S		OUG	II	01668	021		12	080710	8/7/2010

OFFICE: 311		ROUTE: 564		ST_REF_NO: 00000127900		MILLBROOK DRIVE				
LUMENS	BULB TYPE	MULT SERIES	POLE TYPE	SHADE	ADDRESS NUMBER	REF	LOCATION	TAX DIST	DATE INST	DATE CHANGE
04000	S	M	OUG	II	00000	127	SIDE OF 223 CLEARVIEW DR.	12	091477	1/1/0001
04000	S	M	OOH	II	00200	107		12	090968	1/1/0001
04000	S	M	OUG	II	00260	105		12	101468	1/1/0001
04000	S	M	OUG	II	00261	106		12	101468	1/1/0001
04000	S	M	OUG	II	02431	109		12	101468	1/1/0001
04000	S	M	OUG	II	02571	128		12	091477	1/1/0001
04000	S	M	OUG	II	02588	129		12	091477	1/1/0001
04000	S	M	OUG	II	02595	130		12	091477	1/1/0001
04000	S	M	OUG	II	02410	108		12	101468	1/1/0001
04000	S	M	OUG	II	02470	110		12	101468	1/1/0001
04000	S	M	OUG	II	02500	092		12	090968	1/1/0001

OFFICE: 311		ROUTE: 564		ST_REF_NO: 00000127990		MILLCREEK COURT				
LUMENS	BULB TYPE	MULT SERIES	POLE TYPE	SHADE	ADDRESS NUMBER	REF	LOCATION	TAX DIST	DATE INST	DATE CHANGE
04000	S	M	OUG	II	00000	035	1028 B	12	080895	1/1/0001
04000	S	M	OUG	II	01033	034		12	050886	1/1/0001
04000	S	M	OUG	II	01045	033		12	061580	1/1/0001
04000	S	M	OUG	II	01174	032		12	061580	1/1/0001

OFFICE: 311		ROUTE: 564		ST_REF_NO: 00000128000		MILLCREEK DRIVE				
LUMENS	BULB TYPE	MULT SERIES	POLE TYPE	SHADE	ADDRESS NUMBER	REF	LOCATION	TAX DIST	DATE INST	DATE CHANGE
04000	S	M	OUG	II	00000	028	SIDE OF 1049 MILLCREEK CT.	12	061580	1/1/0001
04000	S	M	OUG	II	00000	031	SIDE OF 3625 APPIAN WAY	12	061580	1/1/0001
04000	S	M	OUG	II	01175	027		12	061580	1/1/0001
04000	S	M	OUG	II	01182	029		12	061580	1/1/0001
04000	S	M	OUG	II	01191	030		12	061580	1/1/0001

OFFICE: 311

ROUTE: 564

ST_REF_NO: 00000128100

MILLER STREET

LUMENS	BULB TYPE	MULT SERIES	POLE TYPE	SHADE	ADDRESS NUMBER	REF	LOCATION	TAX DIST	DATE INST	DATE CHANGE
09500	S	M	SOH	II	00000	015	ACROSS FROM 246 MILLER STREET	12	060305	1/1/0001
09500	S	M	SOH	II	00000	020	SIDE OF 224 MILLER STREET	12	060305	1/1/0001
09500	S	M	SOH	II	00000	025	REAR OF 264 JEFFERSON STREET ON MILLER STREET	12	060305	1/1/0001
09500	S	M	SOH	I	00000	011	OPP. 236-upgraded to 9500 hps cobra June 2005	12	040165	1/1/0001
09500	S	M	SOH	I	00000	196	1ST LT. N. OF W. 2ND ST., E. SIDE-upgraded June 05	12	070566	1/1/0001

OFFICE: 311

ROUTE: 564

ST_REF_NO: 00000128105

MILLPOND ROAD

LUMENS	BULB TYPE	MULT SERIES	POLE TYPE	SHADE	ADDRESS NUMBER	REF	LOCATION	TAX DIST	DATE INST	DATE CHANGE
05800	S	M	CNT	II	00000	021	SIDE OF 3656 MOSSBRIDGE ON MILLPOND RD	12	081202	1/1/0001
05800	S	M	CNT	II	00000	022	SIDE OF 3697 WINTHROP WAY ON MILLPOND RD	12	081202	1/1/0001
05800	S	M	CNT	II	00000	023	SIDE OF 3700 WINTHROP DRIVE ON MILLPOND DRIVE	12	052903	1/1/0001
05800	S	M	CNT	II	00500	029		12	102103	1/1/0001
05800	S	M	CNT	II	00509	028		12	052903	1/1/0001
05800	S	M	CNT	II	00520	027		12	102103	1/1/0001
05800	S	M	CNT	II	00537	026		12	052903	1/1/0001
05800	S	M	CNT	II	00552	025		12	102103	1/1/0001
05800	S	M	CNT	II	00565	024		12	102103	1/1/0001
05800	S	M	CNT	II	00000	001	1ST LT. E. OF BOSTON ROAD, NORTHSIDE	12	110895	1/1/0001
05800	S	M	CNT	II	00000	002	1ST LT. E. OF BOSTON ROAD, SOUTHSIDE	12	110895	1/1/0001
05800	S	M	CNT	II	00000	003	2ND LT. E. OF BOSTON ROAD, NORTHSIDE	12	110895	1/1/0001
05800	S	M	CNT	II	00000	004	2ND LT. E. OF BOSTON ROAD, SOUTHSIDE	12	110895	1/1/0001
05800	S	M	CNT	II	00000	005	3RD LT. E. OF BOSTON ROAD, NORTHSIDE	12	110895	1/1/0001
05800	S	M	CNT	II	00000	006	3RD LT. E. OF BOSTON ROAD, SOUTHSIDE	12	110895	1/1/0001
05800	S	M	CNT	II	00000	007	4TH LT. E. OF BOSTON ROAD, NORTHSIDE	12	110895	1/1/0001
05800	S	M	CNT	II	00000	008	4TH LT. E. OF BOSTON ROAD, SOUTHSIDE	12	110895	1/1/0001
05800	S	M	CNT	II	00000	009	5TH LT. E. OF BOSTON ROAD, NORTHSIDE	12	110895	1/1/0001
05800	S	M	CNT	II	00000	010	1ST LT. W. OF STONE CROSSING LANE, SOUTHSIDE	12	110895	1/1/0001
05800	S	M	CNT	II	00000	011	1ST LT. W. OF STONE CROSSING LANE, NORTHSIDE	12	110895	1/1/0001
05800	S	M	CNT	II	00000	012	1ST LT. E. OF STONE CROSSING LANE, NORTHSIDE	12	110895	1/1/0001

OFFICE: 311		ROUTE: 564		ST_REF_NO: 00000128105		MILLPOND ROAD		LUMENS	BULB TYPE	MULT SERIES	POLE TYPE	SHADE	ADDRESS NUMBER	REF	LOCATION	TAX DIST	DATE INST	DATE CHANGE
05800	S	M	CNT	II	00000	013	2NT LT. E. OF STONE CROSSING LANE, NORTHSIDE	12	110895									1/1/0001
05800	S	M	CNT	II	00000	015	SIDE 3729 WEEPING WILLOW WAY	12	110895									1/1/0001
05800	S	M	CNT	II	00000	017	SIDE OF 3796 WHITE PINE DR.	12	050899									1/1/0001
05800	S	M	CNT	II	00000	019	REAR OF 3598 WHITE PINE DR.	12	050899									1/1/0001
05800	S	M	CNT	II	00000	020	OPP. SIDE OF 3800 SCARLET OAK LANE	12	100897									1/1/0001
05800	S	M	CNT	II	00610	018		12	050899									1/1/0001
05800	S	M	CNT	II	00636	015		12	050899									1/1/0001
05800	S	M	CNT	II	00664	014		12	050899									1/1/0001

OFFICE: 311 ROUTE: 564

OFFICE: 311		ROUTE: 564		ST_REF_NO: 00000128108		MILLSTONE COVE		LUMENS	BULB TYPE	MULT SERIES	POLE TYPE	SHADE	ADDRESS NUMBER	REF	LOCATION	TAX DIST	DATE INST	DATE CHANGE
05800	S		OUG	II	02004	001		12	111813									1/1/0001

OFFICE: 311 ROUTE: 564

OFFICE: 311		ROUTE: 564		ST_REF_NO: 00000128109		MILLSTONE WAY		LUMENS	BULB TYPE	MULT SERIES	POLE TYPE	SHADE	ADDRESS NUMBER	REF	LOCATION	TAX DIST	DATE INST	DATE CHANGE
05800	S		OUG	II	02101	001		12	111813									1/1/0001
05800	S		OUG	II	02124	002		12	111813									1/1/0001
05800	S		OUG	II	02137	003		12	111813									1/1/0001
05800	S		OUG	II	02148	004		12	111813									1/1/0001
05800	S		OUG	II	02169	005		12	111813									1/1/0001

OFFICE: 311 ROUTE: 564

OFFICE: 311		ROUTE: 564		ST_REF_NO: 00000128110		MILL RIDGE ROAD		LUMENS	BULB TYPE	MULT SERIES	POLE TYPE	SHADE	ADDRESS NUMBER	REF	LOCATION	TAX DIST	DATE INST	DATE CHANGE
05800	S	M	CNT	II	00704	001		12	120895									1/1/0001
05800	S	M	CNT	II	00717	002		12	120895									1/1/0001
05800	S	M	CNT	II	00732	003		12	120895									1/1/0001
05800	S	M	CNT	II	00737	004		12	120895									1/1/0001
05800	S	M	CNT	II	00748	005		12	120895									1/1/0001
05800	S	M	CNT	III	00757	007		12	120895									1/1/0001
05800	S	M	CNT	III	00760	006		12	120895									1/1/0001

OFFICE: 311 ROUTE: 564										
ST_REF_NO: 00000128115 MILSOM LANE										
LUMENS	BULB TYPE	MULT SERIES	POLE TYPE	SHADE	ADDRESS NUMBER	REF	LOCATION	TAX DIST	DATE INST	DATE CHANGE
05800	S		CNT	II	02544	004		12	070210	1/1/0001
OFFICE: 311 ROUTE: 564										
ST_REF_NO: 00000128300 MIMI COURT										
LUMENS	BULB TYPE	MULT SERIES	POLE TYPE	SHADE	ADDRESS NUMBER	REF	LOCATION	TAX DIST	DATE INST	DATE CHANGE
05800	S	M	OUG	II	02101	000		12	050169	1/1/0001
05800	S	M	OUG	II	02113	000		12	120667	1/1/0001
OFFICE: 311 ROUTE: 564										
ST_REF_NO: 00000128325 MIMOSA LANE										
LUMENS	BULB TYPE	MULT SERIES	POLE TYPE	SHADE	ADDRESS NUMBER	REF	LOCATION	TAX DIST	DATE INST	DATE CHANGE
05800	S	M	OUG	III	00000	001	SIDE OF 1148 PARK LAWN DR.	12	070893	1/1/0001
05800	S	M	OUG	II	03808	002		12	120889	1/1/0001
OFFICE: 311 ROUTE: 564										
ST_REF_NO: 00000128330 MINT HILL LANE										
LUMENS	BULB TYPE	MULT SERIES	POLE TYPE	SHADE	ADDRESS NUMBER	REF	LOCATION	TAX DIST	DATE INST	DATE CHANGE
05800	S	M	CNT	II	00622	009		12	040606	1/1/0001
05800	S	M	CNT	II	00646	007		12	040606	1/1/0001
05800	S	M	CNT	II	00682	003		12	062705	1/1/0001
05800	S	M	CNT	III	00623	010		12	020899	1/1/0001
05800	S	M	CNT	II	00639	008		12	020899	1/1/0001
05800	S	M	CNT	II	00655	006		12	020899	1/1/0001
05800	S	M	CNT	II	00668	005		12	020899	1/1/0001
05800	S	M	CNT	II	00679	004		12	020899	1/1/0001
05800	S	M	CNT	II	00695	002		12	020899	1/1/0001
05800	S	M	CNT	II	00699	001		12	120894	1/1/0001
OFFICE: 311 ROUTE: 564										
ST_REF_NO: 00000128350 MINT JULEP LANE										
LUMENS	BULB TYPE	MULT SERIES	POLE TYPE	SHADE	ADDRESS NUMBER	REF	LOCATION	TAX DIST	DATE INST	DATE CHANGE
04000	S	M	OUG	II	01901	017		12	111579	1/1/0001
04000	S	M	OUG	II	01912	016		12	111579	1/1/0001
04000	S	M	OUG	II	01925	015		12	111579	1/1/0001
04000	S	M	OUG	II	01936	014		12	111579	1/1/0001

OFFICE: 311

ROUTE: 564

ST_REF_NO: 00000128350 MINT JULEP LANE

LUMENS	BULB TYPE	MULT SERIES	POLE TYPE	SHADE	ADDRESS NUMBER	REF	LOCATION	TAX DIST	DATE INST	DATE CHANGE
04000	S	M	OUG	II	01945	013		12	111579	1/1/0001

OFFICE: 311

ROUTE: 564

ST_REF_NO: 00000128400 MIRAHILL DRIVE

LUMENS	BULB TYPE	MULT SERIES	POLE TYPE	SHADE	ADDRESS NUMBER	REF	LOCATION	TAX DIST	DATE INST	DATE CHANGE
05800	S	M	OUG	II	00000	049	SIDE OF 422 CODELL DR.	12	041581	1/1/0001
05800	S	M	OUG	II	02408	000		12	080172	1/1/0001
05800	S	M	OUG	II	02421	047		12	051476	1/1/0001
05800	S	M	OUG	II	02432	000		12	090170	1/1/0001
05800	S	M	OUG	II	02445	000		12	090170	1/1/0001
05800	S	M	OUG	II	02456	000		12	090170	1/1/0001

OFFICE: 311

ROUTE: 564

ST_REF_NO: 00000128480 MIRA VISTA CIRCLE

LUMENS	BULB TYPE	MULT SERIES	POLE TYPE	SHADE	ADDRESS NUMBER	REF	LOCATION	TAX DIST	DATE INST	DATE CHANGE
05800	S	M	CNT	II	03700	001		12	120898	1/1/0001
05800	S	M	CNT	III	03705	002		12	120898	1/1/0001

OFFICE: 311

ROUTE: 564

ST_REF_NO: 00000128545 MISSION HILLS COURT

LUMENS	BULB TYPE	MULT SERIES	POLE TYPE	SHADE	ADDRESS NUMBER	REF	LOCATION	TAX DIST	DATE INST	DATE CHANGE
05800	S	M	CNT	III	00308	001		12	032304	1/1/0001

OFFICE: 311

ROUTE: 564

ST_REF_NO: 00000128550 MISSION HILLS DRIVE

LUMENS	BULB TYPE	MULT SERIES	POLE TYPE	SHADE	ADDRESS NUMBER	REF	LOCATION	TAX DIST	DATE INST	DATE CHANGE
05800	S	M	CNT	II	00000	001	SIDE OF 2701 WOODLAWN WAY ON MISSION HILLS DR	12	032304	1/1/0001
05800	S	M	CNT	II	02709	002		12	032304	1/1/0001
05800	S	M	CNT	II	02720	003		12	032304	1/1/0001

OFFICE: 311

ROUTE: 564

ST_REF_NO: 00000128595 MIST FLOWER LANE

LUMENS	BULB TYPE	MULT SERIES	POLE TYPE	SHADE	ADDRESS NUMBER	REF	LOCATION	TAX DIST	DATE INST	DATE CHANGE
05800	S		CNT	II	00000	001	SIDE OF 3676 HORSEMINT TR, ON MIST FLOWER LANE	12	071409	1/1/0001
05800	S		CNT	II	00000	004	SIDE OF 3836 STILL MEADOW LN, ON MIST FLOWER LANE	12	071409	1/1/0001
05800	S		CNT	II	00508	002		12	071409	1/1/0001
05800	S		CNT	II	00512	003		12	071409	1/1/0001

OFFICE: 311

ROUTE: 564

ST_REF_NO: 00000128600 MIST LAKE COURT

LUMENS	BULB TYPE	MULT SERIES	POLE TYPE	SHADE	ADDRESS NUMBER	REF	LOCATION	TAX DIST	DATE INST	DATE CHANGE
05800	S	M	OUG	II	00000	119	SIDE OF 3216 MIST LAKE CT.	12	041581	1/1/0001
04000	S	M	OUG	II	03201	118		12	010888	1/1/0001
04000	S	M	OUG	II	03217	121		12	010888	1/1/0001
05800	S	M	OUG	V	03229	122		12	011581	1/1/0001

OFFICE: 311

ROUTE: 564

ST_REF_NO: 00000128605 MISTY COVE ROAD

LUMENS	BULB TYPE	MULT SERIES	POLE TYPE	SHADE	ADDRESS NUMBER	REF	LOCATION	TAX DIST	DATE INST	DATE CHANGE
05800	S	M	OUG	II	00000	021	SIDE OF 2700 CRYSTAL FALLS RD ON MISTY COVE ROAD	12	042605	1/1/0001

OFFICE: 311

ROUTE: 564

ST_REF_NO: 00000128610 MISTY MORNING CIRCLE

LUMENS	BULB TYPE	MULT SERIES	POLE TYPE	SHADE	ADDRESS NUMBER	REF	LOCATION	TAX DIST	DATE INST	DATE CHANGE
05800	S	M	CNT	III	03601	001		12	110894	1/1/0001

OFFICE: 311

ROUTE: 564

ST_REF_NO: 00000128700 MITCHELL AVENUE

LUMENS	BULB TYPE	MULT SERIES	POLE TYPE	SHADE	ADDRESS NUMBER	REF	LOCATION	TAX DIST	DATE INST	DATE CHANGE
04000	S	M	SOH	II	00000	001	E. SIDE, 2ND POLE S. OF LANE ALLEN	12	101583	1/1/0001
04000	S	M	OUG	II	00000	098	OPP. THE SIDE OF 626 LANE ALLEN RD.	12	111583	1/1/0001
04000	S	M	OUG	II	00000	105	SIDE OF 2034 CLAYS MILL RD.	12	041583	1/1/0001
04000	S	M	OUG	II	00576	109		12	101583	1/1/0001
04000	S	M	OUG	II	00584	108		12	041583	1/1/0001
05800	S	M	OUG	II	00587	107	upgrade 1/08	12	101583	1/1/0001
04000	S	M	OUG	II	00598	106		12	031583	1/1/0001

OFFICE: 311

ROUTE: 564

ST_REF_NO: 00000128700 MITCHELL AVENUE

LUMENS	BULB TYPE	MULT SERIES	POLE TYPE	SHADE	ADDRESS NUMBER	REF	LOCATION	TAX DIST	DATE INST	DATE CHANGE
04000	S	M	OUG	II	00602	104		12	101583	1/1/0001
04000	S	M	OUG	II	00609	103		12	101583	1/1/0001
04000	S	M	OUG	II	00628	102		12	101583	1/1/0001
04000	S	M	OUG	II	00644	101		12	101583	1/1/0001
04000	S	M	OUG	II	00660	100		12	101583	1/1/0001
04000	S	M	OUG	II	00000	111	SIDE OF 500 SOUTHLAND DR.	12	031583	1/1/0001
04000	S	M	OUG	II	00568	110		12	031583	1/1/0001

OFFICE: 311

ROUTE: 564

ST_REF_NO: 00000128800 MOBILE COURT

LUMENS	BULB TYPE	MULT SERIES	POLE TYPE	SHADE	ADDRESS NUMBER	REF	LOCATION	TAX DIST	DATE INST	DATE CHANGE
05800	S	M	OUG	II	02000	000		12	090866	1/1/0001
05800	S	M	OUG	II	02011	000		12	090866	1/1/0001

OFFICE: 311

ROUTE: 564

ST_REF_NO: 00000128900 MOCKING BIRD LANE

LUMENS	BULB TYPE	MULT SERIES	POLE TYPE	SHADE	ADDRESS NUMBER	REF	LOCATION	TAX DIST	DATE INST	DATE CHANGE
05800	S	M	OUG	II	00361	026	bad fixture	12	110884	3/2/2009
04000	S	M	OUG	II	00236	035		12	110884	1/1/0001
04000	S	M	OUG	II	00257	034		12	110884	1/1/0001
04000	S	M	OUG	II	00275	032		12	110884	1/1/0001
04000	S	M	OUG	II	00292	031		12	110884	1/1/0001
04000	S	M	OUG	II	00309	030		12	110884	1/1/0001
04000	S	M	OUG	II	00321	029		12	110884	1/1/0001
04000	S	M	OUG	II	00333	028		12	110884	1/1/0001
04000	S	M	OUG	II	00348	027		12	110884	1/1/0001

OFFICE: 311

ROUTE: 564

ST_REF_NO: 00000129100 MOLLOY

LUMENS	BULB TYPE	MULT SERIES	POLE TYPE	SHADE	ADDRESS NUMBER	REF	LOCATION	TAX DIST	DATE INST	DATE CHANGE
05800	S	M	SOH	II	00000	001	SIDE OF 1253 EMBRY AVE., WESTSIDE	12	060899	1/1/0001
05800	S	M	SOH	II	00000	002	SIDE OF 1252 HAMMOND AVE., WESTSIDE	12	060899	1/1/0001

OFFICE: 311		ROUTE: 564		ST_REF_NO: 00000129200		MONA COURT		LUMENS	BULB TYPE	MULT SERIES	POLE TYPE	SHADE	ADDRESS NUMBER	REF	LOCATION	TAX DIST	DATE INST	DATE CHANGE
	05800	S	M	OUG	V	02100	000									12	050774	1/1/0001
	05800	S	M	OUG	II	02112	000									12	050774	1/1/0001

OFFICE: 311		ROUTE: 564		ST_REF_NO: 00000129300		MONACO COURT		LUMENS	BULB TYPE	MULT SERIES	POLE TYPE	SHADE	ADDRESS NUMBER	REF	LOCATION	TAX DIST	DATE INST	DATE CHANGE
	05800	S	M	OUG	V	01245	000									12	080169	1/1/0001

OFFICE: 311		ROUTE: 564		ST_REF_NO: 00000129500		MONIDA COURT		LUMENS	BULB TYPE	MULT SERIES	POLE TYPE	SHADE	ADDRESS NUMBER	REF	LOCATION	TAX DIST	DATE INST	DATE CHANGE
	05800	S	M	OUG	II	00000	051								SIDE OF 3011 PIMLICO PARKWAY	12	100897	1/1/0001
	04000	S	M	OUG	II	03213	052									12	061580	1/1/0001
	04000	S	M	OUG	V	03224	053									12	061580	1/1/0001

OFFICE: 311		ROUTE: 564		ST_REF_NO: 00000129600		MONROE AVENUE		LUMENS	BULB TYPE	MULT SERIES	POLE TYPE	SHADE	ADDRESS NUMBER	REF	LOCATION	TAX DIST	DATE INST	DATE CHANGE
	04000	S	M	SOH	II	00000	175								SIDE 138 OWSLEY AVE.	12	060685	1/1/0001
	04000	S	M	SOH	II	00000	177								SIDE 181 LINCOLN	12	060685	1/1/0001
	04000	S	M	SOH	II	00000	179								SIDE 182 PRESTON AVE.	12	050885	1/1/0001
	04000	S	M	SOH	II	00000	180								SIDE 201 BASSETT AVE.	12	040887	1/1/0001
	04000	S	M	SOH	II	00000	181								SIDE 202 BASSETT AVE.	12	040887	1/1/0001
	04000	S	M	SOH	II	01200	176									12	060685	1/1/0001
	04000	S	M	SOH	II	01309	178									12	040887	1/1/0001

OFFICE: 311		ROUTE: 564		ST_REF_NO: 00000129690		MONTAVESTA CIRCLE		LUMENS	BULB TYPE	MULT SERIES	POLE TYPE	SHADE	ADDRESS NUMBER	REF	LOCATION	TAX DIST	DATE INST	DATE CHANGE
	05800	S	M	OUG	II	00000	010								SIDE OF 3118 MONTAVESTA RD.	12	042067	1/1/0001
	05800	S	M	OUG	V	00924	011									12	080367	1/1/0001

OFFICE: 311

ROUTE: 564

ST_REF_NO: 00000129700

MONTAVESTA ROAD

LUMENS	BULB TYPE	MULT SERIES	POLE TYPE	SHADE	ADDRESS NUMBER	REF	LOCATION	TAX DIST	DATE INST	DATE CHANGE
05800	S	M	OUG	II	00000	006	SIDE OF 904 ALBANY RD.	12	042067	1/1/0001
05800	S	M	OUG	II	00000	048	3RD LT. S. OF LANSDOWNE DR., W. SIDE	12	110172	1/1/0001
05800	S	M	OUG	II	00000	049	4TH LT. S. OF LANSDOWNE DR., W. SIDE	12	110172	1/1/0001
05800	S	M	OUG	II	00000	051	OPP. 3300	12	121273	1/1/0001
05800	S	M	OUG	II	00000	053	OPP. 3350	12	121273	1/1/0001
05800	S	M	OUG	V	00000	069	OPP. 2969	12	110172	1/1/0001
05800	S	M	OUG	II	00000	070	SIDE OF 1400 MOUNT DR.	12	110172	1/1/0001
05800	S	M	OUG	II	00000	130	SIDE OF 3220 PEPPERHILL RD.	12	072374	1/1/0001
05800	S	M	OUG	II	02917	076		12	121273	1/1/0001
05800	S	M	OUG	II	02930	075		12	110172	1/1/0001
05800	S	M	OUG	II	02933	074		12	110172	1/1/0001
05800	S	M	OUG	II	02942	073		12	110172	1/1/0001
05800	S	M	OUG	II	02945	072		12	110172	1/1/0001
05800	S	M	OUG	II	02954	071		12	110172	1/1/0001
05800	S	M	OUG	II	02977	034		12	030171	1/1/0001
05800	S	M	OUG	II	02982	033		12	090170	1/1/0001
05800	S	M	OUG	II	02990	032		12	090170	1/1/0001
05800	S	M	OUG	II	02993	031		12	090170	1/1/0001
05800	S	M	OUG	II	03006	030		12	010172	1/1/0001
05800	S	M	OUG	II	03009	029		12	090170	1/1/0001
05800	S	M	OUG	II	03022	017		12	040368	1/1/0001
05800	S	M	OUG	II	03029	016		12	031769	1/1/0001
05800	S	M	OUG	II	03042	015		12	031769	1/1/0001
05800	S	M	OUG	II	03045	014		12	031769	1/1/0001
05800	S	M	OUG	V	03069	018		12	121273	1/1/0001
05800	S	M	OUG	II	03081	012		12	091167	1/1/0001
05800	S	M	OUG	II	03082	013		12	031769	1/1/0001
05800	S	M	OUG	II	03094	005		12	080367	1/1/0001
05800	S	M	OUG	II	03114	007		12	080367	1/1/0001
05800	S	M	OUG	II	03121	008		12	042067	1/1/0001
05800	S	M	OUG	II	03130	009		12	010171	1/1/0001
05800	S	M	OUG	II	03137	041		12	010172	1/1/0001
05800	S	M	OUG	II	03142	042		12	121273	1/1/0001
05800	S	M	OUG	II	03205	043		12	010172	1/1/0001

OFFICE: 311

ROUTE: 564

ST_REF_NO: 00000129700

MONTAVESTA ROAD

LUMENS	BULB TYPE	MULT SERIES	POLE TYPE	SHADE	ADDRESS NUMBER	REF	LOCATION	TAX DIST	DATE INST	DATE CHANGE
05800	S	M	OUG	II	03214	044		12	091476	1/1/0001
05800	S	M	OUG	II	03221	045		12	091476	1/1/0001
05800	S	M	OUG	II	03300	050		12	110172	1/1/0001
05800	S	M	OUG	II	03300	052		12	110172	1/1/0001
05800	S	M	OUG	II	03350	054		12	121273	1/1/0001
05800	S	M	OUG	II	03350	056		12	121273	1/1/0001
05800	S	M	OUG	II	03389	055		12	121273	1/1/0001
05800	S	M	OUG	II	03406	101		12	091477	1/1/0001
05800	S	M	OUG	II	03413	102		12	121073	1/1/0001
05800	S	M	OUG	II	03422	127		12	091477	1/1/0001
05800	S	M	OUG	II	03433	128		12	071674	1/1/0001
05800	S	M	OUG	II	03442	129		12	071674	1/1/0001

OFFICE: 311

ROUTE: 564

ST_REF_NO: 00000129800

MONTCLAIR DRIVE

LUMENS	BULB TYPE	MULT SERIES	POLE TYPE	SHADE	ADDRESS NUMBER	REF	LOCATION	TAX DIST	DATE INST	DATE CHANGE
09500	S	M	OUG	II	00000	020	SIDE OF 1283 SCOVILLE RD.	12	120864	1/1/0001
05800	S	M	OUG	II	00633	000		12	010665	1/1/0001
05800	S	M	OUG	II	00000	010	SIDE OF 1600 TATES CREEK PK.	12	120864	1/1/0001
05800	S	M	OUG	II	00000	012	SIDE OF 1251 ELDERMERE RD.	12	120864	1/1/0001
05800	S	M	OUG	II	00000	014	SIDE OF 1251 SUMMIT DR.	12	120864	1/1/0001
05800	S	M	OUG	II	00650	017		12	120864	1/1/0001
05800	S	M	OUG	II	00665	000		12	020165	1/1/0001
05800	S	M	OUG	II	00700	000		12	010665	1/1/0001
05800	S	M	OUG	II	00748	013		12	120864	1/1/0001
05800	S	M	OUG	II	00814	000		12	010665	1/1/0001

OFFICE: 311

ROUTE: 564

ST_REF_NO: 00000129810

MONTEREY COURT

LUMENS	BULB TYPE	MULT SERIES	POLE TYPE	SHADE	ADDRESS NUMBER	REF	LOCATION	TAX DIST	DATE INST	DATE CHANGE
05800	S	M	OUG	II	00000	002	SIDE OF 4771 MOSS CREEK DR.	12	030895	1/1/0001
05800	S	M	OUG	IV	04606	001		12	030895	1/1/0001
05800	S	M	OUG	II	04630	003		12	030895	1/1/0001

OFFICE: 311

ROUTE: 564

ST_REF_NO: 00000129900

MONTGOMERY AVENUE

LUMENS	BULB TYPE	MULT SERIES	POLE TYPE	SHADE	ADDRESS NUMBER	REF	LOCATION	TAX DIST	DATE INST	DATE CHANGE
05800	S	M	SOH	II	00000	182	OPP. THE SIDE OF 651 MONTGOMERY	12	120566	1/1/0001
05800	S	M	SOH	II	00664	181		12	120566	1/1/0001
05800	S	M	SOH	II	00676	180		12	120566	1/1/0001
05800	S	M	SOH	II	00682	179		12	120566	1/1/0001
05800	S	M	SOH	II	00686	178		12	120566	1/1/0001

OFFICE: 311

ROUTE: 564

ST_REF_NO: 00000130000

MONTICELLO BOULEVARD

LUMENS	BULB TYPE	MULT SERIES	POLE TYPE	SHADE	ADDRESS NUMBER	REF	LOCATION	TAX DIST	DATE INST	DATE CHANGE
05800	S	M	OUG	II	00000	136	SIDE 3394 POST RD.	12	100885	1/1/0001
05800	S	M	OUG	II	00411	004		12	061579	1/1/0001
05800	S	M	OUG	II	00422	003		12	061579	1/1/0001
05800	S	M	OUG	II	00431	002		12	061579	1/1/0001
05800	S	M	OUG	II	00446	001		12	061579	1/1/0001
05800	S	M	OUG	II	00450	052		12	100885	1/1/0001
05800	S	M	OUG	II	00459	051		12	100885	1/1/0001
05800	S	M	OUG	II	00470	050		12	100885	1/1/0001
05800	S	M	OUG	II	00479	049		12	100885	1/1/0001
05800	S	M	OUG	II	00490	048		12	100885	1/1/0001
05800	S	M	OUG	II	00499	047		12	100885	1/1/0001
05800	S	M	OUG	II	00507	042		12	100885	1/1/0001
05800	S	M	OUG	II	00515	043		12	100885	1/1/0001
05800	S	M	OUG	II	00524	044		12	100885	1/1/0001
05800	S	M	OUG	II	00531	045		12	100885	1/1/0001
05800	S	M	OUG	II	00542	046		12	100885	1/1/0001
05800	S	M	OUG	II	00556	096		12	100885	1/1/0001
05800	S	M	OUG	II	00563	095		12	100885	1/1/0001
05800	S	M	OUG	II	00574	094		12	100885	1/1/0001
05800	S	M	OUG	II	00583	093		12	100885	1/1/0001
05800	S	M	OUG	II	00594	137		12	100885	1/1/0001
05800	S	M	OUG	II	00610	135		12	100885	1/1/0001
05800	S	M	OUG	II	00621	134		12	100885	1/1/0001
05800	S	M	OUG	II	00630	133		12	090885	1/1/0001
05800	S	M	OUG	II	00641	132		12	090885	1/1/0001

OFFICE: 311

ROUTE: 564

ST_REF_NO: 00000130000

MONTICELLO BOULEVARD

LUMENS	BULB TYPE	MULT SERIES	POLE TYPE	SHADE	ADDRESS NUMBER	REF	LOCATION	TAX DIST	DATE INST	DATE CHANGE
05800	S	M	OUG	II	00650	131		12	090885	1/1/0001
05800	S	M	OUG	II	00657	130		12	090885	1/1/0001
05800	S	M	OUG	II	00670	129		12	090885	1/1/0001
05800	S	M	OUG	II	00701	125		12	090885	1/1/0001
05800	S	M	OUG	II	00701	126		12	090885	1/1/0001
05800	S	M	OUG	II	00701	127		12	090885	1/1/0001
05800	S	M	OUG	II	00701	128		12	090885	1/1/0001
05800	S	M	OUG	II	00000	005	SIDE OF 3379 WINTHROP RD.	12	061579	1/1/0001
05800	S	M	OUG	II	00395	006		12	061579	1/1/0001

OFFICE: 311

ROUTE: 564

ST_REF_NO: 00000130100

MONTMULLIN STREET

LUMENS	BULB TYPE	MULT SERIES	POLE TYPE	SHADE	ADDRESS NUMBER	REF	LOCATION	TAX DIST	DATE INST	DATE CHANGE
05800	S	M	SOH	I	00000	001	SIDE OF 545 S.LIMESTONE ST.	0	061578	1/1/0001
05800	S	M	SOH	I	00000	006	OPP. 154	12	061578	1/1/0001
05800	S	M	SOH	I	00102	002		12	061578	1/1/0001
05800	S	M	SOH	I	00118	003		12	061578	1/1/0001
05800	S	M	SOH	I	00133	004		12	061578	1/1/0001
05800	S	M	SOH	I	00142	005		12	061578	1/1/0001
05800	S	M	SOH	I	00171	007		12	061578	1/1/0001
05800	S	M	SOH	I	00182	008		12	061578	1/1/0001
05800	S	M	SOH	I	00198	009		12	061578	1/1/0001

OFFICE: 311

ROUTE: 564

ST_REF_NO: 00000130200

MONTROSE DRIVE

LUMENS	BULB TYPE	MULT SERIES	POLE TYPE	SHADE	ADDRESS NUMBER	REF	LOCATION	TAX DIST	DATE INST	DATE CHANGE
05800	S	M	OUG	II	00000	032	SIDE OF 1555 LASALLE DR.	12	010172	1/1/0001
05800	S	M	OUG	II	01551	000		12	030171	1/1/0001
05800	S	M	OUG	II	01570	000		12	060170	1/1/0001
05800	S	M	OUG	II	01583	000		12	030171	1/1/0001
05800	S	M	OUG	II	01594	000		12	030171	1/1/0001

OFFICE: 311

ROUTE: 564

ST_REF_NO: 00000130230

MOONSTAR COURT

LUMENS	BULB TYPE	MULT SERIES	POLE TYPE	SHADE	ADDRESS NUMBER	REF	LOCATION	TAX DIST	DATE INST	DATE CHANGE
05800	S	M	CNT	II	00000	001	SIDE OF 4481 TURTLE CREEK WAY ON MOONSTAR WAY	12	062907	1/1/0001
05800	S	M	CNT	II	00708	002		12	062907	1/1/0001

OFFICE: 311

ROUTE: 564

ST_REF_NO: 00000130300

MOORE DRIVE

LUMENS	BULB TYPE	MULT SERIES	POLE TYPE	SHADE	ADDRESS NUMBER	REF	LOCATION	TAX DIST	DATE INST	DATE CHANGE
09500	S	M	OUG	II	00000	006	3RD LT. W. OF NICHOLASVILLE RD.,S. SIDE	12	061475	3/24/2012
10000	M	M	OUG	II	00000	001	1ST LT. W. OF NICHOLASVILLE RD., N. SIDE	12	061475	1/1/0001
10000	M	M	OUG	II	00000	002	1ST LT. W. OF NICHOLASVILLE RD.,S. SIDE	12	061475	1/1/0001
09500	S	M	OUG	II	00000	003	2ND LT W OF NICHOLASVILLE RD N SIDE-upgrade 1/08	12	041476	1/1/0001
10000	M	M	OUG	II	00000	004	2ND LT. W. OF NICHOLASVILLE RD.,S. SIDE	12	061475	1/1/0001
10000	M	M	OUG	II	00000	005	3RD LT. W. OF NICHOLASVILLE RD., N. SIDE	12	111478	1/1/0001
10000	M	M	OUG	II	00000	007	4TH LT. W. OF NICHOLASVILLE RD., N. SIDE	12	111478	1/1/0001
10000	M	M	OUG	II	00000	009	4TH LT. W. OF NICHOLASVILLE RD.,S. SIDE	12	111478	1/1/0001
10000	M	M	OUG	II	00000	010	5TH LT. W. OF NICHOLASVILLE RD.,N. SIDE	12	041476	1/1/0001
10000	M	M	OUG	II	00000	011	5TH LT. W. OF NICHOLASVILLE RD., S. SIDE	12	111478	1/1/0001
10000	M	M	OUG	II	00000	012	6TH LT. W. OF NICHOLASVILLE RD.,N. SIDE	12	041476	1/1/0001

OFFICE: 311

ROUTE: 564

ST_REF_NO: 00000130550

MORAY PLACE

LUMENS	BULB TYPE	MULT SERIES	POLE TYPE	SHADE	ADDRESS NUMBER	REF	LOCATION	TAX DIST	DATE INST	DATE CHANGE
05800	S	M	CNT	II	02500	009		12	042506	1/1/0001
05800	S	M	CNT	II	02516	008		12	042506	1/1/0001
05800	S	M	CNT	II	02533	007		12	042506	1/1/0001
05800	S	M	CNT	III	02544	006		12	042506	1/1/0001
05800	S	M	CNT	III	02576	004		12	042506	1/1/0001
05800	S	M	CNT	II	02592	003		12	042506	1/1/0001
05800	S	M	CNT	II	02593	005		12	042506	1/1/0001
05800	S	M	CNT	II	02600	002		12	042506	1/1/0001
05800	S	M	CNT	II	02617	001		12	042506	1/1/0001

OFFICE: 311		ROUTE: 564		ST_REF_NO: 00000130700		MORGAN AVENUE		LUMENS	BULB TYPE	MULT SERIES	POLE TYPE	SHADE	ADDRESS NUMBER	REF	LOCATION	TAX DIST	DATE INST	DATE CHANGE
09500	S	M	SOH	I	00000	021	SIDE OF 1400 BRYAN STATION RD upgraded 7/06		12	100169	1/1/0001							
09500	S	M	SOH	I	00414	020	upgraded 7/06		12	090968	1/1/0001							
09500	S	M	SOH	I	00422	019	upgraded 7/06		12	090968	1/1/0001							
09500	S	M	SOH	I	00426	018	upgraded 7/06		12	090968	1/1/0001							
09500	S	M	SOH	I	00432	017	upgraded 7/06		12	090968	1/1/0001							
09500	S	M	SOH	I	00442	016	upgraded 7/06		12	090968	1/1/0001							
09500	S	M	SOH	I	00450	015	upgraded 7/06		12	090968	1/1/0001							
09500	S	M	SOH	I	00458	014	upgraded 7/06		12	090968	1/1/0001							
09500	S	M	SOH	I	00466	013	upgraded 7/06		12	090968	1/1/0001							
OFFICE: 311		ROUTE: 564		ST_REF_NO: 00000130720		MORGAN HILLS DRIVE		LUMENS	BULB TYPE	MULT SERIES	POLE TYPE	SHADE	ADDRESS NUMBER	REF	LOCATION	TAX DIST	DATE INST	DATE CHANGE
05800	S	M	OUG	III	00600	001			12	020899	1/1/0001							
05800	S	M	OUG	II	00621	002			12	020899	1/1/0001							
05800	S	M	OUG	II	00645	003			12	020899	1/1/0001							
05800	S	M	OUG	II	00660	004			12	020899	1/1/0001							
05800	S	M	OUG	II	00667	005			12	020899	1/1/0001							
05800	S	M	OUG	II	00694	006			12	020899	1/1/0001							
05800	S	M	OUG	II	00713	007			12	020899	1/1/0001							
05800	S	M	OUG	III	00734	008			12	070899	1/1/0001							
OFFICE: 311		ROUTE: 564		ST_REF_NO: 00000130725		MORHAM DRIVE		LUMENS	BULB TYPE	MULT SERIES	POLE TYPE	SHADE	ADDRESS NUMBER	REF	LOCATION	TAX DIST	DATE INST	DATE CHANGE
05800	S	M	OUG	II	03301	002			12	020800	1/1/0001							
05800	S	M	OUG	II	03308	001			12	020800	1/1/0001							
OFFICE: 311		ROUTE: 564		ST_REF_NO: 00000130730		MORNING SIDE COURT		LUMENS	BULB TYPE	MULT SERIES	POLE TYPE	SHADE	ADDRESS NUMBER	REF	LOCATION	TAX DIST	DATE INST	DATE CHANGE
05800	S	M	CNT	II	01309	001			12	100896	1/1/0001							

OFFICE: 311

ROUTE: 564

ST_REF_NO: 00000130740

MORNING SIDE DRIVE

LUMENS	BULB TYPE	MULT SERIES	POLE TYPE	SHADE	ADDRESS NUMBER	REF	LOCATION	TAX DIST	DATE INST	DATE CHANGE
05800	S	M	CNT	II	01112	004		12	100896	1/1/0001
05800	S	M	CNT	II	01121	003		12	100896	1/1/0001
05800	S	M	CNT	II	01140	002		12	100896	1/1/0001
05800	S	M	CNT	II	01156	001		12	100896	1/1/0001
05800	S	M	CNT	II	01201	005		12	100896	1/1/0001
05800	S	M	CNT	II	01220	006		12	100896	1/1/0001
05800	S	M	CNT	II	01232	008		12	100896	1/1/0001
05800	S	M	CNT	II	01239	007		12	100896	1/1/0001

OFFICE: 311

ROUTE: 564

ST_REF_NO: 00000130850

MORRIS AVENUE

LUMENS	BULB TYPE	MULT SERIES	POLE TYPE	SHADE	ADDRESS NUMBER	REF	LOCATION	TAX DIST	DATE INST	DATE CHANGE
05800	S	M	SOH	I	00000	001	1ST LT. N. OF 3RD ST., W. SIDE	12	020563	1/1/0001
05800	S	M	SOH	I	00000	003	1ST LT. N. OF SALEM ST., E. SIDE	12	020563	1/1/0001
05800	S	M	SOH	I	00000	004	2ND LT. N. OF SALEM ST., E. SIDE	12	020563	1/1/0001
05800	S	M	SOH	I	00000	005	3RD LT. N. OF SALEM ST., E. SIDE	12	020563	1/1/0001
04000	S	M	SOH	I	00000	011	1ST LT. S. OF 4TH ST., EASTSIDE OF MORRIS AVENUE	12	040891	1/1/0001
05800	S	M	SOH	I	00326	002		12	020563	1/1/0001

OFFICE: 311

ROUTE: 564

ST_REF_NO: 00000130900

MORRISON AVENUE

LUMENS	BULB TYPE	MULT SERIES	POLE TYPE	SHADE	ADDRESS NUMBER	REF	LOCATION	TAX DIST	DATE INST	DATE CHANGE
05800	S	M	OUG	II	00000	003	SIDE OF 714 HEADLY AVE.	12	110168	1/1/0001
05800	S	M	OUG	II	00000	004	SIDE OF 711 N. BROADWAY	12	121475	1/1/0001
05800	S	M	OUG	II	00412	005		12	121475	1/1/0001

OFFICE: 311

ROUTE: 564

ST_REF_NO: 00000131000

MORROW ALLEY

LUMENS	BULB TYPE	MULT SERIES	POLE TYPE	SHADE	ADDRESS NUMBER	REF	LOCATION	TAX DIST	DATE INST	DATE CHANGE
05800	S	M	SOH	II	00000	001	1ST LT. N. OF W. 3RD ST., E. SIDE	12	021061	1/1/0001
05800	S	M	SOH	II	00000	002	2ND LT. N. OF W. 3RD ST., E. SIDE	12	021061	1/1/0001

OFFICE: 311

ROUTE: 564

ST_REF_NO: 00000131025 MORSEN POINT

LUMENS	BULB TYPE	MULT SERIES	POLE TYPE	SHADE	ADDRESS NUMBER	REF	LOCATION	TAX DIST	DATE INST	DATE CHANGE
05800	S	M	CNT	III	02805	001		12	011304	1/1/0001

OFFICE: 311

ROUTE: 564

ST_REF_NO: 00000131050 MORTON ALLEY

LUMENS	BULB TYPE	MULT SERIES	POLE TYPE	SHADE	ADDRESS NUMBER	REF	LOCATION	TAX DIST	DATE INST	DATE CHANGE
05800	S	M	SOH	II	00000	001	1ST LT. E. OF ESPLANADE, S. SIDE	12	020966	1/1/0001

OFFICE: 311

ROUTE: 564

ST_REF_NO: 00000131200 MOSS COURT

LUMENS	BULB TYPE	MULT SERIES	POLE TYPE	SHADE	ADDRESS NUMBER	REF	LOCATION	TAX DIST	DATE INST	DATE CHANGE
05800	S	M	OUG	II	00000	032	SIDE OF 417 MOSS DR.	12	062363	1/1/0001
05800	S	M	OUG	II	00445	000		12	041664	1/1/0001

OFFICE: 311

ROUTE: 564

ST_REF_NO: 00000131300 MOSS DRIVE

LUMENS	BULB TYPE	MULT SERIES	POLE TYPE	SHADE	ADDRESS NUMBER	REF	LOCATION	TAX DIST	DATE INST	DATE CHANGE
05800	S	M	OUG	II	00000	029	SIDE OF 432 ANNISTON DR.	12	062363	1/1/0001
05800	S	M	OUG	II	00413	030		12	062363	1/1/0001
05800	S	M	OUG	II	00446	000		12	041664	1/1/0001
05800	S	M	OUG	II	00477	034		12	062363	1/1/0001
05800	S	M	OUG	II	00482	035		12	062363	1/1/0001

OFFICE: 311

ROUTE: 564

ST_REF_NO: 00000131303 MOSSBRIDGE WAY

LUMENS	BULB TYPE	MULT SERIES	POLE TYPE	SHADE	ADDRESS NUMBER	REF	LOCATION	TAX DIST	DATE INST	DATE CHANGE
05800	S	M	CNT	II	03613	004		12	081202	1/1/0001
05800	S	M	CNT	II	03620	003		12	081202	1/1/0001
05800	S	M	CNT	II	03636	002		12	081202	1/1/0001
05800	S	M	CNT	II	03657	001		12	081202	1/1/0001
05800	S	M	CNT	II	03704	005		12	081202	1/1/0001
05800	S	M	CNT	II	03721	006		12	081202	1/1/0001
05800	S	M	CNT	II	03736	007		12	081202	1/1/0001
05800	S	M	CNT	III	03745	008		12	081202	1/1/0001

OFFICE: 311

ROUTE: 564

ST_REF_NO: 00000131310

MOSS CREEK DRIVE

LUMENS	BULB TYPE	MULT SERIES	POLE TYPE	SHADE	ADDRESS NUMBER	REF	LOCATION	TAX DIST	DATE INST	DATE CHANGE
05800	S	M	OUG	II	04766	004		12	030895	1/1/0001
05800	S	M	OUG	II	04779	003		12	030895	1/1/0001
05800	S	M	OUG	II	04784	002		12	030895	1/1/0001
05800	S	M	OUG	II	04796	001		12	030895	1/1/0001

OFFICE: 311

ROUTE: 564

ST_REF_NO: 00000131375

MOULTRIE COURT

LUMENS	BULB TYPE	MULT SERIES	POLE TYPE	SHADE	ADDRESS NUMBER	REF	LOCATION	TAX DIST	DATE INST	DATE CHANGE
05800	S	M	CNT	II	01304	001		12	071102	1/1/0001
05800	S	M	CNT	II	01308	002		12	071102	1/1/0001
05800	S	M	CNT	III	01320	003		12	071102	1/1/0001

OFFICE: 311

ROUTE: 564

ST_REF_NO: 00000131400

MOUND VIEW COURT

LUMENS	BULB TYPE	MULT SERIES	POLE TYPE	SHADE	ADDRESS NUMBER	REF	LOCATION	TAX DIST	DATE INST	DATE CHANGE
05800	S	M	OUG	II	03359	000		12	072374	1/1/0001
05800	S	M	OUG	II	03375	000		12	121073	1/1/0001
05800	S	M	OUG	II	03382	000		12	071674	1/1/0001
05800	S	M	OUG	II	03391	000		12	121073	1/1/0001
05800	S	M	OUG	II	03398	000		12	121073	1/1/0001

OFFICE: 311

ROUTE: 564

ST_REF_NO: 00000131450

MOUNT DRIVE

LUMENS	BULB TYPE	MULT SERIES	POLE TYPE	SHADE	ADDRESS NUMBER	REF	LOCATION	TAX DIST	DATE INST	DATE CHANGE
05800	S	M	OUG	II	01400	080		12	121273	1/1/0001
05800	S	M	OUG	II	01400	082		12	110172	1/1/0001
05800	S	M	OUG	II	01401	079		12	121273	1/1/0001
05800	S	M	OUG	II	01401	081		12	121273	1/1/0001

OFFICE: 311

ROUTE: 564

ST_REF_NO: 00000131460

MOUNT JOY PLACE

LUMENS	BULB TYPE	MULT SERIES	POLE TYPE	SHADE	ADDRESS NUMBER	REF	LOCATION	TAX DIST	DATE INST	DATE CHANGE
05800	S	M	CNT	III	01976	001		12	100896	1/1/0001
05800	S	M	CNT	II	01988	002		12	100896	1/1/0001
05800	S	M	CNT	II	02001	003		12	100896	1/1/0001

OFFICE: 311		ROUTE: 564		ST_REF_NO: 00000131460		MOUNT JOY PLACE				
LUMENS	BULB TYPE	MULT SERIES	POLE TYPE	SHADE	ADDRESS NUMBER	REF	LOCATION	TAX DIST	DATE INST	DATE CHANGE
05800	S	M	CNT	II	02004	004		12	100896	1/1/0001
05800	S	M	CNT	II	02016	005		12	100896	1/1/0001
05800	S	M	CNT	II	02033	006		12	060899	1/1/0001
05800	S	M	CNT	II	02040	007		12	060899	1/1/0001

OFFICE: 311		ROUTE: 564		ST_REF_NO: 00000131462		MOUNTAIN LAUREL CIRCLE				
LUMENS	BULB TYPE	MULT SERIES	POLE TYPE	SHADE	ADDRESS NUMBER	REF	LOCATION	TAX DIST	DATE INST	DATE CHANGE
05800	S		CNT	II	02701	001		12	102808	1/1/0001
05800	S		CNT	II	02708	002		12	102808	1/1/0001

OFFICE: 311		ROUTE: 564		ST_REF_NO: 00000131463		MOUNTAIN LAUREL WAY				
LUMENS	BULB TYPE	MULT SERIES	POLE TYPE	SHADE	ADDRESS NUMBER	REF	LOCATION	TAX DIST	DATE INST	DATE CHANGE
05800	S		CNT	II	00000	001	SIDE OF 1448 DAY LILY DRIVE ON MOUNTAIN LAUREL WAY	12	102808	1/1/0001
05800	S		CNT	II	00000	004	SIDE OF 1053 LUCILLE DRIVE ON MOUNTAIN LAUREL WAY	12	102808	1/1/0001
05800	S		CNT	II	00000	005	SIDE OF 1052 LUCILLE DRIVE ON MOUNTAIN LAUREL WAY	12	102808	1/1/0001
05800	S		CNT	II	00000	008	SIDE OF 2701 GOLDENROD LANE ON MOUNTAIN LAUREL WAY	12	102808	1/1/0001
05800	S		CNT	II	00000	012	SIDE OF 2725 RED CLOVER LANE ON MOUNTAIN LAUREL WAY	12	102808	1/1/0001
05800	S		CNT	II	01016	011		12	102808	1/1/0001
05800	S		CNT	II	01036	010		12	102808	1/1/0001
05800	S		CNT	II	01052	009		12	102808	1/1/0001
05800	S		CNT	II	01088	007		12	102808	1/1/0001
05800	S		CNT	II	01101	006		12	102808	1/1/0001
05800	S		CNT	II	01149	002		12	102808	1/1/0001

OFFICE: 311		ROUTE: 564		ST_REF_NO: 00000131470		MOUSAS WAY				
LUMENS	BULB TYPE	MULT SERIES	POLE TYPE	SHADE	ADDRESS NUMBER	REF	LOCATION	TAX DIST	DATE INST	DATE CHANGE
05800	S	M	OUG	II	00200	001		12	083001	1/1/0001
05800	S	M	OUG	II	00234	003		12	083001	1/1/0001

OFFICE: 311		ROUTE: 564		ST_REF_NO: 00000131475		MOVADO COURT		LUMENS	BULB TYPE	MULT SERIES	POLE TYPE	SHADE	ADDRESS NUMBER	REF	LOCATION	TAX DIST	DATE INST	DATE CHANGE
05800	S		CNT	II	03108	001										12	080210	1/1/0001
OFFICE: 311		ROUTE: 564		ST_REF_NO: 00000131500		MOYLAN LANE		LUMENS	BULB TYPE	MULT SERIES	POLE TYPE	SHADE	ADDRESS NUMBER	REF	LOCATION	TAX DIST	DATE INST	DATE CHANGE
05800	S	M	OUG	II	01029	044	bad fixture									12	031581	4/19/2011
04000	S	M	OUG	II	01001	042										12	031581	1/1/0001
04000	S	M	OUG	II	01004	043										12	031581	1/1/0001
05800	S	M	OUG	II	01032	045										12	020897	1/1/0001
05800	S	M	OUG	II	01044	046										12	020897	1/1/0001
05800	S	M	OUG	II	01061	047										12	040897	1/1/0001
05800	S	M	OUG	II	01072	048										12	020897	1/1/0001
05800	S	M	OUG	III	01080	049										12	020897	1/1/0001
OFFICE: 311		ROUTE: 564		ST_REF_NO: 00000131700		MT FORAKER DRIVE		LUMENS	BULB TYPE	MULT SERIES	POLE TYPE	SHADE	ADDRESS NUMBER	REF	LOCATION	TAX DIST	DATE INST	DATE CHANGE
05800	S	M	OUG	II	00000	012	SIDE OF 2969 MT. MCKINLEY WAY									12	111478	1/1/0001
05800	S	M	OUG	II	00000	018	SIDE OF 3261									12	071478	1/1/0001
05800	S	M	OUG	II	03228	014										12	111478	1/1/0001
05800	S	M	OUG	II	03240	015										12	111478	1/1/0001
05800	S	M	OUG	II	03249	016										12	111478	1/1/0001
05800	S	M	OUG	II	03268	017										12	011581	1/1/0001
05800	S	M	OUG	II	03300	019										12	011581	1/1/0001
05800	S	M	OUG	II	03309	020										12	071478	1/1/0001
OFFICE: 311		ROUTE: 564		ST_REF_NO: 00000132300		MT. MCKINLEY WAY		LUMENS	BULB TYPE	MULT SERIES	POLE TYPE	SHADE	ADDRESS NUMBER	REF	LOCATION	TAX DIST	DATE INST	DATE CHANGE
04000	S	M	OUG	II	00000	013	SIDE OF 3300 AZTEC CT.									12	091476	1/1/0001
04000	S	M	OUG	II	00000	015	SIDE OF 3292 CARLSBAD CT.									12	091476	1/1/0001
04000	S	M	OUG	II	00000	038	SIDE OF 3296 CARRIAGE LANE									12	041478	1/1/0001
04000	S	M	OUG	II	02808	009										12	091476	1/1/0001
04000	S	M	OUG	II	02820	011										12	081477	1/1/0001

OFFICE: 311

ROUTE: 564

ST_REF_NO: 00000132300

MT. MCKINLEY WAY

LUMENS	BULB TYPE	MULT SERIES	POLE TYPE	SHADE	ADDRESS NUMBER	REF	LOCATION	TAX DIST	DATE INST	DATE CHANGE
04000	S	M	OUG	II	02825	010		12	041478	1/1/0001
04000	S	M	OUG	II	02840	014		12	091476	1/1/0001
04000	S	M	OUG	II	02845	012		12	091476	1/1/0001
04000	S	M	OUG	II	02889	001		12	011581	1/1/0001
04000	S	M	OUG	II	02901	002		12	111478	1/1/0001
04000	S	M	OUG	II	02908	003		12	111478	1/1/0001
04000	S	M	OUG	II	02925	004		12	071478	1/1/0001
04000	S	M	OUG	II	02932	005		12	011581	1/1/0001
04000	S	M	OUG	II	02949	009		12	111478	1/1/0001
04000	S	M	OUG	II	02960	010		12	011581	1/1/0001

OFFICE: 311

ROUTE: 564

ST_REF_NO: 00000132400

MT RAINIER DRIVE

LUMENS	BULB TYPE	MULT SERIES	POLE TYPE	SHADE	ADDRESS NUMBER	REF	LOCATION	TAX DIST	DATE INST	DATE CHANGE
04000	S	M	OUG	II	00000	055	SIDE OF 3873 SUNDART DR.	12	061580	1/1/0001
05800	S	M	OUG	V	01400	043	upgraded to 5800 hps	12	011579	1/1/0001
04000	S	M	OUG	II	01409	042		12	011579	1/1/0001
04000	S	M	OUG	II	01429	040		12	011581	1/1/0001
04000	S	M	OUG	II	01464	056		12	011579	1/1/0001
04000	S	M	OUG	II	01481	057		12	011579	1/1/0001
04000	S	M	OUG	II	01488	058		12	011579	1/1/0001
04000	S	M	OUG	II	01501	059		12	011579	1/1/0001
04000	S	M	OUG	II	01508	060		12	011579	1/1/0001
05800	S	M	OUG	V	01521	061	upgraded 2/08	12	011579	1/1/0001

OFFICE: 311

ROUTE: 564

ST_REF_NO: 00000132500

MT RUSHMORE WAY

LUMENS	BULB TYPE	MULT SERIES	POLE TYPE	SHADE	ADDRESS NUMBER	REF	LOCATION	TAX DIST	DATE INST	DATE CHANGE
04000	S	M	OUG	II	00000	037	SIDE OF 3082 PIMLICO PKWY.	12	011581	1/1/0001
04000	S	M	OUG	II	01100	036		12	061580	1/1/0001
04000	S	M	OUG	II	01120	038		12	061580	1/1/0001
04000	S	M	OUG	II	01129	039		12	061580	1/1/0001
05800	S	M	OUG	II	01148	040		12	100897	1/1/0001
04000	S	M	OUG	II	01153	048		12	061580	1/1/0001

OFFICE: 311

ROUTE: 564

ST_REF_NO: 00000132500

MT RUSHMORE WAY

LUMENS	BULB TYPE	MULT SERIES	POLE TYPE	SHADE	ADDRESS NUMBER	REF	LOCATION	TAX DIST	DATE INST	DATE CHANGE
05800	S	M	OUG	II	01169	047		12	061580	1/1/0001
04000	S	M	OUG	II	01181	046		12	061580	1/1/0001
04000	S	M	OUG	II	01188	045		12	061580	1/1/0001
05800	S	M	OUG	III	01205	044		12	100897	1/1/0001

OFFICE: 311

ROUTE: 564

ST_REF_NO: 00000132700

MT TABOR ROAD

LUMENS	BULB TYPE	MULT SERIES	POLE TYPE	SHADE	ADDRESS NUMBER	REF	LOCATION	TAX DIST	DATE INST	DATE CHANGE
22000	S	M	SOH	II	00000	300	2ND LT E OF RICHMOND RD, N SIDE ON MT TABOR RD	12	061704	1/1/0001
50000	S	M	OUG	II	00000	302	1ST LT W OF RICHMOND RD, S SIDE ON MT TABOR RD	12	061704	1/1/0001
22000	S	M	OUG	II	00000	303	2ND LT W OF RICHMOND RD, N SIDE ON MT TABOR RD	12	061704	1/1/0001
09500	S	M	SOH	II	00000	001	1ST LT. N. OF RICHMOND RD., E. SIDE	12	121581	1/1/0001
10000	M	M	OUG	II	00000	003	2ND LT. N. OF RICHMOND RD., E. SIDE	12	121581	1/1/0001
10000	M	M	OUG	II	00000	005	3RD LT. N. OF RICHMOND RD., E. SIDE	12	011581	1/1/0001
10000	M	M	OUG	II	00000	007	4TH LT. N. OF RICHMOND RD., E. SIDE	12	011581	1/1/0001
10000	M	M	OUG	II	00000	009	5TH LT. N. OF RICHMOND RD.	12	011581	1/1/0001
05800	S	M	OUG	II	00000	090	3RD LT. W OF RYANS CIRCLE, N SIDE	12	110800	1/1/0001
05800	S	M	OUG	II	00000	091	2ND LT. W OF RYANS CIRCLE, S SIDE	12	110800	1/1/0001
05800	S	M	OUG	II	00000	092	2ND LT. W OF RYANS CIRCLE, N SIDE	12	110800	1/1/0001
05800	S	M	OUG	II	00000	093	1ST LT. W OF RYANS CIRCLE, S SIDE	12	110800	1/1/0001
05800	S	M	OUG	II	00000	094	1ST LT. W OF RYANS CIRCLE, N SIDE	12	110800	1/1/0001
05800	S	M	OUG	II	00000	095	2ND LT. W OF RYANS CIRCLE, S SIDE	21	110800	1/1/0001
05800	S	M	OUG	II	00000	096	2ND LT. W OF RYANS CIRCLE, N SIDE	12	110800	1/1/0001
05800	S	M	OUG	II	00000	097	1ST LT. W OF TODDS ROAD, S SIDE	21	110800	1/1/0001
05800	S	M	OUG	II	00000	098	1ST LT. W OF TODDS ROAD, N SIDE	12	110800	1/1/0001
10000	M	M	OUG	II	00000	002	2ND LT. S. OF RICHMOND RD., E. SIDE	12	011581	1/1/0001
04000	S	M	OUG	II	00000	011	SIDE OF 400 PATCHEN DR.	12	020888	1/1/0001
05800	S	M	OUG	II	00000	012	SIDE OF 387 PATCHEN DR.	12	060893	1/1/0001
09500	S	M	OUG	II	00000	017	SIDE OF 2800 BAYBROOK RD.	12	100897	1/1/0001
09500	S	M	OUG	II	00000	020	SIDE OF 2800 TILDEN RD.	12	081476	1/1/0001
09500	S	M	OUG	II	00000	021	ACROSS FROM 616	12	090893	1/1/0001
09500	S	M	OUG	II	00000	022	SIDE OF 2837 YELLOWSTONE PKWY.	12	071475	1/1/0001

OFFICE: 311

ROUTE: 564

ST_REF_NO: 00000132700

MT TABOR ROAD

LUMENS	BULB TYPE	MULT SERIES	POLE TYPE	SHADE	ADDRESS NUMBER	REF	LOCATION	TAX DIST	DATE INST	DATE CHANGE
05800	S	M	OUG	II	00000	023	1ST LT. W. OF LOCUST HILL DR., N. SIDE	12	020888	1/1/0001
09500	S	M	OUG	II	00000	024	OPP. 628	12	040899	1/1/0001
09500	S	M	OUG	II	00000	025	OPP. 636	12	040899	1/1/0001
09500	S	M	OUG	II	00000	069	SIDE OF 2801 POINT COURT	12	100897	1/1/0001
09500	S	M	OUG	II	00000	072	SIDE OF 2957 CEDARCREST DR.	12	011581	1/1/0001
09500	S	M	OUG	II	00000	073	REAR OF 408 SHROUT CT.	12	091582	1/1/0001
04000	S	M	OUG	II	00420	013		12	020888	1/1/0001
09500	S	M	OUG	II	00457	073		12	100897	1/1/0001
09500	S	M	OUG	II	00465	067		12	100897	1/1/0001
09500	S	M	OUG	II	00469	067		12	091477	1/1/0001
09500	S	M	OUG	II	00489	066		12	100897	1/1/0001
09500	S	M	OUG	II	00493	066		12	091477	1/1/0001
09500	S	M	OUG	II	00513	065		12	091477	1/1/0001
09500	S	M	OUG	II	00534	018		12	081476	1/1/0001
09500	S	M	OUG	II	00541	064		12	090893	1/1/0001
09500	S	M	OUG	II	00558	019		12	111475	1/1/0001
09500	S	M	OUG	II	00565	063		12	090893	1/1/0001
09500	S	M	OUG	II	00613	062		12	091477	1/1/0001

OFFICE: 311

ROUTE: 564

ST_REF_NO: 00000132800

MT VERNON DRIVE

LUMENS	BULB TYPE	MULT SERIES	POLE TYPE	SHADE	ADDRESS NUMBER	REF	LOCATION	TAX DIST	DATE INST	DATE CHANGE
05800	S	M	OUG	III	00000	001	SIDE OF 1200 TATES CREEK	12	100156	1/1/0001
05800	S	M	OUG	II	00660	000		12	072160	1/1/0001
05800	S	M	OUG	III	00673	000		12	050357	1/1/0001
05800	S	M	OUG	III	00684	000		12	050357	1/1/0001
05800	S	M	OUG	III	00697	000		12	082756	1/1/0001
05800	S	M	OUG	III	00704	000		12	100156	1/1/0001
05800	S	M	OUG	III	00721	000		12	050357	1/1/0001
05800	S	M	OUG	III	00732	000		12	100957	1/1/0001
05800	S	M	OUG	III	00749	000		12	100156	1/1/0001

OFFICE: 311		ROUTE: 564		ST_REF_NO: 00000132990		MULBERRY COURT		LUMENS	BULB TYPE	MULT SERIES	POLE TYPE	SHADE	ADDRESS NUMBER	REF	LOCATION	TAX DIST	DATE INST	DATE CHANGE
	05800	S	M	OUG	V	00276	033									12	120170	1/1/0001
	05800	S	M	OUG	II	00289	034									12	070172	1/1/0001

OFFICE: 311		ROUTE: 564		ST_REF_NO: 00000133000		MULBERRY ROAD		LUMENS	BULB TYPE	MULT SERIES	POLE TYPE	SHADE	ADDRESS NUMBER	REF	LOCATION	TAX DIST	DATE INST	DATE CHANGE
	05800	S	M	OUG	II	00000	035								SIDE OF 2425 WOODHILL DR.	12	120170	1/1/0001
	05800	S	M	OUG	II	00000	037								SIDE OF 2404 HEATON CT.	12	120170	1/1/0001
	05800	S	M	OUG	II	00313	036									12	120170	1/1/0001
	05800	S	M	OUG	II	00337	038									12	120170	1/1/0001
	05800	S	M	OUG	II	00353	039									12	120170	1/1/0001
	05800	S	M	OUG	II	00368	040									12	090170	1/1/0001

OFFICE: 311		ROUTE: 564		ST_REF_NO: 00000133005		MULLBERRY DRIVE		LUMENS	BULB TYPE	MULT SERIES	POLE TYPE	SHADE	ADDRESS NUMBER	REF	LOCATION	TAX DIST	DATE INST	DATE CHANGE
	05800	S	M	CNT	II	00000	025								SIDE 4145 PALOMAR BLVD.	12	100894	1/1/0001

OFFICE: 311		ROUTE: 564		ST_REF_NO: 00000133103		MULUNDY WAY		LUMENS	BULB TYPE	MULT SERIES	POLE TYPE	SHADE	ADDRESS NUMBER	REF	LOCATION	TAX DIST	DATE INST	DATE CHANGE
	05800	S		CNT	II	02496	001									12	080610	1/1/0001
	05800	S	M	OUG	II	02300	008									12	042508	1/1/0001
	05800	S	M	OUG	II	02309	007									12	042508	1/1/0001
	05800	S	M	OUG	II	02316	006									12	042508	1/1/0001
	05800	S	M	OUG	II	02328	005									12	042508	1/1/0001
	05800	S	M	OUG	II	02341	004									12	042508	1/1/0001
	05800	S	M	OUG	II	02356	003									12	042508	1/1/0001
	05800	S	M	OUG	II	02365	002									12	042508	1/1/0001
	05800	S	M	OUG	II	02373	001									12	042508	1/1/0001

OFFICE: 311		ROUTE: 564		ST_REF_NO: 00000133105		MUMFORD LANE		LUMENS	BULB TYPE	MULT SERIES	POLE TYPE	SHADE	ADDRESS NUMBER	REF	LOCATION	TAX DIST	DATE INST	DATE CHANGE
	05800	S	M	CNT	II	00000	003								SIDE REAR OF 1337	12	120899	1/1/0001

OFFICE: 311

ROUTE: 564

ST_REF_NO: 00000133105 MUMFORD LANE

LUMENS	BULB TYPE	MULT SERIES	POLE TYPE	SHADE	ADDRESS NUMBER	REF	LOCATION	TAX DIST	DATE INST	DATE CHANGE
05800	S	M	CNT	II	01305	001		12	120899	1/1/0001
05800	S	M	CNT	II	01312	002		12	120899	1/1/0001
05800	S	M	CNT	II	01336	004		12	120899	1/1/0001
05800	S	M	CNT	III	01341	005		12	120899	1/1/0001

OFFICE: 311

ROUTE: 564

ST_REF_NO: 00000133120 MUIRFIELD PLACE

LUMENS	BULB TYPE	MULT SERIES	POLE TYPE	SHADE	ADDRESS NUMBER	REF	LOCATION	TAX DIST	DATE INST	DATE CHANGE
05800	S	M	OUG	II	03801	004		12	120893	1/1/0001
05800	S	M	OUG	II	03821	003		12	120893	1/1/0001
05800	S	M	OUG	II	03824	002		12	120893	1/1/0001
05800	S	M	OUG	II	03836	001		12	120893	1/1/0001

OFFICE: 311

ROUTE: 564

ST_REF_NO: 00000133150 MURPHYS RUN

LUMENS	BULB TYPE	MULT SERIES	POLE TYPE	SHADE	ADDRESS NUMBER	REF	LOCATION	TAX DIST	DATE INST	DATE CHANGE
05800	S		CNT	II	00000	002	SIDE OF 720 E SITH ST, ON MURPHYS RUN	12	112210	1/1/0001
05800	S		CNT	II	00000	003	1ST LT N OF E SIXTH ST, W SIDE ON MURPHYS RUN	12	112210	1/1/0001
05800	S		CNT	II	00520	010		12	112210	1/1/0001
05800	S		CNT	II	00555	001		12	112210	1/1/0001
05800	S		CNT	II	00631	004		12	112210	1/1/0001
05800	S		CNT	II	00642	005		12	112210	1/1/0001

OFFICE: 311

ROUTE: 564

ST_REF_NO: 00000133210 MUSKIE COURT

LUMENS	BULB TYPE	MULT SERIES	POLE TYPE	SHADE	ADDRESS NUMBER	REF	LOCATION	TAX DIST	DATE INST	DATE CHANGE
05800	S	M	OUG	II	00000	104	SIDE OF 3844 TROUT CT.	12	121581	1/1/0001
05800	S	M	OUG	V	03801	105		12	021582	1/1/0001

OFFICE: 311

ROUTE: 564

ST_REF_NO: 00000133250 MUSTANG CROSSING DRIVE

LUMENS	BULB TYPE	MULT SERIES	POLE TYPE	SHADE	ADDRESS NUMBER	REF	LOCATION	TAX DIST	DATE INST	DATE CHANGE
05800	S		CNT	II	00000	052	3RD LT E OF THOROUGHbred WAY, ON MUSTANG CROSSING DRIVE	12	101108	1/1/0001

OFFICE: 311

ROUTE: 564

ST_REF_NO: 00000133250

MUSTANG CROSSING DRIVE

LUMENS	BULB TYPE	MULT SERIES	POLE TYPE	SHADE	ADDRESS NUMBER	REF	LOCATION	TAX DIST	DATE INST	DATE CHANGE
05800	S		CNT	II	00000	053	4TH LT E OF THOROUGHbred WAY, ON MUSTAND CROSSING WAY	12	101108	1/1/0001
05800	S		CNT	II	00505	050		12	101108	1/1/0001
05800	S		CNT	II	00517	051		12	101108	1/1/0001
05800	S		CNT	II	00549	054		12	101108	1/1/0001
05800	S		CNT	II	00573	055		12	101108	1/1/0001

OFFICE: 311

ROUTE: 564

ST_REF_NO: 00000133300

NAKOMI DRIVE

LUMENS	BULB TYPE	MULT SERIES	POLE TYPE	SHADE	ADDRESS NUMBER	REF	LOCATION	TAX DIST	DATE INST	DATE CHANGE
05800	S	M	OUG	II	00721	003		12	061580	1/1/0001
04000	S	M	OUG	II	02905	151		12	101583	1/1/0001
04000	S	M	OUG	V	02913	152		12	101583	1/1/0001

OFFICE: 311

ROUTE: 564

ST_REF_NO: 00000133410

NALLY COURT

LUMENS	BULB TYPE	MULT SERIES	POLE TYPE	SHADE	ADDRESS NUMBER	REF	LOCATION	TAX DIST	DATE INST	DATE CHANGE
05800	S	M	OUG	II	02912	001		12	080895	1/1/0001

OFFICE: 311

ROUTE: 564

ST_REF_NO: 00000133500

NANCY LANE

LUMENS	BULB TYPE	MULT SERIES	POLE TYPE	SHADE	ADDRESS NUMBER	REF	LOCATION	TAX DIST	DATE INST	DATE CHANGE
05800	S	M	OUG	II	00000	042	SIDE OF 546 ROGERS RD.	12	060165	1/1/0001
04000	S	M	OUG	II	02301	086		12	050884	1/1/0001
04000	S	M	OUG	II	02306	087		12	050884	1/1/0001
04000	S	M	OUG	II	02313	088		12	050884	1/1/0001
04000	S	M	OUG	II	02316	089		12	050884	1/1/0001

OFFICE: 311

ROUTE: 564

ST_REF_NO: 00000133600

NANCY HANKS ROAD

LUMENS	BULB TYPE	MULT SERIES	POLE TYPE	SHADE	ADDRESS NUMBER	REF	LOCATION	TAX DIST	DATE INST	DATE CHANGE
05800	S	M	OUG	II	00000	004	REAR OF 1313 NANCY HANKS	12	090170	1/1/0001
05800	S	M	OUG	II	01310	005		12	100170	1/1/0001

OFFICE: 311

ROUTE: 564

ST_REF_NO: 00000133700

NANDINO BOULEVARD

LUMENS	BULB TYPE	MULT SERIES	POLE TYPE	SHADE	ADDRESS NUMBER	REF	LOCATION	TAX DIST	DATE INST	DATE CHANGE
09500	S	M	OUG	II	00000	085	OPP. 848 IN MEDIAN, S. SIDE	12	111476	2/16/2010
09500	S	M	OUG	II	00000	086	OPP. 848, IN MEDIAN, N. SIDE	12	111476	2/16/2010
10000	M	M	OUG	II	00000	001	1ST LT. E. OF GEORGETOWN RD., IN MEDIAN, N. SIDE	12	090169	1/1/0001
10000	M	M	OUG	II	00000	002	1ST LT. E. OF GEORGETOWN RD, IN MEDIAN, S. SIDE	12	090169	1/1/0001
10000	M	M	OUG	II	00000	003	2ND LT. E. OF GEORGETOWN RD., IN MEDIAN, N. SIDE	12	090169	1/1/0001
10000	M	M	OUG	II	00000	004	2ND LT. E. OF GEORGETOWN RD., IN MEDIAN, S. SIDE	12	090169	1/1/0001
09500	S	M	OUG	II	00000	005	3RD LT. E. OF GEORGETOWN RD., IN MEDIAN, N. SIDE	12	090169	1/1/0001
10000	M	M	OUG	II	00000	006	3RD LT. E. OF GEORGETOWN RD., IN MEDIAN, S. SIDE	12	090169	1/1/0001
10000	M	M	OUG	II	00000	007	4TH LT. E. OF GEORGETOWN RD., IN MEDIAN, N. SIDE	12	090169	1/1/0001
10000	M	M	OUG	II	00000	008	4TH LT. E. OF GEORGETOWN RD., IN MEDIAN, S. SIDE	12	090169	1/1/0001
09500	S	M	OUG	II	00000	009	5TH LT. E. OF GEORGETOWN RD., IN MEDIAN, N. SIDE	12	090169	1/1/0001
10000	M	M	OUG	II	00000	010	5TH LT. E. OF GEORGETOWN RD, IN MEDIAN, S. SIDE	12	090169	1/1/0001
10000	M	M	OUG	II	00000	011	6TH LT. E. OF GEORGETOWN RD., IN MEDIAN, N. SIDE	12	090169	1/1/0001
10000	M	M	OUG	II	00000	012	6TH LT. E. OF GEORGETOWN RD., IN MEDIAN, S. SIDE	12	090169	1/1/0001
10000	M	M	OUG	II	00000	013	SIDE OF 1002 TROTWOOD DR.	12	092674	1/1/0001
10000	M	M	OUG	II	00000	016	OPP. PRIMROSE CT.	12	090169	1/1/0001
10000	M	M	OUG	II	00992	041		12	082373	1/1/0001
09500	S	M	OUG	II	00992	043		12	092674	1/1/0001
10000	M	M	OUG	II	00993	040		12	051480	1/1/0001
10000	M	M	OUG	II	00993	042		12	051480	1/1/0001
10000	M	M	OUG	II	01020	039		12	082373	1/1/0001
10000	M	M	OUG	II	01025	036		12	122071	1/1/0001
10000	M	M	OUG	II	01025	038		12	122071	1/1/0001
10000	M	M	OUG	II	01040	037		12	082373	1/1/0001
10000	M	M	OUG	II	01041	034		12	082373	1/1/0001
10000	M	M	OUG	II	01056	017		12	082373	1/1/0001

Street Light Listing run 1/11/2015 10:43:21 AM

Page 766 of 1254

OFFICE: 311		ROUTE: 564		ST_REF_NO: 00000133700		NANDINO BOULEVARD				
LUMENS	BULB TYPE	MULT SERIES	POLE TYPE	SHADE	ADDRESS NUMBER	REF	LOCATION	TAX DIST	DATE INST	DATE CHANGE
10000	M	M	OUG	II	01056	035		12	082373	1/1/0001
09500	S	M	OUG	II	01088	014	change out bad mv fixture 2/08	12	082373	1/1/0001
10000	M	M	OUG	II	01088	015		12	082373	1/1/0001
10000	M	M	OUG	II	00000	087	OPP. 848, IN MEDIAN, S. SIDE	12	111476	1/1/0001
10000	M	M	OUG	II	00000	088	OPP. 848, IN MEDIAN, N. SIDE	12	111476	1/1/0001
10000	M	M	OUG	II	00000	089	OPP. 848, IN MEDIAN, S. SIDE	12	111476	1/1/0001
10000	M	M	OUG	II	00000	090	OPP. 848, IN MEDIAN, N. SIDE	12	111476	1/1/0001
10000	M	M	OUG	II	00000	091	OPP. 848, IN MEDIAN, S. SIDE	12	111476	1/1/0001
10000	M	M	OUG	II	00000	092	OPP. 848, IN MEDIAN, N. SIDE	12	111476	1/1/0001
10000	M	M	OUG	II	00000	093	OPP. 832, IN MEDIAN, S. SIDE	12	111476	1/1/0001
10000	M	M	OUG	II	00000	094	OPP. 832, IN MEDIAN, N. SIDE	12	111476	1/1/0001
10000	M	M	OUG	II	00000	095	OPP. 832 IN MEDIAN, S. SIDE	12	111476	1/1/0001
10000	M	M	OUG	II	00000	096	OPP. 832, IN MEDIAN, N. SIDE	12	111476	1/1/0001
10000	M	M	OUG	II	00000	097	OPP. 832, IN MEDIAN, S. SIDE	12	030897	1/1/0001
10000	M	M	OUG	II	00000	098	OPP. 832, IN MEDIAN, N. SIDE	12	030897	1/1/0001
09500	S	M	OUG	II	00848	082		12	051480	1/1/0001
09500	S	M	OUG	II	00849	083	changed out June 2007 due to car accident	12	111476	1/1/0001
10000	M	M	OUG	II	00849	084		12	111476	1/1/0001
10000	M	M	OUG	II	00865	078		12	051480	1/1/0001
10000	M	M	OUG	II	00868	077		12	091477	1/1/0001
09500	S	M	OUG	II	00884	075		12	081475	1/1/0001
10000	M	M	OUG	II	00897	074		12	051480	1/1/0001
10000	M	M	OUG	II	00897	076		12	051480	1/1/0001
10000	M	M	OUG	II	00913	048		12	041475	1/1/0001
10000	M	M	OUG	II	00928	045		12	051480	1/1/0001
10000	M	M	OUG	II	00928	047		12	051480	1/1/0001
10000	M	M	OUG	II	00945	044		12	041475	1/1/0001
10000	M	M	OUG	II	00945	046		12	041475	1/1/0001
OFFICE: 311		ROUTE: 564		ST_REF_NO: 00000133800		NANTUCKET ROAD				
LUMENS	BULB TYPE	MULT SERIES	POLE TYPE	SHADE	ADDRESS NUMBER	REF	LOCATION	TAX DIST	DATE INST	DATE CHANGE
05800	S	M	OUG	II	03412	052		12	060897	1/1/0001
05800	S	M	OUG	II	00000	010	SIDE OF 3369 LANSDOWNE DRIVE	12	090896	1/1/0001

OFFICE: 311		ROUTE: 564		ST_REF_NO: 00000133800		NANTUCKET ROAD		LUMENS	BULB TYPE	MULT SERIES	POLE TYPE	SHADE	ADDRESS NUMBER	REF	LOCATION	TAX DIST	DATE INST	DATE CHANGE
05800	S	M	OUG	II	03271	000		12	080166	1/1/0001								
05800	S	M	OUG	II	03279	000		12	040969	1/1/0001								
05800	S	M	OUG	II	03288	000		12	080166	1/1/0001								
05800	S	M	OUG	II	03295	000		12	080166	1/1/0001								
05800	S	M	OUG	II	03304	000		12	120869	1/1/0001								
05800	S	M	OUG	II	03311	000		12	080166	1/1/0001								
05800	S	M	OUG	II	03324	000		12	080166	1/1/0001								
05800	S	M	OUG	II	03327	008		12	090896	1/1/0001								
05800	S	M	OUG	II	03340	009		12	090896	1/1/0001								
05800	S	M	OUG	II	03401	050		12	060897	1/1/0001								
05800	S	M	OUG	II	03408	051		12	060897	1/1/0001								
05800	S	M	OUG	II	03416	053		12	060897	1/1/0001								

OFFICE: 311		ROUTE: 564		ST_REF_NO: 00000133825		NAPLES LANE		LUMENS	BULB TYPE	MULT SERIES	POLE TYPE	SHADE	ADDRESS NUMBER	REF	LOCATION	TAX DIST	DATE INST	DATE CHANGE
05800	S	M	CNT	III	02204	006		12	082603	1/1/0001								
05800	S	M	CNT	II	02213	005		12	082603	1/1/0001								
05800	S	M	CNT	II	02216	004		12	082603	1/1/0001								
05800	S	M	CNT	II	02233	003		12	082603	1/1/0001								
05800	S	M	CNT	II	02244	002		12	082603	1/1/0001								
05800	S	M	CNT	II	02249	001		12	082603	1/1/0001								

OFFICE: 311		ROUTE: 564		ST_REF_NO: 00000133900		NARRAGANSETT PARK		LUMENS	BULB TYPE	MULT SERIES	POLE TYPE	SHADE	ADDRESS NUMBER	REF	LOCATION	TAX DIST	DATE INST	DATE CHANGE
04000	S	M	OUG	V	01274	000		12	051074	1/1/0001								
04000	S	M	OUG	II	01287	000		12	120172	1/1/0001								

OFFICE: 311		ROUTE: 564		ST_REF_NO: 00000133950		NARROW LANE		LUMENS	BULB TYPE	MULT SERIES	POLE TYPE	SHADE	ADDRESS NUMBER	REF	LOCATION	TAX DIST	DATE INST	DATE CHANGE
05800	S	M	OUG	II	00000	001	SIDE OF 1109 PARKLAWN DR.	12	060894	1/1/0001								
05800	S	M	OUG	II	00000	003	SIDE OF 1108 CLOVELLY CT.	12	060894	1/1/0001								

OFFICE: 311		ROUTE: 564		ST_REF_NO: 00000133950		NARROW LANE		LUMENS	BULB TYPE	MULT SERIES	POLE TYPE	SHADE	ADDRESS NUMBER	REF	LOCATION	TAX DIST	DATE INST	DATE CHANGE
05800	S	M	OUG	II	01117	002										12	060894	1/1/0001
05800	S	M	OUG	II	01145	004										12	060894	1/1/0001
05800	S	M	OUG	III	01153	005										12	060894	1/1/0001
05800	S	M	OUG	V	01156	006										12	060894	1/1/0001

OFFICE: 311		ROUTE: 564		ST_REF_NO: 00000134000		NASHVILLE COURT		LUMENS	BULB TYPE	MULT SERIES	POLE TYPE	SHADE	ADDRESS NUMBER	REF	LOCATION	TAX DIST	DATE INST	DATE CHANGE
05800	S	M	OUG	II	02033	000										12	090866	1/1/0001

OFFICE: 311		ROUTE: 564		ST_REF_NO: 00000134150		NATAL PLACE		LUMENS	BULB TYPE	MULT SERIES	POLE TYPE	SHADE	ADDRESS NUMBER	REF	LOCATION	TAX DIST	DATE INST	DATE CHANGE
05800	S		CNT	II	04401	001										12	062810	1/1/0001
05800	S		CNT	II	04409	002										12	062810	1/1/0001
05800	S		CNT	II	04424	003										12	062810	1/1/0001

OFFICE: 311		ROUTE: 564		ST_REF_NO: 00000134200		NATCHEZ TRAIL		LUMENS	BULB TYPE	MULT SERIES	POLE TYPE	SHADE	ADDRESS NUMBER	REF	LOCATION	TAX DIST	DATE INST	DATE CHANGE
04000	S	M	OUG	II	00000	001									SIDE OF 913 MAYWICK DR.	12	100888	1/1/0001
04000	S	M	OUG	II	01934	004										12	100888	1/1/0001
04000	S	M	OUG	II	01943	003										12	100888	1/1/0001
04000	S	M	OUG	II	01958	002										12	100888	1/1/0001

OFFICE: 311		ROUTE: 564		ST_REF_NO: 00000134300		NATIONAL AVENUE		LUMENS	BULB TYPE	MULT SERIES	POLE TYPE	SHADE	ADDRESS NUMBER	REF	LOCATION	TAX DIST	DATE INST	DATE CHANGE
09500	S	M	SOH	II	00000	339									1ST LT. E. OF WALTON, S. SIDE	12	101166	1/1/0001
09500	S	M	SOH	I	00000	352									OPP. 928	12	101866	1/1/0001
09500	S	S	SOH	I	00000	353									OPP. 938	12	101866	1/1/0001
09500	S	M	SOH	II	00707	340										12	101166	1/1/0001
09500	S	M	SOH	II	00719	341										12	101166	1/1/0001
09500	S	M	SOH	II	00723	342										12	101166	1/1/0001
09500	S	M	SOH	II	00725	343										12	101166	1/1/0001

OFFICE: 311		ROUTE: 564		ST_REF_NO: 00000134300		NATIONAL AVENUE				
LUMENS	BULB TYPE	MULT SERIES	POLE TYPE	SHADE	ADDRESS NUMBER	REF	LOCATION	TAX DIST	DATE INST	DATE CHANGE
09500	S	M	SOH	II	00737	344		12	101166	1/1/0001
09500	S	M	SOH	II	00801	345		12	101166	1/1/0001
09500	S	M	SOH	II	00819	346		12	101166	1/1/0001
09500	S	M	SOH	II	00829	347		12	101166	1/1/0001
09500	S	M	SOH	V	00831	348		12	101866	1/1/0001
09500	S	S	SOH	I	00905	350		12	101866	1/1/0001
09500	S	S	SOH	I	00909	351		12	101866	1/1/0001
09500	S	M	SOH	I	00935	354		12	101866	1/1/0001
09500	S	M	SOH	II	00951	189		12	050885	1/1/0001

OFFICE: 311		ROUTE: 564		ST_REF_NO: 00000134380		NAVAJO COURT				
LUMENS	BULB TYPE	MULT SERIES	POLE TYPE	SHADE	ADDRESS NUMBER	REF	LOCATION	TAX DIST	DATE INST	DATE CHANGE
05800	S	M	CNT	III	03113	001		12	060897	1/1/0001

OFFICE: 311		ROUTE: 564		ST_REF_NO: 00000134500		NEAL DRIVE				
LUMENS	BULB TYPE	MULT SERIES	POLE TYPE	SHADE	ADDRESS NUMBER	REF	LOCATION	TAX DIST	DATE INST	DATE CHANGE
05800	S	M	OUG	II	02956	060		12	012908	1/1/0001
05800	S	M	OUG	II	02993	004	bad fixture	12	110889	2/14/2011
05800	S	M	OUG	II	00000	031	SIDE REAR OF 501 ANDREA DR.	12	010894	1/1/0001
05800	S	M	OUG	II	00000	033	SIDE REAR OF 500 ANDREA DR.	12	010894	1/1/0001
05800	S	M	OUG	II	02894	032		12	010894	1/1/0001
04000	S	M	OUG	II	02901	024		12	071581	1/1/0001
04000	S	M	OUG	II	02908	023		12	081581	1/1/0001
05800	S	M	OUG	II	02921	022	upgrade-bad fixture	12	071581	1/1/0001
04000	S	M	OUG	II	02932	021		12	050886	1/1/0001
04000	S	M	OUG	II	02941	020		12	071581	1/1/0001
04000	S	M	OUG	II	02964	007		12	110889	1/1/0001
04000	S	M	OUG	II	02972	006		12	110889	1/1/0001
04000	S	M	OUG	V	02984	005		12	110889	1/1/0001
04000	S	M	OUG	II	03008	003		12	110889	1/1/0001
04000	S	M	OUG	II	03020	002		12	110889	1/1/0001
04000	S	M	OUG	II	03021	001		12	110889	1/1/0001

OFFICE: 311

ROUTE: 564

ST_REF_NO: 00000134600

NELMS AVENUE

LUMENS	BULB TYPE	MULT SERIES	POLE TYPE	SHADE	ADDRESS NUMBER	REF	LOCATION	TAX DIST	DATE INST	DATE CHANGE
05800	S	M	SOH	I	00000	001	1ST LT. W. OF S. BROADWAY, N. SIDE	12	080163	1/1/0001
05800	S	M	SOH	I	00000	006	6TH LT. W. OF S. BROADWAY, N. SIDE	12	080163	1/1/0001
05800	S	M	SOH	I	00425	002		12	080163	1/1/0001
05800	S	M	SOH	I	00431	003		12	080163	1/1/0001
05800	S	M	SOH	I	00445	004		12	080163	1/1/0001
05800	S	M	SOH	I	00455	005		12	080163	1/1/0001

OFFICE: 311

ROUTE: 564

ST_REF_NO: 00000134700

NELSON AVENUE

LUMENS	BULB TYPE	MULT SERIES	POLE TYPE	SHADE	ADDRESS NUMBER	REF	LOCATION	TAX DIST	DATE INST	DATE CHANGE
05800	S		CNT	II	00000	060	6TH LT SOUTH OF 6TH STREET, EAST SIDE ON NELSON AVENUE	12	101108	1/1/0001
05800	S		CNT	II	00000	062	4TH LT SOUTH OF 6TH STREET, EAST SIDE ON NELSON AVENUE	12	101108	1/1/0001
05800	S		CNT	II	00000	063	3RD LT SOUTH OF 6TH STREET, EAST SIDE ON NELSON AVENUE	12	101108	1/1/0001
05800	S		CNT	II	00000	065	1ST LT SOUTH OF 6TH STREET, EAST SIDE ON NELSON AVENUE	12	101108	1/1/0001
05800	S		CNT	II	00420	061		12	101108	1/1/0001
05800	S		CNT	II	00536	064		12	101108	1/1/0001
05800	S	M	SOH		00000	040	1ST LT. N. OF E. 3RD ST., E. SIDE	12	120566	1/1/0001
05800	S	M	SOH		00000	042	2ND LT. N. OF E. 3RD ST., E. SIDE	12	120566	1/1/0001
05800	S	M	SOH		00344	044		12	091833	1/1/0001

OFFICE: 311

ROUTE: 564

ST_REF_NO: 00000134900

NEVIUS DRIVE

LUMENS	BULB TYPE	MULT SERIES	POLE TYPE	SHADE	ADDRESS NUMBER	REF	LOCATION	TAX DIST	DATE INST	DATE CHANGE
05800	S	M	OUG	II	03338	023	upgrade due to bad fixture	12	031581	9/15/2008
04000	S	M	OUG	II	00000	009	SIDE OF 2001 FT. HARRODS DR.	12	031581	1/1/0001
04000	S	M	OUG	II	00000	022	SIDE OF 2001 PARASOL DR.	12	031581	1/1/0001
04000	S	M	OUG	II	03323	024		12	031581	1/1/0001
04000	S	M	OUG	II	03358	021		12	031581	1/1/0001
04000	S	M	OUG	II	03363	020		12	031581	1/1/0001
04000	S	M	OUG	II	03383	010		12	031581	1/1/0001
04000	S	M	OUG	II	03394	011		12	031581	1/1/0001

OFFICE: 311							ROUTE: 564			
ST_REF_NO: 00000135000							NEW STREET			
LUMENS	BULB TYPE	MULT SERIES	POLE TYPE	SHADE	ADDRESS NUMBER	REF	LOCATION	TAX DIST	DATE INST	DATE CHANGE
05800	S	M	SOH	I	00000	001	SIDE OF 239 N. MILL ST.	12	020885	1/1/0001
05800	S	M	SOH	I	00000	002	SIDE OF 244 N. BROADWAY	12	020885	1/1/0001

OFFICE: 311							ROUTE: 564			
ST_REF_NO: 00000135100							NEW CIRCLE, N.W. ROAD			
LUMENS	BULB TYPE	MULT SERIES	POLE TYPE	SHADE	ADDRESS NUMBER	REF	LOCATION	TAX DIST	DATE INST	DATE CHANGE
22000	S	M	OUG	II	00131	070		12	071579	3/31/2010
22000	S	M	OUG	II	00233	058	car accident	12	071579	6/5/2009
20000	M	M	OUG	II	00000	001	N. SIDE BETWEEN IBM OVERPASS & BOARDWALK	12	071579	1/1/0001
20000	M	M	OUG	II	00000	002	S. SIDE BETWEEN IBM OVERPASS & BOARDWALK	12	071579	1/1/0001
20000	M	M	OUG	II	00000	003	N. SIDE BETWEEN IBM OVERPASS & BOARDWALK	12	071579	1/1/0001
20000	M	M	OUG	II	00000	004	S. SIDE BETWEEN IBM OVERPASS & BOARDWALK	12	071579	1/1/0001
20000	M	M	OUG	II	00000	005	N. SIDE BETWEEN IBM OVERPASS & BOARDWALK	12	071579	1/1/0001
20000	M	M	OUG	II	00000	006	S. SIDE BETWEEN IBM OVERPASS & BOARDWALK	12	071579	1/1/0001
20000	M	M	OUG	II	00000	007	N. SIDE BETWEEN IBM OVERPASS & BOARDWALK	12	071579	1/1/0001
20000	M	M	OUG	II	00000	008	S. SIDE BETWEEN IBM OVERPASS & BOARDWALK	12	071579	1/1/0001
20000	M	M	OUG	II	00000	009	N. SIDE BETWEEN IBM OVERPASS & BOARDWALK	12	071579	1/1/0001
22000	S	M	OUG	II	00000	010	S. SIDE BETWEEN IBM OVERPASS & BOARDWALK	12	071579	1/1/0001
20000	M	M	OUG	II	00000	011	N. SIDE BETWEEN IBM OVERPASS & BOARDWALK	12	071579	1/1/0001
20000	M	M	OUG	II	00000	012	S. SIDE BETWEEN IBM OVERPASS & BOARDWALK	12	071579	1/1/0001
20000	M	M	OUG	II	00000	013	N. SIDE BETWEEN IBM OVERPASS & BOARDWALK	12	071579	1/1/0001
20000	M	M	OUG	II	00000	014	S. SIDE BETWEEN IBM OVERPASS & BOARDWALK	12	071579	1/1/0001
20000	M	M	OUG	II	00000	015	N. SIDE BETEEN IBM OVERPASS & BOARDWALK	12	071579	1/1/0001
20000	M	M	OUG	II	00000	016	S. SIDE BETWEEN IBM OVERPASS & BOARDWALK	12	071579	1/1/0001
20000	M	M	OUG	II	00000	017	N. SIDE BETWEEN IBM OVERPASS & BOARDWALK	12	071579	1/1/0001
20000	M	M	OUG	II	00000	018	S. SIDE BETWEEN IBM OVERPASS & BOARDWALK	12	071579	1/1/0001
20000	M	M	OUG	II	00000	019	N. SIDE BETWEEN IBM OVERPASS & BOARDWALK	12	071579	1/1/0001
22000	S	M	OUG	II	00000	020	S. SIDE BETWEEN IBM OVERPASS & BOARDWALK	12	071579	1/1/0001
20000	M	M	OUG	II	00000	021	N. SIDE BETWEEN IBM OVERPASS & BOARDWALK	12	071579	1/1/0001
22000	S	M	OUG	II	00000	022	S. SIDE BETWEEN IBM OVERPASS & BOARDWALK	12	071579	1/1/0001
20000	M	M	OUG	II	00000	023	N. SIDE BETWEEN IBM OVERPASS & BOARDWALK	12	071579	1/1/0001
20000	M	M	OUG	II	00000	024	S. SIDE BETWEEN BOARDWALK & RUSSELL CAVE	12	081579	1/1/0001
20000	M	M	OUG	II	00000	025	N. SIDE BETWEEN BOARDWALK & RUSSELL CAVE	12	071579	1/1/0001
20000	M	M	OUG	II	00000	026	S. SIDE BETWEEN BOARDWALK & RUSSELL CAVE	12	071579	1/1/0001

OFFICE: 311

ROUTE: 564

ST_REF_NO: 00000135100

NEW CIRCLE, N.W. ROAD

LUMENS	BULB TYPE	MULT SERIES	POLE TYPE	SHADE	ADDRESS NUMBER	REF	LOCATION	TAX DIST	DATE INST	DATE CHANGE
22000	S	M	OUG	II	00000	027	N. SIDE BETWEEN BOARDWALK & RUSSELL CAVE	12	071579	1/1/0001
20000	M	M	OUG	II	00000	029	N. SIDE BETWEEN BOARDWALK & RUSSELL CAVE	12	071579	1/1/0001
20000	M	M	OUG	II	00000	031	N. SIDE BETWEEN BOARDWALK & RUSSELL CAVE	12	071579	1/1/0001
20000	M	M	OUG	II	00000	033	N. SIDE BETWEEN BOARDWALK & RUSSELL CAVE	12	071579	1/1/0001
20000	M	M	OUG	II	00000	034	S. SIDE BETWEEN BOARDWALK & RUSSELL CAVE	12	071579	1/1/0001
20000	M	M	OUG	II	00000	035	N. SIDE BETWEEN BOARDWALK & RUSSELL CAVE	12	071579	1/1/0001
20000	M	M	OUG	II	00000	036	S. SIDE BETWEEN BOARDWALK & RUSSELL CAVE	12	071579	1/1/0001
20000	M	M	OUG	II	00000	037	N. SIDE BETWEEN BOARDWALK & RUSSELL CAVE	12	071579	1/1/0001
20000	M	M	OUG	II	00000	038	S. SIDE BETWEEN BOARDWALK & RUSSELL CAVE	12	071579	1/1/0001
22000	S	M	OUG	II	00000	039	N. SIDE BETWEEN BOARDWALK & RUSSELL CAVE	12	071579	1/1/0001
20000	M	M	OUG	II	00000	040	S. SIDE BETWEEN BOARDWALK & RUSSELL CAVE	12	071579	1/1/0001
20000	M	M	OUG	II	00000	041	N. SIDE BETWEEN BOARDWALK & RUSSELL CAVE	12	071579	1/1/0001
20000	M	M	OUG	II	00000	042	S. SIDE BETWEEN BOARDWALK & RUSSELL CAVE	12	071579	1/1/0001
20000	M	M	SOH	II	00000	060	SIDE OF 1601 N. BROADWAY	12	071579	1/1/0001
20000	M	M	SOH	II	00176	063		12	081579	1/1/0001
20000	M	M	OUG	II	00176	065		12	071579	1/1/0001
20000	M	M	OUG	II	00176	067		12	071579	1/1/0001
20000	M	M	SOH	II	00177	064		12	071579	1/1/0001
20000	M	M	OUG	II	00206	061		12	071579	1/1/0001
20000	M	M	OUG	II	00208	059		12	071579	1/1/0001
22000	S	M	OUG	II	00232	055		12	071579	1/1/0001
20000	M	M	OUG	II	00232	057		12	071579	1/1/0001
20000	M	M	OUG	II	00245	056		12	071579	1/1/0001
20000	M	M	OUG	II	00255	054		12	071579	1/1/0001
20000	M	M	OUG	II	00260	053		12	071579	1/1/0001
20000	M	M	OUG	II	00268	051		12	071579	1/1/0001
20000	M	M	OUG	II	00275	052		12	071579	1/1/0001
20000	M	M	OUG	II	00285	048		12	071579	1/1/0001
20000	M	M	OUG	II	00285	050		12	071579	1/1/0001
20000	M	M	OUG	II	00300	049		12	071579	1/1/0001
20000	M	M	SOH	II	00313	046		12	071579	1/1/0001
20000	M	M	OUG	II	00320	045		12	071579	1/1/0001
20000	M	M	OUG	II	00320	047		12	071579	1/1/0001
20000	M	M	OUG	II	00130	069		12	071579	1/1/0001

OFFICE: 311

ROUTE: 564

ST_REF_NO: 00000135100

NEW CIRCLE, N.W. ROAD

LUMENS	BULB TYPE	MULT SERIES	POLE TYPE	SHADE	ADDRESS NUMBER	REF	LOCATION	TAX DIST	DATE INST	DATE CHANGE
20000	M	M	OUG	II	00130	071		12	071579	1/1/0001
22000	S	M	OUG	II	00130	073		12	071579	1/1/0001
20000	M	M	OUG	II	00130	075		12	071579	1/1/0001
20000	M	M	OUG	II	00130	077		12	071579	1/1/0001
20000	M	M	OUG	II	00130	079		12	071579	1/1/0001
20000	M	M	OUG	II	00131	072		12	071579	1/1/0001
20000	M	M	OUG	II	00131	074		12	071579	1/1/0001
20000	M	M	OUG	II	00131	076		12	071579	1/1/0001
22000	S	M	OUG	II	00131	078		12	071579	1/1/0001
20000	M	M	OUG	II	00177	066		12	071579	1/1/0001
20000	M	M	OUG	II	00177	068		12	071579	1/1/0001

OFFICE: 311

ROUTE: 564

ST_REF_NO: 00000135110

NEW CIRCLE, N. E. ROAD

LUMENS	BULB TYPE	MULT SERIES	POLE TYPE	SHADE	ADDRESS NUMBER	REF	LOCATION	TAX DIST	DATE INST	DATE CHANGE
50000	S	M	OUG	II	00000	251	E. SIDE BETWEEN LIBERTY RD. & RR OVERPASS	12	071579	9/10/2010
50000	S	M	OUG	II	00000	253	E. SIDE BETWEEN LIBERTY RD. & RR OVERPASS	12	071579	9/10/2010
50000	S	M	OUG	II	00000	255	E. SIDE BETWEEN LIBERTY RD. & RR OVERPASS	12	071579	9/10/2010
22000	S	M	OUG	II	00000	278	W. SIDE BETWEEN RR OVERPASS & PALUMBO DR.	12	071579	9/28/2010
22000	S	M	OUG	II	00000	300	W. SIDE BETWEEN WOODHILL & RICHMOND RD.	12	071579	1/10/2013
22000	S	M	OUG	II	00142	089		12	071579	3/31/2010
22000	S	M	OUG	II	00390	123	bad fixture	12	071579	9/20/2010
22000	S	M	OUG	II	00415	130		12	071579	1/1/0001
22000	S	M	OUG	II	00416	129	changed out bad fixture	12	071579	10/29/2008
22000	S	M	OUG	II	00452	139	bad fixture	12	072579	12/16/2009
22000	S	M	OUG	II	00537	150		12	072579	3/31/2010
22000	S	M	OUG	II	01081	213		12	071579	10/24/2011
20000	M	M	OUG	II	01272	250		12	110800	1/1/2010
22000	S	M	OUG	II	00000	080	SIDE OF 1600 OLD PARIS PIKE	12	071579	1/1/0001
20000	M	M	OUG	II	00106	081		12	071579	1/1/0001
22000	S	M	OUG	II	00115	082		12	071579	1/1/0001
20000	M	M	OUG	II	00116	083		12	071579	1/1/0001
20000	M	M	OUG	II	00125	084		12	071579	1/1/0001
20000	M	M	OUG	II	00126	085		12	071579	1/1/0001

OFFICE: 311

ROUTE: 564

ST_REF_NO: 00000135110

NEW CIRCLE, N. E. ROAD

LUMENS	BULB TYPE	MULT SERIES	POLE TYPE	SHADE	ADDRESS NUMBER	REF	LOCATION	TAX DIST	DATE INST	DATE CHANGE
20000	M	M	OUG	II	00127	086		12	071579	1/1/0001
20000	M	M	OUG	II	00142	087		12	071579	1/1/0001
20000	M	M	OUG	II	00155	088		12	071579	1/1/0001
20000	M	M	OUG	II	00160	095		12	071579	1/1/0001
20000	M	M	OUG	II	00165	090		12	071579	1/1/0001
20000	M	M	OUG	II	00165	091		12	071579	1/1/0001
20000	M	M	SOH	II	00165	092		12	071579	1/1/0001
20000	M	M	OUG	II	00170	093		12	071579	1/1/0001
20000	M	M	OUG	II	00179	094		12	071579	1/1/0001
20000	M	M	OUG	II	00207	096		12	071579	1/1/0001
20000	M	M	OUG	II	00208	097		12	071579	1/1/0001
22000	S	M	OUG	II	00211	098		12	071579	1/1/0001
20000	M	M	OUG	II	00212	099		12	071579	1/1/0001
20000	M	M	OUG	II	00219	100		12	071579	1/1/0001
20000	M	M	OUG	II	00228	101		12	071579	1/1/0001
20000	M	M	OUG	II	00234	103		12	071579	1/1/0001
20000	M	M	OUG	II	00234	105		12	071579	1/1/0001
20000	M	M	OUG	II	00235	102		12	071579	1/1/0001
20000	M	M	OUG	II	00235	104		12	071579	1/1/0001
20000	M	M	OUG	II	00254	107		12	071579	1/1/0001
22000	S	M	OUG	II	00273	106		12	071579	1/1/0001
20000	M	M	OUG	II	00273	108		12	071579	1/1/0001
20000	M	M	OUG	II	00274	109		12	071579	1/1/0001
20000	M	M	OUG	II	00274	111		12	071579	1/1/0001
20000	M	M	OUG	II	00285	110		12	071579	1/1/0001
20000	M	M	OUG	II	00304	113		12	071579	1/1/0001
20000	M	M	OUG	II	00316	115		12	071579	1/1/0001
20000	M	M	OUG	II	00328	117		12	071579	1/1/0001
20000	M	M	OUG	II	00329	116		12	071579	1/1/0001
20000	M	M	OUG	II	00329	118		12	071579	1/1/0001
22000	S	M	OUG	II	00376	119		12	071579	1/1/0001
20000	M	M	OUG	II	00376	121		12	071579	1/1/0001
22000	S	M	OOH	II	00377	120		12	010894	1/1/0001
20000	M	M	OOH	II	00377	122		12	010894	1/1/0001

OFFICE: 311

ROUTE: 564

ST_REF_NO: 00000135110

NEW CIRCLE, N. E. ROAD

LUMENS	BULB TYPE	MULT SERIES	POLE TYPE	SHADE	ADDRESS NUMBER	REF	LOCATION	TAX DIST	DATE INST	DATE CHANGE
20000	M	M	OUG	II	00383	124		12	071579	1/1/0001
20000	M	M	OUG	II	00390	125		12	071579	1/1/0001
20000	M	M	OUG	II	00399	126		12	071579	1/1/0001
20000	M	M	OUG	II	00400	127		12	071579	1/1/0001
20000	M	M	OUG	II	00401	128		12	071579	1/1/0001
20000	M	M	OUG	II	00420	131		12	071579	1/1/0001
22000	S	M	OUG	II	00423	132		12	071579	1/1/0001
20000	M	M	OUG	II	00447	134		12	071579	1/1/0001
20000	M	M	OOH	II	00447	136	upgrade 4/08	12	071579	1/1/0001
20000	M	M	OUG	II	00450	133		12	071579	1/1/0001
20000	M	M	OUG	II	00450	135		12	071579	1/1/0001
20000	M	M	OOH	II	00452	137	upgrade 4/08	12	071579	1/1/0001
20000	M	M	OUG	II	00461	138		12	072579	1/1/0001
20000	M	M	OUG	II	00470	141		12	072579	1/1/0001
20000	M	M	OUG	II	00475	140		12	072579	1/1/0001
20000	M	M	OUG	II	00487	142		12	072579	1/1/0001
22000	S	M	OUG	III	00000	718	1ST LT. N OF EASTLAND DR., WESTSIDE	12	100800	1/1/0001
20000	M	M	OUG	II	00490	143		12	072579	1/1/0001
20000	M	M	OUG	II	00497	144		12	072579	1/1/0001
20000	M	M	OUG	II	00510	145		12	072579	1/1/0001
20000	M	M	OUG	II	00525	146		12	072579	1/1/0001
20000	M	M	OUG	II	00525	148		12	072579	1/1/0001
20000	M	M	OUG	II	00538	147		12	071579	1/1/0001
20000	M	M	OUG	II	00538	149		12	072579	1/1/0001
20000	M	M	OUG	II	00538	151		12	072579	1/1/0001
20000	M	M	OUG	II	00567	152		12	072579	1/1/0001
20000	M	M	OUG	II	00568	153		12	072579	1/1/0001
20000	M	M	OUG	II	00571	154		12	072579	1/1/0001
20000	M	M	OUG	II	00575	156		12	072579	1/1/0001
20000	M	M	OUG	II	00588	155		12	072579	1/1/0001
20000	M	M	OUG	II	00588	157		12	072579	1/1/0001
20000	M	M	OUG	II	00597	158		12	072579	1/1/0001
20000	M	M	OUG	II	00608	159		12	072579	1/1/0001
20000	M	M	OUG	II	00608	161		12	072579	1/1/0001

OFFICE: 311

ROUTE: 564

ST_REF_NO: 00000135110

NEW CIRCLE, N. E. ROAD

LUMENS	BULB TYPE	MULT SERIES	POLE TYPE	SHADE	ADDRESS NUMBER	REF	LOCATION	TAX DIST	DATE INST	DATE CHANGE
20000	M	M	OUG	II	00617	160		12	072579	1/1/0001
20000	M	M	OUG	II	00630	163		12	072579	1/1/0001
20000	M	M	OUG	II	00635	162		12	072579	1/1/0001
20000	M	M	OUG	II	00635	164		12	072579	1/1/0001
20000	M	M	OUG	II	00660	165		12	072579	1/1/0001
20000	M	M	OUG	II	00668	167		12	072579	1/1/0001
22000	S	M	OUG	III	00678	732		12	100800	1/1/0001
22000	S	M	OUG	III	00684	730		12	100800	1/1/0001
22000	S	M	OUG	III	00690	728		12	100800	1/1/0001
22000	S	M	OUG	III	00696	726		12	100800	1/1/0001
22000	S	M	OUG	III	00701	731		12	100800	1/1/0001
22000	S	M	OUG	III	00701	733		12	100800	1/1/0001
22000	S	M	OUG	III	00703	725		12	100800	1/1/0001
22000	S	M	SOH	III	00703	727		12	100800	1/1/0001
22000	S	M	OUG	III	00703	729		12	100800	1/1/0001
22000	S	M	OUG	III	00750	720		12	100800	1/1/0001
22000	S	M	OUG	III	00750	722		12	100800	1/1/0001
22000	S	M	OUG	III	00750	724		12	100800	1/1/0001
22000	S	M	OUG	III	00761	723		12	100800	1/1/0001
22000	S	M	OUG	III	00765	721		12	100800	1/1/0001
22000	S	M	OUG	III	00781	719		12	100800	1/1/0001
22000	S	M	OUG	III	00818	716		12	100800	1/1/0001
22000	S	M	OUG	III	00975	707		12	100800	1/1/0001
22000	S	M	OUG	III	00975	708		12	100800	1/1/0001
22000	S	M	OUG	III	00975	710		12	100800	1/1/0001
22000	S	M	OUG	III	00975	712		12	100800	1/1/0001
22000	S	M	OUG	III	00976	711		12	100800	1/1/0001
22000	S	M	OUG	III	00988	709		12	100800	1/1/0001
20000	M	M	OUG	II	00000	252	W. SIDE BETWEEN LIBERTY RD. & RR OVERPASS	12	071579	1/1/0001
20000	M	M	OUG	II	00000	254	W. SIDE BETWEEN LIBERTY RD. & RR OVERPASS	12	071579	1/1/0001
20000	M	M	OUG	II	00000	256	W. SIDE BETWEEN LIBERTY RD. & RR OVERPASS	12	071579	1/1/0001
20000	M	M	OUG	II	00000	258	W. SIDE BETWEEN LIBERTY RD. & RR OVERPASS	12	071579	1/1/0001
20000	M	M	OUG	II	00000	260	W. SIDE BETWEEN LIBRTY RD. & RR OVERPASS	12	071579	1/1/0001
20000	M	M	OUG	II	00000	261	E. SIDE BETWEEN LIBRTY RD. & RR OVERPASS	12	071579	1/1/0001

OFFICE: 311

ROUTE: 564

ST_REF_NO: 00000135110

NEW CIRCLE, N. E. ROAD

LUMENS	BULB TYPE	MULT SERIES	POLE TYPE	SHADE	ADDRESS NUMBER	REF	LOCATION	TAX DIST	DATE INST	DATE CHANGE
20000	M	M	OUG	II	00000	262	W. SIDE BETWEEN LIBERTY RD. & RR OVERPASS	12	071579	1/1/0001
20000	M	M	OUG	II	00000	263	E. SIDE BETWEEN LIBERTY RD. & RR OVERPASS	12	071579	1/1/0001
20000	M	M	OUG	II	00000	264	W. SIDE BETWEEN LIBERTY RD. & RR OVERPASS	12	071579	1/1/0001
20000	M	M	OUG	II	00000	265	E. SIDE BETWEEN LIBERTY RD. & RR OVERPASS	12	071579	1/1/0001
22000	S	M	OUG	II	00000	266	W. SIDE BETWEEN RR OVERPASS & PALUMBO DR.	12	071579	1/1/0001
20000	M	M	OUG	II	00000	267	E. SIDE BETWEEN RR OVERPASS & PALUMBO DR.	12	071579	1/1/0001
20000	M	M	OUG	II	00000	268	W. SIDE BETWEEN RR OVERPASS & PALUMBO DR.	12	071579	1/1/0001
20000	M	M	OUG	II	00000	269	E. SIDE BETWEEN RR OVERPASS & PALUMBO DR.	12	071579	1/1/0001
20000	M	M	OUG	II	00000	270	W. SIDE BETWEEN RR OVERPASS & PALUMBO DR.	12	071579	1/1/0001
20000	M	M	OUG	II	00000	271	E. SIDE BETWEEN RR OVERPASS & PALUMBO DR.	12	071579	1/1/0001
22000	S	M	OUG	II	00000	272	W. SIDE BETWEEN RR OVERPASS & PALUMBO DR.	12	030801	1/1/0001
20000	M	M	OUG	II	00000	273	E. SIDE BETWEEN RR OVERPASS & PALUMBO DR.	12	071579	1/1/0001
20000	M	M	OUG	II	00000	274	W. SIDE BETWEEN RR OVERPASS & PALUMBO DR.	12	071579	1/1/0001
22000	S	M	OUG	II	00000	275	NE CORNER OF PALUMBO DRIVE upgrade 4/08	12	010696	1/1/0001
20000	M	M	OUG	II	00000	276	W. SIDE BETWEEN RR OVERPASS & PALUMBO DR.	12	071579	1/1/0001
20000	M	M	OUG	II	00000	277	E. SIDE BETWEEN RR OVERPASS & PALUMBO DR.	12	071579	1/1/0001
20000	M	M	OUG	II	00000	279	E. SIDE BETWEEN RR OVERPASS & PALUMBO DR.	12	071579	1/1/0001
22000	S	M	OUG	II	00000	280	W. SIDE BETWEEN PALUMBO & WOODHILL DR.	12	071579	1/1/0001
20000	M	M	OUG	II	00000	281	E. SIDE BETWEEN PALUMBO & WOODHILL DR.	12	071579	1/1/0001
20000	M	M	OUG	II	00000	282	W. SIDE BETWEEN PALUMBO & WOODHILL DR.	12	071579	1/1/0001
22000	S	M	OUG	II	00000	283	E. SIDE BETWEEN PALUMBO & WOODHILL DR.	12	071579	1/1/0001
50000	S	M	OUG	III	00307	114		12	110800	1/1/0001
22000	S	M	OUG	III	01010	706		12	100800	1/1/0001
22000	S	M	OUG	III	01029	705		12	100800	1/1/0001
22000	S	M	OUG	III	01030	704		12	100800	1/1/0001
22000	S	M	OUG	III	01050	702		12	100800	1/1/0001
22000	S	M	OUG	III	01063	701		12	100800	1/1/0001
22000	S	M	OUG	III	01063	703		12	100800	1/1/0001
22000	S	M	OUG	III	01066	700		12	100800	1/1/0001
20000	M	M	SOH	II	01077	211		12	081579	1/1/0001
20000	M	M	OUG	II	01081	215		12	071579	1/1/0001
20000	M	M	OUG	II	01086	212		12	071579	1/1/0001
20000	M	M	OUG	II	01095	217		12	071579	1/1/0001
22000	S	M	OUG	II	01095	219	bad fixture-upgrade to 22,000	12	071579	1/1/0001

OFFICE: 311

ROUTE: 564

ST_REF_NO: 00000135110

NEW CIRCLE, N. E. ROAD

LUMENS	BULB TYPE	MULT SERIES	POLE TYPE	SHADE	ADDRESS NUMBER	REF	LOCATION	TAX DIST	DATE INST	DATE CHANGE
20000	M	M	OUG	II	01106	216		12	071579	1/1/0001
20000	M	M	OUG	II	01114	218		12	071579	1/1/0001
20000	M	M	OUG	II	01114	220		12	071579	1/1/0001
20000	M	M	OUG	II	01114	222		12	071579	1/1/0001
20000	M	M	OUG	II	01139	221		12	071579	1/1/0001
20000	M	M	OUG	II	01139	223		12	071579	1/1/0001
20000	M	M	OUG	II	01153	225		12	071579	1/1/0001
20000	M	M	OUG	II	01160	224		12	071579	1/1/0001
20000	M	M	OUG	II	01160	226		12	071579	1/1/0001
20000	M	M	OUG	II	01165	227		12	071579	1/1/0001
20000	M	M	OUG	II	01171	229		12	071579	1/1/0001
20000	M	M	OUG	II	01171	231		12	071579	1/1/0001
20000	M	M	OUG	II	01184	228		12	071579	1/1/0001
20000	M	M	OUG	II	01184	230		12	071579	1/1/0001
20000	M	M	OUG	II	01184	232		12	071579	1/1/0001
20000	M	M	OUG	II	01196	234		12	071579	1/1/0001
20000	M	M	OUG	II	01205	233		12	071579	1/1/0001
20000	M	M	OUG	II	01205	235		12	071579	1/1/0001
20000	M	M	OUG	II	01209	237		12	071579	1/1/0001
20000	M	M	OUG	II	01209	239		12	071579	1/1/0001
20000	M	M	OUG	II	01209	241		12	071579	1/1/0001
22000	S	M	OUG	II	01216	236		12	071579	1/1/0001
20000	M	M	OUG	II	01216	238		12	071579	1/1/0001
20000	M	M	OUG	II	01216	240		12	071579	1/1/0001
20000	M	M	OUG	II	01237	243		12	071579	1/1/0001
20000	M	M	OUG	II	01237	245		12	071579	1/1/0001
20000	M	M	OUG	II	01237	247		12	071579	1/1/0001
20000	M	M	OUG	II	01264	242		12	071579	1/1/0001
22000	S	M	OUG	II	01264	244		12	071579	1/1/0001
20000	M	M	OUG	II	01264	246		12	071579	1/1/0001
20000	M	M	OUG	II	01272	248		12	071579	1/1/0001
20000	M	M	OUG	II	01281	249		12	071579	1/1/0001
20000	M	M	OUG	II	00000	284	W. SIDE BETWEEN PALUMBO & WOODHILL DR.	12	071579	1/1/0001
22000	S	M	OUG	II	00000	285	E. SIDE BETWEEN PALUMBO & WOODHILL DR.	12	071579	1/1/0001

OFFICE: 311

ROUTE: 564

ST_REF_NO: 00000135110

NEW CIRCLE, N. E. ROAD

LUMENS	BULB TYPE	MULT SERIES	POLE TYPE	SHADE	ADDRESS NUMBER	REF	LOCATION	TAX DIST	DATE INST	DATE CHANGE
20000	M	M	OUG	II	00000	286	W. SIDE BETWEEN PALUMBO & WOODHILL DR.	12	071579	1/1/0001
20000	M	M	OUG	II	00000	287	E. SIDE BETWEEN PALUMBO & WOODHILL DR.	12	071579	1/1/0001
20000	M	M	OUG	II	00000	288	6TH LT. N OF WOODHILL DR., WESTSIDE	12	040896	1/1/0001
20000	M	M	OUG	II	00000	289	E. SIDE BETWEEN PALUMBO & WOODHILL DR.	12	071579	1/1/0001
20000	M	M	OUG	II	00000	290	5TH LT. N OF WOODHILL DR., WESTSIDE	12	040896	1/1/0001
20000	M	M	OUG	II	00000	291	E. SIDE BETWEEN PALUMBO & WOODHILL DR.	12	071579	1/1/0001
20000	M	M	OUG	II	00000	292	W. SIDE BETWEEN PALUMBO & WOODHILL DR.	12	071579	1/1/0001
20000	M	M	OUG	II	00000	293	E. SIDE BETWEEN PALUMBO & WOODHILL DR.	12	071579	1/1/0001
22000	S	M	OUG	II	00000	294	W. SIDE BETWEEN PALUMBO & WOODHILL DR.	12	071579	1/1/0001
20000	M	M	OUG	II	00000	295	E. SIDE BETWEEN PALUMBO & WOODHILL DR.	12	071579	1/1/0001
22000	S	M	OUG	II	00000	296	W. SIDE BETWEEN PALUMBO & WOODHILL DR.	12	071579	1/1/0001
20000	M	M	OUG	II	00000	297	E. SIDE BETWEEN PALUMBO & WOODHILL DR.	12	071579	1/1/0001
20000	M	M	OUG	II	00000	298	W. SIDE BETWEEN PALUMBO & WOODHILL DR.	12	071579	1/1/0001

OFFICE: 311

ROUTE: 564

ST_REF_NO: 00000135120

NEW CIRCLE SERVICE ROAD

LUMENS	BULB TYPE	MULT SERIES	POLE TYPE	SHADE	ADDRESS NUMBER	REF	LOCATION	TAX DIST	DATE INST	DATE CHANGE
05800	S	M	OOH	II	00568	004		12	032067	1/1/0001
05800	S	M	OOH	II	00588	003		12	032067	1/1/0001
05800	S	M	OOH	II	00608	001		12	032067	1/1/0001
05800	S	M	OOH	II	00608	002		12	032067	1/1/0001

OFFICE: 311

ROUTE: 564

ST_REF_NO: 00000135200

NEW ORLEANS COURT

LUMENS	BULB TYPE	MULT SERIES	POLE TYPE	SHADE	ADDRESS NUMBER	REF	LOCATION	TAX DIST	DATE INST	DATE CHANGE
05800	S	M	OUG	II	01705	000		12	071064	1/1/0001
05800	S	M	OUG	II	01710	000		12	040165	1/1/0001
05800	S	M	OUG	II	01717	000		12	040165	1/1/0001

OFFICE: 311

ROUTE: 564

ST_REF_NO: 00000135300

NEW ORLEANS DRIVE

LUMENS	BULB TYPE	MULT SERIES	POLE TYPE	SHADE	ADDRESS NUMBER	REF	LOCATION	TAX DIST	DATE INST	DATE CHANGE
05800	S	M	OUG	II	02002	000		12	090866	1/1/0001
05800	S	M	OUG	II	02013	000		12	090866	1/1/0001

OFFICE: 311		ROUTE: 564		ST_REF_NO: 00000135300		NEW ORLEANS DRIVE				
LUMENS	BULB TYPE	MULT SERIES	POLE TYPE	SHADE	ADDRESS NUMBER	REF	LOCATION	TAX DIST	DATE INST	DATE CHANGE
05800	S	M	OUG	II	02020	000		12	090866	1/1/0001
05800	S	M	OUG	II	02025	000		12	090866	1/1/0001
05800	S	M	OUG	II	02036	000		12	090866	1/1/0001
05800	S	M	OUG	II	02044	000		12	090866	1/1/0001
05800	S	M	OUG	II	02053	000		12	090866	1/1/0001
05800	S	M	OUG	II	02058	000		12	090866	1/1/0001

OFFICE: 311		ROUTE: 564		ST_REF_NO: 00000135348		NEW RIVER COURT				
LUMENS	BULB TYPE	MULT SERIES	POLE TYPE	SHADE	ADDRESS NUMBER	REF	LOCATION	TAX DIST	DATE INST	DATE CHANGE
05800	S	M	CNT	III	00205	001		12	051705	1/1/0001

OFFICE: 311		ROUTE: 564		ST_REF_NO: 00000135350		NEW RIVER PLACE				
LUMENS	BULB TYPE	MULT SERIES	POLE TYPE	SHADE	ADDRESS NUMBER	REF	LOCATION	TAX DIST	DATE INST	DATE CHANGE
05800	S	M	CNT	II	00000	001	SIDE OF 245 MCCONNELLS TRACE BLVD ON NEW RIVER PL	12	051705	1/1/0001
05800	S	M	CNT	II	03021	002		12	051705	1/1/0001
05800	S	M	CNT	II	03033	003		12	051705	1/1/0001
05800	S	M	CNT	II	03052	004		12	100507	1/1/0001
05800	S	M	CNT	II	03064	005		12	051705	1/1/0001

OFFICE: 311		ROUTE: 564		ST_REF_NO: 00000135375		NEWBURY WAY				
LUMENS	BULB TYPE	MULT SERIES	POLE TYPE	SHADE	ADDRESS NUMBER	REF	LOCATION	TAX DIST	DATE INST	DATE CHANGE
05800	S	M	CNT	II	00000	001	SIDE OF 3744 WINTHROP WAY ON NEWBURY WAY	12	081202	1/1/0001
05800	S	M	CNT	III	00423	013		12	122205	1/1/0001
05800	S	M	CNT	II	00427	012		12	122205	1/1/0001
05800	S	M	CNT	II	00460	010		12	122205	1/1/0001
05800	S	M	CNT	II	00461	011		12	122205	1/1/0001
05800	S	M	CNT	II	00484	009		12	122205	1/1/0001
05800	S	M	CNT	II	00496	008		12	122205	1/1/0001
05800	S	M	CNT	II	00500	007		12	052903	1/1/0001
05800	S	M	CNT	II	00520	006		12	052903	1/1/0001
05800	S	M	CNT	II	00533	005		12	052903	1/1/0001

OFFICE: 311

ROUTE: 564

ST_REF_NO: 00000135375 NEWBURY WAY

LUMENS	BULB TYPE	MULT SERIES	POLE TYPE	SHADE	ADDRESS NUMBER	REF	LOCATION	TAX DIST	DATE INST	DATE CHANGE
05800	S	M	CNT	III	00548	004		12	081202	1/1/0001
05800	S	M	CNT	II	00561	003		12	081202	1/1/0001
05800	S	M	CNT	II	00576	002		12	081202	1/1/0001

OFFICE: 311

ROUTE: 564

ST_REF_NO: 00000135500 NEWCASTLE COURT

LUMENS	BULB TYPE	MULT SERIES	POLE TYPE	SHADE	ADDRESS NUMBER	REF	LOCATION	TAX DIST	DATE INST	DATE CHANGE
09500	S	M	OUG	II	00201	000		12	081363	1/1/0001
09500	S	M	OUG	II	00212	000		12	081363	1/1/0001
09500	S	M	OUG	II	00232	000		12	081363	1/1/0001

OFFICE: 311

ROUTE: 564

ST_REF_NO: 00000135600 NEWCASTLE STREET

LUMENS	BULB TYPE	MULT SERIES	POLE TYPE	SHADE	ADDRESS NUMBER	REF	LOCATION	TAX DIST	DATE INST	DATE CHANGE
09500	S	M	OUG	II	00000	001	SIDE OF 2079 DEAUVILLE RD.	12	101162	1/1/0001
09500	S	M	OUG	II	00000	002	SIDE OF 200 LIVERPOOL DR.	12	081363	1/1/0001
09500	S	M	OUG	II	00000	006	SIDE OF 2044 DUNKIRK DR.	12	122065	1/1/0001
09500	S	M	OUG	II	00000	148	SIDE OF 200 NEWCASTLE CT.	12	081363	1/1/0001
09500	S	M	OUG	II	00105	135		12	110761	1/1/0001
09500	S	M	OUG	II	00133	010		12	122065	1/1/0001
09500	S	M	OUG	II	00157	005		12	122065	1/1/0001

OFFICE: 311

ROUTE: 564

ST_REF_NO: 00000135610 NEWMARKET WAY

LUMENS	BULB TYPE	MULT SERIES	POLE TYPE	SHADE	ADDRESS NUMBER	REF	LOCATION	TAX DIST	DATE INST	DATE CHANGE
05800	S	M	CNT	II	02208	002		12	040895	1/1/0001
05800	S	M	CNT	II	02236	001		12	040895	1/1/0001

OFFICE: 311

ROUTE: 564

ST_REF_NO: 00000135700 NEWPORT DRIVE

LUMENS	BULB TYPE	MULT SERIES	POLE TYPE	SHADE	ADDRESS NUMBER	REF	LOCATION	TAX DIST	DATE INST	DATE CHANGE
05800	S	M	OUG	II	03500	000		12	010160	1/1/0001
05800	S	M	OUG	II	03507	000		12	060161	1/1/0001
05800	S	M	OUG	II	03512	000		12	092060	1/1/0001

OFFICE: 311

ROUTE: 564

ST_REF_NO: 00000135720

NEW RIDGE COURT

LUMENS	BULB TYPE	MULT SERIES	POLE TYPE	SHADE	ADDRESS NUMBER	REF	LOCATION	TAX DIST	DATE INST	DATE CHANGE
05800	S	M	CNT	II	01305	001		12	020896	1/1/0001
05800	S	M	CNT	II	01308	002		12	020896	1/1/0001
05800	S	M	CNT	II	01324	004		12	080896	1/1/0001
05800	S	M	CNT	II	01325	003		12	080896	1/1/0001
05800	S	M	CNT	III	01336	005		12	080896	1/1/0001

OFFICE: 311

ROUTE: 564

ST_REF_NO: 00000135900

NEWTOWN CIRCLE

LUMENS	BULB TYPE	MULT SERIES	POLE TYPE	SHADE	ADDRESS NUMBER	REF	LOCATION	TAX DIST	DATE INST	DATE CHANGE
10000	M	M	OUG	II	00000	001	SIDE OF 1051 NEWTOWN PIKE	12	111580	1/1/0001
10000	M	M	OUG	II	00000	002	SIDE OF 1059 NEWTOWN PIKE	12	111580	1/1/0001
10000	M	M	OUG	II	00000	003	2ND LT. W. OF NEWTOWN PIKE, S. SIDE	12	111580	1/1/0001
10000	M	M	OUG	V	00805	004		12	111580	1/1/0001

OFFICE: 311

ROUTE: 564

ST_REF_NO: 00000136000

NEWTOWN PIKE

LUMENS	BULB TYPE	MULT SERIES	POLE TYPE	SHADE	ADDRESS NUMBER	REF	LOCATION	TAX DIST	DATE INST	DATE CHANGE
22000	S		OUG	II	00000	026	DIRECTLY ACROSS FROM GEORGETOWN STREET IN ISLAND	12	120513	1/1/0001
22000	S		OUG	II	00000	028	1ST LT N OF 4TH ST, E SIDE OF NEWTOWN PIKE	12	120513	1/1/0001
22000	S		OUG	II	00000	030	2ND LT N OF 4TH ST, E SIDE OF NEWTOWN PIKE	12	120513	1/1/0001
20000	M		OUG	II	00000	089	1ST LT N OF OLIVIA LANE, E SIDE	12	090909	1/1/0001
22000	S		OUG	II	00000	091	2ND LT N OF OLIVIA LANE, E SIDE	12	090909	1/1/0001
20000	M		OUG	II	00000	107	2ND LT N OF PINTAIL DR, E SIDE	12	090909	1/1/0001
22000	S		OUG	II	00000	162	1ST LT N OF ARISTIDES BLVD, W SIDE ON NEWTOWN PIKE	12	080510	1/1/0001
22000	S		OUG	II	00000	164	2ND LT N OF ARISTIDES BLVD, W SIDE ON NEWTOWN PIKE	12	080510	1/1/0001
22000	S		OUG	II	00000	166	3RD LT N OF ARISTIDES BLVD, W SIDE ON NEWTOWN PIKE	12	080510	1/1/0001
22000	S		OUG	II	00000	168	4TH LT N OF ARISTIDES BLVD, W SIDE ON NEWTOWN PIKE	12	080510	1/1/0001
22000	S		OUG	II	00000	170	5TH LT N OF ARISTIDES BLVD, W SIDE ON NEWTOWN PIKE	12	080510	1/1/0001
50000	S		CNT	II	00000	200	1ST LT N OF W MAIN ST, W SIDE ON NEWTOWN PIKE	12	031511	1/1/0001

OFFICE: 311

ROUTE: 564

ST_REF_NO: 00000136000

NEWTOWN PIKE

LUMENS	BULB TYPE	MULT SERIES	POLE TYPE	SHADE	ADDRESS NUMBER	REF	LOCATION	TAX DIST	DATE INST	DATE CHANGE
22000	S		OUG	II	00000	201	1ST LT N OF W MAIN ST, E SIDE ON NEWTOWN PIKE	12	031511	1/1/0001
22000	S		OUG	II	00000	202	2ND LT N OF W MAIN ST, W SIDE ON NEWTOWN PK	12	031511	1/1/0001
22000	S		OUG	II	00000	203	AT SHORT ST ON NEWTOWN PIKE	12	040611	1/1/0001
22000	S		OUG	II	00000	300	3RD LT N OF 4TH ST, E SIDE OF NEWTOWN PIKE	12	120513	1/1/0001
22000	S	M	OOH	III	00000	006	3RD LT. N. OF W. MAIN ST., E. SIDE	12	042067	3/28/2012
22000	S	M	SOH	II	00000	027	OPPOSITE W. 4TH ST.	12	021580	4/5/2013
22000	S	M	SOH	III	00000	029	1ST. LT. N. OF W. 4TH ST., W. SIDE	12	070165	8/31/2009
22000	S	M	OOH	III	00000	045	SIDE OF 562 HASKINS DR.	12	070165	7/12/2012
22000	S	M	OOH	III	00000	053	4TH LT. N. OF HASKINS DR., W. SIDE	12	070165	7/12/2012
22000	S	M	OUG	II	00000	068	1ST LT. N. OF NANDINO BLVD., W. SIDE	12	101477	7/12/2012
22000	S	M	OUG	II	00000	098	6TH LT. N. OF GRIFFIN GATE BLVD., W. SIDE-lfucg upgrade	12	101477	7/31/2010
22000	S	M	OUG	II	00000	100	7TH LT. N. OF GRIFFIN GATE BLVD., W. SIDE-lfucg upgrade	12	101477	7/31/2010
22000	S	M	OUG	II	00000	102	8TH LT. N. OF GRIFFIN GATE BLVD., W. SIDE-lfucg upgrade	12	101477	7/31/2010
22000	S	M	OUG	II	00000	104	9TH LT. N OF GRIFFIN GATE BLVD., WESTSIDE-lfucg upgrade	12	020898	7/31/2010
22000	S	M	OUG	II	00000	106	10TH LT. N OF GRIFFIN GATE BLVD., WESTSIDE-lfucg upgrade	12	020898	7/31/2010
22000	S	M	OUG	II	00000	108	11TH LT. N. OF GRIFFIN GATE BLVD., W. SIDE-lfucg upgrade	12	020898	7/31/2010
22000	S	M	OUG	II	00000	111	12TH LT. N. OF GRIFFIN GATE BLVD., E. SIDE-bad fixture	12	101477	3/2/2009
22000	S	M	OUG	II	00000	112	6th LT N OF ARISIDES BLVD, W SIDE-chg desc only	12	101477	7/31/2010
20000	M	M	OUG	II	00000	114	7th LT N OF ARISIDES BLVD, W SIDE-chg in description only	12	101477	7/31/2010
20000	M	M	OUG	II	00000	116	8th LT N OF ARISIDES BLVD, W SIDE-chg description only	12	101477	7/31/2010
20000	M	M	OUG	II	00000	118	9th LT N OF ARISIDES BLVD, W SIDE-chg in description only	12	101477	7/31/2010
20000	M	M	OUG	II	00000	090	2ND LT. N. OF GRIFFIN GATE BLVD., W. SIDE	12	101477	1/1/0001
20000	M	M	OUG	II	00000	092	3RD LT. N. OF GRIFFIN GATE BLVD., W. SIDE	12	101477	1/1/0001
20000	M	M	OUG	II	00000	093	3RD LT. N. OF GRIFFIN GATE BLVD., E. SIDE	12	101477	1/1/0001
20000	M	M	OUG	II	00000	094	4TH LT. N. OF GRIFFIN GATE BLVD., W. SIDE	12	101477	1/1/0001
20000	M	M	OUG	II	00000	095	4TH LT. N. OF GRIFFIN GATE BLVD., E. SIDE	12	101477	1/1/0001

OFFICE: 311

ROUTE: 564

ST_REF_NO: 00000136000

NEWTOWN PIKE

LUMENS	BULB TYPE	MULT SERIES	POLE TYPE	SHADE	ADDRESS NUMBER	REF	LOCATION	TAX DIST	DATE INST	DATE CHANGE
20000	M	M	OUG	II	00000	096	5TH LT. N. OF GRIFFIN GATE BLVD., W. SIDE	12	101477	1/1/0001
20000	M	M	OUG	II	00000	097	5TH LT. N. OF GRIFFIN GATE BLVD., E. SIDE	12	101477	1/1/0001
20000	M	M	OUG	II	00000	099	6TH LT. N. OF GRIFFIN GATE BLVD., E. SIDE	12	101477	1/1/0001
20000	M	M	OUG	II	00000	101	7TH LT. N. OF GRIFFIN GATE BLVD., E. SIDE	12	101477	1/1/0001
20000	M	M	OUG	II	00000	103	8TH LT. N. OF GRIFFIN GATE BLVD., E. SIDE	12	101477	1/1/0001
20000	M	M	OUG	II	00000	105	9TH LT. N. OF GRIFFIN GATE BLVD., E. SIDE	12	101477	1/1/0001
20000	M	M	OUG	II	00000	109	11TH LT. N. OF GRIFFIN GATE BLVD., E. SIDE	12	101477	1/1/0001
20000	M	M	OUG	II	00000	110	12TH LT. N. OF GRIFFIN GATE BLVD., W. SIDE	12	101477	1/1/0001
22000	S	M	OUG	II	00000	113	13TH LT.N.OF GRIFFIN GATE BLVD., E. SIDE	12	101477	1/1/0001
22000	S	M	OUG	II	00000	115	14TH LT. N. OF GRIFFIN GATE BLVD., E. SIDE	12	101477	1/1/0001
22000	S	M	OUG	II	00000	117	15TH LT. N. OF GRIFFIN GATE BLVD., E. SIDE	12	101477	1/1/0001
20000	M	M	OOH	III	00000	057	N.W. CORNER OF KENNEDY ROAD	12	071567	1/1/0001
20000	M	M	OOH	III	00000	058	1ST. LT. N. OF KENNEDY ROAD., E. SIDE	12	070165	1/1/0001
20000	M	M	OOH	III	00000	060	2ND LT. N. OF KENNEDY ROAD., E. SIDE	12	070165	1/1/0001
20000	M	M	OUG	II	00000	062	1ST LT. N. OF NEWTOWN CIRCLE, W. SIDE	12	101477	1/1/0001
20000	M	M	OUG	II	00000	063	1ST LT. N. OF NEWTOWN CIRCLE, E. SIDE	12	101477	1/1/0001
20000	M	M	OUG	II	00000	064	2ND LT. N. OF NEWTOWN CIRCLE, W. SIDE	12	101477	1/1/0001
20000	M	M	OUG	II	00000	065	2ND LT. N. OF NEWTOWN CIRCLE, E. SIDE	12	101477	1/1/0001
20000	M	M	OUG	II	00000	066	SW CORNER OF NANDINO BLVD.	12	101477	1/1/0001
20000	M	M	OUG	II	00000	067	OPP. NANDINO BLVD.	12	101477	1/1/0001
20000	M	M	OUG	II	00000	069	1ST LT. N. OF NANDINO BLVD., E. SIDE	12	101477	1/1/0001
20000	M	M	OUG	II	00000	070	2ND LT. N. OF NANDINO BLVD., W. SIDE	12	101477	1/1/0001
20000	M	M	OUG	II	00000	071	2ND LT. N. OF NANDINO BLVD., E. SIDE	12	101477	1/1/0001
22000	S	M	OUG	II	00000	072	3RD LT. N. OF NANDINO BLVD., W. SIDE	12	101477	1/1/0001
20000	M	M	OUG	II	00000	073	3RD LT. N. OF NANDINO BLVD., E. SIDE	12	101477	1/1/0001
20000	M	M	OUG	II	00000	074	4TH LT. N. OF NANDINO BLVD., W. SIDE	12	101477	1/1/0001
20000	M	M	OUG	II	00000	075	4TH LT. N. OF NANDINO BLVD., E. SIDE	12	101477	1/1/0001
20000	M	M	OUG	II	00000	076	5TH LT. N. OF NANDINO BLVD., W. SIDE	12	101477	1/1/0001
20000	M	M	OUG	II	00000	077	5TH LT. N. OF NANDINO BLVD., E. SIDE	12	101477	1/1/0001
20000	M	M	OUG	II	00000	078	6TH LT. N. OF NANDINO BLVD., W. SIDE	12	101477	1/1/0001
20000	M	M	OUG	II	00000	079	6TH LT. N. OF NANDINO BLVD., E. SIDE	12	101477	1/1/0001
20000	M	M	OUG	II	00000	080	7TH LT. N. OF NANDINO BLVD., W. SIDE	12	101477	1/1/0001
20000	M	M	OUG	II	00000	082	8TH LT. N. OF NANDINO BLVD., W. SIDE	12	101477	1/1/0001
20000	M	M	OUG	II	00000	083	8TH LT. N. OF NANDINO BLVD., E. SIDE	12	101477	1/1/0001

OFFICE: 311

ROUTE: 564

ST_REF_NO: 00000136000

NEWTOWN PIKE

LUMENS	BULB TYPE	MULT SERIES	POLE TYPE	SHADE	ADDRESS NUMBER	REF	LOCATION	TAX DIST	DATE INST	DATE CHANGE
20000	M	M	OUG	II	00000	085	9TH LT. N. OF NANDINO BLVD., E. SIDE	12	101477	1/1/0001
20000	M	M	OUG	II	00000	086	1ST LT N OF VILEY RD. ON NEWTOWN RD	12	110891	1/1/0001
20000	M	M	OUG	II	00000	087	SE CORNER OF GRIFFIN GATE BLVD.	12	101477	1/1/0001
20000	M	M	OUG	II	00000	088	2ND LT N OF VILEY RD. ON NEWTOWN RD	12	110891	1/1/0001
22000	S	M	OOH	III	00913	059		12	070165	1/1/0001
20000	M	M	OUG	II	01410	081		12	101477	1/1/0001
20000	M	M	SOH	III	00000	031	SIDE OF 532 BOOKER ST.	12	070165	1/1/0001
20000	M	M	SOH	III	00000	033	1ST. LT. N. OF BOOKER ST., W. SIDE	12	070165	1/1/0001
20000	M	M	SOH	III	00000	035	S.W. CORNER OF MICHIGAN ST.	12	070165	1/1/0001
20000	M	M	SOH	III	00000	037	1ST. LT. N. OF MICHIGAN ST., W. SIDE	12	070165	1/1/0001
20000	M	M	SOH	III	00000	039	N.W. CORNER OF ASH ST.	12	070165	1/1/0001
20000	M	M	OOH	III	00000	040	1ST. LT. N. OF ASH ST., E. SIDE	12	070165	1/1/0001
20000	M	M	SOH	III	00000	041	2ND LT. N. OF ASH ST., W. SIDE	12	070165	1/1/0001
20000	M	M	OOH	III	00000	042	2ND LT. N. OF ASH ST., E. SIDE	12	070165	1/1/0001
20000	M	M	SOH	III	00000	043	3RD LT. N. OF ASH ST., W. SIDE	12	070165	1/1/0001
20000	M	M	OOH	III	00000	044	3RD LT. N. OF ASH ST., E. SIDE	12	070165	1/1/0001
20000	M	M	OOH	III	00000	046	OPPOSITE HASKINS DR.	12	070165	1/1/0001
20000	M	M	OOH	III	00000	048	1ST. LT. N. OF HASKINS DR., E. SIDE	12	070165	1/1/0001
20000	M	M	OOH	III	00000	049	2ND LT. N. OF HASKINS DR., W. SIDE	12	070165	1/1/0001
20000	M	M	OOH	III	00000	050	2ND LT. N. OF HASKINS DR., E. SIDE	12	070165	1/1/0001
22000	S	M	OOH	III	00000	051	3RD LT. N. OF HASKINS DR., W. SIDE	12	070165	1/1/0001
20000	M	M	OOH	III	00000	052	3RD LT. N. OF HASKINS DR., E. SIDE	12	070165	1/1/0001
20000	M	M	OOH	III	00000	054	4TH LT. N. OF HASKINS DR., E. SIDE	12	070165	1/1/0001
20000	M	M	OOH	III	00000	055	1ST. LT N. OF IMPERIAL DR., W. SIDE	12	070165	1/1/0001
20000	M	M	OOH	III	00000	056	1ST. LT N. OF IMPERIAL DR., E. SIDE	12	070165	1/1/0001
20000	M	M	OOH	III	00741	047		12	070165	1/1/0001
20000	M	M	OUG	II	00000	001	N.W. CORNER OF W. MAIN ST.	12	051581	1/1/0001
20000	M	M	SOH	II	00000	003	2ND LT. N. OF W. MAIN ST., W. SIDE	12	080165	1/1/0001
20000	M	M	OOH	III	00000	004	2ND LT. N. OF W. MAIN ST., E. SIDE	12	042067	1/1/0001
20000	M	M	SOH	II	00000	005	3RD LT. N. OF W. MAIN ST., W. SIDE	12	080165	1/1/0001
20000	M	M	SOH	III	00000	007	4TH LT. N. OF W. MAIN ST., W. SIDE	12	070165	1/1/0001
20000	M	M	OOH	III	00000	008	4TH LT. N. OF W. MAIN ST., E. SIDE	12	042067	1/1/0001
20000	M	M	SOH	III	00000	009	5TH LT. N. OF W. MAIN ST., W. SIDE	12	080165	1/1/0001
20000	M	M	OOH	III	00000	011	1ST. LT. N. OF 2ND ST., W. SIDE	12	042067	1/1/0001

OFFICE: 311

ROUTE: 564

ST_REF_NO: 00000136000

NEWTOWN PIKE

LUMENS	BULB TYPE	MULT SERIES	POLE TYPE	SHADE	ADDRESS NUMBER	REF	LOCATION	TAX DIST	DATE INST	DATE CHANGE
20000	M	M	OOH	III	00000	012	1ST. LT. N. OF 2ND ST., E. SIDE	12	042067	1/1/0001
20000	M	M	SOH	III	00000	013	OPPOSITE MARYLAND AVE.	12	070165	1/1/0001
20000	M	M	OOH	III	00000	014	1ST. LT. N. OF MARYLAND AVE., E. SIDE	12	042067	1/1/0001
20000	M	M	SOH	II	00000	015	1ST LT. N. OF MARYLAND AVE., W. SIDE	12	021580	1/1/0001
20000	M	M	SOH	III	00000	016	S.E. CORNER OF W. 3RD ST.	12	042067	1/1/0001
20000	M	M	SOH	III	00000	017	S.W. CORNER OF W. 3RD ST.	12	042067	1/1/0001
20000	M	M	OOH	III	00000	018	1ST. LT. N. OF W. 3RD ST., E. SIDE	12	042067	1/1/0001
20000	M	M	OOH	III	00000	019	1ST. LT. N. OF W. 3RD ST., W. SIDE	12	042067	1/1/0001
20000	M	M	OOH	III	00000	020	1ST. LT. N. OF KING ST., E. SIDE	12	042067	1/1/0001
20000	M	M	OOH	III	00000	021	1ST. LT. N. OF KING ST., W. SIDE	12	042067	1/1/0001
20000	M	M	OOH	III	00340	022		12	042067	1/1/0001
20000	M	M	SOH	II	00349	023		12	021580	1/1/0001
20000	M	M	OOH	III	00362	024		12	042067	1/1/0001
09500	S	M	OUG	III	00000	119	2ND LT. S. OF IRON WORKS PK., EASTSIDE	22	060685	1/1/0001
09500	S	M	OUG	III	00000	120	2ND LT. S. OF IRON WORKS PK., WESTSIDE	22	060685	1/1/0001
09500	S	M	OUG	III	00000	121	1ST LT. S. OF IRON WORKS PK., EASTSIDE	22	060685	1/1/0001
09500	S	M	OUG	III	00000	122	1ST LT. S. OF IRON WORKS PK., WESTSIDE	22	060685	1/1/0001
09500	S	M	OUG	III	00000	123	1ST LT. N. OF IRON WORKS PK., EASTSIDE	22	060685	1/1/0001
09500	S	M	OUG	III	00000	124	1ST LT. N. OF IRON WORKS PK., WESTSIDE	22	060685	1/1/0001
09500	S	M	OUG	III	00000	125	2ND LT. N. OF IRON WORKS PK., EASTSIDE	22	060685	1/1/0001

OFFICE: 311

ROUTE: 564

ST_REF_NO: 00000136050

NEWTOWN SPRINGS DRIVE

LUMENS	BULB TYPE	MULT SERIES	POLE TYPE	SHADE	ADDRESS NUMBER	REF	LOCATION	TAX DIST	DATE INST	DATE CHANGE
05800	S		OUG	II	00712	015		12	042011	1/1/0001
05800	S		OUG	II	00716	014		12	042011	1/1/0001

OFFICE: 311

ROUTE: 564

ST_REF_NO: 00000136100

NIAGARA DRIVE

LUMENS	BULB TYPE	MULT SERIES	POLE TYPE	SHADE	ADDRESS NUMBER	REF	LOCATION	TAX DIST	DATE INST	DATE CHANGE
05800	S	M	OUG	II	00000	054	SIDE OF 1397 TRENT BLVD.	12	022674	1/1/0001
05800	S	M	OUG	II	00000	057	SIDE OF 3666	12	011475	1/1/0001
05800	S	M	OUG	II	03555	065		12	091574	1/1/0001
05800	S	M	OUG	II	03566	064		12	091574	1/1/0001

OFFICE: 311

ROUTE: 564

ST_REF_NO: 00000136100

NIAGARA DRIVE

LUMENS	BULB TYPE	MULT SERIES	POLE TYPE	SHADE	ADDRESS NUMBER	REF	LOCATION	TAX DIST	DATE INST	DATE CHANGE
05800	S	M	OUG	II	03575	063		12	121475	1/1/0001
05800	S	M	OUG	II	03594	062		12	051476	1/1/0001
05800	S	M	OUG	II	03595	061		12	051476	1/1/0001
05800	S	M	OUG	II	03614	060		12	011475	1/1/0001
05800	S	M	OUG	II	03619	059		12	011475	1/1/0001
05800	S	M	OUG	II	03635	058		12	011475	1/1/0001
05800	S	M	OUG	II	03671	056		12	031475	1/1/0001
05800	S	M	OUG	II	03682	055		12	111478	1/1/0001
05800	S	M	OUG	II	03700	066		12	011475	1/1/0001
05800	S	M	OUG	II	03713	067		12	022674	1/1/0001
05800	S	M	OUG	II	03728	068		12	091574	1/1/0001
05800	S	M	OUG	II	03737	069		12	022674	1/1/0001
05800	S	M	OUG	II	03752	070		12	022674	1/1/0001
05800	S	M	OUG	II	03764	082		12	111580	1/1/0001
05800	S	M	OUG	II	03765	083		12	111580	1/1/0001
05800	S	M	OUG	II	03777	084		12	111580	1/1/0001
05800	S	M	OUG	II	03800	091		12	111583	1/1/0001
05800	S	M	OUG	V	03809	095		12	021582	1/1/0001
05800	S	M	OUG	II	03816	094		12	111583	1/1/0001
05800	S	M	OUG	II	03817	096		12	121581	1/1/0001
05800	S	M	OUG	II	03836	097		12	121582	1/1/0001
05800	S	M	OUG	II	03841	098		12	111583	1/1/0001

OFFICE: 311

ROUTE: 564

ST_REF_NO: 00000136200

NICE DRIVE

LUMENS	BULB TYPE	MULT SERIES	POLE TYPE	SHADE	ADDRESS NUMBER	REF	LOCATION	TAX DIST	DATE INST	DATE CHANGE
05800	S	M	OUG	II	00000	039	SIDE OF 2432 REIMS RD.	12	041466	1/1/0001
05800	S	M	OUG	II	00000	046	SIDE OF 1277 CHERBOURG DR.	12	050969	1/1/0001
05800	S	M	OUG	II	01213	040		12	041466	1/1/0001
05800	S	M	OUG	II	01224	041		12	041466	1/1/0001
05800	S	M	OUG	II	01237	042		12	041466	1/1/0001
05800	S	M	OUG	II	01255	043		12	050969	1/1/0001
05800	S	M	OUG	II	01272	044		12	041466	1/1/0001
05800	S	M	OUG	II	01281	045		12	062167	1/1/0001

OFFICE: 311

ROUTE: 564

ST_REF_NO: 00000136300

NICHOLASVILLE ROAD

LUMENS	BULB TYPE	MULT SERIES	POLE TYPE	SHADE	ADDRESS NUMBER	REF	LOCATION	TAX DIST	DATE INST	DATE CHANGE
50000	S	M	SOH	II	00000	500	NORTHWEST CORNER OF NICHOLASVILLE RD AT W REYNOLDS	12	111805	1/1/0001
50000	S	M	OOH	III	01305	009	upgraded light and moved it from 1309 to 1305 Nich Rd.	12	120161	4/15/2009
22000	S	M	OOH	III	01517	019		12	120161	3/28/2012
22000	S	M	OOH	II	01900	046		12	050668	11/12/2013
22000	S	M	OOH	III	00000	002	OPP. 1037	12	120161	1/1/0001
22000	S	M	SOH	III	00000	004	OPP. 1117	12	120161	1/1/0001
20000	M	M	OUG	II	00000	008	OPP. 1305	12	041475	1/1/0001
20000	M	M	OUG	II	00000	010	OPP. FOREST PARK	12	041475	1/1/0001
20000	M	M	OOH	II	00000	012	OPP. 1419	12	041475	1/1/0001
20000	M	M	OUG	II	00000	014	OPP. 1435	12	041475	1/1/0001
20000	M	M	OOH	III	00000	016	OPP. WESTWOOD DR.	12	120161	1/1/0001
20000	M	M	OOH	III	00000	018	OPP. 1517	12	120161	1/1/0001
20000	M	M	OOH	III	00000	020	OPP. 1529	12	120161	1/1/0001
22000	S	M	OOH	III	00000	022	OPP. DANTZLER CT.	12	120161	1/1/0001
20000	M	M	OOH	III	01407	011		12	120161	1/1/0001
20000	M	M	OOH	III	01431	013		12	120161	1/1/0001
20000	M	M	OOH	III	01445	015		12	120161	1/1/0001
20000	M	M	OOH	III	01507	017		12	120161	1/1/0001
22000	S	M	OOH	III	01533	021	changed out bad fixture	12	120161	1/1/0001
20000	M	M	OOH	III	01603	023		12	012362	1/1/0001
22000	S	M	OOH	III	01610	024	upgrade 4/08	12	120161	1/1/0001
20000	M	M	OOH	II	00000	025	OPP. 1620	12	020898	1/1/0001
20000	M	M	OOH	II	00000	027	OPP. 1636	12	020898	1/1/0001
22000	S	M	OOH	III	00000	028	OPP. ARCADIA PARK	12	010894	1/1/0001
22000	S	M	OOH	III	00000	030	OPP. 1707	12	010894	1/1/0001
22000	S	M	OOH	III	00000	032	NE CORNER NICH. RD. @ CENTRAL BAPT. HOSP. ENTR.	12	010894	1/1/0001
22000	S	M	OOH	III	00000	034	OPP. 1733	12	010894	1/1/0001
22000	S	M	OOH	III	00000	036	OPP. 1803	12	010894	1/1/0001
22000	S	M	OUG	II	00000	055	1ST LT. SOUTH OF SOUTHLAND DR.	12	070890	1/1/0001
22000	S	M	OUG	III	00000	056	2ND LT. S. OF JESSELIN DR. ON EASTSIDE	12	100891	1/1/0001
22000	S	M	OUG	II	00000	057	2ND LT. SOUTH OF SOUTHLAND DR.	12	070890	1/1/0001
22000	S	M	OUG	III	00000	058	3RD LT. S. OF JESSELILN DR. ON EASTSIDE	12	100891	1/1/0001
22000	S	M	OUG	II	00000	059	3RD LT. SOUTH OF SOUTHLAND DR.	12	070890	1/1/0001

Street Light Listing run 1/11/2015 10:43:21 AM

Page 789 of 1254

OFFICE: 311

ROUTE: 564

ST_REF_NO: 00000136300

NICHOLASVILLE ROAD

LUMENS	BULB TYPE	MULT SERIES	POLE TYPE	SHADE	ADDRESS NUMBER	REF	LOCATION	TAX DIST	DATE INST	DATE CHANGE
22000	S	M	OUG	III	00000	060	4TH LT. S. OF JESSELIN DR. ON EAST SIDE	12	100891	1/1/0001
22000	S	M	OUG	II	00000	061	4TH LT. SOUTH OF SOUTHLAND DR.	12	070890	1/1/0001
22000	S	M	SOH	III	00000	062	5TH LT. S. OF JESSELIN DR. ON EASTSIDE	12	100891	1/1/0001
22000	S	M	OUG	II	00000	064	5TH LT. SOUTH OF SOUTHLAND DR.	12	070890	1/1/0001
22000	S	M	OUG	III	00000	066	1ST LT. S. OF ZANDALE DR. ON EASTSIDE	12	100891	1/1/0001
22000	S	M	OUG	II	00000	067	6TH LT. SOUTH OF SOUTHLAND DR.	12	070890	1/1/0001
22000	S	M	OUG	III	00000	069	2ND LT. S. OF ZANDALE DR. ON EASTSIDE	12	100891	1/1/0001
22000	S	M	OUG	II	00000	070	7TH LT. SOUTH OF SOUTHLAND DR.	12	070890	1/1/0001
22000	S	M	OUG	III	00000	072	3RD LT. S. OF ZANDALE DR. ON EASTSIDE	12	100891	1/1/0001
22000	S	M	OUG	II	00000	073	1ST LT. SOUTH OF BURT RD.	12	070890	1/1/0001
22000	S	M	OUG	III	00000	075	4TH LT. S. OF ZANDALE DR. ON EASTSIDE	12	100891	1/1/0001
22000	S	M	OUG	II	00000	076	2ND LT. SOUTH OF BURT RD.	12	070890	1/1/0001
22000	S	M	SOH	III	00000	077	5TH LT. S. OF ZANDALE DR. ON EASTSIDE	12	100891	1/1/0001
22000	S	M	OUG	II	00000	078	1ST LT. S. OF LOWERY LANE, W. SIDE	12	020891	1/1/0001
20000	M	M	SOH	III	01628	026		12	120161	1/1/0001
22000	S	M	OOH	III	01705	029		12	120161	1/1/0001
22000	S	M	OOH	III	01713	031		12	012362	1/1/0001
22000	S	M	OOH	III	01721	033		12	120161	1/1/0001
22000	S	M	OOH	III	01739	035		12	012362	1/1/0001
22000	S	M	SOH	III	01740	000		12	010894	1/1/0001
22000	S	M	OOH	II	01807	037		12	050668	1/1/0001
22000	S	M	SOH	II	01824	038		12	040868	1/1/0001
20000	M	M	OOH	II	01827	039		12	050668	1/1/0001
20000	M	M	OOH	II	01832	040		12	050668	1/1/0001
20000	M	M	OUG	II	01847	041		12	050668	1/1/0001
20000	M	M	OUG	II	01855	043		12	050668	1/1/0001
20000	M	M	SOH	II	01860	042		12	040868	1/1/0001
20000	M	M	SOH	II	01864	044		12	040868	1/1/0001
20000	M	M	OUG	II	01865	045		12	050668	1/1/0001
20000	M	M	OUG	II	01907	047		12	050668	1/1/0001
20000	M	M	SOH	II	01914	048		12	040868	1/1/0001
20000	M	M	OOH	II	01915	049		12	050668	1/1/0001
20000	M	M	OOH	II	01949	051		12	050668	1/1/0001
22000	S	M	OOH	II	02100	054		12	011582	1/1/0001

OFFICE: 311

ROUTE: 564

ST_REF_NO: 00000136300

NICHOLASVILLE ROAD

LUMENS	BULB TYPE	MULT SERIES	POLE TYPE	SHADE	ADDRESS NUMBER	REF	LOCATION	TAX DIST	DATE INST	DATE CHANGE
22000	S	M	OUG	III	00000	079	1ST LT. S. OF LOWRY ON EASTSIDE	12	108091	1/1/0001
22000	S	M	OUG	II	00000	080	2ND LT. S. OF LOWERY LANE, W. SIDE	12	020891	1/1/0001
22000	S	M	OUG	III	00000	081	2ND LT. S. OF LOWRY LANE ON EASTSIDE	12	100891	1/1/0001
22000	S	M	SOH	III	00000	083	3RD LT. S. OF LOWRY LANE ON EASTSIDE		100891	1/1/0001
22000	S	M	OUG	II	00000	084	1ST LT S OF STONE RD ON WESTSIDE OF NICHOLASVILLE	12	120890	1/1/0001
22000	S	M	SOH	III	00000	085	1ST LT. S. OF MALABU DR. ON EASTSIDE	12	100891	1/1/0001
22000	S	M	OUG	II	00000	086	1ST LT S OF DENNIS ON WESTSIDE OF NICHOLASVILLE	12	120890	1/1/0001
22000	S	M	OUG	III	00000	087	1ST LT. S. OF SURFSIDE DR. ON EASTSIDE	12	100891	1/1/0001
22000	S	M	OUG	II	00000	088	2ND LT S OF DENNIS ON WESTSIDE OF NICHOLASVILLE	12	120890	1/1/0001
22000	S	M	OUG	III	00000	089	2ND LT. S. OF SURFSIDE DR. ON EASTSIDE	12	100891	1/1/0001
22000	S	M	OUG	II	00000	090	3RD LT S OF DENNIS ON WESTSIDE OF NICHOLASVILLE	12	120890	1/1/0001
22000	S	M	OUG	III	00000	091	1ST LT. S. OF LARKIN RD. ON EASTSIDE	12	100891	1/1/0001
22000	S	M	OUG	II	00000	116	NE CORNER OF REYNOLDS RD.	12	050896	1/1/0001
22000	S	M	SOH	II	00000	117	1ST LT. S OF REYNOLDS RD., WESTSIDE	12	050896	1/1/0001
22000	S	M	OUG	II	00000	118	SE CORNER OF REYNOLDS RD.	12	050896	1/1/0001
22000	S	M	OUG	II	00000	119	2ND LT. S OF REYNOLDS RD., WESTSIDE	12	050896	1/1/0001
22000	S	M	OUG	II	00000	120	SIDE OF 101 BRIGADOON PARKWAY	12	050896	1/1/0001
22000	S	M	OUG	II	00000	121	3RD LT. S OF REYNOLDS RD., WESTSIDE	12	050896	1/1/0001
22000	S	M	OUG	II	00000	122	SIDE OF 100 BRIGADOON PARKWAY	12	050896	1/1/0001
22000	S	M	SOH	II	00000	123		12	050896	1/1/0001
22000	S	M	OUG	II	00000	124	4TH LT. N OF DUNDEE DR., EASTSIDE	12	050896	1/1/0001
22000	S	M	OUG	II	00000	125	5TH LT. S OF REYNOLDS RD., WESTSIDE	12	050896	1/1/0001
22000	S	M	OUG	II	00000	126	3RD LT. N OF DUNDEE DR., EASTSIDE	12	050896	1/1/0001
22000	S	M	OUG	II	00000	128	2ND LT. N OF DUNDEE DR., EASTSIDE	12	050896	1/1/0001
22000	S	M	OUG	II	02550	093		12	070171	1/1/0001
22000	S	M	OUG	II	02550	095		12	041475	1/1/0001
22000	S	M	OUG	II	02555	092		12	120890	1/1/0001
22000	S	M	OUG	II	02575	094		12	120890	1/1/0001
22000	S	M	OUG	II	02587	096		12	120890	1/1/0001
22000	S	M	OUG	II	02600	097		12	070171	1/1/0001
22000	S	M	OUG	II	02604	098		12	070171	1/1/0001

OFFICE: 311

ROUTE: 564

ST_REF_NO: 00000136300

NICHOLASVILLE ROAD

LUMENS	BULB TYPE	MULT SERIES	POLE TYPE	SHADE	ADDRESS NUMBER	REF	LOCATION	TAX DIST	DATE INST	DATE CHANGE
22000	S	M	OUG	II	03199	099		12	050896	1/1/0001
22000	S	M	OUG	II	03200	100		12	050896	1/1/0001
22000	S	M	OUG	II	03211	101		12	050896	1/1/0001
22000	S	M	OUG	II	03211	103		12	050896	1/1/0001
22000	S	M	OUG	II	03211	105		12	050896	1/1/0001
22000	S	M	OUG	II	03220	102		12	050896	1/1/0001
22000	S	M	OUG	II	03220	104		12	050896	1/1/0001
22000	S	M	OUG	II	03220	106		12	050896	1/1/0001
22000	S	M	OUG	II	03251	107		12	050896	1/1/0001
22000	S	M	SOH	II	03251	109		12	050896	1/1/0001
22000	S	M	SOH	II	03251	111		12	050896	1/1/0001
22000	S	M	OUG	II	03251	113		12	050896	1/1/0001
22000	S	M	OUG	II	03261	115		12	050896	1/1/0001
22000	S	M	OUG	II	03270	108		12	050896	1/1/0001
22000	S	M	OUG	II	03270	110		12	050896	1/1/0001
22000	S	M	OUG	II	03280	112		12	050896	1/1/0001
22000	S	M	OUG	II	03296	114		12	050896	1/1/0001
22000	S	M	SOH	II	03301	111		12	121477	1/1/0001
22000	S	M	OUG	II	00000	154	OPP. ROJAY COURT	12	020801	1/1/0001
22000	S	M	OUG	II	00000	156	10TH LT. N OF TIVERTON WAY, EASTSIDE	12	020801	1/1/0001
22000	S	M	OUG	II	00000	158	9TH LT. N OF TIVERTON WAY, EASTSIDE	12	020801	1/1/0001
22000	S	M	OUG	II	00000	159	3RD LT. S OF ROJAY CT., WESTSIDE	12	050896	1/1/0001
22000	S	M	OUG	II	00000	161	4TH LT. S OF ROJAY CT., WESTSIDE	12	050896	1/1/0001
22000	S	M	OUG	II	00000	163	5TH LT. S OF ROJAY CT., WESTSIDE	12	050896	1/1/0001
22000	S	M	OUG	II	00000	165	6TH LT. S OF ROJAY CT. WESTSIDE	12	050896	1/1/0001
22000	S	M	OUG	II	00000	167	7TH LT. S OF ROJAY CT., WESTSIDE	12	050896	1/1/0001
22000	S	M	OUG	II	00000	169	8TH LT. S OF ROJAY CT., WESTSIDE	12	050896	1/1/0001
22000	S	M	OUG	II	00000	171	9TH LT. S OF ROJAY CT, WESTSIDE	12	050896	1/1/0001
22000	S	M	OUG	II	00000	173	10TH LT. S OF ROJAY CT., WESTSIDE	12	050896	1/1/0001
22000	S	M	OUG	II	00000	175	1ST LT. S OF TIVERTON WAY, WESTSIDE	12	050896	1/1/0001
22000	S	M	OUG	II	00000	176	SE CORNER OF TIVERTON WAY	12	050896	1/1/0001
22000	S	M	OUG	II	00000	177	2ND LT. S OF TIVERTON WAY, WESTSIDE	12	050896	1/1/0001
22000	S	M	OUG	II	00000	178	11TH LT. N OF MAN-O-WAR, EASTSIDE	12	050896	1/1/0001
22000	S	M	OUG	III	00000	179	3RD LT. S OF TIVERTON WAY, WESTSIDE	12	100898	1/1/0001

Street Light Listing run 1/11/2015 10:43:21 AM

Page 792 of 1254

OFFICE: 311

ROUTE: 564

ST_REF_NO: 00000136300

NICHOLASVILLE ROAD

LUMENS	BULB TYPE	MULT SERIES	POLE TYPE	SHADE	ADDRESS NUMBER	REF	LOCATION	TAX DIST	DATE INST	DATE CHANGE
22000	S	M	OUG	II	00000	180	10TH LT. N OF MAN-O-WAR, EASTSIDE	12	050896	1/1/0001
22000	S	M	OUG	III	00000	181	4TH LT. S OF TIVERTON WAY, WESTSIDE	12	100898	1/1/0001
22000	S	M	OUG	II	00000	182	9TH LT. N OF MAN-O-WAR, EASTSIDE	12	050896	1/1/0001
22000	S	M	OUG	III	00000	183	5TH LT. S OF TIVERTON WAY,	12	100898	1/1/0001
22000	S	M	OUG	II	00000	184	8TH LT. N OF MAN-O-WAR, EASTSIDE	12	050896	1/1/0001
22000	S	M	OUG	III	00000	185	6TH LT. S OF TIVERTON WAY, WESTSIDE	12	100898	1/1/0001
22000	S	M	OUG	II	00000	186	7TH LT. N OF MAN-O-WAR, EASTSIDE	12	050896	1/1/0001
22000	S	M	OUG	II	00000	187	7TH LT. S OF TIVERTON WAY, WESTSIDE	12	050896	1/1/0001
22000	S	M	OUG	II	00000	188	6TH LT. N OF MAN-O-WAR, EASTSIDE	12	050896	1/1/0001
22000	S	M	OUG	II	00000	189	8TH LT. S OF TIVERTON WAY, WESTSIDE	12	050896	1/1/0001
22000	S	M	OUG	II	00000	190	5TH LT. N OF MAN-O-WAR, EASTSIDE	12	050896	1/1/0001
22000	S	M	OUG	II	00000	191	9TH LT. S OF TIVERTON WAY, WESTSIDE	12	050896	1/1/0001
22000	S	M	OUG	II	00000	192	4TH LT. N OF MAN-O-WAR, EASTSIDE	12	050896	1/1/0001
22000	S	M	OUG	II	00000	193	10TH LT. S OF TIVERTON WAY, WESTSIDE	12	050896	1/1/0001
22000	S	M	OUG	II	00000	194	3RD LT. N OF MAN-O-WAR, EASTSIDE	12	050896	1/1/0001
22000	S	M	OUG	II	00000	196	2ND LT. N OF MAN-O-WAR, EASTSIDE	12	050896	1/1/0001
22000	S	M	SOH	II	00000	197	1ST LT. S OF MAN-O-WAR, WESTSIDE	12	050896	1/1/0001
22000	S	M	OUG	II	00000	198	1ST LT. N OF MAN-O-WAR, EASTSIDE	12	050896	1/1/0001
22000	S	M	OUG	II	00000	199	2ND LT. S OF MAN-O-WAR, WESTSIDE	12	050896	1/1/0001
50000	S	M	OUG	II	00000	200	4TH LT. S OF SOUTH POINT DR., EASTSIDE	12	050896	1/1/0001
22000	S	M	OUG	II	00000	201	3RD LT. S OF MAN-O-WAR, WESTSIDE	12	050896	1/1/0001
22000	S	M	OUG	II	00000	202	2ND LT. S OF MAN-O-WAR, EASTSIDE	12	050896	1/1/0001
22000	S	M	OUG	II	00000	203	4TH LT. S OF MAN-O-WAR, WESTSIDE	12	050896	1/1/0001
22000	S	M	OUG	II	00000	204	3RD LT. S OF MAN-O-WAR, EASTSIDE	12	050896	1/1/0001
22000	S	M	OUG	II	00000	205	5TH LT. S OF MAN-O-WAR, WESTSIDE	12	050896	1/1/0001
22000	S	M	OUG	II	00000	206	4TH LT. S OF MAN-O-WAR, EASTSIDE	12	050896	1/1/0001
22000	S	M	OUG	II	00000	207	6TH LT. S OF MAN-O-WAR, WESTSIDE	12	050896	1/1/0001
22000	S	M	OUG	II	00000	208	NE CORNER OF NICHOLASVILLE RD. & TORONTO	12	060896	1/1/0001
22000	S	M	OUG	II	00000	209	OPP. 4300	12	060896	1/1/0001
22000	S	M	OUG	II	00000	210	SE CORNER OF TORONTO DR.	12	050896	1/1/0001
22000	S	M	OUG	II	00000	216	OPP. 4105	12	060896	1/1/0001
22000	S	M	OUG	I	04100	164		12	080887	1/1/0001
22000	S	M	OUG	I	04170	166		12	080887	1/1/0001
22000	S	M	OUG	II	04300	170		12	121477	1/1/0001

OFFICE: 311

ROUTE: 564

ST_REF_NO: 00000136300

NICHOLASVILLE ROAD

LUMENS	BULB TYPE	MULT SERIES	POLE TYPE	SHADE	ADDRESS NUMBER	REF	LOCATION	TAX DIST	DATE INST	DATE CHANGE
22000	S	M	OUG	II	04300	172		12	121477	1/1/0001
22000	S	M	OUG	II	00000	127	6TH LT. S OF REYNOLDS RD., WESTSIDE	12	050896	1/1/0001
22000	S	M	OUG	II	00000	129	7TH LT. S OF REYNOLDS RD., WESTSIDE	12	050896	1/1/0001
22000	S	M	OUG	II	00000	130	1ST LT. N OF DUNDEE DR., EASTSIDE	12	050896	1/1/0001
22000	S	M	OUG	II	00000	131	8TH LT. S OF REYNOLDS RD. WESTSIDE	12	050896	1/1/0001
22000	S	M	OUG	II	00000	133	9TH LT. S OF REYNOLDS RD., WESTSIDE	12	050896	1/1/0001
22000	S	M	OUG	II	00000	135	10TH LT. S OF REYNOLDS RD., WESTSIDE	12	050896	1/1/0001
22000	S	M	OUG	II	00000	136	4TH LT. N OF WILSON DOWNING, EASTSIDE	12	050896	1/1/0001
22000	S	M	OUG	II	00000	137	11TH LT. S OF REYNOLDS RD., WESTSIDE	12	050896	1/1/0001
22000	S	M	OUG	II	00000	138	3RD LT. N OF WILSON DOWNING, EASTSIDE	12	050896	1/1/0001
22000	S	M	OUG	II	00000	139	12TH LT. S OF REYNOLDS RD., WESTSIDE	12	050896	1/1/0001
22000	S	M	OUG	II	00000	140	2ND LT. N OF WILSON DOWNING, EASTSIDE	12	050896	1/1/0001
22000	S	M	OUG	II	00000	141	13TH LT. S OF REYNOLDS RD., WESTSIDE	12	050896	1/1/0001
22000	S	M	OUG	II	00000	142	1ST LT. N OF WILSON DOWNING, EASTSIDE	12	050896	1/1/0001
22000	S	M	OUG	II	00000	143	1ST LT. S OF WILSON DOWNING, WESTSIDE	12	050896	1/1/0001
22000	S	M	OUG	II	00000	144	1ST LT. S OF WILSON DOWNING, EASTSIDE	12	050896	1/1/0001
22000	S	M	OUG	II	00000	145	2ND LT. S OF WILSON DOWNING, WESTSIDE	12	050896	1/1/0001
22000	S	M	OUG	II	00000	146	2ND LT. S OF WILSON DOWNING, EASTSIDE	12	050896	1/1/0001
22000	S	M	OUG	II	00000	147	3RD LT. S OF WILSON DOWNING, WESTSIDE	12	050896	1/1/0001
22000	S	M	OUG	II	00000	148	3RD LT. S OF WILSON DOWNING	12	050896	1/1/0001
22000	S	M	OUG	II	00000	149	4TH LT. S OF WILSON DOWNING, WESTSIDE	12	050896	1/1/0001
22000	S	M	OUG	II	00000	150	4TH LT. S OF WILSON DOWNING	12	050896	1/1/0001
22000	S	M	OUG	II	00000	151	5TH LT. S OF WILSON DOWNING, WESTSIDE	12	050896	1/1/0001
22000	S	M	OUG	II	00000	152	5TH LT. S OF WILSON DOWNING	12	050896	1/1/0001
22000	S	M	OUG	II	00000	153	6TH LT. S OF WILSON DOWNING, WESTSIDE	12	050896	1/1/0001
22000	S	M	OUG	II	00000	155	1ST LT. S OF ROJAY CT., WESTSIDE	12	050896	1/1/0001
22000	S	M	OUG	II	00000	157	2ND LT. S OF ROJAY CT., WESTSIDE	12	050896	1/1/0001
22000	S	M	OUG	II	00000	160	8TH LT. N OF TIVERTON WAY, EASTSIDE	12	050896	1/1/0001
22000	S	M	OUG	II	00000	162	7TH LT. N OF TIVERTON WAY, EASTSIDE	12	050896	1/1/0001
22000	S	M	OUG	II	00000	164	6TH LT. N OF TIVERTON WAY, EASTSIDE	12	050896	1/1/0001
22000	S	M	OUG	II	00000	166	5TH LT. N OF TIVERTON WAY, EASTSIDE	12	050896	1/1/0001
22000	S	M	OUG	II	00000	168	4TH LT. N OF TIVERTON WAY, EASTSIDE	12	050896	1/1/0001
22000	S	M	OUG	II	00000	170	3RD LT. N OF TIVERTON WAY, EASTSIDE	12	050896	1/1/0001
22000	S	M	OUG	II	00000	172	2ND LT. N OF TIVERTON WAY, EASTSIDE	12	050896	1/1/0001

OFFICE: 311

ROUTE: 564

ST_REF_NO: 00000136300

NICHOLASVILLE ROAD

LUMENS	BULB TYPE	MULT SERIES	POLE TYPE	SHADE	ADDRESS NUMBER	REF	LOCATION	TAX DIST	DATE INST	DATE CHANGE
22000	S	M	OUG	II	00000	174	1ST LT. N OF TIVERTON WAY, EASTSIDE	12	050896	1/1/0001
22000	S	M	OUG	II	03512	132		12	050896	1/1/0001
22000	S	M	OUG	II	03518	134		12	050896	1/1/0001
22000	S	M	OUG	II	00000	195	11TH LT. S OF TIVERTON WAY, WESTSIDE	12	050896	1/1/0001
22000	S	M	OUG	III	00000	200	4TH LT. S OF SOUTH POINT DR., EASTSIDE	12	060889	1/1/0001
22000	S	M	OUG	II	00000	218	OPP. 4105	12	060896	1/1/0001
22000	S	M	OUG	II	00000	220	OPP. 4105	12	060896	1/1/0001
22000	S	M	OUG	II	00000	222	OPP. 4105	12	060896	1/1/0001
22000	S	M	OUG	II	00000	224	NE CORNER OF NICHOLASVILLE & HIGBEE MILL	12	060896	1/1/0001
22000	S	M	OUG	II	00000	225	SW CORNER OF NICHOLASVILLE & HIGBEE MILL	12	060896	1/1/0001
22000	S	M	OUG	II	00000	226	1ST LT. S OF HIGBEE MILL, EASTSIDE	12	060896	1/1/0001
22000	S	M	OUG	III	00000	227	2ND LT. S OF HIGBEE MILL, WESTSIDE	12	060896	1/1/0001
22000	S	M	OUG	III	00000	228	2ND LT. S OF HIGBEE MILL, EASTSIDE	12	060896	1/1/0001
22000	S	M	OUG	III	00000	229	3RD LT. S OF HIGBEE MILL, WESTSIDE	12	060896	1/1/0001
22000	S	M	OUG	III	00000	230	3RD LT. S OF HIGBEE MILL, EASTSIDE	12	060896	1/1/0001
22000	S	M	OUG	III	00000	231	4TH LT. S OF HIGBEE MILL, WESTSIDE	12	060896	1/1/0001
22000	S	M	OUG	III	00000	232	2ND LT. N OF SOUTH POINT DR., EASTSIDE	12	060896	1/1/0001
22000	S	M	OUG	III	00000	233	1ST. LT. N OF SOUTH POINT DR., WESTSIDE	12	060896	1/1/0001
22000	S	M	OUG	III	00000	234	1ST LT. N OF SOUTH POINT DR., EASTSIDE	12	060896	1/1/0001
22000	S	M	OUG	III	00000	235	OPP. SOUTH POINT DR., WESTSIDE	12	060896	1/1/0001
22000	S	M	OUG	III	00000	236	1ST LT. S OF SOUTH POINT DR., EASTSIDE	12	060896	1/1/0001
22000	S	M	OUG	III	00000	237	1ST LT. S OF SOUTH POINT DR., WESTSIDE	12	060896	1/1/0001
22000	S	M	OUG	III	00000	238	2ND LT. S OF SOUTH POINT DR., EASTSIDE	12	060896	1/1/0001
22000	S	M	OUG	III	00000	239	2ND LT. S OF SOUTH POINT DR., WESTSIDE	12	060896	1/1/0001
22000	S	M	OUG	III	00000	240	3RD LT. S OF SOUTH POINT DR., EASTSIDE	12	060896	1/1/0001
22000	S	M	OUG	III	00000	241	3ED LT. S OF SOUTH POINT DR., WESTSIDE	12	060896	1/1/0001
22000	S	M	OUG	III	00000	242	4TH LT. S OF SOUTH POINT DR., EASTSIDE	12	060896	1/1/0001
22000	S	M	OUG	III	00000	243	4TH LT. S OF SOUTH POINT DR., WESTSIDE	12	060896	1/1/0001
22000	S	M	OUG	III	00000	244	5TH LT. S OF SOUTH POINT DR., EASTSIDE	12	060896	1/1/0001
22000	S	M	OUG	III	00000	245	5TH LT. S OF SOUTH POINT DR., WESTSIDE	12	060896	1/1/0001
04000	S	M	SOH	II	00000	252	OPP. 4448	12	060896	1/1/0001
04000	S	M	SOH	II	00000	253	OPP.4448	12	060896	1/1/0001
04000	S	M	SOH	II	00000	255	OPP. 4432	12	060896	1/1/0001
22000	S	M	OUG	II	04105	215		12	060896	1/1/0001

OFFICE: 311		ROUTE: 564		ST_REF_NO: 00000136300		NICHOLASVILLE ROAD				
LUMENS	BULB TYPE	MULT SERIES	POLE TYPE	SHADE	ADDRESS NUMBER	REF	LOCATION	TAX DIST	DATE INST	DATE CHANGE
22000	S	M	OUG	II	04105	217		12	060896	1/1/0001
22000	S	M	OUG	II	04105	219		12	060896	1/1/0001
22000	S	M	OUG	II	04105	221		12	060896	1/1/0001
22000	S	M	OUG	II	04105	223		12	060896	1/1/0001
22000	S	M	OUG	II	04300	212		12	060896	1/1/0001
22000	S	M	OUG	II	04300	214		12	060896	1/1/0001
04000	S	M	SOH	II	04432	256		12	060896	1/1/0001
04000	S	M	OUG	II	04440	250		12	060896	1/1/0001
04000	S	M	OUG	II	04444	251		12	060896	1/1/0001
04000	S	M	SOH	II	04448	208		12	030887	1/1/0001
04000	S	M	SOH	II	04448	254		12	060896	1/1/0001

OFFICE: 311

ROUTE: 564

OFFICE: 311		ROUTE: 564		ST_REF_NO: 00000136310		NICHOLASVILLE SERVICE ROAD				
LUMENS	BULB TYPE	MULT SERIES	POLE TYPE	SHADE	ADDRESS NUMBER	REF	LOCATION	TAX DIST	DATE INST	DATE CHANGE
05800	S	M	OUG	II	00000	001	2ND LT. N. OF WEST LOWRY LANE, E. SIDE	12	020887	1/1/0001
05800	S	M	OUG	II	00000	002	1ST LT. N. OF WEST LOWRY LANE, E. SIDE	12	020887	1/1/0001
05800	S	M	OUG	II	02197	063		12	040172	1/1/0001
05800	S	M	OUG	II	02217	065		12	050867	1/1/0001
05800	S	M	OUG	II	02239	068		12	050867	1/1/0001
05800	S	M	OUG	II	02253	071		12	050867	1/1/0001
05800	S	M	OUG	II	02275	074		12	050867	1/1/0001

OFFICE: 311

ROUTE: 564

OFFICE: 311		ROUTE: 564		ST_REF_NO: 00000136375		NICKWOOD TRAIL				
LUMENS	BULB TYPE	MULT SERIES	POLE TYPE	SHADE	ADDRESS NUMBER	REF	LOCATION	TAX DIST	DATE INST	DATE CHANGE
05800	S	M	OUG	III	00713	001		12	091001	1/1/0001
05800	S	M	OUG	II	00728	002		12	091001	1/1/0001
05800	S	M	OUG	II	00745	003		12	091001	1/1/0001
05800	S	M	OUG	II	00757	004		12	091001	1/1/0001
05800	S	M	OUG	II	00772	005		12	091001	1/1/0001
05800	S	M	OUG	II	00789	006		12	091001	1/1/0001
05800	S	M	OUG	II	00801	008		12	091001	1/1/0001
05800	S	M	OUG	II	00824	007		12	091001	1/1/0001

OFFICE: 311

ROUTE: 564

ST_REF_NO: 00000136400

NICOLET COURT

LUMENS	BULB TYPE	MULT SERIES	POLE TYPE	SHADE	ADDRESS NUMBER	REF	LOCATION	TAX DIST	DATE INST	DATE CHANGE
04000	S	M	OUG	II	01004	086		12	061580	1/1/0001
04000	S	M	OUG	II	01013	087		12	061580	1/1/0001

OFFICE: 311

ROUTE: 564

ST_REF_NO: 00000136500

NILES DRIVE

LUMENS	BULB TYPE	MULT SERIES	POLE TYPE	SHADE	ADDRESS NUMBER	REF	LOCATION	TAX DIST	DATE INST	DATE CHANGE
05800	S	M	OUG	II	00000	014	SIDE OF 3673	12	120171	1/1/0001
05800	S	M	OUG	II	03601	019		12	062267	1/1/0001
05800	S	M	OUG	II	03608	018		12	062267	1/1/0001
05800	S	M	OUG	II	03625	017		12	120171	1/1/0001
05800	S	M	OUG	II	03636	016		12	050969	1/1/0001
05800	S	M	OUG	II	03649	015		12	050969	1/1/0001
05800	S	M	OUG	II	03677	013		12	120171	1/1/0001
05800	S	M	OUG	II	03690	012		12	050969	1/1/0001

OFFICE: 311

ROUTE: 564

ST_REF_NO: 00000136510

NINE EAGLES LANE

LUMENS	BULB TYPE	MULT SERIES	POLE TYPE	SHADE	ADDRESS NUMBER	REF	LOCATION	TAX DIST	DATE INST	DATE CHANGE
05800	S	M	CNT	II	00805	001		12	060896	1/1/0001
05800	S	M	CNT	II	00820	002		12	060896	1/1/0001
05800	S	M	CNT	III	00837	003		12	060896	1/1/0001
05800	S	M	CNT	III	00853	004		12	060896	1/1/0001

OFFICE: 311

ROUTE: 564

ST_REF_NO: 00000136600

NOBLE STREET

LUMENS	BULB TYPE	MULT SERIES	POLE TYPE	SHADE	ADDRESS NUMBER	REF	LOCATION	TAX DIST	DATE INST	DATE CHANGE
09500	S	M	SOH	I	00000	071	1ST LT. E. OF N MARTIN LUTHER KING, N. SIDE	12	111366	3/28/2011
09500	S	M	SOH	I	00000	072	OPP. 228 NOBLE	12	110166	3/28/2011
09500	S	M	SOH	I	00239	070		12	110166	3/28/2011

OFFICE: 311

ROUTE: 564

ST_REF_NO: 00000136700

NORBORNE DRIVE

LUMENS	BULB TYPE	MULT SERIES	POLE TYPE	SHADE	ADDRESS NUMBER	REF	LOCATION	TAX DIST	DATE INST	DATE CHANGE
05800	S	M	OUG	V	02055	000		12	041774	1/1/0001
05800	S	M	OUG	II	02064	179		12	061581	1/1/0001

OFFICE: 311		ROUTE: 564		ST_REF_NO: 00000136700		NORBORNE DRIVE		LUMENS	BULB TYPE	MULT SERIES	POLE TYPE	SHADE	ADDRESS NUMBER	REF	LOCATION	TAX DIST	DATE INST	DATE CHANGE
	05800	S	M	OUG	II	02071	178									12	091476	1/1/0001
	05800	S	M	OUG	II	02084	000									12	072674	1/1/0001
	05800	S	M	OUG	II	02091	000									12	101774	1/1/0001
	05800	S	M	OUG	II	02096	000									12	091573	1/1/0001

OFFICE: 311		ROUTE: 564		ST_REF_NO: 00000136710		NORCROSS COURT		LUMENS	BULB TYPE	MULT SERIES	POLE TYPE	SHADE	ADDRESS NUMBER	REF	LOCATION	TAX DIST	DATE INST	DATE CHANGE
	05800	S	M	CNT	II	01300	001									12	071001	1/1/0001
	05800	S	M	CNT	II	01309	002									12	071001	1/1/0001
	05800	S	M	CNT	III	01316	003									12	071001	1/1/0001

OFFICE: 311		ROUTE: 564		ST_REF_NO: 00000136790		NORMAN LANE		LUMENS	BULB TYPE	MULT SERIES	POLE TYPE	SHADE	ADDRESS NUMBER	REF	LOCATION	TAX DIST	DATE INST	DATE CHANGE
	09500	S	M	OUG	II	00000	001								1ST LT S OF LOWRY LN, EAST SIDE ON NORMAN LN	12	121404	1/1/0001
	09500	S	M	OUG	II	00000	002								2ND LT S OF LOWRY LN, EAST SIDE ON NORMAN LN	12	121404	1/1/0001
	09500	S	M	OUG	II	00000	003								3RD LT S OF LOWRY LN, EAST SIDE ON NORMAN LN	12	121404	1/1/0001
	09500	S	M	OUG	II	00000	004								4TH LT S OF LOWRY LN, EAST SIDE ON NORMAN LN	12	121404	1/1/0001
	09500	S	M	OUG	II	00000	005								5TH LT S OF LOWRY LN, EAST SIDE ON NORMAN LN	12	121404	1/1/0001

OFFICE: 311		ROUTE: 564		ST_REF_NO: 00000136800		NORMANDY ROAD		LUMENS	BULB TYPE	MULT SERIES	POLE TYPE	SHADE	ADDRESS NUMBER	REF	LOCATION	TAX DIST	DATE INST	DATE CHANGE
	04000	S	M	OUG	II	00000	001								SIDE 914 CELIA LANE	12	050889	1/1/0001
	04000	S	M	OUG	II	01713	002									12	050889	1/1/0001
	04000	S	M	OUG	II	01726	003									12	070889	1/1/0001
	04000	S	M	OUG	II	01741	004									12	050889	1/1/0001
	04000	S	M	OUG	II	01750	013									12	050889	1/1/0001
	04000	S	M	OUG	II	01761	005									12	050889	1/1/0001
	04000	S	M	OUG	II	01774	006									12	030889	1/1/0001

OFFICE: 311

ROUTE: 564

ST_REF_NO: 00000136800 NORMANDY ROAD

LUMENS	BULB TYPE	MULT SERIES	POLE TYPE	SHADE	ADDRESS NUMBER	REF	LOCATION	TAX DIST	DATE INST	DATE CHANGE
04000	S	M	OUG	II	01809	007		12	030889	1/1/0001
04000	S	M	OUG	II	01818	008		12	050889	1/1/0001
04000	S	M	OUG	II	01829	009		12	050889	1/1/0001
04000	S	M	OUG	II	01846	010		12	120888	1/1/0001
04000	S	M	OUG	II	01854	011		12	120888	1/1/0001
04000	S	M	OUG	II	01858	012		12	120888	1/1/0001

OFFICE: 311

ROUTE: 564

ST_REF_NO: 00000136900 NORTH COURT

LUMENS	BULB TYPE	MULT SERIES	POLE TYPE	SHADE	ADDRESS NUMBER	REF	LOCATION	TAX DIST	DATE INST	DATE CHANGE
05800	S	M	SOH	I	00000	167	OPP. 1206	12	111866	1/1/0001
05800	S	M	SOH	III	00000	168	SIDE OF 133 CARLISLE AVE.	12	070893	1/1/0001

OFFICE: 311

ROUTE: 564

ST_REF_NO: 00000136925 NORTH ADDISON AVENUE

LUMENS	BULB TYPE	MULT SERIES	POLE TYPE	SHADE	ADDRESS NUMBER	REF	LOCATION	TAX DIST	DATE INST	DATE CHANGE
04000	S	M	SOH	II	00621	034		12	010893	1/1/0001

OFFICE: 311

ROUTE: 564

ST_REF_NO: 00000137000 NORTH BAY DRIVE

LUMENS	BULB TYPE	MULT SERIES	POLE TYPE	SHADE	ADDRESS NUMBER	REF	LOCATION	TAX DIST	DATE INST	DATE CHANGE
04000	S	M	OUG	II	00100	055		12	110886	1/1/0001
04000	S	M	OUG	II	00117	054		12	110886	1/1/0001
04000	S	M	OUG	II	00129	053		12	110886	1/1/0001
04000	S	M	OUG	II	00136	052		12	110886	1/1/0001

OFFICE: 311

ROUTE: 564

ST_REF_NO: 00000137200 NORTH RIDGE DRIVE

LUMENS	BULB TYPE	MULT SERIES	POLE TYPE	SHADE	ADDRESS NUMBER	REF	LOCATION	TAX DIST	DATE INST	DATE CHANGE
05800	S	M	OUG	II	00000	018	OPP. 406	12	091582	1/1/0001
05800	S	M	OUG	II	00401	019		12	091582	1/1/0001
05800	S	M	OUG	II	00416	020		12	091582	1/1/0001
05800	S	M	OUG	II	00425	021		12	091582	1/1/0001
05800	S	M	OUG	II	00434	022		12	091582	1/1/0001
05800	S	M	OUG	II	00439	023		12	091582	1/1/0001

OFFICE: 311

ROUTE: 564

ST_REF_NO: 00000137300

NORTHAMPTON DRIVE

LUMENS	BULB TYPE	MULT SERIES	POLE TYPE	SHADE	ADDRESS NUMBER	REF	LOCATION	TAX DIST	DATE INST	DATE CHANGE
04000	S	M	OUG	II	03802	067		12	020887	1/1/0001
04000	S	M	OUG	II	03815	068		12	020887	1/1/0001
04000	S	M	OUG	II	03826	069		12	020887	1/1/0001
04000	S	M	OUG	II	03839	070		12	020887	1/1/0001
04000	S	M	OUG	II	03854	071		12	020887	1/1/0001
04000	S	M	OUG	II	03867	072		12	020887	1/1/0001
04000	S	M	OUG	II	03882	073		12	020887	1/1/0001
04000	S	M	OUG	II	03905	074		12	020887	1/1/0001
04000	S	M	OUG	II	03914	075		12	020887	1/1/0001
04000	S	M	OUG	II	03929	076		12	020887	1/1/0001
04000	S	M	OUG	II	03946	077		12	020887	1/1/0001
04000	S	M	OUG	II	03957	078		12	020887	1/1/0001
04000	S	M	OUG	II	03970	079		12	020887	1/1/0001
04000	S	M	OUG	II	03981	080		12	020887	1/1/0001
04000	S	M	OUG	II	03994	081		12	020887	1/1/0001

OFFICE: 311

ROUTE: 564

ST_REF_NO: 00000137500

NORTHLAND DRIVE

LUMENS	BULB TYPE	MULT SERIES	POLE TYPE	SHADE	ADDRESS NUMBER	REF	LOCATION	TAX DIST	DATE INST	DATE CHANGE
05800	S	M	OUG	II	00000	001	SIDE OF 1477 N. BROADWAY	12	011662	1/1/0001
05800	S	M	OUG	II	00000	002	1ST LT. E. OF N. BROADWAY, NORTHSIDE	12	100891	1/1/0001
05800	S	M	OUG	II	00000	003	1ST LT. E. OF N. BROADWAY, SOUTHSIDE	12	100891	1/1/0001
05800	S	M	OOH	II	00000	004	2ND LT. E. OF N. BROADWAY, NORTHSIDE	12	100891	1/1/0001
05800	S	M	OUG	II	00000	005	2ND LT. E. OF N. BROADWAY, SOUTHSIDE	12	100891	1/1/0001
09500	S	M	SOH	II	00000	013	5TH LT. E OF RUSSELL CAVE ON SOUTHSIDE	12	060891	1/1/0001
09500	S	M	SOH	II	00000	014	4TH LT E OF RUSSELL CAVE ON SOUTHSIDE OF NORTHLAND	12	050891	1/1/0001
09500	S	M	SOH	II	00000	015	3RD LT E OF RUSSELL CAVE ON SOUTHSIDE OF NORTHLAND	12	050891	1/1/0001
09500	S	M	SOH	II	00000	016	2ND LT E OF RUSSELL CAVE ON SOUTHSIDE OF NORTHLAND	12	050891	1/1/0001
09500	S	M	SOH	II	00000	017	1ST LT E OF RUSSELL CAVE ON SOUTHSIDE OF NORTHLAND	12	050891	1/1/0001
05800	S	M	OUG	II	00309	000		12	061264	1/1/0001
05800	S	M	OUG	II	00315	000		12	061264	1/1/0001

OFFICE: 311

ROUTE: 564

ST_REF_NO: 00000137600

NORTHSIDE DRIVE

LUMENS	BULB TYPE	MULT SERIES	POLE TYPE	SHADE	ADDRESS NUMBER	REF	LOCATION	TAX DIST	DATE INST	DATE CHANGE
05800	S	M	OUG	II	00528	008		12	030888	8/19/2011
05800	S	M	OUG	II	00540	009	upgrade due to bad fixture	12	030888	9/15/2008
05800	S	M	OOH	II	00000	001	SIDE OF 1844 BRYAN STATION RD.	12	060164	1/1/0001
05800	S	M	OUG	II	00000	002	SIDE OF 1848 BRYAN STATION RD.	12	060164	1/1/0001
04000	S	M	OUG	II	00000	005	SIDE OF 1845 WAYLAND DR.	12	030888	1/1/0001
04000	S	M	OUG	II	00414	003		12	030888	1/1/0001
04000	S	M	OUG	II	00426	004		12	030888	1/1/0001
04000	S	M	OUG	II	00505	006		12	030888	1/1/0001
04000	S	M	OUG	II	00516	007		12	030888	1/1/0001
04000	S	M	OUG	II	00552	010		12	030888	1/1/0001
04000	S	M	OUG	II	00564	011		12	030888	1/1/0001
04000	S	M	OUG	II	00600	012		12	030888	1/1/0001
04000	S	M	OUG	II	00608	013		12	030888	1/1/0001
04000	S	M	OUG	II	00621	014		12	030888	1/1/0001
04000	S	M	OUG	II	00632	015		12	030888	1/1/0001
04000	S	M	OUG	II	00645	016		12	030888	1/1/0001
04000	S	M	OUG	II	00656	017		12	030888	1/1/0001
04000	S	M	OUG	II	00000	019	SIDE OF 1853 ENDON DR.	12	030888	1/1/0001
04000	S	M	OUG	II	00669	018		12	030888	1/1/0001

OFFICE: 311

ROUTE: 564

ST_REF_NO: 00000137700

NORTHWOOD DRIVE

LUMENS	BULB TYPE	MULT SERIES	POLE TYPE	SHADE	ADDRESS NUMBER	REF	LOCATION	TAX DIST	DATE INST	DATE CHANGE
04000	S	M	OUG	II	00000	001	SIDE OF 1644 N. LIMESTONE	12	010888	1/1/0001
04000	S	M	OUG	II	00000	015	SIDE OF 1701 BRYAN STATION RD.	12	010888	1/1/0001
04000	S	M	OUG	II	00102	002		12	010888	1/1/0001
04000	S	M	OUG	II	00110	003		12	010888	1/1/0001
04000	S	M	OUG	II	00126	004		12	010888	1/1/0001
04000	S	M	OUG	II	00134	005		12	010888	1/1/0001
04000	S	M	OUG	II	00146	006		12	010888	1/1/0001
04000	S	M	OUG	II	00161	007		12	010888	1/1/0001
04000	S	M	OUG	II	00178	008		12	010888	1/1/0001
04000	S	M	OUG	II	00309	009		12	010888	1/1/0001
04000	S	M	OUG	II	00324	010		12	010888	1/1/0001

OFFICE: 311

ROUTE: 564

ST_REF_NO: 00000137700

NORTHWOOD DRIVE

LUMENS	BULB TYPE	MULT SERIES	POLE TYPE	SHADE	ADDRESS NUMBER	REF	LOCATION	TAX DIST	DATE INST	DATE CHANGE
04000	S	M	OUG	II	00337	011		12	010888	1/1/0001
04000	S	M	OUG	II	00352	012		12	010888	1/1/0001
04000	S	M	OUG	II	00369	013		12	010888	1/1/0001
04000	S	M	OUG	II	00380	014		12	010888	1/1/0001

OFFICE: 311

ROUTE: 564

ST_REF_NO: 00000137800

NORWAY DRIVE

LUMENS	BULB TYPE	MULT SERIES	POLE TYPE	SHADE	ADDRESS NUMBER	REF	LOCATION	TAX DIST	DATE INST	DATE CHANGE
04000	S	M	OUG	II	00000	116	SIDE 228 SOUTHPORT ST.	12	100884	1/1/0001
04000	S	M	OUG	II	00200	120		12	090884	1/1/0001
04000	S	M	OUG	II	00214	119		12	100884	1/1/0001
04000	S	M	OUG	II	00223	118		12	100884	1/1/0001
04000	S	M	OUG	II	00235	117		12	100884	1/1/0001

OFFICE: 311

ROUTE: 564

ST_REF_NO: 00000137900

NOTTINGHAM ROAD

LUMENS	BULB TYPE	MULT SERIES	POLE TYPE	SHADE	ADDRESS NUMBER	REF	LOCATION	TAX DIST	DATE INST	DATE CHANGE
05800	S	M	OUG	II	00322	000		12	081869	1/1/0001
05800	S	M	OUG	II	00333	000		12	060171	1/1/0001
05800	S	M	OUG	II	00350	000		12	060171	1/1/0001
05800	S	M	OUG	II	00365	045		12	121581	1/1/0001
05800	S	M	OUG	II	00378	000		12	060171	1/1/0001
05800	S	M	OUG	II	00389	000		12	080173	1/1/0001
05800	S	M	OUG	II	00398	000		12	090170	1/1/0001

OFFICE: 311

ROUTE: 564

ST_REF_NO: 00000137980

NUTMEG DRIVE

LUMENS	BULB TYPE	MULT SERIES	POLE TYPE	SHADE	ADDRESS NUMBER	REF	LOCATION	TAX DIST	DATE INST	DATE CHANGE
05800	S	M	CNT	II	04200	006		12	110898	1/1/0001
05800	S	M	CNT	II	04209	005		12	110898	1/1/0001
05800	S	M	CNT	II	04220	004		12	110898	1/1/0001
05800	S	M	CNT	II	04229	003		12	110898	1/1/0001
05800	S	M	CNT	II	04236	002		12	110898	1/1/0001
05800	S	M	CNT	II	04245	001		12	110898	1/1/0001

OFFICE: 311

ROUTE: 564

ST_REF_NO: 00000138000 OAK STREET

LUMENS	BULB TYPE	MULT SERIES	POLE TYPE	SHADE	ADDRESS NUMBER	REF	LOCATION	TAX DIST	DATE INST	DATE CHANGE
05800	S	M	SOH	II	00000	007	SIDE OF 762 CHARLES AVE.	12	060266	1/1/0001
05800	S	M	SOH	II	00334	000		12	011865	1/1/0001
05800	S	M	SOH	II	00420	000		12	121365	1/1/0001
05800	S	M	SOH	II	00430	000		12	060266	1/1/0001

OFFICE: 311

ROUTE: 564

ST_REF_NO: 00000138050 OAK CREEK DRIVE

LUMENS	BULB TYPE	MULT SERIES	POLE TYPE	SHADE	ADDRESS NUMBER	REF	LOCATION	TAX DIST	DATE INST	DATE CHANGE
04000	S	M	OUG	II	00000	001	SIDE 1150 ROCKBRIDGE ON OAK CREEK DR.	12	080890	1/1/0001
04000	S	M	OUG	II	04612	002		12	080890	1/1/0001
04000	S	M	OUG	II	04625	003		12	080890	1/1/0001
04000	S	M	OUG	II	04636	004		12	080890	1/1/0001
05800	S	M	OUG	II	04644	005		12	080893	1/1/0001

OFFICE: 311

ROUTE: 564

ST_REF_NO: 00000138100 OAK HILL DRIVE

LUMENS	BULB TYPE	MULT SERIES	POLE TYPE	SHADE	ADDRESS NUMBER	REF	LOCATION	TAX DIST	DATE INST	DATE CHANGE
09500	S	M	OUG	II	00000	014	SIDE OF 463 CARLISLE AVE-upgrade to 9500 8/06	12	051165	1/1/0001
09500	S	M	OUG	II	00000	016	SIDE OF 481 LOCUST AVE-upgrade to 9500 8/06	12	051165	1/1/0001
09500	S	M	OUG	II	00000	117	SIDE OF 431 MEADOW PARK	12	100164	1/1/0001
09500	S	M	OUG	II	01138	015	upgraded to 9500 8/06	12	051165	1/1/0001
09500	S	M	SOH	I	01394	001	upgrade to 9500 8/06	12	090968	1/1/0001
09500	S	M	SOH	I	01404	002	upgrade to 9500 8/06	12	090968	1/1/0001
09500	S	M	SOH	I	01412	003	upgrade to 9500 8/06	12	090968	1/1/0001
09500	S	M	SOH	I	01422	004	upgrade to 9500 8/06	12	090968	1/1/0001
09500	S	M	SOH	I	01508	005	upgrade to 9500 8/06	12	090968	1/1/0001
09500	S	M	OUG	II	01514	078	upgrade to 9500 8/06	12	040163	1/1/0001
09500	S	M	SOH	II	00000	006	SIDE 425 LOUDON AVE-upgrade to 9500 8/06	12	120885	1/1/0001
09500	S	M	SOH	III	00000	008	SIDE OF 941 IDLEWILD CT-upgrade to 9500 8/06	12	111153	1/1/0001
09500	S	M	SOH	II	00805	007	upgraded to 9500 8/06	12	122255	1/1/0001
09500	S	M	SOH	II	00813	018	upgraded to 9500 8/06	12	122255	1/1/0001
09500	S	M	SOH	II	00819	019	upgraded to 9500 8/06	12	122255	1/1/0001
09500	S	M	SOH	II	00823	020	upgraded to 9500 8/06	12	120885	1/1/0001
09500	S	M	SOH	II	00000	009	OPP. 918-upgraded to 9500 8/06	12	020860	1/1/0001

OFFICE: 311

ROUTE: 564

ST_REF_NO: 00000138100 OAK HILL DRIVE

LUMENS	BULB TYPE	MULT SERIES	POLE TYPE	SHADE	ADDRESS NUMBER	REF	LOCATION	TAX DIST	DATE INST	DATE CHANGE
09500	S	M	SOH	II	00000	010	SIDE OF 963 HIGHLAND PARK-upgrade to 9500 8/06	12	011066	1/1/0001
09500	S	M	OUG	II	01016	011	upgraded to 9500 8/06	12	051165	1/1/0001
09500	S	M	OUG	II	01031	012	upgraded to 9500 8/06	12	051165	1/1/0001
09500	S	M	OUG	II	01106	013	upgrade to 9500 8/06	12	051165	1/1/0001

OFFICE: 311

ROUTE: 564

ST_REF_NO: 00000138150 OAKHURST LANE

LUMENS	BULB TYPE	MULT SERIES	POLE TYPE	SHADE	ADDRESS NUMBER	REF	LOCATION	TAX DIST	DATE INST	DATE CHANGE
05800	S	M	CNT	II	00000	003	SIDE OF 2301 CROSS CREEK TRACE ON OAKHURST LANE	12	120404	1/1/0001
05800	S	M	CNT	III	03105	004		12	120404	1/1/0001
05800	S	M	CNT	II	03132	002		12	120404	1/1/0001
05800	S	M	CNT	II	03137	001		12	120404	1/1/0001

OFFICE: 311

ROUTE: 564

ST_REF_NO: 00000138200 OAKLAWN PARK

LUMENS	BULB TYPE	MULT SERIES	POLE TYPE	SHADE	ADDRESS NUMBER	REF	LOCATION	TAX DIST	DATE INST	DATE CHANGE
04000	S	M	OUG	II	00000	215	SIDE OF 3347 PIMLICO PKWY.	12	040171	1/1/0001
04000	S	M	OUG	V	01283	216		12	040171	1/1/0001

OFFICE: 311

ROUTE: 564

ST_REF_NO: 00000138300 OAKMONT COURT

LUMENS	BULB TYPE	MULT SERIES	POLE TYPE	SHADE	ADDRESS NUMBER	REF	LOCATION	TAX DIST	DATE INST	DATE CHANGE
04000	S	M	OUG	II	02601	080		12	071581	1/1/0001
04000	S	M	OUG	V	02608	081		12	021582	1/1/0001

OFFICE: 311

ROUTE: 564

ST_REF_NO: 00000138400 OAKWOOD CIRCLE

LUMENS	BULB TYPE	MULT SERIES	POLE TYPE	SHADE	ADDRESS NUMBER	REF	LOCATION	TAX DIST	DATE INST	DATE CHANGE
05800	S	M	OUG	V	01169	006		12	011966	1/1/0001

OFFICE: 311

ROUTE: 564

ST_REF_NO: 00000138500 OAKWOOD DRIVE

LUMENS	BULB TYPE	MULT SERIES	POLE TYPE	SHADE	ADDRESS NUMBER	REF	LOCATION	TAX DIST	DATE INST	DATE CHANGE
05800	S	M	OUG	II	00000	001	OPP. 1198 IN MEDIAN	12	011966	1/1/0001

OFFICE: 311		ROUTE: 564		ST_REF_NO: 00000138500		OAKWOOD DRIVE		LUMENS	BULB TYPE	MULT SERIES	POLE TYPE	SHADE	ADDRESS NUMBER	REF	LOCATION	TAX DIST	DATE INST	DATE CHANGE
	05800	S	M	OUG	II	00000	002	OPP. 1197 IN MEDIAN	12	011966	1/1/0001							
	05800	S	M	OUG	II	00000	003	OPP. 1190 IN MEDIAN	12	011966	1/1/0001							
	05800	S	M	OUG	II	00000	004	OPP. 1189 IN MEDIAN	12	011966	1/1/0001							
	05800	S	M	OUG	II	01070	019		12	062267	1/1/0001							
	05800	S	M	OUG	II	01082	020		12	011966	1/1/0001							
	05800	S	M	OUG	II	01095	021		12	011966	1/1/0001							
	05800	S	M	OUG	II	01106	022		12	011966	1/1/0001							
	05800	S	M	OUG	II	01115	023		12	062267	1/1/0001							
	05800	S	M	OUG	II	01130	024		12	011966	1/1/0001							
	05800	S	M	OUG	II	01135	009		12	011966	1/1/0001							
	05800	S	M	OUG	II	01154	008		12	011966	1/1/0001							
	05800	S	M	OUG	II	01163	007		12	011966	1/1/0001							
	05800	S	M	OUG	II	01178	005		12	011966	1/1/0001							

OFFICE: 311

ROUTE: 564

OFFICE: 311		ROUTE: 564		ST_REF_NO: 00000138505		OATLANDS PARK		LUMENS	BULB TYPE	MULT SERIES	POLE TYPE	SHADE	ADDRESS NUMBER	REF	LOCATION	TAX DIST	DATE INST	DATE CHANGE
	05800	S	M	CNT	II	01129	005		12	091106	1/1/0001							
	05800	S	M	CNT	II	01145	004		12	091106	1/1/0001							
	05800	S	M	CNT	II	01160	003		12	091106	1/1/0001							
	05800	S	M	CNT	II	01177	002		12	091106	1/1/0001							
	05800	S	M	CNT	III	01193	001		12	091106	1/1/0001							

OFFICE: 311

ROUTE: 564

OFFICE: 311		ROUTE: 564		ST_REF_NO: 00000138510		O'BRIEN COURT		LUMENS	BULB TYPE	MULT SERIES	POLE TYPE	SHADE	ADDRESS NUMBER	REF	LOCATION	TAX DIST	DATE INST	DATE CHANGE
	05800	S	M	OUG	V	00000	001	REAR OF 4052 FORSYTHE DR.	12	090893	1/1/0001							

OFFICE: 311

ROUTE: 564

OFFICE: 311		ROUTE: 564		ST_REF_NO: 00000138575		OCOEE COURT		LUMENS	BULB TYPE	MULT SERIES	POLE TYPE	SHADE	ADDRESS NUMBER	REF	LOCATION	TAX DIST	DATE INST	DATE CHANGE
	05800	S	M	CNT	II	00000	001	SIDE OF 3057 TOWN BRANCH RD ON OCOEE COURT	12	072005	1/1/0001							
	05800	S	M	CNT	II	00109	004		12	072005	1/1/0001							
	05800	S	M	CNT	II	00121	003		12	072005	1/1/0001							

OFFICE: 311		ROUTE: 564		ST_REF_NO: 00000138575		OCOEE COURT		LUMENS	BULB TYPE	MULT SERIES	POLE TYPE	SHADE	ADDRESS NUMBER	REF	LOCATION	TAX DIST	DATE INST	DATE CHANGE
05800	S	M	CNT	II	00129	002										12	072005	1/1/0001
OFFICE: 311		ROUTE: 564		ST_REF_NO: 00000138600		OCTAVIAN WAY		LUMENS	BULB TYPE	MULT SERIES	POLE TYPE	SHADE	ADDRESS NUMBER	REF	LOCATION	TAX DIST	DATE INST	DATE CHANGE
05800	S	M	OUG	II	00000	024	SIDE OF 3542 MILANO RD.	12	090166	1/1/0001								
05800	S	M	OUG	II	00000	049	SIDE OF 3559 APPIAN WAY	12	041067	1/1/0001								
05800	S	M	OUG	II	01179	000		12	090170	1/1/0001								
05800	S	M	OUG	II	01186	048		12	041067	1/1/0001								
05800	S	M	OUG	II	01205	000		12	120869	1/1/0001								
05800	S	M	OUG	V	01224	000		12	081869	1/1/0001								
OFFICE: 311		ROUTE: 564		ST_REF_NO: 00000138695		OGDEN WAY		LUMENS	BULB TYPE	MULT SERIES	POLE TYPE	SHADE	ADDRESS NUMBER	REF	LOCATION	TAX DIST	DATE INST	DATE CHANGE
09500	S		CLN	II	00000	002	ACROSS FROM 2409 OGDEN WAY	12	092609	1/1/0001								
09500	S		CLN	II	00000	004	SIDE OF 985 PRINCESS DOREEN DR, ON OGDEN WAY	12	092609	1/1/0001								
09500	S		CLN	II	00000	005	ACROSS FROM 2429 OGDEN WAY	12	092609	1/1/0001								
09500	S		CLN	II	00000	006	ACROSS FROM 2441 OGDEN WAY	12	092609	1/1/0001								
09500	S		CLN	II	00000	008	ACROSS FROM 2453 OGDEN WAY	12	092609	1/1/0001								
09500	S		CLN	II	00000	011	ACROSS FROM 2481 OGDEN WAY	12	092609	1/1/0001								
09500	S		CLN	II	00000	013	ACROSS FROM 2469 OGDEN WAY	12	092609	1/1/0001								
09500	S		CLN	II	00000	014	OGDEN WAY CORNER OF VILLAGE GREEN	12	092609	1/1/0001								
09500	S		CLN	II	00000	015	OGDEN WAY CORNER OF STAR SHOOT PARKWAY	12	092609	1/1/0001								
09500	S		CLN	II	02401	001		12	092609	1/1/0001								
09500	S		CLN	II	02421	003		12	092609	1/1/0001								
09500	S		CLN	II	02445	007		12	092609	1/1/0001								
09500	S		CLN	II	02461	009		12	092609	1/1/0001								
09500	S		CLN	II	02477	010		12	092609	1/1/0001								
09500	S		CLN	II	02489	012		12	092609	1/1/0001								

OFFICE: 311

ROUTE: 564

ST_REF_NO: 00000138700 OHIO STREET

LUMENS	BULB TYPE	MULT SERIES	POLE TYPE	SHADE	ADDRESS NUMBER	REF	LOCATION	TAX DIST	DATE INST	DATE CHANGE
05800	S	M	SOH	II	00000	097	SIDE OF 304 E. 5TH ST.	12	110166	1/1/0001
05800	S	M	SOH	II	00449	096		12	110166	1/1/0001
05800	S	M	SOH	II	00500	099		12	110466	1/1/0001
05800	S	M	SOH	II	00530	100		12	110466	1/1/0001
05800	S	M	SOH	II	00546	101		12	110466	1/1/0001
05800	S	M	SOH	II	00565	102		12	110466	1/1/0001
05800	S	M	SOH	II	00612	105		12	110466	1/1/0001
05800	S	M	SOH	II	00630	106		12	110466	1/1/0001
05800	S	M	SOH	II	00654	107		12	110466	1/1/0001
05800	S	M	SOH	II	00000	088	SIDE OF 331 E. THIRD ST.	12	110166	1/1/0001
05800	S	M	SOH	II	00000	094	SIDE OF 281 E. 4TH ST.	12	110166	1/1/0001
05800	S	M	SOH	II	00316	089		12	110166	1/1/0001
05800	S	M	SOH	II	00335	092		12	100898	1/1/0001
05800	S	M	SOH	II	00347	090		12	110166	1/1/0001
05800	S	M	SOH	II	00360	091		12	110166	1/1/0001
05800	S	M	SOH	II	00429	095		12	110166	1/1/0001

OFFICE: 311

ROUTE: 564

ST_REF_NO: 00000138710 OHIO TERRACE

LUMENS	BULB TYPE	MULT SERIES	POLE TYPE	SHADE	ADDRESS NUMBER	REF	LOCATION	TAX DIST	DATE INST	DATE CHANGE
05800	S	M	SOH	I	00348	109		12	110466	1/1/0001

OFFICE: 311

ROUTE: 564

ST_REF_NO: 00000138800 OLD CROW COURT

LUMENS	BULB TYPE	MULT SERIES	POLE TYPE	SHADE	ADDRESS NUMBER	REF	LOCATION	TAX DIST	DATE INST	DATE CHANGE
05800	S	M	OUG	II	00000	035	SIDE OF 3010 MONTAVESTA RD.	12	031071	1/1/0001
05800	S	M	OUG	II	03109	000		12	010171	1/1/0001
05800	S	M	OUG	II	03116	000		12	010117	1/1/0001

OFFICE: 311

ROUTE: 564

ST_REF_NO: 00000138900 OLD DOBBIN CIRCLE

LUMENS	BULB TYPE	MULT SERIES	POLE TYPE	SHADE	ADDRESS NUMBER	REF	LOCATION	TAX DIST	DATE INST	DATE CHANGE
05800	S	M	OUG	II	00732	025		12	070863	1/1/0001

OFFICE: 311		ROUTE: 564		ST_REF_NO: 00000139000		OLD DOBBIN ROAD				
LUMENS	BULB TYPE	MULT SERIES	POLE TYPE	SHADE	ADDRESS NUMBER	REF	LOCATION	TAX DIST	DATE INST	DATE CHANGE
05800	S	M	OUG	II	00704	008		12	070863	1/1/0001
05800	S	M	OUG	II	00709	007		12	070863	1/1/0001
05800	S	M	OUG	II	00000	001	SIDE OF 2725 TATES CREEK RD.	12	070863	1/1/0001
05800	S	M	OUG	II	00721	005		12	070863	1/1/0001
05800	S	M	OUG	II	00744	006		12	070863	1/1/0001
05800	S	M	OUG	II	00756	004		12	070863	1/1/0001
05800	S	M	OUG	II	00801	003		12	070863	1/1/0001
05800	S	M	OUG	II	00808	002		12	080164	1/1/0001

OFFICE: 311		ROUTE: 564		ST_REF_NO: 00000139050		OLD FIELD WAY				
LUMENS	BULB TYPE	MULT SERIES	POLE TYPE	SHADE	ADDRESS NUMBER	REF	LOCATION	TAX DIST	DATE INST	DATE CHANGE
05800	S	M	CNT	II	00000	008	SIDE OF 1088 CHASEWOOD WAY	12	100899	1/1/0001
05800	S	M	CNT	III	00000	009	SIDE OF 1089 CHASEWOOD WAY	12	100899	1/1/0001
05800	S	M	CNT	II	03001	001		12	100899	1/1/0001
05800	S	M	CNT	II	03004	002		12	100899	1/1/0001
05800	S	M	CNT	II	03017	003		12	100899	1/1/0001
05800	S	M	CNT	II	03020	004		12	100899	1/1/0001
05800	S	M	CNT	II	03037	005		12	100899	1/1/0001
05800	S	M	CNT	II	03044	006		12	100899	1/1/0001
05800	S	M	CNT	II	03061	007		12	100899	1/1/0001

OFFICE: 311		ROUTE: 564		ST_REF_NO: 00000139100		OLD FRANKFORT SERVICE ROAD				
LUMENS	BULB TYPE	MULT SERIES	POLE TYPE	SHADE	ADDRESS NUMBER	REF	LOCATION	TAX DIST	DATE INST	DATE CHANGE
05800	S	M	OUG	II	00000	049	OPP. 2151	12	020890	1/1/0001
05800	S	M	OUG	II	00000	050	OPP. 2151	12	020890	1/1/0001
05800	S	M	OUG	II	00000	051	OPP. 2185	12	020890	1/1/0001
05800	S	M	OUG	II	00000	052	OPP. 2185	12	020890	1/1/0001
05800	S	M	OUG	II	00000	053	OPP. 2185	12	020890	1/1/0001
05800	S	M	OUG	II	00000	054	OPP. 2185	12	020890	1/1/0001
05800	S	M	OUG	II	00000	055	OPP. 2245	12	020890	1/1/0001
05800	S	M	OUG	II	00000	056	OPP. 2245	12	020890	1/1/0001
05800	S	M	OUG	II	00000	057	OPP. 2253	12	060895	1/1/0001

OFFICE: 311		ROUTE: 564		ST_REF_NO: 00000139100		OLD FRANKFORT SERVICE ROAD		LUMENS	BULB TYPE	MULT SERIES	POLE TYPE	SHADE	ADDRESS NUMBER	REF	LOCATION	TAX DIST	DATE INST	DATE CHANGE
05800	S	M	OUG	II	02269	060										12	060895	1/1/0001
05800	S	M	OUG	II	02269	061										12	060895	1/1/0001
05800	S	M	OUG	II	02301	062										12	060895	1/1/0001
05800	S	M	OUG	IV	02309	064										12	060895	1/1/0001
OFFICE: 311		ROUTE: 564		ST_REF_NO: 00000139200		OLD FRANKFORT ROAD		LUMENS	BULB TYPE	MULT SERIES	POLE TYPE	SHADE	ADDRESS NUMBER	REF	LOCATION	TAX DIST	DATE INST	DATE CHANGE
22000	S		CNT	II	00000	100									3RD LT W OF ROUNDABOUT, N SIDE ON OLD FRANKFORT PIKE	12	042310	5/25/2010
22000	S		CNT	II	00000	101									2ND LT W OF ROUNDABOUT, N SIDE ON OLD FRANKFORT PIKE	12	042310	5/25/2010
22000	S		CNT	II	00000	102									1ST LT W OF ROUNDABOUT, N SIDE ON OLD FRANKFORT PIKE	12	042310	5/25/2010
22000	S		CNT	II	00000	103									1ST LT E OF ROUNDABOUT, N SIDE ON OLD FRANKFORT PIKE	12	042310	5/25/2010
22000	S		CNT	II	00000	104									1ST LT E OF ROUNDABOUT, S SIDE ON OLD FRANKFORT PIKE	12	042310	5/25/2010
22000	S		CNT	II	00000	105									1ST LT W OF ROUNDABOUT, S SIDE ON OLD FRANKFORT PIKE	12	042310	5/25/2010
22000	S		CNT	II	00000	106									2ND LT E OF ROUNDABOUT, S SIDE ON OLD FRANKFORT PIKE	12	042310	5/25/2010
22000	S		CNT	II	00000	107									3RD LT E OF ROUNDABOUT, S SIDE ON OLD FRANKFORT PIKE	12	042310	5/25/2010
50000	S	M	SOH	III	01332	002										12	111477	12/14/2009
10000	M	M	SOH	III	00000	020									OPP. 1530	12	111477	1/1/0001
10000	M	M	SOH	III	00000	022									OPP. 1550	12	111477	1/1/0001
09500	S	M	SOH	III	00000	024									OPP. 1558 mv changeout	12	111477	1/1/0001
09500	S	M	SOH	III	00000	025									X-FROM 1558 OLD FRANKFORT RD	12	111477	1/1/0001
10000	M	M	SOH	III	00000	026									OPP. 1562	12	111477	1/1/0001
10000	M	M	SOH	III	00000	028									OPP. 1610	12	111477	1/1/0001
10000	M	M	SOH	III	00000	030									OPP. 1620	12	111477	1/1/0001
10000	M	M	SOH	III	00000	032									OPP. 1630	12	111477	1/1/0001
10000	M	M	SOH	III	00000	033									OPP. 1750	12	111477	1/1/0001
10000	M	M	SOH	III	00000	035									OPP. 1750	12	111477	1/1/0001
10000	M	M	SOH	III	00000	037									OPP. 1770	12	111477	1/1/0001
10000	M	M	SOH	III	01401	012										12	111477	1/1/0001

OFFICE: 311

ROUTE: 564

ST_REF_NO: 00000139200

OLD FRANKFORT ROAD

LUMENS	BULB TYPE	MULT SERIES	POLE TYPE	SHADE	ADDRESS NUMBER	REF	LOCATION	TAX DIST	DATE INST	DATE CHANGE
10000	M	M	SOH	III	01401	013		12	111477	1/1/0001
10000	M	M	SOH	III	01401	014		12	111477	1/1/0001
10000	M	M	SOH	III	01401	015		12	111477	1/1/0001
10000	M	M	SOH	III	01401	016		12	111477	1/1/0001
10000	M	M	SOH	III	01504	017		12	111477	1/1/0001
10000	M	M	SOH	III	01504	018		12	111477	1/1/0001
05800	S	M	SOH	II	01515	047		12	050891	1/1/0001
05800	S	M	SOH	II	01515	048		12	050891	1/1/0001
10000	M	M	SOH	III	01530	019		12	111477	1/1/0001
10000	M	M	SOH	III	01550	021		12	111477	1/1/0001
09500	S	M	SOH	III	01558	023		12	111477	1/1/0001
10000	M	M	SOH	III	01600	027		12	111477	1/1/0001
10000	M	M	SOH	III	01610	029		12	111477	1/1/0001
10000	M	M	SOH	III	01630	031		12	111477	1/1/0001
10000	M	M	SOH	III	01750	034		12	111477	1/1/0001
10000	M	M	SOH	III	01770	036		12	111477	1/1/0001
10000	M	M	SOH	III	01770	038		12	111477	1/1/0001
10000	M	M	SOH	III	01779	039		12	111477	1/1/0001
10000	M	M	SOH	III	01798	040		12	111477	1/1/0001
10000	M	M	SOH	III	01295	001		12	111477	1/1/0001
10000	M	M	SOH	III	01305	003		12	111477	1/1/0001
10000	M	M	SOH	III	01305	004		12	111477	1/1/0001
10000	M	M	SOH	III	01345	005		12	111477	1/1/0001

OFFICE: 311

ROUTE: 564

ST_REF_NO: 00000139210

OLD GEORGETOWN ROAD

LUMENS	BULB TYPE	MULT SERIES	POLE TYPE	SHADE	ADDRESS NUMBER	REF	LOCATION	TAX DIST	DATE INST	DATE CHANGE
22000	S		SOH	II	00213	250		12	042209	1/1/0001
09500	S	M	SOH	II	00000	202	LINLEE SCHOOL ON OLD GEORGETOWN RD.	12	060899	1/1/0001
09500	S	M	SOH	II	00000	203	SOUTH OF LINLEE SCHOOL	12	060899	1/1/0001
09500	S	M	SOH	II	00000	205	OPP. 2509	12	060899	1/1/0001
09500	S	M	SOH	II	00000	206	OPP. 2495	12	060899	1/1/0001
09500	S	M	SOH	II	00000	207	OPP. 2495	12	060899	1/1/0001
09500	S	M	SOH	II	00000	209	OPP. 2461	12	060899	1/1/0001

OFFICE: 311							ROUTE: 564			
ST_REF_NO: 00000139210							OLD GEORGETOWN ROAD			
LUMENS	BULB TYPE	MULT SERIES	POLE TYPE	SHADE	ADDRESS NUMBER	REF	LOCATION	TAX DIST	DATE INST	DATE CHANGE
09500	S	M	SOH	II	02429	210		12	060899	1/1/0001
09500	S	M	SOH	II	02461	208		12	060899	1/1/0001
09500	S	M	SOH	II	02509	204		12	060899	1/1/0001

OFFICE: 311							ROUTE: 564			
ST_REF_NO: 00000139250							OLD HIGBEE MILL			
LUMENS	BULB TYPE	MULT SERIES	POLE TYPE	SHADE	ADDRESS NUMBER	REF	LOCATION	TAX DIST	DATE INST	DATE CHANGE
05800	S	M	OUG	II	00000	001	SOUTHEAST CORNER OF RESERVE RD AND OLD HIGBEE MILL	12	020106	1/1/0001
09500	S	M	OUG	II	00000	100	1ST LT E OF HARRODSBURG,S SIDE ON OLD HIGBEE MILL	12	031707	1/1/0001
09500	S	M	OUG	II	00000	101	2ND LT E OF HARRODSBURG, S SIDE ON OLD HIGBEE MILL	12	031707	1/1/0001
09500	S	M	OUG	II	00000	102	3RD LT E OF HARRODSBURG, S SIDE ON OLD HIGBEE MILL	12	031707	1/1/0001
09500	S	M	SOH	II	00000	103	1ST LT E OF RESERVE RD, N SIDE ON OLD HIGBEE MILL	12	030207	1/1/0001
09500	S	M	SOH	II	00000	104	1ST LT E OF RESERVE RD, S SIDE ON OLD HIGBEE MILL	12	030207	1/1/0001
09500	S	M	SOH	II	00000	105	2ND LT E OF RESERVE RD, S SIDE ON OLD HIGBEE MILL	12	030207	1/1/0001
09500	S	M	SOH	II	00000	106	3RD LT E OF RESERVE RD, S SIDE ON OLD HIGBEE MILL	12	030207	1/1/0001
09500	S	M	SOH	II	00000	107	4TH LT E OF RESERVE RD, S SIDE ON OLD HIGBEE MILL	12	030207	1/1/0001
09500	S	M	OUG	II	00000	125	1ST LT E OF GLADMAN,N SIDE ON OLD HIGBEE MILL RD	12	072808	1/1/0001
09500	S	M	OUG	II	00000	126	2ND LT E OF GLADMAN,S SIDE ON OLD HIGBEE MILL RD	12	072808	1/1/0001
09500	S	M	OUG	II	00000	127	3RD LT E OF GLADMAN,S SIDE ON OLD HIGBEE MILL RD	12	072808	1/1/0001
09500	S	M	OUG	II	00000	128	4TH LT E OF GLADMAN,S SIDE ON OLD HIGBEE MILL RD	12	072808	1/1/0001
09500	S	M	OUG	II	00000	129	5TH LT E OF GLADMAN,S SIDE ON OLD HIGBEE MILL RD	12	072808	1/1/0001
09500	S	M	OUG	II	00000	130	6TH LT E OF GLADMAN,S SIDE ON OLD HIGBEE MILL RD	12	072808	1/1/0001
09500	S	M	OUG	II	00000	131	7TH LT E OF GLADMAN,S SIDE ON OLD HIGBEE MILL RD	12	072808	1/1/0001

OFFICE: 311

ROUTE: 564

ST_REF_NO: 00000139250

OLD HIGBEE MILL

LUMENS	BULB TYPE	MULT SERIES	POLE TYPE	SHADE	ADDRESS NUMBER	REF	LOCATION	TAX DIST	DATE INST	DATE CHANGE
09500	S	M	OUG	II	00000	132	8TH E OF GLADMAN,S SIDE ON OLD HIGBEE MILL RD	12	072808	1/1/0001
09500	S	M	OUG	II	00000	133	1ST LT E OF HOPEMONT LN,N SIDE ON OLD HIGBEE MILL	12	072808	1/1/0001
09500	S	M	OUG	II	00000	134	2ND LT E OF HOPEMONT LN,N SIDE ON OLD HIGBEE MILL	12	072808	1/1/0001
09500	S	M	OUG	II	00000	135	3RD LT E OF HOPEMONT LN,N SIDE ON OLD HIGBEE MILL	12	072808	1/1/0001
09500	S	M	OUG	II	00000	136	4TH LT E OF HOPEMONT LN,N SIDE ON OLD HIGBEE MILL	12	072808	1/1/0001
09500	S	M	OUG	II	00000	137	1ST LT E OF MARY JANE ,N SIDE ON OLD HIGBEE MILL	12	072808	1/1/0001
09500	S	M	OUG	II	00000	138	2ND LT E OF MARY JANE,N SIDE ON OLD HIGBEE MILL	12	072808	1/1/0001
09500	S	M	OUG	II	00000	139	3RD LT E OF MARY JANE,N SIDE ON OLD HIGBEE MILL	12	072808	1/1/0001
09500	S	M	OUG	II	00000	140	4TH LT E OF MARY JANE,N SIDE ON OLD HIGBEE MILL	12	072808	1/1/0001
09500	S	M	OUG	II	00000	141	5TH LT E OF MARY JANE,N SIDE ON OLD HIGBEE MILL	12	072808	1/1/0001
09500	S	M	OUG	II	02050	022		12	050802	1/1/0001
09500	S	M	OUG	II	02058	021		12	050802	1/1/0001
09500	S	M	OUG	II	02074	020		12	050802	1/1/0001

OFFICE: 311

ROUTE: 564

ST_REF_NO: 00000139260

OLD HOUSE ROAD

LUMENS	BULB TYPE	MULT SERIES	POLE TYPE	SHADE	ADDRESS NUMBER	REF	LOCATION	TAX DIST	DATE INST	DATE CHANGE
05800	S	M	CNT	II	00000	006	SIDE OF 3109 ROUNDWAY DOWN LN ON OLD HOUSE RD	12	101905	1/1/0001
05800	S	M	CNT	II	03000	001		12	101905	1/1/0001
05800	S	M	CNT	II	03009	002		12	101905	1/1/0001
05800	S	M	CNT	II	03028	003		12	101905	1/1/0001
05800	S	M	CNT	II	03045	004		12	101905	1/1/0001
05800	S	M	CNT	II	03061	005		12	101905	1/1/0001

OFFICE: 311

ROUTE: 564

ST_REF_NO: 00000139350

OLD LEESTOWN ROAD

LUMENS	BULB TYPE	MULT SERIES	POLE TYPE	SHADE	ADDRESS NUMBER	REF	LOCATION	TAX DIST	DATE INST	DATE CHANGE
20000	M	M	SOH	II	00000	001	1ST LT. W. OF LEESTOWN RD., S. SIDE	12	071581	1/1/0001
05800	S	M	SOH	II	00000	002	2ND LT. W. OF LEESTOWN RD.,S. SIDE	12	071581	1/1/0001
05800	S	M	SOH	II	00000	003	1ST LT. W. OF LEESTOWN RD.,N. SIDE	12	071581	1/1/0001
05800	S	M	SOH	II	00000	004	2ND LT. W. OF LEESTOWN RD., N. SIDE	12	071581	1/1/0001
05800	S	M	SOH	II	00000	005	3RD LT. W. OF LEESTOWN RD.,N. SIDE	12	121578	1/1/0001
05800	S	M	SOH	II	00000	006	OPP. 3106	12	121578	1/1/0001
05800	S	M	SOH	II	00000	009	3190 IN FRONT OF CHURCH	12	121578	1/1/0001
05800	S	M	SOH	II	00000	011	OPP. 3232	12	121578	1/1/0001
05800	S	M	SOH	II	00000	012	OPP. 3244	12	121578	1/1/0001
05800	S	M	SOH	II	03060	023		12	040899	1/1/0001
05800	S	M	SOH	II	03098	024		12	040899	1/1/0001
05800	S	M	SOH	II	03122	025		12	040899	1/1/0001
05800	S	M	SOH	II	03144	007		12	121578	1/1/0001
05800	S	M	SOH	II	03160	026		12	040899	1/1/0001
05800	S	M	SOH	II	03168	008		12	121578	1/1/0001
05800	S	M	SOH	II	03204	027		12	040899	1/1/0001
05800	S	M	SOH	II	03262	028		12	040899	1/1/0001
05800	S	M	SOH	II	03270	013		12	121578	1/1/0001
05800	S	M	SOH	II	03280	029		12	040899	1/1/0001

OFFICE: 311

ROUTE: 564

ST_REF_NO: 00000139401

OLD MANSE COURT

LUMENS	BULB TYPE	MULT SERIES	POLE TYPE	SHADE	ADDRESS NUMBER	REF	LOCATION	TAX DIST	DATE INST	DATE CHANGE
05800	S	M	OUG	III	00512	002		12	020800	1/1/0001
05800	S	M	OUG	II	00525	001		12	020800	1/1/0001

OFFICE: 311

ROUTE: 564

ST_REF_NO: 00000139405

OLD MILL LANE

LUMENS	BULB TYPE	MULT SERIES	POLE TYPE	SHADE	ADDRESS NUMBER	REF	LOCATION	TAX DIST	DATE INST	DATE CHANGE
05800	S	M	CNT	II	00000	001	OPP. 704	12	110895	1/1/0001
05800	S	M	CNT	II	00000	002	OPP. 716	12	110895	1/1/0001
05800	S	M	CNT	II	00000	003	OPP 724	12	110895	1/1/0001
05800	S	M	CNT	II	00000	004	OPP. 736	12	110895	1/1/0001
05800	S	M	CNT	II	00000	005	OPP. 740	12	110895	1/1/0001

OFFICE: 311

ROUTE: 564

ST_REF_NO: 00000139410

OLD MT. TABOR ROAD

LUMENS	BULB TYPE	MULT SERIES	POLE TYPE	SHADE	ADDRESS NUMBER	REF	LOCATION	TAX DIST	DATE INST	DATE CHANGE
09500	S	M	OOH	III	00000	002	2ND LT. E. OF TATES CREEK ROAD	12	060893	1/1/0001
09500	S	M	OOH	III	00000	003	3RD LT. E. OF TATES CREEK ROAD	12	060893	1/1/0001
09500	S	M	OOH	III	00000	004	4TH LT. E. OF TATES CREEK ROAD	12	060893	1/1/0001
09500	S	M	OOH	III	00000	005	5TH LT. E. OF TATES CREEK ROAD	12	060893	1/1/0001
09500	S	M	OOH	III	00000	007	SIDE REAR OF 2901 CANDLELIGHT WAY	12	060893	1/1/0001
09500	S	M	OOH	III	00000	008	SIDE OF 2900 CANDLELIGHT WAY	12	060893	1/1/0001
09500	S	M	OOH	III	00000	010	1ST LT. W. OF WILLOW GLEN	12	060893	1/1/0001
09500	S	M	OOH	III	00000	011	1ST LT. E. OF WILLOW GLEN	12	060893	1/1/0001
09500	S	M	OOH	III	00000	012	1ST LT. E. OF TABOR OAKS LANE	12	060893	1/1/0001
09500	S	M	OOH	III	00000	013	1ST LT. E. OF EASTBROOK DR.	12	060893	1/1/0001
09500	S	M	SOH	III	00000	014	2ND LT. E. OF EASTBROOK DR.	12	060893	1/1/0001
09500	S	M	SOH	II	00000	015		12	090898	1/1/0001
09500	S	M	OOH	III	00252	009		12	060893	1/1/0001
09500	S	M	OOH	III	00260	006		12	060893	1/1/0001
09500	S	M	SOH	III	00272	001		12	060893	1/1/0001

OFFICE: 311

ROUTE: 564

ST_REF_NO: 00000139450

OLD NASSAU ROAD

LUMENS	BULB TYPE	MULT SERIES	POLE TYPE	SHADE	ADDRESS NUMBER	REF	LOCATION	TAX DIST	DATE INST	DATE CHANGE
05800	S	M	OUG	II	00000	050	SIDE OF 2092 WILLIAMSBURG RD.	12	040566	1/1/0001
05800	S	M	OUG	II	02034	000		12	101465	1/1/0001
05800	S	M	OUG	II	02043	000		12	101465	1/1/0001
05800	S	M	OUG	II	02050	000		12	101465	1/1/0001
05800	S	M	OUG	II	02059	000		12	030767	1/1/0001
05800	S	M	OUG	II	02066	000		12	101465	1/1/0001
05800	S	M	OUG	II	02075	000		12	101465	1/1/0001
05800	S	M	OUG	II	02082	000		12	030767	1/1/0001
05800	S	M	OUG	II	02087	000		12	101465	1/1/0001

OFFICE: 311

ROUTE: 564

ST_REF_NO: 00000139500

OLD PARIS PIKE

LUMENS	BULB TYPE	MULT SERIES	POLE TYPE	SHADE	ADDRESS NUMBER	REF	LOCATION	TAX DIST	DATE INST	DATE CHANGE
09500	S	M	SOH	III	00000	018	1859 OLD PARIS RD., SOUTH END OF PROPERTY	12	070894	1/1/0001
09500	S	M	SOH	III	00000	020	1859 OLD PARIS RD., NORTH END OF PROPERTY	12	070894	1/1/0001

OFFICE: 311

ROUTE: 564

ST_REF_NO: 00000139500

OLD PARIS PIKE

LUMENS	BULB TYPE	MULT SERIES	POLE TYPE	SHADE	ADDRESS NUMBER	REF	LOCATION	TAX DIST	DATE INST	DATE CHANGE
09500	S	M	SOH	III	00000	027	SOUTH OF 1975 OLD PARIS RD.	12	070894	1/1/0001
09500	S	M	SOH	IV	00000	037	OPP. 2134 OLD PARIS RD	12	070894	1/1/0001
09500	S	M	SOH	IV	00000	038	3RD LT. S. OF PARIS PIKE	12	070894	1/1/0001
09500	S	M	SOH	IV	00000	039	2ND LT.S. OF PARIS PIKE	12	070894	1/1/0001
09500	S	M	SOH	III	00000	040	1ST LT. SOUTH OF PARIS PIKE	12	070894	1/1/0001
09500	S	M	SOH	IV	01829	016		12	070894	1/1/0001
09500	S	M	SOH	IV	01849	017		12	070894	1/1/0001
09500	S	M	SOH	III	01859	019		12	070894	1/1/0001
09500	S	M	SOH	III	01877	021		12	070894	1/1/0001
09500	S	M	SOH	III	01889	022		12	070894	1/1/0001
09500	S	M	SOH	III	01897	023		12	070894	1/1/0001
09500	S	M	SOH	III	01949	024		12	070894	1/1/0001
09500	S	M	SOH	III	01953	025		12	070894	1/1/0001
09500	S	M	SOH	III	01957	026		12	070894	1/1/0001
09500	S	M	SOH	III	01981	028		12	070894	1/1/0001
09500	S	M	SOH	III	02009	029		12	070894	1/1/0001
09500	S	M	SOH	III	02013	030		12	070894	1/1/0001
09500	S	M	SOH	III	02025	031		12	070894	1/1/0001
09500	S	M	SOH	IV	02027	032		12	070894	1/1/0001
09500	S	M	SOH	IV	02081	033		12	070894	1/1/0001
09500	S	M	SOH	III	02093	034		12	070894	1/1/0001
09500	S	M	SOH	III	02115	035		12	070894	1/1/0001
09500	S	M	SOH	IV	02115	036		12	070894	1/1/0001
09500	S	M	SOH	III	00000	005	OPP. 1652 OLD PARIS RD.	12	070894	1/1/0001
09500	S	M	SOH	III	01613	001		12	070894	1/1/0001
09500	S	M	SOH	III	01621	002		12	070894	1/1/0001
09500	S	M	SOH	III	01629	003		12	070894	1/1/0001
09500	S	M	SOH	III	01645	004		12	070894	1/1/0001
09500	S	M	SOH	III	01661	006		12	070894	1/1/0001
09500	S	M	SOH	III	01669	007		12	070894	1/1/0001
09500	S	M	SOH	IV	01675	008		12	070894	1/1/0001
09500	S	M	SOH	IV	01685	009		12	070894	1/1/0001
09500	S	M	SOH	IV	01711	010		12	070894	1/1/0001
09500	S	M	SOH	IV	01717	011		12	070894	1/1/0001

OFFICE: 311

ROUTE: 564

ST_REF_NO: 00000139500

OLD PARIS PIKE

LUMENS	BULB TYPE	MULT SERIES	POLE TYPE	SHADE	ADDRESS NUMBER	REF	LOCATION	TAX DIST	DATE INST	DATE CHANGE
09500	S	M	SOH	IV	01731	012		12	070894	1/1/0001
09500	S	M	SOH	IV	01745	013		12	070894	1/1/0001
09500	S	M	SOH	IV	01759	014		12	070894	1/1/0001
09500	S	M	SOH	IV	01811	015		12	070894	1/1/0001

OFFICE: 311

ROUTE: 564

ST_REF_NO: 00000139510

OLD RICHMOND ROAD

LUMENS	BULB TYPE	MULT SERIES	POLE TYPE	SHADE	ADDRESS NUMBER	REF	LOCATION	TAX DIST	DATE INST	DATE CHANGE
09500	S	M	SOH	II	00000	239	AT WALNUT HILL CHILESBURG RD. INTERSECTION (NOV 2011)	12	020898	11/9/2011
09500	S	M	SOH	II	00000	341	1ST LT N OF CLEVELAND RD ON E SIDE OF OLD RICHMOND	12	071901	1/1/0001
09500	S	M	OUG	III	00000	342	1ST LT S OF CLEVELAND RD ON W SIDE OF OLD RICHMOND	12	071901	1/1/0001
09500	S	M	OUG	II	00000	343	1ST LT S OF CLEVELAND RD ON E SIDE OF OLD RICHMOND	12	071901	1/1/0001
09500	S	M	SOH	II	00000	236	OPP. 5899	12	030896	1/1/0001
09500	S	M	SOH	II	00000	237	NW CORNER OF JACKS CREEK	12	030896	1/1/0001
09500	S	M	SOH	II	00000	240	2ND LT. W OF DELONG RD., NORTHSIDE	12	020898	1/1/0001
09500	S	M	SOH	II	00000	241	1ST LT. W OF DELONG RD., NORTHSIDE	12	020898	1/1/0001
09500	S	M	SOH	II	00000	242	2ND LT. W OF DELONG RD., NORTHSIDE	12	020898	1/1/0001
09500	S	M	OUG	II	00000	320	1ST LT. N OF GRIMES MILL RD., WESTSIDE	12	050899	1/1/0001
09500	S	M	OUG	II	00000	321		12	050899	1/1/0001
09500	S	M	OUG	II	00000	322	1ST LT. N OF MCCALLS MILL RD., EASTSIDE	12	050899	1/1/0001
09500	S	M	OUG	II	00000	323	1ST LT. S OF MCCALLS MILL RD., WESTSIDE	12	050899	1/1/0001
09500	S	M	OUG	II	00000	336	1ST LT. N OF WALNUT HILL RD., E SIDE	12	060800	1/1/0001
09500	S	M	SOH	II	00000	337	1ST LT. S OF WALNUT HILL RD., W SIDE	12	040800	1/1/0001
09500	S	M	SOH	II	05902	238		12	030896	1/1/0001
09500	S	M	SOH	II	06401	326		12	060800	1/1/0001
09500	S	M	SOH	II	06401	327		12	060800	1/1/0001

OFFICE: 311

ROUTE: 564

ST_REF_NO: 00000139520

OLD ROSEBUD ROAD

LUMENS	BULB TYPE	MULT SERIES	POLE TYPE	SHADE	ADDRESS NUMBER	REF	LOCATION	TAX DIST	DATE INST	DATE CHANGE
09500	S		CNT	II	00000	001	1ST LT E OF SIR BARTON, N SIDE ON OLD ROSEBUD RD	12	092310	1/1/0001

OFFICE: 311

ROUTE: 564

ST_REF_NO: 00000139520

OLD ROSEBUD ROAD

LUMENS	BULB TYPE	MULT SERIES	POLE TYPE	SHADE	ADDRESS NUMBER	REF	LOCATION	TAX DIST	DATE INST	DATE CHANGE
09500	S		CNT	II	00000	002	2ND LT E OF SIR BARTON, N SIDE ON OLD ROSEBUD LANE	12	092310	1/1/0001
09500	S		CNT	II	00000	003	3RD LT E OF SIR BARTON, N SIDE ON OLD ROSEBUD LANE	12	092310	1/1/0001
09500	S		CNT	II	00000	004	4TH LT E OF SIR BARTON, N SIDE ON OLD ROSEBUD LANE	12	092310	1/1/0001
09500	S		CNT	II	00000	005	5TH LT E OF SIR BARTON, N SIDE ON OLD ROSEBUD LANE	12	092310	1/1/0001
09500	S		CNT	II	00000	006	6TH LT E OF SIR BARTON, N SIDE ON OLD ROSEBUD LANE	12	092310	1/1/0001
09500	S		CNT	II	00000	007	7TH LT E OF SIR BARTON, N SIDE ON OLD ROSEBUD LANE	12	092310	1/1/0001
09500	S		CNT	II	00000	008	2ND LT W OF SIR BARTON, N SIDE ON OLD ROSEBUD LANE	12	092310	1/1/0001
09500	S		CNT	II	00000	009	3RD LT W OF SIR BARTON, N SIDE ON OLD ROSEBUD LANE	12	092310	1/1/0001
09500	S		CNT	II	00000	010	4TH LT W OF SIR BARTON, N SIDE ON OLD ROSEBUD LANE	12	092310	1/1/0001
09500	S		CNT	II	00000	011	5TH LT W OF SIR BARTON, N SIDE ON OLD ROSEBUD LANE	12	092310	1/1/0001
09500	S		CNT	II	00000	012	6TH LT W OF SIR BARTON, N SIDE ON OLD ROSEBUD LANE	12	092310	1/1/0001
09500	S		CNT	II	00000	013	7TH LT W OF SIR BARTON, N SIDE ON OLD ROSEBUD LANE	12	092310	1/1/0001
09500	S		CNT	II	00000	014	8TH LT W OF SIR BARTON, N SIDE ON OLD ROSEBUD LANE	12	092310	1/1/0001
22000	S		CNT	II	00000	050	1ST LT W OF SIR BARTON, N SIDE ON OLD ROSEBUD LANE	12	092310	1/1/0001
22000	S		CNT	II	02600	021		12	092310	1/1/0001
09500	S		CNT	II	02610	020		12	092310	1/1/0001
09500	S		CNT	II	02622	019		12	092310	1/1/0001
09500	S		CNT	II	02636	018		12	092310	1/1/0001
09500	S		CNT	II	02650	017		12	092310	1/1/0001
09500	S		CNT	II	02664	016		12	092310	1/1/0001
09500	S		CNT	II	02676	015		12	092310	1/1/0001

OFFICE: 311

ROUTE: 564

ST_REF_NO: 00000139560 OLD SILO LANE

LUMENS	BULB TYPE	MULT SERIES	POLE TYPE	SHADE	ADDRESS NUMBER	REF	LOCATION	TAX DIST	DATE INST	DATE CHANGE
05800	S		CNT	II	01201	001		12	080508	1/1/0001
05800	S		CNT	II	01212	002		12	080508	1/1/0001
05800	S		CNT	II	01224	003		12	080508	1/1/0001
05800	S		CNT	II	01228	004		12	080508	1/1/0001

OFFICE: 311

ROUTE: 564

ST_REF_NO: 00000139600 OLD SOUTH COURT

LUMENS	BULB TYPE	MULT SERIES	POLE TYPE	SHADE	ADDRESS NUMBER	REF	LOCATION	TAX DIST	DATE INST	DATE CHANGE
04000	S	M	OUG	II	00000	059	SIDE 744 LONGWOOD	12	120886	1/1/0001
04000	S	M	OUG	V	01308	058		12	011581	1/1/0001

OFFICE: 311

ROUTE: 564

ST_REF_NO: 00000139610 OLD SYCAMORE PLACE

LUMENS	BULB TYPE	MULT SERIES	POLE TYPE	SHADE	ADDRESS NUMBER	REF	LOCATION	TAX DIST	DATE INST	DATE CHANGE
05800	S	M	OUG	III	04800	001		12	100896	1/1/0001

OFFICE: 311

ROUTE: 564

ST_REF_NO: 00000139650 OLD TATES CREEK ROAD

LUMENS	BULB TYPE	MULT SERIES	POLE TYPE	SHADE	ADDRESS NUMBER	REF	LOCATION	TAX DIST	DATE INST	DATE CHANGE
05800	S	M	SOH	II	00000	001	OPP. 3760	12	090895	1/1/0001
05800	S	M	OUG	II	03780	002		12	060895	1/1/0001
05800	S	M	OUG	II	03821	013		12	120899	1/1/0001
05800	S	M	OUG	II	03832	012		12	120899	1/1/0001
05800	S	M	OUG	II	03849	011		12	120899	1/1/0001

OFFICE: 311

ROUTE: 564

ST_REF_NO: 00000139700 OLD TODDS ROAD

LUMENS	BULB TYPE	MULT SERIES	POLE TYPE	SHADE	ADDRESS NUMBER	REF	LOCATION	TAX DIST	DATE INST	DATE CHANGE
22000	S		OUG	II	00000	001	1ST LT S OF LIBERTY RD, E SIDE ON OLD TODDS RD	12	122110	1/1/0001
22000	S		OUG	II	00000	400	1ST LT E OF PALUMBO DR, S SIDE ON OLD TODDS RD	12	082911	1/1/0001
09500	S		OUG	II	00000	404	5TH LT E OF PALUMBO DR, N SIDE ON OLD TODDS RD	12	082911	1/1/0001
09500	S		OUG	II	00000	405	6TH LT E OF PALUMBO DR, N SIDE ON OLD TODDS RD	12	082911	1/1/0001

OFFICE: 311

ROUTE: 564

ST_REF_NO: 00000139700

OLD TODDS ROAD

LUMENS	BULB TYPE	MULT SERIES	POLE TYPE	SHADE	ADDRESS NUMBER	REF	LOCATION	TAX DIST	DATE INST	DATE CHANGE
09500	S		OUG	II	00000	406	7TH LT E OF PALUMBO DR, N SIDE ON OLD TODDS RD	12	082911	1/1/0001
09500	S		OUG	II	00000	407	8TH LT E OF PALUMBO DR, N SIDE ON OLD TODDS RD	12	082911	1/1/0001
09500	S		OUG	II	00000	408	9TH LT E OF PALUMBO DR, N SIDE ON OLD TODDS RD	12	082911	1/1/0001
09500	S		SOH	II	00000	409	ACROSS FROM 3021 OLD TODDS RD (10 FT ARM)	12	062311	1/1/0001
09500	S		SOH	II	00000	410	ACROSS FROM 3031 OLD TODDS RD (15 FT ARM)	12	062311	1/1/0001
09500	S		OUG	II	00000	411	12TH LT E OF PALUMBO DR, S SIDE ON OLD TODDS RD	12	082911	1/1/0001
09500	S		OUG	II	00000	412	ACROSS FROM 3041 OLD TODDS RD	12	082911	1/1/0001
09500	S		SOH	II	00000	413	ACROSS FROM 3045 OLD TODDS RD (6 FT ARM)	12	062311	1/1/0001
09500	S		SOH	II	00000	414	ACROSS FROM 3055 OLD TODDS RD (6 FT ARM)	12	062311	1/1/0001
09500	S		SOH	II	00000	415	ACROSS FROM 3059 OLD TODDS RD (6 FT ARM)	12	062311	1/1/0001
09500	S		SOH	II	00000	417	1ST LT W OF MAPLELEAF DR, S SIDE ON OLD TODDS RD (6 FT ARM)	12	062311	1/1/0001
09500	S		OUG	II	00000	418	1ST LT E OF MAPLELEAF DR, S SIDE ON OLD TODDS RD	12	082911	1/1/0001
22000	S		SOH	II	00000	419	ACROSS FROM 3077 OLD TODDS RD (6 FT ARM)	12	062311	1/1/0001
22000	S		SOH	II	03061	416	(6 FT ARM)	12	062311	1/1/0001
10000	M	M	OUG	II	00000	003	OPP. 150 911 ADDRESS CHG ONLY	12	111580	11/12/2010
09500	S	M	OUG	II	00000	005	163 NORTH PATCHEN DRIVE, SOUTHSIDE-911 ADD CHG	12	100892	11/12/2010
09500	S	M	SOH	II	00000	006	911 ADD CHG	12	100892	11/12/2010
09500	S	M	OUG	V	00000	007	163 NORTH PATCHEN DRIVE, NORTHSIDE-911 ADD CHG	12	100892	11/12/2010
09500	S	M	OUG	III	00000	050	SIDE OF 640 TODDS RD.-911 ADD CHG	12	120898	11/12/2010
09500	S	M	OUG	III	00000	051	SIDE OF 520 CODELL DR., NORTHSIDE-911 ADD CHG	12	120898	11/12/2010
09500	S	M	OUG	III	00000	052	OPP. CODELL DR., SOUTHSIDE-911 ADD CHG	12	120898	11/12/2010
05800	S	M	OUG	III	00000	053	1ST LT. E. OF CODELL DR., NORTHSIDE	12	060895	11/12/2010
05800	S	M	OUG	III	00000	054	2ND LT. E. OF CODELL DR., NORTHSIDE	12	060895	11/12/2010
05800	S	M	OUG	III	00000	055	3RD LT. E. OF CODELL DR., NORTHSIDE	12	060895	11/12/2010
50000	S	M	SOH	II	00000	100	911 address changes made 11/12/2010 fna Todds Rd	12	040898	11/12/2010
09500	S	M	OUG	II	00000	199	1ST LT E OF CATERA TRACE, N SIDE ON TODDS RD	12	063006	11/12/2010
50000	S	M	OUG	II	00000	200	1ST LT E OF RICHMOND RD, S SIDE ON TODDS RD	12	062904	11/12/2010

OFFICE: 311

ROUTE: 564

ST_REF_NO: 00000139700

OLD TODDS ROAD

LUMENS	BULB TYPE	MULT SERIES	POLE TYPE	SHADE	ADDRESS NUMBER	REF	LOCATION	TAX DIST	DATE INST	DATE CHANGE
09500	S	M	OUG	II	00000	201	2ND LT E OF CATERA TRACE, N SIDE ON TODDS RD	12	063006	11/12/2010
09500	S	M	OUG	II	00000	202	3RD LT E OF CATERA TRACE, S SIDE ON TODDS RD	12	063006	11/12/2010
09500	S	M	OUG	II	00000	203	4TH LT E OF CATERA TRACE, S SIDE ON TODDS RD	12	063006	11/12/2010
09500	S	M	OUG	II	00000	204	1ST LT E OF ASHLEY GLEN PL, N SIDE ON TODDS RD	12	063006	11/12/2010
09500	S	M	OUG	II	00000	205	2ND LT E OF ASHLEY GLEN PL, S SIDE ON TODDS RD	12	063006	11/12/2010
09500	S	M	OUG	II	00000	206	3RD LT E OF ASHLEY GLEN PL, N SIDE ON TODDS RD	12	063006	11/12/2010
09500	S	M	OUG	II	00000	207	4TH LT E OF ASHLEY GLEN PL, S SIDE ON TODDS RD	12	063006	11/12/2010
09500	S	M	OUG	II	00000	208	1ST LT E OF N MT TABOR, S SIDE ON TODDS RD	12	063006	11/12/2010
09500	S	M	OUG	II	00000	209	2ND LT E OF N MT TABOR, S SIDE ON TODDS RD	12	063006	11/12/2010
09500	S	M	OUG	II	00000	210	3RD LT E OF N MT TABOR, N SIDE ON TODDS RD	12	063006	11/12/2010
09500	S	M	OUG	II	00000	211	1ST LT E OF WOODHILL DR, N SIDE ON TODDS RD	12	063006	11/12/2010
09500	S	M	OUG	II	00000	212	2ND LT E OF WOODHILL DR, S SIDE ON TODDS RD	12	063006	11/12/2010
09500	S	M	OUG	II	00000	213	3RD LT E OF WOODHILL DR, N SIDE ON TODDS RD	12	063006	11/12/2010
09500	S	M	OUG	II	00000	214	4TH LT E OF WOODHILL DR, N SIDE ON TODDS RD	12	063006	11/12/2010
09500	S	M	OUG	II	00000	215	5TH LT E OF WOODHILL DR, S SIDE ON TODDS RD	12	063006	11/12/2010
09500	S	M	OUG	II	00000	216	1ST LT E OF PINWOOD CT, S SIDE ON TODDS RD	12	063006	11/12/2010
09500	S	M	OUG	II	00000	217	2ND LT E OF PINWOOD CT, N SIDE ON TODDS RD	12	063006	11/12/2010
09500	S	M	OUG	II	00000	218	3RD LT E OF PINWOOD CT, N SIDE ON TODDS RD	12	063006	11/12/2010
09500	S	M	OUG	II	00000	219	4TH LT E OF PINWOOD CT, N SIDE ON TODDS RD	12	063006	11/12/2010
09500	S	M	OUG	II	00000	220	5TH LT E OF PINWOOD CT, N SIDE ON TODDS RD	12	063006	11/12/2010
09500	S	M	OUG	II	00000	221	6TH LT E OF PINWOOD CT, N SIDE ON TODDS RD	12	063006	11/12/2010
09500	S	M	OUG	II	00000	222	7TH LT E OF PINWOOD CT, N SIDE ON TODDS RD	12	063006	11/12/2010
09500	S		OUG	II	00000	401	2ND LT E OF PALUMBO DR, S SIDE ON OLD TODDS RD	12	082911	8/29/2011
09500	S		OUG	II	00000	402	3RD LT E OF PALUMBO DR, S SIDE ON OLD TODDS RD	12	082911	8/29/2011
09500	S		OUG	II	00000	403	4TH LT E OF PALUMBO DR, S SIDE ON OLD TODDS RD	12	082911	8/29/2011
10000	M	M	OUG	II	00100	002	911 ADD CHG	12	091582	11/12/2010
10000	M	M	OUG	II	00150	004	911 ADD CHG	12	111580	11/12/2010
05800	S	M	OUG	III	00851	056		12	060895	11/12/2010

Street Light Listing run 1/11/2015 10:43:21 AM

Page 820 of 1254

OFFICE: 311

ROUTE: 564

ST_REF_NO: 00000139700 OLD TODDS ROAD

LUMENS	BULB TYPE	MULT SERIES	POLE TYPE	SHADE	ADDRESS NUMBER	REF	LOCATION	TAX DIST	DATE INST	DATE CHANGE
05800	S	M	SOH	III	00851	057		12	060895	11/12/2010

OFFICE: 311

ROUTE: 564

ST_REF_NO: 00000139730 OLD TOWNE WALK

LUMENS	BULB TYPE	MULT SERIES	POLE TYPE	SHADE	ADDRESS NUMBER	REF	LOCATION	TAX DIST	DATE INST	DATE CHANGE
05800	S		CLN	II	00000	005	SIDE OF 152 OLD TOWNE WALK	12	101709	1/1/0001
05800	S		CLN	II	00000	006	SIDE OF 145 TOWNE SQUARE ON OLD TOWNE WALK	12	101709	1/1/0001
05800	S		CLN	II	00128	002		12	101709	1/1/0001
05800	S		CLN	II	00132	003		12	101709	1/1/0001
05800	S		CLN	II	00148	004		12	101709	1/1/0001

OFFICE: 311

ROUTE: 564

ST_REF_NO: 00000139750 OLDE HURST PLACE

LUMENS	BULB TYPE	MULT SERIES	POLE TYPE	SHADE	ADDRESS NUMBER	REF	LOCATION	TAX DIST	DATE INST	DATE CHANGE
05800	S	M	SOH	I	00000	068	1ST LT. E. OF BARRON ST., N. SIDE	12	111366	1/1/0001
04000	S	M	SOH	I	00000	069	1ST LT. W. OF DEWEESE ST., S. SIDE	12	110266	1/1/0001

OFFICE: 311

ROUTE: 564

ST_REF_NO: 00000139800 OLDHAM AVENUE

LUMENS	BULB TYPE	MULT SERIES	POLE TYPE	SHADE	ADDRESS NUMBER	REF	LOCATION	TAX DIST	DATE INST	DATE CHANGE
05800	S	M	SOH	II	00000	000	SIDE OF 541 EUCLID AVENUE	12	051167	9/9/2009
09500	S	S	SOH	I	00426	000		12	070767	9/9/2009
09500	S	M	SOH	II	00432	100		12	010606	1/1/0001
09500	S	M	SOH	II	00454	101		12	010606	1/1/0001
09500	S	M	SOH	II	00000	001	SIDE OF 552 COLUMBIA	12	100886	1/1/0001
09500	S	M	SOH	II	00000	002	OPP. 520	12	100886	1/1/0001
09500	S	S	SOH	I	00000	605	SIDE OF 542 EUCLID AVE.	12	070767	1/1/0001
05800	S	S	SOH	II	00312	000		12	051167	1/1/0001
05800	S	M	SOH	II	00329	000		12	051167	1/1/0001
05800	S	S	SOH	II	00346	000		12	051167	1/1/0001
05800	S	M	SOH	II	00355	000		12	051167	1/1/0001
09500	S	M	SOH	I	00436	000		12	070767	1/1/0001
09500	S	S	SOH	I	00446	000		12	070767	1/1/0001
09500	S	S	SOH	I	00458	000		12	070767	1/1/0001

OFFICE: 311 ROUTE: 564										
ST_REF_NO: 00000139800 OLDHAM AVENUE										
LUMENS	BULB TYPE	MULT SERIES	POLE TYPE	SHADE	ADDRESS NUMBER	REF	LOCATION	TAX DIST	DATE INST	DATE CHANGE
05800	S	M	SOH	II	00505	004		12	020887	1/1/0001
05800	S	M	SOH	II	00511	000		12	040160	1/1/0001
OFFICE: 311 ROUTE: 564										
ST_REF_NO: 00000139870 OLDWOOD COURT										
LUMENS	BULB TYPE	MULT SERIES	POLE TYPE	SHADE	ADDRESS NUMBER	REF	LOCATION	TAX DIST	DATE INST	DATE CHANGE
05800	S	M	OUG	II	01000	001		12	060897	1/1/0001
05800	S	M	OUG	II	01005	002		12	060897	1/1/0001
05800	S	M	OUG	II	01017	003		12	060897	1/1/0001
05800	S	M	OUG	III	01020	004		12	060897	1/1/0001
OFFICE: 311 ROUTE: 564										
ST_REF_NO: 00000139900 OLEANDER COURT										
LUMENS	BULB TYPE	MULT SERIES	POLE TYPE	SHADE	ADDRESS NUMBER	REF	LOCATION	TAX DIST	DATE INST	DATE CHANGE
09500	S	M	OUG	II	02119	083	upgrade per city request	12	090363	6/29/2009
05800	S	M	OUG	II	00000	082	SIDE OF 2112 OLEANDER DR.	12	090363	1/1/0001
OFFICE: 311 ROUTE: 564										
ST_REF_NO: 00000140000 OLEANDER DRIVE										
LUMENS	BULB TYPE	MULT SERIES	POLE TYPE	SHADE	ADDRESS NUMBER	REF	LOCATION	TAX DIST	DATE INST	DATE CHANGE
05800	S	M	OUG	II	00000	051	SIDE OF 980 HONEYSUCKLE RD.	12	110162	1/1/0001
05800	S	M	OUG	II	00000	075	SIDE OF 2068 ALEXANDRIA DR.	12	090363	1/1/0001
05800	S	M	OUG	II	02011	000		12	120162	1/1/0001
05800	S	M	OUG	II	02020	000		12	081162	1/1/0001
05800	S	M	OUG	II	02033	000		12	102263	1/1/0001
05800	S	M	OUG	II	02048	000		12	090164	1/1/0001
05800	S	M	OUG	II	02064	074		12	090363	1/1/0001
05800	S	M	OUG	II	02104	076		12	090363	1/1/0001
05800	S	M	OUG	II	02113	077		12	090363	1/1/0001
05800	S	M	OUG	II	02128	078		12	090363	1/1/0001
05800	S	M	OUG	II	02141	079		12	090363	1/1/0001

OFFICE: 311

ROUTE: 564

ST_REF_NO: 00000140105

OLIVER LEWIS WAY

LUMENS	BULB TYPE	MULT SERIES	POLE TYPE	SHADE	ADDRESS NUMBER	REF	LOCATION	TAX DIST	DATE INST	DATE CHANGE
50000	S		CNT	II	00000	001	1ST LT N OF VERSAILLES RD, W SIDE ON OLIVER LEWIS WAY	12	031511	1/1/0001
22000	S		CNT	II	00000	002	1ST LT N OF VERSAILLES RD, E SIDE ON OLIVER LEWIS WAY	12	031511	1/1/0001
22000	S		CNT	II	00000	003	2ND LT N OF VERSAILLES RD, W SIDE ON OLIVER LEWIS WAY	12	031511	1/1/0001
22000	S		CNT	II	00000	004	2ND LT N OF VERSAILLES RD, E SIDE ON OLIVER LEWIS WAY	12	031511	1/1/0001
22000	S		CNT	II	00000	005	3RD LT N OF VERSAILLES RD, W SIDE ON OLIVER LEWIS WAY	12	031511	1/1/0001
22000	S		CNT	II	00000	006	3RD LT N OF VERSAILLES RD, E SIDE ON OLIVER LEWIS WAY	12	031511	1/1/0001
22000	S		CNT	II	00000	007	4TH LT N OF VERSAILLES RD, W SIDE ON OLIVER LEWIS WAY	12	031511	1/1/0001
22000	S		CNT	II	00000	008	4TH LT N OF VERSAILLES RD, E SIDE ON OLIVER LEWIS WAY	12	031511	1/1/0001
22000	S		CNT	II	00000	009	5TH LT N OF VERSAILLES RD, W SIDE ON OLIVER LEWIS WAY	12	031511	1/1/0001
22000	S		CNT	II	00000	010	5TH LT N OF VERSAILLES RD, E SIDE ON OLIVER LEWIS WAY	12	031511	1/1/0001
22000	S		CNT	II	00000	011	6TH LT N OF VERSAILLES RD, W SIDE ON OLIVER LEWIS WAY	12	031511	1/1/0001
50000	S		CNT	II	00000	012	6TH LT N OF VERSAILLES RD, E SIDE ON OLIVER LEWIS WAY	12	031511	1/1/0001
50000	S		CNT	II	00000	013	1ST LT N OF MANCHESTER, W SIDE ON OLIVER LEWIS WAY	12	031511	1/1/0001
22000	S		CNT	II	00000	014	1ST LT N OF MANCHESTER, E SIDE ON OLIVER LEWIS WAY	12	031511	1/1/0001
22000	S		CNT	II	00000	015	2ND LT N OF MANCHESTER, W SIDE ON OLIVER LEWIS WAY	12	031511	1/1/0001
09500	S		CNT	II	00000	016	2ND LT N OF MANCHESTER, E SIDE ON OLIVER LEWIS WAY	12	031511	1/1/0001
09500	S		CNT	II	00000	017	3RD LT N OF MANCHESTER, W SIDE ON OLIVER LEWIS WAY	12	031511	1/1/0001
09500	S		CNT	II	00000	018	3RD LT N OF MANCHESTER, E SIDE ON OLIVER LEWIS WAY	12	031511	1/1/0001
09500	S		CNT	II	00000	019	4TH LT N OF MANCHESTER, W SIDE ON OLIVER LEWIS WAY	12	031511	1/1/0001
09500	S		CNT	II	00000	020	4TH LT N OF MANCHESTER, E SIDE ON OLIVER LEWIS WAY	12	031511	1/1/0001

OFFICE: 311		ROUTE: 564		ST_REF_NO: 00000140105		OLIVER LEWIS WAY				
LUMENS	BULB TYPE	MULT SERIES	POLE TYPE	SHADE	ADDRESS NUMBER	REF	LOCATION	TAX DIST	DATE INST	DATE CHANGE
09500	S		CNT	II	00000	021	5TH LT N OF MANCHESTER, W SIDE ON OLIVER LEWIS WAY	12	031511	1/1/0001
09500	S		CNT	II	00000	022	5TH LT N OF MANCHESTER, E SIDE ON OLIVER LEWIS WAY	12	031511	1/1/0001
09500	S		CNT	II	00000	023	6TH LT N OF MANCHESTER, W SIDE ON OLIVER LEWIS WAY	12	031511	1/1/0001
22000	S		CNT	II	00000	024	6TH LT N OF MANCHESTER, E SIDE ON OLIVER LEWIS WAY	12	031511	1/1/0001
22000	S		CNT	II	00000	025	7TH LT N OF MANCHESTER, W SIDE ON OLIVER LEWIS WAY	12	031511	1/1/0001
22000	S		CNT	II	00000	026	8TH LT N OF MANCHESTER, W SIDE ON OLIVER LEWIS WAY	12	031511	1/1/0001
22000	S		CNT	II	00000	027	9TH LT N OF MANCHESTER, E SIDE ON OLIVER LEWIS WAY	12	031511	1/1/0001
22000	S		CNT	II	00000	028	9TH LT N OF MANCHESTER, W SIDE ON OLIVER LEWIS WAY	12	031511	1/1/0001
22000	S		CNT	II	00000	029	8TH LT N OF MANCHESTER, E SIDE ON OLIVER LEWIS WAY	12	031511	1/1/0001
22000	S		CNT	II	00000	030	10TH LT N OF MANCHESTER, W SIDE ON OLIVER LEWIS WAY	12	031511	1/1/0001
50000	S		CNT	II	00000	031	9TH LT N OF MANCHESTER, E SIDE ON OLIVER LEWIS WAY	12	031511	1/1/0001
OFFICE: 311		ROUTE: 564		ST_REF_NO: 00000140120		OLIVIA LANE				
LUMENS	BULB TYPE	MULT SERIES	POLE TYPE	SHADE	ADDRESS NUMBER	REF	LOCATION	TAX DIST	DATE INST	DATE CHANGE
09500	S	M	OUG	II	00000	001	OPP. FROM SIDE OF 1448 NEWTOWN PK.	12	030172	2/10/2012
10000	M	M	OUG	II	00000	002	SIDE OF 1448 NEWTOWN PK.	12	030172	1/1/0001
10000	M	M	OUG	II	00000	003	OPP. 1460	12	030172	1/1/0001
09500	S	M	OUG	II	00000	004	1460 AT END OF STREET	12	030172	1/1/0001
OFFICE: 311		ROUTE: 564		ST_REF_NO: 00000140175		OLMSTEAD COURT				
LUMENS	BULB TYPE	MULT SERIES	POLE TYPE	SHADE	ADDRESS NUMBER	REF	LOCATION	TAX DIST	DATE INST	DATE CHANGE
05800	S	M	CNT	III	02204	002		12	071102	1/1/0001

OFFICE: 311		ROUTE: 564		ST_REF_NO: 00000140200		OLYMPIA CIRCLE		LUMENS	BULB TYPE	MULT SERIES	POLE TYPE	SHADE	ADDRESS NUMBER	REF	LOCATION	TAX DIST	DATE INST	DATE CHANGE
05800	S	M	OUG	II	03605	000										12	041067	1/1/0001
05800	S	M	OUG	II	03616	000										12	041067	1/1/0001
05800	S	M	OUG	II	03629	000										12	041067	1/1/0001

OFFICE: 311		ROUTE: 564		ST_REF_NO: 00000140300		OLYMPIA ROAD		LUMENS	BULB TYPE	MULT SERIES	POLE TYPE	SHADE	ADDRESS NUMBER	REF	LOCATION	TAX DIST	DATE INST	DATE CHANGE
05800	S	M	OUG	II	00000	015	SIDE OF 1136 VENETIAN CIR.									12	071562	1/1/0001
05800	S	M	OUG	II	00000	073	SIDE OF 1112 CENTRE PARKWAY									12	050768	1/1/0001
05800	S	M	OUG	II	03508	000										12	081869	1/1/0001
05800	S	M	OUG	II	03519	000										12	080171	1/1/0001
05800	S	M	OUG	II	03536	000										12	080171	1/1/0001
05800	S	M	OUG	II	03545	000										12	090266	1/1/0001
05800	S	M	OUG	II	03550	000										12	090266	1/1/0001
05800	S	M	OUG	II	03557	000										12	091562	1/1/0001
05800	S	M	OUG	II	03575	000										12	090266	1/1/0001
05800	S	M	OUG	II	03580	000										12	022262	1/1/0001
05800	S	M	OUG	II	03587	000										12	090266	1/1/0001
05800	S	M	OUG	II	03592	000										12	022262	1/1/0001
05800	S	M	OUG	II	03595	000										12	090266	1/1/0001

OFFICE: 311		ROUTE: 564		ST_REF_NO: 00000140350		ONYX CT		LUMENS	BULB TYPE	MULT SERIES	POLE TYPE	SHADE	ADDRESS NUMBER	REF	LOCATION	TAX DIST	DATE INST	DATE CHANGE
04000	S	M	OUG	II	03509	001										12	110891	1/1/0001

OFFICE: 311		ROUTE: 564		ST_REF_NO: 00000140400		ORCHARD AVENUE		LUMENS	BULB TYPE	MULT SERIES	POLE TYPE	SHADE	ADDRESS NUMBER	REF	LOCATION	TAX DIST	DATE INST	DATE CHANGE
09500	S	M	SOH	II	00000	200	SIDE OF 460 PARK AVENUE ON ORCHARD AVENUE									12	010606	1/1/0001
05800	S	M	SOH	I	00612	000										12	011865	1/1/0001
05800	S	M	SOH	V	00622	000										12	011865	1/1/0001

OFFICE: 311		ROUTE: 564		ST_REF_NO: 00000140550		ORLANDO COURT		LUMENS	BULB TYPE	MULT SERIES	POLE TYPE	SHADE	ADDRESS NUMBER	REF	LOCATION	TAX DIST	DATE INST	DATE CHANGE
05800	S	M	CNT	III	04705	001										12	032404	1/1/0001
OFFICE: 311		ROUTE: 564		ST_REF_NO: 00000140575		ORMESBY PLACE		LUMENS	BULB TYPE	MULT SERIES	POLE TYPE	SHADE	ADDRESS NUMBER	REF	LOCATION	TAX DIST	DATE INST	DATE CHANGE
09500	S		CLN	III	00000	001	1ST LT W OF ELLERSLIE PK BLVD, ON ORMESBY PLACE									12	041511	1/1/0001
09500	S		CLN	III	00000	002	SIDE OF 169 ELLERSLIE PK BLVD, ON ORMESBY PLACE									12	041511	1/1/0001
09500	S		CLN	III	00000	004	SIDE OF 173 SOMERSLY PL, ON ORMESBY PLACE									12	041511	1/1/0001
09500	S		CLN	III	03861	007										12	041511	1/1/0001
09500	S		CLN	III	03869	006										12	041511	1/1/0001
09500	S		CLN	III	03873	005										12	041511	1/1/0001
OFFICE: 311		ROUTE: 564		ST_REF_NO: 00000140600		ORMOND CIRCLE		LUMENS	BULB TYPE	MULT SERIES	POLE TYPE	SHADE	ADDRESS NUMBER	REF	LOCATION	TAX DIST	DATE INST	DATE CHANGE
05800	S	M	OUG	II	00000	031	SIDE OF 320 REDDING RD.									12	010171	1/1/0001
05800	S	M	OUG	II	03479	000										12	080173	1/1/0001
05800	S	M	OUG	II	03486	000										12	022674	1/1/0001
05800	S	M	OUG	V	03498	000										12	010172	1/1/0001
OFFICE: 311		ROUTE: 564		ST_REF_NO: 00000140700		OSAGE COURT		LUMENS	BULB TYPE	MULT SERIES	POLE TYPE	SHADE	ADDRESS NUMBER	REF	LOCATION	TAX DIST	DATE INST	DATE CHANGE
05800	S	M	OUG	V	00213	000										12	080172	1/1/0001
05800	S	M	OUG	II	00283	000										12	070172	1/1/0001
OFFICE: 311		ROUTE: 564		ST_REF_NO: 00000140800		OSPREY CIRCLE		LUMENS	BULB TYPE	MULT SERIES	POLE TYPE	SHADE	ADDRESS NUMBER	REF	LOCATION	TAX DIST	DATE INST	DATE CHANGE
04000	S	M	OUG	II	00000	057	SIDE 462 MONTICELLO BLVD.									12	100885	1/1/0001
04000	S	M	OUG	II	00451	056										12	100885	1/1/0001
04000	S	M	OUG	II	00467	055										12	100885	1/1/0001
04000	S	M	OUG	II	00478	054										12	100885	1/1/0001

OFFICE: 311

ROUTE: 564

ST_REF_NO: 00000140800

OSPREY CIRCLE

LUMENS	BULB TYPE	MULT SERIES	POLE TYPE	SHADE	ADDRESS NUMBER	REF	LOCATION	TAX DIST	DATE INST	DATE CHANGE
04000	S	M	OUG	II	00494	053		12	100885	1/1/0001

OFFICE: 311

ROUTE: 564

ST_REF_NO: 00000140900

OTTER CREEK DRIVE

LUMENS	BULB TYPE	MULT SERIES	POLE TYPE	SHADE	ADDRESS NUMBER	REF	LOCATION	TAX DIST	DATE INST	DATE CHANGE
04000	S	M	OUG	II	00000	054	SIDE OF 282 EAGLE CREEK DR.	12	051477	1/1/0001
04000	S	M	OUG	II	00000	058	SIDE OF 3340 BEAVER CREEK DR.	12	051478	1/1/0001
04000	S	M	OUG	II	00000	059	SIDE OF 3333 BEAVER CREEK DR.	12	051478	1/1/0001
04000	S	M	OUG	II	03309	055		12	051478	1/1/0001
04000	S	M	OUG	II	03324	056		12	051478	1/1/0001
04000	S	M	OUG	II	03329	057		12	051477	1/1/0001
04000	S	M	OUG	II	03357	060		12	051478	1/1/0001
04000	S	M	OUG	II	03369	061		12	051478	1/1/0001
04000	S	M	OUG	V	03385	062		12	051477	1/1/0001

OFFICE: 311

ROUTE: 564

ST_REF_NO: 00000140940

OUR TIBBS TRAIL

LUMENS	BULB TYPE	MULT SERIES	POLE TYPE	SHADE	ADDRESS NUMBER	REF	LOCATION	TAX DIST	DATE INST	DATE CHANGE
05800	S		CNT	II	03032	005		12	061011	1/1/0001
05800	S		CNT	II	03049	004		12	061011	1/1/0001
05800	S		CNT	II	03060	003		12	061011	1/1/0001
05800	S		CNT	II	03077	002		12	061011	1/1/0001
05800	S		CNT	III	03085	001		12	061011	1/1/0001

OFFICE: 311

ROUTE: 564

ST_REF_NO: 00000140990

OVER DRIVE

LUMENS	BULB TYPE	MULT SERIES	POLE TYPE	SHADE	ADDRESS NUMBER	REF	LOCATION	TAX DIST	DATE INST	DATE CHANGE
05800	S	M	OUG	II	02409	003		12	090898	1/1/0001
05800	S	M	OUG	II	02416	004		12	090898	1/1/0001
05800	S	M	OUG	III	02432	006		12	090898	1/1/0001
05800	S	M	OUG	III	02433	008		12	090898	1/1/0001

OFFICE: 311

ROUTE: 564

ST_REF_NO: 00000141150

LUMENS	BULB TYPE	MULT SERIES	POLE TYPE	SHADE	ADDRESS NUMBER	REF	LOCATION	TAX DIST	DATE INST	DATE CHANGE
05800	S	M	OUG	II	00000	001	SIDE OF 133 TRADE ST.	12	020888	1/1/0001
05800	S	M	OUG	II	02408	002		12	020888	1/1/0001
05800	S	M	OUG	II	02417	005		12	020888	1/1/0001
05800	S	M	OUG	V	02425	007		12	020888	1/1/0001

OFFICE: 311

ROUTE: 564

ST_REF_NO: 00000141160

OVERLAKE CIRCLE

LUMENS	BULB TYPE	MULT SERIES	POLE TYPE	SHADE	ADDRESS NUMBER	REF	LOCATION	TAX DIST	DATE INST	DATE CHANGE
05800	S	M	CNT	II	02582	001		12	060894	1/1/0001
05800	S	M	CNT	III	02583	002		12	050897	1/1/0001

OFFICE: 311

ROUTE: 564

ST_REF_NO: 00000141175

OVERVIEW

LUMENS	BULB TYPE	MULT SERIES	POLE TYPE	SHADE	ADDRESS NUMBER	REF	LOCATION	TAX DIST	DATE INST	DATE CHANGE
04000	S	M	OUG	II	00804	001		12	100890	1/1/0001
04000	S	M	OUG	II	00809	002		12	090891	1/1/0001
04000	S	M	OUG	II	00828	003		12	090891	1/1/0001
04000	S	M	OUG	II	00837	004		12	090891	1/1/0001
04000	S	M	OUG	II	00852	005		12	090891	1/1/0001
04000	S	M	OUG	II	00861	006		12	090891	1/1/0001
04000	S	M	OUG	II	00873	007		12	090891	1/1/0001
04000	S	M	OUG	II	00885	008		12	090891	1/1/0001
04000	S	M	OUG	II	00891	009		12	090891	1/1/0001
04000	S	M	OUG	V	00909	010		12	090891	1/1/0001

OFFICE: 311

ROUTE: 564

ST_REF_NO: 00000141180

OWLS HEAD LANE

LUMENS	BULB TYPE	MULT SERIES	POLE TYPE	SHADE	ADDRESS NUMBER	REF	LOCATION	TAX DIST	DATE INST	DATE CHANGE
05800	S	M	CNT	II	03105	001		12	120404	1/1/0001

OFFICE: 311

ROUTE: 564

ST_REF_NO: 00000141200

OWEN STREET

LUMENS	BULB TYPE	MULT SERIES	POLE TYPE	SHADE	ADDRESS NUMBER	REF	LOCATION	TAX DIST	DATE INST	DATE CHANGE
05800	S	M	SOH	I	00000	183	1ST LT. S. OF 3RD ST.	12	120666	1/1/0001
05800	S	M	SOH	I	00000	184	2ND LT. S. OF 3RD ST.	12	020865	1/1/0001

OFFICE: 311		ROUTE: 564		ST_REF_NO: 00000141300		OWSLEY AVENUE				
LUMENS	BULB TYPE	MULT SERIES	POLE TYPE	SHADE	ADDRESS NUMBER	REF	LOCATION	TAX DIST	DATE INST	DATE CHANGE
04000	S	M	SOH	II	00000	039	SIDE 1135 RICHMOND RD.	12	050885	1/1/0001
04000	S	M	SOH	II	00000	046	OPP. 210	12	020885	1/1/0001
04000	S	M	SOH	II	00107	040		12	050885	1/1/0001
04000	S	M	SOH	II	00112	041		12	050885	1/1/0001
04000	S	M	SOH	II	00119	042		12	020885	1/1/0001
05800	S	M	SOH	II	00128	043	change out bad fixture 2/08	12	020885	1/1/0001
04000	S	M	SOH	II	00135	044		12	050885	1/1/0001
04000	S	M	SOH	II	00201	045		12	020885	1/1/0001
04000	S	M	SOH	II	00215	047		12	050885	1/1/0001
04000	S	M	SOH	II	00226	048		12	020885	1/1/0001
04000	S	M	SOH	II	00300	049		12	020885	1/1/0001
04000	S	M	SOH	II	00308	050		12	050885	1/1/0001
04000	S	M	SOH	II	00317	051		12	020885	1/1/0001
04000	S	M	SOH	II	00323	052		12	020885	1/1/0001
04000	S	M	SOH	II	00327	054		12	020885	1/1/0001
04000	S	M	SOH	II	00341	055		12	020885	1/1/0001
04000	S	M	SOH	II	00347	056		12	020885	1/1/0001
04000	S	M	SOH	II	00353	057		12	020885	1/1/0001

OFFICE: 311		ROUTE: 564		ST_REF_NO: 00000141400		OXHILL DRIVE				
LUMENS	BULB TYPE	MULT SERIES	POLE TYPE	SHADE	ADDRESS NUMBER	REF	LOCATION	TAX DIST	DATE INST	DATE CHANGE
05800	S	M	OUG	II	01305	000		12	080173	1/1/0001
05800	S	M	OUG	II	01316	000		12	080173	1/1/0001
05800	S	M	OUG	II	01325	000		12	081073	1/1/0001
05800	S	M	OUG	V	01341	000		12	080173	1/1/0001

OFFICE: 311		ROUTE: 564		ST_REF_NO: 00000141500		OXFORD CIRCLE				
LUMENS	BULB TYPE	MULT SERIES	POLE TYPE	SHADE	ADDRESS NUMBER	REF	LOCATION	TAX DIST	DATE INST	DATE CHANGE
22000	S		OUG	II	00000	100	1ST LT N OF VERSAILLES RD., W SIDE ON OXFORD CIRCLE	12	121009	1/1/0001
22000	S		OUG	II	00000	110	SIDE OF 1907 VERSAILLES RD., ON OXFORD CIRCLE	12	121009	1/1/0001
22000	S	M	OUG	II	00000	001	OPP. 100	12	080565	12/4/2009

OFFICE: 311		ROUTE: 564		ST_REF_NO: 00000141500		OXFORD CIRCLE		LUMENS	BULB TYPE	MULT SERIES	POLE TYPE	SHADE	ADDRESS NUMBER	REF	LOCATION	TAX DIST	DATE INST	DATE CHANGE
22000	S	M	OUG	II	00000	011	SIDE OF 2011 VERSAILLES RD.	12	080565	11/17/2009								
09500	S	M	OUG	II	00000	002	OPP. 110	12	080565	1/1/0001								
09500	S	M	OUG	II	00000	003	OPP. 112	12	080565	1/1/0001								
09500	S	M	OOH	II	00000	004	OPP. LONDONDERRY DR.	12	100967	1/1/0001								
09500	S	M	OUG	II	00000	009	3RD LT. N. OF VERSAILLES RD., E. SIDE	12	091477	1/1/0001								
09500	S	M	OUG	II	00000	010	2ND LT. N. OF VERSAILLES RD., E. SIDE	12	091477	1/1/0001								
09500	S	M	OUG	II	00000	020	SIDE OF 1901 CAMBRIDGE DR.	12	080565	1/1/0001								
09500	S	M	OUG	II	00100	015		12	080565	1/1/0001								
09500	S	M	OUG	II	00104	000		12	120558	1/1/0001								
09500	S	M	OUG	II	00114	014		12	080565	1/1/0001								
09500	S	M	OUG	II	01903	017		12	100163	1/1/0001								
09500	S	M	OUG	II	01909	000		12	090159	1/1/0001								
09500	S	M	OUG	II	01915	019		12	081363	1/1/0001								
09500	S	M	OUG	II	01921	015		12	081363	1/1/0001								
09500	S	M	OUG	II	01930	008		12	080565	1/1/0001								
09500	S	M	OUG	II	01931	013		12	090166	1/1/0001								
09500	S	M	OUG	II	01931	014		12	090166	1/1/0001								

OFFICE: 311		ROUTE: 564		ST_REF_NO: 00000141600		PACKANACK COURT		LUMENS	BULB TYPE	MULT SERIES	POLE TYPE	SHADE	ADDRESS NUMBER	REF	LOCATION	TAX DIST	DATE INST	DATE CHANGE
04000	S	M	OUG	II	00000	068	SIDE OF 3220 SHOALLAKE DR.	12	111579	1/1/0001								
04000	S	M	OUG	II	03209	069		12	111579	1/1/0001								
05800	S	M	OUG	II	03224	070	change out bad fixture 2/08	12	111478	1/1/0001								
04000	S	M	OUG	V	03229	071		12	111478	1/1/0001								

OFFICE: 311		ROUTE: 564		ST_REF_NO: 00000141700		PADDOCK COURT		LUMENS	BULB TYPE	MULT SERIES	POLE TYPE	SHADE	ADDRESS NUMBER	REF	LOCATION	TAX DIST	DATE INST	DATE CHANGE
05800	S	M	OUG	II	02697	000		12	050168	1/1/0001								

OFFICE: 311		ROUTE: 564		ST_REF_NO: 00000141800		PAIGE COURT		LUMENS	BULB TYPE	MULT SERIES	POLE TYPE	SHADE	ADDRESS NUMBER	REF	LOCATION	TAX DIST	DATE INST	DATE CHANGE
	05800	S	M	OUG	II	00000	018								SIDE OF 986 LAKELAND DR.	12	091477	1/1/0001
	05800	S	M	OUG	II	02108	000									12	011874	1/1/0001
	05800	S	M	OUG	V	02124	000									12	041470	1/1/0001
OFFICE: 311		ROUTE: 564		ST_REF_NO: 00000141890		PALMBROOKE COURT		LUMENS	BULB TYPE	MULT SERIES	POLE TYPE	SHADE	ADDRESS NUMBER	REF	LOCATION	TAX DIST	DATE INST	DATE CHANGE
	04000	S	M	OUG	II	02105	001									12	010888	1/1/0001
	04000	S	M	OUG	V	02108	002									12	010888	1/1/0001
OFFICE: 311		ROUTE: 564		ST_REF_NO: 00000141892		PALAMINO LANE		LUMENS	BULB TYPE	MULT SERIES	POLE TYPE	SHADE	ADDRESS NUMBER	REF	LOCATION	TAX DIST	DATE INST	DATE CHANGE
	05800	S	M	CNT	V	00812	006									12	080894	1/1/0001
	05800	S	M	CNT	II	00824	005									12	080894	1/1/0001
	05800	S	M	CNT	II	00825	004									12	080894	1/1/0001
	05800	S	M	CNT	II	00900	003									12	080894	1/1/0001
	05800	S	M	CNT	II	00909	002									12	080894	1/1/0001
	05800	S	M	CNT	II	00921	001									12	080894	1/1/0001
OFFICE: 311		ROUTE: 564		ST_REF_NO: 00000141893		PALERMO PLACE		LUMENS	BULB TYPE	MULT SERIES	POLE TYPE	SHADE	ADDRESS NUMBER	REF	LOCATION	TAX DIST	DATE INST	DATE CHANGE
	05800	S	M	CNT	II	00000	001								SIDE OF EVEREST CT ON PALERMO DR	12	061501	1/1/0001
	05800	S	M	CNT	II	04617	007									12	061501	1/1/0001
	05800	S	M	CNT	II	00000	001								SIDE OF 740 ST. ELIAS DR.	12	080800	1/1/0001
	05800	S	M	CNT	II	00000	004								SIDE REAR OF 797 FITZROY LANE	12	080800	1/1/0001
	05800	S	M	CNT	II	04513	002									12	080800	1/1/0001
	05800	S	M	CNT	II	04600	005									12	080800	1/1/0001
OFFICE: 311		ROUTE: 564		ST_REF_NO: 00000141894		PALMETTO SPRINGS WAY		LUMENS	BULB TYPE	MULT SERIES	POLE TYPE	SHADE	ADDRESS NUMBER	REF	LOCATION	TAX DIST	DATE INST	DATE CHANGE
	05800	S	M	CNT	II	04001	001									12	030897	1/1/0001
	05800	S	M	CNT	II	04012	002									12	030897	1/1/0001

OFFICE: 311 ROUTE: 564							ST_REF_NO: 00000141894 PALMETTO SPRINGS WAY			
LUMENS	BULB TYPE	MULT SERIES	POLE TYPE	SHADE	ADDRESS NUMBER	REF	LOCATION	TAX DIST	DATE INST	DATE CHANGE
05800	S	M	CNT	II	04025	003		12	030897	1/1/0001
05800	S	M	CNT	II	04036	004		12	030897	1/1/0001

OFFICE: 311 ROUTE: 564							ST_REF_NO: 00000141895 PALM GROVE COURT			
LUMENS	BULB TYPE	MULT SERIES	POLE TYPE	SHADE	ADDRESS NUMBER	REF	LOCATION	TAX DIST	DATE INST	DATE CHANGE
05800	S	M	CNT	II	02204	002		12	100894	1/1/0001
05800	S	M	CNT	II	02212	001		12	100894	1/1/0001

OFFICE: 311 ROUTE: 564							ST_REF_NO: 00000141896 PALMETTO DRIVE			
LUMENS	BULB TYPE	MULT SERIES	POLE TYPE	SHADE	ADDRESS NUMBER	REF	LOCATION	TAX DIST	DATE INST	DATE CHANGE
05800	S	M	CNT	II	04056	055		12	030897	1/1/0001
05800	S	M	CNT	II	00000	050	SIDE 4092 PALOMAR BLVD.	12	100894	1/1/0001
05800	S	M	CNT	II	00000	056	OPP. 4048	12	100894	1/1/0001
05800	S	M	CNT	II	00000	058	OPP. 4032	12	030897	1/1/0001
05800	S	M	CNT	II	00000	060	OPP. 4020	12	030897	1/1/0001
05800	S	M	CNT	II	04028	059		12	030897	1/1/0001
05800	S	M	CNT	II	04040	057		12	030897	1/1/0001
05800	S	M	CNT	II	04065	054		12	100894	1/1/0001
05800	S	M	CNT	II	04072	053		12	100894	1/1/0001
05800	S	M	CNT	II	04077	052		12	100894	1/1/0001
05800	S	M	CNT	II	04084	051		12	100894	1/1/0001
05800	S	M	CNT	II	04124	004		12	100894	1/1/0001
05800	S	M	CNT	II	04137	005		12	100894	1/1/0001
05800	S	M	CNT	II	04156	008		12	100894	1/1/0001
05800	S	M	CNT	II	04157	007		12	100894	1/1/0001
05800	S	M	CNT	II	04173	009		12	100894	1/1/0001
05800	S	M	CNT	II	04176	010		12	100894	1/1/0001
05800	S	M	CNT	II	04192	012		12	100894	1/1/0001
05800	S	M	CNT	II	04193	011		12	100894	1/1/0001
05800	S	M	CNT	II	04205	013		12	100894	1/1/0001
05800	S	M	CNT	II	04221	015		12	100894	1/1/0001
05800	S	M	CNT	II	04236	016		12	100894	1/1/0001

OFFICE: 311

ROUTE: 564

ST_REF_NO: 00000141896 PALMETTO DRIVE

LUMENS	BULB TYPE	MULT SERIES	POLE TYPE	SHADE	ADDRESS NUMBER	REF	LOCATION	TAX DIST	DATE INST	DATE CHANGE
05800	S	M	CNT	II	04252	018		12	100894	1/1/0001
05800	S	M	CNT	II	04273	019		12	100894	1/1/0001
05800	S	M	CNT	II	04101	001		12	100894	1/1/0001
05800	S	M	CNT	II	04104	002		12	100894	1/1/0001
05800	S	M	CNT	II	04117	003		12	100894	1/1/0001

OFFICE: 311

ROUTE: 564

ST_REF_NO: 00000141897 PALMETTO COURT

LUMENS	BULB TYPE	MULT SERIES	POLE TYPE	SHADE	ADDRESS NUMBER	REF	LOCATION	TAX DIST	DATE INST	DATE CHANGE
05800	S	M	CNT	III	04305	001		12	100894	1/1/0001

OFFICE: 311

ROUTE: 564

ST_REF_NO: 00000141900 PALMS DRIVE

LUMENS	BULB TYPE	MULT SERIES	POLE TYPE	SHADE	ADDRESS NUMBER	REF	LOCATION	TAX DIST	DATE INST	DATE CHANGE
05800	S	M	OUG	II	00000	080	SIDE OF 2136 OLEANDER DR.	12	090363	1/1/0001
05800	S	M	OUG	II	00000	168	SIDE OF 2127 ALEXANDRIA DR.	12	111565	1/1/0001
05800	S	M	OUG	II	02108	081		12	090363	1/1/0001
05800	S	M	OUG	II	02123	165		12	111565	1/1/0001
05800	S	M	OUG	II	02135	166		12	111565	1/1/0001
05800	S	M	OUG	II	02148	167		12	111565	1/1/0001

OFFICE: 311

ROUTE: 564

ST_REF_NO: 00000141925 PALM SPRINGS POINT

LUMENS	BULB TYPE	MULT SERIES	POLE TYPE	SHADE	ADDRESS NUMBER	REF	LOCATION	TAX DIST	DATE INST	DATE CHANGE
05800	S	M	CNT	II	04305	001		12	010406	1/1/0001
05800	S	M	CNT	II	04312	002		12	030504	1/1/0001
05800	S	M	CNT	III	04316	003		12	030504	1/1/0001

OFFICE: 311

ROUTE: 564

ST_REF_NO: 00000142000 PALMYRA AVENUE

LUMENS	BULB TYPE	MULT SERIES	POLE TYPE	SHADE	ADDRESS NUMBER	REF	LOCATION	TAX DIST	DATE INST	DATE CHANGE
05800	S	M	OUG	II	01704	046		12	071581	1/1/0001
05800	S	M	OUG	II	01712	047		12	051582	1/1/0001
05800	S	M	OUG	II	01717	048		12	091581	1/1/0001
05800	S	M	OUG	II	01732	049		12	061581	1/1/0001

OFFICE: 311

ROUTE: 564

ST_REF_NO: 00000142050

PALOMAR BLVD.

LUMENS	BULB TYPE	MULT SERIES	POLE TYPE	SHADE	ADDRESS NUMBER	REF	LOCATION	TAX DIST	DATE INST	DATE CHANGE
05800	S	M	CNT	II	00000	027	SIDE OF 4068 PEPPERTREE DR.	12	100894	1/1/0001
05800	S	M	CNT	II	00000	035	5TH LT. N OF LYON DRIVE	12	030897	1/1/0001
05800	S	M	CNT	II	00000	036	4TH LT. N OF LYON DRIVE	12	030897	1/1/0001
05800	S	M	CNT	II	00000	037	3RD LT. N OF LYON DRIVE	12	030897	1/1/0001
05800	S	M	CNT	II	00000	038	2ND LT. N OF LYON DRIVE	12	030897	1/1/0001
05800	S	M	CNT	II	00000	039	1ST LT. N OF LYON DRIVE	12	030897	1/1/0001
05800	S	M	CNT	II	03937	034		12	030897	1/1/0001
05800	S	M	CNT	II	03949	032		12	100894	1/1/0001
05800	S	M	CNT	II	03952	031		12	100894	1/1/0001
05800	S	M	CNT	II	03964	029		12	100894	1/1/0001
05800	S	M	CNT	II	03985	028		12	030897	1/1/0001
05800	S	M	CNT	II	04004	025		12	100894	1/1/0001
05800	S	M	CNT	II	04013	024		12	100894	1/1/0001
05800	S	M	CNT	II	04020	023		12	100894	1/1/0001
05800	S	M	CNT	II	04025	022		12	100894	1/1/0001
05800	S	M	CNT	II	04032	021		12	100894	1/1/0001
05800	S	M	CNT	II	04041	020		12	100894	1/1/0001
05800	S	M	CNT	II	04048	019		12	100894	1/1/0001
05800	S	M	CNT	II	00000	013	SIDE 4093 PALMETTO DR.	12	100894	1/1/0001
05800	S	M	CNT	II	04057	018		12	100894	1/1/0001
05800	S	M	CNT	II	04068	015		12	100894	1/1/0001
05800	S	M	CNT	II	04069	016		12	100894	1/1/0001
05800	S	M	CNT	II	04077	014		12	100894	1/1/0001
05800	S	M	CNT	II	04093	012		12	100894	1/1/0001
05800	S	M	CNT	II	04096	011		12	100894	1/1/0001
05800	S	M	CNT	II	04109	010		12	100894	1/1/0001
05800	S	M	CNT	II	04112	008		12	100894	1/1/0001
05800	S	M	CNT	II	04113	009		12	100894	1/1/0001
05800	S	M	CNT	II	04125	007		12	100894	1/1/0001
05800	S	M	CNT	II	04128	006		12	100894	1/1/0001
05800	S	M	CNT	II	04148	003		12	100894	1/1/0001
05800	S	M	CNT	II	04149	002		12	100894	1/1/0001
05800	S	M	CNT	II	04152	001		12	100894	1/1/0001

OFFICE: 311

ROUTE: 564

ST_REF_NO: 00000142052 PALOMAR COURT

LUMENS	BULB TYPE	MULT SERIES	POLE TYPE	SHADE	ADDRESS NUMBER	REF	LOCATION	TAX DIST	DATE INST	DATE CHANGE
05800	S	M	CNT	III	02104	001		12	100894	1/1/0001

OFFICE: 311

ROUTE: 564

ST_REF_NO: 00000142060 PALOMAR COVE LANE

LUMENS	BULB TYPE	MULT SERIES	POLE TYPE	SHADE	ADDRESS NUMBER	REF	LOCATION	TAX DIST	DATE INST	DATE CHANGE
05800	S	M	CNT	II	03909	003		12	092206	1/1/0001
05800	S	M	CNT	II	03920	002		12	092206	1/1/0001
05800	S	M	CNT	II	03932	001		12	092206	1/1/0001

OFFICE: 311

ROUTE: 564

ST_REF_NO: 00000142070 PALOMAR TRACE DRIVE

LUMENS	BULB TYPE	MULT SERIES	POLE TYPE	SHADE	ADDRESS NUMBER	REF	LOCATION	TAX DIST	DATE INST	DATE CHANGE
05800	S	M	CNT	II	00000	002	SIDE OF 2172	12	100897	1/1/0001
05800	S	M	CNT	II	02101	009		12	100897	1/1/0001
05800	S	M	CNT	II	02113	008		12	100897	1/1/0001
05800	S	M	CNT	II	02125	007		12	100897	1/1/0001
05800	S	M	CNT	II	02133	006		12	100897	1/1/0001
05800	S	M	CNT	II	02141	005		12	100897	1/1/0001
05800	S	M	CNT	II	02153	004		12	100897	1/1/0001
05800	S	M	CNT	II	02161	003		12	100897	1/1/0001
05800	S	M	CNT	II	02181	001		12	100897	1/1/0001

OFFICE: 311

ROUTE: 564

ST_REF_NO: 00000142100 PALUMBO DRIVE

LUMENS	BULB TYPE	MULT SERIES	POLE TYPE	SHADE	ADDRESS NUMBER	REF	LOCATION	TAX DIST	DATE INST	DATE CHANGE
09500	S	M	OUG	II	00000	010	CORNER OF DARBY CREEK ON PALUMBO	12	061581	2/17/2005
09500	S	M	OUG	II	00000	011	OPP. 2901 - changed out bad fixture	12	061581	2/17/2005
09500	S	M	OUG	II	02458	031	bad fixture	12	011581	4/29/2010
10000	M	M	OUG	II	02300	001		12	110884	1/1/0001
10000	M	M	OUG	II	02301	002		12	060574	1/1/0001
10000	M	M	OUG	II	02312	003		12	091582	1/1/0001
10000	M	M	OUG	II	02335	004		12	101478	1/1/0001
10000	M	M	OUG	II	02345	006		12	080171	1/1/0001
10000	M	M	OUG	II	02348	007		12	030172	1/1/0001

OFFICE: 311

ROUTE: 564

ST_REF_NO: 0000142100

PALUMBO DRIVE

LUMENS	BULB TYPE	MULT SERIES	POLE TYPE	SHADE	ADDRESS NUMBER	REF	LOCATION	TAX DIST	DATE INST	DATE CHANGE
10000	M	M	OUG	II	02364	009		12	110369	1/1/0001
10000	M	M	OUG	II	02371	010		12	030172	1/1/0001
10000	M	M	OUG	II	00000	024	OPP. 2426	12	051475	1/1/0001
10000	M	M	OUG	II	02378	011		12	110369	1/1/0001
10000	M	M	OUG	II	02391	012		12	030172	1/1/0001
10000	M	M	OUG	II	02396	013		12	021475	1/1/0001
10000	M	M	OUG	II	02399	014		12	030172	1/1/0001
10000	M	M	OUG	II	02414	021		12	030172	1/1/0001
10000	M	M	OUG	II	02415	022		12	030172	1/1/0001
10000	M	M	OUG	II	02424	023		12	051475	1/1/0001
10000	M	M	OUG	II	02444	025		12	051475	1/1/0001
10000	M	M	OUG	II	02447	026		12	011581	1/1/0001
10000	M	M	OUG	II	02447	028		12	011581	1/1/0001
10000	M	M	OUG	II	02447	030		12	011581	1/1/0001
10000	M	M	OUG	II	02470	033		12	011581	1/1/0001
10000	M	M	OUG	II	02471	032		12	011581	1/1/0001
10000	M	M	OUG	II	02471	034		12	011581	1/1/0001
10000	M	M	OUG	II	02493	036		12	011581	1/1/0001
10000	M	M	OUG	II	02494	037		12	072674	1/1/0001
10000	M	M	OUG	II	00000	046	OPP. 2562	12	011581	1/1/0001
22000	S	M	OUG	III	00000	054	1ST LT. S. OF TODDS RD., W. SIDE	12	100885	1/1/0001
22000	S	M	OUG	III	00000	055	1ST LT. S. OF TODDS RD., E. SIDE	12	100885	1/1/0001
22000	S	M	OUG	III	00000	056	2ND LT. S. OF TODDS RD., W. SIDE	12	100885	1/1/0001
22000	S	M	OUG	III	00000	058	3RD LT. S. OF TODDS RD., W. SIDE	12	100885	1/1/0001
22000	S	M	OUG	III	00000	059	3RD LT. S. OF TODDS RD., E. SIDE	12	100885	1/1/0001
22000	S	M	SOH	III	00000	060	4TH LT. S. OF TODDS RD., E. SIDE	12	100885	1/1/0001
22000	S	M	OUG	II	00000	061	1ST LT. N OF TODDS RD., E. SIDE	12	070899	1/1/0001
22000	S	M	OUG	II	00000	062	1ST LT. N OF TODDS RD., W. SIDE	12	070899	1/1/0001
22000	S	M	OUG	II	00000	063	2ND LT. N OF TODDS RD., E. SIDE	12	070899	1/1/0001
22000	S	M	OUG	II	00000	064	2ND LT. N OF TODDS RD., W. SIDE	12	070899	1/1/0001
22000	S	M	OUG	II	00000	065	3RD LT. N OF TODDS RD., E. SIDE	12	070899	1/1/0001
22000	S	M	OUG	II	00000	066	3RD LT. N OF TODDS RD., W. SIDE	12	070899	1/1/0001
22000	S	M	OUG	II	00000	067	4TH LT. N OF TODDS RD., E. SIDE	12	070899	1/1/0001
22000	S	M	OUG	II	00000	068	4TH LT. N OF TODDS RD., W. SIDE	12	070899	1/1/0001

OFFICE: 311

ROUTE: 564

ST_REF_NO: 0000142100

PALUMBO DRIVE

LUMENS	BULB TYPE	MULT SERIES	POLE TYPE	SHADE	ADDRESS NUMBER	REF	LOCATION	TAX DIST	DATE INST	DATE CHANGE
22000	S	M	OUG	II	00000	069	5TH LT. N OF TODDS RD., E SIDE	12	070899	1/1/0001
22000	S	M	OUG	II	00000	070	OPP. 2650	12	070899	1/1/0001
10000	M	M	OUG	II	02494	039		12	072674	1/1/0001
10000	M	M	OUG	II	02497	038		12	072674	1/1/0001
10000	M	M	OUG	II	02525	040		12	051475	1/1/0001
10000	M	M	OUG	II	02525	042		12	051475	1/1/0001
10000	M	M	OUG	II	02544	043		12	011581	1/1/0001
10000	M	M	OUG	II	02549	044		12	011581	1/1/0001
10000	M	M	OUG	II	02556	045		12	011581	1/1/0001
10000	M	M	OUG	II	02575	048		12	011581	1/1/0001
09500	S	M	OUG	II	02575	050	upgrade 4/08	12	011581	1/1/0001
10000	M	M	OUG	II	02576	049		12	011581	1/1/0001
10000	M	M	OUG	III	02581	052		12	071583	1/1/0001
10000	M	M	OUG	II	02586	051		12	011581	1/1/0001
22000	S	M	OUG	II	02620	071		12	070899	1/1/0001
10000	M	M	OUG	II	02845	007		12	111580	1/1/0001
10000	M	M	OUG	II	00000	001	SIDE 301 BAINBRIDGE DR	12	110884	1/1/0001
10000	M	M	OUG	II	00000	002	ACROSS FROM 2875	12	010896	1/1/0001
10000	M	M	OUG	II	00000	003	SIDE OF 301 LINDENHURST	12	040890	1/1/0001
10000	M	M	OUG	II	00000	004	OPP. 2845	12	010696	1/1/0001
10000	M	M	OUG	II	00000	006	ACROSS FROM 2845	12	010696	1/1/0001
10000	M	M	OUG	II	00000	008	SIDE OF 500 CODELL DRIVE	12	010896	1/1/0001
10000	M	M	OUG	II	00000	012	OPP. 2875	12	061581	1/1/0001
10000	M	M	OUG	II	00000	013	OPP. 2909	12	061581	1/1/0001
10000	M	M	OUG	II	00000	014	OPP. BAINBRIDGE DR.	12	061581	1/1/0001
09500	S	M	OUG	II	00000	016	2ND LT. ON LEFT FROM JERRICO DR.	12	021581	1/1/0001
10000	M	M	OUG	II	00000	017	CORNER OF LINDENHURST & PALUMBO	12	021581	1/1/0001
10000	M	M	OUG	II	00000	018	1ST LT. ON LEFT FROM JERRICO DR.	12	021581	1/1/0001
10000	M	M	OUG	II	02845	005		12	111580	1/1/0001
10000	M	M	OUG	II	02901	012		12	110884	1/1/0001

OFFICE: 311		ROUTE: 564		ST_REF_NO: 00000142400		PARALLEL ROAD		TAX DIST	DATE INST	DATE CHANGE
LUMENS	BULB TYPE	MULT SERIES	POLE TYPE	SHADE	ADDRESS NUMBER	REF	LOCATION			
05800	S	M	OUG	II	00000	001	SIDE OF 1980 ARBOR STATION ROAD	12	120800	1/1/0001
05800	S	M	OUG	II	01942	002		12	120800	1/1/0001
04000	S	M	OUG	II	01962	024		12	051477	1/1/0001
04000	S	M	OUG	II	01974	023		12	051477	1/1/0001
04000	S	M	OUG	II	01986	022		12	051477	1/1/0001
04000	S	M	OUG	II	02008	003		12	051477	1/1/0001
04000	S	M	OUG	II	02020	002		12	051477	1/1/0001
04000	S	M	OUG	II	02030	001		12	051477	1/1/0001
OFFICE: 311		ROUTE: 564		ST_REF_NO: 00000142500		PARASOL DRIVE		TAX DIST	DATE INST	DATE CHANGE
LUMENS	BULB TYPE	MULT SERIES	POLE TYPE	SHADE	ADDRESS NUMBER	REF	LOCATION			
04000	S	M	OUG	II	02000	035		12	031581	1/1/0001
04000	S	M	OUG	II	02005	034		12	031581	1/1/0001
04000	S	M	OUG	II	02013	033		12	031581	1/1/0001
04000	S	M	OUG	II	02021	051		12	031581	1/1/0001
04000	S	M	OUG	II	02024	050		12	031581	1/1/0001
04000	S	M	OUG	II	02040	048		12	031581	1/1/0001
04000	S	M	OUG	II	02041	049		12	031581	1/1/0001
04000	S	M	OUG	II	02057	047		12	031581	1/1/0001
OFFICE: 311		ROUTE: 564		ST_REF_NO: 00000142600		PARIS AVENUE		TAX DIST	DATE INST	DATE CHANGE
LUMENS	BULB TYPE	MULT SERIES	POLE TYPE	SHADE	ADDRESS NUMBER	REF	LOCATION			
04000	S	M	SOH	II	00000	029	SIDE 1412 N. BROADWAY	12	060685	1/1/0001
04000	S	M	SOH	II	00000	034	SIDE 1319 N. LIMESTONE	12	060685	1/1/0001
04000	S	M	SOH	II	00112	033		12	060685	1/1/0001
04000	S	M	SOH	II	00120	032		12	060685	1/1/0001
04000	S	M	SOH	II	00128	031		12	060685	1/1/0001
04000	S	M	SOH	II	00140	030		12	060685	1/1/0001

OFFICE: 311		ROUTE: 564		ST_REF_NO: 00000142700		PARIS COURT		LUMENS	BULB TYPE	MULT SERIES	POLE TYPE	SHADE	ADDRESS NUMBER	REF	LOCATION	TAX DIST	DATE INST	DATE CHANGE
05800	S	M	SOH	I	00000	117	SIDE OF 814 N. LIMESTONE ST.	12	111366	1/1/0001								
05800	S	M	SOH	I	00000	118	OPP. 145	12	111366	1/1/0001								
05800	S	M	SOH	I	00114	020		12	020466	1/1/0001								
05800	S	M	SOH	V	00157	020		12	020466	1/1/0001								
OFFICE: 311		ROUTE: 564		ST_REF_NO: 00000142710		PARIS PIKE		LUMENS	BULB TYPE	MULT SERIES	POLE TYPE	SHADE	ADDRESS NUMBER	REF	LOCATION	TAX DIST	DATE INST	DATE CHANGE
50000	S	M	SOH	II	00000	013	PARIS PIKE AT ROGERS ROAD	12	052505	1/1/0001								
09500	S	M	SOH	III	00000	011	1ST LT. S. OF KINGSTON RD., E. SIDE	22	020887	1/1/0001								
09500	S	M	SOH	III	00000	012	1ST LT. N. OF KINGSTON RD., E. SIDE	22	020887	1/1/0001								
09500	S	M	SOH	II	00000	050	1ST LT. S OF JOHNSTON RD. EASTSIDE	12	040897	1/1/0001								
09500	S	M	SOH	II	00000	051	1ST LT. N OF JOHNSTON RD., EASTSIDE	12	040897	1/1/0001								
09500	S	M	SOH	II	00000	008	1ST LT. S. OF SWIGERT, E. SIDE	22	020887	1/1/0001								
09500	S	M	SOH	II	00000	009	1ST LT. N. OF SWIGERT, W. SIDE	12	020887	1/1/0001								
09500	S	M	SOH	II	00000	010	1ST LT. N. OF SWIGERT, E. SIDE	12	020887	1/1/0001								
09500	S	M	SOH	III	00000	001	3RD LT. S. OF MUIR STATION RD., W. SIDE	22	070885	1/1/0001								
09500	S	M	SOH	III	00000	002	2ND LT. S. OF MUIR STATION RD., W. SIDE	22	070885	1/1/0001								
09500	S	M	SOH	III	00000	003	1ST LT. S. OF MUIR STATION RD, W. SIDE	22	070885	1/1/0001								
09500	S	M	SOH	III	00000	004	SIDE MUIR STATION RD.	22	070885	1/1/0001								
09500	S	M	SOH	II	00000	060	1ST LT. S OF IRON WORKS ROAD	12	040897	1/1/0001								
09500	S	M	SOH	II	00000	061	OPP. IRON WORKS RD.	12	040897	1/1/0001								
09500	S	M	SOH	III	00000	005	1ST LT. N. OF MUIR STATION, W. SIDE	22	070885	1/1/0001								
09500	S	M	SOH	III	00000	006	2ND LT. N. OF MUIR STATION, W. SIDE	22	070885	1/1/0001								
09500	S	M	SOH	III	00000	007	3RD LT. N. OF MUIR STATION, W. SIDE	22	070885	1/1/0001								
09500	S	M	SOH	II	00000	062	1ST LT. N OF IRON WORKS	12	040897	1/1/0001								
09500	S	M	SOH	II	00000	080	1ST LT. S OF HUGHES LANE	12	040897	1/1/0001								
09500	S	M	SOH	II	00000	081	1ST LT. N OF HUGHES LANE	12	040897	1/1/0001								
OFFICE: 311		ROUTE: 564		ST_REF_NO: 00000142800		PARK AVENUE		LUMENS	BULB TYPE	MULT SERIES	POLE TYPE	SHADE	ADDRESS NUMBER	REF	LOCATION	TAX DIST	DATE INST	DATE CHANGE
09500	S	M	SOH	II	00000	400	OPPOSITE 511 PARK AVENUE	12	010606	1/1/0001								
09500	S	M	SOH	II	00426	100		12	010606	1/1/0001								

OFFICE: 311		ROUTE: 564		ST_REF_NO: 00000142800		PARK AVENUE		TAX DIST	DATE INST	DATE CHANGE
LUMENS	BULB TYPE	MULT SERIES	POLE TYPE	SHADE	ADDRESS NUMBER	REF	LOCATION			
04000	S	M	SOH	I	00000	606	SIDE OF 600 COLUMBIA AVE.	12	051167	1/1/0001
04000	S	M	SOH	I	00000	607	SIDE OF 550 EUCLID AVE.	12	051167	1/1/0001
04000	S	S	SOH	I	00000	619	OPP. 311	12	051167	1/1/0001
04000	S	S	SOH	I	00000	620	SIDE OF 804 E. HIGH ST.	12	051167	1/1/0001
05800	S	M	SOH	II	00000	628	SIDE OF 608 E. MAIN ST.	12	051167	1/1/0001
05800	S	M	SOH	II	00132	629		12	051167	1/1/0001
05800	S	M	SOH	II	00147	630		12	051167	1/1/0001
05800	S	M	SOH	II	00170	631		12	051167	1/1/0001
05800	S	M	SOH	II	00184	632		12	051167	1/1/0001
04000	S	S	SOH	I	00328	618		12	051167	1/1/0001
04000	S	S	SOH	I	00340	617		12	051167	1/1/0001
04000	S	S	SOH	I	00354	616		12	051167	1/1/0001
04000	S	S	SOH	I	00364	615		12	051167	1/1/0001
04000	S	S	SOH	I	00376	614		12	051167	1/1/0001
04000	S	M	SOH	I	00422	608		12	051167	1/1/0001
04000	S	M	SOH	I	00435	609		12	051167	1/1/0001
04000	S	M	SOH	I	00448	610		12	051167	1/1/0001
04000	S	M	SOH	I	00460	611		12	051167	1/1/0001
04000	S	M	SOH	I	00466	612		12	051167	1/1/0001
04000	S	M	SOH	I	00516	613		12	020466	1/1/0001
OFFICE: 311		ROUTE: 564		ST_REF_NO: 00000142900		PARK PLACE		TAX DIST	DATE INST	DATE CHANGE
LUMENS	BULB TYPE	MULT SERIES	POLE TYPE	SHADE	ADDRESS NUMBER	REF	LOCATION			
10000	M	M	OUG	II	00000	001	OPP. 400	12	021477	1/1/0001
10000	M	M	OUG	II	00000	002	1ST LT. ON LEFT FROM RUSSELL CAVE RD.	12	051581	1/1/0001
10000	M	M	OUG	II	00000	003	OPP. 416	12	021477	1/1/0001
10000	M	M	OUG	II	00000	004	2ND LT. ON LEFT FROM RUSSELL CAVE RD.	12	051581	1/1/0001
09500	S	M	OUG	II	00000	005	OPP. 432 upgrade 4/08	12	021477	1/1/0001
10000	M	M	OUG	II	00000	006	3RD LT. ON LEFT FROM RUSSELL CAVE RD.	12	051581	1/1/0001
10000	M	M	OUG	II	00000	007	OPP. 456	12	021477	1/1/0001
09500	S	M	OUG	II	00000	008	4TH LT. ON LEFT FROM RUSSELL CAVE upgrade 1/08	12	051581	1/1/0001

OFFICE: 311

ROUTE: 564

ST_REF_NO: 00000142905

PARK ACCESS DRIVE

LUMENS	BULB TYPE	MULT SERIES	POLE TYPE	SHADE	ADDRESS NUMBER	REF	LOCATION	TAX DIST	DATE INST	DATE CHANGE
05800	S	M	OUG	II	00000	041	2ND LT. W OF CHARWOOD DR.	12	120898	1/1/0001

OFFICE: 311

ROUTE: 564

ST_REF_NO: 00000142910

PARK LAWN DRIVE

LUMENS	BULB TYPE	MULT SERIES	POLE TYPE	SHADE	ADDRESS NUMBER	REF	LOCATION	TAX DIST	DATE INST	DATE CHANGE
05800	S	M	OUG	II	00000	001	SIDE REAR OF 3745 CROSBY DR.	12	060894	1/1/0001
05800	S	M	OUG	III	00000	006	SIDE OF 1116 NARROW LANE	12	070893	1/1/0001
05800	S	M	OUG	V	00000	007	SIDE OF 1117 NARROW LANE	12	070893	1/1/0001
05800	S	M	OUG	III	01117	005		12	070893	1/1/0001
05800	S	M	OUG	II	01128	004		12	120889	1/1/0001
05800	S	M	OUG	II	01137	003		12	120889	1/1/0001
05800	S	M	OUG	III	01152	002		12	070893	1/1/0001

OFFICE: 311

ROUTE: 564

ST_REF_NO: 00000143000

PARKERS MILL ROAD

LUMENS	BULB TYPE	MULT SERIES	POLE TYPE	SHADE	ADDRESS NUMBER	REF	LOCATION	TAX DIST	DATE INST	DATE CHANGE
22000	S		OUG	II	00000	220	1ST LT S OF VERSAILLES RD, W SIDE OF PARKERS MILL RD	12	092013	1/1/0001
09500	S	M	OUG	II	00000	100	1ST LT E OF PARK ENTRANCE, S SIDE ON PARKERS MILL	12	110705	1/1/0001
09500	S	M	OUG	II	00000	101	2ND LT E OF PARK ENTRANCE, S SIDE ON PARKERS MILL	12	110705	1/1/0001
09500	S	M	OUG	II	00000	102	1ST LT W OF PARK ENTRANCE, S SIDE ON PARKERS MILL	12	110705	1/1/0001
09500	S	M	OUG	II	00000	103	2ND LT W OF PARK ENTRANCE, S SIDE ON PARKERS MILL	12	110705	1/1/0001
05800	S	M	OUG	II	00000	141	1ST LT S OF DEDMAN LN ON W SIDE OF PARKERS MILL	12	053101	1/1/0001
05800	S	M	OUG	II	00000	142	1ST LT N OF DEDMAN LN ON W SIDE OF PARKERS MILL	12	053101	1/1/0001
05800	S	M	SOH	II	00000	151	1ST LT S OF FROGTOWN LN ON E SIDE OF PARKERS MILL	12	053101	1/1/0001
05800	S	M	SOH	II	00000	152	1ST LT N OF FROGTOWN LN ON E SIDE OF PARKERS MILL	12	053101	1/1/0001
05800	S	M	SOH	II	00000	153	2ND LT N OF FROGTOWN LN ON E SIDE OF PARKERS MILL	12	053101	1/1/0001
09500	S	M	OUG	II	00000	010	OPP. SIDE OF 1925 CROSS KEYS RD., N. SIDE	12	070889	1/1/0001

OFFICE: 311

ROUTE: 564

ST_REF_NO: 00000143000

PARKERS MILL ROAD

LUMENS	BULB TYPE	MULT SERIES	POLE TYPE	SHADE	ADDRESS NUMBER	REF	LOCATION	TAX DIST	DATE INST	DATE CHANGE
09500	S	M	OUG	II	00000	011	SIDE OF 1298 CROSS KEYS RD.	12	070889	1/1/0001
09500	S	M	OUG	II	00000	013	SIDE OF 1680 WILLIAMSBURG RD.	12	070889	1/1/0001
09500	S	M	OUG	II	00000	014	OPP. 1814	12	070889	1/1/0001
09500	S	M	OUG	II	00000	016	OPP. 1818	12	070889	1/1/0001
09500	S	M	OUG	II	00000	018	3RD LT. S. OF WILLIAMSBURG RD, W. SIDE	12	070889	1/1/0001
09500	S	M	OUG	II	00000	019	OPP. 1823	12	070889	1/1/0001
09500	S	M	OUG	II	00000	021	OPP. 1831	12	020889	1/1/0001
09500	S	M	OUG	II	01626	009		12	070889	1/1/0001
09500	S	M	OUG	II	01628	008		12	070889	1/1/0001
09500	S	M	OUG	II	01700	012		12	070889	1/1/0001
09500	S	M	OOH	II	01814	015		12	070889	1/1/0001
09500	S	M	OUG	II	01822	017		12	070889	1/1/0001
09500	S	M	OUG	II	01831	020		12	070889	1/1/0001
09500	S	M	OUG	II	01835	022		12	020889	1/1/0001
09500	S	M	OUG	II	01858	023		12	020889	1/1/0001
09500	S	M	OUG	II	01861	024		12	020889	1/1/0001
09500	S	M	OUG	II	01866	025		12	020889	1/1/0001
09500	S	M	OUG	II	01879	026		12	020889	1/1/0001
09500	S	M	OUG	II	00000	001	SIDE OF 2321 VERSAILLES RD.	12	070889	1/1/0001
09500	S	M	OUG	II	00000	002	OPP. 1527	12	070889	1/1/0001
09500	S	M	OUG	II	00000	003	OPP. 1527	12	070889	1/1/0001
09500	S	M	SOH	II	01535	004		12	070889	1/1/0001
09500	S	M	OUG	II	01605	005		12	070889	1/1/0001
09500	S	M	OUG	II	01608	007		12	070889	1/1/0001
09500	S	M	OUG	II	01613	006		12	070889	1/1/0001
09500	S	M	OUG	III	00000	046	1ST LT E OF MAN O WAR ON SOUTHSIDE OF PARKERS MILL	12	050891	1/1/0001
09500	S	M	OUG	III	00000	047	1ST LT E OF MAN O WAR ON NORTHSIDE OF PARKERS MILL	12	050891	1/1/0001
09500	S	M	OUG	III	00000	048	1ST LT W OF MAN-O-WAR,NORTHSIDE OF PARKERS MILL RD	12	090891	1/1/0001
09500	S	M	OUG	III	00000	049	1ST LT W OF MAN-O-WAR,SOUTHSIDE OF PARKERS MILL RD	12	090891	1/1/0001
09500	S	M	OUG	III	00000	050	2ND LT W OF MAN-O-WAR,NORTHSIDE OF PARKERS MILL RD	12	090891	1/1/0001

OFFICE: 311		ROUTE: 564								
		ST_REF_NO: 00000143000		PARKERS MILL ROAD						
LUMENS	BULB TYPE	MULT SERIES	POLE TYPE	SHADE	ADDRESS NUMBER	REF	LOCATION	TAX DIST	DATE INST	DATE CHANGE
09500	S	M	OUG	III	00000	051	2ND LT W OF MAN-O-WAR,SOUTHSIDE OF PARKERS MILL RD	12	090891	1/1/0001
09500	S	M	OUG	II	00000	031	OPP. LANE ALLEN RD.	12	020889	1/1/0001
09500	S	M	OUG	II	00000	032	SIDE OF 1180 LANE ALLEN RD.	12	020889	1/1/0001
09500	S	M	OUG	III	00000	039	5TH LT E OF MAN O WAR ON NORTHSIDE OF PARKERS MILL	12	050891	1/1/0001
09500	S	M	OUG	III	00000	040	4TH LT E OF MAN O WAR ON SOUTHSIDE OF PARKERS MILL	12	050891	1/1/0001
09500	S	M	OUG	III	00000	041	4TH LT E OF MAN O WAR ON NORTHSIDE OF PARKERS MILL	12	050891	1/1/0001
09500	S	M	OUG	III	00000	042	3RD LT E OF MAN O WAR ON SOUTHSIDE OF PARKERS MILL	12	050891	1/1/0001
09500	S	M	OUG	III	00000	043	3RD LT E OF MAN O WAR ON NORTHSIDE OF PARKERS MILL	12	050891	1/1/0001
09500	S	M	OUG	III	00000	044	2ND LT E OF MAN O WAR ON SOUTHSIDE OF PARKERS MILL	12	050891	1/1/0001
09500	S	M	OUG	III	00000	045	2ND LT E OF MAN O WAR ON NORTHSIDE OF PARKERS MILL	12	050891	1/1/0001
05800	S		SOH	II	00000	131	1ST LT W OF BOWMANS MILL ON N SIDE OF PARKERS MILL	12	030801	1/1/0001
09500	S	M	OUG	II	01882	027		12	020889	1/1/0001
09500	S	M	OUG	II	01891	028		12	020889	1/1/0001
09500	S	M	OUG	II	01894	029		12	020889	1/1/0001
09500	S	M	OUG	II	01898	030		12	020889	1/1/0001
09500	S	M	OUG	II	01904	033		12	020889	1/1/0001
09500	S	M	SOH	II	01911	035		12	020889	1/1/0001
09500	S	M	OUG	II	01912	034		12	020889	1/1/0001
09500	S	M	OUG	II	01924	036		12	020889	1/1/0001
09500	S	M	SOH	II	01935	037		12	020889	1/1/0001
09500	S	M	OUG	II	01936	038		12	020889	1/1/0001
OFFICE: 311		ROUTE: 564								
		ST_REF_NO: 00000143040		PARK POINTE COURT						
LUMENS	BULB TYPE	MULT SERIES	POLE TYPE	SHADE	ADDRESS NUMBER	REF	LOCATION	TAX DIST	DATE INST	DATE CHANGE
05800	S	M	CNT	II	03609	008		12	050899	1/1/0001
05800	S	M	CNT	II	03616	007		12	050899	1/1/0001
05800	S	M	CNT	II	03629	006		12	050899	1/1/0001

OFFICE: 311		ROUTE: 564		ST_REF_NO: 00000143040		PARK POINTE COURT		LUMENS	BULB TYPE	MULT SERIES	POLE TYPE	SHADE	ADDRESS NUMBER	REF	LOCATION	TAX DIST	DATE INST	DATE CHANGE
05800	S	M	CNT	II	03656	005										12	050899	1/1/0001
05800	S	M	CNT	II	03673	003										12	050899	1/1/0001
05800	S	M	CNT	II	03692	002										12	050899	1/1/0001
05800	S	M	CNT	II	03697	001										12	050899	1/1/0001
05800	S	M	CNT	II	03660	004										12	050899	1/1/0001

OFFICE: 311		ROUTE: 564		ST_REF_NO: 00000143060		PARK RIDGE LANE		LUMENS	BULB TYPE	MULT SERIES	POLE TYPE	SHADE	ADDRESS NUMBER	REF	LOCATION	TAX DIST	DATE INST	DATE CHANGE
05800	S	M	CNT	II	00000	005										12	080900	1/1/0001
05800	S	M	CNT	II	00000	007										12	090800	1/1/0001
05800	S	M	CNT	III	03705	008										12	090800	1/1/0001
05800	S	M	CNT	I	03716	006										12	090800	1/1/0001
05800	S	M	CNT	II	03743	003										12	090800	1/1/0001
05800	S	M	CNT	II	03760	002										12	090800	1/1/0001
05800	S	M	CNT	III	03769	001										12	090800	1/1/0001

OFFICE: 311		ROUTE: 564		ST_REF_NO: 00000143200		PARKSIDE DRIVE		LUMENS	BULB TYPE	MULT SERIES	POLE TYPE	SHADE	ADDRESS NUMBER	REF	LOCATION	TAX DIST	DATE INST	DATE CHANGE
05800	S	M	OUG	II	00637	000										12	050969	1/1/0001
05800	S	M	OUG	II	00650	000										12	031868	1/1/0001
05800	S	M	OUG	II	00701	000										12	091967	1/1/0001
05800	S	M	OUG	II	00712	000										12	091967	1/1/0001
09500	S	M	SOH	II	00000	042										12	050884	1/1/0001
09500	S	M	SOH	II	00000	043										12	050884	1/1/0001
05800	S	M	OUG	II	00000	056										12	050884	1/1/0001
05800	S	M	OUG	II	00000	058										12	050884	1/1/0001
05800	S	M	OUG	II	00000	060										12	050884	1/1/0001
05800	S	M	OUG	II	00000	062										12	050884	1/1/0001
09500	S	M	SOH	II	00403	044										12	050884	1/1/0001
09500	S	M	SOH	II	00415	045										12	050884	1/1/0001
05800	S	M	SOH	II	00423	046										12	050884	1/1/0001
05800	S	M	OUG	II	00508	047										12	050884	1/1/0001

OFFICE: 311

ROUTE: 564

ST_REF_NO: 00000143200

PARKSIDE DRIVE

LUMENS	BULB TYPE	MULT SERIES	POLE TYPE	SHADE	ADDRESS NUMBER	REF	LOCATION	TAX DIST	DATE INST	DATE CHANGE
05800	S	M	OUG	II	00522	049		12	050884	1/1/0001
05800	S	M	OUG	II	00530	051		12	050884	1/1/0001
05800	S	M	OUG	II	00533	048		12	050884	1/1/0001
05800	S	M	OUG	II	00538	053		12	050884	1/1/0001
05800	S	M	OUG	II	00548	055		12	050884	1/1/0001
05800	S	M	OUG	II	00549	050		12	050884	1/1/0001
05800	S	M	OUG	II	00551	052		12	050884	1/1/0001
05800	S	M	OUG	II	00551	054		12	050884	1/1/0001
05800	S	M	OUG	II	00556	057		12	050884	1/1/0001
05800	S	M	OUG	II	00564	059		12	050884	1/1/0001
05800	S	M	OUG	II	00572	061		12	050884	1/1/0001
05800	S	M	OUG	II	00606	063		12	050884	1/1/0001
05800	S	M	OUG	II	00609	064		12	050884	1/1/0001
05800	S	M	OUG	II	00620	065		12	050884	1/1/0001
05800	S	M	OUG	II	00620	066		12	050884	1/1/0001
05800	S	M	OUG	II	00626	000		12	100171	1/1/0001

OFFICE: 311

ROUTE: 564

ST_REF_NO: 00000143300

PARKVIEW AVENUE

LUMENS	BULB TYPE	MULT SERIES	POLE TYPE	SHADE	ADDRESS NUMBER	REF	LOCATION	TAX DIST	DATE INST	DATE CHANGE
05800	S	M	OUG	II	00000	001	OPP. 305	12	051165	1/1/0001
05800	S	M	OOH	II	00000	003	OPP. 327	12	051165	1/1/0001
05800	S	M	OUG	II	00317	002		12	051165	1/1/0001
05800	S	M	OUG	II	00000	005	OPP. 419	12	051165	1/1/0001
05800	S	M	OUG	II	00407	004		12	051165	1/1/0001
05800	S	M	SOH	II	00501	006		12	092765	1/1/0001
05800	S	M	OUG	II	00000	007	SIDE OF 1031 OAK HILL DR.	12	051165	1/1/0001

OFFICE: 311

ROUTE: 564

ST_REF_NO: 00000143400

PARKWAY DRIVE

LUMENS	BULB TYPE	MULT SERIES	POLE TYPE	SHADE	ADDRESS NUMBER	REF	LOCATION	TAX DIST	DATE INST	DATE CHANGE
04000	S	M	OUG	II	00000	068	434 PARKWAY DR., IN MEDIAN	12	020886	1/1/0001
04000	S	M	OUG	II	00000	069	441 PARKWAY DR., IN MEDIAN	12	020886	1/1/0001
04000	S	M	OUG	II	00000	070	442 PARKWAY DR., IN MEDIAN	12	020886	1/1/0001

OFFICE: 311

ROUTE: 564

ST_REF_NO: 00000143400

PARKWAY DRIVE

LUMENS	BULB TYPE	MULT SERIES	POLE TYPE	SHADE	ADDRESS NUMBER	REF	LOCATION	TAX DIST	DATE INST	DATE CHANGE
04000	S	M	OUG	II	00000	071	449 PARKWAY DR., IN MEDIAN	12	020886	1/1/0001
04000	S	M	OUG	II	00000	072	450 PARKWAY DR., IN MEDIAN	12	020886	1/1/0001
04000	S	M	OUG	II	00000	073	461 PARKWAY DR., IN MEDIAN	12	020886	1/1/0001
04000	S	M	OUG	II	00000	074	454 PARKWAY DR., IN MEDIAN	12	020886	1/1/0001
04000	S	M	OUG	II	00000	075	465 PARKWAY DR., IN MEDIAN	12	020886	1/1/0001
04000	S	M	OUG	II	00000	076	460 PARKWAY DR., IN MEDIAN	12	020886	1/1/0001

OFFICE: 311

ROUTE: 564

ST_REF_NO: 00000143450

PARLIAMENT WAY

LUMENS	BULB TYPE	MULT SERIES	POLE TYPE	SHADE	ADDRESS NUMBER	REF	LOCATION	TAX DIST	DATE INST	DATE CHANGE
09500	S	M	OUG	II	00000	001	1ST LT E OF WALDEN DR, N SIDE ON PARLIAMENT WAY	12	011702	1/1/0001
09500	S	M	OUG	II	00000	002	2ND LT E OF WALDEN DR, N SIDE ON PARLIAMENT WAY	12	011702	1/1/0001
09500	S	M	OUG	II	00000	003	3RD LT E OF WALDEN DR, N SIDE ON PARLIAMENT WAY	12	011702	1/1/0001
05800	S	M	OUG	II	00000	001	SIDE OF 3740 OLD TATES CREEK RD.	12	110899	1/1/0001
05800	S	M	OUG	II	00000	005	SIDE REAR OF 3780 LADY DI LANE	12	110899	1/1/0001
05800	S	M	OUG	II	01112	002		12	110899	1/1/0001
05800	S	M	OUG	II	01133	003		12	110899	1/1/0001
05800	S	M	OUG	II	01148	004		12	110899	1/1/0001

OFFICE: 311

ROUTE: 564

ST_REF_NO: 00000143470

PARSONS LANE

LUMENS	BULB TYPE	MULT SERIES	POLE TYPE	SHADE	ADDRESS NUMBER	REF	LOCATION	TAX DIST	DATE INST	DATE CHANGE
05800	S	M	CNT	II	00000	007	ACROSS FROM 4569 PARSONS LANE	12	061606	1/1/0001
05800	S	M	CNT	II	00000	008	SIDE OF 468 LANARKSHIRE PLACE ON PARSONS LANE	12	061606	1/1/0001
05800	S	M	CNT	II	04501	001		12	061606	1/1/0001
05800	S	M	CNT	II	04516	002		12	061606	1/1/0001
05800	S	M	CNT	II	04524	003		12	061606	1/1/0001
05800	S	M	CNT	II	04536	004		12	061606	1/1/0001
05800	S	M	CNT	II	04541	005		12	061606	1/1/0001
05800	S	M	CNT	II	04553	006		12	061606	1/1/0001

OFFICE: 311		ROUTE: 564		ST_REF_NO: 00000143480		PARTERRE COURT		LUMENS	BULB TYPE	MULT SERIES	POLE TYPE	SHADE	ADDRESS NUMBER	REF	LOCATION	TAX DIST	DATE INST	DATE CHANGE
	04000	S	M	OUG	II	01405	001									12	020888	1/1/0001
OFFICE: 311		ROUTE: 564		ST_REF_NO: 00000143490		PARTERRE PLACE		LUMENS	BULB TYPE	MULT SERIES	POLE TYPE	SHADE	ADDRESS NUMBER	REF	LOCATION	TAX DIST	DATE INST	DATE CHANGE
	05800	S	M	CNT	II	00000	001								SIDE OF 1420 SADDLE CLUB WAY ON PARTERRE PLACE	12	091001	1/1/0001
	05800	S	M	CNT	II	00000	002								SIDE OF 1428 SADDLE CLUB WAY ON PARTERRE PLACE	12	091001	1/1/0001
	05800	S	M	OUG	II	02416	003								bad fixture	12	020888	10/28/2009
	04000	S	M	OUG	II	00000	001								SIDE OF 1408 VILEY RD.	12	020888	1/1/0001
	04000	S	M	OUG	II	02403	004									12	020888	1/1/0001
	04000	S	M	OUG	II	02428	002									12	020888	1/1/0001
OFFICE: 311		ROUTE: 564		ST_REF_NO: 00000143500		PASADENA DRIVE		LUMENS	BULB TYPE	MULT SERIES	POLE TYPE	SHADE	ADDRESS NUMBER	REF	LOCATION	TAX DIST	DATE INST	DATE CHANGE
	09500	S	M	SOH	II	00000	001								SIDE OF 2401 NICHOLASVILLE RD	12	040884	1/1/0001
	09500	S	M	OUG	II	00000	007								OPP 195	12	100887	1/1/0001
	09500	S	M	OUG	II	00000	009								OOP 223	12	100887	1/1/0001
	09500	S	M	OUG	II	00000	011								OPP 259	12	100887	1/1/0001
	09500	S	M	OUG	II	00000	014								SIDE OF 2401 REGENCY RD	12	100887	1/1/0001
	09500	S	M	OUG	II	00110	003									12	100887	1/1/0001
	09500	S	M	OUG	II	00119	002									12	100887	1/1/0001
	09500	S	M	OUG	II	00149	004									12	100887	1/1/0001
	09500	S	M	OUG	II	00160	005									12	100887	1/1/0001
	09500	S	M	OUG	II	00175	006									12	100887	1/1/0001
	09500	S	M	OUG	II	00205	008									12	100887	1/1/0001
	09500	S	M	OUG	II	00235	010									12	100887	1/1/0001
	09500	S	M	OUG	II	00271	012									12	100887	1/1/0001
	09500	S	M	SOH	II	00299	013									12	040884	1/1/0001
	05800	S	M	SOH	II	00329	014									12	040884	1/1/0001
	05800	S	M	SOH	II	00348	015									12	040884	1/1/0001
	05800	S	M	OOH	II	00348	017									12	100887	1/1/0001
	05800	S	M	OUG	II	00353	018									12	100887	1/1/0001

OFFICE: 311

ROUTE: 564

ST_REF_NO: 00000143500

PASADENA DRIVE

LUMENS	BULB TYPE	MULT SERIES	POLE TYPE	SHADE	ADDRESS NUMBER	REF	LOCATION	TAX DIST	DATE INST	DATE CHANGE
05800	S	M	OUG	II	00372	019		12	100887	1/1/0001
05800	S	M	OUG	III	00000	001	1ST LT. E. OF CLAYS MILL,N. SIDE	12	100887	1/1/0001
05800	S	M	OUG	III	00000	002	1ST LT. E. OF CLAYS MILL, S. SIDE	12	100887	1/1/0001
05800	S	M	OUG	III	00000	003	2ND LT. E. OF CLAYS MILL, N. SIDE	12	100887	1/1/0001
05800	S	M	OUG	III	00000	004	2ND LT. E. OF CLAYS MILL, S. SIDE	12	100887	1/1/0001
05800	S	M	OUG	III	00000	005	3RD LT. E. OF CLAYS MILL, N. SIDE	12	100887	1/1/0001
05800	S	M	OUG	II	00000	056	SIDE OF 2701 SOUTHVIEW	12	111583	1/1/0001
09500	S	M	OUG	III	00000	069	SIDE OF 2452 HARRODSBURG RD.	12	091583	1/1/0001
09500	S	M	OUG	III	00000	072	SIDE OF 753 SEATTLE DR.	12	091583	1/1/0001
05800	S	M	OUG	II	00000	074	SIDE OF 2837 ARK ROYAL WAY	12	111583	1/1/0001
09500	S	M	OUG	III	00000	088	OPP. 603	12	040890	1/1/0001
09500	S	M	OUG	III	00000	089	SIDE OF 2799 CLAYS MILL	12	091583	1/1/0001
09500	S	M	OUG	III	00000	174	SIDE OF 2801 PHOENIX DR.	12	091583	1/1/0001
05800	S	M	OUG	II	00141	079		12	111583	1/1/0001
05800	S	M	OUG	II	00156	078		12	111583	1/1/0001
05800	S	M	OUG	II	00165	077		12	111583	1/1/0001
05800	S	M	OUG	II	00196	076		12	111583	1/1/0001
05800	S	M	OUG	II	00205	075		12	111583	1/1/0001
05800	S	M	OUG	II	00237	073		12	111583	1/1/0001
05800	S	M	OUG	II	00252	072		12	111583	1/1/0001
05800	S	M	OUG	II	00277	071		12	111583	1/1/0001
05800	S	M	OUG	II	00293	070		12	111583	1/1/0001
05800	S	M	OUG	II	00301	050		12	111583	1/1/0001
05800	S	M	OUG	II	00317	051		12	111583	1/1/0001
05800	S	M	OUG	II	00357	053		12	111583	1/1/0001
05800	S	M	OUG	II	00360	052		12	111583	1/1/0001
05800	S	M	OUG	II	00381	054		12	111583	1/1/0001
05800	S	M	OUG	II	00397	055		12	111583	1/1/0001
05800	S	M	OUG	III	00415	007		12	100887	1/1/0001
05800	S	M	OUG	III	00416	006		12	100887	1/1/0001
09500	S	M	OUG	III	00602	086		12	091583	1/1/0001
09500	S	M	OUG	III	00607	087		12	091583	1/1/0001
09500	S	M	OUG	III	00610	084		12	091583	1/1/0001
09500	S	M	OUG	III	00615	085		12	091583	1/1/0001

Street Light Listing run 1/11/2015 10:43:21 AM

Page 848 of 1254

OFFICE: 311

ROUTE: 564

ST_REF_NO: 00000143500

PASADENA DRIVE

LUMENS	BULB TYPE	MULT SERIES	POLE TYPE	SHADE	ADDRESS NUMBER	REF	LOCATION	TAX DIST	DATE INST	DATE CHANGE
09500	S	M	OUG	III	00621	083		12	091583	1/1/0001
09500	S	M	OUG	III	00622	081		12	091583	1/1/0001
09500	S	M	OUG	III	00623	082		12	091583	1/1/0001
09500	S	M	OUG	III	00628	079		12	091583	1/1/0001
09500	S	M	OUG	III	00631	080		12	091583	1/1/0001
09500	S	M	OUG	III	00634	078		12	091583	1/1/0001
09500	S	M	OUG	III	00703	077		12	091583	1/1/0001
09500	S	M	OUG	III	00706	076		12	091583	1/1/0001
09500	S	M	OUG	III	00711	075		12	091583	1/1/0001
09500	S	M	OUG	III	00717	073		12	091583	1/1/0001
09500	S	M	OUG	III	00725	071		12	091583	1/1/0001
09500	S	M	OUG	III	00796	070		12	091583	1/1/0001

OFFICE: 311

ROUTE: 564

ST_REF_NO: 00000143505

PASCOLI PLACE

LUMENS	BULB TYPE	MULT SERIES	POLE TYPE	SHADE	ADDRESS NUMBER	REF	LOCATION	TAX DIST	DATE INST	DATE CHANGE
09500	S		CLN	III	00000	007	SIDE OF 2400 SAN MILANO PL ON PASCOLI PLACE	12	072213	1/1/0001
09500	S		CLN	III	00000	009	SIDE OF 2401 SAN MILANO PL ON PASCOLI PLACE	12	072213	1/1/0001
09500	S		CLN	III	00000	010	SIDE OF 2400 CORONEO LN ON PASCOLI PLACE	12	072213	1/1/0001
09500	S		CLN	III	00000	023	SIDE OF 2564 CARDUCCI ST ON PASCOLI PLACE	12	072213	1/1/0001
09500	S		CLN	III	02401	001		12	072213	1/1/0001
09500	S		CLN	III	02417	003		12	072213	1/1/0001
09500	S		CLN	III	02476	011		12	072213	1/1/0001
09500	S		CLN	III	02480	012		12	072213	1/1/0001
09500	S		CLN	III	02505	017		12	072213	1/1/0001
09500	S		CLN	III	02517	018		12	072213	1/1/0001
09500	S		CLN	III	02521	019		12	072213	1/1/0001
09500	S		CLN	III	02533	020		12	072213	1/1/0001
09500	S		CLN	III	02545	021		12	072213	1/1/0001
09500	S		CLN	III	02553	022		12	072213	1/1/0001
09500	S		CLN	III	02565	024		12	072213	1/1/0001
09500	S		CLN	III	02584	026		12	072213	1/1/0001

OFFICE: 311		ROUTE: 564		ST_REF_NO: 00000143510		PASSAGE MOUND WAY		LUMENS	BULB TYPE	MULT SERIES	POLE TYPE	SHADE	ADDRESS NUMBER	REF	LOCATION	TAX DIST	DATE INST	DATE CHANGE
05800	S		CNT	II	00000	008	side of 1240 Angus Trail on Passage Mound Way	12	080508									1/1/0001
05800	S		CNT	II	00000	009	side of 3737 Stolen Horse Trace on Passage Mound Way	12	080508									1/1/0001
05800	S		CNT	II	01200	001		12	080508									1/1/0001
05800	S		CNT	II	01205	002		12	080508									1/1/0001
05800	S		CNT	II	01217	003		12	080508									1/1/0001
05800	S		CNT	II	01221	004		12	080508									1/1/0001
05800	S		CNT	II	01245	006		12	080508									1/1/0001
05800	S		CNT	II	01261	007		12	080508									1/1/0001

OFFICE: 311

ROUTE: 564

OFFICE: 311		ROUTE: 564		ST_REF_NO: 00000143520		PARTRIDGE LANE		LUMENS	BULB TYPE	MULT SERIES	POLE TYPE	SHADE	ADDRESS NUMBER	REF	LOCATION	TAX DIST	DATE INST	DATE CHANGE
05800	S	M	CNT	II	00000	002	SIDE OF 2200 CARRINGOTN COURT	12	110800									1/1/0001
05800	S	M	CNT	II	03364	003		12	110800									1/1/0001
05800	S	M	CNT	II	03376	001		12	110800									1/1/0001

OFFICE: 311

ROUTE: 564

OFFICE: 311		ROUTE: 564		ST_REF_NO: 00000143600		PASTERN COURT		LUMENS	BULB TYPE	MULT SERIES	POLE TYPE	SHADE	ADDRESS NUMBER	REF	LOCATION	TAX DIST	DATE INST	DATE CHANGE
04000	S	M	OUG	II	03301	069		12	061581									1/1/0001
04000	S	M	OUG	II	03308	070		12	081582									1/1/0001
04000	S	M	OUG	II	03317	071		12	031581									1/1/0001
04000	S	M	OUG	II	03324	072		12	031581									1/1/0001

OFFICE: 311

ROUTE: 564

OFFICE: 311		ROUTE: 564		ST_REF_NO: 00000143700		PATCHEN DRIVE		LUMENS	BULB TYPE	MULT SERIES	POLE TYPE	SHADE	ADDRESS NUMBER	REF	LOCATION	TAX DIST	DATE INST	DATE CHANGE
50000	S	M	OUG	II	00000	201	1ST LT W OF RICHMOND RD, N SIDE ON PATCHEN DR	12	062904									1/1/0001
10000	M	M	OUG	II	00000	001	SIDE OF 2700 RICHMOND RD.	12	060574									1/1/0001
10000	M	M	OUG	II	00153	003		12	031476									1/1/0001
10000	M	M	OUG	II	00153	004		12	031476									1/1/0001
10000	M	M	OUG	II	00154	004		12	031476									1/1/0001
10000	M	M	OUG	II	00185	005		12	031476									1/1/0001

OFFICE: 311

ROUTE: 564

ST_REF_NO: 00000143700

PATCHEN DRIVE

LUMENS	BULB TYPE	MULT SERIES	POLE TYPE	SHADE	ADDRESS NUMBER	REF	LOCATION	TAX DIST	DATE INST	DATE CHANGE
05800	S	M	OUG	II	00200	014		12	060574	1/1/0001
05800	S	M	OUG	II	00201	015		12	060574	1/1/0001
05800	S	M	OUG	II	00240	016		12	060574	1/1/0001
05800	S	M	OUG	II	00240	018		12	100884	1/1/0001
05800	S	M	OUG	II	00251	017		12	060574	1/1/0001
05800	S	M	OUG	II	00251	019		12	100884	1/1/0001
05800	S	M	OUG	II	00256	016		12	100887	1/1/0001
05800	S	M	OUG	II	00315	015		12	100890	1/1/0001
05800	S	M	OUG	II	00000	014	SIDE OF 316 CHIPPENDALE CIRCLE	12	100884	1/1/0001
05800	S	M	OUG	II	00327	005		12	100884	1/1/0001
05800	S	M	OUG	II	00335	006		12	100890	1/1/0001
05800	S	M	OUG	II	00342	007		12	100887	1/1/0001
05800	S	M	OUG	II	00351	008		12	020888	1/1/0001
05800	S	M	OUG	II	00362	009		12	100890	1/1/0001
05800	S	M	OUG	II	00371	010		12	100890	1/1/0001
05800	S	M	OUG	II	00378	011		12	060893	1/1/0001
05800	S	M	OUG	II	00387	012		12	060893	1/1/0001
05800	S	M	OUG	II	00404	013		12	020888	1/1/0001
05800	S	M	OUG	II	00416	021		12	020888	1/1/0001
05800	S	M	OUG	II	00432	023		12	020888	1/1/0001

OFFICE: 311

ROUTE: 564

ST_REF_NO: 00000143800

PATRICIA LANE

LUMENS	BULB TYPE	MULT SERIES	POLE TYPE	SHADE	ADDRESS NUMBER	REF	LOCATION	TAX DIST	DATE INST	DATE CHANGE
04000	S	M	OUG	II	00000	020	SIDE OF 1041 HUDSON AVE.	12	051477	1/1/0001
04000	S	M	OUG	II	01004	014		12	051477	1/1/0001
04000	S	M	OUG	II	01016	016		12	051477	1/1/0001
04000	S	M	OUG	II	01017	015		12	051477	1/1/0001
04000	S	M	OUG	II	01040	018		12	051477	1/1/0001
04000	S	M	OUG	II	01049	017		12	051477	1/1/0001
04000	S	M	OUG	II	01077	019		12	051477	1/1/0001

OFFICE: 311		ROUTE: 564		ST_REF_NO: 00000143830		PATRICK HENRY WAY				
LUMENS	BULB TYPE	MULT SERIES	POLE TYPE	SHADE	ADDRESS NUMBER	REF	LOCATION	TAX DIST	DATE INST	DATE CHANGE
05800	S	M	OUG	II	02500	001		12	080800	1/1/0001
05800	S	M	OUG	II	02517	002		12	080800	1/1/0001

OFFICE: 311		ROUTE: 564		ST_REF_NO: 00000143850		PATRIOT COURT				
LUMENS	BULB TYPE	MULT SERIES	POLE TYPE	SHADE	ADDRESS NUMBER	REF	LOCATION	TAX DIST	DATE INST	DATE CHANGE
05800	S	M	OUG	II	00604	003		12	050897	1/1/0001
05800	S	M	OUG	II	00617	002		12	050897	1/1/0001
05800	S	M	OUG	II	00620	001		12	050897	1/1/0001

OFFICE: 311		ROUTE: 564		ST_REF_NO: 00000144000		PATTERSON STREET				
LUMENS	BULB TYPE	MULT SERIES	POLE TYPE	SHADE	ADDRESS NUMBER	REF	LOCATION	TAX DIST	DATE INST	DATE CHANGE
09500	S		SOH	II	00000	050	SIDE OF 540 W MAXWELL ST, ON PATTERSON STREET	12	052109	1/1/0001
05800	S	M	SOH	II	00615	459		12	060867	1/1/0001
05800	S	M	SOH	II	00630	458		12	060867	1/1/0001
05800	S	M	SOH	V	00644	457		12	060867	1/1/0001
05800	S	M	SOH	II	00000	460	NE CORNER OF PATTERSON & DERROODE ST.	12	060867	1/1/0001
05800	S	M	SOH	II	00000	462	1ST LT. N. OF RR TRACKS, W. SIDE	12	060867	1/1/0001
05800	S	M	SOH	II	00000	463	OPP. 529	12	060867	1/1/0001
05800	S	M	SOH	II	00000	465	NE CORNER OF PATTERSON & PINE ST.	12	060867	1/1/0001
05800	S	M	SOH	II	00000	467	1ST LT. S. OF MAXWELL ST., E. SIDE	12	060867	1/1/0001
05800	S	M	SOH	II	00419	466		12	060867	1/1/0001
05800	S	M	SOH	II	00509	464		12	060867	1/1/0001
05800	S	M	SOH	II	00569	461		12	060867	1/1/0001
50000	S	M	CNT	III	00000	004	4TH LT. S. OF W. MAIN ST., EASTSIDE	12	010892	1/1/0001
50000	S	M	CNT	III	00000	005	5TH LT. S. OF W. MAIN ST., EASTSIDE	12	010892	1/1/0001

OFFICE: 311		ROUTE: 564		ST_REF_NO: 00000144050		PATTON COURT				
LUMENS	BULB TYPE	MULT SERIES	POLE TYPE	SHADE	ADDRESS NUMBER	REF	LOCATION	TAX DIST	DATE INST	DATE CHANGE
05800	S	M	CNT	III	02309	002		12	102606	1/1/0001
05800	S	M	CNT	II	02316	001		12	102606	1/1/0001

OFFICE: 311		ROUTE: 564		ST_REF_NO: 00000144100		PAUL AVENUE		LUMENS	BULB TYPE	MULT SERIES	POLE TYPE	SHADE	ADDRESS NUMBER	REF	LOCATION	TAX DIST	DATE INST	DATE CHANGE
	05800	S	M	SOH	I	00711	000									12	060269	1/1/0001

OFFICE: 311		ROUTE: 564		ST_REF_NO: 00000144200		PAXON COURT		LUMENS	BULB TYPE	MULT SERIES	POLE TYPE	SHADE	ADDRESS NUMBER	REF	LOCATION	TAX DIST	DATE INST	DATE CHANGE
	04000	S	M	OUG	II	03212	041									12	061580	1/1/0001

OFFICE: 311		ROUTE: 564		ST_REF_NO: 00000144300		PAYNE STREET		LUMENS	BULB TYPE	MULT SERIES	POLE TYPE	SHADE	ADDRESS NUMBER	REF	LOCATION	TAX DIST	DATE INST	DATE CHANGE
	05800	S	M	SOH	I	00000	001								1ST LT. N. OF 165, W. SIDE	12	011369	1/1/0001
	05800	S	M	SOH	I	00000	002								N. OF 151, W. SIDE	12	011369	1/1/0001
	05800	S	M	SOH	I	00000	003								OPP. 145	12	011369	1/1/0001
	05800	S	M	SOH	I	00000	004								OPP. 129	12	011369	1/1/0001

OFFICE: 311		ROUTE: 564		ST_REF_NO: 00000144600		PEACHTREE ROAD		LUMENS	BULB TYPE	MULT SERIES	POLE TYPE	SHADE	ADDRESS NUMBER	REF	LOCATION	TAX DIST	DATE INST	DATE CHANGE
	05800	S	M	OUG	II	00301	000									12	070172	1/1/0001
	05800	S	M	OUG	II	00316	000									12	080171	1/1/0001
	05800	S	M	OUG	II	00329	000									12	080171	1/1/0001
	05800	S	M	OUG	II	00336	000									12	070172	1/1/0001
	05800	S	M	OUG	II	00353	000									12	070172	1/1/0001
	05800	S	M	OUG	II	00368	000									12	070172	1/1/0001
	05800	S	M	OUG	II	00385	000									12	070172	1/1/0001
	05800	S	M	OUG	II	00396	000									12	070172	1/1/0001
	05800	S	M	OUG	II	00405	000									12	080172	1/1/0001
	05800	S	M	OUG	II	00408	000									12	070172	1/1/0001
	05800	S	M	OUG	II	00441	000									12	070172	1/1/0001
	05800	S	M	OUG	II	00452	000									12	070172	1/1/0001
	05800	S	M	OUG	II	00465	000									12	070172	1/1/0001
	05800	S	M	OUG	II	00476	000									12	070172	1/1/0001

OFFICE: 311		ROUTE: 564		ST_REF_NO: 00000144750		PEAKS MILL DRIVE				
LUMENS	BULB TYPE	MULT SERIES	POLE TYPE	SHADE	ADDRESS NUMBER	REF	LOCATION	TAX DIST	DATE INST	DATE CHANGE
05800	S	M	CNT	II	00000	001	SIDE OF 136 WHITE OAK TRACE ON PEAKS MILL DR	12	060304	1/1/0001
05800	S	M	CNT	II	00000	002	SIDE OF 129 WHITE OAK TRACE ON PEAKS MILL DR	12	060304	1/1/0001
05800	S	M	CNT	II	02949	001		12	103005	1/1/0001

OFFICE: 311		ROUTE: 564		ST_REF_NO: 00000144760		PEARL COVE				
LUMENS	BULB TYPE	MULT SERIES	POLE TYPE	SHADE	ADDRESS NUMBER	REF	LOCATION	TAX DIST	DATE INST	DATE CHANGE
05800	S	M	CNT	II	00605	001		12	062307	1/1/0001

OFFICE: 311		ROUTE: 564		ST_REF_NO: 00000144775		PEBBLE BROOK CIRCLE				
LUMENS	BULB TYPE	MULT SERIES	POLE TYPE	SHADE	ADDRESS NUMBER	REF	LOCATION	TAX DIST	DATE INST	DATE CHANGE
05800	S	M	CNT	II	00000	001	SIDE OF 709 STANSBERRY COVE ON PEBBLE BROOK CIRCLE	12	070806	1/1/0001
05800	S	M	CNT	II	04500	040		12	041508	1/1/0001
05800	S	M	CNT	II	04529	030		12	041508	1/1/0001
05800	S	M	CNT	II	04537	020		12	041508	1/1/0001

OFFICE: 311		ROUTE: 564		ST_REF_NO: 00000144800		PEBBLE CREEK DRIVE				
LUMENS	BULB TYPE	MULT SERIES	POLE TYPE	SHADE	ADDRESS NUMBER	REF	LOCATION	TAX DIST	DATE INST	DATE CHANGE
04000	S	M	OUG	II	00600	002		12	111580	1/1/0001
04000	S	M	OUG	II	00608	003		12	111580	1/1/0001
04000	S	M	OUG	II	00624	004		12	111580	1/1/0001
04000	S	M	OUG	V	00632	005		12	111580	1/1/0001

OFFICE: 311		ROUTE: 564		ST_REF_NO: 00000144900		PEBBLE LAKE DRIVE				
LUMENS	BULB TYPE	MULT SERIES	POLE TYPE	SHADE	ADDRESS NUMBER	REF	LOCATION	TAX DIST	DATE INST	DATE CHANGE
05800	S	M	OUG	II	00000	097	SIDE OF 1000 CRYSTAL CT.	12	061580	1/1/0001
04000	S	M	OUG	II	03208	100		12	010888	1/1/0001
05800	S	M	OUG	V	03217	099		12	061580	1/1/0001
05800	S	M	OUG	II	03221	098		12	061580	1/1/0001
04000	S	M	OUG	II	03241	096		12	010888	1/1/0001

OFFICE: 311

ROUTE: 564

ST_REF_NO: 00000144900

PEBBLE LAKE DRIVE

LUMENS	BULB TYPE	MULT SERIES	POLE TYPE	SHADE	ADDRESS NUMBER	REF	LOCATION	TAX DIST	DATE INST	DATE CHANGE
04000	S	M	OUG	II	03252	095		12	010888	1/1/0001
04000	S	M	OUG	II	03264	093		12	090884	1/1/0001
05800	S	M	OUG	II	03265	094		12	061580	1/1/0001

OFFICE: 311

ROUTE: 564

ST_REF_NO: 00000144974

PELICAN CIRCLE

LUMENS	BULB TYPE	MULT SERIES	POLE TYPE	SHADE	ADDRESS NUMBER	REF	LOCATION	TAX DIST	DATE INST	DATE CHANGE
05800	S	M	OUG	III	00000	001	SIDE OF 308 PELICAN LANE ON PELICAN CIRCLE	12	040504	1/1/0001

OFFICE: 311

ROUTE: 564

ST_REF_NO: 00000144975

PELICAN LANE

LUMENS	BULB TYPE	MULT SERIES	POLE TYPE	SHADE	ADDRESS NUMBER	REF	LOCATION	TAX DIST	DATE INST	DATE CHANGE
05800	S	M	OUG	II	00000	004	SIDE OF 1507 NORTH FORBES RD ON PELICAN LANE	12	040504	1/1/0001
05800	S	M	OUG	II	00301	003		12	040504	1/1/0001
05800	S	M	OUG	II	00309	002		12	040504	1/1/0001
05800	S	M	OUG	III	00324	001		12	040504	1/1/0001

OFFICE: 311

ROUTE: 564

ST_REF_NO: 00000145000

PELLINORE COURT

LUMENS	BULB TYPE	MULT SERIES	POLE TYPE	SHADE	ADDRESS NUMBER	REF	LOCATION	TAX DIST	DATE INST	DATE CHANGE
05800	S	M	OUG	II	01701	000		12	010173	1/1/0001
05800	S	M	OUG	II	01708	000		12	010173	1/1/0001
05800	S	M	OUG	V	01720	000		12	071367	1/1/0001

OFFICE: 311

ROUTE: 564

ST_REF_NO: 00000145050

PEMBERTON LANE

LUMENS	BULB TYPE	MULT SERIES	POLE TYPE	SHADE	ADDRESS NUMBER	REF	LOCATION	TAX DIST	DATE INST	DATE CHANGE
05800	S	M	SOH	I	00000	001	1ST LT. FROM 6TH ST.upgraded 10/07	12	012069	1/1/0001
05800	S	M	SOH	I	00000	002	2ND LT. FROM 6TH ST.	12	012069	1/1/0001
05800	S	M	SOH	I	00000	003	3RD LT. FROM 6TH ST.upgraded 10/07	12	012069	1/1/0001
05800	S	M	SOH	I	00000	004	4TH LT. FROM 6TH ST. upgraded 10/07	12	012069	1/1/0001

OFFICE: 311

ROUTE: 564

ST_REF_NO: 00000145100

PEMBERTON STREET

LUMENS	BULB TYPE	MULT SERIES	POLE TYPE	SHADE	ADDRESS NUMBER	REF	LOCATION	TAX DIST	DATE INST	DATE CHANGE
05800	S	M	SOH	III	00501	050		12	120566	1/1/0001
05800	S	M	SOH	II	00524	049		12	120566	1/1/0001
05800	S	M	SOH	III	00545	051		12	120566	1/1/0001
05800	S	M	SOH	III	00561	052		12	120566	1/1/0001

OFFICE: 311

ROUTE: 564

ST_REF_NO: 00000145170

PENBROKE PLACE

LUMENS	BULB TYPE	MULT SERIES	POLE TYPE	SHADE	ADDRESS NUMBER	REF	LOCATION	TAX DIST	DATE INST	DATE CHANGE
05800	S	M	CNT	II	00000	004	SIDE OF 1101 SHEFFIELD PLACE	12	010897	1/1/0001
05800	S	M	CNT	II	03200	005		12	010897	1/1/0001
05800	S	M	CNT	II	03208	003		12	010897	1/1/0001
05800	S	M	CNT	II	03220	001		12	010897	1/1/0001
05800	S	M	CNT	II	03225	002		12	010897	1/1/0001

OFFICE: 311

ROUTE: 564

ST_REF_NO: 00000145250

PENMOKEN PARK ALLEY

LUMENS	BULB TYPE	MULT SERIES	POLE TYPE	SHADE	ADDRESS NUMBER	REF	LOCATION	TAX DIST	DATE INST	DATE CHANGE
05800	S	M	SOH	II	00000	001		12	100893	1/1/0001
05800	S	M	SOH	II	00000	002		12	100893	1/1/0001

OFFICE: 311

ROUTE: 564

ST_REF_NO: 00000145300

PENMOKEN PARK

LUMENS	BULB TYPE	MULT SERIES	POLE TYPE	SHADE	ADDRESS NUMBER	REF	LOCATION	TAX DIST	DATE INST	DATE CHANGE
05800	S	M	SOH	II	00000	008	OPP. 170 IN ISLAND	12	121578	1/1/0001
05800	S	M	SOH	II	00102	000		12	121578	1/1/0001
05800	S	M	SOH	II	00106	000		12	121578	1/1/0001
05800	S	M	SOH	II	00114	000		12	121578	1/1/0001
05800	S	M	SOH	II	00124	000		12	121578	1/1/0001
05800	S	M	SOH	II	00138	000		12	121578	1/1/0001
05800	S	M	SOH	II	00150	000		12	121578	1/1/0001
05800	S	M	SOH	II	00162	000		12	121578	1/1/0001

OFFICE: 311		ROUTE: 564		ST_REF_NO: 00000145400		PENNEBAKER DRIVE				
LUMENS	BULB TYPE	MULT SERIES	POLE TYPE	SHADE	ADDRESS NUMBER	REF	LOCATION	TAX DIST	DATE INST	DATE CHANGE
05800	S	M	OUG	II	00000	066	SIDE OF 1101 WINBURN DR.	12	091477	1/1/0001
05800	S	M	OUG	II	00000	071	SIDE OF 1889 COSTIGAN DR.	12	100171	1/1/0001
05800	S	M	OUG	II	00000	088	SIDE OF 1712 COSTIGAN DR.	12	070172	1/1/0001
05800	S	M	OUG	II	01012	000		12	100171	1/1/0001
05800	S	M	OUG	II	01013	000		12	100171	1/1/0001
05800	S	M	OUG	II	01025	000		12	100171	1/1/0001
05800	S	M	OUG	II	01033	000		12	100171	1/1/0001
05800	S	M	OUG	II	01036	000		12	100171	1/1/0001
05800	S	M	OUG	II	01053	000		12	100171	1/1/0001
05800	S	M	OUG	II	01065	000		12	070172	1/1/0001
05800	S	M	OUG	II	01085	000		12	100874	1/1/0001
05800	S	M	OUG	II	01093	090		12	100897	1/1/0001

OFFICE: 311		ROUTE: 564		ST_REF_NO: 00000145490		PENNSYLVANIA AVENUE				
LUMENS	BULB TYPE	MULT SERIES	POLE TYPE	SHADE	ADDRESS NUMBER	REF	LOCATION	TAX DIST	DATE INST	DATE CHANGE
09500	S	M	CNT	II	00447	001		12	112002	1/1/0001
09500	S	M	CNT	II	00450	002		12	112002	1/1/0001

OFFICE: 311		ROUTE: 564		ST_REF_NO: 00000145500		PENNSYLVANIA COURT				
LUMENS	BULB TYPE	MULT SERIES	POLE TYPE	SHADE	ADDRESS NUMBER	REF	LOCATION	TAX DIST	DATE INST	DATE CHANGE
05800	S	M	SOH	II	00400	000		12	060162	1/1/0001
05800	S	M	SOH	II	00406	000		12	060162	1/1/0001
05800	S	M	SOH	II	00414	000		12	060162	1/1/0001

OFFICE: 311		ROUTE: 564		ST_REF_NO: 00000145550		PENNY LANE				
LUMENS	BULB TYPE	MULT SERIES	POLE TYPE	SHADE	ADDRESS NUMBER	REF	LOCATION	TAX DIST	DATE INST	DATE CHANGE
05800	S	M	CNT	III	00804	003		12	120897	1/1/0001
05800	S	M	CNT	II	00816	002		12	120897	1/1/0001
05800	S	M	CNT	II	00829	001		12	120897	1/1/0001

OFFICE: 311		ROUTE: 564		ST_REF_NO: 00000145600		PENROD DRIVE		LUMENS	BULB TYPE	MULT SERIES	POLE TYPE	SHADE	ADDRESS NUMBER	REF	LOCATION	TAX DIST	DATE INST	DATE CHANGE
04000	S	M	OUG	II	00000	072	OPP. FROM SIDE OF 340 TAYLOR DR.	12	121582	1/1/0001								
04000	S	M	OUG	II	00000	073	OPP. FROM SIDE OF 349 GLENDALE AVE.	12	121582	1/1/0001								
04000	S	M	OUG	II	00000	074	OPP. FROM SIDE OF 352 GLENDALE AVE.	12	121582	1/1/0001								
04000	S	M	OUG	II	00000	075	OPP. FROM SIDE OF 361 HILLSBORO AVE.	12	121582	1/1/0001								
04000	S	M	OUG	II	00000	076	OPP. FROM SIDE OF 356 HILLSBORO AVE.	12	121582	1/1/0001								
04000	S	M	OUG	II	00000	077	OPP. FROM SIDE OF 357 BOILING SPRINGS DR.	12	121582	1/1/0001								
04000	S	M	OUG	II	00000	119	SIDE OF 360 BOILING SPRINGS DR.	12	121582	1/1/0001								
04000	S	M	OUG	II	01541	120		12	121582	1/1/0001								

OFFICE: 311		ROUTE: 564		ST_REF_NO: 00000145700		PENSACOLA DRIVE		LUMENS	BULB TYPE	MULT SERIES	POLE TYPE	SHADE	ADDRESS NUMBER	REF	LOCATION	TAX DIST	DATE INST	DATE CHANGE
04000	S	M	SOH	I	00000	001	SIDE OF 161 WABASH DR.	12	100162	1/1/0001								
04000	S	M	SOH	I	00000	002	OPP. 1857	12	100162	1/1/0001								
04000	S	M	SOH	I	00000	003	OPP. 1865	12	100162	1/1/0001								
04000	S	M	SOH	I	00000	004	OPP. 1869	12	100162	1/1/0001								
04000	S	M	SOH	I	01875	005		12	100162	1/1/0001								

OFFICE: 311		ROUTE: 564		ST_REF_NO: 00000145710		PENSURST SQUARE		LUMENS	BULB TYPE	MULT SERIES	POLE TYPE	SHADE	ADDRESS NUMBER	REF	LOCATION	TAX DIST	DATE INST	DATE CHANGE
05800	S	M	OUG	II	04300	001		12	040894	1/1/0001								
05800	S	M	OUG	II	04308	002		12	040894	1/1/0001								
05800	S	M	OUG	III	04324	003		12	040894	1/1/0001								

OFFICE: 311		ROUTE: 564		ST_REF_NO: 00000145750		PENTALLA POINTE		LUMENS	BULB TYPE	MULT SERIES	POLE TYPE	SHADE	ADDRESS NUMBER	REF	LOCATION	TAX DIST	DATE INST	DATE CHANGE
05800	S	M	CNT	II	04500	003		12	080897	1/1/0001								
05800	S	M	CNT	II	04517	002		12	080897	1/1/0001								
05800	S	M	CNT	II	04524	001		12	080897	1/1/0001								

OFFICE: 311		ROUTE: 564		ST_REF_NO: 00000145800		PENWAY COURT		LUMENS	BULB TYPE	MULT SERIES	POLE TYPE	SHADE	ADDRESS NUMBER	REF	LOCATION	TAX DIST	DATE INST	DATE CHANGE
05800	S	M	OUG	II	00000	026	SIDE OF 593 FOLKSTONE DR.	12	121467	1/1/0001								

OFFICE: 311		ROUTE: 564		ST_REF_NO: 00000145900		PEPPER DRIVE		LUMENS	BULB TYPE	MULT SERIES	POLE TYPE	SHADE	ADDRESS NUMBER	REF	LOCATION	TAX DIST	DATE INST	DATE CHANGE
05800	S	M	OUG	II	00000	143	OPP. 321	12	121582	1/1/0001								
05800	S	M	OUG	II	00220	139		12	121582	1/1/0001								
05800	S	M	OUG	II	00231	140		12	121582	1/1/0001								
05800	S	M	OUG	II	00244	141		12	121582	1/1/0001								
05800	S	M	OUG	II	00255	142		12	121582	1/1/0001								

OFFICE: 311		ROUTE: 564		ST_REF_NO: 00000145990		PEPPERHILL CIRCLE		LUMENS	BULB TYPE	MULT SERIES	POLE TYPE	SHADE	ADDRESS NUMBER	REF	LOCATION	TAX DIST	DATE INST	DATE CHANGE
05800	S	M	OUG	II	01104	195		12	111580	1/1/0001								
04000	S	M	OUG	V	01117	194		12	040888	1/1/0001								

OFFICE: 311		ROUTE: 564		ST_REF_NO: 00000146000		PEPPERHILL ROAD		LUMENS	BULB TYPE	MULT SERIES	POLE TYPE	SHADE	ADDRESS NUMBER	REF	LOCATION	TAX DIST	DATE INST	DATE CHANGE
05800	S	M	OUG	II	00000	084	SIDE OF 3405 BAY LEAF DR.	12	121073	1/1/0001								
05800	S	M	OUG	II	00000	086	SIDE OF 3313 BAY LEAF DR.	12	071674	1/1/0001								
05800	S	M	OUG	II	00000	087	SIDE OF 3405 MONATAVESTA RD.	12	071674	1/1/0001								
05800	S	M	OUG	II	00000	088	SIDE OF 3380 MONTAVESTA RD.	12	121073	1/1/0001								
05800	S	M	OUG	II	00000	090	OPP. 3278	12	121581	1/1/0001								
05800	S	M	OUG	II	00000	092	OPP. 3270	12	121073	1/1/0001								
05800	S	M	OUG	II	00000	094	OPP. 3262	12	121073	1/1/0001								
05800	S	M	OUG	II	00000	115	SIDE OF 3401 GINGERTREE	12	072374	1/1/0001								
05800	S	M	OUG	II	00000	137	SIDE OF 1224 TISHOFF DR.	12	011476	1/1/0001								
05800	S	M	OUG	II	00000	190	SIDE OF 3416 FREELAND DR.	12	011581	1/1/0001								
05800	S	M	OUG	II	00000	193	SIDE OF 1133 CHINOE RD.	12	040888	1/1/0001								
05800	S	M	OUG	II	03184	012		12	030888	1/1/0001								
05800	S	M	OUG	II	03185	011		12	090884	1/1/0001								
05800	S	M	OUG	II	03188	013		12	030888	1/1/0001								

OFFICE: 311

ROUTE: 564

ST_REF_NO: 00000146000

PEPPERHILL ROAD

LUMENS	BULB TYPE	MULT SERIES	POLE TYPE	SHADE	ADDRESS NUMBER	REF	LOCATION	TAX DIST	DATE INST	DATE CHANGE
05800	S	M	OUG	II	03192	014		12	111580	1/1/0001
05800	S	M	OUG	II	03200	015		12	111580	1/1/0001
05800	S	M	OUG	II	03209	116		12	071476	1/1/0001
05800	S	M	OUG	II	03221	114		12	091477	1/1/0001
05800	S	M	OUG	II	03234	113		12	011475	1/1/0001
05800	S	M	OUG	II	03237	098		12	091573	1/1/0001
05800	S	M	OUG	II	03246	097		12	091573	1/1/0001
05800	S	M	OUG	II	03249	096		12	091573	1/1/0001
05800	S	M	OUG	II	03258	095		12	091573	1/1/0001
05800	S	M	OUG	II	03266	093		12	091573	1/1/0001
05800	S	M	OUG	II	03278	091		12	121073	1/1/0001
05800	S	M	OUG	II	03290	089		12	071674	1/1/0001
05800	S	M	OUG	II	03337	083		12	051475	1/1/0001
05800	S	M	OUG	II	03346	132		12	011581	1/1/0001
05800	S	M	OUG	II	03349	133		12	051475	1/1/0001
05800	S	M	OUG	II	03358	134		12	071476	1/1/0001
05800	S	M	OUG	II	03361	135		12	041476	1/1/0001
05800	S	M	OUG	II	03370	136		12	091477	1/1/0001
05800	S	M	OUG	II	03382	163		12	091477	1/1/0001
05800	S	M	OUG	II	03393	164		12	091477	1/1/0001
05800	S	M	OUG	II	03394	165		12	111478	1/1/0001
05800	S	M	OUG	II	03405	166		12	091477	1/1/0001
05800	S	M	OUG	II	03406	167		12	111478	1/1/0001
05800	S	M	OUG	II	03417	189		12	091477	1/1/0001
05800	S	M	SOH	II	03430	191		12	040888	1/1/0001
05800	S	M	OUG	II	03434	192		12	111580	1/1/0001

OFFICE: 311

ROUTE: 564

ST_REF_NO: 00000146010

PEPPERTREE COURT

LUMENS	BULB TYPE	MULT SERIES	POLE TYPE	SHADE	ADDRESS NUMBER	REF	LOCATION	TAX DIST	DATE INST	DATE CHANGE
05800	S	M	CNT	III	00000	001	SIDE 4077 PEPPERTREE DR.	12	100894	1/1/0001

OFFICE: 311

ROUTE: 564

ST_REF_NO: 00000146020

PEPPERTREE DRIVE

LUMENS	BULB TYPE	MULT SERIES	POLE TYPE	SHADE	ADDRESS NUMBER	REF	LOCATION	TAX DIST	DATE INST	DATE CHANGE
05800	S	M	CNT	II	03904	100		12	100894	1/1/0001
05800	S	M	CNT	II	03913	101		12	100894	1/1/0001
05800	S	M	CNT	II	04024	008		12	100894	1/1/0001
05800	S	M	CNT	II	04028	007		12	100894	1/1/0001
05800	S	M	CNT	II	04029	009		12	100894	1/1/0001
05800	S	M	CNT	II	04053	006		12	100894	1/1/0001
05800	S	M	CNT	II	04057	005		12	100894	1/1/0001
05800	S	M	CNT	II	04069	004		12	100894	1/1/0001
05800	S	M	CNT	II	04077	003		12	100894	1/1/0001
05800	S	M	CNT	II	04093	001		12	100894	1/1/0001
05800	S	M	CNT	II	01012	010		12	030897	1/1/0001
05800	S	M	CNT	II	03921	016		12	030897	1/1/0001
05800	S	M	CNT	II	03928	014		12	030897	1/1/0001
05800	S	M	CNT	II	03929	015		12	030897	1/1/0001
05800	S	M	CNT	II	03945	013		12	030897	1/1/0001
05800	S	M	CNT	II	04000	012		12	030897	1/1/0001
05800	S	M	CNT	II	04008	011		12	030897	1/1/0001

OFFICE: 311

ROUTE: 564

ST_REF_NO: 00000146025

PEPPERWOOD PLACE

LUMENS	BULB TYPE	MULT SERIES	POLE TYPE	SHADE	ADDRESS NUMBER	REF	LOCATION	TAX DIST	DATE INST	DATE CHANGE
04000	S	M	OUG	II	03500	001		12	110891	1/1/0001
05800	S	M	OUG	V	03516	002	upgrade 1/08	12	110891	1/1/0001

OFFICE: 311

ROUTE: 564

ST_REF_NO: 00000146050

PERIMETER DRIVE

LUMENS	BULB TYPE	MULT SERIES	POLE TYPE	SHADE	ADDRESS NUMBER	REF	LOCATION	TAX DIST	DATE INST	DATE CHANGE
05800	S	M	OUG	II	00600	006		12	120887	1/1/0001
05800	S	M	OUG	II	00601	007		12	120887	1/1/0001
05800	S	M	OUG	II	00670	004		12	120887	1/1/0001
05800	S	M	OUG	II	00670	005		12	120887	1/1/0001
05800	S	M	OUG	II	00698	001		12	120887	1/1/0001
05800	S	M	OUG	II	00698	002		12	120887	1/1/0001
05800	S	M	OUG	II	00698	003		12	120887	1/1/0001

OFFICE: 311

ROUTE: 564

ST_REF_NO: 00000146100

PERRY STREET

LUMENS	BULB TYPE	MULT SERIES	POLE TYPE	SHADE	ADDRESS NUMBER	REF	LOCATION	TAX DIST	DATE INST	DATE CHANGE
05800	S	M	SOH	V	00000	001	REAR OF 250 DRISCOLL STREET ON PERRY STREET	12	011865	1/1/0001
05800	S	M	SOH	I	00000	024	PERRY & WILLIAMSON	12	031466	1/1/0001
05800	S	M	SOH	I	00000	423	PERRY & EDMOND	12	062066	1/1/0001
05800	S	M	SOH	I	00215	420		12	062066	1/1/0001
05800	S	M	SOH	I	00229	421		12	062066	1/1/0001

OFFICE: 311

ROUTE: 564

ST_REF_NO: 00000146200

PERSHING ROAD

LUMENS	BULB TYPE	MULT SERIES	POLE TYPE	SHADE	ADDRESS NUMBER	REF	LOCATION	TAX DIST	DATE INST	DATE CHANGE
04000	S	M	OUG	II	00000	128	OPP. 1850	12	081583	1/1/0001
04000	S	M	OUG	II	00000	132	SIDE OF 609 LANE ALLEN	12	081583	1/1/0001
04000	S	M	OUG	II	01890	129		12	081583	1/1/0001
04000	S	M	OUG	II	01929	130		12	081583	1/1/0001
04000	S	M	OUG	II	01959	131		12	081583	1/1/0001

OFFICE: 311

ROUTE: 564

ST_REF_NO: 00000146305

PETAL WAY

LUMENS	BULB TYPE	MULT SERIES	POLE TYPE	SHADE	ADDRESS NUMBER	REF	LOCATION	TAX DIST	DATE INST	DATE CHANGE
05800	S		CNT	II	00000	002	SIDE OF 3309 SCOTTISH TRACE ON PETAL WAY	12	051510	1/1/0001
05800	S	M	CNT	II	00000	001	SIDE OF 3149 CHERRY MEADOW PATH ON PETAL WAY	12	092506	1/1/0001

OFFICE: 311

ROUTE: 564

ST_REF_NO: 00000146310

PHEASANT RUN

LUMENS	BULB TYPE	MULT SERIES	POLE TYPE	SHADE	ADDRESS NUMBER	REF	LOCATION	TAX DIST	DATE INST	DATE CHANGE
05800	S	M	CNT	II	00000	001	SIDE 1040 AUTUMN RIDGE DR.	12	060894	1/1/0001
05800	S	M	CNT	II	00000	002	SIDE 1048 AUTUMN RIDGE DR.	12	060894	1/1/0001
05800	S	M	CNT	II	00000	003	SIDE OF 1013 DOE MEADOW CT.	12	110894	1/1/0001
05800	S	M	CNT	II	03609	004		12	110894	1/1/0001
05800	S	M	CNT	II	03620	005		12	110894	1/1/0001
05800	S	M	CNT	II	03625	006		12	110894	1/1/0001
05800	S	M	CNT	II	03633	008		12	110894	1/1/0001
05800	S	M	CNT	II	03652	009		12	110894	1/1/0001
05800	S	M	CNT	II	03660	010		12	100899	1/1/0001

OFFICE: 311		ROUTE: 564		ST_REF_NO: 00000146500		PHOENIX ROAD		LUMENS	BULB TYPE	MULT SERIES	POLE TYPE	SHADE	ADDRESS NUMBER	REF	LOCATION	TAX DIST	DATE INST	DATE CHANGE
05800	S	M	OUG	II	02818	119										12	101583	7/9/2012
04000	S	M	OUG	II	00000	113	SIDE OF 636 WICHITA DR.									12	101583	1/1/0001
04000	S	M	OUG	II	00000	114	SIDE OF 715 PASADENA									12	101583	1/1/0001
04000	S	M	OUG	II	02800	115										12	101583	1/1/0001
04000	S	M	OUG	II	02805	116										12	101583	1/1/0001
04000	S	M	OUG	II	02810	117										12	101583	1/1/0001
04000	S	M	OUG	II	02815	118										12	101583	1/1/0001
OFFICE: 311		ROUTE: 564		ST_REF_NO: 00000146600		PICADILLY STREET		LUMENS	BULB TYPE	MULT SERIES	POLE TYPE	SHADE	ADDRESS NUMBER	REF	LOCATION	TAX DIST	DATE INST	DATE CHANGE
09500	S	M	OUG	II	01901	000										12	050160	1/1/0001
09500	S	M	OUG	II	01904	000										12	121659	1/1/0001
09500	S	M	OUG	II	01909	000										12	100163	1/1/0001
09500	S	M	OUG	II	01912	000										12	121659	1/1/0001
OFFICE: 311		ROUTE: 564		ST_REF_NO: 00000146700		PICADOME, EAST STREET		LUMENS	BULB TYPE	MULT SERIES	POLE TYPE	SHADE	ADDRESS NUMBER	REF	LOCATION	TAX DIST	DATE INST	DATE CHANGE
04000	S	M	SOH	II	00000	103	SIDE 309 ROSEMONT									12	100884	1/1/0001
04000	S	M	OOH	II	00105	104										12	100884	1/1/0001
04000	S	M	OUG	II	00000	099	SIDE 501 SOUTHLAND DRIVE									12	100884	1/1/0001
04000	S	M	OOH	II	00000	100	OPP. 1845 E. PICADOME									12	100884	1/1/0001
04000	S	M	OOH	II	00000	102	SIDE 400 ROSEMONT									12	100884	1/1/0001
04000	S	M	OOH	II	01830	101										12	100884	1/1/0001
OFFICE: 311		ROUTE: 564		ST_REF_NO: 00000146710		PICADOME, NORTH STREET		LUMENS	BULB TYPE	MULT SERIES	POLE TYPE	SHADE	ADDRESS NUMBER	REF	LOCATION	TAX DIST	DATE INST	DATE CHANGE
04000	S	M	OUG	II	00000	110	SIDE 272 LAFAYETTE PARKWAY									12	100884	1/1/0001
04000	S	M	OOH	II	00000	111	OPP.419									12	100884	1/1/0001
04000	S	M	OOH	II	00000	113	OPP.401									12	100884	1/1/0001
04000	S	M	OOH	II	00298	115										12	100884	1/1/0001
04000	S	M	SOH	II	00305	114										12	100884	1/1/0001

OFFICE: 311		ROUTE: 564		ST_REF_NO: 00000146710		PICADOME, NORTH STREET		LUMENS	BULB TYPE	MULT SERIES	POLE TYPE	SHADE	ADDRESS NUMBER	REF	LOCATION	TAX DIST	DATE INST	DATE CHANGE
	04000	S	M	SOH	II	00409	112									12	110884	1/1/0001

OFFICE: 311		ROUTE: 564		ST_REF_NO: 00000146720		PICADOME, WEST STREET		LUMENS	BULB TYPE	MULT SERIES	POLE TYPE	SHADE	ADDRESS NUMBER	REF	LOCATION	TAX DIST	DATE INST	DATE CHANGE
	04000	S	M	SOH	II	00116	090									12	110884	1/1/0001

OFFICE: 311		ROUTE: 564		ST_REF_NO: 00000146800		PIERSON DRIVE		LUMENS	BULB TYPE	MULT SERIES	POLE TYPE	SHADE	ADDRESS NUMBER	REF	LOCATION	TAX DIST	DATE INST	DATE CHANGE
	05800	S	M	OUG	II	02237	000									12	110766	1/1/0001
	05800	S	M	OUG	II	02302	000									12	100171	1/1/0001
	05800	S	M	OUG	II	02311	000									12	040171	1/1/0001
	05800	S	M	OUG	II	02318	000									12	050170	1/1/0001
	05800	S	M	OUG	II	02323	000									12	120167	1/1/0001
	05800	S	M	OUG	II	02338	000									12	100171	1/1/0001
	05800	S	M	OUG	II	02351	000									12	050969	1/1/0001
	05800	S	M	OUG	II	02362	000									12	050170	1/1/0001
	05800	S	M	OUG	II	02379	000									12	091967	1/1/0001
	05800	S	M	OUG	II	02400	000									12	091967	1/1/0001
	05800	S	M	OUG	II	02409	000									12	100171	1/1/0001
	05800	S	M	OUG	II	02424	000									12	060170	1/1/0001
	05800	S	M	OUG	II	02433	000									12	060170	1/1/0001
	05800	S	M	OUG	II	02440	000									12	031868	1/1/0001
	05800	S	M	OUG	II	02453	000									12	050969	1/1/0001
	05800	S	M	OUG	II	02456	000									12	060172	1/1/0001
	05800	S	M	OUG	II	02200	000									12	110766	1/1/0001
	05800	S	M	OUG	II	02213	000									12	110766	1/1/0001
	05800	S	M	OUG	II	02220	000									12	110766	1/1/0001

OFFICE: 311		ROUTE: 564		ST_REF_NO: 00000146850		PIEDMONT PARK		LUMENS	BULB TYPE	MULT SERIES	POLE TYPE	SHADE	ADDRESS NUMBER	REF	LOCATION	TAX DIST	DATE INST	DATE CHANGE
	05800	S	M	CNT	II	02900	001									12	030898	1/1/0001

OFFICE: 311

ROUTE: 564

ST_REF_NO: 00000146900

PIMLICO PARKWAY

LUMENS	BULB TYPE	MULT SERIES	POLE TYPE	SHADE	ADDRESS NUMBER	REF	LOCATION	TAX DIST	DATE INST	DATE CHANGE
05800	S	M	OUG	II	00000	209	SIDE OF 1296 MAYWOOD	12	110171	1/1/0001
05800	S	M	OUG	II	00000	217	SIDE OF 1295 OAKLAWN	12	040171	1/1/0001
05800	S	M	OUG	II	00000	218	SIDE OF 1300 TANFORAN DR.	12	120172	1/1/0001
05800	S	M	OUG	II	00000	221	SIDE OF 1291 NARRAGANSETT	12	120172	1/1/0001
05800	S	M	OUG	II	03319	220		12	111583	1/1/0001
05800	S	M	OUG	II	03323	219		12	072374	1/1/0001
05800	S	M	OUG	II	03346	214		12	051074	1/1/0001
05800	S	M	OUG	II	03355	213		12	040171	1/1/0001
05800	S	M	OUG	II	03362	212		12	051074	1/1/0001
05800	S	M	OUG	II	00000	250	SIDE OF 3292 BOWIE DR.	12	051074	1/1/0001
05800	S	M	OUG	II	00000	251	SIDE OF 1389 TANFORAN DR.	12	081477	1/1/0001
05800	S	M	OUG	II	03199	015		12	041478	1/1/0001
05800	S	M	OUG	II	03210	029		12	111580	1/1/0001
05800	S	M	OUG	II	03211	014		12	101476	1/1/0001
05800	S	M	OUG	II	03222	028		12	041478	1/1/0001
05800	S	M	OUG	II	03227	013		12	081477	1/1/0001
05800	S	M	OUG	II	03234	027		12	091476	1/1/0001
05800	S	M	OUG	II	03239	002		12	031475	1/1/0001
05800	S	M	OUG	II	03246	001		12	031475	1/1/0001
05800	S	M	OUG	II	03255	252		12	051074	1/1/0001
05800	S	M	OUG	II	03278	249		12	072474	1/1/0001
05800	S	M	OUG	II	03287	225		12	051074	1/1/0001
05800	S	M	OUG	II	03294	224		12	051074	1/1/0001
05800	S	M	OUG	II	03299	223		12	120172	1/1/0001
05800	S	M	OUG	II	03306	222		12	051074	1/1/0001
05800	S	M	OUG	II	00000	205	SIDE OF 1303 GAINESWAY	12	080172	1/1/0001
05800	S	M	OUG	II	00000	262	OPP. 3435	12	111583	1/1/0001
05800	S	M	OUG	II	00000	264	OPP. 3455	12	111583	1/1/0001
05800	S	M	OUG	II	00000	266	OPP. 3467	12	111583	1/1/0001
05800	S	M	OUG	II	00000	268	OPP. SOUTHSIDE TATES CREEK COUNTRY CLUB	12	031475	1/1/0001
05800	S	M	OUG	II	00000	269	SOUTHSIDE TATES CREEK COUNTRY CLUB	12	031475	1/1/0001
05800	S	M	OUG	II	00000	270	OPP. 3501	12	031475	1/1/0001
05800	S	M	OUG	II	03374	208		12	051074	1/1/0001
05800	S	M	OUG	II	03381	207		12	110171	1/1/0001

OFFICE: 311

ROUTE: 564

ST_REF_NO: 00000146900

PIMLICO PARKWAY

LUMENS	BULB TYPE	MULT SERIES	POLE TYPE	SHADE	ADDRESS NUMBER	REF	LOCATION	TAX DIST	DATE INST	DATE CHANGE
05800	S	M	OUG	II	03386	206		12	051074	1/1/0001
05800	S	M	OUG	II	03403	257		12	051476	1/1/0001
05800	S	M	OUG	II	03410	258		12	081477	1/1/0001
05800	S	M	OUG	II	03415	259		12	081477	1/1/0001
05800	S	M	OUG	II	03426	260		12	041581	1/1/0001
05800	S	M	OUG	II	03447	263		12	061581	1/1/0001
05800	S	M	OUG	II	03463	265		12	061581	1/1/0001
05800	S	M	OUG	II	00000	001	SIDE OF 3201 MAMMOTH DR.	12	091476	1/1/0001
05800	S	M	OUG	II	00000	002	SIDE OF 3200 MAMMOTH DR.	12	081477	1/1/0001
05800	S	M	OUG	II	00000	003	SIDE OF 3249 MAMMOTH DR.	12	081477	1/1/0001
05800	S	M	OUG	II	00000	025	SIDE OF 3199 CUSTER DR.	12	091477	1/1/0001
09500	S	M	OUG	II	00000	027	SIDE OF 3199 CUSTER DR.	12	091477	1/1/0001
04000	S	M	OUG	II	00000	049	SIDE OF 1180 MT. RUSHMORE	12	061580	1/1/0001
04000	S	M	OUG	II	00000	057	SIDE OF 3066	12	061580	1/1/0001
09500	S	M	OUG	II	00000	073	SIDE OF 3202 CUSTER	12	060890	1/1/0001
09500	S	M	OUG	II	00000	074	SW COR PIMLICO AND MAN O WAR	12	060890	1/1/0001
05800	S	M	OUG	II	00000	097	SIDE OF 3161 HIGH RIDGE	12	091582	1/1/0001
05800	S	M	OUG	II	00000	272	OPP. 3501	12	031475	1/1/0001
05800	S	M	OUG	II	00000	274	OPP. 3501	12	031475	1/1/0001
05800	S	M	OUG	II	00000	277	OPP. 3550	12	031475	1/1/0001
05800	S	M	OUG	II	00000	279	OPP. 3575	12	031475	1/1/0001
05800	S	M	OUG	II	00000	281	OPP. 3575	12	031475	1/1/0001
04000	S	M	OUG	II	03002	050		12	011581	1/1/0001
04000	S	M	OUG	II	03015	054		12	061580	1/1/0001
04000	S	M	OUG	II	03026	055		12	061580	1/1/0001
04000	S	M	OUG	II	03039	056		12	061580	1/1/0001
04000	S	M	OUG	II	03067	058		12	061580	1/1/0001
05800	S	M	OUG	II	03074	033		12	061580	1/1/0001
05800	S	M	OUG	II	03083	032		12	061580	1/1/0001
05800	S	M	OUG	II	03094	031		12	061580	1/1/0001
05800	S	M	OUG	II	03099	030		12	061580	1/1/0001
09500	S	M	OUG	II	03110	072		12	060890	1/1/0001
09500	S	M	OUG	II	03130	026		12	051582	1/1/0001
05800	S	M	OUG	II	03171	096		12	111580	1/1/0001

OFFICE: 311

ROUTE: 564

ST_REF_NO: 00000146900

PIMLICO PARKWAY

LUMENS	BULB TYPE	MULT SERIES	POLE TYPE	SHADE	ADDRESS NUMBER	REF	LOCATION	TAX DIST	DATE INST	DATE CHANGE
05800	S	M	OUG	II	03189	095		12	060890	1/1/0001
05800	S	M	OUG	II	03194	030		12	041478	1/1/0001
05800	S	M	OUG	II	03501	271		12	031475	1/1/0001
05800	S	M	OUG	II	03501	273		12	031475	1/1/0001
05800	S	M	OUG	II	03501	275		12	031475	1/1/0001
05800	S	M	OUG	II	03550	276		12	031475	1/1/0001
05800	S	M	OUG	II	03550	278		12	031475	1/1/0001
05800	S	M	OUG	II	03576	280		12	041581	1/1/0001

OFFICE: 311

ROUTE: 564

ST_REF_NO: 00000146990

PIN OAK, SOUTH STREET

LUMENS	BULB TYPE	MULT SERIES	POLE TYPE	SHADE	ADDRESS NUMBER	REF	LOCATION	TAX DIST	DATE INST	DATE CHANGE
04000	S	M	SOH	II	00000	126	SIDE 397 SOUTHLAND DRIVE	12	100884	1/1/0001
04000	S	M	SOH	II	00000	127	SIDE 397 SOUTHLAND DRIVE	12	100884	1/1/0001
04000	S	M	SOH	II	00000	131	SIDE 268 ROSEMONT	12	100884	1/1/0001
04000	S	M	SOH	II	00106	130		12	100884	1/1/0001
04000	S	M	SOH	II	00114	129		12	100884	1/1/0001
04000	S	M	SOH	II	00124	128		12	100884	1/1/0001

OFFICE: 311

ROUTE: 564

ST_REF_NO: 00000147000

PIN OAK, NORTH AVENUE

LUMENS	BULB TYPE	MULT SERIES	POLE TYPE	SHADE	ADDRESS NUMBER	REF	LOCATION	TAX DIST	DATE INST	DATE CHANGE
04000	S	M	OUG	II	00000	135	SIDE OF 202-204 KOSTER ST.	12	090884	1/1/0001
05800	S	M	OUG	II	00000	136	OPP. 218 N. PIN OAK ST.upgraded 5/08	12	090884	1/1/0001
04000	S	M	OUG	II	00000	137	SIDE 201-203 NORWAY ON N. PIN OAK ST.	12	090884	1/1/0001
04000	S	M	OUG	II	00000	138	SIDE 202 REED LANE	12	100884	1/1/0001
04000	S	M	OUG	II	00000	132	SIDE OF 265 ROSEMONT	12	090884	1/1/0001
04000	S	M	SOH	II	00104	133		12	100884	1/1/0001
04000	S	M	OUG	II	00113	134		12	090884	1/1/0001

OFFICE: 311

ROUTE: 564

ST_REF_NO: 00000147010

PINAS BAY COURT

LUMENS	BULB TYPE	MULT SERIES	POLE TYPE	SHADE	ADDRESS NUMBER	REF	LOCATION	TAX DIST	DATE INST	DATE CHANGE
05800	S	M	OUG	II	03404	182		12	011581	1/1/0001

OFFICE: 311

ROUTE: 564

ST_REF_NO: 00000147010

PINAS BAY COURT

LUMENS	BULB TYPE	MULT SERIES	POLE TYPE	SHADE	ADDRESS NUMBER	REF	LOCATION	TAX DIST	DATE INST	DATE CHANGE
05800	S	M	OUG	II	03413	183		12	101476	1/1/0001
05800	S	M	OUG	V	03424	184		12	111478	1/1/0001

OFFICE: 311

ROUTE: 564

ST_REF_NO: 00000147100

PINAS BAY DRIVE

LUMENS	BULB TYPE	MULT SERIES	POLE TYPE	SHADE	ADDRESS NUMBER	REF	LOCATION	TAX DIST	DATE INST	DATE CHANGE
05800	S	M	OUG	II	00000	152	SIDE OF 1236 TISHOFF DR.	12	041476	1/1/0001
05800	S	M	OUG	II	00000	180	SIDE OF 3412 PINAS BAY CT.	12	101476	1/1/0001
05800	S	M	OUG	II	03408	177		12	091477	1/1/0001
05800	S	M	OUG	II	03421	178		12	091476	1/1/0001
05800	S	M	OUG	II	03424	179		12	011581	1/1/0001

OFFICE: 311

ROUTE: 564

ST_REF_NO: 00000147210

PINDELL COURT

LUMENS	BULB TYPE	MULT SERIES	POLE TYPE	SHADE	ADDRESS NUMBER	REF	LOCATION	TAX DIST	DATE INST	DATE CHANGE
04000	S	M	OUG	II	00000	118	SIDE 4556 PRINCE ALBERT WAY	12	090886	1/1/0001
04000	S	M	OUG	II	00208	119		12	090886	1/1/0001
04000	S	M	OUG	II	00225	120		12	090886	1/1/0001
04000	S	M	OUG	II	00229	121		12	090886	1/1/0001

OFFICE: 311

ROUTE: 564

ST_REF_NO: 00000147300

PINE STREET

LUMENS	BULB TYPE	MULT SERIES	POLE TYPE	SHADE	ADDRESS NUMBER	REF	LOCATION	TAX DIST	DATE INST	DATE CHANGE
22000	S		SOH	II	00000	050	SIDE OF 503 S UPPER ON PINE STREET	12	060210	1/1/0001
22000	S		SOH	II	00000	051	SOUTHEAST CORNER OF PINE ST AND S UPPER ST	12	060210	1/1/0001
09500	S		OUG	II	00000	101	1ST LT N OF TUCKER ALLEY, W SIDE ON PINE ST	12	082009	1/1/0001
09500	S		OUG	II	00000	102	2ND LT N OF TUCKER ALLEY, W SIDE ON PINE	12	082009	1/1/0001
50000	S		CNT	II	00000	700	1ST LT S OF VERSAILLES RD, W SIDE ON PINE STREET	12	031511	1/1/0001
22000	S		OUG	II	00000	701	2ND LT S OF VERSAILLES RD, W SIDE ON PINE STREET	12	031511	1/1/0001
22000	S		OUG	II	00000	702	2ND LT S OF VERSALLES RD, E SIDE ON PINE STREET	12	031511	1/1/0001
22000	S		OUG	II	00000	703	1ST LT S OF VERSAILLES RD, E SIDE ON PINE STREET	12	031511	1/1/0001

OFFICE: 311

ROUTE: 564

ST_REF_NO: 00000147300

PINE STREET

LUMENS	BULB TYPE	MULT SERIES	POLE TYPE	SHADE	ADDRESS NUMBER	REF	LOCATION	TAX DIST	DATE INST	DATE CHANGE
09500	S	M	SOH	II	00000	006	1ST LT. W. OF MILL ST., S. SIDE	12	110168	10/7/2011
22000	S	M	SOH	II	00000	007	SIDE OF 432 S. BROADWAY - chg out due to accident	12	101468	12/15/2009
09500	S	M	SOH	II	00000	009	NE CORNER OF PINE & TUCKER ALLEY-upgrade per LFUCG	12	090368	3/27/2009
09500	S	M	SOH	II	00000	011	SIDE OF 433 SPRING ST.upgrade per LFUCG	12	090368	3/27/2009
50000	S	M	OUG	III	00000	029	1ST LT. N.OF HIGH ST., E. SIDE	12	061583	2/21/2011
09500	S	M	SOH	II	00000	043	SIDE OF 503 MERINO STREET	12	090368	8/15/2012
09500	S	M	SOH	II	00512	012	upgrade per LFUCG	12	090368	3/27/2009
09500	S	M	SOH	II	00616	016	bad fixture	12	090368	1/20/2011
09500	S	M	SOH	II	00710	019		12	090368	8/15/2012
09500	S	M	SOH	II	00726	042		12	090368	8/15/2012
09500	S	M	SOH	II	00740	021		12	090368	8/15/2012
09500	S	M	SOH	II	00752	041		12	090368	8/15/2012
09500	S	M	SOH	II	00760	023		12	090368	8/15/2012
09500	S	M	SOH	II	00766	040		12	090368	8/15/2012
10000	M	M	SOH	II	00000	008	1ST LT. W. OF BROADWAY, S. SIDE	12	090368	1/1/0001
10000	M	M	SOH	II	00000	013	OPP. 526	12	090368	1/1/0001
10000	M	M	SOH	II	00000	015	SIDE OF 435 PATTERSON ST.	12	090368	1/1/0001
10000	M	M	SOH	II	00000	017	SIDE OF 432 MERINO ST.	12	090368	1/1/0001
05800	S	M	SOH	II	00000	031	OPP. 942	12	011865	1/1/0001
22000	S	M	SOH	II	00000	033	SIDE OF 698 MANCHESTER ST.upgrade 4/08	12	062066	1/1/0001
10000	M	M	SOH	II	00540	014		12	090368	1/1/0001
05800	S	M	SOH	II	00934	030		12	062066	1/1/0001
05800	S	M	SOH	II	00952	032		12	062066	1/1/0001
22000	S	M	SOH	II	00000	001	SIDE OF 333 S. LIMESTONE ST.-upgrade 1/08	12	110168	1/1/0001
10000	M	M	SOH	II	00000	002	OPP. FROM SIDE OF 433 JERSEY ST.	12	110168	1/1/0001
10000	M	M	SOH	II	00000	005	SIDE OF 432 S. MILL ST.	12	110168	1/1/0001
10000	M	M	SOH	II	00216	004		12	110168	1/1/0001

OFFICE: 311

ROUTE: 564

ST_REF_NO: 00000147310

PINE BLOOM COURT

LUMENS	BULB TYPE	MULT SERIES	POLE TYPE	SHADE	ADDRESS NUMBER	REF	LOCATION	TAX DIST	DATE INST	DATE CHANGE
05800	S	M	OUG	II	00000	080	SIDE OF 945 PINE BLOOM DR.	12	122067	1/1/0001

OFFICE: 311		ROUTE: 564		ST_REF_NO: 00000147400		PINE BLOOM DRIVE		LUMENS	BULB TYPE	MULT SERIES	POLE TYPE	SHADE	ADDRESS NUMBER	REF	LOCATION	TAX DIST	DATE INST	DATE CHANGE
	05800	S	M	OUG	II	00972	076									12	022167	1/1/0001
	05800	S	M	OUG	II	00973	077									12	060867	1/1/0001
	05800	S	M	OUG	II	00985	062									12	081265	1/1/0001
	05800	S	M	OUG	II	01000	061									12	081265	1/1/0001
	05800	S	M	OUG	II	01015	060									12	081265	1/1/0001
	05800	S	M	OUG	II	01028	059									12	081265	1/1/0001
	05800	S	M	OUG	II	01039	058									12	081265	1/1/0001
	05800	S	M	OUG	II	01048	057									12	081265	1/1/0001
	05800	S	M	OUG	II	00933	079									12	022167	1/1/0001
	05800	S	M	OUG	II	00944	078									12	022167	1/1/0001

OFFICE: 311		ROUTE: 564		ST_REF_NO: 00000147450		PINECREST WAY		LUMENS	BULB TYPE	MULT SERIES	POLE TYPE	SHADE	ADDRESS NUMBER	REF	LOCATION	TAX DIST	DATE INST	DATE CHANGE
	05800	S	M	OUG	II	00000	010								SIDE OF 3841	12	072707	1/1/0001
	05800	S	M	OUG	II	03802	011									12	072707	1/1/0001
	05800	S	M	OUG	II	03832	009									12	072707	1/1/0001
	05800	S	M	OUG	II	03848	008									12	072707	1/1/0001
	05800	S	M	OUG	II	03864	007									12	072707	1/1/0001
	05800	S	M	OUG	II	03880	006									12	072707	1/1/0001
	05800	S	M	OUG	II	03897	005									12	072707	1/1/0001
	05800	S	M	OUG	II	03908	004									12	072707	1/1/0001
	05800	S	M	OUG	II	03917	003									12	072707	1/1/0001
	05800	S	M	OUG	II	03941	001									12	072707	1/1/0001

OFFICE: 311		ROUTE: 564		ST_REF_NO: 00000147510		PINEHURST COURT		LUMENS	BULB TYPE	MULT SERIES	POLE TYPE	SHADE	ADDRESS NUMBER	REF	LOCATION	TAX DIST	DATE INST	DATE CHANGE
	05800	S	M	OUG	II	00000	001								SIDE OF 1913 EDGEWORTH AVE.	12	110893	1/1/0001
	05800	S	M	OUG	II	00201	005									12	110893	1/1/0001
	05800	S	M	OUG	II	00217	004									12	110893	1/1/0001
	05800	S	M	OUG	II	00225	003									12	110893	1/1/0001
	05800	S	M	OUG	II	00237	002									12	110893	1/1/0001

OFFICE: 311		ROUTE: 564		ST_REF_NO: 00000147600		PINE MEADOW COURT		LUMENS	BULB TYPE	MULT SERIES	POLE TYPE	SHADE	ADDRESS NUMBER	REF	LOCATION	TAX DIST	DATE INST	DATE CHANGE
05800	S	M	OUG	II	01508	000										12	060766	1/1/0001
05800	S	M	OUG	II	01513	000										12	060766	1/1/0001
05800	S	M	OUG	V	01528	000										12	042368	1/1/0001

OFFICE: 311		ROUTE: 564		ST_REF_NO: 00000147700		PINE MEADOW ROAD		LUMENS	BULB TYPE	MULT SERIES	POLE TYPE	SHADE	ADDRESS NUMBER	REF	LOCATION	TAX DIST	DATE INST	DATE CHANGE
05800	S	M	OUG	II	01399	000										12	060766	1/1/0001
05800	S	M	OUG	II	01408	000										12	042368	1/1/0001
05800	S	M	OUG	II	01421	000										12	060766	1/1/0001
05800	S	M	OUG	II	01432	000										12	060766	1/1/0001
05800	S	M	OUG	II	01445	000										12	060766	1/1/0001
05800	S	M	OUG	II	01452	000										12	060766	1/1/0001
05800	S	M	OUG	II	01465	000										12	060766	1/1/0001
05800	S	M	OUG	II	01480	000										12	060766	1/1/0001
05800	S	M	OUG	II	01493	000										12	051967	1/1/0001

OFFICE: 311		ROUTE: 564		ST_REF_NO: 00000147750		PINE RIDGE WAY		LUMENS	BULB TYPE	MULT SERIES	POLE TYPE	SHADE	ADDRESS NUMBER	REF	LOCATION	TAX DIST	DATE INST	DATE CHANGE
05800	S	M	OUG	II	03900	001										12	072707	1/1/0001
05800	S	M	OUG	II	03936	003										12	072707	1/1/0001

OFFICE: 311		ROUTE: 564		ST_REF_NO: 00000147800		PINE STRAW COURT		LUMENS	BULB TYPE	MULT SERIES	POLE TYPE	SHADE	ADDRESS NUMBER	REF	LOCATION	TAX DIST	DATE INST	DATE CHANGE
05800	S	M	OUG	II	03108	001										12	050897	1/1/0001

OFFICE: 311		ROUTE: 564		ST_REF_NO: 00000147850		PINWOOD COURT		LUMENS	BULB TYPE	MULT SERIES	POLE TYPE	SHADE	ADDRESS NUMBER	REF	LOCATION	TAX DIST	DATE INST	DATE CHANGE
05800	S	M	OUG	III	00328	004										12	100800	1/1/0001
05800	S	M	OUG	II	00348	003										12	080800	1/1/0001
05800	S	M	OUG	II	00372	002										12	100800	1/1/0001
05800	S	M	OUG	II	00389	001										12	100800	1/1/0001

OFFICE: 311

ROUTE: 564

ST_REF_NO: 00000147900

PINKNEY DRIVE

LUMENS	BULB TYPE	MULT SERIES	POLE TYPE	SHADE	ADDRESS NUMBER	REF	LOCATION	TAX DIST	DATE INST	DATE CHANGE
05800	S	M	OUG	II	00000	032	SIDE OF 819 SUMMERSVILLE DR.	12	060766	1/1/0001
05800	S	M	OUG	II	00839	031		12	060766	1/1/0001
05800	S	M	OUG	II	00852	030		12	060766	1/1/0001
05800	S	M	OUG	II	00863	029		12	051967	1/1/0001
05800	S	M	OUG	II	00880	028		12	060766	1/1/0001
05800	S	M	OUG	II	00892	027		12	060766	1/1/0001

OFFICE: 311

ROUTE: 564

ST_REF_NO: 00000147950

PINK PIGEON PARKWAY

LUMENS	BULB TYPE	MULT SERIES	POLE TYPE	SHADE	ADDRESS NUMBER	REF	LOCATION	TAX DIST	DATE INST	DATE CHANGE
50000	S	M	CNT	II	00000	001	1ST LT N OF MAN-O-WAR W SIDE OF PINK PIGEON PKWY	12	120800	1/1/0001
50000	S	M	CNT	II	00000	002	2ND LT N OF MAN-O-WAR E SIDE OF PINK PIGEON PKWY	12	120800	1/1/0001
22000	S	M	CNT	II	00000	003	2ND LT N OF MAN-O-WAR, W SIDE OF PINK PIGEON PKWY	12	120800	1/1/0001
22000	S	M	CNT	II	00000	004	2ND LT N OF MAN-O-WAR, E SIDE OF PINK PIGEON PKWY	12	120800	1/1/0001
22000	S	M	CNT	II	00000	005	2ND LT S OF ALYSHEBA WAY W SIDE OF PINK PIGEON PKW	12	120800	1/1/0001
22000	S	M	CNT	II	00000	006	2ND LT S OF ALYSHEBA WAY E SIDE OF PINK PIGEON PKW	12	120800	1/1/0001
50000	S	M	CNT	II	00000	008	1ST LT S OF ALYSHEBA WAY E SIDE OF PINK PIGEON PKW	12	120800	1/1/0001
50000	S	M	CNT	II	00000	009	1ST LT N OF ALYSHEBA WAY W SIDE OF PINK PIGEON PKW	12	120800	1/1/0001
22000	S	M	CNT	II	00000	010	1ST LT N OF ALYSHEBA WAY E SIDE OF PINK PIGEON PKW	12	120800	1/1/0001
22000	S	M	CNT	II	00000	011	2ND LT N OF ALYSHEBA WAY W SIDE OF PINK PIGEON PKW	12	120800	1/1/0001
22000	S	M	CNT	II	00000	012	2ND LT N OF ALYSHEBA WAY E SIDE OF PINK PIGEON PKW	12	120800	1/1/0001
22000	S	M	CNT	II	00000	013	3RD LT N OF ALYSHEBA WAY W SIDE OF PINK PIGEON PKW	12	120800	1/1/0001
22000	S	M	CNT	II	00000	014	3RD LT N OF ALYSHEBA WAY E SIDE OF PINK PIGEON PKW	12	120800	1/1/0001
22000	S	M	CNT	II	00000	015	4TH LT N OF VENDOR WAY W SIDE OF PINK PIGEON PKWY	12	120800	1/1/0001

OFFICE: 311

ROUTE: 564

ST_REF_NO: 00000147950

PINK PIGEON PARKWAY

LUMENS	BULB TYPE	MULT SERIES	POLE TYPE	SHADE	ADDRESS NUMBER	REF	LOCATION	TAX DIST	DATE INST	DATE CHANGE
22000	S	M	CNT	II	00000	016	4TH LT N OF VENDOR WAY E SIDE OF PINK PIGEON PKWY	12	120800	1/1/0001
22000	S	M	CNT	II	00000	017	4TH LT S OF VENDOR WAY W SIDE OF PINK PIGEON PKWY	12	120800	1/1/0001
22000	S	M	CNT	II	00000	018	4TH LT S OF VENDOR WAY E SIDE OF PINK PIGEON PKWY	12	120800	1/1/0001
22000	S	M	CNT	II	00000	019	3RD LT S OF VENDOR WAY W SIDE OF PINK PIGOEN PKWY	12	120800	1/1/0001
22000	S	M	CNT	II	00000	020	3RD LT S OF VENDOR WAY E SIDE OF PINK PIGEON PKWY	12	120800	1/1/0001
22000	S	M	CNT	II	00000	021	2ND LT S OF VENDOR WAY W SIDE OF PINK PIGEON PKWY	12	120800	1/1/0001
22000	S	M	CNT	II	00000	022	2ND LT S OF VENDOR WAY E SIDE OF PINK PIGEON PKWY	21	120800	1/1/0001
22000	S	M	CNT	II	00000	023	1ST LT S OF VENDOR WAY W SIDE OF PINK PIGEON PKWY	12	120800	1/1/0001
50000	S	M	CNT	II	00000	024	1ST LT S OF VENDOR WAY E SIDE OF PINK PIGEON PKWY	12	120800	1/1/0001

OFFICE: 311

ROUTE: 564

ST_REF_NO: 00000147960

PINNACLE COURT

LUMENS	BULB TYPE	MULT SERIES	POLE TYPE	SHADE	ADDRESS NUMBER	REF	LOCATION	TAX DIST	DATE INST	DATE CHANGE
05800	S	M	CNT	II	00705	007		12	080897	1/1/0001
05800	S	M	CNT	II	00716	006		12	080897	1/1/0001
05800	S	M	CNT	II	00725	005		12	080897	1/1/0001
05800	S	M	CNT	II	00740	004		12	080897	1/1/0001
05800	S	M	CNT	II	00745	003		12	080897	1/1/0001
05800	S	M	CNT	II	00752	001		12	080897	1/1/0001
05800	S	M	CNT	II	00765	002		12	080897	1/1/0001

OFFICE: 311

ROUTE: 564

ST_REF_NO: 00000147980

PIONEER

LUMENS	BULB TYPE	MULT SERIES	POLE TYPE	SHADE	ADDRESS NUMBER	REF	LOCATION	TAX DIST	DATE INST	DATE CHANGE
05800	S	M	OUG	II	00740	005		12	100606	1/1/0001
05800	S	M	OUG	II	00752	006		12	100606	1/1/0001
05800	S	M	OUG	II	00705	001		12	100898	1/1/0001
05800	S	M	OUG	II	00724	002		12	100898	1/1/0001

OFFICE: 311		ROUTE: 564		ST_REF_NO: 00000148000		PIPESTONE COURT		LUMENS	BULB TYPE	MULT SERIES	POLE TYPE	SHADE	ADDRESS NUMBER	REF	LOCATION	TAX DIST	DATE INST	DATE CHANGE
	04000	S	M	OUG	II	00000	051								SIDE OF 3913 SUNDART CT.	12	011579	1/1/0001
	04000	S	M	OUG	II	01412	052									12	011579	1/1/0001

OFFICE: 311		ROUTE: 564		ST_REF_NO: 00000148200		PITTMAN CREEK COURT		LUMENS	BULB TYPE	MULT SERIES	POLE TYPE	SHADE	ADDRESS NUMBER	REF	LOCATION	TAX DIST	DATE INST	DATE CHANGE
	04000	S	M	OUG	II	00000	049								SIDE OF 222 EAGLE CREEK DR.	12	051477	1/1/0001
	04000	S	M	OUG	II	03313	050									12	051477	1/1/0001
	04000	S	M	OUG	V	03325	051									12	051477	1/1/0001

OFFICE: 311		ROUTE: 564		ST_REF_NO: 00000148300		PLAINVIEW ROAD		LUMENS	BULB TYPE	MULT SERIES	POLE TYPE	SHADE	ADDRESS NUMBER	REF	LOCATION	TAX DIST	DATE INST	DATE CHANGE
	05800	S	M	OUG	II	00000	005								SIDE OF 2790 TILDEN RD.	12	050170	1/1/0001
	05800	S	M	OUG	II	00000	010								SIDE OF 2787 LOCKHURST RD.	12	061968	1/1/0001
	05800	S	M	OUG	II	00376	004									12	100887	1/1/0001
	05800	S	M	OUG	II	00385	003									12	100884	1/1/0001
	05800	S	M	OUG	II	00400	000									12	080169	1/1/0001
	05800	S	M	OUG	II	00401	001									12	100884	1/1/0001
	05800	S	M	OUG	II	00421	000									12	110168	1/1/0001
	05800	S	M	OUG	II	00428	000									12	080169	1/1/0001
	05800	S	M	OUG	II	00441	000									12	121467	1/1/0001
	05800	S	M	OUG	II	00452	000									12	050168	1/1/0001
	05800	S	M	OUG	II	00465	000									12	050168	1/1/0001
	05800	S	M	OUG	II	00472	000									12	061968	1/1/0001
	05800	S	M	OUG	V	00482	000									12	030171	1/1/0001
	05800	S	M	OUG	II	00492	000									12	030171	1/1/0001
	05800	S	M	OUG	II	00505	000									12	040168	1/1/0001
	05800	S	M	OUG	II	00528	000									12	040168	1/1/0001
	05800	S	M	OUG	II	00541	000									12	050170	1/1/0001
	05800	S	M	OUG	II	00552	007									12	091477	1/1/0001
	05800	S	M	OUG	II	00563	000									12	050170	1/1/0001
	05800	S	M	OUG	II	00581	000									12	030171	1/1/0001
	05800	S	M	OUG	II	00598	000									12	122468	1/1/0001

OFFICE: 311

ROUTE: 564

ST_REF_NO: 00000148300 PLAINVIEW ROAD

LUMENS	BULB TYPE	MULT SERIES	POLE TYPE	SHADE	ADDRESS NUMBER	REF	LOCATION	TAX DIST	DATE INST	DATE CHANGE
05800	S	M	OUG	II	00388	002		12	100890	1/1/0001

OFFICE: 311

ROUTE: 564

ST_REF_NO: 00000148350 PLANTATION DRIVE

LUMENS	BULB TYPE	MULT SERIES	POLE TYPE	SHADE	ADDRESS NUMBER	REF	LOCATION	TAX DIST	DATE INST	DATE CHANGE
04000	S	M	OUG	II	03801	041		12	021580	1/1/0001
04000	S	M	OUG	II	03812	040		12	021580	1/1/0001
04000	S	M	OUG	II	03821	039		12	021580	1/1/0001
04000	S	M	OUG	II	03832	038		12	021580	1/1/0001
04000	S	M	OUG	II	03845	037		12	021580	1/1/0001
04000	S	M	OUG	II	03856	036		12	021580	1/1/0001
04000	S	M	OUG	II	03865	035		12	111579	1/1/0001

OFFICE: 311

ROUTE: 564

ST_REF_NO: 00000148375 PLANTERS CT

LUMENS	BULB TYPE	MULT SERIES	POLE TYPE	SHADE	ADDRESS NUMBER	REF	LOCATION	TAX DIST	DATE INST	DATE CHANGE
05800	S	M	OUG	IV	02005	003		12	070893	1/1/0001
04000	S	M	OUG	II	02016	002		12	080891	1/1/0001
04000	S	M	OUG	II	02021	001		12	080891	1/1/0001

OFFICE: 311

ROUTE: 564

ST_REF_NO: 00000148395 PLAUDIT PLACE

LUMENS	BULB TYPE	MULT SERIES	POLE TYPE	SHADE	ADDRESS NUMBER	REF	LOCATION	TAX DIST	DATE INST	DATE CHANGE
09500	S		CNT	II	01900	001		12	030801	1/1/0001
09500	S		CNT	II	01907	002		12	030801	1/1/0001
09500	S		CNT	II	01920	005		12	030801	1/1/0001
09500	S		CNT	II	01921	003		12	030801	1/1/0001
09500	S		CNT	II	01921	004		12	030801	1/1/0001
09500	S		CNT	II	01973	006		12	030801	1/1/0001

OFFICE: 311

ROUTE: 564

ST_REF_NO: 00000148400 PLAZA DRIVE

LUMENS	BULB TYPE	MULT SERIES	POLE TYPE	SHADE	ADDRESS NUMBER	REF	LOCATION	TAX DIST	DATE INST	DATE CHANGE
05800	S	M	OOH	II	00000	007	SIDE OF 245 SOUTHLAND DR.	12	120164	1/1/0001
05800	S	M	OOH	II	00000	009	OPP. 242	12	120164	1/1/0001

OFFICE: 311

ROUTE: 564

ST_REF_NO: 00000148400 PLAZA DRIVE

LUMENS	BULB TYPE	MULT SERIES	POLE TYPE	SHADE	ADDRESS NUMBER	REF	LOCATION	TAX DIST	DATE INST	DATE CHANGE
05800	S	M	OUG	II	00230	010		12	120164	1/1/0001
05800	S	M	OUG	II	00246	008		12	120164	1/1/0001

OFFICE: 311

ROUTE: 564

ST_REF_NO: 00000148405 PLEASANT CREEK LANE

LUMENS	BULB TYPE	MULT SERIES	POLE TYPE	SHADE	ADDRESS NUMBER	REF	LOCATION	TAX DIST	DATE INST	DATE CHANGE
05800	S	M	OUG	II	02705	001		12	100899	1/1/0001

OFFICE: 311

ROUTE: 564

ST_REF_NO: 00000148410 PLEASANT GROVE ROAD

LUMENS	BULB TYPE	MULT SERIES	POLE TYPE	SHADE	ADDRESS NUMBER	REF	LOCATION	TAX DIST	DATE INST	DATE CHANGE
05800	S	M	OUG	III	00000	194	SIDE 4813 WYNDHURST ROAD	12	040895	1/1/0001
05800	S	M	OUG	III	04821	192		12	040895	1/1/0001
05800	S	M	OUG	III	04833	193		12	040895	1/1/0001

OFFICE: 311

ROUTE: 564

ST_REF_NO: 00000148425 PLEASANT POINTE COURT

LUMENS	BULB TYPE	MULT SERIES	POLE TYPE	SHADE	ADDRESS NUMBER	REF	LOCATION	TAX DIST	DATE INST	DATE CHANGE
05800	S	M	OUG	IV	00501	004		12	080895	1/1/0001
05800	S	M	OUG	II	00521	003		12	080895	1/1/0001
05800	S	M	OUG	II	00532	002		12	080895	1/1/0001
05800	S	M	OUG	II	00549	001		12	080895	1/1/0001

OFFICE: 311

ROUTE: 564

ST_REF_NO: 00000148435 PLEASANT POINTE DRIVE

LUMENS	BULB TYPE	MULT SERIES	POLE TYPE	SHADE	ADDRESS NUMBER	REF	LOCATION	TAX DIST	DATE INST	DATE CHANGE
05800	S	M	OUG	II	00000	005	SIDE 548 PLEASANT POINTE CT.	12	080895	1/1/0001
05800	S	M	OUG	II	00000	006	SIDE REAR 549 PLEASANT POINTE CT.	12	080895	1/1/0001
05800	S	M	OUG	II	00201	001		12	080895	1/1/0001
05800	S	M	OUG	II	00220	002		12	080895	1/1/0001
05800	S	M	OUG	II	00233	003		12	080895	1/1/0001
05800	S	M	OUG	II	00245	004		12	080895	1/1/0001
05800	S	M	OUG	II	00309	007		12	080895	1/1/0001
05800	S	M	OUG	II	00328	008		12	080895	1/1/0001
05800	S	M	OUG	II	00344	009		12	080895	1/1/0001

OFFICE: 311

ROUTE: 564

ST_REF_NO: 00000148435

PLEASANT POINTE DRIVE

LUMENS	BULB TYPE	MULT SERIES	POLE TYPE	SHADE	ADDRESS NUMBER	REF	LOCATION	TAX DIST	DATE INST	DATE CHANGE
05800	S	M	OUG	II	00357	010		12	080895	1/1/0001

OFFICE: 311

ROUTE: 564

ST_REF_NO: 00000148460

PLEASANT RIDGE DRIVE

LUMENS	BULB TYPE	MULT SERIES	POLE TYPE	SHADE	ADDRESS NUMBER	REF	LOCATION	TAX DIST	DATE INST	DATE CHANGE
09500	S	M	CNT	II	00000	041	3RD LT W OF TIMBER CK ON PLEASANT RIDGE	12	051601	1/1/0001
09500	S	M	CNT	II	01920	039		12	051601	1/1/0001
05800	S	M	CNT	II	00000	001	SIDE OF 1136 AUTUMN RIDGE DR.	12	100896	1/1/0001
05800	S	M	CNT	II	00000	005	SIDE OF 3698 FOREST SPRING CT.	12	100896	1/1/0001
05800	S	M	CNT	II	00000	006	SIDE OF 1201 PLEASANT RIDGE WAY	12	100896	1/1/0001
05800	S	M	CNT	II	00000	007	SIDE OF 3501 FOREST SPRING CT.	12	100896	1/1/0001
05800	S	M	CNT	II	00000	009	OPP. 1284	12	100896	1/1/0001
05800	S	M	CNT	II	00000	010	SIDE REAR OF 1200 MORNING SIDE DR.	12	100896	1/1/0001
05800	S	M	CNT	II	00000	011	SIDE REAR OF 1153 MORNING SIDE DR.	12	100896	1/1/0001
09500	S	M	CNT	II	00000	012	2ND LT. N OF MORNING SIDE DRIVE, WSIDE	12	060800	1/1/0001
22000	S	M	CNT	II	00000	013	OPP. BRIGHTON PLACE DRIVE	12	060800	1/1/0001
22000	S	M	CNT	II	00000	014	SIDE REAR OF 3360 BRIGHTON PLACE DRIVE	12	060800	1/1/0001
22000	S	M	CNT	II	00000	015	1ST LT. N OF BRIGHTON PLACE DRIVE	12	060800	1/1/0001
22000	S	M	CNT	II	00000	016	1ST LT. S OF WAKEHURST CT., WSIDE	12	060800	1/1/0001
22000	S	M	CNT	II	00000	017	OPP. WAKEHURST CT.	12	060800	1/1/0001
22000	S	M	CNT	II	00000	018	1ST LT. N OF WAKEHURST CT., WSIDE	12	060800	1/1/0001
09500	S	M	CNT	II	00000	023	SIDE OF 3200 DURANGO CT.	12	060800	1/1/0001
09500	S	M	CNT	II	00000	026	SIDE OF 1240 ASPEN ST.	12	070899	1/1/0001
09500	S	M	CNT	II	00000	027	1ST LT. N OF ASPEN DR., W SIDE	12	060800	1/1/0001
09500	S	M	CNT	II	00000	028	REAR OF 3125 NAVAJO CT.	12	060800	1/1/0001
09500	S	M	CNT	II	00000	030	REAR OF 3177 GLENWOOD DR.	12	060800	1/1/0001
09500	S	M	CNT	II	00000	032	REAR OF 1312 REDSTONE DR.	12	060800	1/1/0001
09500	S	M	CNT	II	00000	034	REAR OF 1328 REDSTONE DR.	12	060800	1/1/0001
09500	S	M	CNT	II	00000	036	REAR OF 1360 REDSTONE DR.	12	060800	1/1/0001
09500	S	M	CNT	II	00000	038	1ST LT. S OF COLORADO DR., W SIDE	12	060800	1/1/0001
09500	S		CNT		00000	043	1ST LT W OF BRYANT RD, N SIDE OF PLEASANT RIDGE DR	12	030801	1/1/0001
09500	S		CNT		00000	044	2ND LT E OF MAN-O-WAR, S SIDE OF PLEASANT RIDGE DR	12	030801	1/1/0001

OFFICE: 311

ROUTE: 564

ST_REF_NO: 00000148460

PLEASANT RIDGE DRIVE

LUMENS	BULB TYPE	MULT SERIES	POLE TYPE	SHADE	ADDRESS NUMBER	REF	LOCATION	TAX DIST	DATE INST	DATE CHANGE
09500	S		CNT		00000	045	SIDE OF 1907 PLAUDIT PLACE ON PLEASANT RIDGE DR	12	030801	1/1/0001
09500	S		CNT		00000	046	1ST LT E OF MAN-O-WAR, N SIDE OF PLEASANT RIDGE DR	12	030801	1/1/0001
09500	S		CNT		00000	047	SIDE OF 1907 PLAUDIT PLACE ON PLEASANT RIDGE DR	12	030801	1/1/0001
05800	S	M	CNT	II	01208	002		12	100896	1/1/0001
05800	S	M	CNT	II	01217	003		12	100896	1/1/0001
05800	S	M	CNT	II	01240	004		12	100896	1/1/0001
05800	S	M	CNT	II	01272	008		12	100896	1/1/0001
22000	S	M	CNT	II	01385	019	ref #13-21 upgraded April 2007	12	120899	1/1/0001
22000	S	M	CNT	II	01393	020		12	070899	1/1/0001
22000	S	M	CNT	II	01408	021		12	060800	1/1/0001
09500	S	M	CNT	II	01421	022		12	070899	1/1/0001
09500	S	M	CNT	II	01449	024		12	070899	1/1/0001
09500	S	M	CNT	II	01460	025		12	060800	1/1/0001
09500	S		CNT		01951	040		12	030801	1/1/0001
09500	S		CNT		01951	042		12	030801	1/1/0001

OFFICE: 311

ROUTE: 564

ST_REF_NO: 00000148500

PLEASANT STONE STREET

LUMENS	BULB TYPE	MULT SERIES	POLE TYPE	SHADE	ADDRESS NUMBER	REF	LOCATION	TAX DIST	DATE INST	DATE CHANGE
10000	M	M	SOH	II	00000	001	1ST LT. E. OF LIMESTONE ST., S. SIDE	12	030964	1/1/0001
10000	M	M	SOH	II	00000	002	2ND LT. E. OF LIMESTONE ST., S. SIDE	12	030964	1/1/0001
10000	M	M	SOH	II	00000	003	3RD LT. E. OF LIMESTONE ST., S. SIDE	12	030964	1/1/0001
10000	M	M	SOH	II	00000	004	4TH LT. E. OF LIMESTONE ST., S. SIDE	12	030964	1/1/0001
10000	M	M	SOH	II	00000	005	5TH LT. E. OF LIMESTONE ST., S. SIDE	12	030964	1/1/0001
10000	M	M	SOH	II	00000	006	1ST LT. W. OF WALNUT ST., S. SIDE	12	081064	1/1/0001
10000	M	M	SOH	II	00000	007	1ST LT. W. OF WALNUT ST., N. SIDE	12	081064	1/1/0001

OFFICE: 311

ROUTE: 564

ST_REF_NO: 00000148510

PLUM LANE

LUMENS	BULB TYPE	MULT SERIES	POLE TYPE	SHADE	ADDRESS NUMBER	REF	LOCATION	TAX DIST	DATE INST	DATE CHANGE
05800	S	M	OUG	III	00000	001	SIDE OF 1132 NARROW LANE	12	070893	1/1/0001
05800	S	M	OUG	V	03800	002		12	070893	1/1/0001

OFFICE: 311

ROUTE: 564

ST_REF_NO: 00000148600

PLUMTREE COURT

LUMENS	BULB TYPE	MULT SERIES	POLE TYPE	SHADE	ADDRESS NUMBER	REF	LOCATION	TAX DIST	DATE INST	DATE CHANGE
05800	S	M	OUG	II	00000	062	SIDE OF 328 PEACHTREE	12	070172	1/1/0001
05800	S	M	OUG	II	02462	000		12	080171	1/1/0001
05800	S	M	OUG	II	02475	000		12	080171	1/1/0001

OFFICE: 311

ROUTE: 564

ST_REF_NO: 00000148700

PLUNKETT STREET

LUMENS	BULB TYPE	MULT SERIES	POLE TYPE	SHADE	ADDRESS NUMBER	REF	LOCATION	TAX DIST	DATE INST	DATE CHANGE
09500	S	M	SOH	II	00000	507	1ST LT. S. OF MAXWELL ST., W. SIDE	12	100267	1/1/0001
09500	S	M	SOH	II	00000	508	2ND LT. S. OF MAXWELL ST., W. SIDE	12	100267	1/1/0001
09500	S	M	SOH	II	00000	509	SW CORNER OF PLUNKETT & PINE ST.	12	070171	1/1/0001
09500	S	M	SOH	II	00000	510	1ST LT. S. OF PINE ST., E. SIDE	12	070171	1/1/0001
09500	S	M	SOH	II	00000	511	SW CORNER OF PLUNKETT & CEDAR ST.	12	100267	1/1/0001
09500	S	M	SOH	II	00000	512	1ST LT. S. OF CEDAR ST., E. SIDE	12	100267	1/1/0001
09500	S	M	SOH	II	00000	513	1ST LT. N. OF BOLIVER ST., W. SIDE	12	100267	1/1/0001

OFFICE: 311

ROUTE: 564

ST_REF_NO: 00000148800

PLYMOUTH DRIVE

LUMENS	BULB TYPE	MULT SERIES	POLE TYPE	SHADE	ADDRESS NUMBER	REF	LOCATION	TAX DIST	DATE INST	DATE CHANGE
04000	S	M	OUG	II	00414	075		12	100885	1/1/0001
05800	S	M	OUG	II	00423	076	upgraded 5/08	12	100885	1/1/0001
04000	S	M	OUG	II	00438	092		12	100885	1/1/0001
04000	S	M	OUG	II	00447	091		12	100885	1/1/0001
04000	S	M	OUG	II	00458	090		12	100885	1/1/0001
04000	S	M	OUG	II	00471	089		12	100885	1/1/0001
04000	S	M	OUG	II	00482	029		12	100885	1/1/0001
04000	S	M	OUG	II	00495	028		12	100885	1/1/0001

OFFICE: 311

ROUTE: 564

ST_REF_NO: 00000148805

PLYMOUTH ROCK COURT

LUMENS	BULB TYPE	MULT SERIES	POLE TYPE	SHADE	ADDRESS NUMBER	REF	LOCATION	TAX DIST	DATE INST	DATE CHANGE
05800	S	M	CNT	II	00000	001	SIDE OF 4033 JOHN ALDEN WAY ON PLYMOUTH ROCK CT	12	081705	1/1/0001
05800	S	M	CNT	III	01200	003		12	081705	1/1/0001
05800	S	M	CNT	II	01213	002		12	081705	1/1/0001

OFFICE: 311		ROUTE: 564		ST_REF_NO: 00000148840		POAGE COURT		LUMENS	BULB TYPE	MULT SERIES	POLE TYPE	SHADE	ADDRESS NUMBER	REF	LOCATION	TAX DIST	DATE INST	DATE CHANGE
	05800	S		OUG	V	00301	006									12	021579	1/1/0001

OFFICE: 311		ROUTE: 564		ST_REF_NO: 00000148850		POINT COURT		LUMENS	BULB TYPE	MULT SERIES	POLE TYPE	SHADE	ADDRESS NUMBER	REF	LOCATION	TAX DIST	DATE INST	DATE CHANGE
	05800	S	M	OUG	II	02817	001									12	090898	1/1/0001

OFFICE: 311		ROUTE: 564		ST_REF_NO: 00000149020		POLK LANE		LUMENS	BULB TYPE	MULT SERIES	POLE TYPE	SHADE	ADDRESS NUMBER	REF	LOCATION	TAX DIST	DATE INST	DATE CHANGE
	05800	S	M	OUG	II	00000	001								SIDE OF 1648 ATOMA DRIVE ON POLK LANE	12	121606	1/1/0001
	05800	S	M	OUG	II	02001	004									12	021508	1/1/0001
	05800	S	M	OUG	II	02017	003									12	121606	1/1/0001
	05800	S	M	OUG	II	02052	020									12	021508	1/1/0001
	05800	S	M	OUG	II	02053	021									12	021508	1/1/0001
	05800	S	M	OUG	II	02064	022									12	021508	1/1/0001
	05800	S	M	OUG	II	02073	023									12	021508	1/1/0001
	05800	S	M	OUG	II	02085	024									12	021508	1/1/0001
	05800	S	M	OUG	II	02097	025									12	021508	1/1/0001
	05800	S	M	OUG	II	02104	026									12	021508	1/1/0001

OFFICE: 311		ROUTE: 564		ST_REF_NO: 00000149050		POLO CLUB BLVD		LUMENS	BULB TYPE	MULT SERIES	POLE TYPE	SHADE	ADDRESS NUMBER	REF	LOCATION	TAX DIST	DATE INST	DATE CHANGE
	05800	S		CNT	II	03609	214									12	080508	1/1/0001
	05800	S		CNT	II	03621	212									12	080508	1/1/0001
	05800	S		CNT	II	03641	210									12	080508	1/1/0001
	05800	S		CNT	II	03657	208									12	080508	1/1/0001
	05800	S		CNT	II	03673	206									12	080508	1/1/0001
	09500	S	M	CNT	II	00000	101								1ST LT S OF MOW, W SIDE ON POLO CLUB BLVD	12	041707	1/1/0001
	09500	S	M	CNT	II	00000	102								1ST LT S OF MOW, E SIDE ON POLO CLUB BLVD	12	041707	1/1/0001
	09500	S	M	CNT	II	00000	103								2ND LT S OF MOW, W SIDE ON POLO CLUB BLVD	12	041707	1/1/0001
	09500	S	M	CNT	II	00000	104								2ND LT S OF MOW, E SIDE ON POLO CLUB BLVD	12	041707	1/1/0001
	09500	S	M	CNT	II	00000	105								3RD LT S OF MOW, W SIDE ON POLO CLUB BLVD	12	041707	1/1/0001

OFFICE: 311

ROUTE: 564

ST_REF_NO: 00000149050

POLO CLUB BLVD

LUMENS	BULB TYPE	MULT SERIES	POLE TYPE	SHADE	ADDRESS NUMBER	REF	LOCATION	TAX DIST	DATE INST	DATE CHANGE
09500	S	M	CNT	II	00000	106	3RD LT S OF MOW, E SIDE ON POLO CLUB BLVD	12	041707	1/1/0001
09500	S	M	CNT	II	00000	107	4TH LT S OF MOW, W SIDE ON POLO CLUB BLVD	12	041707	1/1/0001
09500	S	M	CNT	II	00000	108	1ST LT S OF MARKET GARDEN LN, E SIDE ON POLO CLUB	12	041707	1/1/0001
09500	S	M	CNT	II	00000	109	1ST LT S OF MARKET GARDEN LN, W SIDE ON POLO CLUB	12	041707	1/1/0001
09500	S	M	CNT	II	00000	110	2ND LT S OF MARKET GARDEN LN, E SIDE ON POLO CLUB	12	041707	1/1/0001
09500	S	M	CNT	II	00000	111	2ND LT S OF MARKET GARDEN, W SIDE ON POLO CLUB	12	041707	1/1/0001
09500	S	M	CNT	II	00000	112	3RD LT S OF MARKET GARDEN, E SIDE ON POLO CLUB	12	041707	1/1/0001
09500	S	M	CNT	II	00000	113	3RD LT S OF MARKET GARDEN, W SIDE ON POLO CLUB	12	041707	1/1/0001
09500	S	M	CNT	II	00000	114	4TH LT S OF MARKET GARDEN, E SIDE ON POLO CLUB	12	041707	1/1/0001
09500	S	M	CNT	II	00000	115	4TH LT S OF MARKET GARDEN, W SIDE ON POLO CLUB	12	041707	1/1/0001
09500	S	M	CNT	II	00000	116	5TH LT S OF MARKET GARDEN, E SIDE ON POLO CLUB	12	041707	1/1/0001
09500	S	M	CNT	II	00000	117	5TH LT S OF MARKET GARDEN, E SIDE ON POLO CLUB	12	041707	1/1/0001
09500	S	M	CNT	II	00000	118	6TH LT S OF MARKET GARDEN, E SIDE ON POLO CLUB	12	041707	1/1/0001
09500	S	M	CNT	II	00000	119	6TH LT S OF MARKET GARDEN, W SIDE ON POLO CLUB	12	041707	1/1/0001
05800	S	M	CNT	II	00000	123	SIDE OF 3601 BEATEN PATH ON POLO CLUB BLVD	12	080108	1/1/0001
05800	S	M	CNT	II	00000	132	SIDE OF 1196 BRICK HOUSE LANE ON POLO CLUB BLVD	12	080108	1/1/0001
05800	S	M	CNT	II	02029	013		12	051701	1/1/0001
05800	S	M	CNT	II	02997	009		12	051701	1/1/0001
05800	S	M	CNT	II	03013	011		12	051701	1/1/0001
05800	S	M	CNT	II	03024	012		12	100901	1/1/0001
05800	S	M	CNT	II	03040	014		12	051701	1/1/0001
05800	S	M	CNT	II	03045	015		12	051701	1/1/0001
05800	S	M	CNT	II	03045	055		12	041703	1/1/0001
05800	S	M	CNT	II	03056	016		12	041703	1/1/0001
05800	S	M	CNT	II	03072	018		12	041703	1/1/0001

OFFICE: 311

ROUTE: 564

ST_REF_NO: 00000149050

POLO CLUB BLVD

LUMENS	BULB TYPE	MULT SERIES	POLE TYPE	SHADE	ADDRESS NUMBER	REF	LOCATION	TAX DIST	DATE INST	DATE CHANGE
05800	S	M	CNT	II	03073	017		12	041703	1/1/0001
05800	S	M	CNT	II	03089	019		12	041703	1/1/0001
05800	S	M	CNT	II	03096	020		12	041703	1/1/0001
05800	S	M	CNT	II	03201	021		12	041703	1/1/0001
05800	S	M	CNT	II	03216	022		12	041703	1/1/0001
05800	S	M	CNT	II	03229	023		12	041703	1/1/0001
05800	S	M	CNT	II	03236	024		12	041703	1/1/0001
05800	S	M	CNT	II	03616	120		12	080108	1/1/0001
05800	S	M	CNT	II	03624	122		12	080108	1/1/0001
05800	S	M	CNT	II	03644	124		12	080108	1/1/0001
05800	S	M	CNT	II	03652	126		12	080108	1/1/0001
05800	S	M	CNT	II	03660	128		12	080108	1/1/0001
05800	S	M	CNT	II	03668	130		12	080108	1/1/0001
05800	S	M	CNT	II	03686	134		12	080108	1/1/0001
05800	S	M	CNT	II	03716	007		12	091106	1/1/0001
05800	S	M	CNT	II	03732	006		12	091106	1/1/0001
05800	S	M	CNT	II	03744	005		12	091106	1/1/0001
05800	S	M	CNT	II	03756	004		12	091106	1/1/0001
05800	S	M	CNT	II	03768	003		12	091106	1/1/0001
05800	S	M	CNT	II	03784	002		12	091106	1/1/0001
05800	S	M	CNT	II	03800	001		12	091106	1/1/0001

OFFICE: 311

ROUTE: 564

ST_REF_NO: 00000149075

POMPANO LANE

LUMENS	BULB TYPE	MULT SERIES	POLE TYPE	SHADE	ADDRESS NUMBER	REF	LOCATION	TAX DIST	DATE INST	DATE CHANGE
05800	S	M	CNT	II	00000	004	SIDE OF 824 LAUDERDALE ON POMPANO LN	12	032404	1/1/0001
05800	S	M	CNT	II	04712	003		12	032404	1/1/0001
05800	S	M	CNT	II	04729	002		12	032404	1/1/0001
05800	S	M	CNT	II	04736	001		12	032404	1/1/0001

OFFICE: 311

ROUTE: 564

ST_REF_NO: 00000149100

PONTCHARTRAIN COURT

LUMENS	BULB TYPE	MULT SERIES	POLE TYPE	SHADE	ADDRESS NUMBER	REF	LOCATION	TAX DIST	DATE INST	DATE CHANGE
05800	S	M	OUG	II	03200	049		12	111478	1/1/0001

OFFICE: 311

ROUTE: 564

ST_REF_NO: 00000149100 PONTCHARTRAIN COURT

LUMENS	BULB TYPE	MULT SERIES	POLE TYPE	SHADE	ADDRESS NUMBER	REF	LOCATION	TAX DIST	DATE INST	DATE CHANGE
05800	S	M	OUG	V	03213	050		12	111478	1/1/0001
05800	S	M	OUG	II	03220	051		12	111478	1/1/0001
05800	S	M	OUG	II	03229	052		12	111478	1/1/0001

OFFICE: 311

ROUTE: 564

ST_REF_NO: 00000149140 POPHAM COURT

LUMENS	BULB TYPE	MULT SERIES	POLE TYPE	SHADE	ADDRESS NUMBER	REF	LOCATION	TAX DIST	DATE INST	DATE CHANGE
05800	S	M	CNT	II	00000	001	SIDE OF 3032 OLD HOUSE RD ON POPHAM CT	12	100505	1/1/0001
05800	S	M	CNT	III	03108	002		12	100505	1/1/0001

OFFICE: 311

ROUTE: 564

ST_REF_NO: 00000149160 POPLAR SPRINGS LANE

LUMENS	BULB TYPE	MULT SERIES	POLE TYPE	SHADE	ADDRESS NUMBER	REF	LOCATION	TAX DIST	DATE INST	DATE CHANGE
05800	S	M	CNT	II	00000	008	SIDE OF 4412 BREAKWATER CT ON POPLAR SPRINGS LN	12	081501	1/1/0001
05800	S	M	CNT	II	00600	001		12	081501	1/1/0001
05800	S	M	CNT	II	00609	002		12	081501	1/1/0001
05800	S	M	CNT	II	00616	003		12	081501	1/1/0001
05800	S	M	CNT	II	00629	004		12	081501	1/1/0001
05800	S	M	CNT	II	00636	005		12	081501	1/1/0001
05800	S	M	CNT	II	00645	006		12	081501	1/1/0001
05800	S	M	CNT	II	00660	007		12	071803	1/1/0001
05800	S	M	CNT	II	00677	009		12	081501	1/1/0001
05800	S	M	CNT	II	00688	010		12	081501	1/1/0001
05800	S	M	CNT	III	00697	011		12	081501	1/1/0001

OFFICE: 311

ROUTE: 564

ST_REF_NO: 00000149200 POPPY LANE

LUMENS	BULB TYPE	MULT SERIES	POLE TYPE	SHADE	ADDRESS NUMBER	REF	LOCATION	TAX DIST	DATE INST	DATE CHANGE
05800	S	M	OUG	II	02107	000		12	090164	1/1/0001

OFFICE: 311

ROUTE: 564

ST_REF_NO: 00000149300 PORT ROYAL COURT

LUMENS	BULB TYPE	MULT SERIES	POLE TYPE	SHADE	ADDRESS NUMBER	REF	LOCATION	TAX DIST	DATE INST	DATE CHANGE
05800	S	M	OUG	II	01901	074		12	081476	1/1/0001

OFFICE: 311		ROUTE: 564		ST_REF_NO: 00000149300		PORT ROYAL COURT		LUMENS	BULB TYPE	MULT SERIES	POLE TYPE	SHADE	ADDRESS NUMBER	REF	LOCATION	TAX DIST	DATE INST	DATE CHANGE
05800	S	M	OUG	II	01904	075										12	081476	1/1/0001
05800	S	M	OUG	II	01910	076										12	081476	1/1/0001

OFFICE: 311		ROUTE: 564		ST_REF_NO: 00000149400		PORT ROYAL DRIVE		LUMENS	BULB TYPE	MULT SERIES	POLE TYPE	SHADE	ADDRESS NUMBER	REF	LOCATION	TAX DIST	DATE INST	DATE CHANGE
05800	S	M	OUG	II	00000	065	SIDE OF 1900 PORT ROYAL CT.									12	101674	1/1/0001
05800	S	M	OUG	V	01505	063										12	101674	1/1/0001
05800	S	M	OUG	II	01506	064										12	101674	1/1/0001
05800	S	M	OUG	II	01520	067										12	101674	1/1/0001
05800	S	M	OUG	II	01523	066										12	101674	1/1/0001

OFFICE: 311		ROUTE: 564		ST_REF_NO: 00000149490		PORTER PLACE ALLEY		LUMENS	BULB TYPE	MULT SERIES	POLE TYPE	SHADE	ADDRESS NUMBER	REF	LOCATION	TAX DIST	DATE INST	DATE CHANGE
05800	S	M	SOH	II	00000	001	1ST LT. S. OF VERSAILLES RD.									12	120257	1/1/0001
05800	S	M	SOH	II	00000	002	2ND LT. S. OF VERSAILLES RD.									12	091260	1/1/0001
05800	S	M	SOH	II	00000	003	3RD LT. S. OF VERSAILLES RD.									12	091260	1/1/0001
05800	S	M	SOH	II	00000	004	4TH LT. S. OF VERSAILLES RD.									12	091260	1/1/0001

OFFICE: 311		ROUTE: 564		ST_REF_NO: 00000149500		PORTER PLACE		LUMENS	BULB TYPE	MULT SERIES	POLE TYPE	SHADE	ADDRESS NUMBER	REF	LOCATION	TAX DIST	DATE INST	DATE CHANGE
05800	S	M	OUG	III	00832	000										12	050159	1/1/0001
05800	S	M	OUG	III	00842	000										12	052259	1/1/0001
05800	S	M	OUG	III	00856	000										12	052257	1/1/0001

OFFICE: 311		ROUTE: 564		ST_REF_NO: 00000149600		PORTLAND DRIVE		LUMENS	BULB TYPE	MULT SERIES	POLE TYPE	SHADE	ADDRESS NUMBER	REF	LOCATION	TAX DIST	DATE INST	DATE CHANGE
05800	S	M	OUG	II	00614	141	bad fixture									12	101583	3/4/2011
05800	S	M	OUG	II	00621	140										12	101583	11/17/2012
04000	S	M	OUG	II	00000	133	SIDE OF 2806 PHOENIX									12	101583	1/1/0001
04000	S	M	OUG	II	00000	144	SIDE OF 2825 SEATTLE									12	101583	1/1/0001
04000	S	M	OUG	II	00604	143										12	101583	1/1/0001

OFFICE: 311		ROUTE: 564		ST_REF_NO: 00000149600		PORTLAND DRIVE		LUMENS	BULB TYPE	MULT SERIES	POLE TYPE	SHADE	ADDRESS NUMBER	REF	LOCATION	TAX DIST	DATE INST	DATE CHANGE
04000	S	M	OUG	II	00609	142										12	101583	1/1/0001
04000	S	M	OUG	II	00624	139										12	101583	1/1/0001
04000	S	M	OUG	II	00631	138										12	101583	1/1/0001
04000	S	M	OUG	II	00636	137										12	101583	1/1/0001
04000	S	M	OUG	II	00700	136										12	101583	1/1/0001
04000	S	M	OUG	II	00704	135										12	101583	1/1/0001
04000	S	M	OUG	II	00710	134										12	101583	1/1/0001

OFFICE: 311		ROUTE: 564		ST_REF_NO: 00000149700		POST ROAD		LUMENS	BULB TYPE	MULT SERIES	POLE TYPE	SHADE	ADDRESS NUMBER	REF	LOCATION	TAX DIST	DATE INST	DATE CHANGE
09500	S	M	OUG	II	00000	017	SIDE 3348 CLAYS MILL RD.									12	080885	1/1/0001
09500	S	M	OUG	II	00000	019	OPP. 3341									12	080885	1/1/0001
09500	S	M	OUG	II	00000	021	SIDE 3349 HOLWYN RD.									12	080885	1/1/0001
09500	S	M	OUG	II	00000	023	SIDE 3340 HOLWYN RD.									12	080885	1/1/0001
09500	S	M	OUG	II	00000	025	SIDE 3340 HOLWYN RD.									12	080885	1/1/0001
09500	S	M	OUG	II	00000	027	OPP. 3354									12	080885	1/1/0001
09500	S	M	OUG	II	03301	018										12	080885	1/1/0001
09500	S	M	OUG	II	03341	020										12	080885	1/1/0001
09500	S	M	OUG	II	03345	022										12	080885	1/1/0001
09500	S	M	OUG	II	03345	024										12	080885	1/1/0001
09500	S	M	OUG	II	03354	026										12	080885	1/1/0001
04000	S	M	OUG	II	03370	122										12	090885	1/1/0001
04000	S	M	OUG	II	03382	123										12	090885	1/1/0001
04000	S	M	OUG	II	03395	124										12	090885	1/1/0001

OFFICE: 311		ROUTE: 564		ST_REF_NO: 00000149710		POST OAK COURT		LUMENS	BULB TYPE	MULT SERIES	POLE TYPE	SHADE	ADDRESS NUMBER	REF	LOCATION	TAX DIST	DATE INST	DATE CHANGE
04000	S	M	OUG	II	00000	025	SIDE OF 1349 POST OAK RD.									12	091476	1/1/0001

OFFICE: 311		ROUTE: 564		ST_REF_NO: 00000149800		POST OAK ROAD		LUMENS	BULB TYPE	MULT SERIES	POLE TYPE	SHADE	ADDRESS NUMBER	REF	LOCATION	TAX DIST	DATE INST	DATE CHANGE
04000	S	M	OUG	II	00000	012	SIDE 3170 AQUEDUCT	12	060886	1/1/0001								
04000	S	M	OUG	II	00000	019	SIDE OF 3207 PIMLICO PKWY.	12	091476	1/1/0001								
04000	S	M	OUG	II	00000	021	SIDE OF 3209 POST OAK CT.	12	091476	1/1/0001								
04000	S	M	OUG	II	01291	010		12	061581	1/1/0001								
04000	S	M	OUG	II	01309	011		12	061580	1/1/0001								
04000	S	M	OUG	II	01312	024		12	091476	1/1/0001								
04000	S	M	OUG	II	01321	023		12	101478	1/1/0001								
04000	S	M	OUG	II	01333	022		12	091476	1/1/0001								
04000	S	M	OUG	II	01353	020		12	091476	1/1/0001								

OFFICE: 311		ROUTE: 564		ST_REF_NO: 00000149900		POTOMAC DRIVE		LUMENS	BULB TYPE	MULT SERIES	POLE TYPE	SHADE	ADDRESS NUMBER	REF	LOCATION	TAX DIST	DATE INST	DATE CHANGE
04000	S	M	OUG	II	00426	077		12	100885	1/1/0001								
04000	S	M	OUG	II	00433	078		12	100885	1/1/0001								
04000	S	M	OUG	II	00450	088		12	100885	1/1/0001								
04000	S	M	OUG	II	00461	087		12	100885	1/1/0001								
04000	S	M	OUG	II	00470	086		12	100885	1/1/0001								
04000	S	M	OUG	II	00481	034		12	100885	1/1/0001								

OFFICE: 311		ROUTE: 564		ST_REF_NO: 00000150000		POWELL STREET		LUMENS	BULB TYPE	MULT SERIES	POLE TYPE	SHADE	ADDRESS NUMBER	REF	LOCATION	TAX DIST	DATE INST	DATE CHANGE
05800	S	M	SOH	II	00000	001	SIDE OF 521 GOODLOE ST.	12	020860	1/1/0001								

OFFICE: 311		ROUTE: 564		ST_REF_NO: 00000150100		PRALL STREET		LUMENS	BULB TYPE	MULT SERIES	POLE TYPE	SHADE	ADDRESS NUMBER	REF	LOCATION	TAX DIST	DATE INST	DATE CHANGE
05800	S	M	OOH	I	00133	003		12	092874	1/1/0001								
05800	S	M	OOH	I	00147	004		12	092874	1/1/0001								
05800	S	M	OOH	I	00165	005		12	092874	1/1/0001								
05800	S	M	SOH	II	00176	006		12	011865	1/1/0001								
05800	S	M	SOH	I	00195	007		12	061478	1/1/0001								
05800	S	M	OOH	I	00000	001	SIDE OF 567 S. LIMESTONE ST.	12	092874	1/1/0001								

OFFICE: 311		ROUTE: 564		ST_REF_NO: 00000150100		PRALL STREET		LUMENS	BULB TYPE	MULT SERIES	POLE TYPE	SHADE	ADDRESS NUMBER	REF	LOCATION	TAX DIST	DATE INST	DATE CHANGE
05800	S	M	OOH	I	00125	002										12	092874	1/1/0001

OFFICE: 311		ROUTE: 564		ST_REF_NO: 00000150200		PRATHER ROAD		LUMENS	BULB TYPE	MULT SERIES	POLE TYPE	SHADE	ADDRESS NUMBER	REF	LOCATION	TAX DIST	DATE INST	DATE CHANGE
05800	S	M	OUG	II	00000	013	SIDE OF 2034 HART RD.									12	080172	1/1/0001
05800	S	M	SOH	II	01310	000										12	110861	1/1/0001
05800	S	M	OUG	III	01314	000										12	091757	1/1/0001
05800	S	M	OUG	III	01324	000										12	060258	1/1/0001
05800	S	M	OUG	III	01332	000										12	060258	1/1/0001
05800	S	M	OUG	II	01340	000										12	070566	1/1/0001

OFFICE: 311		ROUTE: 564		ST_REF_NO: 00000150250		PREAKNESS DRIVE		LUMENS	BULB TYPE	MULT SERIES	POLE TYPE	SHADE	ADDRESS NUMBER	REF	LOCATION	TAX DIST	DATE INST	DATE CHANGE
05800	S	M	OUG	II	00000	032	ACROSS FROM 277 PREAKNESS DRIVE									12	082602	1/1/0001
05800	S	M	OUG	II	00000	041	ACROSS FROM 140 PREAKNESS DRIVE									12	082602	1/1/0001
05800	S	M	OUG	II	00125	042										12	082602	1/1/0001
05800	S	M	OUG	II	00165	040										12	082602	1/1/0001
05800	S	M	OUG	II	00180	039										12	082602	1/1/0001
05800	S	M	OUG	II	00197	038										12	082602	1/1/0001
05800	S	M	OUG	II	00213	037										12	082602	1/1/0001
05800	S	M	OUG	II	00225	036										12	082602	1/1/0001
05800	S	M	OUG	II	00245	035										12	082602	1/1/0001
05800	S	M	OUG	II	00260	034										12	082602	1/1/0001
05800	S	M	OUG	II	00273	033										12	082602	1/1/0001
05800	S	M	OUG	II	00289	031										12	5/3/01	1/1/0001
05800	S	M	OUG	II	00292	030										12	5/3/01	1/1/0001
05800	S	M	OUG	II	02201	019										12	5/3/01	1/1/0001
05800	S	M	OUG	II	02212	020										12	5/3/01	1/1/0001
05800	S	M	OUG	II	02221	021										12	5/3/01	1/1/0001
05800	S	M	OUG	II	02232	022										12	5/3/01	1/1/0001
05800	S	M	OUG	II	00000	013	SIDE OF 2200 BELMONT DR.									12	090800	1/1/0001
05800	S	M	OUG	II	00312	012										12	090800	1/1/0001

OFFICE: 311

ROUTE: 564

ST_REF_NO: 00000150250

PREAKNESS DRIVE

LUMENS	BULB TYPE	MULT SERIES	POLE TYPE	SHADE	ADDRESS NUMBER	REF	LOCATION	TAX DIST	DATE INST	DATE CHANGE
05800	S	M	OUG	II	00321	011		12	090800	1/1/0001
05800	S	M	OUG	II	00341	010		12	090896	1/1/0001
05800	S	M	OUG	II	00344	009		12	090896	1/1/0001
05800	S	M	OUG	II	00356	007		12	090896	1/1/0001
04000	S	M	OUG	II	00361	008		12	120889	1/1/0001
05800	S	M	OUG	II	00377	006		12	110892	1/1/0001
05800	S	M	OUG	II	00384	005		12	090896	1/1/0001
05800	S	M	OUG	II	00389	003		12	120889	1/1/0001
05800	S	M	OUG	II	00397	001		12	120889	1/1/0001
05800	S	M	OUG	II	00397	002		12	120889	1/1/0001

OFFICE: 311

ROUTE: 564

ST_REF_NO: 00000150270

PRESCOTT LANE

LUMENS	BULB TYPE	MULT SERIES	POLE TYPE	SHADE	ADDRESS NUMBER	REF	LOCATION	TAX DIST	DATE INST	DATE CHANGE
05800	S		OUG	II	00000	008	SIDE OF 2244 SONOMA PLACE ON PRESCOTT LANE	12	092704	1/1/0001
05800	S		OUG	II	00000	009	SIDE OF 2245 SONOMA PLACE ON PRESCOTT LANE	12	092704	1/1/0001
05800	S		OUG	II	00000	012	SIDE OF 1801 STOCKTON WAY ON PRESCOTT LANE	12	092704	1/1/0001
05800	S		OUG	II	00000	013	SIDE OF 1800 STOCKTONWAY ON PRESCOTT LANE	12	092704	1/1/0001
05800	S		OUG	II	00000	015	SIDE OF 2249 PRESCOTT LANE	12	092704	1/1/0001
05800	S		OUG	II	00000	017	SIDE OF 2229 PRESCOTT LANE	12	092704	1/1/0001
05800	S		OUG	II	02212	016		12	092704	1/1/0001
05800	S		OUG	III	02248	014		12	092704	1/1/0001
05800	S		OUG	III	02312	010		12	092704	1/1/0001
05800	S		OUG	II	02360	007		12	092704	1/1/0001
05800	S		OUG	III	02380	006		12	092704	1/1/0001
05800	S		OUG	II	02392	005		12	092704	1/1/0001
05800	S		OUG	II	02412	004		12	092704	1/1/0001
05800	S		OUG	II	02428	003		12	092704	1/1/0001
05800	S		OUG	II	02445	002		12	092704	1/1/0001
05800	S		OUG	III	02456	001		12	092704	1/1/0001

OFFICE: 311

ROUTE: 564

ST_REF_NO: 00000150300

PRESS AVENUE

LUMENS	BULB TYPE	MULT SERIES	POLE TYPE	SHADE	ADDRESS NUMBER	REF	LOCATION	TAX DIST	DATE INST	DATE CHANGE
09500	S	M	OUG	II	00000	001	1ST LT. S OF VIRGINIA AVE., EASTSIDE	12	100897	1/1/0001
09500	S	M	OUG	II	00000	002	2ND LT. S OF VIRGINIA AVE., WESTSIDE	12	100897	1/1/0001
09500	S	M	OUG	II	00000	003	2ND LT. S OF VIRGINIA AVE., EASTSIDE	12	100897	1/1/0001
09500	S	M	OUG	II	00000	004	3RD LT. S OF VIRGINIA AVE., WESTSIDE	12	100897	1/1/0001
09500	S	M	OUG	II	00000	005	3RD LT. S OF VIRGINIA AVE., EASTSIDE	12	100897	1/1/0001
09500	S	M	OUG	II	00000	006	4TH LT. S OF VIRGINIA AVE., WESTSIDE	12	100897	1/1/0001
09500	S	M	OUG	II	00000	007	4TH LT. S OF VIRGINIA AVE., EASTSIDE	12	100897	1/1/0001
09500	S	M	SOH	I	00000	008	OPP. 803	12	050863	1/1/0001
09500	S	M	SOH	I	00000	009	OPP. 817	12	050863	1/1/0001
09500	S	M	SOH	II	00000	010	SIDE OF 178 GAZETTE AVE.	12	050863	1/1/0001
09500	S	M	SOH	I	00000	011	OPP. 833	12	050863	1/1/0001
09500	S	M	SOH	I	00000	012	OPP. 837	12	050863	1/1/0001
09500	S	M	SOH	II	00000	013	1ST LT S OF VIRGINIA AVE., WESTSIDE	12	100897	1/1/0001

OFFICE: 311

ROUTE: 564

ST_REF_NO: 00000150400

PRESTON AVENUE

LUMENS	BULB TYPE	MULT SERIES	POLE TYPE	SHADE	ADDRESS NUMBER	REF	LOCATION	TAX DIST	DATE INST	DATE CHANGE
04000	S	M	SOH	II	00000	078	SIDE OF 1401 RICHMOND RD.	12	050885	1/1/0001
04000	S	M	SOH	II	00000	084	204-206	12	050885	1/1/0001
04000	S	M	SOH	II	00122	079		12	050885	1/1/0001
04000	S	M	SOH	II	00137	080		12	050885	1/1/0001
04000	S	M	SOH	II	00150	081		12	050885	1/1/0001
04000	S	M	SOH	II	00165	082		12	050885	1/1/0001
04000	S	M	SOH	II	00182	083		12	050885	1/1/0001
04000	S	M	SOH	II	00216	085		12	050885	1/1/0001
04000	S	M	SOH	II	00224	086		12	050885	1/1/0001
04000	S	M	SOH	II	00236	087		12	050885	1/1/0001
04000	S	M	SOH	II	00247	088		12	050885	1/1/0001
04000	S	M	SOH	II	00268	089		12	050885	1/1/0001
04000	S	M	SOH	II	00300	090		12	050885	1/1/0001
04000	S	M	SOH	II	00308	091		12	050885	1/1/0001
04000	S	M	SOH	II	00325	092		12	050885	1/1/0001
04000	S	M	SOH	II	00336	093		12	050885	1/1/0001
04000	S	M	SOH	II	00346	094		12	050885	1/1/0001

OFFICE: 311

ROUTE: 564

ST_REF_NO: 00000150400 PRESTON AVENUE

LUMENS	BULB TYPE	MULT SERIES	POLE TYPE	SHADE	ADDRESS NUMBER	REF	LOCATION	TAX DIST	DATE INST	DATE CHANGE
04000	S	M	SOH	II	00369	095		12	050885	1/1/0001
04000	S	M	SOH	II	00378	096		12	050885	1/1/0001

OFFICE: 311

ROUTE: 564

ST_REF_NO: 00000150500 PRESTON COURT

LUMENS	BULB TYPE	MULT SERIES	POLE TYPE	SHADE	ADDRESS NUMBER	REF	LOCATION	TAX DIST	DATE INST	DATE CHANGE
05800	S	M	SOH	I	00000	544	SIDE OF 419 E. HIGH ST.	12	021022	1/1/0001
05800	S	M	SOH	I	00007	545		12	062167	1/1/0001

OFFICE: 311

ROUTE: 564

ST_REF_NO: 00000150600 PRICE AVENUE

LUMENS	BULB TYPE	MULT SERIES	POLE TYPE	SHADE	ADDRESS NUMBER	REF	LOCATION	TAX DIST	DATE INST	DATE CHANGE
05800	S	M	SOH	II	00000	249	SIDE OF 451 W. SIXTH ST.	12	100266	1/1/0001
05800	S	M	SOH	II	00000	252	SIDE OF 449 DELCAMP AVE.	12	100266	1/1/0001
05800	S	M	SOH	II	00612	250		12	100266	1/1/0001
05800	S	M	SOH	II	00622	251		12	100266	1/1/0001
05800	S	M	SOH	II	00723	253		12	100266	1/1/0001
05800	S	M	SOH	II	00734	254		12	100266	1/1/0001
05800	S	M	SOH	V	00742	255		12	121265	1/1/0001

OFFICE: 311

ROUTE: 564

ST_REF_NO: 00000150700 PRICE ROAD

LUMENS	BULB TYPE	MULT SERIES	POLE TYPE	SHADE	ADDRESS NUMBER	REF	LOCATION	TAX DIST	DATE INST	DATE CHANGE
22000	S	M	OUG	II	00000	200	1ST LT W OF LEXINGTON CEMETERY,S SIDE OF PRICE RD	12	121905	1/1/0001
22000	S	M	OUG	II	00000	202	2ND LT W OF LEXINGTON CEMETERY,S SIDE OF PRICE RD	12	121905	1/1/0001
22000	S	M	OUG	II	00000	203	3RD LT W OF LEXINGTON CEMETERY, S SIDE OF PRICE RD	12	121905	1/1/0001
22000	S	M	OUG	II	00000	204	4TH LT W OF LEXINGTON CEMETERY, S SIDE OF PRICE RD	12	121905	1/1/0001
22000	S	M	OUG	II	00000	206	4TH LT W OF LEXINGTON CEMETERY, N SIDE OF PRICE RD	12	121905	1/1/0001
22000	S	M	OUG	II	00000	207	3RD LT W OF LEXINGTON CEMETERY, N SIDE OF PRICE RD	12	121905	1/1/0001
22000	S	M	OUG	II	00000	208	2ND LT W OF LEXINGTON CEMETERY, N SIDE OF PRICE RD	12	121905	1/1/0001

OFFICE: 311

ROUTE: 564

ST_REF_NO: 00000150700

PRICE ROAD

LUMENS	BULB TYPE	MULT SERIES	POLE TYPE	SHADE	ADDRESS NUMBER	REF	LOCATION	TAX DIST	DATE INST	DATE CHANGE
22000	S	M	OUG	II	00000	209	1ST LT W OF LEXINGTON CEMETERY, N SIDE OF PRICE RD	12	121905	1/1/0001
22000	S	M	OUG	II	00000	210	5TH LT W OF LEXINGTON CEMETERY, N SIDE OF PRICE RD	12	121905	1/1/0001
09500	S	M	SOH	II	00000	002	1025 W. MAIN ST. ON PRICE ROAD RAMP	12	030886	1/1/0001
09500	S	M	SOH	II	00000	004	1027 W. MAIN ST. ON PRICE ROAD RAMP	12	030886	1/1/0001
09500	S	M	SOH	II	00000	005	SIDE 1029 W. MAIN ST.	12	030886	1/1/0001
09500	S	M	SOH	II	00000	006	SIDE 1027 W. MAIN ST.	12	030886	1/1/0001
09500	S	M	SOH	II	00000	007	SIDE 1027 W. MAIN ST.	12	030886	1/1/0001
09500	S	M	SOH	II	00000	008	SIDE 1027 W. MAIN ST.	12	030886	1/1/0001
09500	S	M	SOH	II	00000	009	SIDE 1027 W. MAIN ST.	12	030886	1/1/0001
09500	S	M	SOH	II	00000	010	SIDE 1027 W. MAIN ST.	12	030886	1/1/0001
09500	S	M	SOH	II	00000	012	OPP. 251	12	030886	1/1/0001
09500	S	M	SOH	II	00000	013	OPP. 251	12	030886	1/1/0001
09500	S	M	SOH	II	00000	015	OPP. 355	12	030886	1/1/0001
09500	S	M	SOH	II	00000	016	AT 'A' ST., SW CORNER	12	030886	1/1/0001
09500	S	M	SOH	II	00000	017	AT 'B' ST., SW CORNER	12	030886	1/1/0001
09500	S	M	SOH	II	00000	018	AT 'C' ST., SW CORNER	12	030886	1/1/0001
09500	S	M	SOH	II	00000	019	1ST LT. N. OF 'C' ST., W. SIDE	12	030886	1/1/0001
09500	S	M	SOH	II	00000	020	2ND LT. N. OF 'C' ST., W. SIDE	12	030886	1/1/0001
09500	S	M	SOH	II	00000	021	1ST LT. S. OF FAIRDALE DR., E. SIDE	12	030886	1/1/0001
09500	S	M	SOH	II	00000	022	1ST LT. N. OF FAIRDALE DR., W. SIDE	12	030886	1/1/0001
09500	S	M	SOH	II	00000	023	SIDE 803 CHILES AVE.	12	030886	1/1/0001
09500	S	M	SOH	II	00251	011		12	030886	1/1/0001
09500	S	M	SOH	II	00251	014		12	030886	1/1/0001
09500	S	M	SOH	I	00404	024		12	110369	1/1/0001
09500	S	M	SOH	I	00412	025		12	110369	1/1/0001
09500	S	M	SOH	I	00422	026		12	110369	1/1/0001
09500	S	M	SOH	I	00428	027		12	110369	1/1/0001
09500	S	M	SOH	I	00438	028		12	110369	1/1/0001
09500	S	M	SOH	I	00450	029		12	110369	1/1/0001
09500	S	M	SOH	I	00460	030		12	110369	1/1/0001
09500	S	M	SOH	I	00472	031		12	110369	1/1/0001
09500	S	M	SOH	I	00480	032		12	110369	1/1/0001
09500	S	M	SOH	I	00490	033		12	110369	1/1/0001

Street Light Listing run 1/11/2015 10:43:21 AM

Page 891 of 1254

OFFICE: 311

ROUTE: 564

ST_REF_NO: 00000150700 PRICE ROAD

LUMENS	BULB TYPE	MULT SERIES	POLE TYPE	SHADE	ADDRESS NUMBER	REF	LOCATION	TAX DIST	DATE INST	DATE CHANGE
09500	S	M	SOH	I	00496	034		12	110369	1/1/0001

OFFICE: 311

ROUTE: 564

ST_REF_NO: 00000150720 PRICHARD DRIVE

LUMENS	BULB TYPE	MULT SERIES	POLE TYPE	SHADE	ADDRESS NUMBER	REF	LOCATION	TAX DIST	DATE INST	DATE CHANGE
05800	S	M	CNT	II	00000	001	SIDE OF 3100 GILMORE TRACE ON PRICHARD DR	12	113005	1/1/0001
05800	S	M	CNT	II	00000	002	SIDE OF 3009 GILMORE TRACE ON PRICHARD DR	12	113005	1/1/0001
05800	S	M	CNT	II	00000	005	SIDE OF 3097 SANDERSVILLE RD ON PRICHARD DR	12	113005	1/1/0001
05800	S	M	CNT	II	00000	030	SIDE OF 820 YUCCA COURT ON PRICHARD DR	12	121106	1/1/0001
05800	S	M	CNT	II	00000	092	SIDE OF 801 WHITE WOOD FLAT ON PRICHARD DR	12	121106	1/1/0001
05800	S	M	CNT	II	00000	093	SIDE OF 800 WHITE WOOD FLAT ON PRICHARD DR	12	121106	1/1/0001
05800	S	M	CNT	II	00000	094	SIDE OF 3096 SANDERSVILLE RD ON PRICHARD DR	12	121106	1/1/0001
05800	S	M	CNT	II	02977	003		12	113005	1/1/0001
05800	S	M	CNT	II	02989	004		12	113005	1/1/0001
05800	S	M	CNT	II	03016	091		12	121106	1/1/0001
05800	S	M	CNT	II	03028	090		12	121106	1/1/0001
05800	S	M	CNT	II	03045	080		12	121106	1/1/0001
05800	S	M	CNT	II	03052	070		12	121106	1/1/0001
05800	S	M	CNT	II	03064	060		12	121106	1/1/0001
05800	S	M	CNT	II	03076	050		12	121106	1/1/0001
05800	S	M	CNT	II	03089	040		12	121106	1/1/0001
05800	S	M	CNT	II	03117	020		12	121106	1/1/0001
05800	S	M	CNT	II	03124	010		12	121106	1/1/0001

OFFICE: 311

ROUTE: 564

ST_REF_NO: 00000150800 PRIDEMORE COURT

LUMENS	BULB TYPE	MULT SERIES	POLE TYPE	SHADE	ADDRESS NUMBER	REF	LOCATION	TAX DIST	DATE INST	DATE CHANGE
10000	M	M	SOH	II	00000	001	SIDE OF 996 NEW CIRCLE RD.	12	041579	1/1/0001
10000	M	M	SOH	II	00000	002	SIDE OF 1008 NEW CIRCLE RD ON PRIDEMORE CT.	12	041579	1/1/0001
10000	M	M	SOH	II	00000	003	OPP. 1389	12	041579	1/1/0001
10000	M	M	SOH	II	01388	004		12	041579	1/1/0001
10000	M	M	SOH	II	01382	005		12	041579	1/1/0001

OFFICE: 311		ROUTE: 564		ST_REF_NO: 00000150900		PRIMROSE COURT		LUMENS	BULB TYPE	MULT SERIES	POLE TYPE	SHADE	ADDRESS NUMBER	REF	LOCATION	TAX DIST	DATE INST	DATE CHANGE
05800	S	M	OUG	II	00000	068	SIDE OF 1088 NANDINO BLVD.	12	082373	1/1/0001								
05800	S	M	OUG	II	00000	070	SIDE OF 1088 NANDINO BLVD.	12	082373	1/1/0001								
05800	S	M	OUG	V	00961	072		12	051480	1/1/0001								
05800	S	M	OUG	V	00973	071		12	051480	1/1/0001								
05800	S	M	OUG	II	00985	069		12	082373	1/1/0001								
05800	S	M	OUG	II	00997	067		12	082373	1/1/0001								

OFFICE: 311		ROUTE: 564		ST_REF_NO: 00000151000		PRINCE ALBERT ROAD		LUMENS	BULB TYPE	MULT SERIES	POLE TYPE	SHADE	ADDRESS NUMBER	REF	LOCATION	TAX DIST	DATE INST	DATE CHANGE
05800	S	M	OUG	II	00000	069	SIDE 4119 WINNEPEG WAY	12	110886	1/1/0001								
05800	S	M	OUG	II	04000	071		12	110886	1/1/0001								
05800	S	M	OUG	II	04005	070		12	110886	1/1/0001								
05800	S	M	OUG	II	04017	010		12	021579	1/1/0001								
05800	S	M	OUG	II	04028	011		12	021579	1/1/0001								

OFFICE: 311		ROUTE: 564		ST_REF_NO: 00000151100		PRINCE ALBERT WAY		LUMENS	BULB TYPE	MULT SERIES	POLE TYPE	SHADE	ADDRESS NUMBER	REF	LOCATION	TAX DIST	DATE INST	DATE CHANGE
05800	S	M	OUG	II	00000	096	SIDE 204 SOUTHPOINT DR.	12	090886	1/1/0001								
05800	S	M	OUG	II	00000	097	SIDE 133 SOUTHPOINT DR.	12	090886	1/1/0001								
05800	S	M	OUG	II	00000	101	SIDE 201 WHITFIELD DR.	12	090886	1/1/0001								
05800	S	M	OUG	II	04468	013		12	090886	1/1/0001								
05800	S	M	OUG	II	04481	003		12	090886	1/1/0001								
05800	S	M	OUG	II	04484	002		12	090886	1/1/0001								
05800	S	M	OUG	II	04509	100		12	090886	1/1/0001								
05800	S	M	OUG	II	04513	099		12	090886	1/1/0001								
05800	S	M	OUG	II	04524	098		12	090886	1/1/0001								
05800	S	M	OUG	II	04544	114		12	090886	1/1/0001								
05800	S	M	OUG	II	04552	115		12	090886	1/1/0001								
05800	S	M	OUG	II	04561	116		12	090886	1/1/0001								
05800	S	M	OUG	II	04565	117		12	090886	1/1/0001								

OFFICE: 311

ROUTE: 564

ST_REF_NO: 00000151110

PRINCESS ARCH LANE

LUMENS	BULB TYPE	MULT SERIES	POLE TYPE	SHADE	ADDRESS NUMBER	REF	LOCATION	TAX DIST	DATE INST	DATE CHANGE
05800	S	M	CNT	II	00000	001	SIDE OF 2700 JACQUELYN LN ON PRINCESS ARCH LN	12	072401	1/1/0001
05800	S	M	CNT	II	00000	005	SIDE OF 2797 MABLE LANE ON PRINCESS ARCH LN	12	072401	1/1/0001
05800	S	M	CNT	II	00309	004		12	072401	1/1/0001
05800	S	M	CNT	II	00320	003		12	072401	1/1/0001
05800	S	M	CNT	II	00333	002		12	072401	1/1/0001

OFFICE: 311

ROUTE: 564

ST_REF_NO: 00000151115

PRINCESS DOREEN DRIVE

LUMENS	BULB TYPE	MULT SERIES	POLE TYPE	SHADE	ADDRESS NUMBER	REF	LOCATION	TAX DIST	DATE INST	DATE CHANGE
09500	S		CLN	II	00000	001	SIDE OF 2437 FLYING EBONY ON PRINCESS DOREEN	12	091109	1/1/0001
09500	S		CLN	II	00904	002		12	091109	1/1/0001
09500	S		CLN	II	00913	003		12	091109	1/1/0001
09500	S		CLN	II	00916	004		12	091109	1/1/0001
09500	S		CLN	II	00925	005		12	091109	1/1/0001
09500	S		CLN	II	00936	006		12	091109	1/1/0001
09500	S		CLN	II	00944	007		12	091109	1/1/0001
09500	S		CLN	II	00953	008		12	091109	1/1/0001
09500	S		CLN	II	00961	009		12	091109	1/1/0001
09500	S		CLN	II	00966	010		12	091109	1/1/0001
09500	S		CLN	II	00981	011		12	091109	1/1/0001
09500	S		CLN	II	00984	012		12	091109	1/1/0001

OFFICE: 311

ROUTE: 564

ST_REF_NO: 00000151120

PRINCETON CIRCLE

LUMENS	BULB TYPE	MULT SERIES	POLE TYPE	SHADE	ADDRESS NUMBER	REF	LOCATION	TAX DIST	DATE INST	DATE CHANGE
05800	S	M	OUG	IV	00600	002		12	060895	1/1/0001
05800	S	M	OUG	II	00620	001		12	060895	1/1/0001

OFFICE: 311

ROUTE: 564

ST_REF_NO: 00000151300

PROSPECT AVENUE

LUMENS	BULB TYPE	MULT SERIES	POLE TYPE	SHADE	ADDRESS NUMBER	REF	LOCATION	TAX DIST	DATE INST	DATE CHANGE
09500	S	M	SOH	II	00000	012	SIDE OF 117 BURLEY AVE.-upgrade per city's request	12	050886	12/3/2008
09500	S		SOH	II	01100	010	upgrade per city's request	12	050886	12/3/2008

OFFICE: 311		ROUTE: 564		ST_REF_NO: 00000151300		PROSPECT AVENUE		LUMENS	BULB TYPE	MULT SERIES	POLE TYPE	SHADE	ADDRESS NUMBER	REF	LOCATION	TAX DIST	DATE INST	DATE CHANGE
09500	S	M	SOH	II	01109	011	upgrade per city's request	12	050886	12/3/2008								

OFFICE: 311		ROUTE: 564		ST_REF_NO: 00000151310		PROSPEROUS PLACE		LUMENS	BULB TYPE	MULT SERIES	POLE TYPE	SHADE	ADDRESS NUMBER	REF	LOCATION	TAX DIST	DATE INST	DATE CHANGE
05800	S	M	OUG	II	00000	001	1ST LT. E. OF RICHMOND RD, NORTHSIDE	12	040895	1/1/0001								
05800	S	M	OUG	II	00101	002		12	040895	1/1/0001								
05800	S	M	OUG	II	00111	003		12	040895	1/1/0001								
05800	S	M	OUG	II	00119	004		12	040895	1/1/0001								
05800	S	M	OUG	II	00121	005		12	040895	1/1/0001								
05800	S	M	OUG	II	00131	006		12	040895	1/1/0001								
05800	S	M	OUG	II	00141	007		12	040895	1/1/0001								
05800	S	M	OUG	II	00149	008		12	040895	1/1/0001								
05800	S	M	OUG	II	00157	009		12	040895	1/1/0001								
05800	S	M	OUG	II	00162	010		12	060895	1/1/0001								
05800	S	M	OUG	II	00171	011		12	060895	1/1/0001								
05800	S	M	OUG	III	00181	012		12	080897	1/1/0001								
05800	S	M	OUG	III	00181	013		12	080897	1/1/0001								

OFFICE: 311		ROUTE: 564		ST_REF_NO: 00000151400		PROVIDENCE ROAD		LUMENS	BULB TYPE	MULT SERIES	POLE TYPE	SHADE	ADDRESS NUMBER	REF	LOCATION	TAX DIST	DATE INST	DATE CHANGE
05800	S	M	OOH	II	00000	104	SIDE OF 1405 TATES CREEK PIKE	12	120165	1/1/0001								
05800	S	M	OUG	II	00000	107	SIDE OF 305 CASSIDY RD.	12	122165	1/1/0001								
05800	S	M	OOH	II	00000	108	SIDE OF 298 COLONY BLVD	12	120165	1/1/0001								
05800	S	M	OUG	II	00000	109	NE CORNER OF COLONY BLVD.	12	092765	1/1/0001								
05800	S	M	SOH	II	00000	110	OPP. 1126	12	090865	1/1/0001								
05800	S	M	OUG	II	00672	095		12	050357	1/1/0001								
05800	S	M	OUG	III	00681	096		12	100156	1/1/0001								
05800	S	M	OUG	III	00692	097		12	100156	1/1/0001								
05800	S	M	OUG	III	00701	098		12	100156	1/1/0001								
05800	S	M	OUG	III	00708	099		12	100156	1/1/0001								
05800	S	M	OUG	III	00721	100		12	111056	1/1/0001								
05800	S	M	OUG	III	00736	101		12	050357	1/1/0001								

OFFICE: 311		ROUTE: 564		ST_REF_NO: 00000151400		PROVIDENCE ROAD				
LUMENS	BULB TYPE	MULT SERIES	POLE TYPE	SHADE	ADDRESS NUMBER	REF	LOCATION	TAX DIST	DATE INST	DATE CHANGE
05800	S	M	OUG	III	00800	102		12	111056	1/1/0001
05800	S	M	OUG	III	00809	103		12	050257	1/1/0001
05800	S	M	OOH	II	01000	106		12	012166	1/1/0001
05800	S	M	SOH	II	00000	112	OPP. 1140	12	090865	1/1/0001
05800	S	M	SOH	II	00000	113	SIDE OF 300 ROMANY RD.	12	052551	1/1/0001
05800	S	M	OUG	II	00000	114	SIDE OF REAR OF 307 ROMANY RD.	12	110165	1/1/0001
05800	S	M	OUG	II	00000	116	SIDE OF 325 ANDOVER DR.	12	031466	1/1/0001
05800	S	M	SOH	II	01128	111		12	052551	1/1/0001
05800	S	M	OUG	II	01219	115		12	022167	1/1/0001

OFFICE: 311		ROUTE: 564		ST_REF_NO: 00000151410		PUEBLO COURT				
LUMENS	BULB TYPE	MULT SERIES	POLE TYPE	SHADE	ADDRESS NUMBER	REF	LOCATION	TAX DIST	DATE INST	DATE CHANGE
05800	S	M	CNT	II	03361	004		12	051601	1/1/0001
05800	S	M	CNT	II	03373	005		12	051601	1/1/0001
05800	S	M	CNT	II	03388	006		12	051601	1/1/0001
05800	S	M	CNT	II	03409	007		12	051601	1/1/0001
05800	S	M	CNT	II	03428	008		12	051601	1/1/0001
09500	S	M	CNT	II	00000	001	SIDE OF 3213 DURANGO DR.	12	060800	1/1/0001
09500	S	M	CNT	III	03309	003		12	060800	1/1/0001
09500	S	M	CNT	II	03328	002		12	060800	1/1/0001

OFFICE: 311		ROUTE: 564		ST_REF_NO: 00000151500		PURDUE PLACE				
LUMENS	BULB TYPE	MULT SERIES	POLE TYPE	SHADE	ADDRESS NUMBER	REF	LOCATION	TAX DIST	DATE INST	DATE CHANGE
04000	S	M	OUG	II	00000	030	SIDE 341 TULANE DR.	12	060886	1/1/0001
04000	S	M	OUG	II	00300	026		12	060886	1/1/0001
04000	S	M	OUG	II	00309	027		12	060886	1/1/0001
04000	S	M	OUG	II	00316	028		12	060886	1/1/0001
04000	S	M	OUG	II	00329	029		12	060886	1/1/0001

OFFICE: 311 ROUTE: 564										
ST_REF_NO: 00000151540 PUTTER LANE										
LUMENS	BULB TYPE	MULT SERIES	POLE TYPE	SHADE	ADDRESS NUMBER	REF	LOCATION	TAX DIST	DATE INST	DATE CHANGE
05800	S	M	CNT	II	00000	001	SIDE OF 285 FOREST HILL DRIVE	12	040897	1/1/0001
05800	S	M	CNT	II	03204	002		12	040897	1/1/0001
05800	S	M	CNT	II	03217	003		12	040897	1/1/0001

OFFICE: 311 ROUTE: 564										
ST_REF_NO: 00000151550 PYFER COURT										
LUMENS	BULB TYPE	MULT SERIES	POLE TYPE	SHADE	ADDRESS NUMBER	REF	LOCATION	TAX DIST	DATE INST	DATE CHANGE
04000	S	M	OUG	II	00000	060	SIDE OF 3809 HEIMBAUGH LANE	12	091579	1/1/0001

OFFICE: 311 ROUTE: 564										
ST_REF_NO: 00000151600 PYKE ROAD										
LUMENS	BULB TYPE	MULT SERIES	POLE TYPE	SHADE	ADDRESS NUMBER	REF	LOCATION	TAX DIST	DATE INST	DATE CHANGE
04000	S	M	SOH	II	00502	006		12	020886	1/1/0001
04000	S	M	SOH	II	00506	007		12	020886	1/1/0001
04000	S	M	SOH	II	00512	008		12	020886	1/1/0001
04000	S	M	SOH	II	00402	001		12	020886	1/1/0001
04000	S	M	SOH	II	00405	002		12	020886	1/1/0001
04000	S	M	SOH	II	00408	003		12	020886	1/1/0001
04000	S	M	SOH	II	00420	004		12	020886	1/1/0001
04000	S	M	SOH	II	00426	005		12	020886	1/1/0001

OFFICE: 311 ROUTE: 564										
ST_REF_NO: 00000151610 QUAILRIDGE COURT										
LUMENS	BULB TYPE	MULT SERIES	POLE TYPE	SHADE	ADDRESS NUMBER	REF	LOCATION	TAX DIST	DATE INST	DATE CHANGE
05800	S	M	OUG	V	03908	001		12	100892	1/1/0001

OFFICE: 311 ROUTE: 564										
ST_REF_NO: 00000151700 QUAIL RUN										
LUMENS	BULB TYPE	MULT SERIES	POLE TYPE	SHADE	ADDRESS NUMBER	REF	LOCATION	TAX DIST	DATE INST	DATE CHANGE
04000	S	M	OUG	II	00000	014	SIDE 3667 WALDEN DR.	12	110885	1/1/0001
04000	S	M	OUG	V	00500	012		12	111580	1/1/0001
04000	S	M	OUG	II	00505	013		12	111580	1/1/0001

OFFICE: 311		ROUTE: 564		ST_REF_NO: 00000151750		QUAKER HILL LANE				
LUMENS	BULB TYPE	MULT SERIES	POLE TYPE	SHADE	ADDRESS NUMBER	REF	LOCATION	TAX DIST	DATE INST	DATE CHANGE
05800	S	M	CNT	II	00000	001	SIDE OF 2040 SHAKER RUN ROAD ON QUAKER HILL LANE	12	100901	1/1/0001
05800	S	M	CNT	II	03012	002		12	100901	1/1/0001
05800	S	M	CNT	II	03032	003		12	100901	1/1/0001
05800	S	M	CNT	II	03049	004		12	100901	1/1/0001
05800	S	M	CNT	II	03061	005		12	100901	1/1/0001

OFFICE: 311 ROUTE: 564

OFFICE: 311		ROUTE: 564		ST_REF_NO: 00000151800		QUALITY STREET				
LUMENS	BULB TYPE	MULT SERIES	POLE TYPE	SHADE	ADDRESS NUMBER	REF	LOCATION	TAX DIST	DATE INST	DATE CHANGE
09500	S	M	OUG	II	00000	004	3 RD. LT. N. OF VINE ST., E. SIDE	12	070171	1/1/0001
09500	S	M	OUG	II	00000	005	2 ND. LT. N. OF VINE ST., E. SIDE	12	070171	1/1/0001
09500	S	M	OUG	II	00000	006	1 ST. LT. N. OF VINE ST., E. SIDE	12	070171	1/1/0001

OFFICE: 311 ROUTE: 564

OFFICE: 311		ROUTE: 564		ST_REF_NO: 00000151805		QUARRY DRIVE				
LUMENS	BULB TYPE	MULT SERIES	POLE TYPE	SHADE	ADDRESS NUMBER	REF	LOCATION	TAX DIST	DATE INST	DATE CHANGE
09500	S	M	OUG	II	00400	001		12	090898	1/1/0001
09500	S	M	OUG	II	00409	002		12	090898	1/1/0001

OFFICE: 311 ROUTE: 564

OFFICE: 311		ROUTE: 564		ST_REF_NO: 00000151810		QUARTER HORSE COURT				
LUMENS	BULB TYPE	MULT SERIES	POLE TYPE	SHADE	ADDRESS NUMBER	REF	LOCATION	TAX DIST	DATE INST	DATE CHANGE
09500	S	M	CNT	II	00901	003		12	080894	11/14/2012
05800	S	M	CNT	II	00809	006		12	080894	1/1/0001
05800	S	M	CNT	II	00824	005		12	080894	1/1/0001
05800	S	M	CNT	II	00833	004		12	080894	1/1/0001
05800	S	M	CNT	II	00912	002		12	080894	1/1/0001
05800	S	M	CNT	II	00925	001		12	080894	1/1/0001

OFFICE: 311 ROUTE: 564

OFFICE: 311		ROUTE: 564		ST_REF_NO: 00000151900		QUEBEC WAY				
LUMENS	BULB TYPE	MULT SERIES	POLE TYPE	SHADE	ADDRESS NUMBER	REF	LOCATION	TAX DIST	DATE INST	DATE CHANGE
05800	S	M	OUG	II	00000	085	SIDE 132 NORTH BAY DR.	12	110886	1/14/2011
05800	S	M	OUG	II	00234	015		12	021579	10/27/2013

OFFICE: 311

ROUTE: 564

ST_REF_NO: 00000151900 QUEBEC WAY

LUMENS	BULB TYPE	MULT SERIES	POLE TYPE	SHADE	ADDRESS NUMBER	REF	LOCATION	TAX DIST	DATE INST	DATE CHANGE
04000	S	M	OUG	II	00156	086		12	110886	1/1/0001
05800	S	M	OUG	II	00169	087	upgraded to 5800 5/08	12	110886	1/1/0001
04000	S	M	OUG	II	00184	088		12	110886	1/1/0001
04000	S	M	OUG	II	00000	016	SIDE OF 233 QUEBEC WAY	12	021579	1/1/0001
04000	S	M	OUG	II	00000	089	SIDE 4115 WINNEPEG WAY	12	110886	1/1/0001
04000	S	M	OUG	II	00197	012		12	021579	1/1/0001
04000	S	M	OUG	II	00210	013		12	021579	1/1/0001
04000	S	M	OUG	II	00221	014		12	021579	1/1/0001

OFFICE: 311

ROUTE: 564

ST_REF_NO: 00000152000 QUEENSWAY DRIVE

LUMENS	BULB TYPE	MULT SERIES	POLE TYPE	SHADE	ADDRESS NUMBER	REF	LOCATION	TAX DIST	DATE INST	DATE CHANGE
04000	S	M	OUG	II	00000	041	SIDE OF 1803 FAIRWAY DR.	12	041582	1/1/0001
04000	S	M	OUG	II	00000	044	SIDE OF 1718 BON AIR DR.	12	071478	1/1/0001
04000	S	M	OUG	II	00223	000		12	080966	1/1/0001
04000	S	M	OUG	II	00243	043		12	120884	1/1/0001
04000	S	M	OUG	II	00000	045	SIDE OF 1801 BON AIR DR.	12	071478	1/1/0001
04000	S	M	OUG	II	00320	046		12	120884	1/1/0001
04000	S	M	OUG	II	00336	047		12	120884	1/1/0001
04000	S	M	OUG	II	00349	048		12	120884	1/1/0001
04000	S	M	OUG	II	00368	049		12	071478	1/1/0001
04000	S	M	OUG	II	00401	150		12	120884	1/1/0001
04000	S	M	OUG	II	00406	151		12	120884	1/1/0001
04000	S	M	OUG	II	00415	152		12	120884	1/1/0001
04000	S	M	OUG	II	00420	194		12	110884	1/1/0001
05800	S	M	OUG	II	00425	193	upgraded 5/08	12	110884	1/1/0001
04000	S	M	OUG	II	00434	192		12	110884	1/1/0001
04000	S	M	OUG	II	00441	191		12	110884	1/1/0001

OFFICE: 311

ROUTE: 564

ST_REF_NO: 00000152100 QUINCY COURT

LUMENS	BULB TYPE	MULT SERIES	POLE TYPE	SHADE	ADDRESS NUMBER	REF	LOCATION	TAX DIST	DATE INST	DATE CHANGE
05800	S	M	OUG	II	00000	024	SIDE OF 2676 TWINBROOK LANE	12	040172	1/1/0001
05800	S	M	OUG	V	02688	000		12	060172	1/1/0001

OFFICE: 311		ROUTE: 564		ST_REF_NO: 00000152150		QUINN SHEARER COURT		LUMENS	BULB TYPE	MULT SERIES	POLE TYPE	SHADE	ADDRESS NUMBER	REF	LOCATION	TAX DIST	DATE INST	DATE CHANGE
05800	S	M	SOH	V	00000	001	SIDE OF 148 JEFFERSON ST.	12	101464	1/1/0001								
OFFICE: 311		ROUTE: 564		ST_REF_NO: 00000152300		RACE STREET		LUMENS	BULB TYPE	MULT SERIES	POLE TYPE	SHADE	ADDRESS NUMBER	REF	LOCATION	TAX DIST	DATE INST	DATE CHANGE
05800	S	M	SOH	II	00000	009	OPP. 451	12	110964	1/1/0001								
05800	S	M	SOH	II	00000	010	OPP. FROM SIDE OF 442 E. FIFTH ST.	12	110964	1/1/0001								
05800	S	M	SOH	II	00000	001	N.E. CORNER OF RACE & E. THIRD ST.	12	110964	1/1/0001								
05800	S	M	SOH	II	00000	003	S.E. CORNER OF RACE & GRINSTEAD ST.	12	110964	1/1/0001								
05800	S	M	SOH	II	00000	004	OPP. 337	12	110964	1/1/0001								
05800	S	M	SOH	II	00000	005	OPP. FOURTH ST.	12	110964	1/1/0001								
05800	S	M	SOH	II	00000	006	OPP. 411	12	110964	1/1/0001								
05800	S	M	SOH	II	00000	007	OPP. 427	12	110964	1/1/0001								
05800	S	M	SOH	II	00000	008	OPP. 437	12	110964	1/1/0001								
05800	S	M	SOH	II	00000	017	OPP. 146	12	110266	1/1/0001								
05800	S	M	SOH	II	00000	018	OPP. 165	12	110266	1/1/0001								
05800	S	M	SOH	II	00000	019	1 ST. LT. N. OF CORRAL ST., E. SIDE	12	110266	1/1/0001								
05800	S	M	SOH	II	00000	020	SIDE OF 426 E. SECOND ST.	12	110266	1/1/0001								
05800	S	M	SOH	II	00000	023	1 ST. LT. S. OF THIRD ST., W. SIDE	12	110266	1/1/0001								
05800	S	M	SOH	II	00211	021		12	110266	1/1/0001								
05800	S	M	SOH	II	00223	024		12	020920	1/1/0001								
05800	S	M	SOH	II	00243	022		12	110266	1/1/0001								
05800	S	M	SOH	II	00314	002		12	110964	1/1/0001								
OFFICE: 311		ROUTE: 564		ST_REF_NO: 00000152390		RADCLIFFE COURT		LUMENS	BULB TYPE	MULT SERIES	POLE TYPE	SHADE	ADDRESS NUMBER	REF	LOCATION	TAX DIST	DATE INST	DATE CHANGE
05800	S	M	OUG	II	01905	000		12	120266	1/1/0001								
05800	S	M	OUG	II	01912	000		12	060468	1/1/0001								
OFFICE: 311		ROUTE: 564		ST_REF_NO: 00000152400		RADCLIFFE ROAD		LUMENS	BULB TYPE	MULT SERIES	POLE TYPE	SHADE	ADDRESS NUMBER	REF	LOCATION	TAX DIST	DATE INST	DATE CHANGE
05800	S	M	OUG	II	00000	001	SIDE OF 1730 RUSSELL CAVE RD.	12	030166	1/1/0001								

OFFICE: 311

ROUTE: 564

ST_REF_NO: 00000152400

RADCLIFFE ROAD

LUMENS	BULB TYPE	MULT SERIES	POLE TYPE	SHADE	ADDRESS NUMBER	REF	LOCATION	TAX DIST	DATE INST	DATE CHANGE
05800	S	M	OUG	II	00000	002	SIDE OF 1734 CAMERON CT.	12	030166	1/1/0001
05800	S	M	OUG	II	00000	035	SIDE OF 1864 RUSSELL CAVE RD.	12	120266	1/1/0001
05800	S	M	OUG	II	00000	041	SIDE OF 1913 RADCLIFFE CT.	12	100169	1/1/0001
05800	S	M	OUG	II	00000	043	SIDE OF 1910 LINTON RD.	12	120266	1/1/0001
05800	S	M	OUG	II	00000	068	OPP. 407	12	060468	1/1/0001
05800	S	M	OUG	II	00208	000		12	120167	1/1/0001
05800	S	M	OUG	II	00221	000		12	120266	1/1/0001
05800	S	M	OUG	II	00232	000		12	060468	1/1/0001
05800	S	M	OUG	II	00245	000		12	060870	1/1/0001
05800	S	M	OUG	II	00252	000		12	042067	1/1/0001
05800	S	M	OUG	II	00280	000		12	100169	1/1/0001
05800	S	M	OUG	II	00308	000		12	060468	1/1/0001
05800	S	M	OUG	II	00317	000		12	120167	1/1/0001
05800	S	M	OUG	II	00332	000		12	031372	1/1/0001
05800	S	M	OUG	II	00343	000		12	100169	1/1/0001
05800	S	M	OUG	II	00356	000		12	100169	1/1/0001
05800	S	M	OUG	II	00368	000		12	100169	1/1/0001
05800	S	M	OUG	II	00380	000		12	100169	1/1/0001
05800	S	M	OUG	II	00395	000		12	102367	1/1/0001
05800	S	M	OUG	II	00419	000		12	031372	1/1/0001
05800	S	M	OUG	II	00505	000		12	100169	1/1/0001
05800	S	M	OUG	II	00529	000		12	040166	1/1/0001
05800	S	M	OUG	II	00538	000		12	040166	1/1/0001
05800	S	M	OUG	II	00545	000		12	040166	1/1/0001
05800	S	M	OUG	II	00562	000		12	040166	1/1/0001
05800	S	M	OUG	II	00565	000		12	040166	1/1/0001
05800	S	M	OUG	II	00582	000		12	040166	1/1/0001
05800	S	M	OUG	II	00589	000		12	042067	1/1/0001
05800	S	M	OUG	II	00606	000		12	040166	1/1/0001
05800	S	M	OUG	II	00617	000		12	101267	1/1/0001
05800	S	M	OUG	II	00641	000		12	040166	1/1/0001

OFFICE: 311		ROUTE: 564		ST_REF_NO: 00000152450		RAEFORD LANE		LUMENS	BULB TYPE	MULT SERIES	POLE TYPE	SHADE	ADDRESS NUMBER	REF	LOCATION	TAX DIST	DATE INST	DATE CHANGE
05800	S	M	CNT	II	00000	002	SIDE OF 3112 CHADBOURNE LN ON RAEFORD LN	12	033006									1/1/0001
05800	S	M	CNT	II	00000	005	SIDE OF 1209 JEKYLL DR ON RAEFORD LN	12	033006									1/1/0001
05800	S	M	CNT	II	01200	001		12	033006									1/1/0001
05800	S	M	CNT	II	01216	003		12	033006									1/1/0001
05800	S	M	CNT	II	01225	004		12	033006									1/1/0001
05800	S	M	CNT	III	01245	006		12	033006									1/1/0001

OFFICE: 311 ROUTE: 564
ST_REF_NO: 00000152500 RAIN COURT

LUMENS	BULB TYPE	MULT SERIES	POLE TYPE	SHADE	ADDRESS NUMBER	REF	LOCATION	TAX DIST	DATE INST	DATE CHANGE
04000	S	M	OUG	II	00000	112	SIDE OF 3204 COOL WATER ON RAIN COURT	12	011584	1/1/0001
04000	S	M	OUG	V	01001	110		12	021582	1/1/0001
04000	S	M	OUG	II	01008	111		12	101581	1/1/0001

OFFICE: 311 ROUTE: 564
ST_REF_NO: 00000152520 RAIN GARDEN WAY

LUMENS	BULB TYPE	MULT SERIES	POLE TYPE	SHADE	ADDRESS NUMBER	REF	LOCATION	TAX DIST	DATE INST	DATE CHANGE
05800	S		OUG	II	00000	001	SIDE OF 912 TRAMMELL AVE, ON RAIN GARDEN WAY	12	071213	1/1/0001
05800	S		OUG	II	00501	002		12	071213	1/1/0001
05800	S		OUG	II	00504	003		12	071213	1/1/0001
05800	S		OUG	II	00509	004		12	071213	1/1/0001
05800	S		OUG	II	00516	005		12	071213	1/1/0001
05800	S		OUG	II	00521	006		12	071213	1/1/0001

OFFICE: 311 ROUTE: 564
ST_REF_NO: 00000152600 RAINBOW ROAD

LUMENS	BULB TYPE	MULT SERIES	POLE TYPE	SHADE	ADDRESS NUMBER	REF	LOCATION	TAX DIST	DATE INST	DATE CHANGE
04000	S	M	OUG	II	00000	001	SIDE OF 140 SOUTHLAND DR.	12	100889	1/1/0001
05800	S	M	OUG	II	02010	002		12	100889	1/1/0001
04000	S	M	OUG	II	02027	003		12	100889	1/1/0001
04000	S	M	OUG	II	02034	004		12	100889	1/1/0001
04000	S	M	OUG	II	02051	005		12	100889	1/1/0001
04000	S	M	OUG	II	02058	006		12	100889	1/1/0001
04000	S	M	OUG	II	02075	007		12	100889	1/1/0001

OFFICE: 311

ROUTE: 564

ST_REF_NO: 00000152600 RAINBOW ROAD

LUMENS	BULB TYPE	MULT SERIES	POLE TYPE	SHADE	ADDRESS NUMBER	REF	LOCATION	TAX DIST	DATE INST	DATE CHANGE
05800	S	M	OUG	V	02091	000		12	080171	1/1/0001

OFFICE: 311

ROUTE: 564

ST_REF_NO: 00000152700 RAINTREE ROAD

LUMENS	BULB TYPE	MULT SERIES	POLE TYPE	SHADE	ADDRESS NUMBER	REF	LOCATION	TAX DIST	DATE INST	DATE CHANGE
05800	S	M	OUG	II	00000	039	SIDE OF 1817 BIMINI RD.	12	070863	1/1/0001
05800	S	M	OUG	II	00000	040	SIDE OF 1812 BIMINI RD.	12	070863	1/1/0001
05800	S	M	OUG	II	00609	038		12	070863	1/1/0001
05800	S	M	OUG	II	00000	009	SIDE OF 729 OLD DOBBIN RD.	12	070863	1/1/0001
05800	S	M	OUG	II	00000	044	SIDE OF 666 TATESWOOD DR.	12	041367	1/1/0001
05800	S	M	OUG	II	00624	045		12	081666	1/1/0001
05800	S	M	OUG	II	00636	043		12	081666	1/1/0001
05800	S	M	OUG	II	00643	042		12	041367	1/1/0001
05800	S	M	OUG	II	00648	041		12	081666	1/1/0001
05800	S	M	OUG	II	00655	011		12	081666	1/1/0001
05800	S	M	OUG	II	00752	010		12	070863	1/1/0001

OFFICE: 311

ROUTE: 564

ST_REF_NO: 00000152710 RAINWATER CIRCLE

LUMENS	BULB TYPE	MULT SERIES	POLE TYPE	SHADE	ADDRESS NUMBER	REF	LOCATION	TAX DIST	DATE INST	DATE CHANGE
05800	S	M	CNT	II	04101	001		12	080895	1/1/0001
05800	S	M	CNT	II	04108	002		12	080895	1/1/0001
05800	S	M	CNT	II	04109	003		12	080895	1/1/0001

OFFICE: 311

ROUTE: 564

ST_REF_NO: 00000152720 RAINWATER DRIVE

LUMENS	BULB TYPE	MULT SERIES	POLE TYPE	SHADE	ADDRESS NUMBER	REF	LOCATION	TAX DIST	DATE INST	DATE CHANGE
05800	S	M	CNT	II	00000	001	SIDE 4128 CLEARWATER WAY	12	080895	1/1/0001
05800	S	M	CNT	II	00000	004	SIDE 4101 RAINWATER CIRCLE	12	080895	1/1/0001
05800	S	M	CNT	II	00704	002		12	080895	1/1/0001
05800	S	M	CNT	II	00725	003		12	080895	1/1/0001
05800	S	M	CNT	II	00741	005		12	080895	1/1/0001
05800	S	M	CNT	II	00756	006		12	080895	1/1/0001
05800	S	M	CNT	II	00760	008		12	080895	1/1/0001

OFFICE: 311		ROUTE: 564		ST_REF_NO: 00000152720		RAINWATER DRIVE				
LUMENS	BULB TYPE	MULT SERIES	POLE TYPE	SHADE	ADDRESS NUMBER	REF	LOCATION	TAX DIST	DATE INST	DATE CHANGE
05800	S	M	CNT	II	00765	007		12	080895	1/1/0001
05800	S	M	CNT	II	00781	009		12	080895	1/1/0001
OFFICE: 311		ROUTE: 564		ST_REF_NO: 00000152800		RALEIGH COURT				
LUMENS	BULB TYPE	MULT SERIES	POLE TYPE	SHADE	ADDRESS NUMBER	REF	LOCATION	TAX DIST	DATE INST	DATE CHANGE
05800	S	M	OUG	II	01503	120		12	090866	1/1/0001
05800	S	M	OUG	II	01510	119		12	090866	1/1/0001
OFFICE: 311		ROUTE: 564		ST_REF_NO: 00000152900		RALEIGH ROAD				
LUMENS	BULB TYPE	MULT SERIES	POLE TYPE	SHADE	ADDRESS NUMBER	REF	LOCATION	TAX DIST	DATE INST	DATE CHANGE
05800	S	M	OUG	II	00000	037	SIDE OF 1710	12	100466	1/1/0001
05800	S	M	OUG	II	01703	036		12	081265	1/1/0001
05800	S	M	OUG	II	00000	002	SIDE REAR OF 1698 KILKINNEY DR.	12	100466	1/1/0001
05800	S	M	OUG	II	00000	030	SIDE OF 727 HI CREST DR.	12	100466	1/1/0001
05800	S	M	OUG	II	01746	029		12	100466	1/1/0001
05800	S	M	OUG	II	01754	001		12	100466	1/1/0001
05800	S	M	OUG	II	01782	003		12	100466	1/1/0001
05800	S	M	OUG	II	01791	004		12	100466	1/1/0001
05800	S	M	OUG	II	01804	014		12	051167	1/1/0001
05800	S	M	OUG	II	01819	015		12	070767	1/1/0001
05800	S	M	OUG	II	01836	016		12	051167	1/1/0001
05800	S	M	OUG	II	00000	046	1ST LT. S. OF AUGUSTA CT., W. SIDE	12	060162	1/1/0001
05800	S	M	OUG	II	01601	038		12	060162	1/1/0001
05800	S	M	OUG	II	01606	039		12	060162	1/1/0001
05800	S	M	OUG	II	01609	040		12	060162	1/1/0001
05800	S	M	OUG	II	01614	041		12	060162	1/1/0001
05800	S	M	OUG	II	01616	042		12	060162	1/1/0001
05800	S	M	OUG	II	01624	044		12	021565	1/1/0001
05800	S	M	OUG	II	01625	043		12	060162	1/1/0001
05800	S	M	OUG	II	01631	045		12	021565	1/1/0001
05800	S	M	OUG	II	01635	047		12	060162	1/1/0001
05800	S	M	OUG	II	01722	035		12	081265	1/1/0001

OFFICE: 311		ROUTE: 564		ST_REF_NO: 00000153000		RAMBLER ROAD		LUMENS	BULB TYPE	MULT SERIES	POLE TYPE	SHADE	ADDRESS NUMBER	REF	LOCATION	TAX DIST	DATE INST	DATE CHANGE
05800	S	M	OUG	II	00000	010	SIDE OF 216 SOUTHLAND DR..	12	020369	1/1/0001								
05800	S	M	OUG	II	02031	000		12	100768	1/1/0001								
05800	S	M	OUG	II	02038	000		12	010270	1/1/0001								
05800	S	M	OUG	II	02051	000		12	100768	1/1/0001								
05800	S	M	OUG	II	02058	000		12	100768	1/1/0001								
05800	S	M	OUG	II	02075	000		12	100768	1/1/0001								
05800	S	M	OUG	II	02082	000		12	100768	1/1/0001								
05800	S	M	OUG	II	02099	000		12	100268	1/1/0001								
OFFICE: 311		ROUTE: 564		ST_REF_NO: 00000153025		RAMBLEWOOD WAY		LUMENS	BULB TYPE	MULT SERIES	POLE TYPE	SHADE	ADDRESS NUMBER	REF	LOCATION	TAX DIST	DATE INST	DATE CHANGE
05800	S	M	CNT	II	00000	001	SIDE 3568 INDIAN SUMMER TRAIL	12	060895	1/1/0001								
05800	S	M	CNT	II	00000	005	SIDE 3712 SEDONA VISTA	12	060895	1/1/0001								
05800	S	M	CNT	II	01048	006		12	070895	1/1/0001								
05800	S	M	CNT	II	01072	004		12	060895	1/1/0001								
05800	S	M	CNT	II	01077	003		12	060895	1/1/0001								
05800	S	M	CNT	II	01092	002		12	060895	1/1/0001								
OFFICE: 311		ROUTE: 564		ST_REF_NO: 00000153050		RAMBLING CREEK DRIVE		LUMENS	BULB TYPE	MULT SERIES	POLE TYPE	SHADE	ADDRESS NUMBER	REF	LOCATION	TAX DIST	DATE INST	DATE CHANGE
05800	S	M	OUG	II	00000	008	SIDE OF 748 NICKWOOD TRAIL ON RAMBLING CREEK	12	091001	1/1/0001								
05800	S	M	OUG	II	00713	007		12	091001	1/1/0001								
05800	S	M	OUG	II	00724	006		12	091001	1/1/0001								
05800	S	M	OUG	II	00745	005		12	091001	1/1/0001								
05800	S	M	OUG	II	00756	004		12	100899	1/1/0001								
05800	S	M	OUG	II	00760	003		12	100899	1/1/0001								
05800	S	M	OUG	II	00781	002		12	100899	1/1/0001								
05800	S	M	OUG	II	00796	001		12	100899	1/1/0001								

OFFICE: 311		ROUTE: 564		ST_REF_NO: 00000153100		RAMSGATE COURT		LUMENS	BULB TYPE	MULT SERIES	POLE TYPE	SHADE	ADDRESS NUMBER	REF	LOCATION	TAX DIST	DATE INST	DATE CHANGE
05800	S	M	OUG	II	03517	062	upgrade due to bad fixture	12	110885	9/1/2008								
04000	S	M	OUG	II	00000	063	SIDE OF 616 CROMWELL WAY	12	110885	1/1/0001								
OFFICE: 311		ROUTE: 564		ST_REF_NO: 00000153200		RAND AVENUE		LUMENS	BULB TYPE	MULT SERIES	POLE TYPE	SHADE	ADDRESS NUMBER	REF	LOCATION	TAX DIST	DATE INST	DATE CHANGE
09500	S	M	SOH	I	00255	011		12	120162	12/13/2013								
05800	S	M	SOH	I	00000	006	OPP. 203	12	120162	1/1/0001								
05800	S	M	SOH	I	00000	012	SIDEWALK BETWEEN RAND & ELM	12	011865	1/1/0001								
05800	S	M	SOH	I	00112	001		12	120162	1/1/0001								
05800	S	M	SOH	I	00122	002		12	120162	1/1/0001								
05800	S	M	SOH	I	00129	003		12	120162	1/1/0001								
05800	S	M	SOH	I	00145	004		12	120162	1/1/0001								
05800	S	M	SOH	I	00155	005		12	120162	1/1/0001								
05800	S	M	SOH	I	00212	007		12	120162	1/1/0001								
05800	S	M	SOH	I	00222	008		12	120162	1/1/0001								
05800	S	M	SOH	I	00230	009		12	120162	1/1/0001								
05800	S	M	SOH	I	00242	010		12	120162	1/1/0001								
OFFICE: 311		ROUTE: 564		ST_REF_NO: 00000153300		RANDOLPH COURT		LUMENS	BULB TYPE	MULT SERIES	POLE TYPE	SHADE	ADDRESS NUMBER	REF	LOCATION	TAX DIST	DATE INST	DATE CHANGE
05800	S	M	OUG	II	02385	073		12	021580	1/1/0001								
05800	S	M	OUG	II	02398	000		12	080166	1/1/0001								
OFFICE: 311		ROUTE: 564		ST_REF_NO: 00000153400		RANGE COURT		LUMENS	BULB TYPE	MULT SERIES	POLE TYPE	SHADE	ADDRESS NUMBER	REF	LOCATION	TAX DIST	DATE INST	DATE CHANGE
05800	S	M	OUG	II	00000	108	SIDE OF 677 ANNISTON DR	12	010166	1/1/0001								
05800	S	M	OUG	II	02006	109		12	010166	1/1/0001								
OFFICE: 311		ROUTE: 564		ST_REF_NO: 00000153500		RANIER DRIVE		LUMENS	BULB TYPE	MULT SERIES	POLE TYPE	SHADE	ADDRESS NUMBER	REF	LOCATION	TAX DIST	DATE INST	DATE CHANGE
04000	S	M	OUG	II	00000	001	SIDE OF 319 EASTIN RD.	12	010888	1/1/0001								

OFFICE: 311		ROUTE: 564		ST_REF_NO: 00000153500		RANIER DRIVE		LUMENS	BULB TYPE	MULT SERIES	POLE TYPE	SHADE	ADDRESS NUMBER	REF	LOCATION	TAX DIST	DATE INST	DATE CHANGE
	04000	S	M	OUG	II	01809	002									12	010888	1/1/0001
	04000	S	M	OUG	II	01821	003									12	010888	1/1/0001
	04000	S	M	OUG	II	01829	004									12	010888	1/1/0001

OFFICE: 311		ROUTE: 564		ST_REF_NO: 00000153600		RANSOM AVENUE		LUMENS	BULB TYPE	MULT SERIES	POLE TYPE	SHADE	ADDRESS NUMBER	REF	LOCATION	TAX DIST	DATE INST	DATE CHANGE
	05800	S	M	SOH	II	00000	549								SIDE OF 453 E. HIGH	12	021965	1/1/0001
	05800	S	M	SOH	II	00000	553								NW CORNER OF VINE	12	062167	1/1/0001
	05800	S	M	SOH	II	00000	554								2ND LT. N. OF VINE, E. SIDE	12	062167	1/1/0001
	05800	S	M	SOH	II	00000	555								1ST LT. S. OF MAIN	12	062167	1/1/0001
	05800	S	M	SOH	II	00128	552									12	062167	1/1/0001
	05800	S	M	SOH	II	00137	551									12	062167	1/1/0001
	05800	S	M	SOH	II	00162	550									12	020466	1/1/0001

OFFICE: 311		ROUTE: 564		ST_REF_NO: 00000153650		RAPID RUN DRIVE		LUMENS	BULB TYPE	MULT SERIES	POLE TYPE	SHADE	ADDRESS NUMBER	REF	LOCATION	TAX DIST	DATE INST	DATE CHANGE
	09500	S	M	OUG	II	00000	091								1ST LT. SOUTH OF MAN-O-WAR BLVD., EASTSIDE	12	100892	1/1/0001
	09500	S	M	OUG	II	00000	092								2ND LT. SOUTH OF MAN-O-WAR BLVD., EASTSIDE	12	100892	1/1/0001
	09500	S	M	OUG	II	00000	093								3RD LT. SOUTH OF MAN-O-WAR BLVD., EASTSIDE	12	100892	1/1/0001
	09500	S	M	OUG	II	00000	095								SIDE OF 4624 HARTLAND PKY	12	010894	1/1/0001
	05800	S	M	OUG	II	03801	088									12	121581	1/1/0001
	05800	S	M	OUG	II	03808	089									12	011581	1/1/0001
	05800	S	M	OUG	II	03813	090									12	011581	1/1/0001
	09500	S	M	OUG	II	03977	094									12	010894	1/1/0001

OFFICE: 311		ROUTE: 564		ST_REF_NO: 00000153810		RAVENNA LANE		LUMENS	BULB TYPE	MULT SERIES	POLE TYPE	SHADE	ADDRESS NUMBER	REF	LOCATION	TAX DIST	DATE INST	DATE CHANGE
	05800	S	M	CNT	II	00500	001									12	110207	1/1/0001
	05800	S	M	CNT	II	00508	002									12	110207	1/1/0001
	05800	S	M	CNT	II	00520	003									12	110207	1/1/0001

OFFICE: 311		ROUTE: 564		ST_REF_NO: 00000153820		RAWLINGS COURT		LUMENS	BULB TYPE	MULT SERIES	POLE TYPE	SHADE	ADDRESS NUMBER	REF	LOCATION	TAX DIST	DATE INST	DATE CHANGE
05800	S	M	OUG	II	02200	001										12	020801	1/1/0001
05800	S	M	OUG	III	02216	002										12	020801	1/1/0001

OFFICE: 311		ROUTE: 564		ST_REF_NO: 00000154000		REBECCA ROAD		LUMENS	BULB TYPE	MULT SERIES	POLE TYPE	SHADE	ADDRESS NUMBER	REF	LOCATION	TAX DIST	DATE INST	DATE CHANGE
04000	S	M	OUG	II	00761	009										12	050888	1/1/0001
04000	S	M	OUG	II	00769	008										12	050888	1/1/0001
04000	S	M	OUG	II	00778	007										12	050888	1/1/0001
04000	S	M	OUG	II	00000	001	SIDE OF 2995 TATES CREEK RD.									12	050888	1/1/0001
04000	S	M	OUG	II	00000	002	SIDE OF 3005 TATES CREEK RD.									12	050888	1/1/0001
04000	S	M	OUG	II	00790	006										12	050888	1/1/0001
04000	S	M	OUG	II	00842	005										12	050888	1/1/0001
04000	S	M	OUG	II	00862	004										12	050888	1/1/0001
04000	S	M	OUG	II	00881	003										12	050888	1/1/0001

OFFICE: 311		ROUTE: 564		ST_REF_NO: 00000154100		REBEL ROAD		LUMENS	BULB TYPE	MULT SERIES	POLE TYPE	SHADE	ADDRESS NUMBER	REF	LOCATION	TAX DIST	DATE INST	DATE CHANGE
05800	S	M	OUG	II	00000	001	SIDE OF 132 SOUTHLAND RR									12	051066	1/1/0001
05800	S	M	OUG	II	02012	002										12	051066	1/1/0001
05800	S	M	OUG	II	02025	003										12	051066	1/1/0001
05800	S	M	OUG	II	02032	004										12	051066	1/1/0001
05800	S	M	OUG	II	02053	005										12	051066	1/1/0001
05800	S	M	OUG	II	02056	006										12	051066	1/1/0001
05800	S	M	OUG	V	02081	007										12	080896	1/1/0001

OFFICE: 311		ROUTE: 564		ST_REF_NO: 00000154150		RED CEDER COURT		LUMENS	BULB TYPE	MULT SERIES	POLE TYPE	SHADE	ADDRESS NUMBER	REF	LOCATION	TAX DIST	DATE INST	DATE CHANGE
05800	S	M	CNT	III	00105	001										12	091001	1/1/0001

OFFICE: 311

ROUTE: 564

ST_REF_NO: 00000154160

RED CLOVER LANE

LUMENS	BULB TYPE	MULT SERIES	POLE TYPE	SHADE	ADDRESS NUMBER	REF	LOCATION	TAX DIST	DATE INST	DATE CHANGE
05800	S		CNT	II	00000	010	SIDE OF 1401 DAY LILY DR ON RED CLOVER LN	12	102908	1/1/0001
05800	S		CNT	II	02701	001		12	102908	1/1/0001
05800	S		CNT	II	02716	002		12	102908	1/1/0001
05800	S		CNT	II	02736	003		12	102908	1/1/0001
05800	S		CNT	II	02748	004		12	102908	1/1/0001
05800	S		CNT	II	02761	005		12	102908	1/1/0001
05800	S		CNT	II	02764	006		12	102908	1/1/0001
05800	S		CNT	II	02780	007		12	102908	1/1/0001
05800	S		CNT	II	02797	008		12	102908	1/1/0001
05800	S		CNT	II	02813	009		12	102908	1/1/0001

OFFICE: 311

ROUTE: 564

ST_REF_NO: 00000154179

RED LEAF COURT

LUMENS	BULB TYPE	MULT SERIES	POLE TYPE	SHADE	ADDRESS NUMBER	REF	LOCATION	TAX DIST	DATE INST	DATE CHANGE
09500	S		CLN	II	00804	003		12	051609	1/1/0001
09500	S		CLN	II	00809	002		12	051609	1/1/0001
09500	S		CLN	II	00000	001	SIDE OF 2660 RED LEAF DR ON RED LEAF CT	12	051609	5/16/2009

OFFICE: 311

ROUTE: 564

ST_REF_NO: 00000154180

RED LEAF DRIVE

LUMENS	BULB TYPE	MULT SERIES	POLE TYPE	SHADE	ADDRESS NUMBER	REF	LOCATION	TAX DIST	DATE INST	DATE CHANGE
09500	S		CLN	II	00000	001	ACROSS FROM 2605 RED LEAF DR	12	051609	1/1/0001
09500	S		CLN	II	00000	003	ACROSS FROM 2621 RED LEAF DRIVE	12	051609	1/1/0001
09500	S		CLN	II	00000	009	SIDE OF 812 RED LEAF CT, ON RED LEAF DR	12	051609	1/1/0001
09500	S		CLN	II	00000	011	SIDE OF 828 GUNPOWDER, ON RED LEAF DR	12	051609	1/1/0001
09500	S		CLN	II	00000	022	ACROSS FROM 2776 RED LEAF DR	12	051609	1/1/0001
09500	S		CLN	II	00000	024	ACROSS FROM 2784 RED LEAF DR	12	051609	1/1/0001
09500	S		CLN	II	00000	026	ACROSS FROM 2792 RED LEAF DR	12	051609	1/1/0001
09500	S		CLN	II	00000	028	ACROSS FROM 2812 RED LEAF DR	12	051609	1/1/0001
09500	S		CLN	II	00000	029	SIDE OF 800 AMALFI LANE, ON RED LEAF DR	12	051609	1/1/0001
09500	S		CLN	II	00000	030	ACROSS FROM 2812 AMALFI LANE, ON RED LEAF DR	12	051609	1/1/0001
09500	S		CLN	II	02629	004		12	051609	1/1/0001
09500	S		CLN	II	02640	005		12	051609	1/1/0001
09500	S		CLN	II	02645	006		12	051609	1/1/0001

OFFICE: 311

ROUTE: 564

ST_REF_NO: 00000154180

RED LEAF DRIVE

LUMENS	BULB TYPE	MULT SERIES	POLE TYPE	SHADE	ADDRESS NUMBER	REF	LOCATION	TAX DIST	DATE INST	DATE CHANGE
09500	S		CLN	II	02652	007		12	051609	1/1/0001
09500	S		CLN	II	02661	008		12	051609	1/1/0001
09500	S		CLN	II	02677	010		12	051609	1/1/0001
09500	S		CLN	II	02689	012		12	051609	1/1/0001
09500	S		CLN	II	02696	013		12	051609	1/1/0001
09500	S		CLN	II	02709	014		12	051609	1/1/0001
09500	S		CLN	II	02716	015		12	051609	1/1/0001
09500	S		CLN	II	02725	016		12	051609	1/1/0001
09500	S		CLN	II	02732	017		12	051609	1/1/0001
09500	S		CLN	II	02737	018		12	051609	1/1/0001
09500	S		CLN	II	02768	021		12	051609	1/1/0001
09500	S		CLN	II	02780	023		12	051609	1/1/0001
09500	S		CLN	II	02804	027		12	051609	1/1/0001
09500	S		CLN	II	00000	019	SIDE OF 800 GUNPOWDER	12	051609	5/16/2009
09500	S		CLN	II	00000	020	ACROSS FROM 2760 RED LEAF DRIVE	12	051609	5/16/2009
09500	S		CLN	II	02609	002		12	051609	5/16/2009
09500	S		CLN	II	02796	025		12	051609	5/16/2009

OFFICE: 311

ROUTE: 564

ST_REF_NO: 00000154195

RED MILE PLACE

LUMENS	BULB TYPE	MULT SERIES	POLE TYPE	SHADE	ADDRESS NUMBER	REF	LOCATION	TAX DIST	DATE INST	DATE CHANGE
09500	S	M	OUG	II	00000	001	1ST LT W OF RED MILE RD, NORTH SIDE ON RED MILE PL	12	052003	1/1/0001
09500	S	M	OUG	II	00000	002	2ND LT W OF RED MILE RD, NORTH SIDE ON RED MILE PL	12	052003	1/1/0001
09500	S	M	OUG	II	00000	003	3RD LT W OF RED MILE RD, NORTH SIDE ON RED MILE PL	12	052003	1/1/0001

OFFICE: 311

ROUTE: 564

ST_REF_NO: 00000154200

RED MILE ROAD

LUMENS	BULB TYPE	MULT SERIES	POLE TYPE	SHADE	ADDRESS NUMBER	REF	LOCATION	TAX DIST	DATE INST	DATE CHANGE
50000	S	M	OUG	II	00000	001	1ST. LT. W. OF BROADWAY, S. SIDE	12	041478	12/4/2009
50000	S	M	OUG	II	00000	066	1ST. LT. FROM VERSAILLES RD.	12	041578	11/4/2009
22000	S	M	OUG	II	00000	002	1ST. LT. W. OF BROADWAY, N. SIDE	12	041478	1/1/0001
22000	S	M	OUG	II	00000	003	2ND. LT. W. OF BROADWAY, S. SIDE	12	041478	1/1/0001

OFFICE: 311

ROUTE: 564

ST_REF_NO: 00000154200

RED MILE ROAD

LUMENS	BULB TYPE	MULT SERIES	POLE TYPE	SHADE	ADDRESS NUMBER	REF	LOCATION	TAX DIST	DATE INST	DATE CHANGE
22000	S	M	OUG	II	00000	004	2ND. LT. W. OF BROADWAY, N. SIDE	12	041478	1/1/0001
22000	S	M	OUG	II	00000	005	3RD. LT. W. OF BROADWAY, S. SIDE	12	041478	1/1/0001
22000	S	M	OUG	II	00000	006	3RD. LT W. OF BROADWAY, N. SIDE	12	041478	1/1/0001
22000	S	M	OUG	II	00000	007	4TH LT. W. OF BROADWAY, S. SIDE	12	041478	1/1/0001
22000	S	M	OUG	II	00000	008	4TH LT. W. OF BROADWAY, N. SIDE	12	041478	1/1/0001
22000	S	M	OUG	II	00000	009	5TH. LT. W. OF BROADWAY, S. SIDE	12	041478	1/1/0001
22000	S	M	OUG	II	00000	010	5TH. LT. W. OF BROADWAY, N. SIDE	12	041478	1/1/0001
22000	S	M	OUG	II	00000	011	6TH LT. W. OF BROADWAY, S. SIDE	12	041478	1/1/0001
22000	S	M	OUG	II	00000	012	6TH. LT. W. OF BROADWAY, N. SIDE(AT NELMS AVE.)	12	041478	1/1/0001
22000	S	M	OUG	II	00000	013	7TH. LT. W. OF BRAODWAY, S. SIDE	12	041478	1/1/0001
22000	S	M	OUG	II	00000	014	7TH. LT. W. OF BROADWAY, N. SIDE	12	041478	1/1/0001
22000	S	M	OUG	II	00000	015	8TH. LT. W. OF BROADWAY, S. SIDE	12	041478	1/1/0001
22000	S	M	OUG	II	00000	016	8TH LT. W. OF BROADWAY, N. SIDE	12	041478	1/1/0001
22000	S	M	OUG	II	00000	017	9TH. LT. W. OF BROADWAY, S. SIDE	12	041478	1/1/0001
22000	S	M	OUG	II	00000	018	9TH LT. W. OF BROADWAY, N. SIDE	12	041478	1/1/0001
22000	S	M	OUG	II	00000	019	10TH. LT. W. OF BROADWAY, S. SIDE	12	041478	1/1/0001
22000	S	M	OUG	II	00000	020	10TH. LT. W. OF BROADWAY, N. SIDE	12	041478	1/1/0001
22000	S	M	OUG	II	00000	021	11TH. LT. W. OF BROADWAY, S. SIDE	12	041478	1/1/0001
22000	S	M	OUG	II	00000	022	11TH. LT. W. OF BROADWAY, N. SIDE	12	041478	1/1/0001
22000	S	M	OUG	II	00000	023	12TH. LT. W. OF BROADWAY, S. SIDE	12	041478	1/1/0001
22000	S	M	OUG	II	00000	024	12TH. LT. W. OF BROADWAY, N. SIDE	12	041478	1/1/0001
22000	S	M	OUG	II	00000	025	13TH. LT. W. OF BROADWAY, S. SIDE	12	041478	1/1/0001
22000	S	M	OUG	II	00000	026	13TH. LT. W. OF BROADWAY, N. SIDE	12	041478	1/1/0001
22000	S	M	OUG	II	00000	027	14TH. LT. W. OF BROADWAY, S. SIDE	12	041478	1/1/0001
22000	S	M	OUG	II	00000	028	14TH. LT. W. OF BROADWAY, N. SIDE	12	041478	1/1/0001
22000	S	M	OUG	II	00000	029	15TH. LT. W. OF BROADWAY, S. SIDE (OPP. ENTRANCE)	12	041478	1/1/0001
22000	S	M	OUG	II	00000	030	15TH. LT. W. OF BROADWAY, N. SIDE (AT ENTRANCE)	12	041478	1/1/0001
22000	S	M	OUG	II	00000	031	16TH. LT. W. OF BROADWAY, S. SIDE	12	041478	1/1/0001
22000	S	M	OUG	II	00000	032	16TH. LT. W. OF BROADWAY, N. SIDE	12	041478	1/1/0001
22000	S	M	OUG	II	00000	033	17TH. LT. W. OF BROADWAY, LAST LT. S. SIDE	12	041478	1/1/0001
22000	S	M	OUG	II	00000	034	17TH. LT. W. OF BROADWAY, N. SIDE	12	041478	1/1/0001

OFFICE: 311

ROUTE: 564

ST_REF_NO: 00000154200

RED MILE ROAD

LUMENS	BULB TYPE	MULT SERIES	POLE TYPE	SHADE	ADDRESS NUMBER	REF	LOCATION	TAX DIST	DATE INST	DATE CHANGE
22000	S	M	OUG	II	00000	035	18TH. LT. W. OF BROADWAY, N. SIDE (4 LANE ENDS)	12	041478	1/1/0001
22000	S	M	OUG	II	00000	036	19TH. LT. W. OF BROADWAY, N. SIDE	12	041478	1/1/0001
22000	S	M	OUG	II	00000	037	20TH. LT. W. OF BROADWAY, N. SIDE	12	041478	1/1/0001
22000	S	M	OUG	II	00000	038	21ST. LT. W. OF BROADWAY, N. SIDE	12	041478	1/1/0001
22000	S	M	OUG	II	00000	039	22ND. LT. W. OF BROADWAY, N. SIDE	12	041478	1/1/0001
22000	S	M	OUG	II	00000	040	23RD. LT. W. OF BROADWAY, N. SIDE	12	041478	1/1/0001
22000	S	M	OUG	II	00000	041	24TH. LT. W. OF BROADWAY, S. SIDE	12	041478	1/1/0001
22000	S	M	OUG	II	00000	042	25TH. LT. FROM VERSAILLES RD.	12	041478	1/1/0001
22000	S	M	OUG	II	00000	043	24TH. LT. FROM VERSAILLES RD.	12	041478	1/1/0001
22000	S	M	OUG	II	00000	044	23RD. LT. FROM VERSAILLES RD.	12	041478	1/1/0001
22000	S	M	OUG	II	00000	045	22ND. LT. FROM VERSAILLES RD.	12	041478	1/1/0001
22000	S	M	OUG	II	00000	046	21ST. LT. FROM VERSAILLES RD.	12	041478	1/1/0001
22000	S	M	OUG	II	00000	047	20TH. LT. FROM VERSAILLES RD.	12	041478	1/1/0001
22000	S	M	OUG	II	00000	048	19TH. LT. FROM VERSAILLES RD.	12	041478	1/1/0001
22000	S	M	OUG	II	00000	049	18TH. LT. FROM VERSAILLES RD.	12	041478	1/1/0001
22000	S	M	OUG	II	00000	050	17TH. LT. FROM VERSAILLES RD.	12	041478	1/1/0001
22000	S	M	OUG	II	00000	051	16TH. LT. FROM VERSAILLES RD.	12	041478	1/1/0001
22000	S	M	OUG	II	00000	052	15TH. LT. FROM VERSAILLES RD.	12	041478	1/1/0001
22000	S	M	OUG	II	00000	053	14TH. LT. FROM VERSAILLES RD.	12	041478	1/1/0001
22000	S	M	OUG	II	00000	054	13TH. LT. FROM VERSAILLES RD.	12	041478	1/1/0001
22000	S	M	OUG	II	00000	055	12TH. LT. FROM VERSAILLES RD.	12	041478	1/1/0001
22000	S	M	OUG	II	00000	056	11TH. LT. FROM VERSAILLES RD.	12	041478	1/1/0001
22000	S	M	OUG	II	00000	057	10TH. LT. FROM VERSAILLES RD.	12	041478	1/1/0001
22000	S	M	OUG	II	00000	058	9TH. LT. FROM VERSAILLES RD.(AT NANCY HANKS)	12	041478	1/1/0001
22000	S	M	OUG	II	00000	059	8TH. LT. FROM VERSAILLES RD.	12	041478	1/1/0001
22000	S	M	OUG	II	00000	060	7TH. LT. FROM VERSAILLES RD.	12	041478	1/1/0001
22000	S	M	OUG	II	00000	061	6TH. LT. FROM VERSAILLES RD.	12	041478	1/1/0001
22000	S	M	OUG	II	00000	062	5TH. LT. FROM VERSAILLES RD.	12	041478	1/1/0001
22000	S	M	OUG	II	00000	063	4TH. LT. FROM VERSAILLES RD.	12	041478	1/1/0001
22000	S	M	OUG	II	00000	064	3RD. LT. FROM VERSAILLES RD.	12	041478	1/1/0001
22000	S	M	OUG	II	00000	065	2ND. LT. FROM VERSAILLES RD.	12	041478	1/1/0001

OFFICE: 311

ROUTE: 564

ST_REF_NO: 00000154290

RED RAIN CIRCLE

LUMENS	BULB TYPE	MULT SERIES	POLE TYPE	SHADE	ADDRESS NUMBER	REF	LOCATION	TAX DIST	DATE INST	DATE CHANGE
04000	S	M	OUG	II	01001	001		12	010890	1/1/0001
04000	S	M	OUG	V	01008	002		12	010890	1/1/0001

OFFICE: 311

ROUTE: 564

ST_REF_NO: 00000154300

RED RIVER DRIVE

LUMENS	BULB TYPE	MULT SERIES	POLE TYPE	SHADE	ADDRESS NUMBER	REF	LOCATION	TAX DIST	DATE INST	DATE CHANGE
05800	S	M	OUG	II	00000	054	SIDE OF 3725 NIAGARA DR.	12	022674	1/1/0001
05800	S	M	OUG	II	00000	066	SIDE OF 1234 TRENT BLVD.	12	011475	1/1/0001
05800	S	M	OUG	II	00000	075	OPP. FROM SIDE OF 3732	12	121475	1/1/0001
05800	S	M	OUG	II	00000	076	SIDE OF 1440 DALE DR.	12	021475	1/1/0001
05800	S	M	OUG	II	00000	077	OPP. 1343	12	111478	1/1/0001
05800	S	M	OUG	II	01351	076		12	091574	1/1/0001
05800	S	M	OUG	II	01362	075		12	111478	1/1/0001
05800	S	M	OUG	II	01375	074		12	091574	1/1/0001
05800	S	M	OUG	II	01390	073		12	011475	1/1/0001
05800	S	M	OUG	II	03679	064		12	041674	1/1/0001
05800	S	M	OUG	II	03694	065		12	041674	1/1/0001
05800	S	M	OUG	II	03708	072		12	021475	1/1/0001
05800	S	M	OUG	II	03725	073		12	071475	1/1/0001
05800	S	M	OUG	II	03732	074		12	021475	1/1/0001

OFFICE: 311

ROUTE: 564

ST_REF_NO: 00000154340

RED STONE DRIVE

LUMENS	BULB TYPE	MULT SERIES	POLE TYPE	SHADE	ADDRESS NUMBER	REF	LOCATION	TAX DIST	DATE INST	DATE CHANGE
05800	S	M	CNT	II	00000	001	SIDE OF 3160 GLENWOOD DRIVE	12	100896	1/1/0001
05800	S	M	CNT	II	00000	006	OPP. 1289	12	060897	1/1/0001
05800	S	M	CNT	II	00000	015	SIDE OF 1168 COLORADO DR.	12	070899	1/1/0001
05800	S	M	CNT	II	01165	014		12	020899	1/1/0001
05800	S	M	CNT	II	01180	013		12	060897	1/1/0001
05800	S	M	CNT	II	01193	012		12	060897	1/1/0001
05800	S	M	CNT	II	01208	011		12	060897	1/1/0001
05800	S	M	CNT	III	01221	010		12	060897	1/1/0001
05800	S	M	CNT	II	01241	009		12	060897	1/1/0001
05800	S	M	CNT	II	01256	008		12	060897	1/1/0001

OFFICE: 311		ROUTE: 564		ST_REF_NO: 00000154340		RED STONE DRIVE		LUMENS	BULB TYPE	MULT SERIES	POLE TYPE	SHADE	ADDRESS NUMBER	REF	LOCATION	TAX DIST	DATE INST	DATE CHANGE
05800	S	M	CNT	II	01273	007										12	060897	1/1/0001
05800	S	M	CNT	II	01309	002										12	100896	1/1/0001
05800	S	M	CNT	II	01328	003										12	100896	1/1/0001
05800	S	M	CNT	II	01329	004										12	100896	1/1/0001
05800	S	M	CNT	III	01353	005										12	100896	1/1/0001

OFFICE: 311		ROUTE: 564		ST_REF_NO: 00000154350		REDBERRY CIRCLE		LUMENS	BULB TYPE	MULT SERIES	POLE TYPE	SHADE	ADDRESS NUMBER	REF	LOCATION	TAX DIST	DATE INST	DATE CHANGE
04000	S	M	OUG	II	00900	001										12	100890	1/1/0001
04000	S	M	OUG	II	00904	002										12	100890	1/1/0001
04000	S	M	OUG	II	00916	003										12	100890	1/1/0001

OFFICE: 311		ROUTE: 564		ST_REF_NO: 00000154360		REDBUD COURT		LUMENS	BULB TYPE	MULT SERIES	POLE TYPE	SHADE	ADDRESS NUMBER	REF	LOCATION	TAX DIST	DATE INST	DATE CHANGE
05800	S	M	OUG	II	00000	001									SIDE OF 3061 WACO RD.	12	020895	1/1/0001
05800	S	M	OUG	II	03013	002										12	020895	1/1/0001
05800	S	M	OUG	IV	03029	003										12	020895	1/1/0001

OFFICE: 311		ROUTE: 564		ST_REF_NO: 00000154500		REDDING ROAD		LUMENS	BULB TYPE	MULT SERIES	POLE TYPE	SHADE	ADDRESS NUMBER	REF	LOCATION	TAX DIST	DATE INST	DATE CHANGE
09500	S	M	OUG	II	00300	023									SIDE OF 3472 LANSLOWNE DRIVE	12	060269	2/1/2013
05800	S	M	OUG	II	00000	001									8TH LT. W. OF SPANGLER, N. SIDE	12	071475	1/1/0001
04000	S	M	OUG	II	00000	024									SIDE OF 3471 ORMOND CIRCLE	12	060269	1/1/0001
22000	S	M	OUG	II	00000	032									SIDE OF 344 HIGHTOWER	12	010171	1/1/0001
22000	S	M	OUG	II	00000	033									FRONT OF LANSLOWNE ELEMENTARY	12	120667	1/1/0001
22000	S	M	OUG	II	00000	034									SIDE OF 3468 BELLEMEADE	12	022674	1/1/0001
09500	S	M	OUG	II	00000	048									OPP. 349	12	022674	1/1/0001
09500	S	M	OUG	II	00000	049									OPP. THE SIDE OF 3471 WARWICK CT.	12	022674	1/1/0001
04000	S	M	OUG	II	00305	022										12	060269	1/1/0001
09500	S	M	OUG	II	00348	050										12	051478	1/1/0001
09500	S	M	OUG	II	00364	060										12	051475	1/1/0001

OFFICE: 311

ROUTE: 564

ST_REF_NO: 00000154500

REDDING ROAD

LUMENS	BULB TYPE	MULT SERIES	POLE TYPE	SHADE	ADDRESS NUMBER	REF	LOCATION	TAX DIST	DATE INST	DATE CHANGE
09500	S	M	OUG	II	00365	051		12	051478	1/1/0001
05800	S	M	OUG	II	00376	063		12	121579	1/1/0001
05800	S	M	OUG	II	00377	061		12	051478	1/1/0001
05800	S	M	OUG	II	00384	065		12	121579	1/1/0001
05800	S	M	OUG	II	00385	062		12	051478	1/1/0001
05800	S	M	OUG	II	00385	064		12	051478	1/1/0001
05800	S	M	OUG	II	00000	002	7TH LT. W. OF SPANGLER, S. SIDE	12	071475	1/1/0001
05800	S	M	OUG	II	00000	003	6TH LT. W. OF SPANGLER, N. SIDE	12	071475	1/1/0001
05800	S	M	OUG	II	00000	004	5TH LT. W. OF SPANGLER, S. SIDE	12	071475	1/1/0001
05800	S	M	OUG	II	00000	005	4TH LT. W. OF SPANGLER, N. SIDE	12	071475	1/1/0001
05800	S	M	OUG	II	00000	006	3RD LT. W. OF SPANGLER, S. SIDE	12	071475	1/1/0001
05800	S	M	OUG	II	00000	007	2ND LT. W. OF SPANGLER, N. SIDE	12	071475	1/1/0001
05800	S	M	OUG	II	00000	008	1ST LT. W. OF SPANGLER, S. SIDE	12	071475	1/1/0001
05800	S	M	OUG	II	00400	018		12	071475	1/1/0001
05800	S	M	OUG	II	00400	020		12	071475	1/1/0001
05800	S	M	OUG	II	00401	019		12	121579	1/1/0001
05800	S	M	OUG	II	00401	021		12	121579	1/1/0001
05800	S	M	OUG	II	00000	011	11TH LT. W. OF TATES CREEK ON SOUTHSIDE	12	120891	1/1/0001
05800	S	M	OUG	II	00000	017	SIDE OF 3216 KIRKLEVINGTON	12	081476	1/1/0001
09500	S	M	OUG	II	00000	070	1ST LT. W OF TATES CREEK RD., SOUTHSIDE	12	100896	1/1/0001
09500	S	M	OUG	II	00000	071	1ST LT. W OF TATES CREEK RD., NORTHSIDE	12	100896	1/1/0001
09500	S	M	OUG	II	00000	072	2ND LT. W OF TATES CREEK RD., SOUTHSIDE	12	100896	1/1/0001
09500	S	M	OUG	II	00000	073	2ND LT. W OF TATES CREEK RD., NORTHSIDE	12	100896	1/1/0001
05800	S	M	OUG	II	00000	074	4TH LT. W. OF TATES CREEK ON SOUTHSIDE	12	120891	1/1/0001
05800	S	M	OUG	II	00000	075	5TH LT. W. OF TATES CREEK ON SOUTHSIDE	12	120891	1/1/0001
05800	S	M	OUG	II	00000	076	6TH LT. W. OF TATES CREEK ON SOUTHSIDE	12	120891	1/1/0001
05800	S	M	OUG	II	00410	016		12	081477	1/1/0001
05800	S	M	OUG	II	00421	010		12	051582	1/1/0001
05800	S	M	OUG	II	00421	012		12	111580	1/1/0001
05800	S	M	OUG	II	00431	009		12	051582	1/1/0001
05800	S	M	OUG	II	00431	077		12	051582	1/1/0001
05800	S	M	OUG	II	00431	078		12	051582	1/1/0001

OFFICE: 311

ROUTE: 564

ST_REF_NO: 00000154520

REDDING COURT

LUMENS	BULB TYPE	MULT SERIES	POLE TYPE	SHADE	ADDRESS NUMBER	REF	LOCATION	TAX DIST	DATE INST	DATE CHANGE
05800	S	M	OUG	II	03601	001		12	100896	1/1/0001
05800	S	M	OUG	II	03651	002		12	100896	1/1/0001

OFFICE: 311

ROUTE: 564

ST_REF_NO: 00000154600

REDWOOD DRIVE

LUMENS	BULB TYPE	MULT SERIES	POLE TYPE	SHADE	ADDRESS NUMBER	REF	LOCATION	TAX DIST	DATE INST	DATE CHANGE
05800	S	M	OUG	II	00000	035	SIDE OF 1178 BRIARWOOD DR.	12	032772	1/1/0001
05800	S	M	OUG	II	00000	036	SIDE OF 1193 BRIARWOOD DR.	12	080172	1/1/0001
05800	S	M	OUG	II	00000	049	SIDE OF 1054	12	080170	1/1/0001
05800	S	M	OUG	II	01029	050		12	080170	1/1/0001
05800	S	M	OUG	II	01051	048		12	080170	1/1/0001
05800	S	M	OUG	II	01066	047		12	080170	1/1/0001
05800	S	M	OUG	II	01075	046		12	080170	1/1/0001
05800	S	M	OUG	II	01086	045		12	080172	1/1/0001
05800	S	M	OUG	II	01099	044		12	080172	1/1/0001
05800	S	M	OUG	II	01110	043		12	030171	1/1/0001
05800	S	M	OUG	II	01123	042		12	030171	1/1/0001
05800	S	M	OUG	II	01134	041		12	081869	1/1/0001
05800	S	M	OUG	II	01147	040		12	110369	1/1/0001
05800	S	M	OUG	II	01158	039		12	080172	1/1/0001
05800	S	M	OUG	II	01171	038		12	080170	1/1/0001
05800	S	M	OUG	II	01177	037		12	081869	1/1/0001

OFFICE: 311

ROUTE: 564

ST_REF_NO: 00000154700

REED LANE

LUMENS	BULB TYPE	MULT SERIES	POLE TYPE	SHADE	ADDRESS NUMBER	REF	LOCATION	TAX DIST	DATE INST	DATE CHANGE
04000	S	M	OUG	II	00000	057	SIDE OF 1820 CLAYS MILL	12	100884	1/1/0001
04000	S	M	OUG	II	00510	061		12	100884	1/1/0001
04000	S	M	OUG	II	00521	060		12	100884	1/1/0001
04000	S	M	OUG	II	00533	059		12	100884	1/1/0001
04000	S	M	OUG	II	00545	058		12	100884	1/1/0001
04000	S	M	OUG	II	00000	062	SIDE 301 LAFAYETTE DR.	12	100884	1/1/0001
09500	S	M	OUG	II	00000	063	SIDE OF 298 LAFAYETTE PARKWAY	12	100884	1/1/0001
09500	S	M	OUG	II	00000	064	1 ST. LT. E. OF LAFAYETTE PKWY., N. SIDE	12	121582	1/1/0001

OFFICE: 311

ROUTE: 564

ST_REF_NO: 00000154700

REED LANE

LUMENS	BULB TYPE	MULT SERIES	POLE TYPE	SHADE	ADDRESS NUMBER	REF	LOCATION	TAX DIST	DATE INST	DATE CHANGE
09500	S	M	OUG	II	00000	065	OPP. W. VISTA ST.	12	121582	1/1/0001
09500	S	M	OUG	II	00000	066	OPP. 243 WEST VISTA ON REED LANE (IN PARK)	12	100884	1/1/0001
09500	S	M	OUG	II	00000	067	N. SIDE BETWEEN E. & W. VISTA ST.	12	121582	1/1/0001
09500	S	M	OUG	II	00000	068	OPP. 242 EAST VISTA ON REED LANE (IN PARK)	12	100884	1/1/0001
09500	S	M	OUG	II	00000	069	OPP. E. VISTA ST.	12	121582	1/1/0001
09500	S	M	OUG	II	00000	070	N. SIDE BETWEEN E. VISTA & SOUTHPORT ST.	12	121582	1/1/0001
09500	S	M	OUG	II	00000	071	SIDE OF 247 SOUTHPORT ST.	12	100884	1/1/0001
05800	S	M	OUG	II	00000	072	OPP. SOUTHPORT ST.	12	121582	1/1/0001
05800	S	M	OUG	II	00000	073	SIDE OF 240 SOUTHPORT ST.	12	100884	1/1/0001
05800	S	M	OUG	II	00000	074	OPP. 234	12	121582	1/1/0001
05800	S	M	OUG	II	00000	076	OPP. 214	12	121582	1/1/0001
05800	S	M	OUG	II	00000	078	1 ST. LT. E. OF PIN OAK ST., N. SIDE	12	121582	1/1/0001
05800	S	M	OUG	II	00206	077		12	090884	1/1/0001
05800	S	M	OUG	II	00222	075		12	100884	1/1/0001

OFFICE: 311

ROUTE: 564

ST_REF_NO: 00000154800

REGAL LANE

LUMENS	BULB TYPE	MULT SERIES	POLE TYPE	SHADE	ADDRESS NUMBER	REF	LOCATION	TAX DIST	DATE INST	DATE CHANGE
05800	S	M	OUG	II	00000	007	SIDE OF 2029 REBEL RD.	12	100768	1/1/0001
05800	S	M	OUG	II	00000	008	SIDE OF 2046 RAMBLER RD.	12	100768	1/1/0001
05800	S	M	OUG	II	00000	009	SIDE OF 2047 RAMBLER RD.	12	100768	1/1/0001
04000	S	M	OUG	II	00000	010	SIDE 2042 RAINBOW RD.	12	100889	1/1/0001
04000	S	M	OUG	II	00000	011	SIDE 2039 RAINBOW RD.	12	100889	1/1/0001
05800	S	M	OUG	II	00000	019	SIDE OF 2056 REGENCY ROAD	12	070171	1/1/0001

OFFICE: 311

ROUTE: 564

ST_REF_NO: 00000154900

REGENCY CIRCLE

LUMENS	BULB TYPE	MULT SERIES	POLE TYPE	SHADE	ADDRESS NUMBER	REF	LOCATION	TAX DIST	DATE INST	DATE CHANGE
05800	S	M	OUG	II	00225	031	911 address change	12	090884	12/3/2011
04000	S	M	OUG	II	00235	030	911 address change	12	090884	8/11/1996
04000	S	M	OOH	II	00247	029	911 address change	12	090884	8/11/1996
04000	S	M	OUG	II	00263	028	911 address change	12	090884	8/11/1996
04000	S	M	OUG	II	00269	027	911 address change	12	090884	8/11/1996

OFFICE: 311

ROUTE: 564

ST_REF_NO: 00000155000

REGENCY ROAD

LUMENS	BULB TYPE	MULT SERIES	POLE TYPE	SHADE	ADDRESS NUMBER	REF	LOCATION	TAX DIST	DATE INST	DATE CHANGE
09500	S	M	OUG	II	02401	001	car accident	12	100887	11/22/2010
09500	S	M	OUG	II	02549	020	bad fixture	12	111580	1/6/2011
09500	S	M	OUG	II	02646	072	bad fixture	12	100887	11/22/2010
10000	M	M	OUG	II	00000	001	SIDE OF 246 SOUTHLAND DR.	12	040969	1/1/0001
05800	S	M	OUG	II	00000	018	SIDE OF 311 DERBY DR.	12	080171	1/1/0001
09500	S	M	OUG	III	00000	025	OPP. 2200	12	020890	1/1/0001
09500	S	M	OUG	III	00000	028	OPP. WEST LOWRY LANE	12	020890	1/1/0001
09500	S	M	OUG	III	00000	030	OPP. 2300	12	020890	1/1/0001
09500	S	M	OUG	III	00000	031	SIDE OF 271 STONE RD.	12	020890	1/1/0001
09500	S	M	OOH	III	00000	032	SIDE OF 287 STONE RD.	12	020890	1/1/0001
10000	M	M	OUG	II	02003	002		12	030868	1/1/0001
10000	M	M	OUG	II	02012	003		12	030868	1/1/0001
10000	M	M	OUG	II	02013	004		12	030173	1/1/0001
10000	M	M	OUG	II	02020	005		12	120869	1/1/0001
10000	M	M	OUG	II	02021	006		12	120869	1/1/0001
05800	S	M	OUG	II	02032	010		12	091579	1/1/0001
05800	S	M	OUG	II	02039	011		12	030173	1/1/0001
05800	S	M	OUG	II	02050	012		12	080171	1/1/0001
05800	S	M	OUG	II	02051	013		12	030173	1/1/0001
05800	S	M	OUG	II	02064	014		12	030173	1/1/0001
05800	S	M	OUG	II	02075	015		12	030173	1/1/0001
05800	S	M	OUG	II	02084	017		12	080171	1/1/0001
05800	S	M	OUG	II	02098	019		12	080171	1/1/0001
05800	S	M	OUG	II	02101	020		12	080171	1/1/0001
09500	S	M	OUG	III	02200	024		12	020890	1/1/0001
09500	S	M	OUG	III	02201	027		12	020890	1/1/0001
09500	S	M	OUG	III	02250	026		12	020890	1/1/0001
10000	M	M	OUG	II	00000	006	SIDE 298 DENNIS DR.	12	100887	1/1/0001
10000	M	M	OUG	II	00000	008	SE CORNER OF MOORE DR.	12	061475	1/1/0001
10000	M	M	OUG	II	00000	013	2ND LT. N. OF MOORE DR., E. SIDE	12	041476	1/1/0001
10000	M	M	OUG	II	00000	015	1ST LT. N. OF MOORE DR., E. SIDE	12	041476	1/1/0001
10000	M	M	OUG	II	00000	017	1ST LT. S. OF MOORE DR., E. SIDE	12	111478	1/1/0001
10000	M	M	OUG	II	00000	019	1ST LT. S. OF MOORE DR., W. SIDE	12	111478	1/1/0001
10000	M	M	OUG	II	02400	033		12	120891	1/1/0001

OFFICE: 311

ROUTE: 564

ST_REF_NO: 00000155000 REGENCY ROAD

LUMENS	BULB TYPE	MULT SERIES	POLE TYPE	SHADE	ADDRESS NUMBER	REF	LOCATION	TAX DIST	DATE INST	DATE CHANGE
10000	M	M	OUG	II	02416	034		12	120891	1/1/0001
10000	M	M	OUG	II	02417	003		12	041582	1/1/0001
10000	M	M	OUG	II	02433	005		12	041582	1/1/0001
10000	M	M	OUG	II	02433	007		12	041582	1/1/0001
10000	M	M	OUG	II	02514	022		12	111580	1/1/0001
10000	M	M	OUG	II	02514	023		12	111580	1/1/0001
10000	M	M	OUG	II	02548	021		12	111580	1/1/0001
10000	M	M	OUG	II	02551	014		12	111580	1/1/0001
10000	M	M	OUG	II	02601	016		12	111478	1/1/0001
10000	M	M	OUG	II	02625	018		12	111478	1/1/0001
10000	M	M	OUG	II	02655	073		12	100887	1/1/0001
10000	M	M	OUG	II	02660	074		12	100887	1/1/0001
10000	M	M	OUG	II	02660	076		12	100887	1/1/0001
09500	S	M	OUG	II	02665	075	mv changeout	12	100887	1/1/0001
10000	M	M	OUG	II	02683	050		12	061581	1/1/0001
10000	M	M	OUG	II	02697	070		12	061581	1/1/0001
10000	M	M	OUG	II	02698	006		12	061581	1/1/0001
10000	M	M	OUG	II	02698	009		12	061581	1/1/0001
10000	M	M	OUG	II	02699	071		12	100887	1/1/0001

OFFICE: 311

ROUTE: 564

ST_REF_NO: 00000155100 REILUS COURT

LUMENS	BULB TYPE	MULT SERIES	POLE TYPE	SHADE	ADDRESS NUMBER	REF	LOCATION	TAX DIST	DATE INST	DATE CHANGE
04000	S	M	OUG	V	01005	073		12	050886	1/1/0001
04000	S	M	OUG	II	01024	072		12	101582	1/1/0001

OFFICE: 311

ROUTE: 564

ST_REF_NO: 00000155200 REIMS ROAD

LUMENS	BULB TYPE	MULT SERIES	POLE TYPE	SHADE	ADDRESS NUMBER	REF	LOCATION	TAX DIST	DATE INST	DATE CHANGE
05800	S	M	OUG	II	02400	000		12	041466	1/1/0001
05800	S	M	OUG	II	02409	000		12	041466	1/1/0001
05800	S	M	OUG	II	02420	000		12	041466	1/1/0001
05800	S	M	OUG	II	02433	000		12	041466	1/1/0001
05800	S	M	OUG	II	02444	000		12	100967	1/1/0001

OFFICE: 311		ROUTE: 564		ST_REF_NO: 00000155260		REMINGTON WAY		LUMENS	BULB TYPE	MULT SERIES	POLE TYPE	SHADE	ADDRESS NUMBER	REF	LOCATION	TAX DIST	DATE INST	DATE CHANGE
05800	S		OUG	II	00000	004	SIDE OF 1813 STOCKTON WAY ON REMINGTON WAY	12	092704								092704	1/1/0001
05800	S		OUG	II	00000	005	SIDE OF 1812 STOCKTON WAY ON REMINGTON WAY	12	092704								092704	1/1/0001
05800	S		OUG	II	02216	007		12	092704								092704	1/1/0001
05800	S		OUG	II	02268	003		12	092704								092704	1/1/0001
05800	S		OUG	II	02280	002		12	092704								092704	1/1/0001
05800	S		OUG	II	02296	001		12	092704								092704	1/1/0001
OFFICE: 311		ROUTE: 564		ST_REF_NO: 00000155310		RENO COURT		LUMENS	BULB TYPE	MULT SERIES	POLE TYPE	SHADE	ADDRESS NUMBER	REF	LOCATION	TAX DIST	DATE INST	DATE CHANGE
04000	S	M	OUG	II	00308	020		12	120886								120886	1/1/0001
04000	S	M	OUG	II	00329	019		12	120886								120886	1/1/0001
OFFICE: 311		ROUTE: 564		ST_REF_NO: 00000155360		REPUBLIC COURT		LUMENS	BULB TYPE	MULT SERIES	POLE TYPE	SHADE	ADDRESS NUMBER	REF	LOCATION	TAX DIST	DATE INST	DATE CHANGE
05800	S	M	OUG	III	00600	003		12	050897								050897	1/1/0001
05800	S	M	OUG	II	00616	002		12	050897								050897	1/1/0001
05800	S	M	OUG	II	00633	001		12	050897								050897	1/1/0001
OFFICE: 311		ROUTE: 564		ST_REF_NO: 00000155400		RETRAC ROAD		LUMENS	BULB TYPE	MULT SERIES	POLE TYPE	SHADE	ADDRESS NUMBER	REF	LOCATION	TAX DIST	DATE INST	DATE CHANGE
04000	S	M	OUG	II	00315	023		12	110891								110891	1/1/0001
04000	S	M	OUG	II	00330	022		12	110891								110891	1/1/0001
04000	S	M	OUG	II	00347	021		12	110891								110891	1/1/0001
04000	S	M	OUG	II	00362	020		12	110891								110891	1/1/0001
04000	S	M	OUG	II	00386	018		12	110891								110891	1/1/0001
04000	S	M	OUG	II	00387	019		12	110891								110891	1/1/0001
04000	S	M	OUG	II	00399	017		12	110891								110891	1/1/0001
04000	S	M	OUG	II	00406	016		12	110891								110891	1/1/0001
04000	S	M	OUG	II	00419	015		12	110891								110891	1/1/0001
04000	S	M	OUG	II	00427	014		12	110891								110891	1/1/0001

OFFICE: 311		ROUTE: 564		ST_REF_NO: 00000155400		RETRAC ROAD		TAX DIST	DATE INST	DATE CHANGE
LUMENS	BULB TYPE	MULT SERIES	POLE TYPE	SHADE	ADDRESS NUMBER	REF	LOCATION			
04000	S	M	OUG	II	00438	013		12	110891	1/1/0001
05800	S	M	OUG	II	00450	012		12	111579	1/1/0001
04000	S	M	OUG	II	00459	011		12	111579	1/1/0001
04000	S	M	OUG	II	00470	010		12	111579	1/1/0001
04000	S	M	OUG	II	00479	009		12	111579	1/1/0001
04000	S	M	OUG	II	00490	008		12	111579	1/1/0001
04000	S	M	OUG	II	00499	007		12	111579	1/1/0001
04000	S	M	OUG	II	00504	006		12	111579	1/1/0001
04000	S	M	OUG	V	00512	005		12	111579	1/1/0001
OFFICE: 311		ROUTE: 564		ST_REF_NO: 00000155490		REUBEN LANE		TAX DIST	DATE INST	DATE CHANGE
LUMENS	BULB TYPE	MULT SERIES	POLE TYPE	SHADE	ADDRESS NUMBER	REF	LOCATION			
05800	S	M	CNT	II	00000	001	SIDE OF 257 FOREST HILL DRIVE	12	040897	1/1/0001
05800	S	M	CNT	II	03212	002		12	040897	1/1/0001
05800	S	M	CNT	II	03217	003		12	120898	1/1/0001
05800	S	M	CNT	II	03228	004		12	120898	1/1/0001
OFFICE: 311		ROUTE: 564		ST_REF_NO: 00000155493		REVA RIDGE WAY		TAX DIST	DATE INST	DATE CHANGE
LUMENS	BULB TYPE	MULT SERIES	POLE TYPE	SHADE	ADDRESS NUMBER	REF	LOCATION			
05800	S	M	OUG	II	00000	050	1ST LT E OF APPIAN WAY, N SIDE ON REVA RIDGE WAY	12	010206	1/1/0001
05800	S	M	OUG	II	00000	051	2ND LT E OF APPIAN WAY, N SIDE ON REVA RIDGE WAY	12	010206	1/1/0001
OFFICE: 311		ROUTE: 564		ST_REF_NO: 00000155495		REVERE RUN DRIVE		TAX DIST	DATE INST	DATE CHANGE
LUMENS	BULB TYPE	MULT SERIES	POLE TYPE	SHADE	ADDRESS NUMBER	REF	LOCATION			
05800	S	M	OUG	II	00000	005	SIDE OF 2501 PATRICK HENRY WAY	12	080800	1/1/0001
05800	S	M	OUG	III	00816	001		12	080800	1/1/0001
05800	S	M	OUG	II	00833	002		12	080800	1/1/0001
05800	S	M	OUG	II	00852	003		12	080800	1/1/0001
05800	S	M	OUG	II	00861	004		12	080800	1/1/0001
05800	S	M	OUG	II	00893	006		12	080800	1/1/0001

OFFICE: 311

ROUTE: 564

ST_REF_NO: 00000155495

REVERE RUN DRIVE

LUMENS	BULB TYPE	MULT SERIES	POLE TYPE	SHADE	ADDRESS NUMBER	REF	LOCATION	TAX DIST	DATE INST	DATE CHANGE
05800	S	M	OUG	II	00922	007		12	080800	1/1/0001

OFFICE: 311

ROUTE: 564

ST_REF_NO: 00000155500

REYNOLDS, EAST ROAD

LUMENS	BULB TYPE	MULT SERIES	POLE TYPE	SHADE	ADDRESS NUMBER	REF	LOCATION	TAX DIST	DATE INST	DATE CHANGE
50000	S	M	OUG	III	00000	001	SIDE OF 3290 NICHOLASVILLE RD-upgrade 6/05	12	110885	1/1/0001
22000	S	M	OUG	III	00000	003	OPP. 114-upgraded to 22,000 June 2005	12	110885	1/1/0001
22000	S	M	OUG	III	00000	005	OPP. 128-upgraded to 22,000 June 2005	12	110885	1/1/0001
22000	S	M	OUG	III	00000	007	OPP. 144-upgraded to 22,000 June 2005	12	110885	1/1/0001
22000	S	M	OUG	III	00000	009	OPP. 160-upgraded to 22,000 June 2005	12	110885	1/1/0001
22000	S	M	OUG	III	00000	012	205-207-upgraded to 22,000 June 2005	12	110885	1/1/0001
22000	S	M	OUG	III	00000	013	204-208-upgraded to 22,000 June 2005	12	110885	1/1/0001
22000	S	M	OUG	III	00000	014	243-265-upgraded to 22,000 June 2005	12	110885	1/1/0001
22000	S	M	OUG	III	00000	015	220-236-upgraded to 22,000 June 2005	12	110885	1/1/0001
22000	S	M	OUG	III	00000	016	243-265-upgraded to 22,000 June 2005	12	110885	1/1/0001
22000	S	M	OUG	III	00000	017	220-236-upgraded to 22,000 June 2005	12	110885	1/1/0001
22000	S	M	OUG	II	00000	076	6TH LT. W. OF LANSLOWNE DR., N. SIDE-upgrade 6/05	12	010886	1/1/0001
22000	S	M	OUG	II	00000	077	5TH LT. W. OF LANSLOWNE DR., N. SIDE-upgrade 6/05	12	010886	1/1/0001
22000	S	M	OUG	II	00000	078	4TH LT. W. OF LANSLOWNE DR., N. SIDE-update 6/05	12	010886	1/1/0001
22000	S	M	OUG	II	00000	079	3RD LT. W. OF LANSLOWNE DR., N. SIDE-upgrade 6/05	12	010886	1/1/0001
22000	S	M	OUG	II	00000	080	SIDE 193 DONNABROOK CT.-uprade to 22,000 6/05	12	010886	1/1/0001
50000	S	M	OUG	II	00000	081	SIDE 3501 LANSLOWNE DR.-upgrade 6/05	12	010886	1/1/0001
22000	S	M	OUG	III	00100	002	upgraded to 22,000 June 2005	12	110885	1/1/0001
22000	S	M	OUG	III	00120	004	upgraded to 22,000 June 2005	12	110885	1/1/0001
22000	S	M	OUG	III	00138	006	upgraded to 22,000 June 2005	12	110885	1/1/0001
22000	S	M	OUG	III	00155	008	upgraded to 22,000 June 2005	12	110885	1/1/0001
22000	S	M	OUG	III	00176	011	upgraded to 22,000 June 2005	12	110885	1/1/0001
22000	S	M	OUG	III	00179	010	upgraded to 22,000 June 2005	12	110885	1/1/0001

OFFICE: 311

ROUTE: 564

ST_REF_NO: 00000155510

REYNOLDS, W. ROAD

LUMENS	BULB TYPE	MULT SERIES	POLE TYPE	SHADE	ADDRESS NUMBER	REF	LOCATION	TAX DIST	DATE INST	DATE CHANGE
22000	S	M	CNT	II	00000	019	19TH LT W OF NICHOLASVILLE RD,N SIDE ON W REYNOLDS	12	120304	1/1/0001
22000	S	M	CNT	II	00000	020	18TH LT W OF NICHOLASVILLE RD,S SIDE ON W REYNOLDS	12	120304	1/1/0001
22000	S	M	CNT	II	00000	021	17TH LT W OF NICHOLASVILLE RD,N SIDE ON W REYNOLDS	12	120304	1/1/0001
22000	S	M	CNT	II	00000	022	16TH LT W OF NICHOLASVILLE RD,N SIDE ON W REYNOLDS	12	120304	1/1/0001
22000	S	M	CNT	II	00000	023	15TH LT W OF NICHOLASVILLE RD,S SIDE ON W REYNOLDS	12	120304	1/1/0001
22000	S	M	CNT	II	00000	024	14TH LT W OF NICHOLASVILLE RD,N SIDE ON W REYNOLDS	12	120304	1/1/0001
22000	S	M	CNT	II	00000	025	13TH LT W OF NICHOLASVILLE RD,S SIDE ON W REYNOLDS	12	120304	1/1/0001
22000	S	M	CNT	II	00000	026	12TH LT W OF NICHOLASVILLE RD,S SIDE ON W REYNOLDS	12	120304	1/1/0001
22000	S	M	CNT	II	00000	027	11TH LT W OF NVILLE RD,N SIDE ON W REYNOLDS RD	12	103103	1/1/0001
22000	S	M	CNT	II	00000	028	10TH LT W OF NVILLE RD,S SIDE ON W REYNOLDS RD	12	103103	1/1/0001
22000	S	M	CNT	II	00000	030	9TH LT W OF NVILLE RD,N SIDE ON W REYNOLDS RD	12	103103	1/1/0001
22000	S	M	CNT	II	00000	031	8TH LT W OF NVILLE RD,S SIDE ON W REYNOLDS RD	12	103103	1/1/0001
22000	S	M	CNT	II	00000	032	7TH LT W OF NVILLE RD,N SIDE ON W REYNOLDS RD	12	103103	1/1/0001
22000	S	M	CNT	II	00000	033	6TH LT W OF NVILLE RD,S SIDE ON W REYNOLDS RD	12	103103	1/1/0001
22000	S	M	CNT	II	00000	034	5TH LT W OF NVILLE RD,N SIDE ON W REYNOLDS RD	12	103103	1/1/0001
22000	S	M	CNT	II	00000	035	4TH LT W OF NVILLE RD,S SIDE ON W REYNOLDS RD	12	103103	1/1/0001
22000	S	M	CNT	II	00000	036	3RD LT W OF NVILLE RD,N SIDE ON W REYNOLDS RD	12	103103	1/1/0001
22000	S	M	CNT	II	00000	037	2ND LT W OF NVILLE RD,S SIDE ON W REYNOLDS RD	12	103103	1/1/0001
22000	S	M	CNT	II	00000	038	1ST LT W OF NVILLE RD,N SIDE ON W REYNOLDS RD	12	103103	1/1/0001
50000	S	M	SOH	III	00000	101	1ST LT. W. OF RAILROAD, SHILLITO PARK ENT ROAD	12	060895	1/1/0001

Street Light Listing run 1/11/2015 10:43:21 AM

Page 923 of 1254

OFFICE: 311

ROUTE: 564

ST_REF_NO: 00000155520

REYNOLDS ROAD

LUMENS	BULB TYPE	MULT SERIES	POLE TYPE	SHADE	ADDRESS NUMBER	REF	LOCATION	TAX DIST	DATE INST	DATE CHANGE
22000	S	M	CNT	II	00000	201	1ST LT. E OF ROUNDABOUT, S SIDE	12	020801	1/1/0001
22000	S	M	CNT	II	00000	202	1ST LT. E OF ROUNDABOUT, N SIDE	12	020801	1/1/0001
22000	S	M	CNT	II	00000	203	2ND LT. E OF ROUNDABOUT, S SIDE	12	020801	1/1/0001
22000	S	M	CNT	II	00000	204	2ND LT. E OF ROUNDABOUT, N SIDE	12	020801	1/1/0001
22000	S	M	CNT	II	00000	205	3RD LT. E OF ROUNDABOUT, S SIDE	12	020801	1/1/0001
22000	S	M	CNT	II	00000	206	3RD LT. E OF ROUNDABOUT, N SIDE	12	020801	1/1/0001
22000	S	M	CNT	II	00000	207	3RD LT. W OF RUCCIO WAY, S SIDE	12	020801	1/1/0001
22000	S	M	CNT	II	00000	208	3RD LT. W OF RUCCIO WAY, N SIDE	12	020801	1/1/0001
22000	S	M	CNT	II	00000	209	2ND LT. W OF RUCCIO WAY, S SIDE	12	020801	1/1/0001
22000	S	M	CNT	II	00000	210	2ND LT. W OF RUCCIO WAY, N SIDE	12	020801	1/1/0001
22000	S	M	CNT	II	00000	211	1ST LT. W OF RUCCIO WAY, S SIDE	12	020801	1/1/0001
22000	S	M	CNT	II	00000	212	1ST LT. W OF RUCCIO WAY, N SIDE	12	020801	1/1/0001
22000	S	M	CNT	II	00000	213	OPP. RUCCIO WAY	12	020801	1/1/0001
22000	S	M	CNT	II	00000	214	1ST LT. E OF RUCCIO WAY, N SIDE	12	020801	1/1/0001
22000	S	M	CNT	II	00000	215	1ST LT. E OF RUCCIO WAY, S SIDE	12	020801	1/1/0001
22000	S	M	CNT	II	00000	216	2ND LT. E OF RUCCIO WAY, N SIDE	12	020801	1/1/0001
22000	S	M	CNT	II	00000	217	2ND LT. E OF RUCCIO WAY, S SIDE	12	020801	1/1/0001
22000	S	M	CNT	II	00000	218	2ND LT. W OF RUCCIO WAY, N SIDE	12	020801	1/1/0001
22000	S	M	CNT	II	00000	219	2ND LT. W OF RUCCIO WAY, S SIDE	12	020801	1/1/0001
22000	S	M	CNT	II	00000	220	1ST LT. W OF RUCCIO WAY, N SIDE	12	020801	1/1/0001
22000	S	M	CNT	II	00000	221	1ST LT. W OF RUCCIO WAY, S SIDE	12	020801	1/1/0001

OFFICE: 311

ROUTE: 564

ST_REF_NO: 00000155560

RHODERA RIDGE

LUMENS	BULB TYPE	MULT SERIES	POLE TYPE	SHADE	ADDRESS NUMBER	REF	LOCATION	TAX DIST	DATE INST	DATE CHANGE
05800	S	M	OUG	II	00508	001		12	020800	1/1/0001
05800	S	M	OUG	II	00525	002		12	020800	1/1/0001
05800	S	M	OUG	II	00536	003		12	020800	1/1/0001
05800	S	M	OUG	III	00568	005		12	020800	1/1/0001

OFFICE: 311

ROUTE: 564

ST_REF_NO: 00000155600

RIO DOSA DRIVE

LUMENS	BULB TYPE	MULT SERIES	POLE TYPE	SHADE	ADDRESS NUMBER	REF	LOCATION	TAX DIST	DATE INST	DATE CHANGE
09500	S		OUG	II	00000	014	3RD LT S OF MT TABOR RD, E SIDE ON RIO DOSA DR	12	070109	1/1/0001

Street Light Listing run 1/11/2015 10:43:21 AM

Page 924 of 1254

OFFICE: 311

ROUTE: 564

ST_REF_NO: 00000155600

RIO DOSA DRIVE

LUMENS	BULB TYPE	MULT SERIES	POLE TYPE	SHADE	ADDRESS NUMBER	REF	LOCATION	TAX DIST	DATE INST	DATE CHANGE
09500	S		OUG	II	00000	015	2ND LT S OF MT TABOR RD, E SIDE ON RIO DOSA DR	12	070109	1/1/0001
09500	S		OUG	II	00000	016	1ST LT S OF MT TABOR RD, E SIDE ON RIO DOSA DR	12	070109	1/1/0001
22000	S	M	SOH	III	00000	013	1ST LT W OF BONANZA DR,S SIDE ON RIO DOSA DR	12	102103	1/1/0001
05800	S	M	OUG	II	00000	010	OPP. 2923 RIO DOSA	12	110892	1/1/0001
05800	S	M	OUG	II	00000	011	4TH LT. W. OF LOCUST HILL, S. SIDE	12	120886	1/1/0001
22000	S	M	OUG	II	00000	012	5TH LT. W. OF LOCUST HILL, S. SIDE	12	120886	1/1/0001
05800	S	M	OUG	II	00000	005	1ST LT. W. OF LOCUST HILL, S. SIDE	12	120886	1/1/0001
05800	S	M	OUG	II	00000	007	2ND LT. W. OF LOCUST HILL, S. SIDE	12	120886	1/1/0001
05800	S	M	OUG	II	00000	008	OPP. 2949 RIO DOSA	12	110892	1/1/0001
05800	S	M	OUG	II	00000	009	3RD LT. W. OF LOCUST HILL, S. SIDE	12	120886	1/1/0001
05800	S	M	OUG	II	03050	003		12	110884	1/1/0001
05800	S	M	OUG	II	03051	004		12	110884	1/1/0001
05800	S	M	OUG	II	03051	006		12	110884	1/1/0001
05800	S	M	OUG	II	03050	001		12	110884	1/1/0001
05800	S	M	OUG	II	03051	002		12	110884	1/1/0001

OFFICE: 311

ROUTE: 564

ST_REF_NO: 00000155700

RICE PIKE

LUMENS	BULB TYPE	MULT SERIES	POLE TYPE	SHADE	ADDRESS NUMBER	REF	LOCATION	TAX DIST	DATE INST	DATE CHANGE
22000	S		OUG	II	00000	100	1ST LT N OF VERSAILLES RD, E SIDE OF RICE RD	12	092013	1/1/0001

OFFICE: 311

ROUTE: 564

ST_REF_NO: 00000155825

RICHARDSON PLACE

LUMENS	BULB TYPE	MULT SERIES	POLE TYPE	SHADE	ADDRESS NUMBER	REF	LOCATION	TAX DIST	DATE INST	DATE CHANGE
05800	S	M	CNT	II	00000	006	ACROSS FROM 245 RICHARDSON PLACE	12	052607	1/1/0001
05800	S	M	CNT	II	00205	010		12	052607	1/1/0001
05800	S	M	CNT	II	00212	009		12	052607	1/1/0001
05800	S	M	CNT	II	00237	007		12	052607	1/1/0001
05800	S	M	CNT	II	00253	005		12	052607	1/1/0001
05800	S	M	CNT	II	00273	003		12	053106	1/1/0001
05800	S	M	CNT	II	00284	002		12	053106	1/1/0001
05800	S	M	CNT	II	00289	001		12	053106	1/1/0001

OFFICE: 311

ROUTE: 564

ST_REF_NO: 00000155825

RICHARDSON PLACE

LUMENS	BULB TYPE	MULT SERIES	POLE TYPE	SHADE	ADDRESS NUMBER	REF	LOCATION	TAX DIST	DATE INST	DATE CHANGE
05800	S	M	CNT	II	00304	004		12	053106	1/1/0001
05800	S	M	CNT	II	00313	011		12	010407	1/1/0001
05800	S	M	CNT	II	00321	012		12	010407	1/1/0001

OFFICE: 311

ROUTE: 564

ST_REF_NO: 00000155900

RICHMOND AVENUE

LUMENS	BULB TYPE	MULT SERIES	POLE TYPE	SHADE	ADDRESS NUMBER	REF	LOCATION	TAX DIST	DATE INST	DATE CHANGE
04000	S	M	SOH	II	00353	018		12	050885	1/1/0001
04000	S	M	SOH	II	00000	001	SIDE 1103 RICHMOND RD.	12	030889	1/1/0001
04000	S	M	OUG	II	00000	009	SIDE 933 CRAMER AVE	12	110884	1/1/0001
04000	S	M	SOH	II	00000	010	SIDE 1002 AURORA AVE.	12	050885	1/1/0001
04000	S	M	SOH	II	00000	011	SIDE 931 AURORA AVE.	12	050885	1/1/0001
04000	S	M	SOH	II	00000	017	SIDE OF 957 NATIONAL AVE.	12	050885	1/1/0001
04000	S	M	OUG	II	00006	002		12	110884	1/1/0001
04000	S	M	OUG	II	00016	003		12	110884	1/1/0001
04000	S	M	OUG	II	00023	004		12	110884	1/1/0001
04000	S	M	OUG	II	00031	005		12	110884	1/1/0001
04000	S	M	OUG	II	00038	006		12	110884	1/1/0001
04000	S	M	OUG	II	00047	007		12	110884	1/1/0001
04000	S	M	SOH	II	00188	008		12	050885	1/1/0001
04000	S	M	SOH	II	00303	012		12	050885	1/1/0001
04000	S	M	SOH	II	00311	013		12	050885	1/1/0001
04000	S	M	SOH	II	00321	014		12	050885	1/1/0001
04000	S	M	SOH	II	00329	015		13	050885	1/1/0001
04000	S	M	SOH	II	00337	016		12	050885	1/1/0001

OFFICE: 311

ROUTE: 564

ST_REF_NO: 00000156000

RICHMOND ROAD

LUMENS	BULB TYPE	MULT SERIES	POLE TYPE	SHADE	ADDRESS NUMBER	REF	LOCATION	TAX DIST	DATE INST	DATE CHANGE
22000	S	M	OOH	II	00000	020	IN 1200 BLOCK OF RICHMOND RD	12	042301	1/1/0001
22000	S	M	OUG	II	00000	031	1 ST. LT. E. OF SYCAMORE RD., S. SIDE fixture	12	070165	5/6/2008
22000	S	M	OOH	IV	00000	079	2 ND. LT. W. OF IDLE HOUR DR., N. SIDE	12	070260	1/30/2012
22000	S	M	OOH	II	00000	098	AT FONTAINE RD. IN MEDIAN	12	020367	2/2/2011
22000	S	M	OUG	II	00000	199	7 TH. LT. E. OF SQUIRES RD. S. SIDE	12	021478	3/4/2011

Street Light Listing run 1/11/2015 10:43:21 AM

Page 926 of 1254

OFFICE: 311

ROUTE: 564

ST_REF_NO: 00000156000

RICHMOND ROAD

LUMENS	BULB TYPE	MULT SERIES	POLE TYPE	SHADE	ADDRESS NUMBER	REF	LOCATION	TAX DIST	DATE INST	DATE CHANGE
22000	S	M	OUG	II	00000	204	1 ST. LT. E. OF GOLF COURSE ENTRANCE, N. SIDE	12	021478	5/31/2012
22000	S	M	OUG	II	00000	205	1 ST. LT. E. OF GOLF COUSE ENTRANCE, S. SIDE	12	021478	11/7/2013
22000	S	M	OUG	II	00000	300	1ST LT S OF NEW CIRCLE, WEST SIDE OF RICHMOND RD	12	072304	1/1/0001
22000	S	M	OUG	II	00000	301	2ND LT S OF NEW CIRCLE, EAST SIDE OF RICHMOND RD	12	072304	1/1/0001
22000	S	M	OUG	II	00000	302	3RD LT S OF NEW CIRCLE, WEST SIDE OF RICHMOND RD	12	072304	1/1/0001
50000	S	M	OUG	II	00000	303	4TH LT S OF NEW CIRCLE, EAST SIDE OF RICHMOND RD	12	072304	1/1/0001
50000	S	M	OUG	II	00000	304	1ST LT S OF RICHMOND PLAZA, W SIDE OF RICHMOND RD	12	072304	1/1/0001
22000	S	M	OUG	II	00000	305	2ND LT S OF RICHMOND PLAZA DR,E SIDE OF RICHMOND	12	072304	1/1/0001
22000	S	M	OUG	II	00000	306	3RD LT S OF RICHMOND PLAZA DR,W SIDE OF RICHMOND	12	072304	1/1/0001
22000	S	M	OUG	II	00000	307	4TH LT S OF RICHMOND PLAZA DR,E SIDE OF RICHMOND	12	072304	1/1/0001
22000	S	M	OUG	II	00000	308	5TH LT S OF RICHMOND PLAZA DR,W SIDE OF RICHMOND	12	072304	1/1/0001
22000	S	M	OUG	II	00000	309	6TH LT S OF RICHMOND PLAZA DR, E SIDE OF RICHMOND	12	072304	1/1/0001
50000	S	M	OUG	II	00000	310	1ST LT S OF PATCHEN, W SIDE OF RICHMOND RD	12	072304	1/1/0001
22000	S	M	OUG	II	00000	311	2ND LT S OF PATCHEN DR, E SIDE OF RICHMOND RD	12	072304	1/1/0001
22000	S	M	OUG	II	00000	312	3RD LT S OF PATCHEN DR, W SIDE OF RICHMOND RD	12	072304	1/1/0001
22000	S	M	OUG	II	00000	313	4TH LT S OF PATCHEN DR, E SIDE OF RICHMOND RD	12	072304	1/1/0001
22000	S	M	OUG	II	00000	314	5TH LT S OF PATCHEN DR, W SIDE OF RICHMOND RD	12	072304	1/1/0001
22000	S	M	OUG	II	00000	315	6TH LT S OF PATCHEN DR, E SIDE OF RICHMOND RD	12	072304	1/1/0001
22000	S	M	OUG	II	00000	316	7TH LT S OF PATCHEN DR, W SIDE OF RICHMOND RD	12	072304	1/1/0001
22000	S	M	OUG	II	00000	317	8TH LT S OF PATCHEN DR, E SIDE OF RICHMOND RD	12	072304	1/1/0001
22000	S	M	OUG	II	00000	318	9TH LT S OF PATCHEN DR, W SIDE OF RICHMOND RD	12	072304	1/1/0001

OFFICE: 311

ROUTE: 564

ST_REF_NO: 00000156000

RICHMOND ROAD

LUMENS	BULB TYPE	MULT SERIES	POLE TYPE	SHADE	ADDRESS NUMBER	REF	LOCATION	TAX DIST	DATE INST	DATE CHANGE
22000	S	M	OUG	II	00000	319	10TH LT S OF PATCHEN DR, E SIDE OF RICHMOND RD	12	072304	1/1/0001
22000	S	M	OUG	II	00000	320	11TH LT S OF PATCHEN DR, W SIDE OF RICHMOND RD	12	072304	1/1/0001
22000	S	M	OUG	II	00000	321	12TH LT S OF PATCHEN DR, E SIDE OF RICHMOND RD	12	072304	1/1/0001
50000	S	M	SOH	II	00000	322	13TH LT S OF PATCHEN DR, W SIDE OF RICHMOND RD	12	072304	1/1/0001
50000	S	M	OUG	II	00000	323	1ST LT S OF MT TABOR, E SIDE OF RICHMOND RD	12	071504	1/1/0001
22000	S	M	OUG	II	00000	324	2ND LT S OF MT TABOR RD, W SIDE OF RICHMOND RD	12	071504	1/1/0001
22000	S	M	OUG	II	00000	325	3RD LT S OF MT TABOR RD, E SIDE OF RICHMOND RD	12	071504	1/1/0001
22000	S	M	OUG	II	00000	326	4TH LT S OF MT TABOR RD, W SIDE OF RICHMOND RD	12	071504	1/1/0001
22000	S	M	OUG	II	00000	327	5TH LT S OF MT TABOR RD, E SIDE OF RICHMOND RD	12	071504	1/1/0001
22000	S	M	OUG	II	00000	328	6TH LT S OF MT TABOR RD, W SIDE OF RICHMOND RD	12	071504	1/1/0001
22000	S	M	OUG	II	00000	329	7TH LT S OF MT TABOR RD, E SIDE OF RICHMOND RD	12	071504	1/1/0001
22000	S	M	OUG	II	00000	330	8TH LT S OF MT TABOR RD, W SIDE OF RICHMOND RD	12	071504	1/1/0001
22000	S	M	OUG	II	00000	331	9TH LT S OF MT TABOR RD, E SIDE OF RICHMOND RD	12	071504	1/1/0001
50000	S	M	OUG	II	00000	332	1ST LT S OF LUCST HILL, W SIDE OF RICHMOND RD	12	071504	1/1/0001
22000	S	M	OUG	II	00000	333	2ND LT S OF LOCUST HILL DR, E SIDE OF RICHMOND RD	12	071504	1/1/0001
22000	S	M	SOH	II	00000	334	3RD LT S OF LOCUST HILL DR, W SIDE OF RICHMOND RD	12	071504	1/1/0001
22000	S	M	OUG	II	00000	335	4TH LT S OF LOCUST HILL DR, E SIDE OF RICHMOND RD	12	071504	1/1/0001
22000	S	M	SOH	II	00000	336	5TH LT S OF LOCUST HILL DR, W SIDE OF RICHMOND RD	12	071504	1/1/0001
22000	S	M	OUG	II	00000	337	6TH LT S OF LOCUST HILL DR, E SIDE OF RICHMOND RD	12	071504	1/1/0001
22000	S	M	SOH	II	00000	338	7TH LT S OF LOCUST HILL DR, W SIDE OF RICHMOND RD	12	071504	1/1/0001
50000	S	M	OUG	II	00000	339	1ST LT S OF MAN O WAR, E SIDE OF RICHMOND RD	12	061104	1/1/0001

Street Light Listing run 1/11/2015 10:43:21 AM

Page 928 of 1254

OFFICE: 311

ROUTE: 564

ST_REF_NO: 00000156000

RICHMOND ROAD

LUMENS	BULB TYPE	MULT SERIES	POLE TYPE	SHADE	ADDRESS NUMBER	REF	LOCATION	TAX DIST	DATE INST	DATE CHANGE
22000	S	M	OUG	II	00000	340	2nd LT S OF MAN O WAR, WEST SIDE OF RICHMOND RD	12	061104	1/1/0001
50000	S	M	OUG	II	00000	341	3RD LT S OF MAN O WAR, E SIDE OF RICHMOND RD	12	061104	1/1/0001
22000	S	M	OUG	II	00000	342	1st LT S OF PROSPEROUS PL, WEST SIDE OF RICHMOND R	12	061104	1/1/0001
22000	S	M	OUG	II	00000	343	2nd LT S OF PROSPEROUS PL, EAST SIDE OF RICHMOND R	12	061104	1/1/0001
22000	S	M	OUG	II	00000	344	3rd LT S OF PROSPEROUS PL, WEST SIDE OF RICHMOND R	12	061104	1/1/0001
22000	S	M	OUG	II	00000	345	4th LT S OF PROSPEROUS PL, EAST SIDE OF RICHMOND R	12	061104	1/1/0001
22000	S	M	OUG	II	00000	346	5th LT S OF PROSPEROUS PL, WEST SIDE OF RICHMOND R	12	061104	1/1/0001
22000	S	M	OUG	II	00000	347	7th LT S OF PROSPEROUS PL, WEST SIDE OF RICHMOND R	12	061104	1/1/0001
22000	S	M	OUG	II	00000	348	7th LT S OF PROSPEROUS PL, EAST SIDE OF RICHMOND R	12	061104	1/1/0001
50000	S	M	OUG	II	00000	349	8TH LT S OF PROSPEROUS PL, E SIDE OF RICHMOND RD	12	061104	1/1/0001
50000	S	M	OUG	II	00000	350	9TH LT S OF PROSPEROUS PL, W SIDE OF RICHMOND RD	12	061104	1/1/0001
22000	S	M	OUG	II	01200	015	dtc 2013041514	12	040169	4/16/2013
20000	M	M	SOH	II	03160	159		12	040893	1/1/0001
20000	M	M	OUG	II	00000	208	3RD LT E OF GOLF COURSE ENTR,NORTHSIDE ON RICHMOND	12	110891	1/1/0001
50000	S	M	SOH	IV	00000	005	SIDE OF 100 S. HANOVER AVE.mv chg out	12	040164	1/1/0001
20000	M	M	OUG	II	00000	009	OPP. 1005 IN MEDIAN	12	040169	1/1/0001
20000	M	M	OUG	II	00000	010	OPP. 1014 IN MEDIAN	12	040169	1/1/0001
20000	M	M	OOH	II	00000	013	OPP. 1105 IN MEDIAN	12	040169	1/1/0001
22000	S	M	OOH	II	00000	014	OPP. 1024 IN MEDIAN	12	040169	1/1/0001
20000	M	M	OOH	II	00000	017	OPP. 1133 IN MEDIAN	12	040169	1/1/0001
22000	S	M	OOH	II	00000	018	OPP. 1214 IN MEDIAN	12	040169	1/1/0001
20000	M	M	OOH	II	00000	019	AT OWSLEY AVE. IN MEDIAN	12	040169	1/1/0001
20000	M	M	OOH	II	00000	022	OPP. 1211 IN MEDIAN	12	040169	1/1/0001
20000	M	M	OOH	II	00000	023	OPP. 1302 IN MEDIAN	12	040169	1/1/0001
20000	M	M	OOH	II	00000	024	AT LINCOLN AVE. IN MEDIAN	12	040169	1/1/0001
20000	M	M	OOH	II	00000	027	OPP. 1311 IN MEDIAN	12	040169	1/1/0001

Street Light Listing run 1/11/2015 10:43:21 AM

Page 929 of 1254

OFFICE: 311

ROUTE: 564

ST_REF_NO: 00000156000

RICHMOND ROAD

LUMENS	BULB TYPE	MULT SERIES	POLE TYPE	SHADE	ADDRESS NUMBER	REF	LOCATION	TAX DIST	DATE INST	DATE CHANGE
20000	M	M	OOH	II	00000	028	OPP. SYCAMORE RD. IN MEDIAN	12	040169	1/1/0001
20000	M	M	OOH	II	00000	029	AT PRESTON AVE. IN MEDIAN	12	040169	1/1/0001
20000	M	M	OUG	II	00000	032	OPP. 1409 IN MEDIAN	12	040169	1/1/0001
20000	M	M	OUG	II	00000	033	S. SIDE, IN MEDIAN BETWEEN PRESTON & BASSETT AVE.	12	040169	1/1/0001
20000	M	M	OOH	II	00000	035	S. SIDE OPP. BASSETT AVE.	12	040169	1/1/0001
20000	M	M	OUG	II	00000	037	S. SIDE, IN MEDIAN BETWEEN BASSETT & SHERMAN AVE.	12	040169	1/1/0001
20000	M	M	OUG	II	00000	040	OPP. 1601 IN MEDIAN	12	040169	1/1/0001
20000	M	M	OUG	II	00000	041	OPP. 1620 IN MEDIAN	12	040169	1/1/0001
20000	M	M	OUG	II	00000	042	OPP. 1611 IN MEDIAN	12	040169	1/1/0001
20000	M	M	OUG	II	00000	044	OPP. 1617 IN MEDIAN	12	040169	1/1/0001
20000	M	M	OUG	II	00000	045	OPP. 1636 IN MEDIAN	12	040169	1/1/0001
20000	M	M	OUG	II	00000	048	OPP. 1721 IN MEDIAN	12	040169	1/1/0001
20000	M	M	OUG	II	00000	049	OPP. 1648 IN MEDIAN	12	040169	1/1/0001
20000	M	M	OUG	II	00000	052	OPP. 1737 IN MEDIAN	12	040169	1/1/0001
20000	M	M	OOH	II	00000	053	OPP. 1744 IN MEDIAN	12	040169	1/1/0001
20000	M	M	OOH	II	00000	055	AT CHINOE RD. IN MEDIAN	12	040169	1/1/0001
20000	M	M	OOH	II	00000	057	OPP. 1805 IN MEDIAN	12	040169	1/1/0001
20000	M	M	OOH	II	00000	058	OPP. 1800 IN MEDIAN	12	040169	1/1/0001
20000	M	M	OOH	II	00000	061	OPP. 1814 IN MEDIAN	12	040169	1/1/0001
20000	M	M	OOH	II	00000	062	OPP. 1820 IN MEDIAN	12	040169	1/1/0001
20000	M	M	OOH	II	00000	063	OPP. 1824 IN MEDIAN	12	040169	1/1/0001
20000	M	M	OOH	II	00000	065	OPP. 1828 IN MEDIAN	12	040169	1/1/0001
20000	M	M	OOH	II	00000	066	OPP. 1832 IN MEDIAN	12	040169	1/1/0001
20000	M	M	OOH	II	00000	067	OPP. 1832 IN MEDIAN	12	040169	1/1/0001
20000	M	M	OOH	IV	00811	002		12	040164	1/1/0001
20000	M	M	SOH	IV	00812	003		12	040164	1/1/0001
20000	M	M	OUG	IV	00831	004		12	040164	1/1/0001
20000	M	M	SOH	IV	00905	006		12	040164	1/1/0001
20000	M	M	SOH	IV	00909	008		12	040167	1/1/0001
20000	M	M	SOH	IV	00912	007		12	040167	1/1/0001
20000	M	M	SOH	II	01016	012		12	120268	1/1/0001
20000	M	M	OOH	II	01017	011		12	040169	1/1/0001
20000	M	M	SOH	II	01127	016		12	040169	1/1/0001

Street Light Listing run 1/11/2015 10:43:21 AM

Page 930 of 1254

OFFICE: 311

ROUTE: 564

ST_REF_NO: 00000156000

RICHMOND ROAD

LUMENS	BULB TYPE	MULT SERIES	POLE TYPE	SHADE	ADDRESS NUMBER	REF	LOCATION	TAX DIST	DATE INST	DATE CHANGE
20000	M	M	OOH	II	01201	020		12	040169	1/1/0001
22000	S	M	OUG	II	01222	021		12	040169	1/1/0001
20000	M	M	SOH	II	01305	025		12	120268	1/1/0001
20000	M	M	OUG	II	01308	026		12	040169	1/1/0001
20000	M	M	SOH	II	01401	030		12	120268	1/1/0001
20000	M	M	SOH	II	01421	034		12	120268	1/1/0001
20000	M	M	SOH	II	01517	038		12	120268	1/1/0001
22000	S	M	OUG	II	01600	039		12	040169	1/1/0001
20000	M	M	OUG	II	01628	043		12	040169	1/1/0001
20000	M	M	OOH	II	01640	047		12	040169	1/1/0001
20000	M	M	SOH	II	01717	046		12	120268	1/1/0001
20000	M	M	OUG	II	01725	050		12	040169	1/1/0001
20000	M	M	OUG	II	01732	051		12	040169	1/1/0001
20000	M	M	SOH	II	01745	054		12	120268	1/1/0001
20000	M	M	OOH	II	01800	056		12	040169	1/1/0001
20000	M	M	OUG	II	01810	060		12	040169	1/1/0001
20000	M	M	SOH	II	01811	059		12	120268	1/1/0001
20000	M	M	OUG	II	01828	064		12	040169	1/1/0001
22000	S	M	OUG	IV	00000	068	5TH LT. W. OF SHRINERS LANE, SOUTHSIDE	12	050895	1/1/0001
20000	M	M	OOH	IV	00000	069	4 TH. LT. W. OF SHRINERS LANE, N. SIDE	12	070260	1/1/0001
22000	S	M	OUG	IV	00000	070	4TH LT. W. OF SHRINERS LANE, SOUTHSIDE	12	050895	1/1/0001
22000	S	M	OOH	IV	00000	071	3 RD. LT. W. OF SHRINERS LANE, N. SIDE	12	070260	1/1/0001
22000	S	M	OUG	IV	00000	072	3RD LT. W. OF SHRINERS LANE, SOUTHSIDE	12	050895	1/1/0001
20000	M	M	OOH	IV	00000	073	2 ND. LT. W. OF SHRINERS LANE, N. SIDE	12	070260	1/1/0001
22000	S	M	OUG	IV	00000	074	2ND LT. W. OF SHRINERS LANE, SOUTHSIDE	12	050895	1/1/0001
20000	M	M	OOH	IV	00000	075	1 ST. LT. W. OF SHRINERS LANE, N. SIDE	12	070260	1/1/0001
22000	S	M	SOH	IV	00000	076	1 ST. LT. W. OF SHRINERS LANE, S. SIDE	12	070260	1/1/0001
20000	M	M	OOH	IV	00000	077	3 RD. LT. W. OF IDLE HOUR DR., N. SIDE	12	070260	1/1/0001
20000	M	M	OOH	IV	00000	078	1 ST. LT. E. OF SHRINERS LANE, S. SIDE	12	070260	1/1/0001
22000	S	M	OOH	IV	00000	080	2 ND LT E OF SHRINERS LANE, S SIDE upgrade 6/08	12	070260	1/1/0001
20000	M	M	OOH	IV	00000	081	1 ST. LT. W. OF IDLE HOUR DR., N. SIDE	12	070260	1/1/0001
20000	M	M	OOH	IV	00000	082	S. SIDE, OPP. IDLE HOUR DR.	12	070260	1/1/0001
20000	M	M	OOH	IV	00000	083	1 ST. LT. E. OF IDLE HOUR DR., N. SIDE	12	070260	1/1/0001
20000	M	M	OOH	IV	00000	084	2 ND. LT. W. OF LAKESHORE DR., S. SIDE	12	070260	1/1/0001

Street Light Listing run 1/11/2015 10:43:21 AM

Page 931 of 1254

OFFICE: 311

ROUTE: 564

ST_REF_NO: 00000156000

RICHMOND ROAD

LUMENS	BULB TYPE	MULT SERIES	POLE TYPE	SHADE	ADDRESS NUMBER	REF	LOCATION	TAX DIST	DATE INST	DATE CHANGE
20000	M	M	OOH	IV	00000	085	1 ST. LT. W. OF ST. MARGARET DR., N. SIDE	12	070260	1/1/0001
20000	M	M	OOH	II	00000	086	1 ST. LT. W. OF LAKESHORE DR., S. SIDE	12	020367	1/1/0001
20000	M	M	OOH	IV	00000	087	1 ST. LT. E. OF ST. MARGARET DR., N. SIDE	12	070260	1/1/0001
20000	M	M	OOH	IV	00000	088	1 ST. LT. E. OF LAKESHORE DR., S. SIDE	12	070260	1/1/0001
20000	M	M	OOH	IV	00000	089	2 ND. LT. E. OF ST. MARGARET DR., N. SIDE	12	070260	1/1/0001
20000	M	M	OOH	IV	00000	090	2 ND. LT. E. OF LAKESHORE DR., S. SIDE	12	070260	1/1/0001
20000	M	M	OOH	IV	00000	091	3 RD. LT. E. OF ST. MARGARET DR., N. SIDE	12	070260	1/1/0001
20000	M	M	OOH	IV	00000	092	3 RD. LT. E. OF LAKESHORE DR., S. SIDE	12	070260	1/1/0001
20000	M	M	OOH	IV	00000	093	3 RD. LT. W. OF ST. ANN DR., N. SIDE	12	070260	1/1/0001
20000	M	M	OOH	IV	00000	094	2 ND. LT. W. OF FONTAINE RD., S. SIDE	12	070260	1/1/0001
20000	M	M	OOH	IV	00000	095	2 ND. LT. W. OF ST. ANN DR., N. SIDE	12	070260	1/1/0001
20000	M	M	OOH	IV	00000	096	1 ST. LT. W. OF FONTAINE RD., S. SIDE	12	070260	1/1/0001
22000	S	M	OOH	IV	00000	097	1 ST. LT. W. OF ST. ANN DR., N. SIDE	12	070260	1/1/0001
20000	M	M	OOH	IV	00000	099	1 ST. LT. E. OF ST. ANN DR., N. SIDE	12	070260	1/1/0001
22000	S	M	OOH	IV	00000	100	1 ST. LT. E. OF FONTAINE RD., S. SIDE	12	070260	1/1/0001
22000	S	M	OOH	IV	00000	101	2 ND. LT. E. OF ST. ANN DR., N. SIDE upgrade 6/08	12	070260	1/1/0001
22000	S	M	OOH	IV	00000	102	2 ND. LT. E. OF FONTAINE RD., S. SIDE	12	070260	1/1/0001
20000	M	M	OOH	IV	00000	103	3 RD. LT. E. OF ST. ANN DR., N. SIDE	12	070260	1/1/0001
20000	M	M	OOH	IV	00000	105	2 ND. LT. W. OF W. ENTRANCE TO LEX. MALL, N. SIDE	12	070260	1/1/0001
20000	M	M	OOH	IV	00000	106	4 TH. LT. E. OF FONTAINE RD., S. SIDE	12	070260	1/1/0001
20000	M	M	OOH	IV	00000	107	1 ST. LT. W. OF W. ENTRANCE TO LEX. MALL, N. SIDE	12	070260	1/1/0001
22000	S	M	OOH	IV	00000	108	1 ST. LT. E. OF WATER CO. ENTRANCE, S. SIDE	12	070260	1/1/0001
20000	M	M	OOH	IV	00000	109	1 ST. LT. E. OF W. ENTRANCE TO LEX. MALL, N. SIDE	12	070260	1/1/0001
20000	M	M	OOH	IV	00000	110	2 ND. LT. E. OF WATER CO. ENTRANCE, S. SIDE	12	070260	1/1/0001
20000	M	M	OOH	IV	00000	111	2 ND. LT. W. OF E. ENTRANCE TO LEX. MALL, N. SIDE	12	070260	1/1/0001
20000	M	M	OOH	IV	00000	112	3 RD. LT. E. OF WATER CO. ENTRANCE, S. SIDE	12	070260	1/1/0001
20000	M	M	OOH	IV	00000	113	1 ST. LT. W. OF E. ENTRANCE TO LEX. MALL, N. SIDE	12	070260	1/1/0001
20000	M	M	OOH	IV	00000	114	4 TH. LT. E. OF WATER CO. ENTRANCE, S. SIDE	12	070260	1/1/0001
20000	M	M	OOH	IV	00000	115	1 ST. LT. E. OF E. ENTRANCE TO LEX. MALL, N. SIDE	12	070260	1/1/0001
22000	S	M	OOH	IV	00000	116	2 ND. LT. W. OF NEW CIRCLE RD., S. SIDE	12	070260	1/1/0001

Street Light Listing run 1/11/2015 10:43:21 AM

Page 932 of 1254

OFFICE: 311

ROUTE: 564

ST_REF_NO: 00000156000

RICHMOND ROAD

LUMENS	BULB TYPE	MULT SERIES	POLE TYPE	SHADE	ADDRESS NUMBER	REF	LOCATION	TAX DIST	DATE INST	DATE CHANGE
20000	M	M	OOH	IV	00000	117	2 ND. LT. W. OF NEW CIRCLE RD., N. SIDE	12	070260	1/1/0001
20000	M	M	OOH	IV	00000	118	1 ST. LT. W. OF NEW CIRCLE RD., S. SIDE	12	070260	1/1/0001
20000	M	M	OOH	IV	00000	119	1 ST. LT. W. OF NEW CIRCLE RD., N. SIDE	12	070260	1/1/0001
20000	M	M	OUG	II	00000	182	SIDE OF 101 JERRICO DR.	12	021478	1/1/0001
20000	M	M	OUG	II	00000	184	SIDE OF 101 JERRICO RD.	12	021478	1/1/0001
20000	M	M	OUG	II	00000	186	1 ST. LT. E. OF JERRICO DR., N. SIDE	12	011581	1/1/0001
20000	M	M	OUG	II	00000	187	1 ST. LT. E. OF SQUIRES RD., S. SIDE	12	021478	1/1/0001
20000	M	M	OUG	II	00000	188	2 ND. LT. E. OF JERRICO DR., N. SIDE	12	021478	1/1/0001
20000	M	M	OUG	II	00000	189	2 ND. LT. E. OF SQUIRES RD., S. SIDE	12	021478	1/1/0001
20000	M	M	OUG	II	00000	190	3 RD. LT. E. OF JERRICO DR., N. SIDE	12	021478	1/1/0001
20000	M	M	OUG	II	00000	191	3 RD. LT. E. OF SQUIRES RD., S. SIDE	12	021478	1/1/0001
20000	M	M	OUG	II	00000	192	4 TH. LT. E. OF JERRICO DR., N. SIDE	12	021478	1/1/0001
20000	M	M	OUG	II	00000	193	4TH LT. E OF SQUIRES RD., SOUTHSIDE	12	080897	1/1/0001
20000	M	M	OUG	II	00000	194	5 TH. LT. E. OF JERRICO DR., N. SIDE	12	021478	1/1/0001
20000	M	M	OUG	II	00000	195	5TH LT. E OF SQUIRES RD., SOUTHSIDE	12	080897	1/1/0001
20000	M	M	OUG	II	00000	196	6 TH. LT. E. OF JERRICO DR., N. SIDE	12	021478	1/1/0001
20000	M	M	OUG	II	00000	197	6 TH. LT. E. OF SQUIRES RD., S. SIDE	12	021478	1/1/0001
20000	M	M	OUG	II	00000	198	7 TH. LT. E. OF JERRICO DR., N. SIDE	12	021478	1/1/0001
20000	M	M	OUG	II	00000	200	8 TH. LT. E. OF JERRICO DR., N. SIDE	12	021478	1/1/0001
20000	M	M	OUG	II	00000	201	8 TH. LT. E. OF SQUIRES RD., S. SIDE	12	021478	1/1/0001
20000	M	M	OUG	II	00000	202	9 TH. LT. E. OF JERRICO DR., N. SIDE	12	021478	1/1/0001
22000	S	M	OUG	II	00000	203	S. SIDE, OPP. GOLF COURSE ENTRANCE	12	021478	1/1/0001
20000	M	M	OUG	II	00000	206	2 ND. LT. E. OF GOLF COURSE ENTRANCE, N. SIDE	12	021478	1/1/0001
20000	M	M	OUG	II	00000	207	2 ND. LT. E. OF GOLF COURSE ENTRANCE, S. SIDE	12	021478	1/1/0001
20000	M	M	OUG	II	03400	177		12	021478	1/1/0001
20000	M	M	OUG	II	03400	179		12	021478	1/1/0001
20000	M	M	OUG	II	03400	181		12	021478	1/1/0001
20000	M	M	OUG	II	03401	176		12	021478	1/1/0001
20000	M	M	OUG	II	03401	178		12	021478	1/1/0001
20000	M	M	OUG	II	03401	180		12	021478	1/1/0001
20000	M	M	OUG	II	03450	183		12	021478	1/1/0001
20000	M	M	OUG	II	03490	185		12	021478	1/1/0001
20000	M	M	OUG	II	00000	209	3 RD. LT. E. OF GOLF COURSE ENTRANCE, S. SIDE	12	021478	1/1/0001
20000	M	M	OUG	II	00000	210	4 TH. LT. E. OF GOLF COURSE ENTRANCE, N. SIDE	12	021478	1/1/0001

OFFICE: 311

ROUTE: 564

ST_REF_NO: 00000156000

RICHMOND ROAD

LUMENS	BULB TYPE	MULT SERIES	POLE TYPE	SHADE	ADDRESS NUMBER	REF	LOCATION	TAX DIST	DATE INST	DATE CHANGE
20000	M	M	OUG	II	00000	211	4 TH. LT. E. OF GOLF COURSE ENTRANCE, S. SIDE	12	021478	1/1/0001
20000	M	M	OUG	II	00000	212	5 TH. LT. E. OF GOLF COURSE ENTRANCE, N. SIDE	12	021478	1/1/0001
20000	M	M	OUG	II	00000	213	5 TH. LT. E. OF GOLF COURSE ENTRANCE, S. SIDE	12	021478	1/1/0001
20000	M	M	OUG	II	00000	214	6 TH. LT. E. OF GOLF COURSE ENTRANCE, N. SIDE	12	021478	1/1/0001
20000	M	M	OUG	II	00000	215	6 TH. LT. E. OF GOLF COURSE ENTRANCE, S. SIDE	12	021478	1/1/0001
20000	M	M	OUG	II	00000	216	7 TH. LT. W. OF JACOBSON PARK ENTRANCE, N. SIDE	12	021478	1/1/0001
20000	M	M	OUG	II	00000	217	6TH LT. W. OF OLD RICHMOND RD., S. SIDE	12	021478	1/1/0001
20000	M	M	OUG	II	00000	218	6 TH. LT. W. OF JACOBSON PARK ENTRANCE, N. SIDE	12	021478	1/1/0001
20000	M	M	OUG	II	00000	219	5TH LT. W. OF OLD RICHMOND RD., S. SIDE	12	021478	1/1/0001
20000	M	M	OUG	II	00000	220	5TH LT. W. OF JACOBSON PARK ENTRANCE, N. SIDE	12	021478	1/1/0001
20000	M	M	OUG	II	00000	221	4TH LT. W. OF OLD RICHMOND RD., S. SIDE	12	021478	1/1/0001
20000	M	M	OUG	II	00000	222	4TH LT. W. OF JACOBSON PARK ENTRANCE, N. SIDE	12	021478	1/1/0001
22000	S	M	OUG	II	00000	223	3RD LT. W. OF OLD RICHMOND RD., S. SIDE	12	021478	1/1/0001
20000	M	M	OUG	II	00000	224	3RD LT. W. OF JACOBSON PARK ENTRANCE, N. SIDE	12	021478	1/1/0001
20000	M	M	OUG	II	00000	225	2ND LT. W. OF OLD RICHMOND RD., S. SIDE	12	021478	1/1/0001
20000	M	M	OUG	II	00000	226	2ND LT. W. OF JACOBSON PARK ENTRANCE, N. SIDE	12	021478	1/1/0001
20000	M	M	OUG	II	00000	227	1ST LT. W. OF OLD RICHMOND RD., S. SIDE	12	021478	1/1/0001
20000	M	M	OUG	II	00000	228	1ST LT. W. OF JACOBSON PARK ENTRANCE, N. SIDE	12	021478	1/1/0001
20000	M	M	OUG	II	00000	229	S. SIDE, AT OLD RICHMOND RD. IN MEDIAN	12	021478	1/1/0001
20000	M	M	OUG	II	00000	230	1ST LT. E. OF JACOBSON PARK ENTRANCE, N. SIDE	12	021478	1/1/0001
22000	S	M	OUG	II	00000	231	1ST LT. E. OF OLD RICHMOND RD., S. SIDE	12	021478	1/1/0001
20000	M	M	OUG	II	00000	232	2ND LT. E OF JACOBSON PARK ENTRANCE, N SIDE	12	030800	1/1/0001
20000	M	M	OUG	II	00000	233	2ND LT. E OF JACOBSON PARK ENTRANCE, S SIDE	12	030800	1/1/0001
20000	M	M	OUG	II	00000	234	1ST LT. ON OLD RICHMOND RD., S. SIDE	12	021478	1/1/0001
20000	M	M	OUG	II	00000	235	1ST LT. ON OLD RICHMOND RD., N. SIDE	12	021478	1/1/0001

OFFICE: 311		ROUTE: 564		ST_REF_NO: 00000156010		RICHMOND SERVICE ROAD		LUMENS	BULB TYPE	MULT SERIES	POLE TYPE	SHADE	ADDRESS NUMBER	REF	LOCATION	TAX DIST	DATE INST	DATE CHANGE
05800	S	M	OUG	II	00000	003	OPP. 3014	12	011581	1/1/0001								
05800	S	M	OUG	II	03014	004		12	011581	1/1/0001								

OFFICE: 311		ROUTE: 564		ST_REF_NO: 00000156100		RIDGE ROAD		LUMENS	BULB TYPE	MULT SERIES	POLE TYPE	SHADE	ADDRESS NUMBER	REF	LOCATION	TAX DIST	DATE INST	DATE CHANGE
05800	S	M	OUG	II	00501	024	bad fixture	12	100884	7/22/2010								
04000	S	M	OUG	V	00000	021	WEST END OF RIDGE ROAD	12	100884	1/1/0001								
04000	S	M	OUG	II	00517	023		12	100884	1/1/0001								
04000	S	M	SOH	II	00521	022		12	100884	1/1/0001								

OFFICE: 311		ROUTE: 564		ST_REF_NO: 00000156115		RIDGEBROOK ROAD		LUMENS	BULB TYPE	MULT SERIES	POLE TYPE	SHADE	ADDRESS NUMBER	REF	LOCATION	TAX DIST	DATE INST	DATE CHANGE
05800	S	M	OUG	II	00805	001		12	120893	1/1/0001								
05800	S	M	OUG	II	00808	002		12	120893	1/1/0001								
05800	S	M	OUG	II	00825	003		12	120893	1/1/0001								
05800	S	M	OUG	II	00832	004		12	120893	1/1/0001								
05800	S	M	OUG	II	00852	006		12	070896	1/1/0001								
05800	S	M	OUG	II	00853	005		12	120893	1/1/0001								
05800	S	M	OUG	II	00864	007		12	070896	1/1/0001								
05800	S	M	OUG	II	00884	010		12	070896	1/1/0001								
05800	S	M	OUG	II	00885	008		12	070896	1/1/0001								
05800	S	M	OUG	II	00905	009		12	070896	1/1/0001								
05800	S	M	OUG	II	00925	011		12	070896	1/1/0001								
05800	S	M	OUG	II	00932	012		12	110897	1/1/0001								
05800	S	M	OUG	II	00952	014		12	110897	1/1/0001								
05800	S	M	OUG	II	00957	013		12	110897	1/1/0001								
05800	S	M	OUG	II	00968	015		12	110897	1/1/0001								

OFFICE: 311		ROUTE: 564		ST_REF_NO: 00000156120		RIDGEBROOK CIRCLE		LUMENS	BULB TYPE	MULT SERIES	POLE TYPE	SHADE	ADDRESS NUMBER	REF	LOCATION	TAX DIST	DATE INST	DATE CHANGE
05800	S	M	OUG	V	00780	002		12	120893	1/1/0001								

OFFICE: 311

ROUTE: 564

ST_REF_NO: 00000156120

RIDGEBROOK CIRCLE

LUMENS	BULB TYPE	MULT SERIES	POLE TYPE	SHADE	ADDRESS NUMBER	REF	LOCATION	TAX DIST	DATE INST	DATE CHANGE
05800	S	M	OUG	II	00789	001		12	120893	1/1/0001

OFFICE: 311

ROUTE: 564

ST_REF_NO: 00000156125

RIDGEBROOK COURT

LUMENS	BULB TYPE	MULT SERIES	POLE TYPE	SHADE	ADDRESS NUMBER	REF	LOCATION	TAX DIST	DATE INST	DATE CHANGE
05800	S	M	OUG	II	00000	001	SIDE OF 949 RIDGEBROOK RD.	12	110897	1/1/0001
05800	S	M	OUG	III	02312	002		12	110897	1/1/0001

OFFICE: 311

ROUTE: 564

ST_REF_NO: 00000156140

RIDGECAVE COURT

LUMENS	BULB TYPE	MULT SERIES	POLE TYPE	SHADE	ADDRESS NUMBER	REF	LOCATION	TAX DIST	DATE INST	DATE CHANGE
05800	S	M	OUG	II	02112	002	bad fixture	12	010888	1/26/2010
05800	S	M	OUG	V	02120	003	bad fixture	12	010888	4/2/2009
04000	S	M	OUG	II	02105	001		12	010888	1/1/0001

OFFICE: 311

ROUTE: 564

ST_REF_NO: 00000156150

RIDGECAVE ROAD

LUMENS	BULB TYPE	MULT SERIES	POLE TYPE	SHADE	ADDRESS NUMBER	REF	LOCATION	TAX DIST	DATE INST	DATE CHANGE
05800	S	M	CNT	II	00000	006	SIDE OF 3200 SEBASTIAN LN ON RIDGECANE	12	072203	1/1/0001
05800	S	M	CNT	II	03200	001		12	072203	1/1/0001
05800	S	M	CNT	II	03217	002		12	072203	1/1/0001
05800	S	M	CNT	II	03228	003		12	072203	1/1/0001
05800	S	M	CNT	II	03240	004		12	072203	1/1/0001
05800	S	M	CNT	II	03248	005		12	072203	1/1/0001
04000	S	M	OUG	II	03271	114		12	110891	1/1/0001
04000	S	M	OUG	II	00000	100	SIDE OF 3294 GONDOLA	12	081582	1/1/0001
04000	S	M	OUG	II	00000	108	OPP. 3331	12	010888	1/1/0001
04000	S	M	OUG	II	00000	109	OPP. 3323	12	010888	1/1/0001
04000	S	M	OUG	II	03280	113		12	010888	1/1/0001
04000	S	M	OUG	II	03299	112		12	110891	1/1/0001
04000	S	M	OUG	II	03300	111		12	010888	1/1/0001
04000	S	M	OUG	II	03315	110		12	010888	1/1/0001
04000	S	M	OUG	II	03338	107		12	010888	1/1/0001
04000	S	M	OUG	II	03347	106		12	100884	1/1/0001

OFFICE: 311

ROUTE: 564

ST_REF_NO: 00000156150

RIDGECAVE ROAD

LUMENS	BULB TYPE	MULT SERIES	POLE TYPE	SHADE	ADDRESS NUMBER	REF	LOCATION	TAX DIST	DATE INST	DATE CHANGE
04000	S	M	OUG	II	03350	105		12	100884	1/1/0001
04000	S	M	OUG	II	03362	104		12	100884	1/1/0001
04000	S	M	OUG	II	03371	103		12	081582	1/1/0001
04000	S	M	OUG	V	03378	102		12	081582	1/1/0001
04000	S	M	OUG	II	03387	101		12	081582	1/1/0001

OFFICE: 311

ROUTE: 564

ST_REF_NO: 00000156200

RIDGECREST DRIVE

LUMENS	BULB TYPE	MULT SERIES	POLE TYPE	SHADE	ADDRESS NUMBER	REF	LOCATION	TAX DIST	DATE INST	DATE CHANGE
04000	S	M	OUG	II	00000	108	SIDE OF 3186 YELLOWSTONE PARKWAY	12	111580	1/1/0001
04000	S	M	OUG	II	01412	107		12	060890	1/1/0001
04000	S	M	OUG	II	01420	106		12	041581	1/1/0001

OFFICE: 311

ROUTE: 564

ST_REF_NO: 00000156205

RIDGEFIELD LANE

LUMENS	BULB TYPE	MULT SERIES	POLE TYPE	SHADE	ADDRESS NUMBER	REF	LOCATION	TAX DIST	DATE INST	DATE CHANGE
09500	S		CLN	II	00000	001	SIDE OF 2525 FLYING EBONY DR, ON RIDGEFIELD LN	12	091109	1/1/0001
09500	S		CLN	II	00000	007	SIDE OF 925 BELMERE DR, ON RIDGEFIELD LANE	12	091109	1/1/0001
09500	S		CLN	II	02509	002		12	091109	1/1/0001
09500	S		CLN	II	02516	003		12	091109	1/1/0001
09500	S		CLN	II	02521	004		12	091109	1/1/0001
09500	S		CLN	II	02528	005		12	091109	1/1/0001
09500	S		CLN	II	02537	006		12	091109	1/1/0001

OFFICE: 311

ROUTE: 564

ST_REF_NO: 00000156210

RIDGELAND COURT

LUMENS	BULB TYPE	MULT SERIES	POLE TYPE	SHADE	ADDRESS NUMBER	REF	LOCATION	TAX DIST	DATE INST	DATE CHANGE
05800	S	M	OUG	V	00000	001	SIDE OF 4440 HARTLAND PKWY	12	110893	1/1/0001

OFFICE: 311

ROUTE: 564

ST_REF_NO: 00000156300

RIDGEPOINT RUN

LUMENS	BULB TYPE	MULT SERIES	POLE TYPE	SHADE	ADDRESS NUMBER	REF	LOCATION	TAX DIST	DATE INST	DATE CHANGE
05800	S	M	OUG	II	00000	024	1ST LT. N. OF BAYBERRY BEND, E. SIDE	12	041582	1/1/0001
05800	S	M	OUG	II	00000	025	SIDE 3520 TRAILS END ON RIDGEPOINT RUN	12	090884	1/1/0001

OFFICE: 311		ROUTE: 564		ST_REF_NO: 00000156300		RIDGEPOINT RUN		LUMENS	BULB TYPE	MULT SERIES	POLE TYPE	SHADE	ADDRESS NUMBER	REF	LOCATION	TAX DIST	DATE INST	DATE CHANGE
05800	S	M	OUG	II	00000	026	SIDE OF 3601 WINGATE WAY	12	041582	1/1/0001								
05800	S	M	OUG	II	03977	021		12	081581	1/1/0001								
05800	S	M	OUG	II	03986	020		12	111580	1/1/0001								
05800	S	M	OUG	II	03990	018		12	111580	1/1/0001								
OFFICE: 311		ROUTE: 564		ST_REF_NO: 00000156305		RIDGETREE LANE		LUMENS	BULB TYPE	MULT SERIES	POLE TYPE	SHADE	ADDRESS NUMBER	REF	LOCATION	TAX DIST	DATE INST	DATE CHANGE
05800	S	M	OUG	II	00000	004	SIDE OF 3801 ROSEHILL LANE	12	070899	1/1/0001								
05800	S	M	OUG	II	01005	001		12	070899	1/1/0001								
05800	S	M	OUG	II	01008	002		12	070899	1/1/0001								
05800	S	M	OUG	II	01021	003		12	070899	1/1/0001								
05800	S	M	OUG	II	01041	005		12	070899	1/1/0001								
05800	S	M	OUG	III	01052	006		12	070899	1/1/0001								
OFFICE: 311		ROUTE: 564		ST_REF_NO: 00000156307		RIDGE VIEW WAY		LUMENS	BULB TYPE	MULT SERIES	POLE TYPE	SHADE	ADDRESS NUMBER	REF	LOCATION	TAX DIST	DATE INST	DATE CHANGE
05800	S		CNT	II	00000	013	SIDE OF 477 ANDOVER CREEK LANE, ON RIDGE VIEW WAY	12	070709	1/1/0001								
05800	S		CNT	II	03720	005		12	070709	1/1/0001								
05800	S		CNT	II	03733	006		12	070709	1/1/0001								
05800	S		CNT	II	03737	007		12	070709	1/1/0001								
05800	S		CNT	II	03753	008		12	070709	1/1/0001								
05800	S		CNT	II	03756	009		12	070709	1/1/0001								
05800	S		CNT	II	03773	010		12	070709	1/1/0001								
05800	S		CNT	II	03780	011		12	070709	1/1/0001								
05800	S		CNT	II	03789	012		12	070709	1/1/0001								
05800	S	M	CNT	II	03701	001		12	090800	1/1/0001								
05800	S	M	CNT	II	03704	002		12	090800	1/1/0001								
05800	S	M	CNT	II	03713	003		12	090800	1/1/0001								

OFFICE: 311		ROUTE: 564		ST_REF_NO: 00000156310		RIDGEWATER DRIVE		LUMENS	BULB TYPE	MULT SERIES	POLE TYPE	SHADE	ADDRESS NUMBER	REF	LOCATION	TAX DIST	DATE INST	DATE CHANGE
	05800	S	M	CNT	III	00504	003									12	120894	1/1/0001
	05800	S	M	CNT	II	04201	001									12	120894	1/1/0001
	05800	S	M	CNT	II	04208	002									12	120894	1/1/0001
	05800	S	M	CNT	II	04212	003									12	070898	1/1/0001
	05800	S	M	CNT	II	04221	004									12	070898	1/1/0001
	05800	S	M	CNT	II	04232	005									12	070898	1/1/0001
	05800	S	M	CNT	II	04233	006									12	030899	1/1/0001
	05800	S	M	CNT	II	04245	008									12	030899	1/1/0001
	05800	S	M	CNT	II	04248	007									12	030899	1/1/0001
	05800	S	M	CNT	II	04268	009									12	030899	1/1/0001
OFFICE: 311		ROUTE: 564		ST_REF_NO: 00000156320		RIDGEWATER COURT		LUMENS	BULB TYPE	MULT SERIES	POLE TYPE	SHADE	ADDRESS NUMBER	REF	LOCATION	TAX DIST	DATE INST	DATE CHANGE
	05800	S	M	CNT	II	00520	002									12	120894	1/1/0001
	05800	S	M	CNT	II	00529	001									12	120894	1/1/0001
OFFICE: 311		ROUTE: 564		ST_REF_NO: 00000156400		RIDGEWAY ROAD		LUMENS	BULB TYPE	MULT SERIES	POLE TYPE	SHADE	ADDRESS NUMBER	REF	LOCATION	TAX DIST	DATE INST	DATE CHANGE
	05800	S	M	OUG	II	00000	028							OPP. 216		12	050365	1/1/0001
	05800	S	M	OUG	II	00000	029							AT FONTAINE RD. IN ISLAND		12	102164	1/1/0001
	05800	S	M	OUG	II	00202	026									12	070566	1/1/0001
	05800	S	M	OUG	II	00209	027									12	030766	1/1/0001
	05800	S	M	OUG	II	00223	025									12	050365	1/1/0001
	05800	S	M	OUG	II	00311	030									12	021367	1/1/0001
	05800	S	M	OUG	II	00320	031									12	020166	1/1/0001
	05800	S	M	OUG	II	00337	032									12	110164	1/1/0001
	05800	S	M	OUG	II	00400	033									12	110164	1/1/0001
	05800	S	M	OUG	II	00413	034									12	090573	1/1/0001
	05800	S	M	OUG	II	00428	035									12	040165	1/1/0001
	05800	S	M	OUG	II	00439	036									12	122164	1/1/0001

OFFICE: 311		ROUTE: 564		ST_REF_NO: 00000156410		RIGGS COURT		LUMENS	BULB TYPE	MULT SERIES	POLE TYPE	SHADE	ADDRESS NUMBER	REF	LOCATION	TAX DIST	DATE INST	DATE CHANGE
	04000	S	M	OUG	II	03304	112									12	100884	1/1/0001
	04000	S	M	OUG	V	03309	113									12	100884	1/1/0001

OFFICE: 311		ROUTE: 564		ST_REF_NO: 00000156415		RINEY ROAD		LUMENS	BULB TYPE	MULT SERIES	POLE TYPE	SHADE	ADDRESS NUMBER	REF	LOCATION	TAX DIST	DATE INST	DATE CHANGE
	05800	S		CNT	II	00000	001								SIDE OF 3232 SANDERSVILLE RD, ON RINEY RD	12	080210	1/1/0001
	05800	S		CNT	II	00000	004								SIDE OF 3201 TUBURON WAY ON RINEY RD	12	080210	1/1/0001
	05800	S		CNT	II	03104	002									12	080210	1/1/0001
	05800	S		CNT	II	03117	003									12	080210	1/1/0001

OFFICE: 311		ROUTE: 564		ST_REF_NO: 00000156420		RITCHIE COURT		LUMENS	BULB TYPE	MULT SERIES	POLE TYPE	SHADE	ADDRESS NUMBER	REF	LOCATION	TAX DIST	DATE INST	DATE CHANGE
	04000	S	M	OUG	II	00000	001								SIDE OF 3069 ARROWHEAD DR.	12	040894	1/1/0001
	04000	S	M	OUG	II	01412	002									12	010891	1/1/0001
	04000	S	M	OUG	V	01421	003									12	040894	1/1/0001

OFFICE: 311		ROUTE: 564		ST_REF_NO: 00000156500		RITTENHOUSE COURT		LUMENS	BULB TYPE	MULT SERIES	POLE TYPE	SHADE	ADDRESS NUMBER	REF	LOCATION	TAX DIST	DATE INST	DATE CHANGE
	05800	S	M	OUG	V	01836	000									12	100171	1/1/0001
	05800	S	M	OUG	II	01849	000									12	100171	1/1/0001
	05800	S	M	OUG	II	01860	000									12	100171	1/1/0001
	05800	S	M	OUG	II	01877	000									12	100171	1/1/0001
	05800	S	M	OUG	II	01888	000									12	100171	1/1/0001

OFFICE: 311		ROUTE: 564		ST_REF_NO: 00000156575		RIVARD LANE		LUMENS	BULB TYPE	MULT SERIES	POLE TYPE	SHADE	ADDRESS NUMBER	REF	LOCATION	TAX DIST	DATE INST	DATE CHANGE
	05800	S	M	CNT	II	00000	001								SIDE OF 4437 RIVARD LANE	12	070806	1/1/0001
	05800	S	M	CNT	II	00000	030								ACROSS FROM 4421 RIVARD LANE	12	062307	1/1/0001
	05800	S	M	CNT	II	00000	037								SIDE OF 4348 RIVARD LANE	12	062307	1/1/0001
	05800	S	M	CNT	II	04301	042									12	062307	1/1/0001
	05800	S	M	CNT	II	04312	041									12	062307	1/1/0001

OFFICE: 311

ROUTE: 564

ST_REF_NO: 00000156575 RIVARD LANE

LUMENS	BULB TYPE	MULT SERIES	POLE TYPE	SHADE	ADDRESS NUMBER	REF	LOCATION	TAX DIST	DATE INST	DATE CHANGE
05800	S	M	CNT	II	04316	039		12	062307	1/1/0001
05800	S	M	CNT	II	04336	038		12	062307	1/1/0001
05800	S	M	CNT	II	04361	036		12	062307	1/1/0001
05800	S	M	CNT	II	04380	034		12	062307	1/1/0001
05800	S	M	CNT	II	04380	035		12	062307	1/1/0001
05800	S	M	CNT	II	04393	033		12	062307	1/1/0001
05800	S	M	CNT	II	04405	032		12	062307	1/1/0001
05800	S	M	CNT	II	04416	031		12	062307	1/1/0001
05800	S	M	CNT	II	04436	002		12	070806	1/1/0001
05800	S	M	CNT	II	04457	003		12	070806	1/1/0001

OFFICE: 311

ROUTE: 564

ST_REF_NO: 00000156760 RIVERMAN WAY

LUMENS	BULB TYPE	MULT SERIES	POLE TYPE	SHADE	ADDRESS NUMBER	REF	LOCATION	TAX DIST	DATE INST	DATE CHANGE
05800	S	M	OUG	II	00000	002	SIDE OF 4601 SUNNY POINT	12	060897	1/1/0001
05800	S	M	OUG	II	04601	001		12	060897	1/1/0001
05800	S	M	OUG	III	04617	003		12	060897	1/1/0001
05800	S	M	OUG	II	04636	004		12	060897	1/1/0001
05800	S	M	OUG	II	04645	005		12	060897	1/1/0001

OFFICE: 311

ROUTE: 564

ST_REF_NO: 00000156770 RIVER OAK TRAIL

LUMENS	BULB TYPE	MULT SERIES	POLE TYPE	SHADE	ADDRESS NUMBER	REF	LOCATION	TAX DIST	DATE INST	DATE CHANGE
05800	S	M	CNT	II	04300	001		12	030504	1/1/0001
05800	S	M	CNT	II	04308	002		12	030504	1/1/0001
05800	S	M	CNT	II	04317	003		12	052005	1/1/0001
05800	S	M	CNT	II	04329	004		12	052005	1/1/0001
05800	S	M	CNT	II	04341	005		12	030504	1/1/0001
05800	S	M	CNT	II	04345	006		12	030504	1/1/0001
05800	S	M	CNT	II	04361	007		12	030504	1/1/0001
05800	S	M	CNT	II	04368	008		12	030504	1/1/0001
05800	S	M	CNT	II	04373	009		12	030504	1/1/0001

OFFICE: 311

ROUTE: 564

ST_REF_NO: 00000156790

RIVER PARK CIRCLE

LUMENS	BULB TYPE	MULT SERIES	POLE TYPE	SHADE	ADDRESS NUMBER	REF	LOCATION	TAX DIST	DATE INST	DATE CHANGE
05800	S	M	OUG	V	01300	080		12	111580	1/1/0001
05800	S	M	OUG	II	01305	081		12	011583	1/1/0001

OFFICE: 311

ROUTE: 564

ST_REF_NO: 00000156800

RIVER PARK DRIVE

LUMENS	BULB TYPE	MULT SERIES	POLE TYPE	SHADE	ADDRESS NUMBER	REF	LOCATION	TAX DIST	DATE INST	DATE CHANGE
05800	S	M	OOH	II	00000	021	SIDE OF 1561 THAMES DR. (ug to oh feed Dec 2011)	12	060172	12/12/2011
05800	S	M	OUG	II	00000	001	OPP. 3601 IN MEDIAN	12	050867	1/1/0001
05800	S	M	OUG	II	00000	002	OPP. 3600 IN MEDIAN	12	050867	1/1/0001
05800	S	M	OUG	II	03491	112		12	041475	1/1/0001
05800	S	M	OUG	II	03511	114		12	041475	1/1/0001
05800	S	M	OUG	II	03535	116		12	041475	1/1/0001
05800	S	M	OUG	II	03555	118		12	041475	1/1/0001
05800	S	M	OUG	II	03583	129		12	071475	1/1/0001
05800	S	M	OUG	II	03599	131		12	041475	1/1/0001
05800	S	M	OUG	II	03609	003		12	120170	1/1/0001
05800	S	M	OUG	II	03616	004		12	050867	1/1/0001
05800	S	M	OUG	II	03629	005		12	091967	1/1/0001
05800	S	M	OUG	II	03636	020		12	060171	1/1/0001
05800	S	M	OUG	II	00000	038	BESIDE 1309 RIVER PARK CIRCLE	12	030890	1/1/0001
05800	S	M	OUG	II	00000	040	1ST LT. ON RIVER PARK OFF TRENT, W. SIDE	12	030890	1/1/0001
05800	S	M	OUG	II	03676	037		12	080173	1/1/0001
05800	S	M	OUG	II	03676	039		12	080173	1/1/0001

OFFICE: 311

ROUTE: 564

ST_REF_NO: 00000156805

RIVER RIDGE DRIVE

LUMENS	BULB TYPE	MULT SERIES	POLE TYPE	SHADE	ADDRESS NUMBER	REF	LOCATION	TAX DIST	DATE INST	DATE CHANGE
05800	S	M	CNT	II	00000	006	SIDE OF 644 POPLAR SPRINGS LN ON RIVER RIDGE DR	12	081501	1/1/0001
05800	S	M	CNT	II	04409	001		12	081501	1/1/0001
05800	S	M	CNT	II	04420	002		12	081501	1/1/0001
05800	S	M	CNT	II	04432	003		12	081501	1/1/0001
05800	S	M	CNT	II	04440	004		12	081501	1/1/0001
05800	S	M	CNT	II	04461	005		12	081501	1/1/0001
05800	S	M	CNT	II	04472	001		12	010206	1/1/0001

OFFICE: 311		ROUTE: 564		ST_REF_NO: 00000156807		RIVER RUN TRAIL		LUMENS	BULB TYPE	MULT SERIES	POLE TYPE	SHADE	ADDRESS NUMBER	REF	LOCATION	TAX DIST	DATE INST	DATE CHANGE
05800	S	M	CNT	II	03001	007										12	121406	1/1/0001
05800	S	M	CNT	II	03012	006										12	121406	1/1/0001
05800	S	M	CNT	II	03025	005										12	121406	1/1/0001
05800	S	M	CNT	II	03044	004										12	121406	1/1/0001
05800	S	M	CNT	II	03056	003										12	121406	1/1/0001
05800	S	M	CNT	II	03077	002										12	121406	1/1/0001
05800	S	M	CNT	II	03092	001										12	121406	1/1/0001

OFFICE: 311		ROUTE: 564		ST_REF_NO: 00000156808		RIVERSIDE COURT		LUMENS	BULB TYPE	MULT SERIES	POLE TYPE	SHADE	ADDRESS NUMBER	REF	LOCATION	TAX DIST	DATE INST	DATE CHANGE
05800	S	M	CNT	II	04404	001										12	030904	1/1/0001

OFFICE: 311		ROUTE: 564		ST_REF_NO: 00000156810		RIVERWOOD LANE		LUMENS	BULB TYPE	MULT SERIES	POLE TYPE	SHADE	ADDRESS NUMBER	REF	LOCATION	TAX DIST	DATE INST	DATE CHANGE
05800	S	M	CNT	II	00704	001										12	110895	1/1/0001
05800	S	M	CNT	II	00709	002										12	110895	1/1/0001
05800	S	M	CNT	II	00721	003										12	110895	1/1/0001

OFFICE: 311		ROUTE: 564		ST_REF_NO: 00000156900		ROANOKE ROAD		LUMENS	BULB TYPE	MULT SERIES	POLE TYPE	SHADE	ADDRESS NUMBER	REF	LOCATION	TAX DIST	DATE INST	DATE CHANGE
05800	S	M	OUG	II	00000	046									SIDE OF 1600 ALEXANDRIA DR.	12	091167	1/1/0001
05800	S	M	OOH	II	00000	070									SIDE OF 1522 ROANOKE RD.	12	121583	1/1/0001
05800	S	M	OUG	II	00000	071									SIDE OF 1914 SEVEN PINES DR.	12	081476	1/1/0001
05800	S	M	OUG	II	01502	000										12	101674	1/1/0001
05800	S	M	OUG	II	01507	073										12	081476	1/1/0001
05800	S	M	OUG	II	01514	072										12	081476	1/1/0001
05800	S	M	OUG	II	01528	045										12	091167	1/1/0001

OFFICE: 311		ROUTE: 564		ST_REF_NO: 00000157000		ROBERTSON AVENUE		LUMENS	BULB TYPE	MULT SERIES	POLE TYPE	SHADE	ADDRESS NUMBER	REF	LOCATION	TAX DIST	DATE INST	DATE CHANGE
04000	S	M	SOH	II	00000	183									OPP. 1198	12	060685	1/1/0001

OFFICE: 311

ROUTE: 564

ST_REF_NO: 00000157000

ROBERTSON AVENUE

LUMENS	BULB TYPE	MULT SERIES	POLE TYPE	SHADE	ADDRESS NUMBER	REF	LOCATION	TAX DIST	DATE INST	DATE CHANGE
04000	S	M	SOH	II	00000	184	OPP. PRESTON AVE.	12	060685	1/1/0001
04000	S	M	SOH	II	00000	185	OPP. 1306	12	040887	1/1/0001
04000	S	M	SOH	II	00000	186	OPP. BASSETT AVE.	12	040887	1/1/0001
04000	S	M	SOH	II	00000	187	OPP. 1413	12	060685	1/1/0001
04000	S	M	SOH	II	00000	188	OPP. 408 SERMAN AVE.	12	050885	1/1/0001

OFFICE: 311

ROUTE: 564

ST_REF_NO: 00000157100

ROBERTSON STREET

LUMENS	BULB TYPE	MULT SERIES	POLE TYPE	SHADE	ADDRESS NUMBER	REF	LOCATION	TAX DIST	DATE INST	DATE CHANGE
22000	S	M	OUG	III	00000	001	1 ST. LT. N. OF HIGH ST., W. SIDE	12	061583	11/13/2009
05800	S	M	SOH	I	00000	004	SIDE OF 1053 JANE ST.	12	050162	1/1/0001
05800	S	M	SOH	I	00000	009	OPP. 317 NEAR ANDERSON ST.	12	050162	1/1/0001
09500	S	M	SOH	I	00325	008	upgraded 10/07	12	050162	1/1/0001
09500	S	M	SOH	I	00400	007	upgraded 10/07	12	050162	1/1/0001
05800	S	M	SOH	I	00412	006		12	050162	1/1/0001
05800	S	M	SOH	I	00424	005		12	050162	1/1/0001
09500	S	M	SOH	I	00500	003	upgraded 10/07	12	050162	1/1/0001
09500	S	M	SOH	I	00000	002	OPP. 520-upgraded 10/07	12	050162	1/1/0001

OFFICE: 311

ROUTE: 564

ST_REF_NO: 00000157200

ROBIN ROAD

LUMENS	BULB TYPE	MULT SERIES	POLE TYPE	SHADE	ADDRESS NUMBER	REF	LOCATION	TAX DIST	DATE INST	DATE CHANGE
05800	S	M	OUG	II	00000	011	SIDE OF 3109 TATES CREEK RD ON ROBIN RD	12	060601	1/1/0001
05800	S	M	OUG	II	00000	012	SIDE OF 3201 TATES CREEK RD ON ROBIN RD	12	060601	1/1/0001
05800	S	M	OUG	II	00847	007		12	060601	1/1/0001
05800	S	M	OUG	II	00855	008		12	060601	1/1/0001
05800	S	M	OUG	II	00863	009		12	060601	1/1/0001
05800	S	M	OUG	II	00875	010		12	060601	1/1/0001
04000	S	M	OUG	II	00755	001		12	110888	1/1/0001
04000	S	M	OUG	II	00758	002		12	110888	1/1/0001
04000	S	M	OUG	II	00771	003		12	110888	1/1/0001
04000	S	M	OUG	II	00779	004		12	110888	1/1/0001
04000	S	M	OUG	II	00782	005		12	110888	1/1/0001
04000	S	M	OUG	II	00795	006		12	110888	1/1/0001

OFFICE: 311

ROUTE: 564

ST_REF_NO: 00000157240 ROBINHILL WAY

LUMENS	BULB TYPE	MULT SERIES	POLE TYPE	SHADE	ADDRESS NUMBER	REF	LOCATION	TAX DIST	DATE INST	DATE CHANGE
05800	S	M	OUG	II	00000	001	SIDE REAR OF 2201 ROBINSRING CT.	12	070898	1/1/0001
05800	S	M	OUG	III	00000	007	REAR OF 3560	12	070898	1/1/0001
05800	S	M	OUG	II	03512	002		12	070898	1/1/0001
05800	S	M	OUG	II	03529	003		12	070898	1/1/0001
05800	S	M	OUG	II	03544	004		12	070898	1/1/0001
05800	S	M	OUG	II	03565	005		12	070898	1/1/0001
05800	S	M	OUG	III	03585	006		12	070898	1/1/0001

OFFICE: 311

ROUTE: 564

ST_REF_NO: 00000157245 ROBINSON WAY

LUMENS	BULB TYPE	MULT SERIES	POLE TYPE	SHADE	ADDRESS NUMBER	REF	LOCATION	TAX DIST	DATE INST	DATE CHANGE
05800	S		CNT	II	00000	007	SIDE OF 185 FERNDAL PASS ON ROBINSON WAY	12	030609	1/1/0001
05800	S		CNT	II	00105	001		12	030609	1/1/0001
05800	S		CNT	II	00117	002		12	030609	1/1/0001
05800	S		CNT	II	00141	004		12	030609	1/1/0001

OFFICE: 311

ROUTE: 564

ST_REF_NO: 00000157250 ROBINSRING COURT

LUMENS	BULB TYPE	MULT SERIES	POLE TYPE	SHADE	ADDRESS NUMBER	REF	LOCATION	TAX DIST	DATE INST	DATE CHANGE
05800	S	M	OUG	III	02205	001		12	070898	1/1/0001

OFFICE: 311

ROUTE: 564

ST_REF_NO: 00000157280 ROCHESTER COURT

LUMENS	BULB TYPE	MULT SERIES	POLE TYPE	SHADE	ADDRESS NUMBER	REF	LOCATION	TAX DIST	DATE INST	DATE CHANGE
05800	S	M	CNT	II	00000	001	SIDE 1053 RAMBLEWOOD WAY	12	070895	1/1/0001
05800	S	M	CNT	II	00000	051	SIDE 913 DEER CROSSING WAY	12	070895	1/1/0001
05800	S	M	CNT	II	00000	052	SIDE OF 1013 CRIMSON CREEK DR.	12	050897	1/1/0001
05800	S	M	CNT	III	03701	002		12	070895	1/1/0001

OFFICE: 311

ROUTE: 564

ST_REF_NO: 00000157285 ROCKAWAY PLACE

LUMENS	BULB TYPE	MULT SERIES	POLE TYPE	SHADE	ADDRESS NUMBER	REF	LOCATION	TAX DIST	DATE INST	DATE CHANGE
05800	S		CNT	II	02405	001		12	080610	1/1/0001
05800	S		CNT	II	02420	002		12	080610	1/1/0001
05800	S		CNT	II	02441	003		12	080610	1/1/0001

OFFICE: 311

ROUTE: 564

ST_REF_NO: 00000157285

ROCKAWAY PLACE

LUMENS	BULB TYPE	MULT SERIES	POLE TYPE	SHADE	ADDRESS NUMBER	REF	LOCATION	TAX DIST	DATE INST	DATE CHANGE
05800	S		CNT	II	02452	004		12	080610	1/1/0001
05800	S		CNT	II	02473	005		12	080610	1/1/0001
05800	S		CNT	II	02485	006		12	080610	1/1/0001
05800	S		CNT	II	02489	008		12	080610	1/1/0001
05800	S		CNT	II	02508	007		12	080610	1/1/0001
05800	S		CNT	II	02548	009		12	080610	1/1/0001
05800	S		CNT	II	02561	010		12	080610	1/1/0001
05800	S		CNT	II	02576	011		12	080610	1/1/0001
05800	S		CNT	II	02593	012		12	080610	1/1/0001
05800	S		CNT	II	02609	013		12	080610	1/1/0001
05800	S		CNT	II	02620	014		12	080610	1/1/0001
05800	S		CNT	II	02633	015		12	080610	1/1/0001
05800	S		CNT	II	02652	016		12	080610	1/1/0001
05800	S		CNT	II	02665	017		12	080610	1/1/0001

OFFICE: 311

ROUTE: 564

ST_REF_NO: 00000157290

ROCKBRIDGE ROAD

LUMENS	BULB TYPE	MULT SERIES	POLE TYPE	SHADE	ADDRESS NUMBER	REF	LOCATION	TAX DIST	DATE INST	DATE CHANGE
05800	S	M	OUG	II	00145	010		12	090886	1/1/0001
05800	S	M	OUG	II	00152	011		12	090886	1/1/0001
05800	S	M	OUG	II	00165	012		12	090886	1/1/0001
05800	S	M	OUG	II	00000	032	SIDE OF 4600 OAK CREEK DR. ON ROCKBRIDGE	12	080890	1/1/0001
05800	S	M	OUG	II	00000	034	SIDE OF 4600 HICKORY CREEK ON ROCKBRIDGE	12	080890	1/1/0001
05800	S	M	OUG	II	00000	040	SIDE OF 4585 HARTLAND PKY	12	010894	1/1/0001
05800	S	M	OUG	II	01050	009		12	060887	1/1/0001
05800	S	M	OUG	II	01055	008		12	050887	1/1/0001
05800	S	M	OUG	II	01062	007		12	060887	1/1/0001
05800	S	M	OUG	II	01071	006		12	050887	1/1/0001
05800	S	M	OUG	II	01074	005		12	060887	1/1/0001
05800	S	M	OUG	II	01083	004		12	050887	1/1/0001
05800	S	M	OUG	II	01090	003		12	050887	1/1/0001
05800	S	M	OUG	II	01095	002		12	110889	1/1/0001
09500	S	M	OUG	II	01103	025		12	080893	1/1/0001
05800	S	M	OUG	II	01114	026		12	080893	1/1/0001

OFFICE: 311

ROUTE: 564

ST_REF_NO: 00000157290

ROCKBRIDGE ROAD

LUMENS	BULB TYPE	MULT SERIES	POLE TYPE	SHADE	ADDRESS NUMBER	REF	LOCATION	TAX DIST	DATE INST	DATE CHANGE
05800	S	M	OUG	II	01115	027		12	080893	1/1/0001
05800	S	M	OUG	II	01130	028		12	080890	1/1/0001
05800	S	M	OUG	II	01135	029		12	080890	1/1/0001
05800	S	M	OUG	II	01146	030		12	080890	1/1/0001
05800	S	M	OUG	II	01155	031		12	080890	1/1/0001
05800	S	M	OUG	II	01171	033		12	080890	1/1/0001
05800	S	M	OUG	II	01186	036		12	110893	1/1/0001
05800	S	M	OUG	II	01191	035		12	110893	1/1/0001
05800	S	M	OUG	II	01209	037		12	110893	1/1/0001
05800	S	M	OUG	II	01212	038		12	110893	1/1/0001
05800	S	M	OUG	II	01225	039		12	110893	1/1/0001
05800	S	M	OUG	II	00000	013	SIDE OF 4601 SARON	12	110889	1/1/0001
05800	S	M	OUG	II	00000	014	SIDE 4592 LONGBRIDGE ON ROCKBRIDGE	12	090892	1/1/0001
05800	S	M	OUG	II	00000	015	SIDE 4601 LONGBRIDGE ON ROCKBRIDGE	12	090892	1/1/0001
05800	S	M	OUG	II	00000	018	SIDE 4601 THORNWOOD CIRCLE ON ROCKBRIDGE	12	090892	1/1/0001
05800	S	M	OUG	II	00000	024	SIDE REAR OF 4509 BROOKGLEN PLACE	12	020895	1/1/0001
05800	S	M	OUG	II	00940	023		12	020895	1/1/0001
05800	S	M	OUG	II	00953	022		12	020895	1/1/0001
05800	S	M	OUG	II	00956	021		12	110889	1/1/0001
05800	S	M	OUG	II	00965	020		12	110889	1/1/0001
05800	S	M	OUG	II	00968	019		12	090892	1/1/0001
05800	S	M	OUG	II	00985	017		12	110889	1/1/0001
05800	S	M	OUG	II	00992	016		12	020895	1/1/0001
05800	S	M	OUG	II	01027	012		12	060887	1/1/0001
05800	S	M	OUG	II	01034	011		12	110889	1/1/0001
05800	S	M	OUG	II	01039	010		12	050887	1/1/0001

OFFICE: 311

ROUTE: 564

ST_REF_NO: 00000157300

ROCKCASTLE AVENUE

LUMENS	BULB TYPE	MULT SERIES	POLE TYPE	SHADE	ADDRESS NUMBER	REF	LOCATION	TAX DIST	DATE INST	DATE CHANGE
05800	S	M	SOH	II	00000	001	OPP. 728	12	031583	1/1/0001
05800	S	M	SOH	II	00000	003	ROCKCASTLE & SHELBY	12	051368	1/1/0001
05800	S	M	SOH	II	00716	002		12	031583	1/1/0001

OFFICE: 311		ROUTE: 564		ST_REF_NO: 00000157350		ROCKMINSTER ROAD				
LUMENS	BULB TYPE	MULT SERIES	POLE TYPE	SHADE	ADDRESS NUMBER	REF	LOCATION	TAX DIST	DATE INST	DATE CHANGE
09500	S		CLN	II	00000	002	SIDE OF 2401 HEALY LN, ON ROCKMINSTER	12	091109	1/1/0001
09500	S		CLN	II	00000	004	SIDE OF 2400 HEALY LN, ON ROCKMINSTER RD	12	091109	1/1/0001
09500	S		CLN	II	00000	006	SIDE OF 2420 ASTARITA WAY, ON ROCKMINSTER	12	091109	1/1/0001
09500	S		CLN	II	00000	008	SIDE OF 2404 FRANKS WAY, ON ROCKMINSTER RD	12	091109	1/1/0001
09500	S		CLN	II	02340	001		12	091109	1/1/0001
09500	S		CLN	II	02348	003		12	091109	1/1/0001
09500	S		CLN	II	02364	005		12	091109	1/1/0001
09500	S		CLN	II	02376	007		12	091109	1/1/0001
09500	S		CLN	II	02400	009		12	091109	1/1/0001
09500	S		CLN	II	02409	010		12	091109	1/1/0001
09500	S		CLN	II	02420	011		12	091109	1/1/0001
09500	S		CLN	II	02425	012		12	091109	1/1/0001
09500	S		CLN	II	02432	013		12	091109	1/1/0001
09500	S		CLN	II	02437	014		12	091109	1/1/0001
09500	S		CLN	II	02444	015		12	091109	1/1/0001
09500	S		CLN	II	02453	016		12	091109	1/1/0001
09500	S		CLN	II	02460	017		12	091109	1/1/0001
09500	S		CLN	II	02489	018		12	091109	1/1/0001

OFFICE: 311

ROUTE: 564

OFFICE: 311		ROUTE: 564		ST_REF_NO: 00000157500		ROCKY HILL TERRACE				
LUMENS	BULB TYPE	MULT SERIES	POLE TYPE	SHADE	ADDRESS NUMBER	REF	LOCATION	TAX DIST	DATE INST	DATE CHANGE
04000	S	M	OUG	II	00000	028	SIDE 321 STONEYBROOK DR.	12	060886	1/1/0001
04000	S	M	OUG	II	03502	020		12	060886	1/1/0001
04000	S	M	OUG	II	03507	021		12	060886	1/1/0001
04000	S	M	OUG	II	03513	022		12	060886	1/1/0001
04000	S	M	OUG	II	03522	023		12	060886	1/1/0001
04000	S	M	OUG	II	03529	024		12	060886	1/1/0001
04000	S	M	OUG	II	03540	025		12	060886	1/1/0001
04000	S	M	OUG	II	03553	026		12	060886	1/1/0001
04000	S	M	OUG	II	03565	027		12	060886	1/1/0001

OFFICE: 311

ROUTE: 564

ST_REF_NO: 00000157600

ROCKY MOUNTAIN CIRCLE

LUMENS	BULB TYPE	MULT SERIES	POLE TYPE	SHADE	ADDRESS NUMBER	REF	LOCATION	TAX DIST	DATE INST	DATE CHANGE
04000	S	M	OUG	II	01405	049		12	011579	1/1/0001
04000	S	M	OUG	V	01417	050		12	011579	1/1/0001

OFFICE: 311

ROUTE: 564

ST_REF_NO: 00000157700

ROCKY POINT COURT

LUMENS	BULB TYPE	MULT SERIES	POLE TYPE	SHADE	ADDRESS NUMBER	REF	LOCATION	TAX DIST	DATE INST	DATE CHANGE
05800	S	M	OUG	II	02300	000		12	062167	1/1/0001

OFFICE: 311

ROUTE: 564

ST_REF_NO: 00000158000

ROGERS ROAD

LUMENS	BULB TYPE	MULT SERIES	POLE TYPE	SHADE	ADDRESS NUMBER	REF	LOCATION	TAX DIST	DATE INST	DATE CHANGE
05800	S	M	OUG	II	00634	030		12	040664	1/1/0001
05800	S	M	OUG	II	00649	031		12	060465	1/1/0001
05800	S	M	OUG	II	00670	032		12	060465	1/1/0001
05800	S	M	OUG	II	00681	033		12	040664	1/1/0001
10000	M	M	OUG	II	00000	001	SIDE OF 2321 PARIS PIKE	12	091582	1/1/0001
05800	S	M	OUG	II	00000	026	SIDE OF 2342 ALLEN DR.	12	040664	1/1/0001
05800	S	M	OUG	II	00000	039	SIDE OF 2323 NANCY LANE	12	040664	1/1/0001
10000	M	M	OUG	II	00120	003		12	091582	1/1/0001
10000	M	M	OUG	II	00120	005		12	091582	1/1/0001
10000	M	M	OUG	II	00131	006		12	071475	1/1/0001
05800	S	M	OUG	II	00131	008	upgraded to 5800 hps cobra 10/07	12	071475	1/1/0001
10000	M	M	OUG	II	00132	007		12	071475	1/1/0001
05800	S	M	OUG	II	00140	009		12	071475	1/1/0001
05800	S	M	OUG	II	00143	010		12	071475	1/1/0001
05800	S	M	OUG	II	00147	012		12	051476	1/1/0001
05800	S	M	OUG	II	00148	011		12	071475	1/1/0001
05800	S	M	OUG	II	00150	013		12	051476	1/1/0001
05800	S	M	OUG	II	00155	014		12	051476	1/1/0001
05800	S	M	OUG	II	00160	015		12	051476	1/1/0001
05800	S	M	OUG	II	00165	016		12	051476	1/1/0001
05800	S	M	OUG	II	00534	041		12	060465	1/1/0001
05800	S	M	OUG	II	00543	040		12	060465	1/1/0001
05800	S	M	OUG	II	00600	027		12	040664	1/1/0001

OFFICE: 311		ROUTE: 564		ST_REF_NO: 00000158000		ROGERS ROAD		LUMENS	BULB TYPE	MULT SERIES	POLE TYPE	SHADE	ADDRESS NUMBER	REF	LOCATION	TAX DIST	DATE INST	DATE CHANGE
	05800	S	M	OUG	II	00621	029									12	060465	1/1/0001

OFFICE: 311		ROUTE: 564		ST_REF_NO: 00000158050		ROJAY DR		LUMENS	BULB TYPE	MULT SERIES	POLE TYPE	SHADE	ADDRESS NUMBER	REF	LOCATION	TAX DIST	DATE INST	DATE CHANGE
	09500	S	M	OUG	III	00000	003								2ND LT W OF NICHOLASVILLE RD,SOUTHSIDE OF ROJAY DR	12	090891	1/1/0001
	09500	S	M	OUG	III	00000	004								2ND LT W OF NICHOLASVILLE RD,NORTHSIDE OF ROJAY DR	12	090891	1/1/0001
	09500	S	M	OUG	III	00000	005								3RD LT W OF NICHOLASVILLE RD,SOUTHSIDE OF ROJAY DR	12	090891	1/1/0001
	09500	S	M	OUG	III	00000	001								1ST LT W OF NICHOLASVILLE RD,SOUTHSIDE OF ROJAY DR	12	090891	1/1/0001
	09500	S	M	OUG	III	00000	002								1ST LT W OF NICHOLASVILLE RD,NORTHSIDE OF ROJAY DR	12	090891	1/1/0001

OFFICE: 311		ROUTE: 564		ST_REF_NO: 00000158100		ROLAND AVENUE		LUMENS	BULB TYPE	MULT SERIES	POLE TYPE	SHADE	ADDRESS NUMBER	REF	LOCATION	TAX DIST	DATE INST	DATE CHANGE
	09500	S	M	OUG	II	00000	061								SIDE OF 1617 CANTRILL RD.	12	050267	1/1/0001
	09500	S	M	OUG	II	00000	062								1 ST. LT. E. OF CANTRILL RD., S. SIDE	12	050267	1/1/0001
	09500	S	M	OUG	II	00000	140								ACROSS FROM 709	12	111067	1/1/0001
	09500	S	M	OUG	II	00717	139									12	101478	1/1/0001

OFFICE: 311		ROUTE: 564		ST_REF_NO: 00000158125		ROLFE LANE		LUMENS	BULB TYPE	MULT SERIES	POLE TYPE	SHADE	ADDRESS NUMBER	REF	LOCATION	TAX DIST	DATE INST	DATE CHANGE
	05800	S	M	CNT	II	01105	001									12	071001	1/1/0001
	05800	S	M	CNT	II	01112	002									12	071001	1/1/0001

OFFICE: 311		ROUTE: 564		ST_REF_NO: 00000158140		ROLLING CREEK LANE		LUMENS	BULB TYPE	MULT SERIES	POLE TYPE	SHADE	ADDRESS NUMBER	REF	LOCATION	TAX DIST	DATE INST	DATE CHANGE
	05800	S	M	CNT	II	00000	008								SIDE OF 4328 BROOKRIDGE DR.	12	030899	1/1/0001
	05800	S	M	CNT	II	00612	007									12	030899	1/1/0001
	05800	S	M	CNT	II	00621	006									12	030899	1/1/0001

OFFICE: 311		ROUTE: 564		ST_REF_NO: 00000158140		ROLLING CREEK LANE				
LUMENS	BULB TYPE	MULT SERIES	POLE TYPE	SHADE	ADDRESS NUMBER	REF	LOCATION	TAX DIST	DATE INST	DATE CHANGE
05800	S	M	CNT	II	00632	005		12	030899	1/1/0001
05800	S	M	CNT	II	00644	004		12	100899	1/1/0001
05800	S	M	CNT	II	00665	003		12	100899	1/1/0001
05800	S	M	CNT	II	00672	002		12	100899	1/1/0001
05800	S	M	CNT	II	00677	001		12	100899	1/1/0001
05800	S	M	CNT	III	04408	001		12	030899	1/1/0001

OFFICE: 311		ROUTE: 564		ST_REF_NO: 00000158150		ROLLINGDALE ROAD				
LUMENS	BULB TYPE	MULT SERIES	POLE TYPE	SHADE	ADDRESS NUMBER	REF	LOCATION	TAX DIST	DATE INST	DATE CHANGE
05800	S	M	CNT	II	02161	031		12	060105	1/1/0001
05800	S	M	CNT	II	02168	030		12	060105	1/1/0001
04000	S	M	OUG	II	02101	001		12	010888	1/1/0001
04000	S	M	OUG	II	02104	002		12	010888	1/1/0001
04000	S	M	OUG	II	02116	003		12	010888	1/1/0001
04000	S	M	OUG	II	02121	004		12	010888	1/1/0001
04000	S	M	OUG	II	02136	005		12	010888	1/1/0001
04000	S	M	OUG	II	02144	006		12	010888	1/1/0001
04000	S	M	OUG	II	02149	007		12	010888	1/1/0001

OFFICE: 311		ROUTE: 564		ST_REF_NO: 00000158160		ROLLING RIDGE DRIVE				
LUMENS	BULB TYPE	MULT SERIES	POLE TYPE	SHADE	ADDRESS NUMBER	REF	LOCATION	TAX DIST	DATE INST	DATE CHANGE
05800	S	M	OUG	II	02613	001		12	101403	1/1/0001
05800	S	M	OUG	II	02624	002		12	101403	1/1/0001
05800	S	M	OUG	II	02632	003		12	101403	1/1/0001

OFFICE: 311		ROUTE: 564		ST_REF_NO: 00000158200		ROMANY ROAD				
LUMENS	BULB TYPE	MULT SERIES	POLE TYPE	SHADE	ADDRESS NUMBER	REF	LOCATION	TAX DIST	DATE INST	DATE CHANGE
09500	S	M	OUG	II	00329	005		12	030165	1/22/2013
09500	S	M	OUG	II	00369	003	bad fixture	12	030165	3/2/2009
05800	S	M	OUG	II	00112	082		12	121665	1/1/0001
05800	S	M	OUG	II	00145	083		12	090165	1/1/0001

OFFICE: 311

ROUTE: 564

ST_REF_NO: 00000158200

ROMANY ROAD

LUMENS	BULB TYPE	MULT SERIES	POLE TYPE	SHADE	ADDRESS NUMBER	REF	LOCATION	TAX DIST	DATE INST	DATE CHANGE
05800	S	M	OUG	II	00166	084		12	090165	1/1/0001
05800	S	M	OUG	II	00000	001	SIDE OF 957 TURKEY FOOT RD.	12	121673	1/1/0001
10000	M	M	OUG	II	00000	002	SIDE OF 1157 COOPER DR.	12	030165	1/1/0001
05800	S	M	OUG	II	00000	008	OPP. 221	12	041957	1/1/0001
05800	S	M	OUG	II	00000	085	SIDE OF 1202 COOPER DR.	12	100265	1/1/0001
05800	S	M	OUG	II	00000	086	SIDE OF 1193 INDIAN MOUND RD.	12	110165	1/1/0001
05800	S	M	OUG	II	00000	087	SIDE OF 1204 INDIAN MOUND RD.	12	110165	1/1/0001
05800	S	M	OUG	II	00000	088	SIDE OF 1195 LAKEWOOD DR.	12	110165	1/1/0001
05800	S	M	OUG	II	00000	089	SIDE OF 1202 LAKEWOOD DR.	12	110165	1/1/0001
05800	S	M	OUG	II	00213	009		12	041957	1/1/0001
10000	M	M	OUG	II	00307	007		12	030165	1/1/0001
10000	M	M	OUG	II	00330	006		12	030165	1/1/0001

OFFICE: 311

ROUTE: 564

ST_REF_NO: 00000158250

ROOKWOOD PARKWAY

LUMENS	BULB TYPE	MULT SERIES	POLE TYPE	SHADE	ADDRESS NUMBER	REF	LOCATION	TAX DIST	DATE INST	DATE CHANGE
05800	S	M	OUG	II	00000	004	SIDE OF 1698 BRYAN STATION RD.	12	060164	1/1/0001
05800	S	M	OUG	II	00000	006	SIDE OF 1696 WAKEFIELD TERRACE	12	060465	1/1/0001
05800	S	M	OUG	II	00000	012	OPP. 388	12	111874	1/1/0001
05800	S	M	OUG	II	00000	014	OPP. 372	12	111874	1/1/0001
05800	S	M	OUG	II	00000	016	OPP. 356	12	111874	1/1/0001
05800	S	M	OUG	II	00364	015		12	111874	1/1/0001
05800	S	M	OUG	II	00380	013		12	111874	1/1/0001
05800	S	M	OUG	II	00405	005		12	060164	1/1/0001
05800	S	M	OUG	II	00417	007		12	040864	1/1/0001
05800	S	M	OUG	II	00420	008		12	040864	1/1/0001
05800	S	M	OUG	II	00425	009		12	040864	1/1/0001
05800	S	M	OUG	II	00432	010		12	040864	1/1/0001
05800	S	M	OUG	II	00437	011		12	060164	1/1/0001
05800	S	M	OUG	II	00444	012		12	040864	1/1/0001
05800	S	M	OUG	II	00449	013		12	040864	1/1/0001
05800	S	M	OUG	II	00464	014		12	040864	1/1/0001
05800	S	M	OUG	II	00477	054		12	030166	1/1/0001

OFFICE: 311

ROUTE: 564

ST_REF_NO: 00000158300

ROOSEVELT BOULEVARD

LUMENS	BULB TYPE	MULT SERIES	POLE TYPE	SHADE	ADDRESS NUMBER	REF	LOCATION	TAX DIST	DATE INST	DATE CHANGE
05800	S	M	SOH	II	00000	062	FRONT SIDE OF 739 GEORGETOWN ST.	12	060892	1/1/0001
05800	S	M	SOH	I	00000	063	SIDE OF 739 GEORGETOWN ST.	12	100769	1/1/0001
04000	S	M	SOH	I	00222	072		12	100769	1/1/0001
04000	S	M	SOH	I	00232	073		12	100769	1/1/0001
04000	S	M	SOH	I	00240	074		12	100769	1/1/0001
04000	S	M	SOH	I	00246	075		12	100769	1/1/0001
04000	S	M	SOH	I	00401	071		12	100769	1/1/0001
04000	S	M	SOH	I	00409	070		12	100769	1/1/0001
04000	S	M	SOH	I	00425	069		12	100769	1/1/0001
04000	S	M	SOH	I	00437	068		12	100769	1/1/0001
04000	S	M	SOH	I	00441	067		12	100769	1/1/0001
04000	S	M	SOH	I	00451	066		12	100769	1/1/0001
04000	S	M	SOH	I	00457	065		12	100769	1/1/0001
05800	S	M	SOH	I	00472	064		12	100769	1/1/0001

OFFICE: 311

ROUTE: 564

ST_REF_NO: 00000158500

ROSE LANE

LUMENS	BULB TYPE	MULT SERIES	POLE TYPE	SHADE	ADDRESS NUMBER	REF	LOCATION	TAX DIST	DATE INST	DATE CHANGE
09500	S	M	SOH	II	00000	001	SIDE OF 429 LINDEN WALK	12	120889	1/1/0001
09500	S	M	SOH	II	00000	002	1ST LT. E. OF ROSE ST., S. SIDE	12	120889	1/1/0001
09500	S	M	SOH	II	00319	003		12	120889	1/1/0001
09500	S	M	SOH	II	00410	004		12	120889	1/1/0001
09500	S	M	SOH	II	00000	005	OPP. AYLESFORD PLACE	12	120889	1/1/0001
09500	S	M	SOH	II	00000	006	OPP. 422	12	120889	1/1/0001
09500	S	M	SOH	II	00000	007	OPP. 446	12	120889	1/1/0001
09500	S	M	SOH	II	00000	008	OPP. 454	12	120889	1/1/0001
09500	S	M	SOH	II	00000	010	OPP. 468	12	120889	1/1/0001
09500	S	M	SOH	II	00460	009		12	120889	1/1/0001

OFFICE: 311

ROUTE: 564

ST_REF_NO: 00000158600

ROSE STREET

LUMENS	BULB TYPE	MULT SERIES	POLE TYPE	SHADE	ADDRESS NUMBER	REF	LOCATION	TAX DIST	DATE INST	DATE CHANGE
22000	S		CNT	II	00000	112	ACROSS FROM WASHINGTON AVE, ON ROSE STREET	12	112410	1/1/0001

OFFICE: 311

ROUTE: 564

ST_REF_NO: 00000158600

ROSE STREET

LUMENS	BULB TYPE	MULT SERIES	POLE TYPE	SHADE	ADDRESS NUMBER	REF	LOCATION	TAX DIST	DATE INST	DATE CHANGE
22000	S		CNT	II	00000	113	1ST LT S OF WASHINGTON AVE, W SIDE ON ROSE ST	12	112410	1/1/0001
22000	S		CNT	II	00000	114	2ND LT S OF WASHINGTON AVE, W SIDE ON ROSE ST	12	112410	1/1/0001
22000	S		CNT	II	00000	115	2ND LT N OF HUGUELETT DR, E SIDE ON ROSE ST	12	112410	1/1/0001
22000	S		CNT	II	00000	116	1ST LT N OF HUGUELETT DR, E SIDE ON ROSE ST	12	112410	1/1/0001
22000	S	M	SOH	II	00000	008	SIDE OF 302 E. HIGH	12	092263	2/9/2010
22000	S	M	CNT	II	00000	102	1ST LT NORTH OF ROSE LN,WEST SIDE ON ROSE STREET	12	102304	1/1/0001
22000	S	M	CNT	II	00000	103	2ND LT NORTH OF ROSE LN,WEST SIDE ON ROSE STREET	12	102304	1/1/0001
22000	S	M	CNT	II	00000	104	1ST LT SOUTH OF ROSE LN,WEST SIDE ON ROSE STREET	12	102304	1/1/0001
22000	S	M	CNT	II	00000	105	2ND LT SOUTH OF ROSE LN,WEST SIDE ON ROSE STREET	12	102304	1/1/0001
22000	S	M	CNT	II	00000	106	3RD LT SOUTH OF ROSE LN,WEST SIDE ON ROSE STREET	12	102304	1/1/0001
22000	S	M	CNT	II	00000	107	1ST LT SOUTH OF COLUMBIA AVE,WEST SIDE ON ROSE STR	12	102304	1/1/0001
22000	S	M	CNT	II	00000	108	2ND LT SOUTH OF COLUMBIA AVE,WEST SIDE ON ROSE STR	12	102304	1/1/0001
22000	S	M	CNT	II	00000	109	3RD LT SOUTH OF COLUMBIA AVE,WEST SIDE ON ROSE STR	12	102304	1/1/0001
22000	S	M	CNT	II	00000	110	4TH LT SOUTH OF COLUMBIA AVE,WEST SIDE ON ROSE STR	12	102304	1/1/0001
22000	S	M	CNT	II	00000	111	5TH LT SOUTH OF COLUMBIA AVE,WEST SIDE ON ROSE STR	12	102304	1/1/0001
50000	S	M	SOH	II	00282	016		12	092263	11/4/2009
22000	S	M	SOH	II	00000	032	SIDE OF 300 ROSE LANE	12	091563	1/1/0001
22000	S	M	OOH	II	00000	035	3RD ST LT. N. OF COLUMBIA AVE., E. SIDE	12	091263	1/1/0001
22000	S	M	SOH	II	00000	038	1ST LT. S. OF COLUMBIA AVE., E. SIDE	12	091263	1/1/0001
22000	S	M	SOH	II	00000	040	2ND LT. S. OF COLUMBIA, E. SIDE	12	091263	1/1/0001
22000	S	M	OOH	II	00000	043	1ST LT. S. OF CLIFTON AVE., W. SIDE	12	091263	1/1/0001
22000	S	M	OOH	II	00000	045	2ND LT. S. OF CLIFTON AVE., W. SIDE	12	091263	1/1/0001
22000	S	M	SOH	II	00414	030		12	091563	1/1/0001
22000	S	M	SOH	II	00462	034		12	091563	1/1/0001
22000	S	M	SOH	II	00474	036		12	091563	1/1/0001
22000	S	M	SOH	II	00538	042		12	091263	1/1/0001

Street Light Listing run 1/11/2015 10:43:21 AM

Page 954 of 1254

OFFICE: 311

ROUTE: 564

ST_REF_NO: 00000158600

ROSE STREET

LUMENS	BULB TYPE	MULT SERIES	POLE TYPE	SHADE	ADDRESS NUMBER	REF	LOCATION	TAX DIST	DATE INST	DATE CHANGE
22000	S	M	SOH	II	00550	044		12	091263	1/1/0001
50000	S	M	OUG	III	00000	001	1ST LT. S. OF EAST MAIN ST., W. SIDE	12	110888	1/1/0001
50000	S	M	OUG	III	00000	002	2ND LT. S. OF EAST MAIN ST., W. SIDE	12	110888	1/1/0001
50000	S	M	OUG	III	00000	003		12	110888	1/1/0001
50000	S	M	OUG	III	00000	004	1ST LT. N. OF EAST VINE ST., W. SIDE	12	110888	1/1/0001
50000	S	M	OUG	II	00000	005	SW CORNER OF VINE AND ROSE	12	050890	1/1/0001
50000	S	M	OUG	III	00000	006	1ST LT. N. OF EAST HIGH ST., W. SIDE	12	110888	1/1/0001
50000	S	M	SOH	III	00000	007	1ST LT. N. OF EAST HIGH ST., E. SIDE	12	110888	1/1/0001
09500	S	M	SOH	II	00000	009	1ST LT. S. OF E. HIGH, W. SIDE	12	092263	1/1/0001
09500	S	M	SOH	II	00000	011	SIDE OF 270 LYNDBURST PLACE	12	091563	1/1/0001
09500	S	M	SOH	II	00000	012	SIDE OF 301 GROSVENOR AVE.	12	092263	1/1/0001
09500	S	M	SOH	II	00000	013	SIDE OF 271 KALMIA ST.	12	092263	1/1/0001
09500	S	M	SOH	II	00000	014	SIDE OF 302 GROSVENOR AVE.	12	092263	1/1/0001
09500	S	M	SOH	II	00000	015	SIDE OF 273 E. MAXWELL	12	092263	1/1/0001
22000	S	M	SOH	II	00000	017	SIDE OF 278 E. MAXWELL ST.	12	091563	1/1/0001
50000	S	M	OUG	III	00000	063	SIDE 330 E. MAIN	12	110888	1/1/0001
50000	S	M	OUG	III	00000	064	2ND LT. SIDE OF 330 E. MAIN	12	110888	1/1/0001
50000	S	M	OUG	III	00136	065		12	110888	1/1/0001
09500	S	M	SOH	II	00224	010		12	092263	1/1/0001
22000	S	M	SOH	II	00316	018		12	092263	1/1/0001
22000	S	M	SOH	II	00329	019		12	091563	1/1/0001
22000	S	M	SOH	II	00332	020		12	092263	1/1/0001
22000	S	M	SOH	II	00353	021		12	091563	1/1/0001
22000	S	M	SOH	II	00368	022		12	092263	1/1/0001
22000	S	M	SOH	II	00376	024		12	092263	1/1/0001
22000	S	M	SOH	II	00377	023		12	091563	1/1/0001
22000	S	M	SOH	II	00391	025		12	092263	1/1/0001
22000	S	M	SOH	II	00400	026		12	091563	1/1/0001
22000	S	M	SOH	II	00408	028		12	091563	1/1/0001
22000	S	M	OUG	II	00000	095	1ST LT. N OF 4TH ST., WESTSIDE	12	040896	1/1/0001
22000	S	M	OUG	II	00000	096	1ST LT. N OF 4TH ST., EASTSIDE	12	040896	1/1/0001
22000	S	M	OUG	II	00000	097	2ND LT. N OF 4TH ST., WESTSIDE	12	040896	1/1/0001
22000	S	M	OUG	II	00000	098	2ND LT. N OF 4TH ST., EASTSIDE	12	040896	1/1/0001
22000	S	M	OUG	II	00000	099	3RD LT. N OF 4TH ST., WESTSIDE	12	040896	1/1/0001

OFFICE: 311

ROUTE: 564

ST_REF_NO: 00000158600

ROSE STREET

LUMENS	BULB TYPE	MULT SERIES	POLE TYPE	SHADE	ADDRESS NUMBER	REF	LOCATION	TAX DIST	DATE INST	DATE CHANGE
22000	S	M	OUG	II	00000	100	1ST LT. S OF 5TH ST., EASTSIDE	12	040896	1/1/0001
22000	S	M	OUG	II	00000	101	1ST LT. S OF 5TH ST., WESTSIDE	12	040896	1/1/0001

OFFICE: 311

ROUTE: 564

ST_REF_NO: 00000158610

ROSE, NORTH STREET

LUMENS	BULB TYPE	MULT SERIES	POLE TYPE	SHADE	ADDRESS NUMBER	REF	LOCATION	TAX DIST	DATE INST	DATE CHANGE
50000	S	M	OUG	II	00000	066	NE CORNER OF ROSE AND MAIN	12	050890	1/1/0001
50000	S	M	OUG	III	00000	067	1ST LT. N. OF E. MAIN ST., W. SIDE	12	070889	1/1/0001
50000	S	M	OUG	III	00000	068	2ND LT. N. OF E. MAIN ST., E. SIDE	12	070889	1/1/0001
50000	S	M	OOH	III	00000	069	1ST LT. S. OF E. SHORT ST., W. SIDE	12	070889	1/1/0001
22000	S	M	OOH	III	00000	070	1ST LT. N. OF EAST SHORT ST., E. SIDE	12	070889	1/1/0001
22000	S	M	OUG	III	00000	071	1ST LT. N. OF E. SHORT ST, W. SIDE	12	070889	1/1/0001
22000	S	M	OUG	III	00000	072	2ND LT. N. OF E. SHORT ST., E. SIDE	12	070889	1/1/0001
22000	S	M	OUG	III	00000	073	2ND LT. N. OF E. SHORT ST., W. SIDE	12	070889	1/1/0001
22000	S	M	OOH	III	00000	074	1ST LT. N. OF WILSON ST., E. SIDE	12	070889	1/1/0001
22000	S	M	OOH	III	00000	075	1ST LT. S. OF CORRAL ST., E. SIDE	12	070889	1/1/0001
22000	S	M	OUG	III	00000	076	ON N.SIDE OF N. ROSE ST. AND DEWEESE CONNECTION	12	070889	1/1/0001
22000	S	M	OUG	III	00000	077	1ST LT. S. OF CORRAL ST., W. SIDE	12	070889	1/1/0001
22000	S	M	OUG	III	00000	078	1ST LT. N. OF CORRAL ST, E. SIDE	12	070889	1/1/0001
22000	S	M	OUG	III	00000	079	1ST LT. N. OF CORRAL ST., W. SIDE	12	070889	1/1/0001
22000	S	M	OOH	III	00000	080	1ST LT. S. OF E. 2ND ST., E. SIDE	12	070889	1/1/0001
22000	S	M	OUG	III	00000	081	1ST LT. N. OF E. 2ND ST., W. SIDE	12	070889	1/1/0001
22000	S	M	OUG	III	00000	083	OPP. GUNN ST.	12	070889	1/1/0001
22000	S	M	OUG	III	00000	084	SIDE OF 300 E. 3RD ST.	12	070889	1/1/0001
22000	S	M	OOH	III	00000	085	SIDE OF 264 E. 3RD ST.	12	070889	1/1/0001
22000	S	M	OUG	III	00000	086	1ST LT. N. OF E. 3RD ST., E. SIDE	12	070889	1/1/0001
22000	S	M	OUG	III	00000	087	1ST LT. N. OF E 3RD ST., W. SIDE	12	070889	1/1/0001
22000	S	M	OUG	II	00000	088	2ND LT. N. OF E. 3RD ST., E. SIDE	12	070889	1/1/0001
22000	S	M	OUG	III	00000	089	2ND LT. N. OF E. 3RD ST., W. SIDE	12	070889	1/1/0001
22000	S	M	OUG	III	00000	091	2ND LT. S. OF E. 4TH ST., W. SIDE	12	070889	1/1/0001
22000	S	M	OUG	III	00000	092	2ND LT. S. OF E. 4TH ST., E. SIDE	12	070889	1/1/0001
22000	S	M	OUG	III	00000	093	SIDE OF 248 E. 4TH ST.	12	070889	1/1/0001
22000	S	M	OUG	III	00000	094	SIDE OF 262 E. 4TH ST.	12	070889	1/1/0001

OFFICE: 311 ROUTE: 564										
ST_REF_NO: 00000158610 ROSE, NORTH STREET										
LUMENS	BULB TYPE	MULT SERIES	POLE TYPE	SHADE	ADDRESS NUMBER	REF	LOCATION	TAX DIST	DATE INST	DATE CHANGE
22000	S	M	OUG	III	00334	090		12	070889	1/1/0001
OFFICE: 311 ROUTE: 564										
ST_REF_NO: 00000158650 ROSEBANK CIRCLE										
LUMENS	BULB TYPE	MULT SERIES	POLE TYPE	SHADE	ADDRESS NUMBER	REF	LOCATION	TAX DIST	DATE INST	DATE CHANGE
04000	S	M	OUG	II	03909	001		12	100890	1/1/0001
OFFICE: 311 ROUTE: 564										
ST_REF_NO: 00000158700 ROSEBERG COURT										
LUMENS	BULB TYPE	MULT SERIES	POLE TYPE	SHADE	ADDRESS NUMBER	REF	LOCATION	TAX DIST	DATE INST	DATE CHANGE
05800	S	M	OUG	II	00000	068	SIDE OF 1243 DEVONPORT DR.	12	041466	1/1/0001
OFFICE: 311 ROUTE: 564										
ST_REF_NO: 00000158800 ROSECRANS DRIVE										
LUMENS	BULB TYPE	MULT SERIES	POLE TYPE	SHADE	ADDRESS NUMBER	REF	LOCATION	TAX DIST	DATE INST	DATE CHANGE
04000	S	M	OUG	II	00000	001	SIDE OF 828 CELIA LANE	12	100888	1/1/0001
04000	S	M	OUG	II	00000	005	SIDE OF 861 LAUREL HILL RD.	12	100888	1/1/0001
04000	S	M	OUG	II	01709	002		12	100888	1/1/0001
04000	S	M	OUG	II	01720	003		12	100888	1/1/0001
04000	S	M	OUG	II	01733	004		12	100888	1/1/0001
OFFICE: 311 ROUTE: 564										
ST_REF_NO: 00000158810 ROSEHILL LANE										
LUMENS	BULB TYPE	MULT SERIES	POLE TYPE	SHADE	ADDRESS NUMBER	REF	LOCATION	TAX DIST	DATE INST	DATE CHANGE
05800	S	M	OUG	II	00000	001	SIDE REAR OF 3917 WYNDHAM RIDGE	12	070899	1/1/0001
05800	S	M	OUG	II	00000	002	SIDE OF 1020 RIDGETREE LANE	12	070899	1/1/0001
OFFICE: 311 ROUTE: 564										
ST_REF_NO: 00000158825 ROSE DALE COURT										
LUMENS	BULB TYPE	MULT SERIES	POLE TYPE	SHADE	ADDRESS NUMBER	REF	LOCATION	TAX DIST	DATE INST	DATE CHANGE
05800	S	M	CNT	II	04451	001		12	080897	1/1/0001
05800	S	M	CNT	II	04458	003		12	080897	1/1/0001

OFFICE: 311

ROUTE: 564

ST_REF_NO: 00000158830

ROSE GLADE CIRCLE

LUMENS	BULB TYPE	MULT SERIES	POLE TYPE	SHADE	ADDRESS NUMBER	REF	LOCATION	TAX DIST	DATE INST	DATE CHANGE
05800	S	M	CNT	II	04450	001		12	080897	1/1/0001
05800	S	M	CNT	II	04459	002		12	080897	1/1/0001

OFFICE: 311

ROUTE: 564

ST_REF_NO: 00000158850

ROSE HURST WAY

LUMENS	BULB TYPE	MULT SERIES	POLE TYPE	SHADE	ADDRESS NUMBER	REF	LOCATION	TAX DIST	DATE INST	DATE CHANGE
05800	S	M	CNT	II	00000	002	SIDE OF 4450 ROSE DALE COURT	12	080897	1/1/0001
05800	S	M	CNT	II	00720	008		12	080897	1/1/0001
05800	S	M	CNT	II	00737	007		12	080897	1/1/0001
05800	S	M	CNT	II	00749	005		12	080897	1/1/0001
05800	S	M	CNT	II	00756	004		12	080897	1/1/0001
05800	S	M	CNT	II	00785	001		12	100899	1/1/0001

OFFICE: 311

ROUTE: 564

ST_REF_NO: 00000158900

ROSEMARY AVENUE

LUMENS	BULB TYPE	MULT SERIES	POLE TYPE	SHADE	ADDRESS NUMBER	REF	LOCATION	TAX DIST	DATE INST	DATE CHANGE
04000	S	M	SOH	II	00000	047	SIDE 1500 N. LIMESTONE	12	060685	1/1/0001
05800	S	M	OUG	III	00000	051	2ND LT. PAST LONETA AVE.	12	020898	1/1/0001
05800	S	M	OUG	II	00000	052	3RD LT. PAST LONETA AVE.	12	020898	1/1/0001
05800	S	M	OUG	III	00000	053	4TH LT. PAST LONETA AVE.	12	020898	1/1/0001
04000	S	M	SOH	II	00104	048		12	060685	1/1/0001
04000	S	M	SOH	II	00113	049		12	060685	1/1/0001
05800	S	M	SOH	II	00118	050		12	090891	1/1/0001

OFFICE: 311

ROUTE: 564

ST_REF_NO: 00000159000

ROSEMILL DRIVE

LUMENS	BULB TYPE	MULT SERIES	POLE TYPE	SHADE	ADDRESS NUMBER	REF	LOCATION	TAX DIST	DATE INST	DATE CHANGE
04000	S	M	OUG	II	00000	082	SIDE OF 2058 CLAYS MILL RD.	12	041583	1/1/0001
05800	S	M	OUG	V	00496	088		12	031583	1/1/0001
04000	S	M	OUG	II	00566	087		12	031583	1/1/0001
04000	S	M	OUG	II	00573	086		12	101583	1/1/0001
04000	S	M	OUG	II	00582	085		12	101583	1/1/0001
04000	S	M	OUG	II	00589	084		12	041583	1/1/0001
04000	S	M	OUG	II	00593	083		12	041583	1/1/0001

OFFICE: 311

ROUTE: 564

ST_REF_NO: 00000159200

ROSEMONT GARDENS

LUMENS	BULB TYPE	MULT SERIES	POLE TYPE	SHADE	ADDRESS NUMBER	REF	LOCATION	TAX DIST	DATE INST	DATE CHANGE
09500	S	M	SOH	II	00000	175	SIDE OF 1815 NICHOLASVILLE RD ON ROSEMONT GRDN	12	061701	1/1/0001
09500	S	M	SOH	II	00000	176	SIDE OF 1815 NICHOLASVILLE RD ON ROSEMONT GRDN	12	061701	1/1/0001
09500	S	M	SOH	II	00000	177	ACROSS FROM 112 ROSEMONT GARDEN	12	061701	1/1/0001
09500	S	M	SOH	II	00000	191	CORNER OF ROSEMENT BRDN AND EDISON DR	12	061701	1/1/0001
09500	S	M	SOH	II	00121	178		12	061701	1/1/0001
09500	S	M	SOH	II	00125	179		12	061701	1/1/0001
09500	S	M	SOH	II	00133	180		12	061701	1/1/0001
09500	S	M	SOH	II	00137	181		12	061701	1/1/0001
09500	S	M	SOH	II	00145	182		12	061701	1/1/0001
09500	S	M	SOH	II	00153	183		12	061701	1/1/0001
09500	S	M	SOH	II	00161	184		12	061701	1/1/0001
09500	S	M	SOH	II	00169	185		12	061701	1/1/0001
09500	S	M	SOH	II	00175	186		12	061701	1/1/0001
09500	S	M	SOH	II	00181	187		12	061701	1/1/0001
09500	S	M	SOH	II	00189	188		12	061701	1/1/0001
09500	S	M	SOH	II	00193	189		12	061701	1/1/0001
09500	S	M	SOH	II	00199	190		12	061701	1/1/0001
22000	S	M	SOH	III	00000	119	NE CORNER OF CLAYS MILL RD.	12	071583	1/1/0001
09500	S	M	SOH	II	00415	171		12	100884	1/1/0001
09500	S	M	SOH	II	00419	172		12	100884	1/1/0001
22000	S	M	OUG	II	00500	125		12	071583	1/1/0001
22000	S	M	OUG	II	00507	124		12	071583	1/1/0001
22000	S	M	OUG	II	00520	123		12	071583	1/1/0001
22000	S	M	OUG	II	00527	122		12	071583	1/1/0001
22000	S	M	OUG	II	00544	121		12	071583	1/1/0001
22000	S	M	OUG	II	00553	120		12	071583	1/1/0001
09500	S	M	SOH	II	00401	169		12	100884	1/1/0001
09500	S	M	SOH	II	00407	170		12	100884	1/1/0001
09500	S	M	SOH	II	00209	157		12	100884	1/1/0001
09500	S	M	SOH	II	00223	158		12	100884	1/1/0001
09500	S	M	SOH	II	00227	159		12	100884	1/1/0001
09500	S	M	SOH	II	00243	160		12	100884	1/1/0001
09500	S	M	SOH	II	00253	161		12	100884	1/1/0001

Street Light Listing run 1/11/2015 10:43:21 AM

Page 959 of 1254

OFFICE: 311

ROUTE: 564

ST_REF_NO: 00000159200

ROSEMONT GARDENS

LUMENS	BULB TYPE	MULT SERIES	POLE TYPE	SHADE	ADDRESS NUMBER	REF	LOCATION	TAX DIST	DATE INST	DATE CHANGE
09500	S	M	SOH	II	00261	162		12	100884	1/1/0001
09500	S	M	SOH	II	00267	163		12	100884	1/1/0001
09500	S	M	SOH	II	00285	164		12	100884	1/1/0001
09500	S	M	SOH	II	00291	165		12	100884	1/1/0001
09500	S	M	SOH	II	00295	166		12	100884	1/1/0001
09500	S	M	SOH	II	00299	167		12	100884	1/1/0001
09500	S	M	SOH	II	00307	168		12	100884	1/1/0001

OFFICE: 311

ROUTE: 564

ST_REF_NO: 00000159300

ROSEWOOD DRIVE

LUMENS	BULB TYPE	MULT SERIES	POLE TYPE	SHADE	ADDRESS NUMBER	REF	LOCATION	TAX DIST	DATE INST	DATE CHANGE
05800	S	M	OUG	II	00000	097	SIDE OF 628	12	010166	1/1/0001
05800	S	M	OUG	II	00603	094		12	010166	1/1/0001
05800	S	M	OUG	II	00612	095		12	010166	1/1/0001
05800	S	M	OUG	II	00631	096		12	010166	1/1/0001
05800	S	M	OUG	II	00657	098		12	010166	1/1/0001
05800	S	M	OUG	II	00668	099		12	010166	1/1/0001
05800	S	M	OUG	II	00685	100		12	010166	1/1/0001

OFFICE: 311

ROUTE: 564

ST_REF_NO: 00000159400

ROSS AVENUE

LUMENS	BULB TYPE	MULT SERIES	POLE TYPE	SHADE	ADDRESS NUMBER	REF	LOCATION	TAX DIST	DATE INST	DATE CHANGE
05800	S	M	SOH	I	00000	199	1ST LT. N. OF W. 3RD , W. SIDE	12	070166	1/1/0001
05800	S	M	SOH	I	00000	202	S. SIDE OF 4TH ST., E. SIDE	12	070166	1/1/0001
05800	S	M	SOH	I	00000	203	SIDE OF 478 W. 4TH ST.	12	070166	1/1/0001
05800	S	M	SOH	I	00331	200		12	070166	1/1/0001
05800	S	M	SOH	I	00343	201		12	070166	1/1/0001

OFFICE: 311

ROUTE: 564

ST_REF_NO: 00000159410

ROSSINI PLACE

LUMENS	BULB TYPE	MULT SERIES	POLE TYPE	SHADE	ADDRESS NUMBER	REF	LOCATION	TAX DIST	DATE INST	DATE CHANGE
09500	S		CLN	III	02412	002		12	072213	1/1/0001
09500	S		CLN	III	02417	003		12	072213	1/1/0001
09500	S		CLN	III	02433	004		12	072213	1/1/0001

OFFICE: 311

ROUTE: 564

ST_REF_NO: 00000159410

ROSSINI PLACE

LUMENS	BULB TYPE	MULT SERIES	POLE TYPE	SHADE	ADDRESS NUMBER	REF	LOCATION	TAX DIST	DATE INST	DATE CHANGE
09500	S		CLN	III	02445	005		12	072213	1/1/0001

OFFICE: 311

ROUTE: 564

ST_REF_NO: 00000159435

ROSSLYNS DALE

LUMENS	BULB TYPE	MULT SERIES	POLE TYPE	SHADE	ADDRESS NUMBER	REF	LOCATION	TAX DIST	DATE INST	DATE CHANGE
05800	S	M	OUG	II	00000	001	SIDE OF 3828 EVERETTS DALE ON ROSSLYNS DALE	12	030206	1/1/0001
05800	S	M	OUG	II	00000	007	SIDE OF 3817 WINTHROP DR ON ROSSLYNS DALE	12	030206	1/1/0001
05800	S	M	OUG	II	00708	006		12	030206	1/1/0001
05800	S	M	OUG	II	00725	005		12	030206	1/1/0001
05800	S	M	OUG	II	00740	004		12	030206	1/1/0001
05800	S	M	OUG	II	00757	003		12	030206	1/1/0001
05800	S	M	OUG	II	00773	002		12	030206	1/1/0001

OFFICE: 311

ROUTE: 564

ST_REF_NO: 00000159470

ROSWELL DRIVE

LUMENS	BULB TYPE	MULT SERIES	POLE TYPE	SHADE	ADDRESS NUMBER	REF	LOCATION	TAX DIST	DATE INST	DATE CHANGE
05800	S	M	CNT	II	00000	025	4TH LT N OF SMYRNA LN, W SIDE ON ROSWELL DR	12	041002	1/1/0001
05800	S	M	CNT	II	00000	026	4TH LT N OF SMYRNA LN, E SIDE ON ROSWELL DR	12	041002	1/1/0001
05800	S	M	CNT	II	00000	027	5TH LT N OF SMYRNA LN, W SIDE ON ROSWELL DR	12	041002	1/1/0001
05800	S	M	CNT	II	00000	028	5TH LT N OF SMYRNA LN, E SIDE ON ROSWELL DR	12	041002	1/1/0001
05800	S	M	CNT	II	00000	029	1ST LT N OF TUPELO LN, W SIDE ON ROSWELL DR	12	041002	1/1/0001
05800	S	M	CNT	II	00000	030	1ST LT N OF TUPELO LN, E SIDE ON ROSWELL DR	12	041002	1/1/0001
05800	S	M	CNT	II	00000	031	2ND LT N OF TUPLEO LN, W SIDE ON ROSWELL DR	12	041002	1/1/0001
05800	S	M	CNT	II	00000	032	2ND LT N OF TUPLEO LN, E SIDE ON ROSWELL DR	12	041002	1/1/0001
05800	S	M	CNT	II	00000	033	3RD LT N OF TUPELO LN, W SIDE ON ROSWELL DR	12	041002	1/1/0001
05800	S	M	CNT	II	00000	034	3RD LT N OF TUPELO LN, E SIDE ON ROSWELL DR	12	041002	1/1/0001
05800	S	M	CNT	II	00000	035	4TH LT N OF TUPELO LN, W SIDE ON ROSWELL DR	12	041002	1/1/0001
05800	S	M	CNT	II	00000	036	4TH LT N OF TUPELO LN, E SIDE ON ROSWELL DR	12	041002	1/1/0001
05800	S	M	CNT	II	00000	040	SIDE OF 2173 SAVANNAH LANE ON ROSWELL DR	12	041002	1/1/0001
05800	S	M	CNT	II	00000	045	SIDE OF 2188 CAROLINA ON ROSWELL DR	12	081704	1/1/0001
05800	S	M	CNT	II	02128	044		12	081704	1/1/0001
05800	S	M	CNT	II	02137	043		12	081704	1/1/0001
05800	S	M	CNT	II	02141	042		12	081704	1/1/0001
05800	S	M	CNT	II	02152	041		12	081704	1/1/0001

OFFICE: 311

ROUTE: 564

ST_REF_NO: 00000159470

ROSWELL DRIVE

LUMENS	BULB TYPE	MULT SERIES	POLE TYPE	SHADE	ADDRESS NUMBER	REF	LOCATION	TAX DIST	DATE INST	DATE CHANGE
05800	S	M	CNT	II	02173	039		12	041002	1/1/0001
05800	S	M	CNT	II	02184	038		12	041002	1/1/0001
05800	S	M	CNT	II	02193	037		12	041002	1/1/0001
05800	S	M	CNT	II	00000	001	REAR OF 2296 SAVANNAH LANE	12	100899	1/1/0001
05800	S	M	CNT	II	00000	002	REAR OF 1200 BIRMINGHAM LANE	12	100899	1/1/0001
05800	S	M	CNT	II	00000	003	REAR OF 2297 SAVANNAH LANE	12	100899	1/1/0001
05800	S	M	CNT	II	00000	004	REAR OF 1204 BIRMINGHAM LANE	12	100899	1/1/0001
05800	S	M	CNT	II	00000	005	REAR OF 2293 SAVANNAH LANE	12	100899	1/1/0001
05800	S	M	CNT	II	00000	006	REAR OF 1208 BIRMINGHAM LANE	12	100899	1/1/0001
05800	S	M	CNT	II	00000	008	SIDE OF 1240 BIRMINGHAM LANE	12	100899	1/1/0001
05800	S	M	CNT	II	00000	009	REAR OF 1301 ALPHARETTA CT.	12	100899	1/1/0001
05800	S	M	CNT	II	00000	010	SIDE OF 1245 BIRMINGHAM LANE	12	100899	1/1/0001
05800	S	M	CNT	II	00000	011	SIDE OF 1300 SMYRNA LANE	12	100899	1/1/0001
05800	S	M	CNT	II	00000	012	1ST LT. N OF SMYRNA LANE, EASTSIDE	12	100899	1/1/0001
05800	S	M	CNT	II	00000	013	SIDE OF 1301 SMYRNA LANE	12	100899	1/1/0001
05800	S	M	CNT	II	00000	014	2ND LT. N OF SMYRNA LANE, EASTSIDE	12	100899	1/1/0001
05800	S	M	CNT	II	00000	015	2ND LT. N OF SMYRNA LANE, WESTSIDE	12	100899	1/1/0001
05800	S	M	CNT	II	00000	016	3RD LT. N OF SMYRNA LANE, EASTSIDE	12	100899	1/1/0001
05800	S	M	CNT	II	00000	017	3RD LT. N OF SMYRNA LANE, WESTSIDE	12	100899	1/1/0001
05800	S	M	CNT	II	00000	007	REAR OF 1300 ALPHARETTA CT.	12	100899	1/1/0001

OFFICE: 311

ROUTE: 564

ST_REF_NO: 00000159490

ROUNDWAY DOWN LANE

LUMENS	BULB TYPE	MULT SERIES	POLE TYPE	SHADE	ADDRESS NUMBER	REF	LOCATION	TAX DIST	DATE INST	DATE CHANGE
05800	S	M	CNT	II	00000	011	SIDE OF 2177 MARKET GARDEN LN ON ROUNDWAY DOWN LN	12	101905	1/1/0001
05800	S	M	CNT	II	03017	010		12	101905	1/1/0001
05800	S	M	CNT	II	03028	009		12	101905	1/1/0001
05800	S	M	CNT	II	03049	008		12	101905	1/1/0001
05800	S	M	CNT	II	03060	007		12	101905	1/1/0001
05800	S	M	CNT	II	03084	006		12	101905	1/1/0001
05800	S	M	CNT	II	03116	005		12	101905	1/1/0001
05800	S	M	CNT	II	03132	004		12	101905	1/1/0001
05800	S	M	CNT	II	03148	003		12	101905	1/1/0001

OFFICE: 311

ROUTE: 564

ST_REF_NO: 00000159490

ROUNDWAY DOWN LANE

LUMENS	BULB TYPE	MULT SERIES	POLE TYPE	SHADE	ADDRESS NUMBER	REF	LOCATION	TAX DIST	DATE INST	DATE CHANGE
05800	S	M	CNT	II	03165	002		12	101905	1/1/0001
05800	S	M	CNT	II	03172	001		12	101905	1/1/0001

OFFICE: 311

ROUTE: 564

ST_REF_NO: 00000159493

RESERVE COURT

LUMENS	BULB TYPE	MULT SERIES	POLE TYPE	SHADE	ADDRESS NUMBER	REF	LOCATION	TAX DIST	DATE INST	DATE CHANGE
05800	S	M	OUG	II	00000	002	1ST LT W OF RESERVE RD, SOUTH SIDE ON RESERVE CT	12	020106	1/1/0001
05800	S	M	OUG	II	00000	003	2ND LT W OF RESERVE RD, SOUTH SIDE ON RESERVE CT	12	020106	1/1/0001

OFFICE: 311

ROUTE: 564

ST_REF_NO: 00000159500

ROXBURG DRIVE

LUMENS	BULB TYPE	MULT SERIES	POLE TYPE	SHADE	ADDRESS NUMBER	REF	LOCATION	TAX DIST	DATE INST	DATE CHANGE
05800	S	M	OUG	II	03229	016		12	120890	2/1/2010
05800	S	M	OUG	II	03319	028	bad fixture	12	050891	3/17/2010
04000	S	M	OUG	II	00000	003	SIDE OF 766 CINDY BLAIR WAY ON ROXBURG	12	120890	1/1/0001
04000	S	M	OUG	II	00000	004	SIDE OF 775 CINDY BLAIR WAY ON ROXBURG DR	12	120890	1/1/0001
04000	S	M	OUG	II	00000	021	SIDE OF 739 CINDY BLAIR WAY ON ROXBURG DR	12	120890	1/1/0001
04000	S	M	OUG	II	03119	001		12	050891	1/1/0001
04000	S	M	OUG	II	03120	002		12	050891	1/1/0001
04000	S	M	OUG	II	03147	005		12	120890	1/1/0001
04000	S	M	OUG	II	03148	006		12	120890	1/1/0001
04000	S	M	OUG	II	03159	007		12	120890	1/1/0001
04000	S	M	OUG	II	03164	008		12	120890	1/1/0001
04000	S	M	OUG	II	03175	009		12	120890	1/1/0001
04000	S	M	OUG	II	03184	010		12	120890	1/1/0001
04000	S	M	OUG	II	03195	011		12	120890	1/1/0001
04000	S	M	OUG	II	03200	012		12	120890	1/1/0001
04000	S	M	OUG	II	03209	013		12	120890	1/1/0001
04000	S	M	OUG	II	03216	014		12	120890	1/1/0001
04000	S	M	OUG	II	03224	015		12	120890	1/1/0001
04000	S	M	OUG	II	03239	017		12	120890	1/1/0001
04000	S	M	OUG	II	03246	018		12	120890	1/1/0001
04000	S	M	OUG	II	03255	019		12	120890	1/1/0001

OFFICE: 311

ROUTE: 564

ST_REF_NO: 00000159500

ROXBURG DRIVE

LUMENS	BULB TYPE	MULT SERIES	POLE TYPE	SHADE	ADDRESS NUMBER	REF	LOCATION	TAX DIST	DATE INST	DATE CHANGE
04000	S	M	OUG	II	03262	020		12	120890	1/1/0001
04000	S	M	OUG	II	03278	022		12	120890	1/1/0001
04000	S	M	OUG	II	03282	023		12	050891	1/1/0001
04000	S	M	OUG	II	03291	024		12	050891	1/1/0001
04000	S	M	OUG	II	03294	025		12	050891	1/1/0001
04000	S	M	OUG	II	03303	026		12	050891	1/1/0001
04000	S	M	OUG	II	03310	027		12	050891	1/1/0001

OFFICE: 311

ROUTE: 564

ST_REF_NO: 00000159600

ROYAL AVENUE

LUMENS	BULB TYPE	MULT SERIES	POLE TYPE	SHADE	ADDRESS NUMBER	REF	LOCATION	TAX DIST	DATE INST	DATE CHANGE
05800	S	M	SOH	II	00000	001	BETWEEN HILLCREST & LOUDEN	12	110160	1/1/0001
05800	S	M	SOH	II	00000	002	OPP. 920	12	110160	1/1/0001
05800	S	M	SOH	II	00000	003	SIDE OF 553 E. 7TH ST.	12	110160	1/1/0001
05800	S	M	SOH	II	00902	000		12	110160	1/1/0001
05800	S	M	SOH	II	00908	000		12	110160	1/1/0001
05800	S	M	SOH	II	00912	000		12	110160	1/1/0001
05800	S	M	SOH	II	00918	000		12	110160	1/1/0001
05800	S	M	SOH	II	00924	000		12	110160	1/1/0001
05800	S	M	SOH	II	01004	000		12	110160	1/1/0001

OFFICE: 311

ROUTE: 564

ST_REF_NO: 00000159650

ROYAL TROON ROAD

LUMENS	BULB TYPE	MULT SERIES	POLE TYPE	SHADE	ADDRESS NUMBER	REF	LOCATION	TAX DIST	DATE INST	DATE CHANGE
05800	S	M	CNT	II	03201	011		12	100901	1/1/0001
05800	S	M	CNT	II	03225	010		12	100901	1/1/0001
05800	S	M	CNT	II	03244	009		12	100901	1/1/0001
05800	S	M	CNT	II	03256	008		12	100901	1/1/0001
05800	S	M	CNT	II	03285	007		12	100901	1/1/0001
05800	S	M	CNT	II	03301	006		12	100901	1/1/0001
05800	S	M	CNT	II	03316	005		12	100901	1/1/0001
05800	S	M	CNT	II	03352	004		12	100901	1/1/0001
05800	S	M	CNT	II	03357	003		12	100901	1/1/0001
05800	S	M	CNT	II	03381	002		12	100901	1/1/0001

OFFICE: 311

ROUTE: 564

ST_REF_NO: 00000159650

ROYAL TROON ROAD

LUMENS	BULB TYPE	MULT SERIES	POLE TYPE	SHADE	ADDRESS NUMBER	REF	LOCATION	TAX DIST	DATE INST	DATE CHANGE
05800	S	M	CNT	II	03392	001		12	100901	1/1/0001

OFFICE: 311

ROUTE: 564

ST_REF_NO: 00000159800

ROYALTY COURT

LUMENS	BULB TYPE	MULT SERIES	POLE TYPE	SHADE	ADDRESS NUMBER	REF	LOCATION	TAX DIST	DATE INST	DATE CHANGE
05800	S	M	SOH	V	01337	003		12	040466	1/1/0001
05800	S	M	OUG	II	01352	002		12	090166	1/1/0001
05800	S	M	OUG	II	01357	001		12	090166	1/1/0001

OFFICE: 311

ROUTE: 564

ST_REF_NO: 00000159950

RUCCIO WAY

LUMENS	BULB TYPE	MULT SERIES	POLE TYPE	SHADE	ADDRESS NUMBER	REF	LOCATION	TAX DIST	DATE INST	DATE CHANGE
09500	S	M	CNT	II	00000	001	3RD LT. S OF SPORTING CT., E SIDE	12	080800	1/1/0001
09500	S	M	CNT	II	00000	002	3RD LT. S OF SPORTING CT., W SIDE	12	080800	1/1/0001
09500	S	M	CNT	II	00000	003	2ND LT. S OF SPORTING CT., E SIDE	12	080800	1/1/0001
09500	S	M	CNT	II	00000	004	2ND LT. S OF SPORTING CT., W SIDE	12	080800	1/1/0001
09500	S	M	CNT	II	00000	005	1ST LT. S OF SPORTING CT., E SIDE	12	080800	1/1/0001
09500	S	M	CNT	II	00000	006	1ST LT. S SPORTING CT., W SIDE	12	080800	1/1/0001
09500	S	M	CNT	II	00000	007	1ST LT. N OF SPORTING CT., E SIDE	12	080800	1/1/0001
09500	S	M	CNT	II	00000	008	OPP. 285	12	080800	1/1/0001
09500	S	M	CNT	II	00000	009	OPP. 285	12	080800	1/1/0001
09500	S	M	CNT	II	00000	011	OPP. 261	12	080800	1/1/0001
09500	S	M	CNT	II	00000	014	4TH LT. N OF REYNOLDS RD., NE SIDE	12	080800	1/1/0001
09500	S	M	CNT	II	00000	015	4TH LT. N OF REYNOLDS RD., W SIDE	12	080800	1/1/0001
09500	S	M	CNT	II	00000	016	3RD LT. N OF REYNOLDS RD., E SIDE	12	080800	1/1/0001
09500	S	M	CNT	II	00000	017	3RD LT. N OF REYNOLDS RD., W SIDE	12	080800	1/1/0001
09500	S	M	CNT	II	00000	018	2ND LT. N OF REYNOLDS RD., E SIDE	12	080800	1/1/0001
09500	S	M	CNT	II	00000	019	2ND LT. N OF REYNOLDS RD., W SIDE	12	080800	1/1/0001
09500	S	M	CNT	II	00000	020	1ST LT. N OF REYNOLDS RD., E SIDE	12	080800	1/1/0001
09500	S	M	CNT	II	00000	021	1ST LT. N OF REYNOLDS RD., W SIDE	12	080800	1/1/0001
09500	S	M	CNT	II	00249	013		12	080800	1/1/0001
09500	S	M	CNT	II	00261	012		12	080800	1/1/0001
09500	S	M	CNT	II	00273	010		12	080800	1/1/0001

OFFICE: 311

ROUTE: 564

ST_REF_NO: 00000160000

RUGBY ROAD

LUMENS	BULB TYPE	MULT SERIES	POLE TYPE	SHADE	ADDRESS NUMBER	REF	LOCATION	TAX DIST	DATE INST	DATE CHANGE
09500	S	M	OUG	II	00213	000		12	092260	1/1/0001
09500	S	M	OUG	II	00220	000		12	092260	1/1/0001
09500	S	M	OUG	II	00227	000		12	092260	1/1/0001
09500	S	M	OUG	II	00000	001	SIDE OF 130 CHANTILLY	12	120660	1/1/0001
09500	S	M	OUG	II	00137	000		12	120660	1/1/0001
09500	S	M	OUG	II	00142	000		12	120660	1/1/0001
09500	S	M	OUG	II	00154	000		12	120660	1/1/0001
09500	S	M	OUG	II	00155	000		12	120660	1/1/0001
09500	S	M	OUG	II	00162	000		12	120660	1/1/0001
09500	S	M	OUG	II	00174	000		12	121659	1/1/0001
09500	S	M	OUG	II	00201	000		12	121659	1/1/0001
09500	S	M	OUG	II	00206	000		12	050160	1/1/0001

OFFICE: 311

ROUTE: 564

ST_REF_NO: 00000160100

RUNNYMEDE WAY

LUMENS	BULB TYPE	MULT SERIES	POLE TYPE	SHADE	ADDRESS NUMBER	REF	LOCATION	TAX DIST	DATE INST	DATE CHANGE
04000	S	M	OUG	II	02852	019		12	041470	1/1/0001
04000	S	M	OUG	II	02861	018		12	050172	1/1/0001
04000	S	M	OUG	II	02872	017		12	080173	1/1/0001
04000	S	M	OUG	II	02881	016		12	101570	1/1/0001
04000	S	M	OUG	II	00000	005	SIDE OF 434 WESTERFIELD WAY	12	062174	1/1/0001
04000	S	M	OUG	II	02892	015		12	041470	1/1/0001
04000	S	M	OUG	II	02901	014		12	041470	1/1/0001
04000	S	M	OUG	II	02912	013		12	050172	1/1/0001
04000	S	M	OUG	II	02921	012		12	101570	1/1/0001
04000	S	M	OUG	II	02933	011		12	041470	1/1/0001
04000	S	M	OUG	II	02940	010		12	101570	1/1/0001
04000	S	M	OUG	II	02953	009		12	101570	1/1/0001
04000	S	M	OUG	II	02972	008		12	101570	1/1/0001
04000	S	M	OUG	II	02979	007		12	062174	1/1/0001
04000	S	M	OUG	II	02988	006		12	050172	1/1/0001

OFFICE: 311		ROUTE: 564		ST_REF_NO: 00000160200		RUSHWOOD COURT		LUMENS	BULB TYPE	MULT SERIES	POLE TYPE	SHADE	ADDRESS NUMBER	REF	LOCATION	TAX DIST	DATE INST	DATE CHANGE
05800	S	M	OUG	II	00000	080	SIDE OF 849 NANDINO BLVD.	12	111476							12	111476	1/1/0001
05800	S	M	OUG	II	00833	079		12	051480							12	051480	1/1/0001
05800	S	M	OUG	II	00833	081		12	051480							12	051480	1/1/0001
05800	S	M	OUG	V	01016	101		12	051480							12	051480	1/1/0001
05800	S	M	OUG	II	01017	099		12	051480							12	051480	1/1/0001
05800	S	M	OUG	V	01033	100		12	051480							12	051480	1/1/0001

OFFICE: 311		ROUTE: 564		ST_REF_NO: 00000160300		RUSSELL AVENUE		LUMENS	BULB TYPE	MULT SERIES	POLE TYPE	SHADE	ADDRESS NUMBER	REF	LOCATION	TAX DIST	DATE INST	DATE CHANGE
05800	S	M	SOH	II	00000	003	SIDE OF 165 BELL CT. W.	12	070162							12	070162	1/1/0001
05800	S	S	SOH	II	00000	004	OPP. 601	12	070162							12	070162	1/1/0001
05800	S	M	SOH	II	00509	001		12	070162							12	070162	1/1/0001
05800	S	S	SOH	II	00519	002		12	070162							12	070162	1/1/0001
05800	S	M	SOH	II	00615	005		12	070162							12	070162	1/1/0001

OFFICE: 311		ROUTE: 564		ST_REF_NO: 00000160500		RUSSELL CAVE ROAD		LUMENS	BULB TYPE	MULT SERIES	POLE TYPE	SHADE	ADDRESS NUMBER	REF	LOCATION	TAX DIST	DATE INST	DATE CHANGE
22000	S		SOH	II	00890	500		12	011113							12	011113	1/1/0001
09500	S	M	SOH	III	00000	040	2ND LT. N. OF SWIGERT AVE., E. SIDE	22	070885							22	070885	1/1/0001
09500	S	M	SOH	III	00000	041	1ST LT. N. OF SWIGERT AVE., W. SIDE	22	070885							22	070885	1/1/0001
09500	S	M	SOH	III	00000	042	NE CORNER OF SWIGERT AVE	22	070885							22	070885	1/1/0001
09500	S	M	SOH	III	00000	044	1ST LT. S. OF SWIGERT AVE., W. SIDE	22	070885							22	070885	1/1/0001
09500	S	M	SOH	III	00000	054	1ST LT. S. OF SWIGERT AVE., W. SIDE	22	070885							22	070885	1/1/0001
22000	S	M	OUG	II	00000	211	4TH LT N OF RADCLIFFE ON EASTSIDE OF RUSSELL CAVE	12	120890							12	120890	1/1/0001
22000	S	M	OUG	II	00000	212	5TH LT N OF RADCLIFFE ON EASTSIDE OF RUSSELL CAVE	12	120890							12	120890	1/1/0001
09500	S	M	SOH	II	00000	304	1ST LT. S OF HUGHES LAND, EASTSIDE	12	020899							12	020899	1/1/0001
09500	S	M	SOH	II	00000	305	1ST LT. N OF HUGHES LANE, EASTSIDE	12	020899							12	020899	1/1/0001
05800	S	M	SOH	II	00000	306	1ST LT. S OF GREENWICH RD., EASTSIDE	12	020899							12	020899	1/1/0001
05800	S	M	SOH	II	00000	307	1ST LT. N OF GREENWICH RD., WESTSIDE	12	020899							12	020899	1/1/0001
05800	S	M	OUG	II	00000	308	1ST LT. N OF GREENWICH RD., EASTSIDE	12	020899							12	020899	1/1/0001
09500	S	M	SOH	II	00000	309	1ST LT. S OF LEMONS MILL RD., EASTSIDE	12	020899							12	020899	1/1/0001

OFFICE: 311

ROUTE: 564

ST_REF_NO: 00000160500

RUSSELL CAVE ROAD

LUMENS	BULB TYPE	MULT SERIES	POLE TYPE	SHADE	ADDRESS NUMBER	REF	LOCATION	TAX DIST	DATE INST	DATE CHANGE
09500	S	M	SOH	II	00000	310	1ST LT. N OF LEMONS MILL RD., EASTSIDE	12	020899	1/1/0001
09500	S	M	OUG	II	00000	311	1ST LT. N OF LEMONS MILL RD., EASTSIDE	12	020899	1/1/0001
09500	S	M	OUG	II	00000	312	1ST LT. S OF FERGUSON RD., WESTSIDE	12	020899	1/1/0001
09500	S	M	OUG	II	00000	313	1ST LT. N OF FERGUSON RD., WESTSIDE	12	020899	1/1/0001
09500	S	M	OUG	II	00000	314	1ST LT. S OF CARRICK RD., WESTSIDE	12	020899	1/1/0001
09500	S	M	SOH	II	00000	315	1ST LT. N OF CARRICK RD., WESTSIDE	12	020899	1/1/0001
09500	S	M	OUG	II	00000	316	1ST LT. S OF HUME BEDFORD RD., WESTSIDE	12	020899	1/1/0001
05800	S	M	SOH	II	00000	336	1ST LT. W OF GREENWICH RD., WESTSIDE	12	020899	1/1/0001
20000	M	M	OUG	II	00000	028	SOUTHSIDE BETWEEN BOARDWALK	12	020800	1/1/0001
20000	M	M	OUG	II	00000	030	SOUTHSIDE BETWEEN BOARDWALK	12	020800	1/1/0001
20000	M	M	OUG	II	00000	032	SOUTHSIDE BETWEEN BOARDWALK	12	020800	1/1/0001
22000	S	M	OUG	II	00000	130	1ST LT N OF NEW CIRCLE RD WESTSIDE OF RUSSELL CAVE	12	120890	1/1/0001
22000	S	M	SOH	II	00000	131	1ST LT N OF NEW CIRCLE RD EASTSIDE OF RUSSELL CAVE	12	120890	1/1/0001
22000	S	M	OUG	II	00000	132	2ND LT N OF NEW CIRCLE RD WESTSIDE OF RUSSELL CAVE	12	120890	1/1/0001
22000	S	M	SOH	II	00000	133	2ND LT N OF NEW CIRCLE EASTSIDE OF RUSSELL CAVE	12	120890	1/1/0001
22000	S	M	SOH	II	00000	134	3RD LT N OF NEW CIRCLE WESTSIDE OF RUSSELL CAVE	12	120890	1/1/0001
22000	S	M	SOH	II	00000	135	3RD LT N OF NEW CIRCLE ON EASTSIDE OF RUSSELL CAVE	12	040891	1/1/0001
22000	S	M	OUG	II	00000	136	4TH LT N OF NEW CIRCLE RD WESTSIDE OF RUSSELL CAVE	12	120890	1/1/0001
22000	S	M	OOH	II	00000	137	4TH LT N OF NEW CIRCLE EASTSIDE OF RUSSELL CAVE	12	120890	1/1/0001
22000	S	M	OOH	II	00000	138	3RD LT S OF HOLLOW CREEK WESTSIDE OF RUSSELL CAVE	12	120890	1/1/0001
22000	S	M	OUG	II	00000	140	2ND LT S OF HOLLOW CREEK WESTSIDE OF RUSSELL CAVE	12	120890	1/1/0001
22000	S	M	OUG	II	00000	142	1ST LT S OF HOLLOW CREEK WESTSIDE OF RUSSELL CAVE	12	120890	1/1/0001
22000	S	M	SOH	II	00000	145	SIDE OF 401 HOLLOW CREEK ON RUSSELL CAVE	12	120890	1/1/0001
22000	S	M	SOH	II	00000	146	2ND LT N OF HOLLOW CREEK WESTSIDE OF RUSSELL CAVE	12	120890	1/1/0001
22000	S	M	OUG	II	00000	147	1ST LT NORTH OF HAWTHORNE EASTSIDE OF RUSSELL CAVE	12	120890	1/1/0001

OFFICE: 311

ROUTE: 564

ST_REF_NO: 00000160500

RUSSELL CAVE ROAD

LUMENS	BULB TYPE	MULT SERIES	POLE TYPE	SHADE	ADDRESS NUMBER	REF	LOCATION	TAX DIST	DATE INST	DATE CHANGE
22000	S	M	SOH	II	00000	150	OPP. 1586 RUSSELL CAVE	12	040891	1/1/0001
22000	S	M	SOH	II	00000	151	OPP. 1590 RUSSELL CAVE	12	120890	1/1/0001
22000	S	M	SOH	II	00000	153	OPP. 1598 RUSSELL CAVE	12	120890	1/1/0001
22000	S	M	OUG	II	00000	154	3RD LT S OF CANE RUN ON EASTSIDE OF RUSSELL CAVE	12	120890	1/1/0001
22000	S	M	SOH	II	00000	155	3RD LT S OF ASBURY LN ON WESTSIDE OF RUSSELL CAVE	12	120890	1/1/0001
22000	S	M	OUG	II	00000	156	2ND LT S OF CANE RUN ON EASTSIDE OF RUSSELL CAVE	12	120890	1/1/0001
22000	S	M	SOH	II	00000	157	2ND LT S OF ASBURY LN ON WESTSIDE OF RUSSELL CAVE	12	120890	1/1/0001
22000	S	M	OUG	II	00000	158	1ST LT S OF CANE RUN ON EASTSIDE OF RUSSELL CAVE	12	120890	1/1/0001
22000	S	M	SOH	II	00000	160	END OF MEDIAN @ ASBURY LN ON WESTSIDE OF RUSSELL C	12	120890	1/1/0001
22000	S	M	OUG	II	00000	161	1ST LT N OF CANE RUN ON EASTSIDE OF RUSSELL CAVE	12	120890	1/1/0001
22000	S	M	SOH	II	00000	162	SIDE OF 401 ASBURY LN ON RUSSELL CAVE	12	120890	1/1/0001
22000	S	M	OUG	II	00000	163	2ND LT N OF CANE RUN ON EASTSIDE OF RUSSELL CAVE	12	120890	1/1/0001
22000	S	M	SOH	II	00000	164	2ND LT NORTH OF ASBURY LN ON WESTSIDE OF RUSSELL C	12	120890	1/1/0001
22000	S	M	OUG	II	00000	165	3RD LT N OF CANE RUN ON EASTSIDE OF RUSSELL CAVE	12	120890	1/1/0001
22000	S	M	SOH	II	00000	166	OPP. 1678 RUSSELL CAVE	12	120890	1/1/0001
22000	S	M	OUG	II	01506	139		12	120890	1/1/0001
22000	S	M	OUG	II	01510	141		12	120890	1/1/0001
22000	S	M	OUG	II	01518	143		12	120890	1/1/0001
22000	S	M	OUG	II	01522	144		12	120890	1/1/0001
22000	S	M	SOH	II	01545	148		12	120890	1/1/0001
22000	S	M	OUG	II	01578	149		12	120890	1/1/0001
22000	S	M	OUG	II	01594	152		12	120890	1/1/0001
22000	S	M	SOH	II	00000	168	OPP. 1686 RUSSELL CAVE	12	120890	1/1/0001
22000	S	M	OUG	II	00000	170	OPP. 1690 RUSSELL CAVE	12	120890	1/1/0001
22000	S	M	SOH	II	00000	171	OPP. 1694 RUSSELL CAVE	12	120890	1/1/0001
22000	S	M	SOH	II	00000	173	OPP. SOUTHRIDGE DR WESTSIDE OF RUSSELL CAVE	12	120890	1/1/0001

OFFICE: 311

ROUTE: 564

ST_REF_NO: 00000160500

RUSSELL CAVE ROAD

LUMENS	BULB TYPE	MULT SERIES	POLE TYPE	SHADE	ADDRESS NUMBER	REF	LOCATION	TAX DIST	DATE INST	DATE CHANGE
22000	S	M	OUG	II	00000	175	OPP. 1704 RUSSELL CAVE	12	120890	1/1/0001
22000	S	M	SOH	II	00000	176	OPP. 1706 RUSSELL CAVE	12	120890	1/1/0001
22000	S	M	OUG	II	00000	177	OPP. 1710 RUSSELL CAVE	12	120890	1/1/0001
22000	S	M	OUG	II	00000	178	OPP. 1718 RUSSELL CAVE	12	120890	1/1/0001
22000	S	M	OUG	II	00000	179	OPP. 1722 RUSSELL CAVE	12	120890	1/1/0001
22000	S	M	OUG	II	00000	180	OPP. 1730 RUSSELL CAVE	12	120890	1/1/0001
22000	S	M	OUG	II	00000	181	OPP. 1730 RUSSELL CAVE	12	120890	1/1/0001
22000	S	M	OUG	II	00000	187	OPP. 1758 RUSSELL CAVE	12	120890	1/1/0001
22000	S	M	OUG	II	00000	188	OPP. 1762 RUSSELL CAVE	12	120890	1/1/0001
22000	S	M	OUG	II	00000	190	OPP. 1778 RUSSELL CAVE	12	120890	1/1/0001
22000	S	M	OUG	II	00000	192	OPP. CHARLBURY ON WESTSIDE OF RUSSELL CAVE	12	120890	1/1/0001
22000	S	M	OUG	II	00000	194	OPP. 1812 RUSSELL CAVE	12	120890	1/1/0001
22000	S	M	OUG	II	00000	196	OPP. 1824 RUSSELL CAVE	12	120890	1/1/0001
22000	S	M	OUG	II	00000	198	OPP. 1840 RUSSELL CAVE	12	120890	1/1/0001
22000	S	M	SOH	II	00000	202	SIDE 1298 WINBURN ON RUSSELL CAVE	12	120890	1/1/0001
22000	S	M	SOH	II	00000	204	SIDE 1298 WINBURN ON RUSSELL CAVE	12	120890	1/1/0001
22000	S	M	OUG	II	00000	206	1ST LT N OF WINBURN ON WESTSIDE OF RUSSELL CAVE	12	120890	1/1/0001
22000	S	M	OUG	II	00000	207	2ND LT N OF RADCLIFFE ON EASTSIDE OF RUSSELL CAVE	12	120890	1/1/0001
22000	S	M	OUG	II	00000	208	2ND LT N OF WINBURN ON WESTSIDE OF RUSSELL CAVE	12	120890	1/1/0001
22000	S	M	OUG	II	00000	209	3RD LT N OF RADCLIFFE ON EASTSIDE OF RUSSELL CAVE	12	120890	1/1/0001
22000	S	M	OUG	II	00000	210	3RD LT N OF WINBURN ON WESTSIDE OF RUSSELL CAVE	12	120890	1/1/0001
22000	S	M	OUG	II	01678	167		12	120890	1/1/0001
22000	S	M	OUG	II	01688	169		12	120890	1/1/0001
22000	S	M	OUG	II	01698	172		12	120890	1/1/0001
22000	S	M	OUG	II	01700	174		12	120890	1/1/0001
22000	S	M	OUG	II	01737	183		12	120890	1/1/0001
22000	S	M	OUG	II	01737	185		12	120890	1/1/0001
22000	S	M	OUG	II	01738	182		12	120890	1/1/0001
22000	S	M	OUG	II	01746	184		12	120890	1/1/0001
22000	S	M	OUG	II	01754	186		12	120890	1/1/0001

Street Light Listing run 1/11/2015 10:43:21 AM

Page 970 of 1254

OFFICE: 311

ROUTE: 564

ST_REF_NO: 00000160500

RUSSELL CAVE ROAD

LUMENS	BULB TYPE	MULT SERIES	POLE TYPE	SHADE	ADDRESS NUMBER	REF	LOCATION	TAX DIST	DATE INST	DATE CHANGE
22000	S	M	OUG	II	01770	189		12	120890	1/1/0001
22000	S	M	OUG	II	01786	191		12	120890	1/1/0001
22000	S	M	OUG	II	01804	193		12	120890	1/1/0001
22000	S	M	OUG	II	01820	195		12	120890	1/1/0001
22000	S	M	OUG	II	01832	197		12	120890	1/1/0001
22000	S	M	OUG	II	01848	199		12	120890	1/1/0001
22000	S	M	OUG	II	01856	201		12	120890	1/1/0001
22000	S	M	OUG	II	01864	203		12	120890	1/1/0001
22000	S	M	SOH	II	01866	200		12	120890	1/1/0001
22000	S	M	OUG	II	01872	205		12	120890	1/1/0001
20000	M	M	OUG	II	00000	043	1ST LT. S. OF NEW CIRCLE RD., W. SIDE	12	071579	1/1/0001
22000	S	M	SOH	II	00000	101	OPP. 900	12	072056	1/1/0001
09500	S	M	SOH	II	00000	102	OPP. 920	12	080356	1/1/0001
09500	S	M	SOH	III	00000	103	OPP. KEES RD.	12	091453	1/1/0001
09500	S	M	SOH	II	00000	104	OPP. 1020	12	080356	1/1/0001
09500	S	M	SOH	II	00000	105	OPP. 1036	12	091453	1/1/0001
09500	S	M	SOH	II	00000	106	OPP 1008 RUSSELL CAVE ROAD	12	060892	1/1/0001
09500	S	M	SOH	II	00000	109	OPP. NORTHLAND DR.	12	060892	1/1/0001
22000	S	M	SOH	III	00000	115	SIDE OF 400 PARK PLACE	12	060892	1/1/0001
50000	S	M	SOH	III	00000	116	SIDE OF 409 PARK PLACE	12	060892	1/1/0001
50000	S	M	SOH	III	00000	117	SIDE OF 409 PARK PLACE	12	060892	1/1/0001
50000	S	M	SOH	III	00000	118	OPP. 1312 RUSSELL CAVE ROAD	12	060892	1/1/0001
50000	S	M	SOH	III	00000	119	OPP. 1314 RUSSELL CAVE ROAD	12	060892	1/1/0001
50000	S	M	SOH	III	00000	120	OPP. 1316 RUSSELL CAVE ROAD	12	060892	1/1/0001
50000	S	M	SOH	III	00000	121	OPP. 1316 1/2 RUSSELL CAVE ROAD	12	060892	1/1/0001
50000	S	M	SOH	III	00000	122	OPP. ENTRANCE TO NORTH PARK	12	060892	1/1/0001
22000	S	M	SOH	III	00000	123	SIDE OF 320 NEW CIRCLE ROAD	12	060892	1/1/0001
09500	S	M	SOH	II	01051	107		12	060892	1/1/0001
09500	S	M	SOH	II	01051	108		12	060892	1/1/0001
22000	S	M	SOH	II	01121	110		12	060892	1/1/0001
22000	S	M	SOH	III	01124	112		12	060892	1/1/0001
22000	S	M	SOH	III	01124	113		12	060892	1/1/0001
22000	S	M	SOH	III	01124	114		12	060892	1/1/0001
09500	S	M	SOH	III	00000	045	3RD LT. S. OF IRON WORKS, E. SIDE	22	070885	1/1/0001

OFFICE: 311

ROUTE: 564

ST_REF_NO: 00000160500

RUSSELL CAVE ROAD

LUMENS	BULB TYPE	MULT SERIES	POLE TYPE	SHADE	ADDRESS NUMBER	REF	LOCATION	TAX DIST	DATE INST	DATE CHANGE
09500	S	M	SOH	III	00000	046	2ND LT. S. OF IRON WORKS, E. SIDE	12	110885	1/1/0001
09500	S	M	SOH	III	00000	047	1ST LT. S. OF IRON WORKS, E. SIDE	22	070885	1/1/0001
09500	S	M	SOH	III	00000	048	1ST LT. N. OF IRON WORKS, W. SIDE	22	070885	1/1/0001
09500	S	M	SOH	III	00000	049	2ND LT. N. OF IRON WORKS, W. SIDE	22	070885	1/1/0001
09500	S	M	SOH	III	00000	050	1ST LT. N. OF IRON WORKS, E. SIDE	22	070885	1/1/0001
09500	S	M	SOH	III	00000	051	3RD LT. N. OF IRON WORKS, W. SIDE	22	070885	1/1/0001
09500	S	M	SOH	III	00000	052	2ND LT. N. OF IRON WORKS, E. SIDE	22	070885	1/1/0001
09500	S	M	SOH	III	00000	053	4TH LT. N. OF IRON WORKS, W. SIDE	22	070885	1/1/0001
09500	S	M	SOH	II	00000	055	1ST LT. S. OF HUFFMAN MILL, W. SIDE	22	020887	1/1/0001
09500	S	M	SOH	II	00000	056	1ST LT. S. OF HUFFMAN MILL, E. SIDE	22	020887	1/1/0001
09500	S	M	SOH	II	00000	057	1ST LT. N. OF HUFFMAN MILL, W. SIDE	12	020887	1/1/0001

OFFICE: 311

ROUTE: 564

ST_REF_NO: 00000160600

RUTH AVENUE

LUMENS	BULB TYPE	MULT SERIES	POLE TYPE	SHADE	ADDRESS NUMBER	REF	LOCATION	TAX DIST	DATE INST	DATE CHANGE
04000	S		SOH	II	00000	001	SIDE OF 200 WILTON AVENUE	12	090909	1/1/0001
05800	S	M	SOH	I	00000	002	SW CORNER OF RUTH ST. AND THOMPSON RD. ON RUTH	12	030892	1/1/0001

OFFICE: 311

ROUTE: 564

ST_REF_NO: 00000160800

RYE LANE

LUMENS	BULB TYPE	MULT SERIES	POLE TYPE	SHADE	ADDRESS NUMBER	REF	LOCATION	TAX DIST	DATE INST	DATE CHANGE
05800	S	M	OUG	II	00000	017	SIDE OF 573 LIN WAL DR.	12	040166	1/1/0001
05800	S	M	OUG	II	00000	018	SIDE OF 570 RADCLIFFE RD.	12	040166	1/1/0001

OFFICE: 311

ROUTE: 564

ST_REF_NO: 00000160805

SADDLEBRED COURT

LUMENS	BULB TYPE	MULT SERIES	POLE TYPE	SHADE	ADDRESS NUMBER	REF	LOCATION	TAX DIST	DATE INST	DATE CHANGE
05800	S	M	OUG	II	00205	001		12	071002	1/1/0001
05800	S	M	OUG	III	00212	002		12	071002	1/1/0001

OFFICE: 311

ROUTE: 564

ST_REF_NO: 00000160808

SADDLE CLUB WAY

LUMENS	BULB TYPE	MULT SERIES	POLE TYPE	SHADE	ADDRESS NUMBER	REF	LOCATION	TAX DIST	DATE INST	DATE CHANGE
05800	S	M	CNT	II	01312	014		12	091001	1/1/0001

OFFICE: 311		ROUTE: 564		ST_REF_NO: 00000160808		SADDLE CLUB WAY		LUMENS	BULB TYPE	MULT SERIES	POLE TYPE	SHADE	ADDRESS NUMBER	REF	LOCATION	TAX DIST	DATE INST	DATE CHANGE
	05800	S	M	CNT	II	01321	013									12	062205	1/1/0001
	05800	S	M	CNT	II	01332	012									12	062205	1/1/0001
	05800	S	M	CNT	II	01352	010									12	091001	1/1/0001
	05800	S	M	CNT	II	01377	008									12	062205	1/1/0001
	05800	S	M	CNT	II	01384	007									12	062205	1/1/0001
	05800	S	M	CNT	II	01417	003									12	091001	1/1/0001
	05800	S	M	CNT	II	01433	019									12	062205	1/1/0001
	05800	S	M	CNT	II	01445	018									12	062205	1/1/0001
	05800	S	M	CNT	II	01452	017									12	091001	1/1/0001
	05800	S	M	CNT	II	01473	015									12	091001	1/1/0001
	05800	S	M	CNT	II	01345	011									12	020800	1/1/0001
	05800	S	M	CNT	II	01365	009									12	020800	1/1/0001
	05800	S	M	CNT	II	01396	006									12	020800	1/1/0001
	05800	S	M	CNT	II	01404	005									12	020800	1/1/0001
	05800	S	M	CNT	II	01412	004									12	020800	1/1/0001
	05800	S	M	CNT	II	01468	016									12	020800	1/1/0001
OFFICE: 311		ROUTE: 564		ST_REF_NO: 00000160900		SAGE ROAD		LUMENS	BULB TYPE	MULT SERIES	POLE TYPE	SHADE	ADDRESS NUMBER	REF	LOCATION	TAX DIST	DATE INST	DATE CHANGE
	05800	S	M	OUG	II	02101	140									12	090164	1/1/0001
	05800	S	M	OUG	II	02112	141									12	090164	1/1/0001
	05800	S	M	OUG	II	02125	142									12	090164	1/1/0001
	05800	S	M	OUG	II	02136	143									12	090164	1/1/0001
	05800	S	M	OUG	II	02149	144									12	090164	1/1/0001
	05800	S	M	OUG	II	02164	145									12	090164	1/1/0001
OFFICE: 311		ROUTE: 564		ST_REF_NO: 00000161000		SAGINAW COURT		LUMENS	BULB TYPE	MULT SERIES	POLE TYPE	SHADE	ADDRESS NUMBER	REF	LOCATION	TAX DIST	DATE INST	DATE CHANGE
	04000	S	M	OUG	II	00000	087							SIDE OF 3437 BIRKENHEAD DR.		12	100892	1/1/0001
	04000	S	M	OUG	V	00613	086									12	100892	1/1/0001

OFFICE: 311

ROUTE: 564

ST_REF_NO: 00000161100 SALEM ALLEY

LUMENS	BULB TYPE	MULT SERIES	POLE TYPE	SHADE	ADDRESS NUMBER	REF	LOCATION	TAX DIST	DATE INST	DATE CHANGE
05800	S	M	SOH	I	00000	002	NE CORNER OF MORRIS AVE.	12	020563	1/1/0001
05800	S	M	SOH	I	00105	003		12	020563	1/1/0001
05800	S	M	SOH	I	00123	001		12	020563	1/1/0001

OFFICE: 311

ROUTE: 564

ST_REF_NO: 00000161125 SALLEE DRIVE

LUMENS	BULB TYPE	MULT SERIES	POLE TYPE	SHADE	ADDRESS NUMBER	REF	LOCATION	TAX DIST	DATE INST	DATE CHANGE
05800	S	M	OUG	II	00000	006	SIDE REAR OF 3537 MCNAIR WAY	12	120892	1/1/0001
05800	S	M	OUG	II	00000	007	SIDE OF 3532 MCNAIR WAY	12	120892	1/1/0001
05800	S	M	OUG	II	02124	009		12	120892	1/1/0001
05800	S	M	OUG	II	02133	008		12	120892	1/1/0001
05800	S	M	OUG	II	02160	005		12	120892	1/1/0001
05800	S	M	OUG	II	02169	004		12	120892	1/1/0001
05800	S	M	OUG	II	02176	003		12	120892	1/1/0001
05800	S	M	OUG	II	02189	002		12	120892	1/1/0001
05800	S	M	OUG	II	02192	001		12	120892	1/1/0001

OFFICE: 311

ROUTE: 564

ST_REF_NO: 00000161150 SALMON COURT

LUMENS	BULB TYPE	MULT SERIES	POLE TYPE	SHADE	ADDRESS NUMBER	REF	LOCATION	TAX DIST	DATE INST	DATE CHANGE
05800	S	M	OUG	II	03805	099		12	121581	1/1/0001
05800	S	M	OUG	V	03813	100		12	021582	1/1/0001

OFFICE: 311

ROUTE: 564

ST_REF_NO: 00000161200 SALT COURT

LUMENS	BULB TYPE	MULT SERIES	POLE TYPE	SHADE	ADDRESS NUMBER	REF	LOCATION	TAX DIST	DATE INST	DATE CHANGE
05800	S	M	OUG	II	01001	102		12	061580	1/1/0001

OFFICE: 311

ROUTE: 564

ST_REF_NO: 00000161250 SAN MILANO PLACE

LUMENS	BULB TYPE	MULT SERIES	POLE TYPE	SHADE	ADDRESS NUMBER	REF	LOCATION	TAX DIST	DATE INST	DATE CHANGE
09500	S		CLN	III	02400	001		12	072213	1/1/0001
09500	S		CLN	III	02409	002		12	072213	1/1/0001
09500	S		CLN	III	02416	003		12	072213	1/1/0001
09500	S		CLN	III	02428	004		12	072213	1/1/0001

OFFICE: 311

ROUTE: 564

ST_REF_NO: 00000161300

SANDALWOOD COURT

LUMENS	BULB TYPE	MULT SERIES	POLE TYPE	SHADE	ADDRESS NUMBER	REF	LOCATION	TAX DIST	DATE INST	DATE CHANGE
05800	S	M	OUG	II	00000	010	SIDE OF 455 SANDALWOOD DR.	12	041664	1/1/0001
05800	S	M	OUG	V	00439	011		12	041664	1/1/0001

OFFICE: 311

ROUTE: 564

ST_REF_NO: 00000161400

SANDALWOOD DRIVE

LUMENS	BULB TYPE	MULT SERIES	POLE TYPE	SHADE	ADDRESS NUMBER	REF	LOCATION	TAX DIST	DATE INST	DATE CHANGE
05800	S	M	OUG	II	00000	008	SIDE OF 404 ANNISTON DR.	12	041664	1/1/0001
05800	S	M	OUG	II	00000	017	SIDE OF 482 MOSS DR.	12	062363	1/1/0001
05800	S	M	OUG	II	00000	023	SIDE OF 458 ANNISTON DR.	12	062363	1/1/0001
05800	S	M	OUG	V	00404	007		12	062363	1/1/0001
05800	S	M	OUG	II	00428	009		12	062363	1/1/0001
05800	S	M	OUG	II	00463	012		12	062363	1/1/0001
05800	S	M	OUG	II	00474	014		12	062363	1/1/0001
05800	S	M	OUG	II	00491	015		12	061465	1/1/0001
05800	S	M	OUG	II	00506	016		12	041664	1/1/0001
05800	S	M	OUG	II	00530	018		12	062363	1/1/0001
05800	S	M	OUG	II	00541	019		12	062363	1/1/0001
05800	S	M	OUG	II	00554	022		12	062363	1/1/0001

OFFICE: 311

ROUTE: 564

ST_REF_NO: 00000161495

SANDERSVILLE COURT

LUMENS	BULB TYPE	MULT SERIES	POLE TYPE	SHADE	ADDRESS NUMBER	REF	LOCATION	TAX DIST	DATE INST	DATE CHANGE
05800	S	M	CNT	II	00404	001		12	011304	1/1/0001

OFFICE: 311

ROUTE: 564

ST_REF_NO: 00000161600

SANDERSVILLE ROAD

LUMENS	BULB TYPE	MULT SERIES	POLE TYPE	SHADE	ADDRESS NUMBER	REF	LOCATION	TAX DIST	DATE INST	DATE CHANGE
05800	S		CNT	II	00000	001	SIDE OF 3200 SANDERSVILLE RD, ON TIBURON WAY	12	080210	1/1/0001
05800	S		CNT	II	00000	002	SIDE OF 3012 TIBURON CT, ON TIBURON WAY	12	080210	1/1/0001
05800	S		CNT	II	00000	004	SIDE OF 3013 TIBURON CT, ON TIBURON WAY	12	080210	1/1/0001
05800	S		CNT	II	00000	131	across from 3016 Sandersville	12	080908	1/1/0001
05800	S		CNT	II	00000	133	across from 3032 Sandersville	12	080908	1/1/0001
05800	S		CNT	II	00000	134	across from 3040	12	080908	1/1/0001
05800	S		CNT	II	00000	138	in front of dentention area	12	080908	1/1/0001

OFFICE: 311

ROUTE: 564

ST_REF_NO: 00000161600

SANDERSVILLE ROAD

LUMENS	BULB TYPE	MULT SERIES	POLE TYPE	SHADE	ADDRESS NUMBER	REF	LOCATION	TAX DIST	DATE INST	DATE CHANGE
05800	S		CNT	II	00000	140	1ST LT N OF SPURR RD, W SIDE ON SANDERSVILLE RD	12	080210	1/1/0001
05800	S		CNT	II	00000	141	2ND LT N OF SPURR RD, W SIDE ON SANDERSVILLE RD	12	080210	1/1/0001
05800	S		CNT	II	00000	149	SIDE OF 1013 MOVADO CT, ON SANDERSVILLE RD	12	080210	1/1/0001
05800	S		CNT	II	03020	132		12	080908	1/1/0001
05800	S		CNT	II	03048	135		12	080908	1/1/0001
05800	S		CNT	II	03060	136		12	080908	1/1/0001
05800	S		CNT	II	03068	137		12	080908	1/1/0001
05800	S		CNT	II	03108	104		12	080908	1/1/0001
05800	S		CNT	II	03120	003		12	080210	1/1/0001
05800	S		CNT	II	03148	005		12	080210	1/1/0001
05800	S		CNT	II	03169	006		12	080210	1/1/0001
05800	S		CNT	II	03176	142		12	080210	1/1/0001
05800	S		CNT	II	03177	007		12	080210	1/1/0001
05800	S		CNT	II	03189	143		12	080210	1/1/0001
05800	S		CNT	II	03192	008		12	080210	1/1/0001
05800	S		CNT	II	03197	144		12	080210	1/1/0001
05800	S		CNT	II	03212	145		12	080210	1/1/0001
05800	S		CNT	II	03213	009		12	080210	1/1/0001
05800	S		CNT	II	03225	010		12	080210	1/1/0001
05800	S		CNT	II	03225	146		12	080210	1/1/0001
05800	S		CNT	II	03236	011		12	080210	1/1/0001
05800	S		CNT	II	03236	147		12	080210	1/1/0001
05800	S		CNT	II	03253	148		12	080210	1/1/0001
05800	S		CNT	II	03273	013		12	080210	1/1/0001
05800	S		CNT	II	03273	150		12	080210	1/1/0001
05800	S	M	CNT	II	00000	008	SIDE OF 505 SKYVIEW LANE ON SANDERSVILLE RD	12	010504	1/1/0001
05800	S	M	CNT	II	00000	012	SIDE OF 2772 JESSICA LANE ON SANDERSVILLE RD	12	010504	1/1/0001
05800	S	M	OUG	II	01853	013		12	012202	1/1/0001
05800	S	M	OUG	II	01864	012		12	012202	1/1/0001
05800	S	M	OUG	II	01877	011		12	012202	1/1/0001
05800	S	M	OUG	II	01888	010		12	012202	1/1/0001
05800	S	M	OUG	II	01912	008		12	103103	1/1/0001

OFFICE: 311

ROUTE: 564

ST_REF_NO: 00000161600

SANDERSVILLE ROAD

LUMENS	BULB TYPE	MULT SERIES	POLE TYPE	SHADE	ADDRESS NUMBER	REF	LOCATION	TAX DIST	DATE INST	DATE CHANGE
05800	S	M	OUG	II	01925	007		12	103103	1/1/0001
05800	S	M	OUG	II	01940	006		12	103103	1/1/0001
05800	S	M	OUG	II	01945	005		12	100802	1/1/0001
05800	S	M	OUG	II	01961	004		12	100802	1/1/0001
05800	S	M	OUG	II	01976	003		12	100802	1/1/0001
05800	S	M	CNT	II	02816	001		12	010504	1/1/0001
05800	S	M	CNT	II	02829	002		12	010504	1/1/0001
05800	S	M	CNT	II	02836	003		12	010504	1/1/0001
05800	S	M	CNT	II	02849	004		12	010504	1/1/0001
05800	S	M	CNT	II	02860	005		12	010504	1/1/0001
05800	S	M	CNT	II	02873	006		12	010504	1/1/0001
05800	S	M	CNT	II	02889	007		12	010504	1/1/0001
05800	S	M	CNT	II	02913	009		12	010504	1/1/0001
05800	S	M	CNT	II	02941	011		12	010504	1/1/0001
05800	S	M	CNT	II	02957	013		12	010504	1/1/0001
05800	S	M	CNT	II	02964	014		12	010504	1/1/0001
05800	S	M	CNT	II	02977	015		12	010504	1/1/0001
05800	S	M	CNT	II	02988	016		12	010504	1/1/0001
05800	S		CNT	II	03004	130		12	080908	8/9/2008
05800	S	M	CNT	II	03088	107		12	113005	1/1/0001
05800	S	M	CNT	II	03093	106		12	113005	1/1/0001
05800	S	M	CNT	II	03101	105		12	113005	1/1/0001
05800	S	M	CNT	II	03117	103		12	113005	1/1/0001
05800	S	M	CNT	II	03128	102		12	113005	1/1/0001
05800	S	M	CNT	II	03145	101		12	113005	1/1/0001
05800	S	M	CNT	II	03149	100		12	113005	1/1/0001
22000	S	M	SOH	II	00000	050	SOUTHEAST CORNER OF SANDERSVILLE @ GREENDALE	12	010894	1/1/0001
05800	S	M	OUG	II	00000	051	OPP. 2501-E	12	010894	1/1/0001
05800	S	M	OUG	II	02501	052		12	010894	1/1/0001
05800	S	M	OUG	II	02501	054		12	010894	1/1/0001
05800	S	M	OUG	II	00000	003	1ST LT E OF GEORGETOWN RD. N SIDE	12	120800	1/1/0001
05800	S	M	OUG	II	01985	002		12	120800	1/1/0001
05800	S	M	OUG	II	01989	001		12	120800	1/1/0001

OFFICE: 311

ROUTE: 564

ST_REF_NO: 00000161700 SANDPIPER COURT

LUMENS	BULB TYPE	MULT SERIES	POLE TYPE	SHADE	ADDRESS NUMBER	REF	LOCATION	TAX DIST	DATE INST	DATE CHANGE
05800	S	M	OUG	II	00750	000		12	091967	1/1/0001
05800	S	M	OUG	II	00761	000		12	031868	1/1/0001
05800	S	M	OUG	V	00774	000		12	050969	1/1/0001

OFFICE: 311

ROUTE: 564

ST_REF_NO: 00000161800 SANDRA COURT

LUMENS	BULB TYPE	MULT SERIES	POLE TYPE	SHADE	ADDRESS NUMBER	REF	LOCATION	TAX DIST	DATE INST	DATE CHANGE
05800	S	M	OUG	V	02216	096		12	060867	1/1/0001
05800	S	M	OUG	II	02228	095		12	060867	1/1/0001

OFFICE: 311

ROUTE: 564

ST_REF_NO: 00000161900 SANDWOOD PLACE

LUMENS	BULB TYPE	MULT SERIES	POLE TYPE	SHADE	ADDRESS NUMBER	REF	LOCATION	TAX DIST	DATE INST	DATE CHANGE
05800	S	M	OUG	II	00300	009		12	111580	1/1/0001
05800	S	M	OUG	V	00308	010		12	091582	1/1/0001

OFFICE: 311

ROUTE: 564

ST_REF_NO: 00000161950 SANIBEL DRIVE

LUMENS	BULB TYPE	MULT SERIES	POLE TYPE	SHADE	ADDRESS NUMBER	REF	LOCATION	TAX DIST	DATE INST	DATE CHANGE
05800	S	M	CNT	II	00000	001	SIDE OF 1037 KAVENAUGH LANE	12	070896	1/1/0001
05800	S	M	CNT	II	00000	004	OPP. 3424	12	070896	1/1/0001
05800	S	M	CNT	II	03405	002		12	070896	1/1/0001
05800	S	M	CNT	II	03412	003		12	070896	1/1/0001

OFFICE: 311

ROUTE: 564

ST_REF_NO: 00000162000 SANMAUR COURT

LUMENS	BULB TYPE	MULT SERIES	POLE TYPE	SHADE	ADDRESS NUMBER	REF	LOCATION	TAX DIST	DATE INST	DATE CHANGE
05800	S	M	OUG	V	03401	146		12	081475	1/1/0001
05800	S	M	OUG	II	03409	147		12	071476	1/1/0001

OFFICE: 311

ROUTE: 564

ST_REF_NO: 00000162040 SANTA ANITA COURT

LUMENS	BULB TYPE	MULT SERIES	POLE TYPE	SHADE	ADDRESS NUMBER	REF	LOCATION	TAX DIST	DATE INST	DATE CHANGE
05800	S	M	OUG	II	00302	001		12	070898	1/1/0001
05800	S	M	OUG	II	00315	002		12	070898	1/1/0001

OFFICE: 311 **ROUTE:** 564
ST_REF_NO: 00000162040 SANTA ANITA COURT

LUMENS	BULB TYPE	MULT SERIES	POLE TYPE	SHADE	ADDRESS NUMBER	REF	LOCATION	TAX DIST	DATE INST	DATE CHANGE
05800	S	M	OUG	III	00322	003		12	070898	1/1/0001

OFFICE: 311 **ROUTE:** 564
ST_REF_NO: 00000162050 SANTA ANITA DRIVE

LUMENS	BULB TYPE	MULT SERIES	POLE TYPE	SHADE	ADDRESS NUMBER	REF	LOCATION	TAX DIST	DATE INST	DATE CHANGE
05800	S	M	OUG	II	00000	011	SIDE OF 2269 BELMONT DR ON SANTA ANITA DR	12	5/3/01	1/1/0001
05800	S	M	OUG	II	02005	013		12	5/3/01	1/1/0001
05800	S	M	OUG	II	02020	012		12	5/3/01	1/1/0001
05800	S	M	OUG	II	02129	009		12	070898	1/1/0001
05800	S	M	OUG	II	02152	008		12	070898	1/1/0001
05800	S	M	OUG	II	02165	007		12	070898	1/1/0001
05800	S	M	OUG	II	02182	006		12	090896	1/1/0001
05800	S	M	OUG	II	02191	005		12	090896	1/1/0001
05800	S	M	OUG	II	02192	004		12	090896	1/1/0001
04000	S	M	OUG	II	02205	003		12	110892	1/1/0001
04000	S	M	OUG	II	02208	002		12	110892	1/1/0001
04000	S	M	OUG	II	02225	001		12	120889	1/1/0001

OFFICE: 311 **ROUTE:** 564
ST_REF_NO: 00000162060 SANTE FE COURT

LUMENS	BULB TYPE	MULT SERIES	POLE TYPE	SHADE	ADDRESS NUMBER	REF	LOCATION	TAX DIST	DATE INST	DATE CHANGE
05800	S	M	OUG	II	00000	001	1ST LT. EAST OF RIO DOSA, NORTHSIDE	12	100892	1/1/0001
05800	S	M	OUG	II	00000	002	2ND LT. EAST OF RIO DOSA, SOUTHSIDE	12	100892	1/1/0001
05800	S	M	OUG	II	00000	003	3RD LT. EAST OF RIO DOSA AT END OF CUL-DE-SAC	12	100892	1/1/0001

OFFICE: 311 **ROUTE:** 564
ST_REF_NO: 00000162065 SANTEE WAY

LUMENS	BULB TYPE	MULT SERIES	POLE TYPE	SHADE	ADDRESS NUMBER	REF	LOCATION	TAX DIST	DATE INST	DATE CHANGE
05800	S	M	CNT	II	00000	005	SIDE 4068 PALMETTO DR.	12	100894	1/1/0001
05800	S	M	CNT	II	04008	004		12	100894	1/1/0001
05800	S	M	CNT	II	04013	003		12	100894	1/1/0001
05800	S	M	CNT	II	04032	002		12	100894	1/1/0001
05800	S	M	CNT	II	04033	001		12	100894	1/1/0001

OFFICE: 311

ROUTE: 564

ST_REF_NO: 00000162100

SARASOTA COURT

LUMENS	BULB TYPE	MULT SERIES	POLE TYPE	SHADE	ADDRESS NUMBER	REF	LOCATION	TAX DIST	DATE INST	DATE CHANGE
05800	S	M	SOH	V	00000	033	BETWEEN 1701 & 1702	12	011581	1/1/0001
05800	S	M	OUG	II	01703	032		12	070161	1/1/0001
05800	S	M	OUG	II	01712	031		12	070161	1/1/0001
05800	S	M	OUG	II	01717	030		12	070161	1/1/0001
05800	S	M	OUG	II	01801	029		12	071064	1/1/0001

OFFICE: 311

ROUTE: 564

ST_REF_NO: 00000162150

SARON DRIVE

LUMENS	BULB TYPE	MULT SERIES	POLE TYPE	SHADE	ADDRESS NUMBER	REF	LOCATION	TAX DIST	DATE INST	DATE CHANGE
09500	S		CNT	II	00000	100	1st LIGHT WEST OF IVYBRIDGE DR, SOUTH SIDE ON SARON DRIVE	12	102608	1/1/0001
09500	S		CNT	II	00000	101	2nd LIGHT WEST OF IVYBRIDGE DR, SOUTH SIDE ON SARON DRIVE	12	102608	1/1/0001
09500	S		CNT	II	00000	151	1ST LT S OF CHAS DR, W SIDE ON SARON DR	12	011609	1/1/0001
09500	S		CNT	II	00000	152	1ST LT N OF CHAS DR, E SIDE ON SARON DR	12	011609	1/1/0001
09500	S		CNT	II	00000	153	2ND LT N OF CHAS DR, W SIDE ON SARON DR	12	011609	1/1/0001
09500	S		CNT	II	00000	154	3RD LT N OF CHAS DR, E SIDE ON SARON DR	12	011609	1/1/0001
09500	S		CNT	II	00000	155	4TH LT N OF CHAS DR, W SIDE ON SARON DR	12	011609	1/1/0001
09500	S		CNT	II	00000	156	5TH LT N OF CHAS DR, E SIDE ON SARON	12	011609	1/1/0001
09500	S		CNT	II	00000	157	6TH LT N OF CHAS DR, W SIDE ON SARON	12	011609	1/1/0001
09500	S		CNT	II	00000	158	7TH LT N OF CHAS DR, E SIDE ON SARON	12	011609	1/1/0001
09500	S		CNT	II	04269	150		12	011609	1/1/0001
09500	S	M	CNT	II	00000	002	ACROSS FROM HAMMOCK OAK LANE ON SARON DR	12	120902	1/1/0001
09500	S	M	CNT	II	00000	004	ACROSS FROM 4317 SARON DRIVE	12	120902	1/1/0001
09500	S	M	CNT	II	00000	005	ACROSS FROM 4309 SARON DRIVE	12	120902	1/1/0001
09500	S	M	CNT	II	00000	006	SIDE OF 1045 DUVAL STREET ON SARON DRIVE	12	120902	1/1/0001
09500	S	M	CNT	II	00000	007	SIDE OF 1000 FIDDLER CREEK WAY ON SARON DRIVE	12	120902	1/1/0001
09500	S	M	CNT	II	00000	008	SIDE OF 1001 FIDDLERL CREEK WAY ON SARON DRIVE	12	120902	1/1/0001
09500	S	M	CNT	II	04325	003		12	120902	1/1/0001
05800	S	M	OUG	II	00000	016	SIDE OF 818 JARIUS DR.	12	020888	1/1/0001
09500	S	M	CNT	II	00000	020	1ST LT. N OF FAIRHAVEN DR., W SIDE	12	040800	1/1/0001
09500	S	M	CNT	II	00000	021	1ST LT. N OF FAIRHAVEN DR., E SIDE	12	040800	1/1/0001
09500	S	M	CNT	II	00000	022	2ND LT. N OF FAIRHAVEN DR., W SIDE	12	040800	1/1/0001

OFFICE: 311

ROUTE: 564

ST_REF_NO: 00000162150

SARON DRIVE

LUMENS	BULB TYPE	MULT SERIES	POLE TYPE	SHADE	ADDRESS NUMBER	REF	LOCATION	TAX DIST	DATE INST	DATE CHANGE
09500	S	M	CNT	II	00000	023	2ND LT. N OF FAIRHAVEN DR., E SIDE	12	040800	1/1/0001
09500	S	M	CNT	II	00000	024	3RD LT. N OF FAIRHAVEN DR., W SIDE	12	040800	1/1/0001
09500	S	M	CNT	II	00000	025	3RD LT. N OF FAIRHAVEN DR., E SIDE	12	040800	1/1/0001
09500	S	M	CNT	II	00000	026		12	040800	1/1/0001
09500	S	M	CNT	II	00000	050	1ST LT. N OF FAIRHAVEN DR., W SIDE	12	060800	1/1/0001
09500	S	M	CNT	II	00000	051	1ST LT. N OF FAIRHAVEN DR., E SIDE	12	060800	1/1/0001
09500	S	M	CNT	II	00000	052	2ND LT. N OF FAIRHAVEN, W SIDE	12	060800	1/1/0001
09500	S	M	CNT	II	00000	053	2ND LT. N OF FAIRHAVEN DR., E SIDE	12	060800	1/1/0001
09500	S	M	CNT	II	00000	054	3RD LT. N OF FAIRHAVEN DR., W SIDE	12	060800	1/1/0001
09500	S	M	CNT	II	00000	055	3RD LT. N OF FAIRHAVEN DR., E SIDE	12	060800	1/1/0001
09500	S	M	CNT	II	00000	056	4TH LT. N OF FAIRHAVEN DR, W SIDE	12	060800	1/1/0001
05800	S	M	OUG	II	04500	019		12	020888	1/1/0001
05800	S	M	OUG	II	04505	018		12	020888	1/1/0001
05800	S	M	OUG	II	04512	017		12	020888	1/1/0001
05800	S	M	OUG	II	04541	013		12	110889	1/1/0001
05800	S	M	OUG	II	04548	012		12	110888	1/1/0001
05800	S	M	OUG	II	04557	011		12	020888	1/1/0001
05800	S	M	OUG	II	00000	003	OPP. 4604	12	110889	1/1/0001
05800	S	M	OUG	II	00000	005	OPP. 4624	12	110889	1/1/0001
05800	S	M	OUG	II	00000	026		12	100893	1/1/0001
05800	S	M	OUG	II	00000	029	SIDE OF 993 WOODSHIRE WAY	12	020895	1/1/0001
05800	S	M	OUG	II	00000	030	SIDE OF 1000 WOODSHIRE WAY	12	020895	1/1/0001
09500	S	M	CNT	II	00000	041	1ST LT. W OF TATES CREEK, S SIDE	12	090800	1/1/0001
09500	S	M	CNT	II	00000	042	1ST LT. W OF TATES CREEK, N SIDE	12	090800	1/1/0001
09500	S	M	CNT	II	00000	043	2ND LT. W OF TATES CREEK, N SIDE	12	090800	1/1/0001
05800	S	M	OUG	II	04564	010		12	110889	1/1/0001
05800	S	M	OUG	II	04569	006		12	070899	1/1/0001
05800	S	M	OUG	II	04576	008		12	110889	1/1/0001
05800	S	M	OUG	II	04585	001		12	020888	1/1/0001
05800	S	M	OUG	II	04600	002		12	060887	1/1/0001
05800	S	M	OUG	II	04616	004		12	060887	1/1/0001
05800	S	M	OUG	II	04632	006		12	060887	1/1/0001
05800	S	M	OUG	II	04648	021		12	060887	1/1/0001
05800	S	M	OUG	II	04653	022		12	060887	1/1/0001

OFFICE: 311

ROUTE: 564

ST_REF_NO: 00000162150

SARON DRIVE

LUMENS	BULB TYPE	MULT SERIES	POLE TYPE	SHADE	ADDRESS NUMBER	REF	LOCATION	TAX DIST	DATE INST	DATE CHANGE
05800	S	M	OUG	II	04664	023		12	060887	1/1/0001
05800	S	M	OUG	II	04669	025		12	020895	1/1/0001
05800	S	M	OUG	II	04685	027		12	010890	1/1/0001
05800	S	M	OUG	II	04696	028		12	010890	1/1/0001

OFFICE: 311

ROUTE: 564

ST_REF_NO: 00000162175

SATIN LEAF PARK

LUMENS	BULB TYPE	MULT SERIES	POLE TYPE	SHADE	ADDRESS NUMBER	REF	LOCATION	TAX DIST	DATE INST	DATE CHANGE
05800	S	M	CNT	II	02804	006		12	092507	1/1/0001
05800	S	M	CNT	II	02809	005		12	092507	1/1/0001
05800	S	M	CNT	II	02820	004		12	092507	1/1/0001
05800	S	M	CNT	II	02837	003		12	092507	1/1/0001
05800	S	M	CNT	II	02844	002		12	092507	1/1/0001
05800	S	M	CNT	II	02848	001		12	092507	1/1/0001

OFFICE: 311

ROUTE: 564

ST_REF_NO: 00000162185

SAUNDERS SPRINGS WAY

LUMENS	BULB TYPE	MULT SERIES	POLE TYPE	SHADE	ADDRESS NUMBER	REF	LOCATION	TAX DIST	DATE INST	DATE CHANGE
05800	S		OUG	II	00000	007	SIDE OF 1357 SILVER SPRINGS DR ON SAUNDERS SPRINGS WAY	12	042011	1/1/0001
05800	S		OUG	II	00612	006		12	042011	1/1/0001
05800	S		OUG	II	00617	005		12	042011	1/1/0001

OFFICE: 311

ROUTE: 564

ST_REF_NO: 00000162200

SAUNIER AVENUE

LUMENS	BULB TYPE	MULT SERIES	POLE TYPE	SHADE	ADDRESS NUMBER	REF	LOCATION	TAX DIST	DATE INST	DATE CHANGE
09500	S	M	SOH	I	00000	001	1ST LT. N. OF SHORT ST., W. SIDE	12	101262	1/1/0001
09500	S	M	SOH	I	00000	002	1ST LT. N. OF SHORT ST., E. SIDE	12	101262	1/1/0001
09500	S	M	SOH	I	00000	004	OPP. 171	12	101262	1/1/0001
09500	S	M	SOH	I	00000	006	1ST LT. S. OF SECOND ST., W. SIDE	12	101262	1/1/0001
09500	S	M	SOH	I	00157	003		12	101262	1/1/0001
09500	S	M	SOH	I	00179	005		12	101262	1/1/0001

OFFICE: 311

ROUTE: 564

ST_REF_NO: 00000162250

SAVANNAH LANE

LUMENS	BULB TYPE	MULT SERIES	POLE TYPE	SHADE	ADDRESS NUMBER	REF	LOCATION	TAX DIST	DATE INST	DATE CHANGE
05800	S	M	CNT	II	00000	011	SIDE OF 1308 TUPELO LN ON SAVANNAH LANE	12	071102	1/1/0001
05800	S	M	CNT	II	02168	019		12	071102	1/1/0001
05800	S	M	CNT	II	02176	018		12	071102	1/1/0001
05800	S	M	CNT	II	02185	017		12	071102	1/1/0001
05800	S	M	CNT	II	02192	016		12	071102	1/1/0001
05800	S	M	CNT	II	02197	015		12	071102	1/1/0001
05800	S	M	CNT	II	02204	014		12	071102	1/1/0001
05800	S	M	CNT	II	02213	013		12	071102	1/1/0001
05800	S	M	CNT	II	02216	012		12	071102	1/1/0001
05800	S	M	CNT	II	02229	010		12	071102	1/1/0001
05800	S	M	CNT	II	02236	009		12	071102	1/1/0001
05800	S	M	CNT	II	02245	008		12	100899	1/1/0001
05800	S	M	CNT	II	02248	001		12	100899	1/1/0001
05800	S	M	CNT	II	02257	002		12	100899	1/1/0001
05800	S	M	CNT	II	02260	003		12	100899	1/1/0001
05800	S	M	CNT	II	02269	004		12	090897	1/1/0001
05800	S	M	CNT	III	02276	005		12	090897	1/1/0001
05800	S	M	CNT	II	02284	006		12	090897	1/1/0001
05800	S	M	CNT	III	02289	007		12	090897	1/1/0001

OFFICE: 311

ROUTE: 564

ST_REF_NO: 00000162300

SAVOY ROAD

LUMENS	BULB TYPE	MULT SERIES	POLE TYPE	SHADE	ADDRESS NUMBER	REF	LOCATION	TAX DIST	DATE INST	DATE CHANGE
09500	S	M	OUG	II	00241	000		12	050160	1/1/0001
09500	S	M	OUG	II	00200	000		12	120660	1/1/0001
09500	S	M	OUG	II	00213	000		12	060161	1/1/0001
09500	S	M	OUG	II	00228	000		12	050160	1/1/0001

OFFICE: 311

ROUTE: 564

ST_REF_NO: 00000162310

SAWYER COURT

LUMENS	BULB TYPE	MULT SERIES	POLE TYPE	SHADE	ADDRESS NUMBER	REF	LOCATION	TAX DIST	DATE INST	DATE CHANGE
04000	S	M	OUG	II	00000	058	SIDE OF 4357 CALEVARES DR.	12	070886	1/1/0001
04000	S	M	OUG	II	02012	059		12	010885	1/1/0001
04000	S	M	OUG	V	02017	060		12	010885	1/1/0001

OFFICE: 311		ROUTE: 564		ST_REF_NO: 00000162400		SAXON DRIVE		LUMENS	BULB TYPE	MULT SERIES	POLE TYPE	SHADE	ADDRESS NUMBER	REF	LOCATION	TAX DIST	DATE INST	DATE CHANGE
05800	S	M	OUG	II	03233	006	upgrade due to car accident	12	080890	6/20/2011								
04000	S	M	OUG	II	03200	001		12	080890	1/1/0001								
04000	S	M	OUG	II	03205	002		12	080890	1/1/0001								
04000	S	M	OUG	II	03216	003		12	080890	1/1/0001								
04000	S	M	OUG	II	03217	004		12	080890	1/1/0001								
04000	S	M	OUG	II	03232	005		12	080890	1/1/0001								
04000	S	M	OUG	II	03248	007		12	080890	1/1/0001								
04000	S	M	OUG	II	03257	008		12	120890	1/1/0001								
04000	S	M	OUG	II	03260	009		12	120890	1/1/0001								
04000	S	M	OUG	II	03273	010		12	120890	1/1/0001								

OFFICE: 311 ROUTE: 564
ST_REF_NO: 00000162490 SAYBROOK COURT

LUMENS	BULB TYPE	MULT SERIES	POLE TYPE	SHADE	ADDRESS NUMBER	REF	LOCATION	TAX DIST	DATE INST	DATE CHANGE
04000	S	M	OUG	II	00580	110		12	100885	1/1/0001

OFFICE: 311 ROUTE: 564
ST_REF_NO: 00000162500 SAYBROOK ROAD

LUMENS	BULB TYPE	MULT SERIES	POLE TYPE	SHADE	ADDRESS NUMBER	REF	LOCATION	TAX DIST	DATE INST	DATE CHANGE
04000	S	M	OUG	II	03416	106		12	100885	1/1/0001
04000	S	M	OUG	II	03427	107		12	100885	1/1/0001
04000	S	M	OUG	II	03432	108		12	100885	1/1/0001
04000	S	M	OUG	II	03447	109		12	100885	1/1/0001

OFFICE: 311 ROUTE: 564
ST_REF_NO: 00000162600 SAYRE AVENUE

LUMENS	BULB TYPE	MULT SERIES	POLE TYPE	SHADE	ADDRESS NUMBER	REF	LOCATION	TAX DIST	DATE INST	DATE CHANGE
04000	S	S	SOH	II	00000	004	OPP. 602	12	070162	1/1/0001
05800	S	S	SOH	II	00000	006	OPP. 530	12	070162	1/1/0001
05800	S	M	SOH	II	00000	007	SIDE OF 122 FOREST AVE.	12	070162	1/1/0001
04000	S	S	SOH	II	00544	005		12	070162	1/1/0001
04000	S	M	SOH	II	00000	001	1ST LT. W. OF WALTON AVE., S. SIDE	12	020920	1/1/0001
04000	S	M	SOH	II	00000	002	2ND LT. W. OF WALTON AVE., S. SIDE	12	072330	1/1/0001
04000	S	M	SOH	II	00000	003	OPP. 625	12	072330	1/1/0001

OFFICE: 311 ROUTE: 564										
ST_REF_NO: 00000162700 SCARBROUGH COURT										
LUMENS	BULB TYPE	MULT SERIES	POLE TYPE	SHADE	ADDRESS NUMBER	REF	LOCATION	TAX DIST	DATE INST	DATE CHANGE
09500	S	M	OUG	II	00000	114	SIDE OF 523 CRICKLEWOOD upgraded to 9500 1/2006	12	041768	1/1/0001
09500	S	M	OUG	II	01716	000	upgraded to 9500 1/2006	12	110369	1/1/0001

OFFICE: 311 ROUTE: 564										
ST_REF_NO: 00000162710 SCARLETT WAY										
LUMENS	BULB TYPE	MULT SERIES	POLE TYPE	SHADE	ADDRESS NUMBER	REF	LOCATION	TAX DIST	DATE INST	DATE CHANGE
05800	S	M	OUG	III	01409	005		12	031303	1/1/0001
05800	S	M	OUG	II	01421	004		12	031303	1/1/0001
05800	S	M	OUG	II	01433	003		12	031303	1/1/0001
05800	S	M	OUG	II	01441	002		12	031303	1/1/0001
05800	S	M	OUG	III	01449	001		12	031303	1/1/0001

OFFICE: 311 ROUTE: 564										
ST_REF_NO: 00000162740 SCARLETT OAK DRIVE										
LUMENS	BULB TYPE	MULT SERIES	POLE TYPE	SHADE	ADDRESS NUMBER	REF	LOCATION	TAX DIST	DATE INST	DATE CHANGE
05800	S	M	CNT	II	03801	001		12	050899	1/1/0001

OFFICE: 311 ROUTE: 564										
ST_REF_NO: 00000162750 SCARLET OAK LANE										
LUMENS	BULB TYPE	MULT SERIES	POLE TYPE	SHADE	ADDRESS NUMBER	REF	LOCATION	TAX DIST	DATE INST	DATE CHANGE
05800	S	M	CNT	II	00000	003	OPP. 3828	12	100897	1/1/0001
05800	S	M	CNT	II	03812	002		12	100897	1/1/0001
05800	S	M	CNT	III	03848	004		12	100897	1/1/0001
05800	S	M	CNT	II	03873	005		12	100897	1/1/0001
05800	S	M	CNT	III	03888	006		12	100897	1/1/0001

OFFICE: 311 ROUTE: 564										
ST_REF_NO: 00000162770 SCOTCH PINE CIRCLE										
LUMENS	BULB TYPE	MULT SERIES	POLE TYPE	SHADE	ADDRESS NUMBER	REF	LOCATION	TAX DIST	DATE INST	DATE CHANGE
05800	S	M	CNT	III	00604	001		12	100897	1/1/0001

OFFICE: 311

ROUTE: 564

ST_REF_NO: 00000162800

SCOTT STREET

LUMENS	BULB TYPE	MULT SERIES	POLE TYPE	SHADE	ADDRESS NUMBER	REF	LOCATION	TAX DIST	DATE INST	DATE CHANGE
50000	S	M	SOH	II	00000	012	SIDE OF 501 S. LIMESTONE ST.	12	011667	3/8/2010
22000	S	M	SOH	II	00000	001	SIDE OF 684 S. BROADWAY	12	011667	1/1/0001
22000	S	M	SOH	II	00000	005	1ST LT. W. OF RR, N. SIDE	12	032067	1/1/0001
22000	S	M	SOH	II	00000	006	1ST LT. E. OF RR., S. SIDE	12	032067	1/1/0001
22000	S	M	SOH	II	00000	007	1ST LT. E. OF RR., N. SIDE	12	032067	1/1/0001
22000	S	M	SOH	II	00000	008	2ND LT. E. OF RR., S. SIDE	12	032067	1/1/0001
22000	S	M	SOH	II	00000	009	2ND LT. W. OF UPPER ST., N. SIDE	12	032067	1/1/0001
22000	S	M	SOH	II	00000	010	2ND LT. W. OF LIMESTONE ST., S. SIDE	12	032067	1/1/0001
22000	S	M	SOH	II	00000	011	1ST LT. W. OF UPPER ST., N. SIDE	12	032067	1/1/0001
22000	S	M	SOH	II	00310	004		12	032067	1/1/0001
22000	S	M	SOH	II	00321	003		12	032067	1/1/0001
22000	S	M	SOH	II	00328	002		12	032067	1/1/0001

OFFICE: 311

ROUTE: 564

ST_REF_NO: 00000162825

SCOTTISH TRACE

LUMENS	BULB TYPE	MULT SERIES	POLE TYPE	SHADE	ADDRESS NUMBER	REF	LOCATION	TAX DIST	DATE INST	DATE CHANGE
05800	S		CNT	II	03393	014		12	051510	1/1/0001
05800	S	M	CNT	II	00000	003	SIDE OF 2325 LILAC PARK ON SCOTTISH TRACE	12	072706	1/1/0001
05800	S	M	CNT	II	00000	004	SIDE OF 2324 LILAC PARK ON SCOTTISH TRACE	12	072706	1/1/0001
05800	S	M	CNT	II	00000	007	SIDE OF 3001 MANY OAKS PARK ON SCOTTISH TRACE	12	072706	1/1/0001
05800	S	M	CNT	II	00000	008	SIDE OF 3000 MANY OAKS PARK ON SCOTTISH TRACE	12	072706	1/1/0001
05800	S	M	CNT	II	00000	011	SIDE OF 3149 TIMBER NECK COVE ON SCOTTISH TRACE	12	072706	1/1/0001
05800	S	M	CNT	II	03101	017		12	072706	1/1/0001
05800	S	M	CNT	II	03116	018		12	072706	1/1/0001
05800	S	M	CNT	II	03124	019		12	072706	1/1/0001
05800	S	M	CNT	II	03144	020		12	072706	1/1/0001
05800	S	M	CNT	II	03160	021		12	072706	1/1/0001
05800	S	M	CNT	II	03180	022		12	072706	1/1/0001
05800	S	M	CNT	II	03189	023		12	072706	1/1/0001
05800	S	M	CNT	III	03200	001		12	072706	1/1/0001
05800	S	M	CNT	II	03213	002		12	072706	1/1/0001
05800	S	M	CNT	II	03265	005		12	072706	1/1/0001

OFFICE: 311

ROUTE: 564

ST_REF_NO: 00000162825

SCOTTISH TRACE

LUMENS	BULB TYPE	MULT SERIES	POLE TYPE	SHADE	ADDRESS NUMBER	REF	LOCATION	TAX DIST	DATE INST	DATE CHANGE
05800	S	M	CNT	II	03272	006		12	072706	1/1/0001
05800	S	M	CNT	II	03321	009		12	072706	1/1/0001
05800	S	M	CNT	II	03337	010		12	072706	1/1/0001
05800	S	M	CNT	II	03368	012		12	072706	1/1/0001
05800	S	M	CNT	II	03377	013		12	092506	1/1/0001
05800	S	M	CNT	II	03409	015		12	092506	1/1/0001
05800	S	M	CNT	II	03424	016		12	092506	1/1/0001

OFFICE: 311

ROUTE: 564

ST_REF_NO: 00000162850

SCOTTSDALE CIRCLE

LUMENS	BULB TYPE	MULT SERIES	POLE TYPE	SHADE	ADDRESS NUMBER	REF	LOCATION	TAX DIST	DATE INST	DATE CHANGE
05800	S	M	OUG	III	00352	017		12	012706	1/1/0001
05800	S	M	OUG	II	00364	016		12	012005	1/1/0001
05800	S	M	OUG	II	00373	015		12	012706	1/1/0001
05800	S	M	OUG	II	00384	014		12	012005	1/1/0001
05800	S	M	OUG	II	00392	013		12	012005	1/1/0001
05800	S	M	OUG	II	00400	012		12	012706	1/1/0001
05800	S	M	OUG	II	00449	008		12	012005	1/1/0001
05800	S	M	OUG	II	00465	007		12	012005	1/1/0001
05800	S	M	OUG	II	00000	009	SIDE REAR OF 464 SCOTTSDALE CIRCLE	12	3/9/01	1/1/0001
05800	S	M	OUG	II	00412	011		12	3/9/01	1/1/0001
05800	S	M	OUG	II	00421	010		12	3/9/01	1/1/0001
05800	S	M	OUG	II	00480	006		12	3/9/01	1/1/0001
05800	S	M	OUG	II	00488	001		12	080896	1/1/0001
05800	S	M	OUG	II	00500	002		12	080896	1/1/0001
05800	S	M	OUG	II	00512	003		12	080896	1/1/0001
05800	S	M	OUG	II	00521	004		12	100896	1/1/0001
05800	S	M	OUG	III	00532	005		12	080896	1/1/0001

OFFICE: 311

ROUTE: 564

ST_REF_NO: 00000163000

SCOVILLE ROAD

LUMENS	BULB TYPE	MULT SERIES	POLE TYPE	SHADE	ADDRESS NUMBER	REF	LOCATION	TAX DIST	DATE INST	DATE CHANGE
05800	S	M	OUG	II	01275	000		12	030767	1/1/0001
05800	S	M	OOH	II	01213	000		12	120864	1/1/0001

OFFICE: 311

ROUTE: 564

ST_REF_NO: 00000163000

SCOVILLE ROAD

LUMENS	BULB TYPE	MULT SERIES	POLE TYPE	SHADE	ADDRESS NUMBER	REF	LOCATION	TAX DIST	DATE INST	DATE CHANGE
05800	S	M	OUG	II	01233	000		12	120864	1/1/0001
05800	S	M	OUG	I	01234	000		12	010356	1/1/0001
05800	S	M	OUG	II	01262	000		12	120864	1/1/0001

OFFICE: 311

ROUTE: 564

ST_REF_NO: 00000163200

SEATTLE DRIVE

LUMENS	BULB TYPE	MULT SERIES	POLE TYPE	SHADE	ADDRESS NUMBER	REF	LOCATION	TAX DIST	DATE INST	DATE CHANGE
05800	S	M	OUG	II	00616	105		12	080884	7/31/2013
05800	S	M	OUG	II	00711	098	broke pole	12	101583	1/4/2011
04000	S	M	OUG	II	00000	096	SIDE OF 2821 PHOENIX RD.	12	101583	1/1/0001
04000	S	M	OUG	II	00604	107		12	080884	1/1/0001
04000	S	M	OUG	II	00611	106		12	080884	1/1/0001
04000	S	M	OUG	II	00621	104		12	080884	1/1/0001
04000	S	M	OUG	II	00626	103		12	080884	1/1/0001
04000	S	M	OUG	II	00633	102		12	080884	1/1/0001
04000	S	M	OUG	II	00638	101		12	080884	1/1/0001
04000	S	M	OUG	II	00701	100		12	101583	1/1/0001
04000	S	M	OUG	II	00706	099		12	101583	1/1/0001
04000	S	M	OUG	II	00718	097		12	101583	1/1/0001
04000	S	M	OUG	II	00726	095		12	101583	1/1/0001
04000	S	M	OUG	II	00734	094		12	101583	1/1/0001
04000	S	M	OUG	II	00740	093		12	101583	1/1/0001
04000	S	M	OUG	II	00746	092		12	101583	1/1/0001
04000	S	M	OUG	II	00747	091		12	101583	1/1/0001
04000	S	M	OUG	II	00756	090		12	101583	1/1/0001
04000	S	M	OUG	II	02809	112		12	101583	1/1/0001
04000	S	M	OUG	II	02816	111		12	101583	1/1/0001
04000	S	M	OUG	II	02841	110		12	101583	1/1/0001
04000	S	M	OUG	II	02856	109		12	101583	1/1/0001
04000	S	M	OUG	II	02888	108		12	101583	1/1/0001

OFFICE: 311

ROUTE: 564

ST_REF_NO: 00000163225 SEBASTIAN LANE

LUMENS	BULB TYPE	MULT SERIES	POLE TYPE	SHADE	ADDRESS NUMBER	REF	LOCATION	TAX DIST	DATE INST	DATE CHANGE
05800	S	M	CNT	II	03200	001		12	072203	1/1/0001
05800	S	M	CNT	II	03212	008		12	060105	1/1/0001
05800	S	M	CNT	II	03221	007		12	060105	1/1/0001
05800	S	M	CNT	II	03236	006		12	060105	1/1/0001
05800	S	M	CNT	II	03249	005		12	060105	1/1/0001
05800	S	M	CNT	II	03252	004		12	060105	1/1/0001
05800	S	M	CNT	II	03265	003		12	060105	1/1/0001
05800	S	M	CNT	II	03277	002		12	060105	1/1/0001
05800	S	M	CNT	II	03285	009		12	060105	1/1/0001

OFFICE: 311

ROUTE: 564

ST_REF_NO: 00000163250 SEBRING LANE

LUMENS	BULB TYPE	MULT SERIES	POLE TYPE	SHADE	ADDRESS NUMBER	REF	LOCATION	TAX DIST	DATE INST	DATE CHANGE
05800	S	M	CNT	II	00000	001	SIDE OF 2164 ROSWELL DRIVE ON SEBRING LN	12	071102	1/1/0001
05800	S	M	CNT	II	00000	002	SIDE OF 2148 NAPLES LANE ON SEBRING LANE	12	082603	1/1/0001
05800	S	M	CNT	III	01208	006		12	082603	1/1/0001
05800	S	M	CNT	II	01221	005		12	082603	1/1/0001
05800	S	M	CNT	II	01228	004		12	082603	1/1/0001
05800	S	M	CNT	II	01236	003		12	082603	1/1/0001

OFFICE: 311

ROUTE: 564

ST_REF_NO: 00000163300 SECOND, EAST STREET

LUMENS	BULB TYPE	MULT SERIES	POLE TYPE	SHADE	ADDRESS NUMBER	REF	LOCATION	TAX DIST	DATE INST	DATE CHANGE
09500	S	M	SOH	II	00214	005		12	091367	1/11/2013
09500	S	M	SOH	II	00233	004	bad fixture	12	091367	4/8/2010
05800	S	M	SOH	II	00548	016		12	021069	1/1/0001
05800	S	M	SOH	II	00000	009	OPP. 406	12	021069	1/1/0001
05800	S	M	SOH	II	00000	012	OPP. FROM SIDE OF 200 RACE ST.	12	021069	1/1/0001
05800	S	M	SOH	II	00000	015	OPP. 542-upgraded to 5800 hps cobra 10/07	12	021069	1/1/0001
10000	M	M	SOH	II	00207	006		12	020167	1/1/0001
10000	M	M	SOH	II	00244	003		12	020167	1/1/0001
10000	M	M	SOH	II	00257	002		12	091367	1/1/0001
10000	M	M	SOH	II	00270	001		12	091367	1/1/0001
05800	S	M	SOH	II	00301	001		12	021069	1/1/0001

OFFICE: 311

ROUTE: 564

ST_REF_NO: 00000163300

SECOND, EAST STREET

LUMENS	BULB TYPE	MULT SERIES	POLE TYPE	SHADE	ADDRESS NUMBER	REF	LOCATION	TAX DIST	DATE INST	DATE CHANGE
05800	S	M	SOH	II	00312	002		12	021069	1/1/0001
05800	S	M	SOH	II	00321	003		12	021069	1/1/0001
05800	S	M	SOH	II	00330	004		12	021069	1/1/0001
05800	S	M	SOH	II	00345	005		12	021069	1/1/0001
05800	S	M	SOH	II	00356	006		12	021069	1/1/0001
05800	S	M	SOH	II	00367	007		12	021069	1/1/0001
05800	S	M	SOH	II	00378	008		12	021069	1/1/0001
05800	S	M	SOH	II	00416	010		12	021069	1/1/0001
05800	S	M	SOH	II	00429	011		12	021069	1/1/0001
05800	S	M	SOH	II	00519	013		12	021069	1/1/0001
05800	S	M	SOH	II	00528	014		12	021069	1/1/0001

OFFICE: 311

ROUTE: 564

ST_REF_NO: 00000163310

SECOND, WEST STREET

LUMENS	BULB TYPE	MULT SERIES	POLE TYPE	SHADE	ADDRESS NUMBER	REF	LOCATION	TAX DIST	DATE INST	DATE CHANGE
09500	S	M	SOH	II	00000	001	1ST LT. W. OF LIMESTONE, N. SIDE-bad fixture	12	020563	3/2/2009
22000	S	M	SOH	II	00331	010		12	020563	2/11/2010
09500	S	M	SOH	II	00431	014		12	100164	8/19/2013
09500	S	M	SOH	II	00476	019		12	070164	8/20/2012
22000	S	M	SOH	II	00000	008	NW CORNER OF SECOND & N. MILL ST.	12	011863	1/1/0001
10000	M	M	SOH	II	00000	011	1ST LT. W. OF BROADWAY, S. SIDE	12	070164	1/1/0001
05800	S	M	SOH	II	00000	024	OPP. 551	12	080168	1/1/0001
10000	M	M	SOH	II	00000	028	SIDE OF 201 GEORGETOWN ST.	12	080168	1/1/0001
05800	S	M	SOH	I	00000	030	1ST LT. W. OF NEWTOWN PIKE, S. SIDE	12	112068	1/1/0001
05800	S	M	SOH	I	00000	031	1ST LT. W. OF LEE ST., N. SIDE	12	112068	1/1/0001
05800	S	M	SOH	I	00000	032	SW CORNER OF SECOND & LAUDERMAN ALLEY	12	112068	1/1/0001
05800	S	M	SOH	I	00000	033	2ND LT. W. OF LAUDERMAN ALLEY, S. SIDE	12	112068	1/1/0001
10000	M	M	SOH	II	00316	009		12	011863	1/1/0001
10000	M	M	SOH	II	00415	012		12	100164	1/1/0001
10000	M	M	SOH	II	00420	013		12	070164	1/1/0001
10000	M	M	SOH	II	00444	015		12	070164	1/1/0001
10000	M	M	SOH	II	00449	016		12	070164	1/1/0001
10000	M	M	SOH	II	00460	017		12	070164	1/1/0001
10000	M	M	SOH	II	00467	018		12	100164	1/1/0001

OFFICE: 311		ROUTE: 564		ST_REF_NO: 00000163310		SECOND, WEST STREET		LUMENS	BULB TYPE	MULT SERIES	POLE TYPE	SHADE	ADDRESS NUMBER	REF	LOCATION	TAX DIST	DATE INST	DATE CHANGE
	10000	M	M	SOH	II	00487	020									12	100164	1/1/0001
	05800	S	M	SOH	II	00501	021									12	080168	1/1/0001
	05800	S	M	SOH	II	00512	022									12	080168	1/1/0001
	05800	S	M	SOH	II	00537	023									12	080168	1/1/0001
	05800	S	M	SOH	II	00555	025									12	080168	1/1/0001
	05800	S	M	SOH	II	00568	026									12	080168	1/1/0001
	05800	S	M	SOH	II	00583	027									12	080168	1/1/0001
	10000	M	M	SOH	II	00000	003							SIDE OF 190 N. UPPER ST.		12	020563	1/1/0001
	10000	M	M	SOH	II	00000	004							SIDE OF 200 N. UPPER ST.		12	020563	1/1/0001
	22000	S	M	SOH	II	00000	006							SIDE OF 190 MARKET ST.		12	020563	1/1/0001
	22000	S	M	SOH	II	00000	075							SIDE 187 N. BROADWAY		12	120894	1/1/0001
	10000	M	M	SOH	II	00115	002									12	030263	1/1/0001
	10000	M	M	SOH	II	00200	005									12	020563	1/1/0001
	22000	S	M	SOH	II	00251	007									12	070886	1/1/0001

OFFICE: 311

ROUTE: 564

OFFICE: 311		ROUTE: 564		ST_REF_NO: 00000163320		SEDALIA LANE		LUMENS	BULB TYPE	MULT SERIES	POLE TYPE	SHADE	ADDRESS NUMBER	REF	LOCATION	TAX DIST	DATE INST	DATE CHANGE
	05800	S	M	CNT	II	00000	001							SIDE OF 2140 ROSWELL DR ON SEDALIA LN		12	081704	1/1/0001
	05800	S	M	CNT	II	02101	002									12	081704	1/1/0001
	05800	S	M	CNT	II	02108	003									12	081704	1/1/0001

OFFICE: 311

ROUTE: 564

OFFICE: 311		ROUTE: 564		ST_REF_NO: 00000163325		SEDONA VISTA		LUMENS	BULB TYPE	MULT SERIES	POLE TYPE	SHADE	ADDRESS NUMBER	REF	LOCATION	TAX DIST	DATE INST	DATE CHANGE
	05800	S	M	CNT	II	03708	001									12	060895	1/1/0001

OFFICE: 311

ROUTE: 564

OFFICE: 311		ROUTE: 564		ST_REF_NO: 00000163400		SEELEY DRIVE		LUMENS	BULB TYPE	MULT SERIES	POLE TYPE	SHADE	ADDRESS NUMBER	REF	LOCATION	TAX DIST	DATE INST	DATE CHANGE
	05800	S	M	OUG	II	00000	160							SIDE OF 2011 BRIDGEPORT DR.		12	091573	1/1/0001
	05800	S	M	OUG	II	00000	181							SIDE OF 2060 MANOR DR.		12	091477	1/1/0001
	05800	S	M	OUG	II	00000	182							SIDE OF 2083 NORBORNE DR.		12	041774	1/1/0001
	05800	S	M	OUG	II	00000	183							SIDE OF 2076 NORBORNE DR		12	021475	1/1/0001

OFFICE: 311

ROUTE: 564

ST_REF_NO: 00000163400 SEELEY DRIVE

LUMENS	BULB TYPE	MULT SERIES	POLE TYPE	SHADE	ADDRESS NUMBER	REF	LOCATION	TAX DIST	DATE INST	DATE CHANGE
05800	S	M	OUG	II	00484	161		12	091476	1/1/0001
05800	S	M	OUG	II	00493	159		12	041774	1/1/0001
05800	S	M	OUG	II	00496	138		12	091477	1/1/0001

OFFICE: 311

ROUTE: 564

ST_REF_NO: 00000163500 SEINE ROAD

LUMENS	BULB TYPE	MULT SERIES	POLE TYPE	SHADE	ADDRESS NUMBER	REF	LOCATION	TAX DIST	DATE INST	DATE CHANGE
05800	S	M	OUG	II	00000	017	SIDE OF 1323 BORDEAUX	12	072363	1/1/0001
05800	S	M	OUG	II	02413	018		12	072363	1/1/0001
05800	S	M	OUG	II	02422	019		12	072363	1/1/0001
05800	S	M	OUG	II	02433	020		12	100172	1/1/0001

OFFICE: 311

ROUTE: 564

ST_REF_NO: 00000163600 SELF STREET

LUMENS	BULB TYPE	MULT SERIES	POLE TYPE	SHADE	ADDRESS NUMBER	REF	LOCATION	TAX DIST	DATE INST	DATE CHANGE
05800	S	M	SOH	I	00704	000		12	030970	1/1/0001

OFFICE: 311

ROUTE: 564

ST_REF_NO: 00000163700 SELLERS ALLEY

LUMENS	BULB TYPE	MULT SERIES	POLE TYPE	SHADE	ADDRESS NUMBER	REF	LOCATION	TAX DIST	DATE INST	DATE CHANGE
05800	S	M	SOH	I	00000	001	SIDE OF 198 PRALL ST.	12	061478	1/1/0001
05800	S	M	SOH	I	00000	002	SIDE OF 199 PRALL ST.	12	061478	1/1/0001
05800	S	M	SOH	I	00000	003	OPP. 188 COLFAX ST. ON SELLARS	12	010885	1/1/0001
05800	S	M	SOH	I	00000	004	BESIDE 610	12	011865	1/1/0001

OFFICE: 311

ROUTE: 564

ST_REF_NO: 00000163825 SELMA COURT

LUMENS	BULB TYPE	MULT SERIES	POLE TYPE	SHADE	ADDRESS NUMBER	REF	LOCATION	TAX DIST	DATE INST	DATE CHANGE
05800	S	M	CNT	III	01301	001		12	071102	1/1/0001

OFFICE: 311

ROUTE: 564

ST_REF_NO: 00000163850 SEMINOLE CREEK

LUMENS	BULB TYPE	MULT SERIES	POLE TYPE	SHADE	ADDRESS NUMBER	REF	LOCATION	TAX DIST	DATE INST	DATE CHANGE
05800	S	M	OUG	III	00809	002		12	103103	1/1/0001
05800	S	M	OUG	II	00821	001		12	103103	1/1/0001

OFFICE: 311

ROUTE: 564

ST_REF_NO: 00000163875 SENECA PARK

LUMENS	BULB TYPE	MULT SERIES	POLE TYPE	SHADE	ADDRESS NUMBER	REF	LOCATION	TAX DIST	DATE INST	DATE CHANGE
05800	S	M	CNT	III	00901	004		12	091503	1/1/0001
05800	S	M	CNT	II	00908	003		12	091503	1/1/0001
05800	S	M	CNT	II	00925	002		12	091503	1/1/0001
05800	S	M	CNT	II	00932	001		12	091503	1/1/0001

OFFICE: 311

ROUTE: 564

ST_REF_NO: 00000164000 SETON ROAD

LUMENS	BULB TYPE	MULT SERIES	POLE TYPE	SHADE	ADDRESS NUMBER	REF	LOCATION	TAX DIST	DATE INST	DATE CHANGE
09500	S	M	OUG	II	00000	118	SIDE OF 484 LAKESHORE DR.	12	101674	9/7/2011
10000	M	M	OUG	II	00000	115	SIDE OF 491 LAKETOWER DR.	12	050172	1/1/0001
10000	M	M	OUG	II	00000	116	SIDE OF 503 LAKETOWER DR.	12	050172	1/1/0001
10000	M	M	OUG	II	00000	117	SIDE OF 476 LAKESHORE DR.	12	041674	1/1/0001

OFFICE: 311

ROUTE: 564

ST_REF_NO: 00000164100 SEVEN PINES DRIVE

LUMENS	BULB TYPE	MULT SERIES	POLE TYPE	SHADE	ADDRESS NUMBER	REF	LOCATION	TAX DIST	DATE INST	DATE CHANGE
05800	S	M	OUG	II	01901	000		12	101674	1/1/0001
05800	S	M	OUG	II	01904	000		12	101674	1/1/0001
05800	S	M	OUG	II	01913	000		12	101674	1/1/0001
05800	S	M	OUG	II	01917	069		12	081476	1/1/0001

OFFICE: 311

ROUTE: 564

ST_REF_NO: 00000164200 SEVENTH, EAST STREET

LUMENS	BULB TYPE	MULT SERIES	POLE TYPE	SHADE	ADDRESS NUMBER	REF	LOCATION	TAX DIST	DATE INST	DATE CHANGE
09500	S	M	SOH	II	00132	003	bad fixture	12	121065	11/6/2009
22000	S	M	SOH	II	00301	012		12	121068	8/28/2011
09500	S	M	SOH	II	00343	014	opp side of 673 Ohio Street	12	121068	12/10/1968
09500	S	M	SOH	II	00434	021		12	020469	4/30/2013
22000	S	M	SOH	II	00507	500		12	042507	1/1/0001
09500	S	M	SOH	II	00658	033		12	121068	11/28/2013
09500	S	M	SOH	II	00710	037	changed out bad fixture	12	020469	11/2/2009
10000	M	M	SOH	II	00000	001	SIDE OF 674 N. LIMESTONE	12	121068	1/1/0001
10000	M	M	SOH	II	00117	002		12	121068	1/1/0001
10000	M	M	SOH	II	00000	007	SIDE OF 670 WALNUT ST.	12	020469	1/1/0001

OFFICE: 311

ROUTE: 564

ST_REF_NO: 00000164200

SEVENTH, EAST STREET

LUMENS	BULB TYPE	MULT SERIES	POLE TYPE	SHADE	ADDRESS NUMBER	REF	LOCATION	TAX DIST	DATE INST	DATE CHANGE
10000	M	M	SOH	II	00000	017	SIDE OF 657 CHESTNUT ST.	12	020469	1/1/0001
10000	M	M	SOH	II	00000	018	OPP. 406	12	121068	1/1/0001
10000	M	M	SOH	II	00000	020	OPP. 424	12	121068	1/1/0001
10000	M	M	SOH	II	00000	026	SIDE OF 700 MAGOFFIN ST.	12	121068	1/1/0001
10000	M	M	SOH	II	00000	029	SIDE OF 658 JACKSON ST.	12	020469	1/1/0001
10000	M	M	SOH	II	00000	034	OPP. 666	12	121068	1/1/0001
10000	M	M	SOH	II	00145	004		12	121065	1/1/0001
10000	M	M	SOH	II	00160	005		12	121065	1/1/0001
09500	S	M	SOH	II	00173	006	upgrade 6/08	12	121068	1/1/0001
10000	M	M	SOH	II	00207	008		12	121068	1/1/0001
10000	M	M	SOH	II	00217	010		12	121068	1/1/0001
10000	M	M	SOH	II	00218	009		12	020469	1/1/0001
10000	M	M	SOH	II	00230	011		12	020469	1/1/0001
10000	M	M	SOH	II	00308	013		12	121068	1/1/0001
10000	M	M	SOH	II	00340	015		12	121068	1/1/0001
10000	M	M	SOH	II	00347	016		12	121068	1/1/0001
10000	M	M	SOH	II	00410	019		12	121068	1/1/0001
50000	S	M	SOH	II	00449	022	upgraded 7/06	12	121068	1/1/0001
22000	S	M	SOH	II	00502	023		12	020469	1/1/0001
22000	S	M	SOH	II	00515	024		12	121068	1/1/0001
10000	M	M	SOH	II	00528	025		12	020469	1/1/0001
10000	M	M	SOH	II	00552	027		12	121068	1/1/0001
10000	M	M	SOH	II	00571	028		12	121068	1/1/0001
10000	M	M	SOH	II	00601	030		12	121068	1/1/0001
10000	M	M	SOH	II	00628	031		12	121068	1/1/0001
10000	M	M	SOH	II	00644	032		12	121068	1/1/0001
10000	M	M	SOH	II	00700	035		12	121068	1/1/0001
10000	M	M	SOH	II	00733	036		12	121068	1/1/0001
05800	S	M	SOH	II	00000	048	SIDE OF 697 TENNESSEE AVE.	12	121068	1/1/0001
05800	S	M	SOH	II	00000	049	SIDE OF 698 TENNESSEE AVE.	12	121068	1/1/0001
10000	M	M	SOH	II	00753	038		12	121068	1/1/0001
10000	M	M	SOH	II	00763	040		12	121068	1/1/0001
10000	M	M	SOH	II	00766	039		12	020469	1/1/0001
05800	S	M	SOH	II	00828	044		12	121068	1/1/0001

Street Light Listing run 1/11/2015 10:43:21 AM

Page 994 of 1254

OFFICE: 311		ROUTE: 564		ST_REF_NO: 00000164200		SEVENTH, EAST STREET		LUMENS	BULB TYPE	MULT SERIES	POLE TYPE	SHADE	ADDRESS NUMBER	REF	LOCATION	TAX DIST	DATE INST	DATE CHANGE
05800	S	M	SOH	II	00834	045										12	121068	1/1/0001
05800	S	M	SOH	I	00836	046										12	121068	1/1/0001
05800	S	M	SOH	II	00842	047										12	121068	1/1/0001

OFFICE: 311		ROUTE: 564		ST_REF_NO: 00000164250		SEVENTH, WEST STREET		LUMENS	BULB TYPE	MULT SERIES	POLE TYPE	SHADE	ADDRESS NUMBER	REF	LOCATION	TAX DIST	DATE INST	DATE CHANGE
10000	M	M	SOH	II	00000	001	SIDE OF 670 BROADWAY									12	040969	1/1/0001
10000	M	M	SOH	II	00000	003	OPP. 303									12	040969	1/1/0001
10000	M	M	SOH	II	00000	004	SIDE OF 702 DAKOTA ST.									12	040969	1/1/0001
10000	M	M	SOH	II	00000	005	OPP. 235									12	040969	1/1/0001
10000	M	M	SOH	II	00000	008	SIDE OF 700 N. UPPER ST.									12	040969	1/1/0001
10000	M	M	SOH	II	00000	010	SIDE OF 701 N. LIMESTONE									12	040969	1/1/0001
10000	M	M	SOH	II	00108	009										12	040969	1/1/0001
10000	M	M	SOH	II	00204	007										12	040969	1/1/0001
10000	M	M	SOH	II	00223	006										12	040969	1/1/0001
10000	M	M	SOH	II	00311	002										12	040969	1/1/0001

OFFICE: 311		ROUTE: 564		ST_REF_NO: 00000164300		SEVERN WAY		LUMENS	BULB TYPE	MULT SERIES	POLE TYPE	SHADE	ADDRESS NUMBER	REF	LOCATION	TAX DIST	DATE INST	DATE CHANGE
04000	S	M	OUG	II	00000	027	SIDE OF 2852 MIDDLESEX WAY									12	101570	1/1/0001
04000	S	M	OUG	II	00000	035	SIDE OF 608									12	041470	1/1/0001
04000	S	M	OUG	II	00476	061										12	101173	1/1/0001
04000	S	M	OUG	II	00485	060										12	062174	1/1/0001
04000	S	M	OUG	II	00500	059										12	101173	1/1/0001
04000	S	M	OUG	II	00509	058										12	101173	1/1/0001
04000	S	M	OUG	II	00516	057										12	101173	1/1/0001
04000	S	M	OUG	II	00529	056										12	101173	1/1/0001
04000	S	M	OUG	II	00545	028										12	050172	1/1/0001
04000	S	M	OUG	II	00556	029										12	041470	1/1/0001
04000	S	M	OUG	II	00565	030										12	101570	1/1/0001
04000	S	M	OUG	II	00576	031										12	041470	1/1/0001
04000	S	M	OUG	II	00589	032										12	101570	1/1/0001

OFFICE: 311

ROUTE: 564

ST_REF_NO: 00000164300 SEVERN WAY

LUMENS	BULB TYPE	MULT SERIES	POLE TYPE	SHADE	ADDRESS NUMBER	REF	LOCATION	TAX DIST	DATE INST	DATE CHANGE
04000	S	M	OUG	II	00596	033		12	041470	1/1/0001
04000	S	M	OUG	II	00609	034		12	041470	1/1/0001
04000	S	M	OUG	II	00637	036		12	050172	1/1/0001
04000	S	M	OUG	II	00644	037		12	041470	1/1/0001
04000	S	M	OUG	II	00000	062	SIDE OF 402 WESTERFIELD WAY	12	101173	1/1/0001
04000	S	M	OUG	II	00400	069		12	062174	1/1/0001
04000	S	M	OUG	II	00409	068		12	062174	1/1/0001
04000	S	M	OUG	II	00420	067		12	062474	1/1/0001
04000	S	M	OUG	II	00433	066		12	062174	1/1/0001
04000	S	M	OUG	II	00440	065		12	062474	1/1/0001
04000	S	M	OUG	II	00449	064		12	062474	1/1/0001
04000	S	M	OUG	II	00460	063		12	062474	1/1/0001

OFFICE: 311

ROUTE: 564

ST_REF_NO: 00000164320 SEVILLE COURT

LUMENS	BULB TYPE	MULT SERIES	POLE TYPE	SHADE	ADDRESS NUMBER	REF	LOCATION	TAX DIST	DATE INST	DATE CHANGE
05800	S	M	OUG	III	01109	001		12	110899	1/1/0001

OFFICE: 311

ROUTE: 564

ST_REF_NO: 00000164325 SEWANEE LANE

LUMENS	BULB TYPE	MULT SERIES	POLE TYPE	SHADE	ADDRESS NUMBER	REF	LOCATION	TAX DIST	DATE INST	DATE CHANGE
05800	S	M	CNT	II	03000	001		12	101905	1/1/0001
05800	S	M	CNT	II	03016	002		12	101905	1/1/0001
05800	S	M	CNT	II	03033	003		12	101905	1/1/0001
05800	S	M	CNT	II	03049	004		12	101905	1/1/0001

OFFICE: 311

ROUTE: 564

ST_REF_NO: 00000164340 SHADOW GLEN COURT

LUMENS	BULB TYPE	MULT SERIES	POLE TYPE	SHADE	ADDRESS NUMBER	REF	LOCATION	TAX DIST	DATE INST	DATE CHANGE
05800	S	M	OUG	II	00000	002	SIDE OF 340	12	040897	1/1/0001
05800	S	M	OUG	II	00000	004	OPP. 361	12	040897	1/1/0001
05800	S	M	OUG	IV	00000	005	REAR OF 2615 WOODHILL DR.	12	040897	1/1/0001
05800	S	M	OUG	II	00305	001		12	040897	1/1/0001
05800	S	M	OUG	II	00348	003		12	040897	1/1/0001

OFFICE: 311

ROUTE: 564

ST_REF_NO: 00000164400

SHADOW WOOD PLACE

LUMENS	BULB TYPE	MULT SERIES	POLE TYPE	SHADE	ADDRESS NUMBER	REF	LOCATION	TAX DIST	DATE INST	DATE CHANGE
05800	S	M	OUG	V	00200	006		12	011581	1/1/0001
05800	S	M	OUG	II	00216	007		12	011581	1/1/0001

OFFICE: 311

ROUTE: 564

ST_REF_NO: 00000164450

SHADY HILLS DRIVE

LUMENS	BULB TYPE	MULT SERIES	POLE TYPE	SHADE	ADDRESS NUMBER	REF	LOCATION	TAX DIST	DATE INST	DATE CHANGE
05800	S		OUG	II	00000	003	SIDE OF 2480 TREELINE DR, ON SHADY HILLS DRIVE	12	081310	1/1/0001
05800	S	M	OUG	II	00000	001	SIDE OF 745 GRAFTONS MILL LANE	12	110899	1/1/0001
05800	S	M	OUG	II	02484	002		12	110899	1/1/0001

OFFICE: 311

ROUTE: 564

ST_REF_NO: 00000164500

SHADY LANE

LUMENS	BULB TYPE	MULT SERIES	POLE TYPE	SHADE	ADDRESS NUMBER	REF	LOCATION	TAX DIST	DATE INST	DATE CHANGE
04000	S	M	OUG	II	00000	006	OPP. 130	12	120888	1/1/0001
04000	S	M	OUG	II	00000	007	OPP. 138	12	120888	1/1/0001
04000	S	M	OUG	II	00000	010	OPP. 216	12	120888	1/1/0001
05800	S	M	OUG	II	00000	015	OPP. 247	12	120888	1/1/0001
04000	S	M	OUG	II	00000	016	OPP. 255	12	120888	1/1/0001
04000	S	M	OUG	II	00093	001		12	120888	1/1/0001
04000	S	M	OUG	II	00100	002		12	120888	1/1/0001
04000	S	M	SOH	II	00103	003		12	120888	1/1/0001
04000	S	M	OOH	II	00112	004		12	120888	1/1/0001
04000	S	M	SOH	II	00122	005		12	120888	1/1/0001
04000	S	M	SOH	II	00204	008		12	120888	1/1/0001
04000	S	M	OUG	II	00210	009		12	120888	1/1/0001
04000	S	M	OUG	II	00220	011		12	120888	1/1/0001
04000	S	M	OUG	II	00224	012		12	120888	1/1/0001
04000	S	M	OUG	II	00234	013		12	120888	1/1/0001
04000	S	M	OUG	II	00240	014		12	120888	1/1/0001

OFFICE: 311 ROUTE: 564										
ST_REF_NO: 00000164502 SHADY KNOLL REST										
LUMENS	BULB TYPE	MULT SERIES	POLE TYPE	SHADE	ADDRESS NUMBER	REF	LOCATION	TAX DIST	DATE INST	DATE CHANGE
05800	S	M	CNT	II	00000	006	SIDE OF 3061 PRICHARD DR ON SHADY KNOLL REST	12	121406	1/1/0001
05800	S	M	CNT	II	03016	005		12	121406	1/1/0001
05800	S	M	CNT	II	03037	004		12	121406	1/1/0001
05800	S	M	CNT	II	03052	003		12	121406	1/1/0001
05800	S	M	CNT	II	03069	002		12	121406	1/1/0001
05800	S	M	CNT	II	03080	001		12	121406	1/1/0001

OFFICE: 311 ROUTE: 564										
ST_REF_NO: 00000164505 SHADY SPRING COURT										
LUMENS	BULB TYPE	MULT SERIES	POLE TYPE	SHADE	ADDRESS NUMBER	REF	LOCATION	TAX DIST	DATE INST	DATE CHANGE
05800	S	M	OUG	V	04495	006		12	090886	6/26/2009
04000	S	M	OUG	II	04480	008		12	090886	1/1/0001
04000	S	M	OUG	II	04492	007		12	090886	1/1/0001

OFFICE: 311 ROUTE: 564										
ST_REF_NO: 00000164510 SHADYBROOK LANE										
LUMENS	BULB TYPE	MULT SERIES	POLE TYPE	SHADE	ADDRESS NUMBER	REF	LOCATION	TAX DIST	DATE INST	DATE CHANGE
22000	S	M	SOH	II	00000	050	ACROSS FROM 2036 SHADYBROOK LANE	12	111105	1/1/0001
22000	S	M	SOH	II	00000	051	SIDE OF 2044 SHADYBROOK LANE	12	111105	1/1/0001
22000	S	M	SOH	II	00000	040	2ND LT. EAST OF LAKESIDE DR., NORTH SIDE	12	071479	1/1/0001
22000	S	M	SOH	II	00000	041	1ST LT. E. OF LAKESIDE DR., N. SIDE	12	071479	1/1/0001
22000	S	M	SOH	II	00000	042	1ST LT. W. OF LAKESIDE DR., N. SIDE	12	071479	1/1/0001
22000	S	M	SOH	II	00000	043	2ND LT. W. OF LAKESIDE DR., N. SIDE	12	071479	1/1/0001
22000	S	M	SOH	II	00000	044	3RD LT. W. OF LAKESIDE DR., N. SIDE	12	071479	1/1/0001
22000	S	M	SOH	II	00000	045	4TH LT. W. OF LAKESIDE DR., N. SIDE	12	071479	1/1/0001
22000	S	M	SOH	II	00000	046	5TH LT. W. OF LAKESIDE DR., N. SIDE	12	071479	1/1/0001
22000	S	M	SOH	II	00000	047	6TH LT. W. OF LAKESIDE DR., N. SIDE	12	071479	1/1/0001
22000	S	M	SOH	II	00000	048	OPP. 2040	12	100888	1/1/0001
22000	S	M	SOH	II	00000	049	OPP. 1956	12	020890	1/1/0001
09500	S	M	SOH	V	00000	050	BEHIND THE GUARDRAIL AT THE END OF SHADYBROOK LANE	12	030891	1/1/0001
22000	S	M	SOH	II	02013	038	upgraded all existing lites to 22,000 Nov 05	12	031477	1/1/0001
22000	S	M	SOH	II	02017	039		12	031477	1/1/0001

OFFICE: 311		ROUTE: 564		ST_REF_NO: 00000164550		SHAFTSBURY COURT				
LUMENS	BULB TYPE	MULT SERIES	POLE TYPE	SHADE	ADDRESS NUMBER	REF	LOCATION	TAX DIST	DATE INST	DATE CHANGE
05800	S	M	OUG	II	00632	154	upgraded 10/07	12	071476	1/1/0001
05800	S	M	OUG	V	00640	155	upgraded 10/07	12	071476	1/1/0001

OFFICE: 311		ROUTE: 564		ST_REF_NO: 00000164600		SHAFTSBURY ROAD				
LUMENS	BULB TYPE	MULT SERIES	POLE TYPE	SHADE	ADDRESS NUMBER	REF	LOCATION	TAX DIST	DATE INST	DATE CHANGE
05800	S	M	OUG	II	00000	040	SIDE OF 1670 HARROGATE RD.	12	021866	1/1/0001
05800	S	M	OUG	II	00000	041	SIDE OF 1665 HARROGATE RD.	12	021866	1/1/0001
05800	S	M	OUG	II	00462	033		12	021866	1/1/0001
05800	S	M	OUG	II	00473	034		12	021866	1/1/0001
05800	S	M	OUG	II	00486	035		12	080367	1/1/0001
05800	S	M	OUG	II	00501	036		12	100169	1/1/0001
05800	S	M	OUG	II	00512	037		12	021866	1/1/0001
05800	S	M	OUG	II	00531	038		12	021866	1/1/0001
05800	S	M	OUG	II	00540	039		12	021866	1/1/0001
05800	S	M	OUG	II	00573	000		12	111366	1/1/0001
05800	S	M	OUG	II	00580	000		12	041267	1/1/0001
05800	S	M	OUG	II	00589	000		12	041267	1/1/0001
05800	S	M	OUG	II	00604	000		12	041267	1/1/0001
05800	S	M	OUG	II	00612	000		12	081869	1/1/0001
05800	S	M	OUG	II	00619	000		12	081869	1/1/0001

OFFICE: 311		ROUTE: 564		ST_REF_NO: 00000164610		SHAGBARK COURT				
LUMENS	BULB TYPE	MULT SERIES	POLE TYPE	SHADE	ADDRESS NUMBER	REF	LOCATION	TAX DIST	DATE INST	DATE CHANGE
04000	S	M	OUG	II	04404	001		12	010893	1/1/0001
04000	S	M	OUG	V	04413	002		12	010893	1/1/0001

OFFICE: 311		ROUTE: 564		ST_REF_NO: 00000164650		SHAGBARK LANE				
LUMENS	BULB TYPE	MULT SERIES	POLE TYPE	SHADE	ADDRESS NUMBER	REF	LOCATION	TAX DIST	DATE INST	DATE CHANGE
22000	S	M	OUG	II	01101	100		12	072704	1/1/0001
05800	S	M	OUG	II	01100	001		12	070896	1/1/0001
05800	S	M	OUG	II	01105	002		12	100890	1/1/0001

OFFICE: 311		ROUTE: 564		ST_REF_NO: 00000164650		SHAGBARK LANE				
LUMENS	BULB TYPE	MULT SERIES	POLE TYPE	SHADE	ADDRESS NUMBER	REF	LOCATION	TAX DIST	DATE INST	DATE CHANGE
05800	S	M	OUG	II	01112	003		12	100890	1/1/0001
05800	S	M	OUG	II	01117	004		12	100890	1/1/0001
04000	S	M	OUG	II	01125	005		12	100890	1/1/0001
04000	S	M	OUG	II	01137	006		12	100890	1/1/0001

OFFICE: 311		ROUTE: 564		ST_REF_NO: 00000164700		SHAKER DRIVE				
LUMENS	BULB TYPE	MULT SERIES	POLE TYPE	SHADE	ADDRESS NUMBER	REF	LOCATION	TAX DIST	DATE INST	DATE CHANGE
05800	S	M	OUG	II	00000	002	2ND LT. FROM HARRODSBURG RD. ON SERVICE RD.	12	051475	1/1/0001
05800	S	M	OUG	II	00000	003	3RD LT. FROM HARRODSBURG RD. ON SERVICE RD.	12	051475	1/1/0001
05800	S	M	OUG	II	00000	004	SIDE OF 1733 HARRODSBURG RD.	12	051475	1/1/0001
05800	S	M	OUG	II	00000	006	SIDE OF 1733 HARRODSBURG RD.	12	051475	1/1/0001
05800	S	M	OUG	II	00701	005		12	051475	1/1/0001
05800	S	M	OUG	II	00701	007		12	051475	1/1/0001
05800	S	M	OUG	II	00750	008		12	051475	1/1/0001
05800	S	M	OUG	II	00000	001	1ST LT. FROM HARRODSBURG RD. ON SERVICE RD.	12	051475	1/1/0001
05800	S	M	OUG	II	00000	013	OPP. 651	12	020890	1/1/0001
05800	S	M	OUG	II	00000	015	OPP. 601	12	020890	1/1/0001
05800	S	M	OUG	II	00000	017	SIDE 680 MASON HEADLEY	12	020890	1/1/0001
05800	S	M	OUG	II	00601	016		12	020890	1/1/0001
05800	S	M	SOH	II	00650	012		12	020890	1/1/0001
05800	S	M	OUG	II	00651	014		12	020890	1/1/0001
05800	S	M	OUG	II	00675	009		12	020890	1/1/0001
05800	S	M	OUG	II	00675	011		12	020890	1/1/0001

OFFICE: 311		ROUTE: 564		ST_REF_NO: 00000164720		SHAKER OAKS COURT				
LUMENS	BULB TYPE	MULT SERIES	POLE TYPE	SHADE	ADDRESS NUMBER	REF	LOCATION	TAX DIST	DATE INST	DATE CHANGE
05800	S	M	CNT	III	03005	001		12	100901	1/1/0001

OFFICE: 311		ROUTE: 564		ST_REF_NO: 00000164724		SHAKER RUN CIRCLE				
LUMENS	BULB TYPE	MULT SERIES	POLE TYPE	SHADE	ADDRESS NUMBER	REF	LOCATION	TAX DIST	DATE INST	DATE CHANGE
05800	S	M	CNT	III	00000	001	SIDE OF 2080 SHAKER RUN RD ON SHAKER RUN CIRCLE	12	100901	1/1/0001

OFFICE: 311		ROUTE: 564		ST_REF_NO: 00000164725		SHAKER RUN ROAD				
LUMENS	BULB TYPE	MULT SERIES	POLE TYPE	SHADE	ADDRESS NUMBER	REF	LOCATION	TAX DIST	DATE INST	DATE CHANGE
05800	S	M	CNT	II	00000	002	SIDE OF 3044 POLO CLUB BLVD ON SHAKER RUN ROAD	12	100901	1/1/0001
05800	S	M	CNT	II	00000	006	SIDE OF 300 QUAKER HILL LANE ON SHAKER RUN RD	12	100901	1/1/0001
05800	S	M	CNT	II	00000	010	SIDE OF 2000 BALTUSROL LANE ON SHAKER RUN RD	12	100901	1/1/0001
05800	S	M	CNT	II	00000	024	SIDE OF 3216 WINGED FOOT CR ON SHAKER RUN	12	092804	1/1/0001
05800	S	M	CNT	II	02017	003		12	100901	1/1/0001
05800	S	M	CNT	II	02045	005		12	100901	1/1/0001
05800	S	M	CNT	II	02077	007		12	100901	1/1/0001
05800	S	M	CNT	II	02096	008		12	100901	1/1/0001
05800	S	M	CNT	II	02112	009		12	100901	1/1/0001
05800	S	M	CNT	II	02141	011		12	100901	1/1/0001
05800	S	M	CNT	II	02164	012		12	100901	1/1/0001
05800	S	M	CNT	II	02181	013		12	100901	1/1/0001
05800	S	M	CNT	II	02193	014		12	100901	1/1/0001
05800	S	M	CNT	II	02200	028		12	092804	1/1/0001
05800	S	M	CNT	II	02205	027		12	092804	1/1/0001
05800	S	M	CNT	II	02213	026		12	092804	1/1/0001
05800	S	M	CNT	II	02233	025		12	092804	1/1/0001
05800	S	M	CNT	II	02244	023		12	092804	1/1/0001
05800	S	M	CNT	II	02261	022		12	092804	1/1/0001
05800	S	M	CNT	II	02269	021		12	092804	1/1/0001

OFFICE: 311		ROUTE: 564		ST_REF_NO: 00000164800		SHANDON DRIVE				
LUMENS	BULB TYPE	MULT SERIES	POLE TYPE	SHADE	ADDRESS NUMBER	REF	LOCATION	TAX DIST	DATE INST	DATE CHANGE
05800	S	M	OUG	II	00000	040	SIDE OF 701 BURGOPYNE	12	031868	1/1/0001
05800	S	M	OUG	II	02309	046		12	050969	1/1/0001
05800	S	M	OUG	II	02324	045		12	040171	1/1/0001

Street Light Listing run 1/11/2015 10:43:21 AM

Page 1001 of 1254

OFFICE: 311

ROUTE: 564

ST_REF_NO: 00000164800

SHANDON DRIVE

LUMENS	BULB TYPE	MULT SERIES	POLE TYPE	SHADE	ADDRESS NUMBER	REF	LOCATION	TAX DIST	DATE INST	DATE CHANGE
05800	S	M	OUG	II	02329	044		12	031868	1/1/0001
05800	S	M	OUG	II	02340	043		12	091967	1/1/0001
05800	S	M	OUG	II	02357	042		12	040171	1/1/0001
05800	S	M	OUG	II	02368	041		12	031869	1/1/0001
05800	S	M	OUG	II	02416	039		12	060870	1/1/0001
05800	S	M	OUG	II	02429	038		12	100171	1/1/0001

OFFICE: 311

ROUTE: 564

ST_REF_NO: 00000164810

SHANNAWOOD DRIVE

LUMENS	BULB TYPE	MULT SERIES	POLE TYPE	SHADE	ADDRESS NUMBER	REF	LOCATION	TAX DIST	DATE INST	DATE CHANGE
05800	S	M	CNT	II	02212	013		12	100894	1/1/0001
05800	S	M	CNT	II	02221	011		12	100894	1/1/0001
05800	S	M	CNT	III	02224	012		12	100894	1/1/0001
05800	S	M	CNT	III	02229	010		12	100894	1/1/0001
05800	S	M	CNT	III	02233	009		12	100894	1/1/0001
05800	S	M	CNT	III	02241	008		12	100894	1/1/0001
05800	S	M	CNT	II	02261	007		12	10089	1/1/0001
05800	S	M	CNT	II	02276	006		12	100894	1/1/0001
05800	S	M	CNT	II	02284	005		12	100894	1/1/0001
05800	S	M	CNT	II	02289	004		12	100894	1/1/0001
05800	S	M	CNT	II	02304	002		12	100894	1/1/0001
05800	S	M	CNT	II	02305	003		12	100894	1/1/0001

OFFICE: 311

ROUTE: 564

ST_REF_NO: 00000164880

SHANNON COURT

LUMENS	BULB TYPE	MULT SERIES	POLE TYPE	SHADE	ADDRESS NUMBER	REF	LOCATION	TAX DIST	DATE INST	DATE CHANGE
05800	S	M	CNT	III	00209	002		12	042605	1/1/0001
05800	S	M	CNT	II	00220	001		12	042605	1/1/0001

OFFICE: 311

ROUTE: 564

ST_REF_NO: 00000164905

SHANNON TRACE

LUMENS	BULB TYPE	MULT SERIES	POLE TYPE	SHADE	ADDRESS NUMBER	REF	LOCATION	TAX DIST	DATE INST	DATE CHANGE
05800	S	M	CNT	II	02600	001		12	042605	1/1/0001
05800	S	M	CNT	II	02621	002		12	042605	1/1/0001

OFFICE: 311		ROUTE: 564		ST_REF_NO: 00000164905		SHANNON TRACE		LUMENS	BULB TYPE	MULT SERIES	POLE TYPE	SHADE	ADDRESS NUMBER	REF	LOCATION	TAX DIST	DATE INST	DATE CHANGE
	05800	S	M	CNT	III	02636	003									12	042605	1/1/0001

OFFICE: 311		ROUTE: 564		ST_REF_NO: 00000164980		SHARKEY WAY		LUMENS	BULB TYPE	MULT SERIES	POLE TYPE	SHADE	ADDRESS NUMBER	REF	LOCATION	TAX DIST	DATE INST	DATE CHANGE
	05800	S		CNT	II	00000	001								2ND LT N OF LOUIE PL, E SIDE ON SHARKEY WAY	12	021909	1/1/0001
	05800	S		CNT	II	00000	002								3RD LT N OF LOUIE PL, E SIDE ON SHARKEY	12	021909	1/1/0001
	05800	S		CNT	II	00000	003								4TH LT N OF LOUIE PL, E SIDE ON SHARKEY	12	021909	1/1/0001
	05800	S		CNT	II	00000	004								1ST LT N OF TOWNE CENTER DR, W SIDE ON SHARKEY WAY	12	021909	1/1/0001
	05800	S		CNT	II	00000	005								2ND LT N OF TOWNE CENTER DR, W SIDE ON SHARKEY WAY	12	021909	1/1/0001
	05800	S		CNT	II	00000	006								3RD LT N OF TOWNE CENTER DR, W SIDE ON SHARLEY	12	021909	1/1/0001
	05800	S		CNT	II	00000	007								4TH LT N OF TOWNE CENTER DR, W SIDE ON SHARKEY WAY	12	021909	1/1/0001
	05800	S		CNT	II	00000	008								5TH LT N OF TOWNE CENTE DR, W SIDE ON SHARKEY WAY	12	021909	1/1/0001
	05800	S		CNT	II	00000	100								1ST LT N OF LOUIE PL, E SIDE ON SHARKEY WAY	12	021909	1/1/0001

OFFICE: 311		ROUTE: 564		ST_REF_NO: 00000165000		SHASTA CIRCLE		LUMENS	BULB TYPE	MULT SERIES	POLE TYPE	SHADE	ADDRESS NUMBER	REF	LOCATION	TAX DIST	DATE INST	DATE CHANGE
	04000	S	M	OUG	V	00652	006									12	020891	1/1/0001
	04000	S	M	OUG	II	00660	005									12	020891	1/1/0001
	04000	S	M	OUG	II	00677	004									12	020891	1/1/0001
	04000	S	M	OUG	II	00681	003									12	020891	1/1/0001
	04000	S	M	OUG	II	00688	002									12	020891	1/1/0001
	04000	S	M	OUG	II	00696	001									12	020891	1/1/0001

OFFICE: 311		ROUTE: 564		ST_REF_NO: 00000165100		SHAWNEE AVENUE		LUMENS	BULB TYPE	MULT SERIES	POLE TYPE	SHADE	ADDRESS NUMBER	REF	LOCATION	TAX DIST	DATE INST	DATE CHANGE
	09500	S	M	SOH	I	00411	000									12	090968	1/1/0001
	09500	S	M	SOH	I	00415	000									12	090968	1/1/0001
	09500	S	M	SOH	I	00425	000									12	090968	1/1/0001

OFFICE: 311		ROUTE: 564		ST_REF_NO: 00000165100		SHAWNEE AVENUE		LUMENS	BULB TYPE	MULT SERIES	POLE TYPE	SHADE	ADDRESS NUMBER	REF	LOCATION	TAX DIST	DATE INST	DATE CHANGE
09500	S	M	SOH	I	00429	000										12	090968	1/1/0001
09500	S	M	SOH	I	00441	000										12	090968	1/1/0001
09500	S	M	SOH	I	00449	000										12	090968	1/1/0001
09500	S	M	SOH	I	00461	000										12	090968	1/1/0001

OFFICE: 311		ROUTE: 564		ST_REF_NO: 00000165200		SHAWNEE PLACE		LUMENS	BULB TYPE	MULT SERIES	POLE TYPE	SHADE	ADDRESS NUMBER	REF	LOCATION	TAX DIST	DATE INST	DATE CHANGE
05800	S	M	SOH	I	00108	000										12	020158	1/1/0001
05800	S	M	SOH	II	00132	000										12	121578	1/1/0001
05800	S	M	SOH	II	00150	000										12	121578	1/1/0001

OFFICE: 311		ROUTE: 564		ST_REF_NO: 00000165400		SHEFFIELD COURT		LUMENS	BULB TYPE	MULT SERIES	POLE TYPE	SHADE	ADDRESS NUMBER	REF	LOCATION	TAX DIST	DATE INST	DATE CHANGE
05800	S	M	OUG	II	00000	018	SIDE OF 436 ROOKWOOD PKWY									12	040864	1/1/0001

OFFICE: 311		ROUTE: 564		ST_REF_NO: 00000165450		SHEILA CT		LUMENS	BULB TYPE	MULT SERIES	POLE TYPE	SHADE	ADDRESS NUMBER	REF	LOCATION	TAX DIST	DATE INST	DATE CHANGE
04000	S	M	SOH	I	00101	001										12	050891	1/1/0001
04000	S	M	SOH	I	00116	002										12	050891	1/1/0001

OFFICE: 311		ROUTE: 564		ST_REF_NO: 00000165470		SHEFFIELD PLACE		LUMENS	BULB TYPE	MULT SERIES	POLE TYPE	SHADE	ADDRESS NUMBER	REF	LOCATION	TAX DIST	DATE INST	DATE CHANGE
05800	S	M	CNT	II	00000	001	SIDE OF 3209 PENBROKE PLACE									12	010897	1/1/0001
05800	S	M	CNT	II	01109	002										12	010897	1/1/0001
05800	S	M	CNT	II	01117	003										12	010897	1/1/0001
05800	S	M	CNT	II	01129	004										12	010897	1/1/0001
05800	S	M	CNT	III	01133	005										12	010897	1/1/0001
05800	S	M	CNT	II	01140	006										12	010897	1/1/0001
05800	S	M	CNT	II	01153	007										12	010897	1/1/0001
05800	S	M	CNT	II	01164	008										12	010897	1/1/0001
05800	S	M	CNT	II	01173	009										12	010897	1/1/0001

OFFICE: 311		ROUTE: 564		ST_REF_NO: 00000165470		SHEFFIELD PLACE				
LUMENS	BULB TYPE	MULT SERIES	POLE TYPE	SHADE	ADDRESS NUMBER	REF	LOCATION	TAX DIST	DATE INST	DATE CHANGE
05800	S	M	CNT	II	01181	010		12	010897	1/1/0001
05800	S	M	CNT	II	01193	011		12	010897	1/1/0001
05800	S	M	CNT	II	01201	012		12	010897	1/1/0001
05800	S	M	CNT	II	01208	013		12	010897	1/1/0001
05800	S	M	CNT	II	01220	014		12	010897	1/1/0001
05800	S	M	CNT	II	01224	015		12	010897	1/1/0001
05800	S	M	CNT	III	01241	016		12	010897	1/1/0001

OFFICE: 311		ROUTE: 564		ST_REF_NO: 00000165500		SHELBURN COURT				
LUMENS	BULB TYPE	MULT SERIES	POLE TYPE	SHADE	ADDRESS NUMBER	REF	LOCATION	TAX DIST	DATE INST	DATE CHANGE
05800	S	M	OUG	II	00000	034	SIDE OF 1504 THAMES DR.	12	060172	1/1/0001

OFFICE: 311		ROUTE: 564		ST_REF_NO: 00000165600		SHELBY AVENUE				
LUMENS	BULB TYPE	MULT SERIES	POLE TYPE	SHADE	ADDRESS NUMBER	REF	LOCATION	TAX DIST	DATE INST	DATE CHANGE
05800	S	M	SOH	II	00762	000		12	110160	1/1/0001
05800	S	M	SOH	II	00770	000		12	110160	1/1/0001
05800	S	M	SOH	II	00772	000		12	110160	1/1/0001
05800	S	M	SOH	II	00805	000		12	110160	1/1/0001
05800	S	M	SOH	II	00811	000		12	110160	1/1/0001

OFFICE: 311		ROUTE: 564		ST_REF_NO: 00000165800		SHELBY STREET				
LUMENS	BULB TYPE	MULT SERIES	POLE TYPE	SHADE	ADDRESS NUMBER	REF	LOCATION	TAX DIST	DATE INST	DATE CHANGE
05800	S	M	SOH	II	00000	146	SIDE OF 735 JACKSON ST.	12	111366	1/1/0001
05800	S	M	SOH	III	00502	000		12	111366	1/1/0001
05800	S	M	SOH	III	00523	142		12	111366	1/1/0001
05800	S	M	SOH	III	00524	144		12	111366	1/1/0001
05800	S	M	SOH	III	00553	145		12	111366	1/1/0001
05800	S	M	SOH	II	00607	000		12	091167	1/1/0001
05800	S	M	SOH	II	00627	000		12	121365	1/1/0001

OFFICE: 311		ROUTE: 564		ST_REF_NO: 00000165850		SHELL COURT		LUMENS	BULB TYPE	MULT SERIES	POLE TYPE	SHADE	ADDRESS NUMBER	REF	LOCATION	TAX DIST	DATE INST	DATE CHANGE
05800	S		CNT	II	00213	002										12	030609	1/1/0001
05800	S		CNT	II	00228	003										12	030609	1/1/0001
05800	S		CNT	II	00245	004										12	030609	1/1/0001

OFFICE: 311		ROUTE: 564		ST_REF_NO: 00000165900		SHENANDOAH DRIVE		LUMENS	BULB TYPE	MULT SERIES	POLE TYPE	SHADE	ADDRESS NUMBER	REF	LOCATION	TAX DIST	DATE INST	DATE CHANGE
05800	S	M	OUG	II	00000	001									SIDE OF 1015 DELLA upgraded 1/08	12	020889	1/1/0001
04000	S	M	OUG	II	00000	006									SIDE OF 1006 CELIA LANE	12	020889	1/1/0001
04000	S	M	OUG	II	01709	005										12	020889	1/1/0001
04000	S	M	OUG	II	01716	004										12	020889	1/1/0001
04000	S	M	OUG	II	01728	003										12	020889	1/1/0001
04000	S	M	OUG	II	01741	002										12	020889	1/1/0001

OFFICE: 311		ROUTE: 564		ST_REF_NO: 00000165970		SHERARD CIRCLE		LUMENS	BULB TYPE	MULT SERIES	POLE TYPE	SHADE	ADDRESS NUMBER	REF	LOCATION	TAX DIST	DATE INST	DATE CHANGE
05800	S	M	OUG	II	00601	003										12	020800	1/1/0001
05800	S	M	OUG	II	00609	004										12	020800	1/1/0001
05800	S	M	OUG	II	00624	005										12	020800	1/1/0001
05800	S	M	OUG	II	00633	006										12	020800	1/1/0001
05800	S	M	OUG	II	00649	007										12	020800	1/1/0001
05800	S	M	OUG	II	00663	008										12	020800	1/1/0001
05800	S	M	OUG	II	00685	001										12	020800	1/1/0001
05800	S	M	OUG	II	00698	002										12	020800	1/1/0001

OFFICE: 311		ROUTE: 564		ST_REF_NO: 00000165980		SHERBORNE PLACE		LUMENS	BULB TYPE	MULT SERIES	POLE TYPE	SHADE	ADDRESS NUMBER	REF	LOCATION	TAX DIST	DATE INST	DATE CHANGE
05800	S	M	CNT	II	01204	001										12	020800	1/1/0001
05800	S	M	CNT	II	01204	002										12	020800	1/1/0001
05800	S	M	CNT	II	01225	003										12	020800	1/1/0001
05800	S	M	CNT	II	01228	004										12	020800	1/1/0001
05800	S	M	CNT	III	01232	005										21	020800	1/1/0001

OFFICE: 311		ROUTE: 564		ST_REF_NO: 00000166000		SHERIDAN DRIVE				
LUMENS	BULB TYPE	MULT SERIES	POLE TYPE	SHADE	ADDRESS NUMBER	REF	LOCATION	TAX DIST	DATE INST	DATE CHANGE
05800	S	M	OUG	II	00359	017	bad fixture	12	040466	1/23/2010
04000	S	M	OUG	II	00681	026		12	101583	1/1/0001
04000	S	M	OUG	II	00688	025		12	101583	1/1/0001
04000	S	M	OUG	II	00697	024		12	101583	1/1/0001
04000	S	M	OUG	II	00000	034	SIDE OF 2211 CLAYS MILL	12	101583	1/1/0001
04000	S	M	OUG	II	00383	019		12	040766	1/1/0001
04000	S	M	OUG	II	00398	020		12	090166	1/1/0001
04000	S	M	OUG	II	00458	043		12	041483	1/1/0001
04000	S	M	OUG	II	00466	042		12	041583	1/1/0001
04000	S	M	OUG	II	00483	041		12	041583	1/1/0001
04000	S	M	OUG	II	00498	040		12	041583	1/1/0001
04000	S	M	OUG	II	00545	039		12	041583	1/1/0001
04000	S	M	OUG	II	00562	038		12	061583	1/1/0001
05800	S	M	OUG	II	00573	037		12	101583	1/1/0001
04000	S	M	OUG	II	00586	036		12	101583	1/1/0001
04000	S	M	SOH	II	00597	035		12	041583	1/1/0001
04000	S	M	OUG	II	00612	033		12	101583	1/1/0001
04000	S	M	OUG	II	00625	032		12	101583	1/1/0001
04000	S	M	OUG	II	00636	031		12	101583	1/1/0001
04000	S	M	OUG	II	00653	030		12	101583	1/1/0001
04000	S	M	OUG	II	00662	029		12	101583	1/1/0001
04000	S	M	OUG	II	00669	028		12	101583	1/1/0001
04000	S	M	OUG	II	00674	027		12	101583	1/1/0001
04000	S	M	OUG	II	00694	023		12	101583	1/1/0001
04000	S	M	OUG	II	00000	013	SIDE OF 2213 EASTWAY DR.	12	040466	1/1/0001
04000	S	M	OUG	II	00318	014		12	040466	1/1/0001
04000	S	M	OUG	II	00331	015		12	040466	1/1/0001
04000	S	M	OUG	II	00346	016		12	040466	1/1/0001
04000	S	M	OUG	II	00370	018		12	040466	1/1/0001
OFFICE: 311		ROUTE: 564		ST_REF_NO: 00000166100		SHERMAN AVENUE				
LUMENS	BULB TYPE	MULT SERIES	POLE TYPE	SHADE	ADDRESS NUMBER	REF	LOCATION	TAX DIST	DATE INST	DATE CHANGE
04000	S	M	SOH	II	00119	117		12	020885	1/1/0001

OFFICE: 311		ROUTE: 564		ST_REF_NO: 00000166100		SHERMAN AVENUE		LUMENS	BULB TYPE	MULT SERIES	POLE TYPE	SHADE	ADDRESS NUMBER	REF	LOCATION	TAX DIST	DATE INST	DATE CHANGE
	04000	S	M	SOH	II	00132	118									12	020885	1/1/0001
	04000	S	M	SOH	II	00143	119									12	020885	1/1/0001
	04000	S	M	SOH	II	00159	120									12	020885	1/1/0001
	04000	S	M	SOH	II	00175	121									12	020885	1/1/0001
	04000	S	M	SOH	II	00201	122									12	020885	1/1/0001
	04000	S	M	SOH	II	00207	123									12	090891	1/1/0001
	04000	S	M	SOH	II	00220	135									12	090891	1/1/0001
	04000	S	M	SOH	II	00233	124									12	020885	1/1/0001
	04000	S	M	SOH	II	00264	125									12	020885	1/1/0001
	04000	S	M	SOH	II	00271	126									12	020885	1/1/0001
	04000	S	M	SOH	II	00298	127									12	020885	1/1/0001
	04000	S	M	SOH	II	00305	128									12	020885	1/1/0001
	04000	S	M	SOH	II	00321	129									12	020885	1/1/0001
	04000	S	M	SOH	II	00336	130									12	020885	1/1/0001
	04000	S	M	SOH	II	00364	132									12	020885	1/1/0001
	04000	S	M	SOH	II	00381	133									12	020885	1/1/0001
	04000	S	M	SOH	II	00394	134									12	020885	1/1/0001

OFFICE: 311		ROUTE: 564		ST_REF_NO: 00000166250		SHETLAND DRIVE		LUMENS	BULB TYPE	MULT SERIES	POLE TYPE	SHADE	ADDRESS NUMBER	REF	LOCATION	TAX DIST	DATE INST	DATE CHANGE
	09500	S		CLN	II	00000	001									12	051609	1/1/0001
	09500	S		CLN	II	00000	002									12	051609	1/1/0001

OFFICE: 311		ROUTE: 564		ST_REF_NO: 00000166300		SHILOH COURT		LUMENS	BULB TYPE	MULT SERIES	POLE TYPE	SHADE	ADDRESS NUMBER	REF	LOCATION	TAX DIST	DATE INST	DATE CHANGE
	05800	S	M	OUG	II	00000	013									12	070767	1/1/0001

OFFICE: 311		ROUTE: 564		ST_REF_NO: 00000166310		SHIPTONS END		LUMENS	BULB TYPE	MULT SERIES	POLE TYPE	SHADE	ADDRESS NUMBER	REF	LOCATION	TAX DIST	DATE INST	DATE CHANGE
	05800	S	M	OUG	II	04300	001									12	040894	1/1/0001

OFFICE: 311

ROUTE: 564

ST_REF_NO: 00000166310 SHIPTONS END

LUMENS	BULB TYPE	MULT SERIES	POLE TYPE	SHADE	ADDRESS NUMBER	REF	LOCATION	TAX DIST	DATE INST	DATE CHANGE
05800	S	M	OUG	II	04308	002		12	040894	1/1/0001

OFFICE: 311

ROUTE: 564

ST_REF_NO: 00000166340 SHIRETOWN ROAD

LUMENS	BULB TYPE	MULT SERIES	POLE TYPE	SHADE	ADDRESS NUMBER	REF	LOCATION	TAX DIST	DATE INST	DATE CHANGE
05800	S	M	OUG	II	00000	001	SIDE OF 2585 CHECKERBERRY DR.	12	110899	1/1/0001
05800	S	M	OUG	II	00000	002	SIDE OF 2512 TINMOUTH VALE LANE	12	110899	1/1/0001

OFFICE: 311

ROUTE: 564

ST_REF_NO: 00000166390 SHIRLEE COURT

LUMENS	BULB TYPE	MULT SERIES	POLE TYPE	SHADE	ADDRESS NUMBER	REF	LOCATION	TAX DIST	DATE INST	DATE CHANGE
04000	S	M	OUG	V	03017	002		12	050888	1/1/0001
04000	S	M	OUG	II	03029	001		12	050888	1/1/0001

OFFICE: 311

ROUTE: 564

ST_REF_NO: 00000166400 SHIRLEE DRIVE

LUMENS	BULB TYPE	MULT SERIES	POLE TYPE	SHADE	ADDRESS NUMBER	REF	LOCATION	TAX DIST	DATE INST	DATE CHANGE
04000	S	M	OUG	II	00000	005	SIDE 3029 SHIRLEE CT.	12	050888	1/1/0001
05800	S	M	OUG	II	02984	001		12	050888	1/1/0001
04000	S	M	OUG	II	02991	002		12	050888	1/1/0001
04000	S	M	OUG	II	03001	003		12	050888	1/1/0001
04000	S	M	OUG	II	03005	004		12	050888	1/1/0001
04000	S	M	OUG	II	03040	006		12	050888	1/1/0001

OFFICE: 311

ROUTE: 564

ST_REF_NO: 00000166500 SHOAL LAKE DRIVE

LUMENS	BULB TYPE	MULT SERIES	POLE TYPE	SHADE	ADDRESS NUMBER	REF	LOCATION	TAX DIST	DATE INST	DATE CHANGE
04000	S	M	OUG	II	03201	067		12	111478	1/1/0001
04000	S	M	OUG	V	03209	066		12	111478	1/1/0001
04000	S	M	OUG	II	03216	065		12	111478	1/1/0001
04000	S	M	OUG	II	00000	057	SIDE OF 3252	12	111478	1/1/0001
05800	S	M	OUG	II	03225	064	upgrade-bad fixture	12	111579	1/1/0001
04000	S	M	OUG	II	03232	063		12	111579	1/1/0001
04000	S	M	OUG	II	03245	060		12	111478	1/1/0001
04000	S	M	OUG	II	03257	059		12	111579	1/1/0001

OFFICE: 311		ROUTE: 564		ST_REF_NO: 00000166500		SHOAL LAKE DRIVE				
LUMENS	BULB TYPE	MULT SERIES	POLE TYPE	SHADE	ADDRESS NUMBER	REF	LOCATION	TAX DIST	DATE INST	DATE CHANGE
04000	S	M	OUG	V	03261	058		12	111478	1/1/0001
04000	S	M	OUG	II	03281	056		12	111478	1/1/0001
04000	S	M	OUG	II	03293	055		12	111478	1/1/0001
04000	S	M	OUG	II	03296	054		12	111478	1/1/0001
04000	S	M	OUG	II	03305	053		12	111579	1/1/0001

OFFICE: 311		ROUTE: 564		ST_REF_NO: 00000166530		SHORESIDE DRIVE				
LUMENS	BULB TYPE	MULT SERIES	POLE TYPE	SHADE	ADDRESS NUMBER	REF	LOCATION	TAX DIST	DATE INST	DATE CHANGE
05800	S	M	CNT	II	00000	001	OPP. 409	12	070899	1/1/0001
05800	S	M	CNT	II	00000	002	SIDE OF 376	12	070899	1/1/0001
05800	S	M	CNT	II	00000	011	SIDE OF 3585 FOREST COVE LANE	12	070899	1/1/0001
05800	S	M	CNT	II	00000	013	OPP. 204	12	110899	1/1/0001
05800	S	M	CNT	II	00000	014	SIDE OF 413	12	070899	1/1/0001
05800	S	M	CNT	II	00000	015	3RD LT. W OF RICHMOND RD., NORTHSIDE	12	110899	1/1/0001
05800	S	M	CNT	II	00000	016	2ND LT. W OF RICHMOND RD., SOUTHSIDE	12	110899	1/1/0001
05800	S	M	CNT	II	00000	017	2ND LT. W OF RICHMOND RD., NORTHSIDE	12	110899	1/1/0001
05800	S	M	CNT	II	00000	018	1ST LT. W OF RICHMOND RD., SOUTHSIDE	12	110899	1/1/0001
05800	S	M	CNT	II	00000	019	1ST LT. W OF RICHMOND RD., NORTHSIDE	12	110899	1/1/0001
05800	S	M	CNT	II	00216	012		12	070899	1/1/0001
05800	S	M	CNT	II	00248	010		12	070899	1/1/0001
05800	S	M	CNT	II	00265	009		12	070899	1/1/0001
05800	S	M	CNT	II	00288	008		12	070899	1/1/0001
05800	S	M	CNT	II	00313	007		12	070899	1/1/0001
05800	S	M	CNT	II	00329	006		12	070899	1/1/0001
05800	S	M	CNT	II	00340	005		12	070899	1/1/0001
05800	S	M	CNT	II	00361	004		12	070899	1/1/0001
05800	S	M	CNT	II	00372	003		12	070899	1/1/0001

OFFICE: 311		ROUTE: 564		ST_REF_NO: 00000166600		SHORT, EAST STREET				
LUMENS	BULB TYPE	MULT SERIES	POLE TYPE	SHADE	ADDRESS NUMBER	REF	LOCATION	TAX DIST	DATE INST	DATE CHANGE
16000	S	M	GRN	IV	00000	327	6TH LT W OF N MLK BLVD,N SIDE ON E SHORT ST	12	070101	1/1/0001
16000	S	M	GRN	IV	00000	328	5TH LT W OF N MLK BLVD,S SIDE ON E SHORT ST	12	070101	1/1/0001

OFFICE: 311

ROUTE: 564

ST_REF_NO: 00000166600

SHORT, EAST STREET

LUMENS	BULB TYPE	MULT SERIES	POLE TYPE	SHADE	ADDRESS NUMBER	REF	LOCATION	TAX DIST	DATE INST	DATE CHANGE
16000	S	M	GRN	IV	00000	329	5TH LT W OF N MLK BLVD,N SIDE ON E SHORT ST	12	070101	1/1/0001
16000	S	M	GRN	IV	00000	330	4TH LT W OF N MLK BLVD,S SIDE ON E SHORT ST	12	070101	1/1/0001
16000	S	M	GRN	IV	00000	331	4TH LT W OF N MLK BLVD,N SIDE ON E SHORT ST	12	070101	1/1/0001
16000	S	M	GRN	IV	00000	332	3RD LT W OF N MLK, S SIDE ON E SHORT ST	12	070101	1/1/0001
16000	S	M	GRN	IV	00000	333	3RD LT W OF N MLK BLVD,N SIDE ON E SHORT ST	12	070101	1/1/0001
16000	S	M	GRN	IV	00000	334	2ND LT W OF N MLK BLVD,S SIDE ON E SHORT ST	12	070101	1/1/0001
16000	S	M	GRN	IV	00000	335	2ND LT W OF N MLK BLVD,N SIDE ON E SHORT ST	12	070101	1/1/0001
16000	S	M	GRN	IV	00000	336	1ST LT W OF N MLK BLVD,S SIDE ON E SHORT ST	12	070101	1/1/0001
16000	S	M	GRN	IV	00000	337	1ST LT W OF N MLK BLVD, N SIDE ON E SHORT ST	12	070101	1/1/0001
20000	M	M	SOH	III	00000	001	1ST LT. E. OF LIMESTONE ST., N. SIDE	12	102061	1/1/0001
22000	S	M	OUG	II	00000	012	1ST LT. E. OF WALNUT ST., S. SIDE	12	062774	1/1/0001
22000	S	M	SOH	III	00000	013	1ST LT. E. OF WALNUT ST., N. SIDE	12	102061	1/1/0001
22000	S	M	SOH	III	00000	014	2ND LT. E. OF WALNUT ST., N. SIDE	12	102061	1/1/0001
22000	S	M	OOH	II	00000	015	2ND LT. E. OF WALNUT ST., SOUTHSIDE	12	050885	1/1/0001
22000	S	M	SOH	III	00000	016	3RD LT. E. OF WALNUT ST., N. SIDE	12	102061	1/1/0001
22000	S	M	SOH	III	00000	017	1ST LT. E. OF ESPLANADE, S. SIDE	12	050885	1/1/0001
22000	S	M	OOH	III	00000	021	NW CORNER OF SHORT & DEWEESE ST.	12	061563	1/1/0001
22000	S	M	OOH	III	00000	022	1ST LT. E. OF DEWEESE, S. SIDE	12	070889	1/1/0001
22000	S	S	SOH	III	00000	023	1ST LT. E. OF DEWEESE ST., N. SIDE	12	061563	1/1/0001
22000	S	M	OOH	III	00000	025	OPP. 336 E. SHORT ST.	12	070889	1/1/0001
20000	M	M	SOH	III	00000	028	1ST LT. W. OF N. EASTERN AVE., S. SIDE	12	061563	1/1/0001
22000	S	M	OOH	III	00000	029	1ST LT. E. OF NORTHEASTERN AVE., N. SIDE	12	061563	1/1/0001
22000	S	M	OOH	III	00000	031	2ND LT. E. OF NORTHEASTERN AVE., N. SIDE	12	051163	1/1/0001
22000	S	M	OOH	III	00000	033	3RD LT. E. OF NORTHEASTERN AVE., N. SIDE	12	051163	1/1/0001
20000	M	M	OOH	III	00000	035	1ST LT. W. OF MIDLAND AVE., N. SIDE	12	051163	1/1/0001
09500	S	M	OOH	III	00000	050	SIDE OF 170 ESPLANADE ST. ON SE CORNER	12	050898	1/1/0001
22000	S	M	OOH	III	00000	051	SIDE OF 170 ESPLANADE ST., SOUTHSIDE	12	050898	1/1/0001
22000	S	M	OOH	III	00248	018		12	061563	1/1/0001
22000	S	M	OOH	III	00255	019		12	061563	1/1/0001
22000	S	M	SOH	III	00260	020		12	061563	1/1/0001
20000	M	M	SOH	III	00322	024		12	061563	1/1/0001
20000	M	S	OOH	III	00342	026		12	061563	1/1/0001
22000	S	M	OOH	III	00359	027		12	030897	1/1/0001

OFFICE: 311

ROUTE: 564

ST_REF_NO: 00000166610

SHORT, WEST STREET

LUMENS	BULB TYPE	MULT SERIES	POLE TYPE	SHADE	ADDRESS NUMBER	REF	LOCATION	TAX DIST	DATE INST	DATE CHANGE
50000	S	M	SOH	III	00000	007	1ST LT. E. OF UPPER ST., N. SIDE	12	102061	3/11/2010
50000	S	M	SOH	III	00000	013	2ND LT. E. OF MILL ST., N. SIDE	12	102061	2/9/2010
22000	S	M	SOH	III	00000	016	1ST LT. E. OF MILL ST., S. SIDE	12	102061	1/15/2010
22000	S	M	SOH	III	00000	017	1ST LT. W. OF MILL ST., N. SIDE	12	102061	1/14/2010
22000	S	M	SOH	III	00000	022	1ST LT. E. OF BROADWAY, N. SIDE	12	102061	1/15/2010
22000	S	M	SOH	II	00102	051	bad fixture	12	090885	10/11/2010
50000	S	M	SOH	II	00349	021		12	090885	2/18/2012
22000	S	M	SOH	II	00514	023		12	030885	1/14/2010
22000	S	M	SOH	II	00591	050	upgrade per city request	12	030885	5/12/2010
22000	S	M	SOH	III	00000	018	3RD LT. E. OF BROADWAY, S. SIDE	12	102061	1/1/0001
20000	M	M	SOH	III	00000	019	2ND LT. W. OF MILL ST., N. SIDE	12	102061	1/1/0001
20000	M	M	SOH	III	00000	020	2ND LT. E. OF BROADWAY, S. SIDE	12	102061	1/1/0001
20000	M	M	SOH	II	00000	024	1ST LT. W. OF BROADWAY, N. SIDE	12	091579	1/1/0001
20000	M	M	SOH	II	00000	026	1ST LT. W. OF SAUNIER AVE., N. SIDE	12	091579	1/1/0001
10000	M	M	SOH	II	00000	032	1ST LT. E. OF BRUCE ST., N. SIDE	12	040164	1/1/0001
09500	S	M	SOH	II	00000	041	OPP. 712	12	051368	1/1/0001
09500	S	M	SOH	II	00000	043	OPP. 736	12	051368	1/1/0001
05800	S	M	SOH	II	00000	045	1ST LT. W. OF NEWTOWN PIKE, S. SIDE	12	100719	1/1/0001
09500	S	M	SOH	II	00000	046	SW CORNER OF SHORT AND FELIX ST.	12	030885	1/1/0001
09500	S	M	SOH	II	00000	047	OPP. 541	12	030885	1/1/0001
20000	M	M	SOH	II	00424	025		12	091579	1/1/0001
22000	S	M	SOH	II	00425	028		12	030885	1/1/0001
09500	S	M	SOH	II	00506	029		12	030885	1/1/0001
09500	S	M	SOH	II	00511	027		12	030885	1/1/0001
10000	M	M	SOH	II	00521	030		12	040164	1/1/0001
09500	S	M	SOH	II	00535	031		12	030885	1/1/0001
09500	S	M	SOH	II	00555	048		12	030885	1/1/0001
09500	S	M	SOH	II	00563	033		12	030885	1/1/0001
09500	S	M	SOH	II	00566	049		12	030885	1/1/0001
10000	M	M	SOH	II	00575	034		12	040164	1/1/0001
09500	S	M	SOH	II	00587	035		12	030885	1/1/0001
09500	S	M	SOH	II	00603	036		12	060368	1/1/0001
09500	S	M	SOH	II	00612	037		12	051368	1/1/0001
09500	S	M	SOH	II	00625	038		12	051368	1/1/0001

OFFICE: 311

ROUTE: 564

ST_REF_NO: 00000166610

SHORT, WEST STREET

LUMENS	BULB TYPE	MULT SERIES	POLE TYPE	SHADE	ADDRESS NUMBER	REF	LOCATION	TAX DIST	DATE INST	DATE CHANGE
09500	S	M	SOH	II	00640	039		12	051368	1/1/0001
09500	S	M	SOH	II	00700	040		12	051368	1/1/0001
09500	S	M	SOH	II	00724	042		12	051368	1/1/0001
09500	S	M	SOH	II	00750	044		12	051368	1/1/0001
20000	M	M	SOH	III	00000	001	4TH LT. E. OF UPPER ST., N. SIDE	12	102061	1/1/0001
20000	M	M	SOH	III	00000	002	2ND LT. E. OF WRENN ALLEY, S. SIDE	12	102061	1/1/0001
20000	M	M	SOH	III	00000	003	3RD LT. E. OF UPPER ST., N. SIDE	12	102061	1/1/0001
22000	S	M	SOH	III	00000	004	1ST LT. E. OF WRENN ALLEY, S. SIDE	12	102061	1/1/0001
20000	M	M	SOH	III	00000	005	2ND LT. E. OF UPPER ST., N. SIDE	12	102061	1/1/0001
20000	M	M	SOH	III	00000	006	1ST LT. E. OF UPPER ST., S. SIDE	12	102061	1/1/0001
20000	M	M	SOH	III	00000	008	3RD LT. E. OF CHEAPSIDE, S. SIDE	12	102061	1/1/0001
20000	M	M	SOH	III	00000	009	2ND LT. E. OF MARKET ST., N. SIDE	12	102061	1/1/0001
20000	M	M	SOH	III	00000	010	2ND LT. E. OF CHEAPSIDE, S. SIDE	12	102061	1/1/0001
20000	M	M	OOH	III	00000	011	1ST LT. E. OF MARKET ST., N. SIDE	12	102061	1/1/0001
22000	S	M	SOH	III	00000	012	1ST LT. E. OF CHEAPSIDE, S. SIDE	12	102061	1/1/0001
20000	M	M	SOH	III	00000	014	2ND LT. E. OF MILL ST., S. SIDE	12	102061	1/1/0001
20000	M	M	SOH	III	00000	015	1ST LT. E. OF MILL ST., N. SIDE	12	102061	1/1/0001

OFFICE: 311

ROUTE: 564

ST_REF_NO: 00000166620

SHOREWATER COURT

LUMENS	BULB TYPE	MULT SERIES	POLE TYPE	SHADE	ADDRESS NUMBER	REF	LOCATION	TAX DIST	DATE INST	DATE CHANGE
05800	S	M	CNT	III	04005	001		12	080895	1/1/0001

OFFICE: 311

ROUTE: 564

ST_REF_NO: 00000166800

SHRINER'S LANE

LUMENS	BULB TYPE	MULT SERIES	POLE TYPE	SHADE	ADDRESS NUMBER	REF	LOCATION	TAX DIST	DATE INST	DATE CHANGE
05800	S	M	OOH	II	00000	001	1ST. LT. S. OF RICHMOND RD., W. SIDE	12	080863	1/1/0001
05800	S	M	OOH	II	00000	002	2ND LT. S. OF RICHMOND RD., W. SIDE	12	080863	1/1/0001
05800	S	M	OOH	II	00000	003	3RD LT. S. OF RICHMOND RD., W. SIDE	12	080863	1/1/0001
05800	S	M	OOH	II	00000	007	OPPOSITE 200	12	080863	1/1/0001
05800	S	M	OOH	II	00000	008	OPPOSITE 216	12	080863	1/1/0001
05800	S	M	OOH	II	00000	009	OPPOSITE 224	12	080863	1/1/0001
05800	S	M	OUG	II	00000	010	SIDE OF 1945 FONTAINE RD.	12	080863	1/1/0001
05800	S	M	OOH	II	00000	004	4TH LT. S. OF RICHMOND RD., W. SIDE	12	080863	1/1/0001

OFFICE: 311		ROUTE: 564		ST_REF_NO: 00000166800		SHRINER'S LANE				
LUMENS	BULB TYPE	MULT SERIES	POLE TYPE	SHADE	ADDRESS NUMBER	REF	LOCATION	TAX DIST	DATE INST	DATE CHANGE
05800	S	M	OOH	II	00000	005	5TH LT. S. OF RICHMOND RD., W. SIDE	12	080863	1/1/0001
05800	S	M	OOH	II	00000	006	OPPOSITE 200	12	080863	1/1/0001

OFFICE: 311		ROUTE: 564		ST_REF_NO: 00000166900		SHROPSHIRE AVENUE				
LUMENS	BULB TYPE	MULT SERIES	POLE TYPE	SHADE	ADDRESS NUMBER	REF	LOCATION	TAX DIST	DATE INST	DATE CHANGE
09500	S		OUG	II	00000	050	1ST LT N OF MIDLAND AVE, W SIDE ON SHROPSHIRE	12	081413	1/1/0001
09500	S		OUG	II	00000	051	1ST LT N OF MIDLAND AVE, E SIDE ON SHROPSHIRE	12	081413	1/1/0001
09500	S		OUG	II	00000	052	2ND LT N OF MIDLAND AVE, W SIDE ON SHROPSHIRE	12	081413	1/1/0001
09500	S		OUG	II	00000	053	1ST LT E OF GOODLOE ST, S SIDE ON SHROPSHIRE	12	081413	1/1/0001
09500	S		OUG	II	00000	054	1ST LT E OF GOODLOE ST, N SIDE ON SHROPSHIRE	12	081413	1/1/0001
09500	S		OUG	II	00000	055	2ND LT E OF GOODLOE ST, S SIDE ON SHROPSHIRE	12	081413	1/1/0001
09500	S		OUG	II	00000	056	2ND LT E OF GOODLOE ST, N SIDE ON SHROPSHIRE	12	081413	1/1/0001
05800	S		CNT	II	00000	363	SIDE OF 540 E FOURTH ST, ON SHROPSHIRE AVE	12	080610	1/1/0001
05800	S		CNT	II	00000	364	SIDE OF 556 E FOURTH ST, ON SHROPSHIRE	12	080610	1/1/0001
05800	S		CNT	II	00000	365	1ST LT N OF E THIRD ST, W SIDE ON SHROPSHIRE AVE	12	080610	1/1/0001
05800	S		CNT	II	00000	366	1ST LT N OF E THIRD ST, E SIDE ON SHROPSHIRE AVE	12	080610	1/1/0001
05800	S		CNT	II	00416	362		12	080610	1/1/0001
05800	S		CNT	II	00432	361		12	080610	1/1/0001
05800	S		CNT	II	00441	360		12	080610	1/1/0001
05800	S		CNT	II	00473	359		12	080610	1/1/0001
05800	S		CNT	II	00481	358		12	080610	1/1/0001
05800	S	M	SOH	I	00000	003	1ST LT S OF E THIRD ST, E SIDE	12	110366	9/9/2009
05800	S	M	SOH	II	00000	100	SIDE OF 466 BRECKENRIDGE ST ON SHROPSHIRE AVE	12	120705	1/1/0001
50000	S	M	SOH	II	00000	123	SIDE OF 500 7TH ST.	12	111366	9/9/2009
22000	S	M	SOH	II	00000	200	SIDE OF 446 E 7TH ST ON SHROPSHIRE	12	020806	1/1/0001
05800	S	M	SOH	II	00631	121		12	111366	9/9/2009

OFFICE: 311

ROUTE: 564

ST_REF_NO: 00000166900

SHROPSHIRE AVENUE

LUMENS	BULB TYPE	MULT SERIES	POLE TYPE	SHADE	ADDRESS NUMBER	REF	LOCATION	TAX DIST	DATE INST	DATE CHANGE
09500	S	M	SOH	II	00667	201		12	020806	1/1/0001
05800	S	M	SOH	III	00707	124		12	111366	9/9/2009
05800	S	M	SOH	III	00000	128	1ST. LT. S. OF LOUDON AVE., W. SIDE	12	111366	1/1/0001
05800	S	M	SOH	III	00000	130	N.W. CORNER OF R.R.	12	111366	1/1/0001
05800	S	M	SOH	II	00611	120		12	111366	1/1/0001
05800	S	M	SOH	II	00661	122		12	111366	1/1/0001
05800	S	M	SOH	III	00715	129		12	111366	1/1/0001
05800	S	M	SOH	III	00723	125		12	111366	1/1/0001
05800	S	M	SOH	III	00733	126		12	111366	1/1/0001
05800	S	M	SOH	III	00741	127		12	111366	1/1/0001

OFFICE: 311

ROUTE: 564

ST_REF_NO: 00000167000

SHROUT COURT

LUMENS	BULB TYPE	MULT SERIES	POLE TYPE	SHADE	ADDRESS NUMBER	REF	LOCATION	TAX DIST	DATE INST	DATE CHANGE
05800	S	M	OUG	II	00400	070		12	011581	1/1/0001
05800	S	M	OUG	V	00416	071		12	091582	1/1/0001

OFFICE: 311

ROUTE: 564

ST_REF_NO: 00000167075

SHUMARD OAK DRIVE

LUMENS	BULB TYPE	MULT SERIES	POLE TYPE	SHADE	ADDRESS NUMBER	REF	LOCATION	TAX DIST	DATE INST	DATE CHANGE
05800	S	M	OUG	II	00504	001		12	081903	1/1/0001

OFFICE: 311

ROUTE: 564

ST_REF_NO: 00000167200

SIERRA DRIVE

LUMENS	BULB TYPE	MULT SERIES	POLE TYPE	SHADE	ADDRESS NUMBER	REF	LOCATION	TAX DIST	DATE INST	DATE CHANGE
04000	S	M	OUG	II	00000	005	OPP. 337	12	010888	1/1/0001
04000	S	M	OUG	II	00310	008		12	010888	1/1/0001
04000	S	M	OUG	II	00318	007		12	010888	1/1/0001
04000	S	M	OUG	II	00327	006		12	010888	1/1/0001
04000	S	M	OUG	II	00350	003		12	010888	1/1/0001
04000	S	M	OUG	II	00351	004		12	010888	1/1/0001
04000	S	M	OUG	II	00362	001		12	010888	1/1/0001
04000	S	M	OUG	II	00363	002		12	010888	1/1/0001

OFFICE: 311		ROUTE: 564		ST_REF_NO: 00000167400		SILVER LANE		LUMENS	BULB TYPE	MULT SERIES	POLE TYPE	SHADE	ADDRESS NUMBER	REF	LOCATION	TAX DIST	DATE INST	DATE CHANGE
05800	S	M	OUG	II	00000	004	SIDE OF 564 SOUTH RIDGE DR.	12	090170	1/1/0001								
05800	S	M	OUG	II	00000	015	SIDE OF 584 LIN WAL DR.	12	030166	1/1/0001								
05800	S	M	OUG	II	01708	002		12	090170	1/1/0001								
05800	S	M	OUG	II	01709	003		12	090170	1/1/0001								
05800	S	M	OUG	II	01727	001		12	090170	1/1/0001								
05800	S	M	OUG	II	01732	016		12	040166	1/1/0001								
OFFICE: 311		ROUTE: 564		ST_REF_NO: 00000167420		SILVER CREEK WAY		LUMENS	BULB TYPE	MULT SERIES	POLE TYPE	SHADE	ADDRESS NUMBER	REF	LOCATION	TAX DIST	DATE INST	DATE CHANGE
05800	S	M	CNT	II	00000	001	SIDE OF 2716 JACQUELYN LANE ON SILVER CREEK WAY	12	072401	1/1/0001								
05800	S	M	CNT	II	00301	005		12	072401	1/1/0001								
05800	S	M	CNT	II	00308	004		12	072401	1/1/0001								
05800	S	M	CNT	II	00325	003		12	072401	1/1/0001								
OFFICE: 311		ROUTE: 564		ST_REF_NO: 00000167450		SILVER MARE COURT		LUMENS	BULB TYPE	MULT SERIES	POLE TYPE	SHADE	ADDRESS NUMBER	REF	LOCATION	TAX DIST	DATE INST	DATE CHANGE
05800	S	M	OUG	III	02709	001		12	083105	1/1/0001								
OFFICE: 311		ROUTE: 564		ST_REF_NO: 00000167500		SILVERLEAF COURT		LUMENS	BULB TYPE	MULT SERIES	POLE TYPE	SHADE	ADDRESS NUMBER	REF	LOCATION	TAX DIST	DATE INST	DATE CHANGE
05800	S	M	OUG	V	00622	068		12	042264	1/1/0001								
OFFICE: 311		ROUTE: 564		ST_REF_NO: 00000167550		SILVERLEAF DRIVE		LUMENS	BULB TYPE	MULT SERIES	POLE TYPE	SHADE	ADDRESS NUMBER	REF	LOCATION	TAX DIST	DATE INST	DATE CHANGE
05800	S	M	OUG	II	00000	066	SIDE OF 1916 BRYNELL DR.	12	042264	1/1/0001								
05800	S	M	OUG	II	00615	067		12	061465	1/1/0001								
05800	S	M	OUG	II	00638	069		12	061465	1/1/0001								
05800	S	M	OUG	II	00000	070	SIDE OF 636 LOMBARDY DR.	12	060468	1/1/0001								

OFFICE: 311		ROUTE: 564		ST_REF_NO: 00000167554		SILVER SPRINGS DRIVE		LUMENS	BULB TYPE	MULT SERIES	POLE TYPE	SHADE	ADDRESS NUMBER	REF	LOCATION	TAX DIST	DATE INST	DATE CHANGE
05800	S		OUG	II	01345	006										12	042011	1/1/0001
05800	S		OUG	II	01357	005										12	042011	1/1/0001

OFFICE: 311		ROUTE: 564		ST_REF_NO: 00000167555		SILVERTREE CIRCLE		LUMENS	BULB TYPE	MULT SERIES	POLE TYPE	SHADE	ADDRESS NUMBER	REF	LOCATION	TAX DIST	DATE INST	DATE CHANGE
05800	S	M	CNT	III	02205	001										12	100894	1/1/0001

OFFICE: 311		ROUTE: 564		ST_REF_NO: 00000167556		SIMBA WAY		LUMENS	BULB TYPE	MULT SERIES	POLE TYPE	SHADE	ADDRESS NUMBER	REF	LOCATION	TAX DIST	DATE INST	DATE CHANGE
05800	S	M	OUG	II	00000	004	END OF COURT ON SIMBA WAY									12	080800	1/1/0001
05800	S	M	OUG	II	00200	001										12	080800	1/1/0001
05800	S	M	OUG	II	00219	002										12	080800	1/1/0001
05800	S	M	OUG	II	00234	003										12	080800	1/1/0001

OFFICE: 311		ROUTE: 564		ST_REF_NO: 00000167560		SIMCOE COURT		LUMENS	BULB TYPE	MULT SERIES	POLE TYPE	SHADE	ADDRESS NUMBER	REF	LOCATION	TAX DIST	DATE INST	DATE CHANGE
05800	S	M	OUG	V	03416	174										12	011581	1/1/0001
05800	S	M	OUG	II	03428	173										12	011581	1/1/0001
05800	S	M	OUG	II	03440	171										12	011581	1/1/0001
05800	S	M	OUG	II	03441	172										12	091577	1/1/0001
05800	S	M	OUG	V	03452	170										12	011581	1/1/0001

OFFICE: 311		ROUTE: 564		ST_REF_NO: 00000167600		SIMCOE DRIVE		LUMENS	BULB TYPE	MULT SERIES	POLE TYPE	SHADE	ADDRESS NUMBER	REF	LOCATION	TAX DIST	DATE INST	DATE CHANGE
05800	S	M	OUG	II	03401	168										12	091577	1/1/0001
05800	S	M	OUG	II	03408	169										12	091577	1/1/0001

OFFICE: 311		ROUTE: 564		ST_REF_NO: 00000167700		SIMPSON AVENUE		LUMENS	BULB TYPE	MULT SERIES	POLE TYPE	SHADE	ADDRESS NUMBER	REF	LOCATION	TAX DIST	DATE INST	DATE CHANGE
09500	S	M	CNT	II	00000	007	1ST LT. E OF EXPORT ST., NORTHSIDE									12	070899	12/16/2008

OFFICE: 311

ROUTE: 564

ST_REF_NO: 00000167700

SIMPSON AVENUE

LUMENS	BULB TYPE	MULT SERIES	POLE TYPE	SHADE	ADDRESS NUMBER	REF	LOCATION	TAX DIST	DATE INST	DATE CHANGE
09500	S	M	CNT	II	00000	008		12	070899	12/16/2008
09500	S	M	CNT	II	00000	009		12	070899	12/16/2008
09500	S	M	CNT	II	00000	010	4TH LT. E OF EXPORT ST., N SIDE	12	070899	12/16/2008
09500	S	M	CNT	II	00000	011	5TH LT. E OF EXPORT ST., N SIDE	12	070899	12/16/2008
09500	S	M	CNT	II	00000	001	1ST LT. E OF S. BROADWAY, N SIDE	12	070899	1/1/0001
09500	S	M	CNT	II	00000	002	2ND LT. E OF S. BROADWAY, N SIDE	12	070899	1/1/0001
09500	S	M	CNT	II	00000	003	3RD LT. E OF S. BROADWAY, N SIDE	12	070899	1/1/0001
09500	S	M	CNT	II	00000	004	4TH LT. E OF S. BROADWAY, N SIDE	12	070899	1/1/0001
09500	S	M	CNT	II	00000	005	5TH LT. E OF S. BROADWAY, N SIDE	12	070899	1/1/0001
09500	S	M	CNT	II	00000	006	6TH LT. E OF S. BROADWAY, N SIDE	12	070899	1/1/0001

OFFICE: 311

ROUTE: 564

ST_REF_NO: 00000167800

SIOUX DRIVE

LUMENS	BULB TYPE	MULT SERIES	POLE TYPE	SHADE	ADDRESS NUMBER	REF	LOCATION	TAX DIST	DATE INST	DATE CHANGE
04000	S	M	OUG	II	00000	073	SIDE OF 1511 ELIZABETH ST.	12	090884	1/1/0001
04000	S	M	OUG	II	00178	075		12	090884	1/1/0001
04000	S	M	OUG	II	00190	074		12	090884	1/1/0001

OFFICE: 311

ROUTE: 564

ST_REF_NO: 00000167850

SIR BARTON WAY

LUMENS	BULB TYPE	MULT SERIES	POLE TYPE	SHADE	ADDRESS NUMBER	REF	LOCATION	TAX DIST	DATE INST	DATE CHANGE
22000	S		CNT	II	00000	112	4TH LT S OF OLD ROSEBUD RD, W SIDE ON SIR BARTON WAY	12	061011	1/1/0001
22000	S		CNT	II	00000	114	3RD LT S OF OLD ROSEBUD RD, W SIDE ON SIR BARTON WAY	12	061011	1/1/0001
22000	S		CNT	II	00000	116	2ND LT S OF OLD ROSEBUD RD, W SIDE ON SIR BARTON WAY	12	061011	1/1/0001
22000	S		CNT	II	00000	118	1ST LT S OF OLD ROSEBUD RD, W SIDE ON SIR BARTON WAY	12	061011	1/1/0001
22000	S		CNT	II	00000	122	20TH LT S OF SANFORD WAY, W SIDE ON SIR BARTON WAY	12	061011	1/1/0001
22000	S		CNT	II	00000	124	19TH LT S OF SANFORD WAY, W SIDE ON SIR BARTON WAY	12	061011	1/1/0001
22000	S		CNT	II	00000	126	18TH LT S OF SANFORD WAY, W SIDE ON SIR BARTON WAY	12	061011	1/1/0001
22000	S		CNT	II	00000	128	17TH LT S OF SANFORD WAY, W SIDE ON SIR BARTON WAY	12	061011	1/1/0001

OFFICE: 311

ROUTE: 564

ST_REF_NO: 00000167850

SIR BARTON WAY

LUMENS	BULB TYPE	MULT SERIES	POLE TYPE	SHADE	ADDRESS NUMBER	REF	LOCATION	TAX DIST	DATE INST	DATE CHANGE
22000	S		CNT	II	00000	129	5TH LT N OF OLD ROSEBUD RD, E SIDE ON SIR BARTON WAY	12	061011	1/1/0001
22000	S		CNT	II	00000	130	16TH LT S OF SANFORD WAY, W SIDE ON SIR BARTON WAY	12	061011	1/1/0001
22000	S		CNT	II	00000	131	6TH LT N OF OLD ROSEBUD RD, E SIDE ON SIR BARTON WAY	12	061011	1/1/0001
22000	S		CNT	II	00000	132	15TH LT S OF SANFORD WAY, W SIDE ON SIR BARTON WAY	12	061011	1/1/0001
22000	S		CNT	II	00000	133	7TH LT N OF OLD ROSEBUD RD, E SIDE ON SIR BARTON WAY	12	061011	1/1/0001
22000	S		CNT	II	00000	134	14TH LT S OF SANFORD WAY, W SIDE ON SIR BARTON WAY	12	061011	1/1/0001
22000	S		CNT	II	00000	135	8TH LT N OF OLD ROSEBUD RD, E SIDE ON SIR BARTON WAY	12	061011	1/1/0001
22000	S		CNT	II	00000	136	13TH LT S OF SANFORD WAY, W SIDE ON SIR BARTON WAY	12	061011	1/1/0001
22000	S		CNT	II	00000	137	9TH LT N OF OLD ROSEBUD RD, E SIDE ON SIR BARTON WAY	12	061011	1/1/0001
22000	S		CNT	II	00000	138	12TH LT S OF SANFORD WAY, W SIDE ON SIR BARTON WAY	12	061011	1/1/0001
22000	S		CNT	II	00000	139	10TH LT N OF OLD ROSEBUD RD, E SIDE ON SIR BARTON WAY	12	061011	1/1/0001
22000	S		CNT	II	00000	140	11TH LT S OF SANFORD WAY, W SIDE ON SIR BARTON WAY	12	061011	1/1/0001
22000	S		CNT	II	00000	141	11TH LT N OF OLD ROSEBUD RD, E SIDE ON SIR BARTON WAY	12	061011	1/1/0001
22000	S		CNT	II	00000	142	10TH LT S OF SANFORD WAY, W SIDE ON SIR BARTON WAY	12	061011	1/1/0001
22000	S		CNT	II	00000	143	12TH LT N OF OLD ROSEBUD RD, E SIDE ON SIR BARTON WAY	12	061011	1/1/0001
22000	S		CNT	II	00000	144	9TH LT S OF SANFORD WAY, W SIDE ON SIR BARTON WAY	12	061011	1/1/0001
22000	S		CNT	II	00000	145	13TH LT N OF OLD ROSEBUD RD, E SIDE ON SIR BARTON WAY	12	061011	1/1/0001
22000	S		CNT	II	00000	146	8TH LT S OF SANFORD WAY, W SIDE ON SIR BARTON WAY	12	061011	1/1/0001
22000	S		CNT	II	00000	147	14TH LT N OF OLD ROSEBUD RD, E SIDE ON SIR BARTON WAY	12	061011	1/1/0001
22000	S		CNT	II	00000	148	7TH LT S OF SANFORD WAY, W SIDE ON SIR BARTON WAY	12	061011	1/1/0001

OFFICE: 311

ROUTE: 564

ST_REF_NO: 00000167850

SIR BARTON WAY

LUMENS	BULB TYPE	MULT SERIES	POLE TYPE	SHADE	ADDRESS NUMBER	REF	LOCATION	TAX DIST	DATE INST	DATE CHANGE
22000	S		CNT	II	00000	149	15TH LT N OF OLD ROSEBUD RD, E SIDE ON SIR BARTON WAY	12	061011	1/1/0001
22000	S		CNT	II	00000	150	6TH LT S OF SANFORD WAY, W SIDE ON SIR BARTON WAY	12	061011	1/1/0001
22000	S		CNT	II	00000	151	16TH LT N OF OLD ROSEBUD RD, E SIDE ON SIR BARTON WAY	12	061011	1/1/0001
22000	S		CNT	II	00000	152	5TH LT S OF SANFORD WAY, W SIDE ON SIR BARTON WAY	12	061011	1/1/0001
22000	S		CNT	II	00000	153	17TH LT N OF OLD ROSEBUD RD, E SIDE ON SIR BARTON WAY	12	061011	1/1/0001
22000	S		CNT	II	00000	154	4TH LT S OF SANFORD WAY, W SIDE ON SIR BARTON WAY	12	061011	1/1/0001
22000	S		CNT	II	00000	155	18TH LT N OF OLD ROSEBUD RD, E SIDE ON SIR BARTON WAY	12	061011	1/1/0001
22000	S		CNT	II	00000	156	3RD LT S OF SANFORD WAY, W SIDE ON SIR BARTON WAY	12	061011	1/1/0001
22000	S		CNT	II	00000	157	19TH LT N OF OLD ROSEBUD RD, E SIDE ON SIR BARTON WAY	12	061011	1/1/0001
22000	S		CNT	II	00000	158	2ND LT S OF SANFORD WAY, W SIDE ON SIR BARTON WAY	12	061011	1/1/0001
22000	S		CNT	II	00000	159	20TH LT N OF OLD ROSEBUD RD, E SIDE ON SIR BARTON WAY	12	061011	1/1/0001
22000	S		CNT	II	00000	160	1ST LT S OF SANFORD WAY, W SIDE ON SIR BARTON WAY	12	061011	1/1/0001
22000	S		CNT	II	00000	161	1ST LT N OF SANFORD WAY, E SIDE ON SIR BARTON WAY	12	061011	1/1/0001
22000	S		CNT	II	00000	162	4TH LT S OF GREY LAG WAY, W SIDE ON SIR BARTON WAY	12	061011	1/1/0001
22000	S		CNT	II	00000	163	2ND LT N OF SANFORD WAY, E SIDE ON SIR BARTON WAY	12	061011	1/1/0001
22000	S		CNT	II	00000	164	3RD LT S OF GREY LAG WAY, W SIDE ON SIR BARTON WAY	12	061011	1/1/0001
22000	S		CNT	II	00000	165	3RD LT N OF SANFORD WAY, E SIDE ON SIR BARTON WAY	12	061011	1/1/0001
22000	S		CNT	II	00000	166	2ND LT S OF GREY LAG WAY, W SIDE ON SIR BARTON WAY	12	061011	1/1/0001
22000	S		CNT	II	00000	167	4TH LT N OF SANFORD WYA, E SIDE ON SIR BARTON WAY	12	061011	1/1/0001
22000	S		CNT	II	00000	168	1ST LT S OF GREY LAG WAY, W SID EON SIR BARTON WAY	12	061011	1/1/0001

OFFICE: 311

ROUTE: 564

ST_REF_NO: 00000167850

SIR BARTON WAY

LUMENS	BULB TYPE	MULT SERIES	POLE TYPE	SHADE	ADDRESS NUMBER	REF	LOCATION	TAX DIST	DATE INST	DATE CHANGE
22000	S		CNT	II	00000	169	1ST LT N OF GREY LAG WAY, E SIDE ON SIR BARTON WAY	12	061011	1/1/0001
22000	S		CNT	II	00000	170	6TH LT S OF CARDUCCI ST, W SIDE ON SIR BARTON WAY	12	061011	1/1/0001
22000	S		CNT	II	00000	171	2ND LT N OF GREY LAG WAY, E SIDE ON SIR BARTON WAY	12	061011	1/1/0001
22000	S		CNT	II	00000	172	5TH LT S OF CARDUCCI ST, W SIDE ON SIR BARTON WAY	12	061011	1/1/0001
22000	S		CNT	II	00000	173	3RD LT N OF GREY LAG WAY, E SIDE ON SIR BARTON WAY	12	061011	1/1/0001
22000	S		CNT	II	00000	174	4TH LT S OF CARDUCCI ST, W SIDE ON SIR BARTON WAY	12	061011	1/1/0001
22000	S		CNT	II	00000	175	4TH LT N OF GREY LAG WAY, E SIDE ON SIR BARTON WAY	12	061011	1/1/0001
22000	S		CNT	II	00000	176	3RD LT S OF CARDUCCI ST, W SIDE ON SIR BARTON WAY	12	061011	1/1/0001
22000	S		CNT	II	00000	177	5TH LT N OF GREY LAG WAY, E SIDE ON SIR BARTON WAY	12	061011	1/1/0001
22000	S		CNT	II	00000	178	2ND LT S OF CARDUCCI ST, W SIDE ON SIR BARTON WAY	12	061011	1/1/0001
22000	S		CNT	II	00000	179	6TH LT N OF GREY LAG WAY, E SIDE ON SIR BARTON WAY	12	061011	1/1/0001
22000	S		CNT	II	00000	180	1ST LT S OF CARDUCCI ST, W SIDE ON SIR BARTON WAY	12	061011	1/1/0001
22000	S		CNT	II	00000	181	7TH LT N OF GREY LAG WAY, E SIDE ON SIR BARTON WAY	12	061011	1/1/0001
22000	S		CNT	II	00000	182	17TH LT S OF WINCHESTER RD, W SIDE ON SIR BARTON WAY	12	061011	1/1/0001
22000	S		CNT	II	00000	183	8TH LT N OF GREY LAG WAY, E SIDE ON SIR BARTON WAY	12	061011	1/1/0001
22000	S		CNT	II	00000	184	16TH LT S OF WINCHESTER RD, W SIDE ON SIR BARTON WAY	12	061011	1/1/0001
22000	S		CNT	II	00000	185	9TH LT N OF GREY LAG WAY, E SIDE ON SIR BARTON WAY	12	061011	1/1/0001
22000	S		CNT	II	00000	186	15TH LT S OF WINCHESTER RD, W SIDE ON SIR BARTON WAY	12	061011	1/1/0001
22000	S		CNT	II	00000	187	10TH LT N OF GREY LAG WAY, E SIDE ON SIR BARTON WAY	12	061011	1/1/0001
22000	S		CNT	II	00000	188	14TH LT S OF WINCHESTER RD, W SIDE ON SIR BARTON WAY	12	061011	1/1/0001

OFFICE: 311

ROUTE: 564

ST_REF_NO: 00000167850

SIR BARTON WAY

LUMENS	BULB TYPE	MULT SERIES	POLE TYPE	SHADE	ADDRESS NUMBER	REF	LOCATION	TAX DIST	DATE INST	DATE CHANGE
22000	S		CNT	II	00000	189	11TH LT N OF GREY LAG WAY, E SIDE ON SIR BARTON WAY	12	061011	1/1/0001
22000	S		CNT	II	00000	190	13TH LT S OF WINCHESTER RD, W SIDE ON SIR BARTON WAY	12	061011	1/1/0001
22000	S		CNT	II	00000	191	12TH LT N OF GREY LAG WAY, E SIDE ON SIR BARTON WAY	12	061011	1/1/0001
22000	S		CNT	II	00000	192	12TH LT S OF WINCHESTER RD, W SIDE ON SIR BARTON WAY	12	061011	1/1/0001
22000	S		CNT	II	00000	193	13TH LT N OF GREY LAG, E SIDE ON SIR BARTON WAY	12	061011	1/1/0001
22000	S		CNT	II	00000	194	11TH LT S OF WINCHESTER RD, W SIDE ON SIR BARTON WAY	12	061011	1/1/0001
22000	S		CNT	II	00000	195	14TH LT N OF GREY LAG WAY, E SIDE ON SIR BARTON WAY	12	061011	1/1/0001
22000	S		CNT	II	00000	196	10TH LT S OF WINCHESTER RD, W SIDE ON SIR BARTON WAY	12	061011	1/1/0001
22000	S		CNT	II	00000	197	15TH LT N OF GREY LAG WAY, E SIDE ON SIR BARTON WAY	12	061011	1/1/0001
22000	S		CNT	II	00000	198	9TH LT S OF WINCHESTER RD, W SIDE ON SIR BARTON WAY	12	061011	1/1/0001
22000	S		CNT	II	00000	199	16TH LT N OF GREY LAG WAY, E SIDE ON SIR BARTON WAY	12	061011	1/1/0001
22000	S		CNT	II	00000	200	8TH LT S OF WINCHESTER RD, W SIDE ON SIR BARTON WAY	12	061011	1/1/0001
22000	S		CNT	II	00000	201	1ST LT N OF WAR ADMIRAL WAY, E SIDE ON SIR BARTON WAY	12	061011	1/1/0001
22000	S		CNT	II	00000	202	7TH LT S OF WINCHESTER RD, W SIDE ON SIR BARTON WAY	12	061011	1/1/0001
22000	S		CNT	II	00000	203	2ND LT N OF WAR ADMIRAL WAY, E SIDE ON SIR BARTON WAY	12	061011	1/1/0001
22000	S		CNT	II	00000	204	6TH LT S OF WINCHESTER RD, W SIDE ON SIR BARTON WAY	12	061011	1/1/0001
22000	S		CNT	II	00000	205	3RD LT N OF WAR ADMIRAL WAY, E SIDE ON SIR BARTON WAY	12	061011	1/1/0001
22000	S		CNT	II	00000	206	5TH LT S OF WINCHESTER RD, W SIDE ON SIR BARTON WAY	12	061011	1/1/0001
22000	S		CNT	II	00000	207	4TH LT N OF WAR ADMIRAL WAY, E SIDE ON SIR BARTON WAY	12	061011	1/1/0001
22000	S		CNT	II	00000	208	4TH LT S OF WINCHESTER RD, W SIDE ON SIR BARTON WAY	12	061011	1/1/0001

OFFICE: 311

ROUTE: 564

ST_REF_NO: 00000167850

SIR BARTON WAY

LUMENS	BULB TYPE	MULT SERIES	POLE TYPE	SHADE	ADDRESS NUMBER	REF	LOCATION	TAX DIST	DATE INST	DATE CHANGE
22000	S		CNT	II	00000	209	5TH LT N OF WAR ADMIRAL WAY, E SIDE ON SIR BARTON WAY	12	061011	1/1/0001
22000	S		CNT	II	00000	210	3RD LT S OF WINCHESTER RD, W SIDE ON SIR BARTON WAY	12	061011	1/1/0001
22000	S		CNT	II	00000	211	6TH LT N OF WAR ADMIRAL WAY, E SIDE ON SIR BARTON WAY	12	061011	1/1/0001
22000	S		CNT	II	00000	212	2ND LT S OF WINCHESTER RD, W SIDE ON SIR BARTON WAY	12	061011	1/1/0001
22000	S		CNT	II	00000	213	7TH LT N OF WAR ADMIRAL WAY, E SIDE ON SIR BARTON WAY	12	061011	1/1/0001
22000	S		CNT	II	00000	214	1ST LT S OF WINCHESTER RD, W SIDE ON SIR BARTON WAY	12	061011	1/1/0001
50000	S	M	CNT	II	00000	021	1ST LT N OF VENDOR WAY,W SIDE OF SIR BARTON WAY	12	030703	1/1/0001
22000	S	M	CNT	II	00000	023	3RD LT N OF VENDOR WAY,W SIDE OF SIR BARTON WAY	12	030703	1/1/0001
22000	S	M	CNT	II	00000	025	5TH LT N OF VENDOR WAY,W SIDE OF SIR BARTON WAY	12	030703	1/1/0001
22000	S	M	CNT	II	00000	027	7TH LT N OF VENDOR WAY,W SIDE OF SIR BARTON WAY	12	030703	1/1/0001
22000	S	M	CNT	II	00000	031	11TH LT N OF VENDOR WAY, W SIDE OF SIR BARTON WAY	12	030703	1/1/0001
22000	S	M	CNT	II	00000	033	13TH LT N OF VENDOR WAY, W SIDE OF SIR BARTON WAY	12	030703	1/1/0001
22000	S	M	CNT	II	00000	035	15TH LT N OF VENDOR WAY, W SIDE OF SIR BARTON WAY	12	030703	1/1/0001
50000	S	M	CNT	II	00000	037	17TH LT N OF VENDOR WAY, W SIDE OF SIR BARTON WAY	12	030703	1/1/0001
50000	S	M	CNT	II	00000	100	1ST LT N OF STAR SHOOT PKWY,W SIDE ON SIR BARTON	12	032707	1/1/0001
50000	S	M	CNT	II	00000	101	1ST LT N OF STAR SHOOT PKWY,E SIDE ON SIR BARTON	12	032707	1/1/0001
22000	S	M	CNT	II	00000	102	2ND LT N OF STAR SHOOT PW, W SIDE ON SIR BARTON	12	032707	1/1/0001
22000	S	M	CNT	II	00000	103	2ND LT N OF STAR SHOOT PW, E SIDE ON SIR BARTON	12	032707	1/1/0001
22000	S	M	CNT	II	00000	104	3RD LT N OF STAR SHOOT PW, W SIDE ON SIR BARTON	12	032707	1/1/0001
22000	S	M	CNT	II	00000	105	3RD LT N OF STAR SHOOT PW, E SIDE ON SIR BARTON	12	032707	1/1/0001

OFFICE: 311

ROUTE: 564

ST_REF_NO: 00000167850

SIR BARTON WAY

LUMENS	BULB TYPE	MULT SERIES	POLE TYPE	SHADE	ADDRESS NUMBER	REF	LOCATION	TAX DIST	DATE INST	DATE CHANGE
22000	S	M	CNT	II	00000	106	4TH LT N OF STAR SHOOT PW, W SIDE ON SIR BARTON	12	032707	1/1/0001
22000	S	M	CNT	II	00000	107	4TH LT N OF STAR SHOOT PW, E SIDE ON SIR BARTON	12	032707	1/1/0001
22000	S	M	CNT	II	00000	108	5TH LT N OF STAR SHOOT PW, W SIDE ON SIR BARTON	12	032707	1/1/0001
22000	S	M	CNT	II	00000	109	5TH LT N OF STAR SHOOT PW, E SIDE ON SIR BARTON	12	032707	1/1/0001
22000	S	M	CNT	II	00000	110	6TH LT N OF STAR SHOOT PW, W SIDE ON SIR BARTON	12	032707	1/1/0001
22000	S	M	CNT	II	00000	111	6T LT N OF STAR SHOOT PW, E SIDE ON SIR BARTON	12	032707	1/1/0001
22000	S	M	CNT	II	00000	113	7TH LT N OF STAR SHOOT PW, E SIDE ON SIR BARTON	12	032707	1/1/0001
22000	S	M	CNT	II	00000	115	8TH LT N OF STAR SHOOT PW, E SIDE ON SIR BARTON	12	032707	1/1/0001
22000	S	M	CNT	II	00000	117	9T LT N OF STAR SHOOT PW, E SIDE ON SIR BARTON	12	032707	1/1/0001
22000	S	M	CNT	II	00000	119	10TH LT N OF STAR SHOOT PW, E SIDE ON SIR BARTON	12	032707	1/1/0001
50000	S	M	CNT	II	00000	121	1ST LT N OF OLD ROSEBUD, E SIDE ON SIR BARTON	12	032707	1/1/0001
22000	S	M	CNT	II	00000	123	2ND LT N OF OLD ROSEBUD RD, E SIDE ON SIR BARTON	12	032707	1/1/0001
22000	S	M	CNT	II	00000	125	3RD LT N OF OLD ROSEBUD RD, E SIDE ON SIR BARTON	12	032707	1/1/0001
22000	S	M	CNT	II	00000	127	4TH LT N OF OLD ROSEBUD RD, E SIDE ON SIR BARTON	12	032707	1/1/0001
50000	S	M	CNT	II	00000	001	1ST LT N OF MAN-O-WAR W SIDE OF SIR BARTON WAY	12	120800	1/1/0001
50000	S	M	CNT	II	00000	002	1ST LT N OF MAN-O-WAR E SIDE OF SIR BARTON WAY	12	120800	1/1/0001
22000	S	M	CNT	II	00000	003	2ND LT. N OF MAN-O-WAR W SIDE OF SIR BARTON WAY	12	120800	1/1/0001
22000	S	M	CNT	II	00000	004	2ND LT N OF MAN-O-WAR E SIDE OF SIR BARTON WAY	12	120800	1/1/0001
22000	S	M	CNT	II	00000	005	3RD LT N OF MAN-O-WAR W SIDE OF SIR BARTON WAY	21	120800	1/1/0001
22000	S	M	CNT	II	00000	006	3RD LT N OF MAN-O-WAR E SIDE OF SIR BARTON WAY	12	120800	1/1/0001

OFFICE: 311		ROUTE: 564		ST_REF_NO: 00000167850		SIR BARTON WAY		TAX DIST	DATE INST	DATE CHANGE
LUMENS	BULB TYPE	MULT SERIES	POLE TYPE	SHADE	ADDRESS NUMBER	REF	LOCATION			
22000	S	M	CNT	II	00000	007	2ND LT S OF MAN-O-WAR W SIDE OF SIR BARTON WAY	12	120800	1/1/0001
22000	S	M	CNT	II	00000	008	2ND LT S OF PAVILION WAY E SIDE OF SIR BARTON WAY	12	120800	1/1/0001
50000	S	M	CNT	II	00000	009	1ST LT S OF ALYSHEBA WAY W SIDE OF SIR BARTON WAY	12	120800	1/1/0001
50000	S	M	CNT	II	00000	010	1ST LT S OF PAVILION WAY E SIDE OF SIR BARTON WAY	12	120800	1/1/0001
22000	S	M	CNT	II	00000	011	1ST LT N OF ALYSHEBA WAY W SIDE OF SIR BARTON WAY	12	120800	1/1/0001
50000	S	M	CNT	II	00000	012	1ST LT N OF PAVILION WAY E SIDE OF SIR BARTON WAY	12	120800	1/1/0001
22000	S	M	CNT	II	00000	013	2ND LT N OF ALYSHEBA WAY W SIDE OF SIR BARTON WAY	12	120800	1/1/0001
22000	S	M	CNT	II	00000	014	2ND LT N OF PAVILION WAY E SIDE OF SIR BARTON WAY	12	120800	1/1/0001
22000	S	M	CNT	II	00000	015	3RD LT N OF ALYSHEBA WAY W SIDE OF SIR BARTON WAY	12	120800	1/1/0001
22000	S	M	CNT	II	00000	016	3RD LT N OF PAVILION WAY E SIDE OF SIR BARTON WAY	12	120800	1/1/0001
22000	S	M	CNT	II	00000	017	2ND LT S OF VENDOR WAY W SIDE OF SIR BARTON WAY	12	120800	1/1/0001
22000	S	M	CNT	II	00000	018	2ND LT S OF VENDOR WAY W SIDE OF SIR BARTON WAY	12	120800	1/1/0001
22000	S	M	CNT	II	00000	019	1ST LT S OF VENDOR WAY E SIDE OF SIR BARTON WAY	12	120800	1/1/0001
50000	S	M	SOH	II	00000	020	1ST LT S OF VENDOR WAY E SIDE OF SIR BARTON WAY	12	120800	1/1/0001
OFFICE: 311		ROUTE: 564		ST_REF_NO: 00000167900		SIXTH, EAST STREET		TAX DIST	DATE INST	DATE CHANGE
LUMENS	BULB TYPE	MULT SERIES	POLE TYPE	SHADE	ADDRESS NUMBER	REF	LOCATION			
22000	S		SOH	II	00000	300	SIDE OF 567 OHIO STREET ON E SIXTH STREET	12	030409	1/1/0001
05800	S		OUG	II	00549	053		12	101108	1/1/0001
05800	S		OUG	II	00569	054		12	101108	1/1/0001
05800	S		OUG	II	00589	055		12	101108	1/1/0001
05800	S		OUG	II	00609	056		12	101108	1/1/0001
05800	S		CNT	II	00632	401		12	112210	1/1/0001

OFFICE: 311

ROUTE: 564

ST_REF_NO: 00000167900

SIXTH, EAST STREET

LUMENS	BULB TYPE	MULT SERIES	POLE TYPE	SHADE	ADDRESS NUMBER	REF	LOCATION	TAX DIST	DATE INST	DATE CHANGE
05800	S		CNT	II	00635	400		12	112210	1/1/0001
05800	S		CNT	II	00650	350		12	112210	1/1/0001
05800	S		CNT	II	00671	351		12	112210	1/1/0001
05800	S		CNT	II	00715	353		12	112210	1/1/0001
05800	S		CNT	II	00720	352		12	112210	1/1/0001
05800	S		CNT	II	00730	354		12	112210	1/1/0001
05800	S		CNT	II	00731	356		12	112210	1/1/0001
05800	S		CNT	II	00734	355		12	112210	1/1/0001
50000	S	M	SOH	II	00000	001	SIDE OF 572 N. LIME-upgrade per LFUCG	12	110168	3/4/2009
22000	S	M	SOH	II	00000	004	OPP. 138-upgrade per LFUCG	12	110168	3/4/2009
05800	S	M	OUG	II	00000	200	1ST LT E OF BLUEGRASS PARK, N SIDE ON E SIXTH	12	012706	1/1/0001
05800	S	M	OUG	II	00000	201	2ND LT E OF BLUEGRASS PARK, N SIDE ON E SIXTH	12	012706	1/1/0001
05800	S	M	OUG	II	00000	202	3RD LT E OF BLUEGRASS PARK, N SIDE ON E SIXTH	12	012706	1/1/0001
22000	S	M	SOH	II	00115	002	upgrade per LFUCG	12	110168	3/4/2009
22000	S	M	SOH	II	00122	003	upgrade per LFUCG	12	110168	3/4/2009
22000	S	M	SOH	II	00154	005	upgrade per LFUCG	12	110168	3/4/2009
22000	S	M	SOH	II	00165	013	upgrade per LFUCG	12	021367	3/4/2009
22000	S	M	SOH	II	00182	014	upgrade per LFUCG	12	021367	3/4/2009
22000	S	M	SOH	II	00209	015	upgrade per LFUCG	12	062167	3/4/2009
22000	S	M	SOH	II	00222	016	upgrade per LFUCG	12	021367	3/4/2009
09500	S	M	SOH	II	00295	008		12	110168	4/12/2013
10000	M	M	SOH	II	00000	007	SIDE OF 571 ELM TREE LANE	12	110168	1/1/0001
05800	S	M	SOH	II	00000	017	OPP. 439	12	121467	1/1/0001
10000	M	M	SOH	II	00231	006		12	110168	1/1/0001
10000	M	M	SOH	II	00304	009		12	110168	1/1/0001
10000	M	M	SOH	II	00323	010		12	110168	1/1/0001
10000	M	M	SOH	II	00410	011		12	110168	1/1/0001
10000	M	M	SOH	II	00427	012		12	110168	1/1/0001
05800	S	M	SOH	II	00445	018		12	121467	1/1/0001
05800	S	M	SOH	II	00602	019		12	121467	1/1/0001

OFFICE: 311

ROUTE: 564

ST_REF_NO: 00000167910

SIXTH, WEST STREET

LUMENS	BULB TYPE	MULT SERIES	POLE TYPE	SHADE	ADDRESS NUMBER	REF	LOCATION	TAX DIST	DATE INST	DATE CHANGE
09500	S		OUG	II	00000	052	1ST LT N OF JEFFERSON ST, W SIDE ON W SIXTH ST	12	010709	1/1/0001
09500	S		OUG	II	00000	053	2ND LT N OF JEFFERSON ST, E SIDE ON W SIXTH ST	12	010709	1/1/0001
09500	S		OUG	II	00000	054	3RD LT N OF JEFFERSON ST, W SIDE ON W SIXTH ST	12	010709	1/1/0001
09500	S		OUG	II	00000	055	4TH LT N OF JEFFERSON ST, W SIDE ON W SIXTH ST	12	010709	1/1/0001
22000	S		OUG	III	00000	056	5TH LT N OF JEFFERSON ST, E SIDE ON W SIXTH ST	12	010709	1/1/0001
09500	S	M	SOH	II	00000	005	OPP. 224	12	030768	8/27/2011
22000	S	M	SOH	II	00000	008	BESIDE 572 N. UPPER	12	041768	5/30/2013
22000	S	M	SOH	II	00000	012	FRONT OF RAINBO BAKERY	12	100768	9/20/2011
22000	S	M	SOH	II	00106	010		12	030168	3/4/2010
22000	S	M	SOH	II	00000	001	SIDE OF 602 N. BROADWAY	12	030168	1/1/0001
10000	M	M	SOH	II	00000	002	SIDE OF 568 N. BROADWAY	12	030168	1/1/0001
10000	M	M	SOH	II	00000	007	OPP. 208	12	030168	1/1/0001
10000	M	M	SOH	II	00000	100	SIDE OF 559 N. BROADWAY	12	100768	1/1/0001
09500	S	M	SOH	II	00220	006	upgrade 6/08	12	030168	1/1/0001
10000	M	M	SOH	II	00308	004		12	041768	1/1/0001
10000	M	M	SOH	II	00315	003		12	030168	1/1/0001
22000	S	M	SOH	II	00409	002		12	100768	1/1/0001
10000	M	M	SOH	II	00418	003		12	100768	1/1/0001
10000	M	M	SOH	II	00423	004		12	100768	1/1/0001
10000	M	M	SOH	II	00430	005		12	100768	1/1/0001
10000	M	M	SOH	II	00445	006		12	100768	1/1/0001
10000	M	M	SOH	II	00450	007		12	100768	1/1/0001
10000	M	M	SOH	II	00453	008		12	100768	1/1/0001
10000	M	M	SOH	II	00467	010		12	100768	1/1/0001
10000	M	M	SOH	II	00470	009		12	100768	1/1/0001
10000	M	M	SOH	II	00484	011		12	100768	1/1/0001
10000	M	M	SOH	II	00119	009		12	030768	1/1/0001

OFFICE: 311

ROUTE: 564

ST_REF_NO: 00000168000

SKAIN ALLEY

LUMENS	BULB TYPE	MULT SERIES	POLE TYPE	SHADE	ADDRESS NUMBER	REF	LOCATION	TAX DIST	DATE INST	DATE CHANGE
04000	S	S	SOH	II	00000	001	SIDE OF 147 FOREST AVE.	12	070162	1/1/0001
04000	S	S	SOH	II	00000	002	SIDE OF 150 INDIANA	12	070162	1/1/0001
22000	S	M	OUG	III	00000	032		12	102391	1/1/0001
22000	S	M	OUG	III	00000	033		12	100891	1/1/0001

OFFICE: 311

ROUTE: 564

ST_REF_NO: 00000168095

SKY VIEW LANE

LUMENS	BULB TYPE	MULT SERIES	POLE TYPE	SHADE	ADDRESS NUMBER	REF	LOCATION	TAX DIST	DATE INST	DATE CHANGE
05800	S		CNT	II	00601	019		12	080610	1/1/0001
05800	S		CNT	II	00616	020		12	080610	1/1/0001
05800	S		CNT	II	00633	021		12	080610	1/1/0001
05800	S	M	CNT	II	00000	012	SIDE OF 2889 SANDERSVILLE RD ON SKY VIEW LANE	12	010504	1/1/0001
05800	S	M	CNT	II	00000	015	SIDE OF 548 GREEN VALLEY DR ON SKY VIEW LANE	12	010504	1/1/0001
05800	S	M	CNT	II	00000	016	SIDE OF 621 HOPEWELL PARK ON SKY VIEW LANE	12	010504	1/1/0001
05800	S	M	CNT	II	00401	001		12	071902	1/1/0001
05800	S	M	CNT	II	00408	002		12	071902	1/1/0001
05800	S	M	CNT	II	00421	003		12	071902	1/1/0001
05800	S	M	CNT	II	00428	004		12	071902	1/1/0001
05800	S	M	CNT	II	00445	005		12	071902	1/1/0001
05800	S	M	CNT	II	00448	006		12	071902	1/1/0001
05800	S	M	CNT	II	00465	007		12	071902	1/1/0001
05800	S	M	CNT	II	00468	008		12	071902	1/1/0001
05800	S	M	CNT	II	00485	009		12	071902	1/1/0001
05800	S	M	CNT	II	00497	010		12	071902	1/1/0001
05800	S	M	CNT	II	00500	011		12	071902	1/1/0001
05800	S	M	CNT	II	00525	013		12	010504	1/1/0001
05800	S	M	CNT	II	00533	014		12	010504	1/1/0001
05800	S	M	CNT	II	00573	017		12	010504	1/1/0001
05800	S	M	CNT	II	00592	018		12	010504	1/1/0001

OFFICE: 311

ROUTE: 564

ST_REF_NO: 00000168100

SKILLMAN ALLEY

LUMENS	BULB TYPE	MULT SERIES	POLE TYPE	SHADE	ADDRESS NUMBER	REF	LOCATION	TAX DIST	DATE INST	DATE CHANGE
05800	S	M	SOH	I	00000	001	1ST LT. N. OF CHURCH ST.	12	020563	1/1/0001
05800	S	M	SOH	I	00000	002	2ND LT. N. OF CHURCH ST.	12	020563	1/1/0001
05800	S	M	SOH	I	00000	003	1ST LT. S. OF 2ND ST.	12	020563	1/1/0001

OFFICE: 311

ROUTE: 564

ST_REF_NO: 00000168200

SLASHES ROAD

LUMENS	BULB TYPE	MULT SERIES	POLE TYPE	SHADE	ADDRESS NUMBER	REF	LOCATION	TAX DIST	DATE INST	DATE CHANGE
09500	S	M	SOH	II	01206	100		12	011007	1/1/0001
05800	S	M	SOH	I	00000	070	SIDE OF 238 HANOVER	12	080268	1/1/0001
05800	S	M	SOH	I	00000	071	SIDE OF 303 DESHA RD.	12	080268	1/1/0001
05800	S	M	OUG	I	00000	072	OPP. 1013	12	080268	1/1/0001
05800	S	M	OUG	I	00000	073	OPP. 1008	12	080268	1/1/0001
05800	S	M	OUG	I	00000	074	OPP. THE SIDE OF 225 IRVINE RD.	12	080268	1/1/0001
05800	S	M	OUG	I	00000	075	OPP. SIDE OF 301 IRVINE RD.	12	080268	1/1/0001
05800	S	M	OUG	I	00000	076	OPP. 1107	12	080268	1/1/0001
05800	S	M	OUG	I	00000	077	OPP. THE SIDE OF 300 IRVINE RD.	12	080268	1/1/0001
05800	S	M	OUG	I	00000	078	OPP. 1113	12	080268	1/1/0001
05800	S	M	OUG	I	00000	079	OPP. 1120	12	080268	1/1/0001
05800	S	M	OUG	I	00000	080	OPP. THE SIDE OF 244 MCDOWELL	12	080268	1/1/0001
05800	S	M	OUG	II	00000	081	OPP. THE SIDE OF 314 MCDOWELL	12	080268	1/1/0001
05800	S	M	OUG	I	00000	082	SIDE OF 233 SYCAMORE	12	080268	1/1/0001

OFFICE: 311

ROUTE: 564

ST_REF_NO: 00000168400

SMITH STREET

LUMENS	BULB TYPE	MULT SERIES	POLE TYPE	SHADE	ADDRESS NUMBER	REF	LOCATION	TAX DIST	DATE INST	DATE CHANGE
05800	S	M	SOH	II	00000	001	1ST LT. W. OF 6TH ST.	12	040165	1/1/0001
05800	S	M	SOH	II	00000	002	OPP.549	12	010165	1/1/0001
05800	S	M	SOH	II	00000	003	AT WILLY ST.	12	032520	1/1/0001
05800	S	M	SOH	II	00465	005		12	040165	1/1/0001
05800	S	M	SOH	II	00510	004		12	010165	1/1/0001
05800	S	M	SOH	II	00411	007		12	010165	1/1/0001
05800	S	M	SOH	II	00441	006		12	060366	1/1/0001

OFFICE: 311 ROUTE: 564										
ST_REF_NO: 00000168660 SMUGGLERS NOTCH DRIVE										
LUMENS	BULB TYPE	MULT SERIES	POLE TYPE	SHADE	ADDRESS NUMBER	REF	LOCATION	TAX DIST	DATE INST	DATE CHANGE
05800	S	M	OUG	II	00000	001	SIDE OF 2537 CHECKERERRY DR.	12	110899	1/1/0001
05800	S	M	OUG	II	00621	002		12	110899	1/1/0001
05800	S	M	OUG	II	00629	003		12	110899	1/1/0001
05800	S	M	OUG	II	00644	004		12	110899	1/1/0001
05800	S	M	OUG	II	00661	005		12	110899	1/1/0001
05800	S	M	OUG	II	00668	006		12	110899	1/1/0001
05800	S	M	OUG	II	00693	007		12	110899	1/1/0001
05800	S	M	OUG	II	00709	008		12	110899	1/1/0001

OFFICE: 311 ROUTE: 564										
ST_REF_NO: 00000168680 SMYRNA LANE										
LUMENS	BULB TYPE	MULT SERIES	POLE TYPE	SHADE	ADDRESS NUMBER	REF	LOCATION	TAX DIST	DATE INST	DATE CHANGE
05800	S	M	CNT	II	00000	003	SIDE OF 2253 SAVANNAH LANE	12	100899	1/1/0001
05800	S	M	CNT	II	01300	001		12	100899	1/1/0001
05800	S	M	CNT	II	01305	002		12	100899	1/1/0001

OFFICE: 311 ROUTE: 564										
ST_REF_NO: 00000168700 SNAFFLE ROAD										
LUMENS	BULB TYPE	MULT SERIES	POLE TYPE	SHADE	ADDRESS NUMBER	REF	LOCATION	TAX DIST	DATE INST	DATE CHANGE
05800	S	M	OUG	II	00000	012	SIDE OF 2013 FT. HARRODS DR.	12	031581	1/1/0001
04000	S	M	OUG	II	00000	013	SIDE OF 2020 FT. HARRODS DR.	12	031581	1/1/0001
05800	S	M	CNT	II	00000	036	1ST LT N OF MANTILLA DR., EASTSIDE	12	020800	1/1/0001
05800	S	M	CNT	II	00000	037	2ND LT N OF MANTILLA DR., EASTSIDE	12	020800	1/1/0001
05800	S	M	CNT	II	00000	038	1ST LT S OF BEAUMONT CTR. CIRCLE, EASTSIDE	12	020800	1/1/0001
04000	S	M	OUG	II	00000	060	SIDE OF 3398 MANTILLA DR.	12	031581	1/1/0001
05800	S	M	CNT	II	03275	035		12	020800	1/1/0001
05800	S	M	CNT	II	03284	034		12	020800	1/1/0001
05800	S	M	CNT	II	03291	036		12	080897	1/1/0001
05800	S	M	CNT	II	03296	032		12	020800	1/1/0001
05800	S	M	OUG	II	03307	031		12	031581	1/1/0001
05800	S	M	OUG	II	03310	030		12	031581	1/1/0001
05800	S	M	OUG	II	03322	028		12	031581	1/1/0001
05800	S	M	OUG	II	03323	029		12	031581	1/1/0001
05800	S	M	OUG	II	03338	026		12	031581	1/1/0001

OFFICE: 311		ROUTE: 564		ST_REF_NO: 00000168700		SNAFFLE ROAD		LUMENS	BULB TYPE	MULT SERIES	POLE TYPE	SHADE	ADDRESS NUMBER	REF	LOCATION	TAX DIST	DATE INST	DATE CHANGE
05800	S	M	OUG	II	03343	027										12	031581	1/1/0001
05800	S	M	OUG	II	03355	025										12	031581	1/1/0001
05800	S	M	OUG	II	03374	014	upgrade 1/08									12	031581	1/1/0001
04000	S	M	OUG	II	03391	015										12	011584	1/1/0001
09500	S	M	OUG	II	03394	016										12	111581	1/1/0001
09500	S	M	OUG	II	03403	017										12	031581	1/1/0001
04000	S	M	OUG	II	03410	061										12	111581	1/1/0001
04000	S	M	OUG	II	03430	059										12	111581	1/1/0001
04000	S	M	OUG	II	03439	082										12	081582	1/1/0001
04000	S	M	OUG	II	03450	081										12	011584	1/1/0001
04000	S	M	OUG	II	03459	080										12	081582	1/1/0001
04000	S	M	OUG	II	03466	115										12	100884	1/1/0001

OFFICE: 311		ROUTE: 564		ST_REF_NO: 00000168800		SNOW ROAD		LUMENS	BULB TYPE	MULT SERIES	POLE TYPE	SHADE	ADDRESS NUMBER	REF	LOCATION	TAX DIST	DATE INST	DATE CHANGE
05800	S	M	OUG	II	02816	056	chg'ing str addr from 2816 to 2800 per drafting & upgrade lt (repair)									12	111579	10/23/2012
05800	S	M	OUG	II	02849	059										12	111579	1/7/2011
05800	S	M	OUG	II	02856	060										12	111579	5/12/2011
04000	S	M	OUG	II	02801	055										12	111579	1/1/0001
04000	S	M	OUG	II	02825	057										12	111579	1/1/0001
04000	S	M	OUG	II	02840	058										12	111579	1/1/0001

OFFICE: 311		ROUTE: 564		ST_REF_NO: 00000168810		SNYDER PLACE		LUMENS	BULB TYPE	MULT SERIES	POLE TYPE	SHADE	ADDRESS NUMBER	REF	LOCATION	TAX DIST	DATE INST	DATE CHANGE
05800	S	M	SOH	I	00000	300	1ST LT. N. OF E. 5TH									12	091566	1/1/0001
05800	S	M	SOH	I	00000	301	AT END OF STREET									12	020865	1/1/0001

OFFICE: 311		ROUTE: 564		ST_REF_NO: 00000169010		SOLBERG LANE		LUMENS	BULB TYPE	MULT SERIES	POLE TYPE	SHADE	ADDRESS NUMBER	REF	LOCATION	TAX DIST	DATE INST	DATE CHANGE
04000	S	M	OUG	II	00000	040	SIDE OF 3853 GLADMAN WAY									12	091579	1/1/0001
04000	S	M	OUG	II	04077	039										12	091579	1/1/0001

OFFICE: 311		ROUTE: 564		ST_REF_NO: 00000169010		SOLBERG LANE				
LUMENS	BULB TYPE	MULT SERIES	POLE TYPE	SHADE	ADDRESS NUMBER	REF	LOCATION	TAX DIST	DATE INST	DATE CHANGE
04000	S	M	OUG	II	04092	038		12	091579	1/1/0001
04000	S	M	OUG	II	04100	037		12	091579	1/1/0001

OFFICE: 311		ROUTE: 564		ST_REF_NO: 00000169015		SOMERSLY COVE				
LUMENS	BULB TYPE	MULT SERIES	POLE TYPE	SHADE	ADDRESS NUMBER	REF	LOCATION	TAX DIST	DATE INST	DATE CHANGE
09500	S		CLN	III	00000	001	CORNER OF SOMERLY PLACE AND SOMERSLY COVE	12	041511	1/1/0001
09500	S		CLN	III	03801	002		12	041511	1/1/0001

OFFICE: 311		ROUTE: 564		ST_REF_NO: 00000169020		SOMERSLY PLACE				
LUMENS	BULB TYPE	MULT SERIES	POLE TYPE	SHADE	ADDRESS NUMBER	REF	LOCATION	TAX DIST	DATE INST	DATE CHANGE
09500	S		CLN	III	00000	013	SIDE OF 3861 ORMESBY PL, ON SOMERSLY PLACE	12	041511	1/1/0001
09500	S		CLN	III	00172	001		12	041511	1/1/0001
09500	S		CLN	III	00177	002		12	041511	1/1/0001
09500	S		CLN	III	00189	003		12	041511	1/1/0001
09500	S		CLN	III	00197	004		12	041511	1/1/0001
09500	S		CLN	III	00232	006		12	041511	1/1/0001
09500	S		CLN	III	00248	008		12	041511	1/1/0001
09500	S		CLN	III	00296	014		12	041511	1/1/0001
09500	S		CLN	III	00300	015		12	041511	1/1/0001

OFFICE: 311		ROUTE: 564		ST_REF_NO: 00000169040		SONOMA PLACE				
LUMENS	BULB TYPE	MULT SERIES	POLE TYPE	SHADE	ADDRESS NUMBER	REF	LOCATION	TAX DIST	DATE INST	DATE CHANGE
05800	S		OUG	II	02204	001		12	092704	1/1/0001
05800	S		OUG	II	02240	003		12	092704	1/1/0001

OFFICE: 311		ROUTE: 564		ST_REF_NO: 00000169050		SORRENTO LANE				
LUMENS	BULB TYPE	MULT SERIES	POLE TYPE	SHADE	ADDRESS NUMBER	REF	LOCATION	TAX DIST	DATE INST	DATE CHANGE
05800	S	M	CNT	III	00700	004		12	020899	1/1/0001
05800	S	M	CNT	II	00717	003		12	100899	1/1/0001
05800	S	M	CNT	II	00729	002		12	020899	1/1/0001

OFFICE: 311

ROUTE: 564

ST_REF_NO: 00000169050

SORRENTO LANE

LUMENS	BULB TYPE	MULT SERIES	POLE TYPE	SHADE	ADDRESS NUMBER	REF	LOCATION	TAX DIST	DATE INST	DATE CHANGE
05800	S	M	CNT	II	00736	001		12	100899	1/1/0001

OFFICE: 311

ROUTE: 564

ST_REF_NO: 00000169060

SOUP PERKINS ALLEY (FNA MORRIS ALLEY)

LUMENS	BULB TYPE	MULT SERIES	POLE TYPE	SHADE	ADDRESS NUMBER	REF	LOCATION	TAX DIST	DATE INST	DATE CHANGE
05800	S		SOH	I	00000	006		12	032163	1/1/0001
05800	S		SOH	I	00000	007		12	011427	1/1/0001
05800	S		SOH	I	00000	008	3RD LT N OF 4TH ST, E SIDE	12	032163	1/1/0001
05800	S		SOH	I	00000	009	4TH LT N OF 4TH ST, E SIDE	12	060859	1/1/0001
04000	S		SOH	I	00000	010	1ST LT N OF 4TH ST, EASTSIDE OF SOUP PERKINS ALLEY	12	040891	4/5/1991

OFFICE: 311

ROUTE: 564

ST_REF_NO: 00000169200

SOUTH FORBES ROAD

LUMENS	BULB TYPE	MULT SERIES	POLE TYPE	SHADE	ADDRESS NUMBER	REF	LOCATION	TAX DIST	DATE INST	DATE CHANGE
22000	S		OOH	II	00000	031	1st LT S OF LEESTOWN RD, E SIDE ON S FORBES RD	12	011813	1/1/0001

OFFICE: 311

ROUTE: 564

ST_REF_NO: 00000169300

SOUTH POINT DRIVE

LUMENS	BULB TYPE	MULT SERIES	POLE TYPE	SHADE	ADDRESS NUMBER	REF	LOCATION	TAX DIST	DATE INST	DATE CHANGE
09500	S	M	CNT	II	00000	104	SIDE OF 4505 GREY OAK LN ON SOUTH POINT	12	060205	1/1/0001
09500	S	M	CNT	II	00000	107	SIDE OF 4441 LARGO LANE ON SOUTH POINT	12	060205	1/1/0001
09500	S	M	CNT	II	00000	109	ACROSS FROM 448 SOUTH POINT	12	060205	1/1/0001
09500	S	M	CNT	II	00000	110	SIDE OF 4437 BROOKRIDGE DR ON SOUTH POINT DR	12	050404	1/1/0001
09500	S	M	CNT	II	00393	101		12	060205	1/1/0001
09500	S	M	CNT	II	00405	102		12	060205	1/1/0001
09500	S	M	CNT	II	00408	103		12	060205	1/1/0001
09500	S	M	CNT	II	00425	105		12	060205	1/1/0001
09500	S	M	CNT	II	00436	106		12	050404	1/1/0001
09500	S	M	CNT	II	00460	111		12	050404	1/1/0001
09500	S	M	CNT	II	00468	112		12	050404	1/1/0001
09500	S	M	CNT	II	00481	113		12	050404	1/1/0001
09500	S	M	CNT	II	00492	114		12	050404	1/1/0001

OFFICE: 311

ROUTE: 564

ST_REF_NO: 00000169300

SOUTH POINT DRIVE

LUMENS	BULB TYPE	MULT SERIES	POLE TYPE	SHADE	ADDRESS NUMBER	REF	LOCATION	TAX DIST	DATE INST	DATE CHANGE
09500	S	M	CNT	II	00509	115		12	050404	1/1/0001
09500	S	M	CNT	II	00516	116		12	050404	1/1/0001
09500	S	M	CNT	II	00540	118		12	050404	1/1/0001
09500	S	M	CNT	II	00553	119		12	050404	1/1/0001
09500	S	M	CNT	II	00564	120		12	050404	1/1/0001
09500	S	M	CNT	II	00577	121		12	050404	1/1/0001
09500	S	M	CNT	II	00585	122		12	050404	1/1/0001
09500	S	M	CNT	II	00592	123		12	050404	1/1/0001
09500	S	M	CNT	II	00000	059	OPP. 669	12	110899	1/1/0001
09500	S	M	CNT	II	00000	060	OPP. 661	12	110899	1/1/0001
05800	S	M	OUG	II	00000	065	SIDE 4537 PRINCE ALBERT WAY	12	090886	1/1/0001
05800	S	M	OUG	II	00120	061		12	090886	1/1/0001
05800	S	M	OUG	II	00121	062		12	090886	1/1/0001
05800	S	M	OUG	II	00128	063		12	090886	1/1/0001
05800	S	M	OUG	II	00129	064		12	090886	1/1/0001
05800	S	M	OUG	II	00201	066		12	090886	1/1/0001
05800	S	M	OUG	II	00204	067		12	090886	1/1/0001
05800	S	M	OUG	II	00209	068		12	090886	1/1/0001
05800	S	M	OUG	II	00216	069		12	090886	1/1/0001
05800	S	M	OUG	II	00217	070		12	090886	1/1/0001
05800	S	M	OUG	II	00224	071		12	090886	1/1/0001
05800	S	M	OUG	II	00229	072		12	090886	1/1/0001
05800	S	M	OUG	II	00236	073		12	090886	1/1/0001
05800	S	M	OUG	II	00237	074		12	090886	1/1/0001
05800	S	M	OUG	II	00240	075		12	090886	1/1/0001
05800	S	M	OUG	II	00245	076		12	090886	1/1/0001
05800	S	M	OUG	II	00252	077		12	090886	1/1/0001
05800	S	M	OUG	II	00257	078		12	090886	1/1/0001
05800	S	M	OUG	II	00269	080		12	090886	1/1/0001
05800	S	M	OUG	II	00273	082		12	090886	1/1/0001
05800	S	M	OUG	II	00000	001	OPP. 280	12	011579	1/1/0001
05800	S	M	OUG	II	00000	003	OPP. FROM SIDE OF 4500 MARWOOD DR.	12	011579	1/1/0001
05800	S	M	OUG	II	00000	005	OPP. 300	12	011579	1/1/0001
05800	S	M	OUG	II	00000	007	OPP. 312	12	011579	1/1/0001

OFFICE: 311

ROUTE: 564

ST_REF_NO: 00000169300

SOUTH POINT DRIVE

LUMENS	BULB TYPE	MULT SERIES	POLE TYPE	SHADE	ADDRESS NUMBER	REF	LOCATION	TAX DIST	DATE INST	DATE CHANGE
05800	S	M	OUG	II	00000	030	SIDE OF 4513 GRAVES DR.	12	011581	1/1/0001
09500	S	M	CNT	II	00000	051	1ST LT. S OF CLEARWATER WAY, EASTSIDE	12	110899	1/1/0001
05800	S	M	CNT	II	00000	052	OPP. 733	12	100899	1/1/0001
05800	S	M	CNT	II	00000	053	OPP. 721	12	100899	1/1/0001
05800	S	M	CNT	II	00000	054	OPP. 713	12	100899	1/1/0001
05800	S	M	CNT	II	00000	055	5TH LT. S OF CLEARWATER WAY, E SIDE	12	100899	1/1/0001
05800	S	M	CNT	II	00000	056	OPP. 693	12	100899	1/1/0001
05800	S	M	CNT	II	00000	057	OPP. 689	12	100899	1/1/0001
09500	S	M	CNT	II	00000	161	OPP. 653	12	030800	1/1/0001
09500	S	M	CNT	II	00000	162	1ST LT. S OF ST. ELIAS DR., W SIDE	12	030800	1/1/0001
09500	S	M	CNT	II	00000	164	OPP. 630	12	030800	1/1/0001
09500	S	M	CNT	II	00000	165	1ST LT. S OF HENDERSON DR., E SIDE	12	030800	1/1/0001
09500	S	M	CNT	II	00000	166	1ST LT. S OF HENDERSON DR., W SIDE	12	030800	1/1/0001
09500	S	M	CNT	II	00000	167	2ND LT. S OF HENDERSON DR., E SIDE	12	030800	1/1/0001
09500	S	M	CNT	II	00000	168	2ND LT. S OF HENDERSON DR., W SIDE	12	030800	1/1/0001
09500	S	M	CNT	II	00000	169	SIDE OF 4600 PALERMO LANE	12	030800	1/1/0001
09500	S	M	CNT	II	00000	170	SIDE OF 4525 PALERMO LANE	12	030800	1/1/0001
09500	S	M	CNT	II	00000	171	REAR OF 793 FITZROY LANE	12	030800	1/1/0001
09500	S	M	CNT	II	00000	172	REAR OF 4524 ALVERSTONE PLACE	12	030800	1/1/0001
09500	S	M	CNT	II	00000	173	REAR OF 773 FITZROY LANE	12	030800	1/1/0001
09500	S	M	CNT	II	00000	174	REAR OF 4498 TANGLEHURST LANE	12	030800	1/1/0001
09500	S	M	CNT	II	00000	175	REAR OF 761 FITZROY LANE	12	030800	1/1/0001
09500	S	M	CNT	II	00000	176	REAR OF 4500 TANGLEHURST LANE	12	030800	1/1/0001
05800	S	M	OUG	II	00325	009		12	011579	1/1/0001
05800	S	M	OUG	II	00333	028		12	011579	1/1/0001
05800	S	M	OUG	II	00353	032		12	011581	1/1/0001
05800	S	M	OUG	II	00369	034		12	011581	1/1/0001
09500	S	M	CNT	II	00630	163		12	030800	1/1/0001
09500	S	M	CNT	II	00000	058	OPP. 677	12	110899	1/1/0001

OFFICE: 311

ROUTE: 564

ST_REF_NO: 00000169500

SOUTH RIDGE DRIVE

LUMENS	BULB TYPE	MULT SERIES	POLE TYPE	SHADE	ADDRESS NUMBER	REF	LOCATION	TAX DIST	DATE INST	DATE CHANGE
05800	S	M	OUG	II	00000	001	SIDE OF 1700 RUSSELL CAVE	12	091582	1/1/0001

OFFICE: 311		ROUTE: 564		ST_REF_NO: 00000169500		SOUTH RIDGE DRIVE		TAX DIST	DATE INST	DATE CHANGE
LUMENS	BULB TYPE	MULT SERIES	POLE TYPE	SHADE	ADDRESS NUMBER	REF	LOCATION			
05800	S	M	OUG	II	00000	005	SIDE OF 1723 SILVER LANE	12	091582	1/1/0001
05800	S	M	OUG	II	00000	011	SIDE OF 1711 BLUE RIDGE	12	091582	1/1/0001
05800	S	M	OUG	II	00000	012	SIDE OF 1706 BLUE RIDGE	12	091582	1/1/0001
05800	S	M	OUG	II	00400	017		12	091582	1/1/0001
05800	S	M	OUG	II	00402	016		12	091582	1/1/0001
05800	S	M	OUG	II	00409	015		12	091582	1/1/0001
05800	S	M	OUG	II	00422	014		12	091582	1/1/0001
05800	S	M	OUG	II	00435	013		12	091582	1/1/0001
05800	S	M	OUG	II	00504	010		12	091582	1/1/0001
05800	S	M	OUG	II	00521	009		12	091582	1/1/0001
05800	S	M	OUG	II	00532	008		12	091582	1/1/0001
05800	S	M	OUG	II	00549	007		12	091582	1/1/0001
05800	S	M	OUG	II	00560	006		12	091582	1/1/0001
05800	S	M	OUG	II	00614	004		12	091582	1/1/0001
05800	S	M	OUG	II	00627	003		12	091582	1/1/0001
05800	S	M	OUG	II	00638	002		12	091582	1/1/0001
OFFICE: 311		ROUTE: 564		ST_REF_NO: 00000169600		SOUTHERN AVENUE		TAX DIST	DATE INST	DATE CHANGE
LUMENS	BULB TYPE	MULT SERIES	POLE TYPE	SHADE	ADDRESS NUMBER	REF	LOCATION			
04000	S	M	SOH	II	00000	048	SIDE 256 AMERICAN AVE.	12	050886	1/1/0001
04000	S	M	SOH	II	01305	049		12	050886	1/1/0001
04000	S	M	SOH	II	01315	050		12	050886	1/1/0001
04000	S	M	SOH	II	01321	051		12	050886	1/1/0001
OFFICE: 311		ROUTE: 564		ST_REF_NO: 00000169700		SOUTHBEND DRIVE		TAX DIST	DATE INST	DATE CHANGE
LUMENS	BULB TYPE	MULT SERIES	POLE TYPE	SHADE	ADDRESS NUMBER	REF	LOCATION			
04000	S	M	OUG	II	00000	138	SIDE OF 287 LAFAYETTE PARKWAY-911 addr chg	12	101583	5/4/1996
04000	S	M	OUG	II	00512	139	911 address change	12	101583	5/4/1996
04000	S	M	OUG	II	00524	140	911 address change	12	101583	5/4/1996
04000	S	M	OUG	II	00000	133	SIDE OF 1848 CLAYS MILL	12	101583	1/1/0001
04000	S	M	OUG	II	00000	137	SIDE OF 289 LAFAYETTE PARKWAY	12	101583	1/1/0001
04000	S	M	OUG	II	00511	136		12	101583	1/1/0001

OFFICE: 311		ROUTE: 564		ST_REF_NO: 00000169700		SOUTHBEND DRIVE				
LUMENS	BULB TYPE	MULT SERIES	POLE TYPE	SHADE	ADDRESS NUMBER	REF	LOCATION	TAX DIST	DATE INST	DATE CHANGE
04000	S	M	OUG	II	00531	135		12	101583	1/1/0001
04000	S	M	OUG	II	00539	134		12	101583	1/1/0001

OFFICE: 311		ROUTE: 564		ST_REF_NO: 00000169800		SOUTHGATE DRIVE				
LUMENS	BULB TYPE	MULT SERIES	POLE TYPE	SHADE	ADDRESS NUMBER	REF	LOCATION	TAX DIST	DATE INST	DATE CHANGE
05800	S	M	OUG	II	00000	057	SIDE OF 494 N. BARKLEY	12	051166	9/30/2008
04000	S	M	OUG	II	00000	055	SIDE OF 499 STRATFORD DR.	12	040766	1/1/0001
04000	S	M	OUG	II	00000	056	SIDE OF 538 STRATFORD DR.	12	051166	1/1/0001
04000	S	M	OUG	II	00000	059	SIDE OF 488 S. BARKLEY	12	051166	1/1/0001
04000	S	M	OUG	II	00000	089	SIDE OF 563 ROSEMILL	12	031583	1/1/0001
04000	S	M	OUG	II	00000	090	OPP. THE SIDE OF 566 MITCHELL	12	031583	1/1/0001
04000	S	M	OUG	II	00000	114	SIDE OF 503 FAIRFIELD DR.	12	090968	1/1/0001
04000	S	M	OUG	II	00000	115	SIDE OF 499 HOLLY HILL	12	090968	1/1/0001
05800	S	M	OUG	II	00000	116	SIDE OF 500 HOLLYHILL DR.	12	110899	1/1/0001
04000	S	M	OUG	II	00000	159	SIDE OF 542 SHERIDAN DR.	12	041583	1/1/0001
04000	S	M	OUG	II	00000	160	SIDE OF 543 SHERIDAN DR.	12	041583	1/1/0001
04000	S	M	OUG	II	00000	161	SIDE OF 498 LONGVIEW DR.	12	041583	1/1/0001
04000	S	M	OUG	II	00000	162	SIDE OF 563 LONGVIEW DR.	12	031583	1/1/0001
04000	S	M	OUG	II	00000	163	SIDE OF 498 ROSEMILL DR.	12	031583	1/1/0001
05800	S	M	OUG	II	02329	058		12	020167	1/1/0001

OFFICE: 311		ROUTE: 564		ST_REF_NO: 00000169900		SOUTHLAND DRIVE				
LUMENS	BULB TYPE	MULT SERIES	POLE TYPE	SHADE	ADDRESS NUMBER	REF	LOCATION	TAX DIST	DATE INST	DATE CHANGE
09500	S	M	OUG	III	00128	006		12	061267	12/1/2012
22000	S	M	OUG	III	00216	014		12	061267	12/1/2012
22000	S	M	OUG	III	00246	016		12	061267	2/8/2013
22000	S	M	OOH	II	00353	027		12	021478	2/20/2013
20000	M	M	SOH	II	00000	048	SIDE OF 500 ROSEMONT GARDENS	12	021478	1/1/0001
20000	M	M	OOH	II	00500	046		12	021478	1/1/0001
20000	M	M	OOH	II	00527	045		12	021478	1/1/0001
20000	M	M	OOH	II	00531	047		12	021478	1/1/0001
20000	M	M	OOH	II	00450	038		12	040890	1/1/0001

OFFICE: 311

ROUTE: 564

ST_REF_NO: 00000169900

SOUTHLAND DRIVE

LUMENS	BULB TYPE	MULT SERIES	POLE TYPE	SHADE	ADDRESS NUMBER	REF	LOCATION	TAX DIST	DATE INST	DATE CHANGE
20000	M	M	OOH	II	00455	039		12	021478	1/1/0001
20000	M	M	OOH	II	00457	041		12	021478	1/1/0001
20000	M	M	OOH	II	00472	040		12	021478	1/1/0001
20000	M	M	OOH	II	00496	043		12	021478	1/1/0001
20000	M	M	OOH	II	00496	044		12	021478	1/1/0001
20000	M	M	OOH	II	00501	042		12	021478	1/1/0001
20000	M	M	OUG	III	00000	002	SIDE OF 1975 NICHOLASVILLE RD.	12	061267	1/1/0001
20000	M	M	OUG	III	00000	003	2ND LT. W. OF NICHOLASVILLE RD., N. SIDE	12	061267	1/1/0001
20000	M	M	OUG	III	00000	005	3RD LT. W. OF NICHOLASVILLE RD., N. SIDE	12	061267	1/1/0001
20000	M	M	OUG	III	00000	009	1ST. LT. E. OF RAINBOW RD., N. SIDE	12	061267	1/1/0001
20000	M	M	OUG	III	00000	013	1ST. LT. E. OF RAMBLER RD., N. SIDE	12	061267	1/1/0001
20000	M	M	OUG	III	00000	015	1ST. LT. W. OF RAMBLER RD., N. SIDE	12	061267	1/1/0001
20000	M	M	OUG	III	00000	017	OPP. REGENCY RD., NW CORNER	12	061267	1/1/0001
20000	M	M	OUG	III	00000	018	1ST. LT. W. OF REGENCY RD., S. SIDE	12	061267	1/1/0001
20000	M	M	OUG	III	00000	019	1ST. LT. W. OF REGENCY RD., N. SIDE	12	061267	1/1/0001
20000	M	M	OUG	III	00000	020	2ND LT. W. OF REGENCY RD., S. SIDE	12	061267	1/1/0001
20000	M	M	OUG	III	00132	008		12	061267	1/1/0001
20000	M	M	OUG	III	00144	010		12	061267	1/1/0001
20000	M	M	OUG	III	00185	007		12	061267	1/1/0001
20000	M	M	OUG	III	00204	012		12	061267	1/1/0001
20000	M	M	OUG	III	00205	011		12	061267	1/1/0001
22000	S	M	OUG	III	00299	021	upgraded 5/08	12	061267	1/1/0001
20000	M	M	OOH	II	00300	024		12	021478	1/1/0001
20000	M	M	OOH	II	00301	023		12	020173	1/1/0001
20000	M	M	OOH	II	00307	025		12	021478	1/1/0001
20000	M	M	OOH	II	00326	028		12	021478	1/1/0001
20000	M	M	OOH	II	00368	030		12	021478	1/1/0001
20000	M	M	OUG	II	00373	029		12	021478	1/1/0001
20000	M	M	OOH	II	00391	031		12	021478	1/1/0001
20000	M	M	OOH	II	00392	032		12	021478	1/1/0001
20000	M	M	OUG	III	00396	022		12	061267	1/1/0001
22000	S	M	OOH	II	00398	034	upgraded 5/08	12	021478	1/1/0001
22000	S	M	OOH	II	00403	033	upgraded 5/08	12	021478	1/1/0001
20000	M	M	OOH	II	00423	035		12	021478	1/1/0001

Street Light Listing run 1/11/2015 10:43:21 AM

Page 1038 of 1254

OFFICE: 311		ROUTE: 564		ST_REF_NO: 00000169900		SOUTHLAND DRIVE				
LUMENS	BULB TYPE	MULT SERIES	POLE TYPE	SHADE	ADDRESS NUMBER	REF	LOCATION	TAX DIST	DATE INST	DATE CHANGE
20000	M	M	OOH	II	00424	036		12	021478	1/1/0001
20000	M	M	OOH	II	00441	037		12	021478	1/1/0001

OFFICE: 311		ROUTE: 564		ST_REF_NO: 00000170000		SOUTHLAND SERVICE ROAD				
LUMENS	BULB TYPE	MULT SERIES	POLE TYPE	SHADE	ADDRESS NUMBER	REF	LOCATION	TAX DIST	DATE INST	DATE CHANGE
05800	S	M	OUG	II	00000	006	3RD LT. W. OF ENTRANCE TO SERVICE RD., N. SIDE	12	120164	1/1/0001
05800	S	M	OUG	II	00239	005		12	120164	1/1/0001
05800	S	M	OOH	II	00245	004		12	120164	1/1/0001
05800	S	M	OOH	II	00259	003		12	120164	1/1/0001
05800	S	M	OOH	II	00271	002		12	120164	1/1/0001
05800	S	M	OUG	II	00287	001		12	120164	1/1/0001

OFFICE: 311		ROUTE: 564		ST_REF_NO: 00000170010		SOUTHMOOR PARK				
LUMENS	BULB TYPE	MULT SERIES	POLE TYPE	SHADE	ADDRESS NUMBER	REF	LOCATION	TAX DIST	DATE INST	DATE CHANGE
05800	S	M	OUG	II	04221	001		12	040894	1/1/0001
05800	S	M	OUG	II	04232	002		12	040894	1/1/0001
05800	S	M	OUG	II	04240	003		12	040894	1/1/0001
05800	S	M	OUG	II	04264	004		12	040894	1/1/0001
05800	S	M	OUG	II	04276	005		12	040894	1/1/0001
05800	S	M	OUG	II	04289	006		12	040894	1/1/0001
05800	S	M	OUG	II	04300	007		12	040894	1/1/0001
05800	S	M	OUG	II	04313	008		12	040894	1/1/0001

OFFICE: 311		ROUTE: 564		ST_REF_NO: 00000170100		SOUTHPORT DRIVE				
LUMENS	BULB TYPE	MULT SERIES	POLE TYPE	SHADE	ADDRESS NUMBER	REF	LOCATION	TAX DIST	DATE INST	DATE CHANGE
04000	S	M	OUG	II	00000	105	SIDE 309 N. PICADOME	12	100884	1/1/0001
04000	S	M	OUG	II	00207	106		12	100884	1/1/0001
04000	S	M	OUG	II	00220	107		12	100884	1/1/0001
04000	S	M	OUG	II	00231	108		12	100884	1/1/0001
04000	S	M	OUG	II	00236	109		12	100884	1/1/0001

OFFICE: 311

ROUTE: 564

ST_REF_NO: 00000170200

SOUTHVIEW DRIVE

LUMENS	BULB TYPE	MULT SERIES	POLE TYPE	SHADE	ADDRESS NUMBER	REF	LOCATION	TAX DIST	DATE INST	DATE CHANGE
05800	S	M	OOH	II	00000	052	SIDE OF 398 STRATFORD DR.	12	040466	10/10/2013
22000	S	M	OUG	III	00000	165	SIDE OF 398 SHERIDAN DR.	12	041583	2/1/2010
05800	S	M	OUG	II	00000	009	SIDE OF 500 WESTERFIELD	12	111583	1/1/0001
04000	S	M	OUG	II	00000	051	SIDE OF 454 STRATFORD DR.	12	040766	1/1/0001
20000	M	M	SOH	III	00000	160	SIDE OF 461 STRATFORD DR.	12	041583	1/1/0001
20000	M	M	OUG	III	00000	161	SIDE OF 451 SHERIDAN DR.	12	041583	1/1/0001
20000	M	M	OUG	III	00000	164	SIDE OF 399 STRATFORD DR.	12	041583	1/1/0001
20000	M	M	OUG	III	00000	166	SIDE OF 400 LONGVIEW DR.	12	041583	1/1/0001
20000	M	M	OUG	III	02100	162		12	041583	1/1/0001
04000	S	M	OUG	II	02321	053		12	040766	1/1/0001
04000	S	M	OUG	II	02322	054		12	051166	1/1/0001
04000	S	M	OUG	II	02401	116		12	090968	1/1/0001
04000	S	M	OUG	II	02412	117		12	112068	1/1/0001
05800	S	M	OUG	II	02514	119		12	112068	1/1/0001
05800	S	M	OUG	II	02538	121		12	101468	1/1/0001
04000	S	M	OUG	II	02553	122		12	090968	1/1/0001
04000	S	M	OUG	II	02562	123		12	090968	1/1/0001
05800	S	M	OUG	II	02605	025		12	111583	1/1/0001
05800	S	M	SOH	II	02610	024		12	111583	1/1/0001
05800	S	M	OUG	II	02617	023		12	111583	1/1/0001
05800	S	M	OUG	II	02701	022		12	111583	1/1/0001
05800	S	M	OUG	II	02708	020		12	111583	1/1/0001
05800	S	M	OUG	II	02709	021		12	111583	1/1/0001
05800	S	M	OUG	II	02801	019		12	111583	1/1/0001
05800	S	M	OUG	II	02804	018		12	111583	1/1/0001
05800	S	M	OUG	II	02813	017		12	111583	1/1/0001
05800	S	M	OUG	II	02818	016		12	111583	1/1/0001
05800	S	M	OUG	II	02823	015		12	111583	1/1/0001
05800	S	M	OUG	II	02828	014		12	111583	1/1/0001
05800	S	M	OUG	II	02833	013		12	111583	1/1/0001
05800	S	M	OUG	II	02836	012		12	111583	1/1/0001
05800	S	M	OUG	II	02841	011		12	111583	1/1/0001
05800	S	M	OUG	II	02844	010		12	111583	1/1/0001
05800	S	M	OUG	II	02904	008		12	111583	1/1/0001

OFFICE: 311

ROUTE: 564

ST_REF_NO: 00000170200

SOUTHVIEW DRIVE

LUMENS	BULB TYPE	MULT SERIES	POLE TYPE	SHADE	ADDRESS NUMBER	REF	LOCATION	TAX DIST	DATE INST	DATE CHANGE
05800	S	M	OUG	II	02905	007		12	111583	1/1/0001
20000	M	M	OOH	III	00000	167	SIDE OF 404 SOUTHLAND DR.	12	041583	1/1/0001
20000	M	M	OOH	III	00000	168	SIDE OF 398 SOUTHLAND DR.	12	041583	1/1/0001
20000	M	M	OOH	III	00000	169	SIDE OF 404 SOUTHLAND DR.	12	041583	1/1/0001
20000	M	M	OOH	III	00000	170	SIDE OF 398 SOUTHLAND DR.	12	041583	1/1/0001
05800	S	M	OUG	II	00000	006	OPP. 2913	12	111583	1/1/0001
05800	S	M	OUG	II	02921	005		12	111583	1/1/0001
05800	S	M	OUG	II	02929	003		12	111583	1/1/0001
05800	S	M	OUG	II	02930	004		12	111583	1/1/0001
05800	S	M	OUG	II	02940	002		12	111583	1/1/0001
05800	S	M	OUG	II	02941	001		12	111583	1/1/0001

OFFICE: 311

ROUTE: 564

ST_REF_NO: 00000170350

SOVEREIGN LANE

LUMENS	BULB TYPE	MULT SERIES	POLE TYPE	SHADE	ADDRESS NUMBER	REF	LOCATION	TAX DIST	DATE INST	DATE CHANGE
05800	S	M	CNT	II	00000	008	SIDE OF 1121 ROLFE LANE ON SOVEREIGN LN	12	071001	1/1/0001
05800	S	M	CNT	II	00000	012	SIDE OF 2061 ALLEGHENY WAY ON SOVEREIGN LANE	12	082203	1/1/0001
22000	S	M	CNT	II	00000	050	1ST LT N OF BEAUMONT CTR,W SIDE ON SOVEREIGN	12	031705	1/1/0001
09500	S	M	CNT	II	00000	051	3RD LT N OF BEAUMONT CTR,W SIDE ON SOVEREIGN	12	031705	1/1/0001
09500	S	M	CNT	II	00000	052	5TH LT N OF BEAUMONT CTR,W SIDE ON SOVEREIGN	12	031705	1/1/0001
09500	S	M	CNT	II	00000	053	6TH LT N OF BEAUMONT CTR,W SIDE ON SOVEREIGN	12	031705	1/1/0001
09500	S	M	CNT	II	00000	054	8TH LT N OF BEAUMONT CTR,W SIDE ON SOVEREIGN	12	031705	1/1/0001
05800	S	M	CNT	II	02105	011		12	082203	1/1/0001
05800	S	M	CNT	II	02116	010		12	082203	1/1/0001
05800	S	M	CNT	II	02133	009		12	082203	1/1/0001
05800	S	M	CNT	II	02165	007		12	071001	1/1/0001
09500	S	M	CNT	II	00000	001	SIDE REAR OF 1197 CROSSMAN CT.	12	120899	1/1/0001
09500	S	M	CNT	II	00000	002	1ST LT. N OF BEAUMONT CENTRE LANE, W SIDE	12	120899	1/1/0001
09500	S	M	CNT	II	00000	003	OPP. CROSSMAN CT, W SIDE	21	120899	1/1/0001
09500	S	M	CNT	II	00000	004	SIDE REAR OF 1197 LACY LANE	12	120899	1/1/0001

OFFICE: 311

ROUTE: 564

ST_REF_NO: 00000170350

SOVEREIGN LANE

LUMENS	BULB TYPE	MULT SERIES	POLE TYPE	SHADE	ADDRESS NUMBER	REF	LOCATION	TAX DIST	DATE INST	DATE CHANGE
09500	S	M	CNT	II	00000	005	3RD LT. N OF BEAUMONT CENTRE LANE, W SIDE	12	120899	1/1/0001
09500	S	M	CNT	II	00000	006	SIDE REAR OF 1120 BENJAMIN DR.	12	120899	1/1/0001

OFFICE: 311

ROUTE: 564

ST_REF_NO: 00000170400

SPANGLER DRIVE

LUMENS	BULB TYPE	MULT SERIES	POLE TYPE	SHADE	ADDRESS NUMBER	REF	LOCATION	TAX DIST	DATE INST	DATE CHANGE
05800	S	M	OUG	II	00000	017	SIDE REAR OF 3625 LAREDO	12	110893	1/1/0001
05800	S	M	OUG	II	00000	018	OPP. 3390	12	081582	1/1/0001
05800	S	M	OUG	II	00000	020	OPP. 3398	12	081582	1/1/0001
05800	S	M	OUG	II	00000	021	OPP. DOWNING PLACE	12	081582	1/1/0001
05800	S	M	OUG	II	00000	023	1 ST. LT. S. OF REDDING RD., W. SIDE	12	071475	1/1/0001
05800	S	M	OUG	II	00000	025	2 ND. LT. S. OF REDDING RD., W. SIDE	12	071475	1/1/0001
05800	S	M	OUG	II	00000	027	OPP. FOREHAND CT.	12	071475	1/1/0001
05800	S	M	OUG	II	00000	028	SIDE OF 400 FOREHAND CT.	12	071475	1/1/0001
05800	S	M	OUG	II	00000	029	OPP. BACKHAND CT.	12	071475	1/1/0001
05800	S	M	OUG	II	00000	030	SIDE OF 400 BACKHAND CT.	12	071475	1/1/0001
05800	S	M	OUG	II	00000	122	SIDE OF 3369 DOWNING PLACE	12	081582	1/1/0001
05800	S	M	OUG	II	00000	123	1 ST. LT. N. OF RIDGEPOINT RUN, W. SIDE	12	081582	1/1/0001
05800	S	M	OUG	II	00000	222	SIDE OF 3977 RIDGEPOINT RUN	12	081581	1/1/0001
05800	S	M	OUG	II	03200	022		12	071475	1/1/0001
05800	S	M	OUG	II	03200	024		12	071475	1/1/0001
05800	S	M	OUG	II	03210	026		12	071475	1/1/0001
05800	S	M	OUG	II	03274	006		12	111478	1/1/0001
05800	S	M	OUG	II	03343	001		12	081476	1/1/0001
05800	S	M	OUG	II	03350	002		12	081476	1/1/0001
05800	S	M	OUG	II	03355	003		12	051478	1/1/0001
05800	S	M	OUG	II	03362	004		12	081476	1/1/0001
05800	S	M	OUG	II	03367	005		12	051478	1/1/0001
05800	S	M	OUG	II	03379	034		12	111478	1/1/0001
05800	S	M	OUG	II	03394	019		12	110893	1/1/0001

OFFICE: 311

ROUTE: 564

ST_REF_NO: 00000170500 SPARKS ROAD

LUMENS	BULB TYPE	MULT SERIES	POLE TYPE	SHADE	ADDRESS NUMBER	REF	LOCATION	TAX DIST	DATE INST	DATE CHANGE
04000	S	M	OUG	II	01102	036		12	080885	1/1/0001
04000	S	M	OUG	II	01109	037		12	080885	1/1/0001
04000	S	M	OUG	II	01118	038		12	080885	1/1/0001
04000	S	M	OUG	II	01122	039		12	080885	1/1/0001
04000	S	M	OUG	II	01135	040		12	080885	1/1/0001
04000	S	M	OUG	II	01143	041		12	080885	1/1/0001

OFFICE: 311

ROUTE: 564

ST_REF_NO: 00000170550 SPARROW COURT

LUMENS	BULB TYPE	MULT SERIES	POLE TYPE	SHADE	ADDRESS NUMBER	REF	LOCATION	TAX DIST	DATE INST	DATE CHANGE
04000	S	M	OUG	II	03800	001		12	100890	1/1/0001
04000	S	M	OUG	V	03816	002		12	100890	1/1/0001

OFFICE: 311

ROUTE: 564

ST_REF_NO: 00000170600 SPARTA COURT

LUMENS	BULB TYPE	MULT SERIES	POLE TYPE	SHADE	ADDRESS NUMBER	REF	LOCATION	TAX DIST	DATE INST	DATE CHANGE
05800	S	M	OUG	II	00000	003	3RD LT. S. OF VERSAILLES RD., W. SIDE	12	101964	1/1/0001
05800	S	M	OUG	II	00880	002		12	101964	1/1/0001
05800	S	M	OUG	II	01316	001		12	101964	1/1/0001

OFFICE: 311

ROUTE: 564

ST_REF_NO: 00000170750 SPECULATOR COURT

LUMENS	BULB TYPE	MULT SERIES	POLE TYPE	SHADE	ADDRESS NUMBER	REF	LOCATION	TAX DIST	DATE INST	DATE CHANGE
05800	S	M	OUG	II	01201	001		12	040897	1/1/0001
05800	S	M	OUG	II	01209	002		12	040897	1/1/0001
05800	S	M	OUG	II	01221	003		12	040897	1/1/0001
05800	S	M	OUG	III	01229	004		12	040897	1/1/0001

OFFICE: 311

ROUTE: 564

ST_REF_NO: 00000170800 SPEIGLE STREET

LUMENS	BULB TYPE	MULT SERIES	POLE TYPE	SHADE	ADDRESS NUMBER	REF	LOCATION	TAX DIST	DATE INST	DATE CHANGE
09500	S	M	SOH	II	00000	005	OPP. SIDE OF 425-upgraded 10/07	12	082258	1/1/0001
05800	S	M	SOH	I	00433	000		12	050162	1/1/0001
05800	S	M	SOH	I	00453	000		12	082258	1/1/0001
05800	S	M	SOH	I	00463	000		12	050162	1/1/0001

OFFICE: 311

ROUTE: 564

ST_REF_NO: 00000170800 SPEIGLE STREET

LUMENS	BULB TYPE	MULT SERIES	POLE TYPE	SHADE	ADDRESS NUMBER	REF	LOCATION	TAX DIST	DATE INST	DATE CHANGE
09500	S	M	SOH	I	00000	001	SIDE OF 1033 JANE ST.-upgraded 10/07	12	050162	1/1/0001

OFFICE: 311

ROUTE: 564

ST_REF_NO: 00000170810 SPENDTHRIFT "A" COURT

LUMENS	BULB TYPE	MULT SERIES	POLE TYPE	SHADE	ADDRESS NUMBER	REF	LOCATION	TAX DIST	DATE INST	DATE CHANGE
05800	S	M	OUG	II	01107	009		12	091564	1/1/0001
05800	S	M	OUG	V	01115	010		12	091564	1/1/0001

OFFICE: 311

ROUTE: 564

ST_REF_NO: 00000170815 SPENCE ALLEY

LUMENS	BULB TYPE	MULT SERIES	POLE TYPE	SHADE	ADDRESS NUMBER	REF	LOCATION	TAX DIST	DATE INST	DATE CHANGE
09500	S	M	SOH	II	00000	040	1ST LT ON CORNER OF SPENCE ALLEY AND EAST 7TH STR	12	040202	1/1/0001
09500	S	M	SOH	II	00000	041	2ND LT ON CORNER OF SPENCE ALLEY & ELSMERE PARK	12	040202	1/1/0001
09500	S	M	SOH	II	00000	001	NW CORNER OF SEVENTH STREET ON SPENCE ALLEY	12	030801	1/1/0001
09500	S	M	SOH	II	00000	002	2ND LIGHT N OF SEVENTH STREET ON SPENCE ALLEY	12	030801	1/1/0001
09500	S	M	SOH	I	00000	003	3RD LT. N. OF SEVENTH ST.	12	030801	1/1/0001
09500	S	M	SOH	III	00000	004	4TH LT. N. OF SEVENTH ST.	12	030801	1/1/0001
05800	S		SOH	I	00000	005	5TH LT N OF SEVENTH STREET ON SPENCE ALLEY	12	030801	1/1/0001
05800	S		SOH	III	00000	006	6TH LIGHT N OF SEVENTH STREET ON SPENCE ALLEY	12	030801	1/1/0001

OFFICE: 311

ROUTE: 564

ST_REF_NO: 00000170820 SPENDTHRIFT "B" COURT

LUMENS	BULB TYPE	MULT SERIES	POLE TYPE	SHADE	ADDRESS NUMBER	REF	LOCATION	TAX DIST	DATE INST	DATE CHANGE
05800	S	M	OUG	II	00000	008	SIDE OF 1110 SPENDTHRIFT RD.	12	091564	1/1/0001

OFFICE: 311

ROUTE: 564

ST_REF_NO: 00000170830 SPENDTHRIFT "C" COURT

LUMENS	BULB TYPE	MULT SERIES	POLE TYPE	SHADE	ADDRESS NUMBER	REF	LOCATION	TAX DIST	DATE INST	DATE CHANGE
05800	S	M	OUG	II	00000	107	SIDE OF 1123 SPENDTHRIFT RD.	12	011966	1/1/0001
05800	S	M	OUG	V	01131	108		12	011966	1/1/0001

OFFICE: 311

ROUTE: 564

ST_REF_NO: 00000170840

SPENDTHRIFT "D" COURT

LUMENS	BULB TYPE	MULT SERIES	POLE TYPE	SHADE	ADDRESS NUMBER	REF	LOCATION	TAX DIST	DATE INST	DATE CHANGE
05800	S	M	OUG	II	01124	011		12	091564	1/1/0001

OFFICE: 311

ROUTE: 564

ST_REF_NO: 00000170900

SPENDTHRIFT ROAD

LUMENS	BULB TYPE	MULT SERIES	POLE TYPE	SHADE	ADDRESS NUMBER	REF	LOCATION	TAX DIST	DATE INST	DATE CHANGE
05800	S	M	OUG	II	00000	003	OPP. 1120	12	091564	1/1/0001
05800	S	M	OUG	II	00000	010	SIDE OF 1038 GAINESWAY DR.	12	091564	1/1/0001
05800	S	M	OUG	II	01103	005		12	091564	1/1/0001
05800	S	M	OUG	II	01110	004		12	091564	1/1/0001
05800	S	M	OUG	II	00000	006	SIDE OF 3464 DIXIANA DR.	12	091564	1/1/0001
05800	S	M	OUG	II	01136	001		12	091564	1/1/0001
05800	S	M	OUG	II	01139	002		12	091564	1/1/0001

OFFICE: 311

ROUTE: 564

ST_REF_NO: 00000170910

SPICEWOOD COURT

LUMENS	BULB TYPE	MULT SERIES	POLE TYPE	SHADE	ADDRESS NUMBER	REF	LOCATION	TAX DIST	DATE INST	DATE CHANGE
05800	S	M	CNT	III	04001	001		12	100894	1/1/0001

OFFICE: 311

ROUTE: 564

ST_REF_NO: 00000170940

SPORTING COURT

LUMENS	BULB TYPE	MULT SERIES	POLE TYPE	SHADE	ADDRESS NUMBER	REF	LOCATION	TAX DIST	DATE INST	DATE CHANGE
09500	S	M	CNT	II	00000	001	1ST LT. W OF RUCCIO WAY, N SIDE	12	080800	1/1/0001
09500	S	M	CNT	II	00400	002		12	080800	1/1/0001
09500	S	M	CNT	II	00401	003		12	080800	1/1/0001
09500	S	M	CNT	II	00408	004		12	080800	1/1/0001
09500	S	M	CNT	II	00413	005		12	080800	1/1/0001

OFFICE: 311

ROUTE: 564

ST_REF_NO: 00000171050

SPRING STREET

LUMENS	BULB TYPE	MULT SERIES	POLE TYPE	SHADE	ADDRESS NUMBER	REF	LOCATION	TAX DIST	DATE INST	DATE CHANGE
09500	S		OUG	II	00000	200	1ST LT W OF PINE ST, SOUTH SIDE ON SPRING ST	12	082009	1/1/0001
09500	S		OUG	II	00000	201	2ND LT W OF PINE ST, SOUTH SIDE ON SPRING ST	12	082009	1/1/0001
09500	S		OUG	II	00000	202	3RD LT W OF PINE ST, SOUTH SIDE ON SPRING ST	12	082009	1/1/0001
09500	S		OUG	II	00000	203	4TH LT W OF PINE ST, SOUTH SIDE ON SPRING ST	12	082009	1/1/0001
09500	S		OUG	II	00000	204	5TH LT W OF PINE ST, SOUTH SIDE ON SPRING ST	12	082009	1/1/0001

OFFICE: 311 ROUTE: 564										
ST_REF_NO: 00000171050 SPRING STREET										
LUMENS	BULB TYPE	MULT SERIES	POLE TYPE	SHADE	ADDRESS NUMBER	REF	LOCATION	TAX DIST	DATE INST	DATE CHANGE
09500	S		OUG	II	00000	205	6TH LT W OF PINE ST, S SIDE ON SPRING STREET	12	042210	1/1/0001
05800	S	M	SOH	II	00000	475	OPP. 403	12	060867	1/1/0001
05800	S	M	SOH	II	00425	474		12	060867	1/1/0001

OFFICE: 311 ROUTE: 564										
ST_REF_NO: 00000171075 SPRING CREEK DRIVE										
LUMENS	BULB TYPE	MULT SERIES	POLE TYPE	SHADE	ADDRESS NUMBER	REF	LOCATION	TAX DIST	DATE INST	DATE CHANGE
05800	S	M	OUG	II	04601	001		21	080890	1/1/0001
05800	S	M	OUG	II	04612	002		12	080890	1/1/0001
05800	S	M	OUG	II	04621	003		12	080890	1/1/0001
05800	S	M	OUG	II	04636	004		12	080890	1/1/0001
05800	S	M	OUG	II	04648	006		12	080890	1/1/0001
05800	S	M	OUG	II	04649	005		12	080890	1/1/0001
05800	S	M	OUG	II	04669	007		12	080890	1/1/0001
05800	S	M	OUG	II	04685	008		12	080893	1/1/0001
05800	S	M	OUG	II	04697	009		12	080893	1/1/0001
05800	S	M	OUG	II	04704	010		12	080890	1/1/0001
05800	S	M	OUG	II	04713	011		12	080890	1/1/0001
05800	S	M	OUG	II	04724	012		12	080890	1/1/0001
05800	S	M	OUG	II	04733	013		12	080890	1/1/0001

OFFICE: 311 ROUTE: 564										
ST_REF_NO: 00000171090 SPRING CREEK CIRCLE										
LUMENS	BULB TYPE	MULT SERIES	POLE TYPE	SHADE	ADDRESS NUMBER	REF	LOCATION	TAX DIST	DATE INST	DATE CHANGE
04000	S	M	OUG	II	04805	001		12	080890	1/1/0001
05800	S	M	OUG	IV	04812	002		12	080893	1/1/0001

OFFICE: 311 ROUTE: 564										
ST_REF_NO: 00000171100 SPRING GROVE AVENUE										
LUMENS	BULB TYPE	MULT SERIES	POLE TYPE	SHADE	ADDRESS NUMBER	REF	LOCATION	TAX DIST	DATE INST	DATE CHANGE
04000	S	M	OUG	II	00000	097	SIDE OF 679 SPRINGHURST	12	101583	1/1/0001
04000	S	M	OUG	II	00000	126	SIDE OF 627 LANE ALLEN	12	081583	1/1/0001
04000	S	M	OUG	II	00000	127	OPP. 1900	12	081583	1/1/0001

OFFICE: 311		ROUTE: 564		ST_REF_NO: 00000171200		SPRING HILL DRIVE		LUMENS	BULB TYPE	MULT SERIES	POLE TYPE	SHADE	ADDRESS NUMBER	REF	LOCATION	TAX DIST	DATE INST	DATE CHANGE
04000	S	M	OUG	II	00000	025	SIDE 1608 CLAYS MILL ROAD ON SPRINGHILL DRIVE	12	100884	1/1/0001								
04000	S	M	OUG	II	00537	026		12	100884	1/1/0001								
04000	S	M	OUG	II	00501	030		12	100884	1/1/0001								
04000	S	M	OUG	II	00508	029		12	100884	1/1/0001								
04000	S	M	OUG	II	00517	028		12	100884	1/1/0001								
04000	S	M	OUG	II	00526	027		12	100884	1/1/0001								

OFFICE: 311		ROUTE: 564		ST_REF_NO: 00000171250		SPRING MEADOWS DRIVE		LUMENS	BULB TYPE	MULT SERIES	POLE TYPE	SHADE	ADDRESS NUMBER	REF	LOCATION	TAX DIST	DATE INST	DATE CHANGE
05800	S	M	OUG	II	00000	001	SIDE OF 1919 HARRODSBURG RD.	12	040889	1/1/0001								
05800	S	M	OUG	II	00703	002		12	040889	1/1/0001								
05800	S	M	OUG	II	00704	003		12	040889	1/1/0001								
05800	S	M	OUG	II	00735	004		12	040889	1/1/0001								
05800	S	M	OUG	II	00744	005		12	040889	1/1/0001								
05800	S	M	OUG	II	00779	006		12	040889	1/1/0001								
05800	S	M	OUG	II	00800	007		12	040889	1/1/0001								
05800	S	M	OUG	II	00827	008		12	040889	1/1/0001								
05800	S	M	OUG	II	00847	009		12	040889	1/1/0001								

OFFICE: 311		ROUTE: 564		ST_REF_NO: 00000171300		SPRING RUN ROAD		LUMENS	BULB TYPE	MULT SERIES	POLE TYPE	SHADE	ADDRESS NUMBER	REF	LOCATION	TAX DIST	DATE INST	DATE CHANGE
05800	S	M	OUG	II	00000	051	SIDE OF 3909 PINECREST WAY ON SPRING RUN RD	12	072707	1/1/0001								
05800	S	M	OUG	II	00000	052	SIDE OF 1177 PINE RIDGE WAY ON SPRING RUN RD	12	072707	1/1/0001								
05800	S	M	OUG	II	00000	053	SIDE OF 3901 PINE RIDGE WAY ON SPRING RUN RD	12	072707	1/1/0001								
05800	S	M	OUG	II	00000	056	ACROSS FROM 1125 SPRING RUN RD	12	072707	1/1/0001								
05800	S	M	OUG	II	01137	055		12	072707	1/1/0001								
05800	S	M	OUG	II	01152	054		12	072707	1/1/0001								
05800	S	M	OUG	II	00000	043	SIDE OF 1057 WEDGEWOOD	12	080884	1/1/0001								
05800	S	M	OUG	II	00000	060	SIDE REAR OF 3800 BINGHAM DR.	12	040897	1/1/0001								
05800	S	M	OUG	II	00988	047		12	031581	1/1/0001								

Street Light Listing run 1/11/2015 10:43:21 AM

Page 1047 of 1254

OFFICE: 311

ROUTE: 564

ST_REF_NO: 00000171300

SPRING RUN ROAD

LUMENS	BULB TYPE	MULT SERIES	POLE TYPE	SHADE	ADDRESS NUMBER	REF	LOCATION	TAX DIST	DATE INST	DATE CHANGE
05800	S	M	OUG	II	00997	048		12	031581	1/1/0001
05800	S	M	OUG	II	01012	049		12	031581	1/1/0001
05800	S	M	OUG	II	01017	050		12	121583	1/1/0001
05800	S	M	OUG	II	01028	051		12	031581	1/1/0001
05800	S	M	OUG	II	01037	052		12	031583	1/1/0001
05800	S	M	OUG	II	01044	038		12	071581	1/1/0001
05800	S	M	OUG	II	01053	039		12	121583	1/1/0001
05800	S	M	OUG	II	01072	042		12	071581	1/1/0001
05800	S	M	OUG	II	01073	041		12	121581	1/1/0001
05800	S	M	OUG	II	01092	044		12	071581	1/1/0001
05800	S	M	OUG	II	01100	045		12	080884	1/1/0001
05800	S	M	OUG	II	01113	046		12	071581	1/1/0001
05800	S	M	OUG	II	01205	061		12	040897	1/1/0001
05800	S	M	OUG	II	01212	062		12	040897	1/1/0001
05800	S	M	OUG	II	01217	063		12	040897	1/1/0001
05800	S	M	OUG	II	01236	064		12	040897	1/1/0001
05800	S	M	OUG	II	01237	065		12	040897	1/1/0001
05800	S	M	OUG	II	00000	046	SIDE OF 3821 LEE ADAMS	12	121583	1/1/0001
04000	S	M	OUG	II	00956	054		12	100890	1/1/0001
04000	S	M	OUG	II	00961	053		12	100892	1/1/0001
05800	S	M	OUG	II	00972	045		12	031581	1/1/0001

OFFICE: 311

ROUTE: 564

ST_REF_NO: 00000171390

SPRING STATION CIRCLE

LUMENS	BULB TYPE	MULT SERIES	POLE TYPE	SHADE	ADDRESS NUMBER	REF	LOCATION	TAX DIST	DATE INST	DATE CHANGE
05800	S	M	OUG	V	02039	023		12	011066	1/1/0001

OFFICE: 311

ROUTE: 564

ST_REF_NO: 00000171400

SPRING STATION DRIVE

LUMENS	BULB TYPE	MULT SERIES	POLE TYPE	SHADE	ADDRESS NUMBER	REF	LOCATION	TAX DIST	DATE INST	DATE CHANGE
05800	S	M	OUG	II	00000	012	OPP. 1967	12	011066	1/1/0001
05800	S	M	OUG	II	00000	018	OPP. 2072	12	011066	1/1/0001
05800	S	M	OUG	II	00000	020	SIDE OF 1910 GLENGARRY WAY	12	011066	1/1/0001
05800	S	M	OUG	II	01903	007		12	011066	1/1/0001

OFFICE: 311		ROUTE: 564		ST_REF_NO: 00000171400		SPRING STATION DRIVE		TAX DIST	DATE INST	DATE CHANGE
LUMENS	BULB TYPE	MULT SERIES	POLE TYPE	SHADE	ADDRESS NUMBER	REF	LOCATION			
05800	S	M	OUG	II	01908	008		12	011066	1/1/0001
05800	S	M	OUG	II	01927	009		12	011066	1/1/0001
05800	S	M	OUG	II	01936	010		12	011066	1/1/0001
05800	S	M	OUG	V	01955	011		12	041267	1/1/0001
05800	S	M	OUG	II	01983	013		12	011066	1/1/0001
05800	S	M	OUG	II	01996	014		12	011066	1/1/0001
05800	S	M	OUG	II	02011	015		12	041267	1/1/0001
05800	S	M	OUG	II	02047	016		12	011066	1/1/0001
05800	S	M	OUG	II	02060	017		12	071668	1/1/0001
05800	S	M	OUG	II	02084	019		12	011066	1/1/0001
OFFICE: 311		ROUTE: 564		ST_REF_NO: 00000171500		SPRING STATION COURT		TAX DIST	DATE INST	DATE CHANGE
LUMENS	BULB TYPE	MULT SERIES	POLE TYPE	SHADE	ADDRESS NUMBER	REF	LOCATION			
05800	S	M	OUG	II	00000	021	SIDE OF 2016 SPRING STATION DR.	12	011066	1/1/0001
05800	S	M	OUG	V	02036	022		12	011066	1/1/0001
OFFICE: 311		ROUTE: 564		ST_REF_NO: 00000171550		SPRING VALLEY LANE		TAX DIST	DATE INST	DATE CHANGE
LUMENS	BULB TYPE	MULT SERIES	POLE TYPE	SHADE	ADDRESS NUMBER	REF	LOCATION			
05800	S	M	CNT	II	00000	007	SIDE OF 2529 BUCK LANE ON SPRING VALLEY LANE	12	090602	1/1/0001
05800	S	M	CNT	II	00201	001		12	090602	1/1/0001
05800	S	M	CNT	II	00213	002		12	090602	1/1/0001
05800	S	M	CNT	II	00229	003		12	090602	1/1/0001
05800	S	M	CNT	II	00245	004		12	090602	1/1/0001
05800	S	M	CNT	II	00260	005		12	090602	1/1/0001
05800	S	M	CNT	II	00277	006		12	090602	1/1/0001
05800	S	M	CNT	II	00313	008		12	090602	1/1/0001
05800	S	M	CNT	II	00332	009		12	090602	1/1/0001
05800	S	M	CNT	III	00341	010		12	090602	1/1/0001

OFFICE: 311

ROUTE: 564

ST_REF_NO: 00000171560

SPRING VALLEY LOOP

LUMENS	BULB TYPE	MULT SERIES	POLE TYPE	SHADE	ADDRESS NUMBER	REF	LOCATION	TAX DIST	DATE INST	DATE CHANGE
05800	S	M	CNT	II	00000	001	SIDE OF 228 SPRING VALLEY LN ON SPRING VALLEY LOOP	12	090602	1/1/0001
05800	S	M	CNT	II	00000	002	SIDE OF 2508 SPRING VALLEY LOOP	12	090602	1/1/0001
05800	S	M	CNT	II	02529	003		12	090602	1/1/0001
05800	S	M	CNT	II	02548	004		12	090602	1/1/0001
05800	S	M	CNT	II	02565	005		12	090602	1/1/0001
05800	S	M	CNT	II	02581	006		12	090602	1/1/0001
05800	S	M	CNT	II	02597	007		12	090602	1/1/0001

OFFICE: 311

ROUTE: 564

ST_REF_NO: 00000171600

SPRINGHURST DRIVE

LUMENS	BULB TYPE	MULT SERIES	POLE TYPE	SHADE	ADDRESS NUMBER	REF	LOCATION	TAX DIST	DATE INST	DATE CHANGE
05800	S	M	OUG	II	00583	096	BAD FIXTURE	12	101583	3/2/2009
05800	S	M	OUG	II	00595	095	BAD FIXTURE	12	101583	3/2/2009
05800	S	M	OUG	II	00670	094	BAD FIXTURE	12	101583	3/2/2009
05800	S	M	OUG	II	00000	091	SIDE OF 2100 HARRODSBURG RD.	12	101583	1/1/0001
04000	S	M	OUG	II	00682	093		12	101583	1/1/0001
04000	S	M	OUG	II	00699	092		12	101583	1/1/0001

OFFICE: 311

ROUTE: 564

ST_REF_NO: 00000171700

SPRINGRIDGE DRIVE

LUMENS	BULB TYPE	MULT SERIES	POLE TYPE	SHADE	ADDRESS NUMBER	REF	LOCATION	TAX DIST	DATE INST	DATE CHANGE
04000	S	M	SOH	II	00000	072	SIDE OF 2204 HARRODSBURG RD.	12	101583	1/1/0001
04000	S	M	OUG	II	00600	081		12	101583	1/1/0001
04000	S	M	OUG	II	00609	080		12	101583	1/1/0001
04000	S	M	OUG	II	00624	079		12	040885	1/1/0001
04000	S	M	OUG	II	00637	078		12	101583	1/1/0001
04000	S	M	OUG	II	00648	077		12	101583	1/1/0001
04000	S	M	OUG	II	00658	076		12	101583	1/1/0001
04000	S	M	OUG	II	00670	075		12	101583	1/1/0001
04000	S	M	OUG	II	00687	074		12	101583	1/1/0001
04000	S	M	OUG	II	00694	073		12	101583	1/1/0001

OFFICE: 311

ROUTE: 564

ST_REF_NO: 00000171710 SPRINGVIEW CIRCLE

LUMENS	BULB TYPE	MULT SERIES	POLE TYPE	SHADE	ADDRESS NUMBER	REF	LOCATION	TAX DIST	DATE INST	DATE CHANGE
05800	S	M	CNT	III	00604	002		12	100899	1/1/0001
05800	S	M	CNT	II	00616	001		12	100899	1/1/0001

OFFICE: 311

ROUTE: 564

ST_REF_NO: 00000171715 SPRINGWATER CIRCLE

LUMENS	BULB TYPE	MULT SERIES	POLE TYPE	SHADE	ADDRESS NUMBER	REF	LOCATION	TAX DIST	DATE INST	DATE CHANGE
05800	S	M	CNT	II	00000	001	SIDE 4124 SPRINGWATER DR.	12	080895	1/1/0001
05800	S	M	CNT	III	00805	002		12	080895	1/1/0001

OFFICE: 311

ROUTE: 564

ST_REF_NO: 00000171720 SPRINGWATER DRIVE

LUMENS	BULB TYPE	MULT SERIES	POLE TYPE	SHADE	ADDRESS NUMBER	REF	LOCATION	TAX DIST	DATE INST	DATE CHANGE
05800	S	M	CNT	II	04100	001		12	080895	1/1/0001
05800	S	M	CNT	II	04109	002		12	080895	1/1/0001
05800	S	M	CNT	II	04112	003		12	080895	1/1/0001
05800	S	M	CNT	III	04132	004		12	080895	1/1/0001

OFFICE: 311

ROUTE: 564

ST_REF_NO: 00000171750 SPRINGWOOD COURT

LUMENS	BULB TYPE	MULT SERIES	POLE TYPE	SHADE	ADDRESS NUMBER	REF	LOCATION	TAX DIST	DATE INST	DATE CHANGE
04000	S	M	OUG	II	00900	001		12	110889	1/1/0001
04000	S	M	OUG	II	00913	002		12	110889	1/1/0001
04000	S	M	OUG	II	00920	003		12	110889	1/1/0001

OFFICE: 311

ROUTE: 564

ST_REF_NO: 00000171775 SPRINTER TRAIL DRIVE

LUMENS	BULB TYPE	MULT SERIES	POLE TYPE	SHADE	ADDRESS NUMBER	REF	LOCATION	TAX DIST	DATE INST	DATE CHANGE
05800	S	M	OUG	II	00000	005	SIDE OF 2625 ROLLING RIDGE DR ON SPRINTER TRAIL DR	12	101403	1/1/0001
05800	S	M	OUG	II	00204	001		12	071002	1/1/0001
05800	S	M	OUG	II	00225	002		12	101403	1/1/0001
05800	S	M	OUG	II	00232	003		12	071002	1/1/0001
05800	S	M	OUG	II	00245	004		12	101403	1/1/0001

OFFICE: 311		ROUTE: 564		ST_REF_NO: 00000171800		SPRUCE STREET				
LUMENS	BULB TYPE	MULT SERIES	POLE TYPE	SHADE	ADDRESS NUMBER	REF	LOCATION	TAX DIST	DATE INST	DATE CHANGE
09500	S	M	SOH	II	00000	001	N.W. CORNER OF CLARK ST.	12	011369	4/30/2011
09500	S	M	SOH	I	00000	076	OPP. WICKLIFFE ST.	12	110166	4/30/2011
09500	S	M	SOH	I	00000	077	1ST. LT. S. OF 2ND ST., E. SIDE	12	110166	4/30/2011
09500	S	M	SOH	I	00000	079	1ST. LT. S. OF 3RD ST., E. SIDE	12	110166	4/30/2011
09500	S	M	SOH	I	00000	080	OPP. NOBLE ST.	12	110166	4/30/2011
09500	S	M	SOH	II	00172	002		12	011369	4/30/2011
09500	S	M	SOH	I	00206	078		12	110166	4/30/2011

OFFICE: 311		ROUTE: 564		ST_REF_NO: 00000171805		SPRUCEWOOD DRIVE				
LUMENS	BULB TYPE	MULT SERIES	POLE TYPE	SHADE	ADDRESS NUMBER	REF	LOCATION	TAX DIST	DATE INST	DATE CHANGE
05800	S		OUG	II	00700	004		12	080409	1/1/0001
05800	S		OUG	II	00720	003		12	080409	1/1/0001
05800	S		OUG	II	00741	002		12	080409	1/1/0001
05800	S		OUG	II	00752	001		12	080409	1/1/0001

OFFICE: 311		ROUTE: 564		ST_REF_NO: 00000171850		SPURR ALLEY				
LUMENS	BULB TYPE	MULT SERIES	POLE TYPE	SHADE	ADDRESS NUMBER	REF	LOCATION	TAX DIST	DATE INST	DATE CHANGE
05800	S	M	SOH	I	00000	001	N. OF CENTRAL AVE., E. SIDE	12	081434	1/1/0001

OFFICE: 311		ROUTE: 564		ST_REF_NO: 00000171900		SPURR PIKE				
LUMENS	BULB TYPE	MULT SERIES	POLE TYPE	SHADE	ADDRESS NUMBER	REF	LOCATION	TAX DIST	DATE INST	DATE CHANGE
05800	S		CNT	II	00000	013	SIDE OF 2501 MILSOM LANE ON SPURR RD	12	070210	1/1/0001
05800	S		CNT	II	00000	015	SIDE OF 2244 WALCOT WAY ON SPURR RD	12	070210	1/1/0001
05800	S		CNT	II	02252	012		12	070210	1/1/0001
05800	S	M	CNT	III	00000	001	1ST LT EAST OF GEORGETOWN RD, NORTH SIDE ON SPURR	12	041706	1/1/0001
05800	S	M	CNT	II	00000	002	2ND LT EAST OF GEORGETOWN RD, NORTH SIDE ON SPURR	12	041706	1/1/0001
05800	S	M	CNT	II	00000	003	SIDE OF 2501 GLASCOW LANE ON SPURR RD	12	041706	1/1/0001
05800	S	M	CNT	II	00000	004	SIDE OF 2500 GLASCOW LANE ON SPURR RD	12	041706	1/1/0001
05800	S	M	CNT	II	00000	011	SIDE OF 2500 LANGSTANE LANE ON SPURR RD	12	041706	1/1/0001
05800	S	M	CNT	II	02273	010		12	041706	1/1/0001

OFFICE: 311

ROUTE: 564

ST_REF_NO: 00000171900

SPURR PIKE

LUMENS	BULB TYPE	MULT SERIES	POLE TYPE	SHADE	ADDRESS NUMBER	REF	LOCATION	TAX DIST	DATE INST	DATE CHANGE
05800	S	M	CNT	II	02284	009		12	041706	1/1/0001
05800	S	M	CNT	II	02301	008		12	041706	1/1/0001
05800	S	M	CNT	II	02316	007		12	041706	1/1/0001
05800	S	M	CNT	II	02329	006		12	041706	1/1/0001
05800	S	M	CNT	II	02341	005		12	041706	1/1/0001

OFFICE: 311

ROUTE: 564

ST_REF_NO: 00000171910

SPYGLASS LANE

LUMENS	BULB TYPE	MULT SERIES	POLE TYPE	SHADE	ADDRESS NUMBER	REF	LOCATION	TAX DIST	DATE INST	DATE CHANGE
05800	S	M	OUG	II	00000	002	SIDE OF 3801 MUIRFIELD PLACE	12	120893	1/1/0001
05800	S	M	OUG	II	00000	007	SIDE OF 3837 MUIRFIELD PLACE	12	120893	1/1/0001
05800	S	M	OUG	III	00791	001		12	050896	1/1/0001
05800	S	M	OUG	II	00814	003		12	120893	1/1/0001
05800	S	M	OUG	II	00827	004		12	120893	1/1/0001
05800	S	M	OUG	II	00842	005		12	120893	1/1/0001
05800	S	M	OUG	II	00867	006		12	120893	1/1/0001
05800	S	M	OUG	II	00887	008		12	120893	1/1/0001

OFFICE: 311

ROUTE: 564

ST_REF_NO: 00000171950

SQUIRES CIRCLE

LUMENS	BULB TYPE	MULT SERIES	POLE TYPE	SHADE	ADDRESS NUMBER	REF	LOCATION	TAX DIST	DATE INST	DATE CHANGE
09500	S	M	OUG	II	00000	002	SIDE OF 300 LAKEBEND	12	030888	1/1/0001
09500	S	M	OUG	II	00000	011	OPP. 433	12	030888	1/1/0001
09500	S	M	OUG	II	00000	013	OPP. 447	12	030888	1/1/0001
09500	S	M	OUG	II	00000	024	OPP. BEAVER CREEK	12	030888	1/1/0001
09500	S	M	OUG	II	00000	025	OPP. 425	12	030888	1/1/0001
09500	S	M	OUG	II	00000	026	OPP. 429	12	030888	1/1/0001
09500	S	M	OUG	II	00000	028	OPP. 409	12	030888	1/1/0001
09500	S	M	OUG	II	00384	004		12	030888	1/1/0001
09500	S	M	OUG	II	00389	001		12	030888	1/1/0001
09500	S	M	OUG	II	00396	003		12	030888	1/1/0001
09500	S	M	OUG	II	00405	029		12	030888	1/1/0001
10000	M	M	OUG	II	00413	027		12	011581	1/1/0001
09500	S	M	OUG	II	00441	012		12	030888	1/1/0001

OFFICE: 311

ROUTE: 564

ST_REF_NO: 0000171950

SQUIRES CIRCLE

LUMENS	BULB TYPE	MULT SERIES	POLE TYPE	SHADE	ADDRESS NUMBER	REF	LOCATION	TAX DIST	DATE INST	DATE CHANGE
09500	S	M	OUG	II	00460	015		12	030888	1/1/0001

OFFICE: 311

ROUTE: 564

ST_REF_NO: 0000172000

SQUIRES ROAD

LUMENS	BULB TYPE	MULT SERIES	POLE TYPE	SHADE	ADDRESS NUMBER	REF	LOCATION	TAX DIST	DATE INST	DATE CHANGE
09500	S	M	OUG	II	00575	020		12	030888	1/11/2013
05800	S	M	SOH	II	00000	001	OPP. 579	12	020885	1/1/0001
05800	S	M	OUG	II	00000	003	SIDE OF 3199 DEWEY DR.	12	081477	1/1/0001
05800	S	M	SOH	II	00000	019	OPP. 571	12	040888	1/1/0001
05800	S	M	OUG	II	00301	037		12	011584	1/1/0001
05800	S	M	OUG	II	00304	036		12	010885	1/1/0001
05800	S	M	OUG	II	00321	035		12	010885	1/1/0001
05800	S	M	OUG	II	00324	034		12	010885	1/1/0001
05800	S	M	OUG	II	00337	033		12	010885	1/1/0001
05800	S	M	OUG	II	00000	006	1ST LT. E. OF COVE LAKE DR., S. SIDE	12	030888	1/1/0001
05800	S	M	OUG	II	00000	007	1ST LT. E. OF COVE LAKE DR., N. SIDE	12	030888	1/1/0001
05800	S	M	OUG	II	00000	008	2ND LT. E. OF COVE LAKE DR., S. SIDE	12	030888	1/1/0001
05800	S	M	OUG	II	00000	009	2ND LT. E. OF COVE LAKE DR., N. SIDE	12	030888	1/1/0001
09500	S	M	OUG	II	00000	041	1ST LT. E OF BROOKWIND WAY, S SIDE	12	110800	1/1/0001
09500	S	M	OUG	II	00000	042	2ND LT. E OF BROOKWIND WAY, S SIDE	12	110800	1/1/0001
09500	S	M	OUG	II	00000	043	2ND LT. W OF RICHMOND RD., S SIDE	12	110800	1/1/0001
09500	S	M	OUG	II	00000	044	1ST LT. W OF RICHMOND RD., S SIDE	12	110800	1/1/0001
05800	S	M	SOH	II	00000	002	SIDE OF 3201 HUNTERS POINT	12	020885	1/1/0001
05800	S	M	SOH	II	00000	004	OPP. 613	12	020885	1/1/0001
05800	S	M	SOH	II	00000	005	OPP. 625	12	020885	1/1/0001
05800	S	M	SOH	II	00000	034	OPP. 629	12	010888	1/1/0001
05800	S	M	OUG	II	00605	011		12	081477	1/1/0001
05800	S	M	OUG	II	00621	012		12	081477	1/1/0001
05800	S	M	OUG	II	00625	033		12	011581	1/1/0001
05800	S	M	OUG	II	00636	013		12	011581	1/1/0001
05800	S	M	OUG	II	00640	015		12	041478	1/1/0001
05800	S	M	OUG	II	00641	014		12	111478	1/1/0001
05800	S	M	OUG	II	00649	016		12	041478	1/1/0001
05800	S	M	OUG	II	00656	017		12	041478	1/1/0001

OFFICE: 311

ROUTE: 564

ST_REF_NO: 00000172000 SQUIRES ROAD

LUMENS	BULB TYPE	MULT SERIES	POLE TYPE	SHADE	ADDRESS NUMBER	REF	LOCATION	TAX DIST	DATE INST	DATE CHANGE
05800	S	M	OUG	II	00661	018		12	041478	1/1/0001

OFFICE: 311

ROUTE: 564

ST_REF_NO: 00000172010 SQUIRES ROAD BIKE PATH

LUMENS	BULB TYPE	MULT SERIES	POLE TYPE	SHADE	ADDRESS NUMBER	REF	LOCATION	TAX DIST	DATE INST	DATE CHANGE
05800	S	M	SOH	II	00000	123	SIDE OF 1369 GRAFTON CT.	12	110897	1/1/0001
05800	S	M	SOH	II	00000	124	REAR OF 3236 PONTCHARTRAIN CT.	12	110897	1/1/0001
05800	S	M	SOH	II	00000	125	REAR OF 3205 PEBBLE LAKE DR.	12	110897	1/1/0001
05800	S	M	SOH	II	00000	126	SIDE REAR OF 3221 BUCKHORN DR.	12	110897	1/1/0001
05800	S	M	SOH	II	00000	127	SIDE OF 3216 BUCKHORN DR.	12	110897	1/1/0001
05800	S	M	SOH	II	00000	128	REAR OF 3209 MIST LAKE CT.	12	110897	1/1/0001
05800	S	M	SOH	II	00000	129	REAR OF 636 SQUIRES RD.	12	110897	1/1/0001

OFFICE: 311

ROUTE: 564

ST_REF_NO: 00000172100 ST ANN DRIVE

LUMENS	BULB TYPE	MULT SERIES	POLE TYPE	SHADE	ADDRESS NUMBER	REF	LOCATION	TAX DIST	DATE INST	DATE CHANGE
05800	S	M	OUG	II	00000	013	OPP. 236	12	070158	1/1/0001
05800	S	M	OUG	II	00000	014	OPP. 248	12	070158	1/1/0001
05800	S	M	OUG	II	00000	015	OPP. 260	12	051658	1/1/0001
05800	S	M	OUG	II	00216	000		12	082258	1/1/0001
05800	S	M	OUG	II	00000	001	1ST. LT. N. OF RICHMOND RD., IN MEDIAN, W. SIDE	12	051159	1/1/0001
05800	S	M	OUG	II	00000	002	1ST. LT. N. OF RICHMOND RD., IN MEDIAN, E. SIDE	12	051159	1/1/0001
05800	S	M	OUG	II	00000	003	2ND LT. N. OF RICHMOND RD., IN MEDIAN, W. SIDE	12	051159	1/1/0001
05800	S	M	OUG	II	00000	004	2ND LT. N. OF RICHMOND RD., IN MEDIAN, E. SIDE	12	051159	1/1/0001
05800	S	M	OUG	II	00000	005	SIDE OF 2145 COLBURN BLVD.	12	070156	1/1/0001
05800	S	M	OUG	II	00130	000		12	070156	1/1/0001
05800	S	M	OUG	II	00145	000		12	070156	1/1/0001
05800	S	M	OUG	II	00162	000		12	070156	1/1/0001
05800	S	M	OUG	II	00190	000		12	032756	1/1/0001
05800	S	M	OUG	III	00201	000		12	070158	1/1/0001
05800	S	M	OUG	II	00232	025		12	090898	1/1/0001

OFFICE: 311

ROUTE: 564

ST_REF_NO: 00000172200

ST ANTHONY DRIVE

LUMENS	BULB TYPE	MULT SERIES	POLE TYPE	SHADE	ADDRESS NUMBER	REF	LOCATION	TAX DIST	DATE INST	DATE CHANGE
05800	S	M	OUG	II	00000	003	SIDE OF 1828 BRYAN STATION	12	050164	1/1/0001
04000	S	M	OUG	II	00000	007	SIDE OF 1833 WAYLAND DR.	12	030888	1/1/0001
04000	S	M	OUG	II	00000	022	SIDE OF 1829 EDON DR.	12	030888	1/1/0001
05800	S	M	OUG	II	00405	004		12	050164	1/1/0001
04000	S	M	OUG	II	00415	005		12	030888	1/1/0001
04000	S	M	OUG	II	00429	006		12	030888	1/1/0001
04000	S	M	OUG	II	00512	008		12	030888	1/1/0001
04000	S	M	OUG	II	00523	009		12	030888	1/1/0001
04000	S	M	OUG	II	00531	010		12	030888	1/1/0001
04000	S	M	OUG	II	00547	011		12	030888	1/1/0001
04000	S	M	OUG	II	00560	012		12	030888	1/1/0001
04000	S	M	OUG	II	00564	013		12	030888	1/1/0001
04000	S	M	OUG	II	00580	014		12	030888	1/1/0001
04000	S	M	OUG	II	00592	015		12	030888	1/1/0001
04000	S	M	OUG	II	00605	016		12	030888	1/1/0001
04000	S	M	OUG	II	00617	017		12	030888	1/1/0001
04000	S	M	OUG	II	00629	018		12	030888	1/1/0001
04000	S	M	OUG	II	00632	019		12	030888	1/1/0001
04000	S	M	OUG	II	00657	020		12	030888	1/1/0001
04000	S	M	OUG	II	00665	021		12	030888	1/1/0001

OFFICE: 311

ROUTE: 564

ST_REF_NO: 00000172300

ST CHRISTOPHER DRIVE

LUMENS	BULB TYPE	MULT SERIES	POLE TYPE	SHADE	ADDRESS NUMBER	REF	LOCATION	TAX DIST	DATE INST	DATE CHANGE
05800	S	M	OUG	III	02005	000		12	041557	1/1/0001
05800	S	M	OUG	III	02020	000		12	072757	1/1/0001
05800	S	M	OUG	III	02045	000		12	072757	1/1/0001
05800	S	M	OUG	III	02056	000		12	070158	1/1/0001
05800	S	M	OUG	III	02081	000		12	072757	1/1/0001
05800	S	M	OUG	III	02088	000		12	072757	1/1/0001
05800	S	M	OUG	III	02121	000		12	072757	1/1/0001

OFFICE: 311

ROUTE: 564

ST_REF_NO: 00000172310 ST CLAIR COURT

LUMENS	BULB TYPE	MULT SERIES	POLE TYPE	SHADE	ADDRESS NUMBER	REF	LOCATION	TAX DIST	DATE INST	DATE CHANGE
04000	S	M	OUG	II	03705	001		12	120887	1/1/0001

OFFICE: 311

ROUTE: 564

ST_REF_NO: 00000172350 ST ELIAS DRIVE

LUMENS	BULB TYPE	MULT SERIES	POLE TYPE	SHADE	ADDRESS NUMBER	REF	LOCATION	TAX DIST	DATE INST	DATE CHANGE
05800	S	M	CNT	II	00000	001	SIDE OF 4474 TANGLE HURST LANE	12	080800	1/1/0001
05800	S	M	CNT	II	00000	003	OPP. 725	12	080800	1/1/0001
05800	S	M	CNT	II	00000	006	1ST LT. W OF SOUTH POINT DR., N SIDE	12	080800	1/1/0001
05800	S	M	CNT	II	00737	004		12	080800	1/1/0001
05800	S	M	CNT	II	00752	005		12	080800	1/1/0001
05800	S	M	CNT	II	00752	007		12	080800	1/1/0001

OFFICE: 311

ROUTE: 564

ST_REF_NO: 00000172400 ST GEORGE DRIVE

LUMENS	BULB TYPE	MULT SERIES	POLE TYPE	SHADE	ADDRESS NUMBER	REF	LOCATION	TAX DIST	DATE INST	DATE CHANGE
05800	S	M	SOH	II	00304	000		12	120158	1/1/0001

OFFICE: 311

ROUTE: 564

ST_REF_NO: 00000172450 ST JAMES COURT

LUMENS	BULB TYPE	MULT SERIES	POLE TYPE	SHADE	ADDRESS NUMBER	REF	LOCATION	TAX DIST	DATE INST	DATE CHANGE
05800	S	M	OUG	III	00000	001	SIDE OF 2131 ST. MATHILDA DR.	12	072757	1/1/0001
05800	S	M	OUG	III	00208	000		12	072757	1/1/0001

OFFICE: 311

ROUTE: 564

ST_REF_NO: 00000172500 ST JAMES DRIVE

LUMENS	BULB TYPE	MULT SERIES	POLE TYPE	SHADE	ADDRESS NUMBER	REF	LOCATION	TAX DIST	DATE INST	DATE CHANGE
05800	S	M	OUG	II	00000	006	SIDE OF 2130 ST. MATHILDA DR.	12	071856	1/1/0001
05800	S	M	OUG	II	00000	001	SIDE OF 2125 COBURN BLVD.	12	070155	1/1/0001
05800	S	M	OUG	II	00130	000		12	070155	1/1/0001
05800	S	M	OUG	II	00145	000		12	070155	1/1/0001
05800	S	M	OUG	II	00162	000		12	070155	1/1/0001
05800	S	M	OUG	II	00177	000		12	071856	1/1/0001

OFFICE: 311

ROUTE: 564

ST_REF_NO: 00000172550

ST JOHNS COURT

LUMENS	BULB TYPE	MULT SERIES	POLE TYPE	SHADE	ADDRESS NUMBER	REF	LOCATION	TAX DIST	DATE INST	DATE CHANGE
05800	S	M	OUG	III	00405	004		12	011703	1/1/0001
05800	S	M	OUG	II	00417	003		12	011703	1/1/0001
05800	S	M	OUG	II	00420	002		12	012005	1/1/0001

OFFICE: 311

ROUTE: 564

ST_REF_NO: 00000172600

ST JOSEPH DRIVE

LUMENS	BULB TYPE	MULT SERIES	POLE TYPE	SHADE	ADDRESS NUMBER	REF	LOCATION	TAX DIST	DATE INST	DATE CHANGE
05800	S	M	OUG	II	00000	020	SIDE 551 BOB-O-LINK	12	110884	1/1/0001
05800	S	M	OUG	II	00000	021	SIDE 364 MOCKINGBIRD LANE	12	110884	1/1/0001
05800	S	M	OUG	II	00000	022	OPP. MOCKINGBIRD LANE	12	110884	1/1/0001
05800	S	M	OUG	II	00000	023	SIDE REAR 365 MOCKINGBIRD LANE	12	110884	1/1/0001
05800	S	M	OUG	II	00000	024	OPP. HUMMINGBIRD LANE	12	040887	1/1/0001
05800	S	M	OUG	II	00000	025	SIDE 365 HUMMINGBIRD LANE	12	040887	1/1/0001

OFFICE: 311

ROUTE: 564

ST_REF_NO: 00000172680

ST JULIE DRIVE

LUMENS	BULB TYPE	MULT SERIES	POLE TYPE	SHADE	ADDRESS NUMBER	REF	LOCATION	TAX DIST	DATE INST	DATE CHANGE
05800	S	M	OUG	II	00000	001	SIDE OF 191 IDLE HOUR DR.	12	090898	1/1/0001

OFFICE: 311

ROUTE: 564

ST_REF_NO: 00000172700

ST MARGARET DRIVE

LUMENS	BULB TYPE	MULT SERIES	POLE TYPE	SHADE	ADDRESS NUMBER	REF	LOCATION	TAX DIST	DATE INST	DATE CHANGE
05800	S	M	OUG	III	00000	016	OPP. 261	12	040158	1/1/0001
05800	S	M	OUG	II	00000	018	OPP. 289	12	040159	1/1/0001
05800	S	M	OUG	III	00130	000		12	070155	1/1/0001
05800	S	M	OUG	III	00141	000		12	070155	1/1/0001
05800	S	M	OUG	III	00158	000		12	071055	1/1/0001
05800	S	M	OUG	III	00173	000		12	032756	1/1/0001
05800	S	M	OUG	III	00193	000		12	032756	1/1/0001
05800	S	M	OUG	II	00194	000		12	032756	1/1/0001
05800	S	M	OUG	III	00212	000		12	032756	1/1/0001
05800	S	M	OUG	III	00225	000		12	041557	1/1/0001
05800	S	M	OUG	III	00240	000		12	041957	1/1/0001
05800	S	M	OUG	III	00249	000		12	041557	1/1/0001

OFFICE: 311 **ROUTE: 564**
ST_REF_NO: 00000172700 ST MARGARET DRIVE

LUMENS	BULB TYPE	MULT SERIES	POLE TYPE	SHADE	ADDRESS NUMBER	REF	LOCATION	TAX DIST	DATE INST	DATE CHANGE
05800	S	M	OUG	III	00277	000		12	051658	1/1/0001
05800	S	M	OUG	V	00000	001	SIDE OF 2017 RICHMOND RD., IN MEDIAN	12	070155	1/1/0001
05800	S	M	OUG	II	00000	002	SIDE OF 2001 RICHMOND RD., IN MEDIAN	12	012472	1/1/0001
05800	S	M	OUG	II	00000	003	SIDE REAR OF 2017 RICHMOND RD., IN MEDIAN	12	050159	1/1/0001
05800	S	M	OUG	II	00000	004	SIDE REAR OF 2001 RICHMOND RD., IN MEDIAN	12	050159	1/1/0001
05800	S	M	OUG	III	00117	000		12	070155	1/1/0001

OFFICE: 311 **ROUTE: 564**
ST_REF_NO: 00000172800 ST MARTIN'S AVENUE

LUMENS	BULB TYPE	MULT SERIES	POLE TYPE	SHADE	ADDRESS NUMBER	REF	LOCATION	TAX DIST	DATE INST	DATE CHANGE
05800	S	M	OUG	II	00000	007	SIDE OF 462 ERIE RD.	12	070566	1/1/0001
05800	S	M	OUG	II	00966	010		12	070566	1/1/0001
05800	S	M	OUG	II	00981	008		12	070566	1/1/0001
05800	S	M	OUG	II	01013	014		12	070566	1/1/0001
05800	S	M	OUG	II	01026	015		12	070566	1/1/0001
05800	S	M	OUG	II	00953	009		12	070566	1/1/0001

OFFICE: 311 **ROUTE: 564**
ST_REF_NO: 00000172900 ST MATHILDA DRIVE

LUMENS	BULB TYPE	MULT SERIES	POLE TYPE	SHADE	ADDRESS NUMBER	REF	LOCATION	TAX DIST	DATE INST	DATE CHANGE
05800	S	M	OUG	III	00000	001	SIDE OF 196 IDLE HOUR	12	041557	1/1/0001
05800	S	M	OUG	II	00000	003	OPP. ST. WILLIAM	12	032756	1/1/0001
05800	S	M	OUG	II	02034	000		12	032756	1/1/0001
05800	S	M	OUG	II	02112	000		12	032756	1/1/0001
05800	S	M	OUG	III	02129	000		12	041557	1/1/0001
05800	S	M	OUG	III	02130	000		12	072457	1/1/0001
05800	S	M	OUG	II	02143	000		12	071856	1/1/0001

OFFICE: 311 **ROUTE: 564**
ST_REF_NO: 00000173000 ST MICHAEL DRIVE

LUMENS	BULB TYPE	MULT SERIES	POLE TYPE	SHADE	ADDRESS NUMBER	REF	LOCATION	TAX DIST	DATE INST	DATE CHANGE
05800	S	M	OUG	II	02005	000		12	040159	1/1/0001
05800	S	M	OUG	II	02020	000		12	040159	1/1/0001
05800	S	M	OUG	II	02029	000		12	070886	1/1/0001

OFFICE: 311

ROUTE: 564

ST_REF_NO: 00000173000

ST MICHAEL DRIVE

LUMENS	BULB TYPE	MULT SERIES	POLE TYPE	SHADE	ADDRESS NUMBER	REF	LOCATION	TAX DIST	DATE INST	DATE CHANGE
05800	S	M	OUG	II	02048	000		12	050160	1/1/0001
05800	S	M	OUG	II	02064	000		12	050160	1/1/0001
05800	S	M	OUG	II	02109	000		12	051167	1/1/0001
05800	S	M	OUG	II	02132	000		12	050160	1/1/0001
05800	S	M	OUG	II	02148	000		12	070158	1/1/0001

OFFICE: 311

ROUTE: 564

ST_REF_NO: 00000173100

ST PHILLIP DRIVE

LUMENS	BULB TYPE	MULT SERIES	POLE TYPE	SHADE	ADDRESS NUMBER	REF	LOCATION	TAX DIST	DATE INST	DATE CHANGE
05800	S	M	OUG	II	00000	001	SIDE OF 2213 COBURN BLVD.	12	070155	1/1/0001
05800	S	M	OUG	III	00000	007	SIDE OF 194 ST. ANN DR.	12	072757	1/1/0001
05800	S	M	OUG	II	00130	000		12	070155	1/1/0001
05800	S	M	OUG	II	00145	000		12	070155	1/1/0001
05800	S	M	OUG	II	00162	000		12	070155	1/1/0001
05800	S	M	OUG	III	00173	000		12	021258	1/1/0001
05800	S	M	OUG	III	00181	000		12	070158	1/1/0001

OFFICE: 311

ROUTE: 564

ST_REF_NO: 00000173130

ST STEPHENS GREEN

LUMENS	BULB TYPE	MULT SERIES	POLE TYPE	SHADE	ADDRESS NUMBER	REF	LOCATION	TAX DIST	DATE INST	DATE CHANGE
05800	S	M	CNT	III	01985	001		12	100896	1/1/0001
05800	S	M	CNT	II	02000	002		12	100896	1/1/0001
05800	S	M	CNT	II	02017	003		12	100896	1/1/0001
05800	S	M	CNT	II	02024	004		12	100896	1/1/0001
05800	S	M	CNT	III	02037	005		12	100896	1/1/0001

OFFICE: 311

ROUTE: 564

ST_REF_NO: 00000173200

ST TERESA DRIVE

LUMENS	BULB TYPE	MULT SERIES	POLE TYPE	SHADE	ADDRESS NUMBER	REF	LOCATION	TAX DIST	DATE INST	DATE CHANGE
05800	S	M	OUG	II	02004	000		12	051658	1/1/0001
05800	S	M	OUG	II	02021	000		12	051658	1/1/0001
05800	S	M	OUG	II	02040	000		12	052258	1/1/0001
05800	S	M	OUG	II	02057	000		12	051658	1/1/0001
05800	S	M	OUG	II	02068	000		12	051658	1/1/0001

OFFICE: 311

ROUTE: 564

ST_REF_NO: 00000173200

ST TERESA DRIVE

LUMENS	BULB TYPE	MULT SERIES	POLE TYPE	SHADE	ADDRESS NUMBER	REF	LOCATION	TAX DIST	DATE INST	DATE CHANGE
05800	S	M	OUG	II	02081	000		12	051658	1/1/0001
05800	S	M	OUG	II	02100	000		12	051658	1/1/0001
05800	S	M	OUG	II	02113	000		12	051658	1/1/0001

OFFICE: 311

ROUTE: 564

ST_REF_NO: 00000173300

ST WILLIAM DRIVE

LUMENS	BULB TYPE	MULT SERIES	POLE TYPE	SHADE	ADDRESS NUMBER	REF	LOCATION	TAX DIST	DATE INST	DATE CHANGE
05800	S	M	OUG	II	00162	000		12	070155	1/1/0001
05800	S	M	OUG	II	00175	000		12	032756	1/1/0001
05800	S	M	OUG	II	00182	000		12	032756	1/1/0001
05800	S	M	OUG	II	00000	001	SIDE OF 2053 COBURN DR.	12	070155	1/1/0001
05800	S	M	OUG	II	00130	000		12	070155	1/1/0001
05800	S	M	OUG	II	00145	000		12	070155	1/1/0001

OFFICE: 311

ROUTE: 564

ST_REF_NO: 00000173450

STALLION RUN

LUMENS	BULB TYPE	MULT SERIES	POLE TYPE	SHADE	ADDRESS NUMBER	REF	LOCATION	TAX DIST	DATE INST	DATE CHANGE
05800	S	M	OUG	II	00000	001	SIDE OF 2700 TRAILWOOD LN ON STALLION RUN	12	083105	1/1/0001
05800	S	M	OUG	II	00000	004	SIDE OF 2701 SILVER MARE CT ON STALLION RUN	12	083105	1/1/0001
05800	S	M	OUG	II	00204	002		12	083105	1/1/0001
05800	S	M	OUG	II	00216	003		12	083105	1/1/0001
05800	S	M	OUG	II	00240	005		12	083105	1/1/0001
05800	S	M	OUG	III	00256	006		12	083105	1/1/0001

OFFICE: 311

ROUTE: 564

ST_REF_NO: 00000173600

STANFORD DRIVE

LUMENS	BULB TYPE	MULT SERIES	POLE TYPE	SHADE	ADDRESS NUMBER	REF	LOCATION	TAX DIST	DATE INST	DATE CHANGE
04000	S	M	OUG	II	00000	049	SIDE OF 132 VANDERBILT DR.	12	060886	1/1/0001
04000	S	M	OUG	II	03005	050		12	060886	1/1/0001
04000	S	M	OUG	II	03016	051		12	060886	1/1/0001
04000	S	M	OUG	II	03029	052		12	060886	1/1/0001
04000	S	M	OUG	II	03037	053		12	060886	1/1/0001
04000	S	M	OUG	II	03049	054		12	060886	1/1/0001
04000	S	M	OUG	II	03064	055		12	060886	1/1/0001

OFFICE: 311

ROUTE: 564

ST_REF_NO: 00000173700

STANLEY AVENUE

LUMENS	BULB TYPE	MULT SERIES	POLE TYPE	SHADE	ADDRESS NUMBER	REF	LOCATION	TAX DIST	DATE INST	DATE CHANGE
04000	S	M	SOH	II	00000	055	SIDE 104 AMERICAN AVE.	12	050886	1/1/0001
04000	S	M	SOH	II	00000	056	1301-1303	12	050886	1/1/0001
04000	S	M	SOH	II	01317	057		12	050886	1/1/0001

OFFICE: 311

ROUTE: 564

ST_REF_NO: 00000173705

STANSBERRY COVE

LUMENS	BULB TYPE	MULT SERIES	POLE TYPE	SHADE	ADDRESS NUMBER	REF	LOCATION	TAX DIST	DATE INST	DATE CHANGE
05800	S	M	CNT	II	00000	002	SIDE OF 677 STANSBERRY COVE	12	070806	1/1/0001
05800	S	M	CNT	II	00604	007		12	070806	1/1/0001
05800	S	M	CNT	II	00625	008		12	070806	1/1/0001
05800	S	M	CNT	II	00644	009		12	070806	1/1/0001
05800	S	M	CNT	II	00652	001		12	070806	1/1/0001
05800	S	M	CNT	II	00680	003		12	070806	1/1/0001
05800	S	M	CNT	II	00689	004		12	070806	1/1/0001
05800	S	M	CNT	II	00700	005		12	070806	1/1/0001
05800	S	M	CNT	II	00716	006		12	070806	1/1/0001

OFFICE: 311

ROUTE: 564

ST_REF_NO: 00000173710

STANTON WAY

LUMENS	BULB TYPE	MULT SERIES	POLE TYPE	SHADE	ADDRESS NUMBER	REF	LOCATION	TAX DIST	DATE INST	DATE CHANGE
10000	M	M	OUG	II	00000	012	OPP. 1919	12	081582	1/1/0001
10000	M	M	OUG	II	00000	013	OPP. 1911	12	081582	1/1/0001
10000	M	M	OUG	II	01919	011		12	081582	1/1/0001
09500	S	M	OUG	II	01927	009		12	081582	1/1/0001
10000	M	M	OUG	II	01927	010		12	081582	1/1/0001
10000	M	M	OUG	II	01935	005		12	081582	1/1/0001
10000	M	M	OUG	II	01935	007		12	081582	1/1/0001
10000	M	M	OUG	II	01938	004		12	051475	1/1/0001
10000	M	M	OUG	II	01938	006		12	051475	1/1/0001
10000	M	M	OUG	II	01938	008		12	051475	1/1/0001
10000	M	M	OUG	II	01943	003		12	081582	1/1/0001
10000	M	M	OUG	II	01951	001		12	051475	1/1/0001

OFFICE: 311

ROUTE: 564

ST_REF_NO: 00000173760

STAR OF DANUBE WAY

LUMENS	BULB TYPE	MULT SERIES	POLE TYPE	SHADE	ADDRESS NUMBER	REF	LOCATION	TAX DIST	DATE INST	DATE CHANGE
09500	S		CLN	II	00000	001	SIDE OF 2509 FLYING EBONY DR, ON STAR OF DANUBE WAY	12	091109	1/1/0001
09500	S		CLN	II	00909	002		12	091109	1/1/0001
09500	S		CLN	II	00912	003		12	091109	1/1/0001
09500	S		CLN	II	00920	004		12	091109	1/1/0001
09500	S		CLN	II	00932	005		12	091109	1/1/0001

OFFICE: 311

ROUTE: 564

ST_REF_NO: 00000173770

STAR GAZE DRIVE

LUMENS	BULB TYPE	MULT SERIES	POLE TYPE	SHADE	ADDRESS NUMBER	REF	LOCATION	TAX DIST	DATE INST	DATE CHANGE
09500	S		CLN	II	00901	001		12	091109	1/1/0001
09500	S		CLN	II	00904	002		12	091109	1/1/0001
09500	S		CLN	II	00913	003		12	091109	1/1/0001
09500	S		CLN	II	00924	004		12	091109	1/1/0001
09500	S		CLN	II	00933	005		12	091109	1/1/0001
09500	S		CLN	II	00941	006		12	091109	1/1/0001
09500	S		CLN	II	00952	007		12	091109	1/1/0001
09500	S		CLN	II	00961	008		12	091109	1/1/0001
09500	S		CLN	II	00969	009		12	091109	1/1/0001
09500	S		CLN	II	00973	010		12	091109	1/1/0001
09500	S		CLN	II	00978	011		12	091109	1/1/0001
09500	S		CLN	II	00985	012		12	091109	1/1/0001

OFFICE: 311

ROUTE: 564

ST_REF_NO: 00000173780

STAR SHOOT PARKWAY

LUMENS	BULB TYPE	MULT SERIES	POLE TYPE	SHADE	ADDRESS NUMBER	REF	LOCATION	TAX DIST	DATE INST	DATE CHANGE
22000	S		CNT	II	00000	050	7th It east of Liberty Rd, south side on Star Shoot Pkwy	12	092308	1/1/0001
22000	S		CNT	II	00000	051	7th It east of Liberty Rd, north side on Star Shoot Pkwy	12	092308	1/1/0001
22000	S		CNT	II	00000	052	6th It east of Liberty Rd, south side on Star Shoot Pkwy	12	092308	1/1/0001
22000	S		CNT	II	00000	053	6th It east of Liberty Rd, north side on Star Shoot Pkwy	12	092308	1/1/0001
22000	S		CNT	II	00000	054	5th It east of Liberty Rd, south side on Star Shoot Pkwy	12	092308	1/1/0001
22000	S		CNT	II	00000	055	5th It east of Liberty Rd, north side on Star Shoot Pkwy	12	092308	1/1/0001
22000	S		CNT	II	00000	056	4th It east of Liberty Rd, south side on Star Shoot Pkwy	12	092308	1/1/0001
22000	S		CNT	II	00000	057	4th It east of Liberty Rd, north side on Star Shoot Pkwy	12	092308	1/1/0001
22000	S		CNT	II	00000	058	3rd It east of Liberty Rd, south side on Star Shoot Pkwy	12	092308	1/1/0001

Street Light Listing run 1/11/2015 10:43:21 AM

Page 1063 of 1254

OFFICE: 311

ROUTE: 564

ST_REF_NO: 00000173780

STAR SHOOT PARKWAY

LUMENS	BULB TYPE	MULT SERIES	POLE TYPE	SHADE	ADDRESS NUMBER	REF	LOCATION	TAX DIST	DATE INST	DATE CHANGE
22000	S		CNT	II	00000	059	3rd lt east of Liberty Rd, north side on Star Shoot Pkwy	12	092308	1/1/0001
22000	S		CNT	II	00000	060	2nd lt east of Liberty Rd, south side on Star Shoot Pkwy	12	092308	1/1/0001
22000	S		CNT	II	00000	061	2nd lt east of Liberty Rd, north side on Star Shoot Pkwy	12	092308	1/1/0001
50000	S		CNT	II	00000	062	1st lt east of Liberty Rd, south side on Star Shoot Parkway	12	092308	1/1/0001
50000	S		CNT	II	00000	063	1st lt east of Liberty Rd, north side on Star Shoot Parkway	12	092308	1/1/0001
50000	S	M	CNT	II	00000	001	1ST LT W OF SIR BARTON WAY,N SIDE ON STAR SHOOT	12	071305	1/1/0001
50000	S	M	CNT	II	00000	002	1ST LT W OF SIR BARTON WAY,S SIDE ON STAR SHOOT	12	071305	1/1/0001
22000	S	M	CNT	II	00000	003	2ND LT W OF SIR BARTON WAY,N SIDE ON STAR SHOOT	12	071305	1/1/0001
22000	S	M	CNT	II	00000	004	2ND LT W OF SIR BARTON WAY,S SIDE ON STAR SHOOT	12	071305	1/1/0001
22000	S	M	CNT	II	00000	005	3RD LT W OF SIR BARTON WAY,N SIDE ON STAR SHOOT	12	071305	1/1/0001
22000	S	M	CNT	II	00000	006	3RD LT W OF SIR BARTON WAY,S SIDE ON STAR SHOOT	12	071305	1/1/0001
22000	S	M	CNT	II	00000	007	4TH LT W OF SIR BARTON WAY,N SIDE ON STAR SHOOT	12	071305	1/1/0001
22000	S	M	CNT	II	00000	008	4TH LT W OF SIR BARTON WAY,S SIDE ON STAR SHOOT	12	071305	1/1/0001
22000	S	M	CNT	II	00000	009	5TH LT W OF SIR BARTON WAY,N SIDE ON STAR SHOOT	12	071305	1/1/0001
22000	S	M	CNT	II	00000	010	5TH LT W OF SIR BARTON WAY,S SIDE ON STAR SHOOT	12	071305	1/1/0001
50000	S	M	CNT	II	00000	011	6TH LT W OF SIR BARTON WAY,N SIDE ON STAR SHOOT	12	071305	1/1/0001
22000	S	M	CNT	II	00000	012	6TH LT W OF SIR BARTON WAY,S SIDE ON STAR SHOOT	12	071305	1/1/0001
22000	S	M	CNT	II	00000	013	1ST LT W OF OGDEN WAY,N SIDE ON STAR SHOOT	12	071305	1/1/0001
22000	S	M	CNT	II	00000	014	1ST LT W OF OGDEN WAY,S SIDE ON STAR SHOOT	12	071305	1/1/0001
22000	S	M	CNT	II	00000	015	2ND LT W OF OGDEN WAY,N SIDE ON STAR SHOOT	12	071305	1/1/0001
22000	S	M	CNT	II	00000	016	2ND LT W OF OGDEN WAY,S SIDE ON STAR SHOOT	12	071305	1/1/0001
22000	S	M	CNT	II	00000	017	3RD LT W OF OGDEN WAY,N SIDE ON STAR SHOOT	12	071305	1/1/0001
22000	S	M	CNT	II	00000	018	3RD LT W OF OGDEN WAY,S SIDE ON STAR SHOOT	12	071305	1/1/0001
22000	S	M	CNT	II	00000	019	4TH LT W OF OGDEN WAY,N SIDE ON STAR SHOOT	12	071305	1/1/0001

OFFICE: 311

ROUTE: 564

ST_REF_NO: 00000173780

STAR SHOOT PARKWAY

LUMENS	BULB TYPE	MULT SERIES	POLE TYPE	SHADE	ADDRESS NUMBER	REF	LOCATION	TAX DIST	DATE INST	DATE CHANGE
22000	S	M	CNT	II	00000	020	4TH LT W OF OGDEN WAY,S SIDE ON STAR SHOOT	12	071305	1/1/0001
22000	S	M	CNT	II	00000	021	5TH LT W OF OGDEN WAY,N SIDE ON STAR SHOOT	12	071305	1/1/0001
50000	S	M	CNT	II	00000	022	5TH LT W OF OGDEN WAY,S SIDE ON STAR SHOOT	12	071305	1/1/0001
50000	S	M	CNT	II	00000	023	1ST LT W OF PINK PIGEON WAY,N SIDE ON STAR SHOOT	12	071305	1/1/0001
22000	S	M	CNT	II	00000	024	1ST LT W OF PINK PIGEON WAY,S SIDE ON STAR SHOOT	12	071305	1/1/0001
22000	S	M	CNT	II	00000	025	2ND LT W OF PINK PIGEON WAY,N SIDE ON STAR SHOOT	12	071305	1/1/0001
22000	S	M	CNT	II	00000	026	2ND LT W OF PINK PIGEON WAY,S SIDE ON STAR SHOOT	12	071305	1/1/0001
22000	S	M	CNT	II	00000	027	3RD LT W OF PINK PIGEON WYA,N SIDE ON STAR SHOOT	12	071305	1/1/0001
22000	S	M	CNT	II	00000	028	3RD LT W OF PINK PIGEON,S SIDE ON STAR SHOOT	12	071305	1/1/0001
22000	S	M	CNT	II	00000	029	4TH LT W OF PINK PIGEON,N SIDE ON STAR SHOOT	12	071305	1/1/0001
22000	S	M	CNT	II	00000	030	4TH LT W OF PINK PIGEON WAY,S SIDE ON STAR SHOOT	12	071305	1/1/0001
22000	S	M	CNT	II	00000	031	5TH LT W OF PINK PIGEON,N SIDE ON STAR SHOOT	12	071305	1/1/0001
22000	S	M	CNT	II	00000	032	5TH LT W OF PINK PIGEON WAY,S SIDE ON STAR SHOOT	12	071305	1/1/0001
22000	S	M	CNT	II	00000	033	6TH LT W OF PINK PIGEON WAY,N SIDE ON STAR SHOOT	12	071305	1/1/0001
22000	S	M	CNT	II	00000	034	6TH LT W OF PINK PIGEON WAY,S SIDE ON STAR SHOOT	12	071305	1/1/0001
22000	S	M	CNT	II	00000	035	7TH LT W OF PINK PIGEON WAY,N SIDE ON STAR SHOOT	12	071305	1/1/0001
22000	S	M	CNT	II	00000	036	7TH LT W OF PINK PIGEON WAY,S SIDE ON STAR SHOOT	12	071305	1/1/0001
22000	S	M	CNT	II	00000	037	8TH LT W OF PINK PIGEON WAY,N SIDE ON STAR SHOOT	12	071305	1/1/0001
50000	S	M	CNT	II	00000	038	8TH LT W OF PINK PIGEON,S SIDE ON STAR SHOOT	12	071305	1/1/0001
50000	S	M	CNT	II	00000	039	1ST LT W OF FLYING EBONY,N SIDE ON STAR SHOOT	12	071305	1/1/0001
22000	S	M	CNT	II	00000	040	1ST LT W OF FLYING EBONY DR,S SIDE ON STAR SHOOT	12	071305	1/1/0001

OFFICE: 311

ROUTE: 564

ST_REF_NO: 00000173780

STAR SHOOT PARKWAY

LUMENS	BULB TYPE	MULT SERIES	POLE TYPE	SHADE	ADDRESS NUMBER	REF	LOCATION	TAX DIST	DATE INST	DATE CHANGE
22000	S	M	CNT	II	00000	041	2ND LT W OF FLYING EBONY DR,N SIDE ON STAR SHOOT	12	071305	1/1/0001
22000	S	M	CNT	II	00000	042	2ND LT W OF FLYING EBONY,S SIDE ON STAR SHOOT	12	071305	1/1/0001
22000	S	M	CNT	II	00000	043	3RD LT W OF FLYING EBONY,N SIDE ON STAR SHOOT	12	071305	1/1/0001
22000	S	M	CNT	II	00000	044	3RD LT W OF FLYING EBONY,S SIDE ON STAR SHOOT	12	071305	1/1/0001

OFFICE: 311

ROUTE: 564

ST_REF_NO: 00000173800

STARLING DRIVE

LUMENS	BULB TYPE	MULT SERIES	POLE TYPE	SHADE	ADDRESS NUMBER	REF	LOCATION	TAX DIST	DATE INST	DATE CHANGE
05800	S	M	OUG	II	03120	002		12	080601	1/1/0001
05800	S	M	OUG	II	03133	001		12	080601	1/1/0001
04000	S	M	OUG	II	00000	001	SIDE 590 ALBANY RD.	12	050888	1/1/0001

OFFICE: 311

ROUTE: 564

ST_REF_NO: 00000173900

STATE STREET

LUMENS	BULB TYPE	MULT SERIES	POLE TYPE	SHADE	ADDRESS NUMBER	REF	LOCATION	TAX DIST	DATE INST	DATE CHANGE
09500	S	M	SOH	II	00000	002	SIDE OF 1245 SOUTH LIMESTONE ON STATE STREET	12	030104	1/1/0001
09500	S	M	SOH	II	00112	003		12	030104	1/1/0001
09500	S	M	SOH	II	00130	004		12	030104	1/1/0001
09500	S	M	SOH	I	00139	000		12	052163	1/1/0001
09500	S	M	SOH	II	00144	005		12	030104	1/1/0001
09500	S	M	SOH	II	00204	006		12	030104	1/1/0001
09500	S	M	SOH	II	00208	007		12	030104	1/1/0001
09500	S	M	SOH	II	00214	008		12	030104	1/1/0001
09500	S	M	SOH	II	00218	009		12	030104	1/1/0001
09500	S	M	SOH	II	00224	010	all lights on State upgraded to 9500 July 2007	12	030104	1/1/0001

OFFICE: 311

ROUTE: 564

ST_REF_NO: 00000173950

STATESMAN WAY

LUMENS	BULB TYPE	MULT SERIES	POLE TYPE	SHADE	ADDRESS NUMBER	REF	LOCATION	TAX DIST	DATE INST	DATE CHANGE
05800	S	M	OUG	III	00000	023	SIDE OF 756 PIONEER LN ON STATESMAN WAY	12	100606	1/1/0001
05800	S	M	OUG	III	00000	025	ACROSS FROM 796 STATESMAN WAY	12	100606	1/1/0001

OFFICE: 311

ROUTE: 564

ST_REF_NO: 00000173950 STATESMAN WAY

LUMENS	BULB TYPE	MULT SERIES	POLE TYPE	SHADE	ADDRESS NUMBER	REF	LOCATION	TAX DIST	DATE INST	DATE CHANGE
05800	S	M	OUG	II	00729	010		12	091602	1/1/0001
05800	S	M	OUG	II	00753	021		12	100606	1/1/0001
05800	S	M	OUG	II	00757	022		12	100606	1/1/0001
05800	S	M	OUG	II	00784	024		12	100606	1/1/0001
05800	S	M	OUG	II	00000	010		12	100898	1/1/0001
05800	S	M	OUG	II	00709	001		12	100898	1/1/0001
05800	S	M	OUG	II	00809	009		12	100898	1/1/0001

OFFICE: 311

ROUTE: 564

ST_REF_NO: 00000173980 STEAMBOAT ROAD

LUMENS	BULB TYPE	MULT SERIES	POLE TYPE	SHADE	ADDRESS NUMBER	REF	LOCATION	TAX DIST	DATE INST	DATE CHANGE
05800	S	M	OUG	III	04217	001		12	060897	1/1/0001
05800	S	M	OUG	II	04204	002		12	060897	1/1/0001
05800	S	M	OUG	II	04225	003		12	060897	1/1/0001
05800	S	M	OUG	III	04237	004		12	060897	1/1/0001
05800	S	M	OUG	II	04252	005		12	060897	1/1/0001
05800	S	M	OUG	II	04265	006		12	060897	1/1/0001
05800	S	M	OUG	II	04272	007		12	060897	1/1/0001
05800	S	M	OUG	II	04285	008		12	060897	1/1/0001

OFFICE: 311

ROUTE: 564

ST_REF_NO: 00000174025 STEDMAN DR

LUMENS	BULB TYPE	MULT SERIES	POLE TYPE	SHADE	ADDRESS NUMBER	REF	LOCATION	TAX DIST	DATE INST	DATE CHANGE
04000	S	M	OUG	II	02100	001		12	080891	1/1/0001

OFFICE: 311

ROUTE: 564

ST_REF_NO: 00000174100 STEPHEN FOSTER DRIVE

LUMENS	BULB TYPE	MULT SERIES	POLE TYPE	SHADE	ADDRESS NUMBER	REF	LOCATION	TAX DIST	DATE INST	DATE CHANGE
05800	S	M	OUG	II	00000	025	SIDE OF 3652 CROSBY	12	080173	1/1/0001
05800	S	M	OUG	II	00000	028	SIDE OF 1316 JANELLE CT.	12	080173	1/1/0001
05800	S	M	OUG	II	01307	024		12	060867	1/1/0001
05800	S	M	OUG	II	01318	033		12	080173	1/1/0001
05800	S	M	OUG	V	01335	032		12	071674	1/1/0001
05800	S	M	OUG	II	01348	031		12	080173	1/1/0001

OFFICE: 311		ROUTE: 564		ST_REF_NO: 00000174100		STEPHEN FOSTER DRIVE				
LUMENS	BULB TYPE	MULT SERIES	POLE TYPE	SHADE	ADDRESS NUMBER	REF	LOCATION	TAX DIST	DATE INST	DATE CHANGE
05800	S	M	OUG	II	01359	030		12	080173	1/1/0001
05800	S	M	OUG	II	01375	029		12	080173	1/1/0001
05800	S	M	OUG	II	01457	027		12	080173	1/1/0001
05800	S	M	OUG	II	01470	026		12	080173	1/1/0001

OFFICE: 311		ROUTE: 564		ST_REF_NO: 00000174200		STEPHENS LANE				
LUMENS	BULB TYPE	MULT SERIES	POLE TYPE	SHADE	ADDRESS NUMBER	REF	LOCATION	TAX DIST	DATE INST	DATE CHANGE
05800	S	M	OUG	II	00000	075	SIDE OF 977 PINE BLOOM	12	022167	1/1/0001
05800	S	M	OUG	II	02183	074		12	060867	1/1/0001
05800	S	M	OUG	II	00000	164	SIDE OF 2204 WINTERBERRY DR.	12	111565	1/1/0001
05800	S	M	OUG	II	02176	073		12	091167	1/1/0001

OFFICE: 311		ROUTE: 564		ST_REF_NO: 00000174275		SPERLING DRIVE				
LUMENS	BULB TYPE	MULT SERIES	POLE TYPE	SHADE	ADDRESS NUMBER	REF	LOCATION	TAX DIST	DATE INST	DATE CHANGE
05800	S	M	CNT	II	00000	001	1ST LT E OF HAYS BLVD, SOUTH SIDE OF STERLING DR	12	062307	1/1/0001
05800	S	M	CNT	II	00000	002	2ND LT E OF HAYS BLVD, SOUTH SIDE OF STERLING DR	12	062307	1/1/0001
05800	S	M	CNT	II	00000	003	3RD LT E OF HAYS BLVD, SOUTH SIDE OF STERLING DR	12	062307	1/1/0001
05800	S	M	CNT	II	00000	007	SIDE OF 4473 WILLMAN WAY ON STERLING DR	12	062307	1/1/0001
05800	S	M	CNT	II	04120	004		12	062307	1/1/0001
05800	S	M	CNT	II	04128	005		12	062307	1/1/0001
05800	S	M	CNT	II	04132	006		12	062307	1/1/0001

OFFICE: 311		ROUTE: 564		ST_REF_NO: 00000174300		STERLINGTON ROAD				
LUMENS	BULB TYPE	MULT SERIES	POLE TYPE	SHADE	ADDRESS NUMBER	REF	LOCATION	TAX DIST	DATE INST	DATE CHANGE
05800	S	M	OUG	II	02335	200		12	051906	1/1/0001
05800	S	M	OUG	II	02339	104		12	051906	1/1/0001
05800	S	M	OUG	II	02347	103		12	051906	1/1/0001
05800	S	M	OUG	II	02350	102		12	051906	1/1/0001
05800	S	M	OUG	II	02359	101		12	051906	1/1/0001

OFFICE: 311

ROUTE: 564

ST_REF_NO: 00000174300

STERLINGTON ROAD

LUMENS	BULB TYPE	MULT SERIES	POLE TYPE	SHADE	ADDRESS NUMBER	REF	LOCATION	TAX DIST	DATE INST	DATE CHANGE
05800	S	M	OUG	II	02370	100		12	051906	1/1/0001
04000	S	M	OUG	II	00000	070	SIDE OF 2398	12	021580	1/1/0001
04000	S	M	OUG	II	02375	065		12	021580	1/1/0001
04000	S	M	OUG	V	02382	064		12	021580	1/1/0001
04000	S	M	OUG	II	02394	063		12	021580	1/1/0001

OFFICE: 311

ROUTE: 564

ST_REF_NO: 00000174400

STETSON LANE

LUMENS	BULB TYPE	MULT SERIES	POLE TYPE	SHADE	ADDRESS NUMBER	REF	LOCATION	TAX DIST	DATE INST	DATE CHANGE
05800	S	M	OUG	II	02701	000		12	041068	1/1/0001
05800	S	M	OUG	II	02706	003		12	020800	1/1/0001
05800	S	M	OUG	II	02713	002		12	020800	1/1/0001
05800	S	M	OUG	III	02726	001		12	020800	1/1/0001

OFFICE: 311

ROUTE: 564

ST_REF_NO: 00000174530

STILL CREEK WAY

LUMENS	BULB TYPE	MULT SERIES	POLE TYPE	SHADE	ADDRESS NUMBER	REF	LOCATION	TAX DIST	DATE INST	DATE CHANGE
05800	S		CNT	II	00000	001	SIDE OF 3745 RIDGE VIEW WAY, ON STILL CREEK WAY	12	070709	1/1/0001
05800	S		CNT	II	00000	002	SIDE OF 3701 HORSEMINT TR, ON STILL CREEK WAY	12	071409	1/1/0001

OFFICE: 311

ROUTE: 564

ST_REF_NO: 00000174550

STILL MEADOW LANE

LUMENS	BULB TYPE	MULT SERIES	POLE TYPE	SHADE	ADDRESS NUMBER	REF	LOCATION	TAX DIST	DATE INST	DATE CHANGE
05800	S		CNT	II	00000	024	STILL MEADOW LANE @ANDOVER CREEK PATH	12	071409	1/1/0001
05800	S		CNT	II	00000	025	1ST LT W OF CHILESBURG RD, N SIDE ON STILL MEADOW LANE	12	071409	1/1/0001
05800	S		CNT	II	00000	026	1ST LT W OF CHILESBURG RD, S SIDE ON STILL MEADOW LANE	12	071409	1/1/0001
05800	S		CNT	II	03833	020		12	071409	1/1/0001
05800	S		CNT	II	03845	021		12	071409	1/1/0001
05800	S		CNT	II	03848	022		12	071409	1/1/0001
05800	S		CNT	II	03861	023		12	071409	1/1/0001
05800	S	M	CNT	II	00000	011	SIDE OF 3752 HORSEMINT TRAIL ON STILL MEADOW LANE	12	111306	1/1/0001

OFFICE: 311		ROUTE: 564		ST_REF_NO: 00000174550		STILL MEADOW LANE				
LUMENS	BULB TYPE	MULT SERIES	POLE TYPE	SHADE	ADDRESS NUMBER	REF	LOCATION	TAX DIST	DATE INST	DATE CHANGE
05800	S	M	CNT	II	03809	010		12	111306	1/1/0001
05800	S	M	CNT	II	03817	009		12	111306	1/1/0001
05800	S	M	CNT	II	03824	008		12	111306	1/1/0001
OFFICE: 311		ROUTE: 564		ST_REF_NO: 00000174600		STILLWATER ROAD				
LUMENS	BULB TYPE	MULT SERIES	POLE TYPE	SHADE	ADDRESS NUMBER	REF	LOCATION	TAX DIST	DATE INST	DATE CHANGE
04000	S	M	OUG	II	00000	038	SIDE 559 HALIFAX DR.	12	100885	1/1/0001
04000	S	M	OUG	II	03400	041		12	100885	1/1/0001
04000	S	M	OUG	II	03409	040		12	100885	1/1/0001
04000	S	M	OUG	II	03424	039		12	100885	1/1/0001
OFFICE: 311		ROUTE: 564		ST_REF_NO: 00000174700		STILLWELL AVENUE				
LUMENS	BULB TYPE	MULT SERIES	POLE TYPE	SHADE	ADDRESS NUMBER	REF	LOCATION	TAX DIST	DATE INST	DATE CHANGE
04000	S	M	SOH	II	01108	015		12	050886	1/1/0001
04000	S	M	SOH	II	01111	016		12	050886	1/1/0001
OFFICE: 311		ROUTE: 564		ST_REF_NO: 00000174720		STILLWOOD COURT				
LUMENS	BULB TYPE	MULT SERIES	POLE TYPE	SHADE	ADDRESS NUMBER	REF	LOCATION	TAX DIST	DATE INST	DATE CHANGE
05800	S	M	CNT	III	04901	001		12	080896	1/1/0001
OFFICE: 311		ROUTE: 564		ST_REF_NO: 00000174765		STOCKTON WAY				
LUMENS	BULB TYPE	MULT SERIES	POLE TYPE	SHADE	ADDRESS NUMBER	REF	LOCATION	TAX DIST	DATE INST	DATE CHANGE
05800	S		OUG	II	01805	002		12	092704	1/1/0001
05800	S		OUG	II	01812	001		12	092704	1/1/0001
OFFICE: 311		ROUTE: 564		ST_REF_NO: 00000174770		STOLEN HORSE TRACE				
LUMENS	BULB TYPE	MULT SERIES	POLE TYPE	SHADE	ADDRESS NUMBER	REF	LOCATION	TAX DIST	DATE INST	DATE CHANGE
05800	S	M	CNT	II	00000	001	SIDE OF 1217 PASSAGE MOUND WAY ON STOLEN HORSE TR	12	062808	1/1/0001

OFFICE: 311		ROUTE: 564		ST_REF_NO: 00000174770		STOLEN HORSE TRACE		LUMENS	BULB TYPE	MULT SERIES	POLE TYPE	SHADE	ADDRESS NUMBER	REF	LOCATION	TAX DIST	DATE INST	DATE CHANGE
05800	S	M	CNT	II	00000	002									SIDE OF 1208 PASSAGE MOUND WAY ON STOLEN HORSE TR	12	062808	1/1/0001
05800	S	M	CNT	II	03608	003										12	062808	1/1/0001
05800	S	M	CNT	II	03620	004										12	062808	1/1/0001
05800	S	M	CNT	II	03637	005										12	062808	1/1/0001
05800	S	M	CNT	II	03644	006										12	062808	1/1/0001
05800	S	M	CNT	II	03644	008										12	062808	1/1/0001
05800	S	M	CNT	II	03661	007										12	062808	1/1/0001
05800	S	M	CNT	II	03673	009										12	062808	1/1/0001
05800	S	M	CNT	II	03697	010										12	062808	1/1/0001
05800	S	M	CNT	II	03705	011										12	062808	1/1/0001
05800	S	M	CNT	II	03717	012										12	062808	1/1/0001
05800	S	M	CNT	II	03725	013										12	062808	1/1/0001
05800	S	M	CNT	II	03737	014										12	062808	1/1/0001
05800	S	M	CNT	II	03749	015										12	062808	1/1/0001

OFFICE: 311

ROUTE: 564

ST_REF_NO: 00000174800

STOLL-POOLE COURT

LUMENS	BULB TYPE	MULT SERIES	POLE TYPE	SHADE	ADDRESS NUMBER	REF	LOCATION	TAX DIST	DATE INST	DATE CHANGE
05800	S	M	SOH	II	00401	001		12	063003	1/1/0001
05800	S	M	SOH	II	00405	002		12	063003	1/1/0001
05800	S	M	SOH	II	00413	003		12	063003	1/1/0001
05800	S	M	SOH	II	00421	004		12	063003	1/1/0001
05800	S	M	SOH	II	00424	005		12	063003	1/1/0001

OFFICE: 311

ROUTE: 564

ST_REF_NO: 00000174900

STONE AVENUE

LUMENS	BULB TYPE	MULT SERIES	POLE TYPE	SHADE	ADDRESS NUMBER	REF	LOCATION	TAX DIST	DATE INST	DATE CHANGE
09500	S		SOH	II	00000	006	2ND LT S OF E HIGH, E SIDE	12	090909	1/1/0001
09500	S		SOH	II	00000	007	2ND LT N OF E MAXWELL, E SIDE	12	090909	1/1/0001
09500	S	M	SOH	I	00000	001	SIDE OF 252 E. HIGH	12	010163	9/9/2009
09500	S	M	SOH	I	00000	002	STONE & LYNDHURST	12	010163	9/9/2009
09500	S	M	SOH	I	00000	003	1ST LT. S. OF LYNDHURST	12	010163	9/9/2009
09500	S	M	SOH	I	00000	004	STONE & KALMIA	12	010163	9/9/2009
09500	S	M	SOH	I	00000	005	SIDE OF 251 E. MAXWELL	12	010163	9/9/2009

Street Light Listing run 1/11/2015 10:43:21 AM

Page 1071 of 1254

OFFICE: 311

ROUTE: 564

ST_REF_NO: 00000175000

STONE ROAD

LUMENS	BULB TYPE	MULT SERIES	POLE TYPE	SHADE	ADDRESS NUMBER	REF	LOCATION	TAX DIST	DATE INST	DATE CHANGE
05800	S	M	OOH	II	00000	140	REAR OF 481 SEVERN WAY	12	111583	1/1/0001
05800	S	M	OOH	II	00000	141	OPP. 424	12	111583	1/1/0001
05800	S	M	OOH	II	00000	142	OPP. 402	12	111583	1/1/0001
05800	S	M	OOH	II	00401	143		12	111583	1/1/0001
04000	S	M	OOH	II	00000	107	OPP. THE REAR OF 520 ANDREA	12	111583	1/1/0001
04000	S	M	OOH	II	00000	109	OPP. THE REAR OF 508 ANDREA	12	111583	1/1/0001
04000	S	M	OOH	II	00000	111	OPP. SIDE OF 2898 NEAL DR.	12	111583	1/1/0001
04000	S	M	OOH	II	00000	113	OPP. SOUTHVIEW	12	111583	1/1/0001
04000	S	M	OOH	II	00000	114	REAR OF 440 COVENTRY CT.	12	111583	1/1/0001
04000	S	M	OOH	II	00000	115	OPP. THE REAR OF 420 COVENTRY	12	111583	1/1/0001
04000	S	M	SOH	II	00000	116	REAR OF 410 COVENTRY CT.	12	111583	1/1/0001
04000	S	M	OOH	II	00000	117	OPP. 819	12	111583	1/1/0001
04000	S	M	OOH	II	00000	119	OPP. 775	12	111583	1/1/0001
04000	S	M	OOH	II	00000	121	OPP. 775	12	111583	1/1/0001
04000	S	M	OOH	II	00000	123	OPP. 727	12	111583	1/1/0001
05800	S	M	OOH	II	00000	125	OPP. 665	12	111583	1/1/0001
04000	S	M	SOH	II	00000	126	SIDE 661	12	111583	1/1/0001
05800	S	M	OOH	II	00000	127	SIDE OF 290 BIG RUN RD.	12	111583	1/1/0001
05800	S	M	OOH	II	00000	128	OPP. BIG RUN RD.	12	111583	1/1/0001
05800	S	M	OOH	II	00000	129	REAR OF 295 GOLD RUSH	12	111583	1/1/0001
05800	S	M	OOH	II	00000	130	OPP. THE REAR OF 287 GOLD RUSH	12	111583	1/1/0001
05800	S	M	OOH	II	00000	131	REAR OF 265 GOLD RUSH	12	111583	1/1/0001
05800	S	M	OOH	II	00000	132	OPP. 560	12	111583	1/1/0001
05800	S	M	OOH	II	00000	134	OPP. 500	12	111583	1/1/0001
05800	S	M	OOH	II	00000	136	OPP. 500	12	111583	1/1/0001
05800	S	M	OOH	II	00000	138	SIDE OF 402 WESTERFIELD	12	111583	1/1/0001
05800	S	M	OUG	II	00450	139		12	070886	1/1/0001
05800	S	M	OUG	II	00500	135		12	080888	1/1/0001
05800	S	M	OUG	II	00500	137		12	080888	1/1/0001
05800	S	M	SOH	II	00550	133		12	111583	1/1/0001
04000	S	M	OOH	II	00727	122		12	111583	1/1/0001
04000	S	M	OOH	II	00727	124		12	111583	1/1/0001
04000	S	M	SOH	II	00775	120		12	111583	1/1/0001
04000	S	M	OOH	II	00795	118		12	111583	1/1/0001

Street Light Listing run 1/11/2015 10:43:21 AM

Page 1072 of 1254

OFFICE: 311		ROUTE: 564		ST_REF_NO: 00000175001		STONECASE DR				
LUMENS	BULB TYPE	MULT SERIES	POLE TYPE	SHADE	ADDRESS NUMBER	REF	LOCATION	TAX DIST	DATE INST	DATE CHANGE
05800	S	M	CNT	II	00000	002	SIDE OF 901 STONECASE CT.	12	040897	1/1/0001
05800	S	M	CNT	II	03196	001		12	040897	1/1/0001

OFFICE: 311		ROUTE: 564		ST_REF_NO: 00000175002		STONECASE COURT				
LUMENS	BULB TYPE	MULT SERIES	POLE TYPE	SHADE	ADDRESS NUMBER	REF	LOCATION	TAX DIST	DATE INST	DATE CHANGE
05800	S	M	CNT	II	00000	001	SIDE REAR OF 3193 STONECASE DRIVE	12	040897	1/1/0001
05800	S	M	CNT	II	00912	002		12	040897	1/1/0001
05800	S	M	CNT	II	00937	003		12	040897	1/1/0001

OFFICE: 311		ROUTE: 564		ST_REF_NO: 00000175005		STONE CREEK DR				
LUMENS	BULB TYPE	MULT SERIES	POLE TYPE	SHADE	ADDRESS NUMBER	REF	LOCATION	TAX DIST	DATE INST	DATE CHANGE
04000	S	M	OUG	II	00000	001	SIDE OF 3560 BOSTON ROAD	12	010894	1/1/0001
04000	S	M	OUG	II	00000	017	SIDE OF 420 MERRIBROOK	12	010894	1/1/0001
05800	S	M	OUG	II	00408	015		12	090896	1/1/0001
05800	S	M	OUG	II	00416	014		12	100896	1/1/0001
05800	S	M	OUG	II	00425	013		12	090896	1/1/0001
04000	S	M	OUG	II	00428	012		12	110891	1/1/0001
04000	S	M	OUG	II	00449	011		12	110891	1/1/0001
04000	S	M	OUG	II	00452	010		12	100893	1/1/0001
04000	S	M	OUG	II	00461	009		12	110891	1/1/0001
04000	S	M	OUG	II	00476	008		12	100893	1/1/0001
04000	S	M	OUG	II	00485	007		12	110891	1/1/0001
04000	S	M	OUG	II	00500	002		12	010894	1/1/0001
04000	S	M	OUG	II	00512	003		12	110891	1/1/0001
04000	S	M	OUG	II	00521	004		12	110891	1/1/0001
04000	S	M	OUG	II	00536	005		12	110891	1/1/0001
04000	S	M	OUG	II	00541	006		12	110891	1/1/0001

OFFICE: 311		ROUTE: 564		ST_REF_NO: 00000175008		STONE CREEK CT				
LUMENS	BULB TYPE	MULT SERIES	POLE TYPE	SHADE	ADDRESS NUMBER	REF	LOCATION	TAX DIST	DATE INST	DATE CHANGE
04000	S	M	OUG	II	03509	001		12	110891	1/1/0001

OFFICE: 311		ROUTE: 564		ST_REF_NO: 00000175009		STONE CROSSING LANE		LUMENS	BULB TYPE	MULT SERIES	POLE TYPE	SHADE	ADDRESS NUMBER	REF	LOCATION	TAX DIST	DATE INST	DATE CHANGE
05800	S	M	CNT	II	00000	001	1ST LT. SOUTH OF MILLPOND ROAD, WESTSIDE	12	120895	1/1/0001								
05800	S	M	CNT	II	00000	002	1ST LT. SOUTH OF MILLPOND ROAD, EASTSIDE	12	120895	1/1/0001								
05800	S	M	CNT	II	00000	003	SIDE REAR OF 704 OLD MILL LANE	12	120895	1/1/0001								
05800	S	M	CNT	II	00000	004	SIDE 700 MILL RIDGE ROAD	12	120895	1/1/0001								
05800	S	M	CNT	II	03932	005		12	120895	1/1/0001								
05800	S	M	CNT	II	03940	006		12	120895	1/1/0001								
OFFICE: 311		ROUTE: 564		ST_REF_NO: 00000175010		STONEGATE WAY		LUMENS	BULB TYPE	MULT SERIES	POLE TYPE	SHADE	ADDRESS NUMBER	REF	LOCATION	TAX DIST	DATE INST	DATE CHANGE
05800	S	M	OUG	II	00349	001	upgrade due to bad fixture	12	070886	9/23/2008								
04000	S	M	OUG	II	00329	003		12	070886	1/1/0001								
04000	S	M	OUG	II	00340	002		12	070886	1/1/0001								
04000	S	M	OUG	II	00312	004		12	070886	1/1/0001								
OFFICE: 311		ROUTE: 564		ST_REF_NO: 00000175011		STONEY PARK LANE		LUMENS	BULB TYPE	MULT SERIES	POLE TYPE	SHADE	ADDRESS NUMBER	REF	LOCATION	TAX DIST	DATE INST	DATE CHANGE
05800	S	M	CNT	II	02760	001		12	091001	1/1/0001								
05800	S	M	CNT	II	02776	002		12	091001	1/1/0001								
05800	S	M	CNT	II	02793	003		12	091001	1/1/0001								
OFFICE: 311		ROUTE: 564		ST_REF_NO: 00000175012		STONECROP DRIVE		LUMENS	BULB TYPE	MULT SERIES	POLE TYPE	SHADE	ADDRESS NUMBER	REF	LOCATION	TAX DIST	DATE INST	DATE CHANGE
05800	S		CNT	II	00000	005	SIDE OF 451 ARUM PARK ON STONECROP DR	12	062810	1/1/0001								
05800	S		CNT	II	00000	009	SIDE OF 4525 ARUM PARK ON STONECROP DR	12	062810	1/1/0001								
05800	S		CNT	III	01008	001		12	062810	1/1/0001								
05800	S		CNT	II	01024	002		12	062810	1/1/0001								
05800	S		CNT	II	01032	003		12	062810	1/1/0001								
05800	S		CNT	II	01044	004		12	062810	1/1/0001								
05800	S		CNT	II	01076	006		12	062810	1/1/0001								
05800	S		CNT	II	01084	007		12	062810	1/1/0001								
05800	S		CNT	II	01100	008		12	062810	1/1/0001								

OFFICE: 311		ROUTE: 564		ST_REF_NO: 00000175012		STONECROP DRIVE				
LUMENS	BULB TYPE	MULT SERIES	POLE TYPE	SHADE	ADDRESS NUMBER	REF	LOCATION	TAX DIST	DATE INST	DATE CHANGE
05800	S		CNT	II	01133	010		12	062810	1/1/0001
05800	S		CNT	III	01145	011		12	062810	1/1/0001

OFFICE: 311		ROUTE: 564		ST_REF_NO: 00000175100		STONEHAVEN DRIVE				
LUMENS	BULB TYPE	MULT SERIES	POLE TYPE	SHADE	ADDRESS NUMBER	REF	LOCATION	TAX DIST	DATE INST	DATE CHANGE
05800	S	M	OUG	II	00000	053	SIDE OF 1701 HARROGATE	12	021866	1/1/0001
05800	S	M	OUG	II	00451	049		12	030166	1/1/0001
05800	S	M	OUG	II	00466	050		12	030166	1/1/0001
05800	S	M	OUG	II	00475	051		12	030166	1/1/0001
05800	S	M	OUG	II	00490	052		12	021866	1/1/0001
05800	S	M	OUG	II	00510	097		12	111366	1/1/0001
05800	S	M	OUG	II	00521	098		12	111366	1/1/0001
05800	S	M	OUG	II	00534	099		12	010173	1/1/0001
05800	S	M	OUG	II	00545	100		12	041267	1/1/0001
05800	S	M	OUG	II	00558	102		12	111366	1/1/0001
05800	S	M	OUG	II	00569	103		12	120270	1/1/0001
05800	S	M	OUG	II	00582	104		12	041768	1/1/0001
05800	S	M	OUG	II	00593	105		12	041267	1/1/0001
05800	S	M	OUG	II	00606	106		12	111366	1/1/0001
05800	S	M	OUG	II	00617	107		12	111366	1/1/0001

OFFICE: 311		ROUTE: 564		ST_REF_NO: 00000175150		STONEHEDGE PLACE				
LUMENS	BULB TYPE	MULT SERIES	POLE TYPE	SHADE	ADDRESS NUMBER	REF	LOCATION	TAX DIST	DATE INST	DATE CHANGE
04000	S	M	OUG	II	00000	001	SIDE OF 408 PATCHEN DR.	12	020888	1/1/0001
04000	S	M	OUG	II	00412	002		12	020888	1/1/0001

OFFICE: 311		ROUTE: 564		ST_REF_NO: 00000175200		STONEWALL ROAD				
LUMENS	BULB TYPE	MULT SERIES	POLE TYPE	SHADE	ADDRESS NUMBER	REF	LOCATION	TAX DIST	DATE INST	DATE CHANGE
04000	S	M	OUG	II	00000	001	SIDE OF VICKSBURG RD.	12	100888	1/1/0001
04000	S	M	OUG	II	00000	006	SIDE OF 1912 APPOMATTOX RD.	12	100888	1/1/0001
04000	S	M	OUG	II	00964	002		12	100888	1/1/0001

OFFICE: 311

ROUTE: 564

ST_REF_NO: 00000175200 STONEWALL ROAD

LUMENS	BULB TYPE	MULT SERIES	POLE TYPE	SHADE	ADDRESS NUMBER	REF	LOCATION	TAX DIST	DATE INST	DATE CHANGE
04000	S	M	OUG	II	00969	003		12	100888	1/1/0001
04000	S	M	OUG	II	00990	004		12	100888	1/1/0001
04000	S	M	OUG	II	00993	005		12	100888	1/1/0001

OFFICE: 311

ROUTE: 564

ST_REF_NO: 00000175300 STONEYBROOK DRIVE

LUMENS	BULB TYPE	MULT SERIES	POLE TYPE	SHADE	ADDRESS NUMBER	REF	LOCATION	TAX DIST	DATE INST	DATE CHANGE
05800	S	M	OUG	II	00300	041		12	060886	7/1/2013
04000	S	M	OUG	II	00307	042		12	060886	1/1/0001
04000	S	M	OUG	II	00313	043		12	060886	1/1/0001
04000	S	M	OUG	II	00317	044		12	060886	1/1/0001
04000	S	M	OUG	II	00323	045		12	060886	1/1/0001
04000	S	M	OUG	II	00331	046		12	060886	1/1/0001
04000	S	M	OUG	II	00335	047		12	060886	1/1/0001

OFFICE: 311

ROUTE: 564

ST_REF_NO: 00000175305 STONEYHURST PLACE

LUMENS	BULB TYPE	MULT SERIES	POLE TYPE	SHADE	ADDRESS NUMBER	REF	LOCATION	TAX DIST	DATE INST	DATE CHANGE
05800	S	M	OUG	III	04301	002		12	010897	1/1/0001
05800	S	M	OUG	II	04304	001		12	010897	1/1/0001

OFFICE: 311

ROUTE: 564

ST_REF_NO: 00000175310 STONEWOOD LANE

LUMENS	BULB TYPE	MULT SERIES	POLE TYPE	SHADE	ADDRESS NUMBER	REF	LOCATION	TAX DIST	DATE INST	DATE CHANGE
05800	S	M	OUG	II	02258	015		12	110899	1/1/0001
05800	S	M	OUG	II	02275	014		12	110899	1/1/0001
05800	S	M	OUG	II	02282	013		12	110899	1/1/0001
05800	S	M	OUG	II	02294	011		12	110899	1/1/0001
05800	S	M	OUG	II	02318	009		12	110899	1/1/0001
05800	S	M	OUG	II	02323	010		12	110899	1/1/0001
05800	S	M	OUG	II	00000	001	IN MEDIAN AT LIBERTY ROAD	12	120893	1/1/0001
05800	S	M	OUG	II	00000	002	IN MEDIAN AT LIBERTY ROAD	12	120893	1/1/0001
05800	S	M	OUG	II	00000	003	SIDE OF 793 RIDGEBROOK CIRCLE	12	120893	1/1/0001
05800	S	M	OUG	II	00000	028	SIDE OF 833 EASTMONT ROAD	12	020801	1/1/0001

OFFICE: 311

ROUTE: 564

ST_REF_NO: 00000175310

STONEWOOD LANE

LUMENS	BULB TYPE	MULT SERIES	POLE TYPE	SHADE	ADDRESS NUMBER	REF	LOCATION	TAX DIST	DATE INST	DATE CHANGE
05800	S	M	OUG	III	02009	036		12	020801	1/1/0001
05800	S	M	OUG	II	02016	035		12	020801	1/1/0001
05800	S	M	OUG	II	02037	034		12	020801	1/1/0001
05800	S	M	OUG	II	02056	033		12	020801	1/1/0001
05800	S	M	OUG	II	02077	032		12	020801	1/1/0001
05800	S	M	OUG	II	02089	031		12	020801	1/1/0001
05800	S	M	OUG	II	02100	030		12	020801	1/1/0001
05800	S	M	OUG	II	02131	027		12	110897	1/1/0001
05800	S	M	OUG	II	02138	026		12	110897	1/1/0001
05800	S	M	OUG	II	02151	025		12	110897	1/1/0001
05800	S	M	OUG	II	02167	024		12	110897	1/1/0001
05800	S	M	OUG	II	02178	023		12	110897	1/1/0001
05800	S	M	OUG	II	02187	022		12	110897	1/1/0001
05800	S	M	OUG	II	02198	021		12	110897	1/1/0001
05800	S	M	OUG	II	02211	020		12	110897	1/1/0001
05800	S	M	OUG	II	02218	019		12	110897	1/1/0001
05800	S	M	OUG	II	02231	018		12	110897	1/1/0001
05800	S	M	OUG	II	02238	017		12	110897	1/1/0001
05800	S	M	OUG	II	02251	016		12	110897	1/1/0001
05800	S	M	OUG	II	02330	008		12	110897	1/1/0001
05800	S	M	OUG	II	02367	007		12	120893	1/1/0001
05800	S	M	OUG	II	02378	006		12	120893	1/1/0001
05800	S	M	OUG	II	02391	005		12	120893	1/1/0001
05800	S	M	OUG	II	02399	004		12	120893	1/1/0001
05800	S	M	OUG	II	02299	012		12	110899	1/1/0001

OFFICE: 311

ROUTE: 564

ST_REF_NO: 00000175450

STOWBRIDGE LANE

LUMENS	BULB TYPE	MULT SERIES	POLE TYPE	SHADE	ADDRESS NUMBER	REF	LOCATION	TAX DIST	DATE INST	DATE CHANGE
05800	S	M	OUG	II	01016	002		12	050887	7/2/2013
04000	S	M	OUG	II	00000	004	SIDE 4693 IRONBRIDGE DR.	12	050887	1/1/0001
04000	S	M	OUG	II	00000	008	OPP. 1076	12	050887	1/1/0001
04000	S	M	OUG	II	00000	009	OPP. 1092	12	050887	1/1/0001
04000	S	M	OUG	II	01009	001		12	050887	1/1/0001

OFFICE: 311

ROUTE: 564

ST_REF_NO: 00000175450

STOWBRIDGE LANE

LUMENS	BULB TYPE	MULT SERIES	POLE TYPE	SHADE	ADDRESS NUMBER	REF	LOCATION	TAX DIST	DATE INST	DATE CHANGE
04000	S	M	OUG	II	01025	003		12	050887	1/1/0001
04000	S	M	OUG	II	01041	005		12	050887	1/1/0001
04000	S	M	OUG	II	01052	006		12	050887	1/1/0001
04000	S	M	OUG	II	01057	007		12	050887	1/1/0001
04000	S	M	OUG	V	01104	010		12	050887	1/1/0001

OFFICE: 311

ROUTE: 564

ST_REF_NO: 00000175500

STRADER ROAD

LUMENS	BULB TYPE	MULT SERIES	POLE TYPE	SHADE	ADDRESS NUMBER	REF	LOCATION	TAX DIST	DATE INST	DATE CHANGE
09500	S	M	OOH	II	00000	114	SIDE 1118 WINCHESTER RD.	12	120884	1/1/0001
09500	S	M	OOH	II	00000	115	OPP. 1018	12	110884	1/1/0001
09500	S	M	OUG	II	00000	118	SIDE 871 HENRY CLAY BLVD	12	110884	1/1/0001
09500	S	M	OUG	II	01030	116		12	110884	1/1/0001
09500	S	M	OUG	II	01042	117		12	110884	1/1/0001
09500	S	M	OUG	II	01601	119		12	110884	1/1/0001
05800	S	M	OUG	II	01608	120		12	110884	1/1/0001
05800	S	M	OUG	II	01616	121		12	110884	1/1/0001
05800	S	M	OUG	II	01628	122		12	110884	1/1/0001
05800	S	M	OUG	II	01652	124		12	110884	1/1/0001
05800	S	M	OUG	II	01667	125		12	110884	1/1/0001

OFFICE: 311

ROUTE: 564

ST_REF_NO: 00000175600

STRATFORD DRIVE

LUMENS	BULB TYPE	MULT SERIES	POLE TYPE	SHADE	ADDRESS NUMBER	REF	LOCATION	TAX DIST	DATE INST	DATE CHANGE
05800	S	M	OUG	II	00656	015		12	101583	10/2/2013
04000	S	M	OUG	V	00000	014	NEXT TO 660 STRATFORD DR. IN CIRCLE	12	101583	1/1/0001
04000	S	M	OUG	II	00000	020	SIDE OF 2230 CLAYS MILL RD.	12	061583	1/1/0001
04000	S	M	OUG	II	00366	025		12	040766	1/1/0001
04000	S	M	OUG	II	00367	026		12	040766	1/1/0001
04000	S	M	OUG	II	00386	027		12	040766	1/1/0001
04000	S	M	OUG	II	00395	028		12	040766	1/1/0001
04000	S	M	OUG	II	00461	029		12	040766	1/1/0001
04000	S	M	OUG	II	00470	030		12	060766	1/1/0001
04000	S	M	OUG	II	00487	031		12	040766	1/1/0001

OFFICE: 311

ROUTE: 564

ST_REF_NO: 00000175600

STRATFORD DRIVE

LUMENS	BULB TYPE	MULT SERIES	POLE TYPE	SHADE	ADDRESS NUMBER	REF	LOCATION	TAX DIST	DATE INST	DATE CHANGE
04000	S	M	OUG	II	00498	032		12	040766	1/1/0001
04000	S	M	OUG	II	00545	033		12	080166	1/1/0001
04000	S	M	OUG	II	00558	034		12	080166	1/1/0001
04000	S	M	OUG	II	00569	035		12	080166	1/1/0001
04000	S	M	OUG	II	00586	022		12	061583	1/1/0001
04000	S	M	OUG	II	00598	021		12	061583	1/1/0001
04000	S	M	OUG	II	00605	019		12	101583	1/1/0001
04000	S	M	OUG	II	00616	018		12	101583	1/1/0001
04000	S	M	OUG	II	00632	017		12	101583	1/1/0001
04000	S	M	OUG	II	00645	016		12	101583	1/1/0001
04000	S	M	OUG	II	00304	021		12	040466	1/1/0001
04000	S	M	OUG	II	00319	022		12	060766	1/1/0001
04000	S	M	OUG	II	00342	023		12	090166	1/1/0001
04000	S	M	OUG	II	00343	024		12	040766	1/1/0001

OFFICE: 311

ROUTE: 564

ST_REF_NO: 00000175800

STRAWBERRY LANE

LUMENS	BULB TYPE	MULT SERIES	POLE TYPE	SHADE	ADDRESS NUMBER	REF	LOCATION	TAX DIST	DATE INST	DATE CHANGE
04000	S	M	OUG	II	01320	053		12	080886	1/1/0001
04000	S	M	OUG	II	01327	054		12	111478	1/1/0001
04000	S	M	OUG	II	01343	056		12	111478	1/1/0001
04000	S	M	OUG	II	01352	057		12	061580	1/1/0001
04000	S	M	OUG	II	01359	084		12	061580	1/1/0001
04000	S	M	OUG	II	01367	082		12	061580	1/1/0001
04000	S	M	OUG	II	01371	081		12	061580	1/1/0001
04000	S	M	OUG	II	01383	079		12	061580	1/1/0001

OFFICE: 311

ROUTE: 564

ST_REF_NO: 00000175803

STRAWBERRY FIELDS ROAD

LUMENS	BULB TYPE	MULT SERIES	POLE TYPE	SHADE	ADDRESS NUMBER	REF	LOCATION	TAX DIST	DATE INST	DATE CHANGE
05800	S	M	OUG	II	00000	001	CORNER OF OLD PARIS PIKE AND STRAWBERRY FIELDS RD	12	082602	1/1/0001
05800	S	M	OUG	II	00120	002		12	082602	1/1/0001
05800	S	M	OUG	II	00125	003		12	082602	1/1/0001
05800	S	M	OUG	II	00144	004		12	082602	1/1/0001

OFFICE: 311

ROUTE: 564

ST_REF_NO: 00000175803

STRAWBERRY FIELDS ROAD

LUMENS	BULB TYPE	MULT SERIES	POLE TYPE	SHADE	ADDRESS NUMBER	REF	LOCATION	TAX DIST	DATE INST	DATE CHANGE
05800	S	M	OUG	II	00161	005		12	082602	1/1/0001
05800	S	M	OUG	II	00180	006		12	082602	1/1/0001
05800	S	M	OUG	II	00192	007		12	082602	1/1/0001
05800	S	M	OUG	II	00201	008		12	082602	1/1/0001
05800	S	M	OUG	III	00216	009		12	082602	1/1/0001

OFFICE: 311

ROUTE: 564

ST_REF_NO: 00000175810

STREAMWATER PLACE

LUMENS	BULB TYPE	MULT SERIES	POLE TYPE	SHADE	ADDRESS NUMBER	REF	LOCATION	TAX DIST	DATE INST	DATE CHANGE
05800	S	M	CNT	III	04004	001		12	080895	1/1/0001

OFFICE: 311

ROUTE: 564

ST_REF_NO: 00000176010

STUART HALL BOULEVARD

LUMENS	BULB TYPE	MULT SERIES	POLE TYPE	SHADE	ADDRESS NUMBER	REF	LOCATION	TAX DIST	DATE INST	DATE CHANGE
09500	S	M	CNT	II	00000	001	SIDE OF 372 HAYS BLVD ON STUARD HALL BLVD	12	053106	1/1/0001
09500	S	M	CNT	II	00000	002	SIDE OF 301 JANE BRIGGS AVE ON STUARD HALL BLVD	12	053106	1/1/0001
05800	S	M	CNT	II	00000	003	SIDE OF 292 JANE BRIGGS AVE ON STUARD HALL BLVD	12	053106	1/1/0001
05800	S	M	CNT	II	00000	004	SIDE OF 301 RICHARDSON PL ON STUARD HALL BLVD	12	053106	1/1/0001
05800	S	M	CNT	II	00000	005	SIDE OF 288 RICHARDSON PL ON STUARD HALL BLVD	12	053106	1/1/0001
05800	S	M	CNT	II	00000	010	SIDE OF 373 HAYS BLVD ON STUART HALL BLVD	12	010407	1/1/0001
05800	S	M	CNT	II	00000	020	SIDE OF 4372 STUART HALL	12	010407	1/1/0001
05800	S	M	CNT	II	00000	060	IN REAR OF CIRCLE ON STUART HALL BLVD	12	010407	1/1/0001
05800	S	M	CNT	II	04356	050		12	010407	1/1/0001
05800	S	M	CNT	II	04368	040		12	010407	1/1/0001
05800	S	M	CNT	II	04372	030		12	010407	1/1/0001
05800	S	M	CNT	II	04452	008		12	010407	1/1/0001

OFFICE: 311

ROUTE: 564

ST_REF_NO: 00000176200

SUBURBAN COURT

LUMENS	BULB TYPE	MULT SERIES	POLE TYPE	SHADE	ADDRESS NUMBER	REF	LOCATION	TAX DIST	DATE INST	DATE CHANGE
04000	S	M	SOH	II	00000	001	SIDE OF 1801 NICHOLASVILLE RD.	12	030887	1/1/0001
04000	S	M	SOH	II	00109	002		12	030887	1/1/0001

OFFICE: 311

ROUTE: 564

ST_REF_NO: 00000176200 SUBURBAN COURT

LUMENS	BULB TYPE	MULT SERIES	POLE TYPE	SHADE	ADDRESS NUMBER	REF	LOCATION	TAX DIST	DATE INST	DATE CHANGE
04000	S	M	SOH	II	00114	003		12	030887	1/1/0001
04000	S	M	SOH	II	00125	004		12	030887	1/1/0001
04000	S	M	SOH	II	00132	005		12	030887	1/1/0001
04000	S	M	SOH	II	00141	006		12	030887	1/1/0001
04000	S	M	SOH	II	00147	007		12	030887	1/1/0001
04000	S	M	SOH	II	00152	008		12	030887	1/1/0001
04000	S	M	SOH	II	00163	009		12	030887	1/1/0001
04000	S	M	SOH	II	00170	010		12	030887	1/1/0001
04000	S	M	SOH	II	00175	011		12	020891	1/1/0001

OFFICE: 311

ROUTE: 564

ST_REF_NO: 00000176225 SUFFOLK CIRCLE

LUMENS	BULB TYPE	MULT SERIES	POLE TYPE	SHADE	ADDRESS NUMBER	REF	LOCATION	TAX DIST	DATE INST	DATE CHANGE
05800	S	M	OUG	IV	03901	002		12	120892	1/1/0001
05800	S	M	OUG	II	03925	001		12	120892	1/1/0001

OFFICE: 311

ROUTE: 564

ST_REF_NO: 00000176260 SUGAR CREEK DRIVE

LUMENS	BULB TYPE	MULT SERIES	POLE TYPE	SHADE	ADDRESS NUMBER	REF	LOCATION	TAX DIST	DATE INST	DATE CHANGE
05800	S	M	OUG	III	03813	007		12	020800	1/1/0001
05800	S	M	OUG	II	03820	006		12	020800	1/1/0001
05800	S	M	OUG	II	03836	005		12	020800	1/1/0001
05800	S	M	OUG	II	03847	004		12	020800	1/1/0001
05800	S	M	OUG	II	03864	003		12	020800	1/1/0001
05800	S	M	OUG	II	03869	002		12	020800	1/1/0001
05800	S	M	OUG	II	03881	001		12	020800	1/1/0001

OFFICE: 311

ROUTE: 564

ST_REF_NO: 00000176400 SULIER COURT

LUMENS	BULB TYPE	MULT SERIES	POLE TYPE	SHADE	ADDRESS NUMBER	REF	LOCATION	TAX DIST	DATE INST	DATE CHANGE
04000	S	M	OUG	II	03601	042		12	111580	1/1/0001
04000	S	M	OUG	II	03608	043		12	111580	1/1/0001
04000	S	M	OUG	II	03621	044		12	111478	1/1/0001

OFFICE: 311		ROUTE: 564		ST_REF_NO: 00000176410		SULLIVANS TRACE				
LUMENS	BULB TYPE	MULT SERIES	POLE TYPE	SHADE	ADDRESS NUMBER	REF	LOCATION	TAX DIST	DATE INST	DATE CHANGE
05800	S		CNT	II	02600	021		12	041109	1/1/0001
05800	S		CNT	II	02748	026		12	080513	1/1/0001
05800	S		CNT	II	02765	025		12	080513	1/1/0001
05800	S		CNT	II	02785	023		12	041109	1/1/0001
05800	S		CNT	II	02793	022		12	041109	1/1/0001
05800	S		CNT	II	02932	003		12	041109	1/1/0001
05800	S		CNT	II	02952	001		12	041109	1/1/0001

OFFICE: 311		ROUTE: 564		ST_REF_NO: 00000176710		SUMMER BREEZE COURT				
LUMENS	BULB TYPE	MULT SERIES	POLE TYPE	SHADE	ADDRESS NUMBER	REF	LOCATION	TAX DIST	DATE INST	DATE CHANGE
05800	S	M	CNT	III	00000	001	SIDE OF 1024 SUMMER WIND LANE	12	110800	1/1/0001

OFFICE: 311		ROUTE: 564		ST_REF_NO: 00000176720		SUMMER PLACE COURT				
LUMENS	BULB TYPE	MULT SERIES	POLE TYPE	SHADE	ADDRESS NUMBER	REF	LOCATION	TAX DIST	DATE INST	DATE CHANGE
05800	S	M	CNT	III	05004	001		12	110800	1/1/0001

OFFICE: 311		ROUTE: 564		ST_REF_NO: 00000176730		SUMMER WIND LANE				
LUMENS	BULB TYPE	MULT SERIES	POLE TYPE	SHADE	ADDRESS NUMBER	REF	LOCATION	TAX DIST	DATE INST	DATE CHANGE
05800	S	M	CNT	II	01005	004		12	110800	1/1/0001
05800	S	M	CNT	II	01020	003		12	110800	1/1/0001
05800	S	M	CNT	II	01029	002		12	110800	1/1/0001
05800	S	M	CNT	II	01032	001		12	110800	1/1/0001

OFFICE: 311		ROUTE: 564		ST_REF_NO: 00000176740		SUMMERFIELD DRIVE				
LUMENS	BULB TYPE	MULT SERIES	POLE TYPE	SHADE	ADDRESS NUMBER	REF	LOCATION	TAX DIST	DATE INST	DATE CHANGE
05800	S	M	CNT	II	00000	001	SIDE OF 109 MASTERSON STATION DR.	12	030898	1/1/0001
05800	S	M	CNT	II	00000	005	SIDE OF 2912	12	030898	1/1/0001
05800	S	M	CNT	II	02892	008		12	030898	1/1/0001
05800	S	M	CNT	II	02905	007		12	030898	1/1/0001
05800	S	M	CNT	II	02917	006		12	030898	1/1/0001
05800	S	M	CNT	II	02945	004		12	030898	1/1/0001

OFFICE: 311		ROUTE: 564		ST_REF_NO: 00000176740		SUMMERFIELD DRIVE				
LUMENS	BULB TYPE	MULT SERIES	POLE TYPE	SHADE	ADDRESS NUMBER	REF	LOCATION	TAX DIST	DATE INST	DATE CHANGE
05800	S	M	CNT	II	02952	003		12	030898	1/1/0001
05800	S	M	CNT	II	02969	002		12	030898	1/1/0001

OFFICE: 311		ROUTE: 564		ST_REF_NO: 00000176800		SUMMERHAYES COURT				
LUMENS	BULB TYPE	MULT SERIES	POLE TYPE	SHADE	ADDRESS NUMBER	REF	LOCATION	TAX DIST	DATE INST	DATE CHANGE
04000	S	M	OUG	II	02004	067		12	091579	1/1/0001
04000	S	M	OUG	II	02013	068		12	091579	1/1/0001
04000	S	M	OUG	II	02024	069		12	111579	1/1/0001

OFFICE: 311		ROUTE: 564		ST_REF_NO: 00000176900		SUMMERSHADE CIRCLE				
LUMENS	BULB TYPE	MULT SERIES	POLE TYPE	SHADE	ADDRESS NUMBER	REF	LOCATION	TAX DIST	DATE INST	DATE CHANGE
05800	S	M	OUG	II	00617	071	bad fixture	12	061580	12/21/2009
04000	S	M	OUG	II	00000	062	SIDE 1320 STRAWBERRY LANE	12	080886	1/1/0001
04000	S	M	OUG	II	00605	073		12	061580	1/1/0001
04000	S	M	OUG	II	00612	072		12	061580	1/1/0001
04000	S	M	OUG	II	00628	070		12	111478	1/1/0001
04000	S	M	OUG	II	00629	063		12	111478	1/1/0001

OFFICE: 311		ROUTE: 564		ST_REF_NO: 00000177000		SUMMERSVILLE DRIVE				
LUMENS	BULB TYPE	MULT SERIES	POLE TYPE	SHADE	ADDRESS NUMBER	REF	LOCATION	TAX DIST	DATE INST	DATE CHANGE
05800	S	M	OUG	II	00000	003	SIDE OF 1492 PINE MEADOWS	12	051066	1/1/0001
05800	S	M	OUG	II	00000	011	SIDE OF 827	12	051066	1/1/0001
05800	S	M	OUG	II	00000	014	SIDE OF 1396 PINE MEADOWS	12	060766	1/1/0001
05800	S	M	OUG	II	00809	013		12	051066	1/1/0001
05800	S	M	OUG	II	00824	012		12	051066	1/1/0001
05800	S	M	OUG	II	00852	010		12	051066	1/1/0001
05800	S	M	OUG	II	00857	009		12	051067	1/1/0001
05800	S	M	OUG	II	00876	008		12	051066	1/1/0001
05800	S	M	OUG	II	00877	007		12	051967	1/1/0001
05800	S	M	OUG	II	00892	006		12	060766	1/1/0001
05800	S	M	OUG	II	00905	005		12	051066	1/1/0001

OFFICE: 311

ROUTE: 564

ST_REF_NO: 00000177000 SUMMERVILLE DRIVE

LUMENS	BULB TYPE	MULT SERIES	POLE TYPE	SHADE	ADDRESS NUMBER	REF	LOCATION	TAX DIST	DATE INST	DATE CHANGE
05800	S	M	OUG	II	00916	004		12	051066	1/1/0001

OFFICE: 311

ROUTE: 564

ST_REF_NO: 00000177100 SUMMIT DRIVE

LUMENS	BULB TYPE	MULT SERIES	POLE TYPE	SHADE	ADDRESS NUMBER	REF	LOCATION	TAX DIST	DATE INST	DATE CHANGE
05800	S	M	OUG	II	01200	001		12	020165	1/1/0001
05800	S	M	OUG	II	01200	002		12	020165	1/1/0001
05800	S	M	OUG	II	01217	000		12	030767	1/1/0001
05800	S	M	OUG	II	01230	000		12	120864	1/1/0001
05800	S	M	OUG	II	01241	000		12	020165	1/1/0001
05800	S	M	OUG	II	01252	000		12	120864	1/1/0001

OFFICE: 311

ROUTE: 564

ST_REF_NO: 00000177210 SUNCREST COURT

LUMENS	BULB TYPE	MULT SERIES	POLE TYPE	SHADE	ADDRESS NUMBER	REF	LOCATION	TAX DIST	DATE INST	DATE CHANGE
04000	S	M	SOH	II	00000	037	SIDE 129 PARIS AVE.	12	060685	1/1/0001
04000	S	M	SOH	II	01403	038		12	060685	1/1/0001

OFFICE: 311

ROUTE: 564

ST_REF_NO: 00000177300 SUNDART DRIVE

LUMENS	BULB TYPE	MULT SERIES	POLE TYPE	SHADE	ADDRESS NUMBER	REF	LOCATION	TAX DIST	DATE INST	DATE CHANGE
04000	S	M	OUG	II	00000	035	SIDE OF 3399 CARRIAGE LANE	12	120893	1/1/0001
04000	S	M	OUG	II	00000	046	SIDE OF 3344 CARRIAGE LANE	12	041478	1/1/0001
04000	S	M	OUG	II	03872	036		12	061580	1/1/0001
04000	S	M	OUG	II	03885	047		12	011579	1/1/0001
04000	S	M	OUG	II	03901	046		12	011579	1/1/0001
04000	S	M	OUG	II	03917	045		12	011579	1/1/0001
04000	S	M	OUG	II	03925	044		12	011579	1/1/0001

OFFICE: 311

ROUTE: 564

ST_REF_NO: 00000177325 SUNDROP PATH

LUMENS	BULB TYPE	MULT SERIES	POLE TYPE	SHADE	ADDRESS NUMBER	REF	LOCATION	TAX DIST	DATE INST	DATE CHANGE
05800	S		CNT	II	00501	021		12	071409	1/1/0001
05800	S	M	CNT	II	00512	003		12	111306	1/1/0001
05800	S	M	CNT	II	00524	002		12	111306	1/1/0001

OFFICE: 311 **ROUTE:** 564
ST_REF_NO: 00000177325 SUNDROP PATH

LUMENS	BULB TYPE	MULT SERIES	POLE TYPE	SHADE	ADDRESS NUMBER	REF	LOCATION	TAX DIST	DATE INST	DATE CHANGE
05800	S	M	CNT	II	00532	001		12	111306	1/1/0001

OFFICE: 311 **ROUTE:** 564
ST_REF_NO: 00000177350 SUNNINGDALE DRIVE

LUMENS	BULB TYPE	MULT SERIES	POLE TYPE	SHADE	ADDRESS NUMBER	REF	LOCATION	TAX DIST	DATE INST	DATE CHANGE
05800	S	M	CNT	II	02201	001		12	120404	1/1/0001
05800	S	M	CNT	II	02205	002		12	120404	1/1/0001
05800	S	M	CNT	II	02213	003		12	120404	1/1/0001
05800	S	M	CNT	II	02216	004		12	120404	1/1/0001
05800	S	M	CNT	II	02225	005		12	120404	1/1/0001
05800	S	M	CNT	II	02240	006		12	120404	1/1/0001
05800	S	M	CNT	II	02249	007		12	120404	1/1/0001
05800	S	M	CNT	II	02260	008		12	120404	1/1/0001
05800	S	M	CNT	II	02268	009		12	120404	1/1/0001
05800	S	M	CNT	II	02281	010		12	120404	1/1/0001
05800	S	M	CNT	II	02293	011		12	120404	1/1/0001
05800	S	M	CNT	III	02309	012		12	120404	1/1/0001

OFFICE: 311 **ROUTE:** 564
ST_REF_NO: 00000177351 SUNNINGDALE COURT

LUMENS	BULB TYPE	MULT SERIES	POLE TYPE	SHADE	ADDRESS NUMBER	REF	LOCATION	TAX DIST	DATE INST	DATE CHANGE
05800	S	M	CNT	III	03109	001		12	120404	1/1/0001

OFFICE: 311 **ROUTE:** 564
ST_REF_NO: 00000177370 SUNNY POINT

LUMENS	BULB TYPE	MULT SERIES	POLE TYPE	SHADE	ADDRESS NUMBER	REF	LOCATION	TAX DIST	DATE INST	DATE CHANGE
05800	S	M	OUG	II	04700	001		12	060897	1/1/0001
05800	S	M	OUG	III	04704	002		12	060897	1/1/0001

OFFICE: 311 **ROUTE:** 564
ST_REF_NO: 00000177380 SUNNY SLOPE TRACE

LUMENS	BULB TYPE	MULT SERIES	POLE TYPE	SHADE	ADDRESS NUMBER	REF	LOCATION	TAX DIST	DATE INST	DATE CHANGE
05800	S	M	CNT	II	00000	027	SIDE OF 4004 SWEETSPIRE DR ON SUNNY SLOPE TRACE	12	010808	1/1/0001
05800	S	M	CNT	II	00701	001		12	010808	1/1/0001

OFFICE: 311

ROUTE: 564

ST_REF_NO: 00000177380

SUNNY SLOPE TRACE

LUMENS	BULB TYPE	MULT SERIES	POLE TYPE	SHADE	ADDRESS NUMBER	REF	LOCATION	TAX DIST	DATE INST	DATE CHANGE
05800	S	M	CNT	II	00712	002		12	010808	1/1/0001
05800	S	M	CNT	II	00721	003		12	010808	1/1/0001
05800	S	M	CNT	II	00737	004		12	010808	1/1/0001
05800	S	M	CNT	II	00740	005		12	010808	1/1/0001
05800	S	M	CNT	II	00752	006		12	010808	1/1/0001
05800	S	M	CNT	II	00773	007		12	010808	1/1/0001
05800	S	M	CNT	II	00776	008		12	010808	1/1/0001
05800	S	M	CNT	II	00781	009		12	010808	1/1/0001
05800	S	M	CNT	II	00800	010		12	010808	1/1/0001
05800	S	M	CNT	II	00808	011		12	010808	1/1/0001
05800	S	M	CNT	II	00821	012		12	010808	1/1/0001
05800	S	M	CNT	II	00829	013		12	010808	1/1/0001
05800	S	M	CNT	II	00841	014		12	010808	1/1/0001
05800	S	M	CNT	II	00853	015		12	010808	1/1/0001
05800	S	M	CNT	II	00889	019		12	010808	1/1/0001
05800	S	M	CNT	II	00900	020		12	010808	1/1/0001
05800	S	M	CNT	II	00913	021		12	010808	1/1/0001
05800	S	M	CNT	II	00920	022		12	010808	1/1/0001
05800	S	M	CNT	II	00937	023		12	010808	1/1/0001
05800	S	M	CNT	II	00948	024		12	010808	1/1/0001
05800	S	M	CNT	II	00969	025		12	010808	1/1/0001
05800	S	M	CNT	II	00976	026		12	010808	1/1/0001

OFFICE: 311

ROUTE: 564

ST_REF_NO: 00000177395

SUN SEEKER COURT

LUMENS	BULB TYPE	MULT SERIES	POLE TYPE	SHADE	ADDRESS NUMBER	REF	LOCATION	TAX DIST	DATE INST	DATE CHANGE
05800	S	M	OUG	III	02509	005		12	052006	1/1/0001
05800	S	M	OUG	II	02525	004		12	052006	1/1/0001
05800	S	M	OUG	II	02537	003		12	052006	1/1/0001
05800	S	M	OUG	II	02552	002		12	052006	1/1/0001
05800	S	M	OUG	III	02569	001		12	052006	1/1/0001

OFFICE: 311		ROUTE: 564		ST_REF_NO: 00000177400		SUNSET DRIVE		LUMENS	BULB TYPE	MULT SERIES	POLE TYPE	SHADE	ADDRESS NUMBER	REF	LOCATION	TAX DIST	DATE INST	DATE CHANGE
05800	S	M	SOH	I	00802	006										12	032757	2/20/2013
04000	S	M	SOH	I	00000	001	SIDE OF 904 TATES CREEK									12	032757	1/1/0001
04000	S	M	SOH	I	00000	007	OPP. 745									12	032757	1/1/0001
04000	S	M	SOH	I	00700	014										12	022167	1/1/0001
04000	S	M	SOH	I	00707	013										12	032757	1/1/0001
04000	S	M	SOH	I	00712	012										12	032757	1/1/0001
04000	S	M	SOH	I	00714	011										12	032757	1/1/0001
04000	S	M	SOH	I	00722	010										12	032757	1/1/0001
04000	S	M	SOH	I	00726	009										12	031757	1/1/0001
04000	S	M	SOH	I	00730	008										12	032757	1/1/0001
04000	S	M	SOH	I	00812	005										12	032757	1/1/0001
04000	S	M	SOH	I	00816	004										12	032757	1/1/0001
04000	S	M	SOH	I	00822	003										12	032757	1/1/0001
04000	S	M	SOH	I	00830	002										12	032757	1/1/0001

OFFICE: 311

ROUTE: 564

OFFICE: 311		ROUTE: 564		ST_REF_NO: 00000177600		SURFSIDE DRIVE		LUMENS	BULB TYPE	MULT SERIES	POLE TYPE	SHADE	ADDRESS NUMBER	REF	LOCATION	TAX DIST	DATE INST	DATE CHANGE
05800	S	M	OUG	II	00000	088	SIDE OF 220 MALIBU DR.									12	100174	1/1/0001
05800	S	M	OUG	II	00000	089	OPP. 228									12	100967	1/1/0001
05800	S	M	OUG	II	00000	091	OPP. 168									12	100967	1/1/0001
05800	S	M	OUG	II	00000	093	OPP. 108									12	100967	1/1/0001
05800	S	M	OUG	II	00106	094										12	061968	1/1/0001
05800	S	M	OUG	II	00128	092										12	020168	1/1/0001
05800	S	M	OOH	II	00188	090										12	100967	1/1/0001

OFFICE: 311

ROUTE: 564

OFFICE: 311		ROUTE: 564		ST_REF_NO: 00000177700		SURREY LANE		LUMENS	BULB TYPE	MULT SERIES	POLE TYPE	SHADE	ADDRESS NUMBER	REF	LOCATION	TAX DIST	DATE INST	DATE CHANGE
04000	S	M	OUG	II	00000	007	SIDE OF 747 CINDY BLAIR WAY ON SURREY LANE									12	120890	1/1/0001
04000	S	M	OUG	II	00800	001										12	120890	1/1/0001
04000	S	M	OUG	II	00805	002										12	120890	1/1/0001
04000	S	M	OUG	II	00816	003										12	120890	1/1/0001
04000	S	M	OUG	II	00821	004										12	120890	1/1/0001

OFFICE: 311							ROUTE: 564			
ST_REF_NO: 00000177700							SURREY LANE			
LUMENS	BULB TYPE	MULT SERIES	POLE TYPE	SHADE	ADDRESS NUMBER	REF	LOCATION	TAX DIST	DATE INST	DATE CHANGE
04000	S	M	OUG	II	00828	005		12	120890	1/1/0001
04000	S	M	OUG	II	00833	006		12	120890	1/1/0001
OFFICE: 311							ROUTE: 564			
ST_REF_NO: 00000177800							SUTHERLAND DRIVE			
LUMENS	BULB TYPE	MULT SERIES	POLE TYPE	SHADE	ADDRESS NUMBER	REF	LOCATION	TAX DIST	DATE INST	DATE CHANGE
05800	S	M	OUG	II	00000	130	SIDE OF 1220 GAINESWAY DR.	12	030970	1/1/0001
05800	S	M	OUG	V	03252	162		12	100170	1/1/0001
05800	S	M	OUG	II	03259	161		12	120172	1/1/0001
05800	S	M	OUG	II	03276	160		12	120172	1/1/0001
05800	S	M	OUG	II	03283	159		12	041470	1/1/0001
05800	S	M	OUG	II	03296	015		12	090266	1/1/0001
05800	S	M	OUG	II	03303	138		12	110171	1/1/0001
05800	S	M	OUG	II	03316	137		12	120667	1/1/0001
05800	S	M	OUG	II	03327	012		12	090266	1/1/0001
05800	S	M	OUG	II	03338	135		12	110171	1/1/0001
05800	S	M	OUG	II	03355	134		12	120172	1/1/0001
05800	S	M	OUG	II	03368	133		12	042067	1/1/0001
05800	S	M	OUG	II	03379	008		12	090266	1/1/0001
05800	S	M	OUG	II	03392	131		12	110171	1/1/0001
05800	S	M	OUG	II	03411	198		12	030171	1/1/0001
05800	S	M	OUG	II	03420	199		12	051771	1/1/0001
05800	S	M	OUG	II	03435	200		12	081475	1/1/0001
05800	S	M	OUG	II	03464	201		12	072374	1/1/0001
05800	S	M	OUG	II	03467	202		12	081475	1/1/0001
05800	S	M	OUG	II	03520	203		12	080172	1/1/0001
OFFICE: 311							ROUTE: 564			
ST_REF_NO: 00000177900							SUTTON PLACE			
LUMENS	BULB TYPE	MULT SERIES	POLE TYPE	SHADE	ADDRESS NUMBER	REF	LOCATION	TAX DIST	DATE INST	DATE CHANGE
09500	S	M	OUG	II	00000	001	SIDE OF 224 MANDALAY RD.	12	120960	1/1/0001
09500	S	M	OUG	II	00000	003	SIDE OF 159 CHANTILLY ST.	12	092260	1/1/0001
09500	S	M	OUG	II	00109	000		12	100160	1/1/0001
09500	S	M	OUG	II	00219	000		12	092260	1/1/0001

OFFICE: 311		ROUTE: 564		ST_REF_NO: 00000177900		SUTTON PLACE		LUMENS	BULB TYPE	MULT SERIES	POLE TYPE	SHADE	ADDRESS NUMBER	REF	LOCATION	TAX DIST	DATE INST	DATE CHANGE
	09500	S	M	OUG	II	00226	000									12	100160	1/1/0001
	09500	S	M	SOH	II	00231	000									12	100160	1/1/0001
OFFICE: 311		ROUTE: 564		ST_REF_NO: 00000177985		SUZANNE CIRCLE		LUMENS	BULB TYPE	MULT SERIES	POLE TYPE	SHADE	ADDRESS NUMBER	REF	LOCATION	TAX DIST	DATE INST	DATE CHANGE
	05800	S	M	CNT	II	02700	001									12	071902	1/1/0001
	05800	S	M	CNT	III	02705	002									12	071902	1/1/0001
OFFICE: 311		ROUTE: 564		ST_REF_NO: 00000178000		SWANSEA COURT		LUMENS	BULB TYPE	MULT SERIES	POLE TYPE	SHADE	ADDRESS NUMBER	REF	LOCATION	TAX DIST	DATE INST	DATE CHANGE
	05800	S	M	OUG	II	00000	069	SIDE OF 1275 DEVONPORT								12	090170	1/1/0001
OFFICE: 311		ROUTE: 564		ST_REF_NO: 00000178150		SWEET CLOVER LANE		LUMENS	BULB TYPE	MULT SERIES	POLE TYPE	SHADE	ADDRESS NUMBER	REF	LOCATION	TAX DIST	DATE INST	DATE CHANGE
	05800	S		OUG	II	00000	007	SIDE OF 2101 MILLSTONE WAY, ON SWEET CLOVER LANE								12	111813	1/1/0001
	05800	S		OUG	II	00000	008	SIDE OF 2104 MILLSTONE WAY ON SWEET CLOVER LANE								12	111813	1/1/0001
	05800	S		OUG	II	03145	000									12	111813	1/1/0001
	05800	S		OUG	II	03161	001									12	111813	1/1/0001
	05800	S		OUG	II	03173	002									12	111813	1/1/0001
	05800	S		OUG	II	03193	003									12	111813	1/1/0001
	05800	S		OUG	II	03212	004									12	111813	1/1/0001
	05800	S		OUG	II	03221	005									12	111813	1/1/0001
	05800	S		OUG	II	03244	006									12	111813	1/1/0001
	05800	S		OUG	II	03288	009									12	111813	1/1/0001
	05800	S		OUG	II	03308	010									12	111813	1/1/0001
	05800	S		OUG	II	03325	011									12	111813	1/1/0001
	05800	S		OUG	II	03344	012									12	111813	1/1/0001
	05800	S		OUG	II	03360	013									12	111813	1/1/0001
	05800	S		OUG	II	03377	014									12	111813	1/1/0001

OFFICE: 311		ROUTE: 564		ST_REF_NO: 00000178200		SWEET WATER COURT		LUMENS	BULB TYPE	MULT SERIES	POLE TYPE	SHADE	ADDRESS NUMBER	REF	LOCATION	TAX DIST	DATE INST	DATE CHANGE
	04000	S	M	OUG	II	00000	116								SIDE OF 3272 BUCKHORN DR.	12	011581	1/1/0001
	04000	S	M	OUG	II	03216	117									12	091582	1/1/0001
OFFICE: 311		ROUTE: 564		ST_REF_NO: 00000178250		SWEET WILLIAM COURT		LUMENS	BULB TYPE	MULT SERIES	POLE TYPE	SHADE	ADDRESS NUMBER	REF	LOCATION	TAX DIST	DATE INST	DATE CHANGE
	04000	S	M	OUG	II	00000	002								OPP. 2920	12	110889	1/1/0001
	04000	S	M	OUG	II	00000	003								OPP. 2912	12	110889	1/1/0001
OFFICE: 311		ROUTE: 564		ST_REF_NO: 00000178300		SWEETBAY DRIVE		LUMENS	BULB TYPE	MULT SERIES	POLE TYPE	SHADE	ADDRESS NUMBER	REF	LOCATION	TAX DIST	DATE INST	DATE CHANGE
	04000	S	M	OUG	II	00000	074								SIDE OF 604 CENTENNIAL	12	061580	1/1/0001
	04000	S	M	OUG	II	00000	075								SIDE OF 620 SUMMERSHADE	12	061580	1/1/0001
OFFICE: 311		ROUTE: 564		ST_REF_NO: 00000178310		SWEETBERRY COURT		LUMENS	BULB TYPE	MULT SERIES	POLE TYPE	SHADE	ADDRESS NUMBER	REF	LOCATION	TAX DIST	DATE INST	DATE CHANGE
	05800	S	M	CNT	III	02204	001									12	100894	1/1/0001
OFFICE: 311		ROUTE: 564		ST_REF_NO: 00000178375		SWEETBRIAR CIRCLE		LUMENS	BULB TYPE	MULT SERIES	POLE TYPE	SHADE	ADDRESS NUMBER	REF	LOCATION	TAX DIST	DATE INST	DATE CHANGE
	04000	S	M	OUG	V	03904	001									12	100890	1/1/0001
OFFICE: 311		ROUTE: 564		ST_REF_NO: 00000178380		SWEETLEAF COURT		LUMENS	BULB TYPE	MULT SERIES	POLE TYPE	SHADE	ADDRESS NUMBER	REF	LOCATION	TAX DIST	DATE INST	DATE CHANGE
	05800	S	M	CNT	III	00000	001								SIDE 3977 PALOMAR BLVD.	12	100894	1/1/0001
OFFICE: 311		ROUTE: 564		ST_REF_NO: 00000178390		SWEETSPIRE DRIVE		LUMENS	BULB TYPE	MULT SERIES	POLE TYPE	SHADE	ADDRESS NUMBER	REF	LOCATION	TAX DIST	DATE INST	DATE CHANGE
	05800	S	M	CNT	II	00000	001								SIDE OF 885 SUNNY SLOPE TRACE ON SWEETSPIRE DR	12	111907	1/1/0001

OFFICE: 311

ROUTE: 564

ST_REF_NO: 00000178390

SWEETSPIRE DRIVE

LUMENS	BULB TYPE	MULT SERIES	POLE TYPE	SHADE	ADDRESS NUMBER	REF	LOCATION	TAX DIST	DATE INST	DATE CHANGE
05800	S	M	CNT	II	03909	002		12	111907	1/1/0001
05800	S	M	CNT	II	03920	003		12	111907	1/1/0001
05800	S	M	CNT	II	03933	004		12	111907	1/1/0001
05800	S	M	CNT	II	03948	005		12	111907	1/1/0001
05800	S	M	CNT	II	03961	006		12	111907	1/1/0001
05800	S	M	CNT	II	03976	007		12	111907	1/1/0001
05800	S	M	CNT	II	03996	008		12	111907	1/1/0001
05800	S	M	CNT	II	04009	009		12	111907	1/1/0001
05800	S	M	CNT	II	04025	010		12	111907	1/1/0001

OFFICE: 311

ROUTE: 564

ST_REF_NO: 00000178400

SWEETWOOD PLACE

LUMENS	BULB TYPE	MULT SERIES	POLE TYPE	SHADE	ADDRESS NUMBER	REF	LOCATION	TAX DIST	DATE INST	DATE CHANGE
05800	S	M	OUG	V	00201	023		12	021582	1/1/0001

OFFICE: 311

ROUTE: 564

ST_REF_NO: 00000178500

SWIGERT AVENUE

LUMENS	BULB TYPE	MULT SERIES	POLE TYPE	SHADE	ADDRESS NUMBER	REF	LOCATION	TAX DIST	DATE INST	DATE CHANGE
05800	S	M	OUG	II	00700	009		12	052068	1/1/0001
05800	S	M	OUG	II	00716	010		12	050969	1/1/0001
05800	S	M	OUG	II	00748	011		12	050969	1/1/0001
05800	S	M	OUG	II	00768	012		12	120167	1/1/0001

OFFICE: 311

ROUTE: 564

ST_REF_NO: 00000178700

SYCAMORE ROAD

LUMENS	BULB TYPE	MULT SERIES	POLE TYPE	SHADE	ADDRESS NUMBER	REF	LOCATION	TAX DIST	DATE INST	DATE CHANGE
05800	S	M	OUG	II	00000	001	OPP. THE SIDE OF 1310 RICHMOND RD.	12	010865	1/1/0001
05800	S	M	OUG	II	00000	002	OPP. 115	12	010865	1/1/0001
05800	S	M	OUG	II	00000	003	OPP. 121	12	010865	1/1/0001
05800	S	M	OUG	II	00000	004	OPP. 129	12	050365	1/1/0001
05800	S	M	OUG	II	00000	005	SYCAMORE & FINCASTLE, NE CORNER	12	050365	1/1/0001
05800	S	M	OUG	II	00207	006		12	040165	1/1/0001
05800	S	M	OUG	II	00220	007		12	040165	1/1/0001
05800	S	M	OUG	II	00233	008		12	040165	1/1/0001

OFFICE: 311		ROUTE: 564		ST_REF_NO: 00000178700		SYCAMORE ROAD		LUMENS	BULB TYPE	MULT SERIES	POLE TYPE	SHADE	ADDRESS NUMBER	REF	LOCATION	TAX DIST	DATE INST	DATE CHANGE
	05800	S	M	OUG	II	00320	009									12	040165	1/1/0001
	05800	S	M	OUG	II	00329	010									12	040165	1/1/0001

OFFICE: 311		ROUTE: 564		ST_REF_NO: 00000178705		SYMONS CIRCLE		LUMENS	BULB TYPE	MULT SERIES	POLE TYPE	SHADE	ADDRESS NUMBER	REF	LOCATION	TAX DIST	DATE INST	DATE CHANGE
	05800	S	M	CNT	III	03101	001									12	113005	1/1/0001

OFFICE: 311		ROUTE: 564		ST_REF_NO: 00000178710		SYRINGA DRIVE		LUMENS	BULB TYPE	MULT SERIES	POLE TYPE	SHADE	ADDRESS NUMBER	REF	LOCATION	TAX DIST	DATE INST	DATE CHANGE
	05800	S	M	CNT	II	00000	001								SIDE 4132 PALOMAR BLVD.	12	100894	1/1/0001
	05800	S	M	CNT	II	04088	002									12	100894	1/1/0001

OFFICE: 311		ROUTE: 564		ST_REF_NO: 00000178750		TABASAW COURT		LUMENS	BULB TYPE	MULT SERIES	POLE TYPE	SHADE	ADDRESS NUMBER	REF	LOCATION	TAX DIST	DATE INST	DATE CHANGE
	04000	S	M	OUG	II	00000	001								SIDE OF 3900 FOREST GREEN	12	120887	1/1/0001

OFFICE: 311		ROUTE: 564		ST_REF_NO: 00000178800		TAHOE ROAD		LUMENS	BULB TYPE	MULT SERIES	POLE TYPE	SHADE	ADDRESS NUMBER	REF	LOCATION	TAX DIST	DATE INST	DATE CHANGE
	04000	S	M	OUG	II	03313	127									12	110884	1/1/0001
	04000	S	M	OUG	II	03320	126									12	041581	1/1/0001
	04000	S	M	OUG	II	03341	125									12	011581	1/1/0001

OFFICE: 311		ROUTE: 564		ST_REF_NO: 00000178900		TAHOMA ROAD		LUMENS	BULB TYPE	MULT SERIES	POLE TYPE	SHADE	ADDRESS NUMBER	REF	LOCATION	TAX DIST	DATE INST	DATE CHANGE
	04000	S	M	OUG	II	00000	002								OPP. 246	12	120888	1/1/0001
	04000	S	M	OOH	II	00000	015								102, IN MEDIAN	12	120888	1/1/0001
	04000	S	M	OOH	II	00000	016								102, IN MEDIAN	12	120888	1/1/0001
	04000	S	M	OUG	II	00000	017								SIDE OF 1900 NICHOLASVILLE RD., IN MEDIAN	12	120888	1/1/0001
	04000	S	M	OUG	II	00000	018								SIDE OF 1900 NICHOLASVILLE RD., IN MEDIAN	12	120888	1/1/0001
	04000	S	M	SOH	II	00105	014									12	120888	1/1/0001

OFFICE: 311

ROUTE: 564

ST_REF_NO: 00000178900

TAHOMA ROAD

LUMENS	BULB TYPE	MULT SERIES	POLE TYPE	SHADE	ADDRESS NUMBER	REF	LOCATION	TAX DIST	DATE INST	DATE CHANGE
04000	S	M	SOH	II	00111	013		12	120888	1/1/0001
04000	S	M	OOH	II	00120	012		12	120888	1/1/0001
04000	S	M	SOH	II	00121	011		12	120888	1/1/0001
04000	S	M	OOH	II	00134	010		12	120888	1/1/0001
04000	S	M	SOH	II	00201	009		12	120888	1/1/0001
04000	S	M	OUG	II	00205	008		12	120888	1/1/0001
04000	S	M	OUG	II	00213	007		12	120888	1/1/0001
04000	S	M	OUG	II	00220	006		12	120888	1/1/0001
04000	S	M	OOH	II	00230	005		12	120888	1/1/0001
04000	S	M	OUG	II	00236	004		12	120888	1/1/0001
04000	S	M	OUG	II	00241	003		12	120888	1/1/0001
04000	S	M	OUG	II	00251	001		12	120888	1/1/0001

OFFICE: 311

ROUTE: 564

ST_REF_NO: 00000179000

TALISMAN ROAD

LUMENS	BULB TYPE	MULT SERIES	POLE TYPE	SHADE	ADDRESS NUMBER	REF	LOCATION	TAX DIST	DATE INST	DATE CHANGE
05800	S	M	OUG	II	00000	109	SIDE OF 2156 GARDEN SPRINGS DR.	12	090363	1/1/0001
05800	S	M	OUG	II	02113	000		12	090164	1/1/0001
05800	S	M	OUG	II	02124	000		12	111565	1/1/0001
05800	S	M	OUG	II	02137	000		12	111565	1/1/0001

OFFICE: 311

ROUTE: 564

ST_REF_NO: 00000179090

TALLOW COURT

LUMENS	BULB TYPE	MULT SERIES	POLE TYPE	SHADE	ADDRESS NUMBER	REF	LOCATION	TAX DIST	DATE INST	DATE CHANGE
05800	S		CNT	III	00600	003		12	061710	1/1/0001
05800	S		CNT	II	00613	002		12	061710	1/1/0001
05800	S		CNT	II	00620	001		12	061710	1/1/0001

OFFICE: 311

ROUTE: 564

ST_REF_NO: 00000179100

TALLY ROAD

LUMENS	BULB TYPE	MULT SERIES	POLE TYPE	SHADE	ADDRESS NUMBER	REF	LOCATION	TAX DIST	DATE INST	DATE CHANGE
04000	S	M	OUG	II	00000	009	SIDE OF 616 TEAKWOOD DR.	12	111580	1/1/0001
04000	S	M	OUG	II	00609	000		12	121673	1/1/0001
04000	S	M	OUG	II	00620	000		12	121673	1/1/0001

OFFICE: 311

ROUTE: 564

ST_REF_NO: 00000179100 TALLY ROAD

LUMENS	BULB TYPE	MULT SERIES	POLE TYPE	SHADE	ADDRESS NUMBER	REF	LOCATION	TAX DIST	DATE INST	DATE CHANGE
04000	S	M	OUG	II	00629	000		12	121673	1/1/0001
04000	S	M	OUG	II	00636	000		12	121673	1/1/0001
04000	S	M	OUG	II	00641	000		12	121673	1/1/0001
04000	S	M	OUG	II	00648	039		12	051475	1/1/0001
04000	S	M	OUG	II	00657	040		12	111478	1/1/0001
04000	S	M	OUG	II	00664	085		12	061580	1/1/0001

OFFICE: 311

ROUTE: 564

ST_REF_NO: 00000179200 TAMARACK COURT

LUMENS	BULB TYPE	MULT SERIES	POLE TYPE	SHADE	ADDRESS NUMBER	REF	LOCATION	TAX DIST	DATE INST	DATE CHANGE
05800	S	M	OUG	II	02036	063		12	090363	1/1/0001

OFFICE: 311

ROUTE: 564

ST_REF_NO: 00000179300 TAMARACK DRIVE

LUMENS	BULB TYPE	MULT SERIES	POLE TYPE	SHADE	ADDRESS NUMBER	REF	LOCATION	TAX DIST	DATE INST	DATE CHANGE
05800	S	M	OUG	II	00000	039	SIDE OF 874 HONEYSUCKLE	12	102263	1/1/0001
05800	S	M	OUG	II	00000	067	TAMARACK & GARDEN SPRINGS DR.	12	102263	1/1/0001
05800	S	M	OUG	II	02008	040		12	120162	1/1/0001
05800	S	M	OUG	II	02019	041		12	102263	1/1/0001
05800	S	M	OUG	II	02031	062		12	090164	1/1/0001
05800	S	M	OUG	II	02047	064		12	090164	1/1/0001
05800	S	M	OUG	II	02062	065		12	102263	1/1/0001
05800	S	M	OUG	II	02075	066		12	090164	1/1/0001
05800	S	M	OUG	II	02107	134		12	090164	1/1/0001
05800	S	M	OUG	II	02116	135		12	090164	1/1/0001
05800	S	M	OUG	II	02131	136		12	090164	1/1/0001
05800	S	M	OUG	II	02140	137		12	080164	1/1/0001
05800	S	M	OUG	II	02159	138		12	080164	1/1/0001

OFFICE: 311

ROUTE: 564

ST_REF_NO: 00000179350 TAMMY COURT

LUMENS	BULB TYPE	MULT SERIES	POLE TYPE	SHADE	ADDRESS NUMBER	REF	LOCATION	TAX DIST	DATE INST	DATE CHANGE
05800	S	M	OUG	II	00000	135	SIDE OF 1289 WARD DR.	12	100374	1/1/0001
05800	S	M	OUG	V	01273	136		12	100774	1/1/0001

OFFICE: 311		ROUTE: 564		ST_REF_NO: 00000179400		TAMPA COURT		LUMENS	BULB TYPE	MULT SERIES	POLE TYPE	SHADE	ADDRESS NUMBER	REF	LOCATION	TAX DIST	DATE INST	DATE CHANGE
	05800	S	M	OUG	II	01505	000									12	090866	1/1/0001

OFFICE: 311		ROUTE: 564		ST_REF_NO: 00000179500		TANBARK ROAD		LUMENS	BULB TYPE	MULT SERIES	POLE TYPE	SHADE	ADDRESS NUMBER	REF	LOCATION	TAX DIST	DATE INST	DATE CHANGE
	05800	S	M	CNT	II	00984	103									12	082203	1/1/0001
	05800	S	M	CNT	II	00992	102									12	082203	1/1/0001
	05800	S	M	CNT	II	01004	101									12	082203	1/1/0001
	05800	S	M	CNT	II	01012	100									12	082203	1/1/0001
	04000	S	M	OUG	II	00000	010							OPP. 1124		12	010893	1/1/0001
	05800	S	M	OUG	II	00000	015							SIDE REAR OF 1109 SHAGBARK LANE		12	070896	1/1/0001
	05800	S	M	OUG	II	00000	016							SIDE REAR OF 1124 SHAGBARK LANE		12	070896	1/1/0001
	05800	S	M	CNT	II	00000	043							SIDE OF 1125 FOUR WYNDYS TRAIL		12	080897	1/1/0001
	05800	S	M	CNT	II	00948	042									12	080897	1/1/0001
	05800	S	M	CNT	II	00964	041									12	080897	1/1/0001
	05800	S	M	CNT	II	00976	040									12	080897	1/1/0001
	05800	S	M	OUG	II	01017	023									12	110893	1/1/0001
	05800	S	M	OUG	II	01040	022									12	110893	1/1/0001
	05800	S	M	SOH	II	01049	020									12	110893	1/1/0001
	05800	S	M	OUG	II	01052	021									12	110893	1/1/0001
	04000	S	M	OUG	II	01065	018									12	010893	1/1/0001
	04000	S	M	OUG	II	01068	019									12	010893	1/1/0001
	04000	S	M	OUG	II	01069	017									12	100890	1/1/0001
	04000	S	M	OUG	II	01093	014									12	100890	1/1/0001
	04000	S	M	OUG	II	01112	013									12	100890	1/1/0001
	05800	S	M	OUG	II	01117	012									12	070896	1/1/0001
	05800	S	M	OUG	II	01124	011									12	070896	1/1/0001
	04000	S	M	OUG	II	01128	009									12	060887	1/1/0001
	04000	S	M	OUG	II	01136	008									12	060887	1/1/0001
	04000	S	M	OUG	II	01144	007									12	050893	1/1/0001
	04000	S	M	OUG	II	01149	006									12	060887	1/1/0001
	04000	S	M	OUG	II	01156	005									12	060887	1/1/0001
	04000	S	M	OUG	II	01165	004									12	060887	1/1/0001
	04000	S	M	OUG	II	01172	003									12	060887	1/1/0001

OFFICE: 311

ROUTE: 564

ST_REF_NO: 00000179500 TANBARK ROAD

LUMENS	BULB TYPE	MULT SERIES	POLE TYPE	SHADE	ADDRESS NUMBER	REF	LOCATION	TAX DIST	DATE INST	DATE CHANGE
04000	S	M	OUG	II	01177	002		12	060887	1/1/0001
04000	S	M	OUG	II	01184	001		12	060887	1/1/0001

OFFICE: 311

ROUTE: 564

ST_REF_NO: 00000179600 TANFORAN DRIVE

LUMENS	BULB TYPE	MULT SERIES	POLE TYPE	SHADE	ADDRESS NUMBER	REF	LOCATION	TAX DIST	DATE INST	DATE CHANGE
04000	S	M	OUG	V	01280	000		12	051074	1/1/0001
04000	S	M	OUG	II	01288	000		12	072374	1/1/0001
04000	S	M	OUG	II	01301	000		12	051074	1/1/0001
04000	S	M	OUG	II	01304	000		12	120172	1/1/0001
04000	S	M	OUG	II	01313	000		12	051074	1/1/0001
04000	S	M	OUG	II	01324	000		12	051074	1/1/0001
04000	S	M	OUG	II	01333	000		12	072474	1/1/0001
04000	S	M	OUG	II	01344	000		12	072374	1/1/0001
04000	S	M	OUG	II	01356	000		12	072474	1/1/0001
04000	S	M	OUG	II	01368	000		12	072374	1/1/0001
04000	S	M	OUG	II	01380	000		12	051074	1/1/0001
04000	S	M	OUG	II	01388	000		12	051074	1/1/0001

OFFICE: 311

ROUTE: 564

ST_REF_NO: 00000179650 TANGLE HURST LANE

LUMENS	BULB TYPE	MULT SERIES	POLE TYPE	SHADE	ADDRESS NUMBER	REF	LOCATION	TAX DIST	DATE INST	DATE CHANGE
05800	S	M	CNT	III	04500	005		12	061501	1/1/0001
05800	S	M	CNT	II	00000	002	SIDE OF 701 ST. ELIAS DR.	12	080800	1/1/0001
05800	S	M	CNT	II	04450	001		12	080897	1/1/0001
05800	S	M	CNT	II	04475	003		12	080800	1/1/0001
05800	S	M	CNT	II	04478	004		12	080800	1/1/0001

OFFICE: 311

ROUTE: 564

ST_REF_NO: 00000179800 TANGLEY WAY

LUMENS	BULB TYPE	MULT SERIES	POLE TYPE	SHADE	ADDRESS NUMBER	REF	LOCATION	TAX DIST	DATE INST	DATE CHANGE
04000	S	M	OUG	II	00000	056	SIDE OF 3861 WALHAMPTON	12	020887	1/1/0001
04000	S	M	OUG	II	00000	066	SIDE OF 367	12	020887	1/1/0001
04000	S	M	OUG	II	00267	057		12	020887	1/1/0001

OFFICE: 311

ROUTE: 564

ST_REF_NO: 00000179800 TANGLEY WAY

LUMENS	BULB TYPE	MULT SERIES	POLE TYPE	SHADE	ADDRESS NUMBER	REF	LOCATION	TAX DIST	DATE INST	DATE CHANGE
04000	S	M	OUG	II	00278	058		12	020887	1/1/0001
04000	S	M	OUG	II	00291	059		12	020887	1/1/0001
04000	S	M	OUG	II	00302	060		12	020887	1/1/0001
04000	S	M	OUG	II	00310	061		12	020887	1/1/0001
04000	S	M	OUG	II	00331	062		12	020887	1/1/0001
04000	S	M	OUG	II	00342	063		12	020887	1/1/0001
04000	S	M	OUG	II	00351	064		12	020887	1/1/0001
04000	S	M	OUG	II	00366	065		12	020887	1/1/0001

OFFICE: 311

ROUTE: 564

ST_REF_NO: 00000179900 TANNER COURT

LUMENS	BULB TYPE	MULT SERIES	POLE TYPE	SHADE	ADDRESS NUMBER	REF	LOCATION	TAX DIST	DATE INST	DATE CHANGE
05800	S	M	OUG	II	02699	000		12	061269	1/1/0001

OFFICE: 311

ROUTE: 564

ST_REF_NO: 00000179950 TARA LANE

LUMENS	BULB TYPE	MULT SERIES	POLE TYPE	SHADE	ADDRESS NUMBER	REF	LOCATION	TAX DIST	DATE INST	DATE CHANGE
05800	S	M	OUG	II	02021	012	bad fixture	12	080891	1/17/2010
04000	S	M	OUG	II	00000	010	SIDE OF 3909 GLADMAN WAY	12	111579	1/1/0001
05800	S	M	OUG	II	00000	013	SIDE OF 3932 FORSYTHE DR.	12	070893	1/1/0001
04000	S	M	OUG	II	02009	011		12	080891	1/1/0001

OFFICE: 311

ROUTE: 564

ST_REF_NO: 00000180000 TARLETON COURT

LUMENS	BULB TYPE	MULT SERIES	POLE TYPE	SHADE	ADDRESS NUMBER	REF	LOCATION	TAX DIST	DATE INST	DATE CHANGE
04000	S	M	OUG	II	00000	001	SIDE OF 1023 DELLA DR.	12	020889	1/1/0001
04000	S	M	OUG	II	01708	004		12	020889	1/1/0001
04000	S	M	OUG	II	01720	003		12	020889	1/1/0001
04000	S	M	OUG	II	01732	002		12	020889	1/1/0001

OFFICE: 311

ROUTE: 564

ST_REF_NO: 00000180100 TARTAN DRIVE

LUMENS	BULB TYPE	MULT SERIES	POLE TYPE	SHADE	ADDRESS NUMBER	REF	LOCATION	TAX DIST	DATE INST	DATE CHANGE
09500	S	M	SOH	II	00000	010	SIDE OF 127 TARTAN DRIVE	12	092104	1/1/0001
05800	S	M	OUG	II	00000	017	OPP. 103-upgrade due to car accident	12	110885	5/31/2011

OFFICE: 311

ROUTE: 564

ST_REF_NO: 00000180100

TARTAN DRIVE

LUMENS	BULB TYPE	MULT SERIES	POLE TYPE	SHADE	ADDRESS NUMBER	REF	LOCATION	TAX DIST	DATE INST	DATE CHANGE
04000	S	M	OUG	II	00000	018	OPP. 107	12	110885	1/1/0001
04000	S	M	OUG	II	00115	019		12	010886	1/1/0001
04000	S	M	OUG	II	00124	020		12	010886	1/1/0001
04000	S	M	OUG	II	00135	021		12	010886	1/1/0001
04000	S	M	OUG	II	00000	022	SIDE 2900 ARGYLE DR.	12	010886	1/1/0001
04000	S	M	OUG	II	00000	074	OPP. 176	12	060886	1/1/0001
04000	S	M	OUG	II	00000	075	OPP. 184	12	060886	1/1/0001
04000	S	M	OUG	II	00159	023		12	010886	1/1/0001
04000	S	M	OUG	II	00171	024		12	010886	1/1/0001

OFFICE: 311

ROUTE: 564

ST_REF_NO: 00000180200

TATES CREEK PIKE

LUMENS	BULB TYPE	MULT SERIES	POLE TYPE	SHADE	ADDRESS NUMBER	REF	LOCATION	TAX DIST	DATE INST	DATE CHANGE
05800	S	M	SOH	II	00000	003	ACROSS FROM 3732 OLD TATES CRK PIKE	12	112603	1/1/0001
05800	S	M	SOH	II	00000	004	ACROSS FROM 3752 OLD TATES CRK PIKE	12	112603	1/1/0001
05800	S	M	SOH	II	00000	005	ACROSS FROM 3788 OLD TATES CRK PIKE	12	112603	1/1/0001
05800	S	M	SOH	II	00000	006	ACROSS FROM LANTERN CREEK CT ON OLD TATES CRK PIKE	12	112603	1/1/0001
05800	S	M	SOH	II	00000	007	ACROSS FROM 3816 OLD TATES CRK PIKE	12	112603	1/1/0001
05800	S	M	SOH	II	00000	008	ACROSS FROM JONESTOWN LN ON OLD TATES CRK PIKE	12	112603	1/1/0001
05800	S	M	SOH	II	00000	010	ACROSS FROM 3700 OLD TATES CRK PIKE	12	112603	1/1/0001
05800	S	M	SOH	II	03700	009		12	112603	1/1/0001

OFFICE: 311

ROUTE: 564

ST_REF_NO: 00000180300

TATES CREEK ROAD

LUMENS	BULB TYPE	MULT SERIES	POLE TYPE	SHADE	ADDRESS NUMBER	REF	LOCATION	TAX DIST	DATE INST	DATE CHANGE
22000	S	M	OUG	II	00000	004	OPP. 1700-bad fixture	12	091477	3/2/2009
22000	S	M	OUG	II	00000	119	2ND LT S OF REDDING RD W SIDE ON TATES CREEK RD	12	083101	1/1/0001
22000	S	M	OUG	II	00000	121	3RD LT S OF REDDING RD W SIDE ON TATES CREEK RD	12	083101	1/1/0001
22000	S	S	OOH	III	00901	167	moved from East High 2/2005	12	101165	4/4/2013
50000	S	S	OOH	III	01482	178	moved from East High, 2/2005	12	101165	10/20/2012
22000	S	M	SOH	II	01546	263		12	081705	1/1/0001
22000	S	M	OOH	II	02709	030		12	091477	11/14/2013

Street Light Listing run 1/11/2015 10:43:21 AM

Page 1098 of 1254

OFFICE: 311

ROUTE: 564

ST_REF_NO: 00000180300

TATES CREEK ROAD

LUMENS	BULB TYPE	MULT SERIES	POLE TYPE	SHADE	ADDRESS NUMBER	REF	LOCATION	TAX DIST	DATE INST	DATE CHANGE
22000	S	M	OUG	II	03100	052	bad fixture	12	091477	1/3/2011
22000	S	M	OUG	II	03226	070		12	091477	10/9/2013
22000	S	M	OUG	II	03228	068		12	091477	10/9/2013
22000	S	M	OUG	II	03300	078	bad fixture	12	091477	3/2/2009
22000	S	M	OUG	II	03380	088		12	091477	10/8/2011
22000	S	M	OUG	II	03498	100		12	091477	4/12/2012
22000	S	M	OUG	II	00000	128	6TH LT. S OF ARMSTRONG MILL, EASTSIDE	12	030896	1/1/0001
22000	S	M	OUG	II	00000	231	2ND LT. N OF HARTLAND PKWY, W SIDE	12	020801	1/1/0001
22000	S	M	OUG	II	00000	233	1ST LT. N OF HARTLAND PKWY, W SIDE	12	020801	1/1/0001
22000	S	M	OUG	II	00000	236	1ST LT. S OF HARTLAND PKWY, E SIDE	12	020801	1/1/0001
20000	M	M	OOH	III	00914	168	moved from East High 2/2005	12	110965	1/1/0001
20000	M	M	OOH	III	01003	169	moved from East High, 2/2005	12	101165	1/1/0001
20000	M	M	SOH	III	01010	170	moved from East High, 2/2005	12	110165	1/1/0001
20000	M	M	SOH	III	01015	171	moved from East High, 2/2005	12	110165	1/1/0001
20000	M	S	SOH	III	01104	172	moved from East High, 2/2005	12	110165	1/1/0001
20000	M	S	OOH	III	01116	173	moved from East High, 2/2005	12	101165	1/1/0001
20000	M	S	SOH	III	01200	174	moved from East High, 2/2005	12	110165	1/1/0001
20000	M	S	SOH	III	01216	176	moved from East High, 2/2005	12	110165	1/1/0001
20000	M	S	OOH	III	01415	177	moved from East High, 2/2005	12	101165	1/1/0001
20000	M	S	OOH	III	01481	179	moved from East High, 2/2005	12	101165	1/1/0001
20000	M	M	OOH	III	01500	180	moved from East High, 2/2005	12	110965	1/1/0001
20000	M	M	OUG	II	00000	002	OPP. 1620	12	091477	1/1/0001
22000	S	M	OUG	II	00000	006	OPP. 1700	12	091477	1/1/0001
20000	M	M	OUG	II	00000	008	OPP. 1704	12	091477	1/1/0001
20000	M	M	OUG	II	00000	010	OPP. 1708	12	091477	1/1/0001
20000	M	M	OUG	II	00000	012	OPP. 1750	12	091477	1/1/0001
20000	M	M	OUG	II	00000	014	OPP. 1763	12	091477	1/1/0001
20000	M	M	OUG	II	00000	017	OPP. 1781	12	091477	1/1/0001
20000	M	M	OUG	II	00000	019	OPP. 1789	12	091477	1/1/0001
20000	M	M	OUG	II	00000	023	SE CORNER OF TATES CREEK & NEW MT. TABOR RD.	12	051582	1/1/0001
20000	M	M	OUG	II	00000	027	OPP. 2655	12	091477	1/1/0001
20000	M	M	OUG	II	00000	029	OPP. 2705	12	091477	1/1/0001
20000	M	M	OUG	II	00000	031	OPP. 2709	12	091477	1/1/0001

OFFICE: 311

ROUTE: 564

ST_REF_NO: 00000180300

TATES CREEK ROAD

LUMENS	BULB TYPE	MULT SERIES	POLE TYPE	SHADE	ADDRESS NUMBER	REF	LOCATION	TAX DIST	DATE INST	DATE CHANGE
20000	M	M	OUG	II	00000	032	OPP. 2721	12	091477	1/1/0001
20000	M	M	OUG	II	00000	034	OPP. 2721	12	091477	1/1/0001
22000	S	M	OUG	II	00000	036	OPP. OLD DOBBIN RD.mv changeout	12	030893	1/1/0001
20000	M	M	OUG	II	00000	038	OPP. 2805	12	030893	1/1/0001
20000	M	M	OUG	II	00000	040	NE CORNER OF OLD MT. TABOR & TATES CREEK	12	091477	1/1/0001
20000	M	M	SOH	II	00000	041	OPP. OLD MT. TABOR RD.	12	091477	1/1/0001
20000	M	M	OOH	II	00000	043	OPP. 2910	12	091477	1/1/0001
20000	M	M	OOH	III	01554	182	moved from East High, 2/2005	12	110965	1/1/0001
20000	M	M	OOH	III	01557	183	moved from East High, 2/2005	12	110965	1/1/0001
20000	M	M	OUG	III	01600	184	moved from East High, 2/2005	12	110965	1/1/0001
20000	M	M	OUG	II	01609	185	moved from East High, 2/2005	12	070176	1/1/0001
20000	M	M	OOH	II	01620	003		12	091477	1/1/0001
20000	M	M	OOH	II	01700	005		12	091477	1/1/0001
20000	M	M	SOH	II	01704	007		12	091477	1/1/0001
20000	M	M	OOH	II	01708	011		12	091477	1/1/0001
20000	M	M	SOH	II	01750	013		12	091477	1/1/0001
20000	M	M	SOH	II	01763	015		12	091477	1/1/0001
20000	M	M	OOH	II	01781	016		12	091477	1/1/0001
20000	M	M	OOH	II	01789	018		12	091477	1/1/0001
20000	M	M	OOH	II	01789	020		12	091477	1/1/0001
20000	M	M	OUG	II	01833	021		12	091477	1/1/0001
20000	M	M	OUG	II	01833	025		12	091477	1/1/0001
20000	M	M	SOH	II	02645	022		12	091477	1/1/0001
20000	M	M	SOH	II	02655	024		12	091477	1/1/0001
20000	M	M	OOH	II	02655	026		12	091477	1/1/0001
20000	M	M	SOH	II	02705	028		12	091477	1/1/0001
20000	M	M	SOH	II	02721	033		12	091477	1/1/0001
20000	M	M	OOH	II	02725	035		12	091477	1/1/0001
20000	M	M	OOH	II	02801	037		12	091477	1/1/0001
20000	M	M	OOH	II	02805	039		12	091477	1/1/0001
20000	M	M	OOH	II	02910	042		12	091477	1/1/0001
20000	M	M	OOH	II	02995	045		12	091477	1/1/0001
20000	M	M	SOH	II	03005	047		12	091477	1/1/0001
20000	M	M	SOH	II	03025	049		12	091477	1/1/0001

OFFICE: 311

ROUTE: 564

ST_REF_NO: 00000180300

TATES CREEK ROAD

LUMENS	BULB TYPE	MULT SERIES	POLE TYPE	SHADE	ADDRESS NUMBER	REF	LOCATION	TAX DIST	DATE INST	DATE CHANGE
20000	M	M	OOH	II	03025	051		12	091477	1/1/0001
20000	M	M	OUG	II	03100	044		12	091477	1/1/0001
20000	M	M	OUG	II	03100	046		12	091477	1/1/0001
20000	M	M	OUG	II	03100	048		12	091477	1/1/0001
20000	M	M	OUG	II	03100	050		12	091477	1/1/0001
20000	M	M	OOH	II	03033	053		12	091477	1/1/0001
20000	M	M	OOH	II	03037	055		12	091477	1/1/0001
20000	M	M	OOH	II	03045	057		12	091477	1/1/0001
20000	M	M	OOH	II	03101	059		12	091477	1/1/0001
20000	M	M	SOH	II	03109	061		12	091477	1/1/0001
20000	M	M	OUG	II	03150	054		12	100896	1/1/0001
20000	M	M	OUG	II	03150	056		12	091477	1/1/0001
20000	M	M	OUG	II	03200	058		12	091477	1/1/0001
20000	M	M	OOH	II	03201	063		12	091477	1/1/0001
20000	M	M	OUG	II	03202	060		12	091477	1/1/0001
20000	M	M	OUG	II	03204	062		12	091477	1/1/0001
20000	M	M	OOH	II	03205	065		12	091477	1/1/0001
20000	M	M	OUG	II	03208	064		12	091477	1/1/0001
20000	M	M	OUG	II	03212	066		12	091477	1/1/0001
20000	M	M	OOH	II	03217	067		12	091477	1/1/0001
20000	M	M	SOH	II	03225	069		12	091477	1/1/0001
20000	M	M	OOH	II	03245	071		12	091477	1/1/0001
20000	M	M	SOH	II	03249	077		12	091477	1/1/0001
20000	M	M	OUG	II	03252	072		12	091477	1/1/0001
20000	M	M	OUG	II	03252	074		12	091477	1/1/0001
20000	M	M	OOH	II	03257	073		12	091477	1/1/0001
20000	M	M	OOH	II	03263	075		12	091477	1/1/0001
20000	M	M	OUG	II	03300	076		12	091477	1/1/0001
20000	M	M	OOH	II	03301	079		12	091477	1/1/0001
20000	M	M	SOH	II	03315	081		12	091477	1/1/0001
20000	M	M	OUG	II	03320	080		12	091477	1/1/0001
20000	M	M	OOH	II	03331	083		12	091477	1/1/0001
20000	M	M	OOH	II	03331	085		12	091477	1/1/0001
20000	M	M	SOH	II	03331	087		12	091477	1/1/0001

OFFICE: 311

ROUTE: 564

ST_REF_NO: 00000180300

TATES CREEK ROAD

LUMENS	BULB TYPE	MULT SERIES	POLE TYPE	SHADE	ADDRESS NUMBER	REF	LOCATION	TAX DIST	DATE INST	DATE CHANGE
20000	M	M	OOH	II	03331	089		12	091477	1/1/0001
20000	M	M	OOH	II	03331	091		12	091477	1/1/0001
20000	M	M	OUG	II	03346	082		12	091477	1/1/0001
20000	M	M	OUG	II	03346	084		12	091477	1/1/0001
20000	M	M	OUG	II	03368	086		12	091477	1/1/0001
20000	M	M	OUG	II	03380	090		12	091477	1/1/0001
20000	M	M	OUG	II	03380	092		12	091477	1/1/0001
20000	M	M	OUG	II	03380	094		12	091477	1/1/0001
20000	M	M	OOH	II	03391	093		12	091477	1/1/0001
20000	M	M	OOH	II	03393	095		12	091477	1/1/0001
20000	M	M	OUG	II	03478	096		12	091477	1/1/0001
22000	S	M	OUG	II	00000	117	1ST LT. S OF REDING RD., WESTSIDE	12	100896	1/1/0001
20000	M	M	OUG	II	00000	097	OPP. 3494	12	091477	1/1/0001
20000	M	M	OUG	II	00000	099	OPP. 3496	12	091477	1/1/0001
22000	S	M	SOH	II	00000	101	OPP. 3500-upgraded 10/07	12	091477	1/1/0001
20000	M	M	SOH	II	00000	103	OPP. 3502	12	091477	1/1/0001
20000	M	M	SOH	II	00000	105	OPP. 3506	12	091477	1/1/0001
20000	M	M	OUG	II	00000	115	OPP. 3534	12	091477	1/1/0001
22000	S	M	OUG	II	00000	122	3RD LT. S OF ARMSTRONG MILL, EASTSIDE	12	030896	1/1/0001
22000	S	M	OUG	II	00000	124	4TH LT. S OF ARMSTRONG MILL, EASTSIDE	12	030896	1/1/0001
22000	S	M	OUG	II	00000	126	5TH LT. S OF ARMSTRONG MILL, EASTSIDE	12	030896	1/1/0001
22000	S	M	OUG	II	00000	130	7TH LT. S OF ARMSTRONG MILL, EASTSIDE	12	030896	1/1/0001
22000	S	M	OUG	II	00000	132	8TH LT S OF ARMSTRONG MILL, EASTSIDE	12	030896	1/1/0001
22000	S	M	OUG	II	00000	134	9TH LT. S OF ARMSTRONG MILL, EASTSIDE	12	030896	1/1/0001
22000	S	M	OUG	II	00000	136	8TH LT. N OF APPIAN WAY, EASTSIDE	12	030896	1/1/0001
22000	S	M	OUG	II	00000	138	7TH LT. N OF APPIAN WAY, EASTSIDE	12	030896	1/1/0001
22000	S	M	OUG	II	00000	140	6TH LT. N OF APPIAN WAY, EASTSIDE	12	030896	1/1/0001
22000	S	M	OUG	II	00000	142	5TH LT. N OF APPIAN WAY, EASTSIDE	12	030896	1/1/0001
22000	S	M	OUG	II	00000	144	4TH LT. N OF APPIAN WAY, EASTSIDE	12	030896	1/1/0001
22000	S	M	OUG	III	00000	146	3RD LT.N. OF APPIAN WAY, E.SIDE	12	010894	1/1/0001
22000	S	M	OUG	III	00000	147	3RD LT.N. OF WILSON DOWNING, W.SIDE	12	010894	1/1/0001
22000	S	M	OUG	III	00000	148	2ND LT.N.OF APPIAN WAY, E.SIDE	12	010894	1/1/0001
22000	S	M	OUG	III	00000	149	2ND LT. N. OF WILSON DOWNING, W.SIDE	12	010894	1/1/0001
22000	S	M	OUG	III	00000	150	1ST LT. N. OF APPIAN WAY, E.SIDE	12	010894	1/1/0001

Street Light Listing run 1/11/2015 10:43:21 AM

Page 1102 of 1254

OFFICE: 311

ROUTE: 564

ST_REF_NO: 00000180300

TATES CREEK ROAD

LUMENS	BULB TYPE	MULT SERIES	POLE TYPE	SHADE	ADDRESS NUMBER	REF	LOCATION	TAX DIST	DATE INST	DATE CHANGE
50000	S	M	OUG	III	00000	151	1ST LT. N. OF WILSON DOWNING, W.SIDE	12	010894	1/1/0001
50000	S	M	OUG	III	00000	152	1ST LT. S. OF APPIAN WAY, E.SIDE	12	010894	1/1/0001
22000	S	M	OUG	III	00000	153	1ST LT. S. OF WILSON DOWNING, W.SIDE	12	010894	1/1/0001
22000	S	M	OUG	III	00000	154	2ND LT. S. OF APPIAN WAY, E.SIDE	12	010894	1/1/0001
22000	S	M	OUG	III	00000	156	3RD LT. S. OF APPIAN WAY, E.SIDE	12	010894	1/1/0001
20000	M	M	OUG	II	03496	098		12	091477	1/1/0001
20000	M	M	OUG	II	03500	102		12	091477	1/1/0001
20000	M	M	OUG	II	03504	104		12	091477	1/1/0001
20000	M	M	OUG	II	03508	106		12	091477	1/1/0001
20000	M	M	OUG	II	03514	108		12	091477	1/1/0001
20000	M	M	OUG	II	03514	110		12	091477	1/1/0001
20000	M	M	OUG	II	03525	107		12	091477	1/1/0001
20000	M	M	OUG	II	03525	109		12	091477	1/1/0001
20000	M	M	OUG	II	03525	111		12	091477	1/1/0001
20000	M	M	OUG	II	03525	113		12	091477	1/1/0001
20000	M	M	SOH	II	03534	112		12	091477	1/1/0001
20000	M	M	OUG	II	03534	114		12	091477	1/1/0001
20000	M	M	OUG	II	03534	116		12	091477	1/1/0001
22000	S	M	OUG	II	03600	118		12	091477	1/1/0001
22000	S	M	OUG	II	03600	120		12	091477	1/1/0001
22000	S	M	OUG	III	00000	155	2ND LT. S. OF WILSON DOWNING, W.SIDE	12	010894	1/1/0001
22000	S	M	OUG	III	00000	157	3RD LT. S. OF WILSON DOWNING, W.SIDE	12	010894	1/1/0001
22000	S	M	OUG	III	00000	158	4TH LT. S. OF APPIAN WAY, E.SIDE	12	010894	1/1/0001
22000	S	M	OUG	III	00000	159	4TH LT. S. OF WILSON DOWNING, W.SIDE	12	010894	1/1/0001
22000	S	M	OUG	III	00000	160	5TH LT. S. OF APPIAN WAY, E.SIDE	12	010894	1/1/0001
22000	S	M	OUG	III	00000	161	5TH LT. N. OF MAN-OF-WAR, W.SIDE	12	010894	1/1/0001
22000	S	M	OUG	III	00000	162	4TH LT. N. OF MAN-O-WAR, E.SIDE	12	010894	1/1/0001
22000	S	M	OUG	III	00000	163	4TH LT. N. OF MAN-O-WAR, W.SIDE	12	010894	1/1/0001
22000	S	M	OUG	III	00000	164	3RD LT. N. OF MAN-O-WAR, E.SIDE	12	010894	1/1/0001
22000	S	M	OUG	III	00000	165	3RD LT. N. OF MAN-O-WAR, W.SIDE	12	010894	1/1/0001
22000	S	M	OUG	III	00000	166	2ND LT. N. OF MAN-O-WAR, E.SIDE	12	010894	1/1/0001
22000	S	M	OUG	III	00000	167	2ND LT. N. OF MAN-O-WAR, W.SIDE	12	010894	1/1/0001
22000	S	M	OUG	III	00000	168	1ST LT. N. OF MAN-O-WAR, E.SIDE	12	010894	1/1/0001
50000	S	M	OUG	III	00000	169	1ST LT. N. OF MAN-O-WAR, W.SIDE	12	010894	1/1/0001

OFFICE: 311

ROUTE: 564

ST_REF_NO: 00000180300

TATES CREEK ROAD

LUMENS	BULB TYPE	MULT SERIES	POLE TYPE	SHADE	ADDRESS NUMBER	REF	LOCATION	TAX DIST	DATE INST	DATE CHANGE
50000	S	M	OUG	III	00000	170	1ST LT. S. OF MAN-O-WAR, E.SIDE	12	010894	1/1/0001
22000	S	M	OUG	III	00000	171	1ST LT. S. OF MAN-O-WAR, W.SIDE	12	010894	1/1/0001
22000	S	M	OUG	III	00000	172	2ND LT. S. OF MAN-O-WAR, E.SIDE	12	010894	1/1/0001
22000	S	M	OUG	III	00000	173	2ND LT. S. OF MAN-O-WAR, W.SIDE	12	010894	1/1/0001
22000	S	M	OUG	III	00000	174	3RD LT. S. OF MAN-O-WAR, E.SIDE	1	010894	1/1/0001
22000	S	M	OUG	III	00000	175	3RD LT. S. OF MAN-O-WAR, W.SIDE	12	010894	1/1/0001
22000	S	M	OUG	III	00000	176	4TH LT. N OF SHAGBARK, EASTSIDE	12	050896	1/1/0001
22000	S	M	OUG	III	00000	177	4TH LT. N OF SHAGBARK, WESTSIDE	12	050896	1/1/0001
22000	S	M	OUG	III	00000	178	3RD LT. N OF SHAGBARK, EASTSIDE	12	050896	1/1/0001
22000	S	M	OUG	III	00000	179	3RD LT. N OF SHAGBARK, WESTSIDE	12	050896	1/1/0001
22000	S	M	OUG	III	00000	180	2ND LT. N OF SHAGBARK, EASTSIDE	12	050896	1/1/0001
22000	S	M	OUG	III	00000	181	2ND LT. N OF SHAGBARK, WESTSIDE	12	100898	1/1/0001
22000	S	M	OUG	III	00000	182	1ST LT. N OF SHAGBARK, EASTSIDE	12	050896	1/1/0001
50000	S	M	OUG	III	00000	183	1ST LT. N OF SHAGBARK, WESTSIDE	12	100898	1/1/0001
50000	S	M	OUG	III	00000	184	1ST LT. S OF SHAGBARK, EASTSIDE	12	050896	1/1/0001
50000	S	M	OUG	III	00000	185	1ST LT. S OF SHAGBARK, WESTSIDE	12	050896	1/1/0001
22000	S	M	OUG	III	00000	186	2ND LT. S OF SHAGBARK, EASTSIDE	12	050896	1/1/0001
22000	S	M	OUG	III	00000	187	2ND LT. S OF SHAGBARK, WESTSIDE	12	050896	1/1/0001
22000	S	M	OUG	III	00000	188	2ND LT. N OF HARTLAND PKWY, EASTSIDE	12	050896	1/1/0001
22000	S	M	OUG	III	00000	189	2ND LT N OF VETERANS PARK, WESTSIDE	12	050896	1/1/0001
22000	S	M	OUG	III	00000	190	1ST LT. N OF HARTLAND PKWY., EASTSIDE	12	050896	1/1/0001
22000	S	M	OUG	III	00000	191	1ST LT. N OF VETERANS PARK, WESTSIDE	12	050896	1/1/0001
22000	S	M	OUG	III	00000	192	1ST LT. S OF HARTLAND PKWY., EASTSIDE	12	050896	1/1/0001
22000	S	M	OUG	III	00000	193	1ST LT. S OF VETERANS PARK, WESTSIDE	12	050896	1/1/0001
22000	S	M	OUG	III	00000	194	2ND LT. S OF HARTLAND PKWY., EASTSIDE	12	050896	1/1/0001
22000	S	M	OUG	III	00000	195	2ND LT. S OF VETERANS PARK, WESTSIDE	12	050896	1/1/0001
22000	S	M	OUG	III	00000	196	3RD LT. S OF HARTLAND PKWY., EASTSIDE	12	050896	1/1/0001
22000	S	M	OUG	III	00000	197	3RD LT. S OF VETERANS PARK, WESTSIDE	12	050896	1/1/0001
22000	S	S	OUG	III	00000	198	4TH LT. S OF HARTLAND PKWY., EASTSIDE	12	050896	1/1/0001
22000	S	M	OUG	III	00000	199	4TH LT. S OF VETERANS PARK, WESTSIDE	12	050896	1/1/0001
22000	S	M	OUG	III	00000	200	6TH LT. N OF ROCKBRIDGE RD., EASTSIDE	12	050896	1/1/0001
22000	S	M	OUG	III	00000	201	5TH LT. N OF ROCKBRIDGE, WESTSIDE	12	050896	1/1/0001
22000	S	M	OUG	III	00000	202	5TH LT. N OF ROCKBRIDGE RD., EASTSIDE	12	050896	1/1/0001
22000	S	M	OUG	III	00000	203	4TH LT. N OF ROCKBRIDGE. WESTSIDE	12	050896	1/1/0001

OFFICE: 311		ROUTE: 564		ST_REF_NO: 00000180300		TATES CREEK ROAD		TAX DIST	DATE INST	DATE CHANGE
LUMENS	BULB TYPE	MULT SERIES	POLE TYPE	SHADE	ADDRESS NUMBER	REF	LOCATION			
22000	S	M	OUG	III	00000	204	4TH LT. N OF ROCKBRIDGE, EASTSIDE	12	050896	1/1/0001
22000	S	M	OUG	III	00000	205	3RD LT. N OF ROCKBRIDGE, WESTSIDE	12	050896	1/1/0001
22000	S	M	OUG	III	00000	206	3RD LT. N OF ROCKBRIDGE, EASTSIDE	12	050896	1/1/0001
22000	S	M	OUG	III	00000	207	2ND LT. N OF ROCKBRIDGE, WESTSIDE	12	050896	1/1/0001
22000	S	M	OUG	III	00000	208	2ND LT. N OF ROCKBRIDGE, EASTSIDE	12	050896	1/1/0001
22000	S	M	OUG	III	00000	209	1ST LT. N OF ROCKBRIDGE, WESTSIDE	12	050896	1/1/0001
22000	S	M	OUG	III	00000	210	1ST LT. N OF ROCKBRIDGE, EASTSIDE	12	050896	1/1/0001
22000	S	M	OUG	III	00000	211	1ST LT. S OF ROCKBRIDGE, WESTSIDE	12	050896	1/1/0001
22000	S	M	OUG	III	00000	212	1ST LT. S OF ROCKBRIDGE., EASTSIDE	12	050896	1/1/0001
22000	S	M	OUG	III	00000	213	2ND LT. S OF ROCKBRIDGE, WESTSIDE	12	050896	1/1/0001
22000	S	M	OUG	III	00000	214	2ND LT. S OF ROCKBRIDGE, EASTSIDE	12	050896	1/1/0001
22000	S	M	OUG	III	00000	215	3RD LT. S OF ROCKBRIDGE, WESTSIDE	12	050896	1/1/0001
22000	S	M	OUG	III	00000	216	3RD LT. S OF ROCKBRIDGE, EASTSIDE	12	050896	1/1/0001
22000	S	M	OUG	III	00000	217	4TH LT. S OF ROCKBRIDGE, WESTSIDE	12	050896	1/1/0001
22000	S	M	OUG	III	00000	218	4TH LT. S OF ROCKBRIDGE, EASTSIDE	12	050896	1/1/0001
22000	S	M	OUG	III	00000	219	5TH LT. S OF ROCKBRIDGE, WESTSIDE	12	050896	1/1/0001
22000	S	M	OUG	III	00000	220	5TH LT. S OF ROCKBRIDGE, EASTSIDE	12	050896	1/1/0001
22000	S	M	OUG	III	00000	221	2ND LT. N OF FOREST LAKE, WESTSIDE	12	050896	1/1/0001
22000	S	M	OUG	III	00000	222	1ST LT. N OF FOREST LAKE DR., EASTSIDE	12	050896	1/1/0001
22000	S	M	OUG	III	00000	223	1ST LT. N OF FOREST LAKE, WESTSIDE	12	050896	1/1/0001
22000	S	M	OUG	III	00000	224	1ST LT. S OF FOREST LAKE DR., EASTSIDE	12	050896	1/1/0001
22000	S	M	OUG	III	00000	225	1ST LT. S OF FOREST LAKE, WESTSIDE	12	050896	1/1/0001
22000	S	M	OUG	III	00000	226	2ND LT. S OF FOREST LAKE DR., EASTSIDE	12	050896	1/1/0001
22000	S	M	OUG	III	00000	227	2ND LT. S OF FOREST LAKE, WESTSIDE	12	050896	1/1/0001
22000	S	M	OUG	III	00000	228	3RD LT. S OF FOREST LAKE DR., EASTSIDE	12	050896	1/1/0001
22000	S	M	OUG	III	00000	229	3RD LT. S OF FOREST LAKE, WESTSIDE	12	050896	1/1/0001
22000	S	M	OUG	III	00000	230	4TH LT. S OF FOREST LAKE DR., EASTSIDE	12	050896	1/1/0001
22000	S	M	OUG	III	00000	232	2ND LT. N OF HARTLAND PKWY, EASTSIDE	12	050896	1/1/0001
22000	S	M	OUG	III	00000	234	1ST LT. N OF HARTLAND PKWY, EASTSIDE	12	050896	1/1/0001
OFFICE: 311		ROUTE: 564		ST_REF_NO: 00000180400		TATESBROOK DRIVE		TAX DIST	DATE INST	DATE CHANGE
LUMENS	BULB TYPE	MULT SERIES	POLE TYPE	SHADE	ADDRESS NUMBER	REF	LOCATION			
05800	S	M	OUG	II	01076	060		12	030890	10/10/2012

OFFICE: 311		ROUTE: 564		ST_REF_NO: 00000180400		TATESBROOK DRIVE				
LUMENS	BULB TYPE	MULT SERIES	POLE TYPE	SHADE	ADDRESS NUMBER	REF	LOCATION	TAX DIST	DATE INST	DATE CHANGE
04000	S	M	OUG	II	00996	056		12	030890	1/1/0001
04000	S	M	OUG	II	01007	057		12	050886	1/1/0001
04000	S	M	OUG	II	01036	058		12	030890	1/1/0001
04000	S	M	OUG	II	01051	059		12	050886	1/1/0001
04000	S	M	OUG	II	01087	061		12	111580	1/1/0001
04000	S	M	OUG	II	01100	062		12	011581	1/1/0001
04000	S	M	OUG	II	01107	041		12	111580	1/1/0001
04000	S	M	OUG	II	01128	040		12	111580	1/1/0001
04000	S	M	OUG	II	01135	039		12	111580	1/1/0001
04000	S	M	OUG	II	01156	038		12	111580	1/1/0001
04000	S	M	OUG	II	01163	015		12	111478	1/1/0001
05800	S	M	OUG	II	01172	014	upgrade 6/08	12	111478	1/1/0001
04000	S	M	OUG	II	01191	013		12	111580	1/1/0001

OFFICE: 311		ROUTE: 564		ST_REF_NO: 00000180500		TATESWOOD DRIVE				
LUMENS	BULB TYPE	MULT SERIES	POLE TYPE	SHADE	ADDRESS NUMBER	REF	LOCATION	TAX DIST	DATE INST	DATE CHANGE
05800	S	M	OUG	II	00000	030	SIDE OF 1842 BELLEFONTE DR.	12	070863	1/1/0001
05800	S	M	OUG	II	00611	000		12	070863	1/1/0001
05800	S	M	OUG	II	00618	000		12	070863	1/1/0001
05800	S	M	OUG	II	00627	000		12	070863	1/1/0001
05800	S	M	OUG	II	00634	000		12	080966	1/1/0001
05800	S	M	OUG	II	00639	050		12	041367	1/1/0001
05800	S	M	OUG	II	00650	049		12	080171	1/1/0001
05800	S	M	OUG	II	00655	048		12	080171	1/1/0001
05800	S	M	OUG	II	00659	047		12	041367	1/1/0001
05800	S	M	OUG	II	00666	046		12	041367	1/1/0001

OFFICE: 311		ROUTE: 564		ST_REF_NO: 00000180540		TATTON PARK				
LUMENS	BULB TYPE	MULT SERIES	POLE TYPE	SHADE	ADDRESS NUMBER	REF	LOCATION	TAX DIST	DATE INST	DATE CHANGE
09500	S		CLN	III	00000	001	SIDE OF 200 SOMERSLY PL, ON TATTON PARK	12	041511	1/1/0001
09500	S		CLN	III	03892	002		12	041511	1/1/0001
09500	S		CLN	III	03896	003		12	041511	1/1/0001

OFFICE: 311		ROUTE: 564		ST_REF_NO: 00000180600		TAVISTOCK DRIVE		LUMENS	BULB TYPE	MULT SERIES	POLE TYPE	SHADE	ADDRESS NUMBER	REF	LOCATION	TAX DIST	DATE INST	DATE CHANGE
04000	S	M	OUG	II	00000	101	SIDE OF 144 TIVERTON WAY	12	020887	1/1/0001								
OFFICE: 311		ROUTE: 564		ST_REF_NO: 00000180700		TAWAS COURT		LUMENS	BULB TYPE	MULT SERIES	POLE TYPE	SHADE	ADDRESS NUMBER	REF	LOCATION	TAX DIST	DATE INST	DATE CHANGE
04000	S	M	OUG	II	00000	089	SIDE OF 3225 BUCKHORN DR.	12	061580	1/1/0001								
04000	S	M	OUG	II	01004	088		12	061580	1/1/0001								
OFFICE: 311		ROUTE: 564		ST_REF_NO: 00000180750		TAXIM COURT		LUMENS	BULB TYPE	MULT SERIES	POLE TYPE	SHADE	ADDRESS NUMBER	REF	LOCATION	TAX DIST	DATE INST	DATE CHANGE
05800	S	M	OUG	II	02913	001		12	020895	10/31/2012								
04000	S	M	OUG	V	02901	002		12	110889	1/1/0001								
OFFICE: 311		ROUTE: 564		ST_REF_NO: 00000180800		TAYLOR DRIVE		LUMENS	BULB TYPE	MULT SERIES	POLE TYPE	SHADE	ADDRESS NUMBER	REF	LOCATION	TAX DIST	DATE INST	DATE CHANGE
05800	S	M	OUG	II	00325	070		12	121582	7/16/2012								
05800	S	M	OUG	II	00252	064		12	121582	1/1/0001								
05800	S	M	OUG	II	00261	065		12	121582	1/1/0001								
05800	S	M	OUG	II	00272	066		12	121582	1/1/0001								
05800	S	M	OUG	II	00281	067		12	121582	1/1/0001								
05800	S	M	OUG	II	00292	068		12	121582	1/1/0001								
04000	S	M	OUG	II	00314	069		12	121582	1/1/0001								
04000	S	M	OUG	II	00336	071		12	121582	1/1/0001								
05800	S	M	OUG	II	00209	059		12	121582	1/1/0001								
05800	S	M	OUG	II	00219	060		12	121582	1/1/0001								
05800	S	M	OUG	II	00225	061		12	121582	1/1/0001								
05800	S	M	OUG	II	00232	062		12	121582	1/1/0001								
05800	S	M	OUG	II	00241	063		12	121582	1/1/0001								
OFFICE: 311		ROUTE: 564		ST_REF_NO: 00000181000		TAZWELL DRIVE		LUMENS	BULB TYPE	MULT SERIES	POLE TYPE	SHADE	ADDRESS NUMBER	REF	LOCATION	TAX DIST	DATE INST	DATE CHANGE
04000	S	M	OUG	II	00000	001	SIDE OF 941 MASON HEADLEY	12	050888	1/1/0001								

OFFICE: 311

ROUTE: 564

ST_REF_NO: 00000181000 TAZWELL DRIVE

LUMENS	BULB TYPE	MULT SERIES	POLE TYPE	SHADE	ADDRESS NUMBER	REF	LOCATION	TAX DIST	DATE INST	DATE CHANGE
04000	S	M	OUG	II	00000	002	SIDE OF 941 MASON HEADLEY	12	050888	1/1/0001
04000	S	M	OUG	II	00000	003	SIDE OF 942 WOLF RUN RD.	12	050888	1/1/0001
04000	S	M	OUG	II	00000	004	SIDE OF 937 WOLF RUN DR.	12	050888	1/1/0001
04000	S	M	OUG	II	00000	007	SIDE OF 1619 DUNTREATH DR.	12	050888	1/1/0001
04000	S	M	OUG	II	00000	008	OPP. 1630	12	050888	1/1/0001
04000	S	M	OUG	II	01643	006		12	050888	1/1/0001
04000	S	M	OUG	II	01647	005		12	050888	1/1/0001

OFFICE: 311

ROUTE: 564

ST_REF_NO: 00000181040 TEA OLIVE WAY

LUMENS	BULB TYPE	MULT SERIES	POLE TYPE	SHADE	ADDRESS NUMBER	REF	LOCATION	TAX DIST	DATE INST	DATE CHANGE
05800	S	M	CNT	II	00000	001	SIDE OF 5141 IVY BRIDGE ON TEA OLIVE WAY	12	033007	1/1/0001
05800	S	M	CNT	III	00905	002		12	081404	1/1/0001

OFFICE: 311

ROUTE: 564

ST_REF_NO: 00000181050 TEABERRY CIRCLE

LUMENS	BULB TYPE	MULT SERIES	POLE TYPE	SHADE	ADDRESS NUMBER	REF	LOCATION	TAX DIST	DATE INST	DATE CHANGE
04000	S	M	OUG	II	04000	002		12	120892	1/1/0001
04000	S	M	OUG	II	04013	001		12	100890	1/1/0001

OFFICE: 311

ROUTE: 564

ST_REF_NO: 00000181100 TEAKWOOD ROAD

LUMENS	BULB TYPE	MULT SERIES	POLE TYPE	SHADE	ADDRESS NUMBER	REF	LOCATION	TAX DIST	DATE INST	DATE CHANGE
04000	S	M	OUG	II	00000	002	SIDE OF 968 TURKEY FOOT RD.	12	121673	1/1/0001
04000	S	M	OUG	II	00608	003		12	071674	1/1/0001
04000	S	M	OUG	II	00617	004		12	081477	1/1/0001
04000	S	M	OUG	II	00624	005		12	031475	1/1/0001
04000	S	M	OUG	II	00633	006		12	121673	1/1/0001
04000	S	M	OUG	II	00640	007		12	121673	1/1/0001
04000	S	M	OUG	II	00645	008		12	121673	1/1/0001
04000	S	M	OUG	II	00652	041		12	051475	1/1/0001
04000	S	M	OUG	II	00657	059		12	111478	1/1/0001
04000	S	M	OUG	II	00668	058		12	111478	1/1/0001

OFFICE: 311		ROUTE: 564		ST_REF_NO: 00000181200		TEAROSE COURT		LUMENS	BULB TYPE	MULT SERIES	POLE TYPE	SHADE	ADDRESS NUMBER	REF	LOCATION	TAX DIST	DATE INST	DATE CHANGE
05800	S	M	OUG	II	00855	000										12	120162	1/1/0001
OFFICE: 311		ROUTE: 564		ST_REF_NO: 00000181210		TEAROSE DRIVE		LUMENS	BULB TYPE	MULT SERIES	POLE TYPE	SHADE	ADDRESS NUMBER	REF	LOCATION	TAX DIST	DATE INST	DATE CHANGE
05800	S	M	OUG	II	00000	043	SIDE OF 2015 TAMARACK DR.									12	090363	1/1/0001
05800	S	M	OUG	II	00000	048	SIDE OF 2008 OLEANDER DR.									12	070162	1/1/0001
05800	S	M	OUG	II	00881	000										12	090363	1/1/0001
05800	S	M	OUG	II	00908	000										12	090164	1/1/0001
05800	S	M	OUG	II	00935	000										12	120162	1/1/0001
05800	S	M	OUG	II	00964	000										12	070162	1/1/0001
OFFICE: 311		ROUTE: 564		ST_REF_NO: 00000181250		TELLURIDE CIRCLE		LUMENS	BULB TYPE	MULT SERIES	POLE TYPE	SHADE	ADDRESS NUMBER	REF	LOCATION	TAX DIST	DATE INST	DATE CHANGE
05800	S	M	CNT	II	00000	001	SIDE OF 1782 TIMBER CREEK DR.									12	100896	1/1/0001
05800	S	M	CNT	II	00000	003	SIDE OF 1213									12	100896	1/1/0001
05800	S	M	CNT	II	01212	002										12	100896	1/1/0001
05800	S	M	CNT	II	01240	004										12	100896	1/1/0001
OFFICE: 311		ROUTE: 564		ST_REF_NO: 00000181300		TEMPLE DRIVE		LUMENS	BULB TYPE	MULT SERIES	POLE TYPE	SHADE	ADDRESS NUMBER	REF	LOCATION	TAX DIST	DATE INST	DATE CHANGE
04000	S	M	OUG	II	00000	006	SIDE OF 232 WILSON DOWNING RD.									12	070887	1/1/0001
04000	S	M	OUG	II	03612	007										12	070887	1/1/0001
04000	S	M	OUG	II	03627	008										12	070887	1/1/0001
05800	S	M	OUG	II	03705	009	upgraded 5/08									12	070887	1/1/0001
04000	S	M	OUG	II	03717	010										12	070887	1/1/0001
04000	S	M	OUG	II	03728	011										12	070887	1/1/0001
04000	S	M	OUG	II	03745	012										12	070887	1/1/0001
04000	S	M	OUG	II	03765	013										12	070887	1/1/0001
04000	S	M	OUG	II	03770	014										12	070887	1/1/0001
04000	S	M	OUG	II	03785	015										12	070887	1/1/0001
04000	S	M	OUG	II	03794	016										12	070887	1/1/0001

OFFICE: 311		ROUTE: 564		ST_REF_NO: 00000181400		TEMPLEMAN ALLEY				
LUMENS	BULB TYPE	MULT SERIES	POLE TYPE	SHADE	ADDRESS NUMBER	REF	LOCATION	TAX DIST	DATE INST	DATE CHANGE
05800	S	M	SOH	I	00000	265	1ST LT. E. OF LIMESTONE ST., S. SIDE	12	100266	1/1/0001
05800	S	M	SOH	I	00000	266	2ND LT. E. OF LIMESTONE ST., S. SIDE	12	020165	1/1/0001
05800	S	M	SOH	I	00000	267	1ST LT. W. OF WALNUT ST., S. SIDE	12	020165	1/1/0001

OFFICE: 311		ROUTE: 564		ST_REF_NO: 00000181450		TEMPO COURT				
LUMENS	BULB TYPE	MULT SERIES	POLE TYPE	SHADE	ADDRESS NUMBER	REF	LOCATION	TAX DIST	DATE INST	DATE CHANGE
05800	S	M	OUG	II	03800	001		12	070899	1/1/0001
05800	S	M	OUG	III	03808	002		12	070899	1/1/0001

OFFICE: 311		ROUTE: 564		ST_REF_NO: 00000181500		TENNESSEE AVENUE				
LUMENS	BULB TYPE	MULT SERIES	POLE TYPE	SHADE	ADDRESS NUMBER	REF	LOCATION	TAX DIST	DATE INST	DATE CHANGE
05800	S	M	SOH	II	00681	000		12	110160	1/1/0001
05800	S	M	SOH	II	00693	000		12	110160	1/1/0001

OFFICE: 311		ROUTE: 564		ST_REF_NO: 00000181600		TERRACE VIEW DRIVE				
LUMENS	BULB TYPE	MULT SERIES	POLE TYPE	SHADE	ADDRESS NUMBER	REF	LOCATION	TAX DIST	DATE INST	DATE CHANGE
05800	S	M	OUG	II	00000	030	SIDE OF 1715 HILL RISE DR ON TERRACE VIEW DR	12	123005	1/1/0001
05800	S	M	OUG	II	00000	001	SIDE REAR 1714 VERSAILLES RD.	12	020895	1/1/0001
05800	S	M	OUG	II	00712	002		12	020895	1/1/0001
05800	S	M	OUG	II	00723	003		12	020895	1/1/0001
05800	S	M	OUG	II	00730	004		12	020895	1/1/0001
05800	S	M	OUG	II	00747	005		12	020895	1/1/0001
05800	S	M	OUG	V	00758	006		12	020895	1/1/0001
05800	S	M	OUG	II	01695	009		12	020895	1/1/0001
05800	S	M	OUG	II	01706	008		12	020895	1/1/0001
05800	S	M	OUG	II	01715	007		12	020895	1/1/0001

OFFICE: 311		ROUTE: 564		ST_REF_NO: 00000181630		TERRANOVA COURT				
LUMENS	BULB TYPE	MULT SERIES	POLE TYPE	SHADE	ADDRESS NUMBER	REF	LOCATION	TAX DIST	DATE INST	DATE CHANGE
05800	S	M	CNT	III	02204	003		12	081704	1/1/0001
05800	S	M	CNT	II	02208	002		12	112805	1/1/0001

OFFICE: 311

ROUTE: 564

ST_REF_NO: 00000181630 TERRANOVA COURT

LUMENS	BULB TYPE	MULT SERIES	POLE TYPE	SHADE	ADDRESS NUMBER	REF	LOCATION	TAX DIST	DATE INST	DATE CHANGE
05800	S	M	CNT	III	02229	001		12	112805	1/1/0001

OFFICE: 311

ROUTE: 564

ST_REF_NO: 00000181700 TETBURY LANE

LUMENS	BULB TYPE	MULT SERIES	POLE TYPE	SHADE	ADDRESS NUMBER	REF	LOCATION	TAX DIST	DATE INST	DATE CHANGE
04000	S	M	OUG	II	00000	001	SIDE OF 308 NORTHWOOD DR.	12	010888	1/1/0001
04000	S	M	OUG	II	00000	002	SIDE OF 181 NORTHWOOD DR.	12	010888	1/1/0001
05800	S	M	SOH	II	00000	012	SIDE OF 314 MANHATTAN DR.	12	090968	1/1/0001

OFFICE: 311

ROUTE: 564

ST_REF_NO: 00000181800 TETON COURT

LUMENS	BULB TYPE	MULT SERIES	POLE TYPE	SHADE	ADDRESS NUMBER	REF	LOCATION	TAX DIST	DATE INST	DATE CHANGE
04000	S	M	OUG	II	00000	059	SIDE OF 3027 PIMLICO PKWY.	12	061580	1/1/0001

OFFICE: 311

ROUTE: 564

ST_REF_NO: 00000181900 TEXACO ROAD

LUMENS	BULB TYPE	MULT SERIES	POLE TYPE	SHADE	ADDRESS NUMBER	REF	LOCATION	TAX DIST	DATE INST	DATE CHANGE
04000	S	M	SOH	II	00000	014	SIDE OF 203 WILTON AVE.	12	082465	1/1/0001
04000	S	M	SOH	II	00000	016	SIDE OF 138 CLYDE ST.	12	082465	1/1/0001
04000	S	M	SOH	II	00000	017	SIDE OF 143 CLYDE ST.	12	082465	1/1/0001
04000	S	M	SOH	II	01107	015		12	082465	1/1/0001
04000	S	M	SOH	II	01203	018		12	082465	1/1/0001
04000	S	M	SOH	II	01207	019		12	082465	1/1/0001
04000	S	M	SOH	II	01211	020		12	082465	1/1/0001

OFFICE: 311

ROUTE: 564

ST_REF_NO: 00000182000 THAMES DRIVE

LUMENS	BULB TYPE	MULT SERIES	POLE TYPE	SHADE	ADDRESS NUMBER	REF	LOCATION	TAX DIST	DATE INST	DATE CHANGE
05800	S	M	OUG	II	00000	011	SIDE OF 3601 RIVER PARK DR.	12	011568	1/1/0001
05800	S	M	OUG	II	00000	012	SIDE OF 3608 RIVER PARK DR.	12	050867	1/1/0001
05800	S	M	OUG	II	00000	016	SIDE OF 1460	12	050867	1/1/0001
05800	S	M	OUG	II	00000	029	SIDE OF 3640 RIVER PARK DR.	12	060171	1/1/0001
05800	S	M	OUG	II	01413	013		12	080173	1/1/0001
05800	S	M	OUG	II	01420	014		12	062267	1/1/0001
05800	S	M	OUG	II	01433	015		12	011568	1/1/0001

OFFICE: 311

ROUTE: 564

ST_REF_NO: 00000182000

THAMES DRIVE

LUMENS	BULB TYPE	MULT SERIES	POLE TYPE	SHADE	ADDRESS NUMBER	REF	LOCATION	TAX DIST	DATE INST	DATE CHANGE
05800	S	M	OUG	II	01461	017		12	120869	1/1/0001
05800	S	M	OUG	II	01468	018		12	040168	1/1/0001
05800	S	M	OUG	II	01565	028		12	060172	1/1/0001
05800	S	M	OUG	II	01581	027		12	060172	1/1/0001
05800	S	M	OUG	II	01590	026		12	060172	1/1/0001
05800	S	M	OUG	II	01605	025		12	120170	1/1/0001
05800	S	M	OUG	II	01616	024		12	060171	1/1/0001
05800	S	M	OUG	II	01629	023		12	060172	1/1/0001
05800	S	M	OUG	II	01640	022		12	060171	1/1/0001
05800	S	M	OUG	II	01481	019		12	120869	1/1/0001
05800	S	M	OUG	II	01500	033		12	060172	1/1/0001
05800	S	M	OUG	II	01515	032		12	080173	1/1/0001
05800	S	M	OUG	II	01524	031		12	060172	1/1/0001
05800	S	M	OUG	II	01547	030		12	080173	1/1/0001

OFFICE: 311

ROUTE: 564

ST_REF_NO: 00000182150

THE KINGS COURT

LUMENS	BULB TYPE	MULT SERIES	POLE TYPE	SHADE	ADDRESS NUMBER	REF	LOCATION	TAX DIST	DATE INST	DATE CHANGE
05800	S	M	OUG	II	00000	001	SIDE REAR OF 1326	12	060895	1/1/0001
05800	S	M	OUG	IV	01315	002		12	060895	1/1/0001
05800	S	M	OUG	II	01335	003		12	060895	1/1/0001
05800	S	M	OUG	II	01350	004		12	060895	1/1/0001
05800	S	M	OUG	IV	01375	005		12	060895	1/1/0001

OFFICE: 311

ROUTE: 564

ST_REF_NO: 00000182300

THIRD, EAST STREET

LUMENS	BULB TYPE	MULT SERIES	POLE TYPE	SHADE	ADDRESS NUMBER	REF	LOCATION	TAX DIST	DATE INST	DATE CHANGE
09500	S	M	SOH	II	00431	027		12	021568	11/3/2011
09500	S	M	SOH	II	00560	035	upgraded and moved across the street-car accident	12	032568	5/29/2009
10000	M	M	SOH	II	00000	034	OPP 547	12	032568	1/1/0001
10000	M	M	SOH	II	00000	037	OPP. NELSON AVE.	12	110887	1/1/0001
20000	M	M	SOH	IV	00000	038	1ST LT. W. OF MIDLAND AVE., S. SIDE	12	020164	1/1/0001
50000	S	S	SOH	IV	00000	045	1ST LT. W. OF WALTON AVE., S. SIDE	12	020764	1/1/0001
50000	S	M	SOH	IV	00000	046	OPP. WALTON AVE.	12	021464	1/1/0001

OFFICE: 311

ROUTE: 564

ST_REF_NO: 00000182300

THIRD, EAST STREET

LUMENS	BULB TYPE	MULT SERIES	POLE TYPE	SHADE	ADDRESS NUMBER	REF	LOCATION	TAX DIST	DATE INST	DATE CHANGE
50000	S	S	OOH	IV	00000	047	1ST LT. E. OF WALTON AVE., S. SIDE	12	020764	1/1/0001
20000	M	S	SOH	IV	00000	048	1ST LT. E. OF WALTON AVE., N. SIDE	12	021464	1/1/0001
20000	M	M	SOH	IV	00000	049	2ND LT. E. OF WALTON AVE., S. SIDE	12	021464	1/1/0001
20000	M	M	SOH	IV	00000	050	2ND LT. E. OF WALTON AVE., N. SIDE	12	022464	1/1/0001
20000	M	S	SOH	IV	00000	051	3RD LT. E. OF WALTON AVE., S. SIDE	12	022464	1/1/0001
20000	M	M	SOH	IV	00000	052	4TH LT. E. OF WALTON AVE., S. SIDE	12	061582	1/1/0001
20000	M	S	SOH	IV	00000	053	5TH LT. E. OF WALTON AVE., S. SIDE	12	020164	1/1/0001
20000	M	M	OOH	IV	00000	054	3RD LT. W. OF ZESTA PLACE, N. SIDE	12	050564	1/1/0001
22000	S	M	OOH	IV	00000	055	6TH LT. E. OF WALTON AVE., S. SIDE	12	030801	1/1/0001
20000	M	M	OOH	IV	00000	056	2ND LT. W. OF ZESTA PLACE, N. SIDE	12	050564	1/1/0001
20000	M	M	SOH	IV	00000	057	7TH LT. E. OF WALTON AVE., S. SIDE	12	022464	1/1/0001
20000	M	M	SOH	IV	00000	058	NW CORNER OF THIRD & ZESTA PLACE	12	022464	1/1/0001
20000	M	S	SOH	IV	00000	059	8TH LT. E. OF WALTON AVE., S. SIDE	12	020164	1/1/0001
20000	M	M	SOH	IV	00000	065	SW CORNER OF THIRD & DAYTON AVE.	12	020164	1/1/0001
10000	M	M	SOH	II	00530	032		12	021568	1/1/0001
10000	M	M	SOH	II	00537	033		12	032568	1/1/0001
09500	S	M	SOH	II	00563	036		12	032568	1/1/0001
20000	M	M	SOH	IV	00612	041		12	020164	1/1/0001
20000	M	M	SOH	IV	00620	043		12	020164	1/1/0001
20000	M	M	SOH	IV	00621	042		12	020764	1/1/0001
20000	M	M	SOH	IV	00633	044		12	020764	1/1/0001
20000	M	S	SOH	IV	00779	060		12	022464	1/1/0001
20000	M	S	SOH	IV	00780	061		12	020164	1/1/0001
20000	M	S	SOH	IV	00801	062		12	022464	1/1/0001
20000	M	S	SOH	IV	00814	063		12	020164	1/1/0001
20000	M	M	SOH	IV	00817	064		12	022464	1/1/0001
20000	M	M	SOH	IV	00817	066		12	022464	1/1/0001
20000	M	M	SOH	IV	00834	067		12	022464	1/1/0001
20000	M	M	SOH	IV	00838	068		12	030896	1/1/0001
20000	M	S	SOH	IV	00840	069		12	020164	1/1/0001
20000	M	M	SOH	IV	00907	070		12	022464	1/1/0001
20000	M	M	SOH	IV	00916	071		12	022464	1/1/0001
20000	M	M	SOH	IV	00919	072		12	022464	1/1/0001
20000	M	M	OOH	IV	00924	073		12	060164	1/1/0001

OFFICE: 311

ROUTE: 564

ST_REF_NO: 00000182300

THIRD, EAST STREET

LUMENS	BULB TYPE	MULT SERIES	POLE TYPE	SHADE	ADDRESS NUMBER	REF	LOCATION	TAX DIST	DATE INST	DATE CHANGE
20000	M	M	OOH	IV	00927	074		12	060164	1/1/0001
20000	M	M	OOH	IV	00928	077		12	060164	1/1/0001
20000	M	M	OOH	IV	00929	076		12	060164	1/1/0001
20000	M	M	OOH	IV	00933	078		12	060164	1/1/0001
20000	M	M	OOH	IV	00941	080		12	060164	1/1/0001
20000	M	M	OOH	IV	00942	079		12	060164	1/1/0001
20000	M	M	OOH	IV	00952	081		12	060164	1/1/0001
20000	M	M	OOH	IV	00960	083		12	060164	1/1/0001
20000	M	M	OOH	IV	01001	082		12	060164	1/1/0001
20000	M	M	OOH	IV	01015	084		12	060164	1/1/0001
10000	M	M	SOH	II	00000	001	1ST LT. E. OF LIMESTONE ST., N. SIDE	12	071464	1/1/0001
10000	M	M	SOH	II	00000	003	2ND LT. E. OF LIMESTONE ST., N. SIDE	12	071464	1/1/0001
10000	M	M	SOH	II	00000	011	OPP. 228	12	032568	1/1/0001
10000	M	M	SOH	II	00000	013	OPP. 246	12	021568	1/1/0001
10000	M	M	SOH	II	00114	002		12	100164	1/1/0001
10000	M	M	SOH	II	00132	004		12	100164	1/1/0001
10000	M	M	SOH	II	00147	005		12	071464	1/1/0001
10000	M	M	SOH	II	00152	006		12	100164	1/1/0001
10000	M	M	SOH	II	00167	007		12	071464	1/1/0001
10000	M	M	SOH	II	00200	008		12	032568	1/1/0001
10000	M	M	SOH	II	00211	009		12	032568	1/1/0001
10000	M	M	SOH	II	00220	010		12	021568	1/1/0001
10000	M	M	SOH	II	00240	012		12	021568	1/1/0001
10000	M	M	SOH	II	00258	014		12	032568	1/1/0001
10000	M	M	SOH	II	00310	017		12	032568	1/1/0001
10000	M	M	SOH	II	00319	018		12	021568	1/1/0001
10000	M	M	SOH	II	00330	019		12	021568	1/1/0001
10000	M	M	SOH	II	00337	020		12	032568	1/1/0001
10000	M	M	SOH	II	00344	021		12	021568	1/1/0001
10000	M	M	SOH	II	00348	022		12	021568	1/1/0001
10000	M	M	SOH	II	00371	023		12	032568	1/1/0001
10000	M	M	SOH	II	00400	024		12	032568	1/1/0001
10000	M	M	SOH	II	00407	025		12	032568	1/1/0001
10000	M	M	SOH	II	00424	026		12	032568	1/1/0001

OFFICE: 311

ROUTE: 564

ST_REF_NO: 00000182300

THIRD, EAST STREET

LUMENS	BULB TYPE	MULT SERIES	POLE TYPE	SHADE	ADDRESS NUMBER	REF	LOCATION	TAX DIST	DATE INST	DATE CHANGE
09500	S	M	SOH	II	00502	028		12	021568	1/1/0001
10000	M	M	SOH	II	00505	029		12	032568	1/1/0001
10000	M	M	SOH	II	00514	030		12	021568	1/1/0001
10000	M	M	SOH	II	00525	031		12	032568	1/1/0001

OFFICE: 311

ROUTE: 564

ST_REF_NO: 00000182310

THIRD, WEST STREET

LUMENS	BULB TYPE	MULT SERIES	POLE TYPE	SHADE	ADDRESS NUMBER	REF	LOCATION	TAX DIST	DATE INST	DATE CHANGE
09500	S	M	SOH	II	00000	012	SIDE OF 283 N. BROADWAY	12	110164	6/23/2012
50000	S	M	SOH	II	00000	200	NORTHEAST CORNER OF W THIRD ST @ N BROADWAY	12	111805	1/1/0001
10000	M	M	SOH	II	00000	011	SIDE OF 262 N. BROADWAY	12	011863	1/1/0001
10000	M	M	SOH	II	00000	013	SIDE OF 301 N. BROADWAY	12	122165	1/1/0001
10000	M	M	SOH	II	00000	034	OPP. 609	12	042065	1/1/0001
20000	M	M	OOH	III	00000	035	SIDE OF 300 NEWTOWN PIKE	12	042067	1/1/0001
05800	S	M	SOH	I	00000	036	SIDE OF 301 NEWTOWN PIKE	12	060266	1/1/0001
05800	S	M	SOH	V	00000	037	1ST LT. W. OF NEWTOWN PIKE, S. SIDE	12	060266	1/1/0001
05800	S	M	SOH	I	00000	038	SW CORNER OF THIRD & HICKORY ST.	12	060266	1/1/0001
10000	M	M	SOH	II	00304	009		12	011863	1/1/0001
10000	M	M	SOH	II	00304	010		12	011863	1/1/0001
10000	M	M	SOH	II	00412	014		12	071464	1/1/0001
10000	M	M	SOH	II	00421	015		12	071464	1/1/0001
10000	M	M	SOH	II	00424	016		12	071464	1/1/0001
10000	M	M	SOH	II	00435	017		12	122165	1/1/0001
10000	M	M	SOH	II	00442	018		12	071464	1/1/0001
10000	M	M	SOH	II	00449	019		12	071464	1/1/0001
10000	M	M	SOH	II	00452	020		12	110164	1/1/0001
10000	M	M	SOH	II	00455	021		12	122165	1/1/0001
10000	M	M	SOH	II	00468	022		12	071464	1/1/0001
10000	M	M	SOH	II	00478	024		12	110164	1/1/0001
10000	M	M	SOH	II	00485	023		12	071464	1/1/0001
10000	M	M	SOH	II	00497	025		12	071464	1/1/0001
10000	M	M	SOH	II	00502	026		12	042065	1/1/0001
10000	M	M	SOH	II	00515	027		12	042065	1/1/0001

OFFICE: 311		ROUTE: 564		ST_REF_NO: 00000182310		THIRD, WEST STREET		LUMENS	BULB TYPE	MULT SERIES	POLE TYPE	SHADE	ADDRESS NUMBER	REF	LOCATION	TAX DIST	DATE INST	DATE CHANGE
10000	M	M	SOH	II	00524	028										12	042065	1/1/0001
10000	M	M	SOH	II	00531	029										12	040969	1/1/0001
10000	M	M	SOH	II	00540	030										12	042065	1/1/0001
10000	M	M	SOH	II	00549	031										12	042065	1/1/0001
10000	M	M	SOH	II	00556	032										12	042065	1/1/0001
10000	M	M	SOH	II	00601	033										12	042065	1/1/0001
10000	M	M	SOH	II	00000	001								SIDE OF 267 N. LIMESTONE ST.		12	020563	1/1/0001
10000	M	M	SOH	II	00000	006								SIDE OF 262 MARKET ST.		12	020563	1/1/0001
10000	M	M	SOH	II	00000	007								1ST LT. W. OF MARKET ST., S. SIDE		12	020563	1/1/0001
10000	M	M	SOH	II	00000	008								1ST LT. E. OF MILL ST., S. SIDE		12	011863	1/1/0001
10000	M	M	SOH	II	00110	002										12	020563	1/1/0001
10000	M	M	SOH	II	00120	003										12	020563	1/1/0001
10000	M	M	SOH	II	00133	004										12	020563	1/1/0001
10000	M	M	SOH	II	00204	005										12	020563	1/1/0001
OFFICE: 311		ROUTE: 564		ST_REF_NO: 00000182400		THIRSTANE COURT		LUMENS	BULB TYPE	MULT SERIES	POLE TYPE	SHADE	ADDRESS NUMBER	REF	LOCATION	TAX DIST	DATE INST	DATE CHANGE
05800	S	M	OUG	II	01609	000										12	030166	1/1/0001
05800	S	M	OUG	II	01620	000										12	030166	1/1/0001
OFFICE: 311		ROUTE: 564		ST_REF_NO: 00000182490		THISTLE PARK		LUMENS	BULB TYPE	MULT SERIES	POLE TYPE	SHADE	ADDRESS NUMBER	REF	LOCATION	TAX DIST	DATE INST	DATE CHANGE
05800	S		CNT	II	02317	005										12	051510	1/1/0001
05800	S		CNT	II	02329	004										12	051510	1/1/0001
05800	S		CNT	II	02337	002										12	051510	1/1/0001
05800	S	M	CNT	II	02304	006										12	092506	1/1/0001
05800	S	M	CNT	II	02336	003										12	092506	1/1/0001
05800	S	M	CNT	II	02352	001										12	092506	1/1/0001

OFFICE: 311		ROUTE: 564		ST_REF_NO: 00000182500		THISTLETON CIRCLE				
LUMENS	BULB TYPE	MULT SERIES	POLE TYPE	SHADE	ADDRESS NUMBER	REF	LOCATION	TAX DIST	DATE INST	DATE CHANGE
05800	S	M	OUG	II	00000	001	SIDE OF 3410 THISTLETON DR.	12	040894	1/1/0001
05800	S	M	OUG	V	00309	002		12	040894	1/1/0001

OFFICE: 311		ROUTE: 564		ST_REF_NO: 00000182800		THOMPSON ROAD				
LUMENS	BULB TYPE	MULT SERIES	POLE TYPE	SHADE	ADDRESS NUMBER	REF	LOCATION	TAX DIST	DATE INST	DATE CHANGE
05800	S	M	SOH	II	00000	008	OPP. 313	12	070886	1/1/0001
05800	S	M	SOH	II	00100	001		12	070886	1/1/0001
05800	S	M	SOH	II	00104	002		12	070886	1/1/0001
05800	S	M	SOH	II	00110	003		12	070886	1/1/0001
05800	S	M	SOH	II	00114	004		12	070886	1/1/0001
05800	S	M	SOH	II	00120	005		12	070886	1/1/0001
05800	S	M	SOH	II	00126	006		12	070886	1/1/0001
05800	S	M	SOH	II	00306	007		12	070886	1/1/0001
05800	S	M	SOH	II	00320	009		12	070886	1/1/0001
05800	S	M	SOH	II	00359	010		12	070886	1/1/0001
05800	S	M	SOH	II	00369	011		12	070886	1/1/0001
05800	S	M	SOH	II	00369	012		12	070886	1/1/0001

OFFICE: 311		ROUTE: 564		ST_REF_NO: 00000182900		THORNBERRY COURT				
LUMENS	BULB TYPE	MULT SERIES	POLE TYPE	SHADE	ADDRESS NUMBER	REF	LOCATION	TAX DIST	DATE INST	DATE CHANGE
05800	S	M	OUG	II	00000	065	SIDE OF 348 PEACHTREE RD.	12	070172	1/1/0001
05800	S	M	OUG	II	02462	066		12	070172	1/1/0001
05800	S	M	OUG	II	02475	067		12	070172	1/1/0001

OFFICE: 311		ROUTE: 564		ST_REF_NO: 00000182910		THORNBRIDGE LANE				
LUMENS	BULB TYPE	MULT SERIES	POLE TYPE	SHADE	ADDRESS NUMBER	REF	LOCATION	TAX DIST	DATE INST	DATE CHANGE
04000	S	M	OUG	II	04501	001		12	110889	1/1/0001
04000	S	M	OUG	II	04508	002		12	090892	1/1/0001
04000	S	M	OUG	II	04517	003		12	090892	1/1/0001

OFFICE: 311		ROUTE: 564		ST_REF_NO: 00000182950		THORNHILL LANE		LUMENS	BULB TYPE	MULT SERIES	POLE TYPE	SHADE	ADDRESS NUMBER	REF	LOCATION	TAX DIST	DATE INST	DATE CHANGE
	05800	S	M	OUG	II	00000	002								SIDE OF 1506 WYNDHAM HILLS DRIVE	12	020897	1/1/0001
	04000	S	M	OUG	II	03893	001									12	100890	1/1/0001

OFFICE: 311		ROUTE: 564		ST_REF_NO: 00000182990		THORNWOOD CIRCLE		LUMENS	BULB TYPE	MULT SERIES	POLE TYPE	SHADE	ADDRESS NUMBER	REF	LOCATION	TAX DIST	DATE INST	DATE CHANGE
	04000	S	M	OUG	II	04604	001									12	110889	1/1/0001
	04000	S	M	OUG	II	04617	003									12	020895	1/1/0001

OFFICE: 311		ROUTE: 564		ST_REF_NO: 00000182992		THOROUGHNBRED WAY		LUMENS	BULB TYPE	MULT SERIES	POLE TYPE	SHADE	ADDRESS NUMBER	REF	LOCATION	TAX DIST	DATE INST	DATE CHANGE
	05800	S		CNT	II	00000	023								SIDE OF 504 MUSTANG CROSSING, ON THOROUGHNBRED	12	112210	1/1/0001
	05800	S		CNT	II	00000	025								SIDE OF 502 GRANDSTAND DR, ON THOROUGHNBRED WAY	12	112210	1/1/0001
	05800	S		CNT	II	00609	001									12	101108	1/1/0001
	05800	S		CNT	II	00613	002									12	101108	1/1/0001
	05800	S		CNT	II	00645	003									12	101108	1/1/0001
	05800	S		CNT	II	00657	004									12	101108	1/1/0001
	05800	S		CNT	II	00673	024									12	112210	1/1/0001
	05800	S		CNT	II	00686	029									12	112210	1/1/0001
	05800	S		CNT	II	00719	026									12	112210	1/1/0001
	05800	S		CNT	II	00730	028									12	112210	1/1/0001
	05800	S		CNT	II	00731	027									12	112210	1/1/0001

OFFICE: 311		ROUTE: 564		ST_REF_NO: 00000182995		THUNDERSTICK DRIVE		LUMENS	BULB TYPE	MULT SERIES	POLE TYPE	SHADE	ADDRESS NUMBER	REF	LOCATION	TAX DIST	DATE INST	DATE CHANGE
	09500	S		OUG	II	00000	015								1ST LT E OF EXECUTIVE DR, S SIDE ON THUNDERSTICK DR	12	110608	1/1/0001
	09500	S		OUG	II	00000	016								2ND LT E OF EXECUTIVE DR, S SIDE OF THUNDERSTICK DR	12	110608	1/1/0001
	09500	S	M	OUG	II	00000	017								SIDE 2233 EXECUTIVE DR.	12	100887	1/1/0001
	09500	S	M	OUG	II	02277	005									12	120889	1/1/0001
	09500	S	M	OUG	II	02277	007									12	120889	1/1/0001

OFFICE: 311

ROUTE: 564

ST_REF_NO: 00000182995

THUNDERSTICK DRIVE

LUMENS	BULB TYPE	MULT SERIES	POLE TYPE	SHADE	ADDRESS NUMBER	REF	LOCATION	TAX DIST	DATE INST	DATE CHANGE
09500	S	M	OUG	II	02296	002		12	120889	1/1/0001
09500	S	M	OUG	II	02297	001		12	120889	1/1/0001
09500	S	M	OUG	II	02297	003		12	120889	1/1/0001

OFFICE: 311

ROUTE: 564

ST_REF_NO: 00000183000

THURMAN DRIVE

LUMENS	BULB TYPE	MULT SERIES	POLE TYPE	SHADE	ADDRESS NUMBER	REF	LOCATION	TAX DIST	DATE INST	DATE CHANGE
05800	S	M	OUG	II	00000	034	SIDE OF 1720 SILVER LANE	12	091582	1/1/0001
05800	S	M	OUG	II	00000	039	OPP. 509	12	091582	1/1/0001
05800	S	M	OUG	II	00513	038		12	091582	1/1/0001
05800	S	M	OUG	II	00520	037		12	091582	1/1/0001
05800	S	M	OUG	II	00533	036		12	091582	1/1/0001
05800	S	M	OUG	II	00541	035		12	091582	1/1/0001

OFFICE: 311

ROUTE: 564

ST_REF_NO: 00000183100

TIBBS LANE

LUMENS	BULB TYPE	MULT SERIES	POLE TYPE	SHADE	ADDRESS NUMBER	REF	LOCATION	TAX DIST	DATE INST	DATE CHANGE
05800	S	M	OUG	III	00423	000		12	123055	1/1/0001
05800	S	M	OUG	III	00436	000		12	123055	1/1/0001

OFFICE: 311

ROUTE: 564

ST_REF_NO: 00000183150

TIBURON WAY

LUMENS	BULB TYPE	MULT SERIES	POLE TYPE	SHADE	ADDRESS NUMBER	REF	LOCATION	TAX DIST	DATE INST	DATE CHANGE
05800	S		CNT	II	03005	002		12	080210	1/1/0001
05800	S		CNT	II	03012	001		12	080210	1/1/0001
05800	S		CNT	II	03249	012		12	062513	1/1/0001

OFFICE: 311

ROUTE: 564

ST_REF_NO: 00000183200

TILDEN ROAD

LUMENS	BULB TYPE	MULT SERIES	POLE TYPE	SHADE	ADDRESS NUMBER	REF	LOCATION	TAX DIST	DATE INST	DATE CHANGE
05800	S	M	OUG	II	00000	001	SIDE OF 601 MT. TABOR	12	050170	1/1/0001
05800	S	M	OUG	II	00000	002	SIDE OF 568 PLAINVIEW RD.	12	050168	1/1/0001
05800	S	M	OUG	II	00000	016	SIDE OF 593 EUREKA SPRINGS DR.	12	041476	1/1/0001
05800	S	M	OUG	II	02804	017		12	041476	1/1/0001

OFFICE: 311		ROUTE: 564		ST_REF_NO: 00000183225		TIFFANIE COURT		LUMENS	BULB TYPE	MULT SERIES	POLE TYPE	SHADE	ADDRESS NUMBER	REF	LOCATION	TAX DIST	DATE INST	DATE CHANGE
05800	S	M	CNT	II	00801	001										12	111907	1/1/0001
05800	S	M	CNT	II	00804	002										12	111907	1/1/0001
05800	S	M	CNT	II	00817	003										12	111907	1/1/0001
05800	S	M	CNT	II	00837	004										12	111907	1/1/0001

OFFICE: 311		ROUTE: 564		ST_REF_NO: 00000183250		TIMBER CREEK DRIVE		LUMENS	BULB TYPE	MULT SERIES	POLE TYPE	SHADE	ADDRESS NUMBER	REF	LOCATION	TAX DIST	DATE INST	DATE CHANGE
05800	S	M	CNT	II	00000	003										12	100896	1/1/0001
05800	S	M	CNT	II	01755	001										12	060897	1/1/0001
05800	S	M	CNT	II	01766	010										12	100896	1/1/0001
05800	S	M	CNT	II	01775	009										12	100896	1/1/0001
05800	S	M	CNT	II	01786	008										12	100896	1/1/0001
05800	S	M	CNT	II	01799	007										12	100896	1/1/0001
05800	S	M	CNT	II	01810	006										12	100896	1/1/0001
05800	S	M	CNT	III	01834	005										12	100896	1/1/0001
05800	S	M	CNT	II	01840	004										12	100896	1/1/0001
05800	S	M	CNT	II	01866	002										12	100896	1/1/0001
05800	S	M	CNT	II	01873	001										12	100896	1/1/0001

OFFICE: 311		ROUTE: 564		ST_REF_NO: 00000183260		TIMBERNECK COVE		LUMENS	BULB TYPE	MULT SERIES	POLE TYPE	SHADE	ADDRESS NUMBER	REF	LOCATION	TAX DIST	DATE INST	DATE CHANGE
05800	S	M	CNT	III	03106	004										12	080806	1/1/0001
05800	S	M	CNT	II	03121	003										12	080806	1/1/0001
05800	S	M	CNT	II	03136	002										12	080806	1/1/0001
05800	S	M	CNT	II	03148	001										12	080806	1/1/0001

OFFICE: 311		ROUTE: 564		ST_REF_NO: 00000183275		TIMBER OAK COURT		LUMENS	BULB TYPE	MULT SERIES	POLE TYPE	SHADE	ADDRESS NUMBER	REF	LOCATION	TAX DIST	DATE INST	DATE CHANGE
05800	S	M	CNT	III	02708	002										12	091001	1/1/0001
05800	S	M	CNT	II	02720	001										12	091001	1/1/0001

OFFICE: 311 ROUTE: 564										
ST_REF_NO: 00000183300 TIMBERHILL COURT										
LUMENS	BULB TYPE	MULT SERIES	POLE TYPE	SHADE	ADDRESS NUMBER	REF	LOCATION	TAX DIST	DATE INST	DATE CHANGE
05800	S	M	OUG	II	00000	103	SIDE OF 370 CODELL DR.	12	020474	1/1/0001
OFFICE: 311 ROUTE: 564										
ST_REF_NO: 00000183400 TIMBROOK COURT										
LUMENS	BULB TYPE	MULT SERIES	POLE TYPE	SHADE	ADDRESS NUMBER	REF	LOCATION	TAX DIST	DATE INST	DATE CHANGE
04000	S	M	OUG	V	03601	053		12	111580	1/1/0001
04000	S	M	OUG	II	03617	052		12	111580	1/1/0001
04000	S	M	OUG	II	03628	051		12	111580	1/1/0001
OFFICE: 311 ROUTE: 564										
ST_REF_NO: 00000183430 TINMOUTH VALE LANE										
LUMENS	BULB TYPE	MULT SERIES	POLE TYPE	SHADE	ADDRESS NUMBER	REF	LOCATION	TAX DIST	DATE INST	DATE CHANGE
05800	S	M	OUG	II	02404	004		12	110899	1/1/0001
05800	S	M	OUG	II	02528	002		12	110899	1/1/0001
05800	S	M	OUG	II	02528	003		12	110899	1/1/0001
05800	S	M	OUG	II	02552	001		12	110899	1/1/0001
OFFICE: 311 ROUTE: 564										
ST_REF_NO: 00000183450 TIPCHIK DRIVE										
LUMENS	BULB TYPE	MULT SERIES	POLE TYPE	SHADE	ADDRESS NUMBER	REF	LOCATION	TAX DIST	DATE INST	DATE CHANGE
05800	S	M	OUG	II	00000	001	SIDE OF 2612 WOODHILL DR.	12	040897	1/1/0001
OFFICE: 311 ROUTE: 564										
ST_REF_NO: 00000183490 TISDALE COURT										
LUMENS	BULB TYPE	MULT SERIES	POLE TYPE	SHADE	ADDRESS NUMBER	REF	LOCATION	TAX DIST	DATE INST	DATE CHANGE
05800	S	M	OUG	II	03442	102	bad fixture	12	110885	3/2/2009
04000	S	M	OUG	II	03446	103		12	110885	1/1/0001
OFFICE: 311 ROUTE: 564										
ST_REF_NO: 00000183500 TISDALE DRIVE										
LUMENS	BULB TYPE	MULT SERIES	POLE TYPE	SHADE	ADDRESS NUMBER	REF	LOCATION	TAX DIST	DATE INST	DATE CHANGE
05800	S	M	OUG	II	03330	133		12	110885	8/1/2013
04000	S	M	OUG	II	00000	125	OPP. 3429	12	110885	1/1/0001
04000	S	M	OUG	II	00000	130	SIDE OF 3373 FRASERDALE DR.	12	110885	1/1/0001
04000	S	M	OUG	II	03258	107		12	110885	1/1/0001

OFFICE: 311		ROUTE: 564		ST_REF_NO: 00000183500		TISDALE DRIVE		LUMENS	BULB TYPE	MULT SERIES	POLE TYPE	SHADE	ADDRESS NUMBER	REF	LOCATION	TAX DIST	DATE INST	DATE CHANGE
	04000	S	M	OUG	II	03265	108									12	110885	1/1/0001
	04000	S	M	OUG	II	03278	109									12	110885	1/1/0001
	04000	S	M	OUG	II	03286	110									12	110885	1/1/0001
	04000	S	M	OUG	II	03297	111									12	110885	1/1/0001
	04000	S	M	OUG	II	03310	112									12	110885	1/1/0001
	04000	S	M	OUG	II	03321	113									12	110885	1/1/0001
	04000	S	M	OUG	II	03342	132									12	110885	1/1/0001
	04000	S	M	OUG	II	03354	131									12	110885	1/1/0001
	04000	S	M	OUG	II	03378	129									12	110885	1/1/0001
	04000	S	M	OUG	II	03398	128									12	110885	1/1/0001
	04000	S	M	OUG	II	03409	127									12	110885	1/1/0001
	04000	S	M	OUG	II	03421	126									12	110885	1/1/0001

OFFICE: 311

ROUTE: 564

OFFICE: 311		ROUTE: 564		ST_REF_NO: 00000183590		TISHOFF COURT		LUMENS	BULB TYPE	MULT SERIES	POLE TYPE	SHADE	ADDRESS NUMBER	REF	LOCATION	TAX DIST	DATE INST	DATE CHANGE
	05800	S	M	OUG	II	03409	145									12	091477	1/1/0001
	05800	S	M	OUG	II	03417	144									12	011476	1/1/0001
	05800	S	M	OUG	II	03424	143									12	091476	1/1/0001

OFFICE: 311

ROUTE: 564

OFFICE: 311		ROUTE: 564		ST_REF_NO: 00000183600		TISHOFF DRIVE		LUMENS	BULB TYPE	MULT SERIES	POLE TYPE	SHADE	ADDRESS NUMBER	REF	LOCATION	TAX DIST	DATE INST	DATE CHANGE
	05800	S	M	OUG	II	00000	139								SIDE OF 3369 PEPPERHILL RD.	12	041476	1/1/0001
	05800	S	M	OUG	II	01201	142									12	081475	1/1/0001
	05800	S	M	OUG	II	01208	141									12	041476	1/1/0001
	05800	S	M	OUG	II	01216	140									12	011476	1/1/0001
	05800	S	M	OUG	II	01232	138									12	081475	1/1/0001
	05800	S	M	OUG	II	01233	153									12	081475	1/1/0001
	05800	S	M	OUG	II	01245	154									12	011476	1/1/0001
	05800	S	M	OUG	II	01261	155									12	091477	1/1/0001
	05800	S	M	OUG	V	01269	156									12	071476	1/1/0001

OFFICE: 311

ROUTE: 564

ST_REF_NO: 00000183690

TIVERTON WAY

LUMENS	BULB TYPE	MULT SERIES	POLE TYPE	SHADE	ADDRESS NUMBER	REF	LOCATION	TAX DIST	DATE INST	DATE CHANGE
05800	S	M	OUG	II	00100	002		12	020887	1/1/0001
05800	S	M	OUG	II	00101	001		12	020887	1/1/0001
05800	S	M	OUG	II	00000	040	SIDE OF 485 FOX HARBOUR DRIVE	12	010897	1/1/0001
05800	S	M	OUG	II	00109	003		12	020887	1/1/0001
05800	S	M	OUG	II	00116	004		12	020887	1/1/0001
05800	S	M	OUG	II	00129	005		12	020887	1/1/0001
05800	S	M	OUG	II	00137	006		12	020887	1/1/0001
05800	S	M	OUG	II	00145	007		12	020887	1/1/0001
05800	S	M	OUG	II	00147	008		12	020887	1/1/0001
05800	S	M	OUG	II	00156	009		12	020887	1/1/0001
05800	S	M	OUG	II	00157	010		12	020887	1/1/0001
05800	S	M	OUG	II	00172	011		12	020887	1/1/0001
05800	S	M	OUG	II	00180	012		12	020887	1/1/0001
05800	S	M	OUG	II	00187	013		12	020887	1/1/0001
05800	S	M	OUG	II	00196	014		12	020887	1/1/0001
05800	S	M	OUG	II	00207	015		12	020887	1/1/0001
05800	S	M	OUG	II	00212	016		12	020887	1/1/0001
05800	S	M	OUG	II	00221	017		12	020887	1/1/0001
05800	S	M	OUG	II	00232	018		12	020887	1/1/0001
05800	S	M	OUG	II	00239	019		12	020887	1/1/0001
05800	S	M	OUG	II	00256	020		12	020887	1/1/0001
05800	S	M	OUG	II	00259	021		12	020887	1/1/0001
05800	S	M	OUG	II	00272	022		12	020887	1/1/0001
05800	S	M	OUG	II	00299	023		12	020887	1/1/0001
05800	S	M	OUG	II	00308	024		12	020887	1/1/0001
05800	S	M	OUG	II	00317	025		12	020887	1/1/0001
05800	S	M	OUG	II	00328	026		12	020887	1/1/0001
05800	S	M	OUG	II	00337	027		12	020887	1/1/0001
05800	S	M	OUG	II	00348	028		12	020887	1/1/0001
05800	S	M	OUG	II	00360	029		12	020887	1/1/0001
05800	S	M	OUG	II	00367	030		12	020887	1/1/0001
05800	S	M	OUG	II	00375	031		12	020887	1/1/0001
05800	S	M	OUG	II	00404	102		12	020887	1/1/0001

OFFICE: 311

ROUTE: 564

ST_REF_NO: 00000183700

TIVERTON, WEST WAY

LUMENS	BULB TYPE	MULT SERIES	POLE TYPE	SHADE	ADDRESS NUMBER	REF	LOCATION	TAX DIST	DATE INST	DATE CHANGE
09500	S	M	OUG	II	00000	001	1ST LT. W. OF NICHOLASVILLE RD., NORTHSIDE	12	060893	1/1/0001
09500	S	M	OUG	II	00000	003	2ND LT. W. OF NICHOLASVILLE RD., NORTHSIDE	12	060893	1/1/0001
09500	S	M	OUG	II	00000	005		12	060893	1/1/0001
09500	S	M	OUG	II	00000	007	4TH LT. W. OF NICHOLASVILLE RD., NORTHSIDE	12	060893	1/1/0001
09500	S	M	OUG	II	00000	009	SIDE 3992 W. TIVERTON CT.	12	050893	1/1/0001
09500	S	M	OUG	II	00104	002		12	111580	1/1/0001
09500	S	M	OUG	II	00128	004		12	111580	1/1/0001
09500	S	M	OUG	II	00128	006		12	111580	1/1/0001
09500	S	M	OUG	II	00152	016		12	060893	1/1/0001
09500	S	M	OUG	II	00156	017		12	060893	1/1/0001

OFFICE: 311

ROUTE: 564

ST_REF_NO: 00000183710

TIVERTON, W. COURT

LUMENS	BULB TYPE	MULT SERIES	POLE TYPE	SHADE	ADDRESS NUMBER	REF	LOCATION	TAX DIST	DATE INST	DATE CHANGE
09500	S		OUG	II	00000	012	OPP 3992 W. TIVERTON CT.	12	060893	1/1/0001
09500	S	M	OUG	II	00000	014	OPP. 3992 W. TIVERTON CT.	12	060893	1/1/0001
09500	S	M	OUG	III	03992	011		12	050893	1/1/0001
09500	S	M	OUG	II	03992	013		12	050893	1/1/0001

OFFICE: 311

ROUTE: 564

ST_REF_NO: 00000183800

TODD STREET

LUMENS	BULB TYPE	MULT SERIES	POLE TYPE	SHADE	ADDRESS NUMBER	REF	LOCATION	TAX DIST	DATE INST	DATE CHANGE
05800	S	M	SOH	II	00000	001	SIDE REAR OF 167 JEFFERSON ST.	12	061269	1/1/0001

OFFICE: 311

ROUTE: 564

ST_REF_NO: 00000183900

TODDS ROAD

LUMENS	BULB TYPE	MULT SERIES	POLE TYPE	SHADE	ADDRESS NUMBER	REF	LOCATION	TAX DIST	DATE INST	DATE CHANGE
22000	S		OUG	II	00000	100	3RD LT E OF FOREST HILL DR, N SIDE ON TODDS RD	12	122110	1/1/0001
22000	S		OUG	II	00000	101	3RD LT E OF FOREST HILL DR, S SIDE ON TODDS RD	12	122110	1/1/0001
22000	S		OUG	II	00000	102	2ND LT E OF FOREST HILL DR, N SIDE ON TODDS RD	12	122110	1/1/0001
22000	S		OUG	II	00000	103	2ND LT E OF FOREST HILL DR, S SIDE ON TODDS RD	12	122110	1/1/0001

OFFICE: 311

ROUTE: 564

ST_REF_NO: 00000183900

TODDS ROAD

LUMENS	BULB TYPE	MULT SERIES	POLE TYPE	SHADE	ADDRESS NUMBER	REF	LOCATION	TAX DIST	DATE INST	DATE CHANGE
22000	S		OUG	II	00000	104	1ST LT E OF FOREST HILL DR, N SIDE ON TODDS RD	12	122110	1/1/0001
22000	S		OUG	II	00000	105	1ST LT E OF FOREST HILL DR, S SIDE ON TODDS RD	12	122110	1/1/0001
22000	S		OUG	II	00000	106	8TH LT E OF MOW BLVD, N SIDE ON TODDS RD	12	122110	1/1/0001
22000	S		OUG	II	00000	107	7TH LT E OF MOW BLVD, S SIDE ON TODDS RD	12	122110	1/1/0001
22000	S		OUG	II	00000	108	7TH LT E OF MOW BLVD, N SIDE ON TODDS RD	12	122110	1/1/0001
22000	S		OUG	II	00000	109	6TH LT E OF MOW BLVD, S SIDE ON TODDS RD	12	122110	1/1/0001
22000	S		OUG	II	00000	110	6TH LT E OF MOW BLVD, N SIDE ON TODDS RD	12	122110	1/1/0001
22000	S		OUG	II	00000	111	5TH LT E OF MOW BLVD, S SIDE ON TODDS RD	12	122110	1/1/0001
22000	S		OUG	II	00000	112	5TH LT E OF MOW BLVD, N SIDE ON TODDS RD	12	122110	1/1/0001
22000	S		OUG	II	00000	113	4TH LT E OF MOW BLVD, S SIDE ON TODDS RD	12	122110	1/1/0001
22000	S		OUG	II	00000	114	4TH LT E OF MOW BLVD, N SIDE ON TODDS RD	12	122110	1/1/0001
22000	S		OUG	II	00000	115	3RD LT E OF MOW BLVD, S SIDE ON TODDS RD	12	122110	1/1/0001
22000	S		OUG	II	00000	116	3RD LT E OF MOW BLVD, N SIDE ON TODDS RD	12	122110	1/1/0001
22000	S		OUG	II	00000	117	2ND LT E OF MOW BLVD, S SIDE ON TODDS RD	12	122110	1/1/0001
22000	S		OUG	II	00000	118	2ND LT E OF MOW BLVD, N SIDE ON TODDS RD	12	122110	1/1/0001
22000	S		OUG	II	00000	119	1ST LT E OF MOW BLVD, S SIDE ON TODDS RD	12	122110	1/1/0001
22000	S		OUG	II	00000	120	1ST LT E OF MOW BLVD, N SIDE ON TODDS RD	12	122110	1/1/0001
50000	S	M	OOH	II	00000	999	TODDS ROAD AT CHILESBURG-TEMP UNTIL SPRING 2002	12	010202	1/1/0001
09500	S	M	OUG	III	00000	001	3RD LT NORTH OF MAN-O-WAR,EASTSIDE OF TODDS RD	12	090891	1/1/0001
09500	S	M	OUG	II	00000	324	1ST LT. N OF CHILESBURG RD., WESTSIDE	12	050899	1/1/0001
09500	S	M	OUG	II	00000	325	1ST LT. S OF CHILESBURG RD., WESTSIDE	12	050899	1/1/0001
09500	S	M	OUG	II	00000	334	1ST LT. NW OF ANDOVER VILLAGE DR., SW SIDE	12	070899	1/1/0001
09500	S	M	OUG	II	00000	335	1ST LT. SE OF ANDOVER VILLAGE DR. SW	12	070899	1/1/0001
09500	S	M	OUG	II	00000	315	1ST LT. S OF FOREST HILL DR., W SIDE	12	060800	1/1/0001
09500	S	M	OUG	II	00000	316	1ST LT. N OF KAVENAUGH LANE, W SIDE	12	060800	1/1/0001
09500	S	M	OUG	II	00000	317	1ST LT. S OF KAVENUAGH LANE, W SIDE	12	060800	1/1/0001
09500	S	M	OUG	II	00000	318	1ST LT. N OF AUTUMN RIDGE DR., E SIDE	12	060800	1/1/0001
09500	S	M	OUG	II	00000	328	1ST LT. N OF KIMBOLTON DR., E SIDE	12	060800	1/1/0001
09500	S	M	OUG	II	00000	329	1ST LT. S OF CYPRESS POINT WAY, W SIDE	12	060800	1/1/0001
09500	S	M	OOH	II	00000	340	1ST LT. W OF CLEVELAND RD., N SIDE	12	060800	1/1/0001
09500	S	M	OOH	II	00000	341	1ST LT. E OF CLEVELAND RD., S SIDE	12	060800	1/1/0001

OFFICE: 311

ROUTE: 564

ST_REF_NO: 00000183990

TOM ALLEY

LUMENS	BULB TYPE	MULT SERIES	POLE TYPE	SHADE	ADDRESS NUMBER	REF	LOCATION	TAX DIST	DATE INST	DATE CHANGE
09500	S		SOH	II	00000	001	1ST LT N OF MAGOFFIN ST, W SIDE ON TOM ALLEY	12	120310	1/1/0001
09500	S		SOH	II	00000	002	2ND LT N OF MAGOFFIN ST, E SIDE ON TOM ALLEY	12	120310	1/1/0001
09500	S		SOH	II	00000	003	3RD LT N OF MAGOFFIN ST, E SIDE ON TOM ALLEY	12	120310	1/1/0001
09500	S		SOH	II	00000	004	4TH LT N OF MAGOFFIN ST, W SIDE ON TOM ALLEY	12	120310	1/1/0001

OFFICE: 311

ROUTE: 564

ST_REF_NO: 00000184000

TOMAHAWK TRAIL

LUMENS	BULB TYPE	MULT SERIES	POLE TYPE	SHADE	ADDRESS NUMBER	REF	LOCATION	TAX DIST	DATE INST	DATE CHANGE
04000	S	M	OUG	II	00868	002		12	050890	1/1/0001
04000	S	M	OUG	II	00873	001		12	050890	1/1/0001
04000	S	M	OUG	II	00000	009	OPP. 821	12	060890	1/1/0001
04000	S	M	OUG	II	00000	010	OPP. 817	12	060890	1/1/0001
04000	S	M	OUG	II	00000	011	OPP. 805	12	060890	1/1/0001
04000	S	M	OUG	II	00828	008		12	050890	1/1/0001
04000	S	M	OUG	II	00832	007		12	050890	1/1/0001
04000	S	M	OUG	II	00841	006		12	050890	1/1/0001
05800	S	M	OUG	II	00844	005	upgraded 5/08	12	050890	1/1/0001
04000	S	M	OUG	II	00853	004		12	050890	1/1/0001
04000	S	M	OUG	II	00864	003		12	050890	1/1/0001

OFFICE: 311

ROUTE: 564

ST_REF_NO: 00000184100

TONER STREET

LUMENS	BULB TYPE	MULT SERIES	POLE TYPE	SHADE	ADDRESS NUMBER	REF	LOCATION	TAX DIST	DATE INST	DATE CHANGE
05800	S	M	SOH	I	00000	006	SIDE OF 308 W. SIXTH ST.	12	080165	1/1/0001
05800	S	M	SOH	II	00527	003		12	031583	1/1/0001
05800	S	M	SOH	I	00545	004		12	080165	1/1/0001
05800	S	M	SOH	I	00555	005		12	080165	1/1/0001
05800	S	M	SOH	I	00505	001		12	080165	1/1/0001
05800	S	M	SOH	I	00519	002		12	080165	1/1/0001

OFFICE: 311

ROUTE: 564

ST_REF_NO: 00000184150

TOPAZ CT

LUMENS	BULB TYPE	MULT SERIES	POLE TYPE	SHADE	ADDRESS NUMBER	REF	LOCATION	TAX DIST	DATE INST	DATE CHANGE
04000	S	M	OUG	V	03500	002		12	110891	1/1/0001

OFFICE: 311		ROUTE: 564		ST_REF_NO: 00000184150		TOPAZ CT		LUMENS	BULB TYPE	MULT SERIES	POLE TYPE	SHADE	ADDRESS NUMBER	REF	LOCATION	TAX DIST	DATE INST	DATE CHANGE
	04000	S	M	OUG	II	03512	001									12	110891	1/1/0001
OFFICE: 311		ROUTE: 564		ST_REF_NO: 00000184200		TOPEKA ROAD		LUMENS	BULB TYPE	MULT SERIES	POLE TYPE	SHADE	ADDRESS NUMBER	REF	LOCATION	TAX DIST	DATE INST	DATE CHANGE
	04000	S	M	OUG	II	00000	061								SIDE OF 607 WICHITA	12	111583	1/1/0001
	04000	S	M	OUG	II	00000	064								SIDE OF 619 PASADENA	12	111583	1/1/0001
	04000	S	M	OUG	V	00601	062									12	111583	1/1/0001
	04000	S	M	OUG	II	00602	063									12	111583	1/1/0001
	04000	S	M	OUG	II	02401	059									12	111583	1/1/0001
	04000	S	M	OUG	II	02408	060									12	111583	1/1/0001
OFFICE: 311		ROUTE: 564		ST_REF_NO: 00000184300		TORONTO COURT		LUMENS	BULB TYPE	MULT SERIES	POLE TYPE	SHADE	ADDRESS NUMBER	REF	LOCATION	TAX DIST	DATE INST	DATE CHANGE
	05800	S	M	OUG	V	03975	037								bad fixture	12	110886	3/2/2009
	04000	S	M	OUG	II	03997	038									12	110886	1/1/0001
OFFICE: 311		ROUTE: 564		ST_REF_NO: 00000184400		TORONTO ROAD		LUMENS	BULB TYPE	MULT SERIES	POLE TYPE	SHADE	ADDRESS NUMBER	REF	LOCATION	TAX DIST	DATE INST	DATE CHANGE
	05800	S	M	OUG	II	00000	026								OPP. 149	12	110886	1/1/0001
	05800	S	M	OUG	II	00105	021									12	110886	1/1/0001
	05800	S	M	OUG	II	00109	022									12	110886	1/1/0001
	05800	S	M	OUG	II	00121	023									12	110886	1/1/0001
	05800	S	M	OUG	II	00129	024									12	110886	1/1/0001
	05800	S	M	OUG	II	00137	025									12	110886	1/1/0001
	05800	S	M	OUG	II	00157	027									12	110886	1/1/0001
	05800	S	M	OUG	II	00174	028									12	110886	1/1/0001
	05800	S	M	OUG	II	00177	029									12	110886	1/1/0001
	05800	S	M	OUG	V	00181	090								upgraded 5/08	12	110886	1/1/0001
	05800	S	M	OUG	II	00189	030									12	110886	1/1/0001
	05800	S	M	OUG	II	00196	031									12	110886	1/1/0001
	05800	S	M	OUG	II	00205	032									12	110886	1/1/0001

OFFICE: 311

ROUTE: 564

ST_REF_NO: 00000184400

TORONTO ROAD

LUMENS	BULB TYPE	MULT SERIES	POLE TYPE	SHADE	ADDRESS NUMBER	REF	LOCATION	TAX DIST	DATE INST	DATE CHANGE
05800	S	M	SOH	II	00216	033		12	110886	1/1/0001
04000	S	M	OUG	V	00232	036		12	110886	1/1/0001
05800	S	M	OUG	II	00233	034		12	110886	1/1/0001
05800	S	M	OUG	II	00244	035		12	110886	1/1/0001

OFFICE: 311

ROUTE: 564

ST_REF_NO: 00000184580

TOWN BRANCH ROAD

LUMENS	BULB TYPE	MULT SERIES	POLE TYPE	SHADE	ADDRESS NUMBER	REF	LOCATION	TAX DIST	DATE INST	DATE CHANGE
05800	S	M	CNT	II	02945	015		12	100507	1/1/0001
05800	S	M	CNT	II	02949	014		12	100507	1/1/0001
05800	S	M	CNT	II	02960	013		12	100507	1/1/0001
05800	S	M	CNT	II	02973	012		12	100507	1/1/0001
05800	S	M	CNT	II	02993	010		12	080102	1/1/0001
05800	S	M	CNT	II	02996	009		12	080102	1/1/0001
05800	S	M	CNT	II	03004	008		12	080102	1/1/0001
05800	S	M	CNT	II	03013	007		12	080102	1/1/0001
05800	S	M	CNT	II	03020	006		12	090605	1/1/0001
05800	S	M	CNT	II	03032	005		12	090605	1/1/0001
05800	S	M	CNT	II	03041	004		12	090605	1/1/0001
05800	S	M	CNT	II	03052	003		12	090605	1/1/0001
05800	S	M	CNT	II	03061	002		12	090605	1/1/0001
05800	S	M	CNT	II	03072	001		12	090605	1/1/0001

OFFICE: 311

ROUTE: 564

ST_REF_NO: 00000184583

TOWN BRANCH COVE

LUMENS	BULB TYPE	MULT SERIES	POLE TYPE	SHADE	ADDRESS NUMBER	REF	LOCATION	TAX DIST	DATE INST	DATE CHANGE
05800	S	M	CNT	II	00105	001		12	100507	1/1/0001

OFFICE: 311

ROUTE: 564

ST_REF_NO: 00000184584

TOWNE CENTER DRIVE

LUMENS	BULB TYPE	MULT SERIES	POLE TYPE	SHADE	ADDRESS NUMBER	REF	LOCATION	TAX DIST	DATE INST	DATE CHANGE
05800	S		CLN	II	00137	015		12	101709	1/1/0001
05800	S		CLN	II	00140	014		12	101709	1/1/0001
05800	S		CLN	II	00156	012		12	101709	1/1/0001

OFFICE: 311		ROUTE: 564		ST_REF_NO: 00000184584		TOWNE CENTER DRIVE		LUMENS	BULB TYPE	MULT SERIES	POLE TYPE	SHADE	ADDRESS NUMBER	REF	LOCATION	TAX DIST	DATE INST	DATE CHANGE
	05800	S		CLN	II	00157	013									12	101709	1/1/0001
	05800	S		CLN	II	00172	010									12	101709	1/1/0001
	05800	S		CLN	II	00173	011									12	101709	1/1/0001

OFFICE: 311		ROUTE: 564		ST_REF_NO: 00000184585		TOWNE SQUARE PARK		LUMENS	BULB TYPE	MULT SERIES	POLE TYPE	SHADE	ADDRESS NUMBER	REF	LOCATION	TAX DIST	DATE INST	DATE CHANGE
	05800	S		CLN	II	00000	005								SIDE OF 224 TOWNE SQUARE PARK	12	101709	1/1/0001
	05800	S		CLN	II	00000	006								SIDE OF 172 TOWNE CENTER DR, ON TOWNE SQUARE	12	101709	1/1/0001
	05800	S		CLN	II	00000	007								SIDE OF 173 TOWNE CENTER DR, ON TOWNE SQUARE	12	101709	1/1/0001
	05800	S		CLN	II	00000	008								SIDE OF 168 TOWNE SQUARE PARK	12	101709	1/1/0001
	05800	S		CLN	II	00132	012									12	101709	1/1/0001
	05800	S		CLN	II	00137	011									12	101709	1/1/0001
	05800	S		CLN	II	00148	010									12	101709	1/1/0001
	05800	S		CLN	II	00164	009									12	101709	1/1/0001
	05800	S		CLN	II	00228	004									12	101709	1/1/0001
	05800	S		CLN	II	00248	003									12	101709	1/1/0001
	05800	S		CLN	II	00260	002									12	101709	1/1/0001

OFFICE: 311		ROUTE: 564		ST_REF_NO: 00000184600		TOWNLEY DRIVE		LUMENS	BULB TYPE	MULT SERIES	POLE TYPE	SHADE	ADDRESS NUMBER	REF	LOCATION	TAX DIST	DATE INST	DATE CHANGE
	05800	S	M	OUG	II	01462	146								bad fixture	12	121582	7/20/2009
	04000	S	M	OUG	II	00000	145								OPP. 1455	12	121582	1/1/0001
	04000	S	M	OUG	II	00000	150								OPP. 1499	12	121582	1/1/0001
	04000	S	M	OUG	II	01416	152									12	121582	1/1/0001
	04000	S	M	OUG	II	01446	144									12	121582	1/1/0001
	04000	S	M	OUG	II	01471	147									12	121582	1/1/0001
	04000	S	M	OUG	II	01482	148									12	121582	1/1/0001
	04000	S	M	OUG	II	01491	149									12	121582	1/1/0001
	04000	S	M	OUG	II	01505	151									12	121582	1/1/0001

OFFICE: 311		ROUTE: 564		ST_REF_NO: 00000184610		TRADE STREET		LUMENS	BULB TYPE	MULT SERIES	POLE TYPE	SHADE	ADDRESS NUMBER	REF	LOCATION	TAX DIST	DATE INST	DATE CHANGE
05800	S	M	OUG	II	00000	001	SIDE OF 2401 MERCHANT ST.	12	110885								1/1/0001	
05800	S	M	OUG	II	00000	004	SIDE OF 2400 MERCHANT ST.	12	020888								1/1/0001	
05800	S	M	OUG	II	00000	006	OPP. 124	12	020888								1/1/0001	
05800	S	M	OUG	II	00000	008	OPP. 132	12	020888								1/1/0001	
05800	S	M	OUG	II	00000	010	OPP. 132	12	020888								1/1/0001	
05800	S	M	OUG	II	00000	012	SIDE OF 157 TRADE ST.	12	020888								1/1/0001	
05800	S	M	OUG	II	00100	002		12	110891								1/1/0001	
05800	S	M	OUG	II	00108	003		12	090898								1/1/0001	
05800	S	M	OUG	II	00116	005		12	110885								1/1/0001	
05800	S	M	OUG	II	00132	007		12	110891								1/1/0001	
05800	S	M	OUG	II	00132	009		12	110891								1/1/0001	
05800	S	M	OUG	II	00148	011		12	020888								1/1/0001	
05800	S	M	OUG	II	00156	013		12	020888								1/1/0001	
05800	S	M	OUG	II	00165	015		12	020888								1/1/0001	
05800	S	M	OUG	III	00172	014		12	090898								1/1/0001	
05800	S	M	OUG	II	00172	016		12	090898								1/1/0001	
05800	S	M	OUG	III	00172	018		12	090898								1/1/0001	
05800	S	M	OUG	III	00173	017		12	090898								1/1/0001	

OFFICE: 311		ROUTE: 564		ST_REF_NO: 00000184620		TRADE CENTER DR		LUMENS	BULB TYPE	MULT SERIES	POLE TYPE	SHADE	ADDRESS NUMBER	REF	LOCATION	TAX DIST	DATE INST	DATE CHANGE
09500	S		OUG	II	00000	001	1ST LT E OF NEW CIRCLE RD, S SIDE OF TRADE CENTER	12	030801								1/1/0001	
09500	S		OUG	II	00000	002	1ST LT E OF NEW CIRCLE RD, N SIDE OF TRADE CENTER	12	030801								1/1/0001	
09500	S		OUG	II	00000	003	2ND LT E OF NEW CIRCLE RD, S SIDE OF TRADE CENTER	12	030801								1/1/0001	
09500	S		OUG	II	00000	004	2ND ST E OF NEW CIRCLE RD, N SIDE OF TRADE CENTER	12	030801								1/1/0001	
09500	S		OUG	II	00000	005	3RD LT E OF NEW CIRCLE, S SIDE OF TRADE CENTER DR	12	030801								1/1/0001	
09500	S		OUG	II	00000	006	3RD LT E OF NEW CIRCLE, N SIDE OF TRADE CENTER DR	12	030801								1/1/0001	
09500	S		OUG	II	00000	007	4TH LT E OF NEW CIRCLE, N SIDE OF TRADE CENTER DR	12	030801								1/1/0001	

OFFICE: 311		ROUTE: 564		ST_REF_NO: 00000184620		TRADE CENTER DR		LUMENS	BULB TYPE	MULT SERIES	POLE TYPE	SHADE	ADDRESS NUMBER	REF	LOCATION	TAX DIST	DATE INST	DATE CHANGE
09500	S		OUG	II	00000	008	4TH LT E OF NEW CIRCLE, S SIDE OF TRADE CENTER DR	12	030801									1/1/0001
09500	S		OUG	II	00000	009	5TH LT E OF NEW CIRCLE, N SIDE OF TRADE CENTER DR	12	030801									1/1/0001
09500	S		OUG	II	00000	010	5TH LT E OF NEW CIRCLE, S SIDE OF TRADE CENTER DR	12	030801									1/1/0001
09500	S		OUG	II	00000	011	6TH LT E OF NEW CIRCLE, N SIDE OF TRADE CENTER DR	12	030801									1/1/0001
09500	S		OUG	II	00000	012	SIDE OF 2400 FORTUNE DRIVE, S SIDE OF TRADE CENTER	12	030801									1/1/0001
OFFICE: 311		ROUTE: 564		ST_REF_NO: 00000184625		TRADITION WAY		LUMENS	BULB TYPE	MULT SERIES	POLE TYPE	SHADE	ADDRESS NUMBER	REF	LOCATION	TAX DIST	DATE INST	DATE CHANGE
05800	S	M	OUG	II	00000	003	SIDE OF 197 ACORN FALLS DR ON TRADITION WAY	12	083104									1/1/0001
05800	S	M	OUG	II	04317	002		12	083104									1/1/0001
OFFICE: 311		ROUTE: 564		ST_REF_NO: 00000184630		TOWNSEND RIDGE DRIVE		LUMENS	BULB TYPE	MULT SERIES	POLE TYPE	SHADE	ADDRESS NUMBER	REF	LOCATION	TAX DIST	DATE INST	DATE CHANGE
05800	S	M	CNT	II	00509	001		12	102103									1/1/0001
05800	S	M	CNT	II	00520	002		12	102103									1/1/0001
05800	S	M	CNT	II	00537	003		12	102103									1/1/0001
05800	S	M	CNT	II	00556	004		12	102103									1/1/0001
05800	S	M	CNT	II	00573	005		12	102103									1/1/0001
05800	S	M	CNT	II	00589	006		12	102103									1/1/0001
05800	S	M	CNT	II	00601	007		12	052903									1/1/0001
OFFICE: 311		ROUTE: 564		ST_REF_NO: 00000184675		TRADEWIND WAY		LUMENS	BULB TYPE	MULT SERIES	POLE TYPE	SHADE	ADDRESS NUMBER	REF	LOCATION	TAX DIST	DATE INST	DATE CHANGE
05800	S	M	CNT	II	00000	001	SIDE OF 724 STANSBERRY COVE ON TRADEWIND WAY	12	070806									1/1/0001

OFFICE: 311		ROUTE: 564		ST_REF_NO: 00000184700		TRAFTON STREET		LUMENS	BULB TYPE	MULT SERIES	POLE TYPE	SHADE	ADDRESS NUMBER	REF	LOCATION	TAX DIST	DATE INST	DATE CHANGE
04000	S	M	SOH	II	00000	001	SIDE 133 VERSAILLES RD.	12	030886	1/1/0001								
04000	S	M	SOH	II	00000	002	OPP. 105	12	030886	1/1/0001								
04000	S	M	SOH	II	00000	003	OPP. 105	12	070886	1/1/0001								
04000	S	M	SOH	II	00120	004		12	070886	1/1/0001								
04000	S	M	SOH	II	00130	005		12	030886	1/1/0001								
04000	S	M	SOH	II	00130	006		12	070886	1/1/0001								

OFFICE: 311		ROUTE: 564		ST_REF_NO: 00000184750		TRAILSIDE DRIVE		LUMENS	BULB TYPE	MULT SERIES	POLE TYPE	SHADE	ADDRESS NUMBER	REF	LOCATION	TAX DIST	DATE INST	DATE CHANGE
05800	S	M	CNT	II	00000	005	SIDE OF 2917 PIEDMONT PARK	12	030898	1/1/0001								
05800	S	M	CNT	II	02900	001		12	030898	1/1/0001								
05800	S	M	CNT	II	02913	002		12	030898	1/1/0001								
05800	S	M	CNT	III	02932	003		12	030898	1/1/0001								
05800	S	M	CNT	II	02940	004		12	030898	1/1/0001								
05800	S	M	CNT	II	02959	006		12	030898	1/1/0001								
05800	S	M	CNT	II	02976	007		12	030898	1/1/0001								
05800	S	M	CNT	III	02988	008		12	030898	1/1/0001								
05800	S	M	CNT	III	03004	009		12	030898	1/1/0001								

OFFICE: 311		ROUTE: 564		ST_REF_NO: 00000184775		TRAILWOOD LANE		LUMENS	BULB TYPE	MULT SERIES	POLE TYPE	SHADE	ADDRESS NUMBER	REF	LOCATION	TAX DIST	DATE INST	DATE CHANGE
05800	S	M	CNT	II	00000	001	SIDE OF 201 BLACKWATER LN ON TRAILWOOD LANE	12	060304	1/1/0001								
05800	S	M	CNT	II	00000	002	SIDE OF 192 WHITE OAK TRACE ON TRAILWOOD LANE	12	060304	1/1/0001								
05800	S	M	CNT	II	00000	003	SIDE OF 201 WHITE OAK TRACE ON TRAILWOOD LANE	12	060304	1/1/0001								
05800	S	M	OUG	II	00000	011	SIDE OF 201 CLOVER VALLEY DR ON TRAILWOOD DR	12	083105	1/1/0001								
05800	S	M	OUG	II	02624	002		12	071002	1/1/0001								
05800	S	M	OUG	II	02645	003		12	071002	1/1/0001								
05800	S	M	OUG	II	02656	004		12	071002	1/1/0001								
05800	S	M	OUG	II	02669	005		12	071002	1/1/0001								
05800	S	M	OUG	II	02676	006		12	071002	1/1/0001								

OFFICE: 311		ROUTE: 564		ST_REF_NO: 00000184775		TRAILWOOD LANE				
LUMENS	BULB TYPE	MULT SERIES	POLE TYPE	SHADE	ADDRESS NUMBER	REF	LOCATION	TAX DIST	DATE INST	DATE CHANGE
05800	S	M	OUG	II	02693	007		12	083105	1/1/0001
05800	S	M	OUG	II	02705	008		12	083105	1/1/0001
05800	S	M	OUG	II	02716	009		12	083105	1/1/0001
05800	S	M	OUG	II	02733	010		12	083105	1/1/0001
05800	S	M	CNT	II	02764	003		12	091001	1/1/0001
05800	S	M	CNT	II	02784	002		12	091001	1/1/0001
05800	S	M	CNT	II	02797	001		12	091001	1/1/0001
05800	S	M	CNT	II	03000	001		12	103005	1/1/0001
05800	S	M	CNT	II	03017	002		12	100507	1/1/0001
05800	S	M	CNT	II	03036	003		12	103005	1/1/0001
05800	S	M	CNT	II	03053	004		12	103005	1/1/0001
05800	S	M	CNT	II	03072	005		12	103005	1/1/0001

OFFICE: 311		ROUTE: 564		ST_REF_NO: 00000184780		TRAMMELL AVENUE				
LUMENS	BULB TYPE	MULT SERIES	POLE TYPE	SHADE	ADDRESS NUMBER	REF	LOCATION	TAX DIST	DATE INST	DATE CHANGE
05800	S		OUG	II	00910	002		12	071213	1/1/0001
05800	S		OUG	II	00914	001		12	071213	1/1/0001

OFFICE: 311		ROUTE: 564		ST_REF_NO: 00000184800		TRANSCRIPT AVENUE				
LUMENS	BULB TYPE	MULT SERIES	POLE TYPE	SHADE	ADDRESS NUMBER	REF	LOCATION	TAX DIST	DATE INST	DATE CHANGE
05800	S	M	SOH	I	00000	007	IN INTERSECTION AT PRESS AVE.	12	050863	1/1/0001
05800	S	M	SOH	I	00120	000		12	011061	1/1/0001
05800	S	M	SOH	I	00124	000		12	011061	1/1/0001
05800	S	M	SOH	I	00140	000		12	011061	1/1/0001
05800	S	M	SOH	I	00146	000		12	011061	1/1/0001
05800	S	M	SOH	I	00152	000		12	050863	1/1/0001
05800	S	M	SOH	I	00158	000		12	050863	1/1/0001
05800	S	M	SOH	I	00208	000		12	011061	1/1/0001
05800	S	M	SOH	I	00216	000		12	011061	1/1/0001

OFFICE: 311 ROUTE: 564							ST_REF_NO: 00000184900 TRANSPORT COURT			
LUMENS	BULB TYPE	MULT SERIES	POLE TYPE	SHADE	ADDRESS NUMBER	REF	LOCATION	TAX DIST	DATE INST	DATE CHANGE
05800	S	M	OUG	II	00000	014	OPP. 444	12	120170	1/1/0001
05800	S	M	OUG	II	00427	012		12	120170	1/1/0001
05800	S	M	OUG	II	00428	011		12	081475	1/1/0001
05800	S	M	OUG	II	00444	015		12	081475	1/1/0001
05800	S	M	OUG	V	00460	016		12	081475	1/1/0001

OFFICE: 311 ROUTE: 564							ST_REF_NO: 00000185000 TRANSYLVANIA PARK			
LUMENS	BULB TYPE	MULT SERIES	POLE TYPE	SHADE	ADDRESS NUMBER	REF	LOCATION	TAX DIST	DATE INST	DATE CHANGE
09500	S	M	OUG	I	00000	012	OPP. 425 IN MEDIAN	12	050867	1/1/0001
09500	S	M	OUG	I	00000	013	OPP. 424 IN MEDIAN	12	050867	1/1/0001
05800	S	M	OUG	I	00000	001	OPP. 309 IN MEDIAN	12	050867	1/1/0001
05800	S	M	OUG	I	00000	002	OPP. 325 IN MEDIAN	12	050867	1/1/0001
05800	S	M	OUG	I	00000	003	OPP. 337 IN MEDIAN	12	050867	1/1/0001
05800	S	M	OUG	I	00000	004	OPP. 361 IN MEDIAN	12	050867	1/1/0001
05800	S	M	OUG	I	00000	005	OPP. 367 IN MEDIAN	12	050867	1/1/0001
05800	S	M	OUG	I	00000	006	OPP. 368 IN MEDIAN	12	050867	1/1/0001
05800	S	M	OUG	I	00000	007	OPP. 362 IN MEDIAN	12	050867	1/1/0001
05800	S	M	OUG	I	00000	008	OPP. 340 IN MEDIAN	12	050867	1/1/0001
05800	S	M	OUG	I	00000	009	OPP. 318 IN MEDIAN	12	050867	1/1/0001
05800	S	M	OUG	I	00000	010	OPP. 314 IN MEDIAN	12	050867	1/1/0001
09500	S	M	OUG	I	00000	011	OPP. 411 IN MEDIAN	12	050867	1/1/0001
09500	S	M	OUG	I	00000	014	OPP. 410 IN MEDIAN	12	050867	1/1/0001
05800	S	M	SOH	I	00000	015	OPP. 336 IN MEDIAN	12	050867	1/1/0001

OFFICE: 311 ROUTE: 564							ST_REF_NO: 00000185100 TRAVELLER ROAD			
LUMENS	BULB TYPE	MULT SERIES	POLE TYPE	SHADE	ADDRESS NUMBER	REF	LOCATION	TAX DIST	DATE INST	DATE CHANGE
04000	S	M	OUG	II	01700	015		12	020889	1/1/0001
04000	S	M	OUG	II	01713	014		12	020889	1/1/0001
04000	S	M	OUG	II	01724	013		12	020889	1/1/0001
04000	S	M	OUG	II	01733	012		12	020889	1/1/0001
04000	S	M	OUG	II	01740	011		12	020889	1/1/0001
04000	S	M	OUG	II	01753	010		12	020889	1/1/0001

OFFICE: 311		ROUTE: 564		ST_REF_NO: 00000185100		TRAVELLER ROAD		LUMENS	BULB TYPE	MULT SERIES	POLE TYPE	SHADE	ADDRESS NUMBER	REF	LOCATION	TAX DIST	DATE INST	DATE CHANGE
05800	S	M	OUG	II	00000	001	SIDE OF 1037 LANE ALLEN ROAD	12	120892							12	120892	1/1/0001
04000	S	M	OUG	II	01761	009		12	020889							12	020889	1/1/0001
05800	S	M	OUG	II	01804	008		12	120892							12	120892	1/1/0001
05800	S	M	OUG	II	01817	007		12	120892							12	120892	1/1/0001
05800	S	M	OUG	II	01824	006		12	120892							12	120892	1/1/0001
05800	S	M	OUG	II	01833	005		12	120892							12	120892	1/1/0001
05800	S	M	OUG	II	01841	004		12	120892							12	120892	1/1/0001
05800	S	M	OUG	II	01853	003		12	120892							12	120892	1/1/0001
05800	S	M	OUG	II	01864	002		12	120892							12	120892	1/1/0001

OFFICE: 311		ROUTE: 564		ST_REF_NO: 00000185200		TRAVIS COURT		LUMENS	BULB TYPE	MULT SERIES	POLE TYPE	SHADE	ADDRESS NUMBER	REF	LOCATION	TAX DIST	DATE INST	DATE CHANGE
04000	S	M	OUG	II	00000	061	SIDE OF 3248 SHOAL LAKE	12	111580							12	111580	1/1/0001
04000	S	M	OUG	V	03208	062		12	111478							12	111478	1/1/0001

OFFICE: 311		ROUTE: 564		ST_REF_NO: 00000185250		TREELINE WAY		LUMENS	BULB TYPE	MULT SERIES	POLE TYPE	SHADE	ADDRESS NUMBER	REF	LOCATION	TAX DIST	DATE INST	DATE CHANGE
05800	S		OUG	II	00000	009	SIDE OF 2444	12	081310							12	081310	1/1/0001
05800	S		OUG	II	02428	004		12	081310							12	081310	1/1/0001
05800	S		OUG	II	02436	003		12	081310							12	081310	1/1/0001
05800	S		OUG	II	02449	002		12	081310							12	081310	1/1/0001
05800	S		OUG	III	02472	001		12	081310							12	081310	1/1/0001
05800	S		OUG	III	02496	008		12	081310							12	081310	1/1/0001
05800	S		OUG	II	02517	007		12	081310							12	081310	1/1/0001
05800	S		OUG	II	02528	006		12	081310							12	081310	1/1/0001
05800	S		OUG	III	02552	005		12	081310							12	081310	1/1/0001

OFFICE: 311		ROUTE: 564		ST_REF_NO: 00000185300		TREMONT AVENUE		LUMENS	BULB TYPE	MULT SERIES	POLE TYPE	SHADE	ADDRESS NUMBER	REF	LOCATION	TAX DIST	DATE INST	DATE CHANGE
05800	S	M	SOH	I	00000	596	SIDE OF 1100 HIGH ST.	12	070767							12	070767	1/1/0001
05800	S	M	SOH	I	00712	587		12	070767							12	070767	1/1/0001

OFFICE: 311

ROUTE: 564

ST_REF_NO: 00000185300

TREMONT AVENUE

LUMENS	BULB TYPE	MULT SERIES	POLE TYPE	SHADE	ADDRESS NUMBER	REF	LOCATION	TAX DIST	DATE INST	DATE CHANGE
05800	S	M	SOH	I	00726	588		12	070767	1/1/0001
05800	S	M	SOH	I	00738	589		12	070767	1/1/0001
05800	S	M	SOH	I	00806	590		12	070767	1/1/0001
05800	S	M	SOH	I	00816	591		12	070767	1/1/0001
05800	S	M	SOH	I	00830	592		12	070767	1/1/0001
05800	S	M	SOH	I	00836	593		12	070767	1/1/0001
05800	S	M	SOH	I	00844	594		12	070767	1/1/0001
05800	S	M	SOH	I	00850	595		12	070767	1/1/0001

OFFICE: 311

ROUTE: 564

ST_REF_NO: 00000185400

TRENT BOULEVARD

LUMENS	BULB TYPE	MULT SERIES	POLE TYPE	SHADE	ADDRESS NUMBER	REF	LOCATION	TAX DIST	DATE INST	DATE CHANGE
05800	S	M	OUG	II	00000	069	SIDE 3724 APPIAN WAY	12	050886	1/1/0001
05800	S	M	OUG	II	00000	070	SIDE OF 3733 APPIAN WAY	12	090884	1/1/0001
05800	S	M	OUG	II	01019	071		12	090884	1/1/0001
05800	S	M	OUG	II	01058	050		12	050886	1/1/0001
05800	S	M	OUG	II	01070	049		12	011583	1/1/0001
05800	S	M	OUG	II	01082	048		12	011583	1/1/0001
05800	S	M	OUG	II	01090	047		12	011583	1/1/0001
05800	S	M	OUG	II	01095	046		12	111580	1/1/0001
05800	S	M	OUG	II	01111	028		12	111478	1/1/0001
05800	S	M	OUG	II	00000	018	SIDE OF 3693 CLAREDON DR.	12	101477	1/1/0001
05800	S	M	OUG	II	00000	024	SIDE OF 3621 FOX RUN RD.	12	111580	1/1/0001
09500	S	M	OUG	II	00000	046	BESIDE 3701 TRENT CIRCLE	12	030890	1/1/0001
05800	S	M	OUG	II	00000	049	SIDE OF 3701 NIAGARA	12	091574	1/1/0001
05800	S	M	OUG	II	00000	051	SIDE OF 3578 NIAGARA	12	091574	1/1/0001
05800	S	M	OUG	II	00000	052	SIDE OF 3579 NIAGARA	12	121475	1/1/0001
05800	S	M	OUG	II	00000	053	SIDE OF 3575 NIAGARA DR.	12	010888	1/1/0001
05800	S	M	OUG	II	00000	054	SIDE 3701 ARBOR CT. ON TRENT BLVD	12	090892	1/1/0001
05800	S	M	OUG	II	00000	068	SIDE OF 1404 DALE DR.	12	041674	1/1/0001
05800	S	M	OUG	II	01118	027		12	111580	1/1/0001
05800	S	M	OUG	II	01127	026		12	111580	1/1/0001
05800	S	M	OUG	II	01138	025		12	111580	1/1/0001
05800	S	M	OUG	II	01158	023		12	111478	1/1/0001

OFFICE: 311

ROUTE: 564

ST_REF_NO: 00000185400

TRENT BOULEVARD

LUMENS	BULB TYPE	MULT SERIES	POLE TYPE	SHADE	ADDRESS NUMBER	REF	LOCATION	TAX DIST	DATE INST	DATE CHANGE
05800	S	M	OUG	II	01175	011		12	111478	1/1/0001
05800	S	M	OUG	II	01178	010		12	111478	1/1/0001
05800	S	M	OUG	II	01198	008		12	111478	1/1/0001
05800	S	M	OUG	II	01207	007		12	081477	1/1/0001
05800	S	M	OUG	II	01214	006		12	081477	1/1/0001
05800	S	M	OUG	II	01230	017		12	101477	1/1/0001
05800	S	M	OUG	II	01235	071		12	071475	1/1/0001
05800	S	M	OUG	II	01242	070		12	011475	1/1/0001
05800	S	M	OUG	II	01251	069		12	041674	1/1/0001
05800	S	M	OUG	II	01271	067		12	041674	1/1/0001
09500	S	M	OUG	II	01321	041		12	080173	1/1/0001
09500	S	M	OUG	II	01321	042		12	111478	1/1/0001
09500	S	M	OUG	II	01321	043		12	080173	1/1/0001
09500	S	M	OUG	II	01397	048		12	022674	1/1/0001
05800	S	M	OUG	II	01401	050		12	011475	1/1/0001

OFFICE: 311

ROUTE: 564

ST_REF_NO: 00000185410

TRENT CIRCLE

LUMENS	BULB TYPE	MULT SERIES	POLE TYPE	SHADE	ADDRESS NUMBER	REF	LOCATION	TAX DIST	DATE INST	DATE CHANGE
05800	S	M	OUG	II	00000	003	END OF TRENT CIRCLE	12	100892	1/1/0001
05800	S	M	OUG	II	03704	001		12	100892	1/1/0001
05800	S	M	OUG	II	03713	002		12	100892	1/1/0001

OFFICE: 311

ROUTE: 564

ST_REF_NO: 00000185500

TREPASSEY COURT

LUMENS	BULB TYPE	MULT SERIES	POLE TYPE	SHADE	ADDRESS NUMBER	REF	LOCATION	TAX DIST	DATE INST	DATE CHANGE
04000	S	M	OUG	II	03638	081		12	110885	1/1/0001
05800	S	M	OUG	II	03649	082	upgraded 5/08	12	110885	1/1/0001

OFFICE: 311

ROUTE: 564

ST_REF_NO: 00000185550

TREVEY POINT

LUMENS	BULB TYPE	MULT SERIES	POLE TYPE	SHADE	ADDRESS NUMBER	REF	LOCATION	TAX DIST	DATE INST	DATE CHANGE
05800	S	M	CNT	III	01005	002		12	091503	1/1/0001
05800	S	M	CNT	II	01012	001		12	091503	1/1/0001

OFFICE: 311		ROUTE: 564		ST_REF_NO: 00000185600		TRINITY ROAD		LUMENS	BULB TYPE	MULT SERIES	POLE TYPE	SHADE	ADDRESS NUMBER	REF	LOCATION	TAX DIST	DATE INST	DATE CHANGE
04000	S	M	OUG	II	03112	005										12	120890	1/1/0001
04000	S	M	OUG	II	03125	004										12	120890	1/1/0001
04000	S	M	OUG	II	03149	003										12	120890	1/1/0001
04000	S	M	OUG	II	03175	002										12	120890	1/1/0001
04000	S	M	OUG	II	03197	001										12	120890	1/1/0001

OFFICE: 311		ROUTE: 564		ST_REF_NO: 00000185624		TRIPLE CROWN CIRCLE		LUMENS	BULB TYPE	MULT SERIES	POLE TYPE	SHADE	ADDRESS NUMBER	REF	LOCATION	TAX DIST	DATE INST	DATE CHANGE
05800	S		CNT	II	00000	203									SIDE F 520 MURPHYS RUN, ON TRIPLE CROWN CIRCLE	12	112210	1/1/0001
05800	S		CNT	II	00000	209									SIDE OF 516 GRANDSTAND DR, ON TRIPLE CROWN CIRCLE	12	112210	1/1/0001
05800	S		CNT	II	00725	204										12	112210	1/1/0001
05800	S		CNT	II	00726	208										12	112210	1/1/0001
05800	S		CNT	II	00734	207										12	112210	1/1/0001
05800	S		CNT	II	00735	205										12	112210	1/1/0001
05800	S		CNT	II	00748	206										12	112210	1/1/0001

OFFICE: 311		ROUTE: 564		ST_REF_NO: 00000185625		TRIPLE CROWN PARKWAY		LUMENS	BULB TYPE	MULT SERIES	POLE TYPE	SHADE	ADDRESS NUMBER	REF	LOCATION	TAX DIST	DATE INST	DATE CHANGE
05800	S		CNT	II	00000	004									TRIPLE CROWN PARKWAY CORNER OF NELSON AVENUE	12	101108	1/1/0001
05800	S		CNT	II	00000	204									IN MEDIAN AT TRIPLE CROWN PARKWAY AND CIRCLE	12	112210	1/1/0001
05800	S		CNT	II	00616	001										12	101108	1/1/0001
05800	S		CNT	II	00634	002										12	101108	1/1/0001
05800	S		CNT	II	00641	003										12	101108	1/1/0001
05800	S		CNT	II	00660	200										12	112210	1/1/0001
05800	S		CNT	II	00661	201										12	112210	1/1/0001
05800	S		CNT	II	00668	203										12	112210	1/1/0001
05800	S		CNT	II	00669	202										12	112210	1/1/0001

OFFICE: 311

ROUTE: 564

ST_REF_NO: 00000185700

TROTWOOD DRIVE

LUMENS	BULB TYPE	MULT SERIES	POLE TYPE	SHADE	ADDRESS NUMBER	REF	LOCATION	TAX DIST	DATE INST	DATE CHANGE
05800	S	M	OUG	II	01001	031		12	090171	1/1/0001
05800	S	M	OUG	II	01002	032		12	092674	1/1/0001
05800	S	M	OUG	II	01018	030		12	092674	1/1/0001
05800	S	M	OUG	II	01033	029		12	092674	1/1/0001
05800	S	M	OUG	II	01034	028		12	051480	1/1/0001

OFFICE: 311

ROUTE: 564

ST_REF_NO: 00000185710

TROUT COURT

LUMENS	BULB TYPE	MULT SERIES	POLE TYPE	SHADE	ADDRESS NUMBER	REF	LOCATION	TAX DIST	DATE INST	DATE CHANGE
05800	S	M	OUG	II	00000	085	SIDE OF 3768 NIAGARA DR.	12	111580	1/1/0001
05800	S	M	OUG	II	03813	086		12	111580	1/1/0001
05800	S	M	OUG	II	03832	087		12	111580	1/1/0001
05800	S	M	OUG	II	03845	101		12	011581	1/1/0001
05800	S	M	OUG	II	03856	102		12	121581	1/1/0001
05800	S	M	OUG	V	03864	103		12	021582	1/1/0001

OFFICE: 311

ROUTE: 564

ST_REF_NO: 00000185800

TROY TRAIL

LUMENS	BULB TYPE	MULT SERIES	POLE TYPE	SHADE	ADDRESS NUMBER	REF	LOCATION	TAX DIST	DATE INST	DATE CHANGE
05800	S	M	OUG	II	00701	055		12	110885	1/1/0001
04000	S	M	OUG	II	00716	056		12	110885	1/1/0001
04000	S	M	OUG	II	00721	057		12	110885	1/1/0001
04000	S	M	OUG	II	00740	058		12	110885	1/1/0001
04000	S	M	OUG	II	00749	059		12	120887	1/1/0001

OFFICE: 311

ROUTE: 564

ST_REF_NO: 00000185850

TRUE ALLEY

LUMENS	BULB TYPE	MULT SERIES	POLE TYPE	SHADE	ADDRESS NUMBER	REF	LOCATION	TAX DIST	DATE INST	DATE CHANGE
04000	S	M	SOH	I	00000	002	BEHIND 109 7TH ST. ON TRUE ALLEY	12	030892	1/1/0001
04000	S	M	SOH	I	00000	003	BEHIND 129 7TH ST. ON TRUE ALLEY	12	030892	1/1/0001
04000	S	M	SOH	I	00000	001	BEHIND 147 7TH ST.	12	050365	1/1/0001
04000	S	M	SOH	I	00000	004	BEHIND 166 EDDIE ST. ON TRUE ALLEY	12	030892	1/1/0001
04000	S	M	SOH	I	00000	005	BEHIND 186 EDDIE ST. ON TRUE ALLEY	12	030892	1/1/0001

OFFICE: 311		ROUTE: 564		ST_REF_NO: 00000185900		TUCKER ALLEY		LUMENS	BULB TYPE	MULT SERIES	POLE TYPE	SHADE	ADDRESS NUMBER	REF	LOCATION	TAX DIST	DATE INST	DATE CHANGE
05800	S	M	SOH	I	00000	001	1ST LT. S. OF MAXWELL ST., E. SIDE	12	050365	1/1/0001								

OFFICE: 311		ROUTE: 564		ST_REF_NO: 00000186000		TUCKER STREET		LUMENS	BULB TYPE	MULT SERIES	POLE TYPE	SHADE	ADDRESS NUMBER	REF	LOCATION	TAX DIST	DATE INST	DATE CHANGE
05800	S	M	SOH	V	00000	001	AT WATER ST.	12	111583	1/1/0001								
05800	S	M	SOH	II	00000	002	2ND LT. S. OF W. MAIN ST.	12	010893	1/1/0001								

OFFICE: 311		ROUTE: 564		ST_REF_NO: 00000186100		TUDOR DRIVE		LUMENS	BULB TYPE	MULT SERIES	POLE TYPE	SHADE	ADDRESS NUMBER	REF	LOCATION	TAX DIST	DATE INST	DATE CHANGE
04000	S	M	OUG	II	00000	001	SIDE OF 680 BETH LANE ON TUDOR DR.	12	080890	1/1/0001								
04000	S	M	OUG	II	00000	008	OPP. 3253 TUDOR DR.	12	120890	1/1/0001								
04000	S	M	OUG	II	03205	002		12	080890	1/1/0001								
04000	S	M	OUG	II	03212	003		12	080890	1/1/0001								
04000	S	M	OUG	II	03221	004		12	080890	1/1/0001								
04000	S	M	OUG	II	03228	005		12	080890	1/1/0001								
04000	S	M	OUG	II	03237	006		12	100890	1/1/0001								
04000	S	M	OUG	II	03244	007		12	120890	1/1/0001								
04000	S	M	OUG	II	03261	009		12	120890	1/1/0001								

OFFICE: 311		ROUTE: 564		ST_REF_NO: 00000186150		TURFWAY DRIVE		LUMENS	BULB TYPE	MULT SERIES	POLE TYPE	SHADE	ADDRESS NUMBER	REF	LOCATION	TAX DIST	DATE INST	DATE CHANGE
05800	S		OUG	II	00325	004		12	041513	1/1/0001								
05800	S	M	OUG	II	00000	001	SIDE 2188 SANTA ANITA DRIVE	12	090896	1/1/0001								
05800	S	M	OUG	II	00308	002		12	090896	1/1/0001								
05800	S	M	OUG	II	00319	003		12	090896	1/1/0001								

OFFICE: 311		ROUTE: 564		ST_REF_NO: 00000186200		TULANE DRIVE		LUMENS	BULB TYPE	MULT SERIES	POLE TYPE	SHADE	ADDRESS NUMBER	REF	LOCATION	TAX DIST	DATE INST	DATE CHANGE
04000	S	M	OUG	II	00300	019		12	060886	1/1/0001								
04000	S	M	OUG	II	00312	020		12	060886	1/1/0001								
04000	S	M	OUG	II	00321	021		12	060886	1/1/0001								

OFFICE: 311		ROUTE: 564		ST_REF_NO: 00000186200		TULANE DRIVE		LUMENS	BULB TYPE	MULT SERIES	POLE TYPE	SHADE	ADDRESS NUMBER	REF	LOCATION	TAX DIST	DATE INST	DATE CHANGE
04000	S	M	OUG	II	00328	022										12	060886	1/1/0001
05800	S	M	OUG	II	00340	023										12	060886	1/1/0001
04000	S	M	OUG	II	00352	024										12	060886	1/1/0001
04000	S	M	OUG	II	00364	025										12	060886	1/1/0001

OFFICE: 311		ROUTE: 564		ST_REF_NO: 00000186210		TULIP TRACE		LUMENS	BULB TYPE	MULT SERIES	POLE TYPE	SHADE	ADDRESS NUMBER	REF	LOCATION	TAX DIST	DATE INST	DATE CHANGE
05800	S	M	OUG	II	00000	001										12	020895	1/1/0001
05800	S	M	OUG	II	02993	002										12	020895	1/1/0001
05800	S	M	OUG	II	03001	003										12	020895	1/1/0001
05800	S	M	OUG	IV	03017	004										12	020895	1/1/0001
05800	S	M	OUG	II	03032	005										12	020895	1/1/0001

OFFICE: 311		ROUTE: 564		ST_REF_NO: 00000186300		TULSA DRIVE		LUMENS	BULB TYPE	MULT SERIES	POLE TYPE	SHADE	ADDRESS NUMBER	REF	LOCATION	TAX DIST	DATE INST	DATE CHANGE
04000	S	M	OUG	II	00000	025										12	101583	1/1/0001
04000	S	M	OUG	II	02320	026										12	101583	1/1/0001
04000	S	M	OUG	II	02361	027										12	101583	1/1/0001
04000	S	M	OUG	II	02380	028										12	101583	1/1/0001
04000	S	M	OUG	II	02411	029										12	101583	1/1/0001
04000	S	M	OUG	II	02420	030										12	101583	1/1/0001
04000	S	M	OUG	II	02451	031										12	101583	1/1/0001
04000	S	M	OUG	II	02490	032										12	101583	1/1/0001

OFFICE: 311		ROUTE: 564		ST_REF_NO: 00000186400		TUNDRA COURT		LUMENS	BULB TYPE	MULT SERIES	POLE TYPE	SHADE	ADDRESS NUMBER	REF	LOCATION	TAX DIST	DATE INST	DATE CHANGE
04000	S	M	OUG	II	00604	053										12	101478	1/1/0001
04000	S	M	OUG	II	00609	052										12	101478	1/1/0001

OFFICE: 311		ROUTE: 564		ST_REF_NO: 00000186480		TURF COURT		LUMENS	BULB TYPE	MULT SERIES	POLE TYPE	SHADE	ADDRESS NUMBER	REF	LOCATION	TAX DIST	DATE INST	DATE CHANGE
	04000	S	M	OUG	II	00700	086									12	061580	1/1/0001
	04000	S	M	OUG	V	00704	088									12	021582	1/1/0001
	05800	S	M	OUG	II	00705	087									12	050898	1/1/0001

OFFICE: 311		ROUTE: 564		ST_REF_NO: 00000186490		TURKEY FOOT COURT		LUMENS	BULB TYPE	MULT SERIES	POLE TYPE	SHADE	ADDRESS NUMBER	REF	LOCATION	TAX DIST	DATE INST	DATE CHANGE
	04000	S	M	OUG	II	00000	114								SIDE OF 800 TURKEY FOOT RD.	12	011581	1/1/0001
	04000	S	M	OUG	V	00812	113									12	011584	1/1/0001

OFFICE: 311		ROUTE: 564		ST_REF_NO: 00000186500		TURKEYFOOT ROAD		LUMENS	BULB TYPE	MULT SERIES	POLE TYPE	SHADE	ADDRESS NUMBER	REF	LOCATION	TAX DIST	DATE INST	DATE CHANGE
	04000	S	M	OUG	II	00000	020								OPP. 996	12	071475	1/1/0001
	04000	S	M	OUG	II	00000	023								SIDE OF 600 TEAKWOOD DR.	12	121673	1/1/0001
	04000	S	M	OUG	II	00000	025								OPP. 957	12	031475	1/1/0001
	05800	S	M	OUG	II	00000	034								SIDE OF 621 AUTUMN LANE	12	051475	1/1/0001
	04000	S	M	OUG	II	00000	076								SIDE OF 1379 STRAWBERRY LANE	12	061580	1/1/0001
	04000	S	M	OUG	II	00000	077								SIDE OF 1372 STRAWBERRY LANE	12	011581	1/1/0001
	04000	S	M	OUG	II	00000	101								SIDE OF 800 TURKEY FOOT CT.	12	011581	1/1/0001
	04000	S	M	OUG	II	00000	105								SIDE OF 1345 GRAY HAWK ON TURKEY FOOT	12	011584	1/1/0001
	05800	S	M	OUG	II	00904	033									12	111478	1/1/0001
	05800	S	M	OUG	II	00905	032									12	041476	1/1/0001
	05800	S	M	OUG	II	00920	031									12	101476	1/1/0001
	05800	S	M	OUG	II	00921	030									12	081475	1/1/0001
	05800	S	M	OUG	II	00929	029									12	051475	1/1/0001
	05800	S	M	OUG	II	00937	028									12	051475	1/1/0001
	05800	S	M	OUG	II	00944	027									12	051475	1/1/0001
	04000	S	M	OUG	II	00953	026									12	121673	1/1/0001
	04000	S	M	OUG	II	00969	024									12	121673	1/1/0001
	04000	S	M	OUG	II	00981	022									12	121673	1/1/0001
	04000	S	M	OUG	II	00988	021									12	121673	1/1/0001
	04000	S	M	OUG	II	01004	019									12	121673	1/1/0001
	04000	S	M	OUG	II	01017	018									12	121673	1/1/0001

OFFICE: 311

ROUTE: 564

ST_REF_NO: 00000186500

TURKEYFOOT ROAD

LUMENS	BULB TYPE	MULT SERIES	POLE TYPE	SHADE	ADDRESS NUMBER	REF	LOCATION	TAX DIST	DATE INST	DATE CHANGE
04000	S	M	OUG	II	01024	017		12	121673	1/1/0001
04000	S	M	OUG	II	01033	016		12	121673	1/1/0001
04000	S	M	OUG	II	01040	015		12	121673	1/1/0001
04000	S	M	OUG	II	01049	037		12	051475	1/1/0001
04000	S	M	OUG	II	01052	038		12	041476	1/1/0001
04000	S	M	OUG	II	01061	064		12	111478	1/1/0001
04000	S	M	OUG	II	01064	065		12	111580	1/1/0001
04000	S	M	OUG	II	01085	078		12	101582	1/1/0001
04000	S	M	OUG	II	01117	103		12	011584	1/1/0001
04000	S	M	OUG	II	01128	100		12	061580	1/1/0001
04000	S	M	OUG	II	01140	098		12	041581	1/1/0001
04000	S	M	OUG	II	01148	096		12	011584	1/1/0001

OFFICE: 311

ROUTE: 564

ST_REF_NO: 00000186505

TURNBERRY LANE

LUMENS	BULB TYPE	MULT SERIES	POLE TYPE	SHADE	ADDRESS NUMBER	REF	LOCATION	TAX DIST	DATE INST	DATE CHANGE
04000	S	M	OUG	V	01001	004		12	020888	1/1/0001
04000	S	M	OUG	II	01012	003		12	110889	1/1/0001
04000	S	M	OUG	II	01020	001		12	020888	1/1/0001
04000	S	M	OUG	II	01021	002		12	020888	1/1/0001

OFFICE: 311

ROUTE: 564

ST_REF_NO: 00000186510

TURNBRIDGE ROAD

LUMENS	BULB TYPE	MULT SERIES	POLE TYPE	SHADE	ADDRESS NUMBER	REF	LOCATION	TAX DIST	DATE INST	DATE CHANGE
04000	S	M	OUG	II	01021	002		12	060887	1/1/0001
04000	S	M	OUG	II	01024	003		12	060887	1/1/0001
04000	S	M	OUG	II	01037	004		12	060887	1/1/0001
04000	S	M	OUG	V	01040	005		12	060887	1/1/0001
04000	S	M	OUG	II	01008	001		12	020888	1/1/0001

OFFICE: 311

ROUTE: 564

ST_REF_NO: 00000186520

TURTLE CIRCLE

LUMENS	BULB TYPE	MULT SERIES	POLE TYPE	SHADE	ADDRESS NUMBER	REF	LOCATION	TAX DIST	DATE INST	DATE CHANGE
05800	S	M	CNT	V	00000	001		12	080894	1/1/0001

OFFICE: 311		ROUTE: 564		ST_REF_NO: 00000186545		TURTLE CREEK COVE				
LUMENS	BULB TYPE	MULT SERIES	POLE TYPE	SHADE	ADDRESS NUMBER	REF	LOCATION	TAX DIST	DATE INST	DATE CHANGE
05800	S	M	CNT	II	04300	003		12	062907	1/1/0001
05800	S	M	CNT	II	04309	002		12	062907	1/1/0001
05800	S	M	CNT	II	04324	001		12	062907	1/1/0001

OFFICE: 311		ROUTE: 564		ST_REF_NO: 00000186550		TURTLE CREEK WAY				
LUMENS	BULB TYPE	MULT SERIES	POLE TYPE	SHADE	ADDRESS NUMBER	REF	LOCATION	TAX DIST	DATE INST	DATE CHANGE
05800	S	M	CNT	II	04401	001		12	062907	1/1/0001
05800	S	M	CNT	II	04404	013		12	062907	1/1/0001
05800	S	M	CNT	II	04425	012		12	062907	1/1/0001
05800	S	M	CNT	II	04433	011		12	062907	1/1/0001
05800	S	M	CNT	II	04440	010		12	062907	1/1/0001
05800	S	M	CNT	II	04449	009		12	062907	1/1/0001
05800	S	M	CNT	II	04460	008		12	062907	1/1/0001
05800	S	M	CNT	II	04473	007		12	062907	1/1/0001
05800	S	M	CNT	II	04477	006		12	062907	1/1/0001
05800	S	M	CNT	II	04489	005		12	062907	1/1/0001
05800	S	M	CNT	II	04501	004		12	062907	1/1/0001
05800	S	M	CNT	II	04504	003		12	062907	1/1/0001
05800	S	M	CNT	II	04517	002		12	062907	1/1/0001

OFFICE: 311		ROUTE: 564		ST_REF_NO: 00000186600		TUSCALOOSA LANE				
LUMENS	BULB TYPE	MULT SERIES	POLE TYPE	SHADE	ADDRESS NUMBER	REF	LOCATION	TAX DIST	DATE INST	DATE CHANGE
04000	S	M	OUG	II	00000	071	SIDE OF 3069	12	111579	1/1/0001
04000	S	M	OUG	II	00000	084	SIDE OF 2957	12	111579	1/1/0001
04000	S	M	OUG	II	02900	087		12	111579	1/1/0001
04000	S	M	OUG	II	02913	086		12	111579	1/1/0001
04000	S	M	OUG	II	02920	085		12	111579	1/1/0001
04000	S	M	OUG	V	02944	083		12	111579	1/1/0001
04000	S	M	OUG	II	02956	082		12	111579	1/1/0001
04000	S	M	OUG	II	02969	081		12	111579	1/1/0001
04000	S	M	OUG	II	02980	080		12	111579	1/1/0001
04000	S	M	OUG	II	02996	079		12	111579	1/1/0001

OFFICE: 311

ROUTE: 564

ST_REF_NO: 00000186600

TUSCALOOSA LANE

LUMENS	BULB TYPE	MULT SERIES	POLE TYPE	SHADE	ADDRESS NUMBER	REF	LOCATION	TAX DIST	DATE INST	DATE CHANGE
04000	S	M	OUG	II	03005	078		12	111579	1/1/0001
04000	S	M	OUG	V	03020	077		12	111579	1/1/0001
04000	S	M	OUG	II	03029	076		12	111579	1/1/0001
04000	S	M	OUG	V	03032	075		12	111579	1/1/0001
04000	S	M	OUG	II	03044	074		12	111579	1/1/0001
04000	S	M	OUG	II	03057	073		12	111579	1/1/0001
04000	S	M	OUG	II	03064	072		12	111579	1/1/0001
04000	S	M	OUG	V	03092	070		12	111579	1/1/0001

OFFICE: 311

ROUTE: 564

ST_REF_NO: 00000186700

TUCSON DRIVE

LUMENS	BULB TYPE	MULT SERIES	POLE TYPE	SHADE	ADDRESS NUMBER	REF	LOCATION	TAX DIST	DATE INST	DATE CHANGE
04000	S	M	OUG	II	00000	009	SIDE OF 2360 TULSA DR.	12	101583	1/1/0001
04000	S	M	OUG	II	00000	017	SIDE OF 663 HILL 'N DALE	12	101583	1/1/0001
04000	S	M	OUG	V	00601	013		12	101583	1/1/0001
04000	S	M	OUG	II	00609	012		12	101583	1/1/0001
04000	S	M	OUG	II	00620	011		12	101583	1/1/0001
04000	S	M	OUG	II	00629	010		12	101583	1/1/0001
04000	S	M	OUG	II	02320	014		12	101583	1/1/0001
04000	S	M	OUG	II	02351	015		12	101583	1/1/0001
04000	S	M	OUG	II	02370	016		12	101583	1/1/0001

OFFICE: 311

ROUTE: 564

ST_REF_NO: 00000186730

TUPELO LANE

LUMENS	BULB TYPE	MULT SERIES	POLE TYPE	SHADE	ADDRESS NUMBER	REF	LOCATION	TAX DIST	DATE INST	DATE CHANGE
05800	S	M	CNT	II	00000	001	SIDE OF 2217 SAVANNAH LANE ON TUPELO LANE	12	071102	1/1/0001
05800	S	M	CNT	II	01300	003		12	071102	1/1/0001
05800	S	M	CNT	II	01305	002		12	071102	1/1/0001

OFFICE: 311

ROUTE: 564

ST_REF_NO: 00000186740

TUSCANY LANE

LUMENS	BULB TYPE	MULT SERIES	POLE TYPE	SHADE	ADDRESS NUMBER	REF	LOCATION	TAX DIST	DATE INST	DATE CHANGE
05800	S	M	CNT	II	01401	001		12	112805	1/1/0001
05800	S	M	CNT	II	01404	002		12	112805	1/1/0001

OFFICE: 311

ROUTE: 564

ST_REF_NO: 00000186750

TWAIN RIDGE DRIVE

LUMENS	BULB TYPE	MULT SERIES	POLE TYPE	SHADE	ADDRESS NUMBER	REF	LOCATION	TAX DIST	DATE INST	DATE CHANGE
05800	S	M	CNT	II	02036	050		12	080505	1/1/0001
05800	S	M	CNT	II	02052	051		12	080505	1/1/0001
05800	S	M	CNT	II	02057	052		12	080505	1/1/0001
05800	S	M	CNT	II	02072	053		12	080505	1/1/0001
05800	S	M	CNT	II	02077	054		12	080505	1/1/0001
05800	S	M	CNT	II	02093	055		12	080505	1/1/0001
05800	S	M	CNT	II	02101	056		12	080505	1/1/0001
05800	S	M	CNT	II	02112	057		12	080505	1/1/0001
05800	S	M	CNT	II	02121	058		12	080505	1/1/0001
05800	S	M	OUG	II	01991	045		12	011581	1/1/0001
05800	S	M	OUG	II	02000	046		12	070886	1/1/0001
05800	S	M	OUG	II	02012	047		12	070886	1/1/0001
05800	S	M	OUG	II	02021	048		12	010885	1/1/0001
05800	S	M	OUG	II	00000	010	NW CORNER OF COPPERFIELD	12	040894	1/1/0001
05800	S	M	OUG	II	00000	020	1ST LT. W OF CLAYS MILL RD., NORTHSIDE	12	110896	1/1/0001
05800	S	M	OUG	II	00000	021	OPP. 1700	12	110896	1/1/0001
05800	S	M	OUG	II	00000	022	2ND LT. W OF CLAYS MILL RD., NORTHSIDE	12	110896	1/1/0001
05800	S	M	OUG	II	00000	024	SIDE OF 3797 KINGS GLEN PARK	12	110896	1/1/0001
05800	S	M	OUG	II	00000	025	SIDE OF 1801 HAVERWOOD PARK	12	110896	1/1/0001
05800	S	M	OUG	II	00000	026	SIDE OF HEATHMOOR CT.	12	110896	1/1/0001
05800	S	M	OUG	II	00000	027	REAR OF 4300 FIELDSTONE PLACE PARK	12	110896	1/1/0001
05800	S	M	OUG	II	00000	028	SIDE REAR OF 4240 KENSINGTON GARDEN CT.	12	110896	1/1/0001
05800	S	M	OUG	II	00000	029	REAR OF 4301 STONEYHURST PLACE	12	110896	1/1/0001
05800	S	M	OUG	II	00000	030	REAR OF 4252 CANTERBURY GREEN WAY	12	110896	1/1/0001
05800	S	M	OUG	II	00000	034	OPP. BUCKLAND PLACE	12	040894	1/1/0001
05800	S	M	OUG	II	00000	035	REAR OF 4300 SHIPTONS END	12	040894	1/1/0001
05800	S	M	OUG	II	00000	036	REAR OF 4292 SOUTHMOOR PARK	12	040894	1/1/0001
05800	S	M	OUG	II	00000	037	REAR OF 4300 SOUTHMOOR PARK	12	040894	1/1/0001
05800	S	M	OUG	II	00000	038		12	040894	1/1/0001
05800	S	M	OUG	II	00000	039	SIDE OF 1901 MELFORD PLACE	12	040894	1/1/0001
05800	S	M	OUG	II	00000	040	REAR OF 4221 SOUTHMOOR PARK	12	040894	1/1/0001
05800	S	M	OUG	II	00000	041	REAR OF 1913 MELFORD PLACE	12	040894	1/1/0001
05800	S	M	OUG	II	00000	042	OPP. CALVEVARAS DR.	12	040894	1/1/0001
05800	S	M	OUG	II	01716	023		12	110896	1/1/0001

OFFICE: 311

ROUTE: 564

ST_REF_NO: 00000186750

TWAIN RIDGE DRIVE

LUMENS	BULB TYPE	MULT SERIES	POLE TYPE	SHADE	ADDRESS NUMBER	REF	LOCATION	TAX DIST	DATE INST	DATE CHANGE
05800	S	M	OUG	II	01980	043		12	011581	1/1/0001
05800	S	M	OUG	II	01988	044		12	011581	1/1/0001

OFFICE: 311

ROUTE: 564

ST_REF_NO: 00000186800

TWELFTH STREET

LUMENS	BULB TYPE	MULT SERIES	POLE TYPE	SHADE	ADDRESS NUMBER	REF	LOCATION	TAX DIST	DATE INST	DATE CHANGE
09500	S	M	OOH	II	00000	021	1ST LT S OF BROADWAY E SIDE OF TWELTH ST	12	042601	1/1/0001
04000	S	M	SOH	II	00000	009	SIDE 1200 N. BROADWAY	12	080885	1/1/0001
04000	S	M	SOH	II	00000	015	OPP. 102	12	080885	1/1/0001
04000	S	M	SOH	II	00000	016	SIDE 1103 N. LIME	12	080885	1/1/0001
04000	S	M	SOH	II	00107	014		12	080885	1/1/0001
04000	S	M	SOH	II	00115	013		12	080885	1/1/0001
04000	S	M	SOH	II	00121	012		12	080885	1/1/0001
05800	S	M	SOH	II	00131	011		12	080885	1/1/0001
04000	S	M	SOH	II	00137	010		12	060685	1/1/0001
05800	S	M	OUG	II	00200	000		12	090761	1/1/0001
05800	S	M	OUG	II	00212	000		12	090761	1/1/0001
05800	S	M	OUG	II	00218	000		12	090761	1/1/0001
05800	S	M	OUG	II	00222	000		12	090761	1/1/0001

OFFICE: 311

ROUTE: 564

ST_REF_NO: 00000186900

TWILLINGATE COURT

LUMENS	BULB TYPE	MULT SERIES	POLE TYPE	SHADE	ADDRESS NUMBER	REF	LOCATION	TAX DIST	DATE INST	DATE CHANGE
05800	S	M	OUG	II	00000	039	SIDE OF 589 CROMWELL WAY	12	110885	9/20/2011
04000	S	M	OUG	II	03486	040		12	110885	1/1/0001

OFFICE: 311

ROUTE: 564

ST_REF_NO: 00000187000

TWINBROOKE LANE

LUMENS	BULB TYPE	MULT SERIES	POLE TYPE	SHADE	ADDRESS NUMBER	REF	LOCATION	TAX DIST	DATE INST	DATE CHANGE
05800	S	M	OUG	II	00000	021	SIDE OF 613 FOLKSTONE DR.	12	030171	1/1/0001
05800	S	M	OUG	II	02664	023		12	060172	1/1/0001
05800	S	M	OUG	II	02677	022		12	040172	1/1/0001

OFFICE: 311		ROUTE: 564		ST_REF_NO: 00000187005		TWIN PINES WAY		LUMENS	BULB TYPE	MULT SERIES	POLE TYPE	SHADE	ADDRESS NUMBER	REF	LOCATION	TAX DIST	DATE INST	DATE CHANGE
05800	S	M	CNT	II	00000	006	SIDE 3765 WHITE PINE DRIVE	12	110895	1/1/0001								
05800	S	M	CNT	II	00000	007	SIDE 3752 WHITE PINE DRIVE	12	110895	1/1/0001								
05800	S	M	CNT	II	00584	008		12	110895	1/1/0001								
05800	S	M	CNT	II	00617	005		12	110895	1/1/0001								
05800	S	M	CNT	II	00640	004		12	110895	1/1/0001								
05800	S	M	CNT	II	00653	003		12	110895	1/1/0001								
05800	S	M	CNT	II	00664	002		12	110895	1/1/0001								
05800	S	M	CNT	II	00684	009		12	050899	1/1/0001								
05800	S	M	CNT	III	00700	010		12	050899	1/1/0001								

OFFICE: 311

ROUTE: 564

ST_REF_NO: 00000187006

TWIN SHORES COURT

LUMENS	BULB TYPE	MULT SERIES	POLE TYPE	SHADE	ADDRESS NUMBER	REF	LOCATION	TAX DIST	DATE INST	DATE CHANGE
05800	S	M	CNT	II	00205	001		12	070899	1/1/0001

OFFICE: 311

ROUTE: 564

ST_REF_NO: 00000187030

TYLER COURT

LUMENS	BULB TYPE	MULT SERIES	POLE TYPE	SHADE	ADDRESS NUMBER	REF	LOCATION	TAX DIST	DATE INST	DATE CHANGE
05800	S	M	CNT	II	03304	007		12	020800	1/1/0001
05800	S	M	CNT	II	03316	006		12	020800	1/1/0001
05800	S	M	CNT	II	03341	005		12	020800	1/1/0001
05800	S	M	CNT	II	03360	004		12	020800	1/1/0001
05800	S	M	CNT	II	03377	002		12	020800	1/1/0001
05800	S	M	CNT	II	03380	003		12	020800	1/1/0001
05800	S	M	CNT	II	03397	001		12	020800	1/1/0001

OFFICE: 311

ROUTE: 564

ST_REF_NO: 00000187040

TYNEBRAE ROAD

LUMENS	BULB TYPE	MULT SERIES	POLE TYPE	SHADE	ADDRESS NUMBER	REF	LOCATION	TAX DIST	DATE INST	DATE CHANGE
05800	S	M	OUG	II	00000	001	SIDE OF 4088 KENESAW DR.	12	110899	1/1/0001
05800	S	M	OUG	II	04904	002		12	110899	1/1/0001

OFFICE: 311

ROUTE: 564

ST_REF_NO: 00000187050

TYRUS COURT

LUMENS	BULB TYPE	MULT SERIES	POLE TYPE	SHADE	ADDRESS NUMBER	REF	LOCATION	TAX DIST	DATE INST	DATE CHANGE
04000	S	M	OUG	II	00799	001		12	110889	1/1/0001

OFFICE: 311

ROUTE: 564

ST_REF_NO: 00000187100

UHLAN COURT

LUMENS	BULB TYPE	MULT SERIES	POLE TYPE	SHADE	ADDRESS NUMBER	REF	LOCATION	TAX DIST	DATE INST	DATE CHANGE
05800	S	M	SOH	I	00000	001	SIDE OF 1017 S. BROADWAY	12	111562	1/1/0001
05800	S	M	SOH	I	00406	000		12	111562	1/1/0001
05800	S	M	SOH	I	00418	000		12	111562	1/1/0001

OFFICE: 311

ROUTE: 564

ST_REF_NO: 00000187250

UNITY DRIVE

LUMENS	BULB TYPE	MULT SERIES	POLE TYPE	SHADE	ADDRESS NUMBER	REF	LOCATION	TAX DIST	DATE INST	DATE CHANGE
09500	S	M	OUG	II	00000	001	SIDE OF 1001 RED MILE-upgraded 10/05	12	020890	1/1/0001
09500	S	M	SOH	II	00000	036	SIDE REAR OF 601 ADDISON AVE-upgraded 10/05	12	020886	1/1/0001
09500	S	M	OUG	II	01151	002	upgraded 10/05	12	020890	1/1/0001

OFFICE: 311

ROUTE: 564

ST_REF_NO: 00000187300

UNIVERSITY AVENUE

LUMENS	BULB TYPE	MULT SERIES	POLE TYPE	SHADE	ADDRESS NUMBER	REF	LOCATION	TAX DIST	DATE INST	DATE CHANGE
09500	S	M	OUG	II	00000	001	SIDE OF 1201 SOUTH LIMESTONE ON UNIVERSITY AVE	12	022404	7/28/2011
09500	S	M	SOH	II	00110	000	upgraded all lts on University to 9500 7/07	12	121578	1/1/0001
09500	S	M	SOH	II	00114	002		12	022404	1/1/0001
09500	S	M	SOH	II	00126	000		12	121578	1/1/0001
09500	S	M	SOH	II	00130	003		12	022404	1/1/0001
09500	S	M	SOH	II	00138	000		12	121578	1/1/0001
09500	S	M	SOH	II	00200	004		12	022404	1/1/0001
09500	S	M	SOH	II	00208	031		12	081104	1/1/0001
09500	S	M	SOH	II	00210	005		12	022404	1/1/0001
09500	S	M	SOH	II	00216	006		12	022404	1/1/0001
09500	S	M	SOH	II	00220	032		12	081104	1/1/0001
09500	S	M	SOH	II	00224	007		12	022404	1/1/0001

OFFICE: 311

ROUTE: 564

ST_REF_NO: 00000187500

UPPER, NORTH STREET

LUMENS	BULB TYPE	MULT SERIES	POLE TYPE	SHADE	ADDRESS NUMBER	REF	LOCATION	TAX DIST	DATE INST	DATE CHANGE
22000	S	M	SOH	III	00000	004	2ND LT. N. OF MAIN ST., W. SIDE	12	102061	2/11/2010
22000	S	M	SOH	III	00000	008	2ND LT. N. OF SHORT ST., W. SIDE	12	102061	2/11/2010
22000	S	M	SOH	II	00000	009	NE CORNER OF UPPER & CHURCH ST.	12	011863	2/11/2010
09500	S	M	SOH	II	00449	100		12	012606	1/1/0001
22000	S	M	SOH	II	00601	033		12	061465	5/29/2013
09500	S	M	SOH	II	00667	037	car accident	12	061465	9/29/2009
10000	M	M	SOH	II	00614	034		12	061465	1/1/0001
10000	M	M	SOH	II	00633	035		12	061465	1/1/0001
10000	M	M	SOH	II	00654	036		12	061465	1/1/0001
05800	S	M	SOH	I	00713	038		12	040165	1/1/0001
05800	S	M	SOH	I	00733	039		12	040165	1/1/0001
05800	S	M	SOH	I	00743	040		12	040165	1/1/0001
05800	S	M	SOH	I	00761	041		12	040165	1/1/0001
05800	S	M	SOH	V	00775	042		12	091566	1/1/0001
09500	S	M	SOH	II	00000	029	OPP. 510 upgrade-bad fixture	12	061465	1/1/0001
10000	M	M	SOH	II	00000	031	OPP. 542	12	061465	1/1/0001
09500	S	M	SOH	II	00457	027		12	061465	1/1/0001
09500	S	M	SOH	II	00462	028		12	092765	1/1/0001
10000	M	M	SOH	II	00526	030		12	061465	1/1/0001
10000	M	M	SOH	II	00562	032		12	061465	1/1/0001
20000	M	M	SOH	III	00000	002	1ST LT. N. OF MAIN ST., W. SIDE	12	102061	1/1/0001
20000	M	M	SOH	III	00000	006	1ST LT. N. OF SHORT ST., W. SIDE	12	102061	1/1/0001
10000	M	M	SOH	II	00000	013	SW CORNER OF UPPER & SECOND ST.	12	011865	1/1/0001
10000	M	M	SOH	II	00000	014	SIDE OF 201 W. SECOND ST.	12	100163	1/1/0001
10000	M	M	SOH	II	00000	018	1ST LT. S. OF THIRD ST., W. SIDE	12	020563	1/1/0001
10000	M	M	SOH	II	00000	019	1ST LT. N. OF THIRD ST., E. SIDE	12	020563	1/1/0001
10000	M	M	SOH	II	00000	021	OPP. SALEM ST.	12	020563	1/1/0001
10000	M	M	SOH	II	00000	023	SW CORNER OF UPPER & FOURTH ST.	12	020563	1/1/0001
20000	M	M	SOH	III	00114	003		12	102061	1/1/0001
20000	M	M	SOH	III	00142	007		12	102061	1/1/0001
10000	M	M	SOH	II	00163	010		12	011863	1/1/0001
10000	M	M	SOH	II	00177	011		12	011865	1/1/0001
10000	M	M	SOH	II	00187	012		12	011865	1/1/0001
10000	M	M	SOH	II	00217	015		12	011863	1/1/0001

OFFICE: 311

ROUTE: 564

ST_REF_NO: 00000187500

UPPER, NORTH STREET

LUMENS	BULB TYPE	MULT SERIES	POLE TYPE	SHADE	ADDRESS NUMBER	REF	LOCATION	TAX DIST	DATE INST	DATE CHANGE
09500	S	M	SOH	II	00226	016		12	011863	1/1/0001
10000	M	M	SOH	II	00246	017		12	020563	1/1/0001
10000	M	M	SOH	II	00318	020		12	020563	1/1/0001
10000	M	M	SOH	II	00360	022		12	020563	1/1/0001
09500	S	M	SOH	II	00412	024		12	092765	1/1/0001
09500	S	M	SOH	II	00425	025		12	061465	1/1/0001
09500	S	M	SOH	II	00438	026		12	061465	1/1/0001

OFFICE: 311

ROUTE: 564

ST_REF_NO: 00000187510

UPPER, SOUTH STREET

LUMENS	BULB TYPE	MULT SERIES	POLE TYPE	SHADE	ADDRESS NUMBER	REF	LOCATION	TAX DIST	DATE INST	DATE CHANGE
22000	S	M	SOH	II	00000	020	NW CORNER OF UPPER & MAXWELL ST.	12	120166	11/4/2009
50000	S	M	SOH	II	00000	024	NW CORNER OF UPPER & PINE ST.	12	032067	6/2/2010
50000	S	M	SOH	II	00000	025	OPP. 503	12	120166	6/2/2010
09500	S	M	SOH	II	00000	038	2nd LT. S. OF RR CROSSING, W. SIDE-upgrade bad fixture	12	121966	3/2/2009
09500	S	M	CNT	II	00000	100	1ST LT N OF BOLIVAR, W SIDE ON S UPPER	12	031507	1/1/0001
09500	S	M	CNT	II	00000	101	2ND LT N OF BOLIVAR, W SIDE ON S UPPER	12	031507	1/1/0001
09500	S	M	CNT	II	00000	102	3RD LT N OF BOLIVAR, W SIDE ON S UPPER	12	031507	1/1/0001
09500	S	M	CNT	II	00000	103	4TH LT N OF BOLIVAR, W SIDE ON S UPPER	12	031507	1/1/0001
09500	S	M	SOH	II	00333	014		12	032067	10/6/2011
10000	M	M	SOH	II	00000	036	2ND LT. S. OF BOLIVAR ST., W. SIDE	12	032067	1/1/0001
22000	S	M	SOH	II	00000	037	1ST LT S OF RR CROSSING, W SIDE-upgraded/relocated	12	121966	1/1/0001
10000	M	M	SOH	II	00000	039	3rd LT. S. OF RR CROSSING, W. SIDE	12	032067	1/1/0001
10000	M	M	SOH	II	00000	040	4th LT. S. OF RR CROSSING, W. SIDE	12	032067	1/1/0001
10000	M	M	SOH	II	00000	041	2ND LT. N. OF SCOTT ST., W. SIDE	12	120166	1/1/0001
09500	S	M	SOH	II	00000	042	2ND LT N OF SCOTT ST E. SIDE-upgrade 1/08	12	032067	1/1/0001
09500	S	M	SOH	II	00000	043	1ST LT N OF SCOTT ST W. SIDE-upgrade 1/08	12	032067	1/1/0001
09500	S	M	SOH	II	00000	044	1ST LT N OF SCOTT ST E. SIDE-upgrade 1/08	12	120166	1/1/0001
10000	M	M	SOH	III	00000	001	1ST LT. S. OF MAIN ST., W. SIDE	12	011364	1/1/0001
10000	M	M	SOH	III	00000	002	1ST LT. S. OF MAIN ST., E. SIDE	12	011364	1/1/0001
10000	M	M	SOH	II	00000	010	SW CORNER OF UPPER & HIGH ST.	12	120166	1/1/0001
10000	M	M	SOH	II	00000	011	OPP. 307	12	071367	1/1/0001
10000	M	M	SOH	II	00000	026	OPP. 515	12	120166	1/1/0001

OFFICE: 311		ROUTE: 564		ST_REF_NO: 00000187510		UPPER, SOUTH STREET		LUMENS	BULB TYPE	MULT SERIES	POLE TYPE	SHADE	ADDRESS NUMBER	REF	LOCATION	TAX DIST	DATE INST	DATE CHANGE
10000	M	M	SOH	II	00000	028	OPP. CEDAR STREET	12	032067	1/1/0001								
10000	M	M	SOH	II	00000	029	1ST LT. S. OF CEDAR ST., W. SIDE	12	120166	1/1/0001								
10000	M	M	SOH	II	00000	030	2ND LT. S. OF CEDAR ST., W. SIDE	12	032067	1/1/0001								
10000	M	M	SOH	II	00000	031	1ST LT. S. OF EUCLID AVE., W. SIDE	12	120166	1/1/0001								
10000	M	M	SOH	II	00000	032	SIDE OF 130 W. EUCLID AVE.	12	071367	1/1/0001								
10000	M	M	SOH	II	00000	033	NW CORNER OF UPPER & BOLIVAR ST.	12	120166	1/1/0001								
10000	M	M	SOH	II	00000	035	1ST LT. S. OF BOLIVAR ST., W. SIDE	12	120166	1/1/0001								
50000	S	M	OUG	III	00000	083	SW CORNER OF UPPER & VINE ST.	12	070171	1/1/0001								
50000	S	M	OUG	III	00000	084	1ST LT. S. OF VINE ST., E. SIDE	12	070171	1/1/0001								
50000	S	M	OUG	III	00000	085	2ND LT. S. OF VINE ST., W. SIDE	12	070171	1/1/0001								
50000	S	M	OUG	III	00000	086	2ND LT. S. OF VINE ST., E. SIDE	12	070171	1/1/0001								
10000	M	M	SOH	III	00119	003		12	011364	1/1/0001								
10000	M	M	SOH	III	00130	004		12	011364	1/1/0001								
10000	M	M	SOH	II	00317	012		12	120166	1/1/0001								
10000	M	M	SOH	II	00324	013		12	022167	1/1/0001								
10000	M	M	SOH	II	00344	015		12	071367	1/1/0001								
10000	M	M	SOH	II	00355	016		12	120166	1/1/0001								
10000	M	M	SOH	II	00356	017		12	071367	1/1/0001								
10000	M	M	SOH	II	00371	018		12	032067	1/1/0001								
10000	M	M	SOH	II	00380	019		12	071367	1/1/0001								
10000	M	M	SOH	II	00400	021		12	071367	1/1/0001								
10000	M	M	SOH	II	00417	022		12	120166	1/1/0001								
10000	M	M	SOH	II	00418	023		12	070171	1/1/0001								
10000	M	M	SOH	II	00517	027		12	032067	1/1/0001								
OFFICE: 311		ROUTE: 564		ST_REF_NO: 00000187600		VALDOSTA COURT		LUMENS	BULB TYPE	MULT SERIES	POLE TYPE	SHADE	ADDRESS NUMBER	REF	LOCATION	TAX DIST	DATE INST	DATE CHANGE
05800	S	M	OUG	V	01450	000		12	090766	1/1/0001								
05800	S	M	OUG	II	01465	000		12	090766	1/1/0001								

OFFICE: 311		ROUTE: 564		ST_REF_NO: 00000187650		VALENCIA DRIVE		LUMENS	BULB TYPE	MULT SERIES	POLE TYPE	SHADE	ADDRESS NUMBER	REF	LOCATION	TAX DIST	DATE INST	DATE CHANGE
05800	S		CLN	II	00000	007	ACROSS FROM 2296 VALENCIA DRIVE	12	120409	1/1/0001								
05800	S		CLN	II	00000	008	ACROSS FROM 2312 VALENCIA DRIVE	12	120409	1/1/0001								
05800	S		CLN	II	02212	001		12	120409	1/1/0001								
05800	S		CLN	II	02213	002		12	120409	1/1/0001								
05800	S		CLN	II	02236	003		12	120409	1/1/0001								
05800	S		CLN	II	02248	004		12	120409	1/1/0001								
05800	S		CLN	II	02260	005		12	120409	1/1/0001								
05800	S		CLN	II	02269	006		12	120409	1/1/0001								
OFFICE: 311		ROUTE: 564		ST_REF_NO: 00000187700		VALHALLA DRIVE		LUMENS	BULB TYPE	MULT SERIES	POLE TYPE	SHADE	ADDRESS NUMBER	REF	LOCATION	TAX DIST	DATE INST	DATE CHANGE
04000	S	M	OUG	II	00000	071	SIDE OF 1301 GRAFTON CT.	12	061580	1/1/0001								
04000	S	M	OUG	II	00000	110	SIDE OF 3312	12	011581	1/1/0001								
04000	S	M	OUG	II	00000	114	SIDE OF 3340	12	011581	1/1/0001								
04000	S	M	OUG	II	03200	060		12	061580	1/1/0001								
04000	S	M	OUG	II	03217	061		12	061580	1/1/0001								
04000	S	M	OUG	II	03220	070		12	061580	1/1/0001								
04000	S	M	OUG	II	03245	107		12	111580	1/1/0001								
05800	S	M	OUG	III	03264	108		12	100897	1/1/0001								
04000	S	M	OUG	II	03285	109		12	111580	1/1/0001								
04000	S	M	OUG	II	03333	111		12	111580	1/1/0001								
04000	S	M	OUG	II	03349	112		12	011581	1/1/0001								
04000	S	M	OUG	V	03364	113		12	011581	1/1/0001								
OFFICE: 311		ROUTE: 564		ST_REF_NO: 00000187800		VALLEY AVENUE		LUMENS	BULB TYPE	MULT SERIES	POLE TYPE	SHADE	ADDRESS NUMBER	REF	LOCATION	TAX DIST	DATE INST	DATE CHANGE
05800	S	M	SOH	II	00000	001	OPP. 943	12	030886	1/1/0001								
05800	S	M	SOH	II	00000	002	OPP. 959	12	030886	1/1/0001								
05800	S	M	SOH	II	00000	003	OPP. WILLARD	12	030886	1/1/0001								
05800	S	M	SOH	II	00000	004	OPP. 1005	12	030886	1/1/0001								

OFFICE: 311

ROUTE: 564

ST_REF_NO: 00000187900

VALLEY ROAD

LUMENS	BULB TYPE	MULT SERIES	POLE TYPE	SHADE	ADDRESS NUMBER	REF	LOCATION	TAX DIST	DATE INST	DATE CHANGE
04000	S	M	OUG	II	00000	003	SIDE OF 224 TAHOMA RD.	12	120888	1/1/0001
04000	S	M	SOH	II	00000	004	SIDE OF 227 TAHOMA RD.	12	120888	1/1/0001
04000	S	M	OUG	II	00000	005	SIDE OF 220 SHADY LANE	12	120888	1/1/0001
04000	S	M	OUG	II	00175	002		12	070888	1/1/0001
04000	S	M	OUG	II	00183	001		12	070888	1/1/0001

OFFICE: 311

ROUTE: 564

ST_REF_NO: 00000187970

VALLEY BROOK DRIVE

LUMENS	BULB TYPE	MULT SERIES	POLE TYPE	SHADE	ADDRESS NUMBER	REF	LOCATION	TAX DIST	DATE INST	DATE CHANGE
05800	S	M	CNT	II	00352	009		12	032304	1/1/0001
05800	S	M	CNT	II	00368	010		12	032304	1/1/0001
05800	S	M	CNT	II	00377	011		12	032304	1/1/0001
05800	S	M	CNT	II	00000	001	SIDE OF 289 MASTERSON STATION DRIVE	12	020801	1/1/0001
05800	S	M	CNT	II	00276	002		12	020801	1/1/0001
05800	S	M	CNT	II	00289	003		12	020801	1/1/0001
05800	S	M	CNT	II	00300	004		12	020801	1/1/0001
05800	S	M	CNT	II	00313	005		12	020801	1/1/0001
05800	S	M	CNT	II	00316	006		12	020801	1/1/0001
05800	S	M	CNT	II	00329	007		12	020801	1/1/0001
05800	S	M	CNT	II	00340	008		12	020801	1/1/0001

OFFICE: 311

ROUTE: 564

ST_REF_NO: 00000188000

VALLEY FARM DRIVE

LUMENS	BULB TYPE	MULT SERIES	POLE TYPE	SHADE	ADDRESS NUMBER	REF	LOCATION	TAX DIST	DATE INST	DATE CHANGE
05800	S	M	OUG	II	00000	119	SIDE OF 967	12	080173	1/1/0001
05800	S	M	OUG	II	00000	121	SIDE OF 1909 COLBYVILLE CT.	12	100774	1/1/0001
05800	S	M	OUG	II	00000	123	SIDE OF 1910 BEDINGER CT.	12	100774	1/1/0001
05800	S	M	OUG	II	00000	125	SIDE OF 1901 LEITNER CT.	12	111580	1/1/0001
05800	S	M	OUG	II	00944	116		12	080173	1/1/0001
05800	S	M	OUG	II	00955	117		12	050774	1/1/0001
05800	S	M	OUG	II	00968	118		12	050874	1/1/0001
05800	S	M	OUG	II	00996	120		12	050774	1/1/0001
05800	S	M	OUG	II	01044	124		12	111580	1/1/0001
05800	S	M	OUG	II	01068	126		12	111580	1/1/0001

OFFICE: 311		ROUTE: 564		ST_REF_NO: 00000188050		VALLEY HAVEN COUT		LUMENS	BULB TYPE	MULT SERIES	POLE TYPE	SHADE	ADDRESS NUMBER	REF	LOCATION	TAX DIST	DATE INST	DATE CHANGE
05800	S	M	CNT	II	03113	001										12	020800	1/1/0001
05800	S	M	CNT	III	03312	002										12	020800	1/1/0001

OFFICE: 311		ROUTE: 564		ST_REF_NO: 00000188100		VAN BUREN DRIVE		LUMENS	BULB TYPE	MULT SERIES	POLE TYPE	SHADE	ADDRESS NUMBER	REF	LOCATION	TAX DIST	DATE INST	DATE CHANGE
05800	S	M	OUG	II	00000	047	SIDE OF 544 ASBURY DR.									12	030171	1/1/0001
05800	S	M	OUG	II	00000	054	SIDE OF 528 ASBURY DR.									12	010172	1/1/0001
05800	S	M	OUG	II	01502	053										12	010172	1/1/0001
05800	S	M	OUG	II	01515	052										12	010172	1/1/0001
05800	S	M	OUG	II	01535	051										12	030171	1/1/0001
05800	S	M	OUG	II	01555	050										12	010172	1/1/0001
05800	S	M	OUG	II	01570	049										12	010172	1/1/0001
05800	S	M	OUG	II	01587	048										12	010172	1/1/0001

OFFICE: 311		ROUTE: 564		ST_REF_NO: 00000188150		VANBRUGH COURT		LUMENS	BULB TYPE	MULT SERIES	POLE TYPE	SHADE	ADDRESS NUMBER	REF	LOCATION	TAX DIST	DATE INST	DATE CHANGE
05800	S	M	CNT	III	01005	002										12	090898	1/1/0001
05800	S	M	CNT	II	01016	001										12	090898	1/1/0001

OFFICE: 311		ROUTE: 564		ST_REF_NO: 00000188300		VANCOUVER COURT		LUMENS	BULB TYPE	MULT SERIES	POLE TYPE	SHADE	ADDRESS NUMBER	REF	LOCATION	TAX DIST	DATE INST	DATE CHANGE
04000	S	M	OUG	II	04100	009										12	021579	1/1/0001
04000	S	M	OUG	II	04113	008										12	021579	1/1/0001
04000	S	M	OUG	V	04125	007										12	021579	1/1/0001

OFFICE: 311		ROUTE: 564		ST_REF_NO: 00000188400		VANDERBILT DRIVE		LUMENS	BULB TYPE	MULT SERIES	POLE TYPE	SHADE	ADDRESS NUMBER	REF	LOCATION	TAX DIST	DATE INST	DATE CHANGE
05800	S	M	OUG	II	00200	010										12	060886	1/1/0001
05800	S	M	OUG	II	00204	012										12	060886	1/1/0001
05800	S	M	OUG	II	00205	011										12	060886	1/1/0001
05800	S	M	OUG	II	00217	013										12	060886	1/1/0001

OFFICE: 311		ROUTE: 564		ST_REF_NO: 00000188400		VANDERBILT DRIVE		LUMENS	BULB TYPE	MULT SERIES	POLE TYPE	SHADE	ADDRESS NUMBER	REF	LOCATION	TAX DIST	DATE INST	DATE CHANGE
05800	S	M	OUG	II	00228	014										12	060886	1/1/0001
05800	S	M	OUG	II	00237	015										12	060886	1/1/0001
05800	S	M	OUG	II	00248	016										12	060886	1/1/0001
05800	S	M	OUG	II	00256	017										12	060886	1/1/0001
05800	S	M	OUG	II	00265	018										12	060886	1/1/0001

OFFICE: 311		ROUTE: 564		ST_REF_NO: 00000188450		VANDERPOOL ALLEY		LUMENS	BULB TYPE	MULT SERIES	POLE TYPE	SHADE	ADDRESS NUMBER	REF	LOCATION	TAX DIST	DATE INST	DATE CHANGE
05800	S	M	SOH	II	00000	001									1ST LT. N. OF EUCLID AVE., E. SIDE	12	091260	1/1/0001

OFFICE: 311		ROUTE: 564		ST_REF_NO: 00000188650		VENETIAN CIRCLE		LUMENS	BULB TYPE	MULT SERIES	POLE TYPE	SHADE	ADDRESS NUMBER	REF	LOCATION	TAX DIST	DATE INST	DATE CHANGE
05800	S	M	OUG	II	01205	000										12	041067	1/1/0001
05800	S	M	OUG	II	01220	045										12	090884	1/1/0001
05800	S	M	OUG	V	01229	000										12	081869	1/1/0001

OFFICE: 311		ROUTE: 564		ST_REF_NO: 00000188700		VENETIAN WAY		LUMENS	BULB TYPE	MULT SERIES	POLE TYPE	SHADE	ADDRESS NUMBER	REF	LOCATION	TAX DIST	DATE INST	DATE CHANGE
05800	S	M	OUG	II	00000	017									SIDE OF 3556 OLYMPIA ROAD	12	072264	1/1/0001
05800	S	M	OUG	II	01144	000										12	071562	1/1/0001
05800	S	M	OUG	II	01155	000										12	022262	1/1/0001
05800	S	M	OUG	II	01164	000										12	071562	1/1/0001
05800	S	M	OUG	II	01179	000										12	080171	1/1/0001
05800	S	M	OUG	II	01190	000										12	080171	1/1/0001

OFFICE: 311		ROUTE: 564		ST_REF_NO: 00000188800		VENICE PARK		LUMENS	BULB TYPE	MULT SERIES	POLE TYPE	SHADE	ADDRESS NUMBER	REF	LOCATION	TAX DIST	DATE INST	DATE CHANGE
04000	S	M	OOH	II	00000	143									SIDE 258 ROSEMONT	12	100884	1/1/0001
04000	S	M	SOH	II	00104	142										12	100884	1/1/0001
04000	S	M	SOH	II	00111	141										12	080884	1/1/0001
04000	S	M	SOH	II	00118	140										12	100884	1/1/0001

OFFICE: 311

ROUTE: 564

ST_REF_NO: 00000188800 VENICE PARK

LUMENS	BULB TYPE	MULT SERIES	POLE TYPE	SHADE	ADDRESS NUMBER	REF	LOCATION	TAX DIST	DATE INST	DATE CHANGE
04000	S	M	OOH	II	00127	139		12	080884	1/1/0001

OFFICE: 311

ROUTE: 564

ST_REF_NO: 00000188870 VENTURE COURT

LUMENS	BULB TYPE	MULT SERIES	POLE TYPE	SHADE	ADDRESS NUMBER	REF	LOCATION	TAX DIST	DATE INST	DATE CHANGE
09500	S	M	OUG	II	00000	001	OPP. 100 VENTURE COURT	12	090898	1/1/0001
09500	S	M	OUG	II	00000	002	SIDE OF 100 VENTURE CT.	12	090898	1/1/0001
09500	S	M	OUG	II	00100	004		12	090898	1/1/0001
09500	S	M	OUG	II	00101	003		12	090898	1/1/0001
09500	S	M	OUG	II	00116	006		12	090898	1/1/0001
09500	S	M	OUG	II	00133	005		12	090898	1/1/0001
09500	S	M	OUG	II	00133	007		12	090898	1/1/0001
09500	S	M	OUG	II	00140	008		12	090898	1/1/0001
09500	S	M	OUG	III	00149	009		12	090898	1/1/0001

OFFICE: 311

ROUTE: 564

ST_REF_NO: 00000188879 VERBENA COVE

LUMENS	BULB TYPE	MULT SERIES	POLE TYPE	SHADE	ADDRESS NUMBER	REF	LOCATION	TAX DIST	DATE INST	DATE CHANGE
05800	S		CNT	III	00601	001		12	061710	1/1/0001

OFFICE: 311

ROUTE: 564

ST_REF_NO: 00000188880 VERBENA PARK

LUMENS	BULB TYPE	MULT SERIES	POLE TYPE	SHADE	ADDRESS NUMBER	REF	LOCATION	TAX DIST	DATE INST	DATE CHANGE
05800	S		CNT	III	04501	004		12	061710	1/1/0001
05800	S		CNT	II	04509	003		12	061710	1/1/0001
05800	S		CNT	II	04525	002		12	061710	1/1/0001
05800	S		CNT	II	04528	001		12	061710	1/1/0001

OFFICE: 311

ROUTE: 564

ST_REF_NO: 00000188885 VERMILLION PEAK PASS

LUMENS	BULB TYPE	MULT SERIES	POLE TYPE	SHADE	ADDRESS NUMBER	REF	LOCATION	TAX DIST	DATE INST	DATE CHANGE
05800	S	M	CNT	II	00000	005	SIDE OF 4616 PALERMO LN ON VERMILLION PEAK PASS	12	061501	1/1/0001
05800	S	M	CNT	II	00700	010		12	081401	1/1/0001
05800	S	M	CNT	II	00717	011		12	081401	1/1/0001

OFFICE: 311

ROUTE: 564

ST_REF_NO: 00000188885

VERMILLION PEAK PASS

LUMENS	BULB TYPE	MULT SERIES	POLE TYPE	SHADE	ADDRESS NUMBER	REF	LOCATION	TAX DIST	DATE INST	DATE CHANGE
05800	S	M	CNT	II	00733	009		12	081401	1/1/0001
05800	S	M	CNT	II	00745	008		12	081401	1/1/0001
05800	S	M	CNT	II	00757	007		12	081401	1/1/0001
05800	S	M	CNT	II	00796	004		12	061501	1/1/0001
05800	S	M	CNT	II	00806	003		12	061501	1/1/0001
05800	S	M	CNT	II	00818	002		12	061501	1/1/0001
05800	S	M	CNT	II	00838	001		12	061501	1/1/0001

OFFICE: 311

ROUTE: 564

ST_REF_NO: 00000188890

VERO COURT

LUMENS	BULB TYPE	MULT SERIES	POLE TYPE	SHADE	ADDRESS NUMBER	REF	LOCATION	TAX DIST	DATE INST	DATE CHANGE
05800	S	M	CNT	II	01000	006		12	070896	1/1/0001
05800	S	M	CNT	II	01017	005		12	070896	1/1/0001
05800	S	M	CNT	II	01024	004		12	070896	1/1/0001
05800	S	M	CNT	II	01041	003		12	070896	1/1/0001
05800	S	M	CNT	II	01048	002		12	070896	1/1/0001
05800	S	M	CNT	II	01065	001		12	070896	1/1/0001

OFFICE: 311

ROUTE: 564

ST_REF_NO: 00000189000

VERSAILLES ROAD

LUMENS	BULB TYPE	MULT SERIES	POLE TYPE	SHADE	ADDRESS NUMBER	REF	LOCATION	TAX DIST	DATE INST	DATE CHANGE
22000	S		OUG	II	00000	500	1ST LT W OF WESTMORLAND DR, N SIDE OF VERSAILLES ROAD	12	092013	1/1/0001
22000	S		OUG	II	00000	550	1ST LT E OF MASON HEADLEY, S SIDE ON VERSAILLES RD	12	071611	1/1/0001
22000	S		SOH	II	00000	600	NE CORNER OF VERSAILLES AND FORBES RD	12	111909	1/1/0001
22000	S		OUG	II	00000	602	1ST LT W OF OLIVER LEWIS WAY, N SIDE ON VERSAILLES RD.	12	031511	1/1/0001
50000	S		CNT	II	00000	603	1ST LT W OF OLIVER LEWIS WAY, S SIDE ON VERSAILLES RD	12	031511	1/1/0001
22000	S		OUG	II	00000	604	2ND LT W OF OLIVER LEWIS WAY, S SIDE ON VERSAILLES RD	12	031511	1/1/0001
22000	S		SOH	II	00000	612	2ND LT W OF ALEXANDRIA, N SIDE ON VERSAILLES RD	12	022311	1/1/0001
22000	S		OUG	II	00000	710	1ST LT W OF ROSALIE LN, N SIDE OF VERSAILLES ROAD	12	092013	1/1/0001

OFFICE: 311

ROUTE: 564

ST_REF_NO: 00000189000

VERSAILLES ROAD

LUMENS	BULB TYPE	MULT SERIES	POLE TYPE	SHADE	ADDRESS NUMBER	REF	LOCATION	TAX DIST	DATE INST	DATE CHANGE
22000	S		OUG	II	00000	711	1ST LT E OF OLD VERSAILLES RD, S SIDE OF VERSAILLES ROAD	12	092013	1/1/0001
22000	S		OUG	II	00000	740	1ST LT E OF WESTMORLAND DR, S SIDE OF VERSAILLES ROAD	12	092013	1/1/0001
22000	S		OUG	II	01318	601		12	121509	1/1/0001
50000	S		SOH	II	02089	400	VERSAILLES RD AT CEMETARY ENTRANCE	12	102009	1/1/0001
22000	S	M	OUG	II	00000	060	OPP. 2089	12	031582	5/6/2011
22000	S	M	OUG	II	00000	063	OPP. 2089	12	031582	5/6/2011
22000	S	M	OUG	II	00000	065	OPP. 2089	12	031582	5/6/2011
22000	S	M	OUG	II	00000	071	OPP. 2205	12	031582	5/6/2011
22000	S	M	OUG	II	00000	073	OPP. 2225	12	031582	5/6/2011
22000	S	M	OOH	II	01306	002		12	031582	4/14/2011
22000	S	M	OOH	II	01307	005		12	031582	4/14/2011
22000	S	M	OOH	II	01314	004		12	031582	4/14/2011
22000	S	M	OOH	II	01317	007		12	031582	2/1/2011
22000	S	M	OOH	II	01317	009		12	031582	2/1/2011
22000	S	M	OOH	II	01404	012		12	031582	2/1/2011
22000	S	M	SOH	II	01407	013		12	031582	2/1/2011
22000	S	M	OOH	II	01408	014		12	031582	2/1/2011
22000	S	M	OOH	II	01411	015		12	031582	2/1/2011
22000	S	M	SOH	II	01417	017		12	031582	2/1/2011
22000	S	M	OOH	II	01420	016		12	031582	2/1/2011
22000	S	M	OOH	II	01502	018		12	031582	3/22/2011
22000	S	M	SOH	II	01509	019		12	031582	3/22/2011
22000	S	M	OOH	II	01518	022		12	031582	3/22/2011
22000	S	M	OOH	II	01521	023		12	031582	3/22/2011
22000	S	M	OOH	II	01524	024		12	031582	3/22/2011
22000	S	M	SOH	II	01525	025		12	031582	3/22/2011
22000	S	M	OOH	II	01528	026		12	031582	3/22/2011
22000	S	M	SOH	II	01533	027		12	031582	3/22/2011
22000	S	M	SOH	II	01609	031		12	031582	3/30/2011
22000	S	M	SOH	II	01613	033		12	031582	3/30/2011
22000	S	M	OOH	II	01616	034		12	031582	3/30/2011
22000	S	M	SOH	II	01703	035		12	031582	3/30/2011
22000	S	M	SOH	II	01709	037		12	031582	3/30/2011

OFFICE: 311

ROUTE: 564

ST_REF_NO: 00000189000

VERSAILLES ROAD

LUMENS	BULB TYPE	MULT SERIES	POLE TYPE	SHADE	ADDRESS NUMBER	REF	LOCATION	TAX DIST	DATE INST	DATE CHANGE
22000	S	M	OOH	II	01710	036		12	031582	3/30/2011
22000	S	M	OOH	II	01714	038		12	031582	3/30/2011
22000	S	M	SOH	II	01715	039	upgrade per city request	12	031582	4/28/2010
22000	S	M	OOH	II	01718	040	upgrade per city request	12	031582	4/28/2010
22000	S	M	SOH	II	01721	041	upgrade per city request	12	031582	4/28/2010
22000	S	M	OOH	II	01802	042		12	031582	4/14/2011
22000	S	M	SOH	II	01803	043		12	031582	4/14/2011
22000	S	M	OOH	II	01806	044		12	031582	4/14/2011
22000	S	M	SOH	II	01809	045		12	031582	4/14/2011
22000	S	M	OOH	II	01814	046		12	031582	4/14/2011
22000	S	M	OUG	II	01820	048		12	031582	4/14/2011
50000	S	M	OUG	II	01828	050	lfucg upgrade	12	031582	10/20/2010
22000	S	M	OUG	II	01830	052		12	031582	4/14/2011
22000	S	M	SOH	II	01901	500	upgrade per city request	12	012407	3/9/2011
22000	S	M	OOH	II	01905	047		12	031582	4/14/2011
50000	S	M	SOH	II	02001	049	lfucg upgrade	12	031582	10/20/2010
22000	S	M	OUG	II	02003	051		12	031582	4/14/2011
22000	S	M	OOH	II	02005	053		12	031582	5/6/2011
22000	S	M	OUG	II	02011	055		12	031582	5/6/2011
22000	S	M	OUG	II	02050	054		12	031582	5/6/2011
22000	S	M	OUG	II	02050	056		12	031582	1/1/2011
22000	S	M	OUG	II	02089	057		12	031582	5/6/2011
22000	S	M	OOH	II	02089	062		12	031582	5/6/2011
22000	S	M	OOH	II	02089	064		12	031582	5/6/2011
22000	S	M	OOH	II	02089	066		12	031582	5/6/2011
22000	S	M	OOH	II	02189	068		12	031582	5/6/2011
22000	S	M	OOH	II	02197	070		12	031582	5/6/2011
22000	S	M	OOH	II	02213	072		12	031582	2/1/2011
22000	S	M	OOH	II	02233	074		12	031582	5/6/2011
22000	S	M	OUG	II	02284	075		12	031582	5/6/2011
22000	S	M	OUG	II	02284	077		12	031582	5/6/2011
22000	S	M	OOH	II	02293	076		12	031582	5/6/2011
22000	S	M	OUG	II	02312	083	chg'd out bad fixture	12	031582	7/30/2009
50000	S	M	OUG	II	02492	091		12	031582	11/9/2011

OFFICE: 311

ROUTE: 564

ST_REF_NO: 00000189000

VERSAILLES ROAD

LUMENS	BULB TYPE	MULT SERIES	POLE TYPE	SHADE	ADDRESS NUMBER	REF	LOCATION	TAX DIST	DATE INST	DATE CHANGE
22000	S	M	OUG	III	00000	112	1ST LT W OF MAN-O-WAR,SOUTHSIDE OF VERSAILLES RD	12	090891	1/1/0001
22000	S	M	OUG	III	00000	113	4TH LT. E. OF AIRPORT RD., NORTHSIDE	22	060685	1/1/0001
22000	S	M	OUG	III	00000	114	2ND LT W OF MAN-O-WAR,SOUTHSIDE OF VERSAILLES RD	12	090891	1/1/0001
22000	S	M	OUG	III	00000	115	3RD LT. E. OF AIRPORT RD., NORTHSIDE	22	060685	1/1/0001
22000	S	M	OUG	III	00000	116	3RD LT W OF MAN-O-WAR,SOUTHSIDE OF VERSAILLES RD	12	090891	1/1/0001
22000	S	M	OUG	III	00000	117	2ND LT. E. OF AIRPORT RD., NORTHSIDE	22	060685	1/1/0001
22000	S	M	OUG	III	00000	118	4TH LT W OF MAN-O-WAR,SOUTHSIDE OF VERSAILLES RD	12	090891	1/1/0001
22000	S	M	OUG	III	00000	119	1ST LT. E. OF AIRPORT RD., NORTHSIDE	22	060685	1/1/0001
22000	S	M	OUG	III	00000	120	5TH LT W OF MAN-O-WAR,SOUTHSIDE OF VERSAILLES RD	12	090891	1/1/0001
22000	S	M	OUG	III	00000	121	OPP. AIRPORT RD., NORTHSIDE	22	060685	1/1/0001
22000	S	M	OUG	III	00000	122	1ST LT. W. OF AIRPORT RD., SOUTHSIDE	22	060685	1/1/0001
22000	S	M	OUG	III	00000	123	1ST LT. W. OF AIRPORT RD., NORTHSIDE	22	060685	1/1/0001
22000	S	M	OUG	III	00000	124	2ND LT. W. OF AIRPORT RD., SOUTHSIDE	22	060685	1/1/0001
22000	S	M	OUG	III	00000	125	2ND LT. W. OF AIRPORT RD., NORTHSIDE	22	060685	1/1/0001
22000	S	M	OUG	III	00000	126	3RD LT. W. OF AIRPORT RD., SOUTHSIDE	22	060685	1/1/0001
22000	S	M	OUG	III	00000	127	3RD LT. W. OF AIRPORT RD., NORTHSIDE	22	060685	1/1/0001
22000	S	M	OUG	III	00000	128	4TH LT. W. OF AIRPORT RD., SOUTHSIDE	22	060685	1/1/0001
22000	S	M	OUG	III	00000	129	4TH LT. W. OF AIRPORT RD., NORTHSIDE	22	060685	1/1/0001
22000	S	M	OUG	III	00000	130	5TH LT. W. OF AIRPORT RD., SOUTHSIDE	22	060685	1/1/0001
22000	S	M	OUG	III	00000	131	5TH LT. W. OF AIRPORT RD., NORTHSIDE	22	060685	1/1/0001
22000	S	M	OUG	III	00000	132	6TH LT. W. OF AIRPORT RD., SOUTHSIDE	22	060685	1/1/0001
22000	S	M	OUG	III	00000	133	IN MEDIAN OF MAN-O-WAR,SOUTHSIDE AT VERSAILLES RD	12	090891	1/1/0001
22000	S	M	OUG	III	00000	134	OPP. MAN-O-WAR, NORTHSIDE	12	110895	1/1/0001
22000	S	M	OUG	III	00000	135	1ST LT E OF MAN-O-WAR,SOUTHSIDE OF VERSAILLES RD	12	090891	1/1/0001
22000	S	M	OUG	III	00000	136	1ST LT. E.OF MAN-O-WAR, NORTHSIDE	12	110895	1/1/0001
22000	S	M	OUG	III	00000	137	2ND LT E OF MAN-O-WAR,SOUTHSIDE OF VERSAILLES RD	12	090891	1/1/0001
22000	S	M	OUG	III	00000	138	2ND LT. E. OF MAN-O-WAR, NORTHSIDE	12	110895	1/1/0001
22000	S	M	OUG	III	00000	139	3RD LT E OF MAN-O-WAR,SOUTHSIDE OF VERSAILLES RD	12	090891	1/1/0001

OFFICE: 311

ROUTE: 564

ST_REF_NO: 00000189000

VERSAILLES ROAD

LUMENS	BULB TYPE	MULT SERIES	POLE TYPE	SHADE	ADDRESS NUMBER	REF	LOCATION	TAX DIST	DATE INST	DATE CHANGE
22000	S	M	OUG	III	00000	140	3RD LT. E. OF MAN-O-WAR, NORTHSIDE	12	110895	1/1/0001
22000	S	M	OUG	III	00000	141	4TH LT E OF MAN-O-WAR,SOUTHSIDE OF VERSAILLES RD	12	090891	1/1/0001
22000	S	M	OUG	III	00000	142	4TH LT. E. OF MAN-O-WAR, NORTHSIDE	12	110895	1/1/0001
22000	S	M	OUG	III	00000	143	5TH LT E OF MAN-O-WAR,SOUTHSIDE OF VERSAILLES RD	12	090891	1/1/0001
22000	S	M	OUG	III	00000	144	5TH LT. E. OF MAN-O-WAR, NORTHSIDE	12	110895	1/1/0001
22000	S	M	OUG	III	00000	145	6TH LT E OF MAN-O-WAR,SOUTHSIDE OF VERSAILLES RD	12	090891	1/1/0001
22000	S	M	OUG	III	00000	146	6TH LT E OF MAN-O-WAR,NORTHSIDE OF VERSAILLES RD	12	090891	1/1/0001
22000	S	M	OUG	III	00000	147	7TH LT E OF MAN-O-WAR,SOUTHSIDE OF VERSAILLES RD	12	090891	1/1/0001
22000	S	M	OUG	III	00000	148	7TH LT E OF MAN-O-WAR,NORTHSIDE OF VERSAILLES RD	12	090891	1/1/0001
22000	S	M	OUG	III	00000	149	8TH LT E OF MAN-O-WAR,SOUTHSIDE OF VERSAILLES RD	12	090891	1/1/0001
20000	M	M	OUG	II	00000	093	SIDE OF 1200 COLONIAL DR.	12	031582	1/1/0001
22000	S	M	OUG	II	00000	095	SIDE OF 1205 COLONIAL DR. upgrade 5/08	12	031582	1/1/0001
20000	M	M	OUG	II	02418	087		12	031582	1/1/0001
20000	M	M	OOH	II	02421	088		12	031582	1/1/0001
20000	M	M	OUG	II	02422	089		12	031582	1/1/0001
22000	S	M	OOH	II	02425	090	upgrade 5/08	12	031582	1/1/0001
22000	S	M	OOH	II	02481	092	upgrade 5/08	12	031582	1/1/0001
20000	M	M	OOH	II	02489	094		12	031582	1/1/0001
22000	S	M	OOH	II	02499	096	upgrade 5/08	12	031582	1/1/0001
20000	M	M	OUG	II	02512	097		12	031582	1/1/0001
22000	S	M	OUG	II	00000	058	S.W. CORNER OF VERSAILLES & MASON HEADLEY RD.	12	031582	1/1/0001
22000	S	M	OUG	II	00000	067	OPP. 2189 upgraded 5/08	12	031582	1/1/0001
22000	S	M	OUG	II	00000	069	OPP. 2197 upgraded 5/08	12	031582	1/1/0001
50000	S	M	OOH	II	01510	020	upgraded to 50,000 hps 12/06	12	031582	1/1/0001
50000	S	M	SOH	II	01517	021	upgraded to 50,000 hps 12/06	12	031582	1/1/0001
22000	S	M	OOH	II	01600	028	upgrade 5/08	12	031582	1/1/0001
22000	S	M	SOH	II	01603	029	upgrade 5/08	12	031582	1/1/0001
22000	S	M	OOH	II	01608	030		12	031582	1/1/0001

OFFICE: 311

ROUTE: 564

ST_REF_NO: 00000189000

VERSAILLES ROAD

LUMENS	BULB TYPE	MULT SERIES	POLE TYPE	SHADE	ADDRESS NUMBER	REF	LOCATION	TAX DIST	DATE INST	DATE CHANGE
22000	S	M	OOH	II	01612	032	upgrade 5/08	12	031582	1/1/0001
22000	S	M	OUG	II	02089	059	upgrade 5/08	12	031582	1/1/0001
22000	S	M	OOH	II	02089	061		12	031582	1/1/0001
20000	M	M	OUG	II	02300	079		12	031582	1/1/0001
20000	M	M	SOH	II	02301	078		12	031582	1/1/0001
22000	S	M	OUG	II	02308	081	upgrade 5/08	12	031582	1/1/0001
22000	S	M	OOH	II	02323	082		12	031582	1/1/0001
20000	M	M	OOH	II	02347	084		12	031582	1/1/0001
20000	M	M	OOH	II	02401	086		12	031582	1/1/0001
20000	M	M	OUG	II	02402	085		12	031582	1/1/0001
20000	M	M	OOH	II	01247	001		12	031582	1/1/0001
22000	S	M	OOH	II	01301	003	upgrade 5/08	12	031582	1/1/0001
22000	S	M	OOH	II	01320	008	upgrade 5/08	12	031582	1/1/0001
22000	S	M	OOH	II	01326	010	bad fixture-upgrade to 22,000 hps	12	031582	1/1/0001
22000	S	M	SOH	II	01333	011	mv changeout	12	031582	1/1/0001

OFFICE: 311

ROUTE: 564

ST_REF_NO: 00000189100

VERSIE COURT

LUMENS	BULB TYPE	MULT SERIES	POLE TYPE	SHADE	ADDRESS NUMBER	REF	LOCATION	TAX DIST	DATE INST	DATE CHANGE
05800	S	M	OUG	V	01301	041		12	080173	1/1/0001
05800	S	M	OUG	II	01317	040		12	080173	1/1/0001

OFFICE: 311

ROUTE: 564

ST_REF_NO: 00000189200

VICKSBURG ROAD

LUMENS	BULB TYPE	MULT SERIES	POLE TYPE	SHADE	ADDRESS NUMBER	REF	LOCATION	TAX DIST	DATE INST	DATE CHANGE
04000	S	M	OUG	II	00000	001	SIDE OF 929 MAYWICK DR.	12	100888	1/1/0001
04000	S	M	OUG	II	01930	006		12	100888	1/1/0001
04000	S	M	OUG	II	01938	005		12	100888	1/1/0001
04000	S	M	OUG	II	01945	004		12	100888	1/1/0001
04000	S	M	OUG	II	01962	003		12	100888	1/1/0001
04000	S	M	OUG	II	01969	002		12	100888	1/1/0001

OFFICE: 311		ROUTE: 564		ST_REF_NO: 00000189300		VICTORIA WAY		LUMENS	BULB TYPE	MULT SERIES	POLE TYPE	SHADE	ADDRESS NUMBER	REF	LOCATION	TAX DIST	DATE INST	DATE CHANGE
	09500	S		OUG	II	00000	068	ACROSS FROM 4000 VICTORIA WAY	12	040213	1/1/0001							
	05800	S	M	OUG	II	04008	069		12	120892	1/1/0001							
	05800	S	M	OUG	II	04021	072		12	110886	1/1/0001							
	05800	S	M	OUG	II	04024	070		12	120892	1/1/0001							
	05800	S	M	OUG	II	00000	073	OPP. 4025	12	110886	1/1/0001							
	05800	S	M	OUG	II	00000	076	OPP. TORONTO	12	110886	1/1/0001							
	05800	S	M	OUG	II	00000	078	OPP. 4069	12	110886	1/1/0001							
	05800	S	M	OUG	II	00000	080	OPP. 4081	12	110886	1/1/0001							
	05800	S	M	OUG	II	04032	071		12	120892	1/1/0001							
	04000	S	M	OUG	V	04033	074		12	110886	1/1/0001							
	05800	S	M	OUG	II	04037	075		12	110886	1/1/0001							
	05800	S	M	OUG	II	04053	077		12	110886	1/1/0001							
	04000	S	M	OUG	V	04061	084		12	110886	1/1/0001							
	05800	S	M	OUG	II	04073	079		12	110886	1/1/0001							
	05800	S	M	OUG	II	04104	081		12	110886	1/1/0001							
	05800	S	M	OUG	II	04113	082		12	110886	1/1/0001							
	05800	S	M	OUG	II	04120	083		12	110886	1/1/0001							
OFFICE: 311		ROUTE: 564		ST_REF_NO: 00000189400		VICTORY AVENUE		LUMENS	BULB TYPE	MULT SERIES	POLE TYPE	SHADE	ADDRESS NUMBER	REF	LOCATION	TAX DIST	DATE INST	DATE CHANGE
	05800	S	M	OOH	II	00000	038	SIDE 1109 RICHMOND RD upgrade 6/08	12	110884	1/1/0001							
	04000	S	M	OUG	II	00101	037		12	080885	1/1/0001							
	04000	S	M	OUG	II	00111	036		12	110884	1/1/0001							
	04000	S	M	OUG	II	00117	035		12	110884	1/1/0001							
	04000	S	M	OUG	II	00120	034		12	080885	1/1/0001							
	04000	S	M	OUG	II	00133	033		12	110884	1/1/0001							
	04000	S	M	OUG	II	00141	032		12	110884	1/1/0001							
	04000	S	M	OUG	II	00148	031		12	110884	1/1/0001							
OFFICE: 311		ROUTE: 564		ST_REF_NO: 00000189600		VILLAGE DRIVE		LUMENS	BULB TYPE	MULT SERIES	POLE TYPE	SHADE	ADDRESS NUMBER	REF	LOCATION	TAX DIST	DATE INST	DATE CHANGE
	50000	S	M	OUG	II	00000	001	SIDE OF 2205 VERSAILLES RD.	12	060870	10/26/2009							

OFFICE: 311		ROUTE: 564		ST_REF_NO: 00000189600		VILLAGE DRIVE		LUMENS	BULB TYPE	MULT SERIES	POLE TYPE	SHADE	ADDRESS NUMBER	REF	LOCATION	TAX DIST	DATE INST	DATE CHANGE
22000	S	M	SOH	II	00000	002	SIDE 2197 VERSAILLES RD.	12	100892	1/1/0001								
09500	S	M	OUG	II	00000	007	SIDE OF 2223 DEVONPORT DR.	12	090170	1/1/0001								
09500	S	M	OUG	II	00000	009	OPP. 1302	12	090170	1/1/0001								
09500	S	M	OUG	II	00000	036	SIDE OF 2051 CUMMINS CT.	12	060870	1/1/0001								
09500	S	M	OUG	II	01242	042		12	091477	1/1/0001								
09500	S	M	OUG	II	01261	039		12	100172	1/1/0001								
09500	S	M	OUG	II	01261	041		12	100172	1/1/0001								
09500	S	M	OUG	II	01262	040		12	100172	1/1/0001								
09500	S	M	OUG	II	01274	038		12	100172	1/1/0001								
09500	S	M	OUG	II	01281	037		12	080171	1/1/0001								
22000	S	M	OUG	II	01346	006		12	060870	1/1/0001								
09500	S	M	OUG	II	01346	008		12	060870	1/1/0001								
22000	S	M	OUG	II	01429	005		12	030774	1/1/0001								
22000	S	M	OUG	II	01430	004		12	101570	1/1/0001								
22000	S	M	OUG	II	01465	003		12	101570	1/1/0001								

OFFICE: 311		ROUTE: 564		ST_REF_NO: 00000189790		VINCENT WAY		LUMENS	BULB TYPE	MULT SERIES	POLE TYPE	SHADE	ADDRESS NUMBER	REF	LOCATION	TAX DIST	DATE INST	DATE CHANGE
09500	S	M	CNT	II	00000	001	1ST LT E OF CLAYS MILL, SOUTH SIDE ON VINCENT WAY	12	111004	1/1/0001								
09500	S	M	CNT	II	00000	002	2ND LT E OF CLAYS MILL, SOUTH SIDE ON VINCENT WAY	12	111004	1/1/0001								
09500	S	M	CNT	II	00000	003	3RD LT E OF CLAYS MILL, SOUTH SIDE ON VINCENT WAY	12	111004	1/1/0001								
09500	S	M	CNT	II	00000	004	4TH LT E OF CLAYS MILL, SOUTH SIDE ON VINCENT WAY	12	111004	1/1/0001								
09500	S	M	CNT	II	00000	005	5TH LT E OF CLAYS MILL, SOUTH SIDE ON VINCENT WAY	12	111004	1/1/0001								
09500	S	M	CNT	II	00000	006	6TH LT E OF CLAYS MILL, SOUTH SIDE ON VINCENT WAY	12	111004	1/1/0001								
09500	S	M	CNT	II	00000	007	7TH LT E OF CLAYS MILL, SOUTH SIDE ON VINCENT WAY	12	111004	1/1/0001								
09500	S	M	CNT	II	00000	008	8TH LT E OF CLAYS MILL, SOUTH SIDE ON VINCENT WAY	12	111004	1/1/0001								
09500	S	M	CNT	II	00000	009	9TH LT E OF CLAYS MILL, SOUTH SIDE ON VINCENT WAY	12	111004	1/1/0001								

OFFICE: 311		ROUTE: 564		ST_REF_NO: 00000189790		VINCENT WAY				
LUMENS	BULB TYPE	MULT SERIES	POLE TYPE	SHADE	ADDRESS NUMBER	REF	LOCATION	TAX DIST	DATE INST	DATE CHANGE
09500	S	M	CNT	II	00000	010	10TH LT E OF CLAYS MILL, SOUTH SIDE ON VINCENT WAY	12	111004	1/1/0001
09500	S	M	CNT	II	00000	011	11TH LT E OF CLAYS MILL, SOUTH SIDE ON VINCENT WAY	12	111004	1/1/0001
09500	S	M	CNT	II	00000	012	12TH LT E OF CLAYS MILL, SOUTH SIDE ON VINCENT WAY	12	111004	1/1/0001

OFFICE: 311		ROUTE: 564		ST_REF_NO: 00000189810		VINE, OLD EAST STREET				
LUMENS	BULB TYPE	MULT SERIES	POLE TYPE	SHADE	ADDRESS NUMBER	REF	LOCATION	TAX DIST	DATE INST	DATE CHANGE
10000	M	M	SOH	II	00000	011	SIDE OF 127 WOODLAND AVE.	12	011967	1/1/0001
10000	M	M	SOH	II	00000	012	SIDE OF 123 WOODLAND AVE.	12	011967	1/1/0001
10000	M	M	SOH	II	00449	010		12	011967	1/1/0001
10000	M	M	SOH	II	00000	002	2ND LT. W. OF SOUTHEASTERN AVE., S. SIDE	12	071475	1/1/0001
10000	M	M	SOH	II	00000	003	1ST LT. W. OF SOUTHEASTERN AVE., S. SIDE	12	071475	1/1/0001
10000	M	M	SOH	II	00000	004	NE CORNER OF OLD VINE & SOUTHEASTERN AVE.	12	011967	1/1/0001
10000	M	M	SOH	II	00000	008	SIDE OF 121 RANSOM AVE.	12	011967	1/1/0001
10000	M	M	SOH	II	00000	009	SIDE OF 122 RANSOM AVE.	12	011967	1/1/0001
10000	M	M	SOH	II	00400	005		12	011967	1/1/0001
10000	M	M	SOH	II	00432	006		12	100892	1/1/0001
10000	M	M	SOH	II	00436	007		12	011967	1/1/0001

OFFICE: 311		ROUTE: 564		ST_REF_NO: 00000189830		WEST VINE STREET				
LUMENS	BULB TYPE	MULT SERIES	POLE TYPE	SHADE	ADDRESS NUMBER	REF	LOCATION	TAX DIST	DATE INST	DATE CHANGE
16000	S	M	GRN	IV	00000	174	3RD LT W OF S BROADWAY, S SIDE ON W VINE ST	12	070101	1/1/0001
16000	S	M	GRN	IV	00000	175	4TH LT W OF S BROADWAY, S SIDE ON W VINE ST	12	070101	1/1/0001
16000	S	M	GRN	IV	00000	176	7TH LT W OF S BROADWAY,S SIDE ON WEST VINE ST	12	070101	1/1/0001
16000	S	M	GRN	IV	00000	177	5TH LT W OF S BROADWAY, N SIDE ON W VINE ST	12	070101	1/1/0001
16000	S	M	GRN	IV	00000	178	6TH LT W OF S BROADWAY, S SIDE ON W VINE ST	12	070101	1/1/0001
16000	S	M	GRN	IV	00000	179	4TH LT W OF S BROADWAY,N SIDE ON W VINE ST	12	070101	1/1/0001
16000	S	M	GRN	IV	00000	180	5TH LT W OF S BROADWAY,S SIDE ON W VINE ST	12	070101	1/1/0001
16000	S	M	GRN	IV	00000	181	3RD LT W OF S BROADWAY,N SIDE ON W VINE ST	12	070101	1/1/0001
16000	S	M	GRN	IV	00000	183	2ND LT W OF S BROADWAY,N SIDE ON W VINE ST	12	070101	1/1/0001
16000	S	M	GRN	IV	00000	184	2ND LT W OF S BROADWAY,S SIDE ON W VINE ST	12	070101	1/1/0001

OFFICE: 311

ROUTE: 564

ST_REF_NO: 00000189830

WEST VINE STREET

LUMENS	BULB TYPE	MULT SERIES	POLE TYPE	SHADE	ADDRESS NUMBER	REF	LOCATION	TAX DIST	DATE INST	DATE CHANGE
16000	S	M	GRN	IV	00000	185	1ST LT W OF S BROADWAY,N SIDE ON W VINE ST	12	070101	1/1/0001
16000	S	M	GRN	IV	00000	186	1ST LT W OF S BROADWAY,S SIDE ON W VINE ST	12	070101	1/1/0001
16000	S	M	GRN	IV	00000	187	1ST LT E OF S BROADWAY,N SIDE ON W VINE ST	12	070101	1/1/0001
16000	S	M	GRN	IV	00000	188	1ST LT E OF S BROADWAY,S SIDE ON W VINE ST	12	070101	1/1/0001
16000	S	M	GRN	IV	00000	189	2ND LT E OF S BROADWAY,N SIDE ON W VINE ST	12	070101	1/1/0001
16000	S	M	GRN	IV	00000	190	2ND LT E OF S BROADWAY,S SIDE ON W VINE ST	12	070101	1/1/0001
16000	S	M	GRN	IV	00000	191	3RD LT E OF S BROADWAY,N SIDE ON W VINE ST	12	070101	1/1/0001
16000	S	M	GRN	IV	00000	192	3RD LT E OF S BROADWAY,S SIDE ON W VINE ST	12	070101	1/1/0001
16000	S	M	GRN	IV	00000	193	4TH LT E OF S BROADWAY,N SIDE ON W VINE ST	12	070101	1/1/0001
16000	S	M	GRN	IV	00000	194	4TH LT E OF S BROADWAY,S SIDE ON W VINE ST	12	070101	1/1/0001
16000	S	M	GRN	IV	00000	195	5TH LT E OF S BROADWAY,N SIDE ON W VINE ST	12	070101	1/1/0001
16000	S	M	GRN	IV	00000	196	5TH LT E OF S BROADWAY,S SIDE ON W VINE ST	12	070101	1/1/0001
16000	S	M	GRN	IV	00000	197	6TH LT E OF S BROADWAY,N SIDE ON W VINE ST	12	070101	1/1/0001
16000	S	M	GRN	IV	00000	198	6TH LT E OF S BROADWAY,S SIDE ON W VINE ST	12	070101	1/1/0001
16000	S	M	GRN	IV	00000	199	7TH LT E OF S BROADWAY,N SIDE ON W VINE ST	12	070101	1/1/0001
16000	S	M	GRN	IV	00000	200	7TH LT E OF S BROADWAY,S SIDE ON W VINE ST	12	070101	1/1/0001
16000	S	M	GRN	IV	00000	201	1ST LT E OF S MILL ST,N SIDE ON W VINE ST	12	070101	1/1/0001
16000	S	M	GRN	IV	00000	202	1ST LT E OF S MILL ST,S SIDE ON W VINE ST	12	070101	1/1/0001
16000	S	M	GRN	IV	00000	203	2ND LT E OF S MILL ST,N SIDE ON W VINE ST	12	070101	1/1/0001
16000	S	M	GRN	IV	00000	204	2ND LT E OF S MILL ST,S SIDE ON W VINE ST	12	070101	1/1/0001
16000	S	M	GRN	IV	00000	205	3RD LT E OF S MILL ST,N SIDE ON W VINE ST	12	070101	1/1/0001
16000	S	M	GRN	IV	00000	206	3RD LT E OF S MILL ST,S SIDE ON W VINE ST	12	070101	1/1/0001
16000	S	M	GRN	IV	00000	207	4TH LT E OF S MILL ST,N SIDE ON W VINE ST	12	070101	1/1/0001
16000	S	M	GRN	IV	00000	208	4TH LT E OF S MILL ST,S SIDE ON W VINE ST	12	070101	1/1/0001
16000	S	M	GRN	IV	00000	209	5TH LT E OF S MILL ST,N SIDE ON W VINE ST	12	070101	1/1/0001
16000	S	M	GRN	IV	00000	210	5TH LT E OF S MILL ST,S SIDE ON W VINE ST	12	070101	1/1/0001
16000	S	M	GRN	IV	00000	211	6TH LT E OF S MILL ST,N SIDE ON W VINE ST	12	070101	1/1/0001
16000	S	M	GRN	IV	00000	212	6TH LT E OF S MILL ST,S SIDE ON W VINE ST	12	070101	1/1/0001
16000	S	M	GRN	IV	00000	213	7TH LT E OF S MILL ST,N SIDE ON W VINE ST	12	070101	1/1/0001
16000	S	M	GRN	IV	00000	214	7TH LT E OF S MILL ST,S SIDE ON W VINE ST	12	070101	1/1/0001
16000	S	M	GRN	IV	00000	215	8TH LT E OF S MILL ST,N SIDE ON W VINE ST	12	070101	1/1/0001
16000	S	M	GRN	IV	00000	216	8TH LT E OF S MILL ST,S SIDE ON W VINE ST	12	070101	1/1/0001
16000	S	M	GRN	IV	00000	218	1ST LT E OF S UPPER ST,S SIDE ON W VINE ST	12	070101	1/1/0001
16000	S	M	GRN	IV	00000	220	2ND LT E OF S UPPER ST,S SIDE ON W VINE ST	12	070101	1/1/0001

Street Light Listing run 1/11/2015 10:43:21 AM

Page 1167 of 1254

OFFICE: 311

ROUTE: 564

ST_REF_NO: 00000189830

WEST VINE STREET

LUMENS	BULB TYPE	MULT SERIES	POLE TYPE	SHADE	ADDRESS NUMBER	REF	LOCATION	TAX DIST	DATE INST	DATE CHANGE
16000	S	M	GRN	IV	00000	222	3RD LT E OF S UPPER ST,S SIDE ON W VINE ST	12	070101	1/1/0001
16000	S	M	GRN	IV	00000	224	4TH LT E OF S UPPER ST,S SIDE ON W VINE ST	12	070101	1/1/0001
16000	S	M	GRN	IV	00000	226	5TH LT E OF S UPPER ST,S SIDE ON W VINE ST	12	070101	1/1/0001
16000	S	M	GRN	IV	00000	228	6TH LT E OF S UPPER ST, S SIDE ON W VINE ST	12	070101	1/1/0001
16000	S	M	GRN	IV	00000	230	7TH LT E OF S UPPER ST,S SIDE ON W VINE ST	12	070101	1/1/0001

OFFICE: 311

ROUTE: 564

ST_REF_NO: 00000189836

VILLAGE GREEN AVENUE

LUMENS	BULB TYPE	MULT SERIES	POLE TYPE	SHADE	ADDRESS NUMBER	REF	LOCATION	TAX DIST	DATE INST	DATE CHANGE
09500	S		CLN	II	00000	001	1ST LT N OF FLYING EBONY, W SIDE ON VILLAGE GREEN AVE	12	092609	1/1/0001
09500	S		CLN	II	00000	002	1ST LT N OF FLYING EBONY, E SIDE ON VILLAGE GREEN AVE	12	092609	1/1/0001
09500	S		CLN	II	00000	003	2ND LT N OF FLYING EBONY, W SIDE ON VILLAGE GREEN AVE	12	092609	1/1/0001
09500	S		CLN	II	00000	004	2ND LT N OF FLYING EBONY, E SIDE ON VILLAGE GREEN AVE	12	092609	1/1/0001
09500	S		CLN	II	00000	005	3RD LT N OF FLYING EBONY, W SIDE ON VILLAGE GREEN AVE	12	092609	1/1/0001
09500	S		CLN	II	00000	006	3RD LT N OF FLYING EBONY, E SIDE ON VILLAGE GREEN AVE	12	092609	1/1/0001
09500	S		CLN	II	00000	007	4TH LT N OF FLYING EBONY, W SIDE ON VILLAGE GREEN AVE	12	092609	1/1/0001
09500	S		CLN	II	00000	008	4TH LT N OF FLYING EBONY, E SIDE ON VILLAGE GREEN AVE	12	092609	1/1/0001
09500	S		CLN	II	00000	009	5TH LT N OF FLYING EBONY, W SIDE ON VILLAGE GREEN AVE	12	092609	1/1/0001
09500	S		CLN	II	00000	010	5TH LT N OF FLYING EBONY, E SIDE ON VILLAGE GREEN AVE	12	092609	1/1/0001
09500	S		CLN	II	00000	011	1ST LT N OF FRANKS WAY, E SIDE ON VILLAGE GREEN AVE	12	092609	1/1/0001
09500	S		CLN	II	00000	012	1ST LT N OF FRANKS WAY, W SIDE ON VILLAGE GREEN AVE	12	092609	1/1/0001
09500	S		CLN	II	00000	013	2ND LT N OF FRANKS WAY, E SIDE ON VILLAGE GREEN	12	092609	1/1/0001
09500	S		CLN	II	00000	014	2ND LT N OF FRANKS WAY, W SIDE ON VILLAGE GREEN AVE	12	092609	1/1/0001
09500	S		CLN	II	00000	015	3RD LT N OF FRANKS WAY, E SIDE ON VILLAGE GREEN AVE	12	092609	1/1/0001

OFFICE: 311

ROUTE: 564

ST_REF_NO: 00000189836 VILLAGE GREEN AVENUE

LUMENS	BULB TYPE	MULT SERIES	POLE TYPE	SHADE	ADDRESS NUMBER	REF	LOCATION	TAX DIST	DATE INST	DATE CHANGE
09500	S		CLN	II	00000	016	3RD LT N OF FRANKS WAY, W SIDE ON VILLAGE GREEN AVE	12	092609	1/1/0001
09500	S		CLN	II	00000	017	SIDE OF 2480 FRANKS WAY, ON VILLAGE GREEN AVE	12	092609	1/1/0001

OFFICE: 311

ROUTE: 564

ST_REF_NO: 00000189838 VINSON COURT

LUMENS	BULB TYPE	MULT SERIES	POLE TYPE	SHADE	ADDRESS NUMBER	REF	LOCATION	TAX DIST	DATE INST	DATE CHANGE
05800	S	M	OUG	III	01108	001		12	061201	1/1/0001

OFFICE: 311

ROUTE: 564

ST_REF_NO: 00000189840 VINTAGE CIRCLE

LUMENS	BULB TYPE	MULT SERIES	POLE TYPE	SHADE	ADDRESS NUMBER	REF	LOCATION	TAX DIST	DATE INST	DATE CHANGE
04000	S	M	OUG	V	01471	003		12	090892	1/1/0001
04000	S	M	OUG	II	01479	002		12	090892	1/1/0001
04000	S	M	OUG	II	01494	001		12	090892	1/1/0001

OFFICE: 311

ROUTE: 564

ST_REF_NO: 00000190000 VIOLET ROAD

LUMENS	BULB TYPE	MULT SERIES	POLE TYPE	SHADE	ADDRESS NUMBER	REF	LOCATION	TAX DIST	DATE INST	DATE CHANGE
05800	S	M	OUG	II	00000	146	SIDE OF 2109 CYPRESS DR.	12	090164	1/1/0001
05800	S	M	OUG	II	02112	147		12	090164	1/1/0001
05800	S	M	OUG	II	02121	148		12	090164	1/1/0001
05800	S	M	OUG	II	02132	149		12	090164	1/1/0001
05800	S	M	OUG	II	02145	150		12	090164	1/1/0001
05800	S	M	OUG	II	02156	151		12	090164	1/1/0001

OFFICE: 311

ROUTE: 564

ST_REF_NO: 00000190100 VIRGINIA AVENUE

LUMENS	BULB TYPE	MULT SERIES	POLE TYPE	SHADE	ADDRESS NUMBER	REF	LOCATION	TAX DIST	DATE INST	DATE CHANGE
09500	S	M	CNT	III	00000	001	1ST LT. E OF S. BROADWAY, NORTHSIDE	12	110897	1/1/0001
09500	S	M	OUG	III	00000	002	1ST LT E OF S BROADWAY, SOUTHSIDE	12	100897	1/1/0001
09500	S	M	CNT	III	00000	003	2ND LT. E. OF S. BROADWAY, NORTHSIDE	12	110897	1/1/0001
09500	S	M	OUG	III	00000	004	2ND LT. E OF S BROADWAY, SOUTHSIDE	12	100897	1/1/0001
09500	S	M	CNT	III	00000	005	3RD LT. E OF S. BROADWAY, NORTHSIDE	12	110897	1/1/0001

OFFICE: 311

ROUTE: 564

ST_REF_NO: 00000190100

VIRGINIA AVENUE

LUMENS	BULB TYPE	MULT SERIES	POLE TYPE	SHADE	ADDRESS NUMBER	REF	LOCATION	TAX DIST	DATE INST	DATE CHANGE
09500	S	M	OUG	III	00000	006	3RD LT. E OF S BROADWAY, SOUTHSIDE	12	100897	1/1/0001
09500	S	M	CNT	III	00000	007	3RD LT. W OF EXPORT ST., NORTHSIDE	12	110897	1/1/0001
09500	S	M	OUG	III	00000	008	3RD LT W OF EXPORT ST., SOUTHSIDE	12	100897	1/1/0001
09500	S	M	CNT	III	00000	009	2ND LT. W OF EXPORT ST., NORTHSIDE	12	110897	1/1/0001
09500	S	M	OUG	III	00000	010	2ND LT W OF EXPORT ST., SOUTHSIDE	12	100897	1/1/0001
09500	S	M	CNT	III	00000	011	1ST LT. W OF EXPORT ST., NORTHSIDE	12	110897	1/1/0001
09500	S	M	OUG	III	00000	012	1ST LT W OF EXPORT ST., SOUTHSIDE	12	100897	1/1/0001
09500	S	M	CNT	III	00000	013	1ST LT. E OF EXPORT ST., NORTHSIDE	12	110897	1/1/0001
09500	S	M	OUG	III	00000	014	1ST LT. E OF EXPORT ST., SOUTHSIDE	12	100897	1/1/0001
09500	S	M	CNT	III	00000	015	2ND LT. E PF EXPORT ST., NORTHSIDE	12	110897	1/1/0001
09500	S	M	OUG	III	00000	016	2ND LT E OF EXPORT ST., SOUTHSIDE	12	100897	1/1/0001
09500	S	M	CNT	III	00000	017	3RD LT. E OF EXPORT ST., NORTHSIDE	12	110897	1/1/0001
09500	S	M	OUG	III	00000	018	3RD LT E OF EXPORT ST., SOUTHSIDE	12	100897	1/1/0001
09500	S	M	CNT	III	00000	019	4TH LT. E OF EXPORT ST., NORTHSIDE	12	110897	1/1/0001
09500	S	M	OUG	III	00000	020	4TH LT E OF EXPORT ST., SOUTHSIDE	12	100897	1/1/0001
09500	S	M	CNT	III	00000	021	3RD LT. W OF WINNIE ST., NORTHSIDE	12	110897	1/1/0001
09500	S	M	OUG	III	00000	022	3RD LT. W OF PRESS AVE., SOUTHSIDE	12	100897	1/1/0001
09500	S	M	CNT	III	00000	023	2ND LT. W OF WINNIE ST., NORTHSIDE	12	110897	1/1/0001
09500	S	M	OUG	III	00000	024	2ND LT W OF PRESS AVE., SOUTHSIDE	12	100897	1/1/0001
09500	S	M	CNT	III	00000	025	1ST LT. W OF WINNIE ST., NORTHSIDE	12	110897	1/1/0001
09500	S	M	OUG	III	00000	026	1ST LT W OF PRESS AVE., SOUTHSIDE	12	100897	1/1/0001
09500	S	M	CNT	III	00000	027	1ST LT. E OF WINNIE ST., NORTHSIDE	12	110897	1/1/0001
09500	S	M	OUG	III	00000	028	1ST LT E OF PRESS AVE., SOUTHSIDE	12	100897	1/1/0001
09500	S	M	CNT	III	00000	029	2ND LT. E OF WINNIE ST., NORTHSIDE	12	110897	1/1/0001
09500	S	M	OUG	III	00000	030	2ND LT E OF PRESS AVE., SOUTHSIDE	12	100897	1/1/0001
09500	S	M	CNT	III	00000	031	3RD LT. E OF WINNIE ST., NORTHSIDE	12	110897	1/1/0001
09500	S	M	OUG	III	00000	032	3RD LT E OF PRESS AVE., SOUTHSIDE	12	100897	1/1/0001
09500	S	M	CNT	III	00000	033	4TH LT. E OF WINNIE ST., NORTHSIDE	12	110897	1/1/0001
09500	S	M	OUG	III	00000	034	4TH LT E OF PRESS AVE., SOUTHSIDE	12	100897	1/1/0001
09500	S	M	CNT	III	00000	035	4TH LT. W OF S. LIMESTONE, NORTHSIDE	12	110897	1/1/0001
09500	S	M	OUG	III	00000	036	4TH LT W OF S. LIMESTONE, SOUTHSIDE	12	100897	1/1/0001
09500	S	M	CNT	III	00000	037	3RD LT. W OF S. LIMESTONE, NORTHSIDE	12	110897	1/1/0001
09500	S	M	OUG	III	00000	038	3RD LT W OF S LIMESTONE, SOUTHSIDE	12	100897	1/1/0001
09500	S	M	CNT	III	00000	039	2ND LT. W OF S. LIMESTONE, NORTHSIDE	12	110897	1/1/0001

OFFICE: 311

ROUTE: 564

ST_REF_NO: 00000190100 VIRGINIA AVENUE

LUMENS	BULB TYPE	MULT SERIES	POLE TYPE	SHADE	ADDRESS NUMBER	REF	LOCATION	TAX DIST	DATE INST	DATE CHANGE
09500	S	M	OUG	III	00000	040	2ND LT W OF S. LIMESTONE, SOUTHSIDE	12	100897	1/1/0001
09500	S	M	CNT	III	00000	041	1ST LT. W OF S. LIMESTONE, NORTHSIDE	12	110897	1/1/0001
09500	S	M	OUG	III	00000	042	1ST LT W OF S. LIMESTONE, SOUTHSIDE	12	100897	1/1/0001

OFFICE: 311

ROUTE: 564

ST_REF_NO: 00000190200 VISTA DRIVE

LUMENS	BULB TYPE	MULT SERIES	POLE TYPE	SHADE	ADDRESS NUMBER	REF	LOCATION	TAX DIST	DATE INST	DATE CHANGE
04000	S	M	OUG	II	00000	091	SIDE 411 N. PICADOME STREET	12	100884	1/1/0001
04000	S	M	OUG	II	00210	092		12	100884	1/1/0001

OFFICE: 311

ROUTE: 564

ST_REF_NO: 00000190210 VISTA, EAST STREET

LUMENS	BULB TYPE	MULT SERIES	POLE TYPE	SHADE	ADDRESS NUMBER	REF	LOCATION	TAX DIST	DATE INST	DATE CHANGE
05800	S	M	OUG	II	00000	101	1ST LT N OF ROSEMONT GRDN, E SIDE ON VISTA STR	12	112503	1/1/0001
05800	S	M	OUG	II	00110	102	VISTA	12	112503	1/1/0001
04000	S	M	OUG	II	00000	094	OPP. 230 E. VISTA STREET	12	100884	1/1/0001
04000	S	M	OUG	II	00222	093		12	100884	1/1/0001
04000	S	M	OUG	II	00242	095		12	100884	1/1/0001

OFFICE: 311

ROUTE: 564

ST_REF_NO: 00000190220 VISTA, WEST STREET

LUMENS	BULB TYPE	MULT SERIES	POLE TYPE	SHADE	ADDRESS NUMBER	REF	LOCATION	TAX DIST	DATE INST	DATE CHANGE
04000	S	M	OUG	II	00000	097	OPP. 231 W. VISTA STREET	12	100884	1/1/0001
04000	S	M	OUG	II	00223	096		12	100884	1/1/0001
04000	S	M	OUG	II	00243	098		12	100884	1/1/0001

OFFICE: 311

ROUTE: 564

ST_REF_NO: 00000190250 VON ALLEY

LUMENS	BULB TYPE	MULT SERIES	POLE TYPE	SHADE	ADDRESS NUMBER	REF	LOCATION	TAX DIST	DATE INST	DATE CHANGE
05800	S	M	SOH	II	00000	001	1 ST. LT. N. OF FIFTH ST., E. SIDE	12	080161	1/1/0001
05800	S	M	SOH	II	00000	002	1 ST. LT. N. OF FAYETTE PARK, E. SIDE	12	080161	1/1/0001
05800	S	M	SOH	II	00000	003	2ND LT. N. OF FAYETTE PARK, E. SIDE	12	080161	1/1/0001
05800	S	M	SOH	II	00000	004	1 ST. LT. S. OF SIXTH ST., E. SIDE	12	080161	1/1/0001

OFFICE: 311		ROUTE: 564		ST_REF_NO: 00000190255		VONBRYAN TRACE		LUMENS	BULB TYPE	MULT SERIES	POLE TYPE	SHADE	ADDRESS NUMBER	REF	LOCATION	TAX DIST	DATE INST	DATE CHANGE
05800	S	M	CNT	II	00504	001		12	070806	1/1/0001								
05800	S	M	CNT	II	00512	002		12	070806	1/1/0001								
05800	S	M	CNT	II	00533	003		12	070806	1/1/0001								
05800	S	M	CNT	II	00544	004		12	070806	1/1/0001								
05800	S	M	CNT	II	00557	005		12	070806	1/1/0001								
05800	S	M	CNT	II	00576	006		12	070806	1/1/0001								
05800	S	M	CNT	II	00589	007		12	070806	1/1/0001								
05800	S	M	CNT	II	00600	008		12	070806	1/1/0001								
05800	S	M	CNT	II	00620	009		12	070806	1/1/0001								
05800	S	M	CNT	II	00629	010		12	070806	1/1/0001								
05800	S	M	CNT	II	00641	011		12	070806	1/1/0001								
05800	S	M	CNT	II	00660	012		12	070806	1/1/0001								
05800	S	M	CNT	II	00673	013		12	070806	1/1/0001								

OFFICE: 311

ROUTE: 564

OFFICE: 311		ROUTE: 564		ST_REF_NO: 00000190300		VON LIST WAY		LUMENS	BULB TYPE	MULT SERIES	POLE TYPE	SHADE	ADDRESS NUMBER	REF	LOCATION	TAX DIST	DATE INST	DATE CHANGE
05800	S	M	OUG	II	00000	100	SIDE OF 425 LAKESHORE DR.	12	091573	1/1/0001								
05800	S	M	OUG	II	00000	167	SIDE OF 2059	12	061475	1/1/0001								
05800	S	M	OUG	V	02036	169		12	041674	1/1/0001								
05800	S	M	OUG	II	02039	168		12	111478	1/1/0001								
05800	S	M	OUG	II	02056	166		12	041774	1/1/0001								
05800	S	M	OUG	II	02063	165		12	021475	1/1/0001								
05800	S	M	OUG	II	02068	164		12	061475	1/1/0001								
05800	S	M	OUG	II	02079	163		12	041774	1/1/0001								
05800	S	M	OUG	II	02088	162		12	111478	1/1/0001								

OFFICE: 311

ROUTE: 564

OFFICE: 311		ROUTE: 564		ST_REF_NO: 00000190310		VON SNEIDERN COURT		LUMENS	BULB TYPE	MULT SERIES	POLE TYPE	SHADE	ADDRESS NUMBER	REF	LOCATION	TAX DIST	DATE INST	DATE CHANGE
04000	S	M	OUG	II	03708	082		12	120887	1/1/0001								
04000	S	M	OUG	II	03721	081		12	110885	1/1/0001								

OFFICE: 311

ROUTE: 564

ST_REF_NO: 00000190400

WABASH DRIVE

LUMENS	BULB TYPE	MULT SERIES	POLE TYPE	SHADE	ADDRESS NUMBER	REF	LOCATION	TAX DIST	DATE INST	DATE CHANGE
04000	S	M	SOH	I	00000	001	1ST LT. FROM NICHOLASVILLE RD.	12	100162	1/1/0001
04000	S	M	SOH	I	00000	002	2ND LT. FROM NICHOLASVILLE RD.	12	100162	1/1/0001
04000	S	M	SOH	I	00103	000		12	100162	1/1/0001
04000	S	M	SOH	I	00108	000		12	100162	1/1/0001
04000	S	M	SOH	I	00109	000		12	100162	1/1/0001
04000	S	M	SOH	I	00114	000		12	100162	1/1/0001
04000	S	M	SOH	I	00118	000		12	100162	1/1/0001
04000	S	M	SOH	I	00124	000		12	100162	1/1/0001
04000	S	M	SOH	I	00130	000		12	100162	1/1/0001
04000	S	M	SOH	I	00136	000		12	100162	1/1/0001
04000	S	M	SOH	I	00140	000		12	100162	1/1/0001
04000	S	M	SOH	I	00146	000		12	100162	1/1/0001
04000	S	M	SOH	I	00154	000		12	100162	1/1/0001
04000	S	M	SOH	I	00160	000		12	100162	1/1/0001
04000	S	M	SOH	I	00164	000		12	100162	1/1/0001

OFFICE: 311

ROUTE: 564

ST_REF_NO: 00000190600

WACO DRIVE

LUMENS	BULB TYPE	MULT SERIES	POLE TYPE	SHADE	ADDRESS NUMBER	REF	LOCATION	TAX DIST	DATE INST	DATE CHANGE
05800	S	M	OUG	II	00000	120	SIDE OF 700 PASADENA	12	101583	1/1/0001
05800	S	M	OUG	II	00000	121	REAR OF 634 PASADENA	12	101583	1/1/0001
05800	S	M	OUG	II	00000	122	SIDE 701 PORTLAND	12	101583	1/1/0001
05800	S	M	OUG	II	00000	123	SIDE 638 PORTLAND	12	101583	1/1/0001
05800	S	M	OUG	II	00000	124	SIDE - REAR OF 700 PORTLAND	12	101583	1/1/0001
05800	S	M	OUG	II	00000	125	SIDE OF 639 SEATTLE	12	101583	1/1/0001
05800	S	M	OUG	II	00000	126	SIDE OF 700 SEATTLE	12	101583	1/1/0001
05800	S	M	OUG	II	00000	127	SIDE - REAR 638 SEATTLE	12	101583	1/1/0001
05800	S	M	OUG	II	00000	128	SIDE OF 701 NAKOMI	12	101583	1/1/0001
05800	S	M	OUG	II	02920	133		12	110889	1/1/0001
05800	S	M	OUG	II	02933	134		12	110889	1/1/0001
05800	S	M	OUG	II	02953	136		12	110889	1/1/0001
05800	S	M	SOH	II	02961	137		12	110889	1/1/0001

OFFICE: 311		ROUTE: 564		ST_REF_NO: 00000190610		WACO ROAD		LUMENS	BULB TYPE	MULT SERIES	POLE TYPE	SHADE	ADDRESS NUMBER	REF	LOCATION	TAX DIST	DATE INST	DATE CHANGE
	05800	S	M	OUG	II	00000	135	SIDE OF 704 DARDANELLES DR.	12	020895	1/1/0001							
	05800	S	M	OUG	II	00000	143	SIDE OF 3001 HONEY LOCUST WAY	12	020895	1/1/0001							
	05800	S	M	OUG	II	00000	145	SIDE OF 3001 REDBUD CT.	12	020895	1/1/0001							
	05800	S	M	OUG	II	00000	149	SIDE OF 648 NAKOMI DRIVE	12	020800	1/1/0001							
	05800	S	M	OUG	II	02904	148		12	020800	1/1/0001							
	05800	S	M	OUG	II	02916	147		12	020800	1/1/0001							
	05800	S	M	OUG	II	02960	138		12	050897	1/1/0001							
	05800	S	M	OUG	II	02985	139		12	050897	1/1/0001							
	05800	S	M	OUG	II	02992	140		12	050897	1/1/0001							
	05800	S	M	OUG	II	03009	141		12	050897	1/1/0001							
	05800	S	M	OUG	II	03012	142		12	050897	1/1/0001							
	05800	S	M	OUG	II	03040	144		12	020895	1/1/0001							
	05800	S	M	OUG	II	03056	146		12	020895	1/1/0001							
OFFICE: 311		ROUTE: 564		ST_REF_NO: 00000190800		WAKEFIELD TERRACE		LUMENS	BULB TYPE	MULT SERIES	POLE TYPE	SHADE	ADDRESS NUMBER	REF	LOCATION	TAX DIST	DATE INST	DATE CHANGE
	05800	S	M	OUG	II	00000	015	SIDE OF 404 ROOKWOOD	12	050164	1/1/0001							
	05800	S	M	OUG	II	01684	016		12	060465	1/1/0001							
OFFICE: 311		ROUTE: 564		ST_REF_NO: 00000190850		WAKEHURST COURT		LUMENS	BULB TYPE	MULT SERIES	POLE TYPE	SHADE	ADDRESS NUMBER	REF	LOCATION	TAX DIST	DATE INST	DATE CHANGE
	05800	S	M	CNT	II	01305	004		12	080502	1/1/0001							
	05800	S	M	CNT	II	01316	003		12	080502	1/1/0001							
	05800	S	M	CNT	II	01325	002		12	080502	1/1/0001							
	05800	S	M	CNT	II	01332	001		12	080502	1/1/0001							
OFFICE: 311		ROUTE: 564		ST_REF_NO: 00000190880		WALCOT WAY		LUMENS	BULB TYPE	MULT SERIES	POLE TYPE	SHADE	ADDRESS NUMBER	REF	LOCATION	TAX DIST	DATE INST	DATE CHANGE
	05800	S		CNT	II	00000	001	SIDE OF 2484 HUNTLY PL ON WALCOT WAY	12	070210	1/1/0001							
	05800	S		CNT	II	02244	011		12	070210	1/1/0001							
	05800	S		CNT	II	02277	010		12	070210	1/1/0001							

OFFICE: 311		ROUTE: 564		ST_REF_NO: 00000190880		WALCOT WAY		LUMENS	BULB TYPE	MULT SERIES	POLE TYPE	SHADE	ADDRESS NUMBER	REF	LOCATION	TAX DIST	DATE INST	DATE CHANGE
05800	S		CNT	II	02295	008										12	070210	1/1/0001
05800	S		CNT	II	02344	004										12	070210	1/1/0001
05800	S		CNT	II	02377	002										12	070210	1/1/0001
OFFICE: 311		ROUTE: 564		ST_REF_NO: 00000190900		WALDEN DRIVE		LUMENS	BULB TYPE	MULT SERIES	POLE TYPE	SHADE	ADDRESS NUMBER	REF	LOCATION	TAX DIST	DATE INST	DATE CHANGE
09500	S	M	OUG	II	00000	020									3RD LT S OF REDDING RD, W SIDE ON WALDEN DR	12	011702	1/1/0001
09500	S	M	OUG	II	00000	021									4TH LT S OF REDDING RD, W SIDE ON WALDEN DR	12	011702	1/1/0001
09500	S	M	OUG	II	00000	022									5TH LT S OF REDDING RD, W SIDE ON WALDEN DR	12	011702	1/1/0001
09500	S	M	OUG	II	00000	023									6TH LT S OF REDDING RD, E SIDE ON WALDEN DR	12	011702	1/1/0001
09500	S	M	OUG	II	00000	024									7TH LT S OF REDDING RD, W SIDE ON WALDEN DR	12	011702	1/1/0001
09500	S	M	OUG	II	00000	025									8TH LT S OF REDDING RD, E SIDE ON WALDEN DR	12	011702	1/1/0001
09500	S	M	OUG	II	00000	026									9TH LT S OF REDDING RD, E SIDE ON WALDEN DR	12	011702	1/1/0001
09500	S	M	OUG	II	00000	027									10TH LT S OF REDDING RD, E SIDE ON WALDEN DR	12	011702	1/1/0001
09500	S	M	OUG	II	00000	028									11TH LT S OF REDDING RD, E SIDE ON WALDEN DR	12	011702	1/1/0001
09500	S	M	OUG	II	00000	029									12TH LT S OF REDDING RD, E SIDE ON WALDEN DR	12	011702	1/1/0001
05800	S	M	OUG	II	00000	008									SIDE OF 552 BIG BEAR LANE	12	020800	1/1/0001
05800	S	M	OUG	II	00000	010									REAR OF 527 BIG BEAR LANE	12	020800	1/1/0001
05800	S	M	OUG	II	03532	009										12	020800	1/1/0001
05800	S	M	OUG	II	03630	007										12	02800	1/1/0001
05800	S	M	OUG	II	03659	006										12	111580	1/1/0001
05800	S	M	OUG	II	03671	004										12	111580	1/1/0001
05800	S	M	OUG	II	03678	003										12	111580	1/1/0001
05800	S	M	OUG	II	03683	002										12	111580	1/1/0001
05800	S	M	OUG	V	03690	011										12	111580	1/1/0001
05800	S	M	OUG	II	03698	001										12	111580	1/1/0001
OFFICE: 311		ROUTE: 564		ST_REF_NO: 00000191000		WALDO WAY		LUMENS	BULB TYPE	MULT SERIES	POLE TYPE	SHADE	ADDRESS NUMBER	REF	LOCATION	TAX DIST	DATE INST	DATE CHANGE
05800	S	M	OUG	II	00000	015									SIDE OF 638 CHARBURY	12	120266	1/1/0001
05800	S	M	OUG	II	00601	010										12	040171	1/1/0001
05800	S	M	OUG	II	00612	011										12	060468	1/1/0001

OFFICE: 311		ROUTE: 564		ST_REF_NO: 00000191000		WALDO WAY		LUMENS	BULB TYPE	MULT SERIES	POLE TYPE	SHADE	ADDRESS NUMBER	REF	LOCATION	TAX DIST	DATE INST	DATE CHANGE
05800	S	M	OUG	II	00617	012										12	041068	1/1/0001
05800	S	M	OUG	II	00632	013										12	101478	1/1/0001
05800	S	M	OUG	II	00641	014										12	120266	1/1/0001

OFFICE: 311		ROUTE: 564		ST_REF_NO: 00000191100		WALHAMPTON DRIVE		LUMENS	BULB TYPE	MULT SERIES	POLE TYPE	SHADE	ADDRESS NUMBER	REF	LOCATION	TAX DIST	DATE INST	DATE CHANGE
05800	S	M	OUG	II	03801	050										12	060899	1/1/0001
04000	S	M	OUG	II	03808	051										12	020887	1/1/0001
04000	S	M	OUG	II	03825	052										12	020887	1/1/0001
04000	S	M	OUG	II	03832	053										12	020887	1/1/0001
04000	S	M	OUG	II	03849	054										12	020887	1/1/0001
04000	S	M	OUG	II	03856	055										12	020887	1/1/0001

OFFICE: 311		ROUTE: 564		ST_REF_NO: 00000191200		WALLACE COURT		LUMENS	BULB TYPE	MULT SERIES	POLE TYPE	SHADE	ADDRESS NUMBER	REF	LOCATION	TAX DIST	DATE INST	DATE CHANGE
04000	S	M	OUG	II	00102	040										12	110885	1/1/0001
04000	S	M	OUG	II	00113	039										12	110885	1/1/0001
04000	S	M	OUG	II	00112	038										12	110885	1/1/0001

OFFICE: 311		ROUTE: 564		ST_REF_NO: 00000191300		WALLER AVENUE		LUMENS	BULB TYPE	MULT SERIES	POLE TYPE	SHADE	ADDRESS NUMBER	REF	LOCATION	TAX DIST	DATE INST	DATE CHANGE
22000	S		SOH	II	00114	040										12	042709	1/1/0001
50000	S	M	OOH	III	00000	002										12	110761	3/2/2009
50000	S	M	SOH	II	00000	007										12	051264	5/12/1964
09500	S	M	SOH	II	00000	022										12	050901	1/1/0001
50000	S	M	SOH	II	00000	033										12	050901	4/29/2009
22000	S	M	SOH	II	00110	032										12	050901	4/29/2009
22000	S	M	SOH	II	00120	031										12	050901	4/29/2009
09500	S	M	SOH	II	00121	030										12	050901	1/1/0001

OFFICE: 311

ROUTE: 564

ST_REF_NO: 00000191300

WALLER AVENUE

LUMENS	BULB TYPE	MULT SERIES	POLE TYPE	SHADE	ADDRESS NUMBER	REF	LOCATION	TAX DIST	DATE INST	DATE CHANGE
09500	S	M	SOH	II	00135	029		12	050901	1/1/0001
09500	S	M	SOH	II	00137	028		12	050901	1/1/0001
09500	S	M	SOH	II	00205	027		12	050901	1/1/0001
09500	S	M	SOH	II	00209	026		12	050901	1/1/0001
09500	S	M	SOH	II	00211	025		12	050901	1/1/0001
09500	S	M	SOH	II	00219	024		12	050901	1/1/0001
09500	S	M	SOH	II	00228	023		12	050901	1/1/0001
22000	S	M	OOH	III	00000	001	1ST LT. E. OF HARRODSBURG RD., S. SIDE	12	110761	1/1/0001
22000	S	M	OOH	III	00000	003	2ND LT. E. OF HARRODSBURG RD., S. SIDE	12	110761	1/1/0001
22000	S	M	OOH	III	00000	005	3RD LT. E. OF HARRODSBURG RD., S. SIDE	12	110761	1/1/0001
50000	S	M	OOH	II	00000	009	OPP. 401	12	051264	1/1/0001
50000	S	M	OOH	II	00000	011	OPP. 393	12	051264	1/1/0001
50000	S	M	OOH	II	00330	021		12	051264	1/1/0001
50000	S	M	OOH	II	00342	019		12	051264	1/1/0001
50000	S	M	OOH	II	00343	020		12	051264	1/1/0001
50000	S	M	OOH	II	00353	018		12	051264	1/1/0001
50000	S	M	OOH	II	00366	017		12	051264	1/1/0001
50000	S	M	OOH	II	00373	016		12	051264	1/1/0001
50000	S	M	OOH	II	00385	014		12	051264	1/1/0001
50000	S	M	OOH	II	00386	013		12	051264	1/1/0001
50000	S	M	OOH	II	00386	015		12	051264	1/1/0001
50000	S	M	OOH	II	00393	012		12	051267	1/1/0001
50000	S	M	OOH	II	00397	010		12	051264	1/1/0001
50000	S	M	OOH	II	00405	008		12	051264	1/1/0001
22000	S	M	OOH	III	00525	004		12	110761	1/1/0001
22000	S	M	OOH	III	00525	006		12	110761	1/1/0001

OFFICE: 311

ROUTE: 564

ST_REF_NO: 00000191400

WALLINGFORD DRIVE

LUMENS	BULB TYPE	MULT SERIES	POLE TYPE	SHADE	ADDRESS NUMBER	REF	LOCATION	TAX DIST	DATE INST	DATE CHANGE
04000	S	M	OUG	II	00000	098	SIDE 603 HALIFAX DR.	12	100885	1/1/0001
04000	S	M	OUG	II	03401	097		12	100885	1/1/0001
04000	S	M	OUG	II	03418	099		12	100885	1/1/0001
04000	S	M	OUG	II	03429	100		12	100885	1/1/0001

OFFICE: 311		ROUTE: 564		ST_REF_NO: 00000191400		WALLINGFORD DRIVE		LUMENS	BULB TYPE	MULT SERIES	POLE TYPE	SHADE	ADDRESS NUMBER	REF	LOCATION	TAX DIST	DATE INST	DATE CHANGE
	04000	S	M	OUG	II	03442	101									12	100885	1/1/0001

OFFICE: 311		ROUTE: 564		ST_REF_NO: 00000191408		WALNUT CREEK DRIVE		LUMENS	BULB TYPE	MULT SERIES	POLE TYPE	SHADE	ADDRESS NUMBER	REF	LOCATION	TAX DIST	DATE INST	DATE CHANGE
	05800	S		OUG	II	00000	021								side of 232 Hays Blvd on Walnut Creek Drive	12	091808	1/1/0001
	05800	S		OUG	II	00000	022								side of 233 Hays Blvd on Walnut Creek Drive	12	091808	1/1/0001
	05800	S		OUG	II	04336	011									12	091808	1/1/0001
	05800	S		OUG	II	04349	012									12	091808	1/1/0001
	05800	S		OUG	II	04364	013									12	091808	1/1/0001
	05800	S		OUG	II	04369	014									12	091808	1/1/0001
	05800	S		OUG	II	04388	015									12	091808	1/1/0001
	05800	S		OUG	II	04401	016									12	091808	1/1/0001
	05800	S		OUG	II	04417	017									12	091808	1/1/0001
	05800	S		OUG	II	04424	018									12	091808	1/1/0001
	05800	S		OUG	II	04441	019									12	091808	1/1/0001
	05800	S		OUG	II	04456	020									12	091808	1/1/0001
	05800	S		OUG	II	04516	023									12	091808	1/1/0001
	05800	S		OUG	II	04524	024									12	091808	1/1/0001
	05800	S		OUG	II	04541	025									12	091808	1/1/0001
	05800	S		OUG	II	04552	026									12	091808	1/1/0001
	05800	S	M	OUG	II	04300	003									12	083104	1/1/0001
	05800	S	M	OUG	II	04312	002									12	083104	1/1/0001
	05800	S	M	OUG	II	04317	001									12	083104	1/1/0001

OFFICE: 311		ROUTE: 564		ST_REF_NO: 00000191410		WALNUT HILL - CHILESBURO ROAD		LUMENS	BULB TYPE	MULT SERIES	POLE TYPE	SHADE	ADDRESS NUMBER	REF	LOCATION	TAX DIST	DATE INST	DATE CHANGE
	05800	S	M	OUG	II	00801	008									12	040895	1/1/0001
	05800	S	M	OUG	II	00809	007									12	040895	1/1/0001
	05800	S	M	OUG	II	00821	006									12	040895	1/1/0001
	05800	S	M	OUG	II	00825	005									12	040895	1/1/0001
	05800	S	M	OUG	II	00833	004									12	040895	1/1/0001
	05800	S	M	OUG	II	00845	003									12	040895	1/1/0001

OFFICE: 311

ROUTE: 564

ST_REF_NO: 00000191410

WALNUT HILL - CHILESBURG ROAD

LUMENS	BULB TYPE	MULT SERIES	POLE TYPE	SHADE	ADDRESS NUMBER	REF	LOCATION	TAX DIST	DATE INST	DATE CHANGE
05800	S	M	OUG	II	00853	002		12	040895	1/1/0001
05800	S	M	OUG	II	00861	001		12	040895	1/1/0001

OFFICE: 311

ROUTE: 564

ST_REF_NO: 00000191500

MARTIN LUTHER KING BLVD, NORTH

LUMENS	BULB TYPE	MULT SERIES	POLE TYPE	SHADE	ADDRESS NUMBER	REF	LOCATION	TAX DIST	DATE INST	DATE CHANGE
05800	S	M	SOH	II	00666	043		12	111366	1/3/2013
10000	M	M	SOH	II	00000	034	1ST LT. N. OF FIFTH ST., W. SIDE	12	020167	1/1/0001
10000	M	M	SOH	II	00000	036	2ND LT. N. OF FIFTH ST., W. SIDE	12	020167	1/1/0001
10000	M	M	SOH	II	00000	037	1ST LT. S. OF RAND AVE., E. SIDE	12	030167	1/1/0001
10000	M	M	SOH	II	00000	038	SIDE OF 203 RAND AVE.	12	030167	1/1/0001
04000	S	M	SOH	II	00000	040	SIDE OF 173 E. SIXTH ST.	12	111366	1/1/0001
04000	S	M	SOH	II	00000	042	SIDE OF 178 ALABAMA AVE.	12	111366	1/1/0001
22000	S	M	SOH	II	00439	031		12	030167	1/1/0001
10000	M	M	SOH	II	00460	032		12	030167	1/1/0001
10000	M	M	SOH	II	00473	033		12	020167	1/1/0001
10000	M	M	SOH	II	00514	035		12	030167	1/1/0001
10000	M	M	SOH	II	00565	039		12	030167	1/1/0001
04000	S	M	SOH	II	00620	041		12	111366	1/1/0001
04000	S	M	OUG	III	00656	045		12	070894	1/1/0001
22000	S	M	CNT	II	00000	002	1ST LT N OF E MAIN ON EASTSIDE OF NORTH M.L.K.BLVD	12	120890	1/1/0001
22000	S	M	CNT	II	00000	003	2ND LT N OF E MAIN ON WESTSIDE OF NORTH M.L.K.BLVD	12	120890	1/1/0001
22000	S	M	CNT	II	00000	004	2ND LT N OF E MAIN ON EASTSIDE OF NORTH M.L.K.BLVD	12	120890	1/1/0001
22000	S	M	SOH	III	00000	005	1ST LT. N. OF SHORT ST., W. SIDE	12	102061	1/1/0001
22000	S	M	SOH	III	00000	006	1ST LT. N. OF SHORT ST., E. SIDE	12	102061	1/1/0001
22000	S	M	SOH	III	00000	007	2ND LT. N. OF SHORT ST., W. SIDE	12	102061	1/1/0001
22000	S	M	SOH	III	00000	008	2ND LT. N. OF SHORT ST., E. SIDE	12	102061	1/1/0001
22000	S	M	SOH	III	00000	009	1ST LT. N. OF BARR ST., W. SIDE	12	102061	1/1/0001
22000	S	M	SOH	III	00000	010	3RD LT. N. OF SHORT ST., E. SIDE	12	102061	1/1/0001
10000	M	M	SOH	II	00000	013	1ST LT. N. OF PLEASANT STONE, W. SIDE	12	061664	1/1/0001
10000	M	M	SOH	II	00000	015	2ND LT. N. OF PLEASANT STONE, W. SIDE	12	061664	1/1/0001
10000	M	M	SOH	II	00000	017	SIDE OF 165 CONSTITUTION ST.	12	061664	1/1/0001

OFFICE: 311

ROUTE: 564

ST_REF_NO: 00000191500

MARTIN LUTHER KING BLVD, NORTH

LUMENS	BULB TYPE	MULT SERIES	POLE TYPE	SHADE	ADDRESS NUMBER	REF	LOCATION	TAX DIST	DATE INST	DATE CHANGE
10000	M	M	SOH	II	00000	019	NW CORNER OF WALNUT & HOUSTON ALLEY	12	061664	1/1/0001
10000	M	M	SOH	II	00000	021	SIDE OF 167 E. THIRD ST.	12	061664	1/1/0001
10000	M	M	SOH	II	00000	026	OPP. 355	12	030167	1/1/0001
10000	M	M	SOH	II	00000	028	SIDE OF 203 E. FOURTH	12	030167	1/1/0001
22000	S	M	OOH	III	00000	044	3RD LT N OF E MAIN ON EASTSIDE OF NORTH M.L.K.BLVD	12	120890	1/1/0001
09500	S	M	OUG	II	00155	011		12	010171	1/1/0001
10000	M	M	SOH	II	00166	012		12	020865	1/1/0001
10000	M	M	SOH	II	00174	014		12	020865	1/1/0001
10000	M	M	SOH	II	00190	016		12	020865	1/1/0001
09500	S	M	SOH	II	00218	018	upgrade 6/08	12	020865	1/1/0001
10000	M	M	SOH	II	00230	020		12	061664	1/1/0001
10000	M	M	SOH	II	00312	022		12	020167	1/1/0001
10000	M	M	SOH	II	00315	023		12	030167	1/1/0001
10000	M	M	SOH	II	00334	024		12	030167	1/1/0001
10000	M	M	SOH	II	00341	025		12	020167	1/1/0001
10000	M	M	SOH	II	00367	027		12	020167	1/1/0001
22000	S	M	SOH	II	00415	029		12	020167	1/1/0001
22000	S	M	SOH	II	00438	030		12	030167	1/1/0001

OFFICE: 311

ROUTE: 564

ST_REF_NO: 00000191750

WALSH COURT

LUMENS	BULB TYPE	MULT SERIES	POLE TYPE	SHADE	ADDRESS NUMBER	REF	LOCATION	TAX DIST	DATE INST	DATE CHANGE
05800	S	M	OUG	II	02105	004		12	110897	1/1/0001
05800	S	M	OUG	II	02120	003		12	110897	1/1/0001
05800	S	M	OUG	II	02201	001		12	110897	1/1/0001
05800	S	M	OUG	III	02216	022		12	110897	1/1/0001

OFFICE: 311

ROUTE: 564

ST_REF_NO: 00000191800

WALTON AVENUE

LUMENS	BULB TYPE	MULT SERIES	POLE TYPE	SHADE	ADDRESS NUMBER	REF	LOCATION	TAX DIST	DATE INST	DATE CHANGE
22000	S	M	SOH	III	00105	002	bad fixture	12	040164	6/30/2010
10000	M	M	SOH	II	00000	005	SIDE OF 700 BULLOCK PLACE	12	041064	1/1/0001
10000	M	M	SOH	II	00000	009	SIDE OF 701 FRANKLIN AVE.	12	041064	1/1/0001
10000	M	S	SOH	II	00000	012	SIDE OF 703 HAMBRICK AVE.	12	081064	1/1/0001

Street Light Listing run 1/11/2015 10:43:21 AM

Page 1180 of 1254

OFFICE: 311

ROUTE: 564

ST_REF_NO: 00000191800

WALTON AVENUE

LUMENS	BULB TYPE	MULT SERIES	POLE TYPE	SHADE	ADDRESS NUMBER	REF	LOCATION	TAX DIST	DATE INST	DATE CHANGE
10000	M	M	SOH	II	00000	017	N.E. CORNER OF WALTON & AURORA AVE.	12	041064	1/1/0001
50000	S	M	SOH	II	00000	020	1 ST. LT. S. OF THIRD ST., W. SIDE	12	041064	1/1/0001
10000	M	S	SOH	II	00157	008		12	041064	1/1/0001
10000	M	S	SOH	II	00171	010		12	041064	1/1/0001
10000	M	S	SOH	II	00179	011		12	041064	1/1/0001
09500	S	S	SOH	II	00212	013	change out bad mv fixture	12	041064	1/1/0001
10000	M	M	SOH	II	00213	014		12	041064	1/1/0001
10000	M	M	SOH	II	00220	015		12	081064	1/1/0001
10000	M	M	SOH	II	00229	016		12	041064	1/1/0001
10000	M	S	SOH	II	00243	018		12	041064	1/1/0001
10000	M	S	SOH	II	00264	019		12	041064	1/1/0001
10000	M	M	SOH	III	00000	001	N.E. CORNER OF WALTON & MAIN ST.	12	041064	1/1/0001
10000	M	S	SOH	III	00000	003	OPP. 115	12	041064	1/1/0001
10000	M	S	SOH	II	00000	007	OPP. 147	12	041064	1/1/0001
09500	S	M	SOH	II	00121	004	change out bad mv fixture 2/08	12	041064	1/1/0001
09500	S	S	SOH	II	00139	006	upgrade 1/08	12	041064	1/1/0001

OFFICE: 311

ROUTE: 564

ST_REF_NO: 00000191900

WANDA WAY

LUMENS	BULB TYPE	MULT SERIES	POLE TYPE	SHADE	ADDRESS NUMBER	REF	LOCATION	TAX DIST	DATE INST	DATE CHANGE
05800	S	M	OUG	II	00000	001	SIDE OF 201 KINGSTON RD.	12	111366	1/1/0001
05800	S	M	OUG	II	00000	002	SIDE OF 209 KINGSTON RD.	12	111366	1/1/0001
05800	S	M	OUG	II	00000	004	SIDE OF 192 ELMWOOD	12	111366	1/1/0001
05800	S	M	OUG	II	00000	005	SIDE OF 189 ELMWOOD	12	080169	1/1/0001
05800	S	M	OUG	II	02416	003		12	111874	1/1/0001
05800	S	M	OUG	II	02444	006		12	050169	1/1/0001
05800	S	M	OUG	II	02461	007		12	111366	1/1/0001
05800	S	M	OUG	II	02472	008		12	042067	1/1/0001
05800	S	M	OUG	II	02485	009		12	111366	1/1/0001

OFFICE: 311

ROUTE: 564

ST_REF_NO: 00000192000

WANSTEAD WAY

LUMENS	BULB TYPE	MULT SERIES	POLE TYPE	SHADE	ADDRESS NUMBER	REF	LOCATION	TAX DIST	DATE INST	DATE CHANGE
05800	S	M	OUG	II	00000	043	SIDE OF 1672 MARGATE	12	021866	1/1/0001

OFFICE: 311		ROUTE: 564		ST_REF_NO: 00000192000		WANSTEAD WAY		LUMENS	BULB TYPE	MULT SERIES	POLE TYPE	SHADE	ADDRESS NUMBER	REF	LOCATION	TAX DIST	DATE INST	DATE CHANGE
05800	S	M	OUG	II	00000	048	SIDE OF 1678 HARROGATE	12	021866	1/1/0001								
05800	S	M	OUG	II	00480	044		12	021866	1/1/0001								
05800	S	M	OUG	II	00491	045		12	021866	1/1/0001								
05800	S	M	OUG	II	00508	046		12	021866	1/1/0001								
05800	S	M	OUG	II	00519	047		12	021866	1/1/0001								

OFFICE: 311		ROUTE: 564		ST_REF_NO: 00000192050		WARBLER HILL CIRCLE		LUMENS	BULB TYPE	MULT SERIES	POLE TYPE	SHADE	ADDRESS NUMBER	REF	LOCATION	TAX DIST	DATE INST	DATE CHANGE
04000	S	M	OUG	II	04001	001		12	100890	1/1/0001								
04000	S	M	OUG	II	04013	002		12	100890	1/1/0001								

OFFICE: 311		ROUTE: 564		ST_REF_NO: 00000192100		WARD DRIVE		LUMENS	BULB TYPE	MULT SERIES	POLE TYPE	SHADE	ADDRESS NUMBER	REF	LOCATION	TAX DIST	DATE INST	DATE CHANGE
05800	S	M	OUG	II	00839	153		12	111579	1/1/0001								
05800	S	M	OUG	II	00848	152		12	111579	1/1/0001								
05800	S	M	OUG	II	00857	151		12	111579	1/1/0001								
05800	S	M	OUG	II	00866	150		12	111579	1/1/0001								
05800	S	M	OUG	II	00877	149		12	111579	1/1/0001								
05800	S	M	OUG	II	00884	148		12	111579	1/1/0001								
05800	S	M	OUG	II	00895	147		12	100374	1/1/0001								
05800	S	M	OUG	II	00902	146		12	081475	1/1/0001								
05800	S	M	OUG	II	00909	145		12	100374	1/1/0001								
05800	S	M	OUG	II	00922	144		12	081475	1/1/0001								
05800	S	M	OUG	II	00927	143		12	100374	1/1/0001								
05800	S	M	OUG	II	00938	142		12	081475	1/1/0001								
05800	S	M	OUG	II	00947	141		12	100374	1/1/0001								
05800	S	M	OUG	II	00958	140		12	120893	1/1/0001								
09500	S	M	OUG	II	00000	158	OPP. 793	12	010893	1/1/0001								
05800	S	M	OUG	II	00805	157		12	111579	1/1/0001								
05800	S	M	OUG	II	00812	156		12	111579	1/1/0001								
05800	S	M	OUG	II	00821	155	upgraded to 5800 hps 10/07	12	111579	1/1/0001								
05800	S	M	OUG	II	00832	154		12	111579	1/1/0001								

OFFICE: 311

ROUTE: 564

ST_REF_NO: 00000192300

WARFIELD PLACE

LUMENS	BULB TYPE	MULT SERIES	POLE TYPE	SHADE	ADDRESS NUMBER	REF	LOCATION	TAX DIST	DATE INST	DATE CHANGE
05800	S		OUG	II	00849	005		12	122708	1/1/0001
05800	S	M	OUG	II	00837	123		12	031908	1/1/0001
05800	S	M	OUG	II	00804	121		12	030766	1/1/0001
05800	S	M	OUG	II	00821	122		12	030766	1/1/0001

OFFICE: 311

ROUTE: 564

ST_REF_NO: 00000192350

WARGRAVE WALK

LUMENS	BULB TYPE	MULT SERIES	POLE TYPE	SHADE	ADDRESS NUMBER	REF	LOCATION	TAX DIST	DATE INST	DATE CHANGE
05800	S	M	CNT	II	03701	001		12	091106	1/1/0001
05800	S	M	CNT	II	03709	002		12	091106	1/1/0001
05800	S	M	CNT	II	03724	003		12	091106	1/1/0001
05800	S	M	CNT	II	03744	004		12	091106	1/1/0001
05800	S	M	CNT	II	03757	005		12	091106	1/1/0001
05800	S	M	CNT	II	03769	006		12	091106	1/1/0001
05800	S	M	CNT	II	03785	007		12	091106	1/1/0001

OFFICE: 311

ROUTE: 564

ST_REF_NO: 00000192400

WARNOCK STREET

LUMENS	BULB TYPE	MULT SERIES	POLE TYPE	SHADE	ADDRESS NUMBER	REF	LOCATION	TAX DIST	DATE INST	DATE CHANGE
05800	S	M	SOH	I	00000	026	AT GOODLOE ST.	12	111466	1/1/0001
05800	S	M	SOH	I	00000	029	1ST LT. N. OF 2ND ST.	12	110266	1/1/0001
05800	S	M	SOH	I	00000	033	OPP. 270	12	110266	1/1/0001
05800	S	M	SOH	I	00243	031		12	110266	1/1/0001

OFFICE: 311

ROUTE: 564

ST_REF_NO: 00000192500

WARREN COURT

LUMENS	BULB TYPE	MULT SERIES	POLE TYPE	SHADE	ADDRESS NUMBER	REF	LOCATION	TAX DIST	DATE INST	DATE CHANGE
05800	S	M	SOH	I	00000	519	1ST LT. E. OF LIME	12	100267	1/1/0001
05800	S	M	SOH	I	00000	520	2ND LT. E. OF LIME	12	100267	1/1/0001
05800	S	M	SOH	I	00120	521		12	100267	1/1/0001

OFFICE: 311

ROUTE: 564

ST_REF_NO: 00000192700

WARRINGTON DRIVE

LUMENS	BULB TYPE	MULT SERIES	POLE TYPE	SHADE	ADDRESS NUMBER	REF	LOCATION	TAX DIST	DATE INST	DATE CHANGE
05800	S	M	OUG	II	00000	090	SIDE OF 588 SHAFTSBURY	12	111366	1/1/0001

OFFICE: 311

ROUTE: 564

ST_REF_NO: 00000192700

WARRINGTON DRIVE

LUMENS	BULB TYPE	MULT SERIES	POLE TYPE	SHADE	ADDRESS NUMBER	REF	LOCATION	TAX DIST	DATE INST	DATE CHANGE
05800	S	M	OUG	II	00614	091		12	111366	1/1/0001
05800	S	M	OUG	II	00629	092		12	102367	1/1/0001
05800	S	M	OUG	II	00638	093		12	111366	1/1/0001
05800	S	M	OUG	II	00651	094		12	111366	1/1/0001
05800	S	M	OUG	II	00662	095		12	111366	1/1/0001

OFFICE: 311

ROUTE: 564

ST_REF_NO: 00000192800

WARWICK COURT

LUMENS	BULB TYPE	MULT SERIES	POLE TYPE	SHADE	ADDRESS NUMBER	REF	LOCATION	TAX DIST	DATE INST	DATE CHANGE
05800	S	M	OUG	II	00000	052	SIDE OF 361 REDDING RD.	12	022674	1/1/0001
05800	S	M	OUG	II	00000	067	SIDE OF 340 REDDING RD.	12	051475	1/1/0001
05800	S	M	OUG	II	03432	056		12	022674	1/1/0001
05800	S	M	OUG	II	03445	055		12	022674	1/1/0001
05800	S	M	OUG	II	03452	054		12	022674	1/1/0001
05800	S	M	OUG	II	03465	053		12	091774	1/1/0001

OFFICE: 311

ROUTE: 564

ST_REF_NO: 00000192900

WASHINGTON AVE

LUMENS	BULB TYPE	MULT SERIES	POLE TYPE	SHADE	ADDRESS NUMBER	REF	LOCATION	TAX DIST	DATE INST	DATE CHANGE
22000	S		CNT	II	00000	016	6TH LT E OF S LIME, S SIDE ON WASHINGTON AVE	12	112410	1/1/0001
22000	S		CNT	II	00000	017	7TH LT E OF S LIME, S SIDE ON WASHINGTON AVE	12	112410	1/1/0001
22000	S		CNT	II	00000	018	8TH LT E OF S LIME, S SIDE ON WASHINGTON AVE	12	112410	1/1/0001
22000	S		CNT	II	00000	019	9TH LT E OF S LIME, S SIDE ON WASHINGTON AVE	12	112410	1/1/0001
22000	S		CNT	II	00000	020	10TH LT E OF S LIME, S SIDE ON WASHINGTON AVE	12	112410	1/1/0001
09500	S	M	CNT	II	00000	011	1ST LT E OF S LIME,S SIDE ON WASHINGTON AVE	12	100403	1/1/0001
09500	S	M	CNT	II	00000	012	2ND LT E OF S LIME,S SIDE ON WASHINGTON AVE	12	100403	1/1/0001
09500	S	M	CNT	II	00000	013	3RD LT E OF S LIME,S SIDE ON WASHINGTON AVE	12	100403	1/1/0001
09500	S	M	CNT	II	00000	014	4TH LT E OF S LIME,S SIDE ON WASHINGTON AVE	12	100403	1/1/0001
09500	S	M	CNT	II	00000	015	5TH LT E OF S LIME,S SIDE ON WASHINGTON AVE	12	100403	1/1/0001

OFFICE: 311

ROUTE: 564

ST_REF_NO: 00000192950

WATER STREET

LUMENS	BULB TYPE	MULT SERIES	POLE TYPE	SHADE	ADDRESS NUMBER	REF	LOCATION	TAX DIST	DATE INST	DATE CHANGE
10000	M	M	OUG	II	00000	001	2 ND. LT. W. OF QUALITY ST., S. SIDE	12	070171	1/1/0001

OFFICE: 311

ROUTE: 564

ST_REF_NO: 00000192950

WATER STREET

LUMENS	BULB TYPE	MULT SERIES	POLE TYPE	SHADE	ADDRESS NUMBER	REF	LOCATION	TAX DIST	DATE INST	DATE CHANGE
09500	S	M	OUG	II	00000	002	1 ST. LT. W. OF QUALITY ST., N. SIDE	12	070171	1/1/0001
10000	M	M	OUG	II	00000	003	1 ST. LT. W. OF QUALITY ST., S. SIDE	12	070171	1/1/0001
09500	S	M	OUG	II	00000	004	1 ST. LT. E. OF QUALITY ST., S. SIDE	12	070171	1/1/0001
09500	S	M	OUG	II	00000	005	2 ND. LT. E. OF QUALITY ST., S. SIDE	12	070171	1/1/0001
10000	M	M	SOH	II	00000	006	2 ND. LT. E. OF AYRES ALLEY, N. SIDE	12	041583	1/1/0001
10000	M	M	SOH	II	00000	007	1 ST. LT. E. OF AYRES ALLEY, N. SIDE	12	041583	1/1/0001
09500	S	M	OUG	II	00000	008	4TH LT. W. OF ROSE ST., N. SIDE	12	110888	1/1/0001
09500	S	M	OUG	II	00000	009	3RD LT. W. OF ROSE ST., N. SIDE	12	110888	1/1/0001
09500	S	M	OUG	II	00000	010	2ND LT. W. OF ROSE ST., N. SIDE	12	110888	1/1/0001
09500	S	M	OUG	II	00000	011	1ST LT. W. OF ROSE ST., N. SIDE	12	110888	1/1/0001
09500	S	M	OUG	II	00000	012	1ST LT. E. OF ROSE ST., N. SIDE	12	110888	1/1/0001
09500	S	M	OUG	II	00000	013	2ND LT. E. OF ROSE ST., N. SIDE	12	110888	1/1/0001
09500	S	M	OUG	II	00000	014	3RD LT. E. OF ROSE ST., N. SIDE	12	110888	1/1/0001
09500	S	M	OUG	II	00000	015	4TH LT. E. OF ROSE ST., N. SIDE	12	110888	1/1/0001
22000	S	M	OUG	II	00000	016	5TH LT. E. OF ROSE ST., N. SIDE	12	110888	1/1/0001
22000	S	M	OUG	II	00000	017	6TH LT. E. OF ROSE ST., S. SIDE	12	110888	1/1/0001
22000	S	M	OUG	II	00000	018	7TH LT. E. OF ROSE ST., S. SIDE	12	110888	1/1/0001
22000	S	M	OUG	II	00000	019	8TH LT. E. OF ROSE ST., S. SIDE	12	110888	1/1/0001
22000	S	M	OUG	II	00000	020	9TH LT. E. OF ROSE ST., S. SIDE	12	110888	1/1/0001

OFFICE: 311

ROUTE: 564

ST_REF_NO: 00000192955

WATERCREST COURT

LUMENS	BULB TYPE	MULT SERIES	POLE TYPE	SHADE	ADDRESS NUMBER	REF	LOCATION	TAX DIST	DATE INST	DATE CHANGE
05800	S	M	CNT	II	04301	001		12	030899	1/1/0001
05800	S	M	CNT	III	04305	002		12	030899	1/1/0001

OFFICE: 311

ROUTE: 564

ST_REF_NO: 00000192960

WATER KNOLL COURT

LUMENS	BULB TYPE	MULT SERIES	POLE TYPE	SHADE	ADDRESS NUMBER	REF	LOCATION	TAX DIST	DATE INST	DATE CHANGE
05800	S	M	CNT	II	02612	002		12	060894	1/1/0001
05800	S	M	CNT	II	02621	003		12	060894	1/1/0001
05800	S	M	CNT	V	02633	004		12	060894	1/1/0001

OFFICE: 311		ROUTE: 564		ST_REF_NO: 00000193100		WATERFORD PARK		LUMENS	BULB TYPE	MULT SERIES	POLE TYPE	SHADE	ADDRESS NUMBER	REF	LOCATION	TAX DIST	DATE INST	DATE CHANGE
05800	S	M	OUG	II	00000	233	SIDE OF 3287 PIMLICO PARKWAY	12	051074	1/1/0001								
05800	S	M	OUG	V	03260	236		12	051074	1/1/0001								
05800	S	M	OUG	II	03272	235		12	051074	1/1/0001								
05800	S	M	OUG	II	03283	234		12	051074	1/1/0001								

OFFICE: 311		ROUTE: 564		ST_REF_NO: 00000193103		WATERLILY COVE		LUMENS	BULB TYPE	MULT SERIES	POLE TYPE	SHADE	ADDRESS NUMBER	REF	LOCATION	TAX DIST	DATE INST	DATE CHANGE
05800	S	M	CNT	III	04405	002		12	030904	1/1/0001								
05800	S	M	CNT	II	04413	001		12	030904	1/1/0001								

OFFICE: 311		ROUTE: 564		ST_REF_NO: 00000193105		WATERMILL LANE		LUMENS	BULB TYPE	MULT SERIES	POLE TYPE	SHADE	ADDRESS NUMBER	REF	LOCATION	TAX DIST	DATE INST	DATE CHANGE
04000	S	M	OUG	II	01041	002		12	110889	1/1/0001								
04000	S	M	OUG	II	01044	001		12	020888	1/1/0001								
04000	S	M	OUG	II	01008	005		12	020888	1/1/0001								
04000	S	M	OUG	II	01017	004		12	110889	1/1/0001								
04000	S	M	OUG	II	01028	003		12	110888	1/1/0001								

OFFICE: 311		ROUTE: 564		ST_REF_NO: 00000193110		WATERS EDGE PLACE		LUMENS	BULB TYPE	MULT SERIES	POLE TYPE	SHADE	ADDRESS NUMBER	REF	LOCATION	TAX DIST	DATE INST	DATE CHANGE
05800	S	M	OUG	V	02085	137		12	091573	1/1/0001								
05800	S	M	OUG	II	02092	136		12	091573	1/1/0001								

OFFICE: 311		ROUTE: 564		ST_REF_NO: 00000193120		WATERSTONE LANE		LUMENS	BULB TYPE	MULT SERIES	POLE TYPE	SHADE	ADDRESS NUMBER	REF	LOCATION	TAX DIST	DATE INST	DATE CHANGE
05800	S	M	CNT	II	00000	003	SIDE REAR 4308	12	120894	1/1/0001								
05800	S	M	CNT	II	04300	001		12	120894	1/1/0001								
05800	S	M	CNT	II	04313	002		12	120894	1/1/0001								

OFFICE: 311		ROUTE: 564		ST_REF_NO: 00000193130		WATERTRACE DRIVE				
LUMENS	BULB TYPE	MULT SERIES	POLE TYPE	SHADE	ADDRESS NUMBER	REF	LOCATION	TAX DIST	DATE INST	DATE CHANGE
05800	S	M	CNT	II	00000	001	SIDE OF 4101 CLEARWATER WAY	12	040895	1/1/0001
05800	S	M	CNT	II	00000	051	1ST LT. N. OF CLEARWATER WAY	12	080895	1/1/0001
05800	S	M	CNT	II	00000	052	2ND LT. N. OF CLEARWATER WAY	12	080895	1/1/0001
05800	S	M	CNT	II	00000	053	SIDE OF 4000 SHOREWATER CIRCLE	12	080895	1/1/0001
05800	S	M	CNT	II	00000	057	SIDE 4000 CREEKWATER COURT	12	080895	1/1/0001
05800	S	M	CNT	II	04153	056		12	080895	1/1/0001
05800	S	M	CNT	II	04176	055		12	080895	1/1/0001
05800	S	M	CNT	II	04177	054		12	080895	1/1/0001
05800	S	M	CNT	II	04205	002		12	120894	1/1/0001
05800	S	M	CNT	II	04212	003		12	120894	1/1/0001
05800	S	M	CNT	II	04224	005		12	120894	1/1/0001
05800	S	M	CNT	II	04225	004		12	120894	1/1/0001
05800	S	M	CNT	II	04249	006		12	120894	1/1/0001
05800	S	M	CNT	II	04264	007		12	120894	1/1/0001
05800	S	M	CNT	II	04269	008		12	040895	1/1/0001
05800	S	M	CNT	III	04276	009		12	040895	1/1/0001

OFFICE: 311 ROUTE: 564
ST_REF_NO: 00000193140 WATERTRACE COURT

LUMENS	BULB TYPE	MULT SERIES	POLE TYPE	SHADE	ADDRESS NUMBER	REF	LOCATION	TAX DIST	DATE INST	DATE CHANGE
05800	S	M	CNT	II	04308	001		12	040895	1/1/0001

OFFICE: 311 ROUTE: 564
ST_REF_NO: 00000193290 WATSON ALLEY

LUMENS	BULB TYPE	MULT SERIES	POLE TYPE	SHADE	ADDRESS NUMBER	REF	LOCATION	TAX DIST	DATE INST	DATE CHANGE
04000	S	M	SOH	I	00000	002	2ND LT. W. OF WOODLAND AVE., S. SIDE	12	090889	1/1/0001
04000	S	M	SOH	I	00000	003	3RD LT. W. OF WOODLAND AVE., N. SIDE	12	090889	1/1/0001
04000	S	M	SOH	I	00000	004	4TH LT. W. OF WOODLAND AVE., S. SIDE	12	090889	1/1/0001
04000	S	M	SOH	I	00000	005	5TH LT. W. OF WOODLAND AVE., N. SIDE	12	090889	1/1/0001
04000	S	M	SOH	I	00000	006	6TH LT. W. OF WOODLAND AVE., S. SIDE	12	090889	1/1/0001
04000	S	M	SOH	I	00000	007	7TH LT. W. OF WOODLAND AVE., N. SIDE	12	090889	1/1/0001

OFFICE: 311

ROUTE: 564

ST_REF_NO: 00000193350 WAVECREST WAY

LUMENS	BULB TYPE	MULT SERIES	POLE TYPE	SHADE	ADDRESS NUMBER	REF	LOCATION	TAX DIST	DATE INST	DATE CHANGE
05800	S	M	CNT	II	03000	001		12	091603	1/1/0001
05800	S	M	CNT	II	03001	002		12	091603	1/1/0001
05800	S	M	CNT	II	03005	003		12	091603	1/1/0001
05800	S	M	CNT	II	03032	004		12	091603	1/1/0001
05800	S	M	CNT	II	03057	005		12	091603	1/1/0001
05800	S	M	CNT	II	03060	007		12	050804	1/1/0001
05800	S	M	CNT	II	03077	008		12	050804	1/1/0001
05800	S	M	CNT	II	03337	006		12	050804	1/1/0001

OFFICE: 311

ROUTE: 564

ST_REF_NO: 00000193400 WAVERLY DRIVE

LUMENS	BULB TYPE	MULT SERIES	POLE TYPE	SHADE	ADDRESS NUMBER	REF	LOCATION	TAX DIST	DATE INST	DATE CHANGE
05800	S	M	OUG	II	00000	002	SIDE OF 484 ERIE RD.	12	012160	1/1/0001
05800	S	M	OUG	II	00960	000		12	050159	1/1/0001
05800	S	M	OUG	II	00965	000		12	050159	1/1/0001
05800	S	M	OUG	II	00974	000		12	012160	1/1/0001
05800	S	M	OUG	II	00000	001	OPP. 929	12	123055	1/1/0001
05800	S	M	OUG	II	00935	000		12	123055	1/1/0001
05800	S	M	OUG	II	00944	000		12	050159	1/1/0001
05800	S	M	OUG	II	00951	000		12	050159	1/1/0001

OFFICE: 311

ROUTE: 564

ST_REF_NO: 00000193500 WAXWING WAY

LUMENS	BULB TYPE	MULT SERIES	POLE TYPE	SHADE	ADDRESS NUMBER	REF	LOCATION	TAX DIST	DATE INST	DATE CHANGE
05800	S	M	OUG	II	00000	019	SIDE OF 3837 SUGAR CREEK DRIVE	12	020800	1/1/0001
04000	S	M	OUG	II	00601	015		12	111580	1/1/0001
05800	S	M	OUG	II	00604	016		12	020800	1/1/0001
05800	S	M	OUG	II	00612	017		12	020800	1/1/0001
05800	S	M	OUG	II	00621	018		12	020800	1/1/0001

OFFICE: 311

ROUTE: 564

ST_REF_NO: 00000193600 WAYCROSS CIRCLE

LUMENS	BULB TYPE	MULT SERIES	POLE TYPE	SHADE	ADDRESS NUMBER	REF	LOCATION	TAX DIST	DATE INST	DATE CHANGE
05800	S	M	OUG	II	00000	005	SIDE OF 1783 RALEIGH DR.	12	100466	1/1/0001

OFFICE: 311

ROUTE: 564

ST_REF_NO: 00000193620

WHITE CHAPEL COURT

LUMENS	BULB TYPE	MULT SERIES	POLE TYPE	SHADE	ADDRESS NUMBER	REF	LOCATION	TAX DIST	DATE INST	DATE CHANGE
05800	S	M	CNT	III	00508	002		12	060800	1/1/0001
05800	S	M	CNT	II	00513	001		12	060800	1/1/0001

OFFICE: 311

ROUTE: 564

ST_REF_NO: 00000193700

WAYLAND DRIVE

LUMENS	BULB TYPE	MULT SERIES	POLE TYPE	SHADE	ADDRESS NUMBER	REF	LOCATION	TAX DIST	DATE INST	DATE CHANGE
04000	S	M	OUG	II	00000	001	SIDE OF 441 NORTHSIDE DR.	12	030888	1/1/0001
04000	S	M	OUG	II	00000	004	SIDE OF 504 ST. ANTHONY DR.	12	030888	1/1/0001
05800	S	M	OUG	II	00000	005	SIDE OF 509 HI-CREST DR.	12	050164	1/1/0001
05800	S	M	OUG	II	00000	013	SIDE OF 470 SANDLEWOOD DR.	12	062363	1/1/0001
05800	S	M	OUG	II	00000	018	SIDE OF 429 BRYANWOOD PKWY.	12	050466	1/1/0001
05800	S	M	OUG	II	01806	007		12	050164	1/1/0001
05800	S	M	OUG	II	01817	006		12	060164	1/1/0001
04000	S	M	OUG	II	01832	003		12	030888	1/1/0001
04000	S	M	OUG	II	01840	002		12	030888	1/1/0001

OFFICE: 311

ROUTE: 564

ST_REF_NO: 00000193710

WAYLAND COURT

LUMENS	BULB TYPE	MULT SERIES	POLE TYPE	SHADE	ADDRESS NUMBER	REF	LOCATION	TAX DIST	DATE INST	DATE CHANGE
04000	S	M	SOH	II	00000	002	SIDE OF 313 THOMPSON RD.	12	070886	1/1/0001
04000	S	M	SOH	II	01104	001		12	070886	1/1/0001

OFFICE: 311

ROUTE: 564

ST_REF_NO: 00000193720

WAYNE'S BLVD.

LUMENS	BULB TYPE	MULT SERIES	POLE TYPE	SHADE	ADDRESS NUMBER	REF	LOCATION	TAX DIST	DATE INST	DATE CHANGE
05800	S	M	CNT	II	04900	005		12	080896	1/1/0001
05800	S	M	CNT	II	04905	004		12	080896	1/1/0001
05800	S	M	CNT	II	04916	003		12	080896	1/1/0001
05800	S	M	CNT	II	04928	001		12	080896	1/1/0001
05800	S	M	CNT	II	04929	002		12	080896	1/1/0001

OFFICE: 311

ROUTE: 564

ST_REF_NO: 00000193800

WEBER WAY

LUMENS	BULB TYPE	MULT SERIES	POLE TYPE	SHADE	ADDRESS NUMBER	REF	LOCATION	TAX DIST	DATE INST	DATE CHANGE
04000	S	M	OUG	II	00000	008	SIDE OF 3865 LEE ADAMS WAY	12	031581	1/1/0001

OFFICE: 311

ROUTE: 564

ST_REF_NO: 00000193800

WEBER WAY

LUMENS	BULB TYPE	MULT SERIES	POLE TYPE	SHADE	ADDRESS NUMBER	REF	LOCATION	TAX DIST	DATE INST	DATE CHANGE
04000	S	M	OUG	II	00000	016	SIDE OF 964 GREGORY WAY	12	031581	1/1/0001
04000	S	M	OUG	II	00000	027	OPP. 4104 WEBER WAY	12	100890	1/1/0001
04000	S	M	OUG	II	00000	028	OPP. 4116 WEBER WAY	12	100890	1/1/0001
04000	S	M	OUG	II	03913	009		12	121583	1/1/0001
04000	S	M	OUG	II	03928	010		12	121583	1/1/0001
04000	S	M	OUG	II	03933	011		12	121583	1/1/0001
04000	S	M	OUG	II	03952	012		12	031581	1/1/0001
04000	S	M	OUG	II	03957	013		12	121583	1/1/0001
04000	S	M	OUG	II	03974	014		12	031581	1/1/0001
04000	S	M	OUG	II	03981	015		12	031581	1/1/0001
04000	S	M	OUG	II	04001	017		12	100890	1/1/0001
04000	S	M	OUG	II	04012	018		12	100890	1/1/0001
04000	S	M	OUG	II	04016	019		12	100890	1/1/0001
04000	S	M	OUG	II	04024	020		12	100890	1/1/0001
04000	S	M	OUG	II	04029	021		12	100890	1/1/0001
04000	S	M	OUG	II	04045	022		12	100890	1/1/0001
04000	S	M	OUG	II	04052	023		12	100890	1/1/0001
04000	S	M	OUG	II	04069	024		12	100890	1/1/0001
04000	S	M	OUG	II	04076	025		12	100890	1/1/0001
04000	S	M	OUG	II	04089	026		12	100890	1/1/0001
04000	S	M	OUG	II	04127	030		12	100890	1/1/0001
04000	S	M	OUG	II	04132	029		12	120892	1/1/0001
04000	S	M	OUG	II	04156	031		12	100890	1/1/0001
04000	S	M	OUG	II	04157	032		12	100890	1/1/0001
04000	S	M	OUG	II	04169	033		12	100890	1/1/0001
04000	S	M	OUG	II	04192	034		12	120892	1/1/0001
04000	S	M	OUG	II	04193	035		12	100890	1/1/0001

OFFICE: 311

ROUTE: 564

ST_REF_NO: 00000193850

WEBSTER COURT

LUMENS	BULB TYPE	MULT SERIES	POLE TYPE	SHADE	ADDRESS NUMBER	REF	LOCATION	TAX DIST	DATE INST	DATE CHANGE
05800	S	M	CNT	II	00000	001	SIDE OF 3288 SNAFFLE RD.	12	020800	1/1/0001
05800	S	M	CNT	III	00000	002	REAR OF 3286 SNAFFLE RD.	12	020800	1/1/0001

OFFICE: 311		ROUTE: 564		ST_REF_NO: 00000193900		WEDGEFIELD PLACE		LUMENS	BULB TYPE	MULT SERIES	POLE TYPE	SHADE	ADDRESS NUMBER	REF	LOCATION	TAX DIST	DATE INST	DATE CHANGE
	05800	S	M	OUG	V	00201	026									12	011581	1/1/0001
OFFICE: 311		ROUTE: 564		ST_REF_NO: 00000194000		WEDGEWOOD COURT		LUMENS	BULB TYPE	MULT SERIES	POLE TYPE	SHADE	ADDRESS NUMBER	REF	LOCATION	TAX DIST	DATE INST	DATE CHANGE
	04000	S	M	OUG	II	00000	051								SIDE OF 1020 WEDGEWOOD RD.	12	121581	1/1/0001
	04000	S	M	OUG	V	03813	052									12	021582	1/1/0001
OFFICE: 311		ROUTE: 564		ST_REF_NO: 00000194100		WEDGEWOOD ROAD		LUMENS	BULB TYPE	MULT SERIES	POLE TYPE	SHADE	ADDRESS NUMBER	REF	LOCATION	TAX DIST	DATE INST	DATE CHANGE
	05800	S	M	OUG	II	00996	051									12	050897	1/1/0001
	05800	S	M	OUG	II	01001	052									12	050897	1/1/0001
	04000	S	M	OUG	II	01016	049									12	081582	1/1/0001
	04000	S	M	OUG	II	01017	050									12	081582	1/1/0001
	04000	S	M	OUG	II	01045	048									12	081582	1/1/0001
	04000	S	M	OUG	II	01048	047									12	121581	1/1/0001
OFFICE: 311		ROUTE: 564		ST_REF_NO: 00000194105		WEEPING WILLOW LANE		LUMENS	BULB TYPE	MULT SERIES	POLE TYPE	SHADE	ADDRESS NUMBER	REF	LOCATION	TAX DIST	DATE INST	DATE CHANGE
	05800	S	M	CNT	II	00000	003								SIDE 636 TWIN PINES WAY	12	110895	1/1/0001
	05800	S	M	CNT	II	03712	002									12	110895	1/1/0001
	05800	S	M	CNT	II	03725	001									12	110895	1/1/0001
OFFICE: 311		ROUTE: 564		ST_REF_NO: 00000194140		WELDON COURT		LUMENS	BULB TYPE	MULT SERIES	POLE TYPE	SHADE	ADDRESS NUMBER	REF	LOCATION	TAX DIST	DATE INST	DATE CHANGE
	05800	S	M	OUG	II	01100	001									12	110899	1/1/0001
OFFICE: 311		ROUTE: 564		ST_REF_NO: 00000194175		WELLESLEY HEIGHTS WAY		LUMENS	BULB TYPE	MULT SERIES	POLE TYPE	SHADE	ADDRESS NUMBER	REF	LOCATION	TAX DIST	DATE INST	DATE CHANGE
	09500	S	M	OUG	II	00000	001								WELLESLEY HEIGHTS WAY AT VERSAILLES RD	12	030204	1/1/0001

OFFICE: 311

ROUTE: 564

ST_REF_NO: 00000194200

WELLINGTON WAY

LUMENS	BULB TYPE	MULT SERIES	POLE TYPE	SHADE	ADDRESS NUMBER	REF	LOCATION	TAX DIST	DATE INST	DATE CHANGE
50000	S		CNT	II	00000	103	SW CORNER OF WELLINGTON WAY ROUNDABOUT	12	020801	1/1/0001
22000	S	M	CNT	II	00000	013	1ST LT W OF DORCHESTER PLACE, S SIDE ON WELLINGTON	12	103101	1/1/0001
22000	S	M	CNT	II	00000	014	2ND LT W OF DORCHESTER PLACE, N SIDE ON WELLINGTON	12	103101	1/1/0001
22000	S	M	CNT	II	00000	015	3RD LT W OF DORCHESTER PLACE, S SIDE ON WELLINGTON	12	103101	1/1/0001
22000	S	M	CNT	II	00000	016	4TH LT W OF DORCHESTER PLACE, N SIDE ON WELLINGTON	12	103101	1/1/0001
22000	S	M	CNT	II	00000	017	5TH LT W OF DORCHESTER PLACE, S SIDE ON WELLINGTON	12	103101	1/1/0001
22000	S	M	CNT	II	00000	018	6TH LT W OF DORCHESTER PLACE, N SIDE ON WELLINGTON	12	103101	1/1/0001
22000	S	M	CNT	II	00000	019	7TH LT W OF DORCHESTER PLACE, S SIDE ON WELLINGTON	12	103101	1/1/0001
22000	S	M	CNT	II	00000	020	8TH LT W OF DORCHESTER PLACE, N SIDE ON WELLINGTON	12	103101	1/1/0001
22000	S	M	CNT	II	00000	021	1ST LT W OF MARSTEN PLACE, S SIDE ON WELLINGTON	12	103101	1/1/0001
22000	S	M	CNT	II	00000	022	2ND LT W OF MARSTEN PLACE, N SIDE ON WELLINGTON	12	103101	1/1/0001
22000	S	M	CNT	II	00000	023	3RD LT W OF MARSTEN PLACE, S SIDE ON WELLINGTON	12	103101	1/1/0001
22000	S	M	CNT	II	00000	024	4TH LT W OF MARSTEN PLACE, N SIDE ON WELLINGTON	12	103101	1/1/0001
22000	S	M	CNT	II	00000	025	5TH LT W OF MARSTEN PLACE, S SIDE ON WELLINGTON	12	103101	1/1/0001
22000	S	M	CNT	II	00000	026	1ST LT W OF DRAYTON PLACE, N SIDE ON WELLINGTON	12	103101	1/1/0001
22000	S	M	CNT	II	00000	027	2ND LT W OF DRAYTON PLACE, S SIDE ON WELLINGTON	12	103101	1/1/0001
22000	S	M	CNT	II	00000	028	3RD LT W OF DRAYTON PLACE, N SIDE ON WELLINGTON	12	103101	1/1/0001
22000	S	M	CNT	II	00000	029	4TH LT W OF DRAYTON PLACE, S SIDE ON WELLINGTON	12	103101	1/1/0001
22000	S	M	CNT	II	00000	030	5TH LT W OF DRAYTON PLACE, N SIDE ON WELLINGTON	12	103101	1/1/0001
22000	S	M	CNT	II	00000	031	6TH LT W OF DRAYTON PLACE, S SIDE ON WELLINGTON	12	103101	1/1/0001

OFFICE: 311

ROUTE: 564

ST_REF_NO: 00000194200

WELLINGTON WAY

LUMENS	BULB TYPE	MULT SERIES	POLE TYPE	SHADE	ADDRESS NUMBER	REF	LOCATION	TAX DIST	DATE INST	DATE CHANGE
50000	S	M	CNT	II	00000	032	7TH LT W OF DRAYTON PLACE, N SIDE ON WELLINGTON	12	103101	1/1/0001
50000	S	M	CNT	II	00000	033	8TH LT W OF DRAYTON PLACE, S SIDE ON WELLINGTON	12	103101	1/1/0001
50000	S	M	CNT	II	00000	101	NE CORNER OF WELLINGTON WAY ROUNDABOUT	12	020801	7/2/2009
50000	S	M	CNT	II	00000	102	IN ISLAND AT ROUNDABOUT -upgrade per city req	12	020801	7/2/2009
50000	S	M	CNT	II	00000	104	NW CORNER OF WELLINGTON WAY ROUNDABOUT-per city re	12	020801	7/2/2009
05800	S	M	OUG	II	00000	022	OPP. 748 WELLINGTON WAY	12	100890	1/1/0001
05800	S	M	CNT	II	00000	036	OPP. 840	12	060899	1/1/0001
05800	S	M	CNT	II	00000	037	SIDE OF 856 MEADOWBROOK DR.	12	060899	1/1/0001
05800	S	M	CNT	II	00000	038	1ST LT. S OF MEADOWBROOK DR.	12	060899	1/1/0001
05800	S	M	CNT	II	00000	039	OPP. WESTMEATH PLACE	12	060899	1/1/0001
05800	S	M	CNT	II	00000	040		12	060899	1/1/0001
05800	S	M	CNT	II	00000	041	OPP. GLADMAN WAY	12	060899	1/1/0001
05800	S	M	CNT	II	00000	042	SIDE REAR OF 2041 MOUNTJOY PLACE	12	060899	1/1/0001
05800	S	M	CNT	II	00000	043	2ND LT. E OF HARRODSBURG RD., NORTHSIDE	12	060899	1/1/0001
05800	S	M	CNT	II	00000	044	2ND LT. E OF HARRODSBURG RD., SOUTHSIDE	12	060899	1/1/0001
05800	S	M	CNT	II	00000	045	1ST LT. E OF HARRODSBURG RD., NORTHSIDE	12	060899	1/1/0001
05800	S	M	CNT	II	00000	046	1ST LT. E OF HARRODSBURG RD., SOUTHSIDE	12	060899	1/1/0001
09500	S	M	CNT	III	00000	047	1ST LT. W OF HARRODSBURG RD., SOUTHSIDE	12	060899	1/1/0001
09500	S	M	CNT	III	00000	048	1ST LT. W OF HARRODSBURG RD., NORTHSIDE	12	060899	1/1/0001
09500	S	M	CNT	III	00000	049	2ND LT. W OF HARRODSBURG RD., SOUTHSIDE	12	060899	1/1/0001
05800	S	M	CNT	II	00000	075	SIDE OF 2180 PALOMAR TRACE DRIVE	12	100897	1/1/0001
05800	S	M	CNT	II	00000	077		12	100897	1/1/0001
05800	S	M	OUG	II	00744	021		12	100890	1/1/0001
05800	S	M	CNT	II	00768	025		12	110895	1/1/0001
05800	S	M	CNT	II	00773	026		12	110895	1/1/0001
05800	S	M	CNT	II	00780	027		12	110895	1/1/0001
05800	S	M	CNT	II	00785	028		12	110895	1/1/0001
05800	S	M	CNT	II	00792	029		12	110895	1/1/0001
05800	S	M	CNT	II	00797	030		12	060899	1/1/0001
05800	S	M	CNT	II	00800	031		12	060899	1/1/0001
05800	S	M	CNT	II	00808	032		12	060899	1/1/0001
05800	S	M	CNT	II	00816	033		12	060899	1/1/0001

OFFICE: 311

ROUTE: 564

ST_REF_NO: 00000194200

WELLINGTON WAY

LUMENS	BULB TYPE	MULT SERIES	POLE TYPE	SHADE	ADDRESS NUMBER	REF	LOCATION	TAX DIST	DATE INST	DATE CHANGE
05800	S	M	CNT	II	00828	034		12	060899	1/1/0001
05800	S	M	CNT	II	00832	035		12	060899	1/1/0001
05800	S	M	CNT	II	01086	076		12	100897	1/1/0001
05800	S	M	SOH	II	00000	002	OPP. 620 WELLINGTON WAY	12	120890	1/1/0001
05800	S	M	OUG	II	00000	004	OPP. 632 WELLINGTON WAY	12	120890	1/1/0001
05800	S	M	OUG	II	00000	005	OPP. 640 WELLINGTON WAY	12	120890	1/1/0001
22000	S	M	CNT	II	00000	105	1ST LT. W OF ROUNDABOUT, N SIDE	12	020801	1/1/0001
22000	S	M	CNT	II	00000	106	1ST LT. W OF ROUNDABOUT, S SIDE	12	020801	1/1/0001
22000	S	M	CNT	II	00000	107	2ND LT. W OF ROUNDABOUT, S SIDE	12	020801	1/1/0001
22000	S	M	CNT	II	00000	108	2ND LT. W OF ROUNDABOUT, N SIDE	12	020801	1/1/0001
22000	S	M	CNT	II	00000	109	3RD LT. W OF ROUNDABOUT, S SIDE	12	020801	1/1/0001
22000	S	M	CNT	II	00000	110	3RD LT. W OF ROUNDABOUT, N SIDE	12	020801	1/1/0001
22000	S	M	CNT	II	00000	111	4TH LT. W OF ROUNDABOUT, S SIDE	12	020801	1/1/0001
22000	S	M	CNT	II	00000	112	4TH LT. W OF ROUNDABOUT, N SIDE	12	020801	1/1/0001
05800	S	M	OUG	II	00616	001		12	120890	1/1/0001
05800	S	M	OUG	II	00628	003		12	120890	1/1/0001
05800	S	M	OUG	II	00648	006		12	120890	1/1/0001
05800	S	M	OUG	II	00652	007		12	120890	1/1/0001
05800	S	M	OUG	II	00661	008		12	120890	1/1/0001
05800	S	M	OUG	II	00664	009		12	100890	1/1/0001
05800	S	M	OUG	II	00672	010		12	100890	1/1/0001
05800	S	M	OUG	II	00680	013		12	100890	1/1/0001
05800	S	M	OUG	II	00681	011		12	100890	1/1/0001
05800	S	M	OUG	II	00684	012		12	100890	1/1/0001
05800	S	M	OUG	II	00705	014		12	100890	1/1/0001
05800	S	M	OUG	II	00708	015		12	100890	1/1/0001
05800	S	M	OUG	II	00712	016		12	100890	1/1/0001
05800	S	M	OUG	II	00725	017		12	100890	1/1/0001
05800	S	M	OUG	II	00729	018		12	100890	1/1/0001
05800	S	M	OUG	II	00732	019		12	100890	1/1/0001
05800	S	M	OUG	II	00736	020		12	100890	1/1/0001
05800	S	M	CNT	II	00000	023	SIDE OF 3200 BLENHEIM WAY	12	060894	1/1/0001
05800	S	M	CNT	II	00000	024	SIDE OF 3193 BLENHEIM WAY	12	060894	1/1/0001

OFFICE: 311		ROUTE: 564		ST_REF_NO: 00000194210		WELLINGTON LANE		LUMENS	BULB TYPE	MULT SERIES	POLE TYPE	SHADE	ADDRESS NUMBER	REF	LOCATION	TAX DIST	DATE INST	DATE CHANGE
05800	S	M	CNT	II	00000	001	SIDE OF 809 WELLINGTON WAY	12	060899	1/1/0001								
05800	S	M	CNT	II	03208	004		12	060899	1/1/0001								
05800	S	M	CNT	II	03209	002		12	060899	1/1/0001								
05800	S	M	CNT	III	03221	003		12	060899	1/1/0001								
05800	S	M	CNT	II	03236	005		12	060899	1/1/0001								
05800	S	M	CNT	II	03241	006		12	060899	1/1/0001								
05800	S	M	CNT	II	03248	007		12	060899	1/1/0001								
05800	S	M	CNT	II	03257	008		12	060899	1/1/0001								

OFFICE: 311		ROUTE: 564		ST_REF_NO: 00000194300		WELLS COURT		LUMENS	BULB TYPE	MULT SERIES	POLE TYPE	SHADE	ADDRESS NUMBER	REF	LOCATION	TAX DIST	DATE INST	DATE CHANGE
05800	S	M	OUG	II	00000	053	SIDE OF 723 BISHOP	12	100169	1/1/0001								
05800	S	M	OUG	V	00626	055		12	011667	1/1/0001								
05800	S	M	OUG	II	00638	054		12	011667	1/1/0001								

OFFICE: 311		ROUTE: 564		ST_REF_NO: 00000194350		WELSH PARK		LUMENS	BULB TYPE	MULT SERIES	POLE TYPE	SHADE	ADDRESS NUMBER	REF	LOCATION	TAX DIST	DATE INST	DATE CHANGE
05800	S	M	CNT	II	00405	001		12	061606	1/1/0001								
05800	S	M	CNT	II	00408	002		12	061606	1/1/0001								
05800	S	M	CNT	II	00421	003		12	061606	1/1/0001								
05800	S	M	CNT	II	00432	004		12	061606	1/1/0001								
05800	S	M	CNT	II	00448	005		12	061606	1/1/0001								

OFFICE: 311		ROUTE: 564		ST_REF_NO: 00000194400		WEM COURT		LUMENS	BULB TYPE	MULT SERIES	POLE TYPE	SHADE	ADDRESS NUMBER	REF	LOCATION	TAX DIST	DATE INST	DATE CHANGE
05800	S	M	OUG	II	00000	088	SIDE OF 3836 WEM DR.	12	020887	9/30/2012								
04000	S	M	OUG	V	00312	089		12	020887	1/1/0001								

OFFICE: 311		ROUTE: 564		ST_REF_NO: 00000194500		WEM DRIVE		LUMENS	BULB TYPE	MULT SERIES	POLE TYPE	SHADE	ADDRESS NUMBER	REF	LOCATION	TAX DIST	DATE INST	DATE CHANGE
04000	S	M	OUG	II	03800	082		12	020887	1/1/0001								

OFFICE: 311		ROUTE: 564		ST_REF_NO: 00000194500		WEM DRIVE		LUMENS	BULB TYPE	MULT SERIES	POLE TYPE	SHADE	ADDRESS NUMBER	REF	LOCATION	TAX DIST	DATE INST	DATE CHANGE
04000	S	M	OUG	II	03813	083										12	020887	1/1/0001
04000	S	M	OUG	II	03824	084										12	020887	1/1/0001
04000	S	M	OUG	II	03837	085										12	020887	1/1/0001
04000	S	M	OUG	II	03849	086										12	020887	1/1/0001
04000	S	M	OUG	II	03864	087										12	020887	1/1/0001

OFFICE: 311		ROUTE: 564		ST_REF_NO: 00000194650		WERNE DRIVE		LUMENS	BULB TYPE	MULT SERIES	POLE TYPE	SHADE	ADDRESS NUMBER	REF	LOCATION	TAX DIST	DATE INST	DATE CHANGE
05800	S	M	OUG	II	00704	001										12	102367	1/1/0001
05800	S	M	OUG	II	00719	002										12	080173	1/1/0001
05800	S	M	OUG	II	00726	003										12	080173	1/1/0001
05800	S	M	OUG	II	00736	004										12	080173	1/1/0001
05800	S	M	OUG	V	00742	005										12	080173	1/1/0001

OFFICE: 311		ROUTE: 564		ST_REF_NO: 00000194675		WESLEY COURT		LUMENS	BULB TYPE	MULT SERIES	POLE TYPE	SHADE	ADDRESS NUMBER	REF	LOCATION	TAX DIST	DATE INST	DATE CHANGE
05800	S	M	OUG	III	04812	001										12	061201	1/1/0001

OFFICE: 311		ROUTE: 564		ST_REF_NO: 00000194740		WEST LEESWAY		LUMENS	BULB TYPE	MULT SERIES	POLE TYPE	SHADE	ADDRESS NUMBER	REF	LOCATION	TAX DIST	DATE INST	DATE CHANGE
05800	S	M	OUG	II	00101	001										12	010897	1/1/0001
05800	S	M	OUG	II	00104	002										12	010897	1/1/0001
05800	S	M	OUG	II	00108	003										12	010897	1/1/0001
05800	S	M	OUG	II	00115	004										12	010897	1/1/0001

OFFICE: 311		ROUTE: 564		ST_REF_NO: 00000194900		WEST TIVERTON WAY		LUMENS	BULB TYPE	MULT SERIES	POLE TYPE	SHADE	ADDRESS NUMBER	REF	LOCATION	TAX DIST	DATE INST	DATE CHANGE
09500	S	M	OUG	II	00000	001									1ST LT W OF NICHOLASVILLE RD., SSIDE	12	040899	1/1/0001
09500	S	M	OUG	II	00000	003									3RD LT W OF NICHOLASVILLE RD., SSIDE	12	040899	1/1/0001
09500	S	M	OUG	II	00000	009									SIDE OF 3980 ENTERPRISE	12	100884	1/1/0001
09500	S	M	OUG	II	00128	008										12	100884	1/1/0001

OFFICE: 311

ROUTE: 564

ST_REF_NO: 00000194900

WEST TIVERTON WAY

LUMENS	BULB TYPE	MULT SERIES	POLE TYPE	SHADE	ADDRESS NUMBER	REF	LOCATION	TAX DIST	DATE INST	DATE CHANGE
09500	S	M	OUG	II	00152	010		12	100884	1/1/0001

OFFICE: 311

ROUTE: 564

ST_REF_NO: 00000194950

WESTBROOK DRIVE

LUMENS	BULB TYPE	MULT SERIES	POLE TYPE	SHADE	ADDRESS NUMBER	REF	LOCATION	TAX DIST	DATE INST	DATE CHANGE
05800	S	M	OUG	III	03917	008		12	020897	1/1/0001
05800	S	M	OUG	II	03933	007		12	020897	1/1/0001
05800	S	M	OUG	II	03941	006		12	020897	1/1/0001
05800	S	M	OUG	II	03948	005		12	020897	1/1/0001
05800	S	M	OUG	II	03965	004		12	020897	1/1/0001
05800	S	M	OUG	II	03968	003		12	020897	1/1/0001
05800	S	M	OUG	II	03981	002		12	020897	1/1/0001
04000	S	M	OUG	II	03989	001		12	100890	1/1/0001

OFFICE: 311

ROUTE: 564

ST_REF_NO: 00000195100

WESTERFIELD WAY

LUMENS	BULB TYPE	MULT SERIES	POLE TYPE	SHADE	ADDRESS NUMBER	REF	LOCATION	TAX DIST	DATE INST	DATE CHANGE
05800	S	M	OUG	II	00505	069		12	121583	1/20/2014
04000	S	M	OUG	II	00475	073		12	121583	1/1/0001
04000	S	M	OUG	II	00486	072		12	121583	1/1/0001
04000	S	M	OUG	II	00491	071		12	121583	1/1/0001
04000	S	M	OUG	II	00498	070		12	121583	1/1/0001
04000	S	M	OUG	II	00508	068		12	121583	1/1/0001
04000	S	M	OUG	II	00000	001	SIDE OF 2893 RUNNYMEADE WAY	12	041470	1/1/0001
04000	S	M	OUG	II	00000	002	SIDE OF 2900 RUNNYMEADE WAY	12	041470	1/1/0001
04000	S	M	OUG	II	00000	004	SIDE OF 2996 RUNNYMEADE WAY	12	050172	1/1/0001
04000	S	M	OUG	II	00000	042	SIDE OF 464 SEVERN WAY	12	062174	1/1/0001
04000	S	M	OUG	II	00403	043		12	101173	1/1/0001
04000	S	M	OUG	II	00419	041		12	101173	1/1/0001
04000	S	M	OUG	II	00422	040		12	101173	1/1/0001
04000	S	M	OUG	II	00435	039		12	101173	1/1/0001
04000	S	M	OUG	II	00455	003		12	041470	1/1/0001

OFFICE: 311		ROUTE: 564		ST_REF_NO: 00000195200		WESTGATE DRIVE		TAX DIST	DATE INST	DATE CHANGE
LUMENS	BULB TYPE	MULT SERIES	POLE TYPE	SHADE	ADDRESS NUMBER	REF	LOCATION			
09500	S	M	SOH	II	00000	001	SIDE 1901 VERSAILLES RD.	12	030886	1/1/0001
09500	S	M	SOH	II	00107	010		12	060886	1/1/0001
09500	S	M	SOH	II	00111	002		12	030886	1/1/0001
09500	S	M	SOH	II	00115	003		12	030886	1/1/0001
09500	S	M	SOH	II	00123	005		12	030886	1/1/0001
09500	S	M	SOH	II	00125	004		12	030886	1/1/0001
09500	S	M	SOH	II	00129	006		12	030886	1/1/0001
09500	S	M	SOH	II	00139	007		12	030886	1/1/0001
09500	S	M	SOH	II	00147	008		12	030886	1/1/0001
09500	S	M	SOH	II	00149	009		12	030886	1/1/0001
OFFICE: 311		ROUTE: 564		ST_REF_NO: 00000195250		WESTHAMPTON DRIVE		TAX DIST	DATE INST	DATE CHANGE
LUMENS	BULB TYPE	MULT SERIES	POLE TYPE	SHADE	ADDRESS NUMBER	REF	LOCATION			
05800	S	M	OUG	II	00000	011	SIDE OF 2032 MERCER RD. ON	12	010894	1/1/0001
05800	S	M	OUG	II	00000	012	SIDE OF 2016 MERCER RD.	12	010894	1/1/0001
05800	S	M	OUG	II	00100	002		12	010894	1/1/0001
05800	S	M	OUG	II	00100	004		12	010894	1/1/0001
05800	S	M	OUG	II	00100	006		12	010894	1/1/0001
05800	S	M	OUG	II	00101	001		12	010894	1/1/0001
05800	S	M	OUG	II	00101	003		12	010894	1/1/0001
05800	S	M	OUG	II	00101	005		12	010894	1/1/0001
05800	S	M	OUG	II	00117	009		12	010894	1/1/0001
05800	S	M	OUG	II	00124	010		12	010894	1/1/0001
OFFICE: 311		ROUTE: 564		ST_REF_NO: 00000195300		WESTLAND DRIVE		TAX DIST	DATE INST	DATE CHANGE
LUMENS	BULB TYPE	MULT SERIES	POLE TYPE	SHADE	ADDRESS NUMBER	REF	LOCATION			
05800	S	M	OUG	II	00532	000		12	090673	1/1/0001
05800	S	M	OUG	II	00706	000		12	010270	1/1/0001
05800	S	M	OUG	II	00713	000		12	090673	1/1/0001
05800	S	M	OUG	II	00739	000		12	010270	1/1/0001
05800	S	M	OUG	II	00773	000		12	010270	1/1/0001
05800	S	M	OUG	V	00790	000		12	010270	1/1/0001

OFFICE: 311		ROUTE: 564		ST_REF_NO: 00000195315		WESTMEATH WAY				
LUMENS	BULB TYPE	MULT SERIES	POLE TYPE	SHADE	ADDRESS NUMBER	REF	LOCATION	TAX DIST	DATE INST	DATE CHANGE
05800	S	M	CNT	II	00000	001	SIDE OF 3656 GLADMAN WAY	12	060899	1/1/0001
05800	S	M	CNT	II	00000	004	SIDE OF 1949	12	060899	1/1/0001
05800	S	M	CNT	II	00000	005	SIDE OF 1937	12	060899	1/1/0001
05800	S	M	CNT	II	01900	008		12	060899	1/1/0001
05800	S	M	CNT	II	01909	007		12	060899	1/1/0001
05800	S	M	CNT	II	01920	006		12	060899	1/1/0001
05800	S	M	CNT	II	01956	003		12	060899	1/1/0001
05800	S	M	CNT	II	01957	002		12	060899	1/1/0001

OFFICE: 311		ROUTE: 564		ST_REF_NO: 00000195325		WESTMONT CIRCLE				
LUMENS	BULB TYPE	MULT SERIES	POLE TYPE	SHADE	ADDRESS NUMBER	REF	LOCATION	TAX DIST	DATE INST	DATE CHANGE
05800	S	M	OUG	II	03508	002		12	120892	1/1/0001
05800	S	M	OUG	II	03513	001		12	120892	1/1/0001

OFFICE: 311		ROUTE: 564		ST_REF_NO: 00000195350		WESTMONT COURT				
LUMENS	BULB TYPE	MULT SERIES	POLE TYPE	SHADE	ADDRESS NUMBER	REF	LOCATION	TAX DIST	DATE INST	DATE CHANGE
05800	S	M	OUG	IV	02156	005		12	120892	1/1/0001
05800	S	M	OUG	II	02169	004		12	120892	1/1/0001
05800	S	M	OUG	II	02176	003		12	120892	1/1/0001
05800	S	M	OUG	II	02185	002		12	120892	1/1/0001
05800	S	M	OUG	II	02196	001		12	120892	1/1/0001

OFFICE: 311		ROUTE: 564		ST_REF_NO: 00000195400		WESTMINSTER DRIVE				
LUMENS	BULB TYPE	MULT SERIES	POLE TYPE	SHADE	ADDRESS NUMBER	REF	LOCATION	TAX DIST	DATE INST	DATE CHANGE
09500	S	M	OUG	II	00000	006	SIDE OF 1905 DEAUVILLE DR.	12	120960	1/1/0001
09500	S	M	OUG	II	01903	000		12	102258	1/1/0001
09500	S	M	OUG	II	01906	008		12	110761	1/1/0001
09500	S	M	OUG	II	01913	007		12	110761	1/1/0001

OFFICE: 311 ROUTE: 564										
ST_REF_NO: 00000195500 WESTRIDGE CIRCLE										
LUMENS	BULB TYPE	MULT SERIES	POLE TYPE	SHADE	ADDRESS NUMBER	REF	LOCATION	TAX DIST	DATE INST	DATE CHANGE
05800	S	M	OUG	II	00000	001	SIDE OF 724 MALABU DR.	12	060897	1/1/0001
05800	S	M	OUG	II	03409	002		12	060897	1/1/0001
05800	S	M	OUG	III	03416	003		12	060897	1/1/0001
OFFICE: 311 ROUTE: 564										
ST_REF_NO: 00000195600 WESTSIDE DRIVE										
LUMENS	BULB TYPE	MULT SERIES	POLE TYPE	SHADE	ADDRESS NUMBER	REF	LOCATION	TAX DIST	DATE INST	DATE CHANGE
04000	S	M	OUG	II	02902	163		12	101583	1/1/0001
04000	S	M	OUG	II	02911	162		12	101583	1/1/0001
OFFICE: 311 ROUTE: 564										
ST_REF_NO: 00000195650 WESTWOOD COURT										
LUMENS	BULB TYPE	MULT SERIES	POLE TYPE	SHADE	ADDRESS NUMBER	REF	LOCATION	TAX DIST	DATE INST	DATE CHANGE
05800	S	M	SOH	II	00000	007	OPP. 219, IN MEDIAN	12	121578	1/1/0001
05800	S	M	SOH	II	00205	000		12	121578	1/1/0001
OFFICE: 311 ROUTE: 564										
ST_REF_NO: 00000195700 WESTWOOD DRIVE										
LUMENS	BULB TYPE	MULT SERIES	POLE TYPE	SHADE	ADDRESS NUMBER	REF	LOCATION	TAX DIST	DATE INST	DATE CHANGE
05800	S	M	SOH	II	00000	001	SIDE OF 1447 S. LIMESTONE	12	110163	1/1/0001
05800	S	M	SOH	II	00101	006		12	010893	1/1/0001
05800	S	M	SOH	II	00107	000		12	110163	1/1/0001
05800	S	M	SOH	II	00111	000		12	110163	1/1/0001
05800	S	M	SOH	II	00115	000		12	121578	1/1/0001
05800	S	M	SOH	II	00121	007		12	010893	1/1/0001
05800	S	M	SOH	II	00125	000		12	121578	1/1/0001
OFFICE: 311 ROUTE: 564										
ST_REF_NO: 00000195800 WEYBRIDGE COURT										
LUMENS	BULB TYPE	MULT SERIES	POLE TYPE	SHADE	ADDRESS NUMBER	REF	LOCATION	TAX DIST	DATE INST	DATE CHANGE
05800	S	M	OUG	II	00000	003	SIDE OF 866 LANE ALLEN RD.	12	120165	1/1/0001
05800	S	M	OUG	II	02013	004		12	120165	1/1/0001

OFFICE: 311

ROUTE: 564

ST_REF_NO: 00000195850

WEYMOUTH COURT

LUMENS	BULB TYPE	MULT SERIES	POLE TYPE	SHADE	ADDRESS NUMBER	REF	LOCATION	TAX DIST	DATE INST	DATE CHANGE
05800	S	M	CNT	II	03100	001		12	020898	1/1/0001
05800	S	M	CNT	II	03105	002		12	020898	1/1/0001
05800	S	M	CNT	II	03116	003		12	020898	1/1/0001
05800	S	M	CNT	III	03132	004		12	020898	1/1/0001

OFFICE: 311

ROUTE: 564

ST_REF_NO: 00000195900

WHEATCROFT COURT

LUMENS	BULB TYPE	MULT SERIES	POLE TYPE	SHADE	ADDRESS NUMBER	REF	LOCATION	TAX DIST	DATE INST	DATE CHANGE
05800	S	M	OUG	II	00800	000		12	011667	1/1/0001
05800	S	M	OUG	II	00813	000		12	060468	1/1/0001
05800	S	M	OUG	V	00829	000		12	011667	1/1/0001

OFFICE: 311

ROUTE: 564

ST_REF_NO: 00000196000

WHIPPLE COURT

LUMENS	BULB TYPE	MULT SERIES	POLE TYPE	SHADE	ADDRESS NUMBER	REF	LOCATION	TAX DIST	DATE INST	DATE CHANGE
05800	S	M	OUG	II	00000	050	SIDE OF 1025 NANDINO BLVD.	12	090171	1/1/0001
05800	S	M	OUG	II	01003	049		12	082373	1/1/0001
05800	S	M	OUG	II	01036	052		12	051480	1/1/0001
05800	S	M	OUG	II	01051	053		12	051480	1/1/0001
05800	S	M	OUG	V	01067	056		12	092674	1/1/0001
05800	S	M	OUG	II	01068	054		12	092674	1/1/0001
05800	S	M	OUG	V	01068	055		12	092674	1/1/0001
05800	S	M	OUG	II	01119	051		12	082373	1/1/0001

OFFICE: 311

ROUTE: 564

ST_REF_NO: 00000196075

WHISPERING BROOK TRACE

LUMENS	BULB TYPE	MULT SERIES	POLE TYPE	SHADE	ADDRESS NUMBER	REF	LOCATION	TAX DIST	DATE INST	DATE CHANGE
05800	S	M	OUG	II	00000	001	SIDE OF 725 RAMBLING CREEK ON WHISPERING BROOK TR	12	091001	1/1/0001
05800	S	M	OUG	II	00716	002		12	091001	1/1/0001
05800	S	M	OUG	II	00733	003		12	091001	1/1/0001
05800	S	M	OUG	III	00744	004		12	091001	1/1/0001

OFFICE: 311

ROUTE: 564

ST_REF_NO: 00000196100

WHISPERING HILLS DRIVE

LUMENS	BULB TYPE	MULT SERIES	POLE TYPE	SHADE	ADDRESS NUMBER	REF	LOCATION	TAX DIST	DATE INST	DATE CHANGE
04000	S	M	OUG	II	00000	007	SIDE OF 3700 CAMELOT	12	101475	1/1/0001
04000	S	M	OUG	II	00414	008		12	081476	1/1/0001
04000	S	M	OUG	II	00421	009		12	081476	1/1/0001
04000	S	M	OUG	II	00434	010		12	081476	1/1/0001
04000	S	M	OUG	II	00449	011		12	041478	1/1/0001
05800	S	M	OUG	II	00458	012		12	081476	1/1/0001
04000	S	M	OUG	II	00473	013		12	041478	1/1/0001
04000	S	M	OUG	II	00478	014		12	041478	1/1/0001
04000	S	M	OUG	II	00494	016		12	081476	1/1/0001
04000	S	M	OUG	II	00497	015		12	081476	1/1/0001
04000	S	M	OUG	II	00509	017		12	041478	1/1/0001

OFFICE: 311

ROUTE: 564

ST_REF_NO: 00000196200

WHITE AVENUE

LUMENS	BULB TYPE	MULT SERIES	POLE TYPE	SHADE	ADDRESS NUMBER	REF	LOCATION	TAX DIST	DATE INST	DATE CHANGE
04000	S	M	SOH	II	00000	019	SIDE 344 RICHMOND AVE.	12	050885	1/1/0001
04000	S	M	SOH	II	00239	020		12	050885	1/1/0001

OFFICE: 311

ROUTE: 564

ST_REF_NO: 00000196475

WHITEBERRY DRIVE

LUMENS	BULB TYPE	MULT SERIES	POLE TYPE	SHADE	ADDRESS NUMBER	REF	LOCATION	TAX DIST	DATE INST	DATE CHANGE
05800	S	M	CNT	II	00000	005	SIDE OF 100 RED CEDAR CT ON WHITEBERRY DR	12	091001	1/1/0001
05800	S	M	CNT	II	02601	001		12	091001	1/1/0001
05800	S	M	CNT	II	02609	002		12	091001	1/1/0001
05800	S	M	CNT	II	02620	003		12	120403	1/1/0001
05800	S	M	CNT	II	02637	004		12	091001	1/1/0001
05800	S	M	CNT	II	02657	006		12	091001	1/1/0001
05800	S	M	CNT	II	02668	007		12	120403	1/1/0001
05800	S	M	CNT	II	02673	008		12	091001	1/1/0001
05800	S	M	CNT	II	02700	009		12	120403	1/1/0001
05800	S	M	CNT	III	02713	010		12	120403	1/1/0001
05800	S	M	CNT	II	02732	011		12	091001	1/1/0001
05800	S	M	CNT	II	02748	012		12	091001	1/1/0001
05800	S	M	CNT	II	02764	013		12	091001	1/1/0001

OFFICE: 311		ROUTE: 564		ST_REF_NO: 00000196475		WHITEBERRY DRIVE				
LUMENS	BULB TYPE	MULT SERIES	POLE TYPE	SHADE	ADDRESS NUMBER	REF	LOCATION	TAX DIST	DATE INST	DATE CHANGE
05800	S	M	CNT	II	02784	014		12	091001	1/1/0001
05800	S	M	CNT	II	02796	015		12	091001	1/1/0001

OFFICE: 311		ROUTE: 564		ST_REF_NO: 00000196500		WHITEHALL PLACE				
LUMENS	BULB TYPE	MULT SERIES	POLE TYPE	SHADE	ADDRESS NUMBER	REF	LOCATION	TAX DIST	DATE INST	DATE CHANGE
05800	S	M	SOH	II	01024	000		12	121262	1/1/0001
05800	S	M	OUG	II	01028	000		12	050160	1/1/0001
05800	S	M	OUG	II	01033	000		12	060161	1/1/0001
05800	S	M	OUG	II	01038	000		12	090266	1/1/0001

OFFICE: 311		ROUTE: 564		ST_REF_NO: 00000196503		WHITE OAK TRACE				
LUMENS	BULB TYPE	MULT SERIES	POLE TYPE	SHADE	ADDRESS NUMBER	REF	LOCATION	TAX DIST	DATE INST	DATE CHANGE
05800	S	M	CNT	II	00000	009	SIDE OF 2900 BRIGGS PLACE ON WHITE OAK TRACE	12	060304	1/1/0001
05800	S	M	CNT	II	00101	001		12	060304	1/1/0001
05800	S	M	CNT	II	00112	002		12	060304	1/1/0001
05800	S	M	CNT	II	00117	003		12	060304	1/1/0001
05800	S	M	CNT	II	00128	004		12	060304	1/1/0001
05800	S	M	CNT	II	00137	005		12	060304	1/1/0001
05800	S	M	CNT	II	00141	006		12	060304	1/1/0001
05800	S	M	CNT	II	00157	007		12	060304	1/1/0001
05800	S	M	CNT	III	00168	008		12	060304	1/1/0001
05800	S	M	CNT	II	00200	010		12	060304	1/1/0001
05800	S	M	CNT	II	00217	011		12	060304	1/1/0001
05800	S	M	CNT	II	00232	012		12	060304	1/1/0001
05800	S	M	CNT	II	00257	013		12	060304	1/1/0001

OFFICE: 311		ROUTE: 564		ST_REF_NO: 00000196505		WHITE PINE DRIVE				
LUMENS	BULB TYPE	MULT SERIES	POLE TYPE	SHADE	ADDRESS NUMBER	REF	LOCATION	TAX DIST	DATE INST	DATE CHANGE
05800	S	M	CNT	II	00000	005	SIDE OF 3708	12	110895	1/1/0001
05800	S	M	CNT	III	03606	013		12	040897	1/1/0001
05800	S	M	CNT	II	03614	012		12	040897	1/1/0001

OFFICE: 311		ROUTE: 564		ST_REF_NO: 00000196505		WHITE PINE DRIVE		LUMENS	BULB TYPE	MULT SERIES	POLE TYPE	SHADE	ADDRESS NUMBER	REF	LOCATION	TAX DIST	DATE INST	DATE CHANGE
	05800	S	M	CNT	II	03633	011									12	040897	1/1/0001
	05800	S	M	CNT	III	03649	010									12	040897	1/1/0001
	05800	S	M	CNT	II	03661	009									12	040897	1/1/0001
	05800	S	M	CNT	II	03677	008									12	040897	1/1/0001
	05800	S	M	CNT	II	03692	007									12	040897	1/1/0001
	05800	S	M	CNT	II	03709	006									21	110895	1/1/0001
	05800	S	M	CNT	II	03753	004									12	110895	1/1/0001
	05800	S	M	CNT	II	03768	003									12	110895	1/1/0001
	05800	S	M	CNT	II	03784	002									12	110895	1/1/0001
	05800	S	M	CNT	II	03797	001									12	110895	1/1/0001

OFFICE: 311

ROUTE: 564

OFFICE: 311		ROUTE: 564		ST_REF_NO: 00000196560		WHITE WOOD FLAT		LUMENS	BULB TYPE	MULT SERIES	POLE TYPE	SHADE	ADDRESS NUMBER	REF	LOCATION	TAX DIST	DATE INST	DATE CHANGE
	05800	S	M	CNT	II	00801	001									12	121106	1/1/0001
	05800	S	M	CNT	II	00812	002									12	121106	1/1/0001
	05800	S	M	CNT	II	00829	003									12	121106	1/1/0001
	05800	S	M	CNT	II	00844	004									12	121106	1/1/0001
	05800	S	M	CNT	II	00865	005									12	121106	1/1/0001

OFFICE: 311

ROUTE: 564

OFFICE: 311		ROUTE: 564		ST_REF_NO: 00000196610		WHITEWATER CIRCLE		LUMENS	BULB TYPE	MULT SERIES	POLE TYPE	SHADE	ADDRESS NUMBER	REF	LOCATION	TAX DIST	DATE INST	DATE CHANGE
	05800	S	M	CNT	II	00500	001									12	080895	1/1/0001
	05800	S	M	CNT	III	00512	002									12	080895	1/1/0001

OFFICE: 311

ROUTE: 564

OFFICE: 311		ROUTE: 564		ST_REF_NO: 00000196620		WHITEWATER DRIVE		LUMENS	BULB TYPE	MULT SERIES	POLE TYPE	SHADE	ADDRESS NUMBER	REF	LOCATION	TAX DIST	DATE INST	DATE CHANGE
	05800	S	M	CNT	II	00000	004									12	080895	1/1/0001
	05800	S	M	CNT	III	04005	006									12	080895	1/1/0001
	05800	S	M	CNT	II	04013	005									12	080895	1/1/0001
	05800	S	M	CNT	III	04033	003									12	080895	1/1/0001
	05800	S	M	CNT	II	04048	002									12	080895	1/1/0001

OFFICE: 311

ROUTE: 564

ST_REF_NO: 00000196620

WHITEWATER DRIVE

LUMENS	BULB TYPE	MULT SERIES	POLE TYPE	SHADE	ADDRESS NUMBER	REF	LOCATION	TAX DIST	DATE INST	DATE CHANGE
05800	S	M	CNT	II	04057	001		12	080895	1/1/0001

OFFICE: 311

ROUTE: 564

ST_REF_NO: 00000196700

WHITFIELD DRIVE

LUMENS	BULB TYPE	MULT SERIES	POLE TYPE	SHADE	ADDRESS NUMBER	REF	LOCATION	TAX DIST	DATE INST	DATE CHANGE
05800	S	M	CNT	II	00000	001	SIDE OF 4384 BROOKRIDGE DR ON WHITFIELD DR	12	060205	1/1/0001
05800	S	M	CNT	III	00000	002	SIDE OF 4401 WHITFIELD CIRCLE ON WHITFIELD DR	12	050404	1/1/0001
05800	S	M	CNT	III	00521	003		12	060205	1/1/0001
04000	S	M	OUG	II	00000	102	SIDE 4501 ALIGAN WAY	12	090886	1/1/0001
04000	S	M	OUG	II	00200	088		12	090886	1/1/0001
04000	S	M	OUG	II	00209	089		12	090886	1/1/0001
04000	S	M	OUG	II	00224	090		12	090886	1/1/0001
04000	S	M	OUG	II	00233	091		12	090886	1/1/0001
04000	S	M	OUG	II	00304	124		12	080886	1/1/0001
04000	S	M	OUG	II	00312	125		12	080886	1/1/0001
05800	S	M	CNT	II	00000	131	SIDE OF 400 AMBERLEY DRIVE	12	060800	1/1/0001
05800	S	M	CNT	II	00000	139	SIDE OF 545 AMBERLEY DRIVE	12	060800	1/1/0001
04000	S	M	OUG	II	00321	126		12	080886	1/1/0001
04000	S	M	OUG	II	00333	127		12	080886	1/1/0001
04000	S	M	OUG	II	00344	128		12	080886	1/1/0001
05800	S	M	CNT	II	00349	129		12	060800	1/1/0001
05800	S	M	CNT	II	00361	130		12	060800	1/1/0001
05800	S	M	CNT	II	00384	132		12	060800	1/1/0001
05800	S	M	CNT	II	00397	133		12	060800	1/1/0001
05800	S	M	CNT	II	00404	134		12	060800	1/1/0001
05800	S	M	CNT	II	00416	135		12	060800	1/1/0001
05800	S	M	CNT	II	00429	136		12	060800	1/1/0001
05800	S	M	CNT	II	00444	137		12	060800	1/1/0001
05800	S	M	CNT	II	00452	138		12	060800	1/1/0001
05800	S	M	CNT	II	00477	140		12	060800	1/1/0001

OFFICE: 311

ROUTE: 564

ST_REF_NO: 00000196705 WHITFIELD CIRCLE

LUMENS	BULB TYPE	MULT SERIES	POLE TYPE	SHADE	ADDRESS NUMBER	REF	LOCATION	TAX DIST	DATE INST	DATE CHANGE
05800	S	M	CNT	III	04401	001		12	050404	1/1/0001

OFFICE: 311

ROUTE: 564

ST_REF_NO: 00000196750 WHITMER WAY

LUMENS	BULB TYPE	MULT SERIES	POLE TYPE	SHADE	ADDRESS NUMBER	REF	LOCATION	TAX DIST	DATE INST	DATE CHANGE
09500	S		OUG	II	00000	001	1ST LT N OF MCKINLEY ST., E SIDE OF WHITMER WAY	12	102309	1/1/0001
09500	S		OUG	II	00000	002	2ND LT N OF MCKINLEY ST., E SIDE OF WHITMER WAY	12	102309	1/1/0001
09500	S		OUG	II	01805	003		12	102309	1/1/0001
09500	S		OUG	II	01820	004		12	102309	1/1/0001
09500	S		OUG	II	01824	005		12	102309	1/1/0001
09500	S		OUG	II	01840	006		12	102309	1/1/0001
09500	S		OUG	II	01848	007		12	102309	1/1/0001

OFFICE: 311

ROUTE: 564

ST_REF_NO: 00000196800 WHITNEY AVENUE

LUMENS	BULB TYPE	MULT SERIES	POLE TYPE	SHADE	ADDRESS NUMBER	REF	LOCATION	TAX DIST	DATE INST	DATE CHANGE
05800	S	M	SOH	III	00765	000		12	020166	1/1/0001
05800	S	M	SOH	III	00801	000		12	121365	1/1/0001
05800	S	M	SOH	III	00829	000		12	020865	1/1/0001
05800	S	M	SOH	III	00849	000		12	011865	1/1/0001
05800	S	M	SOH	II	00869	000		12	060266	1/1/0001
05800	S	M	SOH	III	00911	000		12	121365	1/1/0001
05800	S	M	SOH	III	00937	000		12	011865	1/1/0001
05800	S	M	SOH	III	00715	000		12	011865	1/1/0001
05800	S	M	SOH	III	00737	000		12		1/1/0001

OFFICE: 311

ROUTE: 564

ST_REF_NO: 00000196840 WHITNEY WOODS PLACE

LUMENS	BULB TYPE	MULT SERIES	POLE TYPE	SHADE	ADDRESS NUMBER	REF	LOCATION	TAX DIST	DATE INST	DATE CHANGE
05800	S	M	OUG	III	00704	001		12	090898	1/1/0001
05800	S	M	OUG	II	00713	002		12	090898	1/1/0001
05800	S	M	OUG	II	00721	003		12	090898	1/1/0001
05800	S	M	OUG	II	00732	004		12	090898	1/1/0001

OFFICE: 311		ROUTE: 564		ST_REF_NO: 00000196840		WHITNEY WOODS PLACE		LUMENS	BULB TYPE	MULT SERIES	POLE TYPE	SHADE	ADDRESS NUMBER	REF	LOCATION	TAX DIST	DATE INST	DATE CHANGE
05800	S	M	OUG	III	00740	005										12	090898	1/1/0001
OFFICE: 311		ROUTE: 564		ST_REF_NO: 00000196850		WHITT COURT		LUMENS	BULB TYPE	MULT SERIES	POLE TYPE	SHADE	ADDRESS NUMBER	REF	LOCATION	TAX DIST	DATE INST	DATE CHANGE
05800	S	M	OUG	II	00000	110	SIDE OF 657 ANNISTON DR.									12	010166	1/1/0001
05800	S	M	OUG	V	02013	111										12	010166	1/1/0001
OFFICE: 311		ROUTE: 564		ST_REF_NO: 00000196900		WHITTINGTON COURT		LUMENS	BULB TYPE	MULT SERIES	POLE TYPE	SHADE	ADDRESS NUMBER	REF	LOCATION	TAX DIST	DATE INST	DATE CHANGE
05800	S	M	OUG	II	00000	148	SIDE OF 3353 PEPPERHILL RD.									12	081475	1/1/0001
05800	S	M	OUG	V	01201	149										12	011581	1/1/0001
OFFICE: 311		ROUTE: 564		ST_REF_NO: 00000196910		WHITWOOD PLACE		LUMENS	BULB TYPE	MULT SERIES	POLE TYPE	SHADE	ADDRESS NUMBER	REF	LOCATION	TAX DIST	DATE INST	DATE CHANGE
04000	S	M	OUG	II	02708	031										12	090884	1/1/0001
OFFICE: 311		ROUTE: 564		ST_REF_NO: 00000197000		WICHITA DRIVE		LUMENS	BULB TYPE	MULT SERIES	POLE TYPE	SHADE	ADDRESS NUMBER	REF	LOCATION	TAX DIST	DATE INST	DATE CHANGE
04000	S	M	OUG	II	00604	041										12	101583	1/1/0001
04000	S	M	OUG	II	00609	040										12	101583	1/1/0001
04000	S	M	OUG	II	00616	039										12	101583	1/1/0001
04000	S	M	OUG	II	00619	038										12	101583	1/1/0001
04000	S	M	OUG	II	00624	037										12	101583	1/1/0001
04000	S	M	OUG	II	00629	036										12	101583	1/1/0001
04000	S	M	OUG	II	00634	035										12	101583	1/1/0001
04000	S	M	OUG	II	00637	034										12	101583	1/1/0001
04000	S	M	OUG	II	00644	033										12	101583	1/1/0001

OFFICE: 311

ROUTE: 564

ST_REF_NO: 00000197010 WICKLAND CIRCLE

LUMENS	BULB TYPE	MULT SERIES	POLE TYPE	SHADE	ADDRESS NUMBER	REF	LOCATION	TAX DIST	DATE INST	DATE CHANGE
05800	S	M	OUG	V	01954	000		12	071668	1/1/0001

OFFICE: 311

ROUTE: 564

ST_REF_NO: 00000197020 WICKLAND COURT

LUMENS	BULB TYPE	MULT SERIES	POLE TYPE	SHADE	ADDRESS NUMBER	REF	LOCATION	TAX DIST	DATE INST	DATE CHANGE
05800	S	M	OUG	II	00000	037	OPP. 331	12	011066	1/1/0001
05800	S	M	OUG	II	00343	038		12	011066	1/1/0001

OFFICE: 311

ROUTE: 564

ST_REF_NO: 00000197100 WICKLAND DRIVE

LUMENS	BULB TYPE	MULT SERIES	POLE TYPE	SHADE	ADDRESS NUMBER	REF	LOCATION	TAX DIST	DATE INST	DATE CHANGE
05800	S	M	OUG	II	00000	029	SIDE OF 1937	12	011066	1/1/0001
05800	S	M	OUG	II	01877	036		12	011066	1/1/0001
05800	S	M	OUG	II	01896	034		12	011066	1/1/0001
05800	S	M	OUG	II	01905	033		12	011066	1/1/0001
05800	S	M	OUG	II	01914	032		12	011066	1/1/0001
05800	S	M	OUG	II	01929	031		12	091167	1/1/0001
05800	S	M	OUG	II	01942	030		12	011066	1/1/0001

OFFICE: 311

ROUTE: 564

ST_REF_NO: 00000197200 WICKLIFFE STREET

LUMENS	BULB TYPE	MULT SERIES	POLE TYPE	SHADE	ADDRESS NUMBER	REF	LOCATION	TAX DIST	DATE INST	DATE CHANGE
05800	S	M	SOH	I	00000	075	1ST LT. W. OF SPRUCE ST., S. SIDE	12	110166	1/1/0001
05800	S	M	SOH	I	00212	073		12	110166	1/1/0001
05800	S	M	SOH	I	00220	074		12	110166	1/1/0001

OFFICE: 311

ROUTE: 564

ST_REF_NO: 00000197250 WIDENER COURT

LUMENS	BULB TYPE	MULT SERIES	POLE TYPE	SHADE	ADDRESS NUMBER	REF	LOCATION	TAX DIST	DATE INST	DATE CHANGE
05800	S	M	CNT	II	00700	001		12	110897	1/1/0001
05800	S	M	CNT	II	00724	002		12	110897	1/1/0001

OFFICE: 311		ROUTE: 564		ST_REF_NO: 00000197275		WIGGINTON POINT		LUMENS	BULB TYPE	MULT SERIES	POLE TYPE	SHADE	ADDRESS NUMBER	REF	LOCATION	TAX DIST	DATE INST	DATE CHANGE
05800	S	M	CNT	II	00000	005	SIDE OF 652 GREEN VALLEY DR ON WIGGINTON POINT	12	101905	1/1/0001								
05800	S	M	CNT	II	02704	004		12	101905	1/1/0001								
05800	S	M	CNT	II	02721	003		12	101905	1/1/0001								
05800	S	M	CNT	II	02740	002		12	101905	1/1/0001								
05800	S	M	CNT	II	02749	001		12	101905	1/1/0001								
OFFICE: 311		ROUTE: 564		ST_REF_NO: 00000197400		WILDWOOD AVENUE		LUMENS	BULB TYPE	MULT SERIES	POLE TYPE	SHADE	ADDRESS NUMBER	REF	LOCATION	TAX DIST	DATE INST	DATE CHANGE
04000	S	M	SOH	II	00000	001	SIDE OF 200 SHADY LANE	12	120888	1/1/0001								
04000	S	M	OOH	II	00000	002	SIDE OF 137 TAHOMA RD.	12	120888	1/1/0001								
OFFICE: 311		ROUTE: 564		ST_REF_NO: 00000197500		WILGUS AVENUE		LUMENS	BULB TYPE	MULT SERIES	POLE TYPE	SHADE	ADDRESS NUMBER	REF	LOCATION	TAX DIST	DATE INST	DATE CHANGE
05800	S	M	SOH	I	00000	001	SIDE OF 407 E. 3RD ST.	12	100162	1/1/0001								
05800	S	M	SOH	I	00000	002	OPP. 325	12	100162	1/1/0001								
05800	S	M	SOH	I	00331	000		12	100162	1/1/0001								
05800	S	M	SOH	I	00338	000		12	100162	1/1/0001								
OFFICE: 311		ROUTE: 564		ST_REF_NO: 00000197600		WILHITE DRIVE		LUMENS	BULB TYPE	MULT SERIES	POLE TYPE	SHADE	ADDRESS NUMBER	REF	LOCATION	TAX DIST	DATE INST	DATE CHANGE
09500	S	M	OUG	II	02680	006	bad fixture	12	111478	12/7/2010								
09500	S	M	OUG	II	02691	008		12	111478	12/13/2012								
05800	S	M	OUG	II	00000	013	OPP. 2600	12	041577	1/1/0001								
05800	S	M	OUG	II	00000	015	OPP. 2600	12	041577	1/1/0001								
05800	S	M	OUG	II	00000	017	OPP. 2600	12	041577	1/1/0001								
05800	S	M	OUG	II	02600	014		12	041577	1/1/0001								
05800	S	M	OUG	II	02600	016		12	041577	1/1/0001								
05800	S	M	OUG	II	02600	018		12	041577	1/1/0001								
10000	M	M	OUG	II	02620	001		12	111478	1/1/0001								
10000	M	M	OUG	II	02620	002		12	111478	1/1/0001								
10000	M	M	OUG	II	02660	003		12	111478	1/1/0001								

OFFICE: 311

ROUTE: 564

ST_REF_NO: 00000197600

WILHITE DRIVE

LUMENS	BULB TYPE	MULT SERIES	POLE TYPE	SHADE	ADDRESS NUMBER	REF	LOCATION	TAX DIST	DATE INST	DATE CHANGE
10000	M	M	OUG	II	02670	005		12	111478	1/1/0001
10000	M	M	OUG	II	02691	009		12	111478	1/1/0001
10000	M	M	OUG	II	02700	010		12	041578	1/1/0001
10000	M	M	OUG	II	02700	011		12	041578	1/1/0001

OFFICE: 311

ROUTE: 564

ST_REF_NO: 00000197650

WILKERSON ALLEY

LUMENS	BULB TYPE	MULT SERIES	POLE TYPE	SHADE	ADDRESS NUMBER	REF	LOCATION	TAX DIST	DATE INST	DATE CHANGE
05800	S	M	SOH	I	00000	001	1ST LT. S. OF FIFTH ST., E. SIDE	12	070963	1/1/0001
05800	S	M	SOH	I	00000	002	1ST LT. S. OF FIFTH ST., W. SIDE	12	070963	1/1/0001
05800	S	M	SOH	I	00000	003	2ND LT. S. OF FIFTH ST., W. SIDE	12	070963	1/1/0001

OFFICE: 311

ROUTE: 564

ST_REF_NO: 00000197660

WILKES WAY

LUMENS	BULB TYPE	MULT SERIES	POLE TYPE	SHADE	ADDRESS NUMBER	REF	LOCATION	TAX DIST	DATE INST	DATE CHANGE
05800	S	M	OUG	II	02112	005		12	060401	1/1/0001
05800	S	M	OUG	II	02129	004		12	060401	1/1/0001
05800	S	M	OUG	II	02148	003		12	060401	1/1/0001
05800	S	M	OUG	II	02168	002		12	060401	1/1/0001
05800	S	M	OUG	III	02177	001		12	060401	1/1/0001

OFFICE: 311

ROUTE: 564

ST_REF_NO: 00000197700

WILLARD STREET

LUMENS	BULB TYPE	MULT SERIES	POLE TYPE	SHADE	ADDRESS NUMBER	REF	LOCATION	TAX DIST	DATE INST	DATE CHANGE
05800	S	M	SOH	II	00000	001	SIDE 950 MANCHESTER	12	030886	1/1/0001
05800	S	M	SOH	II	00000	002	SIDE 950 MANCHESTER	12	030886	1/1/0001
05800	S	M	SOH	II	00000	008	SIDE 969 VALLEY AVE.	12	020893	1/1/0001
05800	S	M	SOH	II	00221	003		12	030886	1/1/0001
05800	S	M	SOH	II	00237	004		12	030886	1/1/0001
05800	S	M	SOH	II	00249	005		12	030886	1/1/0001
05800	S	M	SOH	II	00261	006		12	030886	1/1/0001
05800	S	M	SOH	II	00279	007		12	030886	1/1/0001

OFFICE: 311

ROUTE: 564

ST_REF_NO: 00000197800

WILL FANT DRIVE

LUMENS	BULB TYPE	MULT SERIES	POLE TYPE	SHADE	ADDRESS NUMBER	REF	LOCATION	TAX DIST	DATE INST	DATE CHANGE
05800	S	M	SOH	III	00000	001	SIDE OF 2112 WILL FANT DR.	12	120158	1/1/0001
05800	S	M	OUG	III	00000	002	OPP. 2157	12	040159	1/1/0001
05800	S	M	OUG	III	02120	000		12	040159	1/1/0001
05800	S	M	OUG	III	02145	000		12	040159	1/1/0001

OFFICE: 311

ROUTE: 564

ST_REF_NO: 00000197900

WILLIAMSBURG COURT

LUMENS	BULB TYPE	MULT SERIES	POLE TYPE	SHADE	ADDRESS NUMBER	REF	LOCATION	TAX DIST	DATE INST	DATE CHANGE
04000	S	M	OUG	II	00000	001	SIDE OF 1725 WILLIAMSBURG RD.	12	020889	1/1/0001
04000	S	M	OUG	V	01713	002		12	020889	1/1/0001

OFFICE: 311

ROUTE: 564

ST_REF_NO: 00000198000

WILLIAMSBURG ROAD

LUMENS	BULB TYPE	MULT SERIES	POLE TYPE	SHADE	ADDRESS NUMBER	REF	LOCATION	TAX DIST	DATE INST	DATE CHANGE
04000	S	M	OUG	II	01680	022		12	020889	1/1/0001
04000	S	M	OUG	II	01688	023		12	020889	1/1/0001
04000	S	M	OUG	II	01696	024		12	020889	1/1/0001
04000	S	M	OUG	II	01701	025		12	020889	1/1/0001
04000	S	M	OUG	II	01705	026		12	020889	1/1/0001
04000	S	M	OUG	II	01724	029		12	020889	1/1/0001
04000	S	M	OUG	II	01729	027		12	020889	1/1/0001
04000	S	M	OUG	II	01733	028		12	020889	1/1/0001
04000	S	M	OUG	II	01803	030		12	020889	1/1/0001
04000	S	M	OUG	II	01804	031		12	020889	1/1/0001
04000	S	M	OUG	II	01813	032		12	020889	1/1/0001
04000	S	M	OUG	II	00000	036	SIDE OF 1165 LANE ALLEN RD.	12	020889	1/1/0001
04000	S	M	OUG	II	00000	044	SIDE OF 1175 ATHENIA DR.	12	120888	1/1/0001
04000	S	M	OUG	II	00000	045	SIDE OF 1174 ATHENIA DR.	12	120888	1/1/0001
04000	S	M	OUG	II	00000	046	OPP. 2029	12	120888	1/1/0001
05800	S	M	OUG	II	00000	051	SIDE OF 2093 FALLON RD.	12	101465	1/1/0001
05800	S	M	OUG	II	00000	056	SIDE OF 2135 GEORGIAN WAY	12	101465	1/1/0001
04000	S	M	OUG	II	01824	033		12	020889	1/1/0001
04000	S	M	OUG	II	01833	034		12	020889	1/1/0001
04000	S	M	OUG	II	01844	035		12	020889	1/1/0001

OFFICE: 311		ROUTE: 564		ST_REF_NO: 00000198000		WILLIAMSBURG ROAD		LUMENS	BULB TYPE	MULT SERIES	POLE TYPE	SHADE	ADDRESS NUMBER	REF	LOCATION	TAX DIST	DATE INST	DATE CHANGE
	04000	S	M	OUG	II	01904	037									12	120888	1/1/0001
	04000	S	M	OUG	II	01915	038									12	120888	1/1/0001
	04000	S	M	OUG	II	01920	039									12	120888	1/1/0001
	04000	S	M	OUG	II	01928	040									12	120888	1/1/0001
	04000	S	M	OUG	II	01936	041									12	120888	1/1/0001
	04000	S	M	OUG	II	01943	042									12	120888	1/1/0001
	04000	S	M	OUG	II	02005	043									12	120888	1/1/0001
	04000	S	M	OUG	II	02038	047									12	120888	1/1/0001
	04000	S	M	OUG	II	02045	048									12	120888	1/1/0001
	04000	S	M	OUG	II	02054	049									12	120888	1/1/0001
	04000	S	M	OUG	II	02061	050									12	120888	1/1/0001
	05800	S	M	OUG	II	02077	052									12	101465	1/1/0001
	05800	S	M	OUG	II	02084	053									12	101465	1/1/0001
	05800	S	M	OUG	II	02091	054									12	101465	1/1/0001
	05800	S	M	OUG	II	02096	055									12	101465	1/1/0001
OFFICE: 311		ROUTE: 564		ST_REF_NO: 00000198120		WILLIS DRIVE		LUMENS	BULB TYPE	MULT SERIES	POLE TYPE	SHADE	ADDRESS NUMBER	REF	LOCATION	TAX DIST	DATE INST	DATE CHANGE
	05800	S	M	OUG	II	02001	004									12	121606	1/1/0001
	05800	S	M	OUG	II	02012	003									12	121606	1/1/0001
	05800	S	M	OUG	II	02025	002									12	021508	1/1/0001
	05800	S	M	OUG	II	02037	001									12	121606	1/1/0001
OFFICE: 311		ROUTE: 564		ST_REF_NO: 00000198125		WILLMAN WAY		LUMENS	BULB TYPE	MULT SERIES	POLE TYPE	SHADE	ADDRESS NUMBER	REF	LOCATION	TAX DIST	DATE INST	DATE CHANGE
	05800	S	M	CNT	II	00000	004							SIDE OF 4513 GILLMOSS LANE ON WILLMAN WAY	12	062307	1/1/0001	
	05800	S	M	CNT	II	04473	001								12	062307	1/1/0001	
	05800	S	M	CNT	II	04477	002								12	062307	1/1/0001	
	05800	S	M	CNT	II	04489	003								12	062307	1/1/0001	

OFFICE: 311

ROUTE: 564

ST_REF_NO: 00000198200

WILLOWLAWN AVENUE

LUMENS	BULB TYPE	MULT SERIES	POLE TYPE	SHADE	ADDRESS NUMBER	REF	LOCATION	TAX DIST	DATE INST	DATE CHANGE
04000	S	M	SOH	II	00000	095	SIDE 136 LOCUST AVE.	12	050885	1/1/0001
04000	S	M	SOH	II	00000	096	SIDE 201 LOCUST AVE.	12	050885	1/1/0001
04000	S	M	SOH	II	00000	097	SIDE 116 BLUEGRASS AVE.	12	050885	1/1/0001
04000	S	M	SOH	II	00000	098	SIDE 201 BLUEGRASS AVE.	12	050885	1/1/0001
04000	S	M	SOH	II	01406	099		12	050885	1/1/0001

OFFICE: 311

ROUTE: 564

ST_REF_NO: 00000198210

WILLOWLAWN LANE

LUMENS	BULB TYPE	MULT SERIES	POLE TYPE	SHADE	ADDRESS NUMBER	REF	LOCATION	TAX DIST	DATE INST	DATE CHANGE
04000	S	M	SOH	II	00000	100	OPP. 1403 1/2	12	050885	1/1/0001
04000	S	M	SOH	II	00000	101	REAR 1413 HIGHLAWN	12	050885	1/1/0001
04000	S	M	SOH	II	00000	102	REAR 1431 HIGHLAWN	12	050885	1/1/0001
04000	S	M	SOH	II	00000	103	OPP. REAR 1443 HIGHLAWN AVE.	12	050885	1/1/0001
04000	S	M	SOH	II	00000	104	SIDE 1445 HIGHLAWN AVE.	12	050885	1/1/0001
04000	S	M	SOH	II	00000	105	SIDE 1445 HIGHLAWN AVE.	12	050885	1/1/0001

OFFICE: 311

ROUTE: 564

ST_REF_NO: 00000198215

WILLOW SPRING

LUMENS	BULB TYPE	MULT SERIES	POLE TYPE	SHADE	ADDRESS NUMBER	REF	LOCATION	TAX DIST	DATE INST	DATE CHANGE
05800	S	M	CNT	II	03512	001		12	110894	1/1/0001
05800	S	M	CNT	II	03517	002		12	060894	1/1/0001
05800	S	M	CNT	II	03528	003		12	060894	1/1/0001
05800	S	M	CNT	II	03605	004		12	060894	1/1/0001
05800	S	M	CNT	II	03608	005		12	060894	1/1/0001
05800	S	M	CNT	II	03620	006		12	060894	1/1/0001

OFFICE: 311

ROUTE: 564

ST_REF_NO: 00000198220

WILLOW OAK CIRCLE

LUMENS	BULB TYPE	MULT SERIES	POLE TYPE	SHADE	ADDRESS NUMBER	REF	LOCATION	TAX DIST	DATE INST	DATE CHANGE
05800	S	M	CNT	II	00000	008	SIDE 3932 LAUREL OAK LANE	12	110895	1/1/0001
05800	S	M	CNT	II	00744	015		12	110895	1/1/0001
05800	S	M	CNT	II	00749	014		12	110895	1/1/0001
05800	S	M	CNT	II	00760	013		12	110895	1/1/0001
05800	S	M	CNT	II	00772	012		12	050899	1/1/0001

OFFICE: 311		ROUTE: 564		ST_REF_NO: 00000198220		WILLOW OAK CIRCLE		LUMENS	BULB TYPE	MULT SERIES	POLE TYPE	SHADE	ADDRESS NUMBER	REF	LOCATION	TAX DIST	DATE INST	DATE CHANGE
	05800	S	M	CNT	II	00781	011									12	110895	1/1/0001
	05800	S	M	CNT	III	00797	010									12	050899	1/1/0001
	05800	S	M	CNT	II	00813	009									12	050899	1/1/0001
	05800	S	M	CNT	II	00837	007									12	050899	1/1/0001
	05800	S	M	CNT	II	00853	005									12	110895	1/1/0001
	05800	S	M	CNT	II	00860	006									12	110895	1/1/0001
	05800	S	M	CNT	II	00865	004									12	110895	1/1/0001
	05800	S	M	CNT	II	00884	003									12	110895	1/1/0001
	05800	S	M	CNT	II	00888	002									12	110895	1/1/0001
	05800	S	M	CNT	II	00893	001									12	110895	1/1/0001

OFFICE: 311		ROUTE: 564		ST_REF_NO: 00000198300		WILLOWOOD ROAD		LUMENS	BULB TYPE	MULT SERIES	POLE TYPE	SHADE	ADDRESS NUMBER	REF	LOCATION	TAX DIST	DATE INST	DATE CHANGE
	05800	S	M	OUG	II	00000	001								OPP. 3531	12	080159	1/1/0001
	05800	S	M	OUG	II	03502	000									12	022359	1/1/0001
	05800	S	M	OUG	II	03507	000									12	040159	1/1/0001
	05800	S	M	OUG	II	03510	000									12	022359	1/1/0001
	05800	S	M	OUG	II	03517	000									12	022359	1/1/0001
	05800	S	M	OUG	II	03520	000									12	040159	1/1/0001
	05800	S	M	OUG	II	03535	000									12	050159	1/1/0001
	05800	S	M	OUG	II	03538	000									12	080159	1/1/0001

OFFICE: 311		ROUTE: 564		ST_REF_NO: 00000198400		WILLY STREET		LUMENS	BULB TYPE	MULT SERIES	POLE TYPE	SHADE	ADDRESS NUMBER	REF	LOCATION	TAX DIST	DATE INST	DATE CHANGE
	05800	S		SOH	II	00482	000									13	011865	1/1/0001
	05800	S	M	SOH	I	00000	001								SIDE OF 498 Willy (911 address change)	12	032520	2/26/2013
	05800	S	M	SOH	II	00514	000									12	011865	1/1/0001

OFFICE: 311		ROUTE: 564		ST_REF_NO: 00000198450		WILMINGTON LANE		LUMENS	BULB TYPE	MULT SERIES	POLE TYPE	SHADE	ADDRESS NUMBER	REF	LOCATION	TAX DIST	DATE INST	DATE CHANGE
	05800	S	M	CNT	II	00000	001								SIDE OF 3377 MALONE DRIVE	12	110800	1/1/0001

OFFICE: 311

ROUTE: 564

ST_REF_NO: 00000198450

WILMINGTON LANE

LUMENS	BULB TYPE	MULT SERIES	POLE TYPE	SHADE	ADDRESS NUMBER	REF	LOCATION	TAX DIST	DATE INST	DATE CHANGE
05800	S	M	CNT	II	02208	002		12	110800	1/1/0001
05800	S	M	CNT	II	02213	003		12	110800	1/1/0001
05800	S	M	CNT	II	02224	004		12	110800	1/1/0001

OFFICE: 311

ROUTE: 564

ST_REF_NO: 00000198500

WILSON STREET

LUMENS	BULB TYPE	MULT SERIES	POLE TYPE	SHADE	ADDRESS NUMBER	REF	LOCATION	TAX DIST	DATE INST	DATE CHANGE
05800	S	M	SOH	I	00000	001	SIDE OF 158 DEWEESE	12	110266	1/1/0001
04000	S	M	SOH	I	00317	002		12	110266	1/1/0001
04000	S	M	SOH	I	00333	003		12	110266	1/1/0001
04000	S	M	SOH	I	00345	004		12	110266	1/1/0001
04000	S	M	SOH	I	00355	005		12	110266	1/1/0001
04000	S	M	SOH	I	00369	006		12	110266	1/1/0001

OFFICE: 311

ROUTE: 564

ST_REF_NO: 00000198600

WILSON DOWNING ROAD

LUMENS	BULB TYPE	MULT SERIES	POLE TYPE	SHADE	ADDRESS NUMBER	REF	LOCATION	TAX DIST	DATE INST	DATE CHANGE
09500	S	M	OUG	II	00000	049	1ST LT E OF CREEL CT N SIDE OF WILSON DOWNING	12	080601	1/1/0001
09500	S	M	OUG	II	00000	050	2ND LT E OF CREEL CT N SIDE OF WILSON DOWNING	12	080601	1/1/0001
09500	S	M	OUG	II	00000	051	3RD LT E OF CREEL CT N SIDE OF WILSON DOWNING	12	080601	1/1/0001
09500	S	M	OUG	II	00000	052	4TH LT E OF CREEK CT N SIDE OF WILSON DOWNING	12	080601	1/1/0001
09500	S	M	OUG	II	00000	053	1ST LT E OF ALLANTE BROOK CT N SIDE OF WILSON DOWN	12	080601	1/1/0001
09500	S	M	OUG	II	00000	054	2ND LT E OF ALLANTE BROOK CT N SIDE OF WILSON DOWN	12	080601	1/1/0001
09500	S	M	OUG	II	00000	055	3RD LT E OF ALLANTE BROOK CT N SIDE OF WILSON DOWN	12	080601	1/1/0001
09500	S	M	OUG	II	00000	056	1ST LT E OF RIDGEPOINT DR N SIDE OF WILSON DOWNING	12	080601	1/1/0001
09500	S	M	OUG	II	00000	057	2ND LT E OF RIDGEPOINT DR N SIDE OF WILSON DOWNING	12	080601	1/1/0001
09500	S	M	OUG	II	00000	058	3RD LT E OF RIDGEPOINT DR S SIDE OF WILSON DOWNING	12	080601	1/1/0001

OFFICE: 311

ROUTE: 564

ST_REF_NO: 00000198600

WILSON DOWNING ROAD

LUMENS	BULB TYPE	MULT SERIES	POLE TYPE	SHADE	ADDRESS NUMBER	REF	LOCATION	TAX DIST	DATE INST	DATE CHANGE
09500	S	M	OUG	II	00000	059	4TH LT E OF RIDGEPOINT DR N SIDE OF WILSON DOWNING	12	080601	1/1/0001
09500	S	M	OUG	II	00000	060	5TH LT E OF RIDGEPOINT DR S SIDE OF WILSON DOWNING	12	080601	1/1/0001
09500	S	M	OUG	II	00000	061	6TH LT E OF RIDGEPOINT DR N SIDE OF WILSON DOWNING	12	080601	1/1/0001
09500	S	M	OUG	II	00000	062	1ST LT E OF WALDEN DR S SIDE OF WILSON DOWNING	12	080601	1/1/0001
09500	S	M	OUG	II	00000	063	2ND LT E OF WALDEN DR N SIDE OF WILSON DOWNING	12	080601	1/1/0001
09500	S	M	OUG	II	00000	064	3RD LT E OF WALDEN DR N SIDE OF WILSON DOWNING	12	080601	1/1/0001
09500	S	M	OUG	II	00000	065	4TH LT E OF WALDEN DR N SIDE OF WILSON DOWNING	12	080601	1/1/0001
09500	S	M	OUG	II	00000	066	5TH LT E OF WALDEN DR N SIDE OF WILSON DOWNING	12	080601	1/1/0001
09500	S	M	OUG	II	00000	067	6TH LT E OF WALDEN DR N SIDE OF WILSON DOWNING	12	080601	1/1/0001
09500	S	M	OUG	II	00000	068	7TH LT E OF WALDEN DR N SIDE OF WILSON DOWNING	12	080601	1/1/0001
09500	S	M	OUG	II	00000	069	8TH LT E OF WALDEN DR S SIDE OF WILSON DOWNING	12	080601	1/1/0001
09500	S	M	OUG	II	00000	070	9TH LT E OF WALDEN DR N SIDE OF WILSON DOWNING	12	080601	1/1/0001
50000	S	M	OUG	II	00000	600	1ST LT E OF NICH RD,S SIDE ON WILSON DOWNING	12	020906	1/1/0001
09500	S	M	SOH	II	00000	001	1ST LT. E. OF NICHOLASVILLE RD., N. SIDE	12	030886	1/1/0001
09500	S	M	SOH	II	00000	002	2ND LT. E. OF NICHOLASVILLE RD., N. SIDE	12	030886	1/1/0001
09500	S	M	SOH	II	00000	003	3RD LT. E. OF NICHOLASVILLE RD., N. SIDE	12	030886	1/1/0001
09500	S	M	SOH	II	00000	005	OPP. 116	12	030886	1/1/0001
09500	S	M	SOH	II	00000	007	OPP. 120	12	030886	1/1/0001
09500	S	M	SOH	II	00000	009	OPP. 124	12	030886	1/1/0001
09500	S	M	SOH	II	00000	011	OPP. 199	12	030886	1/1/0001
09500	S	M	SOH	II	00000	035	OPP. 340	12	030886	1/1/0001
09500	S	M	SOH	II	00000	037	OPP. 340	12	030886	1/1/0001
09500	S	M	SOH	II	00000	038	OPP. 400	12	030886	1/1/0001
09500	S	M	SOH	II	00000	040	OPP. 400	12	030886	1/1/0001
09500	S	M	SOH	II	00000	042	OPP. 400 WILSON DOWNING ROAD	12	020892	1/1/0001

Street Light Listing run 1/11/2015 10:43:21 AM

Page 1216 of 1254

OFFICE: 311

ROUTE: 564

ST_REF_NO: 00000198600

WILSON DOWNING ROAD

LUMENS	BULB TYPE	MULT SERIES	POLE TYPE	SHADE	ADDRESS NUMBER	REF	LOCATION	TAX DIST	DATE INST	DATE CHANGE
09500	S	M	SOH	II	00000	043	OPP. 400 WILSON DOWNING ROAD	12	020892	1/1/0001
09500	S	M	SOH	II	00000	044	1ST LT. W. OF CAMELOT DR., NORTHSIDE	12	020892	1/1/0001
09500	S	M	SOH	II	00000	045	SIDE 3700 CAMELOT DR., S. SIDE	12	030886	1/1/0001
09500	S	M	SOH	II	00000	046	1ST LT. E. OF CAMELOT DR., NORTHSIDE	12	020892	1/1/0001
09500	S	M	SOH	II	00000	047	2ND LT. E. OF CAMELOT DR., NORTHSIDE	12	020892	1/1/0001
09500	S	M	SOH	II	00000	048	2ND LT. E. OF CAMELOT DR., S. SIDE	12	030886	1/1/0001
09500	S	M	SOH	II	00112	004		12	030886	1/1/0001
09500	S	M	SOH	II	00116	006		12	030886	1/1/0001
09500	S	M	SOH	II	00120	008		12	030886	1/1/0001
09500	S	M	SOH	II	00128	010		12	030886	1/1/0001
09500	S	M	SOH	II	00132	012		12	030886	1/1/0001
09500	S	M	SOH	II	00136	014		12	030886	1/1/0001
09500	S	M	SOH	II	00144	016		12	030886	1/1/0001
09500	S	M	SOH	II	00201	013		12	030886	1/1/0001
09500	S	M	SOH	II	00205	015		12	030886	1/1/0001
09500	S	M	SOH	II	00208	020		12	030886	1/1/0001
09500	S	M	SOH	II	00213	017		12	030886	1/1/0001
09500	S	M	SOH	II	00215	018		12	030886	1/1/0001
09500	S	M	SOH	II	00216	022		12	030886	1/1/0001
09500	S	M	SOH	II	00219	019		12	030886	1/1/0001
09500	S	M	SOH	II	00232	024		12	030886	1/1/0001
09500	S	M	SOH	II	00244	026		12	030886	1/1/0001
09500	S	M	SOH	II	00256	028		12	030886	1/1/0001
09500	S	M	SOH	II	00272	030		12	030886	1/1/0001
09500	S	M	SOH	II	00284	032		12	030886	1/1/0001
09500	S	M	SOH	II	00301	021		12	030886	1/1/0001
09500	S	M	SOH	II	00305	023		12	030886	1/1/0001
09500	S	M	SOH	II	00311	025		12	030886	1/1/0001
09500	S	M	SOH	II	00319	027		12	030886	1/1/0001
09500	S	M	SOH	II	00325	029		12	030886	1/1/0001
09500	S	M	SOH	II	00331	031		12	030886	1/1/0001
09500	S	M	SOH	II	00339	033		12	030886	1/1/0001
09500	S	M	SOH	II	00340	034		12	030886	1/1/0001
09500	S	M	SOH	II	00340	036		12	030886	1/1/0001

OFFICE: 311 ROUTE: 564							ST_REF_NO: 00000198600 WILSON DOWNING ROAD			
LUMENS	BULB TYPE	MULT SERIES	POLE TYPE	SHADE	ADDRESS NUMBER	REF	LOCATION	TAX DIST	DATE INST	DATE CHANGE
09500	S	M	SOH	II	00400	039		12	030886	1/1/0001
09500	S	M	SOH	II	00400	041		12	030886	1/1/0001

OFFICE: 311 ROUTE: 564							ST_REF_NO: 00000198800 WILTON AVENUE			
LUMENS	BULB TYPE	MULT SERIES	POLE TYPE	SHADE	ADDRESS NUMBER	REF	LOCATION	TAX DIST	DATE INST	DATE CHANGE
04000	S	M	SOH	II	00000	019	SIDE OF 1200 LEESTOWN RD.	12	070886	1/1/0001
04000	S	M	SOH	II	00105	018		12	070886	1/1/0001
04000	S	M	SOH	II	00111	017		12	070886	1/1/0001
04000	S	M	SOH	II	00117	016		12	070886	1/1/0001
04000	S	M	SOH	II	00123	015		12	070886	1/1/0001
04000	S	M	SOH	II	00129	014		12	070886	1/1/0001
04000	S	M	SOH	II	00201	013		12	082465	1/1/0001
04000	S	M	SOH	II	00205	012		12	082465	1/1/0001
04000	S	M	SOH	II	00211	011		12	082465	1/1/0001

OFFICE: 311 ROUTE: 564							ST_REF_NO: 00000198900 WINBURN DRIVE			
LUMENS	BULB TYPE	MULT SERIES	POLE TYPE	SHADE	ADDRESS NUMBER	REF	LOCATION	TAX DIST	DATE INST	DATE CHANGE
09500	S	M	OUG	II	01060	060		12	102574	4/20/2010
05800	S	M	OUG	II	00000	011	SIDE OF 1840 MCCULLOUGH DR.	12	061269	1/1/0001
10000	M	M	OUG	II	00000	017	SIDE OF 1801 GERALD DR.	12	091477	1/1/0001
05800	S	M	OUG	II	01053	061		12	030171	1/1/0001
05800	S	M	OUG	II	01053	063		12	030171	1/1/0001
05800	S	M	OUG	II	01053	065		12	030171	1/1/0001
05800	S	M	OUG	II	01060	062		12	102574	1/1/0001
05800	S	M	OUG	II	01060	064		12	102574	1/1/0001
10000	M	M	OUG	II	01093	059		12	030171	1/1/0001
10000	M	M	OUG	II	01108	058		12	041476	1/1/0001
10000	M	M	OUG	II	01116	056		12	041476	1/1/0001
09500	S	M	OUG	II	01133	055	change out bad fixture 2/08	12	081475	1/1/0001
10000	M	M	OUG	II	01164	014		12	120887	1/1/0001
10000	M	M	OUG	II	01165	015		12	061269	1/1/0001
10000	M	M	OUG	II	01191	013		12	061269	1/1/0001

OFFICE: 311

ROUTE: 564

ST_REF_NO: 00000198900

WINBURN DRIVE

LUMENS	BULB TYPE	MULT SERIES	POLE TYPE	SHADE	ADDRESS NUMBER	REF	LOCATION	TAX DIST	DATE INST	DATE CHANGE
05800	S	M	OUG	II	00000	010	SIDE OF 1788 MCCULLOUGH DR.	12	061269	1/1/0001
05800	S	M	OUG	II	01231	009		12	061269	1/1/0001
05800	S	M	OUG	II	01238	008		12	070172	1/1/0001
05800	S	M	OUG	II	01247	007		12	061269	1/1/0001
05800	S	M	OUG	II	01254	006		12	100171	1/1/0001
05800	S	M	OUG	II	01259	005		12	070172	1/1/0001
05800	S	M	OUG	II	01274	004		12	070172	1/1/0001
05800	S	M	OUG	II	01287	003		12	061269	1/1/0001
05800	S	M	OUG	II	01294	002		12	010885	1/1/0001
05800	S	M	OUG	II	01299	001		12	061269	1/1/0001

OFFICE: 311

ROUTE: 564

ST_REF_NO: 00000199000

WINCHESTER ROAD

LUMENS	BULB TYPE	MULT SERIES	POLE TYPE	SHADE	ADDRESS NUMBER	REF	LOCATION	TAX DIST	DATE INST	DATE CHANGE
50000	S	M	SOH	II	00000	060	NW CORNER OF INDUSTRY RD ON N SIDE OF WINCHESTER	12	043001	1/1/0001
50000	S	M	OUG	II	00000	061	OPPOSITE 1209 WINCHESTER	12	043001	1/1/0001
22000	S	M	OUG	II	00000	063	2ND LT E OF INDUSTRY RD ON S SIDE OF WINCHESTER	12	043001	1/1/0001
22000	S	M	OUG	II	00000	064	2ND LT E OF INDUSTRY RD ON N SIDE OF WINCHESTER	12	043001	1/1/0001
50000	S	M	OUG	II	00000	067	1ST LT E OF ASHTON AVE ON N SIDE OF WINCHESTER	12	043001	1/1/0001
22000	S	M	OUG	II	00000	069	OPPOSITE HELM ST ON N SIDE OF WINCHESTER	12	043001	1/1/0001
22000	S	M	OUG	II	00000	070	1ST LT E OF HELM ST ON S SIDE OF WINCHESTER	12	043001	1/1/0001
22000	S	M	OUG	II	00000	071	1ST LT E OF HELM ST ON N SIDE OF WINCHESTER	12	043001	1/1/0001
22000	S	M	OUG	II	00000	072	2ND LT E OF HELM ST ON S SIDE OF WINCHESTER	12	043001	1/1/0001
22000	S	M	OUG	II	00000	073	1ST LT E OF NEW CIRCLE RD ON N SIDE OF WINCHESTER	12	043001	1/1/0001
22000	S	M	OUG	II	00000	074	1ST LT E OF NEW CIRCLE RD ON S SIDE OF WINCHESTER	12	043001	1/1/0001
22000	S	M	OUG	II	00000	075	2ND LT E OF NEW CIRCLE ON N SIDE OF WINCHESTER RD	12	043001	1/1/0001
22000	S	M	OUG	II	00000	076	2ND LT E OF NEW CIRCLE ON S SIDE OF WINCHESTER RD	12	043001	1/1/0001
22000	S	M	OUG	II	00000	077	3RD LT E OF NEW CIRCLE ON N SIDE OF WINCHESTER RD	12	043001	1/1/0001

OFFICE: 311

ROUTE: 564

ST_REF_NO: 00000199000

WINCHESTER ROAD

LUMENS	BULB TYPE	MULT SERIES	POLE TYPE	SHADE	ADDRESS NUMBER	REF	LOCATION	TAX DIST	DATE INST	DATE CHANGE
22000	S	M	OUG	II	00000	078	3RD LT E OF NEW CIRCLE ON S SIDE OF WINCHESTER RD	12	043001	1/1/0001
22000	S	M	OUG	II	00000	079	4TH LT E OF NEW CIRCLE ON N SIDE OF WINCHESTER RD	12	043001	1/1/0001
22000	S	M	OUG	II	00000	080	4TH LT E OF NEW CIRCLE ON S SIDE OF WINCHESTER RD	12	043001	1/1/0001
22000	S	M	OUG	II	00000	081	5TH LT E OF NEW CIRCLE ON N SIDE OF WINCHESTER RD	12	043001	1/1/0001
50000	S	M	OUG	II	00000	082	5TH LT E OF NEW CIRCLE ON S SIDE OF WINCHESTER	12	043001	1/1/0001
50000	S	M	OUG	II	00000	083	1ST LT E OF EASTLAND PKWY ON N SIDE OF WINCHESTER	12	043001	1/1/0001
22000	S	M	OUG	II	00000	084	1ST LT E OF EASTLAND PKWY ON S SIDE OF WINCHESTER	12	043001	1/1/0001
22000	S	M	OUG	II	00000	085	2ND LT E OF EASTLAND PKWY ON N SIDE OF WINCHESTER	12	043001	1/1/0001
22000	S	M	OUG	II	00000	086	2ND LT E OF EASTLAND PKWY ON S SIDE OF WINCHESTER	12	043001	1/1/0001
22000	S	M	OUG	II	00000	087	3RD LT E OF EASTLAND PKWY ON N SIDE OF WINCHESTER	12	043001	1/1/0001
50000	S	M	OUG	II	00000	088	3RD LT E OF EASTLAND PKWY ON S SIDE OF WINCHESTER	12	043001	1/1/0001
50000	S	M	OUG	II	00000	089	1ST LT E OF FORTUNE DR ON N SIDE OF WINCHESTER	12	043001	1/1/0001
22000	S	M	OUG	II	00000	090	1ST LT E OF FORTUNE DR ON S SIDE OF WINCHESTER	12	043001	1/1/0001
22000	S	M	OUG	II	00000	091	2ND LT E OF FORTUNE DR ON N SIDE OF WINCHESTER	12	043001	1/1/0001
22000	S		OUG	II	00000	501	2nd LT E OF FORTUNE DR, S SIDE ON WINCHESTER RD	12	040310	4/3/2010
22000	S		OUG	II	00000	502	3rd LT E OF FORTUNE DR, N SIDE ON WINCHESTER RD	12	040310	4/3/2010
22000	S		OUG	II	00000	503	3rd LT E OF FORTUNE DR, S SIDE ON WINCHESTER RD	12	040310	4/3/2010
22000	S		OUG	II	00000	504	4th LT E OF FORTUNE DR, N SIDE ON WINCHESTER RD	12	040310	4/3/2010
22000	S		OUG	II	00000	505	4th LT E OF FORTUNE DR, S SIDE ON WINCHESTER RD	12	040310	4/3/2010
22000	S		OUG	II	00000	506	5th LT E OF FORTUNE DR, N SIDE ON WINCHESTER RD	12	040310	4/3/2010

OFFICE: 311

ROUTE: 564

ST_REF_NO: 00000199000

WINCHESTER ROAD

LUMENS	BULB TYPE	MULT SERIES	POLE TYPE	SHADE	ADDRESS NUMBER	REF	LOCATION	TAX DIST	DATE INST	DATE CHANGE
22000	S		OUG	II	00000	507	5TH LT E OF FORTUNE DR, S SIDE ON WINCHESTER RD	12	040310	4/3/2010
22000	S		OUG	II	00000	508	6TH LT E OF FORTUNE DR, N SIDE ON WINCHESTER RD	12	040310	4/3/2010
22000	S		OUG	II	00000	509	6TH LT E OF FORTUNE DR, S SIDE ON WINCHESTER RD	12	040310	4/3/2010
22000	S		OUG	II	00000	510	7TH LT E OF FORTUNE DR, N SIDE ON WINCHESTER RD	12	040310	4/3/2010
22000	S		OUG	II	00000	511	7TH LT E OF FORTUNE DR, S SIDE ON WINCHESTER RD	12	040310	4/3/2010
22000	S		OUG	II	00000	512	8TH LT E OF FORTUNE DR, N SIDE ON WINCHESTER RD	12	040310	4/3/2010
22000	S		OUG	II	00000	513	8TH LT E OF FORTUNE DR, S SIDE ON WINCHESTER RD	12	040310	4/3/2010
22000	S		OUG	II	00000	514	1st LT E OF PATCHEN WILKES DR, N SIDE ON WINCHESTER RD	12	040310	4/3/2010
22000	S		OUG	II	00000	515	1ST LT E OF PATCHEN WILKES DR, S SIDE ON WINCHESTER RD	12	040310	4/3/2010
22000	S		OUG	II	00000	516	2ND LT E OF PATCHEN WILKES DR, N SIDE ON WINCHESTER RD	12	040310	4/3/2010
22000	S		OUG	II	00000	517	2ND LT E OF PATCHEN WILKES DR, S SIDE ON WINCHESTER RD	12	040310	4/3/2010
22000	S		OUG	II	00000	518	3RD LT E OF PATCHEN WILKES DR, N SIDE ON WINCHESTER RD	12	040310	4/3/2010
22000	S		OUG	II	00000	519	3RD LT E OF PATCHEN WILKES DR, S SIDE ON WINCHESTER RD	12	040310	4/3/2010
22000	S		OUG	II	00000	520	4TH LT E OF PATCHEN WILKES DR, N SIDE ON WINCHESTER RD	12	040310	4/3/2010
22000	S		OUG	II	00000	521	4TH LT E OF PATCHEN WILKES DR, S SIDE ON WINCHESTER RD	12	040310	4/3/2010
22000	S		OUG	II	00000	522	5TH LT E OF PATCHEN WILKES DR, N SIDE ON WINCHESTER RD	12	040310	4/3/2010
22000	S		OUG	II	00000	523	5TH LT E OF PATCHEN WILKES DR, S SIDE ON WINCHESTER RD	12	040310	4/3/2010
22000	S		OUG	II	00000	524	6TH LT E OF PATCHEN WILKES DR, N SIDE ON WINCHESTER RD	12	040310	4/3/2010
22000	S		OUG	II	00000	525	6TH LT E OF PATCHEN WILKES DR, S SIDE ON WINCHESTER RD	12	040310	4/3/2010
22000	S		OUG	II	00000	526	7TH LT E OF PATCHEN WILKES DR, N SIDE ON WINCHESTER RD	12	040310	4/3/2010

OFFICE: 311

ROUTE: 564

ST_REF_NO: 00000199000

WINCHESTER ROAD

LUMENS	BULB TYPE	MULT SERIES	POLE TYPE	SHADE	ADDRESS NUMBER	REF	LOCATION	TAX DIST	DATE INST	DATE CHANGE
22000	S		OUG	II	00000	527	7TH LT E OF PATCHEN WILKES DR, S SIDE ON WINCHESTER RD	12	040310	4/3/2010
22000	S		OUG	II	00000	528	8TH LT E OF PATCHEN WILKES DR, N SIDE ON WINCHESTER RD	12	040310	4/3/2010
22000	S		OUG	II	00000	529	8TH LT E OF PATCHEN WILKES DR, S SIDE ON WINCHESTER RD	12	040310	4/3/2010
22000	S		OUG	II	00000	530	9TH LT E OF PATCHEN WILKES DR, N SIDE ON WINCHESTER RD	12	040310	4/3/2010
22000	S		OUG	II	00000	531	9TH LT E OF PATCHEN WILKES DR, S SIDE ON WINCHESTER RD	12	040310	4/3/2010
22000	S		OUG	II	00000	532	10TH LT E OF PATCHEN WILKES DR, N SIDE ON WINCHESTER RD	12	040310	4/3/2010
22000	S		OUG	II	00000	533	10TH LT E OF PATCHEN WILKES DR, S SIDE ON WINCHESTER RD	12	040310	4/3/2010
22000	S		OUG	II	00000	534	11TH LT E OF PATCHEN WILKES DR, N SIDE ON WINCHESTER RD	12	040310	4/3/2010
22000	S		OUG	II	00000	535	11TH LT E OF PATCHEN WILKES DR, S SIDE ON WINCHESTER RD	12	040310	4/3/2010
22000	S		OUG	II	00000	536	12TH LT E OF PATCHEN WILKES DR, N SIDE ON WINCHESTER RD	12	040310	4/3/2010
22000	S		OUG	II	00000	537	12TH LT E OF PATCHEN WILKES DR, S SIDE ON WINCHESTER RD	12	040310	4/3/2010
22000	S		OUG	II	00000	538	13TH LT E OF PATCHEN WILKES DR, N SIDE ON WINCHESTER RD	12	040310	4/3/2010
22000	S		OUG	II	00000	539	13TH LT E OF PATCHEN WILKES DR, S SIDE ON WINCHESTER RD	12	040310	4/3/2010
22000	S		OUG	II	00000	540	14TH LT E OF PATCHEN WILKES DR, N SIDE ON WINCHESTER RD	12	040310	4/3/2010
22000	S		OUG	II	00000	541	14TH LT E OF PATCHEN WILKES DR, S SIDE ON WINCHESTER RD	12	040310	4/3/2010
22000	S		OUG	II	00000	542	15TH LT E OF PATCHEN WILKES DR, N SIDE ON WINCHESTER RD	12	040310	4/3/2010
22000	S		OUG	II	00000	543	15TH LT E OF PATCHEN WILKES DR, S SIDE ON WINCHESTER RD	12	040310	4/3/2010
22000	S		OUG	II	00000	544	16TH LT E OF PATCHEN WILKES DR, N SIDE ON WINCHESTER RD	12	040310	4/3/2010
22000	S		OUG	II	00000	545	16TH LT E OF PATCHEN WILKES DR, S SIDE ON WINCHESTER RD	12	040310	4/3/2010
22000	S		OUG	II	00000	546	17TH LT E OF PATCHEN WILKES DR, N SIDE ON WINCHESTER RD	12	040310	4/3/2010

OFFICE: 311

ROUTE: 564

ST_REF_NO: 00000199000

WINCHESTER ROAD

LUMENS	BULB TYPE	MULT SERIES	POLE TYPE	SHADE	ADDRESS NUMBER	REF	LOCATION	TAX DIST	DATE INST	DATE CHANGE
22000	S		OUG	II	00000	547	17TH LT E OF PATCHEN WILKES DR, S SIDE ON WINCHESTER RD	12	040310	4/3/2010
22000	S		OUG	II	00000	548	18TH LT E OF PATCHEN WILKES DR, N SIDE ON WINCHESTER RD	12	040310	4/3/2010
22000	S		OUG	II	00000	549	18TH LT E OF PATCHEN WILKES DR, S SIDE ON WINCHESTER RD	12	040310	4/3/2010
22000	S		OUG	II	00000	550	19TH LT E OF PATCHEN WILKES DR, N SIDE ON WINCHESTER RD	12	040310	4/3/2010
22000	S		OUG	II	00000	551	19TH LT E OF PATCHEN WILKES DR, S SIDE ON WINCHESTER RD	12	040310	4/3/2010
22000	S		OUG	II	00000	552	20TH LT E OF PATCHEN WILKES DR, N SIDE ON WINCHESTER RD	12	040310	4/3/2010
22000	S		OUG	II	00000	553	20TH LT E OF PATCHEN WILKES DR, S SIDE ON WINCHESTER RD	12	040310	4/3/2010
22000	S		OUG	II	00000	554	21ST LT E OF PATCHEN WILKES DR, N SIDE ON WINCHESTER RD	12	040310	4/3/2010
50000	S		OUG	II	00000	555	1ST LT E OF SIR BARTON WAY, S SIDE ON WINCHESTER RD	12	040310	4/3/2010
50000	S		OUG	II	00000	556	1ST LT E OF EXECUTIVE DR, N SIDE ON WINCHESTER RD	12	040310	4/3/2010
22000	S		OUG	II	00000	557	2ND LT E OF SIR BARTON WAY, S SIDE ON WINCHESTER RD	12	040310	4/3/2010
22000	S		OUG	II	00000	558	2ND LT E OF EXECUTIVE DR, N SIDE ON WINCHESTER RD	12	040310	4/3/2010
22000	S		OUG	II	00000	559	3RD LT E OF SIR BARTON WAY, S SIDE ON WINCHESTER RD	12	040310	4/3/2010
22000	S		OUG	II	00000	560	3RD LT E OF EXECUTIVE DR, N SIDE ON WINCHESTER RD	12	040310	4/3/2010
22000	S		OUG	II	00000	561	4TH LT E OF SIR BARTON WAY, S SIDE ON WINCHESTER RD	12	040310	4/3/2010
22000	S		OUG	II	00000	562	4TH LT E OF EXECUTIVE DR, N SIDE ON WINCHESTER RD	12	040310	4/3/2010
22000	S		OUG	II	00000	563	OPPOSITE THUNDERSTICK DR	12	040310	4/3/2010
22000	S		OUG	II	00000	564	1ST LT E OF THUNDERSTICK DR, N SIDE ON WINCHESTER RD	12	040310	4/3/2010
22000	S		OUG	II	00000	565	1ST LT E OF THUNDERSTICK DR, S SIDE ON WINCHESTER RD	12	040310	4/3/2010
50000	S		OOH	II	00000	566	2ND LT E OF THUNDERSTICK DR, N SIDE ON WINCHESTER RD	12	040310	4/3/2010
22000	S	M	OUG	II	01209	062		12	043001	1/1/0001

OFFICE: 311

ROUTE: 564

ST_REF_NO: 00000199000

WINCHESTER ROAD

LUMENS	BULB TYPE	MULT SERIES	POLE TYPE	SHADE	ADDRESS NUMBER	REF	LOCATION	TAX DIST	DATE INST	DATE CHANGE
50000	S	M	OUG	II	01250	065		12	043001	1/1/0001
22000	S	M	OUG	II	01300	066		12	043001	1/1/0001
22000	S	M	OUG	II	01312	068		12	043001	1/1/0001
50000	S	M	SOH	IV	00000	001	OPP. LOUDON AVE.	12	040466	1/1/0001
50000	S	M	OOH	IV	01104	003		12	040466	1/1/0001
50000	S	M	OUG	IV	01105	004		12	040466	1/1/0001
50000	S	M	OUG	IV	01107	006		12	040466	1/1/0001
50000	S	M	OUG	II	01109	008		12	010270	1/1/0001
50000	S	M	OOH	IV	01116	005		12	040466	1/1/0001
50000	S	M	OOH	IV	01118	007		12	040466	1/1/0001
50000	S	M	OUG	II	01119	010		12	010270	1/1/0001
50000	S	M	OOH	II	01120	011		12	010270	1/1/0001
50000	S	M	OUG	II	01133	012		12	010270	1/1/0001
50000	S	M	OOH	II	01136	013		12	010270	1/1/0001
50000	S	M	OOH	II	01200	016		12	031282	1/1/0001
50000	S	M	OUG	II	01201	015		12	010270	1/1/0001
50000	S	M	OUG	III	00000	027	OPP. HUME RD.	22	060685	1/1/0001
50000	S	M	OUG	III	00000	028	1ST LT. E. OF HUME RD., NORTHSIDE	22	060685	1/1/0001
50000	S	M	OUG	III	00000	029	1ST LT. E. OF HUME RD., SOUTHSIDE	22	060685	1/1/0001
50000	S	M	OUG	III	00000	030	2ND LT. E. OF HUME RD., NORTHSIDE	22	060685	1/1/0001
09500	S	M	OUG	II	00000	050	1ST LT. W OF BRYANT RD., NORTHSIDE	12	120896	1/1/0001
09500	S	M	OUG	II	00000	051	1ST LT. E OF BRYANT RD., NORTHSIDE	12	120896	1/1/0001
09500	S	M	OUG	III	00000	031	2ND LT. W. OF BAHAMA RD., SOUTHSIDE	22	060685	1/1/0001
09500	S	M	OUG	II	00000	032	1ST LT. W. OF BAHAMA RD., N. SIDE	22	020889	1/1/0001
09500	S	M	OUG	III	00000	033	1ST LT. W. OF BAHAMA RD., SOUTHSIDE	22	060685	1/1/0001
09500	S	M	OUG	III	00000	034	1ST LT. E. OF BAHAMA RD., SOUTHSIDE	22	060685	1/1/0001
09500	S	M	OUG	II	00000	035	1ST LT. E. OF BAHAMA RD., N. SIDE	22	020889	1/1/0001
09500	S	M	OUG	III	00000	036	2ND LT. E. OF BAHAMA RD., SOUTHSIDE	22	060685	1/1/0001
09500	S	M	OUG	III	00000	037	1ST LT. W. OF ROYSTER RD., SOUTHSIDE	22	060685	1/1/0001
09500	S	M	OUG	III	00000	038	2ND LT. W. OF ROYSTER RD., NORTHSIDE	22	060685	1/1/0001
09500	S	M	OUG	III	00000	039	1ST LT. W. OF ROYSTER RD., NORTHSIDE	22	060685	1/1/0001
09500	S	M	OUG	III	00000	040	1ST LT. E. OF ROYSTER RD., NORTHSIDE	22	060685	1/1/0001
09500	S	M	OUG	III	00000	041	1ST LT. E. OF ROYSTER RD., SOUTHSIDE	22	060685	1/1/0001
09500	S	M	OUG	II	00000	150	1ST LT. W OF HALEY RD., NORTHSIDE	12	050897	1/1/0001

OFFICE: 311

ROUTE: 564

ST_REF_NO: 00000199000

WINCHESTER ROAD

LUMENS	BULB TYPE	MULT SERIES	POLE TYPE	SHADE	ADDRESS NUMBER	REF	LOCATION	TAX DIST	DATE INST	DATE CHANGE
09500	S	M	OUG	II	00000	100	2ND LT. W OF CLEVELAND RD., NORTHSIDE	12	090897	1/1/0001
09500	S	M	OUG	II	00000	101	1ST LT. W OF CLEVELAND RD., NORTHSIDE	12	090897	1/1/0001
09500	S	M	OUG	II	00000	102	1ST LT. E OF CLEVELAND RD., NORTHSIDE	12	090897	1/1/0001
09500	S	M	OUG	II	00000	103	2ND LT. E OF CLEVELAND RD., NORTHSIDE	12	090897	1/1/0001
09500	S	M	OUG	II	00000	151	OPP. HALEY ROAD, SOUTHSIDE	12	050897	1/1/0001
09500	S	M	OUG	II	00000	152	1ST LT. E OF HALEY RD., NORTHSIDE	12	050897	1/1/0001
09500	S	M	OUG	II	00000	200	1ST LT. W OF COMBS FERRY RD., NORTHSIDE	12	050897	1/1/0001
09500	S	M	OUG	II	00000	201	1ST LT. E OF COMBS FERRY RD., NORTHSIDE	12	050897	1/1/0001

OFFICE: 311

ROUTE: 564

ST_REF_NO: 00000199100

WINDERMERE ROAD

LUMENS	BULB TYPE	MULT SERIES	POLE TYPE	SHADE	ADDRESS NUMBER	REF	LOCATION	TAX DIST	DATE INST	DATE CHANGE
04000	S	M	OUG	II	03001	002		12	050888	1/1/0001
04000	S	M	OUG	II	03005	001		12	050888	1/1/0001
04000	S	M	OUG	II	03029	003		12	050888	1/1/0001
05800	S	M	OUG	II	03038	004		12	050888	1/1/0001
04000	S	M	OUG	II	03054	005		12	050888	1/1/0001
05800	S	M	OUG	II	03075	006	upgraded 5/08	12	050888	1/1/0001

OFFICE: 311

ROUTE: 564

ST_REF_NO: 00000199190

WINDFIELD PLACE

LUMENS	BULB TYPE	MULT SERIES	POLE TYPE	SHADE	ADDRESS NUMBER	REF	LOCATION	TAX DIST	DATE INST	DATE CHANGE
04000	S	M	OUG	II	00419	001		12	060892	1/1/0001
04000	S	M	OUG	II	00430	002		12	020890	1/1/0001
04000	S	M	OUG	II	00447	003		12	020890	1/1/0001

OFFICE: 311

ROUTE: 564

ST_REF_NO: 00000199290

WINDING CIRCLE

LUMENS	BULB TYPE	MULT SERIES	POLE TYPE	SHADE	ADDRESS NUMBER	REF	LOCATION	TAX DIST	DATE INST	DATE CHANGE
05800	S	M	OUG	II	00000	287	SIDE OF 3513 WINDING DR.	12	051480	1/1/0001
05800	S	M	OUG	V	01004	288		12	051480	1/1/0001

OFFICE: 311

ROUTE: 564

ST_REF_NO: 00000199300

WINDING DRIVE

LUMENS	BULB TYPE	MULT SERIES	POLE TYPE	SHADE	ADDRESS NUMBER	REF	LOCATION	TAX DIST	DATE INST	DATE CHANGE
05800	S	M	OUG	II	00000	282	SIDE OF 3525 WILLOWOOD DR.	12	051480	1/1/0001
05800	S	M	OUG	II	03512	286		12	051480	1/1/0001
05800	S	M	OUG	II	03524	285		12	051480	1/1/0001
05800	S	M	OUG	II	03532	284		12	051480	1/1/0001
05800	S	M	OUG	II	03537	283		12	051480	1/1/0001

OFFICE: 311

ROUTE: 564

ST_REF_NO: 00000199400

WINDING BROOK COURT

LUMENS	BULB TYPE	MULT SERIES	POLE TYPE	SHADE	ADDRESS NUMBER	REF	LOCATION	TAX DIST	DATE INST	DATE CHANGE
04000	S	M	OUG	II	03800	003		12	111581	1/1/0001
04000	S	M	OUG	V	03817	004		12	021582	1/1/0001

OFFICE: 311

ROUTE: 564

ST_REF_NO: 00000199425

WINDING OAK TRAIL

LUMENS	BULB TYPE	MULT SERIES	POLE TYPE	SHADE	ADDRESS NUMBER	REF	LOCATION	TAX DIST	DATE INST	DATE CHANGE
05800	S	M	CNT	II	00000	004	SIDE OF 3081 SHADY KNOLL REST ON WINDING OAK TRAIL	12	112906	1/1/0001
05800	S	M	CNT	II	00000	007	SIDE OF 3092 MADDIE LANE ON WINDING OAK TRAIL	12	112906	1/1/0001
05800	S	M	CNT	II	00000	018	SIDE OF 3001 MADDIE LANE ON WINDING OAK TRAIL	12	112906	1/1/0001
05800	S	M	CNT	II	00000	020	SIDE OF 3000 RIVER RUN TRAIL ON WINDING OAK TRAIL	12	112906	1/1/0001
05800	S	M	CNT	II	00805	021		12	112906	1/1/0001
05800	S	M	CNT	II	00836	019		12	112906	1/1/0001
05800	S	M	CNT	II	00868	017		12	112906	1/1/0001
05800	S	M	CNT	II	00885	016		12	112906	1/1/0001
05800	S	M	CNT	II	00904	015		12	112906	1/1/0001
05800	S	M	CNT	II	00913	014		12	112906	1/1/0001
05800	S	M	CNT	II	00917	013		12	112906	1/1/0001
05800	S	M	CNT	II	00929	012		12	112906	1/1/0001
05800	S	M	CNT	II	00941	011		12	112906	1/1/0001
05800	S	M	CNT	II	00960	010		12	112906	1/1/0001
05800	S	M	CNT	II	00976	009		12	112906	1/1/0001
05800	S	M	CNT	II	00992	008		12	112906	1/1/0001
05800	S	M	CNT	II	01024	006		12	112906	1/1/0001

Street Light Listing run 1/11/2015 10:43:21 AM

Page 1226 of 1254

OFFICE: 311 ROUTE: 564							ST_REF_NO: 00000199425 WINDING OAK TRAIL			
LUMENS	BULB TYPE	MULT SERIES	POLE TYPE	SHADE	ADDRESS NUMBER	REF	LOCATION	TAX DIST	DATE INST	DATE CHANGE
05800	S	M	CNT	II	01040	005		12	112906	1/1/0001
05800	S	M	CNT	II	01072	003		12	112906	1/1/0001
05800	S	M	CNT	II	01085	002		12	112906	1/1/0001
05800	S	M	CNT	II	01096	001		12	112906	1/1/0001

OFFICE: 311 ROUTE: 564							ST_REF_NO: 00000199450 WINDRUSH CIRCLE			
LUMENS	BULB TYPE	MULT SERIES	POLE TYPE	SHADE	ADDRESS NUMBER	REF	LOCATION	TAX DIST	DATE INST	DATE CHANGE
04000	S	M	OUG	II	03505	001		12	040894	1/1/0001
04000	S	M	OUG	II	03516	002		12	110891	1/1/0001
04000	S	M	OUG	V	03525	003		12	040894	1/1/0001

OFFICE: 311 ROUTE: 564							ST_REF_NO: 00000199500 WINDSOR COURT			
LUMENS	BULB TYPE	MULT SERIES	POLE TYPE	SHADE	ADDRESS NUMBER	REF	LOCATION	TAX DIST	DATE INST	DATE CHANGE
04000	S	M	OUG	II	02511	113		12	092368	1/1/0001

OFFICE: 311 ROUTE: 564							ST_REF_NO: 00000199570 WINDSTAR WAY			
LUMENS	BULB TYPE	MULT SERIES	POLE TYPE	SHADE	ADDRESS NUMBER	REF	LOCATION	TAX DIST	DATE INST	DATE CHANGE
05800	S	M	CNT	II	00000	001	SIDE OF 4561 WINDSTAR	12	110207	1/1/0001
05800	S	M	CNT	II	00000	003	SIDE OF 517 REVENNA LN ON WINDSTAR	12	110207	1/1/0001
05800	S	M	CNT	II	00000	006	SIDE OF 4520 BILTMORE PL ON WINDSTAR	12	110207	1/1/0001
05800	S	M	CNT	II	00000	025	SIDE OF 4545 WINDSTAR	12	110207	1/1/0001
05800	S	M	CNT	II	04505	028		12	110207	1/1/0001
05800	S	M	CNT	II	04516	027		12	110207	1/1/0001
05800	S	M	CNT	II	04525	026		12	110207	1/1/0001
05800	S	M	CNT	II	04545	024		12	110207	1/1/0001
05800	S	M	CNT	II	04561	023		12	110207	1/1/0001
05800	S	M	CNT	II	04568	022		12	110207	1/1/0001
05800	S	M	CNT	II	04588	020		12	110207	1/1/0001
05800	S	M	CNT	II	04604	019		12	110207	1/1/0001
05800	S	M	CNT	II	04612	018		12	110207	1/1/0001
05800	S	M	CNT	II	04644	015		12	110207	1/1/0001

OFFICE: 311		ROUTE: 564		ST_REF_NO: 00000199570		WINDSTAR WAY		LUMENS	BULB TYPE	MULT SERIES	POLE TYPE	SHADE	ADDRESS NUMBER	REF	LOCATION	TAX DIST	DATE INST	DATE CHANGE
	05800	S	M	CNT	II	04668	013									12	110207	1/1/0001
	05800	S	M	CNT	II	04681	012									12	110207	1/1/0001
	05800	S	M	CNT	II	04713	009									12	110207	1/1/0001
	05800	S	M	CNT	II	04720	008									12	110207	1/1/0001
	05800	S	M	CNT	II	04732	007									12	110207	1/1/0001
	05800	S	M	CNT	II	04753	005									12	110207	1/1/0001
	05800	S	M	CNT	II	04757	004									12	110207	1/1/0001
	05800	S	M	CNT	II	04776	002									12	110207	1/1/0001

OFFICE: 311		ROUTE: 564		ST_REF_NO: 00000199600		WINDWOOD COURT		LUMENS	BULB TYPE	MULT SERIES	POLE TYPE	SHADE	ADDRESS NUMBER	REF	LOCATION	TAX DIST	DATE INST	DATE CHANGE
	05800	S	M	OUG	II	02404	000									12	120170	1/1/0001
	05800	S	M	OUG	II	02421	000									12	120170	1/1/0001

OFFICE: 311		ROUTE: 564		ST_REF_NO: 00000199725		WINDY MEADOW WAY		LUMENS	BULB TYPE	MULT SERIES	POLE TYPE	SHADE	ADDRESS NUMBER	REF	LOCATION	TAX DIST	DATE INST	DATE CHANGE
	05800	S	M	CNT	II	00000	001								SIDE 1064 DEER CROSSING WAY	12	060895	1/1/0001
	05800	S	M	CNT	IV	03609	002									12	060895	1/1/0001

OFFICE: 311		ROUTE: 564		ST_REF_NO: 00000199750		WINGED FOOT CIRCLE		LUMENS	BULB TYPE	MULT SERIES	POLE TYPE	SHADE	ADDRESS NUMBER	REF	LOCATION	TAX DIST	DATE INST	DATE CHANGE
	05800	S	M	CNT	II	03205	001									12	092804	1/1/0001

OFFICE: 311		ROUTE: 564		ST_REF_NO: 00000199800		WINN WAY DRIVE		LUMENS	BULB TYPE	MULT SERIES	POLE TYPE	SHADE	ADDRESS NUMBER	REF	LOCATION	TAX DIST	DATE INST	DATE CHANGE
	05800	S	M	OUG	II	00286	005									12	110888	4/18/2013
	04000	S	M	OUG	II	00000	001								SIDE OF 2028 HEATHER WAY	12	110888	1/1/0001
	04000	S	M	OUG	II	00268	002									12	110888	1/1/0001
	04000	S	M	OUG	II	00275	003									12	110888	1/1/0001
	04000	S	M	OUG	II	00282	004									12	110888	1/1/0001
	04000	S	M	OUG	II	00292	006									12	110888	1/1/0001

OFFICE: 311		ROUTE: 564		ST_REF_NO: 00000200000		WINNEPEG WAY		LUMENS	BULB TYPE	MULT SERIES	POLE TYPE	SHADE	ADDRESS NUMBER	REF	LOCATION	TAX DIST	DATE INST	DATE CHANGE
04000	S	M	OUG	II	00000	039	SIDE OF 176 TORONTO RD.	12	110886	1/1/0001								
04000	S	M	OUG	II	04012	040		12	110886	1/1/0001								
05800	S	M	OUG	II	04023	041	change out bad fixture 2/08	12	110886	1/1/0001								
04000	S	M	OUG	II	00000	050	SIDE OF 4013 PRINCE ALBERT RD.	12	110886	1/1/0001								
04000	S	M	OUG	II	04034	042		12	110886	1/1/0001								
04000	S	M	OUG	II	04051	043		12	110886	1/1/0001								
04000	S	M	OUG	II	04063	044		12	110886	1/1/0001								
04000	S	M	OUG	II	04074	045		12	110886	1/1/0001								
04000	S	M	OUG	II	04087	046		12	110886	1/1/0001								
04000	S	M	OUG	II	04098	047		12	110886	1/1/0001								
04000	S	M	OUG	II	04106	048		12	110886	1/1/0001								
04000	S	M	OUG	II	04118	049		12	110886	1/1/0001								
04000	S	M	OUG	II	04138	051		12	110886	1/1/0001								

OFFICE: 311		ROUTE: 564		ST_REF_NO: 00000200100		WINNIE STREET		LUMENS	BULB TYPE	MULT SERIES	POLE TYPE	SHADE	ADDRESS NUMBER	REF	LOCATION	TAX DIST	DATE INST	DATE CHANGE
05800	S	M	OUG	I	00000	001	1ST LT. N. OF VIRGINIA AVE., E. SIDE	12	092874	1/1/0001								
05800	S	M	OUG	I	00000	002	2ND LT. N. OF VIRGINIA AVE., E. SIDE	12	092874	1/1/0001								
05800	S	M	OUG	I	00000	003	3RD LT. N. OF VIRGINIA AVE., E. SIDE	12	092874	1/1/0001								
05800	S	M	OUG	I	00000	004	4TH LT. N. OF VIRGINIA AVE., E. SIDE	12	092874	1/1/0001								
05800	S	M	OUG	I	00000	005	5TH LT. N. OF VIRGINIA AVE., E. SIDE	12	092874	1/1/0001								
05800	S	M	OUG	I	00000	006	6TH LT. N. OF VIRGINIA AVE., E. SIDE	12	092874	1/1/0001								
05800	S	M	OUG	I	00000	007	7TH LT. N. OF VIRGINIA AVE., E. SIDE	12	092874	1/1/0001								
05800	S	M	OUG	I	00000	008	8TH LT. N. OF VIRGINIA AVE., E. SIDE	12	092874	1/1/0001								

OFFICE: 311		ROUTE: 564		ST_REF_NO: 00000200200		WINONA WAY		LUMENS	BULB TYPE	MULT SERIES	POLE TYPE	SHADE	ADDRESS NUMBER	REF	LOCATION	TAX DIST	DATE INST	DATE CHANGE
04000	S	M	OUG	II	00000	001	SIDE OF 2020 BELLEFONTE DR.	12	110888	1/1/0001								
04000	S	M	OUG	II	00000	003	SIDE OF 321 LOWRY LANE	12	110888	1/1/0001								
04000	S	M	OUG	II	02024	002		12	110888	1/1/0001								

OFFICE: 311		ROUTE: 564		ST_REF_NO: 00000200285		WINSLOW STREET		LUMENS	BULB TYPE	MULT SERIES	POLE TYPE	SHADE	ADDRESS NUMBER	REF	LOCATION	TAX DIST	DATE INST	DATE CHANGE
10000	M		SOH	II	00000	001	1ST LT E OF S UPPER ST, S SIDE	12	091861									1/1/0001
22000	S		CNT	II	00000	005	1ST ST W OF S LIMESTONE ST, S SIDE ON WINSLOW	12	052710									1/1/0001
20000	M	M	SOH	II	00000	003	W. EUCLID, NW CORNER OF JERSEY ST-per audit	12	030767									11/12/2010
20000	M	M	SOH	II	00000	004	2ND LT W OF S LIMESTONE, S SIDE-correcting addr & ref audit	12	030767									11/12/2010
10000	M	M	SOH	II	00130	002	correcting ref # per audit	12	030767									11/12/2010
OFFICE: 311		ROUTE: 564		ST_REF_NO: 00000200310		WINTER HAVEN		LUMENS	BULB TYPE	MULT SERIES	POLE TYPE	SHADE	ADDRESS NUMBER	REF	LOCATION	TAX DIST	DATE INST	DATE CHANGE
05800	S	M	CNT	II	00000	003	SIDE 3520 INDIAN SUMMER TRAIL	12	060894									1/1/0001
05800	S	M	CNT	II	01105	001		12	060894									1/1/0001
05800	S	M	CNT	II	01112	002		12	060894									1/1/0001
05800	S	M	CNT	II	01141	004		12	060894									1/1/0001
05800	S	M	CNT	II	01148	005		12	060894									1/1/0001
05800	S	M	CNT	II	01160	006		12	060894									1/1/0001
OFFICE: 311		ROUTE: 564		ST_REF_NO: 00000200340		WINTER HILL LANE		LUMENS	BULB TYPE	MULT SERIES	POLE TYPE	SHADE	ADDRESS NUMBER	REF	LOCATION	TAX DIST	DATE INST	DATE CHANGE
05800	S	M	CNT	II	00000	004	SIDE OF 833 PENNY LANE	12	120897									1/1/0001
05800	S	M	CNT	II	00000	013	SIDE REAR OF 3700 ANSLEY COURT	12	020898									1/1/0001
05800	S	M	CNT	II	00000	015	SIDE OF 3701 MIRA VISTA CIRCLE	12	120898									1/1/0001
05800	S	M	CNT	II	00000	017	SIDE OF 3700 LONG MEADOW CT.	12	120898									1/1/0001
05800	S	M	CNT	II	00540	024		12	090800									1/1/0001
05800	S	M	CNT	III	00545	023		12	090800									1/1/0001
05800	S	M	CNT	II	00548	024		12	090800									1/1/0001
05800	S	M	CNT	II	00560	021		12	090800									1/1/0001
05800	S	M	CNT	II	00569	020		12	090800									1/1/0001
05800	S	M	CNT	II	00593	016		12	120898									1/1/0001
05800	S	M	CNT	II	00617	014		12	120898									1/1/0001
05800	S	M	CNT	II	00633	019		12	120898									1/1/0001
05800	S	M	CNT	II	00644	012		12	020898									1/1/0001
05800	S	M	CNT	II	00649	018		12	120898									1/1/0001

OFFICE: 311 ROUTE: 564										
ST_REF_NO: 00000200340 WINTER HILL LANE										
LUMENS	BULB TYPE	MULT SERIES	POLE TYPE	SHADE	ADDRESS NUMBER	REF	LOCATION	TAX DIST	DATE INST	DATE CHANGE
05800	S	M	CNT	II	00657	011		12	020898	1/1/0001
05800	S	M	CNT	II	00672	010		12	020898	1/1/0001
05800	S	M	CNT	II	00677	009		12	020898	1/1/0001
05800	S	M	CNT	II	00689	008		12	020898	1/1/0001
05800	S	M	CNT	II	00696	001		12	120897	1/1/0001
05800	S	M	CNT	II	00704	002		12	120897	1/1/0001
05800	S	M	CNT	II	00725	003		12	120897	1/1/0001
05800	S	M	CNT	II	00741	005		12	120897	1/1/0001
05800	S	M	CNT	II	00752	006		12	120897	1/1/0001
05800	S	M	CNT	III	00760	007		12	120897	1/1/0001
OFFICE: 311 ROUTE: 564										
ST_REF_NO: 00000200400 WINTER PARK COURT										
LUMENS	BULB TYPE	MULT SERIES	POLE TYPE	SHADE	ADDRESS NUMBER	REF	LOCATION	TAX DIST	DATE INST	DATE CHANGE
04000	S	M	OUG	V	00600	024		12	081476	1/1/0001
04000	S	M	OUG	II	00609	023		12	111475	1/1/0001
OFFICE: 311 ROUTE: 564										
ST_REF_NO: 00000200500 WINTER PARK DRIVE										
LUMENS	BULB TYPE	MULT SERIES	POLE TYPE	SHADE	ADDRESS NUMBER	REF	LOCATION	TAX DIST	DATE INST	DATE CHANGE
04000	S	M	OUG	II	00000	048	SIDE OF 608 ICE CIRCLE	12	101478	1/1/0001
04000	S	M	OUG	II	02801	050		12	041478	1/1/0001
04000	S	M	OUG	II	02808	049		12	101478	1/1/0001
04000	S	M	OUG	II	02836	047		12	111579	1/1/0001
04000	S	M	OUG	II	02849	046		12	101478	1/1/0001
04000	S	M	OUG	II	02860	045		12	111579	1/1/0001
OFFICE: 311 ROUTE: 564										
ST_REF_NO: 00000200600 WINTERBERRY DRIVE										
LUMENS	BULB TYPE	MULT SERIES	POLE TYPE	SHADE	ADDRESS NUMBER	REF	LOCATION	TAX DIST	DATE INST	DATE CHANGE
05800	S	M	OUG	II	00000	177	SIDE OF 2135 ALEXANDRIA	12	111565	1/1/0001
05800	S	M	OUG	II	00000	178	SIDE OF 2136 ALEXANDRIA	12	111565	1/1/0001
05800	S	M	OUG	II	00000	180	SIDE OF 2151	12	111565	1/1/0001
05800	S	M	OUG	II	02100	105		12	090363	1/1/0001

OFFICE: 311

ROUTE: 564

ST_REF_NO: 00000200600

WINTERBERRY DRIVE

LUMENS	BULB TYPE	MULT SERIES	POLE TYPE	SHADE	ADDRESS NUMBER	REF	LOCATION	TAX DIST	DATE INST	DATE CHANGE
05800	S	M	OUG	II	02109	106		12	090164	1/1/0001
05800	S	M	OUG	II	02124	181		12	111565	1/1/0001
05800	S	M	OUG	II	02152	179		12	111565	1/1/0001
05800	S	M	OUG	II	02184	176		12	111565	1/1/0001
05800	S	M	OUG	II	02196	175		12	090266	1/1/0001
05800	S	M	OUG	II	02208	174		12	111565	1/1/0001
05800	S	M	OUG	II	02227	173		12	071568	1/1/0001
05800	S	M	OUG	II	02240	172		12	111565	1/1/0001
05800	S	M	OUG	II	02255	171		12	111565	1/1/0001
05800	S	M	OUG	II	02268	170		12	090266	1/1/0001
05800	S	M	OUG	II	02280	169		12	111565	1/1/0001

OFFICE: 311

ROUTE: 564

ST_REF_NO: 00000200700

WINTERGARDEN DRIVE

LUMENS	BULB TYPE	MULT SERIES	POLE TYPE	SHADE	ADDRESS NUMBER	REF	LOCATION	TAX DIST	DATE INST	DATE CHANGE
05800	S	M	OUG	II	02837	042		12	101578	8/12/2013
05800	S	M	OUG	II	02900	069	changed out bad fixture	12	111579	7/8/2006
05800	S	M	OUG	II	02917	068	changed out bad fixture	12	011579	7/8/2006
05800	S	M	OUG	II	02968	054	changed out bad fixture	12	111579	7/8/2006
04000	S	M	OUG	II	00000	061	SIDE OF 2857 SNOW RD.	12	111580	1/1/0001
04000	S	M	OUG	II	00000	065	SIDE OF 2960	12	111579	1/1/0001
04000	S	M	OUG	II	02800	039		12	101578	1/1/0001
04000	S	M	OUG	II	02813	040		12	101578	1/1/0001
04000	S	M	OUG	II	02824	041		12	101578	1/1/0001
04000	S	M	OUG	II	02836	043		12	101578	1/1/0001
04000	S	M	OUG	II	02861	044		12	101578	1/1/0001
04000	S	M	OUG	II	02881	062		12	111580	1/1/0001
04000	S	M	OUG	II	02920	067		12	011579	1/1/0001
04000	S	M	OUG	II	02941	066		12	011579	1/1/0001
04000	S	M	OUG	II	02965	064		12	111579	1/1/0001
04000	S	M	OUG	II	02977	063		12	111579	1/1/0001

OFFICE: 311

ROUTE: 564

ST_REF_NO: 00000200800

WINTHROP Drive

LUMENS	BULB TYPE	MULT SERIES	POLE TYPE	SHADE	ADDRESS NUMBER	REF	LOCATION	TAX DIST	DATE INST	DATE CHANGE
05800	S	M	OUG	II	00000	001	ST LT S OF WAVELAND MUSEUM, W SIDE ON WINTHROP	12	012406	1/1/0001
05800	S	M	OUG	II	00000	002	2ND LT S OF WAVELAND MUSEUM, W SIDE ON WINTHROP	12	012406	1/1/0001
22000	S	M	CNT	II	00000	100	1ST LT S OF MOW, E SIDE ON WINTHROP DR	12	071907	1/1/0001
22000	S	M	CNT	II	00000	101	1ST LT S OF MOW, W SIDE ON WINTRHOP DR	12	071907	1/1/0001
09500	S	M	CNT	II	00000	102	2ND LT S OF MOW, E SIDE ON WINTHROP DR	12	071907	1/1/0001
09500	S	M	CNT	II	00000	103	2ND LT S OF MOW, W SIDE ON WINTHROP DR	12	071907	1/1/0001
09500	S	M	CNT	II	00000	104	3RD LT S OF MOW, E SIDE ON WINTHROP DR	12	071907	1/1/0001
09500	S	M	CNT	II	00000	105	4TH LT S OF MOW, E SIDE ON WINTHROP DR	12	071907	1/1/0001
05800	S	M	CNT	II	03637	005		12	081202	1/1/0001
05800	S	M	CNT	II	03649	006		12	081202	1/1/0001
05800	S	M	CNT	II	03661	007		12	081202	1/1/0001
05800	S	M	CNT	II	03677	008		12	081202	1/1/0001
05800	S	M	CNT	II	03689	009		12	081202	1/1/0001
05800	S	M	CNT	II	03701	010		12	081202	1/1/0001
05800	S	M	CNT	II	03721	011		12	081202	1/1/0001
05800	S	M	CNT	II	03736	012		12	081202	1/1/0001
05800	S	M	CNT	II	03753	013		12	081202	1/1/0001
05800	S	M	OUG	II	03768	003		12	012406	1/1/0001
05800	S	M	OUG	II	03785	004		12	012406	1/1/0001
05800	S	M	OUG	II	03796	005		12	012406	1/1/0001
05800	S	M	OUG	II	03809	006		12	012406	1/1/0001
05800	S	M	OUG	II	03825	007		12	012406	1/1/0001
05800	S	M	OUG	II	03836	008		12	012406	1/1/0001
05800	S	M	OUG	II	03853	009		12	012406	1/1/0001
05800	S	M	OUG	II	03857	010		12	012406	1/1/0001
05800	S	M	OUG	II	03877	012		12	012406	1/1/0001
05800	S	M	OUG	II	03909	014		12	012406	1/1/0001
05800	S	M	OUG	II	03924	015		12	012406	1/1/0001
05800	S	M	OUG	II	03941	016		12	012406	1/1/0001
05800	S	M	OUG	II	03956	017		12	012406	1/1/0001
05800	S	M	OUG	II	03973	018		12	012406	1/1/0001
04000	S	M	OUG	II	00000	012	SIDE OF 403 MONTICELLO BLVD.	12	061579	1/1/0001
04000	S	M	OUG	II	00000	058	SIDE 398 MONTICELLO BLVD.	12	100885	1/1/0001

Street Light Listing run 1/11/2015 10:43:21 AM

Page 1233 of 1254

OFFICE: 311

ROUTE: 564

ST_REF_NO: 00000200800

WINTHROP Drive

LUMENS	BULB TYPE	MULT SERIES	POLE TYPE	SHADE	ADDRESS NUMBER	REF	LOCATION	TAX DIST	DATE INST	DATE CHANGE
04000	S	M	OUG	II	00000	063	SIDE 470 DENVER LANE	12	100885	1/1/0001
04000	S	M	OUG	II	00000	072	SIDE 426 POTOMAC DR.	12	100885	1/1/0001
04000	S	M	OUG	II	03387	059		12	100885	1/1/0001
04000	S	M	OUG	II	03406	060		12	100885	1/1/0001
04000	S	M	OUG	II	03415	061		12	100885	1/1/0001
04000	S	M	OUG	II	03427	062		12	100885	1/1/0001
04000	S	M	OUG	II	03454	069		12	100885	1/1/0001
04000	S	M	OUG	II	03467	070		12	100885	1/1/0001
04000	S	M	OUG	II	03474	071		12	100885	1/1/0001
04000	S	M	OUG	II	03498	073		12	100885	1/1/0001
04000	S	M	OUG	II	03510	074		12	100885	1/1/0001
04000	S	M	OUG	II	03518	008		12	110891	1/1/0001
04000	S	M	OUG	II	03527	007		12	110891	1/1/0001
05800	S	M	OUG	II	03530	006		12	110891	1/1/0001
05800	S	M	OUG	II	03539	005		12	110891	1/1/0001
05800	S	M	OUG	II	03550	004		12	110891	1/1/0001
05800	S	M	OUG	II	03551	003		12	110891	1/1/0001
05800	S	M	OUG	II	03567	001		12	110891	1/1/0001

OFFICE: 311

ROUTE: 564

ST_REF_NO: 00000200900

WISEMAN DRIVE

LUMENS	BULB TYPE	MULT SERIES	POLE TYPE	SHADE	ADDRESS NUMBER	REF	LOCATION	TAX DIST	DATE INST	DATE CHANGE
04000	S	M	OUG	II	00000	068	SIDE OF 2928 EAST HILLS DR.	12	111579	1/1/0001
04000	S	M	OUG	II	00000	069	SIDE OF 3052 TUSCALOOSA LANE	12	111579	1/1/0001

OFFICE: 311

ROUTE: 564

ST_REF_NO: 00000201000

WISHBONE CIRCLE

LUMENS	BULB TYPE	MULT SERIES	POLE TYPE	SHADE	ADDRESS NUMBER	REF	LOCATION	TAX DIST	DATE INST	DATE CHANGE
04000	S	M	OUG	II	00000	046	SIDE OF 621 GALAXIE DR.	12	081477	1/1/0001
04000	S	M	OUG	II	00000	049	SIDE OF 936	12	081477	1/1/0001
04000	S	M	OUG	II	00908	047		12	111580	1/1/0001
04000	S	M	OUG	II	00913	048		12	111580	1/1/0001
04000	S	M	OUG	II	00937	050		12	111478	1/1/0001
04000	S	M	OUG	II	00937	051		12	111478	1/1/0001

OFFICE: 311

ROUTE: 564

ST_REF_NO: 00000201000 WISHBONE CIRCLE

LUMENS	BULB TYPE	MULT SERIES	POLE TYPE	SHADE	ADDRESS NUMBER	REF	LOCATION	TAX DIST	DATE INST	DATE CHANGE
04000	S	M	OUG	II	00949	052		12	081477	1/1/0001

OFFICE: 311

ROUTE: 564

ST_REF_NO: 00000201100 WITHERS AVENUE

LUMENS	BULB TYPE	MULT SERIES	POLE TYPE	SHADE	ADDRESS NUMBER	REF	LOCATION	TAX DIST	DATE INST	DATE CHANGE
09500	S		SOH	II	00000	050	SIDE OF 1400 N BROADWAY ON WITHERS AVE	12	100610	1/1/0001
04000	S	M	SOH	II	00000	023	SIDE 1390 N. BROADWAY	12	060685	1/1/0001
04000	S	M	SOH	II	00000	028	SIDE 1211 N. LIMESTONE	12	060685	1/1/0001
04000	S	M	SOH	II	00100	027		12	060685	1/1/0001
04000	S	M	SOH	II	00109	026		12	060685	1/1/0001
05800	S	M	SOH	II	00117	025	change out bad fixture 2/08	12	060685	1/1/0001
04000	S	M	SOH	II	00127	024		12	060685	1/1/0001

OFFICE: 311

ROUTE: 564

ST_REF_NO: 00000201105 WITHROW WAY

LUMENS	BULB TYPE	MULT SERIES	POLE TYPE	SHADE	ADDRESS NUMBER	REF	LOCATION	TAX DIST	DATE INST	DATE CHANGE
05800	S	M	SOH	II	00000	001	1ST LT. E. OF 3RD ST.	12	010892	1/1/0001
05800	S	M	SOH	II	00000	002	2ND LT. E. OF 3RD ST.	12	010892	1/1/0001

OFFICE: 311

ROUTE: 564

ST_REF_NO: 00000201200 WITTHUHN WAY

LUMENS	BULB TYPE	MULT SERIES	POLE TYPE	SHADE	ADDRESS NUMBER	REF	LOCATION	TAX DIST	DATE INST	DATE CHANGE
05800	S	M	OUG	II	00929	004	bad fixture	12	051581	9/1/2009
04000	S	M	OUG	II	00900	007		12	101583	1/1/0001
04000	S	M	OUG	II	00909	006		12	111580	1/1/0001
04000	S	M	OUG	II	00916	005		12	120886	1/1/0001
04000	S	M	OUG	II	00936	003		12	091579	1/1/0001
04000	S	M	OUG	II	00941	002		12	021580	1/1/0001
04000	S	M	OUG	II	00956	001		12	091579	1/1/0001

OFFICE: 311

ROUTE: 564

ST_REF_NO: 00000201300 WOLF RUN ROAD

LUMENS	BULB TYPE	MULT SERIES	POLE TYPE	SHADE	ADDRESS NUMBER	REF	LOCATION	TAX DIST	DATE INST	DATE CHANGE
05800	S	M	OUG	II	00957	008	bad fixture	12	050888	5/19/2010
04000	S	M	OUG	II	00000	001	SIDE OF 1571 BEACON HILL RD.	12	050888	1/1/0001

OFFICE: 311		ROUTE: 564		ST_REF_NO: 00000201300		WOLF RUN ROAD		LUMENS	BULB TYPE	MULT SERIES	POLE TYPE	SHADE	ADDRESS NUMBER	REF	LOCATION	TAX DIST	DATE INST	DATE CHANGE
04000	S	M	OUG	II	00910	002										12	050888	1/1/0001
04000	S	M	OUG	II	00918	003										12	050888	1/1/0001
04000	S	M	OUG	II	00929	004										12	050888	1/1/0001
04000	S	M	OUG	II	00933	005										12	050888	1/1/0001
04000	S	M	OUG	II	00941	006										12	050888	1/1/0001
04000	S	M	OUG	II	00950	007										12	050888	1/1/0001
04000	S	M	OUG	II	00961	009										12	050888	1/1/0001

OFFICE: 311		ROUTE: 564		ST_REF_NO: 00000201400		WOOD RIDGE ROAD		LUMENS	BULB TYPE	MULT SERIES	POLE TYPE	SHADE	ADDRESS NUMBER	REF	LOCATION	TAX DIST	DATE INST	DATE CHANGE
04000	S	M	OUG	II	01101	024										12	011583	1/1/0001
04000	S	M	OUG	II	01112	025										12	071581	1/1/0001
04000	S	M	OUG	II	01129	026										12	071581	1/1/0001
04000	S	M	OUG	II	01136	027										12	101581	1/1/0001

OFFICE: 311		ROUTE: 564		ST_REF_NO: 00000201500		WOOD VALLEY COURT		LUMENS	BULB TYPE	MULT SERIES	POLE TYPE	SHADE	ADDRESS NUMBER	REF	LOCATION	TAX DIST	DATE INST	DATE CHANGE
05800	S	M	OUG	II	00000	103										12	121073	1/1/0001
05800	S	M	OUG	II	03313	104										12	121073	1/1/0001
05800	S	M	OUG	II	03316	105										12	121073	1/1/0001
05800	S	M	OUG	II	03325	000										12	071674	1/1/0001
05800	S	M	OUG	II	03332	000										12	071674	1/1/0001

OFFICE: 311		ROUTE: 564		ST_REF_NO: 00000201600		WOODBINE AVENUE		LUMENS	BULB TYPE	MULT SERIES	POLE TYPE	SHADE	ADDRESS NUMBER	REF	LOCATION	TAX DIST	DATE INST	DATE CHANGE
04000	S	M	OUG	II	00000	051										12	120884	1/1/0001
04000	S	M	OUG	II	00523	054										12	080884	1/1/0001
04000	S	M	OUG	II	00531	053										12	080884	1/1/0001
05800	S	M	OUG	II	00539	052										12	080884	1/1/0001
04000	S	M	OUG	II	00508	056										12	080884	1/1/0001
04000	S	M	OUG	II	00516	055										12	080884	1/1/0001

OFFICE: 311

ROUTE: 564

ST_REF_NO: 00000201604

WOODBROOK PLACE

LUMENS	BULB TYPE	MULT SERIES	POLE TYPE	SHADE	ADDRESS NUMBER	REF	LOCATION	TAX DIST	DATE INST	DATE CHANGE
05800	S	M	CNT	II	00000	001	OPP. 205	12	060898	1/1/0001
05800	S	M	CNT	II	00221	002		12	060898	1/1/0001
05800	S	M	CNT	III	02908	001		12	060898	1/1/0001
05800	S	M	CNT	III	00236	003		12	060898	1/1/0001

OFFICE: 311

ROUTE: 564

ST_REF_NO: 00000201610

WOODCREEK COURT

LUMENS	BULB TYPE	MULT SERIES	POLE TYPE	SHADE	ADDRESS NUMBER	REF	LOCATION	TAX DIST	DATE INST	DATE CHANGE
05800	S	M	OUG	II	04600	002		12	100893	1/1/0001
05800	S	M	OUG	II	04608	001		12	100893	1/1/0001

OFFICE: 311

ROUTE: 564

ST_REF_NO: 00000201690

WOODCREST PLACE

LUMENS	BULB TYPE	MULT SERIES	POLE TYPE	SHADE	ADDRESS NUMBER	REF	LOCATION	TAX DIST	DATE INST	DATE CHANGE
04000	S	M	OUG	II	00404	001		12	020888	1/1/0001
04000	S	M	OUG	II	00409	002		12	020888	1/1/0001

OFFICE: 311

ROUTE: 564

ST_REF_NO: 00000201700

WOODCROSS PLACE

LUMENS	BULB TYPE	MULT SERIES	POLE TYPE	SHADE	ADDRESS NUMBER	REF	LOCATION	TAX DIST	DATE INST	DATE CHANGE
05800	S	M	OUG	II	00300	021		12	011581	1/1/0001
05800	S	M	OUG	V	00308	020		12	011581	1/1/0001

OFFICE: 311

ROUTE: 564

ST_REF_NO: 00000201800

WOODFORD DRIVE

LUMENS	BULB TYPE	MULT SERIES	POLE TYPE	SHADE	ADDRESS NUMBER	REF	LOCATION	TAX DIST	DATE INST	DATE CHANGE
09500	S	M	SOH	II	00000	001	SIDE 1533 VERSAILLES RD.	12	030886	1/1/0001
09500	S	M	SOH	II	00000	005	NW CORNER OF WOODFORD & GLOVER AVE.	12	121578	1/1/0001
09500	S	M	SOH	II	00000	008	OPP. 130	12	050887	1/1/0001
09500	S	M	SOH	II	00099	003		12	030886	1/1/0001
09500	S	M	SOH	II	00105	002		12	121578	1/1/0001
09500	S	M	SOH	II	00112	004		12	030886	1/1/0001
09500	S	M	SOH	II	00116	007		12	030886	1/1/0001
09500	S	M	SOH	II	00131	006		12	121578	1/1/0001
09500	S	M	OUG	II	00138	094		12	100163	1/1/0001

OFFICE: 311		ROUTE: 564		ST_REF_NO: 00000201810		WOODGLEN COURT		LUMENS	BULB TYPE	MULT SERIES	POLE TYPE	SHADE	ADDRESS NUMBER	REF	LOCATION	TAX DIST	DATE INST	DATE CHANGE
04000	S	M	OUG	II	00908	001		12	060887	1/1/0001								
04000	S	M	OUG	II	00921	002		12	020888	1/1/0001								
04000	S	M	OUG	II	00932	003		12	060887	1/1/0001								
04000	S	M	OUG	II	00941	004		12	060887	1/1/0001								
04000	S	M	OUG	II	00948	005		12	060887	1/1/0001								
05800	S	M	OUG	II	00965	006	upgrade 5/08	12	020888	1/1/0001								
OFFICE: 311		ROUTE: 564		ST_REF_NO: 00000201820		WOODGLEN DRIVE		LUMENS	BULB TYPE	MULT SERIES	POLE TYPE	SHADE	ADDRESS NUMBER	REF	LOCATION	TAX DIST	DATE INST	DATE CHANGE
04000	S	M	OUG	II	00000	002	SIDE 940 WOODGLEN CT.	12	020888	1/1/0001								
04000	S	M	OUG	II	04608	001		12	060887	1/1/0001								
OFFICE: 311		ROUTE: 564		ST_REF_NO: 00000201850		WOODHAVEN PLACE		LUMENS	BULB TYPE	MULT SERIES	POLE TYPE	SHADE	ADDRESS NUMBER	REF	LOCATION	TAX DIST	DATE INST	DATE CHANGE
05800	S	M	OUG	II	00000	001	SIDE OF 3797 WINTHROP, ON WOODHAVEN PLACE	12	012406	1/1/0001								
05800	S	M	OUG	II	00704	002		12	012406	1/1/0001								
05800	S	M	OUG	II	00717	003		12	012406	1/1/0001								
05800	S	M	OUG	II	00732	004		12	012406	1/1/0001								
05800	S	M	OUG	II	00745	005		12	012406	1/1/0001								
05800	S	M	OUG	II	00760	006		12	012406	1/1/0001								
05800	S	M	OUG	II	00769	007		12	012406	1/1/0001								
OFFICE: 311		ROUTE: 564		ST_REF_NO: 00000201900		WOODHILL DRIVE		LUMENS	BULB TYPE	MULT SERIES	POLE TYPE	SHADE	ADDRESS NUMBER	REF	LOCATION	TAX DIST	DATE INST	DATE CHANGE
05800	S	M	OUG	II	00000	032	SIDE OF 292 MULBERRY CT.	12	090170	1/1/0001								
22000	S	M	OUG	II	00000	050	1ST LT. E. OF NEW CIRCLE RD., SOUTHSIDE	12	040893	1/1/0001								
22000	S	M	OUG	II	00000	051	1ST LT. E. OF NEW CIRCLE RD., NORTHSIDE	12	040893	1/1/0001								
22000	S	M	OUG	II	00000	052	2ND LT. E. OF NEW CIRCLE RD., SOUTHSIDE	12	040893	1/1/0001								
22000	S	M	OUG	II	00000	053	3RD LT. E. OF NEW CIRCLE RD., SOUTHSIDE	12	040893	1/1/0001								
22000	S	M	OUG	II	00000	054	4TH LT. E. OF NEW CIRCLE RD., SOUTHSIDE	12	040893	1/1/0001								
22000	S	M	OUG	II	00000	055	2ND LT. E. OF NEW CIRCLE RD., NORTHSIDE	12	040893	1/1/0001								

OFFICE: 311

ROUTE: 564

ST_REF_NO: 00000201900

WOODHILL DRIVE

LUMENS	BULB TYPE	MULT SERIES	POLE TYPE	SHADE	ADDRESS NUMBER	REF	LOCATION	TAX DIST	DATE INST	DATE CHANGE
22000	S	M	OUG	II	00000	056	5TH LT. E. OF NEW CIRCLE RD., SOUTHSIDE	12	040893	1/1/0001
05800	S	M	OUG	II	00000	079	OPP. 2441	12	070172	1/1/0001
05800	S	M	OUG	II	00000	082	SIDE OF 476 PEACHTREE RD.	12	070172	1/1/0001
05800	S	M	OUG	II	00000	101	OPP. 2505	12	091475	1/1/0001
20000	M	M	OUG	II	00000	299	NEW CIRCLE ROAD AT WOODHILL	12	040893	1/1/0001
20000	M	M	OUG	II	00000	301	NEW CIRCLE ROAD AT WOODHILL	12	040893	1/1/0001
05800	S	M	OUG	II	02400	030		12	070172	1/1/0001
05800	S	M	OUG	II	02401	029		12	041581	1/1/0001
05800	S	M	OUG	II	02417	031		12	070172	1/1/0001
05800	S	M	OUG	II	02424	037		12	080171	1/1/0001
05800	S	M	OUG	II	02433	057		12	080171	1/1/0001
05800	S	M	OUG	II	02449	080		12	070172	1/1/0001
05800	S	M	OUG	II	02456	081		12	080172	1/1/0001
05800	S	M	OUG	II	02480	083		12	080172	1/1/0001
05800	S	M	OUG	II	02483	086		12	080172	1/1/0001
05800	S	M	OUG	II	02496	087		12	011674	1/1/0001
05800	S	M	OUG	II	02497	100		12	080172	1/1/0001
05800	S	M	OUG	II	02631	014		12	011581	1/1/0001
05800	S	M	OUG	II	02646	013		12	011581	1/1/0001
05800	S	M	OUG	II	00000	002	SIDE OF 217 SHADOW WOOD PLACE	12	111580	1/1/0001
05800	S	M	OUG	II	00000	003	OPP. 2686 WOODHILL DRIVE	12	090884	1/1/0001
05800	S	M	OUG	II	00000	004	SIDE OF 208 FAIRLEAF	12	111580	1/1/0001
05800	S	M	OUG	II	00000	005	SIDE OF 301 SANDWOOD PLACE	12	111580	1/1/0001
05800	S	M	OUG	II	00000	011	SIDE OF 209 CROSSFIELD PLACE	12	011581	1/1/0001
05800	S	M	OUG	II	00000	012	SIDE 493 LARKWOOD DR.	12	090884	1/1/0001
05800	S	M	OUG	II	00000	015	SIDE OF 216 TIPCHIK DR.	12	040897	1/1/0001
05800	S	M	OUG	II	02579	018		12	040897	1/1/0001
05800	S	M	OUG	II	02600	017		12	040897	1/1/0001
05800	S	M	OUG	II	02611	016		12	040897	1/1/0001
05800	S	M	OUG	II	02699	001		12	111580	1/1/0001

OFFICE: 311		ROUTE: 564		ST_REF_NO: 00000202000		WOODLAKE WAY		TAX DIST	DATE INST	DATE CHANGE
LUMENS	BULB TYPE	MULT SERIES	POLE TYPE	SHADE	ADDRESS NUMBER	REF	LOCATION			
05800	S		OUG	II	00475	007		12	071309	1/1/0001
05800	S	M	OUG	II	00459	006		12	091477	1/1/0001
05800	S	M	OUG	II	00466	000		12	061674	1/1/0001
05800	S	M	OUG	II	00471	004		12	011475	1/1/0001
05800	S	M	OUG	II	00491	000		12	061674	1/1/0001
05800	S	M	OUG	II	00494	000		12	061674	1/1/0001
OFFICE: 311		ROUTE: 564		ST_REF_NO: 00000202100		WOODLAND AVENUE		TAX DIST	DATE INST	DATE CHANGE
LUMENS	BULB TYPE	MULT SERIES	POLE TYPE	SHADE	ADDRESS NUMBER	REF	LOCATION			
22000	S		SOH	II	00000	200	ACROSS FROM 387 WOODLAND AVE	12	111809	1/1/0001
09500	S	M	SOH	II	00000	010	OPP. 172	12	080965	9/10/2012
09500	S	M	SOH	II	00343	018		12	050165	1/9/2012
10000	M	M	OUG	II	00000	001	SIDE OF 508 E. MAIN ST.	12	060886	1/1/0001
10000	M	M	SOH	II	00114	003		12	071365	1/1/0001
10000	M	M	SOH	II	00121	004		12	050165	1/1/0001
10000	M	M	SOH	II	00132	005		12	071365	1/1/0001
10000	M	M	SOH	II	00143	006		12	080965	1/1/0001
22000	S	M	SOH	II	00000	035	SIDE OF ALLEN HOUSE - E BUILDING	12	060899	1/1/0001
22000	S	M	OOH	II	00000	036	OPP. CLIFTON AVE.	12	102367	1/1/0001
22000	S	M	OOH	II	00000	037	1ST LT. N. OF HILLTOP AVE., W. SIDE	12	102367	1/1/0001
22000	S	M	OOH	II	00000	038	1ST LT. N. OF HILLTOP AVE., E. SIDE	12	102367	1/1/0001
10000	M	M	SOH	II	00000	012	SIDE OF 499 E. HIGH ST.	12	080965	1/1/0001
50000	S	M	SOH	II	00000	013	SE CORNER OF WOODLAND & HIGH ST.	12	050165	1/1/0001
22000	S	M	SOH	II	00000	027	SIDE OF 470 ROSE LANE	12	020168	1/1/0001
22000	S	M	SOH	II	00000	032	SE CORNER OF WOODLAND & COLUMBIA AVE.	12	010567	1/1/0001
22000	S	M	SOH	II	00000	033	SIDE OF 502 COLUMBIA AVE	12	060899	1/1/0001
22000	S	M	OOH	II	00000	034	OPP. WATSON ALLEY	12	102367	1/1/0001
10000	M	M	SOH	II	00148	007		12	071365	1/1/0001
10000	M	M	SOH	II	00155	008		12	080965	1/1/0001
10000	M	M	SOH	II	00164	009		12	050165	1/1/0001
10000	M	M	SOH	II	00180	011		12	071365	1/1/0001
50000	S	M	SOH	II	00209	014		12	080965	1/1/0001
10000	M	M	SOH	II	00300	015		12	071365	1/1/0001

OFFICE: 311		ROUTE: 564		ST_REF_NO: 00000202100		WOODLAND AVENUE		LUMENS	BULB TYPE	MULT SERIES	POLE TYPE	SHADE	ADDRESS NUMBER	REF	LOCATION	TAX DIST	DATE INST	DATE CHANGE
10000	M	M	SOH	II	00312	016		12	071365	1/1/0001								
10000	M	M	SOH	II	00326	017		12	071365	1/1/0001								
10000	M	M	SOH	II	00348	019		12	050165	1/1/0001								
10000	M	M	SOH	II	00353	020		12	050165	1/1/0001								
10000	M	M	SOH	II	00364	021		12	071365	1/1/0001								
09500	S	M	SOH	II	00375	022	change out bad mv fixture 2/08	12	050165	1/1/0001								
22000	S	M	SOH	II	00401	023		12	010567	1/1/0001								
22000	S	M	SOH	II	00412	024		12	010567	1/1/0001								
22000	S	M	SOH	II	00419	025		12	020168	1/1/0001								
22000	S	M	SOH	II	00428	026		12	010567	1/1/0001								
22000	S	M	SOH	II	00459	029		12	020168	1/1/0001								
22000	S	M	SOH	II	00510	028		12	010567	1/1/0001								
22000	S	M	SOH	II	00560	030		12	020168	1/1/0001								
22000	S	M	SOH	II	00573	031		12	020168	1/1/0001								

OFFICE: 311		ROUTE: 564		ST_REF_NO: 00000202200		WOODLARK AVENUE		LUMENS	BULB TYPE	MULT SERIES	POLE TYPE	SHADE	ADDRESS NUMBER	REF	LOCATION	TAX DIST	DATE INST	DATE CHANGE
05800	S	M	OUG	II	00000	039	OPP. 1700 IN ISLAND	12	071581	1/1/0001								
05800	S	M	OUG	II	01704	040		12	051582	1/1/0001								
05800	S	M	OUG	II	01713	041		12	051582	1/1/0001								
05800	S	M	OUG	II	01720	042		12	091581	1/1/0001								
05800	S	M	OUG	II	01740	044		12	061581	1/1/0001								
05800	S	M	OUG	II	01747	043		12	091581	1/1/0001								

OFFICE: 311		ROUTE: 564		ST_REF_NO: 00000202205		WOODLAWN WAY		LUMENS	BULB TYPE	MULT SERIES	POLE TYPE	SHADE	ADDRESS NUMBER	REF	LOCATION	TAX DIST	DATE INST	DATE CHANGE
05800	S	M	CNT	II	00000	004	SIDE OF 301 VALLEY BROOK DR ON WOODLAWN WAY	12	032304	1/1/0001								
05800	S	M	CNT	II	00000	013	SIDE OF 416 MEADOW VALLEY RD ON WOODLAWN WAY	12	032304	1/1/0001								
05800	S	M	CNT	II	02676	012		12	032304	1/1/0001								
05800	S	M	CNT	II	02685	011		12	032304	1/1/0001								
05800	S	M	CNT	II	02700	010		12	032304	1/1/0001								

OFFICE: 311		ROUTE: 564		ST_REF_NO: 00000202205		WOODLAWN WAY				
LUMENS	BULB TYPE	MULT SERIES	POLE TYPE	SHADE	ADDRESS NUMBER	REF	LOCATION	TAX DIST	DATE INST	DATE CHANGE
05800	S	M	CNT	II	02709	009		12	032304	1/1/0001
05800	S	M	CNT	III	02728	008		12	032304	1/1/0001
05800	S	M	CNT	II	02732	007		12	032304	1/1/0001
05800	S	M	CNT	II	02744	006		12	032304	1/1/0001
05800	S	M	CNT	III	02757	014		12	032304	1/1/0001
05800	S	M	CNT	II	02760	005		12	032304	1/1/0001
05800	S	M	CNT	II	00000	002	SIDE OF 301 DEERFIELD LANE	12	020801	1/1/0001
05800	S	M	CNT	II	00000	003	SIDE OF 292 VALLEY BROOK DRIVE	12	020801	1/1/0001
05800	S	M	CNT	II	02796	001		12	020801	1/1/0001

OFFICE: 311		ROUTE: 564		ST_REF_NO: 00000202210		WOODRIDGE ROAD				
LUMENS	BULB TYPE	MULT SERIES	POLE TYPE	SHADE	ADDRESS NUMBER	REF	LOCATION	TAX DIST	DATE INST	DATE CHANGE
05800	S	M	OUG	II	01153	028		12	060894	1/1/0001
05800	S	M	OUG	II	01156	030		12	060894	1/1/0001
05800	S	M	OUG	II	01161	029		12	060894	1/1/0001
05800	S	M	OUG	II	01172	031		12	060894	1/1/0001

OFFICE: 311		ROUTE: 564		ST_REF_NO: 00000202300		WOODS AVENUE				
LUMENS	BULB TYPE	MULT SERIES	POLE TYPE	SHADE	ADDRESS NUMBER	REF	LOCATION	TAX DIST	DATE INST	DATE CHANGE
04000	S	M	SOH	II	00000	141	OPP. 105	12	020885	1/1/0001
04000	S	M	SOH	II	00000	142	SIDE 144 BROWN AVE	12	100884	1/1/0001

OFFICE: 311		ROUTE: 564		ST_REF_NO: 00000202610		WOODSHIRE WAY				
LUMENS	BULB TYPE	MULT SERIES	POLE TYPE	SHADE	ADDRESS NUMBER	REF	LOCATION	TAX DIST	DATE INST	DATE CHANGE
05800	S		OUG	III	01005	005		12	061709	1/1/0001
05800	S	M	OUG	II	00000	003	SIDE 4725 BROOKSIDE WAY	12	030895	1/1/0001
04000	S	M	OUG	II	00988	002		12	020895	1/1/0001

OFFICE: 311		ROUTE: 564		ST_REF_NO: 00000202800		WOODSPOINT ROAD				
LUMENS	BULB TYPE	MULT SERIES	POLE TYPE	SHADE	ADDRESS NUMBER	REF	LOCATION	TAX DIST	DATE INST	DATE CHANGE
05800	S	M	OUG	II	00000	016	1ST LT. S. OF RICHMOND RD., W. SIDE	12	102164	1/1/0001

OFFICE: 311

ROUTE: 564

ST_REF_NO: 00000202800

WOODSPOINT ROAD

LUMENS	BULB TYPE	MULT SERIES	POLE TYPE	SHADE	ADDRESS NUMBER	REF	LOCATION	TAX DIST	DATE INST	DATE CHANGE
05800	S	M	OUG	II	00000	017	SIDE OF 1600 RICHMOND RD.	12	102164	1/1/0001
05800	S	M	OOH	II	00000	018	SIDE OF HENRY CLAY HOME	12	102164	1/1/0001
05800	S	M	SOH	II	00000	019	SIDE OF 1600 ASHWOOD DR.	12	102164	1/1/0001
05800	S	M	OOH	II	00000	020	SIDE OF HENRY CLAY HOME	12	102164	1/1/0001
05800	S	M	OUG	II	00000	021	IN ISLAND AT FINCASTLE	12	102164	1/1/0001
05800	S	M	OUG	II	00000	022	IN ISLAND AT FINCASTLE	12	102164	1/1/0001
05800	S	M	OUG	II	00209	023		12	102164	1/1/0001
05800	S	M	OUG	II	00228	024		12	050172	1/1/0001
05800	S	M	OUG	II	00241	025		12	050365	1/1/0001

OFFICE: 311

ROUTE: 564

ST_REF_NO: 00000202900

WOODSTOCK CIRCLE

LUMENS	BULB TYPE	MULT SERIES	POLE TYPE	SHADE	ADDRESS NUMBER	REF	LOCATION	TAX DIST	DATE INST	DATE CHANGE
04000	S	M	OUG	II	00000	001	SIDE OF 750 MALABU DR ON WOODSTOCK CIRCLE	12	080891	1/1/0001
04000	S	M	OUG	II	00000	002	OPP. 3411 WOODSTOCK CIRCLE	12	080891	1/1/0001
04000	S	M	OUG	V	03423	003		12	080891	1/1/0001

OFFICE: 311

ROUTE: 564

ST_REF_NO: 00000203000

WOODSTON COURT

LUMENS	BULB TYPE	MULT SERIES	POLE TYPE	SHADE	ADDRESS NUMBER	REF	LOCATION	TAX DIST	DATE INST	DATE CHANGE
05800	S	M	OUG	II	00387	115		12	062774	1/1/0001
05800	S	M	OUG	II	00000	114	SIDE OF 424 LARKWOOD DR.	12	062774	1/1/0001

OFFICE: 311

ROUTE: 564

ST_REF_NO: 00000203010

WOODSTREAM COURT

LUMENS	BULB TYPE	MULT SERIES	POLE TYPE	SHADE	ADDRESS NUMBER	REF	LOCATION	TAX DIST	DATE INST	DATE CHANGE
05800	S	M	CNT	III	00500	003		12	120894	1/1/0001
05800	S	M	CNT	II	00516	002		12	120894	1/1/0001
05800	S	M	CNT	II	00525	001		12	120894	1/1/0001

OFFICE: 311

ROUTE: 564

ST_REF_NO: 00000203100

WOODVIEW DRIVE

LUMENS	BULB TYPE	MULT SERIES	POLE TYPE	SHADE	ADDRESS NUMBER	REF	LOCATION	TAX DIST	DATE INST	DATE CHANGE
04000	S	M	OUG	II	00373	032		12	030888	1/1/0001
04000	S	M	OUG	II	00380	031		12	091579	1/1/0001

OFFICE: 311

ROUTE: 564

ST_REF_NO: 00000203100

WOODVIEW DRIVE

LUMENS	BULB TYPE	MULT SERIES	POLE TYPE	SHADE	ADDRESS NUMBER	REF	LOCATION	TAX DIST	DATE INST	DATE CHANGE
04000	S	M	OUG	II	00389	030		12	091579	1/1/0001
04000	S	M	OUG	II	00400	020		12	091579	1/1/0001
05800	S	M	OUG	II	00409	019		12	090897	1/1/0001
04000	S	M	OUG	II	00416	018		12	091579	1/1/0001
04000	S	M	OUG	II	00429	006		12	091579	1/1/0001
04000	S	M	OUG	II	00436	005		12	030888	1/1/0001
05800	S	M	OUG	II	00453	004		12	030895	1/1/0001
04000	S	M	OUG	II	00456	003		12	111580	1/1/0001
04000	S	M	OUG	V	00472	001		12	091579	1/1/0001
04000	S	M	OUG	II	00477	002		12	111580	1/1/0001

OFFICE: 311

ROUTE: 564

ST_REF_NO: 00000203300

WORCESTER DRIVE

LUMENS	BULB TYPE	MULT SERIES	POLE TYPE	SHADE	ADDRESS NUMBER	REF	LOCATION	TAX DIST	DATE INST	DATE CHANGE
04000	S	M	OUG	II	00603	121		12	090885	1/1/0001
04000	S	M	OUG	II	00608	120		12	090885	1/1/0001
04000	S	M	OUG	II	00623	119		12	090885	1/1/0001
04000	S	M	OUG	II	00632	118		12	090885	1/1/0001
04000	S	M	OUG	II	00643	117		12	090885	1/1/0001

OFFICE: 311

ROUTE: 564

ST_REF_NO: 00000203350

WOTHINGTON LANE

LUMENS	BULB TYPE	MULT SERIES	POLE TYPE	SHADE	ADDRESS NUMBER	REF	LOCATION	TAX DIST	DATE INST	DATE CHANGE
05800	S	M	CNT	II	00000	001	SIDE OF 421 WHITFIELD DRIVE ON WOTHINGTON LANE	12	030504	1/1/0001

OFFICE: 311

ROUTE: 564

ST_REF_NO: 00000203400

WRENN COURT

LUMENS	BULB TYPE	MULT SERIES	POLE TYPE	SHADE	ADDRESS NUMBER	REF	LOCATION	TAX DIST	DATE INST	DATE CHANGE
05800	S	M	SOH	II	00000	001	1ST LT W OF SHORT STREET, S SIDE ON WRENN CT	12	110702	1/1/0001
05800	S	M	SOH	II	00000	002	2ND LT W OF SHORT STREET, S SIDE ON WRENN CT	12	110702	1/1/0001
05800	S	M	SOH	II	00000	003	3RD LT W OF SHORT STREE, S SIDE ON WRENN CT	12	110702	1/1/0001

OFFICE: 311

ROUTE: 564

ST_REF_NO: 00000203600

WYATT PARKWAY

LUMENS	BULB TYPE	MULT SERIES	POLE TYPE	SHADE	ADDRESS NUMBER	REF	LOCATION	TAX DIST	DATE INST	DATE CHANGE
05800	S	M	OUG	II	00000	108	SIDE OF 852 HENRY CLAY BLVD.	12	110884	1/1/0001
05800	S	M	OUG	II	01614	109		12	110884	1/1/0001
05800	S	M	OUG	II	01625	110		12	110884	1/1/0001
05800	S	M	OUG	II	01642	111		12	110884	1/1/0001
05800	S	M	OUG	II	01649	112		12	110884	1/1/0001
05800	S	M	OUG	II	01700	113		12	110884	1/1/0001
05800	S	M	OUG	II	01713	000		12	061269	1/1/0001
05800	S	M	OUG	II	01720	000		12	040969	1/1/0001
05800	S	M	OUG	II	01733	000		12	091967	1/1/0001
05800	S	M	OUG	II	01744	000		12	050172	1/1/0001
05800	S	M	OUG	II	01753	000		12	091967	1/1/0001

OFFICE: 311

ROUTE: 564

ST_REF_NO: 00000203630

WYNDHAM FOREST CIRCLE

LUMENS	BULB TYPE	MULT SERIES	POLE TYPE	SHADE	ADDRESS NUMBER	REF	LOCATION	TAX DIST	DATE INST	DATE CHANGE
05800	S	M	OUG	II	00000	006	SIDE OF 3973 WESTBROOK DR.	12	070899	1/1/0001
05800	S	M	OUG	II	01208	001		12	070899	1/1/0001
05800	S	M	OUG	II	01220	002		12	020897	1/1/0001
05800	S	M	OUG	II	01233	003		12	020897	1/1/0001
05800	S	M	OUG	II	01244	004		12	020897	1/1/0001
05800	S	M	OUG	III	01249	005		12	020897	1/1/0001

OFFICE: 311

ROUTE: 564

ST_REF_NO: 00000203650

WYNDHAM HILLS DRIVE

LUMENS	BULB TYPE	MULT SERIES	POLE TYPE	SHADE	ADDRESS NUMBER	REF	LOCATION	TAX DIST	DATE INST	DATE CHANGE
05800	S	M	OUG	II	00000	059	SIDE OF 3837 WINTHROP DR ON WYNDHAM HILLS DR	12	030206	1/1/0001
05800	S	M	OUG	II	00713	058		12	030206	1/1/0001
05800	S	M	OUG	II	00717	057		12	030206	1/1/0001
05800	S	M	OUG	II	00729	056		12	030206	1/1/0001
05800	S	M	OUG	II	00745	055		12	030206	1/1/0001
05800	S	M	OUG	II	00753	054		12	030206	1/1/0001
05800	S	M	OUG	II	00765	053		12	030206	1/1/0001
05800	S	M	OUG	II	00793	052		12	030206	1/1/0001
05800	S	M	OUG	II	00802	051		12	030206	1/1/0001

Street Light Listing run 1/11/2015 10:43:21 AM

Page 1245 of 1254

OFFICE: 311

ROUTE: 564

ST_REF_NO: 00000203650

WYNDHAM HILLS DRIVE

LUMENS	BULB TYPE	MULT SERIES	POLE TYPE	SHADE	ADDRESS NUMBER	REF	LOCATION	TAX DIST	DATE INST	DATE CHANGE
05800	S	M	OUG	II	00000	030	SIDE OF 1100 FOLEYS RETREAT	12	020897	1/1/0001
05800	S	M	OUG	II	00000	018	OPP. 969 WYNDHAM HILLS DR	12	100890	1/1/0001
05800	S	M	OUG	II	00000	034	SIDE OF 3812 JESSES DOMINION	12	020897	1/1/0001
05800	S	M	OUG	II	00000	039	SIDE OF 3800 WYNDSONG TRAIL	12	020897	1/1/0001
05800	S	M	OUG	II	00000	041	1ST LT. E OF CLAYS MILL, SOUTHSIDE	12	020897	1/1/0001
05800	S	M	OUG	II	00898	010		12	100890	1/1/0001
05800	S	M	OUG	II	00901	011		12	100890	1/1/0001
05800	S	M	OUG	II	00912	012		12	100890	1/1/0001
05800	S	M	OUG	II	00921	013		12	100890	1/1/0001
05800	S	M	OUG	II	00932	014		12	100890	1/1/0001
05800	S	M	OUG	II	00941	015		12	100890	1/1/0001
05800	S	M	OUG	II	00948	016		12	100890	1/1/0001
05800	S	M	OUG	II	00961	017		12	100890	1/1/0001
05800	S	M	OUG	II	00981	019		12	100890	1/1/0001
05800	S	M	OUG	II	00984	020		12	100890	1/1/0001
05800	S	M	OUG	II	01001	021		12	020897	1/1/0001
05800	S	M	OUG	II	01004	022		12	020897	1/1/0001
05800	S	M	OUG	II	01017	023		12	020897	1/1/0001
05800	S	M	OUG	II	01028	024		12	020897	1/1/0001
05800	S	M	OUG	II	01041	025		12	020897	1/1/0001
05800	S	M	OUG	II	01048	026		12	020897	1/1/0001
05800	S	M	OUG	II	01093	029		12	020897	1/1/0001
05800	S	M	OUG	II	01109	031		12	020897	1/1/0001
05800	S	M	OUG	II	01124	032		12	020897	1/1/0001
05800	S	M	OUG	II	01153	036		12	020897	1/1/0001
05800	S	M	OUG	II	01168	037		12	070899	1/1/0001
05800	S	M	OUG	II	01173	038		12	020897	1/1/0001
05800	S	M	OUG	II	01197	040		12	020897	1/1/0001
05800	S	M	OUG	II	01221	042		12	020897	1/1/0001
05800	S	M	OUG	II	00000	002	OPP. 822 WYNDHAM HILLS DR	12	100890	1/1/0001
05800	S	M	OUG	II	00000	004	OPP. 842 WYNDHAM HILLS DR.	12	100890	1/1/0001
05800	S	M	OUG	II	00000	009	OPP. 894 WYNDHAM HILLS DR	12	100890	1/1/0001
05800	S	M	OUG	II	00814	001		12	100890	1/1/0001
05800	S	M	OUG	II	00834	003		12	100890	1/1/0001

Street Light Listing run 1/11/2015 10:43:21 AM

Page 1246 of 1254

OFFICE: 311

ROUTE: 564

ST_REF_NO: 00000203650

WYNDHAM HILLS DRIVE

LUMENS	BULB TYPE	MULT SERIES	POLE TYPE	SHADE	ADDRESS NUMBER	REF	LOCATION	TAX DIST	DATE INST	DATE CHANGE
05800	S	M	OUG	II	00854	005		12	100890	1/1/0001
05800	S	M	OUG	II	00859	022		12	100890	1/1/0001
05800	S	M	OUG	II	00862	006		12	100890	1/1/0001
05800	S	M	OUG	II	00879	007		12	100890	1/1/0001
05800	S	M	OUG	II	00882	008		12	100890	1/1/0001
05800	S	M	OUG	II	01061	027		12	090898	1/1/0001
05800	S	M	OUG	II	01072	028		12	090898	1/1/0001
05800	S	M	OUG	II	01129	033		12	090898	1/1/0001
05800	S	M	OUG	II	01148	035		12	090898	1/1/0001

OFFICE: 311

ROUTE: 564

ST_REF_NO: 00000203675

WYNDHAM HILLS COURT

LUMENS	BULB TYPE	MULT SERIES	POLE TYPE	SHADE	ADDRESS NUMBER	REF	LOCATION	TAX DIST	DATE INST	DATE CHANGE
04000	S	M	OUG	V	03900	001		12	100890	1/1/0001

OFFICE: 311

ROUTE: 564

ST_REF_NO: 00000203680

WYNDHURST ROAD

LUMENS	BULB TYPE	MULT SERIES	POLE TYPE	SHADE	ADDRESS NUMBER	REF	LOCATION	TAX DIST	DATE INST	DATE CHANGE
05800	S	M	OUG	III	04821	195		12	040895	1/1/0001

OFFICE: 311

ROUTE: 564

ST_REF_NO: 00000203685

WYNDHAM RIDGE

LUMENS	BULB TYPE	MULT SERIES	POLE TYPE	SHADE	ADDRESS NUMBER	REF	LOCATION	TAX DIST	DATE INST	DATE CHANGE
05800	S	M	OUG	II	00000	003	REAR OF 1073 WYNDHAM HILLS DR.	12	090898	1/1/0001
05800	S	M	OUG	II	03917	006		12	020897	1/1/0001
05800	S	M	OUG	II	03924	005		12	020897	1/1/0001
05800	S	M	OUG	II	03929	004		12	090898	1/1/0001
05800	S	M	OUG	II	03957	001		12	020897	1/1/0001
05800	S	M	OUG	III	03972	002		12	090898	1/1/0001

OFFICE: 311

ROUTE: 564

ST_REF_NO: 00000203690

WYNDSONG TRAIL

LUMENS	BULB TYPE	MULT SERIES	POLE TYPE	SHADE	ADDRESS NUMBER	REF	LOCATION	TAX DIST	DATE INST	DATE CHANGE
05800	S	M	OUG	II	03801	001		12	020897	1/1/0001
05800	S	M	OUG	II	03812	002		12	020897	1/1/0001

OFFICE: 311

ROUTE: 564

ST_REF_NO: 00000203690

WYNDSONG TRAIL

LUMENS	BULB TYPE	MULT SERIES	POLE TYPE	SHADE	ADDRESS NUMBER	REF	LOCATION	TAX DIST	DATE INST	DATE CHANGE
05800	S	M	OUG	II	03829	003		12	020897	1/1/0001
05800	S	M	OUG	II	03840	004		12	020897	1/1/0001

OFFICE: 311

ROUTE: 564

ST_REF_NO: 00000203695

YAMACRAW PLACE

LUMENS	BULB TYPE	MULT SERIES	POLE TYPE	SHADE	ADDRESS NUMBER	REF	LOCATION	TAX DIST	DATE INST	DATE CHANGE
05800	S	M	CNT	II	00101	001		12	080102	1/1/0001
05800	S	M	CNT	II	00120	002		12	080102	1/1/0001
05800	S	M	CNT	II	00133	003		12	080102	1/1/0001
05800	S	M	CNT	II	00144	004		12	103005	1/1/0001
05800	S	M	CNT	II	00161	005		12	103005	1/1/0001
05800	S	M	CNT	II	00173	006		12	103005	1/1/0001

OFFICE: 311

ROUTE: 564

ST_REF_NO: 00000203700

YALE DRIVE

LUMENS	BULB TYPE	MULT SERIES	POLE TYPE	SHADE	ADDRESS NUMBER	REF	LOCATION	TAX DIST	DATE INST	DATE CHANGE
04000	S	M	OUG	II	00000	001	SIDE OF 3701 TEMPLE DR.	12	070887	1/1/0001
05800	S	M	OUG	II	00000	056	SIDE 312 TULANE DR.upgraded 10/07	12	060886	1/1/0001
04000	S	M	OUG	II	00405	002		12	070887	1/1/0001
04000	S	M	OUG	II	00414	003		12	070887	1/1/0001
04000	S	M	OUG	II	00426	004		12	070887	1/1/0001
04000	S	M	OUG	II	00446	005		12	070887	1/1/0001

OFFICE: 311

ROUTE: 564

ST_REF_NO: 00000203800

YARMOUTH COURT

LUMENS	BULB TYPE	MULT SERIES	POLE TYPE	SHADE	ADDRESS NUMBER	REF	LOCATION	TAX DIST	DATE INST	DATE CHANGE
05800	S	M	OUG	V	02290	000		12	100172	1/1/0001
05800	S	M	OUG	II	02298	000		12	100172	1/1/0001

OFFICE: 311

ROUTE: 564

ST_REF_NO: 00000203900

YARNALLTON PIKE

LUMENS	BULB TYPE	MULT SERIES	POLE TYPE	SHADE	ADDRESS NUMBER	REF	LOCATION	TAX DIST	DATE INST	DATE CHANGE
09500	S	M	SOH	II	00000	121	SE CORNER OF SPURR RD.	12	020801	1/1/0001

OFFICE: 311

ROUTE: 564

ST_REF_NO: 00000204050

YEARLING CIRCLE

LUMENS	BULB TYPE	MULT SERIES	POLE TYPE	SHADE	ADDRESS NUMBER	REF	LOCATION	TAX DIST	DATE INST	DATE CHANGE
05800	S	M	OUG	III	00208	001		12	083105	1/1/0001

OFFICE: 311

ROUTE: 564

ST_REF_NO: 00000204200

YELLOWSTONE PARKWAY

LUMENS	BULB TYPE	MULT SERIES	POLE TYPE	SHADE	ADDRESS NUMBER	REF	LOCATION	TAX DIST	DATE INST	DATE CHANGE
05800	S	M	OUG	II	00000	082	SIDE OF 3208 CHESTERFIELD CIRCLE	12	111580	3/19/2013
05800	S	M	OUG	II	00000	001	SIDE OF 2980 WINTER GARDEN	12	111579	1/1/0001
05800	S	M	OUG	II	00000	004	SIDE OF 613 WINTER PARK CT.	12	111475	1/1/0001
05800	S	M	OUG	II	00000	005	SIDE OF 2801 WINTER PARK DR.	12	041478	1/1/0001
05800	S	M	OUG	II	00000	006	SIDE OF 613 EUREKA SPRINGS DR.	12	021476	1/1/0001
04000	S	M	OUG	II	00000	031	SIDE OF 3230 PIMLICO PKWY.	12	041478	1/1/0001
05800	S	M	OUG	II	00000	055	SIDE OF 1369 LEANING TREE LANE	12	111580	1/1/0001
05800	S	M	OUG	II	00000	071	REAR OF 2395 CHAUVIN DR.	12	021580	1/1/0001
05800	S	M	OUG	II	00000	072	REAR OF 2398 STERLINGTON RD.	12	021580	1/1/0001
05800	S	M	OUG	II	02829	002		12	111475	1/1/0001
05800	S	M	OUG	II	02848	062		12	111579	1/1/0001
05800	S	M	OUG	II	02900	088		12	111580	1/1/0001
05800	S	M	OUG	II	02900	089		12	111580	1/1/0001
05800	S	M	OUG	II	02900	090		12	111580	1/1/0001
05800	S	M	OUG	II	03166	111		12	060890	1/1/0001
05800	S	M	OUG	II	03175	018		12	101478	1/1/0001
05800	S	M	OUG	II	03178	110		12	111580	1/1/0001
05800	S	M	OUG	II	03187	017		12	041478	1/1/0001
04000	S	M	OUG	II	03190	109		12	061580	1/1/0001
05800	S	M	OUG	II	03199	016		12	091476	1/1/0001
04000	S	M	OUG	II	03272	079		12	111583	1/1/0001
04000	S	M	OUG	II	03277	078		12	061580	1/1/0001
04000	S	M	OUG	II	00000	085	SIDE OF 3186 PIMLICO PKWY.	12	061580	1/1/0001
04000	S	M	OUG	II	03209	084		12	061580	1/1/0001
04000	S	M	OUG	II	03220	083		12	111583	1/1/0001
04000	S	M	OUG	II	03248	081		12	061581	1/1/0001
04000	S	M	OUG	II	03257	080		12	111583	1/1/0001

OFFICE: 311		ROUTE: 564		ST_REF_NO: 00000204220		YELLOWWOOD TRACE		LUMENS	BULB TYPE	MULT SERIES	POLE TYPE	SHADE	ADDRESS NUMBER	REF	LOCATION	TAX DIST	DATE INST	DATE CHANGE
05800	S	M	CNT	II	00000	001	SIDE OF 849 SUNNY SLOPE TRACE ON YELLOWWOOD TRACE	12	111907	1/1/0001								
05800	S	M	CNT	II	00000	006	SIDE OF 753 SUNNY SLOPE TRACE ON YELLOWWOOD TRACE	12	111907	1/1/0001								
05800	S	M	CNT	II	03904	002		12	111907	1/1/0001								
05800	S	M	CNT	II	03921	003		12	111907	1/1/0001								
05800	S	M	CNT	II	03925	004		12	111907	1/1/0001								
05800	S	M	CNT	II	03937	005		12	111907	1/1/0001								
OFFICE: 311		ROUTE: 564		ST_REF_NO: 00000204300		YORK STREET		LUMENS	BULB TYPE	MULT SERIES	POLE TYPE	SHADE	ADDRESS NUMBER	REF	LOCATION	TAX DIST	DATE INST	DATE CHANGE
05800	S	M	SOH	II	00174	010		12	111805	1/1/0001								
09500	S	M	SOH	II	00000	101	SIDE OF 748 N. LIMESTONE	12	060800	1/1/0001								
05800	S	M	SOH	I	00108	158		12	111866	1/1/0001								
05800	S	M	SOH	I	00134	160		12	111866	1/1/0001								
05800	S	M	SOH	I	00166	000		12	111866	1/1/0001								
05800	S	M	SOH	I	00000	164	SIDE OF 751 MAPLE AVE.	12	111866	1/1/0001								
05800	S	M	SOH	I	00188	163		12	111866	1/1/0001								
05800	S	M	SOH	I	00202	165		12	111866	1/1/0001								
OFFICE: 311		ROUTE: 564		ST_REF_NO: 00000204310		YORKSHIRE COURT		LUMENS	BULB TYPE	MULT SERIES	POLE TYPE	SHADE	ADDRESS NUMBER	REF	LOCATION	TAX DIST	DATE INST	DATE CHANGE
05800	S	M	OUG	V	01201	002		12	110893	1/1/0001								
05800	S	M	OUG	II	01213	001		12	110893	1/1/0001								
OFFICE: 311		ROUTE: 564		ST_REF_NO: 00000204400		YORKTOWN ROAD		LUMENS	BULB TYPE	MULT SERIES	POLE TYPE	SHADE	ADDRESS NUMBER	REF	LOCATION	TAX DIST	DATE INST	DATE CHANGE
04000	S	M	OUG	II	00000	001	SIDE 930 CELIA LANE	12	070889	1/1/0001								
04000	S	M	OUG	II	01710	002		12	070889	1/1/0001								
04000	S	M	OUG	II	01722	003		12	070889	1/1/0001								
04000	S	M	OUG	II	01737	004		12	070889	1/1/0001								
04000	S	M	OUG	II	01742	005		12	070889	1/1/0001								

OFFICE: 311

ROUTE: 564

ST_REF_NO: 00000204400

YORKTOWN ROAD

LUMENS	BULB TYPE	MULT SERIES	POLE TYPE	SHADE	ADDRESS NUMBER	REF	LOCATION	TAX DIST	DATE INST	DATE CHANGE
04000	S	M	OUG	II	00000	011	OPP. 1828	12	050889	1/1/0001
04000	S	M	OUG	II	01757	006		12	070889	1/1/0001
04000	S	M	OUG	II	01766	007		12	070889	1/1/0001
04000	S	M	OUG	II	01781	008		12	050889	1/1/0001
04000	S	M	OUG	II	01805	009		12	050889	1/1/0001
04000	S	M	OUG	II	01817	010		12	050889	1/1/0001

OFFICE: 311

ROUTE: 564

ST_REF_NO: 00000204450

YOSEMITE COURT

LUMENS	BULB TYPE	MULT SERIES	POLE TYPE	SHADE	ADDRESS NUMBER	REF	LOCATION	TAX DIST	DATE INST	DATE CHANGE
04000	S	M	OUG	II	00000	037	SIDE OF 3876 SUNDART DR.	12	011581	1/1/0001
04000	S	M	OUG	V	01401	038		12	011579	1/1/0001

OFFICE: 311

ROUTE: 564

ST_REF_NO: 00000204500

YOSEMITE WAY

LUMENS	BULB TYPE	MULT SERIES	POLE TYPE	SHADE	ADDRESS NUMBER	REF	LOCATION	TAX DIST	DATE INST	DATE CHANGE
04000	S	M	OUG	II	00000	053	SIDE OF 3889 SUNDART DR.	12	061580	1/1/0001
04000	S	M	OUG	II	01425	054		12	011579	1/1/0001

OFFICE: 311

ROUTE: 564

ST_REF_NO: 00000204600

YOUNG DRIVE

LUMENS	BULB TYPE	MULT SERIES	POLE TYPE	SHADE	ADDRESS NUMBER	REF	LOCATION	TAX DIST	DATE INST	DATE CHANGE
05800	S	M	OUG	III	00000	001	1ST LT. W. OF NEW CIRCLE RD., S. SIDE	12	040159	1/1/0001
05800	S	M	OUG	II	00000	006	SIDE OF 321 ST. GEORGE DR.	12	092062	1/1/0001
05800	S	M	OUG	II	02150	007		12	092062	1/1/0001
05800	S	M	OUG	II	02150	008		12	092062	1/1/0001
05800	S	M	OUG	II	02158	009		12	092062	1/1/0001
05800	S	M	OUG	II	02158	010		12	092062	1/1/0001
05800	S	M	OUG	III	02216	005		12	040159	1/1/0001
05800	S	M	OUG	III	02220	004		12	040159	1/1/0001
05800	S	M	OUG	III	02228	002		12	040159	1/1/0001
05800	S	M	OUG	III	02228	003		12	040159	1/1/0001

OFFICE: 311		ROUTE: 564		ST_REF_NO: 00000204650		YUCCA COURT		LUMENS	BULB TYPE	MULT SERIES	POLE TYPE	SHADE	ADDRESS NUMBER	REF	LOCATION	TAX DIST	DATE INST	DATE CHANGE
	05800	S	M	CNT	II	00805	001									12	112906	1/1/0001
OFFICE: 311		ROUTE: 564		ST_REF_NO: 00000204700		YUMA COURT		LUMENS	BULB TYPE	MULT SERIES	POLE TYPE	SHADE	ADDRESS NUMBER	REF	LOCATION	TAX DIST	DATE INST	DATE CHANGE
	04000	S	M	OUG	II	02401	065									12	101583	1/1/0001
	04000	S	M	OUG	II	02408	066									12	101583	1/1/0001
	04000	S	M	OUG	II	02421	067									12	101583	1/1/0001
	04000	S	M	OUG	V	02428	068									12	101583	1/1/0001
OFFICE: 311		ROUTE: 564		ST_REF_NO: 00000204750		ZEM ALLEY		LUMENS	BULB TYPE	MULT SERIES	POLE TYPE	SHADE	ADDRESS NUMBER	REF	LOCATION	TAX DIST	DATE INST	DATE CHANGE
	05800	S	M	SOH	I	00000	001							1ST LT. S. OF W. 4TH ST., E. SIDE	12	021965	1/1/0001	
OFFICE: 311		ROUTE: 564		ST_REF_NO: 00000204790		ZANDALE DRIVE		LUMENS	BULB TYPE	MULT SERIES	POLE TYPE	SHADE	ADDRESS NUMBER	REF	LOCATION	TAX DIST	DATE INST	DATE CHANGE
	09500	S	M	OUG	II	00000	001							SIDE OF 2200 NICHOLASVILLE RD.	12	110888	1/1/0001	
	09500	S	M	OUG	II	00000	005							OPP. 137	12	110888	1/1/0001	
	09500	S	M	OUG	II	00115	002								12	110888	1/1/0001	
	09500	S	M	OUG	II	00127	003								12	110888	1/1/0001	
	09500	S	M	OUG	II	00133	004								12	110888	1/1/0001	
	05800	S	M	OUG	II	00145	006								12	110888	1/1/0001	
	05800	S	M	OUG	II	00154	007								12	110888	1/1/0001	
	05800	S	M	OUG	II	00162	008								12	110888	1/1/0001	
	05800	S	M	OUG	II	00209	009								12	110888	1/1/0001	
	05800	S	M	OUG	II	00217	010								12	110888	1/1/0001	
	05800	S	M	OUG	II	00225	011								12	110888	1/1/0001	
	05800	S	M	OUG	II	00236	012								12	110888	1/1/0001	
	05800	S	M	OUG	II	00248	013								12	110888	1/1/0001	
	05800	S	M	OUG	II	00257	014								12	110888	1/1/0001	
	05800	S	M	OUG	II	00265	015								12	110888	1/1/0001	
	05800	S	M	OUG	II	00268	016								12	110888	1/1/0001	

OFFICE: 311

ROUTE: 564

ST_REF_NO: 00000204790

ZANDALE DRIVE

LUMENS	BULB TYPE	MULT SERIES	POLE TYPE	SHADE	ADDRESS NUMBER	REF	LOCATION	TAX DIST	DATE INST	DATE CHANGE
05800	S	M	OUG	II	00273	017		12	110888	1/1/0001
05800	S	M	OUG	II	00277	018		12	110888	1/1/0001
05800	S	M	OUG	II	00000	180	OPP. 3145 STARLING DR.	12	020886	1/1/0001
05800	S	M	OUG	II	00000	181	OPP. STARLING DR.	12	020886	1/1/0001
05800	S	M	OUG	II	00000	182	OPP. 743	12	020886	1/1/0001
05800	S	M	OUG	II	00000	185	OPP. 766 HILDEEN DR.	12	020886	1/1/0001
05800	S	M	OUG	II	00000	192	OPP. BRECKENWOOD DR.	12	020886	1/1/0001
05800	S	M	OUG	II	00000	193	SIDE REAR 3301 LANSDOWNE	12	020886	1/1/0001
05800	S	M	OUG	II	00280	019		12	110888	1/1/0001
05800	S	M	OUG	II	00284	020		12	110888	1/1/0001
05800	S	M	OUG	II	00288	021		12	110888	1/1/0001
05800	S	M	OUG	II	00301	022		12	110888	1/1/0001
05800	S	M	OUG	II	00307	023		12	110888	1/1/0001
05800	S	M	OUG	II	00310	024		12	110888	1/1/0001
05800	S	M	OUG	II	00317	025		12	110888	1/1/0001
05800	S	M	OUG	II	00320	026		12	110888	1/1/0001
05800	S	M	OUG	II	00328	028		12	110888	1/1/0001
05800	S	M	OUG	II	00329	027		12	110888	1/1/0001
05800	S	M	OUG	II	00335	029		12	110888	1/1/0001
05800	S	M	OUG	II	00747	183		12	020886	1/1/0001
05800	S	M	OUG	II	00755	184		12	020886	1/1/0001
05800	S	M	OUG	II	00765	186		12	020886	1/1/0001
05800	S	M	OUG	II	00769	187		12	020886	1/1/0001
05800	S	M	OUG	II	00773	188		12	020886	1/1/0001
04000	S	M	OUG	V	00781	350		12	020886	1/1/0001
05800	S	M	OUG	II	00790	191		12	020886	1/1/0001
05800	S	M	OUG	II	00793	189		12	020886	1/1/0001
05800	S	M	OUG	II	00797	190		12	020886	1/1/0001

OFFICE: 311

ROUTE: 564

ST_REF_NO: 00000204800

ZANDALE, WEST DRIVE

LUMENS	BULB TYPE	MULT SERIES	POLE TYPE	SHADE	ADDRESS NUMBER	REF	LOCATION	TAX DIST	DATE INST	DATE CHANGE
05800	S	M	OUG	II	00000	009	SIDE OF 2217 NICHOLASVILLE RD.	12	040172	1/1/0001

OFFICE: 311

ROUTE: 564

ST_REF_NO: 00000204850 ZESTA PLACE

LUMENS	BULB TYPE	MULT SERIES	POLE TYPE	SHADE	ADDRESS NUMBER	REF	LOCATION	TAX DIST	DATE INST	DATE CHANGE
05800	S	M	SOH	II	00000	001	1ST LT. N. OF THIRD ST., E. SIDE	12	121365	1/1/0001
05800	S	M	SOH	II	00000	002	2ND LT. N. OF THIRD ST., E. SIDE	12	121365	1/1/0001
05800	S	M	SOH	V	00000	003	W. SIDE , AT MAGNOLIA AVE.	12	121365	1/1/0001

OFFICE: 311

ROUTE: 564

ST_REF_NO: 00000205100 ZORN COURT

LUMENS	BULB TYPE	MULT SERIES	POLE TYPE	SHADE	ADDRESS NUMBER	REF	LOCATION	TAX DIST	DATE INST	DATE CHANGE
05800	S	M	OUG	II	00705	000		12	052068	1/1/0001
05800	S	M	OUG	II	00716	000		12	050969	1/1/0001

OFFICE: 311

ROUTE: 564

ST_REF_NO: 00000440050 COLTER PASS

LUMENS	BULB TYPE	MULT SERIES	POLE TYPE	SHADE	ADDRESS NUMBER	REF	LOCATION	TAX DIST	DATE INST	DATE CHANGE
05800	S		CNT	II	00000	002	SIDE OF 2516 ROCKAWAY PLACE ON COLTER PASS	12	080610	1/1/0001
05800	S		CNT	II	01201	001		12	080610	1/1/0001

KENTUCKY UTILITIES COMPANY

CASE NO. 2014-00371

**Response to Lexington-Fayette Urban County
Government's Request for Information
Dated January 7, 2015**

Question No. 12

Responding Witness: Paul Gregory "Greg" Thomas

Q-12. What is the cost to KU (per unit) of obtaining each type of street light?

A-12. See the requested information in the table below.

Type of Installation	Material	Labor	Total
5800L HPS COBRA, 30' WD	\$546	\$661	\$1,208
5800L HPS COBRA, 25' ORN, D BUR	\$1,175	\$731	\$1,905
5800L HPS COBRA, 25' ORN, PED	\$1,275	\$994	\$2,269
9500L HPS COBRA, 35' WD	\$683	\$593	\$1,276
9500L HPS COBRA, 30' ORN, D BUR	\$1,580	\$737	\$2,317
9500L HPS COBRA, 30' ORN, PED	\$1,558	\$994	\$2,553
22000L HPS COBRA, 35' WD	\$715	\$661	\$1,376
22000L HPS COBRA, 30' ORN D BUR	\$1,613	\$737	\$2,349
22000L HPS COBRA, 30' ORN, PED	\$1,591	\$994	\$2,585
50000L HPS COBRA, 35' WD	\$799	\$661	\$1,460
50000L HPS COBRA, 30' ORN, D BUR	\$1,696	\$737	\$2,433
50000L HPS COBRA, 30' ORN, PED	\$1,674	\$994	\$2,669
5800L HPS ACORN, DEC POLE, D BUR	\$1,054	\$536	\$1,590
5800L HPS ACORN, DEC POLE, PED	\$1,097	\$876	\$1,973
5800L HPS ACORN, HIST POLE, D BUR	\$2,091	\$536	\$2,627
5800L HPS ACORN, HIST POLE, PED	\$2,133	\$876	\$3,009
9500L HPS ACORN, DEC POLE, D BUR	\$1,046	\$536	\$1,582
9500L HPS ACORN, DEC POLE, PED	\$1,089	\$876	\$1,965
9500L HPS ACORN, HIST POLE, D BUR	\$2,083	\$536	\$2,619
9500L HPS ACORN, HIST POLE, PED	\$2,125	\$876	\$3,002
5800L HPS COL., DEC POLE, D BUR	\$821	\$536	\$1,358
5800L HPS COL., DEC POLE, PED	\$864	\$876	\$1,740
9500L HPS COL., DEC POLE, D BUR	\$825	\$536	\$1,361
9500L HPS COL., DEC POLE, PED	\$867	\$876	\$1,743
5800L HPS VICTORIAN, PED	\$2,581	\$876	\$3,458
9500L HPS VICTORIAN, PED	\$2,531	\$876	\$3,407
5800L HPS CONTEMP, 25' D BUR	\$1,520	\$737	\$2,257
5800L HPS CONTEMP, 25' PED	\$1,689	\$994	\$2,683
9500L HPS CONTEMP, 30' PED	\$1,188	\$832	\$2,019
22000L HPS CONTEMP, 30' PED	\$1,188	\$832	\$2,020
50000L HPS CONTEMP, 30' PED	\$1,189	\$832	\$2,021

KENTUCKY UTILITIES COMPANY

CASE NO. 2014-00371

**Response to Lexington-Fayette Urban County
Government's Request for Information
Dated January 7, 2015**

Question No. 13

Responding Witness: Paul Gregory "Greg" Thomas

- Q-13. How many new public street lights were installed in Fayette County for each of the last 3 years? Please also indicate the types of lights installed and the number of these lights which replaced previously existing street lights.
- A-13. See the requested information in the table below.

Summary of Work Performed for Specific Time Period

1/1/2012 – 12/31/2012

Rate Code	Pole Cat	Lumens	Bulb Type	Newly Installed	Permanent Removal	Upgrade/ Replacement
474	OUG	22000	S	0	12	39
474	OUG	22000	S	29	0	0
463	SOH	09500	S	0	4	53
463	SOH	09500	S	0	1	0
463	SOH	09500	S	2	0	0
463	SOH	09500	S	1	0	0
462	SOH	05800	S	0	19	26
462	SOH	05800	S	3	0	0
461	SOH	04000	S	0	5	3
461	SOH	04000	S	4	0	0
458	OUG	20000	M	0	3	3
458	OUG	20000	M	3	0	0
473	OOH	09500	S	0	0	5
472	OUG	05800	S	0	8	100
472	OUG	05800	S	18	0	0
471	OUG	04000	S	0	0	11
474	OOH	22000	S	0	2	45
472	OOH	05800	S	0	0	11
447	SOH	10000	M	0	5	5
471	OOH	04000	S	0	0	0
475	OOH	50000	S	0	0	4
473	OUG	09500	S	0	2	71
465	SOH	50000	S	0	0	19
457	OOH	10000	M	0	0	1
464	SOH	22000	S	0	21	33
475	OUG	50000	S	0	0	13
475	OUG	50000	S	6	0	0
420	ACD	09500	S	0	0	12
457	OUG	10000	M	0	0	2
448	SOH	20000	M	0	3	2
458	OOH	20000	M	0	2	1
476	CNT	05800	S	0	2	0
476	CNT	05800	S	1	0	0
360	GRN	16000	S	3	0	0
TOTALS:				70	89	459

Summary of Work Performed for Specific Time Period

1/1/2013 – 12/31/2013

Rate Code	Pole Cat	Lumens	Bulb Type	Newly Installed	Permanent Removal	Upgrade/ Replacement
474	OUG	22000	S	0	15	8
474	OUG	22000	S	25	0	0
463	SOH	09500	S	0	0	7
463	SOH	09500	S	2	0	0
462	SOH	05800	S	0	5	4
462	SOH	05800	S	11	0	0
461	SOH	04000	S	0	2	1
458	OUG	20000	M	0	12	0
472	OUG	05800	S	0	2	27
472	OUG	05800	S	11	0	0
471	OUG	04000	S	0	3	0
471	OUG	04000	S	3	0	0
474	OOH	22000	S	0	3	4
474	OOH	22000	S	1	0	0
472	OOH	05800	S	0	0	1
447	SOH	10000	M	0	3	0
471	OOH	04000	S	0	0	0
475	OOH	50000	S	0	0	0
473	OUG	09500	S	0	1	8
473	OUG	09500	S	14	0	0
465	SOH	50000	S	0	0	1
464	SOH	22000	S	0	1	6
464	SOH	22000	S	2	0	0
475	OUG	50000	S	0	1	2
475	OUG	50000	S	1	0	0
457	OUG	10000	M	0	0	0
448	SOH	20000	M	0	1	0
448	SOH	20000	M	1	0	0
458	OOH	20000	M	0	6	0
476	CNT	05800	S	0	0	0
476	CNT	05800	S	21	0	0
477	CNT	09500	S	0	0	2
468	CLN	09500	S	49	0	0

TOTALS:**141****55****71**

**Summary of Work Performed for Specific Time Period
1/1/2014 – 12/31/2014**

Rate Code	Pole Cat	Lumens	Bulb Type	Newly Installed	Permanent Removal	Upgrade/ Replacement
467	CLN	05800	S	20	0	0
468	CLN	09500	S	41	0	0
477	CNT	09500	S	3	0	0
478	CNT	22000	S	13	3	0
447	SOH	10000	M	0	4	11
448	SOH	20000	M	0	6	4
457	OOH	10000	M	0	0	2
457	OUG	10000	M	0	0	3
458	OUG	20000	M	0	3	7
458	OOH	20000	M	0	4	4
461	SOH	04000	S	0	2	3
462	SOH	05800	S	2	5	10
463	SOH	09500	S	3	4	10
464	SOH	22000	S	3	6	46
465	SOH	50000	S	0	0	8
471	OUG	04000	S	0	0	18
472	OUG	05800	S	230	2	7
473	OOH	09500	S	0	2	0
473	OUG	09500	S	3	25	1
474	OUG	22000	S	33	5	5
474	OUG	22000	S	0	7	7
475	OOH	50000	S	0	2	1
475	OUG	50000	S	4	1	1
476	CNT	05800	S	128	6	0

TOTALS: 483 87 148

KENTUCKY UTILITIES COMPANY

CASE NO. 2014-00371

**Response to Lexington-Fayette Urban County
Government's Request for Information
Dated January 7, 2015**

Question No. 14

Responding Witness: Paul Gregory "Greg" Thomas

- Q-14. Please provide both the number and type of public street lights in Fayette County for which service or maintenance was performed in each of the last 3 years and the same information system-wide.
- a. Please provide the basis for generating the above repair or maintenance order (i.e., referral from 311, customer complaint, KU for each of the above.
- A-14. KU does not track this information by type or county. Lexington Crew Center and KU system-wide repair orders for street and other outdoor lights during the periods in question are in the table below.

	2014	2013	2012
Lexington	4,055	4,680	4,095
System-wide	19,055	20,035	19,722

- a. KU does not track repairs by reporting source. Refer to the detailed response to Question No. 16 for the basis of KU's policies and practices regarding repairs and maintenance. Street light repairs that were referred by Lexcall/311 are shown in the table below.

	2014	2013	2012
Hotline Calls	1,119	1,271	934

KENTUCKY UTILITIES COMPANY

CASE NO. 2014-00371

**Response to Lexington-Fayette Urban County
Government's Request for Information
Dated January 7, 2015**

Question No. 15

Responding Witness: Paul Gregory "Greg" Thomas

- Q-15. How many existing street lights are scheduled (or anticipated) to be replaced by KU in Fayette County over the next 5 years for which the LFUCG currently and/or in the future will pay a monthly tariff? Please provide the quantity of each type of light being removed and the quantity and type of light that will replace it.
- A-15. KU has no scheduled replacements of any current LFUCG street lighting fixtures.

KENTUCKY UTILITIES COMPANY

CASE NO. 2014-00371

**Response to Lexington-Fayette Urban County
Government's Request for Information
Dated January 7, 2015**

Question No. 16

Responding Witness: Paul Gregory "Greg" Thomas

Q-16. Please explain in detail KU's current policies, procedures, practices, and/or guidelines for maintaining street lights in Fayette County and provide copies of the same.

- (a) Does KU regularly inspect individual street lights or the collective street lighting in Fayette County? Do these inspections take place only upon the receipt by KU of a complaint regarding a particular street light?
- (b) What is the average response time to replace a non-working street light in Fayette County?
- (c) Does this information differ depending upon the type of street light? If so, please provide a detailed explanation.

A-16. KU maintains its street lights and other lighting products consistent with the original KU installation standards, and in compliance with 807 KAR 5:041. Electric: Section 2 – General Requirements, Section 3 – Acceptable Standards, and Section 5 – Maintenance or Continuity of Service. A copy of these installation standards is attached.

- a. KU conducts proactive lighting patrols as part of its normal operations. These night-time patrols are integrated into KU's normally scheduled operations for outage response activities. When not responding to outages, KU's outage technicians, who are on duty 24 hours a day, 7 days a week, undertake lighting patrol and maintenance activities, among other duties that they perform daily.

STREET LIGHT PATROL/REPAIR SCHEDULE

In addition to needed street light repairs reported via the public, LFUCG, and internally, concerted patrol and repairs are performed on the following annual schedule.

MONTH	ZONE	ZIP CODE
JAN	1	40507
JAN	2	40508
FEB	3	40505
MAR	4	40502
APR	5	40511
MAY	6	40503
JUN	7	40509
JUL	8	40504
AUG	9	40517
SEPT	10	40516
SEPT	11	40513
OCT	12	40515
NOV	13	40514
DEC	14	40510

Arterials are scheduled for patrol semi-annually in May and October to identify and repair those lights along the following routes:

Man-O-War Blvd – New Circle Road

Versailles Road – Winchester Road

Harrodsburg Road – Paris Pike

Nicholasville Road – Newtown Pike

Tates Creek Road – Georgetown Road

Richmond Road – Leestown Road

KU also issues repair orders in response to light outages reported by KU employees and contractors, customers, LFUCG personnel, police, fire departments, and the general public. Outages can be reported via:

1. Website: <https://lge-ku.com/customer-service/report-streetlight-outage>

2. Residential Call Center: 1-800-981-0600

3. LexCall

Lexcall is a process for the reporting of street light outages through LFUCG's 311 call in reporting system. Daily outages are emailed to KU and then entered into the work management system from which a repair order is generated.

Relevant repair metrics are provided to LFUCG quarterly.

b. In 2014, when repairs could be completed by component replacement (bulb and/or photovoltaic control replacement), KU's average street light repair took 1.58 days.

c. No.

The Street Lighting Section of the Construction Standards Handbook is organized into three general areas, as follows:

Design

The most widely accepted reference for street light theory and design is the STREET LIGHTING MANUAL, published by the Edison Electric Institute. Our Company's guidelines for street lighting design have been based largely on material from this book: we have included such topics as comparison of light sources, selection of light distribution patterns, selection of luminaire mounting height & spacing of luminaires, and description of several types of control circuits.

Construction

When the basic design of a street light system has been decided upon, attention must be given to construction techniques. The construction drawings represent the accumulated experience of the Company's operating personnel. Drawings are provided for the variety of situations which commonly arise: standard overhead construction, ornamental overhead, underground construction, and customer outdoor lights.

Material

The items of material which appear in the Design and Construction pages of the Street Lighting Section are listed alphabetically in the remaining sheets of the Section. Information is given on material description, manufacturer, catalog number, and purchase price estimate; it is hoped that this information will serve as a guide in the preparation of purchase requisitions. Since this data is subject to frequent change, these sheets can be reprinted without the necessity for revising other drawings in the Street Lighting Section.

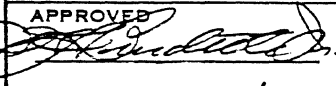
CONSTRUCTION STANDARD - KENTUCKY UTILITIES CO. & OLD DOMINION POWER CO.			
APPROVED 	REVISED	Street Lighting Introduction	SCALE _____
DATE 10-26-81			DRAWING NO. A-9-1.0

STREET / PRIVATE OUTDOOR LIGHTING
CONSTRUCTION MATERIAL LIST

Items included on the Street / Private Outdoor Lighting Material List have been approved for use in the Kentucky Utilities Company and Old Dominion Power Company properties and are in accord with construction standards approved to date.

This list has been tabulated in a convenient and usable form and includes all information necessary for correctly preparing requisitions. Its purpose is to assist in selecting construction material that has been tested, examined and approved as to quality and cost and which will provide the fewest stocking and handling problems. Changes will be made as required and a complete new list will be issued as the need arises.

There are a few items that have not been included in this list, such as Experimental and Special Use Items (see A-10-8.01), new items which were not available when this list was published, and of course, items that do not fulfill our construction requirements. If items are requisitioned which do not appear on this list, a complete description and catalog information must be given. Some note of comment should be shown on the requisition or attached to it explaining the reason for ordering other than approved material.

LEGEND FOR MANUFACTURERS

AE---AMERICAN ELECTRIC
AME---AMERICAN METAL PRODUCTS
BLK---BLACKBURN
CH---CROUSE-HINDS
FP---FISHER PIERCE
GE---GENERAL ELECTRIC
HAP---HAPCO
KER---KEARNEY
PK---P&K POLE PRODUCTS
RIP---RIPLEY
SHE---SHERMAN
UM---UTILITY METALS
WHA---WHATLEY

NOTE - PRICES SHOWN ARE ESTIMATED NET PRICES DELIVERED, AND ARE PRICED PER UNIT UNLESS OTHERWISE SHOWN IN LIST. SEE DRAWING A-10-1.01 FOR INSTRUCTIONS ON PREPARATION OF REQUISITIONS.

CONSTRUCTION STANDARD -- KENTUCKY UTILITIES CO. & OLD DOMINION POWER CO.

APPROVED:	REVISED	STREET / PRIVATE	SCALE
<i>W. E. Johnson</i>		OUTDOOR LIGHTING	
DATE: 11-15-90		MATERIAL LIST	DRAWING NO A-9-10.1

Lamp	Watts	Pattern	Fixture MCP*
HPS	50	III	001309
HPS	70	III	001308
HPS	100	III	001307
HPS	50	V	001306
HPS	70	V	001305
HPS	100	V	001304

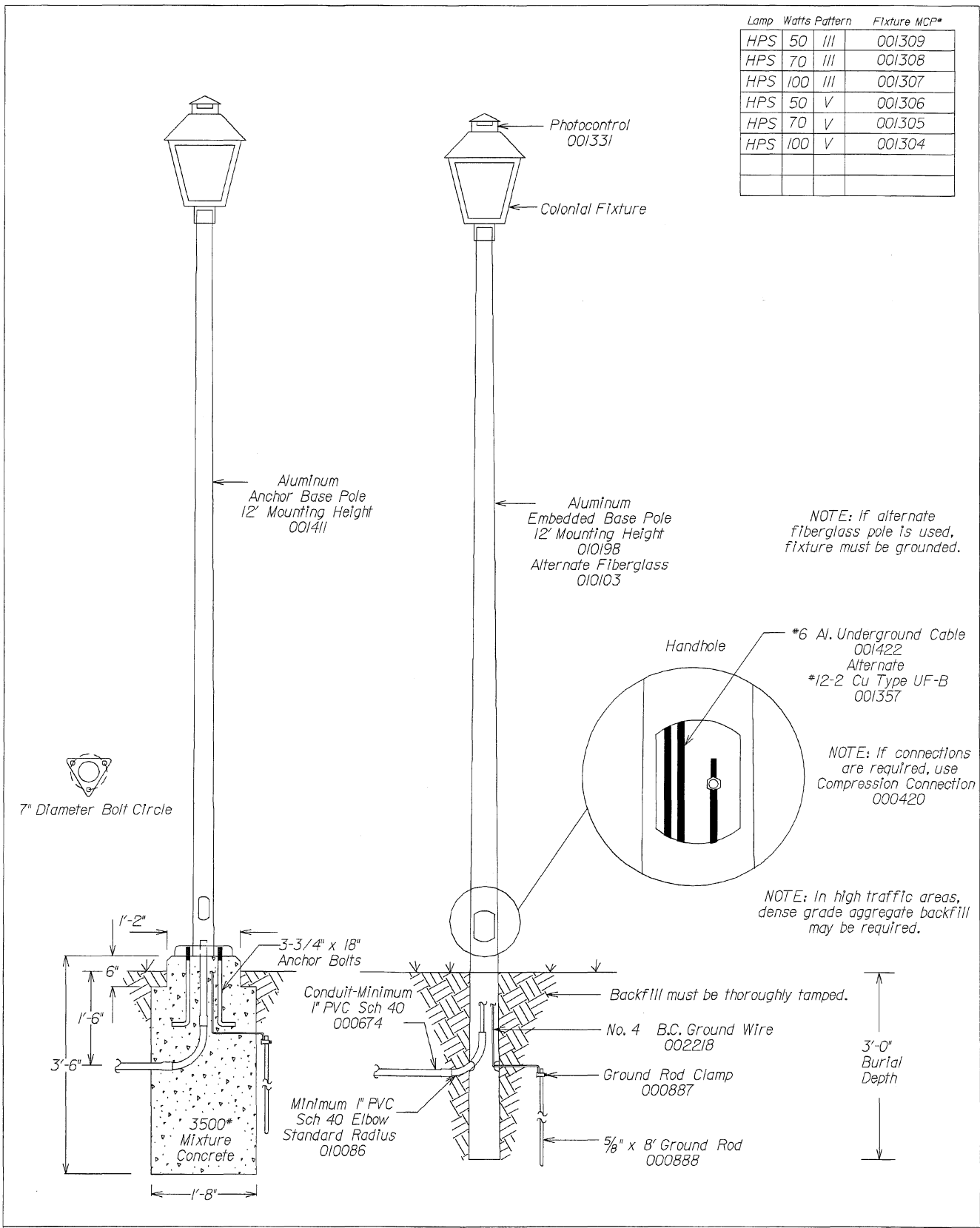

CONSTRUCTION STANDARD - KENTUCKY UTILITIES CO. & OLD DOMINION POWER CO.

APPROVED <i>[Signature]</i> Date <u>3-11-96</u>	REVISED _____ _____ _____	COLONIAL FIXTURE ORNAMENTAL POLE INSTALLATION	Scale: Drawing Number A-9-11.0
---	------------------------------------	--	--------------------------------------

Lamp	Watts	Pattern	Fixture MCP*
HPS	70	III	001319
HPS	100	III	001320
HPS	200	III	001321
HPS	400	III	001322
MH	175	III	005986
MH	400	III	005970
MH	1000	II	005987

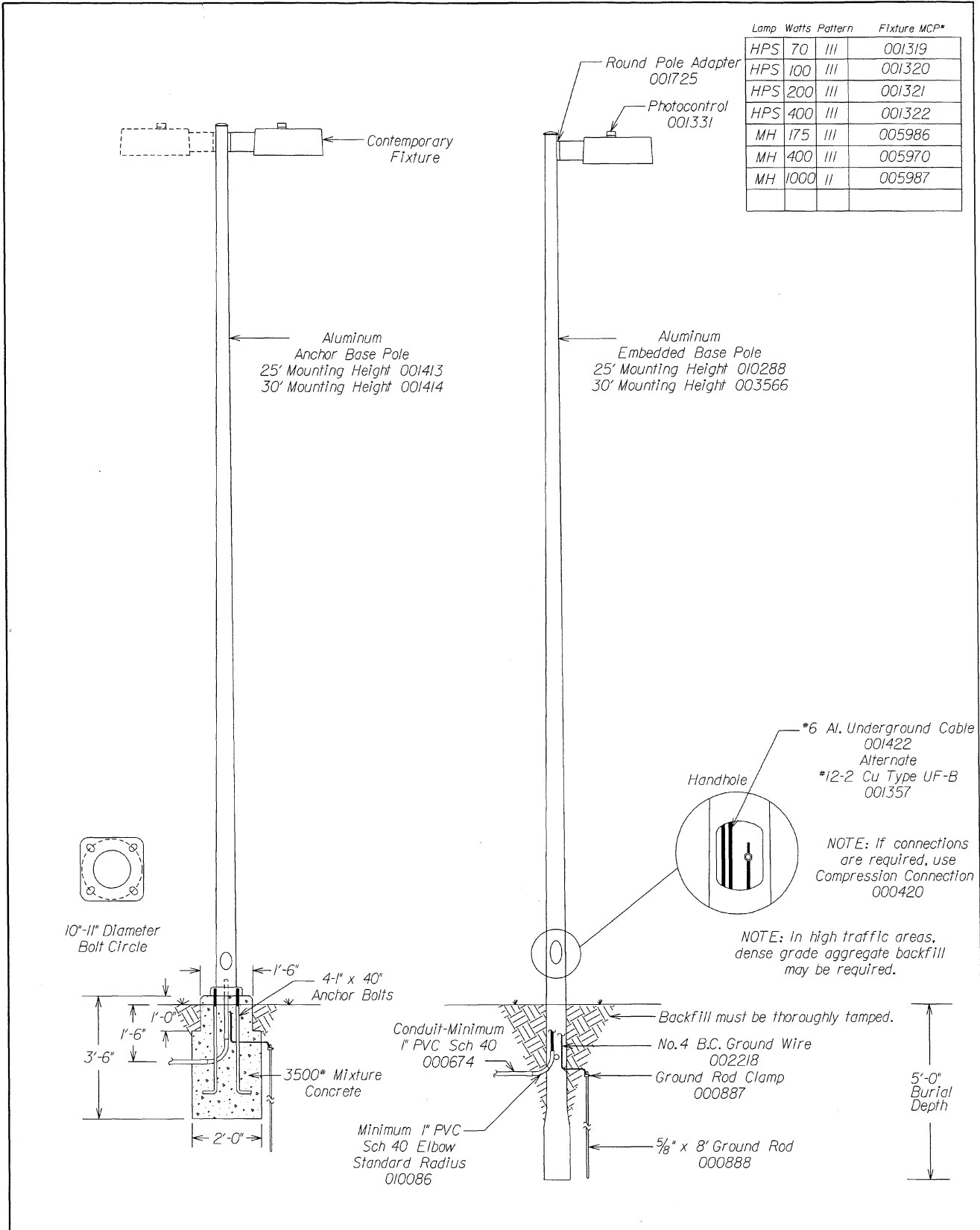

CONSTRUCTION STANDARD - KENTUCKY UTILITIES CO. & OLD DOMINION POWER CO.

APPROVED  Date 10-17-96	REVISED 8/26/96	CONTEMPORARY FIXTURE ORNAMENTAL POLE INSTALLATION	Scale: Drawing Number A-9-12.0
--	--------------------	--	--------------------------------------

Lamp	Watts	Pattern	Fixture MCP#
HPS	50	V	001323
HPS	70	V	001324
HPS	100	V	001325

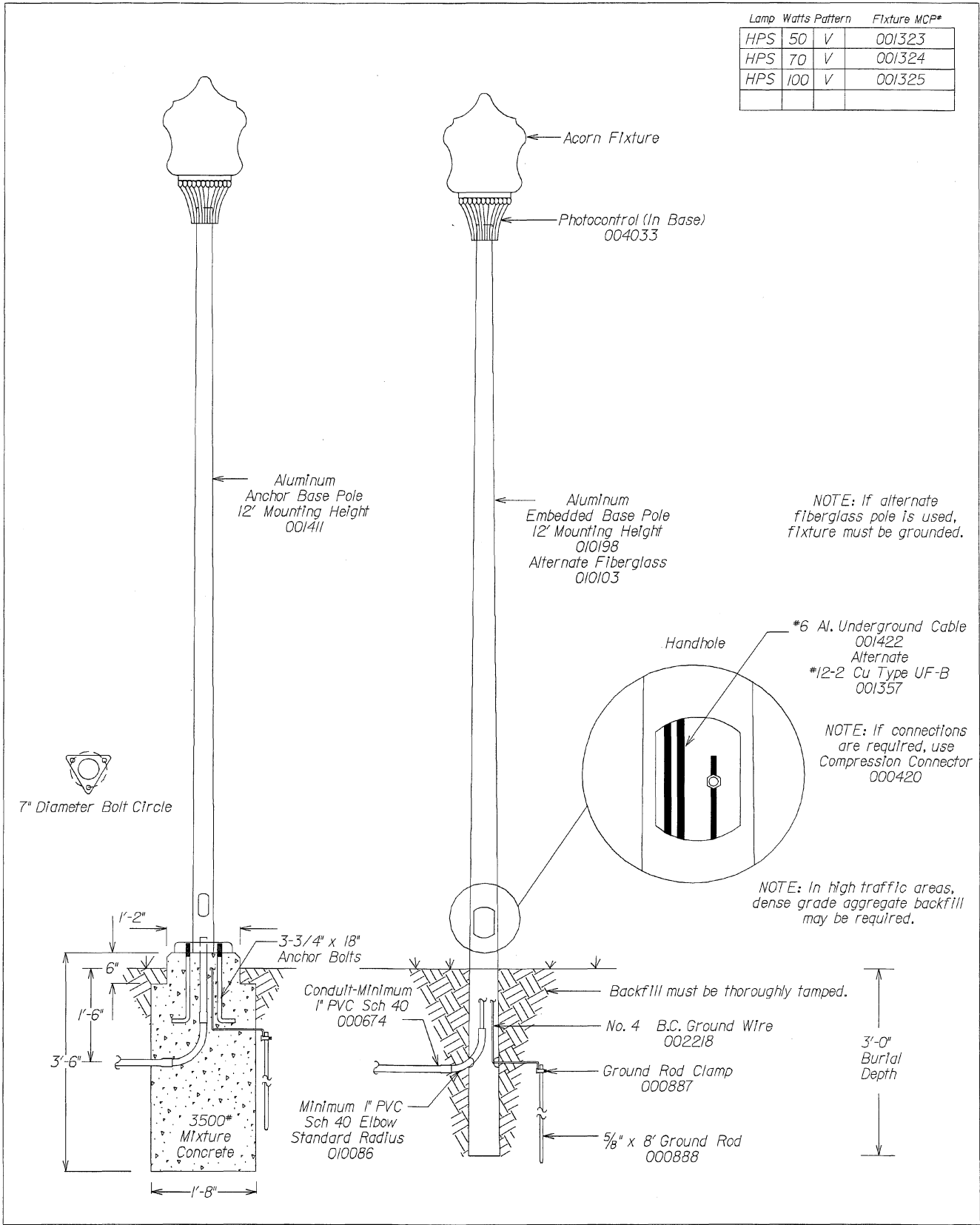

CONSTRUCTION STANDARD - KENTUCKY UTILITIES CO. & OLD DOMINION POWER CO.

APPROVED  Date 3-11-96	REVISED 	ACORN FIXTURE DECORATIVE POLE INSTALLATION	Scale: Drawing Number A-9-13.0
---	-------------	---	--------------------------------------

Lamp	Watts	Pattern	Fixture MCP*
HPS	50	V	001323
HPS	70	V	001324
HPS	100	V	001325

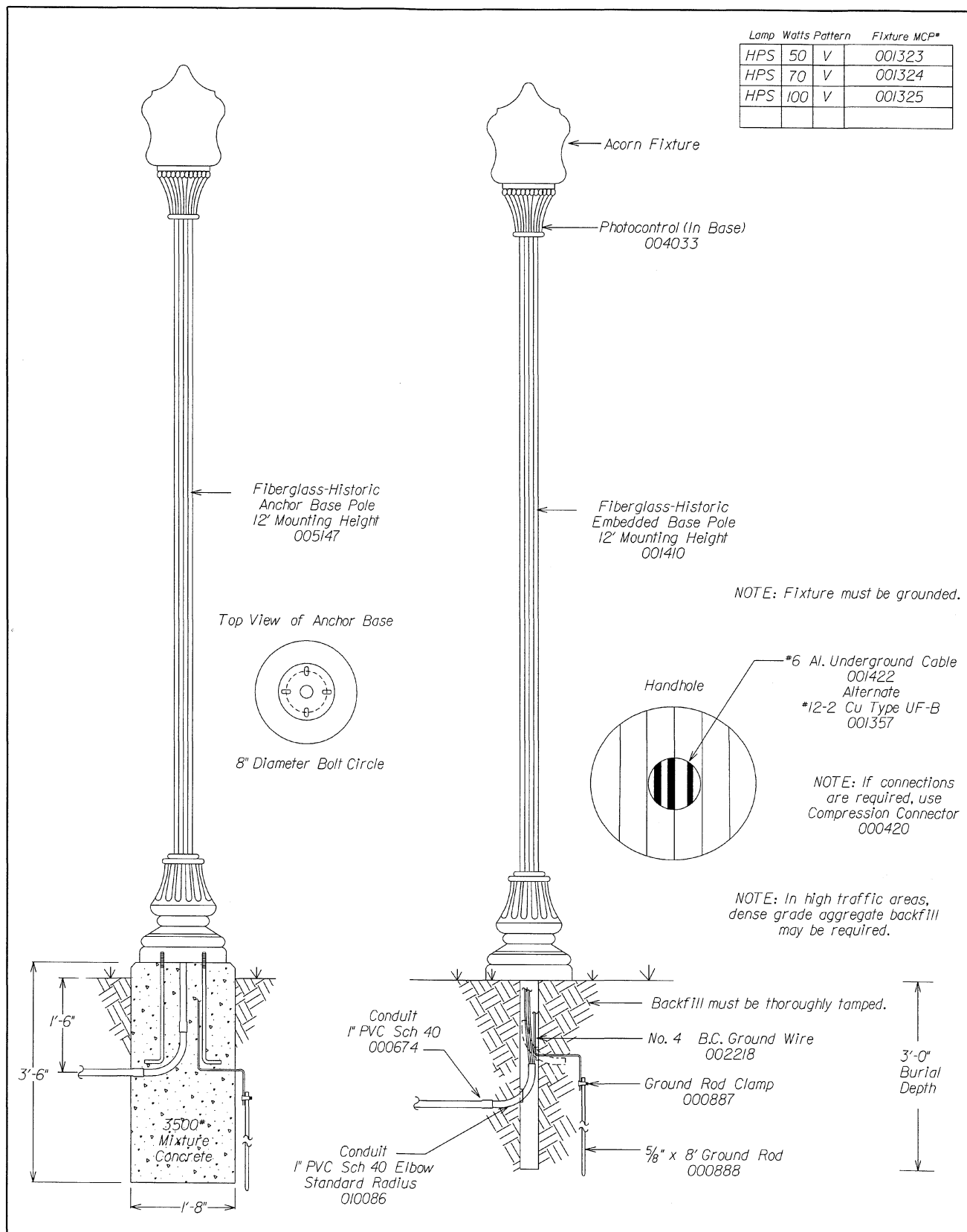

NOTE: Fixture must be grounded.

NOTE: If connections are required, use Compression Connector 000420

NOTE: In high traffic areas, dense grade aggregate backfill may be required.

Backfill must be thoroughly tamped.

CONSTRUCTION STANDARD - KENTUCKY UTILITIES CO. & OLD DOMINION POWER CO.

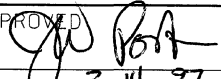
APPROVED

 Date 3-14-97

REVISED

ACORN FIXTURE
 HISTORIC POLE INSTALLATION

Scale:
 Drawing Number
 A-9-13.5

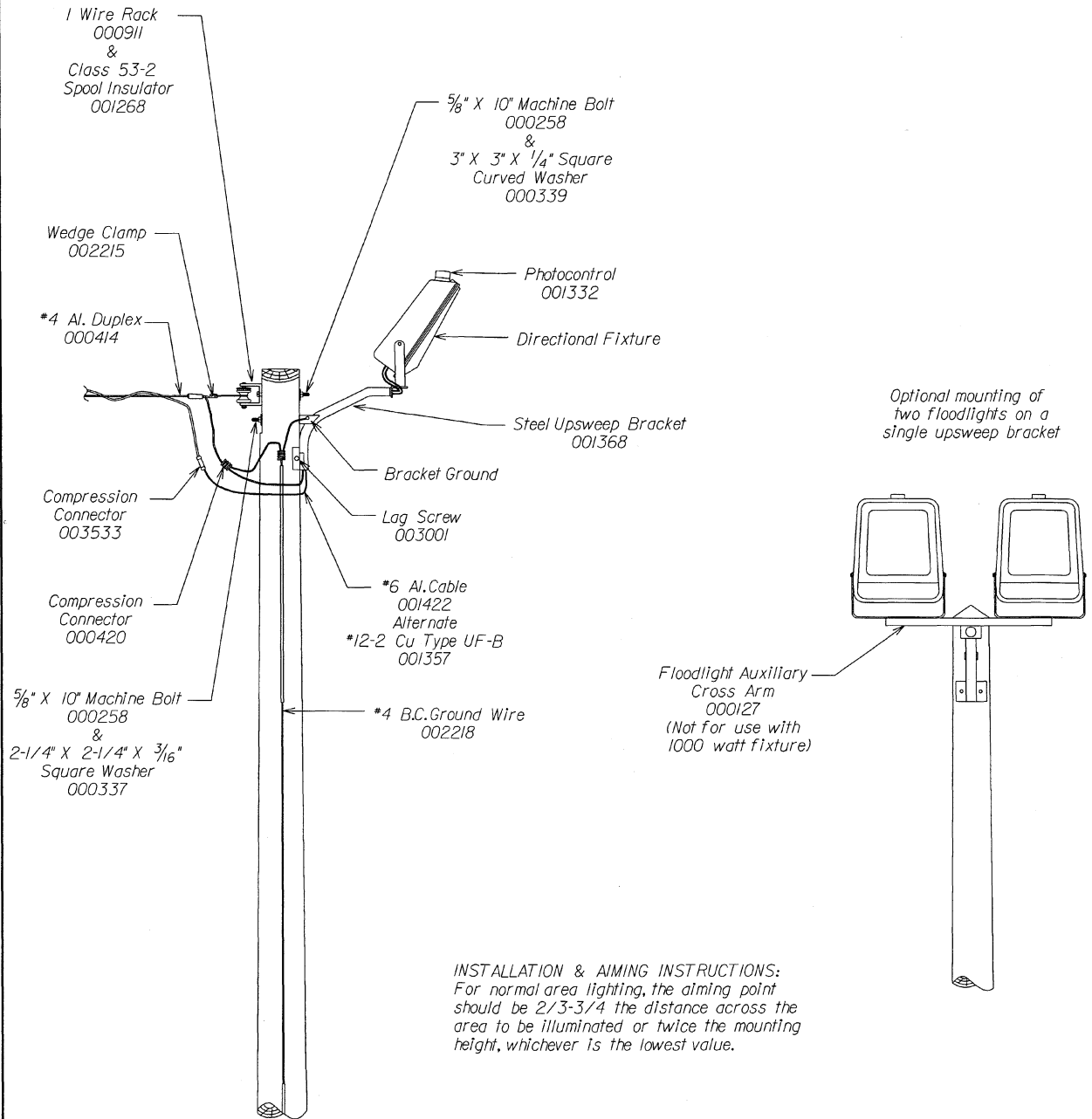
Lamp	Watts	Pattern	Fixture MCP*
HPS	100	6X6	001330
HPS	200	6X6	001329
HPS	400	6X6	001328
MH	175	6X6	005983
MH	400	7X6	005984
MH	1000	7X7	005985



CONSTRUCTION STANDARD - KENTUCKY UTILITIES CO. & OLD DOMINION POWER CO.

APPROVED  Date 10-17-96	REVISED	DIRECTIONAL FIXTURE WOOD POLE INSTALLATION	Scale:
	9/23/96		Drawing Number A-9-14.0

High Pressure Sodium

The high pressure sodium (HPS) Lamp is the Company's most efficient light source. An HPS lamp produces approximately 125 lumens per watt. The HPS lamp produces light by passing a current through a gas and is a member of the high intensity discharge (HID) family of lights. A ballast transformer is required to provide the correct starting and operating voltage. The Company offers the 4000, 5800, 9500, 22000, 50000 approximate lumen HPS lamps for street lighting. The HPS lamp has an average rated life of 24,000 hours and requires 3 minutes to reach full light output.

Mercury Vapor

The mercury vapor lamp belongs to the same HID family of lamps as noted above in which light is produced by the passage of an electric current through a vapor or gas. The sizes of mercury vapor lamps provided by our Company are 3500, 7000, 10000 and 20000 approximate lumens. The rated life of a mercury vapor lamp is 24,000 hours, and its efficiency is about 60 lumens per watt. A ballast transformer is required to provide the correct starting and operating voltage. Mercury lamps require approximately 5 minutes to reach full light output.

Incandescent

The incandescent, or filament, lamp produces light by virtue of a wire or filament heated to incandescence by the flow of electric current through it. Our Company no longer offers incandescent street lights in the following nominal sizes: 1000, 2500, 4000, 6000 and 10000 lumens. The average rated life of incandescent lamps is 6000 hours, and their efficiency in converting electrical energy into light is very low at approximately 20 lumens per watt. Incandescent light sources do not require any auxiliary equipment, such as ballasts. However, they are quite sensitive to variations in voltage. For example, an operating voltage of 10% above lamp rating would result in a loss of 70% of the normal lamp life.

Incandescent lights were used primarily in residential and rural areas, where traffic volume is relatively low.

Other Light Sources

Fluorescent lamps create light by the electrical stimulation of phosphors coated on the inside of a glass tube. Although popular for indoor lighting, fluorescent light has not proved to be economical for street lighting. Fluorescent street lighting is no longer offered by our Company.

Several street lighting sources are currently available, such as metal halide and low pressure sodium, both being vapor discharge lamps. Until these sources become economically competitive and overcome their other shortcomings, they will not be offered by our Company.

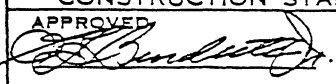
CONSTRUCTION STANDARD - KENTUCKY UTILITIES CO. & OLD DOMINION POWER CO.			
APPROVED 	REVISED	STREET LIGHTING DESIGN LIGHT SOURCES	SCALE
DATE 9-26-83			DRAWING NO. A-9-2.0

Mounting Height

The mounting height of a luminaire is the distance from the surface of the road to the center of the light source. A luminaire should be mounted high enough to minimize glare to oncoming vehicles, and to provide uniform distribution of illumination on the roadway surface. The following table gives suggested mounting heights.

<u>Lamp Lumens</u>	<u>Mounting Height</u>
3500-7000	25'
9500-50000	30'

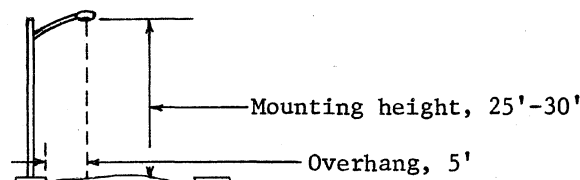

Spacing

The spacing of luminaires is a function of the desired light level on the pavement surface. The information given below has been condensed from application data provided by manufacturers, and from industry standards. It reflects the need for higher illumination levels where pedestrian and vehicle traffic is heavier.

<u>Type of Area</u>	<u>Suggested Luminaire</u>	<u>Spacing</u>
Residential	3500 L MV	150'-260'
	4000 L HPS	
	5800 L HPS	
	7000 L MV	
Collectors	9500 L HPS	110'-150'
	10000 L MV	
Downtown	20000 L MV	70'-150'
	22000 L HPS	
	50000 L HPS	

Brackets

In selecting a bracket length, the objective is to place the luminaire above the pavement, rather than the shoulder of the roadway. In most areas, a 6 ft. bracket will do the job; however, in some locations, where the supporting pole is farther back, it may be necessary to use longer brackets. In any case, the luminaire should not extend more than 5 ft. over the edge of the pavement.

CONSTRUCTION STANDARD - KENTUCKY UTILITIES CO. & OLD DOMINION POWER CO.					
APPROVED  DATE 9-26-83	REVISED <table border="1" style="width: 100%; height: 30px;"> <tr><td> </td><td> </td></tr> </table>			Street Lighting Design LUMINAIRE PLACEMENT	SCALE _____ DRAWING NO. A-9-3.0

Street lighting luminaires are capable of spreading light into several distribution patterns; the design of a street lighting system includes the selection of one of these patterns. On this page are shown the several light patterns commonly used by our Company, with a description of applications. Moving the lamp socket changes the pattern.

Type II



Type II - This distribution is generally applicable to luminaires located at or near the side of relatively narrow roadways.

Type III

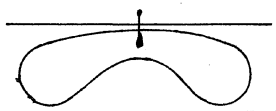

Type III - This type of distribution is intended for luminaires mounted at or near the side of medium-width roadways.

Type IV

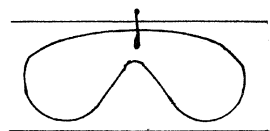

Type IV - This type of distribution is intended for side-of-road mounting and is generally used on wide roadways.

Type V

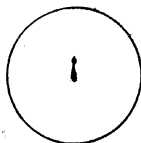

Type V - This type of distribution has equal light output at all angles, and is used by our Company for all private outdoor light applications.

CONSTRUCTION STANDARD - KENTUCKY UTILITIES CO. & OLD DOMINION POWER CO.

APPROVED

REVISED

DATE 9-26-83

Street Lighting Design
 LIGHT DISTRIBUTION PATTERNS

SCALE _____

DRAWING NO.
 A-9-4.0

ILLUMINATION PATTERNS

Luminaire Socket Positions

GE ITT/AE

Before 1/1/83 After 1/1/83 Before 1/1/83 After 1/1/83

Mercury Vapor

3500 Lumens				
Type II	3	1A	D	D2
Type III	2	2A	A	A2
7000 Lumens				
Type II	3	1A	D	D2
Type III	2	2A	A	A2
10000 Lumens				
Type II	2	5	D	D1
Type III	1	1	A	D2
20000 Lumens				
Type II	7	5	D	D
Type III	6	1	A	A

High Pressure Sodium

4000 Lumens				
Type II	-	1B	-	D2
Type III	-	2B	-	A2
5800 Lumens				
Type II	-	1B	-	D2
Type III	-	2B	-	A2
9500 Lumens				
Type II	-	1B	-	D2
Type III	-	2B	-	A2
22000 Lumens				
Type II	-	2	-	D1
Type III	-	3	-	B2
50000 Lumens				
Type II	2	2	D	D
Type III	3	3	A	A

CONSTRUCTION STANDARD - KENTUCKY UTILITIES CO. & OLD DOMINION POWER CO.

APPROVED 	REVISED 3-15-90 WJG	STREET LIGHTING DESIGN LUMINAIRE SOCKET POSITIONS	SCALE _____
	DATE 9-26-83		DRAWING NO. A-9-5.0

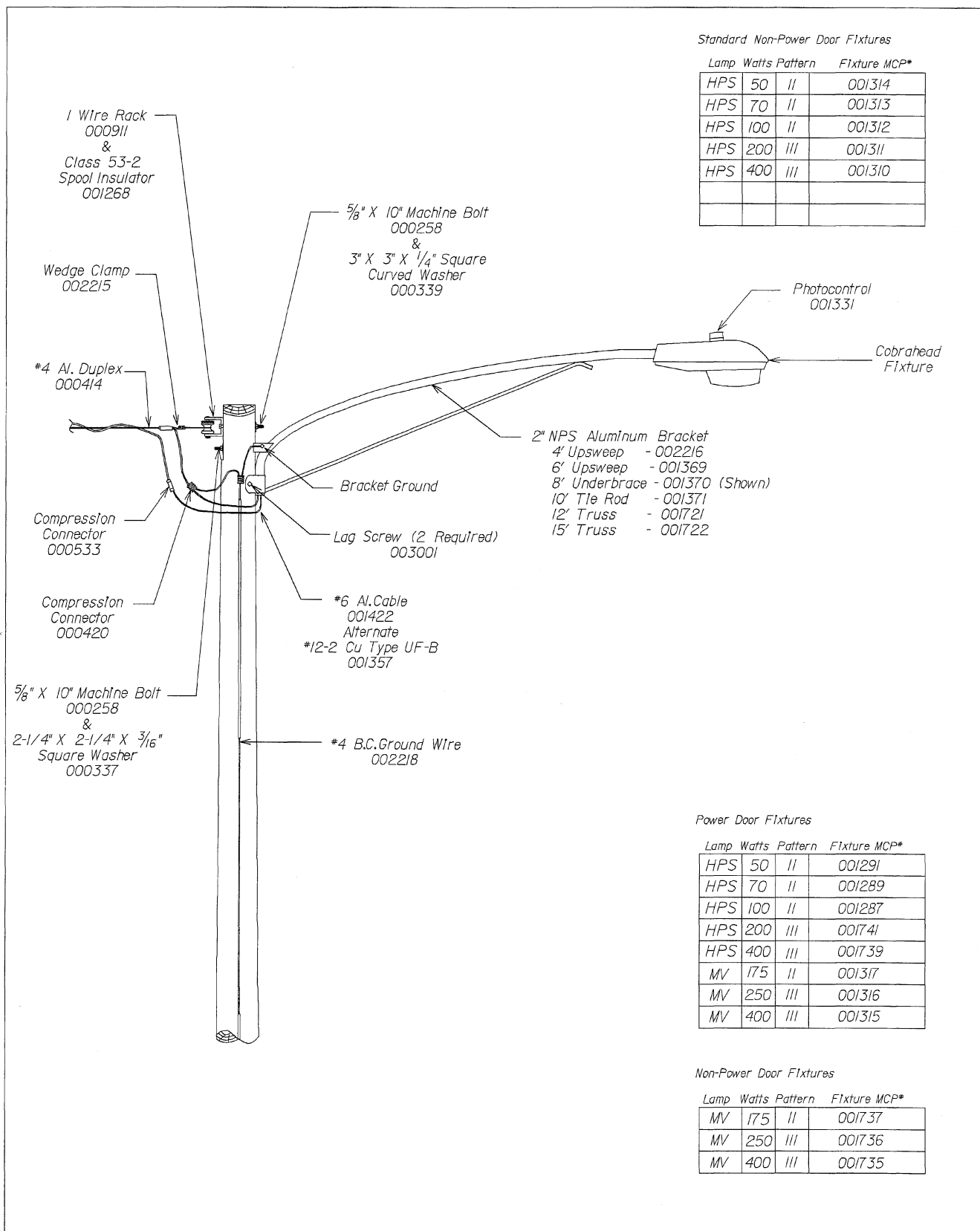

Standard Non-Power Door Fixtures

Lamp	Watts	Pattern	Fixture MCP*
HPS	50	II	001314
HPS	70	II	001313
HPS	100	II	001312
HPS	200	III	001311
HPS	400	III	001310

Power Door Fixtures

Lamp	Watts	Pattern	Fixture MCP*
HPS	50	II	001291
HPS	70	II	001289
HPS	100	II	001287
HPS	200	III	001741
HPS	400	III	001739
MV	175	II	001317
MV	250	III	001316
MV	400	III	001315

Non-Power Door Fixtures

Lamp	Watts	Pattern	Fixture MCP*
MV	175	II	001737
MV	250	III	001736
MV	400	III	001735

CONSTRUCTION STANDARD - KENTUCKY UTILITIES CO. & OLD DOMINION POWER CO.

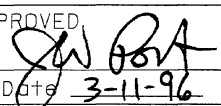
APPROVED:  Date: 3-11-96	REVISED <table border="1" style="width: 100%; height: 40px;"> <tr><td> </td><td> </td></tr> <tr><td> </td><td> </td></tr> </table>					COBRAHEAD FIXTURE WOOD POLE INSTALLATION	Scale: Drawing Number A-9-6.0

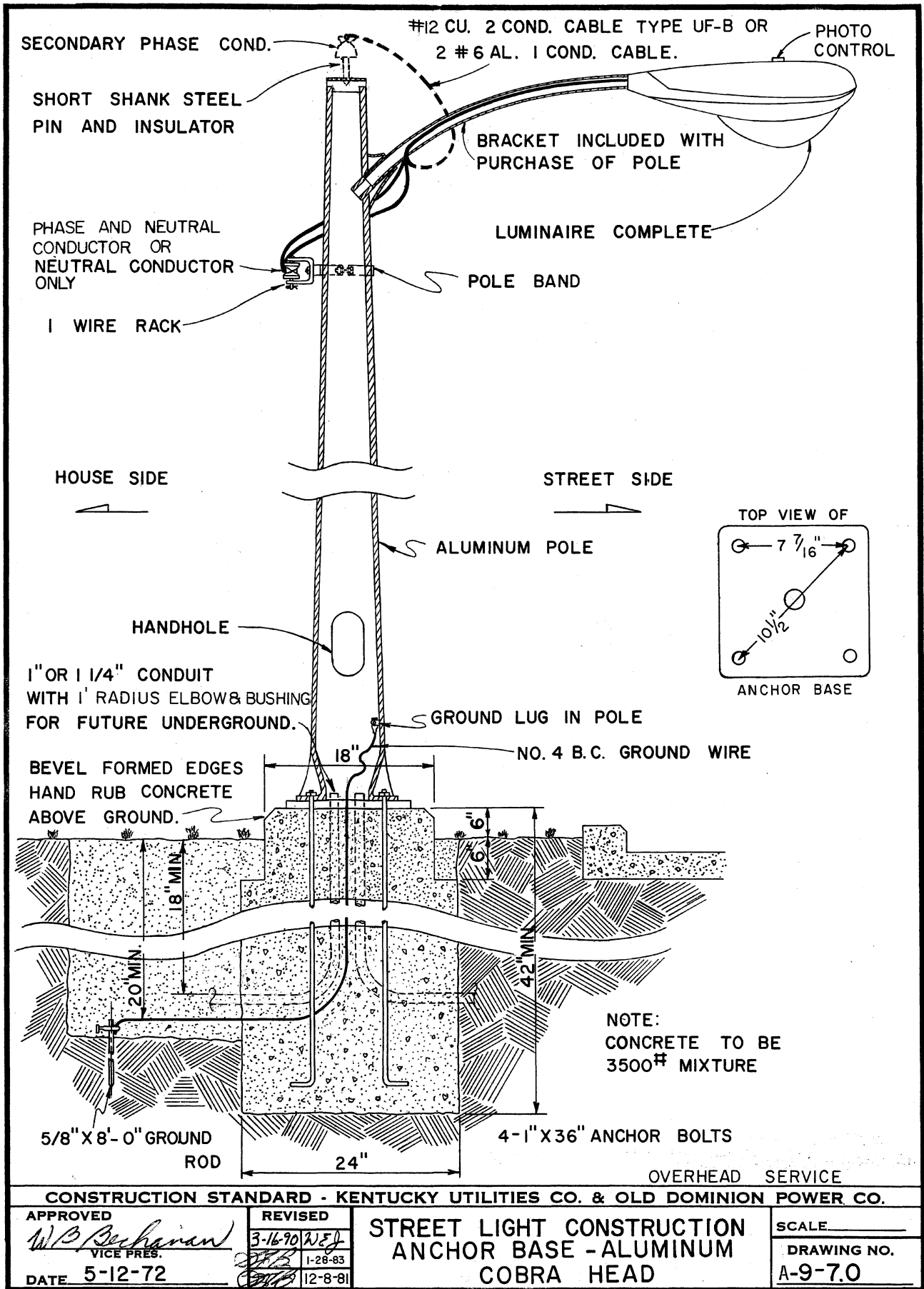

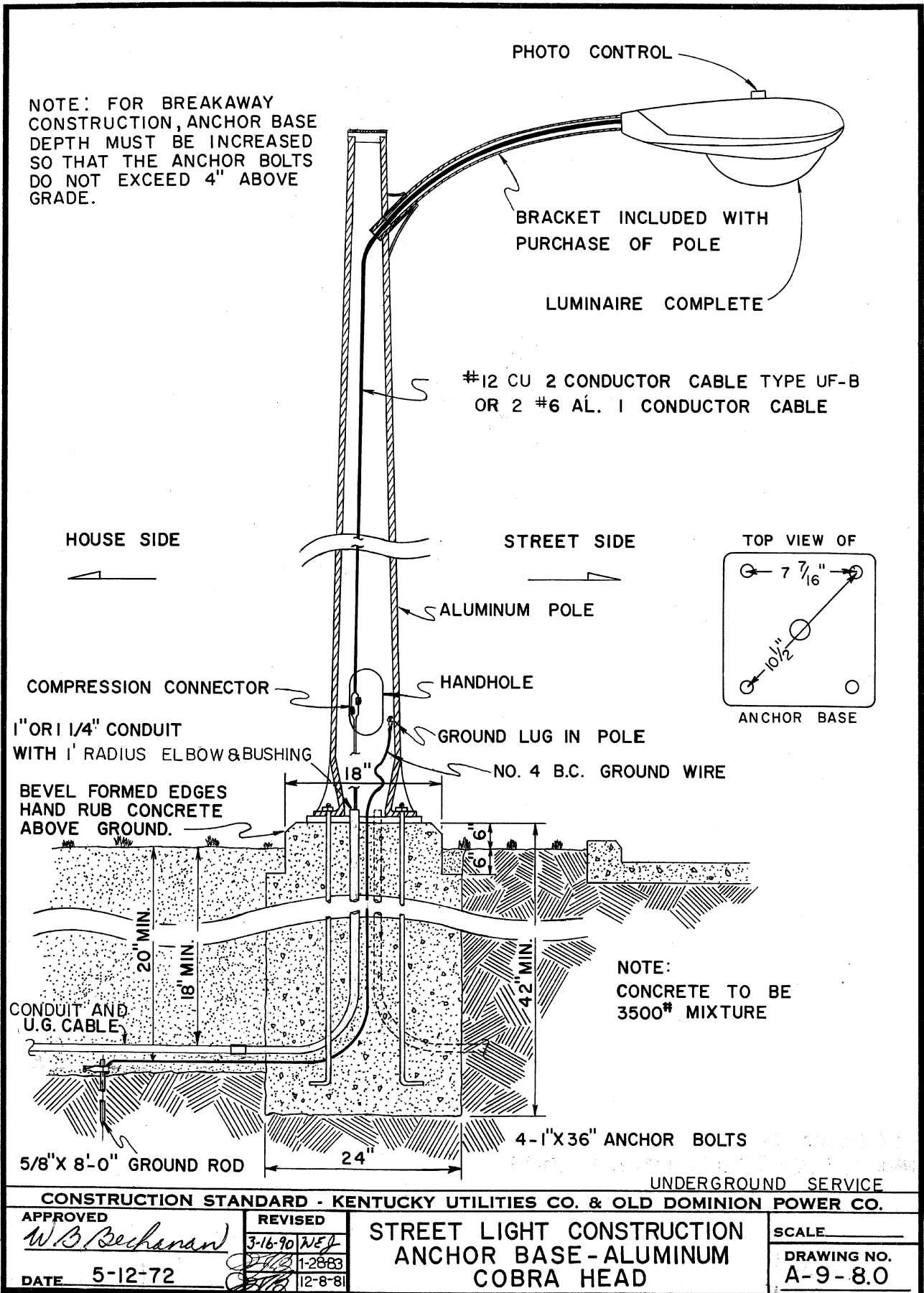

Due to varying soil conditions encountered in the field, there are two (2) manners in which U.G. street light cables can be installed. The Company representative (engineer, foreman, inspector, etc.) will determine which practice must be used in each area dependent upon local conditions.

1. Cable installation in plastic duct

Cable may be installed in Schedule 40 PVC plastic duct on bottom of 18" deep trench. Trench should be reasonably smooth along bottom to avoid future stress points in duct. Care should be exercised in backfilling to see that no large, sharp rocks fall directly onto the plastic duct. Combinations of dirt, gravel and similar substances are suitable for backfill over the cut for a depth of four (4) to six (6) inches. Continue backfill to ground elevation with any available fill material.

2. Cable installation in metal conduit

Cable may be installed in galvanized steel conduit on bottom of minimum 12" deep trench if solid, shelf rock is encountered. Backfill to consist of any available fill material.

CONSTRUCTION STANDARD - KENTUCKY UTILITIES CO. & OLD DOMINION POWER CO.			
APPROVED 	REVISED	SPECIFICATIONS FOR INSTALLATION OF UG STREET LIGHT CABLE	SCALE _____
DATE 10-30-80			DRAWING NO. A-9-8.1

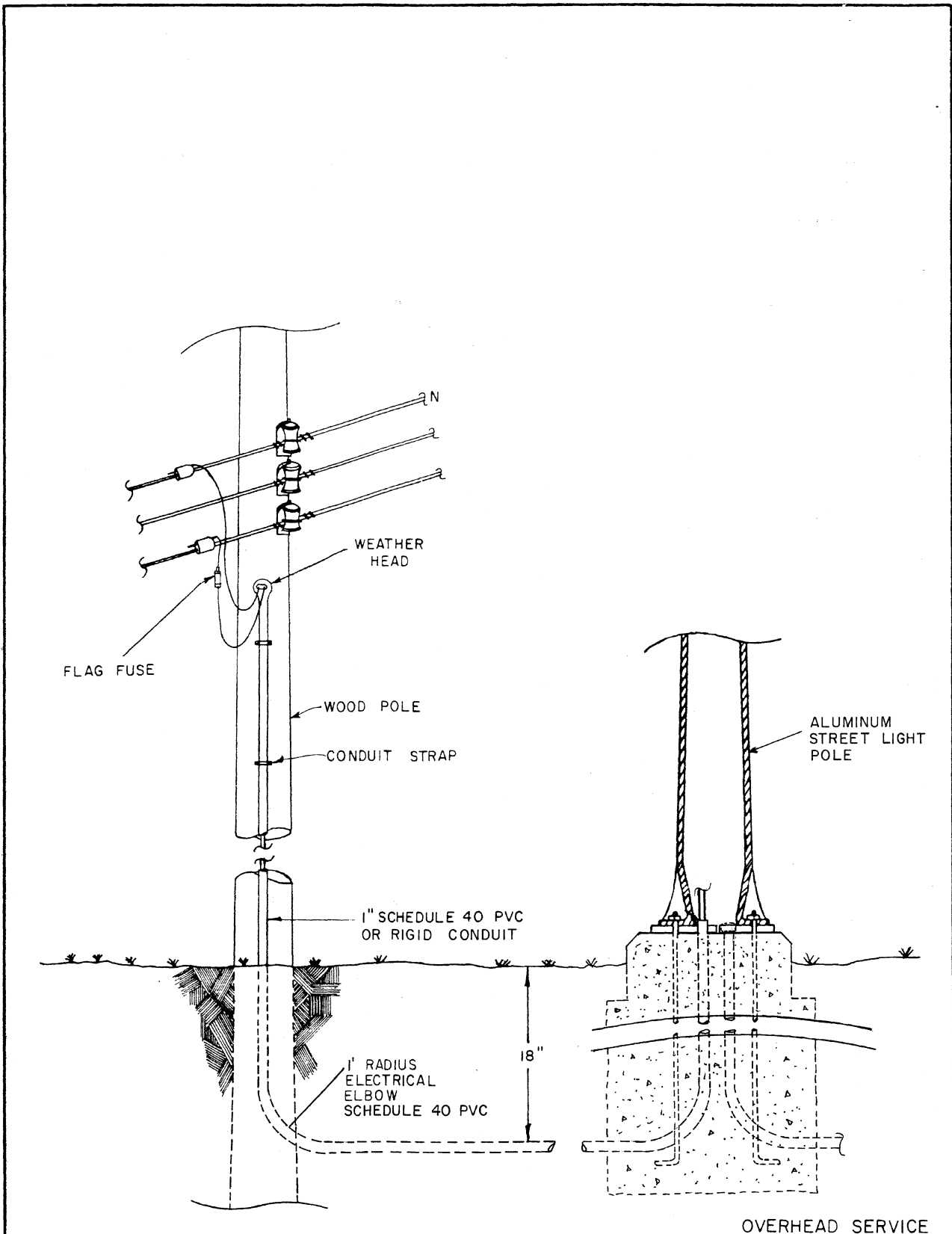

OVERHEAD SERVICE

CONSTRUCTION STANDARD - KENTUCKY UTILITIES CO. & OLD DOMINION POWER CO.

APPROVED <i>W. E. Johnson</i> DATE 3-16-90	REVISED _____ _____ _____	UNDERGROUND STREET/PRIVATE OUTDOOR LIGHT RISER ARRANGEMENT	SCALE _____ DRAWING NO. A-9-8.15
--	------------------------------------	---	--

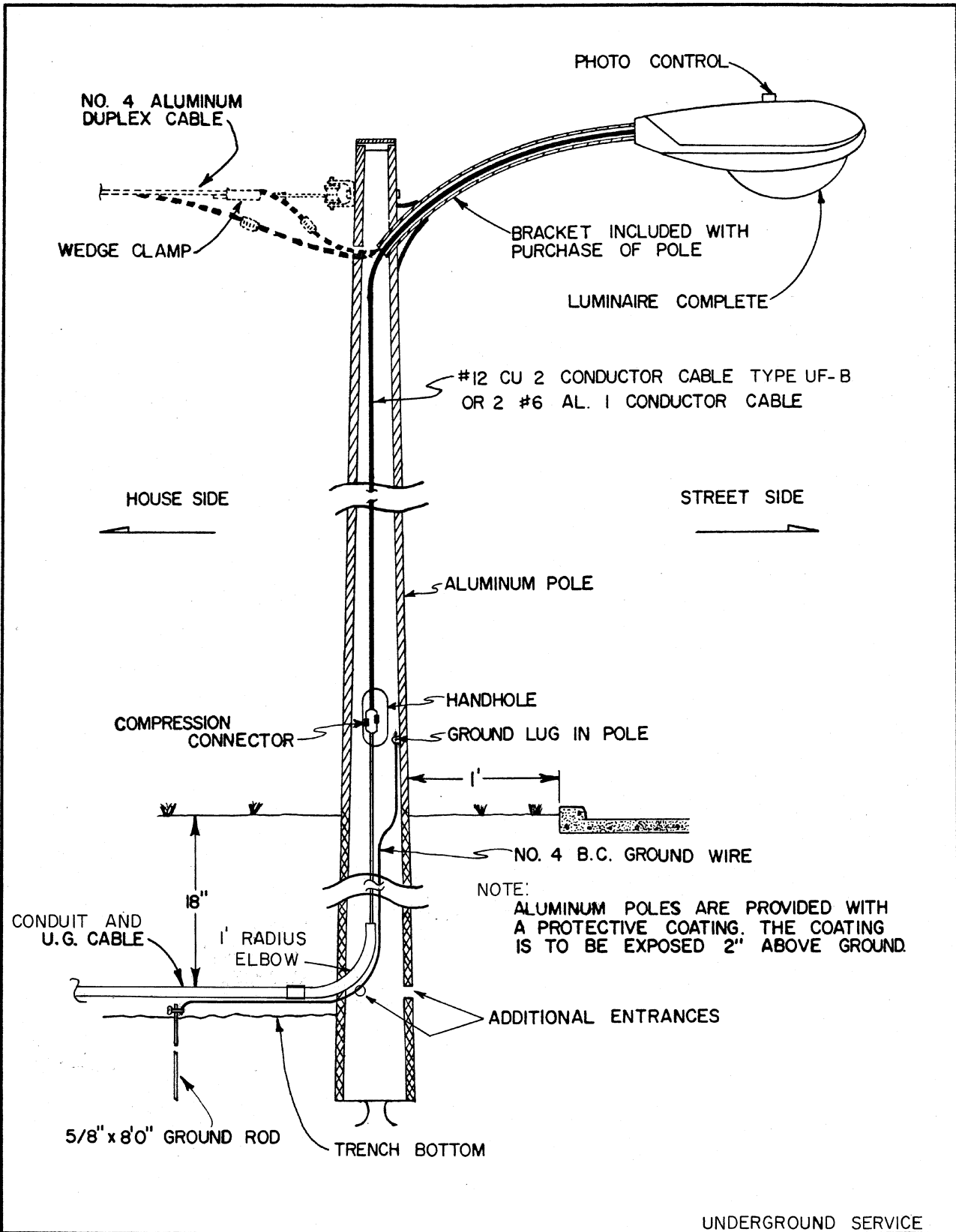

UNDERGROUND SERVICE

CONSTRUCTION STANDARD - KENTUCKY UTILITIES CO. & OLD DOMINION POWER CO.

APPROVED

[Signature]

REVISED

3-16-90 WEL

**STREET LIGHT CONSTRUCTION
EMBEDDED BASE-ALUMINUM
COBRA HEAD**

SCALE _____

DRAWING NO.

A-9-8.2

DATE 9-25-85

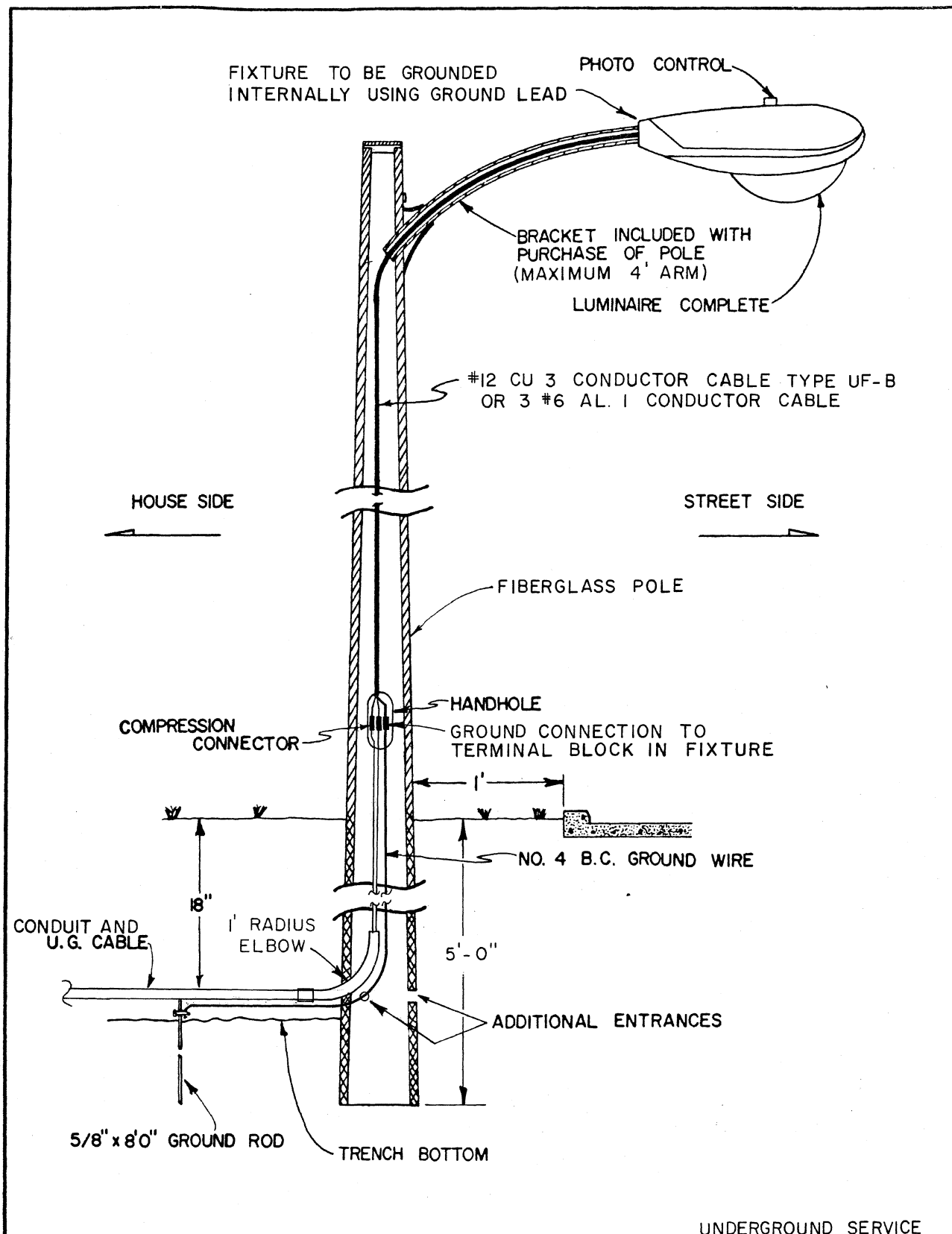

UNDERGROUND SERVICE

CONSTRUCTION STANDARD - KENTUCKY UTILITIES CO. & OLD DOMINION POWER CO.

APPROVED

REVISED

STREET LIGHT CONSTRUCTION
EMBEDDED BASE-FIBERGLASS
COBRA HEAD

SCALE

DRAWING NO.

DATE

9-25-85

3-16-90

2JEG

A-9-8.3

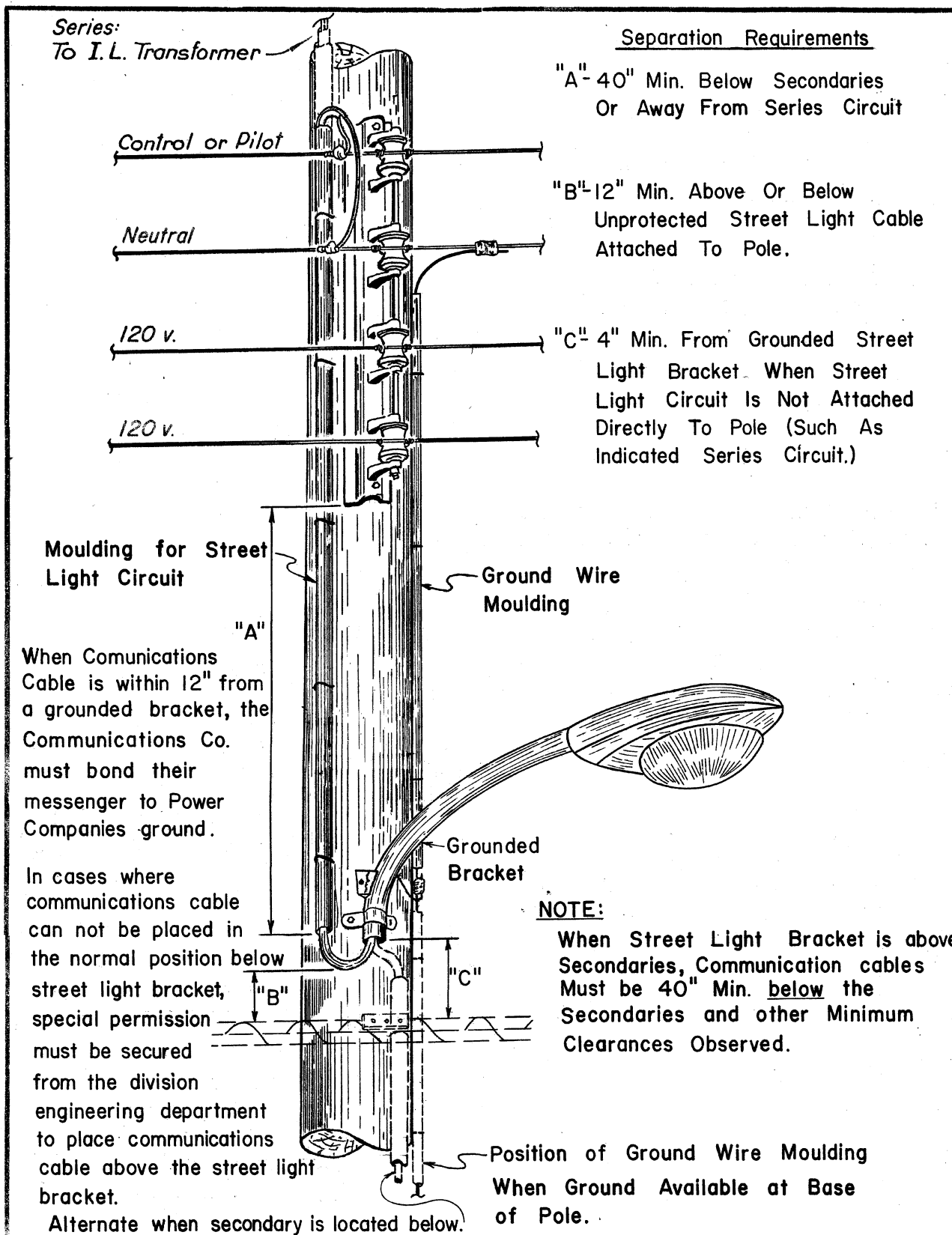

CONSTRUCTION STANDARD-KENTUCKY UTILITIES CO. & OLD DOMINION POWER CO.			
APPROVED <i>W.B. Bechanan</i> Vice Pres. DATE 8-15-73	REVISED	STREET LIGHT CONSTRUCTION CLEARANCE REQUIREMENTS FOR COMMUNICATION CABLES	SCALE DRAWING NO. A-9-8.5

YARD TYPE / PACKAGE LIGHT WOOD POLE INSTALLATION

ASSEMBLY DESCRIPTION

80 06 22 . XX

ASSEMBLY DETAILING 2' MAST ARM
INSTALLATION ON WOOD POLE

80 06 22. 01 LUMINAIRE - 70 WATTS - HPS
80 06 22. 02 LUMINAIRE - 100 WATTS - HPS

MATERIAL LIST

ITEM	IIN NUMB.	DESCRIPTION	01	02
1	7001327	70 W HPS / 2' MAST ARM KIT (KU ONLY)	1	
	7001326	100 W HPS / 2' MAST ARM KIT		1
2	7000258	5/8"X10" MACHINE BOLT SQ HD W/NUT	1	1
3	7000911	1 WIRE RACK	1	1
4	7001268	3" SPOOL INSULATOR	1	1
5	7002215	WEDGE CLAMP VARIES	*	*
6	7000339	3"X3"X1/4" SQ. CURVED WASHER	1	1
7	VARIES	VARIOUS SMALL CONNECTOR	*	*
8	7000913	8' X 1/2" U-SHAPED GROUND MOLDING	*	*
9	7001357	#12-2/C CONDUCTOR W/GROUND UF-B	*	*
10	1197519	#6 BARE CU. SOFT DRAWN.	*	*
11	7002252	STAPLES, 1-1/2" (IF REQUIRED)	*	*

* AS REQUIRED

NOTES:

⚠ Package light kit includes, NEMA head, optics, lamp, photo control, 2/wire - pre-wired cable, mast arm, 5/8" mounting bolt & lag screws and grounding bolt.

⚠ Install cable guard 1/2", ground wire molding (IIN 7000913) if length along pole exceeds 2 ft. Vertical riser must be covered with cable guard even if jacketed conductor cable is used. If 3-#6al. poly is used you may use 1"x 10' cable guard U shaped PVC IIN # 1160501.

⚠ Pole and pole grounding not included in this standard.

Grounding notes:

All existing and new fixtures and mast arms must be grounded unless grounding negatively impacts safety or the reliability of the structure. Grounding of both the fixture and the mast arm can be accomplished by grounding either the fixture, the mast arm or both. In general a visible external ground is preferred.

Internal grounding can be accomplished by attaching a separate ground wire of a 3-wire cable (i.e. 12-2/C w/ground) between the pole ground and ground lug in the fixture.

For external grounding, the pole ground wire is fastened to mast arm with 3/8" x 1-1/4" carriage bolt, nut and lock washer (IIN #3003808) using a minimum of #6 bare SD Cu. Older installations with no grounding provisions can be grounded by drilling the support and using a self tapping screw and washer.

UTILITY	LAMP WATTS	PATTERN	FIXTURE IIN#	
KU ONLY	HPS	70	V	7001327
LG&E / KU	HPS	100	V	7001326

Note:
Face eye of photoelectric control north.



DETAIL " A "
MAST ARM GROUNDING FOR
2 WIRE INSTALLATIONS

TYPICAL INSTALLATION

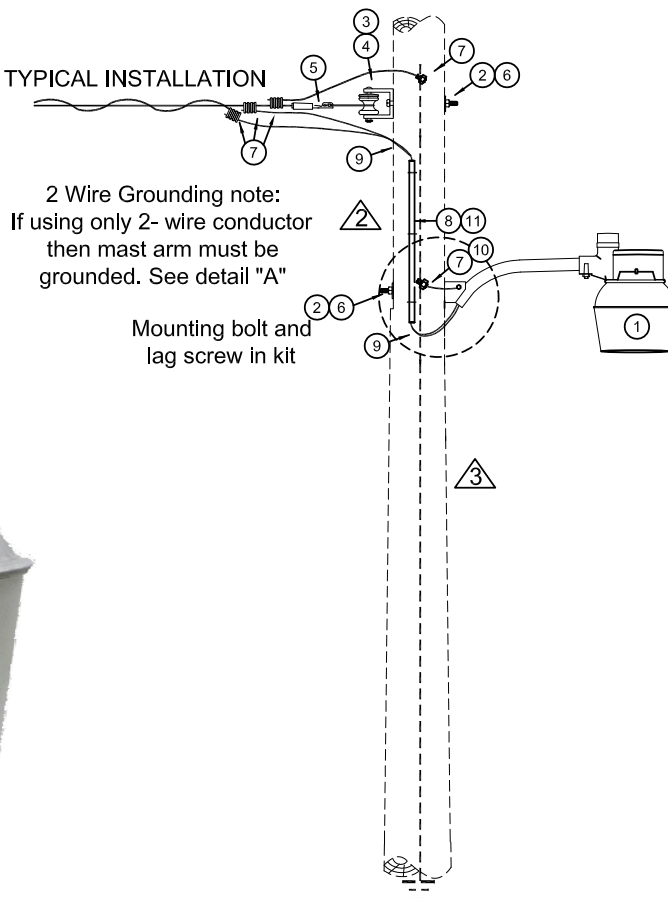

2 Wire Grounding note:
If using only 2- wire conductor
then mast arm must be
grounded. See detail "A"

Mounting bolt and
lag screw in kit

KENTUCKY UTILITIES COMPANY

CASE NO. 2014-00371

**Response to Lexington-Fayette Urban County
Government's Request for Information
Dated January 7, 2015**

Question No. 17

Responding Witness: Robert M. Conroy

Q-17.

A-17. The Lexington-Fayette Urban County Government's Request for Information issued on January 7, 2015 did not include a Question No. 17.

KENTUCKY UTILITIES COMPANY

CASE NO. 2014-00371

**Response to Lexington-Fayette Urban County
Government's Request for Information
Dated January 7, 2015**

Question No. 18

Responding Witness: Paul Gregory "Greg" Thomas

- Q-18. Please describe in detail all maintenance that must be performed by KU on each type of street light to ensure that it operates properly and provide a list of each element of the required maintenance and its monthly cost.
- A-18. Normal maintenance consists of replacing the items listed in the table below as needed. The current unit costs are for materials specific to each installation and do not include associated installation costs (labor, minor materials, equipment, etc.), which are not tracked at this level of detail. Maintenance is required when KU has identified or received a report that the street light is inoperative. The most common maintenance performed on a street light is the replacement of a burned out bulb and/or replacement of an inoperative photoelectric control.

Normal Street Light Maintenance Material

Item #	Unit Description	Unit Cost
7001343	LAMP,HPS,4000L,50W	\$ 6.90
7001344	LAMP,HPS,5800L,70W	\$ 6.90
7001345	LAMP,HPS,9500L,100W	\$ 6.90
7001346	LAMP,HPS,22000L,200W	\$ 8.30
7001347	LAMP,HPS,50000L,400W	\$ 7.66
7001349	LAMP,MV,10000L,250W	\$ 5.80
7001350	LAMP,MV,20000L,400W	\$ 6.45
7001331	CONTROL,PHOTOELECTRIC,105-130V,GRAY COVER,ELECTRONIC,1000W,1800VA,TIME DELAYED,1.5 FCS TURN ON,CADMIUM-SULFIDE PHOTOCELL,MINIMUM 160 JOULE MOV ARRESTER,TWISTLOCK BASE,DUSK TO DAWN,USE IN 120V ONLY	\$ 3.04
7001718	CAP,SHORTING,PHOTOCONTROL BASE,LOCKING TYPE	\$ 3.51
7010269	STARTER,LIGHTING,HPS,50W-400W,PLUG-IN TYPE,GE	\$ 22.65

KENTUCKY UTILITIES COMPANY

CASE NO. 2014-00371

**Response to Lexington-Fayette Urban County
Government's Request for Information
Dated January 7, 2015**

Question No. 19

Responding Witness: Paul Gregory "Greg" Thomas

Q-19. Is KU able to ascertain, at any given time, the number of street lights in Fayette County that are actually in proper working order? If so, please provide a detailed explanation, and further explain:

- (a) How many street lights (on average) are actually in proper working order at any given time;
- (b) Whether the LFUCG is charged the monthly tariff rate for non-working street lights for the periods of time within which such street lights are non-operational or not working properly;
- (c) The amount of time it takes (on average) to bring such street lights into working order; and
- (d) Whether this information differs among different types of street lights. If so, please provide this information for each type of light.

A-19. No, KU cannot ascertain the number of street lights in Fayette County that are operable at any given time. However, as described in the response to Question No. 16 (a), KU proactively identifies street light outages and relies upon customers to report service problems.

- a. All lights, unless reported otherwise, are considered to be in proper working order. KU estimates it performs 3,460 street light repairs annually to LFUCG street lighting. A typical daily estimate of operable fixtures, based on the average 2014 repair time as described in Question No. 16(b) and a total of 30,100 lights, would be 99.95% $(1 - (3,460 \times 1.58) / (30,100 \times 365))$.
- b. The LFUCG pays a monthly tariff for all street lights it has requested.
- c. See the response to Question No. 16(b).
- d. See the response to Question No. 16(c).

KENTUCKY UTILITIES COMPANY

CASE NO. 2014-00371

**Response to Lexington-Fayette Urban County
Government's Request for Information
Dated January 7, 2015**

Question No. 20

Responding Witness: Dr. Martin J. Blake

- Q-20. How was KU's proposed monthly rate for each type of street light determined?
- (a) Please describe in detail each element of the proposed monthly rate for each type of street light (fixed costs, energy costs, maintenance costs, etc.), including the percentage of the rate attributable to each element.
 - (b) Does the number of existing street lights influence the proposed monthly rate for each type of street light (e.g. is there any use of a weighted average cost)?
 - (c) Does this differ from the existing rate elements? If so, in what regard?
 - (d) What percentage of KU's proposed monthly rate for each type of street light is comprised of maintenance?
 - (e) What percentage of KU's proposed monthly rate for each type of street light is comprised of costs associated with acquiring or installing the street light? Please provide this information for each type of street light for which the LFUCG currently pays a monthly tariff.
- A-20. In developing rates for lighting in this proceeding, KU applied the same percentage increase that was applied to other rate classes to each of the lighting rates that the Commission has approved as being just and reasonable in previous rate cases.
- a. KU does not maintain separate accounting records for each type of street light. The requested information is not available. The accounting information that is available is total cost information for the lighting rate class as a whole.
 - b. No.
 - c. See the response to part a.
 - d. See the response to part a.
 - e. See the response to part a.

KENTUCKY UTILITIES COMPANY

CASE NO. 2014-00371

**Response to Lexington-Fayette Urban County
Government's Request for Information
Dated January 7, 2015**

Question No. 21

Responding Witness: Christopher M. Garrett

Q-21. What depreciable life basis (if any) for each type of street light does KU utilize? Is this the standard industry basis?

A-21. KU utilizes one depreciable life established for all assets in the street lighting account. The account is depreciated at a rate of 4.00%, with an average service life of 28 years and an average remaining life of 21.2 years. The methods utilized are those typically employed within the industry.

KENTUCKY UTILITIES COMPANY

CASE NO. 2014-00371

**Response to Lexington-Fayette Urban County
Government's Request for Information
Dated January 7, 2015**

Question No. 22

Responding Witness: Robert M. Conroy

- Q-22. Does the LFUCG continue to pay for KU's cost of installing or acquiring the street light beyond the depreciable life basis of the street light?
- A-22. LFUCG pays a monthly rate per street light based upon the type of light. The rates are segregated by fixture type, amperage, pole type, ornament style, etc. regardless of the lights' depreciable lives.

KENTUCKY UTILITIES COMPANY

CASE NO. 2014-00371

**Response to Lexington-Fayette Urban County
Government's Request for Information
Dated January 7, 2015**

Question No. 23

Responding Witness: Robert M. Conroy

Q-23. From the perspective of the proposed rate for each type of street light, does KU propose to treat the existing street lights in Fayette County any differently than those that will in the future be installed? If so, please provide a detailed explanation.

A-23. No. KU will follow its approved tariffs for any existing and future street lights.

KENTUCKY UTILITIES COMPANY

CASE NO. 2014-00371

**Response to Lexington-Fayette Urban County
Government's Request for Information
Dated January 7, 2015**

Question No. 24

Responding Witness: Paul Gregory "Greg" Thomas

- Q-24. Does KU anticipate utilizing new technology to capture savings potential in the installation, rehabilitation, and maintenance of street lights? Please describe in detail how KU plans to implement cost and energy saving measures (i.e. retrofitting old installations or introducing new technology)?
- A-24. KU continually evaluates new technology, such as LED lighting, but has no imminent implementation plans that deviate from current operational practices.

To acquire experience with new technologies, KU partnered with LFUCG on an informal test installation of LED lights.

KENTUCKY UTILITIES COMPANY

CASE NO. 2014-00371

**Response to Lexington-Fayette Urban County
Government's Request for Information
Dated January 7, 2015**

Question No. 25

Responding Witness: Robert M. Conroy / Dr. Martin J. Blake

- Q-25. Is it KU's position that it could have actually justified seeking a greater rate increase for any type of street light for which the LFUCG currently pays a monthly tariff? If so, for which types of lighting? Please provide a detailed explanation of the basis for this position (for each different type of light) and provide any supporting documents or work papers.
- A-25. KU disagrees with the premise of the question. KU did not calculate a proposed revenue increase by light type. As stated in response to Question No. 20(a), KU applied the same percentage increase to all lights.

KENTUCKY UTILITIES COMPANY

CASE NO. 2014-00371

**Response to Lexington-Fayette Urban County
Government's Request for Information
Dated January 7, 2015**

Question No. 26

Responding Witness: Robert M. Conroy

Q-26. Has KU compared or analyzed the proposed monthly rate for each type of street light to those charged by other utilities in jurisdictions of similar size to Lexington-Fayette County, Kentucky? If so, please identify each jurisdiction to which the rates were compared or analyzed and provide the monthly rate for each type of street light in those jurisdictions.

A-26. No.

KENTUCKY UTILITIES COMPANY

CASE NO. 2014-00371

**Response to Lexington-Fayette Urban County
Government's Request for Information
Dated January 7, 2015**

Question No. 27

Responding Witness: Paul Gregory "Greg" Thomas

- Q-27. What are KU's current policies, procedures, practices, and/or guidelines pertaining to the trimming and/or removal of street trees (and other trees effecting utility lines) in Fayette County that might potentially interfere with service?
- A-27. The Distribution Vegetation Management Program is a centralized program which encompasses right of way maintenance for KU and LG&E. The program is managed by a Forestry Manager and eight Utility Arborists. Two Utility Arborists are assigned to the Lexington Operations area, which includes Lexington and Fayette County. All arborists are certified by the International Society of Arboriculture. KU employs five professional tree contractor companies (Nelson, Phillips, Townsend, Asplundh, and Wright). Utility line clearing is undertaken to maintain safety, reliability of service, and access to the utility's facilities for maintenance and repair.

KU's Distribution Vegetation Management Program encompasses approximately 14,000 miles of right of way maintenance. The Lexington Operations area includes over 2,800 miles of right of way in Fayette and surrounding counties.

The primary focus and core value of the Program is to ensure the health and safety of our employees, business partners, and the public. Contractors and their employees will recognize and follow all laws, rules and regulations regarding public and worker safety. Any incident must be reported to the appropriate safety consultant immediately. Tree Trimming Contractors are held accountable for safety according to OSHA and Company standards. Every new contract employee must complete a safety training program within the first 30 days.

KU employs an Integrated Vegetation Management ("IVM") Program that is the process of using chemical, manual, or mechanical techniques to control undesirable vegetation and includes natural or directional pruning, environmentally safe herbicides, and tree removals.

The IVM Program includes flexibility to operate and maintain variable easement widths, differences between rural and urban service areas, applicable codes or ordinances, and the need to maintain some level of flexibility in addressing landowner requests or concerns. Schedules and priorities for tree trimming are based on vegetation growth, cycle-last trim date, reliability data, and visual inspections. Reliability centered maintenance concepts are employed in establishing tree trimming priorities.

The plan includes the application of a flexible multi-cycle strategy to address growth and tree density which will vary across the service area. The plan is to maintain a proactive trim cycle while balancing the reactive needs of worst performing circuits. KU's goal is to maintain an average trim cycle of five years or less. The plan also employs an "Enhanced Hazard Tree" program to focus on removal of off right-of-way trees.

All tree-trimming is governed by approved principles of modern arboriculture and shall adhere to International Society of Arboriculture (ISA) standards. Other standards utilized in the program include ANSI A.300, NESC, and OSHA 1910.269 as well as compliance with tree ordinances and local codes.

Each customer on the circuit receives a mailing notification letter and an automated phone call, one to two weeks prior to beginning the circuit work. The tree crew "knocks on the door" before the work begins. Permission from the property owner is obtained for tree removals. Arborists coordinate street tree work with City Foresters in urban areas. Customer complaints are investigated to resolution. A customer survey measures customer satisfaction with the tree trimming program. Customer satisfaction is included in the contractor evaluation.

Customer education about tree trimming and planting trees is provided in consumer mail inserts, participation in community events, media announcements, and on the corporate web site.

Contractors' performance is evaluated based on safety, productivity, quality, and customer satisfaction on a quarterly and annual basis.

A Vegetation Management Plan was submitted, pursuant to the Commission's Order, in Administrative Case 2006-00494, on December 19, 2007.

KU has adopted and uses the written guidelines for tree trimming as set forth in the recommendations of the International Society of Arboriculture ("ISA") as published in ANSI A300 (Part 1) and "Pruning Trees Near Electric Utility Lines." Both publications are copyrighted and may not be copied without the publisher's permission. Parties may arrange to examine the publications by contacting counsel for KU.

KENTUCKY UTILITIES COMPANY

CASE NO. 2014-00371

**Response to Lexington-Fayette Urban County
Government's Request for Information
Dated January 7, 2015**

Question No. 28

Responding Witness: Robert M. Conroy

Q-28. Does KU allow, in any way, the non-governmental utilization of public street lights in Fayette County?

(a) If so, please provide a detailed explanation of each different type of such utilization that occurs in Fayette County, the extent of each type of utilization, the names of any parties that have agreements with KU regarding such usage in Fayette County, the amount and type of compensation or consideration (monetary or otherwise) that KU typically receives for such usage, copies of any pertinent agreements for such usage, and the total amount of compensation that KU receives for such activities

A-28. KU does not segregate lighting by government / non-government use. The Lighting Service ("LS") is available to any customer.

KENTUCKY UTILITIES COMPANY

CASE NO. 2014-00371

**Response to Lexington-Fayette Urban County
Government's Request for Information
Dated January 7, 2015**

Question No. 29

Responding Witness: John P. Malloy

Q-29. Does KU have a timeframe for offering electronic data interchange (EDI) billing, both invoice and receipt of payment, to its Major Account customers?

A-29. KU will have the ability to send and receive EDI billing data by the end of the 1st quarter 2015. The offering will have various options for EDI protocol and will be dependent upon customers' technical ability to receive and send data. Customer implementation will require extensive testing, with the timeframe for implementation varying for each customer.

KENTUCKY UTILITIES COMPANY

CASE NO. 2014-00371

**Response to Lexington-Fayette Urban County
Government's Request for Information
Dated January 7, 2015**

Question No. 30

Responding Witness: Kent W. Blake

Q-30. Please refer to page 2 of 3 of the Comparative Income Statement filed with your application (Filing Requirement 807 KAR 5:001 Section 16(8)(i), Tab 61).

- a. What is the explanation for the expected decrease in Public Street & Highway Lighting income between the base and test year periods?
- b. With respect to the base year period, how many different Public Street & Highway class customers exist?
- c. Approximately what percentage of the base year period income for the Public Street & Highway class customers is derived from LFUCG?

A-30.

- a. The test year period includes forecasted revenues based on planned volumes multiplied by an average tariff rate across all lighting customer classes. The base period includes monthly revenue amounts that contain actual volumes multiplied by specific individual tariffs by customer class with a different mix of actual volumes more weighted toward the higher tariff classes.
- b. The Company considers Public Street & Highway as a single class. There are 1,265 customers as noted on Filing Requirement 807 KAR 5:001 Section 16(8)(i), Tab 61.
- c. The percentage of the base period income derived for the total Company from the Public Street & Highway class customers from LFUCG is 45% for the six months actual portion of the base period. The forecast is not prepared on an individual customer basis.

KENTUCKY UTILITIES COMPANY

CASE NO. 2014-00371

**Response to Lexington-Fayette Urban County
Government's Request for Information
Dated January 7, 2015**

Question No. 31

Responding Witness: Dr. Martin J. Blake

Q-31. Please refer to Schedule M-1.1 (page 1 of 1) of your application (Tab 65). Please list the primary sources of revenue included in 'Other Miscellaneous Revenues' (\$17,133,241).

A-31.

Revenue Source	Base Period Revenue
Transmission Service	\$ 15,674,484
Ancillary Services	971,366
Forfeited Refundable Advances	304,632
Return Check Charges	148,762
Excess Facilities Charges	25,988
Tax Remittance Compensation	7,646
Other Miscellaneous Revenues	364
	<hr/>
	\$ 17,133,241

KENTUCKY UTILITIES COMPANY

CASE NO. 2014-00371

**Response to Lexington-Fayette Urban County
Government's Request for Information
Dated January 7, 2015**

Question No. 32

Responding Witness: Dr. Martin J. Blake

Q-32. Please reference Schedule M-2.3 (pages 8-12) of your application (Tab 65). Do the revenue projections that you have provided include all of the income that would be received through the application of the various demand charges that would apply to actual billings (e.g., penalties for high demand in prior months, low power factor, etc.)?

A-32. Yes. KU's demand forecast is based on historic billed demand that includes billed minimum and power factor components. Redundant capacity charges, which are based on demand rates, are included as pro forma adjustments to the demand revenues for Rates PS and TOD.

KENTUCKY UTILITIES COMPANY

CASE NO. 2014-00371

**Response to Lexington-Fayette Urban County
Government's Request for Information
Dated January 7, 2015**

Question No. 33

Responding Witness: Paul Gregory "Greg" Thomas

- Q-33. Please refer to the pre-filed testimony of Paul W. Thompson regarding the measurement of distribution performance (p. 35). What was KU's Customer Average Interruption Duration Index ("CAIDI") for 2013 and where did this place KU in the referenced benchmarking study?
- A-33. The KU (Kentucky) distribution system performance for 2013 achieved a CAIDI of 110.08 minutes, excluding major events. This improves on 2012 CAIDI by 2.31 minutes and places KU (Kentucky) CAIDI in the third quartile of the Southeastern Electric Exchange's (SEE) 2013 benchmarking study. CAIDI is calculated by dividing SAIDI by SAIFI and is negatively impacted by an improving SAIFI. KU's focus has been directed toward top quartile achievement in its SAIDI and SAIFI results. KU's (Kentucky) 2013 performance in SAIDI (82.79) and SAIFI (0.752) place the utility in the top quartile for both indices.

KENTUCKY UTILITIES COMPANY

CASE NO. 2014-00371

**Response to Lexington-Fayette Urban County
Government's Request for Information
Dated January 7, 2015**

Question No. 34

Responding Witness: Robert M. Conroy

- Q-34. Please refer to Schedule N, page 22 of your application (Tab 66), Schedule N, page 22. Is it an accurate statement that there is no proposed increase to the Cable Television Attachment Charges? If not, what is the additional projected income from any increase in these charges and where is it accounted for in the revenue of the company?
- A-34. Yes, it is an accurate statement that there is no proposed increase to the Cable Television Attachment Charges.